

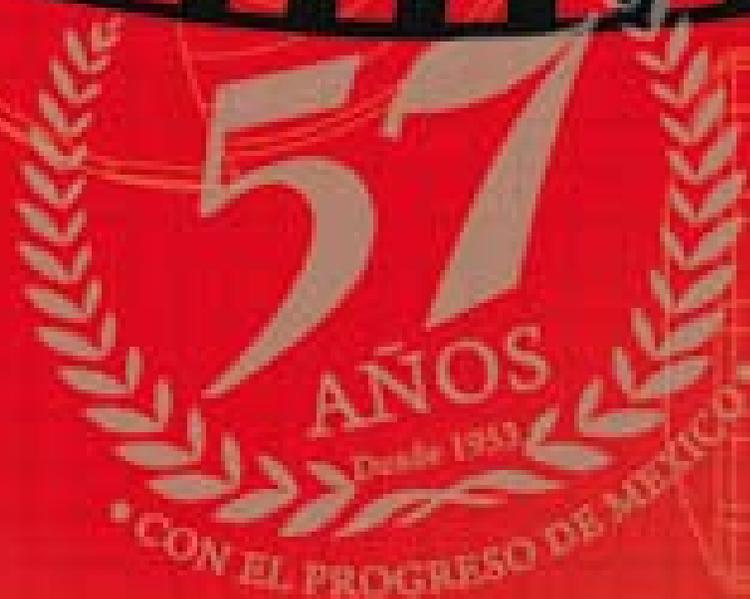

CATÁLOGO MAESTRO
MASTER CATALOG
2010/2011

\$ 200,00



GONHER®

GONHER.

AUTOPARTES

Cuando necesite ayuda, nosotros resolvemos su problema.



**Somos el *Equipo de Personas*
que trabaja para tener los clientes
más satisfechos del mundo.**

**Reiteramos nuestro compromiso
con la *Calidad de Servicio***

Asistencia Técnica y Aplicaciones

Llame sin costo: 01(800)8308400



No Charge Direct Line

**If you help...call us, we can help solve your problem.
We are the People Team that works for the customer satisfaction.
We reiterate our commitment for a continue improvement.**

To Our Quality Service.

Total Quality **service for our costumers.**

Thechnical assistance and Applications, *Dail Collet to:*

01 (800) 528-06-25 / (52-8) 15-33-140

GONHER DE MEXICO,

S.A. DE C.V.

fue incorporada en 1953

como una compañía

manufacturera de filtros

automotrices, y controla

actualmente más del 70%

del mercado de filtros

en todas sus

diferentes líneas.

El liderazgo en el mercado mexicano ha sido alcanzado y mantenido debido a nuestras altas normas de calidad en manufactura y servicio al cliente. Esto ha sido logrado en un mercado que cuenta con un número de empresas filtreras nacionales y además con grandes compañías internacionales.

GONHER DE MEXICO, S.A. DE C.V. es también uno de los líderes en Centro y Sudamérica, con oficinas en San José de Costa Rica.

Línea de Productos

Gonher ofrece su experiencia de muchos años en la manufactura de filtros automotrices y de servicio pesado en los siguientes productos.

- Filtros Sellados para aceite, combustible y agua.
- Filtros tipo cartucho para aceite y combustible.
- Filtros para aire automotriz.
- Filtros para aire servicio pesado.
- Filtros especiales.

Actualmente se producen más de 900 modelos de filtros, y tenemos la capacidad técnica para desarrollar los filtros necesarios de acuerdo a las necesidades del mercado.

Area de manufactura

La fábrica de Gonher se encuentra localizada en Santa Catarina, un suburbio de la ciudad industrial de Monterrey, N.L., en el noreste de México, 150 millas al sur del estado fronterizo de Texas.

Las aéreas de manufactura reúnen los mas altos estándares internacionales de calidad requeridos por los fabricantes de equipo original lo que las distingue de otros Fabricantes siendo acreedoras a diferentes reconocimientos otorgados en la industria de autopartes.

Gonher tiene la capacidad para exportar mas de 15 millones de unidades al año.

Mercado Doméstico

Gonher ha establecido 36 oficinas de venta en las principales ciudades de México, Costa Rica y E.U. Cada una de ellas cuenta con su propia fuerza de ventas, área de bodega, equipo de reparto y toda la infraestructura necesaria para dar el mejor servicio posible dentro de su territorio.

Servicio

Gonher es el líder y siempre toma las medidas necesarias para continuar siéndolo, dando el mejor servicio día a día a nuestros clientes.

Lo invitamos a ser parte de la prosperidad de Gonher.

Gonher utiliza en todos sus análisis, los procedimientos señalados en el manual de "Society or Automotive Engineers".

Todos los productos fabricados por Gonher están garantizados contra cualquier defecto en materiales y mano de obra.

GONHER
AUTOPARTES

GONHER DE MEXICO,

S.A. DE C.V.,

was incorporated

in 1953 as an

automotive

filter manufacturer

and keeps, at present

a total market-share

above 70% for

every product

line in Mexico

Leadership in the Mexican market has been reached and maintained due to high quality standards in manufacturing and service to its customers. This position has been fulfilled in a market service by several domestic manufacturers and the main international companies.

Gonher is also one of the leading filter suppliers in Central and South America markets with sales offices in San Jose, Costa Rica.

Line of Products

Gonher offers experience of many years in the manufacturing of automotive and heavy duty filters with the following product lines.

- Spin on, for oil, fuel and water applications.
- Cartridge, for oil and fuel.
- Automotive air.
- Heavy Duty Air.
- Filter specialities.

At present more than 900 models are produced and we have the technical capability to enlarge the product line according to market needs.

Manufacturing Facilities

Gonher manufacturing facilities are located in Santa Catarina, N.L, a suburb of the industrial city of Monterrey, in northeastern Mexico, 150 miles south of the Texas state.

The main areas of manufacture reunite the highest international standards of quality required by the original equipment manufacturer that distinguishes them of other Manufacturers being deserving to different recognitions granted in the industry from auto parts.

Gonher has an export capacity of more than 18 million units per year.

Domestic Marketing

Gonher has established 36 offices in the main cities of Mexico, one in Costa Rica and E.U. Each one of them counts on its own force of sales, warehouse, equipment of distribution and all the necessary infrastructure to give the best possible service within its territory.

Through them, approximately 13,000 costumers are served in Mexico and over 300 costumers in Central and South America.

Service

Gonher is the leader and always takes the necessary steps to continue being a successful company on the basis of day to day service to our costumers.

We invite you to share Gonher success.

Gonher quality statement "Society of Automotive Engineers" procedures are used in testing Gonher Products.

Gonher Products are warranted against defects in design and workmanship.

GONHER
AUTOPARTS

Si usted posee un automóvil, usted debe saber esto:

Es la Ley

El uso de Filtros  o de filtros de otras marcas de calidad no anula la garantía de su vehículo

Algunos representantes de servicio de los comercios de venta de automóviles o mecánicos declaran falsamente que una marca de filtro de repuesto no se puede utilizar en el vehículo de los consumidores durante el período de garantía. La reclamación de que el uso de la marca de repuesto “anula la garantía”, con la implicación de que sólo los filtros de la marca de equipo original pueden ser utilizados. Esto, por supuesto, tiende a poner en duda la calidad del filtro de reemplazo.

Esa afirmación no es cierta. Si se enfrenta a tal demanda, los consumidores deben exigir esta declaración por escrito. No siempre recibirá ninguna declaración por escrito como debería. Sin embargo, el consumidor puede sentirse incómodo acerca del uso de filtros de repuesto que no son de equipo original. Con el gran número de consumidores que prefieren utilizar el Filtros GONHER, esta afirmación engañosa debe ser corregida.

Salvo que específicamente se renuncia por escrito por la Comisión Federal de Comercio, en virtud del Acta Magnuson-Moss del mejoramiento de Garantía, un fabricante no podrá condicionar la garantía del vehículo sobre el uso de cualquier marca de filtro a menos que el fabricante proporciona el filtro de forma gratuita.

Así que, si al consumidor se le dice que sólo filtro de equipos originales no anulará la garantía, deberá pedir que el filtro del equipo original le sea suministrado de forma gratuita. Si se cobrara por el filtro, el fabricante puede estar violando la ley federal.

If you own a car, you should know this:

It's The Law

Using  or other quality brand name filters does not void vehicle warranty.

Consumer purchasers of automotive filters are sometimes told by an automobile dealer's service representative or mechanic that a brand of replacement filter cannot be used in the consumer's vehicle during the warranty period. The claim is made that use of the brand will “void the warranty” with the implication that only the original equipment brand of filters may be used. This, of course, tends to cast doubt on the quality of the replacement filter.

That claim is simply not true. If confronted with such a claim, consumers should ask for the statement in writing. They will not receive it as no such written statement would be provided. Nevertheless, the consumer may feel uneasy about using replacement filters that are not original equipment. With the large number of consumers who prefer to use GONHER filters, this misleading claim should be corrected.

Unless specifically waived in writing by the Federal Trade Commission, under the Magnuson-Moss Warranty improvement Act, a manufacturer may not make its vehicle warranty conditional on use of any brand of filter unless the manufacturer provides the filter free of charge.

So if the consumer is told that only original equipment filter will not void the warranty, he should request that the OE filter be supplied free of charge. If he is charged for the filter, the manufacturer may be violating Federal law.

Tabla de Contenido

NUEVOS PRODUCTOS	9
APLICACIONES DE FILTROS EN MOTORES MAS COMUNES EN SERVICIO PESADO	17
APLICACIONES DE FILTROS PARA UNIDADES MAS COMUNES EN SERVICIO PESADO	21
APLICACIONES AUTOMOTRIZ	
RELACIÓN DE MODELOS POR MARCA DE AUTOMÓVILES	34
NOTAS DE SUPERINDICE.....	38
ACURA.....	39
ALFA ROMEO.....	40
AM GENERAL	41
AUDI	41
BMW	45
BUICK	47
CADILLAC.....	49
CHEVROLET	51
CHRYSLER	62
DODGE	66
EAGLE.....	73
FERRARI.....	73
FIAT	73
FORD	74
GEO	83
GIANT.....	83
GMC	83
HONDA.....	85
HUMMER	87
HYUNDAI	88
INFINITI	89
ISUZU	89
JAGUAR	90
JEEP	92
KIA	94
LADA	95
LAMBORGHINI	95
LAND ROVER	95
LEXUS.....	96
LINCOLN.....	97
MAYBACH.....	98
MAZDA.....	98
M.G.	98
MERCEDES BENZ.....	101
MERCURY	105
MINI	107
MITSUBISHI.....	107
NISSAN	109
OLDSMOBILE.....	113
OPEL	113
PASSPORT.....	114
PEUGEOT.....	114
PLYMOUTH.....	115
PONTIAC.....	116
PORSCHE	119
RENAULT	120
ROLLS ROYCE.....	121
ROVER	121
SAAB	121
SATURN	122
SCION.....	124
SEAT	124
SMART.....	125
STERLING.....	126
SUBARU.....	126

SUZUKI	126
TOYOTA.....	128
VOLKSWAGEN	132
VOLVO	138
APLICACIONES SERVICIO PESADO	
ADVANCE MIXER, INC.	142
AGCO.....	142
AKSA	142
ALLIS CHALMERS.....	142
AMERICAN	158
AMERICAN LAFRANCE.....	158
AUTOCAR	158
BANDIT INDUSTRIES, INC.	158
BARKO	158
BEAVER.....	158
BELARUS.....	158
BITELLI.....	158
BLUE BIRD	158
BOBCAT	159
BOMAG	159
BRUCE	161
CARPENTER.....	161
CARRIER	162
CASE	163
CASE / INTERNATIONAL	183
CATERPILLAR	187
CHAMPION.....	235
CHANGAN	235
CHICAGO PNEUMATIC.....	235
CHRYSLER.....	236
CITROEN.....	240
CLARK.....	240
CLEVELAND	246
CMI	246
COACH & EQUIPMENT	246
COLEMAN.....	247
COLLINS.....	247
CONTINENTAL TELEDYNE	247
CORBEIL BUS.....	247
CUMMINS	248
DAEWOO.....	255
DAF	256
DANA.....	256
DEMAG.....	256
DETROIT DIESEL	256
DEUTZ	259
DIAMOND REO.....	263
DINA	263
DODGE	264
DREESER.....	268
ELDORADO BUS.....	268
ERF	268
EUCLID	268
FAIRBANKS	276
FAVELLE FAVCO	276
FENDT	276
FIAT	276
FIAT-ALLIS.....	276
FIAT-HITACHI.....	281
FORD	282
FORDSON	308
FREIGHTLINER.....	308
FULLER	316

Tabla de Contenido

FURUKAWA	316
GALION	316
GARDNER-DENVER.....	319
GENERAL MOTORS / CHEVROLET.....	320
GIRARDIN	339
HINO	339
HITACHI	341
HOUGH	341
HYSTER	347
HYUNDAI	361
I.H.C. HARVESTER.....	362
INGERSOLL-RAND.....	400
ISUZU	406
IVECO	407
JCB (J.C. BAMFORD)	407
JOHN DEERE	414
KENWORTH	501
KOHLER	506
KOMATSU	507
KRYSTAL BUS	524
KW-DART	524
LANDINI.....	524
LIEBHERR.....	524
LISTER.....	524
MACK	537
M.A.N.....	526
MASSEY-FERGUSON	546
MCCORMICK	557
MERCEDES BENZ	557
MICHIGAN.....	570
MID BUS.....	577
MINNEAPOLIS-MOLINE	577
NAVISTAR INT.	579
NEW HOLLAND	581
NISSAN	587
NORTHERN LIGHTS	589
NUFFIELDS	589
OLIVER	591
PERKINS.....	595
PETERBILT.....	597
P & H CO.....	593
ROLLS ROYCE.....	603
SCANIA	603
SCHWING	608
STERLING.....	608
TEREX	612
THERMO KING.....	615
THOMAS BUS	617
TIMBERJACK	617
TOYOTA.....	617
TRANS TECH	621
VOLKSWAGEN	621
VOLVO	621
WABCO.....	634
WESTERN STAR.....	637
WHITE	637
WINNEBAGO	643
WINPOWER.....	643

REFERENCIA CRUZADA

CÓDIGO DE FABRICANTES.....	646
NOTAS DE SUPERINDICE PARA REFERENCIA CRUZADA.....	651
SERIES 0.....	652
SERIES 1.....	654

Tabla de Contenido

SERIES 2.....	674
SERIES 3.....	688
SERIES 4.....	700
SERIES 5.....	712
SERIES 6.....	720
SERIES 7.....	727
SERIES 8.....	735
SERIES 9.....	744
SERIES A.....	755
SERIES B.....	788
SERIES C.....	792
SERIES D.....	803
SERIES E.....	806
SERIES F.....	810
SERIES G.....	828
SERIES H.....	842
SERIES I.....	845
SERIES J.....	846
SERIES K.....	847
SERIES L.....	849
SERIES M.....	863
SERIES N.....	871
SERIES O.....	872
SERIES P.....	876
SERIES Q.....	897
SERIES R.....	899
SERIES S.....	900
SERIES T.....	907
SERIES U.....	911
SERIES V.....	911
SERIES W.....	914
SERIES X.....	922
SERIES Y.....	922
SERIES Z.....	923
GUÍA DE PRODUCTOS	
FILTROS TIPO SELLADO.....	925
FILTROS TIPO CARTUCHO.....	943
FILTROS PARA AIRE AUTOMOTRIZ.....	955
FILTROS PARA AIRE SERVICIO PESADO.....	989
FILTROS PARA GASOLINA.....	1007
FILTROS RACOR.....	1025
LOCALICE EL FILTRO POR SUS MEDIDAS	
SELLADOS PARA ACEITE.....	1029
SELLADOS PARA AGUA.....	1030
SELLADOS PARA DIESEL.....	1031
CARTUCHOS PARA ACEITE.....	1032
CARTUCHOS PARA DIESEL.....	1032
CIRCULARES PARA AIRE.....	1033
CUADRADOS Y RECTANGULARES PARA AIRE.....	1034
GASOLINA.....	1036
TABLA DE CONVERSIÓN DE PULGADAS A MILÍMETROS.....	1039
INSTRUCCIONES PARA UNA CORRECTA INSTALACIÓN DE FILTROS SELLADOS.....	1040
PROBLEMAS CON LA LUZ DE AVISO PARA LA PRESIÓN DE ACEITE.....	1042
PERDIDA DE ALIMENTACIÓN EN LA BOMBA DE ACEITE.....	1044
DEFICIENCIAS MAS USUALES PROVOCADAS POR LA VÁLVULA REGULADORA DE PRESIÓN ..	1046
FILTROS CON SOPORTE CENTRAL O ELEMENTO COLAPSADO.....	1048

Nuevos Productos

New Products

GONHER
AUTOPARTES

CÓDIGO	MODELO	TIPO	EQUIVALENCIAS	APLICACIONES	DIMENSIONES	FOTOGRAFÍA
CODE	MODEL	TYPE	EQUIVALENCE	APPLICATION	DIMENSIONS	PHOTOGRAPHY
2148	GP-1 GOLD	ACEITE AUTOMOTRIZ	Ford C9NN-6714-A, Allis chalmers 70237000, Case A146696	Ford, Allis chalmers, Case, Toyota, Perkins, Wisconsin, modelos recientes que utilicen aceite sintético	Rosca: 3/4-16 Diámetro Ext.: (3 5/8 in) (3.625 in) (92.0 mm) Altura Total: (5 13/32 in) (5.406 in) (137.3 mm) Diámetro Ext. Empaque: (2.844 in) (2 27/32 in) (72.2 mm) Diámetro Int. Empaque: (2.484 in) (2 31/64 in) (63.1 mm) Altura Empaque: (0.203 in) (13/64 in) (5.2 mm)	
2150	GP-28 GOLD	ACEITE AUTOMOTRIZ	Volkswagen 059115561C	Automóviles y Camionetas Volkswagen, Audi, BMW, Seat, Porsche, modelos recientes que utilicen aceite sintético	Rosca: 3/4-16 Diámetro Ext.: (3 5/64 in) (3.078 in) (78.1 mm) Altura Total: (4 45/64 in) (4.703 in) (119.4 mm) Diámetro Ext. Empaque: (2.844 in) (2 27/32 in) (72.2 mm) Diámetro Int. Empaque: (2.484 in) (2 31/64 in) (63.1 mm) Altura Empaque: (0.203 in) (13/64 in) (5.2 mm) Válvula de alivio: 27-36 PSI Válvula anti drenaje: SI	
2149	GP-37 GOLD	ACEITE AUTOMOTRIZ	Nissan 15208-F4300, 35622-90002	Automóviles y Camionetas Infiniti, Nissan, modelos recientes que utilicen aceite sintético	Rosca: 3/4-16 Diámetro Ext.: (3 19/64 in) (3.296 in) (83.7 mm) Altura Total: (3 59/64 in) (3.921 in) (99.6 mm) Diámetro Ext. Empaque: (2.484 in) (2 31/64 in) (63.1 mm) Diámetro Int. Empaque: (1.813 in) (1 13/16 in) (46 mm) Altura Empaque: (0.125 in) (1/8 in) (3.2 mm) Válvula anti drenaje: SI	
2153	GP-46 GOLD	ACEITE AUTOMOTRIZ	Chrysler 8132313, General Motors 93156298	Automóviles y Camionetas Cadillac, Chevrolet, Chrysler, Isuzu, Jeep, Peugeot, Pontiac, Saab, modelos recientes que utilicen aceite sintético	Rosca: M18X1.5 Diámetro Ext.: (3 5/64 in) (3.078 in) (78.1 mm) Altura Total: (3 25/64 in) (3.390 in) (86.1 mm) Diámetro Ext. Empaque: (2.844 in) (2 27/32 in) (72.2 mm) Diámetro Int. Empaque: (2.484 in) (2 31/64 in) (63.1 mm) Altura Empaque: (0.203 in) (13/64 in) (5.2 mm) Válvula anti drenaje: SI	
2152	GP-58 GOLD	ACEITE AUTOMOTRIZ	Chrysler 4273810, General Motors 25011520, Toyota 90915-20005	Automóviles y Camionetas Chevrolet, Chrysler, Dodge, Ford, Jeep, Plymouth, Renault, Saab, Toyota, modelos recientes que utilicen aceite sintético	Rosca: 3/4-16 Diámetro Ext.: (3 5/64 in) (3.078 in) (78.1 mm) Altura Total: (3 25/64 in) (3.390 in) (86.1 mm) Diámetro Ext. Empaque: (2.844 in) (2 27/32 in) (72.2 mm) Diámetro Int. Empaque: (2.484 in) (2 31/64 in) (63.1 mm) Altura Empaque: (0.203 in) (13/64 in) (5.2 mm) Válvula de alivio: 8-12 PSI Válvula anti drenaje: SI	
2151	GP-3600 GOLD	ACEITE AUTOMOTRIZ	Chrysler 4781452AA, Ford E4FZ-6731-A	Automóviles y Camionetas Dodge, Ford, Jaguar, Jeep, Lincoln, Mazda, Mercury, Toyota, modelos recientes que utilicen aceite sintético	Rosca: 3/4-16 Diámetro Ext.: (3 5/64 in) (3.078 in) (78.1 mm) Altura Total: (4 45/64 in) (4.703 in) (119.4 mm) Diámetro Ext. Empaque: (2.844 in) (2 27/32 in) (72.2 mm) Diámetro Int. Empaque: (2.484 in) (2 31/64 in) (63.1 mm) Altura Empaque: (0.203 in) (13/64 in) (5.2 mm) Válvula de alivio: 8-12 PSI Válvula anti drenaje: SI	

CÓDIGO	MODELO	TIPO	EQUIVALENCIAS	APLICACIONES	DIMENSIONES	FOTOGRAFÍA
CODE	MODEL	TYPE	EQUIVALENCE	APPLICATION	DIMENSIONS	PHOTOGRAPHY
13991	GAC-1	AIRE CABINA	FORD F65Z-19N619-AB, BALDWIN PA4133, LUBER-FINER CAF 1713, MICRON AIR MP-017, PUROLATOR C45384, WIX 24876	FORD: COURIER 2001-2007, E SERIES (VANS) 1997-2006, EXPEDITION 1997-2006, F SEIRES 1997-2008, F SERIES SUPER DUTY 2001-2007, KA 2000-2008. LINCOLN: NAVIGATOR 1998-2006	Largo: (13 21/32 in) (13.656 in) (346.9 mm) Ancho: (5 11/16 in) (5.687 in) (144.4 mm) Altura Total: (1 1/16 in) (1.063 in) (27.0 mm)	
13992	GAC-2	AIRE CABINA	BALDWIN PA4159, CHRYSLER 82205905, 4885955AA, FRAM CF9597A, MANN & HUMMEL MC 1007, MICRON AIR MC622, PUROLATOR C35494, WIX 24864	CHRYSLER: PACIFICA 2004-2008, TOWN & COUNTRY 2000-2008, VOYAGER 2000-2008 DODGE: CARAVAN 2000-2008, GRAND CARAVAN 2000-2008	Largo: (12 13/64 in) (12.203 in) (310.0 mm) Ancho: (9 19/64 in) (9.297 in) (236.1 mm) Altura Total: (59/64 in) (0.922 in) (23.4 mm)	
13993	GAC-3	AIRE CABINA	MANN & HUMMEL CU-2545, MICRON AIR MP-060, SEAT 6Q0820367, 620-820-367, 620-820-367B	SEAT: CORDOBA 2003-2008, IBIZA 2003-2008, LEON 2000-2005. VOLKSWAGEN: CROSSFOX 2007-2009	Largo: (9 7/8 in) (9.875 in) (250.8 mm) Ancho: (8 15/32 in) (8.469 in) (215.1 mm) Altura Total: (1 17/64 in) (1.266 in) (32.1 mm)	
13994	GAC-4	AIRE CABINA	FRAM CF8838, MANN & HUMMEL CU-2945, MICRON AIR MP-033, NISSAN 27891-000AA, 27891-00QAA, RENAULT 77-00-424-098	RENAULT: CLIO 2001-2009, KANGOO 2004-2009, MEGANE 2001-2002	Largo: (9 1/64 in) (9.016 in) (229.0 mm) Ancho: (6 17/64 in) (6.266 in) (159.1 mm) Altura Total: (1 3/16 in) (1.188 in) (30.2 mm)	
13995	GAC-5	AIRE CABINA	MANN & HUMMEL CU-3448, MICRON AIR MP-057, PEUGEOT 6447-AZ	PEUGEOT: 206 2000-2007	Largo: (13 19/32 in) (13.594 in) (345.3 mm) Ancho: (6 55/64 in) (6.859 in) (174.2 mm) Altura Total: (1 9/64 in) (1.141 in) (29.0 mm)	
13996	GAC-6	AIRE CABINA	FRAM CF9366, CF-10135, HONDA 80292-S5A-003, 80292-S5D-A01, 80292-SCV-A01, LUBER-FINER CAF-1758, MANN & HUMMEL MC1006-2, MICRON AIR MP-029, PUROLATOR C15439, WIX 24817	ACURA: CSX 2006, EL 2002-2005, RSX 2002-2006 HONDA: CIVIC 2001-2005, CIVIC HYBRID 2002-2005, CR-V 2002-2006, ELEMENT 2003-2009	Largo: (8 11/32 in) (8.344 in) (211.9 mm) Ancho: (8 17/64 in) (8.266 in) (209.9 mm) Altura Total: (1 3/16 in) (1.188 in) (30.2 mm)	

CÓDIGO	MODELO	TIPO	EQUIVALENCIAS	APLICACIONES	DIMENSIONES	FOTOGRAFÍA
CODE	MODEL	TYPE	EQUIVALENCE	APPLICATION	DIMENSIONS	PHOTOGRAPHY
13997	GAC-7	AIRE CABINA	FORD XS4Z-19N619-CA, YS4Z-19N619-AA, YS4Z-19N619-DB, FRAM CF9118, LUBER-FINER CAF1756, MICRON AIR MP-041, MOTORCRAFT FP41, PUROLATOR C25387, WIX 24808	FORD: ESCORT 2000-2002, FOCUS 2000-2008		
13998	GAC-8	AIRE CABINA	BALDWIN PA4331, MANN & HUMMEL CU-2882, MICRON AIR MP-044, PUROLATOR C45383, WIX 24822, VOLKSWAGEN 1H0 819 644, 1J0 819 644, 1H0 819 644A, 1J0 819 644A, 1H0 819 638 A (GAC-10 VERSIÓN CON CARBÓN ACTIVADO)	AUDI: A3 1997-2004, QUATTRO 2000-2006, S3 2001-2003, TT 2000-2006. SEAT: CORDOBA 2000-2002, IBIZA 2000-2003, LEON 2000-2005, TOLEDO 2000-2005. VOLKSWAGEN: BEETLE 1998-2009, DERBY 1995-2005, GOLF 1993-2006, JETTA 1993-2005, PASSAT 2002-2005	Largo: (10 63/64 in) (10.984 in) (279.0 mm) Ancho: (8 7/64 in) (8.109 in) (206.0 mm) Altura Total: (63/64 in) (0.984 in) (25.0 mm)	
13999	GAC-9	AIRE CABINA	BALDWIN PA4153, FORD F5RZ-19N619-A, F5RZ-19N619-B, F5RZ-19N619-C, F5RZ-19N619-BA, FRAM CF8046, LUBER-FINER CAF1700, MICRON AIR MP-076, MP-097, PUROLATOR C14860, WIX 24771	FORD: CONTOUR 1995-2000, MONDEO 2001-2007. MERCURY: COUGAR 1999-2002, MYSTIQUE 1995-2000	Largo: (20 3/64 in) (20.047 in) (509.2 mm) Ancho: (3 15/16 in) (3.937 in) (100.0 mm) Altura Total: (1 3/16 in) (1.188 in) (30.2 mm)	
13300	GAC-10	AIRE CABINA	BALDWIN PA4331, MANN & HUMMEL CU-2882, MICRON AIR MP-044, PUROLATOR C45383, WIX 24822, VOLKSWAGEN 1H0 819 644, 1J0 819 644, 1H0 819 644A, 1J0 819 644A, 1H0 819 638 A (GAC-8 VERSIÓN NORMAL)	AUDI: A3 1997-2004, QUATTRO 2000-2006, S3 2001-2003, TT 2000-2006. SEAT: CORDOBA 2000-2002, IBIZA 2000-2003, LEON 2000-2005, TOLEDO 2000-2005. VOLKSWAGEN: BEETLE 1998-2009, DERBY 1995-2005, GOLF 1993-2006, JETTA 1993-2005, PASSAT 2002-2005	Largo: (11 7/64 in) (11.109 in) (282.2 mm) Ancho: (8 1/8 in) (8.125 in) (206.4 mm) Altura Total: (1 3/16 in) (1.188 in) (30.2 mm)	
13301	GAC-11	AIRE CABINA	FORD 1-204-459, MANN & HUMMEL CU2433, MICRON AIR MP114	FORD: FIESTA HATCHBACK 1998-2002	Largo: (9 29/64 in) (9.453 in) (240.1 mm) Ancho: (7 7/16 in) (7.438 in) (188.9 mm) Altura Total: (1 3/8 in) (1.375 in) (34.9 mm)	
13303	GAC-13	AIRE CABINA	BALDWIN PA4086, FRAM CF8603, HONDA 80291-S84-A01, LUBER-FINER CAF1708, MANN & HUMMEL MC 1010-2, MICRON AIR MP-066-2, WIX 24782	ACURA: CL 2001-2003, TL 1999-2003 HONDA: ACCORD 1997-2007	Largo: (8 55/64 in) (8.859 in) (225.0 mm) Ancho: (4 3/8 in) (4.375 in) (111.1 mm) Altura Total: (1 3/16 in) (1.188 in) (30.2 mm)	

CÓDIGO	MODELO	TIPO	EQUIVALENCIAS	APLICACIONES	DIMENSIONES	FOTOGRAFÍA
CODE	MODEL	TYPE	EQUIVALENCE	APPLICATION	DIMENSIONS	PHOTOGRAPHY
4560	GAD-36	AIRE SERV. PESADO	NISSAN 16546-9S001	NISSAN: D22 (FRONTIER) 2009-2007, PICK-UP 2009-2008, MOTORES 4 CIL. 2.5L DIESEL TURBO (YD25)	Diámetro Ext.: (5 17/64 in) (5.260 in) (133.6 mm) Diámetro Int.: (2 7/16 in) (2.430 in) (61.7 mm) Altura Total: (8 49/64 in) (8.760 in) (222.5 mm)	
13471	GAD-116	AIRE SERV. LIGERO	NISSAN 16546-ED000, FRAM CA10234, LUBER-FINER AF4023, MANN & HUMMEL C2420, PUROLATOR A15669, WIX 49225	NISSAN: CUBE 2010-2009, TIIDA 2009-2007, VERSA 2010-2007. TODOS CON MOTOR L4 1.8L MR18DE	Largo: (9 5/32 in) (9.156 in) (232.5 mm) Ancho: (5 23/64 in) (5.359 in) (136.1 mm) Altura Total: (1 11/32 in) (1.343 in) (34.1 mm)	
23320	GA-182	AIRE SERV. LIGERO	HONDA 17220-PWA-J10, 17220-PWA-Y10, FRAM CA10233, LUBER FINER AF4019, PUROLATOR A25657, WIX 49086	HONDA: FIT 2008-2007	Largo: (6 37/64 in) (6.578 in) (167.0 mm) Ancho: (5 51/64 in) (5.796 in) (147.2 mm) Altura Total: (2 3/32 in) (2.093 in) (53.1 mm)	Imagen no disponible
23282	GA-249	AIRE SERV. LIGERO	CHRYSLER 53032527AA, 53032527AB, FRAM CA9762, LUBER FINER AF3956, MANN & HUMMEL MA1097, PUROLATOR A35553, WIX 42750	CHRYSLER: ASPEN 2009-2007 DODGE: DURANGO 2009-2004	Largo: (8 57/64 in) (8.890 in) (225.8 mm) Ancho: (8 39/64 in) (8.610 in) (218.6 mm) Altura Total: (1 13/16 in) (1.810 in) (45.9 mm)	
23291	GA-265	AIRE SERV. LIGERO	TOYOTA 178010D060, 178010T030, 1780121050 FRAM CA10190, LUBER FINER AF4015, PUROLATOR A25655, WIX 49104	TOYOTA: COROLLA 2010-2009, MATRIX 2010-2009, YARIS 2010-2006	Largo: (9 1/2 in) (9.500 in) (241.3mm) Ancho: (6 15/16 in) (6.937 in) (176.1 mm) Altura Total: (2 3/64 in) (2.046 in) (51.9 mm)	Imagen no disponible
23318	GA-266	AIRE SERV. LIGERO	GENERAL MOTORS 15942429, FRAM CA10466, AC DELCO A3095C, LUBER FINER AF3095, PUROLATOR A55822, WIX 49429	CHEVROLET: COLORADO 2010-2008 GMC: CANYON 2010-2008 HUMMER: H3 2010-2008	Largo: (12 7/32 in) (12.218 in) (310.3 mm) Ancho: (9 11/16 in) (9.687 in) (146.0 mm) Altura Total: (2 1/64 in) (2.015 in) (51.1 mm)	Imagen no disponible

CÓDIGO	MODELO	TIPO	EQUIVALENCIAS	APLICACIONES	DIMENSIONES	FOTOGRAFÍA
CODE	MODEL	TYPE	EQUIVALENCE	APPLICATION	DIMENSIONS	PHOTOGRAPHY
23321	GA-290	AIRE SERV. LIGERO	GENERAL MOTORS 96628890, 96815102, FRAM CA10115, WIX 49102	CHEVROLET: CAPTIVA 2009-2008 SATURN: GREEN LINE 2008, RED LINE 2010-2008, VUE 2010-2008	Largo: (11 3/16 in) (11.187 in) (284.1 mm) Ancho: (8 55/64 in) (8.859 in) (225.0 mm) Altura Total: (2 17/64 in) (2.265 in) (57.5 mm)	
13444	GA-304	AIRE SERV. LIGERO	KIA 0K2A5-13-Z40A, FRAM CA8548, BALDWIN PA4124, MANN MA1095, PUROLATOR A35258, WIX 46462	KIA SEPHIA L4-1.8 L 1998-01, SPECTRA L4-1.8 L 2000-04	Largo: (13 3/8 in) (13.375 in) (339.7 mm) Ancho: (6 47/64 in) (6.734 in) (171.0 mm) Alto: (1 19/32 in) (1.593 in) (40.4 mm)	
13322	GA-410	AIRE SERV. LIGERO	DONALDSON P500028, FLEETGUARD AF25380, FRAM CA5345, MANN & HUMMEL C 14 177,	TOYOTA HIACE MODELOS 2006-2007 CON MOTOR L4 2.7L FI 16 VALV.	Largo: (5 17/64 in) (5.266 in) (133.7 mm) Ancho: (3 1/64 in) (3.016 in) (76.6 mm) Altura Total: (11 1/16 in) (11.062 in) (281.0 mm)	
13446	GA-433	AIRE SERV. LIGERO	FORD XL3Z9601AA, FRAM CA8958, WIX 42572, BALDWIN PA1682	FORD LIGHTING (99-04), FORD GT (05-06)	Largo: (12.859 in) (12 55/64 in) (326.6 mm) Ancho: (7.656 in) (7 21/32 in) (194.4 mm) Alto: (1.843 in) (1 27/32 in) (46.8 mm)	
23283	GA-488	AIRE SERV. LIGERO	CHRYSLER 5029703AA, 53032700AA, 53032700AB, FRAM CA9589, LUBER FINER LAF5980, PUROLATOR A45512, WIX 49062	DODGE: RAM 2010-2003 MOTOR 6 CIL. 5.9L TURBO DIESEL	Largo: (10 31/32 in) (10.968 in) (278.5 mm) Ancho: (9 15/16 in) (9.937 in) (252.3 mm) Altura Total: (2 19/32 in) (2.593 in) (65.8 mm)	
4531	GA-563	AIRE SERV. PESADO	BALDWIN PA2562, FRAM CA2595, LUBER-FINER LAF8407, PUROLATOR A73536, REYTOR IT128407, WIX 42258	EXCAVADORAS HITACHI SERIES EX. COMPRESORES INGERSOLL RAND DM25, T4-VHP1050, XP1400. CAMIONES DE VOLTEO VOLVO A35C, A40	Diámetro Ext.: (14 45/64 in) (14.703 in) (373.5 mm) Diámetro Int.: (10 9/32 in) (10.281 in) (261.1 mm) Altura Total: (24 in) (24.000 in) (609.6 mm)	

CÓDIGO	MODELO	TIPO	EQUIVALENCIAS	APLICACIONES	DIMENSIONES	FOTOGRAFÍA
CODE	MODEL	TYPE	EQUIVALENCE	APPLICATION	DIMENSIONS	PHOTOGRAPHY
13430	GAVW-618	AIRE SERV. LIGERO	VW 1K0-129-620, K&N 33-2384, MANN C36 188, WIX 49122	VW PASSAT V6 3.2 L 2006-07/JETTA TDI 2.0L DIESEL, AUDI A3 V6 3.2L (03-), AUDI TT V6 3.2L (2007)	Largo: (13 1/2 in) (13.5 in) (343 mm) Ancho: (8 3/4 in) (8.75 in) (222 mm) Alto: (1 1/8 in) (1.125 in) (29 mm)	
13437	GA-1530	AIRE SERV. LIGERO	NISSAN 16546-JA00A WIX 49057, K&N 33-2374	ALTIMA L4 2.5L (2007-2008)	Largo: (12 1/4 in)(12.25 in) (311 mm) Ancho: (5 1/4 in) (5.25 in) (133 mm) Alto: (1 1/8 in) (1.125 in) (29 mm)	
13438	GA-1542	AIRE SERV. LIGERO	FORD 7T42-9601-A, WIX 46935, FRAM CA10242, PUROLATOR A25699, MOTORCRAFT FA1884, MAZDA CY01-13Z40A	FORD FIVE HUNDRED V6 3.5L (2008), EDGE V6 3.5L (2007-08), LINCOLN MKZ Y MKX V6 3.5L (2007-08), MAZDA CX-9 V6 3.5 Y 3.7 (2007-08)	Largo: (12 3/64 in) (12.046 in) (305.9 mm) Ancho: (6 23/32 in) (6.718 in) (170.6 mm) Alto: (1 51/64 in) (1.796 in) (45.6 mm)	
13436	GA-1546	AIRE SERV. LIGERO	NISSAN 16546-EA000, WIX 46916	FRONTIER L4-2.5 L 2005-07 PONITAC G6 V6 3.9L (2008)	Largo: (14 59/64 in) (14.921 in) (378.9 mm) Ancho: (7 9/32 in) (7.281 in) (184.9 mm) Alto: (1 19/64 in) (1.296 in) (32.9 mm)	
23284	GA-1572	AIRE SERV. LIGERO	FORD 6E52-9601-AE, 6E52-9601-EA, FRAM CA10094, LUBER FINER AF2785, MOTORCRAFT FA-1785, PUROLATOR A25582, WIX 49114	FORD: FUSION 2009-2006 MERCURY: MILAN 2009-2006	Largo: (10 5/8 in) (10.625 in) (269.8 mm) Ancho: (6 5/16 in) (6.312 in) (160.3 mm) Alto: (1 61/64 in) (1.960 in) (49.7 mm)	imagen no disponible
23319	GA-3083	AIRE SERV. LIGERO	GENERAL MOTORS 15278634, FRAM CA10110, ACDELCO A3083C, LUBER FINER AF3083, PUROLATOR A66313, WIX 49634	BUICK: ENCLAVE 2010-2008 CHEVROLET: TRAVERSE 2010-2009 GMC: ACADIA 2010-2007 SATURN: OUTLOOK 2010-2007	Largo: (13 23/32 in) (13.718 in) (348.4 mm) Ancho: (11 53/64 in) (11.828 in) (300.4 mm) Alto: (in) (in) (mm)	imagen no disponible

CÓDIGO	MODELO	TIPO	EQUIVALENCIAS	APLICACIONES	DIMENSIONES	FOTOGRAFÍA
CODE	MODEL	TYPE	EQUIVALENCE	APPLICATION	DIMENSIONS	PHOTOGRAPHY
1410	G-911	ACEITE AUTOMOTRIZ	GENERAL MOTORS 19185485, TOYOTA 4152-37010, 4152-YZZA6, FRAM CH10358, LUBER-FINER P980, PUROLATOR L16311, WIX 57064	TOYOTA: COROLLA 2010-2009, MATRIX 2010-2008	Diámetro Ext.: (2 11/32 in) (2.340 in) (59.4 mm) Diámetro Int.: (1 3/32 in) (1.090 in) (27.6 mm) Altura Total: (2 1/4 in) (2.250 in) (57.1 mm)	
1411	G-912	ACEITE AUTOMOTRIZ	TOYOTA 4152-31090, 4152-YZZA1, FRAM CH9972, LUBER-FINER P967, PUROLATOR L25608, WIX 57047	TOYOTA: AVALON 2010-2005, CAMRY 2010-2007, HIGHLANDER 2010-2008, RAV-4 2010-2006, SIENNA 2010-2007, VENZA 2010-2009	Diámetro Ext.: (2 49/64 in) (2.760 in) (70.1 mm) Diámetro Int.: (1 7/64 in) (1.100 in) (27.9 mm) Altura Total: (2 41/64 in) (2.645 in) (67.1 mm)	
1400	G-179	DIESEL SERV. PESADO	ISUZU 8-98037-011-0	ISUZU ELF 300	Diámetro Ext.: (3 53/64 in) (3.828 in) (97.2 mm) Diámetro Int.: (59/64 in) (0.922 in) (23.4 mm) Altura Total: (4 31/64 in) (4.484 in) (113.9 mm)	
7316	GG-308	GASOLINA	FORD 2L22-9155-AB, FRAM G9343, MOTORCRAFT MFG1036, PUROLATOR F65472, WIX 33424	FORD: EXPEDITION 2010-2007, EXPLORER 2003-2002, FOCUS 2010-2009, FREESTAR 2007-2006, RANGER 2010-2004. LINCOLN: NAVIGATOR 2010-2008. MERCURY: MONTEREY 2007-2006, MOUNTAINEER 2004-2002	Diámetro Ext.: (2 1/4 in) (2.250 in) (57.1 mm) Altura Total: (7 3/64 in) (7.046 in) (178.9 mm) Entrada: (3/8 in) (0.375 in) (9.5 mm) Salida: (3/8 in) (0.375 in) (9.5 mm) Retorno de vapores: (5/16 in) (0.312 in) (7.9 mm)	
2297	GPP-523	DIESEL SERV. PESADO	NISSAN 165546-01TOA	NISSAN: D22 (FRONTIER) 2009-2007, PICK-UP 2009-2008, MOTORES 4 CIL. 2.5L DIESEL TURBO (YD25)	Rosca: 3/4-16 Diámetro Ext.: (3 9/32 in) (3.285 in) (83.4 mm) Altura Total: (6 13/16 in) (6.815 in) (173.1 mm) Rosca del puerto: M36X1.5	

**Aplicaciones de filtros en
motores más comunes en
Servicio Pesado**

Applications of filters in
common engines Heavy Duty

FABRICANTE, MODELO		ACEITE FILJO COMPLETO	ACEITE DERIVACIÓN	AIRE PRIMARIO	AIRE SECUNDARIO	COMBUSTIBLE	SEPARADOR DE AGUA	SISTEMA DE ENFRIAMIENTO
MANUFACTURER, MODEL		OIL FULL FLOW	OIL BY-PASS	AIR PRIMARY	AIR SECONDARY	FUEL	FUEL/WATER SEPARATOR	SYSTEM COOLING
CATERPILLAR								
3114		GP-51				GP-110, GP-62 ó GP-1109	GP-11	
3116		GP-51				GP-110, GP-62 ó GP-1109	GP-11	
3116T		GP-51		GA-197R	GA-768R	GP-1105 Y GP-1107		
3126		GP-51		GA-701 ó GA-966R	GA-702 ó GA-967R	GP-1109	GP-1000	GP-1011Q
3126B		GP-51 ó GP-691		GA-197R ó GA-3551	GA-768R	GP-62 ó GP-1109 ó GP-749	GP-1000, GPP-11 ó GPP-103	GP-2071W
3176		GP-52 ó GP-691	GP-57			GP-110, GP-749		GP-1011Q
3208, 3208T		GP-36 ó GP-9586				GP-110	GP-11	
3306, 3306B		GP-51				GP-110	GP-11	GP-2071W
3406, 3406B, 3406C, 3406E		GP-52 ó GP-691		GA-378, GA-229, GA-376, GA-221R		GP-56 ó GP-749	GP-1000	GP-2071W
C10, C12		GP-52 ó GP-691	GP-57	GA-3551, GA-221R, GA-377	GA-723R	GP-749, G-1046	GP-1000, GPP-11	GP-2071W, GP-2127W
C11		GP-691	GP-57	GA-701, GA-968R	GA-702	GP-1109, GP-749	GP-1000, GPP-11, GPP-547	GP-2071W, GP-1011Q
C13		GP-691, GP-9000	GP-57	GA-682R, GA-3551, GA-701	GA-702	GP-749, G-1046	GP-1000, GPP-11, GPP-1291	GP-2071W, GP-2126Q, GP-1011Q
C15, C16		GP-52 ó GP-691	GP-57	GA-682R, GA-3551, GA-539R, GA-534R	GA-683R	GP-749, G-128, GP-1101	GP-1000, GPP-11, GPP-1291	GP-2071W, GP-1010Q, GP-1011Q
C7		GP-51		GA-701	GA-702	GP-1109	GP-547	GP-2071W
C8		GP-691		GA-701	GA-702	GP-1109, GP-749	GP-11, GPP-547	GP-2071W
CUMMINS								
4B 3.9L		GP-390				GPP-18 Y GP-1122	GPP-1122	
6B 5.9L		GP-178				GPP-18 Y GP-1122	GPP-1122	
6C 8.3L		GP-53				GPP-18 Y GP-1122	GPP-1122	GP-2071W
6C 8.3L COMMAND SERIES		GP-3000				GPP-18 Y GP-1122	GPP-1122	GP-2071W
L10		GP-53	GP-57	GA-6886, GA-378, GA-229		GP-11, GP-1101	GP-11	GP-2071W
L10 88 SERIES		GP-3000				GP-11	GP-11	GP-2071W
M11 SERIES		GP-3000, GP-691		GA-3551		G-1046, GP-749	GP-1000, GPP-11	GP-2071W
KT1150		GP-53	G-750			GP-11	GP-11	GP-1011Q
N14		GP-52, GP-691, GP-3000	GP-57	GA-624R, GA-435R, GA-376, GA-694		G-1046, GP-749, GP-1101, GP-11	GP-11, GPP-1000	GP-1011Q, GP-2071W
NT855 SMALL CAM		G-566, GP-53	G-750 ó GP-57			GP-11	GP-11	GP-2071W
NT855 BIG CAM I, II, III		GP-53	GP-57			GP-11	GP-11	GP-2071W
NT855 BIG CAM IV		GP-3000				GP-11	GP-11	GP-2071W
ISB		GP-3937		GA-197R, GA-966R	GA-768R, GA-967R	G-1046, GS-1261	GP-1003S	GP-1011Q, GP-2071W
ISC, ISL		GP-3000		GA-197R, GA-701, GA-966R	GA-197R, GA-702, GA-967R	GP-1109	GP-1003S ó GPP-1022S	GP-1011Q, GP-2071W
ISM		GP-9000 ó GP-9001		GA-682R, GA-197R, GA-624R, GA-3551	GA-683R, GA-768R	G-1046, GP-1101, GP-1109	GP-1000, GPP-1007S, GPP-1022S, GPP-1291	GP-1011Q, GP-2126Q, GP-2127W
ISX, SIGNATURE 600		GP-9000 ó GP-9001		GA-682R, GA-197R, GA-624R, GA-3551, GA-221R	GA-683R, GA-768R, GA-723R	G-1046, G-128, GP-1101	GP-1007S	GP-2126Q, GP-2071W
DETROIT DIESEL								
53 SERIES		G-33, GP-43				G-1174 Y G-1173 ó GP-92 Y GP-93		GP-2071W
71 SERIES		G-33, GP-43	G-31			G-1174 Y G-1173 ó GP-26 Y GP-27	S3202 (SOLO CON FILTROS TIPO ROSCABLE)	GP-2071W
92 SERIES		G-33, GP-43	G-31			G-1175 ó GP-26 Y GP-27	S3202 (SOLO CON FILTROS TIPO ROSCABLE)	GP-2071W
50 SERIES		GP-193				GP-26 Y GP-27	GPP-1287 (PURGADOR), R60P (ROSCA PARA TAZÓN), GPP-1291 (PURGADOR), R90P (ROSCA PARA TAZÓN)	GP-1011Q, GP-2071W

FABRICANTE, MODELO	ACEITE FLUJO COMPLETO	ACEITE DERIVACIÓN	AIRE PRIMARIO	AIRE SECUNDARIO	COMBUSTIBLE	SEPARADOR DE AGUA	SISTEMA DE ENFRIAMIENTO
MANUFACTURER, MODEL	OIL FULL FLOW	OIL BY-PASS	AIR PRIMARY	AIR SECONDARY	FUEL	FUEL/WATER SEPARATOR	SYSTEM COOLING
DETROIT DIESEL							
60 SERIES (ANTERIORES A 1993)	GP-43	GP-57			GP-26 Y GP-27	S3202	GP-2071W
60 SERIES (POSTERIORES A 1993)	GP-193				GP-26 Y GP-27	S3202	GP-2071W
8.2 SERIES	GP-13				GP-92 Y GP-93		
DODGE							
6 CIL. 5.9L TURBO DIESEL	GP-178					GP-1232 (1989-1993), GS-1261 (1999 EN ADELANTE)	
6 CIL. 3.7L	GP-81				GG-8 L		
V6 3.9L	GP-58 ó GP-81				GG-67 ó GG-268 ó GG-249		
V8 5.2L	GP-81				GG-8 L ó GG-67 ó GG-268 ó GG-249		
V8 5.2L GAS NATURAL	GP-81				GG-8 L ó GG-67 ó GG-268 ó GG-249		
V8 5.9L	GP-81						
V10 8.0L	GP-81						
FORD							
351 (5.8L)	GP-1				GG-47		
370 (6.1L)	GP-31				GP-1122		
429 (7.0L)	GP-31				GP-1122		
460 (7.5L)	GP-1				GG-47		
V10 6.8L	GP-68				GG-1872		
6.9L (INTERNATIONAL)	GP-3766				GP-155		
7.3L (INTERNATIONAL)	GP-3766						
7.3L (TURBO INTERNATIONAL 1993 Y RECIENTES)	GP-562					G-178 (1995-1998), G-862 (1999 EN ADELANTE)	
6.6L		G-750			GP-1122		
7.8L		G-750			GP-1122		
FD1060 (5.9L)	GP-178				GPP-1122		
FD1460 (8.3L)	GP-3000				GPP-1122		
GENERAL MOTORS (CHEVROLET & GMC)							
292 (4.8L)	GP-13 ó GP-23				GG-20		
350 (5.7L)	GP-13 ó GP-23				GG-46 ó GG-20		
366 (6.0L)	GP-13 ó GP-23				GG-46 ó GG-20		
427 (7.0L)	GP-13 ó GP-23				GG-46 ó GG-20		
454 (7.4L)	GP-13 ó GP-23, GP-408 (SERIES K 1999 EN ADELANTE)				GG-46 ó GG-20		
VORTEC 7400	GP-205				GG-46		
6.2L DIESEL	GP-13				GP-1122		
6.5L TURBO DIESEL	GP-205						
VORTEC 7800 DIESEL							
INTERNATIONAL							
V8 (301CI, 345CI, 392CI)	GP-1 ó GP-10				GG-5 L		
V8 404CI	GP-1 ó GP-10				GG-5 L ó GG-20		
DT360, DT360	GP-69 ó GP-88				GP-78		

FABRICANTE, MODELO	ACEITE FLUJO COMPLETO	ACEITE DERIVACIÓN	AIRE PRIMARIO	AIRE SECUNDARIO	COMBUSTIBLE	SEPARADOR DE AGUA	SISTEMA DE ENFRÍAMIENTO
MANUFACTURER, MODEL	OIL FULL FLOW	OIL BY-PASS	AIR PRIMARY	AIR SECONDARY	FUEL	FUEL/WATER SEPARATOR	SYSTEM COOLING
INTERNATIONAL							
DT408	GP-152				GP-78		GP-2071W
DT466, DTA,466, DT466	GP-69 ó GP-88				GP-1101 Y GP-78		
T444E	GP-562					G-178 (1995-1998), G-862 (1999 EN ADELANTE)	
530	GP-152				GP-78		GP-2071W
6.9L	GP-3766				GP-155		GP-2071W
7.3L	GP-3766					GP-1287 (PURGADOR), R60P (ROSCA PARA TAZÓN)	GP-2071W
9.0L	GP-10	G-750			GP-1101 Y GP-78	GPP-11	
MERCEDES BENZ							
MBE4000	GP-9000		GA-682R, GA-701	GA-683R, GA-702	G-1046	GPP-1003S, GPP-1291	GP-1011Q
MBE460			GA-197R	GA-768R	G-1046		
MBE900	G-3754		GA-197R, GA-701, GA-930R, GA-966R	GA-702, GA-967R, GA-768R	G-1046	GPP-1291	
MBE904	G-3827, G-3754		GA-197R, GA-701	GA-702	G-1046		
MBE906	G-3754		GA-701	GA-702	G-1046		
MBE926	G-3754		GA-701	GA-702	G-1046		
OM612	G-918		GA-475		GPP-612		
OM646	G-918		GA-475		GPP-612		
OM904	G-3827		GA-801R	GA-802R	G-1046		
OM906	G-3754		GA-682R	GA-683R	G-1046	GP-1287 (PURGADOR), R60P (ROSCA PARA TAZÓN), GPP-1291 (PURGADOR), R90P (ROSCA PARA TAZÓN)	
OM926	G-3754				G-1046		
NAVISTAR							
MAXXFORCE 10	GP-9000		GA-799R	GA-798R			
MAXXFORCE 7	GP-9000		GA-799R	GA-798R			
MAXXFORCE 9	GP-9000		GA-799R	GA-798R			
MAXXFORCE DT	GP-9000		GA-799R	GA-798R			
VT230	G-3752		GA-799R	GA-798R	G-862, G-862T		
VT365	G-3752		GA-799R	GA-798R	G-862, G-862T		
VOLVO							
DH12	GP-51						
TD60	GP-54				GP-1122		GP-2108W
TD70E	GP-54	G-750			GP-1122		GP-2108W
TD122	GP-51	GP-57			GP-1122		GP-2108W
VED7	GP-51	GP-57			GP-1122		GP-2108W
VED12	GP-51	GP-57	GA-624R, GA-435R		GP-96	2010PM-OR, GPP-1287 (PURGADOR), R60P (ROSCA PARA TAZÓN), GPP-1291 (PURGADOR), R90P (ROSCA PARA TAZÓN)	GP-1011Q, GP-2108W
FE6, FE7	GP-51	GP-57			GP-1122		GP-2108W
F6, F7	GP-51	G-750			GP-1122		GP-2108W

Aplicaciones de filtros para
unidades más comunes en
Servicio Pesado

Applications of filters for
common units Heavy Duty

UNIDAD	MOTOR	ACEITE	AIRE PRIMARIO	AIRE SECUNDARIO	COMBUSTIBLE	AGUA	HIDRAULICO
UNIT	ENGINE	OIL	AIR PRIMARY	SECONDARY	FUEL	WATER	HYDRAULIC
CHEVROLET							
C8H042 TW9R (2002-2006)	CATERPILLAR 3126B	GP-51, G-750 (BY PASS)			GP-26, S3202		
KODIAK	CATERPILLAR 3116	GP-51			GP-62, GPP-11, GP-110		
KODIAK	CATERPILLAR 3126B	GP-51, G-750 (BY PASS)	GA-197R	GA-768R	GP-26, S3202		
KODIAK	VORTEC V8 8.1L	GP-408	GA-732R (2004)		GG-46		
DINA							
451	DTA 360 (1994 EN ADELANTE)	GP-43, GP-57 (BY PASS)	GA-109	GA-119	GP-11, GPP-11	GP-2071W	
531	CUMMINS 155 V6 (1973-1977)	G-613, G-500 (BY PASS)	GA-21		GC-1133, GS-1133	GP-2071W, GP-1010Q	
531	PERKINS 354 6L (1984-1988)	GP-31	GA-373		G-296B		
551	NAVISTAR DTA 360 (1994-...)	GP-69, GP-88			GP-78, GP-56		
651	CUMMINS C8.3L 210HP (1994-...)	GP-53			GPP-18, GP-1122, GPP-1122	GP-1010Q, GP-1011Q	
651	NAVISTAR DTA 466 250HP (1994-...)	GP-69, GP-88			GP-1101 y GP-78	GP-2071W, GP-1010Q	
661	CUMMINS 220 NH (1974-1986)	G-566, G-750 (BY PASS)	GA-373		GP-11, GPP-11	GP-2071W, GP-1010Q	
661	CUMMINS NTC 250 (1974-1986)	G-566, G-750 (BY PASS)	GA-373		GP-11, GPP-11	GP-2071W, GP-1010Q	
751	CUMMINS C 8.3L-210 HP (1994-...)	GP-53			GPP-18, GP-1122, GPP-1122	GP-1010Q, GP-1011Q	
751	CUMMINS L10-310 HP (1994-...)	GP-3000, GP-3001			GPP-11	GP-1011Q, GP-1012Q	
3130	6 CL. 354	GP-31			G-297B		
9400	CATERPILLAR 3406 E (1995-2001)	GP-52, GP-691			GP-56	GP-2071W, GP-1010Q	
9400	CUMMINS M-11 (1995-2001)	GP-3000, GP-3001	GA-221R	GA-723R	GPP-1000, GPP-103	GP-1011Q, GP-1013Q	
9400	CUMMINS N-14 (1992-1995)	GP-3000, GP-3001	GA-376		GP-11, GPP-11, GPP-103	GP-1011Q, GP-1013Q	
9400	CUMMINS N-14 ELECTRONICO (1995-2001)	GP-3000, GP-3001	GA-221R	GA-723R	GPP-1000, GPP-103	GP-1011Q, GP-1013Q	
9400	DETROIT DIESEL S-60 (<----> 1993)	GP-43, GP-57 (BY PASS)	GA-388		GP-26 Y GP-27		
9400	DETROIT DIESEL S-60 (1993-2001)	GP-193	GA-221R	GA-723R	GP-26 Y GP-27		
431-KI PERKINS DIESEL	6 CL. 354	GP-1			G-296B		
433 OF	CUMMINS B 3.9 120 HP (1994->)						
455 OF	NAVISTAR DTA 360 170 HP (1994->)						
500 TURBO	CUMMINS 155 V6 (1987-1988)	GP-43, GP-57 (BY PASS)	GA-109	GA-119	GP-11, GPP-11	GP-2071W	
552 OF Y 555 OF	NAVISTAR DTA 360 170 HP (1994->)						
552 OF Y 555 OF	NAVISTAR DTA 466 195 HP (1994->)						
631, 661	CUMMINS 210 V8 (1972-1986)	G-613, G-500 (BY PASS)	GA-21		GC-1133, GS-1133	GP-2071W, GP-1010Q	
634 OF	NAVISTAR DTA 466 210, 250 HP (1994->)						
AVANTE	DETROIT DIESEL 6V-92 330 HP (1994->)	GP-53			GP-26 Y GP-27		
AVANTE	DETROIT DIESEL S-50 300 HP (1994->)	GP-193					
D-1000 Y D-1004	6 CL. 282	GP-20	GA-77		GG-5		
D-3000 Y D-3004	6 CL. 282	GP-20	GA-77		GG-5		
D-3200 Y D-3255 PERKINS DIESEL	6 CL. 236	GP-1	GAK-403		G-296B		

UNIDAD	MOTOR	ACEITE	AIRE PRIMARIO	AIRE SECUNDARIO	COMBUSTIBLE	AGUA	HIDRAULICO
UNIT	ENGINE	OIL	AIR PRIMARY	SECONDARY	FUEL	WATER	HYDRAULIC
DINA							
DORADO	DETROIT DIESEL 6V-92 330 HP (1994---->)	GP-53					
DORADO	DETROIT DIESEL 5-60 365 HP (1994---->)	GP-193					
PARADISO	DETROIT DIESEL 5-60 365 HP (1994---->)	GP-193					
SERIE 3800	NAVISTAR DTA 360 170 HP	GP-88	GA-209	GA-210	GP-78, GP-1108		
SERIE 3800	NAVISTAR DTA 466 210 HP	GP-152	GA-209	GA-210	GP-78, GP-1108		
SERIE G-4500	DETROIT DIESEL 5-60 DDEC IV-12.7L 400 HP	GP-193					
TURBO 600	CUMMINS 210 V8 (1987-1990)	GP-43, GP-57 (BY PASS)	GA-109	GA-119	GP-11, GPP-11	GP-2071W, GP-1010Q	
VIAGGIO	DETROIT DIESEL 5-60 365 HP (1993---->)	GP-193	GA-377		GP-26 Y GP-27	GP-1012Q	
FAMSA							
1314	MERCEDES BENZ OM-366	GP-88	GA-209	GA-210	G-1046, GPP-1287, R60 P		G-162H
1317	MERCEDES BENZ OM-366	GP-88	GA-209	GA-210	G-1046, GPP-1287, R60 P		G-162H
FREIGHTLINER							
ARGOSY	CATERPILLAR C10	GP-52, GP-57 (BY-PASS)	GA-682R	GA-683R	GP-749		
ARGOSY	CUMMINS ISM 370	GP-9000 ó GP-9001	GA-682R	GA-683R	GPP-10225		
ARGOSY	CUMMINS ISX	GP-9000 ó GP-9001	GA-682R	GA-683R	GPP-10075		
ARGOSY	MERCEDES BENZ MBE4000		GA-682R	GA-683R			
BUSSINES CLASS	CUMMINS ISB	GP-3937	GA-682R	GA-683R	GPP-10225		
BUSSINES CLASS	CUMMINS ISC	GP-3000 ó GP-3001	GA-682R	GA-683R	GS-1261, GPP-10035 ó GPP-10225		
BUSSINES CLASS	CUMMINS M11	GP-3000	GA-682R	GA-683R	GP-11, GPP-1000, GPP-10225 ó GPP-11		
CENTURY CLASS C120	CUMMINS SIGNATURE 600	GP-9000 ó GP-9001	GA-682R	GA-683R	GPP-10075	GP-2126Q ó GP-2127W	
CENTURY CST120	CUMMINS ISX	GP-9000 ó GP-9001	GA-682R	GA-683R	GPP-10075		
CENTURY CST120	DETROIT DIESEL 60 SERIES	GP-193	GA-682R	GA-683R	GP-26 Y GP-27, GPP-1287SEP. AGUA		
CENTURY CST120	MERCEDES BENZ MBE4000		GA-682R	GA-683R			
COLUMBIA	CATERPILLAR C12	GP-52, GP-57 (BY-PASS)	GA-682R	GA-683R	GP-749		
COLUMBIA	CATERPILLAR C15	GP-691	GA-682R	GA-683R	GP-749		
COLUMBIA	CUMMINS ISX (2002-2004)	GP-9000 ó GP-9001	GA-682R	GA-683R	GPP-10075	GP-2071W	
COLUMBIA	CUMMINS ISX (2006-2008)	GP-9000 ó GP-9001	GA-682R	GA-683R	GPP-1000	GP-2071W	
COLUMBIA	CUMMINS N14-435	GP-3000	GA-682R	GA-683R	GPP-1000	GP-2071W	
COLUMBIA	DETROIT DIESEL 60 SERIES	GP-193	GA-682R	GA-683R	GP-26 Y GP-27, S3202 ó G-1285SEP. AGUA		
COLUMBIA	MERCEDES BENZ MBE4000		GA-682R	GA-683R			
COLUMBIA CL112	CATERPILLAR C10	GP-52, GP-57 (BY-PASS)	GA-682R	GA-683R	GP-749		
COLUMBIA CL112	CUMMINS ISM	GP-9000 ó GP-9001	GA-682R	GA-683R	GPP-10225		
COLUMBIA CL112	CUMMINS ISX	GP-9000 ó GP-9001	GA-682R	GA-683R	GPP-10075		
COLUMBIA CL112	DETROIT DIESEL 60 SERIES	GP-193	GA-682R	GA-683R	GP-26 Y GP-27, GPP-1287SEP. AGUA		
COLUMBIA CL112	MERCEDES BENZ MBE4000		GA-682R	GA-683R			
CORONADO	CUMMINS ISX	GP-9000 ó GP-9001	GA-682R	GA-683R	GPP-10075		
CORONADO	DETROIT DIESEL 60 SERIES	GP-193	GA-682R	GA-683R	GP-26 Y GP-27		

UNIDAD	MOTOR	ACEITE	AIRE PRIMARIO	AIRE SECUNDARIO	COMBUSTIBLE	AGUA	HIDRAULICO
UNIT	ENGINE	OIL	AIR PRIMARY	SECONDARY	FUEL	WATER	HYDRAULIC
FREIGHTLINER							
CST 120	CUMMINS N14E	GP-3000	GA-966R	GA-967R	GPP-1000		
FC70, F680	CUMMINS ISB	GP-3937	GA-966R	GA-967R	GS-1261		
FL-106	DETROIT DIESEL 550	GP-193			GP-26 Y GP-27		
FL112 6X4	CUMMINS ISM 310	GP-9000 ó GP-9001	GA-966R	GA-967R	GPP-10225		
FL112 6X4 QR	MERCEDES BENZ MBE4000		GA-966R	GA-967R			
FL60	CUMMINS ISB	GP-3937	GA-966R	GA-967R	GS-1261		
FL70	MERCEDES BENZ MBE900	G-3754	GA-966R	GA-967R	G-1046		
FL80 4X2 QR Y 6X2	CUMMINS ISB	GP-3937	GA-966R	GA-967R	GS-1261	GP-2071W	
FL80 4X2 QR Y 6X2	MERCEDES BENZ MBE900	G-3754	GA-966R	GA-967R	G-1046		
FL80 4X2 QR Y 6X4	CUMMINS ISC	GP-3000 ó GP-3001	GA-966R	GA-967R	GPP-10035 ó GPP-10225	GP-2071W	
FLD112	CATERPILLAR C10	GP-52, GP-57 (BY-PASS)	GA-377 ó GA-3551		GP-749		
FLD112	CUMMINS ISM 370	GP-9000 ó GP-9001	GA-377 ó GA-3551		GPP-1000		
FLD120	CATERPILLAR 3406	GP-691	GA-377 ó GA-3551		GP-56		
FLD120	CATERPILLAR C10	GP-52, GP-57 (BY-PASS)	GA-377 ó GA-3551		GP-749	GP-2071W	
FLD120	CATERPILLAR C12	GP-52, GP-57 (BY-PASS)	GA-377 ó GA-3551		GP-749	GP-2071W	
FLD120	CATERPILLAR C15	GP-52, GP-57 (BY-PASS)	GA-377 ó GA-3551		GP-749	GP-2071W	
FLD120	CUMMINS N14-435	GP-3000	GA-377 ó GA-3551		GPP-1000	GP-2071W	
FLD120	DETROIT DIESEL SE60 (2005-2008)	GP-193	GA-3551		GP-26 Y GP-27		
FLD120	DETROIT DIESEL SERIE 60 (HASTA 1993), GP-193 (1994 EN ADELANTE)	GP-43 Y GP-57 (BY PASS)	GA-377 ó GA-3551		GP-26 Y GP-27, S3202 ó G-1285EP, AGUA		
FLD120 SD	CATERPILLAR C11	GP-691	GA-377 ó GA-3551		GP-749		
FLD120 SD	CATERPILLAR C13	GP-691	GA-377 ó GA-3551		GP-749		
FLD120 SD	CUMMINS ISM	GP-3000 ó GP-3001			GPP-10035 ó GPP-10225		
FLD120 SD	CUMMINS ISX	GP-9000 ó GP-9001			GPP-10075		
F565	MERCEDES BENZ MBE906	G-3754	GA-701	GA-702	G-1046		
M2 106 52K	MERCEDES BENZ MBE906	G-3754	GA-701	GA-702	G-1046		
M2 112	MERCEDES BENZ MBE4000		GA-701	GA-702	GPP-1287		
M2 35K	MERCEDES BENZ MBE906	G-3754	GA-701	GA-702	G-1046		
M2 52K, M2 58K	MERCEDES BENZ MBE906	G-3754	GA-701	GA-702	G-1046		
MT45	CUMMINS ISB	GP-3937			GS-1261		
GIANT MOTORS							
GF-3600		GP-205					
GF-6000		GP-205			GG-243		
GF-900		GP-157					
INTERNATIONAL							
3000	DT466E	GP-152			GP-78		
4000	DT466	GP-152	GA-799R	GA-798R	GP-78, G-862	GP-2071W	
4200	VT365	G-3752	GA-799R	GA-798R			
4300	VT365	G-3752	GA-799R	GA-798R			
4400	DT530	GP-152	GA-799R	GA-798R	GP-78	GP-2071W	
4900	DT466E	GP-152			GP-78		
7400	DT466		GA-930R	GA-890R			
7400	DT530	GP-152	GA-930R	GA-890R	GP-78	GP-2071W	

UNIDAD	MOTOR	ACEITE	AIRE PRIMARIO	AIRE SECUNDARIO	COMBUSTIBLE	AGUA	HIDRAULICO
UNIT	ENGINE	OIL	AIR PRIMARY	SECONDARY	FUEL	WATER	HYDRAULIC
INTERNATIONAL							
7600	CUMMINS ISM	GP-9000	GA-930R	GA-890R	GPP-10035 ó GPP-10225		
3000RE	DT466	GP-152			GP-78	GP-2071W	
3300CE	DT466	GP-152			GP-78	GP-2071W	
4300, 4400	DT466	GP-152	GA-799R	GA-798R	GP-78	GP-2071W	
466E	DT466	GP-152	GA-197R	GA-768R	GP-78	GP-2071W	
4700 444	T444E	GP-562	GA-197R ó GA-209	GA-768R ó GA-210	GP-78	GP-2071W	
4700 FBC Y SCD	DT466	GP-152	GA-930R	GA-890R	GP-78	GP-2071W	
4700 FE	DT466		GA-930R	GA-890R	GP-78	GP-2071W	
4700 SCD	T444E	GP-88	GA-930R	GA-890R	GP-78		
4700 SCD	VT365		GA-930R	GA-890R	G-862		
4700 SCD 444	DT444	GP-562	GA-930R	GA-890R	G-862	GP-2071W	
530E	DT530	GP-152	GA-209	GA-210	GP-78	GP-2071W	
9200i, 9400i	CUMMINS ISM	GP-9000 ó GP-9001	GA-682R	GA-683R	GPP-10035 ó GPP-10225	GP-2071W	
9200i, 9400i	CUMMINS ISX	GP-9000 ó GP-9001	GA-682R	GA-683R	GPP-10035 ó GPP-10225	GP-2071W	
9400i	CATERPILLAR C15	GP-52, GP-57 (BY-PASS)	GA-682R	GA-683R	GP-749		
CF500, CF600	VT275		GA-770R		G-1047		
DAY CAB	CUMMINS ISM 330	GP-9000 ó GP-9001	GA-682R	GA-683R	GPP-10075		
DAY CAB	DETROIT DIESEL SERIES 60	GP-193	GA-682R	GA-683R	GP-26 Y GP-27, G-128 ó S3202		
SERIE 4300	DT466	GP-691			GP-78		
SERIE 4400	DT466	GP-691			GP-78		
SERIE 7400	DT530	GP-152			GP-78		
SERIE 9200	CUMMINS ISM 370	GP-9001					
SERIE 9400	CUMMINS N14				GPP-1000		
TRAVELER	DT466				GP-78	GP-2071W	
IRIZAR							
CENTURY (2005)	SCANIA DC 9 03 (EURO 3) 300 HP	GP-171	GA-436		GP-1122	GP-1011Q, GP-1012Q	G-162H
CENTURY K 114 IB	SCANIA D5C12	GP-5					
CENTURY K 124 IB	SCANIA D5C12	GP-51					
ECO POWER	MERCEDES BENZ OM906LA	G-3754	GA-682R	GA-683R	G-1046, GPP-1287, R 60P		G-162H
ISUZU							
ELF 250	4HK1				GPP-111 ó GPP-524		
ELF 300	L4 3.0L (4UJ1-TC)	G-3753	GA-633R		G-179		
ELF 400/450	4HK1-TC	GP-359	GA-633R		GPP-111 ó GPP-524		
KENWORTH							
KW45 y KW55 (2005-07)	MOTOR PACCAR 4 Y 6 CIL	GP-737					
T300 (C7) (2002-2007)	CUMMINS ISB 5.9L 185-260 HP.	GP-3937	GA-197R	GA-768R	GPP-10225, G-1261	GP-2071W	
T300 (C7) (2002-2007)	CUMMINS ISC 5.9L 225-315 HP.	GP-3000, GP-3001	GA-197R	GA-768R	GPP-10225	GP-2071W	
T300 (C7) (2002-2007)	CATERPILLAR 3126 190-250 HP.	GP-51	GA-197R	GA-768R	GP-1108, GP-1109		
T300 (C7) (2002-2007)	CUMMINS L10 (1995-1999)	GP-53, GP-57	GA-3551, GA-596		GP-11, GPP-11, GPP-103		
T450 6x2, 6x4 (C7) (2000-2005)	CUMMINS C8.3 L 250HP	GP-3937	GA-197R	GA-768R	GPP-10225	GP-2071W	
T450 6x2, 6x4 (C7) (2000-2005)	CUMMINS L10-300HP	GP-53, GP-57	GA-3551, GA-596		GP-11, GPP-11, GPP-103		
T450 6x2, 6x4 (C7) (2000-2005)	CATERPILLAR 3306 305 HP	GP-51	GA-3551, GA-596		GP-110		
T600, T600A, T600B (2000-2005)	CUMMINS ISM 330 HP.	GP-9000, GP-9001	GA-3551		GPP-10035		

UNIDAD	MOTOR	ACEITE	AIRE PRIMARIO	AIRE SECUNDARIO	COMBUSTIBLE	AGUA	HIDRAULICO
UNIT	ENGINE	OIL	AIR PRIMARY	SECONDARY	FUEL	WATER	HYDRAULIC
KENWORTH							
T600, T600A, T600B (2000-2005)	CUMMINS ISX 400-450 HP.	GP-9000, GP-9001	GA-389		GPP-10075		
T600, T600A, T600B (2000-2005)	CUMMINS M 11 310-400HP.	GP-3000, GP-3001	GA-3551		GPP-11 (HASTA 1995), GPP-1000 (1995 EN ADELANTE)		
T600, T600A, T600B (2000-2005)	CUMMINS N-14 410-435 HP.	GP-3000, GP-3001	GA-378		GPP-11 (HASTA 1995), GPP-1000 (1995 EN ADELANTE)	GP-2071W	
T600, T600A, T600B (2000-2005)	CATERPILLAR C-10 (10.3 L)	GP-52, GP-691, GP-57	GA-3551		GP-749	GP-1010Q	
T600, T600A, T600B (2000-2005)	CATERPILLAR C-12 (12.0 L)	GP-52, GP-691, GP-57	GA-3551		GP-749	GP-1010Q	
T600, T600A, T600B (2000-2005)	CATERPILLAR C-15 (14.6 L)	GP-52, GP-691, GP-57	GA-3551		GP-110		
T600, T600A, T600B (2000-2005)	CATERPILLAR 3306 (1994-1999)	GP-51			GP-749	GP-1010Q	
T600, T600A, T600B (2000-2005)	CATERPILLAR 3406 E (1994-1999)	GP-52, GP-691	GA-3551		GP-26, GP-27	GP-2071W	
T600, T600A, T600B (2000-2005)	DETROIT DIESEL SERIE 60 365-	GP-193	GA-378		GPP-10075		
T604	CUMMINS SINGATURE 600	GP-9000 ó GP-9001		GA-435R	GPP-10075		
T800 (1999-2005)	CUMMINS ISM 310, 330, 410 HP.	GP-9000, GP-9001	GA-3551		GPP-10035		
T800 (1999-2005)	CUMMINS ISX 400-450HP.	GP-9000, GP-9001	GA-3551		GPP-10075		
T800 (1999-2005)	CUMMINS N-14 330 , 370-435E HP.	GP-3000, GP-3001	GA-3551		GPP-11 (HASTA 1995), GPP-1000 (1995 EN ADELANTE)	GP-2071W	
T800 (1999-2005)	CATERPILLAR 3406E (1994-2005)	GP-52, GP-691	GA-930R		GP-749	GP-1010Q	
T800 (1999-2005)	CATERPILLAR C-12 (12.0 L)	GP-52, GP-691, GP-57	GA-389		GP-749	GP-1010Q	
T800 (1999-2005)	CATERPILLAR C-15 (14.6 L)	GP-52, GP-691, GP-57	GA-389		GP-749	GP-1010Q	
T800 (1999-2005)	DETROIT DIESEL SERIE 60	GP-193	GA-378		GP-26, GP-27	GP-2071W	
T800 (1999-2005)	DETROIT DIESEL SERIE 50 DDEC4	GP-193	GA-378		GP-26, GP-27, S-3202 P		
T2000 (1999-2007)	CUMMINS N-14 435 E+98 435 HP	GP-3000, GP-3001	GA-930R		GPP-11 (HASTA 1995), GPP-1000 (1995 EN ADELANTE)	GP-2071W	
T2000 (1999-2007)	CUMMINS M-11 350, 400 HP	GP-3000, GP-3001			GPP-11 (HASTA 1995), GPP-1000 (1995 EN ADELANTE)		
T2000 (1999-2007)	CATERPILLAR C-12 (12.0 L)	GP-52, GP-691, GP-57	GA-930R		GP-749	GP-1010Q	
T2000 (1999-2007)	CATERPILLAR 3406 (1999-2005)	GP-52, GP-691	GA-930R		GP-749	GP-1010Q	
T2000 (1999-2007)	DETROIT DIESEL DECCA SERIE 60	GP-193			GP-26	GP-2071W	
W900 (2000-2007)	CUMMINS N-14 E+460HP.	GP-3000, GP-3001	GA-378		GPP-11 (HASTA 1995), GPP-1000 (1995 EN ADELANTE)	GP-2071W	
W900 (2000-2007)	CUMMINS ISM 310, 330, 410 HP.	GP-9000, GP-9001			GPP-10035		
W900 (2000-2007)	CUMMINS ISX 400-450HP.	GP-9000, GP-9001	GA-3551		GPP-10075		
W900 (2000-2007)	CATERPILLAR C-12 (12.0 L)	GP-52, GP-691, GP-57	GA-3551		GP-749	GP-1010Q	
W900 (2000-2007)	CATERPILLAR C-15 (14.6 L)	GP-52, GP-691			GP-749	GP-1010Q	
W900 (2000-2007)	DETROIT DIESEL SERIE 60 DDEC4	GP-193 (2 PZAS)	GA-378		GP-26, GP-27	GP-2071W	
MACK							
CONSTRUCCIÓN RD 688S	MACK E7 350-E-TECH (12 L)	GP-51	GA-695		GP-83, GP-84	GP-2022W	
CONSTRUCCIÓN RD 690 S, MR 688 S, CV 713	MACK EM7-300-E TECH (12 L) 300HP.	GP-51	GA-229		GP-83, GP-85	GP-2022W	
TRACTOCAMIONES CH DAY CAB, CH SELECT, CH ELITE, CH PREMIUM, CX VISIÓN,	MACK E7 427-E-TECH (12 L) 427 HP.	GP-51	GA-695			GP-2022W	
MAN							
SERIE 18.3.10	D2866 LOH24		GA-467		GPP-1122		
SERIE 18.4.60	D2876 LOH		GA-467		GPP-1122		

UNIDAD	MOTOR	ACEITE	AIRE PRIMARIO	AIRE SECUNDARIO	COMBUSTIBLE	AGUA	HIDRAULICO
UNIT	ENGINE	OIL	AIR PRIMARY	SECONDARY	FUEL	WATER	HYDRAULIC
MERCEDES-BENZ							
1833-CP	OM926	G-3754			G-1046		G-162H
ALLEGRO	OM906	G-3754	GA-682R	GA-683R	G-1046		G-162H
ANDARE 1628	OM906	G-3754	GA-904R	GA-905R	G-1046, GPP-1060, GPP-1061		G-162H
ANDARE 1728	OM906LA	G-3754	GA-904R	GA-905R	G-1046, GPP-1060, GPP-1061		G-162H
BOXER	OM904	G-3827	GA-904R	GA-905R	G-1046		G-162H
FL-106	DDC 50	GP-193			GP-26, S3202		
FL-112	CUMMINS M11	GP-3000			GP-1101, GPP-1000		
FL-60	CUMMINS ISB	GP-3001					
FL-70	CUMMINS ISB	GP-3001					
FL-80	CUMMINS ISC	GP-3000					
FL-80	CUMMINS ISC	GP-3000					
FLD-112	CUMMINS M11	GP-3000			GP-1101, GPP-1000		
FLD-120	CATERPILLAR 3406	GP-691			GP-749		
FLD-120	CUMMINS N14	GP-3000			GP-1101		
FLD-120 CL	DDC 60	GP-193			GP-26, S3202		
L-1200/39	OM904LA	G-3827	GA-904R	GA-905R	G-1046		G-162H
L-1200/52, L-1400/52, L-1400/59	OM904LA	G-3827	GA-904R	GA-905R	G-1046		G-162H
LK-1400/34, LK-1300/34	OM904LA	G-3827	GA-904R	GA-905R	G-1046		G-162H
M2 33K 4X2 IMPORTADO	MBE 900-1	G-3754			G-1046		
MB 01000/44 OF MBO 1019/44	OM904LA	G-3827	GA-904R	GA-905R	G-1046		G-162H
MB 01200/52 OF MBO 1219/52	OM904LA	G-3827	GA-904R	GA-905R	G-1046		G-162H
MB 01400/60 OF MBO 1419/60	OM904LA	G-3827	GA-904R	GA-905R	G-1046		G-162H
MB 01600/70 OF	OM906LA	G-3754			G-1046		G-162H
MP105/MP120 NACIONAL	OM457LA		GA-682R	GA-683R			G-162H
MULTÉGO	OM460LA		GA-467				G-162H
O400	OM457LA						G-162H
OMC 1400/51	OM906LA	G-3754			G-1046		G-162H
SPRINTER OM612	OM612	G-918	GA-475		GPP-612		G-162H
SPRINTER OM646	OM646	G-918					
SPRINTER OM647	OM647	G-918	GA-475				
TORINO	OM906	G-3754	GA-906R		G-1046		G-162H
SCANIA							
CONSTRUCCIÓN P114 C B 6X4 NA 340 (2003-04)	DC 11 340 (INTERCOOLER) 6 Cil. 11.0L 340 HP.	GP-51				GP-1011Q, GP-1012Q	G-162H
AUTOBUS INTEGRAL K 114 IB 4X2 BUSSCAR, TURIBUSS, K 1141 B-4X2 NB, K 114 IB 4X2 IRIZAR (2003-04)	DC 11 06-340 (INTERCOOLER) 6Cil.-11.0L 340 HP.					GP-1011Q, GP-1012Q	G-162
AUTOBUS INTEGRAL K 124 IB 4X2 NB, K 124 IB 4X2 IRIZAR, VISSITA, K 124 IB 6X2 NB, K 124 IB 6X2 BUSSCAR, Y DOT, K124 IB 4X2 BUSSCAR, K 124 IB 6X2 IRIZAR, (2003-04)	DC 1202-400 6Cil.-12.0 L (INTER-COOLER) 400 HP	GP-51				GP-1011Q, GP-1012Q	G-162H
AUTOBUS K94 IB 4X2 NB 300 HP CAMPIONE, (2003-04)	DC 9 03-300 (INTERCOOLER) 6 Cil. 9.0 L	GP-171	GA-436		GP-1122 (2 PZAS.)	GP-1011Q, GP-1012Q	G-162H
CAMION DE CARGA (C 7) P 94 DB 4X2 NA 220, (2003-04)	MOTOR SCANIA D5C 9 11 6Cil. 5.48L 120 HP.	GP-51				GP-1011Q, GP-1012Q	G-162H

UNIDAD	MOTOR	ACEITE	AIRE PRIMARIO	AIRE SECUNDARIO	COMBUSTIBLE	AGUA	HIDRAULICO
UNIT	ENGINE	OIL	AIR PRIMARY	SECONDARY	FUEL	WATER	HYDRAULIC
SCANIA							
CAMION DE CARGA (C 8) P 340 CB 6x4 NA / NZ (2000-2005)	DC11.06 (6L-11L)	GP-171					G-162H
CAMION DE CARGA (C 8) P 400 CB 8x4 NZ (2000-2005)	DC-1202 (6L-12 L) 400 HP	GP-51				GP-1011Q, GP-1012Q	G-162H
CAMION DE CARGA (C 8) P 94 DB 6x2 NA 260. (2003-04)	DSC 9 12 6 CIL. 9.0L 260 HP.	GP-51	GA-436		GP-112Z (2 PZAS.)	GP-1011Q, GP-1012Q	G-162H
K 300 IB 4x2 NB (2000-2005)	DC11.06 6L-11.0 L 340HP	GP-51				GP-1011Q, GP-1012Q	G-162H
K 300 IB 4x2 NB (2000-2005)	DC9 03 (EUROIII) 260 HP	GP-171	GA-436		GP-112Z (2 PZAS.)	GP-1011Q, GP-1012Q	G-162H
K 340 UB 4x2 LB TURÍSTICO (2000-2005)	DC 11.06 6L-11.0 L 340 HP	GP-51				GP-1011Q, GP-1012Q	G-162H
K 400 IB 4x2 / 6x2 NB (2000-2005)	DC 12.02 6L-12.0 L 400 HP	GP-51				GP-1011Q, GP-1012Q	G-162H
K114 IB	DC11.06	GP-51					G-162H
K114 UB	DC11.06	GP-51					G-162H
K124 IB 4x2 NB400	DSC12.02	GP-51					G-162H
K400 IB 4x2 NB	DSC12.02	GP-51					G-162H
L-260 URBANO15 mts. (2000-2005)	DC9 12 (EUROIII) 6 Cil. 9.0 L 260 HP	GP-171	GA-436		GP-112Z (2 PZAS.)	GP-1011Q, GP-1012Q	G-162H
L-300 IA / UA 6x2 ARTICULADO (2000-2005)	DC9 03 (EUROIII) 260 HP	GP-171	GA-436		GP-112Z (2 PZAS.)	GP-1011Q, GP-1012Q	G-162H
TRACTOCAMIÓN LA 6 X 4 NA (2003-04)	DC-12 6CIL. 400HP.	GP-51				GP-1011Q, GP-1012Q	G-162H
TRACTOCAMIÓN R 124 GA 4x2 Y 6x2 NA 400, R114 LA 4x2NA 340, T 124 LA 6x4 NA 400, (2003-04)	DC-1202 6CIL 400HP.	GP-51				GP-1011Q, GP-1012Q	G-162H
TRACTOCAMIÓN R 340 LA 4x2 NA (2000-2005)	DC 11.06 6L-11L 340 HP.	GP-171					G-162H
TRACTOCAMIÓN R 400 GA 6x4 NA (2000-2005)	DC 12.02 6L-12L 400 HP	GP-51				GP-1011Q, GP-1012Q	G-162H
TRACTOCAMIÓN R 480 GA 6x4 NA (2000-2005)	DC 16 08 6L-12L 480HP.						G-162H
TRACTOCAMIÓN T 400 GA (LA) 6x4 NA (2000-2005)	DC 12.02 6L-12L 400 HP	GP-51					G-162H
STERLING							
A 9500	DDC 60	GP-193			GP-26, S3202		
ACTERRA M6500	MBE 900 4.3L	G-3754			G-1046		
CAMIONES DE CARGA L9500(C7), TRACTOCAMION LT-9500 (2000-2005)	CATERPILLAR 3406 E 355,375,435 HP.	GP-52, GP-691					G-162H
CAMIONES DE CARGA L9500(C7), TRACTOCAMION LT-9500 (2000-2005)	CATERPILLAR C-10 (10.3 L) ; 305, 335, 350, 370 HP.	GP-52, GP-57 (BY PASS)	GA-682R	GA-683R	GP-749, GP-110		G-162H
CAMIONES DE CARGA L9500(C7), TRACTOCAMION LT-9500 (2000-2005)	CATERPILLAR C-12 (12.0 L) ; 355, 380, 395, 410, 430 HP.	GP-52, GP-57 (BY PASS)	GA-682R	GA-683R	GP-749, GP-110		G-162H
CAMIONES DE CARGA L9500(C7), TRACTOCAMION LT-9500 (2000-2005)	CATERPILLAR C-15 (14.6 L) ; 375, 435, 455, 475, 500 HP.	GP-52, GP-691			GP-749, GP-110		G-162H
CAMIONES DE CARGA L9500(C7), TRACTOCAMION LT-9500 (2000-2005)	CATERPILLAR C-16 (15.8 L) ; 575, 600 HP.	GP-52, GP-691			GP-749, GP-110		G-162H

UNIDAD UNIT	MOTOR ENGINE	ACEITE OIL	AIRE		COMBUSTIBLE FUEL	AGUA WATER	HIDRAULICO HYDRAULIC
			PRIMARIO AIR PRIMARY	SECUNDARIO AIR SECONDARY			
STERLING							
CAMIONES DE CARGA L 9500 (C7), TRACTOCAMION LT-9500 (2000-2005)	CUMMINS I S L. 310,330 HP.	GP-3000	GA-682R	GA-683R			G-162H
CAMIONES DE CARGA L 9500 (C7), TRACTOCAMION LT-9500 (2000-2005)	CUMMINS I S M 280,310,330,350,370, 400,425 HP.	GP-9000, GP-9001	GA-682R	GA-683R	GPP-1003S		G-162H
CAMIONES DE CARGA L 9500 (C7), TRACTOCAMION LT-9500 (2000-2005)	CUMMINS I S X; 400,450,475,500,565,600 HP.	GP-9000, GP-9001	GA-682R	GA-683R			G-162H
CAMIONES DE CARGA L 9500 (C7), TRACTOCAMION LT-9500 (2000-2005)	CUMMINS N-14 350,370,435,460,500,525 HP.	GP-3000					G-162H
CAMIONES DE CARGA L 9500 (C7), TRACTOCAMION LT-9500 (2000-2005)	CUMMINS SINGATURE 600.	GP-9000, GP-9001	GA-682R	GA-683R	GP-1007S		G-162H
CAMIONES DE CARGA L 9500 (C7), TRACTOCAMION LT-9500 (2000-2005)	DETROIT DIESEL SERIE 60 11 L. 330,350, 12.7: 370, 430, 430, 470,500 HP.	GP-193	GA-682R	GA-683R	GP-26		G-162H
CAMIONES DE CARGA L 9500 (C7), TRACTOCAMION LT-9500 (2000-2005)	MBE 4000 350 a 450HP.		GA-682R	GA-683R	GPP-1287, S 3226 P		G-162H
CAMIONES DE CARGA M 5500 (C5), M6500 (C6), M7500 (C7), (2000-2005), M 8500 (C8), L 7500 (7), LT 7500 (8)	CATERPILLAR 3126 B (7.2 L) 175, 190, 210, 230, 250, 275, 300 HP.	GP-51	GA-197R	GA-768R	GP-1109, GP-62	GP-1011Q, GP-1012Q	G-162H
CAMIONES DE CARGA M 5500 (C5), M6500 (C6), M7500 (C7), (2000-2005), M 8500 (C8), L 7500 (7), LT 7500 (8)	CATERPILLAR C-7 190, 210, 230, 250, 275, 300 HP	GP-51	GA-197R	GA-768R	GP-1109, GP-62	GP-1011Q, GP-1012Q	G-162H
CAMIONES DE CARGA M 5500 (C5), M6500 (C6), M7500 (C7), (2000-2005), M 8500 (C8), L 7500 (7), LT 7500 (8)	CUMMINS I S B 5.9L 185,190,205,210,225,240, 245, 260 HP.	GP-3937, HD3970	GA-930R, GA-197R	GA-890R, GA-768R	GPP-519, GS-1261	GS-1261	G-162H
CAMIONES DE CARGA M 5500 (C5), M6500 (C6), M7500 (C7), (2000-2005), M 8500 (C8), L 7500 (7), LT 7500 (8)	CUMMINS I S C 225, 240, 260, 285, 300, 315 HP.	GP-3000	GA-197R	GA-768R	GPP-1022S	GP-2071W	G-162H
CAMIONES DE CARGA M 5500 (C5), M6500 (C6), M7500 (C7), (2000-2005), M 8500 (C8), L 7500 (7), LT 7500 (8)	MERCEDES BENZ MBE 900 170,190,210,230,250,260,280 .HP.	G-3754	GA-197R	GA-768R	G-1046		G-162H
TRACTOCAMIÓN AT 9500 (2000-2005)	CATERPILLAR C-10 (10.3 L); 305, 335, 350, 370 HP.	GP-52, GP-57 (BY PASS)	GA-682R	GA-683R	GP-749, GP-110 CORTO		G-162H
TRACTOCAMIÓN AT 9500 (2000-2005)	CATERPILLAR C-12 (12.0 L); 355, 380, 395, 410, 430 HP.	GP-52, GP-57 (BY PASS)	GA-682R	GA-683R	GP-749, GP-110 CORTO		G-162H
TRACTOCAMIÓN AT 9500 (2000-2005)	CATERPILLAR C-15 (14.6 L); 355, 375, 435, 455, 475, 500 HP.	GP-52, GP-691			GP-749, GP-110 CORTO		G-162H
TRACTOCAMIÓN AT 9500 (2000-2005)	CATERPILLAR C-9 (8.8L)	GP-52, GP-691	GA-682R	GA-683R	GP-1109, GP-62		G-162H
TRACTOCAMIÓN AT 9500 (2000-2005)	CUMMINS I S L. 310,330 HP.	GP-3000	GA-682R	GA-683R			G-162H
TRACTOCAMIÓN AT 9500 (2000-2005)	CUMMINS I S M 280,310,330,350,370, 400,425 HP.	GP-9000, GP-9001	GA-682R	GA-683R	GPP-1003S		G-162H
TRACTOCAMIÓN AT 9500 (2000-2005)	DETROIT DIESEL SERIE 60 11 L. 430, 470, 500 HP.	GP-193	GA-682R	GA-683R	GP-26 Y GP-27		G-162H

UNIDAD	MOTOR	ACEITE	AIRE PRIMARIO	AIRE SECUNDARIO	COMBUSTIBLE	AGUA	HIDRAULICO
UNIT	ENGINE	OIL	AIR PRIMARY	SECONDARY	FUEL	WATER	HYDRAULIC
STERLING							
TRACTOCAMIÓN AT 9500 (2000-2005)	MBE 4000 350 a 450HP.		GA-682R	GA-683R	GPP-1287, S 3226 P		G-162H
TRACTOCAMIÓN ST 9500	CATERPILLAR 3406E 355, 375, 435, 455, 475, HP.	GP-52, GP-691					G-162H
TRACTOCAMIÓN ST 9500	CUMMINS N-14 : 350, 370, 435, 460, 500, 525 HP.	GP-3000			GPP-1000		G-162H
TRACTOCAMIÓN ST 9500	DETROIT DIESEL SERIE 60 11 L. 430, 470, 500 HP.	GP-193			GP-26 Y GP-27		G-162H
VOLKSWAGEN							
VW 15-190	CUMMINS 5.9	GP-178	GA-864R				G-162H
VW 17-210 E	MWM 6.12 TCE		GA-864R				G-162H
VW 17-250	CUMMINS 5.9	GP-737	GA-864R				G-162H
VW 24-250	CUMMINS 5.9	GP-737	GA-864R				G-162H
VW 8-150 FEB	CUMMINS 5.9		GA-8150				G-162H
VOLVO							
AUTOBUS 9700 (2003-06)	VOLVO DH 12 420, (6L-12 L) 425 HP	GP-51					
AUTOBUS B 12 MA ARTICULADO (2006)	VOLVO DH 12 D 340, (6L-12 L) 420 HP	GP-51					
AUTOBUS INTEGRAL 7550 2 EJES (2002-04)	ELECTRÓNICO VOLVO D 12B 385, 385 HP.	GP-51, GP-556					
AUTOBUS INTEGRAL 7550 2 EJES (2003-04)	ELECTRÓNICO VOLVO D 12B 425, 425 HP. (EPA 99)	GP-51					
AUTOBUS INTEGRAL C 11 R (2002-05)	CUMMINS ISB 5.9 260 (EPA 2000) 260 HP.	GP-3937	GA-197R	GA-768R	GPP-103		
AUTOBUS INTEGRAL C 12 R (2002-04)	CUMMINS ISC 300 (EPA 2000) 300 HP.	GP-3000	GA-197R	GA-768R	GPP 1022S		G-162H
C-11-R	CUMMINS ISB	GP-3001					
CAMIÓN DE CARGA (C 7) VL 42 R (4.7 TON), VLH42R (6.1 TON), VLH 42R (7.5 TON), (C 8) VLE 64 (2000-2005)	MOTOR VOLVO D 68 6L-5.48L	GP-51, GP-556	GA-435R		GP-96	GP-2126W, GP-2127W	
CHASIS PARA PASAJE C 11 (2002-04)	CUMMINS ISB 5.9 225 HP.	GP-3937	GA-197R	GA-768R	GPP-103		
CONSTRUCCIÓN V H D, VHD 64 B Y F. (2002-05)	CUMMINS ISM 305 HASTA 425 HP.	GP-9000, GP-9001	GA-435R		GPP-1003S		
CONSTRUCCIÓN V H D, VHD 64 B Y F. (2002-05)	VOLVO VED 12 345, 345 HP.	GP-556	GA-435R		GP-96	GP-2108W	
CONSTRUCCIÓN V H D, VHD 64 B Y F. (2002-05)	VOLVO VED 12 385, 425 HP.						
NE64 VOLVO	CUMMINS M11	GP-3000			GP-1101, GPP-1000		
NE64T	CUMMINS M11	GP-3000			GP-1101, GPP-1000		
NR64T VOLVO	CUMMINS M11	GP-3000			GP-1101, GPP-1000		
NR64T VOLVO R44	CUMMINS M11	GP-3000			GP-1101, GPP-1000		
TRACTOCAMIÓN VNL 64 T 420 TÍPICO, VNL 64 T 420 ESTÁNDAR, VNL 64 T DAY CAB, VNL 64 T 430, VNL 64 T 630, VNL 64 T 670, VN (2002-05)	CUMMINS ISM ; 280-425 HP.	GP-9000, GP-9001	GA-435R		GPP-1003S		

UNIDAD	MOTOR	ACEITE	AIRE PRIMARIO	AIRE SECUNDARIO	COMBUSTIBLE	AGUA	HIDRAULICO
UNIT	ENGINE	OIL	AIR PRIMARY	SECONDARY	FUEL	WATER	HYDRAULIC
VOLVO							
TRACTOCAMIÓN VNL 64 T 420 TÍPICO, VNL 64 T 420 ESTÁNDAR, VNL 64 T DAY CAB, VNL 64 T 430, VNL 64 T 630, VNL 64 T 670, VN (2002-05)	CUMMINS ISX ; 400,450,475,500,565,600 HP.	GP-9000, GP-9001	GA-435R			GP-2126W, GP-2127W	
TRACTOCAMIÓN VNL 64 T 420 TÍPICO, VNL 64 T 420 ESTÁNDAR, VNL 64 T DAY CAB, VNL 64 T 430, VNL 64 T 630, VNL 64 T 670, VN (2002-05)	CUMMINS N 14 ; 350,370,410,435,460,500,525 HP.	GP-3000, GP-3001	GA-435R		GPP-1291, GPP-1000, R90P	GP-2071W	
TRACTOCAMIÓN VNL 64 T 420 TÍPICO, VNL 64 T 420 ESTÁNDAR, VNL 64 T DAY CAB, VNL 64 T 430, VNL 64 T 630, VNL 64 T 670, VN (2002-05)	CUMMINS SINGATURE 600	GP-9000, GP-9001	GA-435R		GPP-1007S		
TRACTOCAMIÓN VNL 64 T 420 TÍPICO, VNL 64 T 420 ESTÁNDAR, VNL 64 T DAY CAB, VNL 64 T 430, VNL 64 T 630, VNL 64 T 670, VN (2002-05)	VOLVO VED 12 345 a 465 HP	GP-51, GP-556	GA-435R		GP-96	GP-2108W	
TRACTOCAMIÓN VNL 64 T 660 (2002-04)	DETROIT DIESEL SERIE 60. 330, 370, 400, 470 HP.	GP-193	GA-438		GP-26	GP-1010Q	
VHD 6X4	VED12	GP-51, GP556					
VNL64T 420	VED12	GP-51, GP-556					
VOLVO 7350	D7C	GP-51, GP-556			GP-96		G-162H
VOLVO 7550	N12	GP-51, GP-556			GP-96		G-162H
VOLVO 8300	DH12	GP-51, GP-556			GP-96		G-162H
VOLVO 9300	D9A	GP-51, GP-556					
VOLVO 9700	DH12	GP-51, GP-556			GP-96		G-162H

Aplicaciones Automotriz

Automotive Applications

Modelo	Marca	Modelo	Marca	Modelo	Marca	Modelo	Marca
Model	Make	Model	Make	Model	Make	Model	Make
1		5		C			
100.....	AUDI	500 SERIES.....	BMW	ALBEA.....	FIAT	C SERIES.....	CHEVROLET
100 SERIES.....	BMW	5000.....	AUDI	ALERO.....	OLDSMOBILE	C SERIES.....	MERCEDES BENZ
1000 SERIES.....	IHC	505.....	PEUGEOT	ALHAMBRA.....	SEAT	C30.....	VOLVO
1000D.....	IHC	510.....	NISSAN	ALL TRAC.....	TOYOTA	C70.....	VOLVO
1010.....	IHC	521.....	NISSAN	ALLIANCE.....	AMERICAN MOTORS	CABALLERO.....	GMC
1100 SERIES.....	IHC	540 SERIES.....	VOLVO	ALLIANCE.....	RENAULT	CABRIO.....	SMART
1100D.....	IHC	550 BARCHETTA PININFARINA.....	FERRARI	ALROAD.....	AUDI	CABRIO.....	VOLKSWAGEN
1110.....	IHC	550 MARANELLO.....	FERRARI	ALLURE.....	BUICK	CABRIOLET.....	AUDI
120 SERIES.....	VOLVO	57.....	MAYBACH	ALMERA.....	NISSAN	CABRIOLET.....	VOLKSWAGEN
1200 SERIES.....	IHC	575 MARANELLO.....	FERRARI	ALPINA B7.....	BMW	CABSTAR.....	NISSAN
1200D.....	IHC	575.....	MAYBACH	ALTEA.....	SEAT	CALAIS.....	CADILLAC
1210.....	IHC	599 GTB FIORANO.....	FERRARI	ALTIMA.....	NISSAN	CALIBER.....	DODGE
1300 SERIES.....	IHC	6		ALTIMA HYBRID.....	NISSAN	CALIENTE.....	MERCURY
1300D.....	IHC	600 "K".....	CHRYSLER	AMANTI.....	KIA	CALIFORNIA.....	FERRARI
1310.....	IHC	600 "K".....	DODGE	AMBASSADOR.....	AMERICAN MOTORS	CAMARO.....	CHEVROLET
140 SERIES.....	VOLVO	600 SERIES.....	BMW	AMERICAN.....	AMERICAN MOTORS	CAMION.....	CHEVROLET
147.....	ALFA ROMEO	6000.....	PONTIAC	AMIGO.....	ISUZU	CAMRY.....	TOYOTA
150.....	DODGE	607.....	PEUGEOT	AMX.....	AMERICAN MOTORS	CAMRY HYBRID.....	TOYOTA
1500 S.....	HONDA	612.....	FERRARI	ARMA.....	NISSAN	CANYON.....	GMC
156.....	ALFA ROMEO	616.....	MAZDA	ARNAGE.....	BENTLEY	CAPRICE.....	CHEVROLET
160 SERIES.....	VOLVO	618.....	MAZDA	ARROW.....	PLYMOUTH	CAPTIVA.....	CHEVROLET
1600.....	SUBARU	62.....	MAYBACH	ASCENDER.....	ISUZU	CARAVAN.....	DODGE
164.....	ALFA ROMEO	620.....	NISSAN	ASPEN.....	CHRYSLER	CARAVELLE.....	PLYMOUTH
166.....	ALFA ROMEO	626.....	MAZDA	ASPEN HYBRID.....	CHRYSLER	CARAVELLE.....	RENAULT
180.....	MERCEDES BENZ	626-4.....	MAZDA	ASTRA.....	CHEVROLET	CARIBE.....	VOLKSWAGEN
1800.....	SUBARU	625.....	MAYBACH	ASTRE.....	PONTIAC	CATALINA.....	PONTIAC
1800 SERIES.....	VOLVO	7		ASTRO.....	CHEVROLET	CATERA.....	CADILLAC
180D.....	MERCEDES BENZ	700 SERIES.....	BMW	ASUNA (CANADA).....	PONTIAC	CAVALIER.....	CHEVROLET
190.....	MERCEDES BENZ	720.....	NISSAN	ASUNA SUNFIRE.....	PONTIAC	CAVALIER Z-24.....	CHEVROLET
190D.....	MERCEDES BENZ	740 SERIES.....	VOLVO	ASUNA SUNRUNNER (CANADA).....	PONTIAC	CAYENNE.....	PORSCHE
2		75.....	ROVER	ATLANTIC.....	VOLKSWAGEN	CAYENNE HYBRID.....	PORSCHE
200.....	AUDI	760 SERIES.....	VOLVO	ATOS BY DODGE.....	DODGE	CAYMAN.....	PORSCHE
2000.....	ALFA ROMEO	780 SERIES.....	VOLVO	ATTITUDE.....	DODGE	CC.....	VOLKSWAGEN
2000.....	PONTIAC	8		AURA.....	SATURN	CELEBRITY.....	CHEVROLET
2000 GTX.....	DODGE	80.....	AUDI	AURORA.....	OLDSMOBILE	CELICA.....	TOYOTA
2000GTX.....	EAGLE	800 SERIES.....	BMW	AUTOMOVILES.....	HYUNDAI	CENTURION.....	BUICK
2002.....	BMW	808.....	MAZDA	AVALANCHE.....	CHEVROLET	CENTURY.....	BUICK
2005X.....	NISSAN	819.....	NISSAN	AVALON.....	TOYOTA	CHALLENGER.....	DODGE
206.....	PEUGEOT	825.....	STERLING	AVANZA.....	TOYOTA	CHARADE.....	DAIHATSU
207.....	PEUGEOT	827.....	STERLING	AVENGER.....	DODGE	CHARGER.....	DODGE
210.....	NISSAN	850 SERIES.....	VOLVO	AVEO.....	CHEVROLET	CHEROKEE.....	JEEP
220.....	MERCEDES BENZ	8C COMPETIZIONE.....	ALFA ROMEO	AVIATOR.....	LINCOLN	CHEVELLE.....	CHEVROLET
240 SERIES.....	VOLVO	9		AZERA.....	HYUNDAI	CHEVETTE.....	CHEVROLET
240SX.....	NISSAN	90.....	AUDI	AZTEK.....	PONTIAC	CHEVY.....	CHEVROLET
250.....	DODGE	900.....	SAAB	AZURE.....	BENTLEY	CHEVY C2.....	CHEVROLET
250.....	MERCEDES BENZ	9000.....	SAAB	B		CHEVY MONZA.....	CHEVROLET
260 SERIES.....	VOLVO	9005.....	SAAB	B SERIES.....	MERCEDES BENZ	CHEVY PICK-UP.....	CHEVROLET
280.....	MERCEDES BENZ	9005.....	SAAB	B100.....	DODGE	CHEVY VAN.....	CHEVROLET
3		9005E.....	SAAB	B150.....	DODGE	CHEVY VAN C-20.....	CHEVROLET
300.....	CHRYSLER	9088.....	IHC	B-1600.....	MAZDA	CHEYENNE.....	CHEVROLET
300 SERIES.....	BMW	908C.....	IHC	B-1800.....	MAZDA	CIERA.....	OLDSMOBILE
3000.....	MITSUBISHI	911.....	PORSCHE	B200.....	FORD	CIMARRON.....	CADILLAC
3000 MARK I.....	AUSTIN-HEALEY	912.....	PORSCHE	B-2000.....	MAZDA	CIRRUS.....	CHRYSLER
300C.....	CHRYSLER	928.....	PORSCHE	B-2200.....	MAZDA	CITATION.....	CHEVROLET
300M.....	CHRYSLER	929.....	MAZDA	B-2300.....	MAZDA	CIVIC.....	HONDA
300ZX.....	NISSAN	9-2X.....	SAAB	B250.....	DODGE	CIVIC HYBRID.....	HONDA
306.....	PEUGEOT	9-3.....	SAAB	B-2500.....	MAZDA	CJ SERIES.....	JEEP
307.....	PEUGEOT	930.....	PORSCHE	B-2600.....	MAZDA	CL.....	ACURA
308.....	PEUGEOT	940 SERIES.....	VOLVO	B-3000.....	MAZDA	CL SERIES.....	MERCEDES BENZ
323.....	MAZDA	9-4X.....	SAAB	B350.....	DODGE	CLASSIC.....	AMERICAN MOTORS
330.....	DODGE	9-5.....	SAAB	B-4000.....	MAZDA	CLASSIC.....	VAM
350Z.....	NISSAN	960 SERIES.....	VOLVO	B-800.....	FORD	CLIO.....	RENAULT
360 MODENA.....	FERRARI	9-7X.....	SAAB	BAJA.....	SUBARU	CLK SERIES.....	MERCEDES BENZ
370Z.....	NISSAN	99.....	SAAB	BARRACUDA.....	PLYMOUTH	CLS SERIES.....	MERCEDES BENZ
380.....	MERCEDES BENZ	A		BEETLE.....	VOLKSWAGEN	CLUB WAGON.....	FORD
4		A SERIES.....	MERCEDES BENZ	BELAIR.....	CHEVROLET	CLUBMAN.....	MINI
4 RUNNER.....	TOYOTA	A3.....	AUDI	BELVEDERE.....	PLYMOUTH	COBALT.....	CHEVROLET
400 SS.....	CHEVROLET	A4.....	AUDI	BERETTA.....	CHEVROLET	COLONY PARK.....	MERCURY
4000.....	AUDI	A5.....	AUDI	BISCAYNE.....	CHEVROLET	COLORADO.....	CHEVROLET
400E.....	MERCEDES BENZ	A6.....	AUDI	BLACKWOOD.....	LINCOLN	COLT.....	DODGE
403.....	PEUGEOT	A7.....	AUDI	BLAZER.....	CHEVROLET	COLT.....	PLYMOUTH
404.....	PEUGEOT	A8.....	AUDI	BLS.....	CADILLAC	COMANCHE.....	JEEP
405.....	PEUGEOT	ACADIA.....	GMC	BONNEVILLE.....	PONTIAC	COMBI.....	VOLKSWAGEN
406.....	PEUGEOT	ACADIAN.....	PONTIAC	BORRAGO.....	VOLKSWAGEN	COMET.....	MERCURY
407.....	PEUGEOT	ACCENT.....	HYUNDAI	BOXTER.....	PORSCHE	COMMANDER.....	JEEP
430.....	FERRARI	ACCLAIM.....	PLYMOUTH	BOXTER S.....	PORSCHE	COMMUTER.....	MERCURY
440 SERIES.....	VOLVO	ACCORD.....	HONDA	BRASILIA.....	VOLKSWAGEN	COMPASS.....	JEEP
442.....	OLDSMOBILE	ACCORD CROSSTOUR.....	HONDA	BRAT.....	SUBARU	CONCORD.....	AMERICAN MOTORS
450.....	MERCEDES BENZ	ACE.....	TOYOTA	BRAVADA.....	OLDSMOBILE	CONCORDE.....	CHRYSLER
456 GT.....	FERRARI	ADVENTURE 150.....	CHRYSLER	BREEZE.....	PLYMOUTH	CONCOURS.....	CADILLAC
456 GTA.....	FERRARI	AERIO.....	SUZUKI	BREEZEWAY.....	MERCURY	CONCOURS.....	CHEVROLET
		AEROSTAR.....	FORD	BRONCO.....	FORD	CONTINENTAL.....	BENTLEY
				BRONCO II.....	FORD	CONTINENTAL.....	LINCOLN
				BROOKLANDS.....	BENTLEY	CONTOUR.....	FORD
				BROOKWOOD.....	CHEVROLET	COOPER.....	MINI
				BROUGHAM.....	CADILLAC	COOPER S.....	MINI
				BROUGHAM.....	MERCURY	CORDBA.....	CHRYSLER
				BULLET.....	STERLING	CORDBA.....	SEAT
						COROLLA.....	TOYOTA
						CORONA.....	TOYOTA
						CORONET.....	DODGE
						CORSA.....	CHEVROLET
						CORSAR.....	VOLKSWAGEN

CÓDIGO	SIGNIFICADO	CÓDIGO	SIGNIFICADO	CÓDIGO	SIGNIFICADO
CODE	MEANING	CODE	MEANING	CODE	MEANING
1.....	745	90.....	EXC. TURBO	184.....	ALTURA 5 13/32 IN
2.....	1 ORIFICIO	91.....	EXC. USA	185.....	ALTURA 7 13/32 IN
3.....	1/12/98 EN ADELANTE	92.....	EXC. USO HEAVY DUTY	186.....	BOBCAT, PINTO
4.....	10/92 EN ADELANTE	93.....	EXC. X18	187.....	CARBÓN ACTIVADO
5.....	12/7/98 EN ADELANTE	94.....	EXC. XJ-S	188.....	CHRYSLER
6.....	16 VÁLVULAS	95.....	HASTA 01/00	189.....	COALESCENTE
7.....	2 ORIFICIOS	96.....	HASTA 1/12/98	190.....	CON ASPAS
8.....	2 TUBOS DE CONEXIÓN	97.....	HASTA 10/92	191.....	CON MANGUERA 5 IN MAS LARGA
9.....	2WD	98.....	HASTA 12/7/98	192.....	CON MANGUERA DE 6 IN DE LARGO
10.....	318TI	99.....	HASTA 2/02	193.....	CON MANGUERA DE 9 1/8 IN DE LARGO
11.....	323 SERIES	100.....	HASTA 4/96	194.....	CON PURGADOR
12.....	325 SERIES	101.....	HASTA 4/99	195.....	CON ROSCA PARA TAZÓN
13.....	325CI	102.....	HASTA 5/10/99	196.....	CON ROSCA PARA TAZÓN (1RA OPCIÓN)
14.....	3500 HD	103.....	HASTA 6/01	197.....	CON ROSCA PARA TAZÓN (2DA OPCIÓN)
15.....	4/96 EN ADELANTE	104.....	HASTA 6/91	198.....	CON SOPORTE
16.....	4WD	105.....	HASTA 9/01	199.....	CON VÁLVULA ANTI-DRENAJE
17.....	5/10/99 EN ADELANTE	106.....	HASTA 9/03	200.....	CORTO
18.....	75BHP	107.....	HASTA 9/96	201.....	CUMMINS
19.....	8 VÁLVULAS	108.....	HASTA CHASIS 8C-5-025 820	202.....	CUMPLE CON MEDIDAS ORIGINALES
20.....	8-12 PSI	109.....	HASTA VIN 4AW2005000	203.....	DAIHATSU
21.....	9 11/32 IN DE ANCHO	110.....	HEAVY DUTY	204.....	DETROIT DIESEL
22.....	A4	111.....	LANCER SPORTBACK	205.....	EMPAQUE A LA ORILLA
23.....	A6	112.....	LIGHT DUTY	206.....	EMPAQUE AL CENTRO
24.....	AIRE DE CABINA	113.....	MANGUERA DE 6 IN DE LARGO	207.....	ESTÁNDAR
25.....	AIRE DE CABINA, (CUPRA O TURBO)	114.....	MANGUERA DE 9 1/8 IN DE LARGO	208.....	EXCEPTO MÉXICO
26.....	AIRE DE CABINA, (CUPRA O TURBO), CARBÓN ACTIVADO	115.....	METÁLICO	209.....	FORD
27.....	AIRE DE CABINA, (EXC. CUPRA O TURBO)	116.....	MODELOS FABRICADOS EN ESTADOS UNIDOS	210.....	FORD, MASSEY, PERKINS
28.....	AIRE DE CABINA, CARBÓN ACTIVADO	117.....	MODELOS FABRICADOS EN JAPÓN	211.....	GEO, SUZUKI
29.....	ALT. 2 35/64 IN	118.....	OPCIONAL	212.....	GMC, ISUZU
30.....	ALT. 2 61/64 IN	119.....	OVALADO	213.....	HEAVY DUTY
31.....	ALT. 25/64 IN	120.....	PLÁSTICO	214.....	HIDRÁULICO
32.....	ALT. 3 1/2 IN	121.....	PRIMARIO	215.....	IHC
33.....	ALT. 3 11/32 IN	122.....	QUATTRO	216.....	ISUZU
34.....	ALT. 3 25/64 IN	123.....	RADIAL	217.....	ISUZU, NISSAN
35.....	ALT. 3 27/32 IN	124.....	RAM 1500 Z	218.....	KOMATSU
36.....	ALT. 3 3/16 IN	125.....	RECTANGULAR	219.....	KUBOTA
37.....	ALT. 3 31/32 IN	126.....	RECTANGULAR PARA 24 VÁLVULAS	220.....	KUBOTA, YANMAR
38.....	ALT. 4 45/64 IN	127.....	RECTANGULAR PARA MOTORES SUPER CARGADOS	221.....	LARGO
39.....	ALT. 5 13/32 IN	128.....	REQUIERE 2 PIEZAS	222.....	MAZDA
40.....	ALT. 61/64 IN	129.....	REQUIERE 2 PIEZAS, NO APLICA PARA SUPER CARGADO	223.....	MERCEDES BENZ
41.....	ALT. 7 17/32 IN	130.....	ROSCA EN AMBOS EXTREMOS	225.....	MÉXICO
42.....	ALTA CAPACIDAD	131.....	ROSCA EN UN EXTREMO	226.....	MOTORES VOLKSWAGEN (28-32 PSI)
43.....	ANTES DE 1/16/09	132.....	ROSCA ESTÁNDAR	227.....	MOTORES VOLKSWAGEN (30 PSI)
44.....	ANTES DE 9/25/08	133.....	ROSCA MILIMÉTRICA	228.....	MWM, VW
45.....	ANTI-SMOG	134.....	SEDAN	229.....	NISSAN
46.....	AWD	135.....	SEGUNDA OPCIÓN	230.....	NISSAN, TOYOTA
47.....	C32 AMG	136.....	SELLADO	231.....	OPCIONAL
48.....	CABINA ESTÁNDAR	137.....	SELLADO (8-12 PSI)	232.....	OPCIONAL SECUNDARIO
49.....	CABINA EXTENDIDA	138.....	SHO (SUPER HIGH OUTPUT)	233.....	OPCIONAL, EMPAQUE AL CENTRO
50.....	CALIFORNIA	139.....	SIN ABS	234.....	OTROS
51.....	CANADA	140.....	SIN FIETRO	235.....	OTROS (28-32 PSI)
52.....	CARTUCHO	141.....	SIN HEAT EXCHANGER	236.....	OTROS (30 PSI)
53.....	CILÍNDRICO	142.....	SIN LINEA DE RETORNO	237.....	PARA TRANSMISIÓN
54.....	CON CRUISE	143.....	SIN MANGUERA	238.....	PINTO
55.....	CON FIELTRO	144.....	SIN OIL COOLER	239.....	PLÁSTICO
56.....	CON OIL COOLER	145.....	SIN RAM AIR	240.....	PRIMARIO
57.....	CON RAM AIR	146.....	SIN RETORNO DE VAPORES	241.....	SECUNDARIO
58.....	CON RETORNO DE VAPORES	147.....	SIN SOPORTE	242.....	SEGUNDA OPCIÓN
59.....	CON SOPORTE	149.....	SIN VÁLVULA ANTI DRENAJE (CHECK)	243.....	SEPARADOR
60.....	CON VÁLVULA ANTI DRENAJE	151.....	SLK320	244.....	SIN ASPAS
61.....	CON VÁLVULA CHECK	152.....	SOLO 206 CC	245.....	SIN FIELTRO
62.....	CÓNICO	153.....	STANDARD	246.....	SIN MANGUERA
63.....	CONVERTIBLE	154.....	SUPER DUTY	248.....	SIN VÁLVULA ANTI-DRENAJE
64.....	COUPE	156.....	SUPER CARGADO	249.....	SOLO ESTADOS UNIDOS (ROSCA PARA TAZÓN)
65.....	CUTLASS SUPREME	157.....	SUPREME	250.....	SUBARU
66.....	DESDE 5/98	158.....	TDI	251.....	THERMO KING
67.....	DESPUÉS DE 1/16/09	159.....	TRACCIÓN DELANTERA	252.....	TOYOTA
68.....	DESPUÉS DE 9/25/08	160.....	TRACCIÓN EN LAS 4 RUEDAS	253.....	USA
69.....	DESPUÉS DE CHASIS 8C-5-025 821	161.....	TRANSMISIÓN AUTOMÁTICA	254.....	YANMAR
70.....	DESPUÉS DE VIN 4BW000001	162.....	TRANSMISIÓN ESTÁNDAR		
71.....	DISTANCIA ESTÁNDAR ENTRE EJES	163.....	USO ESTÁNDAR		
72.....	DISTANCIA EXTENDIDA ENTRE EJES	164.....	USO HEAVY DUTY		
73.....	E320	165.....	VAPORES DE ACEITE		
74.....	EMPAQUE A LA ORILLA	166.....	VERIFIQUE DISEÑO ACTUALMENTE INSTALADO		
75.....	EMPAQUE AL CENTRO	167.....	XJ-12		
76.....	ESTADOS UNIDOS (REQUIERE 2)	168.....	XJ-S		
77.....	ESTÁNDAR	169.....	1 ORIFICIO		
78.....	ESTÁNDAR PARA 3500 HD	170.....	10 MICRAS		
79.....	EXC. 325CI	171.....	11-17 PSI		
80.....	EXC. 3500 HD	172.....	2 ORIFICIOS		
81.....	EXC. CALIFORNIA	173.....	28-32 PSI		
82.....	EXC. CAMIONETAS	174.....	30 MICRAS		
83.....	EXC. EVOLUTION MR	177.....	ACEITE HIDRÁULICO		
84.....	EXC. LANCER EVOLUTION	178.....	ACEITE PARA MOTOR		
85.....	EXC. QUATTRO	179.....	ALTURA 11 23/64 IN		
86.....	EXC. RAM 1500 VIN Z	180.....	ALTURA 18 1/32 IN		
87.....	EXC. SUPER DUTY SERIES	181.....	ALTURA 3 11/32 IN		
88.....	EXC. SUPER CARGADO	182.....	ALTURA 3 21/32 IN		
89.....	EXC. SUPREME	183.....	ALTURA 3 47/64 IN		

Marca - Año - Modelo Make-Year-Model	Motor Engine	Aceite Oil	Aire Air	Combustible Fuel
ACURA				
2010				
CSX	L4 2.0L FI I-VTEC	GP-149		
CSX TYPE S	L4 2.0L FI I-VTEC	GP-149		
MDX	V6 3.7L FI VTEC	GP-149		
RDX	L4 2.3L FI TURBO DOHC	GP-149		
RL	V6 3.7L FI VTEC	GP-149		
TL	V6 3.5L FI VTEC	GP-149	GA-171	
TL	V6 3.7L FI VTEC	GP-149	GA-171	
TSX	L4 2.4L FI I-VTEC	GP-149		
TSX	V6 3.5L FI VTEC	GP-149	GA-171	
ZDX	V6 3.7L FI VTEC	GP-149		
2009				
CSX	L4 2.0L FI 16 VALV. DOHC V-TEC	GP-149	GA-138	
CSX	L4 2.0L FI 16 VALV. DOHC V-TEC HIGH OUTPUT	GP-149		
MDX	V6 3.7L FI 24 VALV. SOHC V-TEC	GP-149	GA-383	
RDX	L4 2.3L FI 16 VALV. DOHC TURBO	GP-149		
RL	V6 3.7L FI	GP-149		
TL	V6 3.2L FI 24 VALV. SOHC V-TEC	GP-149	GA-171	
TL	V6 3.5L FI	GP-149	GA-171	
TSX	L4 2.4L FI	GP-149		
2008				
CSX	L4 2.0L FI 16 VALV. DOHC V-TEC	GP-149		
CSX	L4 2.0L FI DOHC V-TEC HIGH-OUTPUT	GP-149		
MDX	V6 3.7L FI	GP-149		
RDX	L4 2.3L FI TURBO	GP-149		
RL	V6 3.5L FI	GP-149	GA-269	
TL	V6 3.2L FI 24 VALV. SOHC V-TEC	GP-149		
TL	V6 3.5L FI 24 VALV. SOHC V-TEC	GP-149		
TSX	L4 2.4L FI I-VTEC	GP-149		
2007				
CSX	L4 2.0L FI CANADA	GP-149	GA-273	
MDX	V6 3.7L FI VTEC	GP-149		
RDX	L4 2.3L	GP-149		
RL	V6 3.5L FI SOHC	GP-149	GA-269	
TL	V6 3.2L FI VTEC 24 VALV.	GP-149	GA-269	
TL TYPE S	V6 3.2L FI 24 VALV. VTEC	GP-149	GA-269	
TL TYPE S	V6 3.5L FI VTEC	GP-149	GA-269	
TSX	L4 2.4L FI I-VTEC 16 VALV.	GP-149	GA-138	
2006				
CSX	L4 2.0L FI CANADA	GP-149	GA-184 GAC-6 ²⁴	
MDX	V6 3.5L FI	GP-149		
RL	V6 3.5L FI	GP-149	GA-269	
RSX	L4 2.0L FI I-VTEC	GP-149	GA-184 GAC-6 ²⁴	
TL	V6 3.2L FI	GP-149	GA-269	
TSX	L4 2.4L FI I-VTEC 16 VALV.	GP-149		
2005				
EL	L4 1.7L FI CANADA	GP-149	GA-194 GAC-6 ²⁴	
MDX	V6 3.5L FI	GP-149		
NSX	V6 3.0L FI DOHC VTEC	GP-212		
NSX	V6 3.2L FI DOHC VTEC	GP-212		
RL	V6 3.5L FI	GP-149		GG-160

Marca - Año - Modelo Make-Year-Model	Motor Engine	Aceite Oil	Aire Air	Combustible Fuel
ACURA (continuación)				
RSX	L4 2.0L MFI I-VTEC	GP-149	GA-184 GAC-6 ²⁴	
TL	V6 3.2L FI	GP-91	GA-269	
TL TYPE S	V6 3.2L FI 24 VALV. VTEC	GP-149	GA-269	
TLX	L4 2.4L FI	GP-149	GA-138	
TSX	L4 2.4L PFI DOHC 16 VALV.	GP-149		
2004				
EL	L4 1.7L FI CANADA	GP-149	GA-194 GAC-6 ²⁴	
MDX	V6 3.5L FI	GP-149		
NSX	V6 3.0L FI DOHC VTEC	GP-212		
NSX	V6 3.2L FI DOHC VTEC	GP-212		
RL	V6 3.5L FI	GP-91		
RSX	L4 2.0L PFI I-VTEC 16 VALV.	GP-149	GA-184 GAC-6 ²⁴	
TL	V6 3.2L FI SOHC J32A1 VTEC	GP-149	GA-170	
TL	V6 3.2L FI SOHC J32A2 VTEC	GP-149		
TLX	L4 2.4L FI	GP-149	GA-138	
TSX	L4 2.4L PFI DOHC I-VTEC 16 VALV.	GP-149		
2003				
CL	V6 3.2L FI 24 VALV. SOHC J32A1 VTEC		GA-170 GAC-13 ²⁴	
CL	V6 3.2L FI 24 VALV. SOHC J32A2 VTEC		GAC-13 ²⁴	
EL	L4 1.7L FI CANADA		GA-194 GAC-6 ²⁴	
NSX	V6 3.0L FI DOHC VTEC	GP-212		
NSX	V6 3.2L FI DOHC VTEC	GP-212		
RL	V6 3.5L FI SOHC	GP-149		GG-160
RSX	L4 2.0L PFI VTEC	GP-149	GA-184 GAC-6 ²⁴	
TL	V6 3.2L FI SOHC J32A1 VTEC	GP-149	GA-170 GAC-13 ²⁴	
TL	V6 3.2L FI SOHC J32A2 VTEC	GP-149	GAC-13 ²⁴	
TL TYPE S	V6 3.2L FI 24 VALV. SOHC J32A2 V-TEC	GP-6811	GAC-13 ²⁴	
2002				
CL	V6 3.2L FI 24 VALV. SOHC J32A1 VTEC		GA-170 GAC-13 ²⁴	
CL	V6 3.2L FI 24 VALV. SOHC J32A2 VTEC		GAC-13 ²⁴	
EL	L4 1.7L FI CANADA		GA-194 GAC-6 ²⁴	
NSX	V6 3.0L FI DOHC VTEC	GP-212		
NSX	V6 3.2L FI DOHC VTEC	GP-212		
RL	V6 3.5L FI SOHC	GP-149		GG-160
RSX	L4 2.0L PFI VTEC	GP-149	GA-184 GAC-6 ²⁴	
TL	V6 3.2L FI SOHC J32A1 VTEC	GP-149	GA-170 GAC-13 ²⁴	
TL	V6 3.2L FI SOHC J32A2 VTEC	GP-149	GAC-13 ²⁴	
2001				
CL	V6 3.2L FI 24 VALV. SOHC J32A1 VTEC		GA-170 GAC-13 ²⁴	
CL	V6 3.2L FI 24 VALV. SOHC J32A2 VTEC		GAC-13 ²⁴	
EL	L4 1.6L FI (CANADA)	GP-91	GA-172	GG-160
EL	L4 1.7L FI 16 VALV. SOHC V-TEC (CANADA)		GA-194	
INTEGRA	L4 1.8L FI	GP-6811		GG-160
NSX	V6 3.0L FI DOHC VTEC	GP-212		
NSX	V6 3.2L FI DOHC VTEC	GP-212		
RL	V6 3.5L FI SOHC	GP-149		GG-160
TL	V6 3.2L FI SOHC VTEC	GP-149	GA-170 GAC-13 ²⁴	

Marca - Año - Modelo Make-Year-Model	Motor Engine	Aceite Oil	Aire Air	Combustible Fuel
ACURA (continuación)				
2000				
CL	L4 2.3L FI DOHC		GA-170	
CL	V6 3.0L FI DOHC		GA-170	
EL	L4 1.6L FI (CANADA)	GP-91	GA-172	GG-160
INTEGRA	L4 1.8L FI	GP-6811		GG-160
NSX	V6 3.0L FI DOHC VTEC	GP-212		
NSX	V6 3.2L FI DOHC VTEC	GP-212		
RL	V6 3.5L FI SOHC	GP-149		GG-160
TL	V6 3.2L FI SOHC VTEC	GP-149	GA-170 GAC-13 ²⁴	
1999				
CL	L4 2.3L FI SOHC VTEC		GA-514	GG-160
CL	V6 3.0L FI SOHC VTEC			GG-160
EL	L4 1.6L FI (CANADA)	GP-91	GA-172	GG-160
INTEGRA	L4 1.8L FI	GP-6811		GG-160
NSX	V6 3.0L FI DOHC	GP-212		
NSX	V6 3.2L FI DOHC	GP-212		
RL	V6 3.5L FI SOHC	GP-149		GG-160
SLX	V6 3.5L FI DOHC	GP-149	GA-198	GG-255
TL	V6 3.2L FI SOHC	GP-149	GA-170 GAC-13 ²⁴	
1998				
CL	L4 2.3L FI SOHC VTEC		GA-514	GG-160
CL	V6 3.0L FI SOHC VTEC			GG-160
EL	L4 1.6L FI CANADA	GP-91	GA-172	GG-160
INTEGRA	L4 1.8L FI	GP-91		GG-160
NSX	V6 3.0L FI DOHC	GP-212		
NSX	V6 3.2L FI DOHC	GP-212		
RL	V6 3.5L FI SOHC	GP-149		GG-160
SLX	V6 3.5L FI DOHC	GP-149	GA-198	GG-255
TL	L5 2.5L FI SOHC			GG-160
TL	V6 3.2L FI SOHC	GP-212		GG-160
1997				
CL	L4 2.2L FI SOHC VTEC		GA-514	GG-160
CL	V6 3.0L FI SOHC VTEC			GG-160
EL	L4 1.6L FI CANADA	GP-91	GA-172	GG-160
INTEGRA	L4 1.8L FI	GP-91		GG-160
NSX	V6 3.0L FI DOHC	GP-212		
NSX	V6 3.2L FI DOHC	GP-212		
RL	V6 3.5L FI SOHC	GP-149		GG-160
SLX	V6 3.2L FI SOHC	GP-149	GA-198	GG-255
TL	L5 2.5L FI SOHC			GG-160
TL	V6 3.2L FI SOHC	GP-212		GG-160
1996				
CL	L4 2.2L FI SOHC		GA-514	GG-160
INTEGRA	L4 1.8L FI DOHC	GP-149		GG-160
NSX	V6 3.0L FI DOHC	GP-212		
RL	V6 3.5L FI SOHC	GP-149		GG-160
SLX	V6 3.2L FI SOHC	GP-149	GA-198	GG-255
TL	L5 2.5L FI SOHC			GG-160
TL	V6 3.2L FI SOHC	GP-212		GG-160
1995				
INTEGRA	L4 1.8L FI DOHC	GP-149		GG-160
LEGEND	V6 3.2L FI DOHC	GP-212		GG-214
NSX	V6 3.0L FI DOHC	GP-212		
TL	L5 2.5L FI SOHC	GP-149		GG-160
1994				
INTEGRA	L4 1.8L FI DOHC	GP-149		GG-160
LEGEND	V6 3.2L FI DOHC	GP-212		GG-214
NSX	V6 3.0L FI DOHC	GP-212		

Marca - Año - Modelo Make-Year-Model	Motor Engine	Aceite Oil	Aire Air	Combustible Fuel
ACURA (continuación)				
VIGOR	5 CIL. 2.5L	GP-149		GG-214
1993				
INTEGRA	L4 1.7L	GP-149		GG-234
INTEGRA	L4 1.8L	GP-149		GG-234
LEGEND	V6 3.2L PFI	GP-212		GG-214
NSX	V6 3.0L FI DOHC	GP-212		
VIGOR	5 CIL. 2.5L	GP-149		
1992				
INTEGRA	L4 1.7L FI DOHC VTEC	GP-149		GG-234
INTEGRA	L4 1.8L FI DOHC	GP-149		GG-234
LEGEND	V6 3.2L PFI	GP-212		GG-214
NSX	V6 3.0L FI DOHC	GP-212		
VIGOR	5 CIL. 2.5L	GP-149		
1991				
INTEGRA	L4 1.8L MFI	GP-91		
LEGEND	V6 3.2L PFI	GP-212		GG-214
NSX	V6 3.0L FI DOHC	GP-212		
1990				
INTEGRA	L4 1.8L MFI	GP-462		
LEGEND	V6 2.7L MFI	GP-212		GG-214
ALFA ROMEO				
2010				
8C COMPETIZIONE	V8 4.7L FI DOHC			
147	TODOS			
156	TODOS			
2007				
147	TODOS			
156	TODOS			
2006				
147	L4 2.0L			
156	L4 2.0L FI 16 VALV.	GP-91		
2005				
147	L4 2.0L			
156	L4 2.0L	GP-91		
2004				
147	L4 2.0L			
156	L4 2.0L	GP-91		
156	V6 2.5L			
156	V6 3.2L			
166	V6 2.5L FI			
166	V6 3.0L FI			
2003				
GTV	V6 3.0L FI			
SPIDER	V6 3.0L FI			
166	V6 2.0L FI TURBO			
166	V6 3.0L FI			
2002				
164	V6 3.0L FI	GP-58		GG-408
1995				
164	V6 3.0L FI	GP-58		GG-408

Marca - Año - Modelo Motor Aceite Aire Combustible
Make-Year-Model Engine Oil Air Fuel

ALFA ROMEO (continuación)

1994				
164	V6 3.0L FI	GP-81		GG-408

1993				
164	V6 3.0L FI	GP-81		GG-408

1992				
164	V6 3.0L FI	GP-81		GG-408

AM GENERAL

2006				
H1	V8 6.6L DIESEL TURBO			

2005				
H1	V8 6.6L DIESEL TURBO			

2004				
H1	V8 6.5L DIESEL TURBO	GP-205		

2003				
H1	V8 6.5L DIESEL TURBO	GP-205		

2002				
HUMMER	V8 6.5L FI TURBO DIESEL	GP-205 ⁶⁰		

2001				
HUMMER	V8 6.5L DIESEL	GP-13 ¹⁵⁰ GP-205 ⁶⁰		
HUMMER	V8 6.5L DIESEL TURBO	GP-13 ¹⁵⁰ GP-205 ⁶⁰		

2000				
HUMMER	V8 6.5L DIESEL	GP-13 ¹⁵⁰ GP-205 ⁶⁰		
HUMMER	V8 6.5L DIESEL TURBO	GP-13 ¹⁵⁰ GP-205 ⁶⁰		

1999				
HUMMER	V8 6.5L DIESEL	GP-13 ¹⁵⁰ GP-205 ⁶⁰		
HUMMER	V8 6.5L DIESEL TURBO	GP-13 ¹⁵⁰ GP-205 ⁶⁰		

1998				
HUMMER	V8 6.5L DIESEL	GP-13 ¹⁵⁰ GP-205 ⁶⁰		
HUMMER	V8 6.5L DIESEL TURBO	GP-13 ¹⁵⁰ GP-205 ⁶⁰		

1997				
HUMMER	V8 6.5L DIESEL	GP-13 ¹⁵⁰ GP-205 ⁶⁰		
HUMMER	V8 6.5L DIESEL TURBO	GP-13 ¹⁵⁰ GP-205 ⁶⁰		

1996				
HUMMER	V8 5.7L FI	GP-3980		GG-46
HUMMER	V8 6.5L DIESEL	GP-13 ¹⁵⁰ GP-205 ⁶⁰		
HUMMER	V8 6.5L DIESEL TURBO	GP-13 ¹⁵⁰ GP-205 ⁶⁰		

1995				
HUMMER	V8 5.7L FI	GP-3980		GG-46
HUMMER	V8 6.5L DIESEL	GP-13 ¹⁵⁰ GP-205 ⁶⁰		

Marca - Año - Modelo Motor Aceite Aire Combustible
Make-Year-Model Engine Oil Air Fuel

AM GENERAL (continuación)

1994				
HUMMER	V8 6.2L DIESEL	GP-13 ¹⁵⁰ GP-205 ⁶⁰		
HUMMER	V8 6.5L DIESEL	GP-13 ¹⁵⁰ GP-205 ⁶⁰		

1993				
HUMMER	V8 6.2L DIESEL	GP-13 ¹⁵⁰ GP-205 ⁶⁰		

1992				
HUMMER	V8 6.2L DIESEL	GP-13 ¹⁵⁰ GP-205 ⁶⁰		

AUDI

2010				
A3	L4 2.0L DI TURBO			GAVW-619
A3	L4 2.0L DI TURBO DIESEL			GAVW-619
A4	L4 2.0L DI 16 VALV. TURBO			
A5	L4 2.0L DI 16 VALV. TURBO			
A5	V6 3.2L DI 24 VALV.			
A6	V6 3.0L DI 24 VÁLVULAS SUPER CARGADO			
A6	V6 3.2L DI 24 VALV.			
A6	V8 4.2L DI 32 VALV.			
A7	V10 5.2L DI 40 VALV.			
A7	V8 4.2L DI 32 VALV.			
A8	V8 4.2L DI 32 VALV.			
Q5	V6 3.2L FI 24 VALV. DOHC			
Q7	V6 3.0L DI 24 VALV. TURBO DIESEL			GAVW-616
Q7	V6 3.6L DI	G-112		GAVW-616
Q7	V8 4.2L DI 32 VALV.			GAVW-616
R8	V10 5.2L DI 40 VALV.			
R8	V8 4.2L DI 32 VALV.			
S4	V6 3.0L DI 24 VALV. SUPER CARGADO			
S5	V6 3.0L DI 24 VALV. SUPER CARGADO			
S5	V8 4.2L FI 32 VALV.			
S6	V10 5.2L DI 40 VALV.			
TT	L4 2.0L DI 16 VALV. TURBO			GAVW-619
TTS	L4 2.0L DI 16 VALV. TURBO			GAVW-619

2009				
A3	L4 2.0L DI 16 VALV. DOHC TURBO			GAVW-617
A3	V6 3.2L DI 24 VALV. DOHC	G-466		GAVW-618
A4	L4 2.0L DI 16 VALV. DOHC TURBO	G-313		GA-2124
A4	V6 3.2L DI 24 VALV. DOHC			GA-2124
A4	V8 4.2L FI 40 VALV. DOHC			
A5	V6 3.2L DI 24 VALV. DOHC			
A6	V6 3.0L			
A6	V6 3.2L DI 24 VALV. DOHC			
A6	V8 4.2L DI 32 VALV. DOHC			
A8	V8 4.2L FI 32 VALV. DOHC			
A8	W12 6.0L FI 48 VALV. DOHC			GG-102
Q5	V6 3.2L FI 24 VALV.			
Q7	V6 3.0L DI TURBO DIESEL			GAVW-616
Q7	V6 3.6L DI 32 VALV. DOHC	G-112		GAVW-616
Q7	V8 4.2L DI 32 VALV. DOHC			GAVW-616
QUATTRO	L4 2.0L DI 16 VALV. DOHC TURBO	G-313		GA-2124
QUATTRO	V6 3.2L DI 24 VALV. DOHC			GA-2124
QUATTRO	V8 4.2L FI 40 VALV. DOHC			
QUATTRO	W12 6.0L FI 48 VALV. DOHC			GG-102
R8	V8 4.2L DI 32 VALV. DOHC			

Marca - Año - Modelo Make-Year-Model	Motor Engine	Aceite Oil	Aire Air	Combustible Fuel
AUDI (continuación)				
RS4	V8 4.2L DI 32 VALV. DOHC			
S4	V8 4.2L FI 40 VALV. DOHC			GG-102
S5	V8 4.2L FI 32 VALV. DOHC			
S6	V10 5.2L DI 40 VALV. DOHC			
S8	V10 5.2L DI 40 VALV. DOHC			
TT	L4 2.0L DI 16 VALV. DOHC TURBO			
TT	V6 3.2L DI 24 VALV. DOHC	G-466	GAVW-618	
TTS	L4 2.0L DI 16 VALV. DOHC TURBO	G-313	GAVW-617	

2008				
A3	L4 2.0L SFI TURBO	G-313	GAVW-617	
A3	V6 3.2L SFI	G-466	GAVW-618	
A4	L4 2.0L DI TURBO	G-313	GA-2124	
A4	V6 3.2L SFI		GA-2124	
A5	V6 3.2L SFI			
A6	V6 3.2L SFI			
A6	V8 4.2L SFI			
A8	V8 4.2L FI			
A8	W12 6.0L FI			GG-102
Q7	V6 3.0L FI TURBO DIESEL			
Q7	V6 3.6L SFI	G-112	GAVW-616	
Q7	V8 4.2L SFI		GAVW-616	
QUATTRO	L4 2.0L DI 16 VALV. DOHC TURBO	G-313	GA-2124	
QUATTRO	V6 3.2L DI 24 VALV. DOHC		GA-2124	
QUATTRO	V8 4.2L DI 40 VALV. DOHC			
QUATTRO	V8 4.2L FI 32 VALV. DOHC			
QUATTRO	V8 4.2L FI 40 VALV. DOHC			
QUATTRO	W12 6.0L FI 48 VALV. DOHC			GG-102
R8	V8 4.2L DI 32 VALV. DOHC			
RS4	V8 4.2L DI			
S4	V8 4.2L FI			
S5	V8 4.2L DI			
S6	V10 5.2L SFI			
S8	V10 5.2L SFI			
TT	L4 2.0L DI TURBO	G-313	GAVW-617	
TT	V6 3.2L FI	G-466	GAVW-618	

2007				
A3	L4 2.0L DI TURBO 16 VALV.	G-313	GAVW-617	
A3	V6 3.2L DI 24 VALV. DOHC	G-466	GAVW-618	
A4	L4 2.0L DI TURBO 16 VALV.	G-313	GA-2124	
A4	V6 3.2L DI 24 VALV.		GA-2124	
A4	V8 4.2L DI TURBO 32 VALV.			
A6	V6 3.2L FI 24 VALV.			
A6	V8 4.2L FI 40 VALV.			
A8	V8 4.2L FI 40 VALV. DOHC			
A8	W12 6.0L SFI 48 VALV.			GG-102
ALLROAD	TODOS			
CABRIOLET	L4 2.0L DI TURBO 16 VALV.	G-313		
CABRIOLET	V6 3.2L DI 24 VALV.			
CABRIOLET	V8 4.2L DI TURBO 32 VALV.			
Q7	V6 3.6L DI	G-112	GAVW-616	
Q7	V8 4.2L DI 32 VALV.		GAVW-616	
QUATTRO	L4 2.0L DI 16 VALV. DOHC BWT TURBO	G-313	GA-2124	
QUATTRO	V6 3.2L DI 24 VALV. DOHC BKH		GA-2124	
QUATTRO	V8 4.2L DI 32 VALV. DOHC TURBO			
QUATTRO	V8 4.2L FI 40 VALV. DOHC BNK			
QUATTRO	V8 4.2L FI 40 VALV. DOHC BVJ			
QUATTRO	V8 4.2L FI 40 VALV. DOHC BXA			

Marca - Año - Modelo Make-Year-Model	Motor Engine	Aceite Oil	Aire Air	Combustible Fuel
AUDI (continuación)				
QUATTRO	W12 6.0L FI 48 VALV. DOHC BSB			GG-102
RS4	V8 4.2L SFI 40 VALV.			
S3	L4 2.0L FI TURBO			
S4	V8 4.2L SFI 40 VALV.			
S6	V10 5.2L DOHC 40 VALV.			
S8	V10 5.2L DI			
TT	L4 2.0L DI TURBO 16 VALV.	G-313		
TT	V6 3.2L DI 24 VALV.	G-466	GAVW-621	

2006				
A3	L4 2.0L FI	G-313	GAVW-617	
A3	V6 3.2L FI	G-466	GAVW-618	
A4	L4 1.8L FI TURBO 20 VALV.	GP-3569	GA-2124	
A4	L4 2.0L DI TURBO 16 VALV.	G-313	GA-2124	
A4	V6 3.0L FI (CABRIO)	GP-171	GA-2124	
A4	V6 3.2L FI		GA-2124	
A6	V6 3.2L DI 24 VALV.			
A6	V8 4.2L DI 40 VALV.			
A8	V8 4.2L FI 32 VALV.			GG-102
A8	W12 6.0L SFI			GG-102
ALLROAD	TODOS			
CABRIOLET	V6 3.0L FI	GP-171		GG-102
QUATTRO	L4 1.8L FI 20 VALV. DOHC AMB TURBO	GP-3569	GA-2124	
QUATTRO	L4 1.8L FI 20 VALV. DOHC AWP TURBO	GP-28	GAVW-621 GAC-10 ²⁸ GAC-8 ²⁴	GG-102
QUATTRO	L4 1.8L FI 20 VALV. DOHC BEA TURBO HO	GP-28	GAVW-621 GAC-10 ²⁸ GAC-8 ²⁴	GG-102
QUATTRO	L4 2.0L DI 16 VALV. DOHC BPG TURBO	G-313	GA-2124	
QUATTRO	V10 5.2L DI 40 VALV. DOHC BXA			
QUATTRO	V6 3.0L FI 30 VALV. DOHC AVK	GP-171	GA-2124	
QUATTRO	V6 3.2L DI 24 VALV. DOHC BKH		GA-2124	
QUATTRO	V6 3.2L FI 24 VALV. DOHC BHE	G-466	GAVW-621 GAC-10 ²⁸ GAC-8 ²⁴	GG-102
QUATTRO	V8 4.2L FI 40 VALV. DOHC BFM			GG-102
QUATTRO	V8 4.2L FI 40 VALV. DOHC BNK			
QUATTRO	W12 6.0L FI 48 VALV. DOHC BSB			GG-102
RS4	V8 4.2L DI DOHC 32 VALV.			
S3	TODOS			
S4	V8 4.2L SFI 40 VALV.			
S6	V8 4.2L FI DOHC			
S8	V10 5.5L DI DOHC			
TT	L4 1.8L FI 20 VALV. TURBO	GP-28	GAVW-621 GAC-10 ²⁸ GAC-8 ²⁴	GG-102

2005				
A3	L4 2.0L FI			
A3	V6 3.2L FI			GG-102
A4	L4 1.8L FI TURBO (CABRIO)	GP-430	GA-277	
A4	L4 1.8L SFI	GP-3569	GA-2124	
A4	L4 2.0L FI	GP-171	GA-2124	GG-102
A4	V6 3.0L FI	GP-171	GA-2124	GG-102
A4	V6 3.2L FI	GP-171	GA-2124	
A6	V6 3.0L FI			GG-408
A6	V8 4.2L FI		GAVW-622	GG-246
A8	V8 4.2L FI 32 VALV.			GG-102
ALLROAD	V6 2.7L DI TWIN TURBO	GP-171	GAVW-622	GG-408
ALLROAD	V8 4.2L SFI 40 VALV.	GP-171	GAVW-622	GG-408
CABRIOLET	L4 1.8L FI			

Marca - Año - Modelo Make-Year-Model	Motor Engine	Aceite Oil	Aire Air	Combustible Fuel
AUDI (continuación)				
CABRIOLET	V6 3.0L FI			
QUATTRO	L4 1.8L FI 20 VALV. DOHC AMB TURBO	GP-3569	GA-2124	
QUATTRO	L4 1.8L FI 20 VALV. DOHC AWP TURBO	GP-28	GAVW-621 GAC-10 ²⁸ GAC-8 ²⁴	GG-102
QUATTRO	L4 1.8L FI 20 VALV. DOHC BEA TURBO HO	GP-28	GAVW-621 GAC-10 ²⁸ GAC-8 ²⁴	GG-102
QUATTRO	L4 2.0L DI 16 VALV. DOHC BPG TURBO	G-313	GA-2124	
QUATTRO	V6 2.7L FI 30 VALV. DOHC BEL BI-TURBO	GP-171	GAVW-622	GG-408
QUATTRO	V6 3.0L FI 30 VALV. DOHC AVK	GP-171	GA-2124	
QUATTRO	V6 3.2L DI 24 VALV. DOHC BKH		GA-2124	
QUATTRO	V6 3.2L DI 30 VALV. DOHC AUK			
QUATTRO	V6 3.2L FI 24 VALV. DOHC BHE	G-466	GAVW-621 GAC-10 ²⁸ GAC-8 ²⁴	GG-102
QUATTRO	V8 4.2L FI 40 VALV. DOHC AWN		GAVW-622	GG-408
QUATTRO	V8 4.2L FI 40 VALV. DOHC BAS BI-TURBO		GAVW-622	GG-408
QUATTRO	V8 4.2L FI 40 VALV. DOHC BAT			
QUATTRO	V8 4.2L FI 40 VALV. DOHC BFM			GG-102
QUATTRO	W12 6.0L FI 48 VALV. DOHC BSB			GG-102
S3	TODOS			
S4	V8 4.2L SFI 40 VALV.			
S6	TODOS			
S8	TODOS			
TT	L4 1.8L FI 20 VALV. TURBO	GP-28	GAVW-621 GAC-10 ²⁸ GAC-8 ²⁴	GG-102
TT	V6 3.2L FI		GAC-10 ²⁸ GAC-8 ²⁴	GG-102

2004				
A3	L4 1.8L FI 20 VALV. TURBO	GP-430	GAVW-621 GAC-10 ²⁸ GAC-8 ²⁴	GG-251
A3	L4 2.0L FI			
A3	V6 3.2L FI			
A4	L4 1.8L FI 20 VALV.	GP-430	GA-2124	
A4	V6 3.0L FI	GP-171	GA-2124	GG-102
A6	V6 2.7L FI BITURBO		GAVW-622	GG-408
A6	V6 3.0L FI			GG-408
A6	V8 4.2L FI 32 VALV.	GP-452	GAVW-622	GG-408 ¹²²
A8	V8 4.2L FI 32 VALV.		GA-2141	GG-102
ALLROAD	V6 2.7L FI 30 VALV. BITURBO		GAVW-622	GG-408
ALLROAD	V8 4.2L SFI		GAVW-622	GG-408
CABRIOLET	L4 1.8L FI			
CABRIOLET	V6 2.8L FI			
QUATTRO	L4 1.8L FI 20 VALV. DOHC AMB TURBO	GP-3569	GA-2124	
QUATTRO	L4 1.8L FI 20 VALV. DOHC AWP TURBO	GP-28	GAVW-621 GAC-10 ²⁸ GAC-8 ²⁴	GG-102
QUATTRO	L4 1.8L FI 20 VALV. DOHC BEA TURBO HO	GP-28	GAVW-621 GAC-10 ²⁸ GAC-8 ²⁴	GG-102
QUATTRO	V6 2.7L FI 30 VALV. DOHC BEL BI-TURBO	GP-171	GAVW-622	GG-408
QUATTRO	V6 3.0L FI 30 VALV. DOHC AVK	GP-171	GAVW-622 GA-2124	GG-251 ¹⁵⁹ GG-102 GG-408 ¹⁶⁰
QUATTRO	V6 3.2L FI 24 VALV. DOHC BHE	G-466	GAVW-621 GAC-10 ²⁸ GAC-8 ²⁴	GG-102

Marca - Año - Modelo Make-Year-Model	Motor Engine	Aceite Oil	Aire Air	Combustible Fuel
AUDI (continuación)				
QUATTRO	V8 4.2L FI 40 VALV. DOHC AWN	GP-452	GAVW-622	GG-408
QUATTRO	V8 4.2L FI 40 VALV. DOHC BAS		GAVW-622	GG-408
QUATTRO	V8 4.2L FI 40 VALV. DOHC BFM			GG-102
RS6	V8 4.2L FI TWIN TURBO 40 VALV.	GP-28 ¹³² GP-452 ¹³³		
S3	TODOS			
S4	V8 4.2L SFI 40 VALV.			
S6	V8 4.2L FI		GAVW-622	GG-408
S8	V8 4.2L SFI	G-112	GA-2141	GG-246
TT	L4 1.8L FI 20 VALV. TURBO	GP-430	GAVW-621 GAC-10 ²⁸ GAC-8 ²⁴	GG-102
TT	V6 3.2L FI		GAC-10 ²⁸ GAC-8 ²⁴	GG-102

2003				
A3	L4 1.8L FI 20 VALV. TURBO	GP-430	GAVW-621 GAC-10 ²⁸ GAC-8 ²⁴	GG-251
A4	L4 1.8L FI 20 VALV.	GP-430	GA-2124	
A4	V6 3.0L FI	GP-171	GA-2124	GG-102
A6	V6 2.7L FI BITURBO		GAVW-622	GG-408
A6	V6 3.0L FI			GG-408
A6	V8 4.2L FI 32 VALV.	GP-452	GAVW-622	GG-408 ¹²²
A8	V8 3.7L FI		GA-2141 ¹²⁵	
A8	V8 4.2L FI 32 VALV.	G-112	GA-2141	GG-408
ALLROAD	V6 2.7L FI 30 VALV. BITURBO		GAVW-622	GG-408
ALLROAD	V8 4.2L SFI		GAVW-622	GG-251 ⁸⁵ GG-408 ¹²²
QUATTRO	L4 1.8L FI 20 VALV. DOHC AMB TURBO	GP-3569	GA-2124	
QUATTRO	L4 1.8L FI 20 VALV. DOHC AWP TURBO	GP-28	GAVW-621 GAC-10 ²⁸ GAC-8 ²⁴	GG-102
QUATTRO	V6 2.7L FI 30 VALV. DOHC BEL BI-TURBO	GP-171	GAVW-622	GG-408
QUATTRO	V6 3.0L FI 30 VALV. DOHC AVK	GP-171	GAVW-622 GA-2124	GG-251 ¹⁵⁹ GG-102 GG-408 ¹⁶⁰
QUATTRO	V8 4.2L FI 40 VALV. DOHC AKB	G-112		GG-408
QUATTRO	V8 4.2L FI 40 VALV. DOHC AUX	G-112		GG-408
QUATTRO	V8 4.2L FI 40 VALV. DOHC AWN	GP-452	GAVW-622	GG-408
RS6	V8 4.2L FI TWIN TURBO	GP-28 ¹³² GP-452 ¹³³		GG-255
S3	L4 1.8L FI 20 VALV. TURBO		GAC-10 ²⁸ GAC-8 ²⁴	
S4	TODOS			
S6	V8 4.2L SFI	GP-452	GAVW-622	GG-408
S8	V8 4.2L SFI	G-112	GA-2141	GG-408
TT	L4 1.8L FI 20 VALV. TURBO	GP-430	GAVW-621 GAC-10 ²⁸ GAC-8 ²⁴	GG-102

2002				
A3	L4 1.8L FI 20 VALV. TURBO	GP-430	GAC-10 ²⁸ GAC-8 ²⁴	
A4	L4 1.8L FI 20 VALV.	GP-430	GA-2124	
A4	V6 3.0L FI	GP-171	GA-2124	GG-102
A6	V6 2.7L SFI TWIN TURBO	GP-171	GAVW-622	GG-408
A6	V6 3.0L SFI	GP-171	GAVW-622	GG-251 ⁸⁵ GG-408 ¹²²
A6	V8 4.2L SFI	GP-452	GAVW-622	GG-408 ¹²²
A8	V6 2.5L DSL		GA-2141 ¹⁵⁸	
A8	V6 2.8L FI		GA-2141	
A8	V8 3.3L DSL		GA-2141 ¹⁵⁸	
A8	V8 3.7L FI		GA-2141 ¹²⁵	
A8	V8 4.2L FI 32 VALV.	G-112	GA-2141	GG-408

Para números Gonher con Superíndice vea página 38
For Gonher with Superscript numbers see page 38

Marca - Año - Modelo Make-Year-Model	Motor Engine	Aceite Oil	Aire Air	Combustible Fuel
AUDI (continuación)				
ALLROAD	V6 2.7L FI 30 VALV. BITURBO		GAVW-622	GG-408
QUATTRO	L4 1.8L FI	GP-28	GAC-10 ²⁸ GAVW-622 GAC-8 ²⁴	GG-251
QUATTRO	V6 2.7L FI 30 VALV. DOHC BI-TURBO	GP-171	GAVW-622	GG-408
QUATTRO	V6 3.0L FI	GP-81	GAVW-622	GG-102 ²² GG-408 ²³
QUATTRO	V8 4.2L FI	G-112		GG-408
RS4	V6 2.7L FI BITURBO			
S3	L4 1.8L FI 20 VALV. TURBO		GAC-10 ²⁸ GAC-8 ²⁴	
S4	V6 2.7L FI	GP-81	GAVW-622	GG-408
S6	V6 2.7L FI	GP-81	GAVW-622	GG-408
S6	V8 4.2L FI	GP-452	GAVW-622	GG-408
S8	V8 4.2L SFI	G-112	GA-2141	GG-408
TT	L4 1.8L FI 20 VALV. TURBO	GP-430	GAVW-621 GAC-10 ²⁸ GAC-8 ²⁴	GG-102
2001				
A3	L4 1.8L FI 20 VALV. TURBO	GP-430	GAC-10 ²⁸ GAC-8 ²⁴	
A4	L4 1.8L FI 20 VALV.	GP-430	GAVW-622	GG-251
A4	V6 2.8L FI 30 VALV.	GP-1	GAVW-622	GG-251
A6	V6 2.7L FI BITURBO 30 VALV.		GAVW-622	GG-408 ¹²²
A6	V6 2.8L SFI 30 VALV.		GAVW-622	GG-251 ⁸⁵ GG-408 ¹²²
A6	V8 4.2L FI 32 VALV.	GP-452	GAVW-622	GG-408
A8	V6 2.5L DSL		GA-2141 ¹⁵⁸	
A8	V6 2.8L FI		GA-2141	
A8	V8 3.3L DSL		GA-2141 ¹⁵⁸	
A8	V8 3.7L FI		GA-2141 ⁹¹	
A8	V8 4.2L SFI 40 VALV.	G-112	GA-2141	GG-408
ALLROAD	V6 2.7L FI 30 VALV. BITURBO		GAVW-622	GG-408
QUATTRO	L4 1.8L FI	GP-28	GAC-10 ²⁸ GAVW-622 GAC-8 ²⁴	GG-251
QUATTRO	V6 2.8L FI	GP-1	GAVW-622	GG-251
QUATTRO	V8 4.2L FI	G-112		GG-408
RS4	V6 2.7L FI			
S3	L4 1.8L FI 20 VALV. TURBO		GAC-10 ²⁸ GAC-8 ²⁴	
S4	V6 2.7L FI	GP-81	GAVW-622	GG-408
S6	TODOS			
S8	V8 4.2L SFI	G-112	GA-2141	GG-408
TT	L4 1.8L FI 20 VALV. TURBO	GP-430	GAVW-621 GAC-10 ²⁸ GAC-8 ²⁴	GG-102
2000				
A3	L4 1.8L FI 20 VALV. TURBO	GP-430	GAC-10 ²⁸ GAC-8 ²⁴	
A4	L4 1.8L FI 20 VALV.	GP-430	GAVW-622	GG-251
A4	V6 2.8L SFI	GP-171	GAVW-622	GG-251
A6	V6 2.7L FI TURBO	GP-171	GAVW-622	GG-246
A6	V6 2.8L SFI	GP-171	GAVW-622	GG-251 GG-246 ¹²²
A6	V8 4.2L FI 32 VALV.	GP-452	GAVW-622	GG-408
A8	V6 2.5L DSL		GA-2141 ¹⁵⁸	
A8	V6 2.8L FI		GA-2141	
A8	V8 3.3L DSL		GA-2141 ¹⁵⁸	
A8	V8 3.7L FI		GA-2141 ⁹¹	
A8	V8 4.2L SFI	G-112	GA-2141	GG-408
ALLROAD	TODOS			
QUATTRO	L4 1.8L FI	GP-28	GAC-10 ²⁸ GAVW-622 GAC-8 ²⁴	GG-251
QUATTRO	V6 2.8L FI	GP-1	GAVW-622	GG-246

Marca - Año - Modelo Make-Year-Model	Motor Engine	Aceite Oil	Aire Air	Combustible Fuel
AUDI (continuación)				
QUATTRO	V8 4.2L FI 40 VALV. DOHC			GG-408
S3	L4 1.8L FI 20 VALV. TURBO			
S4	V6 2.7L SFI TURBO	GP-171	GAVW-622	GG-246
S6	V8 4.2L FI	GP-452		GG-408
S8	V8 4.2L FI		GA-2141	
TT	L4 1.8L FI 20 VALV. TURBO	GP-430	GAVW-621 GAC-10 ²⁸ GAC-8 ²⁴	GG-102
1999				
A3	L4 1.8L FI 20 VALV. TURBO	GP-430	GAC-10 ²⁸ GAC-8 ²⁴	
A4	L4 1.8L FI	GP-430	GAVW-622	GG-251
A4	V6 2.8L FI 30 VALV.	GP-1	GAVW-622	GG-251
A6	V6 2.8L FI 30 VALV.	GP-171	GAVW-622	GG-251
A8	V6 2.5L DSL		GA-2141 ¹⁵⁸	
A8	V6 2.8L FI		GA-2141	
A8	V8 3.3L DSL		GA-2141 ¹⁵⁸	
A8	V8 3.7L SFI 32 VALV.	G-932	GA-2141	GG-408
A8	V8 4.2L FI 32 VALV.	G-932	GA-2141	GG-408
ALLROAD	TODOS			
QUATTRO	V6 2.8L FI	GP-1	GAVW-622	GG-251
QUATTRO	V8 3.7L FI DOHC			GG-408
QUATTRO	V8 4.2L FI			GG-408
S8	V8 4.2L FI		GA-2141	
1998				
A3	L4 1.8L FI	GP-430	GAC-10 ²⁸ GAC-8 ²⁴	
A4	L4 1.8L FI	GP-430	GAVW-622	GG-408
A4	V6 2.8L FI 30 VALV.	GP-1	GAVW-622	GG-251 ⁸⁵ GG-408 ¹²²
A6	V6 2.8L FI 30 VALV.	GP-171	GAVW-120 ¹⁰⁹ GAVW-622 ⁷⁰	GG-246
A8	V6 2.5L DSL		GA-2141 ¹⁵⁸	
A8	V6 2.8L FI		GA-2141	
A8	V8 3.7L SFI 32 VALV.	G-932	GA-2141	GG-408
A8	V8 4.2L FI 32 VALV.	G-932	GA-2141	GG-408
ALLROAD	TODOS			
CABRIOLET	V6 2.8L FI	GP-1	GAVW-120	GG-261
QUATTRO	L4 1.8L FI DOHC TURBO	GP-3569		GG-408
QUATTRO	V6 2.8L FI	GP-1	GAVW-622	GG-408
QUATTRO	V8 3.7L FI DOHC			GG-408
QUATTRO	V8 4.2L FI			GG-408
S8	V8 4.2L FI		GA-2141	
1997				
A3	L4 1.8L FI	GP-430	GAC-10 ²⁸ GAC-8 ²⁴	
A4	L4 1.8L FI 20 VALV.	GP-28	GAVW-622	GG-408
A4	V6 2.8L FI 30 VALV.	GP-1	GAVW-622	GG-251 ⁸⁵ GG-408 ¹²²
A6	5 CIL. 2.2L FI TURBO	GP-28	GAVW-120	GG-246
A6	V6 2.8L FI 30 VALV.	GP-171	GAVW-120	GG-246
A8	V6 2.5L DSL		GA-2141 ¹⁵⁸	
A8	V6 2.8L FI		GA-2141	
A8	V8 3.7L SFI 32 VALV.	G-932	GA-2141	GG-408
A8	V8 4.2L FI 32 VALV.	G-932	GA-2141	GG-408
ALLROAD	TODOS			
CABRIOLET	V6 2.8L FI	GP-1	GAVW-120	GG-261
QUATTRO	L4 1.8L FI DOHC TURBO	GP-28	GAVW-622	GG-408
QUATTRO	V6 2.8L FI	GP-1	GAVW-622	GG-408
QUATTRO	V8 3.7L FI DOHC			GG-408
QUATTRO	V8 4.2L FI			GG-408
S6	L5 2.2L EFI TURBO	GP-28		
S8	V8 4.2L FI		GA-2141	

Marca - Año - Modelo Make-Year-Model	Motor Engine	Aceite Oil	Aire Air	Combustible Fuel
AUDI (continuación)				
1996				
A4	V6 2.8L FI	GP-171	GAVW-622	GG-251 ⁸⁵ GG-408 ¹²²
A6	5 CIL. 2.2L FI TURBO	GP-28	GAVW-120	GG-246
A6	V6 2.8L FI	GP-171	GAVW-120	GG-246
A8	V6 2.8L FI		GA-2141	
A8	V8 3.7L FI		GA-2141	
A8	V8 4.2L FI		GA-2141	
ALLROAD	TODOS			
CABRIOLET	V6 2.8L SFI	GP-171		
S6	L5 2.2L EFI TURBO	GP-28		
S8	V8 4.2L FI		GA-2141	
90	V6 2.8L SFI	GP-28 ¹²² GP-171 ⁸⁵		GG-408
1995				
A6	5 CIL. 2.2L FI TURBO	GP-28	GAVW-120	GG-246
A6	V6 2.8L FI	GP-28 ¹⁰⁸ GP-171 ⁶⁹	GAVW-120	GG-246
A8	V6 2.8L FI		GA-2141	
A8	V8 3.7L FI		GA-2141	
A8	V8 4.2L FI		GA-2141	
ALLROAD	TODOS			
CABRIOLET	V6 2.8L SFI	GP-28		
S6	L5 2.2L EFI TURBO	GP-28		
V8	V8 4.2L FI	GP-452		GG-408
90	V6 2.8L SFI	GP-28		GG-408
100	V6 2.8L FI	GP-28		
1994				
A8	V6 2.8L FI		GA-2141	
A8	V8 3.7L FI		GA-2141	
A8	V8 4.2L FI		GA-2141	
CABRIOLET	V6 2.8L SFI	GP-28		
S4	L5 2.2L FI TURBO	GP-28		
V8	V8 4.2L FI	GP-452		GG-408
90	V6 2.8L SFI	GP-28		GG-408
100	V6 2.8L FI	GP-28		
1993				
S4	L5 2.2L FI TURBO	GP-28		
V8	V8 4.2L FI	GP-452		GG-408
80	L5 2.3L EFI	GP-28	GAVW-2	
100	V6 2.8L FI	GP-28		
1992				
V8	V8 3.6L FI	GP-452		GG-408
V8	V8 4.2L FI	GP-452		GG-408
80	L5 2.3L EFI	GP-28	GAVW-2	
90	L5 2.3L FI	GP-28	GAVW-2	
100	L5 2.3L FI	GP-28	GAVW-4	
1991				
V8	V8 3.6L FI 32 VALV.	GP-452		GG-408
80	L4 2.0L FI	GP-28	GAVW-2	
80	L5 2.3L EFI	GP-28	GAVW-2	
90	L5 2.3L FI	GP-28	GAVW-2	
100	L5 2.3L FI	GP-28	GAVW-4	
200	L5 2.2L FI TURBO	GP-28	GAVW-4	
1990				
V8	V8 3.6L FI	GP-452		GG-408

Marca - Año - Modelo Make-Year-Model	Motor Engine	Aceite Oil	Aire Air	Combustible Fuel
BMW				
2010				
100 SERIES	6 CIL. 3.0L DI 24 VALV. TWIN-TURBO			
100 SERIES	6 CIL. 3.0L FI 24 VALV.			
300 SERIES	6 CIL. 3.0L DI 24 VALV. TWIN-TURBO			
300 SERIES	6 CIL. 3.0L DI 24 VALV. TWIN-TURBO DIESEL			
300 SERIES	6 CIL. 3.0L FI 24 VALV.			
500 SERIES	6 CIL. 3.0L DI 24 VALV. TWIN-TURBO			
500 SERIES	6 CIL. 3.0L FI 24 VALV.			
500 SERIES	V8 4.8L FI 32 VALV.			
600 SERIES	V8 4.8L FI 32 VALV.			
700 SERIES	V12 6.0L DI 48 VALV. TWIN-TURBO		GA-241 ¹²⁸	
700 SERIES	V8 4.4L DI 32 VALV. TWIN-TURBO		GA-241 ¹²⁸	
M SERIES	V10 5.0L FI 40 VALV.			
M SERIES	V8 4.0L FI 32 VALV.			
X3	6 CIL. 3.0L FI 24 VALV.			
X5	6 CIL. 3.0L DI 24 VALV. TURBO DIESEL			
X5	6 CIL. 3.0L FI 24 VALV.			
X5	V8 4.4L DI 32 VALV. TWIN-TURBO			
X5	V8 4.8L FI 32 VALV.			
X6	6 CIL. 3.0L DI 24 VALV. TWIN-TURBO			
X6	V8 4.4L DI 32 VALV. TWIN-TURBO			
Z SERIES	6 CIL. 3.0L DI 24 VALV. TURBO			
Z SERIES	6 CIL. 3.0L FI 24 VALV.			
2009				
100 SERIES	6 CIL. 3.0L DI 24 VALV. DOHC TWIN-TURBO			
100 SERIES	6 CIL. 3.0L FI 24 VALV. DOHC			
300 SERIES	6 CIL. 3.0L DI 24 VALV. DOHC			
300 SERIES	6 CIL. 3.0L DI 24 VALV. DOHC TWIN-TURBO			
500 SERIES	6 CIL. 3.0L DI 24 VALV. DOHC			
500 SERIES	6 CIL. 3.0L DI 24 VALV. DOHC TWIN-TURBO			
500 SERIES	V8 4.8L FI 32 VALV. QOHC			
600 SERIES	V8 4.8L FI 32 VALV. QOHC			
700 SERIES	V12 6.0L FI 48 VALV.		GA-241	
700 SERIES	V8 4.4L DI TWIN-TURBO 32 VALV.		GA-241	
M SERIES	V10 5.0L FI 40 VALV. QOHC			
M SERIES	V8 4.0L FI 32 VALV.			
X3	6 CIL. 3.0L DI 24 VALV. DOHC			
X5	6 CIL. 3.0L DI 24 VALV. DOHC			
X5	V8 4.8L FI 32 VALV. QOHC			
X6	6 CIL. 3.0L DI 24 VALV. DOHC TWIN-TURBO			
X6	V8 4.4L DI 32 VALV. TWIN-TURBO			
Z SERIES	6 CIL. 3.0L FI 24 VALV. DOHC			
Z SERIES	6 CIL. 3.0L FI 24 VALV. DOHC TWIN-TURBO			
2008				
100 SERIES	6 CIL. 3.0L DI 24 VALV. DOHC TWIN-TURBO			
100 SERIES	6 CIL. 3.0L FI 24 VALV. DOHC			
300 SERIES	6 CIL. 3.0L 24 VALV.			
500 SERIES	6 CIL. 3.0L 24 VALV.			

Para números Gonher con Superíndice vea página 38
For Gonher with Superscript numbers see page 38

Marca - Año - Modelo Make-Year-Model	Motor Engine	Aceite Oil	Aire Air	Combustible Fuel
BMW (continuación)				
500 SERIES	V8 4.8L FI 32 VALV.			
600 SERIES	V8 4.8L FI 32 VALV.			
700 SERIES	V12 6.0L FI 48 VALV. QOHC		GA-241	
700 SERIES	V8 4.8L FI 32 VALV. QOHC		GA-241	
ALPINA B7	V8 4.4L FI 32 VALV. SUPER CARGADO		GA-241	
ALPINA B7	V8 4.8L FI 32 VALV.			
M SERIES	V10 5.0L FI 40 VALV.			
M SERIES	V8 4.0L FI 32 VALV.			
X3	6 CIL. 3.0L FI 24 VALV. DOHC			
X5	6 CIL. 3.0L FI 24 VALV. DOHC			
X5	V8 4.8L FI 32 VALV.			
X6	6 CIL. 3.0L FI TURBO			
Z SERIES	6 CIL. 3.0L FI 24 VALV. DOHC			
Z SERIES	6 CIL. 3.2L FI			
2007				
100 SERIES	6 CIL. 3.0L FI			
100 SERIES	L4 2.0L 16 VALV.			
300 SERIES	L6 2.5L FI 24 VALV.			
300 SERIES	L6 3.0L FI 24 VALV.			
500 SERIES	L6 2.5L FI 24 VALV.			
500 SERIES	L6 3.0L FI 24 VALV.	G-954 ¹⁴¹		
500 SERIES	V8 4.8L FI 32 VALV.			
600 SERIES	V8 4.8L FI 32 VALV.			
700 SERIES	V12 6.0L 48 VALV.		GA-241	
700 SERIES	V8 4.8L FI 32 VALV.		GA-241	
ALPINA B7	V8 4.4L FI 32 VALV. SUPER CARGADO		GA-241	
M SERIES	L6 3.2L FI 24 VALV.			
M SERIES	V10 5.0L FI 40 VALV.			
X3	6 CIL. 2.5L FI			
X3	6 CIL. 3.0L FI	G-954	GA-2114	
X5	L6 3.0L FI 24 VALV.			
X5	V8 4.8L FI 32 VALV.			
Z SERIES	L6 2.5L FI 24 VALV.	G-954	GA-2114	
Z SERIES	L6 3.0L FI 24 VALV.	G-954	GA-2114	
Z SERIES	L6 3.2L FI			
2006				
100 SERIES	6 CIL. 3.0L FI			
100 SERIES	L4 2.0L 16 VALV.			
300 SERIES	L6 2.5L FI 24 VALV.	G-954	GA-2114	GG-351
300 SERIES	L6 3.0L FI 24 VALV.	G-954		
500 SERIES	6 CIL. 3.0L FI	G-954		
500 SERIES	V8 4.4L FI			
600 SERIES	V8 4.4L FI			
700 SERIES	V12 6.0L FI 48 VALV.		GA-241	
700 SERIES	V8 4.8L FI		GA-241	
M SERIES	L6 3.2L FI 24 VALV.	G-963	GA-2114	
M SERIES	V10 5.0L FI 40 VALV.			
X3	6 CIL. 2.5L FI			
X3	6 CIL. 3.0L FI	G-954	GA-2114	
X5	6 CIL. 3.0L FI			
X5	V8 4.4L FI 32 VALV.		GAVW-622	
X5	V8 4.8L FI 32 VALV.		GAVW-622	
Z SERIES	L6 2.5L FI 24 VALV.	G-954	GA-2114	
Z SERIES	L6 3.0L FI 24 VALV.	G-954	GA-2114	
2005				
100 SERIES	L4 2.0L 16 VALV.			
300 SERIES	L6 2.5L FI 24 VALV.	G-954	GA-2114	
300 SERIES	L6 3.0L FI 24 VALV.	G-954	GA-2114	
500 SERIES	6 CIL. 3.0L FI	G-954		
500 SERIES	V8 4.4L FI 32 VALV.			
600 SERIES	V8 4.4L FI 32 VALV.			
700 SERIES	V12 6.0L FI 48 VALV.		GA-241	

Marca - Año - Modelo Make-Year-Model	Motor Engine	Aceite Oil	Aire Air	Combustible Fuel
BMW (continuación)				
700 SERIES	V8 4.4L FI 32 VALV.		GA-241	
M SERIES	L6 3.2L FI 24 VALV.		GA-2114	
X3	6 CIL. 2.5L FI	G-954	GA-2114	
X3	6 CIL. 3.0L FI	G-954	GA-2114	
X5	6 CIL. 3.0L FI	G-954	GA-2114	
X5	V8 4.4L FI 32 VALV.		GAVW-622	
X5	V8 4.8L FI 32 VALV.		GAVW-622	
Z SERIES	6 CIL. 2.5L FI	G-954	GA-2114	
Z SERIES	6 CIL. 3.0L FI	G-954	GA-2114	
2004				
100 SERIES	TODOS			
300 SERIES	6 CIL. 2.2L FI	G-954	GA-2114	GG-351
300 SERIES	L6 2.5L FI 24 VALV.	G-954	GA-2114	
300 SERIES	L6 3.0L FI 24 VALV.	G-954	GA-2114	
500 SERIES	6 CIL. 2.8L	G-954	GA-2114	GG-351
500 SERIES	6 CIL. 3.0L FI	G-954	GA-2114	
500 SERIES	V8 4.4L FI	G-984	GAVW-622	
700 SERIES	V12 6.0L FI 48 VALV.		GA-241	
700 SERIES	V8 4.4L FI		GA-241	
M SERIES	L6 3.2L FI 24 VALV.		GA-2114	
X3	6 CIL. 2.5L FI	G-954	GA-2114	
X3	6 CIL. 3.0L FI	G-954	GA-2114	
X5	6 CIL. 3.0L FI	G-954	GA-2114	
X5	V8 4.4L FI 32 VALV.	G-984	GAVW-622	
Z SERIES	6 CIL. 2.5L FI	G-954	GA-2114	
Z SERIES	6 CIL. 3.0L FI	G-954	GA-2114	
2003				
300 SERIES	6 CIL. 2.2L FI	G-954	GA-2114	GG-351
300 SERIES	L6 2.5L FI 24 VALV.	G-954	GA-2114	
300 SERIES	L6 3.0L FI 24 VALV.	G-954	GA-2114	
500 SERIES	6 CIL. 2.8L	G-954	GA-2114	GG-351
500 SERIES	L6 2.5L FI	G-954	GA-2114	
500 SERIES	V8 4.4L FI 32 VALV.	G-984	GAVW-622	
700 SERIES	V12 6.0L FI 48 VALV.		GA-241	
700 SERIES	V8 4.4L FI		GA-241	
M SERIES	L6 3.2L FI 24 VALV.		GA-2114	
M SERIES	V8 5.0L FI 32 VALV.	G-984	GAVW-622	
X5	L6 3.0L FI	G-954		
X5	V8 4.4L FI	G-984	GAVW-622	
X5	V8 4.6L FI	G-984	GAVW-622	
Z SERIES	6 CIL. 2.5L FI	G-954	GA-2114	
Z SERIES	6 CIL. 3.0L FI	G-954	GA-2114	
Z SERIES	V8 5.0L FI	G-984	GAVW-622	
2002				
300 SERIES	6 CIL. 2.2L FI	G-954	GA-2114	GG-351
300 SERIES	L6 2.5L FI 24 VALV.	G-954 ¹³ G-963 ⁷⁹	GA-2114	GG-351 ⁷⁹
300 SERIES	L6 3.0L FI 24 VALV.	G-954	GA-2114	
500 SERIES	6 CIL. 2.8L	G-954	GA-2114	GG-351
500 SERIES	L6 2.5L FI	G-954	GA-2114	
500 SERIES	V8 4.4L FI 32 VALV.	G-984	GAVW-622	GG-351
700 SERIES	V12 5.4L FI	G-984		GG-351
700 SERIES	V8 4.4L FI 32 VALV.	G-984	GA-241 ¹ GAVW-622	GG-351
M SERIES	V8 5.0L FI 32 VALV.	G-984	GAVW-622	
X5	V6 3.0L FI	G-954		
X5	V8 4.4L FI	G-984	GAVW-622	
X5	V8 4.6L FI	G-984	GAVW-622	
Z SERIES	6 CIL. 3.0L FI	G-954	GA-2114	
Z SERIES	L4 2.2L FI	G-954	GA-2114	
Z SERIES	V8 5.0L FI	G-984	GAVW-622	

Marca - Año - Modelo Make-Year-Model	Motor Engine	Aceite Oil	Aire Air	Combustible Fuel
BMW (continuación)				
2001				
300 SERIES	6 CIL. 2.2L FI	G-954	GA-2114	GG-351
300 SERIES	L6 2.5L FI 24 VALV.	G-954 ¹³ G-963 ⁷⁹	GA-2114	GG-351 ⁷⁹
300 SERIES	L6 3.0L FI 24 VALV.	G-954	GA-2114	
500 SERIES	6 CIL. 2.8L	G-954	GA-2114	GG-351
500 SERIES	L6 2.5L FI	G-954	GA-2114	
500 SERIES	V8 4.4L FI 32 VALV.	G-984	GAVW-622	GG-351
700 SERIES	V12 5.4L FI	G-984	GA-2105	GG-351
700 SERIES	V8 4.4L FI 32 VALV.	G-984	GAVW-622	GG-351
M SERIES	V8 5.0L FI 32 VALV.	G-984	GAVW-622	
X5	L6 3.0L FI	G-954		
X5	V8 4.4L FI	G-984	GAVW-622	
Z SERIES	6 CIL. 3.0L FI	G-954	GA-2114	GG-351
Z SERIES	L4 2.2L FI	G-954	GA-2114	GG-351
Z SERIES	V8 5.0L FI	G-984	GAVW-622	
2000				
300 SERIES	L6 2.5L FI 24 VALV.	G-954 ¹¹ G-963 ¹²	GA-2114	GG-351
300 SERIES	L6 2.8L FI 24 VALV.	G-954	GA-2114	GG-351
500 SERIES	L6 2.8L FI 24 VALV.	G-954	GA-2114	GG-351
500 SERIES	V8 4.4L FI 32 VALV.	G-984	GAVW-622	GG-351
700 SERIES	V12 5.4L FI	G-984	GA-2105	GG-351
700 SERIES	V8 4.4L FI 32 VALV.	G-984	GAVW-622	GG-351
M SERIES	V8 5.0L FI 32 VALV.	G-984	GAVW-622	
X5	V8 4.4L FI	G-984	GAVW-622	
Z SERIES	6 CIL. 1.9L FI	G-954	GA-2114	GG-351
Z SERIES	6 CIL. 2.2L FI	G-954	GA-2114	GG-351
Z SERIES	6 CIL. 3.0L FI	G-954	GA-2114	GG-351
Z SERIES	L6 2.8L FI 24 VALV.	G-954	GA-2114	GG-351
Z SERIES	L6 3.2L FI 24 VALV.		GA-2114	
Z SERIES	V8 5.0L FI	G-984	GAVW-622	
1999				
300 SERIES	L4 1.9L SFI 16 VALV.	G-975	GA-2193	GG-351
300 SERIES	L6 2.5L FI 24 VALV.	G-954	GA-2114	GG-351
300 SERIES	L6 2.8L FI 24 VALV.	G-954	GA-2114	GG-351
500 SERIES	L6 2.8L FI 24 VALV.	G-954	GA-2114	GG-351
500 SERIES	V8 4.4L FI 32 VALV.	G-984	GAVW-622	GG-351
700 SERIES	V12 5.4L FI	G-984	GA-2105	GG-351
700 SERIES	V8 4.4L FI 32 VALV.	G-984	GAVW-622	GG-351
M SERIES	L6 3.2L FI (VERSION EUROPEA)	G-963	GA-2114	GG-409
M SERIES	L6 3.2L FI 24 VALV.		GA-2114	
M SERIES	V8 5.0L FI 32 VALV.	G-984	GAVW-622	
Z SERIES	6 CIL. 2.2L FI	G-954	GA-2114	GG-351
Z SERIES	6 CIL. 3.0L FI	G-954	GA-2114	GG-351
Z SERIES	L4 1.9L FI	G-975	GA-2193	GG-351
Z SERIES	L6 2.8L FI 24 VALV.	G-954	GA-2114	GG-351
Z SERIES	L6 3.2L FI 24 VALV.		GA-2114	
Z SERIES	V8 5.0L FI	G-984	GAVW-622	
1998				
300 SERIES	L4 1.9L SFI	G-975	GA-2193	GG-351
300 SERIES	L6 2.5L FI 24 VALV.	G-954	GA-2114	GG-351
300 SERIES	L6 2.8L FI 24 VALV.	G-954	GA-2114	GG-351
500 SERIES	L6 2.8L FI 24 VALV.	G-954	GA-2114	GG-351
500 SERIES	V8 4.4L FI 32 VALV.	G-984	GAVW-622	GG-351
700 SERIES	V12 5.4L FI	G-984	GA-2105	GG-351
700 SERIES	V8 4.4L FI 32 VALV.	G-984	GAVW-622	GG-351
800 SERIES	V12 5.4L FI	G-984	GA-2110	GG-351
M SERIES	L6 3.2L FI (VERSION EUROPEA)	G-963	GA-2114	GG-409
M SERIES	L6 3.2L FI 24 VALV.		GA-2114	
Z SERIES	6 CIL. 2.2L FI	G-954	GA-2114	GG-351
Z SERIES	6 CIL. 3.0L FI	G-954	GA-2114	GG-351

Marca - Año - Modelo Make-Year-Model	Motor Engine	Aceite Oil	Aire Air	Combustible Fuel
BMW (continuación)				
Z SERIES	L4 1.9L FI	G-975	GA-2193	GG-351
Z SERIES	L6 2.8L FI 24 VALV.	G-954	GA-2114	GG-351
Z SERIES	L6 3.2L FI	G-963	GA-2114	GG-351
1997				
300 SERIES	L4 1.9L SFI	G-975	GA-2193	GG-351
300 SERIES	L6 2.5L FI 24 VALV.	G-963	GA-2114	GG-351
300 SERIES	L6 2.8L FI 24 VALV.	G-954	GA-2114	GG-351
500 SERIES	L6 2.8L FI 24 VALV.	G-954	GA-2114	GG-351
500 SERIES	V8 4.4L FI 32 VALV.	G-984	GAVW-622	GG-351
700 SERIES	V12 5.4L FI	G-984	GA-2105	GG-351
700 SERIES	V8 4.4L FI 32 VALV.	G-984	GAVW-622	GG-351
800 SERIES	V12 5.4L FI	G-984	GA-2110	GG-351
M SERIES	L6 3.2L FI (VERSION EUROPEA)	G-963	GA-2114	GG-409
M SERIES	L6 3.2L FI 24 VALV.		GA-2114	
Z SERIES	6 CIL. 2.2L FI	G-954	GA-2114	GG-351
Z SERIES	6 CIL. 3.0L FI	G-954	GA-2114	GG-351
Z SERIES	L4 1.9L FI	G-975	GA-2193	GG-351
Z SERIES	L6 2.8L FI 24 VALV.	G-954	GA-2114	GG-351
Z SERIES	L6 3.2L FI 24 VALV.		GA-2114	
1996				
300 SERIES	L4 1.9L EFI	G-975	GA-2193	GG-351
300 SERIES	L6 2.5L FI 24 VALV.	G-963	GA-2114	GG-351
300 SERIES	L6 2.8L FI 24 VALV.	G-954	GA-2114	GG-351
500 SERIES	6 CIL. 2.5L EFI	G-963		GG-251
500 SERIES	L6 2.8L FI 24 VALV.	G-954	GA-2114	GG-351
700 SERIES	V12 5.4L FI	G-984	GA-2105	GG-351
800 SERIES	V12 5.4L FI	G-984	GA-2110	GG-351
M SERIES	L6 3.2L FI (VERSION EUROPEA)	G-963	GA-2114	GG-409
M SERIES	L6 3.2L FI 24 VALV.		GA-2114	
Z SERIES	L4 1.9L FI	G-975	GA-2193	GG-351
Z SERIES	L6 3.2L FI 24 VALV.		GA-2114	
1995				
300 SERIES	L4 1.8L FI 16 VALV.		GA-2193	GG-351 ¹⁰
300 SERIES	L6 2.5L FI 24 VALV.	G-963	GA-2114	GG-251
700 SERIES	V12 5.4L FI	G-984	GA-2105	GG-351
800 SERIES	V12 5.4L FI	G-984	GA-2110	GG-351
M SERIES	L6 3.0L		GA-2194	
M SERIES	L6 3.2L FI (VERSION EUROPEA)	G-963	GA-2114	GG-409
1994				
300 SERIES	6 CIL. 2.5L FI	G-963	GA-2114	GG-351
1993				
300 SERIES	6 CIL. 2.5L FI	G-963	GA-2114	GG-351
BUICK				
2010				
ALLURE	L4 2.4L DI (CANADA)	G-49		
ALLURE	V6 3.0L DI (CANADA)	GP-406		
ALLURE	V6 3.6L DI (CANADA)	GP-406		
ENCLAVE	V6 3.6L FI	GP-406	GA-3083	
LACROSSE	L4 2.4L DI	G-49		
LACROSSE	V6 3.0L DI	GP-406		
LACROSSE	V6 3.6L DI	GP-406		
LUCERNE	V6 3.9L FI	GP-3675		
LUCERNE	V6 3.9L FI FLEX FUEL	GP-3675		
LUCERNE	V8 4.6L FI	GP-3675		

Para números Gonher con Superíndice vea página 38
For Gonher with Superscript numbers see page 38

Para modelos anteriores a 1990 visite nuestro sitio en internet www.grupogonher.com
For pre-1990 models, visit our Web site www.grupogonher.com

Marca - Año - Modelo Make-Year-Model	Motor Engine	Aceite Oil	Aire Air	Combustible Fuel
BUICK (continuación)				
2009				
ALLURE	V6 3.6L FI 24 VALV. DOHC (CANADA)	GP-406	GA-6479	
ALLURE	V6 3.8L FI (CANADA)	GP-46	GA-6479	
ALLURE	V8 5.3L FI (CANADA)	GP-406		
ENCLAVE	V6 3.6L FI 24 VALV. DOHC	GP-406	GA-3083	
LACROSSE	V6 3.6L FI 24 VALV. DOHC	GP-406	GA-6479	
LACROSSE	V6 3.8L FI	GP-46	GA-6479	
LACROSSE	V8 5.3L FI	GP-406		
LUCERNE	V6 3.9L FI	GP-3675	GA-367	
LUCERNE	V6 3.9L FI FLEX FUEL	GP-3675	GA-367	
LUCERNE	V8 4.6L FI 32 VALV. DOHC	GP-3675	GA-367	
2008				
ALLURE	V6 3.6L FI 24 VALV. DOHC (CANADA)	GP-406	GA-6479	
ALLURE	V6 3.8L FI (CANADA)	GP-46	GA-6479	
ALLURE	V8 5.3L FI (CANADA)	GP-406		
ENCLAVE	V6 3.6L FI 24 VALV. DOHC	GP-406	GA-3083	
LACROSSE	V6 3.6L FI 24 VALV. DOHC	GP-406	GA-6479	
LACROSSE	V6 3.8L FI 24 VALV. DOHC	GP-46	GA-6479	
LACROSSE	V8 5.3L FI	GP-406		
LUCERNE	V6 3.8L FI 24 VALV. DOHC	GP-46	GA-367	
LUCERNE	V8 4.6L FI 32 VALV. DOHC	GP-3675	GA-367	
LUCERNE	V8 5.3L FI	GP-406		
2007				
ALLURE	V6 3.6L FI 24 VALV. DOHC (CANADA)	GP-406	GA-6479	
ALLURE	V6 3.8L FI (CANADA)	GP-46	GA-6479	
LACROSSE	V6 3.6L FI 24 VALV. DOHC	GP-406	GA-6479	
LACROSSE	V6 3.8L FI 24 VALV. DOHC	GP-46	GA-6479	
RAINIER	L6 4.2L SFI	GP-3675	GA-414R	
RAINIER	V8 5.3L SFI	GP-406	GA-414R	
RENDEZVOUS	V6 3.5L FI	GP-46	GA-164	
TERRAZA	V6 3.9L FI	GP-3675	GA-164	
TERRAZA	V6 3.9L FI FLEX FUEL	GP-3675	GA-164	
2006				
ALLURE	V6 3.6L FI CANADA	GP-3675	GA-6479	GG-66
ALLURE	V6 3.8L FI CANADA	GP-46	GA-6479	GG-66
LACROSSE	V6 3.6L FI	GP-3675	GA-6479	GG-66
LACROSSE	V6 3.8L FI	GP-46	GA-6479	GG-66
RAINIER	L6 4.2L SFI	GP-3675	GA-414R	
RAINIER	V8 5.3L SFI	GP-44	GA-414R	
RENDEZVOUS	V6 3.5L SFI	GP-46	GA-164	
RENDEZVOUS	V6 3.6L VVT	GP-3675	GA-164	
TERRAZA	V6 3.5L SFI	GP-46	GA-164	
TERRAZA	V6 3.9L SFI	GP-3675	GA-164	
2005				
ALLURE	V6 3.6L FI CANADA	GP-3675	GA-6479	GG-66
ALLURE	V6 3.8L FI CANADA	GP-46	GA-6479	GG-66
CENTURY	V6 3.1L SFI	GP-46	GA-6479 ¹¹⁸	GG-66
LACROSSE	V6 3.6L FI	GP-3675	GA-6479	GG-66
LACROSSE	V6 3.8L FI	GP-46	GA-6479	GG-66
PARK AVENUE	V6 3.8L FI	GP-46	GA-6479	GG-66
RAINIER	L6 4.2L SFI	GP-3675	GA-414R	GG-209
RAINIER	V8 5.3L SFI	GP-44	GA-414R	GG-209
RENDEZVOUS	V6 3.4L SFI	GP-46	GA-164	
RENDEZVOUS	V6 3.6L SFI	GP-3675	GA-164	
TERRAZA	V6 3.5L SFI	GP-46	GA-164	
2004				
CENTURY	V6 3.1L SFI	GP-46	GA-6479 ¹¹⁸	GG-66
PARK AVENUE	V6 3.8L FI	GP-46	GA-6479	GG-66
RAINIER	L6 4.2L SFI	GP-3675	GA-414R	GG-209

Marca - Año - Modelo Make-Year-Model	Motor Engine	Aceite Oil	Aire Air	Combustible Fuel
BUICK (continuación)				
RAINIER	V8 5.3L SFI	GP-44	GA-414R	GG-209
REGAL	V6 3.8L SFI O SUPER CARGADO	GP-46	GA-6479	GG-66
RENDEZVOUS	V6 3.4L SFI	GP-46	GA-164	
RENDEZVOUS	V6 3.6L SFI	GP-3675	GA-164	
2003				
CENTURY	V6 3.1L SFI	GP-46	GA-6479 ¹¹⁸	GG-66
PARK AVENUE	V6 3.8L FI	GP-46	GA-6479	GG-66
RAINIER	L6 4.2L FI 24 VALV. DOHC VORTEC	GP-3675	GA-414R	GG-209
RAINIER	V8 5.3L FI	GP-44	GA-414R	GG-209
REGAL	V6 3.8L SFI O SUPER CARGADO	GP-46	GA-6479	GG-66
RENDEZVOUS	V6 3.4L SFI	GP-46	GA-164	GG-290
2002				
CENTURY	V6 3.1L SFI	GP-46	GA-6479 ¹¹⁸	GG-66
PARK AVENUE	V6 3.8L FI	GP-46	GA-6479	GG-66
REGAL	V6 3.8L SFI O SUPER CARGADO	GP-46	GA-6479	GG-66
RENDEZVOUS	V6 3.4L SFI	GP-46	GA-164	GG-290
2001				
CENTURY	V6 3.1L SFI	GP-46	GA-6479 ¹¹⁸	GG-66
PARK AVENUE	V6 3.8L FI	GP-46	GA-6479	GG-66
REGAL	V6 3.8L SFI O SUPER CARGADO	GP-46	GA-6479	GG-66
2000				
CENTURY	V6 3.1L SFI	GP-46	GA-6479 ¹¹⁸	GG-66
PARK AVENUE	V6 3.8L FI	GP-46	GA-6479	GG-66
REGAL	V6 3.8L SFI O SUPER CARGADO	GP-46	GA-6479	GG-66
1999				
CENTURY	V6 3.1L SFI	GP-46	GA-6479	GG-66
LESABRE	V6 3.8L FI	GP-46	GA-6479	GG-66
PARK AVENUE	V6 3.8L FI	GP-46	GA-6479	GG-66
REGAL	V6 3.8L SFI O SUPER CARGADO	GP-46	GA-6479	GG-66
1998				
CENTURY	V6 3.1L SFI	GP-46	GA-164	GG-66
LESABRE	V6 3.8L FI	GP-46	GA-6479	GG-66
PARK AVENUE	V6 3.8L FI	GP-46	GA-6479	GG-66
REGAL	V6 3.8L SFI O SUPER CARGADO	GP-46	GA-164	GG-66
1997				
CENTURY	V6 3.1L FI	GP-46	GA-164	GG-66
LESABRE	V6 3.8L FI	GP-46	GA-6479	GG-66
PARK AVENUE	V6 3.8L FI	GP-46	GA-6479	GG-66
REGAL	V6 3.8L SFI O SUPER CARGADO	GP-46	GA-164	GG-66
1996				
CENTURY	L4 2.2L FI	GP-46	GA-153	GG-256
CENTURY	V6 3.1L	GP-46	GA-253	GG-46
LESABRE	V6 3.8L FI	GP-46	GA-6479	GG-66
PARK AVENUE	V6 3.8L FI	GP-46	GA-6479	GG-66
REGAL	V6 3.1L SFI	GP-46	GA-164	GG-66
REGAL	V6 3.8L FI	GP-46	GA-164	GG-66
1995				
CENTURY	L4 2.2L FI	GP-46	GA-153	GG-256
CENTURY	V6 3.1L	GP-46	GA-253	GG-46
LESABRE	V6 3.8L FI	GP-46	GA-6479	GG-66

Marca - Año - Modelo Make-Year-Model	Motor Engine	Aceite Oil	Aire Air	Combustible Fuel
BUICK (continuación)				
PARK AVENUE	V6 3.8L FI	GP-46	GA-6479	GG-66
REGAL	V6 3.1L SFI	GP-46	GA-164	GG-66
REGAL	V6 3.8L FI	GP-46	GA-164	GG-66
1994				
CENTURY	L4 2.2L FI	GP-46	GA-153	GG-256
CENTURY	V6 3.1L	GP-46	GA-253	GG-46
LESABRE	V6 3.8L FI	GP-46	GA-6479	GG-66
PARK AVENUE	V6 3.8L FI	GP-46	GA-6479	GG-66
REGAL	V6 3.1L SFI	GP-46	GA-164	GG-66
REGAL	V6 3.8L FI	GP-46	GA-164	GG-66
1993				
CENTURY	L4 2.2L FI	GP-46	GA-153	GG-581
CENTURY	V6 3.1L	GP-46	GA-153	GG-46
CENTURY	V6 3.3L FI	GP-46	GA-3916	GG-581
LESABRE	V6 3.8L FI	GP-46	GA-6479	GG-581
PARK AVENUE	V6 3.8L FI	GP-46	GA-6479	GG-581
REGAL	V6 3.1L MFI	GP-3980	GA-6626	GG-66
REGAL	V6 3.8L SFI	GP-46	GA-253	GG-66
RIVIERA	V6 3.8L FI	GP-46	GA-3916	GG-581
ROADMASTER	V8 5.7L FI	GP-3	GA-7017	GG-581
SKYLARK	L4 2.3L FI	GP-46	GA-3916	GG-66
SKYLARK	V6 3.3L FI	GP-46	GA-3916	GG-66
1992				
CENTURY	L4 2.5L EFI		GA-3647	GG-256
CENTURY	V6 3.1L	GP-46	GA-153	GG-46
CENTURY	V6 3.3L FI	GP-46	GA-3916	GG-581
LESABRE	V6 3.8L FI	GP-46	GA-6479	GG-581
PARK AVENUE	V6 3.8L FI	GP-46	GA-6479	GG-581
REGAL	V6 3.1L MFI	GP-3980	GA-6626	GG-66
REGAL	V6 3.8L SFI	GP-46	GA-253	GG-66
RIVIERA	V6 3.8L FI	GP-46	GA-3916	GG-64
ROADMASTER	V8 5.7L FI	GP-3	GA-7017	GG-581
SKYLARK	L4 2.3L FI	GP-46	GA-3916	GG-66
SKYLARK	V6 3.3L FI	GP-46	GA-3916	GG-66
1991				
CENTURY	L4 2.5L EFI		GA-3647	GG-256
CENTURY	V6 3.1L	GP-46	GA-153	GG-46
CENTURY	V6 3.3L FI	GP-46	GA-3916	GG-256
LESABRE	V6 3.8L FI	GP-46	GA-3916	GG-46
PARK AVENUE	V6 3.8L FI	GP-46	GA-6479	GG-581
REATA	V6 3.8L SFI	GP-46	GA-3916	GG-64
REGAL	V6 3.1L MFI	GP-3980	GA-6626	GG-46
REGAL	V6 3.8L SFI	GP-46	GA-253	GG-46
RIVIERA	V6 3.8L FI	GP-46	GA-3916	GG-64
ROADMASTER	V8 5.0L FI	GP-3	GA-7017	GG-580 ⁵⁹ GG-581 ¹⁴⁷
SKYLARK	L4 2.3L MFI	GP-46	GA-3916	GG-46
SKYLARK	L4 2.5L EFI		GA-3647	GG-46
SKYLARK	V6 3.3L MFI	GP-46	GA-3916	GG-46
1990				
CENTURY	L4 2.5L EFI		GA-3647	GG-256
CENTURY	V6 2.8L FI	GP-3980	GA-153	
CENTURY	V6 3.1L	GP-46	GA-153	GG-46
CENTURY	V6 3.3L FI	GP-46	GA-3916	GG-256
ELECTRA	V6 3.8L FI	GP-46	GA-3916	GG-46
LESABRE	V6 3.8L FI	GP-46	GA-3916	GG-46
LESABRE	V8 5.0L	GP-3429	GA-59	GG-7 ¹⁵⁰ GG-17 ⁶¹
PARK AVENUE	V6 3.8L FI	GP-46	GA-3916	GG-46
REATA	V6 3.8L SFI	GP-46	GA-3916	GG-64
REGAL	V6 3.1L MFI	GP-3980	GA-6626	GG-46

Marca - Año - Modelo Make-Year-Model	Motor Engine	Aceite Oil	Aire Air	Combustible Fuel
BUICK (continuación)				
REGAL	V6 3.8L SFI	GP-46	GA-253	GG-46
RIVIERA	V6 3.8L FI	GP-46	GA-3916	GG-64
SKYLARK	L4 2.3L MFI	GP-46	GA-3916	GG-46
SKYLARK	L4 2.5L EFI		GA-3647	GG-46
SKYLARK	V6 3.3L FI	GP-46	GA-3916	GG-46
CADILLAC				
2010				
CTS	V6 3.0L DI	G-765		
CTS	V6 3.6L DI	G-765		
CTS	V8 6.2L FI	GP-406		
DTS	V8 4.6L FI	GP-3675		
ESCALADE	V8 6.2L FI	GP-406	GA-348	
ESCALADE HYBRID	V8 6.0L FI	GP-406	GA-348	
SRX	V6 2.8L FI TURBO			
SRX	V6 3.0L DI	GP-406		
STS	V6 3.6L FI	G-765		
STS	V8 4.6L FI	GP-3675		
2009				
CTS	V6 2.8L FI	G-765		
CTS	V6 3.6L FI 24 VALV. DOHC	G-765		
CTS	V8 6.2L FI	GP-406		
DTS	V8 4.6L FI 32 VALV. DOHC	GP-3675	GA-367	
ESCALADE	V8 6.2L FI FLEX FUEL	GP-406	GA-348	
ESCALADE HYBRID	V8 6.0L FI	GP-406	GA-348	
SRX	V6 3.6L FI 24 VALV. DOHC	G-765		
SRX	V8 4.6L FI 32 VALV. DOHC	GP-3675		
STS	V6 2.8L FI	G-765		
STS	V6 3.6L FI 24 VALV. DOHC (LLT) VIN V	G-765		
STS	V6 3.6L FI 24 VALV. DOHC VIN 7	G-765		
STS	V8 4.4L FI 32 VALV. DOHC	GP-68	GA-164	
STS	V8 4.6L FI 32 VALV. DOHC	GP-3675		
XLR	V8 4.4L FI 32 VALV. DOHC	GP-68	GA-1545	
XLR	V8 4.6L FI 32 VALV. DOHC	GP-3675	GA-164 ¹²⁸	
2008				
CTS	V6 2.8L FI	G-765		
CTS	V6 3.6L FI 24 VALV. DOHC	G-765		
CTS	V8 4.6L FI 32 VALV. DOHC			
DTS	V8 4.6L FI	GP-3675	GA-367	
ESCALADE	V8 6.2L SFI	GP-406	GA-348	
ESCALADE HYBRID	V8 6.0L FI	GP-406	GA-348	
SRX	V6 3.6L SFI	G-765		
SRX	V6 3.7L FI	G-765		
SRX	V8 4.6L EFI	GP-3675		
STS	V6 2.8L FI	G-765		
STS	V6 3.6L FI 24 VALV. DOHC	G-765		
STS	V8 4.4L FI 32 VALV. DOHC	GP-68		
STS	V8 4.6L FI 32 VALV. DOHC	GP-3675		
XLR	V8 4.4L SFI SUPER CAR-GADO	GP-68	GA-1545	
XLR	V8 4.6L SFI	GP-3675	GA-164 ¹²⁸	
2007				
BLS	L4 2.0L			
CTS	V6 2.8L FI 24 VALV.	G-765		
CTS	V6 3.6L FI 24 VALV.	G-765		
CTS	V8 6.0L SFI 6 VALV.	GP-406		
DTS	V8 4.6L SFI	GP-3675	GA-367	
ESCALADE	V8 6.2L SFI	GP-406	GA-348	
SRX	V6 3.6L SFI	G-765		
SRX	V8 4.6L FI	GP-3675		
STS	V6 2.8L FI	G-765		

Marca - Año - Modelo Make-Year-Model	Motor Engine	Aceite Oil	Aire Air	Combustible Fuel
CADILLAC (continuación)				
STS	V6 3.6L FI	G-765		
STS	V8 4.4L FI SUPER CARGADO	GP-68		
STS	V8 4.6L FI	GP-3675		
XLR	V8 4.2L FI 32 VALV.		GA-164	
XLR	V8 4.4L FI SUPER CARGADO	GP-68	GA-1545	
XLR	V8 4.6L SFI	GP-3675	GA-164 ¹²⁸	
2006				
CTS	V6 2.8L FI 24 VALV.	G-765		
CTS	V6 3.2L FI			
CTS	V6 3.6L FI 24 VALV.	G-765		
CTS	V8 6.0L SFI 6 VALV.	GP-44		
ESCALADE	V8 5.3L FI	GP-44	GA-348	GG-46
ESCALADE	V8 6.0L FI	GP-44	GA-348	GG-46
SRX	V6 3.6L FI	G-765		
SRX	V8 4.6L FI 32 VALV.	GP-3675		
STS	V6 2.8L FI	G-765		
STS	V6 3.6L FI 24 VALV. DOHC	G-765		
STS	V8 4.6L FI	GP-3675	GA-164	
XLR	V8 4.4L FI SUPER CARGADO	GP-68	GA-1545	
XLR	V8 4.6L FI 32 VALV.	GP-3675	GA-164	
2005				
CTS	V6 2.8L FI 24 VALV.	G-765		
CTS	V6 3.2L FI			
CTS	V6 3.6L FI 24 VALV.	G-765		
CTS	V8 5.7L SFI	GP-44		
DEVILLE	V8 4.6L FI 32 VALV.	GP-3675	GA-164	GG-66
ESCALADE	V8 5.3L FI	GP-44	GA-348	GG-46
ESCALADE	V8 6.0L FI	GP-44	GA-348	GG-46
SRX	V6 3.6L FI	G-765		
SRX	V8 4.6L FI 32 VALV.	GP-3675		
STS	V6 2.8L FI	G-765		
STS	V6 3.6L FI 24 VALV. DOHC	G-765		
STS	V8 4.6L FI	GP-3675	GA-164	
STS	V8 5.7L FI	GP-44		
XLR	V8 4.6L FI 32 VALV.	GP-3675	GA-164	GG-66
2004				
CTS	V6 3.2L FI			GG-66
CTS	V6 3.6L FI 24 VALV.	G-765		
CTS	V8 5.7L SFI	GP-44		
DEVILLE	V8 4.6L FI 32 VALV.	GP-3675	GA-164	GG-66
ESCALADE	V8 5.3L FI	GP-44	GA-348	GG-46
ESCALADE	V8 6.0L FI	GP-44	GA-348	GG-46
SEVILLE	V8 4.6L FI 32 VALV.	GP-3675	GA-164	GG-66
SRX	V6 3.6L FI	G-765		
SRX	V8 4.6L FI 32 VALV.	GP-3675		
XLR	V8 4.6L FI 32 VALV.	GP-3675	GA-164	GG-66
2003				
CTS	V6 3.2L FI			GG-66
DEVILLE	V8 4.6L FI 32 VALV.	GP-3675	GA-164	GG-66
ESCALADE	V8 5.3L FI	GP-44	GA-348	GG-46
ESCALADE	V8 6.0L FI	GP-44	GA-348	GG-46
SEVILLE	V8 4.6L FI 32 VALV.	GP-46	GA-164	GG-66
2002				
DEVILLE	V8 4.6L FI 32 VALV.	GP-3675	GA-164	GG-66
ELDORADO	V8 4.6L FI 32 VALV.	GP-3675	GA-6479	
ESCALADE	V8 5.3L FI	GP-3675	GA-348	GG-46
ESCALADE	V8 6.0L FI	GP-3675	GA-348	GG-46
SEVILLE	V8 4.6L FI 32 VALV.	GP-46	GA-164	GG-66

Marca - Año - Modelo Make-Year-Model	Motor Engine	Aceite Oil	Aire Air	Combustible Fuel
CADILLAC (continuación)				
2001				
CATERA	V6 3.0L FI 24 VALV.	G-45 ⁵² GP-46 ¹³⁶		GG-246
DEVILLE	V8 4.6L FI 32 VALV.	GP-3675	GA-164	GG-66
ELDORADO	V8 4.6L FI 32 VALV.	GP-3675	GA-6479	
ESCALADE	V8 5.3L FI	GP-3675	GA-348	GG-46
ESCALADE	V8 6.0L FI	GP-3675	GA-348	GG-46
SEVILLE	V8 4.6L FI 32 VALV.	GP-46	GA-164	GG-66
2000				
CATERA	V6 3.0L FI 24 VALV.	G-45 ⁵² GP-46 ¹³⁶		GG-246
DEVILLE	V8 4.6L FI 32 VALV.	GP-3675	GA-6479	
ELDORADO	V8 4.6L FI 32 VALV.	GP-3675	GA-6479	
ESCALADE	V8 5.7L SFI	GP-3980 ¹⁶ GP-205 ⁹	GA-673R ¹⁶³ GA-732R ¹⁶⁴	GG-46
SEVILLE	V8 4.6L FI 32 VALV.	GP-46	GA-164	GG-66
1999				
CATERA	V6 3.0L FI 24 VALV.	G-45 ⁵² GP-46 ¹³⁶	GA-145	GG-246
DEVILLE	V8 4.6L FI 32 VALV.	GP-3675	GA-6479	
ELDORADO	V8 4.6L FI 32 VALV.	GP-3675	GA-6479	
ESCALADE	V8 5.7L SFI 32 VALV.	GP-3980 ¹⁶ GP-205 ⁹	GA-673R ¹⁶³ GA-732R ¹⁶⁴	GG-46
SEVILLE	V8 4.6L FI 32 VALV.	GP-46	GA-164	GG-66
1998				
CATERA	V6 3.0L FI 24 VALV.	G-45 ⁵² GP-46 ¹³⁶	GA-145	GG-246
DEVILLE	V8 4.6L FI 32 VALV.	GP-3675	GA-6479	
ELDORADO	V8 4.6L FI 32 VALV.	GP-3675	GA-6479	
SEVILLE	V8 4.6L FI 32 VALV.	GP-3675		GG-66
1997				
CATERA	V6 3.0L FI 24 VALV.	G-45 ⁵² GP-46 ¹³⁶	GA-145	GG-246
DEVILLE	V8 4.6L FI 32 VALV.	GP-3675	GA-6479	
ELDORADO	V8 4.6L FI 32 VALV.	GP-3675	GA-6479	
SEVILLE	V8 4.6L FI 32 VALV.	GP-3675	GA-6479	
1996				
DEVILLE	V8 4.6L FI 32 VALV.	GP-3675	GA-6479	
ELDORADO	V8 4.6L FI 32 VALV.	GP-3675	GA-6479	
SEVILLE	V8 4.6L FI 32 VALV.	GP-3675	GA-6479	GG-581
1995				
CONCOURS	V8 4.9L	GP-3675	GA-6479	GG-581
DEVILLE	V8 4.6L FI 32 VALV.	GP-3675	GA-6479	
ELDORADO	V8 4.6L FI 32 VALV.	GP-3675	GA-6479	
SEVILLE	V8 4.6L FI 32 VALV.	GP-3675	GA-6479	GG-581
1994				
CONCOURS	V8 4.9L FI	GP-3675	GA-6479	GG-581
DEVILLE	V8 4.6L FI	GP-3675	GA-6479	GG-581
DEVILLE	V8 4.9L FI	GP-3675	GA-6479	GG-581
ELDORADO	V8 4.6L FI	GP-3675	GA-6479	GG-581
SEVILLE	V8 4.6L FI	GP-3675	GA-6479	GG-581
1993				
CONCOURS	V8 4.9L	GP-3675	GA-6479	GG-581
DEVILLE	V8 4.9L	GP-3675	GA-6479	GG-581
ELDORADO	V8 4.6L TPI 32 VALV.	GP-3675	GA-6479	GG-64
ELDORADO	V8 4.9L SFI 16 VALV.	GP-3675	GA-6479	GG-64
SEVILLE	V8 4.6L TPI	GP-3675	GA-6479	GG-581
SEVILLE	V8 4.9L SFI	GP-3675	GA-6479	GG-581

Marca - Año - Modelo Motor Aceite Aire Combustible
Make-Year-Model Engine Oil Air Fuel

CADILLAC (continuación)

1992

DEVILLE	V8 4.9L FI	GP-3429	GA-6479	GG-581
ELDORADO	V8 4.9L SFI	GP-3429	GA-6479	GG-64
SEVILLE	V8 4.9L SFI	GP-3429	GA-6479	GG-64

1991

BROUGHAM	V8 5.0L TBI	GP-3	GA-59 GA-100 ⁴⁵	GG-580 ⁵⁹ GG-581 ⁴⁷
BROUGHAM	V8 5.7L TBI	GP-3	GA-59 GA-100 ⁴⁵	GG-580 ⁵⁹ GG-581 ⁴⁷
DEVILLE	V8 4.9L FI	GP-3429	GA-6479	GG-581
ELDORADO	V8 4.9L SFI	GP-3429	GA-6479	GG-64
SEVILLE	V8 4.9L SFI	GP-3429	GA-6479	GG-64

1990

BROUGHAM	V8 5.0L 4BBL	GP-3429	GA-59	GG-7 ¹⁵⁰ GG-17 ⁶¹
BROUGHAM	V8 5.7L TBI	GP-3	GA-59 GA-100 ⁴⁵	GG-580 ⁵⁹ GG-581 ⁴⁷
DEVILLE	V8 4.5L SFI	GP-3429	GA-6479	GG-46
ELDORADO	V8 4.5L SFI	GP-3429	GA-6479	GG-64
SEVILLE	V8 4.5L SFI	GP-3429	GA-6479	GG-64

CHEVROLET

2010

AVALANCHE	V8 5.3L FI FLEX FUEL	GP-406	GA-348	
AVEO	L4 1.6L FI			
CAMARO	V6 3.6L FI	G-765		
CAMARO	V8 6.2L FI	GP-406		
COBALT	L4 2.0L FI TURBO			
COBALT	L4 2.2L FI			
COLORADO	5 CIL. 3.7L FI	GP-3675	GA-266	
COLORADO	L4 2.9L FI	GP-44	GA-266	
COLORADO	V8 5.3L FI	GP-406	GA-266	
CORVETTE	V8 6.2L FI	GP-406		
CORVETTE	V8 6.2L FI SUPER CARGADO			
CORVETTE	V8 7.0L FI	GP-406		
CRUZE	L4 1.4L FI DOHC TURBO			
CRUZE	L4 1.8L MFI DOHC			
EQUINOX	L4 2.4L DI			
EQUINOX	V6 3.0L DI	GP-406		
EXPRESS VAN	V6 4.3L FI	GP-46		
EXPRESS VAN	V8 4.8L FI FLEX FUEL	GP-406		
EXPRESS VAN	V8 5.3L FI FLEX FUEL	GP-406		
EXPRESS VAN	V8 6.0L FI FLEX FUEL	GP-406		
EXPRESS VAN	V8 6.6L FI TURBO DIESEL			
HHR	L4 2.0L FI TURBO			
HHR	L4 2.2L FI FLEX FUEL			
HHR	L4 2.4L FI FLEX FUEL			
IMPALA	V6 3.5L FI	GP-3675		
IMPALA	V6 3.5L FI FLEX FUEL	GP-3675		
IMPALA	V6 3.9L FI FLEX FUEL	GP-3675		
IMPALA	V8 5.3L FI	GP-406		
MALIBU	L4 2.4L FI			
MALIBU	L4 2.4L FI FLEX FUEL			
MALIBU	V6 3.5L FI	GP-3675		
MALIBU	V6 3.6L FI	GP-406		
MALIBU HYBRID	L4 2.4L FI			
SILVERADO	V6 4.3L FI	GP-46	GA-348	
SILVERADO	V8 4.8L FI FLEX-FUEL	GP-406	GA-348	
SILVERADO	V8 5.3L FI FLEX FUEL	GP-406	GA-348	
SILVERADO	V8 6.0L FI FLEX FUEL	GP-406	GA-348	
SILVERADO	V8 6.6L FI TURBO DIESEL			
SILVERADO HYBRID	V8 6.0L FI	GP-406	GA-348	
SUBURBAN	V8 5.3L FI FLEX FUEL	GP-406	GA-348	
SUBURBAN	V8 6.0L FI FLEX FUEL	GP-406	GA-348	

Marca - Año - Modelo Motor Aceite Aire Combustible
Make-Year-Model Engine Oil Air Fuel

CHEVROLET (continuación)

TAHOE	V8 4.8L FI	GP-406	GA-348	
TAHOE	V8 5.3L FI FLEX FUEL	GP-406	GA-348	
TAHOE	V8 6.2L FI	GP-406	GA-348	
TAHOE HYBRID	V8 6.0L FI	GP-406	GA-348	
TRAVERSE	V6 3.6L DI	GP-406	GA-3083	
VOLT	L4 1.4L TURBO Y MOTOR ELECTRICO			

2009

AVALANCHE	V8 5.3L FI	GP-406	GA-348	
AVALANCHE	V8 5.3L FI FLEX FUEL	GP-406	GA-348	
AVALANCHE	V8 6.0L FI	GP-406	GA-348	
AVEO	L4 1.6L FI 16 VALV. DOHC		GA-324	
CAPTIVA	L4 2.4L SFI DOHC			
CAPTIVA	V6 3.6L SFI	GP-406	GA-290	
CHEVY	L4 1.6L SFI	GP-46	GA-134	GG-64
COBALT	L4 2.0L FI 16 VALV. DOHC TURBO	G-49		
COBALT	L4 2.2L FI 16 VALV. DOHC	G-49		
COBALT	L4 2.4L FI 16 VALV. DOHC	G-49		
COLORADO	5 CIL. 3.7L FI	GP-3675	GA-266	
COLORADO	L4 2.9L FI	GP-44	GA-266	
COLORADO	V8 5.3L FI	GP-406	GA-266	
CORVETTE	V8 6.2L FI	GP-406		
CORVETTE	V8 6.2L FI SUPER CARGADO	GP-406		
CORVETTE	V8 7.0L FI	GP-406		
EPICA (CANADA)	6 CIL. 2.5L FI 24 VALV. DOHC	GP-3675		
EQUINOX	V6 3.4L FI	GP-46	GA-367	
EQUINOX	V6 3.6L FI 24 VALV. DOHC	GP-406	GA-367	
EXPRESS VAN	V6 4.3L FI	GP-46	GA-413R	
EXPRESS VAN	V8 4.8L FI	GP-406	GA-413R	
EXPRESS VAN	V8 5.3L FI	GP-406	GA-413R	
EXPRESS VAN	V8 5.3L FI FLEX FUEL	GP-406	GA-413R	
EXPRESS VAN	V8 6.0L FI	GP-406	GA-413R	
EXPRESS VAN	V8 6.6L DIESEL TURBO			
G SERIES	V6 4.3L FI	GP-46	GA-413R	
G SERIES	V8 4.8L FI	GP-406	GA-413R	
G SERIES	V8 5.3L FI	GP-406	GA-413R	
G SERIES	V8 5.3L FI FLEX FUEL	GP-406	GA-413R	
G SERIES	V8 6.0L FI	GP-406	GA-413R	
G SERIES	V8 6.6L DIESEL TURBO			
HHR	L4 2.0L FI 16 VALV. DOHC TURBO	G-49		
HHR	L4 2.2L FI DOHC FLEX FUEL	G-49		
HHR	L4 2.4L FI 16 VALV. DOHC FLEX FUEL	G-49		
IMPALA	V6 3.5L FI	GP-3675		
IMPALA	V6 3.5L FI FLEX FUEL	GP-3675		
IMPALA	V6 3.9L FI FLEX FUEL	GP-3675		
IMPALA	V8 5.3L FI	GP-406		
MALIBU	L4 2.4L FI	G-49	GA-367	
MALIBU	L4 2.4L FI 16 VALV. DOHC ECOTEC	G-49	GA-367	
MALIBU	V6 3.5L FI 24 VALV. DOHC	GP-3675	GA-367	
MALIBU	V6 3.6L FI 24 VALV. DOHC	GP-406	GA-367	
MALIBU HYBRID	L4 2.4L FI 16 VALV. DOHC	G-49	GA-367	
OPTRA	L4 2.0L FI 16 VALV. DOHC	GP-46	GA-328	GG-419
SILVERADO	V6 4.3L FI	GP-46	GA-348	
SILVERADO	V8 4.8L FI	GP-406	GA-348	
SILVERADO	V8 5.3L FI	GP-406	GA-348	
SILVERADO	V8 5.3L FI FLEX FUEL	GP-406	GA-348	
SILVERADO	V8 6.0L FI	GP-406	GA-348	
SILVERADO	V8 6.2L FI	GP-406	GA-348	
SILVERADO	V8 6.2L FI FLEX FUEL	GP-406	GA-348	
SILVERADO	V8 6.6L DIESEL TURBO			
SILVERADO HYBRID	V8 6.0L FI	GP-406	GA-348	
SUBURBAN	V8 5.3L FI	GP-406	GA-348	
SUBURBAN	V8 5.3L FI FLEX FUEL	GP-406	GA-348	

Para números Gonher con Superíndice vea página 38
For Gonher with Superscript numbers see page 38

Para modelos anteriores a 1990 visite nuestro sitio en internet www.grupogonher.com
For pre-1990 models, visit our Web site www.grupogonher.com

Marca - Año - Modelo Make-Year-Model	Motor Engine	Aceite Oil	Aire Air	Combustible Fuel
CHEVROLET (continuación)				
SUBURBAN	V8 6.0L FI	GP-406	GA-348	
TAHOE	V6 4.3L FI	GP-46	GA-348	
TAHOE	V8 4.8L FI	GP-406	GA-348	
TAHOE	V8 5.3L FI	GP-406	GA-348	
TAHOE	V8 5.3L FI FLEX FUEL	GP-406	GA-348	
TAHOE	V8 6.0L FI	GP-406	GA-348	
TAHOE	V8 6.2L FI	GP-406	GA-348	
TAHOE	V8 6.2L FI FLEX FUEL	GP-406	GA-348	
TAHOE	V8 6.6L DIESEL TURBO			
TAHOE HYBRID	V8 6.0L FI	GP-406	GA-348	
TORNADO	L4 1.8L MPFI SOHC	GP-46	GA-289	GG-64
TRAIL BLAZER	6 CIL. 4.2L FI 24 VALV. DOHC	GP-3675	GA-414R	
TRAIL BLAZER	V8 5.3L FI	GP-406	GA-414R	
TRAIL BLAZER	V8 6.0L FI	GP-406	GA-414R	
TRAVERSE	V6 3.6L DI 24 VALV. DOHC	GP-406	GA-3083	
UPLANDER	V6 3.9L FI	GP-3675	GA-164	
UPLANDER	V6 3.9L FI FLEX FUEL	GP-3675	GA-164	

2008				
ASTRA	L4 1.8L FI			
ASTRA	L4 2.0L FI			
AVALANCHE	V8 5.3L SFI	GP-406	GA-348	
AVALANCHE	V8 6.0L SFI	GP-406	GA-348	
AVEO	L4 1.6L FI 16 VALV. DOHC	GP-46	GA-324	
CAPTIVA	L4 2.4L SFI DOHC			
CAPTIVA	V6 3.6L SFI	GP-406	GA-290	
CHEVY C2	L4 1.6L SFI	GP-46	GA-134	GG-64
CHEYENNE	V8 5.3L VORTEC MFI	GP-406	GA-348	
COBALT	L4 2.0L DI 16 VALV. DOHC TURBO	G-49		
COBALT	L4 2.2L FI 16 VALV. DOHC ECOTEC	G-49		
COBALT	L4 2.4L FI 16 VALV. DOHC	G-49		
COLORADO	4 CIL. 2.9L MFI	GP-44	GA-266	
COLORADO	L5 3.7L MFI	GP-3675	GA-266	
COLORADO	V8 5.3L FI	GP-406		
CORSA	L4 1.8L MPFI SOHC	GP-46		GG-64
CORVETTE	V8 6.2L SFI	GP-406		
CORVETTE	V8 7.0L SFI	GP-406		
EPICA (CANADA)	6 CIL. 2.5L FI 24 VALV. DOHC			
EQUINOX	V6 3.4L FI	GP-46	GA-367	
EQUINOX	V6 3.6L SFI	GP-406	GA-367	
EXPRESS VAN	V6 4.3L MFI	GP-46	GA-413R	
EXPRESS VAN	V8 4.8L SFI	GP-406	GA-413R	
EXPRESS VAN	V8 5.3L SFI	GP-406	GA-413R	
EXPRESS VAN	V8 6.0L SFI	GP-406	GA-413R	
EXPRESS VAN	V8 6.6L TURBO DIESEL			
G SERIES	V6 4.3L FI	GP-46	GA-413R	
G SERIES	V8 4.8L FI	GP-406	GA-413R	
G SERIES	V8 5.3L FI FLEX FUEL	GP-406	GA-413R	
G SERIES	V8 6.0L FI	GP-406	GA-413R	
G SERIES	V8 6.6L DIESEL TURBO			
HHR	L4 2.0L FI TURBO	G-49		
HHR	L4 2.2L EFI	G-49		
HHR	L4 2.4L EFI	G-49		
IMPALA	V6 3.5L FI	GP-3675		
IMPALA	V6 3.5L FI FLEX FUEL	GP-3675		
IMPALA	V6 3.9L FI	GP-3675		
IMPALA	V6 3.9L FI FLEX FUEL	GP-3675		
IMPALA	V8 5.3L FI	GP-406		
MALIBU	L4 2.2L MFI	G-49	GA-164	
MALIBU	L4 2.4L FI 16 VALV. DOHC ECOTEC	G-49	GA-367	
MALIBU	V6 3.5L SFI	GP-3675		
MALIBU	V6 3.6L SFI	GP-406	GA-367	
MALIBU	V6 3.9L FI	GP-3675		
MALIBU HYBRID	L4 2.4L FI	G-49	GA-367	

Marca - Año - Modelo Make-Year-Model	Motor Engine	Aceite Oil	Aire Air	Combustible Fuel
CHEVROLET (continuación)				
MERIVA	L4 1.8L FI DOHC ECOTEC	GP-46	GA-289	GG-64
OPTRA	L4 2.0L FI	GP-46	GA-328	GG-419
SILVERADO	V6 4.3L MFI	GP-46	GA-348	
SILVERADO	V8 4.8L FI	GP-406	GA-348	
SILVERADO	V8 5.3L SFI	GP-406	GA-348	
SILVERADO	V8 6.0L SFI	GP-406	GA-348	
SILVERADO	V8 6.2L FI	GP-406	GA-348	
SILVERADO	V8 6.6L TURBO DIESEL			
SILVERADO HYBRID	V8 5.3L FI	GP-406	GA-348	
SUBURBAN	V6 4.3L FI	GP-46	GA-348	
SUBURBAN	V8 4.8L FI	GP-406	GA-348	
SUBURBAN	V8 5.3L SFI	GP-406	GA-348	
SUBURBAN	V8 6.0L SFI	GP-406	GA-348	
SUBURBAN	V8 6.2L FI	GP-406	GA-348	
SUBURBAN	V8 6.6L TURBO DIESEL			
TAHOE	V6 4.3L FI	GP-46	GA-348	
TAHOE	V8 4.8L SFI	GP-406	GA-348	
TAHOE	V8 5.3L SFI	GP-406	GA-348	
TAHOE	V8 6.0L FI	GP-406	GA-348	
TAHOE	V8 6.2L FI	GP-406	GA-348	
TAHOE	V8 6.6L DIESEL TURBO			
TAHOE HYBRID	V8 6.0L FI	GP-406	GA-348	
TORNADO	L4 1.8L MPFI SOHC	GP-46	GA-289	GG-64
TRACKER	L4 2.0L MFI	GP-156	GA-244	GG-206
TRAIL BLAZER	6 CIL. 4.2L SFI	GP-3675	GA-414R	
TRAIL BLAZER	V8 5.3L SFI	GP-406	GA-414R	
TRAIL BLAZER	V8 6.0L SFI	GP-406	GA-414R	
UPLANDER	V6 3.9L SFI	GP-3675	GA-164	
VECTRA	V6 2.8L SFI TURBO			

2007				
ASTRA	L4 1.8L FI			
ASTRA	L4 2.0L FI			
AVALANCHE	V8 5.3L SFI VORTEC	GP-406	GA-348	
AVALANCHE	V8 6.0L SFI	GP-406	GA-348	
AVEO	L4 1.6L FI 16 VALV. DOHC		GA-324	
CHEVY C2	L4 1.6L SFI	GP-46	GA-134	GG-64
CHEYENNE	V8 5.3L VORTEC MFI	GP-406 ¹³³ GP-3675 ¹³²	GA-348	GG-46
COBALT	L4 2.0L FI 16 VALV. DOHC	G-49		
COBALT	L4 2.2L FI 16 VALV. DOHC	G-49		
COBALT	L4 2.4L FI 16 VALV. DOHC	G-49		
COLORADO	L4 2.9L MFI DOHC	GP-44	GA-415	
COLORADO	L5 3.7L MFI DOHC	GP-3675	GA-415	
COLORADO	V8 5.3L FI	GP-406		
CORSA	L4 1.8L MPFI SOHC	GP-46		GG-64
CORVETTE	V8 6.0L SFI	GP-406	GA-164	
CORVETTE	V8 7.0L FI	GP-406		
EQUINOX	V6 3.4L FI	GP-46	GA-367	
EXPRESS VAN	V6 4.3L MFI	GP-46	GA-413R	
EXPRESS VAN	V8 4.8L SFI	GP-406 GP-44	GA-413R	
EXPRESS VAN	V8 5.3L SFI	GP-406	GA-413R	
EXPRESS VAN	V8 6.0L SFI	GP-406	GA-413R	
EXPRESS VAN	V8 6.6L FI TURBO DIESEL			
G SERIES	V6 4.3L FI	GP-46	GA-413R	
G SERIES	V8 4.8L FI	GP-406	GA-413R	
G SERIES	V8 5.3L FI	GP-406	GA-413R	
G SERIES	V8 5.3L FI FLEX FUEL	GP-406	GA-413R	
G SERIES	V8 6.0L FI	GP-406	GA-413R	
G SERIES	V8 6.6L DIESEL TURBO			
HHR	L4 2.2L SFI 16 VALV.	G-49		
HHR	L4 2.4L ECOTEC MFI ALUMINIO	G-49		
IMPALA	V6 3.5L FI	GP-3675		
IMPALA	V6 3.5L FI FLEX FUEL	GP-3675		
IMPALA	V6 3.9L FI	GP-3675		

Marca - Año - Modelo Make-Year-Model	Motor Engine	Aceite Oil	Aire Air	Combustible Fuel
CHEVROLET (continuación)				
IMPALA	V8 5.3L FI	GP-406		
KODIAK	6 CIL. 7.2L (CATERPILLAR 3126 7.2L) DIESEL TURBO ELECTRONICO	GP-51		GP-62 ³⁹ GP-1109 ⁴¹
MALIBU	L4 2.2L ECOTEC DOHC SFI	G-49	GA-164	
MALIBU	V6 3.5L SFI	GP-3675		
MALIBU	V6 3.9L SFI	GP-3675		
MERIVA	L4 1.8L FI	GP-46	GA-289	GG-64
MONTECARLO	V6 3.5L FI 24 VALV. DOHC	GP-3675		
MONTECARLO	V6 3.5L FI FLEX FUEL	GP-3675		
MONTECARLO	V6 3.9L FI	GP-3675		
MONTECARLO	V8 5.3L FI	GP-406		
OPTRA	L4 2.0L FI	GP-46	GA-328	GG-419
SILVERADO	V6 4.3L VORTEC MFI	GP-46	GA-348	GG-46
SILVERADO	V8 4.8L VORTEC MFI	GP-406	GA-348	
SILVERADO	V8 5.3L VORTEC MFI	GP-406	GA-348	
SILVERADO	V8 6.0L SFI	GP-406	GA-348	
SILVERADO	V8 6.2L FI	GP-406	GA-348	
SILVERADO	V8 6.6L TURBO DIESEL			
SILVERADO	V8 8.1L SFI	GP-408	GA-348	
SUBURBAN	V6 4.3L FI	GP-46	GA-348	GG-46
SUBURBAN	V8 4.8L FI	GP-406	GA-348	
SUBURBAN	V8 5.3L SFI	GP-406	GA-348	
SUBURBAN	V8 6.0L SFI	GP-406	GA-348	
SUBURBAN	V8 6.2L FI	GP-406	GA-348	
SUBURBAN	V8 6.6L DIESEL TURBO			
TAHOE	V6 4.3L FI	GP-46	GA-348	
TAHOE	V8 4.8L FI	GP-406	GA-348	
TAHOE	V8 5.3L SFI	GP-406	GA-348	
TAHOE	V8 6.0L FI	GP-406	GA-348	
TAHOE	V8 6.2L FI	GP-406	GA-348	
TORNADO	L4 1.8L MPFI SOHC	GP-46	GA-289	GG-64
TRACKER	L4 2.0L MFI	GP-156	GA-244	GG-206
TRAIL BLAZER	L6 4.2L SFI 24 VALV.	GP-3675	GA-414R	
TRAIL BLAZER	V8 5.3L SFI	GP-406	GA-414R	
TRAIL BLAZER	V8 6.0L SFI	GP-406	GA-414R	
UPLANDER	V6 3.9L SFI	GP-3675	GA-164	
VECTRA	V6 2.8L SFI TURBO			
ZAFIRA	L4 2.2L DI ECOTEC	G-49	GA-334	GG-64
2006				
400 SS	V8 5.3L FI			
ASTRA	L4 2.0L FI		GA-234	GG-64
ASTRA	L4 2.4L FI 16 VALV.		GA-334	GG-64
AVALANCHE	V8 5.3L FI	GP-44	GA-348	GG-46
AVALANCHE	V8 8.1L FI	GP-408	GA-348	
AVEO	L4 1.6L FI 16 VALV. DOHC	GP-46	GA-324	
CHEVY C2	L4 1.6L FI	GP-46	GA-134	GG-64
CHEYENNE	V8 4.8L FI			
CHEYENNE	V8 5.3L FI	GP-3675	GA-348	GG-46
COBALT	L4 2.0L SFI SUPER CAR-GADO	G-49		
COBALT	L4 2.2L SFI	G-49		
COBALT	L4 2.4L SFI	G-49		
COLORADO	L4 2.8L FI	GP-44	GA-415	
COLORADO	L5 3.5L FI	GP-3675	GA-415	
CORSA	L4 1.8L FI	GP-46		GG-64
CORVETTE	V8 6.0L SFI	GP-44	GA-164	
CORVETTE	V8 7.0L FI	GP-406		
EQUINOX	V6 3.4L FI	GP-46	GA-367	
EXPRESS VAN	V6 4.3L MFI	GP-46	GA-413R	
EXPRESS VAN	V8 4.8L SFI	GP-44	GA-413R	
EXPRESS VAN	V8 5.3L FI FLEX FUEL	GP-406	GA-413R	
EXPRESS VAN	V8 5.3L SFI	GP-44	GA-413R	
EXPRESS VAN	V8 6.0L FI	GP-44	GA-413R	
EXPRESS VAN	V8 6.6L FI TURBO DIESEL			
G SERIES	V6 4.3L FI	GP-46	GA-413R	

Marca - Año - Modelo Make-Year-Model	Motor Engine	Aceite Oil	Aire Air	Combustible Fuel
CHEVROLET (continuación)				
G SERIES	V8 4.8L FI	GP-44	GA-413R	
G SERIES	V8 5.3L FI	GP-44	GA-413R	
G SERIES	V8 5.3L FI FLEX FUEL	GP-406	GA-413R	
G SERIES	V8 6.0L FI	GP-44	GA-413R	
G SERIES	V8 6.6L DIESEL TURBO			
HHR	L4 2.2L FI 16 VALV. (ECOTEC)	G-49		
HHR	L4 2.4L FI	G-49		
IMPALA	V6 3.5L FI	GP-3675		
IMPALA	V6 3.5L FI FLEX FUEL	GP-3675		
IMPALA	V6 3.9L FI	GP-3675		
IMPALA	V8 5.3L FI	GP-3675		
KODIAK	6 CIL. 7.2L (CATERPILLAR 3126 7.2L) DIESEL TURBO ELECTRONICO	GP-51		GP-62 ³⁹ GP-1109 ⁴¹
LUV	L4 2.2L FI	GP-6811	GA-198	GG-167
MALIBU	L4 2.2L MFI 16 VALV.	G-49	GA-164	
MALIBU	V6 3.5L SFI	GP-46	GA-164	
MALIBU	V6 3.9L SFI	GP-3675	GA-164	
MERIVA	L4 1.8L FI	GP-46	GA-289	GG-64
OPTRA	L4 2.0L FI	GP-46	GA-328	GG-419
S10	V6 3.5L FI	GP-46		
S10	V6 3.9L FI	GP-3675		
SILVERADO	V6 4.3L MFI	GP-46	GA-348	GG-46
SILVERADO	V8 4.8L MFI	GP-44	GA-348	
SILVERADO	V8 5.3L FI	GP-44	GA-348	GG-46
SILVERADO	V8 6.0L FI	GP-44	GA-348	
SILVERADO	V8 6.6L TURBO DIESEL			
SILVERADO	V8 8.1L FI VORTEC	GP-408	GA-348	
SONORA	V8 5.7L FI	GP-205	GA-348	GG-46
SSR	V8 6.0L SFI	GP-44	GA-392	
SUBURBAN	V8 5.3L SFI	GP-44	GA-348	
SUBURBAN	V8 6.0L SFI	GP-44	GA-348	
SUBURBAN	V8 8.1L FI VORTEC	GP-408	GA-348	
TAHOE	V8 4.8L SFI	GP-44	GA-348	
TAHOE	V8 5.3L SFI	GP-44	GA-348	
TAHOE	V8 5.3L SFI BI-FUEL	GP-44	GA-348	
TORNADO	L4 1.8L FI	GP-46	GA-289	GG-64
TRACKER	L4 2.0L FI 16 VALV.	GP-156	GA-244	GG-206
TRAIL BLAZER	L6 4.2L FI	GP-3675	GA-414R	
TRAIL BLAZER	V8 5.3L SFI	GP-44	GA-414R	
TRAIL BLAZER	V8 6.0L SFI	GP-44	GA-414R	
UPLANDER	V6 3.5L FI	GP-46	GA-164	
VECTRA	L4 2.2L FI	G-49	GA-397	
VECTRA	V6 3.2L FI	G-49	GA-397	
ZAFIRA	L4 1.8L FI 16 VALV.	GP-46	GA-234	GG-64
ZAFIRA	L4 2.2L FI 16 VALV.	G-49	GA-334	GG-64
2005				
400 SS	V8 5.3L FI			
ASTRA	L4 2.0L FI	GP-46	GA-234	GG-64
ASTRA	L4 2.4L FI 16 VALV.		GA-334	GG-64
ASTRO	V6 4.3L MFI	GP-46	GA-165	GG-46
AVALANCHE	V8 5.3L FI	GP-44	GA-348	GG-46
AVALANCHE	V8 8.1L FI	GP-408	GA-348	GG-46
AVEO	L4 1.6L FI 16 VALV. DOHC	GP-46	GA-324	
BLAZER	V6 4.3L FI	GP-3980	GA-165	GG-266
CAVALIER	L4 2.2L FI	G-49	GA-3916	GG-66
CHEVY C2	L4 1.6L FI	GP-46	GA-134	GG-64
CHEYENNE	V8 5.3L FI	GP-44	GA-348	
COBALT	L4 2.0L SFI SUPER CAR-GADO	G-49	GA-414R	
COBALT	L4 2.2L SFI	G-49		
COBALT	L4 2.4L SFI	G-49		
COLORADO	L4 2.8L FI	GP-44	GA-415	GG-581
COLORADO	L5 3.5L FI	GP-3675	GA-415	GG-581
CORSA	L4 1.8L FI	GP-46	GA-289	GG-64
CORVETTE	V8 6.0L FI	GP-44	GA-164	

Para números Gonher con Superíndice vea página 38
For Gonher with Superscript numbers see page 38

Marca - Año - Modelo Make-Year-Model	Motor Engine	Aceite Oil	Aire Air	Combustible Fuel
CHEVROLET (continuación)				
EQUINOX	V6 3.4L FI	GP-46	GA-367	
EXPRESS VAN	V6 4.3L MFI	GP-46	GA-413R	GG-46 ¹³⁰ GG-66 ¹³¹
EXPRESS VAN	V8 4.8L SFI	GP-44	GA-413R	GG-46 ¹³⁰ GG-66 ¹³¹
EXPRESS VAN	V8 5.3L SFI	GP-44	GA-413R	GG-46 ¹³⁰ GG-66 ¹³¹
EXPRESS VAN	V8 6.0L FI	GP-44	GA-413R	GG-46 ¹³⁰ GG-66 ¹³¹
EXPRESS VAN	V8 6.0L FI GAS NATURAL	GP-44	GA-413R	
G SERIES	V6 4.3L FI	GP-46	GA-413R	
G SERIES	V8 4.8L FI	GP-44	GA-413R	
G SERIES	V8 5.3L FI	GP-44	GA-413R	
G SERIES	V8 6.0L FI	GP-44	GA-413R	
IMPALA	V6 3.8L FI	GP-46	GA-6479	GG-66
KODIAK	V8 8.1L FI			GG-46
KODIAK C4500	V8 8.1L FI			GG-66
KODIAK C5500	V8 8.1L FI			GG-66
LUV	L4 2.2L FI	GP-6811	GA-198	GG-167
MALIBU	L4 2.2L FI	G-49	GA-164	
MALIBU	V6 3.1L FI	GP-46	GA-164	
MERIVA	L4 1.8L FI	GP-46	GA-289	GG-64
S10	L4 2.2L FI		GA-3916	GG-66
S10	V6 3.4L FI	GP-46	GA-279	GG-66
S10	V6 3.5L FI	GP-46		
S10	V6 3.8L FI	GP-46	GA-6479	GG-66
S10	V8 4.6L FI	GP-3675	GA-164	GG-66
SILVERADO	V6 4.3L MFI	GP-46	GA-348	GG-46
SILVERADO	V8 4.8L SFI	GP-44	GA-348	GG-46
SILVERADO	V8 5.3L SFI	GP-44	GA-348	GG-46
SILVERADO	V8 6.0L FI	GP-44	GA-348	GG-46
SILVERADO	V8 6.6L TURBO DIESEL			
SILVERADO	V8 8.1L SFI VORTEC	GP-408	GA-348	GG-46
SONORA	V8 5.7L FI	GP-205	GA-348	GG-46
SSR	V8 6.0L FI	GP-44	GA-392	GG-209
SUBURBAN	V8 5.3L FI	GP-44	GA-348	GG-46
SUBURBAN	V8 5.7L FI			
SUBURBAN	V8 6.0L FI	GP-44	GA-348	GG-46
SUBURBAN	V8 8.1L FI	GP-408	GA-348	GG-46
TAHOE	V8 4.8L SFI	GP-44	GA-348	GG-46
TAHOE	V8 5.3L SFI	GP-44		GG-46
TAHOE	V8 5.3L SFI FLEX FUEL	GP-44		
TORNADO	L4 1.8L FI	GP-46	GA-289	GG-64
TRACKER	L4 2.0L FI 16 VALV.	GP-156	GA-244	GG-206
TRAIL BLAZER	L6 4.2L FI	GP-3675	GA-414R	GG-209
TRAIL BLAZER	V8 5.3L FI	GP-44	GA-414R	GG-209
UPLANDER	V6 3.5L FI	GP-46	GA-164	
VECTRA	L4 2.2L FI	G-49	GA-397	
VECTRA	V6 3.2L FI	G-49	GA-397	
VENTURE	V6 3.4L FI	GP-46	GA-164	
W3500	V8 6.0L FI	GP-44		GG-46
W4500	V8 6.0L FI	GP-44		GG-46
ZAFIRA	L4 1.8L FI 16 VALV.	GP-46	GA-234	GG-64
ZAFIRA	L4 2.2L FI 16 VALV.	G-49	GA-334	GG-64
2004				
400 SS	V8 5.3L FI			
ASTRA	L4 1.8L FI 16 VALV.	GP-46		GG-64
ASTRA	L4 2.0L FI	GP-46	GA-234	GG-64
ASTRA	L4 2.2L FI 16 VALV.	G-49	GA-334	GG-64
ASTRA	L4 2.4L FI 16 VALV.		GA-334	GG-64
ASTRO	V6 4.3L MFI	GP-46	GA-165	GG-46
AVALANCHE	V8 5.3L FI	GP-44	GA-348	GG-46
AVALANCHE	V8 8.1L FI	GP-408	GA-348	GG-46
AVEO	L4 1.6L FI 16 VALV. DOHC	GP-46	GA-324	
BLAZER	V6 4.3L FI	GP-3980	GA-165	GG-266
CAVALIER	L4 2.2L FI	G-49	GA-3916	GG-66

Marca - Año - Modelo Make-Year-Model	Motor Engine	Aceite Oil	Aire Air	Combustible Fuel
CHEVROLET (continuación)				
CHEVY C2	L4 1.6L FI	GP-46	GA-134	GG-64
CHEVY PICK-UP	L4 1.6L FI		GA-134	
CHEYENNE	V8 5.3L FI	GP-44	GA-348	
COLORADO	L4 2.8L FI	GP-44	GA-415	GG-581
COLORADO	L5 3.5L FI	GP-44	GA-415	GG-581
CORSA	L4 1.8L FI	GP-46	GA-289	GG-64
CORVETTE	V8 5.7L FI	GP-44	GA-392	GG-299
EXPRESS VAN	V6 4.3L MFI 12 VALV.	GP-46	GA-413R	GG-46
EXPRESS VAN	V8 4.8L SFI 16 VALV.	GP-44	GA-413R	GG-66
EXPRESS VAN	V8 5.3L SFI 16 VALV.	GP-44	GA-413R	GG-66
EXPRESS VAN	V8 6.0L SFI 16 VALV.	GP-44	GA-413R	GG-66
G SERIES	V6 4.3L FI	GP-46	GA-413R	GG-46
G SERIES	V8 4.8L FI	GP-44	GA-413R	
G SERIES	V8 5.3L FI	GP-44	GA-413R	
G SERIES	V8 5.3L FI FLEX FUEL	GP-44	GA-413R	GG-66 ¹³¹
G SERIES	V8 6.0L FI	GP-44	GA-413R	GG-66 ¹³¹
IMPALA	V6 3.8L FI	GP-46	GA-6479	GG-66
KODIAK	V8 8.1L FI			GG-46
LUV	L4 2.2L FI	GP-6811	GA-198	GG-167
MALIBU	L4 2.2L FI	G-49	GA-3916	GG-66
MALIBU	V6 3.1L FI	GP-46	GA-164	GG-66
MERIVA	L4 1.8L FI	GP-46	GA-289	GG-64
S10	L4 2.2L FI	G-49	GA-3916	GG-66
S10	V6 3.4L FI	GP-46	GA-279	GG-66
S10	V6 3.8L FI	GP-46	GA-6479	GG-66
S10	V8 4.6L FI	GP-3675	GA-164	GG-66
S15 ENVOY	6 CIL. 4.2L FI		GA-414R	
S15 ENVOY	V8 4.2L FI		GA-414R	
SILVERADO	V6 4.3L MFI	GP-46	GA-348	GG-46
SILVERADO	V8 4.8L SFI	GP-44	GA-348	GG-46
SILVERADO	V8 5.3L SFI	GP-44	GA-348	GG-46
SILVERADO	V8 6.0L SFI 16 VALV.	GP-44	GA-348	GG-46
SILVERADO	V8 6.6L TURBO DIESEL		GA-348	
SILVERADO	V8 8.1L SFI 16 VALV.	GP-408	GA-348	GG-46
SONORA	V8 5.7L FI	GP-205	GA-348	GG-46
SSR	V8 5.3L SFI	GP-44	GA-392	GG-209
SUBURBAN	V6 4.3L MFI	GP-46	GA-348	GG-46
SUBURBAN	V8 4.8L SFI	GP-44	GA-348	GG-46
SUBURBAN	V8 5.3L FI	GP-44	GA-348	GG-46
SUBURBAN	V8 6.0L SFI	GP-44	GA-348	GG-46
SUBURBAN	V8 8.1L SFI	GP-408	GA-348	GG-46
TAHOE	V8 4.8L FI	GP-44	GA-348	GG-46
TAHOE	V8 5.3L FI FLEX FUEL	GP-44	GA-348	GG-46
TORNADO	L4 1.8L FI	GP-46	GA-289	GG-64
TRACKER	L4 2.0L FI	GP-156	GA-244	GG-206
TRACKER	L4 2.2L FI 16 VALV.			
TRACKER	V6 2.5L FI 24 VALV.	GP-2951	GA-244	GG-206
TRAIL BLAZER	L6 4.2L FI	GP-3675	GA-414R	GG-209
TRAIL BLAZER	V8 5.3L FI	GP-44	GA-414R	GG-209
VECTRA	L4 2.2L FI	G-49	GA-397	
VECTRA	V6 3.2L FI	G-49	GA-397	
VENTURE	V6 3.4L FI	GP-46	GA-164	GG-290
ZAFIRA	L4 1.8L FI 16 VALV.	GP-46	GA-234	GG-64
ZAFIRA	L4 2.2L FI 16 VALV.	G-49	GA-334	GG-64
2003				
400 SS	V8 5.3L FI			
ASTRA	L4 1.8L FI 16 VALV.	GP-46	GA-234	GG-64
ASTRA	L4 2.2L FI 16 VALV.	G-49	GA-334	GG-64
ASTRO	V6 4.3L MFI	GP-46	GA-165	GG-46
AVALANCHE	V8 5.3L FI	GP-44	GA-348	GG-46
AVALANCHE	V8 8.1L FI	GP-408	GA-348	GG-46
BLAZER	V6 4.3L FI	GP-3980	GA-165	GG-266
CAVALIER	L4 2.2L FI	G-49	GA-3916	GG-66
CHEVY	L4 1.4L FI 78 Y	GP-46	GA-134	GG-64

Marca - Año - Modelo Make-Year-Model	Motor Engine	Aceite Oil	Aire Air	Combustible Fuel
CHEVROLET (continuación)				
CHEVY	L4 1.6L FI	GP-46	GA-134	GG-64
CHEVY MONZA	L4 1.4L FI 78 Y	GP-46	GA-134	GG-64
CHEVY MONZA	L4 1.6L FI	GP-46	GA-134	GG-64
CHEVY PICK-UP	L4 1.6L FI	GP-46	GA-134	GG-64
CHEYENNE	V8 5.3L FI	GP-44	GA-348	
CORSA	L4 1.8L FI	GP-46	GA-289	GG-64
CORVETTE	V8 5.7L FI	GP-44	GA-392	GG-299
EXPRESS VAN	V6 4.3L MFI	GP-46	GA-413R	GG-46
EXPRESS VAN	V8 4.8L SFI	GP-44	GA-413R	GG-66
EXPRESS VAN	V8 5.3L SFI	GP-44	GA-413R	GG-66
EXPRESS VAN	V8 5.7L FI	GP-205	GA-413R	GG-581
EXPRESS VAN	V8 6.0L SFI	GP-44	GA-413R	GG-46 ¹³⁰ GG-66 ¹³¹
EXPRESS VAN	V8 6.0L SFI GAS NATURAL	GP-44	GA-413R	
G SERIES	V6 4.3L FI	GP-46	GA-413R	GG-46
G SERIES	V8 4.8L FI	GP-44	GA-413R	GG-66 ¹³¹
G SERIES	V8 5.3L FI	GP-44	GA-413R	GG-66 ¹³¹
G SERIES	V8 5.7L FI	GP-205	GA-413R	GG-581
G SERIES	V8 6.0L FI	GP-44	GA-413R	GG-66 ¹³¹
G SERIES	V8 6.0L FI FLEX FUEL	GP-44	GA-413R	GG-46
G SERIES	V8 6.5L DIESEL TURBO	GP-205	GA-392	GPP-419
IMPALA	V6 3.8L FI	GP-46	GA-6479	GG-66
KODIAK	V8 8.1L FI			GG-46
LUV	L4 2.2L FI	GP-6811	GA-198	GG-167
MALIBU	V6 3.1L FI	GP-46	GA-279	GG-66
S10	L4 2.2L FI	G-49	GA-3916	GG-66
S10	V6 3.4L FI	GP-46	GA-279	GG-66
S10	V6 3.8L FI	GP-46	GA-6479	GG-66
S15 ENVOY	6 CIL. 4.2L FI		GA-414R	GG-581
S15 ENVOY	6 CIL. 5.3L FI		GA-414R	GG-581
S15 ENVOY	V8 4.2L FI		GA-414R	GG-581
S15 ENVOY	V8 5.3L FI		GA-414R	GG-581
SILVERADO	V6 4.3L MFI	GP-46	GA-348	GG-46
SILVERADO	V8 4.8L SFI	GP-44	GA-348	GG-46
SILVERADO	V8 5.3L SFI	GP-44	GA-348	GG-46
SILVERADO	V8 6.0L SFI	GP-44	GA-348	GG-46
SILVERADO	V8 6.6L TURBO DIESEL			
SILVERADO	V8 8.1L SFI	GP-408	GA-348	GG-46
SONORA	V8 5.3L FI	GP-3675	GA-348	GG-46
SONORA	V8 5.7L FI	GP-205	GA-348	GG-46
SSR	V8 5.3L EFI	GP-44	GA-392	GG-209
SUBURBAN	V6 4.3L MFI	GP-46	GA-348	GG-46
SUBURBAN	V8 4.8L SFI	GP-44	GA-348	GG-46
SUBURBAN	V8 5.3L FI	GP-44	GA-348	GG-46
SUBURBAN	V8 5.3L SFI FLEX FUEL	GP-44	GA-348	
SUBURBAN	V8 6.0L SFI	GP-44	GA-348	GG-46
SUBURBAN	V8 6.0L SFI BI-FUEL GAS NATURAL	GP-44	GA-348	
TAHOE	V8 4.8L FI	GP-44	GA-348	GG-46
TAHOE	V8 5.3L FI	GP-44	GA-348	GG-46
TAHOE	V8 5.3L FI FLEX FUEL	GP-44	GA-348	
TRACKER	L4 2.0L FI	GP-156	GA-244	GG-206
TRACKER	L4 2.2L FI 16 VALV.			
TRACKER	V6 2.5L FI 24 VALV.	GP-2951	GA-244	GG-206
TRAIL BLAZER	L6 4.2L FI	GP-3675	GA-414R	GG-209
TRAIL BLAZER	V8 5.3L FI	GP-44	GA-414R	GG-209
VECTRA	L4 2.2L FI	G-49	GA-397	
VECTRA	V6 3.2L FI	G-49	GA-397	
VENTURE	V6 3.4L FI	GP-46	GA-164	GG-290
ZAFIRA	L4 1.8L FI 16 VALV.	GP-46	GA-234	GG-64
ZAFIRA	L4 2.2L FI 16 VALV.	G-49	GA-334	GG-64
2002				
400 SS	V8 5.7L FI			
ASTRA	L4 1.8L FI 16 VALV.	GP-46	GA-234	GG-64
ASTRA	L4 2.2L FI 16 VALV.	G-49	GA-334	GG-64
ASTRO	V6 4.3L SFI	GP-46	GA-165	GG-46

Marca - Año - Modelo Make-Year-Model	Motor Engine	Aceite Oil	Aire Air	Combustible Fuel
CHEVROLET (continuación)				
AVALANCHE	V8 5.3L FI	GP-44	GA-348	GG-46
AVALANCHE	V8 8.1L FI	GP-408	GA-348	GG-46
BLAZER	L6 4.2L FI 24 VALV. DOHC	GP-3675	GA-414R	GG-209
BLAZER	V6 4.3L FI	GP-3980	GA-165	GG-266
CAMARO	V8 5.7L FI	GP-44	GA-392	GG-66
CAVALIER	L4 2.2L FI	G-49 ⁵² GP-46 ¹³⁶	GA-3916	GG-66
CHEVY	L4 1.4L FI 60 Y	GP-46	GA-134	GG-64
CHEVY	L4 1.6L FI	GP-46	GA-134	GG-64
CHEVY MONZA	L4 1.4L FI 60 Y	GP-46	GA-134	GG-64
CHEVY MONZA	L4 1.6L FI	GP-46	GA-134	GG-64
CHEVY PICK-UP	L4 1.6L FI	GP-46	GA-134	GG-64
CHEYENNE	V8 5.7L FI	GP-44	GA-348	
CORSA	L4 1.4L FI 16 VALV.	GP-46		GG-64
CORVETTE	V8 5.7L FI	GP-44	GA-392	GG-299
EXPRESS VAN	V6 4.3L SFI	GP-46	GA-413R	GG-581
EXPRESS VAN	V8 5.0L SFI	GP-205	GA-413R	GG-581
EXPRESS VAN	V8 5.7L SFI	GP-205	GA-413R	GG-581
EXPRESS VAN	V8 6.5L FI TURBO DIESEL	GP-205		GPP-419
EXPRESS VAN	V8 8.1L SFI	GP-408	GA-413R	GG-581
G SERIES	V6 4.3L FI	GP-46	GA-413R	GG-581
G SERIES	V8 5.0L FI	GP-205	GA-413R	GG-581
G SERIES	V8 5.7L FI	GP-205	GA-413R	GG-581
G SERIES	V8 5.7L FI BI-FUEL	GP-205	GA-413R	GG-581
G SERIES	V8 6.5L DIESEL TURBO	GP-205	GA-392	GPP-419
G SERIES	V8 8.1L FI	GP-408	GA-413R	GG-581
IMPALA	V6 3.8L FI	GP-46	GA-6479	GG-66
KODIAK	V8 8.1L FI		GA-732R	GG-46
LUV	L4 2.2L FI	GP-6811	GA-198	GG-167
MALIBU	L4 2.4L FI 16 VALV.			
MALIBU	V6 3.1L FI	GP-46	GA-279	GG-66
PRIZM	L4 1.8L SFI	GP-157	GA-5466	
S10	L4 2.2L FI	GP-46	GA-165	
S10	L6 4.2L FI 24 VALV. DOHC	GP-3675	GA-414R	GG-209
S15 ENVOY	6 CIL. 4.2L FI		GA-414R	GG-581
S15 ENVOY	6 CIL. 5.3L FI		GA-414R	GG-581
S15 ENVOY	V8 4.2L FI		GA-414R	GG-581
S15 ENVOY	V8 5.3L FI		GA-414R	GG-581
SILVERADO	V6 4.3L SFI	GP-46	GA-348	GG-46
SILVERADO	V8 4.8L SFI	GP-3675	GA-348	GG-46
SILVERADO	V8 5.3L SFI	GP-3675	GA-348	GG-46
SILVERADO	V8 6.0L SFI	GP-3675	GA-348	GG-46
SILVERADO	V8 6.6L TURBO DIESEL			
SILVERADO	V8 8.1L SFI	GP-408	GA-348 ⁸⁰ GA-673R ¹⁴	GG-46
SONORA	V8 5.7L FI	GP-205	GA-348	GG-46
SUBURBAN	V6 4.3L SFI O FLEX FUEL	GP-46	GA-348	GG-46
SUBURBAN	V8 4.8L SFI	GP-3675	GA-348	GG-46
SUBURBAN	V8 5.3L SFI O FLEX FUEL	GP-3675	GA-348	GG-46
SUBURBAN	V8 5.7L FI	GP-3675	GA-348	GG-46
SUBURBAN	V8 6.0L SFI	GP-3675	GA-348	GG-46
TAHOE	V6 4.3L FI	GP-46 ¹⁶³	GA-348	
TAHOE	V8 4.8L FI	GP-3675	GA-348	GG-46
TAHOE	V8 5.3L FI	GP-3675	GA-348	GG-46
TAHOE	V8 5.3L FI FLEX FUEL	GP-3675	GA-348	
TAHOE	V8 6.0L FI	GP-3675	GA-348	GG-46
TRACKER	L4 1.6L FI	GP-156	GA-244	GG-206
TRACKER	L4 2.0L FI	GP-156	GA-244	GG-206
TRACKER	L4 2.2L FI 16 VALV.			
TRACKER	V6 2.5L FI 24 VALV.	GP-2951	GA-244	GG-206
TRAIL BLAZER	L6 4.2L FI	GP-3675	GA-414R	GG-209
VENTURE	V6 3.4L FI	GP-46	GA-164	GG-290
ZAFIRA	L4 1.8L FI 16 VALV.	GP-46	GA-234	GG-64
ZAFIRA	L4 2.2L FI 16 VALV.	G-49	GA-334	GG-64
2001				
400 SS	V8 5.7L FI	GP-205	GA-348	GG-46

Marca - Año - Modelo Make-Year-Model	Motor Engine	Aceite Oil	Aire Air	Combustible Fuel
CHEVROLET (continuación)				
ASTRA	L4 1.8L FI 16 VALV.	G-45	GA-234	GG-64
ASTRA	L4 2.2L FI 16 VALV.	G-49		GG-64
ASTRO	V6 4.3L SFI	GP-46 ⁹ GP-3980 ¹⁶	GA-165	GG-46
BLAZER	L4 2.2L SFI	GP-46	GA-165	
BLAZER	V6 4.3L FI	GP-3980	GA-165	GG-266
C SERIES	V8 6.5L TURBO DIESEL	GP-205	GA-673R	
C SERIES	V8 8.1L SFI	GP-408	GA-673R	GG-46
CAMARO	V6 3.8L FI	GP-46	GA-392	GG-66
CAMARO	V8 5.7L FI	GP-44	GA-392	GG-66
CAVALIER	L4 2.2L FI	GP-46	GA-3916	GG-66
CHEVY	L4 1.4L FI	GP-46	GA-134	GG-64
CHEVY	L4 1.6L FI	GP-46	GA-134	GG-64
CHEVY MONZA	L4 1.4L FI	GP-46	GA-134	GG-64
CHEVY MONZA	L4 1.6L FI	GP-46	GA-134	GG-64
CHEVY PICK-UP	L4 1.6L FI	GP-46	GA-134	GG-64
CHEYENNE	V8 5.7L FI	GP-205	GA-348	GG-46
CORVETTE	V8 5.7L FI	GP-44	GA-392	GG-299
EXPRESS VAN	V6 4.3L SFI	GP-46	GA-413R	GG-581
EXPRESS VAN	V8 5.0L SFI	GP-205	GA-413R	GG-581
EXPRESS VAN	V8 5.7L SFI	GP-205	GA-413R	GG-581
EXPRESS VAN	V8 6.5L FI TURBO DIESEL	GP-205	GA-673R ⁷⁸	GPP-419
EXPRESS VAN	V8 8.1L FI	GP-408	GA-413R	GG-581
G SERIES	V6 4.3L FI	GP-46	GA-413R	GG-581
G SERIES	V8 5.0L FI	GP-205	GA-413R	GG-581
G SERIES	V8 5.7L FI	GP-205	GA-413R	GG-581
G SERIES	V8 6.5L DIESEL TURBO	GP-205	GA-392	GPP-419
G SERIES	V8 8.1L FI	GP-408	GA-413R	GG-581
IMPALA	V6 3.8L FI	GP-46	GA-6479	GG-66
KODIAK	V8 6.0L FI	GP-23	GA-59	GG-46
KODIAK	V8 7.0L FI	GP-23	GA-59	GG-46
LUV	L4 2.3L FI	GP-6811	GA-198	GG-167
MALIBU	L4 2.4L FI 16 VALV.			
MALIBU	V6 3.1L FI	GP-46	GA-279	GG-66
METRO	3 CIL. 1.0L FI	GP-58	GA-142	GG-146
METRO	L4 1.3L FI	GP-58		GG-146
PRIZM	L4 1.8L SFI	GP-157	GA-5466	
S10	L4 2.2L FI	GP-46	GA-165	
S10	V6 3.4L FI	GP-3980	GA-165	GG-266
SILVERADO	V6 4.3L SFI	GP-46	GA-348	GG-46
SILVERADO	V8 4.8L SFI	GP-3675	GA-348	GG-46
SILVERADO	V8 5.3L SFI	GP-3675	GA-348	GG-46
SILVERADO	V8 6.0L SFI	GP-3675	GA-348	GG-46
SILVERADO	V8 6.6L TURBO DIESEL			
SILVERADO	V8 8.1L SFI	GP-408	GA-348 ⁸⁰ GA-673R ¹⁴	GG-46
SONORA	V8 5.7L FI	GP-205	GA-348	GG-46
SUBURBAN	V6 4.3L SFI	GP-46	GA-348	GG-46
SUBURBAN	V8 4.8L SFI	GP-3675	GA-348	GG-46
SUBURBAN	V8 5.3L SFI	GP-3675	GA-348	GG-46
SUBURBAN	V8 5.7L FI	GP-3675	GA-348	GG-46
SUBURBAN	V8 6.0L SFI	GP-3675	GA-348	GG-46
TAHOE	V8 4.8L FI	GP-3675	GA-348	GG-46
TAHOE	V8 5.3L FI	GP-3675	GA-348	GG-46
TAHOE	V8 5.7L FI	GP-3980 ¹⁶ GP-205 ⁹	GA-673R ¹⁶³ GA-723R ¹⁶⁴	GG-46
TAHOE	V8 6.0L FI	GP-3675	GA-348	
TRACKER	L4 1.6L FI	GP-156	GA-244	GG-206
TRACKER	L4 2.0L FI	GP-156	GA-244	GG-206
TRACKER	L4 2.2L FI 16 VALV.			
TRACKER	V6 2.5L FI	GP-2951	GA-244	GG-206
VENTURE	V6 3.4L FI	GP-46	GA-164	GG-290
2000				
400 SS	V8 5.7L FI	GP-205	GA-348	GG-46
ASTRA	L4 1.8L FI 16 VALV.	G-45	GA-234	GG-64
ASTRA	L4 2.2L FI 16 VALV.	G-49		GG-64

Marca - Año - Modelo Make-Year-Model	Motor Engine	Aceite Oil	Aire Air	Combustible Fuel
CHEVROLET (continuación)				
ASTRO	V6 4.3L SFI	GP-3980	GA-165	GG-46
BLAZER	L4 2.2L SFI	GP-46	GA-165	GG-266 ¹⁴²
BLAZER	V6 4.3L FI	GP-3980	GA-165	GG-266
C SERIES	V8 5.7L FI	GP-3980 ¹⁶ GP-205 ⁹	GA-673R	GG-46
C SERIES	V8 6.5L DIESEL TURBO	GP-205	GA-673R	
CAMARO	V6 3.8L FI	GP-46	GA-392	GG-66
CAMARO	V8 5.7L FI	GP-44	GA-392	GG-66
CAVALIER	L4 2.2L FI	GP-46	GA-3916	GG-66
CHEVY	L4 1.4L FI	GP-46	GA-134	GG-64
CHEVY	L4 1.6L FI	GP-46	GA-134	GG-64
CHEVY MONZA	L4 1.4L FI	GP-46	GA-134	GG-64
CHEVY MONZA	L4 1.6L FI	GP-46	GA-134	GG-64
CHEVY PICK-UP	L4 1.6L FI	GP-46	GA-134	GG-64
CHEYENNE	V8 5.7L FI	GP-205	GA-348	GG-46
CORVETTE	V8 5.7L FI	GP-44	GA-392	GG-299
EXPRESS VAN	V6 4.3L SFI	GP-46	GA-392	GG-581
EXPRESS VAN	V8 5.0L SFI	GP-205		GG-581
EXPRESS VAN	V8 5.7L SFI	GP-205		GG-581
EXPRESS VAN	V8 6.5L FI TURBO DIESEL	GP-205		GPP-419
EXPRESS VAN	V8 7.4L SFI	GP-408		GG-581
G SERIES	V6 4.3L FI	GP-46 ³⁴ GP-3980 ³⁸	GA-392	GG-581
G SERIES	V8 5.0L FI	GP-205	GA-392	GG-581
G SERIES	V8 5.7L FI	GP-205	GA-392	GG-581
G SERIES	V8 6.5L TURBO DIESEL	GP-205	GA-392	GPP-419
IMPALA	V6 3.4L FI	GP-46	GA-6479	GG-66
IMPALA	V6 3.8L FI	GP-46	GA-6479	GG-66
K SERIES	V8 5.7L FI	GP-3980 ¹⁶ GP-205 ⁹	GA-673R	GG-46
K SERIES	V8 6.5L TURBO DIESEL	GP-205	GA-673R	
K SERIES	V8 7.4L FI	GP-408	GA-673R	GG-46
KODIAK	V8 6.0L FI	GP-23	GA-59	GG-46
KODIAK	V8 7.0L FI	GP-23	GA-59	GG-46
LUV	L4 2.3L FI	GP-6811	GA-198	GG-167
MALIBU	L4 2.4L FI 16 VALV.			
MALIBU	V6 3.1L FI	GP-46	GA-279	GG-66
METRO	3 CIL. 1.0L FI	GP-58	GA-142	GG-146
METRO	L4 1.3L FI	GP-58		GG-146
MOTOR 3500 (con conversion a gas)	6 CIL.		GA-250	
MOTOR 3500 (con conversion a gas)	V8		GA-259	
PRIZM	L4 1.8L SFI	GP-157	GA-5466	
S10	L4 2.2L FI	GP-46	GA-165	
S10	V6 4.3L FI	GP-3980	GA-165	GG-266
S15/T15 JIMMY	V6 4.3L FI	GP-3980	GA-165	
SILVERADO	V6 4.3L SFI	GP-46	GA-348	GG-46
SILVERADO	V8 4.8L SFI	GP-3675	GA-348	GG-46
SILVERADO	V8 5.3L SFI	GP-3675	GA-348	GG-46
SILVERADO	V8 5.7L SFI	GP-3980 ¹⁶ GP-205 ⁹	GA-673R ¹⁶³ GA-732R ¹⁶⁴	GG-46
SILVERADO	V8 6.0L SFI	GP-3675	GA-348	GG-46
SONORA	V8 5.7L FI	GP-205	GA-348	GG-46
SUBURBAN	V6 4.3L SFI	GP-46	GA-348	GG-46
SUBURBAN	V8 4.8L SFI	GP-3675	GA-348	GG-46
SUBURBAN	V8 5.3L SFI	GP-3675	GA-348	GG-46
SUBURBAN	V8 5.7L FI	GP-3980 ¹⁶ GP-205 ⁹	GA-673R ⁷⁷ GA-732R ¹¹⁰	GG-46
SUBURBAN	V8 6.0L SFI	GP-3675	GA-348	GG-46
T10 BLAZER	V6 4.3L FI	GP-3980	GA-165	
TAHOE	V8 4.8L FI	GP-3675	GA-348	GG-46
TAHOE	V8 5.3L FI	GP-3675	GA-348	GG-46
TAHOE	V8 5.7L FI	GP-3980 ¹⁶ GP-205 ⁹	GA-673R ¹⁶³ GA-723R ¹⁶⁴	GG-46
TRACKER	L4 1.6L FI	GP-156	GA-244	GG-206
TRACKER	L4 2.0L FI	GP-156	GA-244	GG-206
TRACKER	L4 2.2L FI 16 VALV.			
VENTURE	V6 3.4L FI	GP-46	GA-164	GG-290

Marca - Año - Modelo Make-Year-Model	Motor Engine	Aceite Oil	Aire Air	Combustible Fuel
CHEVROLET (continuación)				
1999				
400 SS	V8 5.7L FI	GP-205	GA-348	GG-46
400 SS	V8 7.4L FI	GP-205	GA-59	GG-46
ASTRO	V6 4.3L SFI	GP-3980	GA-165	GG-46
BLAZER	V6 4.3L FI	GP-3980	GA-165	GG-266
C SERIES	V8 5.0L FI	GP-3980 ¹⁶ GP-205 ⁹	GA-673R ¹⁶³ GA-732R ¹⁶⁴	GG-46
C SERIES	V8 5.7L FI	GP-3980 ¹⁶ GP-205 ⁹	GA-673R ¹⁶³ GA-732R ¹⁶⁴	GG-46
C SERIES	V8 6.5L DIESEL TURBO	GP-205	GA-673R	
C SERIES	V8 7.4L SFI	GP-408 ³⁶ GP-205 ³⁹	GA-673R ¹⁶³ GA-732R ¹⁶⁴	GG-46
CAMARO	V6 3.8L FI	GP-46	GA-392	GG-66
CAMARO	V8 5.7L FI	GP-44	GA-392	GG-66
CAVALIER	L4 2.2L FI	GP-46	GA-3916	GG-66
CHEVY	L4 1.4L FI	GP-46	GA-134	GG-64
CHEVY	L4 1.6L FI	GP-46	GA-134	GG-64
CHEVY MONZA	L4 1.4L FI	GP-46	GA-134	GG-64
CHEVY MONZA	L4 1.6L FI	GP-46	GA-134	GG-64
CHEVY PICK-UP	L4 1.6L FI	GP-46	GA-134	GG-64
CHEYENNE	V8 5.7L FI	GP-205	GA-348	GG-46
CORVETTE	V8 5.7L FI	GP-44	GA-392	GG-299
EXPRESS VAN	V6 4.3L FI	GP-3980		GG-581
EXPRESS VAN	V8 5.0L SFI	GP-205		GG-581
EXPRESS VAN	V8 5.7L SFI	GP-205		GG-581
EXPRESS VAN	V8 6.5L FI TURBO DIESEL	GP-205		GPP-419
EXPRESS VAN	V8 7.4L SFI	GP-408		GG-581
G SERIES	V6 4.3L SFI	GP-205		GG-581
G SERIES	V8 5.0L FI	GP-205		GG-581
G SERIES	V8 5.7L FI	GP-205		GG-581
G SERIES	V8 6.5L DIESEL TURBO	GP-205		GPP-419
K SERIES	V8 5.0L FI	GP-3980	GA-673R	GG-46
K SERIES	V8 5.7L FI	GP-3980 ¹⁶ GP-205 ⁹	GA-673R ¹⁶³ GA-732R ¹⁶⁴	GG-46
K SERIES	V8 6.5L TURBO DIESEL	GP-408 ¹⁷ GP-205 ¹⁰²	GA-673R ¹⁶³ GA-732R ¹⁶⁴	GG-46
K SERIES	V8 7.4L FI	GP-408 ¹⁷ GP-205 ¹⁰²	GA-673R ¹⁶³ GA-732R ¹⁶⁴	GG-46
KODIAK	V8 6.0L FI	GP-23	GA-59	GG-46
KODIAK	V8 7.0L FI	GP-23	GA-59	GG-46
LUV	L4 2.3L FI	GP-6811	GA-198	GG-167
MALIBU	L4 2.4L FI 16 VALV.	GP-44	GA-279	GG-66
MALIBU	V6 3.1L FI	GP-46	GA-279	GG-66
METRO	3 CIL. 1.0L FI	GP-58	GA-142	GG-146
METRO	L4 1.3L FI	GP-58		GG-146
MOTOR 3500 (con conversión a gas)	6 CIL.		GA-250	
MOTOR 3500 (con conversión a gas)	V8		GA-259	
P SERIES	V6 4.3L SFI	GP-3980		GG-46
P SERIES	V8 5.7L SFI	GP-3980		GG-46
P SERIES	V8 6.5L DIESEL	GP-205		
P SERIES	V8 6.5L TURBO DIESEL	GP-205		
P SERIES	V8 7.4L EFI	GP-205 ¹⁰²	GA-732R	GG-46
P SERIES	V8 7.4L FI	GP-205		GG-46
PRIZM	L4 1.8L SFI	GP-157	GA-5466	
S10	L4 2.2L FI	GP-46	GA-165	
S10	V6 4.3L FI	GP-3980	GA-165	GG-266
S15/T15 JIMMY	V6 4.3L FI	GP-3980	GA-165	
SAFARI	V6 4.3L FI	GP-3980	GA-165	GG-46
SILVERADO	V6 4.3L FI	GP-3980	GA-348	GG-46
SILVERADO	V8 4.8L SFI	GP-3675	GA-348	GG-46
SILVERADO	V8 5.3L SFI	GP-3675	GA-348	GG-46
SILVERADO	V8 6.0L SFI	GP-3675	GA-348	GG-46
SILVERADO	V8 6.5L TURBO DIESEL	GP-205	GA-673R	
SUBURBAN	V8 5.0L SFI	GP-3980 ¹⁶ GP-205 ⁹	GA-673R ¹⁶³ GA-732R ¹⁶⁴	GG-46

Marca - Año - Modelo Make-Year-Model	Motor Engine	Aceite Oil	Aire Air	Combustible Fuel
CHEVROLET (continuación)				
SUBURBAN	V8 5.7L FI	GP-3980 ¹⁶ GP-205 ⁹	GA-673R ¹⁶³ GA-732R ¹⁶⁴	GG-46
T10 BLAZER	V6 4.3L FI	GP-3980	GA-165	
TAHOE	V8 5.7L FI	GP-3980 ¹⁶ GP-205 ⁹	GA-723R	GG-46
TAHOE	V8 6.5L TURBO DIESEL	GP-205	GA-673R	
TIGRA	L4 1.6L FI 16 VALV.	GP-46		
TRACKER	L4 1.6L MFI	GP-58	GA-244	
TRACKER	L4 2.0L FI	GP-156	GA-244	GG-206
TRACKER	L4 2.2L FI 16 VALV.			
VENTURE	V6 3.4L FI	GP-46	GA-164	GG-290
1998				
400 SS	V8 5.7L FI	GP-3	GA-59	GG-46
400 SS	V8 7.4L FI	GP-205	GA-59	GG-46
ASTRO	V6 4.3L SFI	GP-3980	GA-165	GG-46
BLAZER	V6 4.3L FI	GP-3980	GA-165	GG-46
C SERIES	V6 4.3L SFI	GP-3980	GA-673R ¹⁶³ GA-732R ¹⁶⁴	GG-46
C SERIES	V8 5.0L FI	GP-3980 ¹⁶ GP-205 ⁹	GA-673R ¹⁶³ GA-732R ¹⁶⁴	GG-46
C SERIES	V8 5.7L FI	GP-3980 ¹⁶ GP-205 ⁹	GA-673R ¹⁶³ GA-732R ¹⁶⁴	GG-46
C SERIES	V8 6.5L DIESEL TURBO	GP-205	GA-673R	
C SERIES	V8 7.4L FI	GP-205	GA-673R ¹⁶³ GA-732R ¹⁶⁴	GG-46
CAMARO	V6 3.8L FI	GP-46	GA-392	GG-66
CAMARO	V8 5.7L FI	GP-44	GA-392	GG-66
CAVALIER	L4 2.2L FI	GP-46	GA-3916	GG-66
CHEVY	L4 1.4L FI	GP-46	GA-134	GG-64
CHEVY	L4 1.6L FI	GP-46	GA-134	GG-64
CHEVY MONZA	L4 1.4L FI	GP-46	GA-134	GG-64
CHEVY MONZA	L4 1.6L FI	GP-46	GA-134	GG-64
CHEVY PICK-UP	L4 1.6L FI	GP-46	GA-134	GG-64
CHEYENNE	V8 5.7L FI	GP-3	GA-59	GG-46
CORVETTE	V8 5.7L FI	GP-44	GA-392	
EXPRESS VAN	V6 4.3L SFI	GP-3980		GG-581
EXPRESS VAN	V8 5.0L SFI	GP-205		GG-581
EXPRESS VAN	V8 5.7L SFI	GP-205		GG-581
EXPRESS VAN	V8 6.5L FI TURBO DIESEL	GP-205		GPP-419
EXPRESS VAN	V8 7.4L SFI	GP-205		GG-581
G SERIES	V6 4.3L SFI	GP-205		GG-581
G SERIES	V8 5.0L FI	GP-205		GG-581
G SERIES	V8 5.7L FI	GP-205		GG-581
G SERIES	V8 6.5L DIESEL TURBO	GP-205		GPP-419
G SERIES	V8 7.4L FI	GP-205		GG-581
K SERIES	V6 4.3L FI	GP-3980	GA-673R ¹⁶³ GA-732R ¹⁶⁴	GG-46
K SERIES	V8 5.0L FI	GP-3980 ¹⁶ GP-205 ⁹	GA-673R ¹⁶³ GA-732R ¹⁶⁴	GG-46
K SERIES	V8 5.7L FI	GP-3980 ¹⁶ GP-205 ⁹	GA-673R ¹⁶³ GA-732R ¹⁶⁴	GG-46
K SERIES	V8 6.5L TURBO DIESEL	GP-205	GA-673R	
K SERIES	V8 7.4L FI	GP-205	GA-673R ¹⁶³ GA-732R ¹⁶⁴	GG-46
KODIAK	V8 6.0L FI	GP-23	GA-59	GG-46
KODIAK	V8 7.0L FI	GP-23	GA-59	GG-46
LUV	L4 2.3L FI	GP-6811	GA-139	GG-46
MALIBU	L4 2.4L FI 16 VALV.	GP-44	GA-279	GG-66
MALIBU	V6 3.1L FI	GP-46	GA-279	GG-66
METRO	3 CIL. 1.0L FI	GP-58	GA-142	GG-146
METRO	L4 1.3L FI	GP-58		GG-146
MOTOR 3500 (con conversión a gas)	6 CIL.		GA-250	
MOTOR 3500 (con conversión a gas)	V8		GA-259	
P SERIES	V6 4.3L SFI	GP-3980		GG-46
P SERIES	V8 5.7L SFI	GP-3980		GG-46
P SERIES	V8 6.5L DIESEL	GP-205		
P SERIES	V8 6.5L TURBO DIESEL	GP-205		
P SERIES	V8 7.4L SFI	GP-205		GG-46
P SERIES	V8 7.4L FI	GP-205		GG-46
PRIZM	L4 1.8L SFI	GP-157	GA-5466	
S10	L4 2.2L FI	GP-46	GA-165	
S10	V6 4.3L FI	GP-3980	GA-165	GG-266
S15/T15 JIMMY	V6 4.3L FI	GP-3980	GA-165	
SAFARI	V6 4.3L FI	GP-3980	GA-165	GG-46
SILVERADO	V6 4.3L FI	GP-3980	GA-348	GG-46
SILVERADO	V8 4.8L SFI	GP-3675	GA-348	GG-46
SILVERADO	V8 5.3L SFI	GP-3675	GA-348	GG-46
SILVERADO	V8 6.0L SFI	GP-3675	GA-348	GG-46
SILVERADO	V8 6.5L TURBO DIESEL	GP-205	GA-673R	
SUBURBAN	V8 5.0L SFI	GP-3980 ¹⁶ GP-205 ⁹	GA-673R ¹⁶³ GA-732R ¹⁶⁴	GG-46

Para números Gonher con Superíndice vea página 38
For Gonher with Superscript numbers see page 38

Para modelos anteriores a 1990 visite nuestro sitio en internet www.grupogonher.com
For pre-1990 models, visit our Web site www.grupogonher.com

Marca - Año - Modelo Make-Year-Model	Motor Engine	Aceite Oil	Aire Air	Combustible Fuel
CHEVROLET (continuación)				
P SERIES	V8 7.4L EFI	GP-205	GA-732R	GG-46
P SERIES	V8 7.4L FI	GP-205		GG-46
PRIZM	L4 1.8L SFI	GP-157	GA-5466	
S10	L4 2.2L FI	GP-46	GA-165	GG-46
S15/T15 JIMMY	V6 4.3L FI	GP-3980	GA-165	
SAFARI	V6 4.3L FI	GP-3980	GA-165	GG-46
SILVERADO	V8 5.7L FI	GP-205	GA-59	GG-46
SUBURBAN	V6 4.3L SFI	GP-3980	GA-673R ⁷⁷ GA-732R ¹⁰	GG-46
SUBURBAN	V8 5.0L SFI	GP-3980 ¹⁶ GP-205 ⁹	GA-673R ⁷⁷ GA-732R ¹⁰	GG-46
SUBURBAN	V8 5.7L FI	GP-3980 ¹⁶ GP-205 ⁹	GA-673R ⁷⁷ GA-732R ¹⁰	GG-46
SUBURBAN	V8 6.5L TURBO DIESEL	GP-205	GA-673R ⁷⁷	
SUBURBAN	V8 7.4L SFI	GP-205	GA-673R ⁷⁷ GA-732R ¹⁰	GG-46
T10 BLAZER	V6 4.3L FI	GP-3980	GA-165	
TAHOE	V8 5.7L FI	GP-3980 ¹⁶ GP-205 ⁹	GA-673R ¹⁶³ GA-732R ¹⁶⁴	GG-46
TAHOE	V8 6.5L TURBO DIESEL	GP-205	GA-673R	
TRACKER	L4 1.6L FI	GP-58		GG-151
VENTURE	V6 3.4L FI	GP-46	GA-164	GG-290
1997				
400 SS	V8 5.7L FI	GP-3	GA-59	GG-46
400 SS	V8 7.4L FI	GP-205	GA-59	GG-46
ASTRO	V6 4.3L SFI	GP-3980	GA-165	GG-46
BLAZER	V6 4.3L FI	GP-3980	GA-165	GG-46
C SERIES	V6 4.3L SFI	GP-3980	GA-673R ¹⁶³ GA-732R ¹⁶⁴	GG-46
C SERIES	V8 5.0L FI	GP-3980 ¹⁶ GP-205 ⁹	GA-673R ¹⁶³ GA-732R ¹⁶⁴	GG-46
C SERIES	V8 5.7L FI	GP-3980 ¹⁶ GP-205 ⁹	GA-673R ¹⁶³ GA-732R ¹⁶⁴	GG-46
C SERIES	V8 6.5L DIESEL TURBO	GP-205	GA-673R	
C SERIES	V8 7.4L FI	GP-205	GA-673R ¹⁶³ GA-732R ¹⁶⁴	GG-46
CAMARO	V6 3.8L FI	GP-46	GA-165	GG-66
CAMARO	V8 5.7L FI	GP-3	GA-165	GG-66
CAVALIER	L4 2.2L FI	GP-46	GA-3916	GG-66
CAVALIER	L4 2.4L FI 16 VALV.	GP-44	GA-3916	GG-66
CHEVY	L4 1.4L FI	GP-46	GA-134	GG-64
CHEVY	L4 1.6L FI	GP-46	GA-134	GG-64
CHEVY MONZA	L4 1.4L FI	GP-46	GA-134	GG-64
CHEVY MONZA	L4 1.6L FI	GP-46	GA-134	GG-64
CHEVY PICK-UP	L4 1.6L FI	GP-46	GA-134	GG-64
CHEVY VAN C-20	V6 4.3L FI	GP-3980		GG-46
CHEYENNE	V8 5.7L FI	GP-3	GA-59	GG-46
CONCOURS	V8 4.6L FI	GP-3675	GA-6479	GG-581
CORVETTE	V8 5.7L FI	GP-44	GA-392	
CUTLASS	V6 3.1L SFI	GP-46	GA-164 ⁶⁵ GA-279	GG-66
EUROSPORT	V6 3.1L FI	GP-46	GA-153	GG-46
EXPRESS VAN	V6 4.3L SFI	GP-3980		GG-581
EXPRESS VAN	V8 5.0L SFI	GP-205		GG-581
EXPRESS VAN	V8 5.7L SFI	GP-205		GG-581
EXPRESS VAN	V8 6.5L FI TURBO DIESEL	GP-205		GPP-419
EXPRESS VAN	V8 7.4L SFI	GP-205		GG-581
G SERIES	V6 4.3L SFI	GP-205		GG-581
G SERIES	V8 5.0L FI	GP-205		GG-581
G SERIES	V8 5.7L FI	GP-205		GG-581
G SERIES	V8 6.5L DIESEL TURBO	GP-205		GPP-419
G SERIES	V8 7.4L FI	GP-205		GG-581
GEO TRACKER	L4 1.6L FI	GP-58		GG-151
K SERIES	V6 4.3L FI	GP-3980	GA-673R ¹⁶³ GA-732R ¹⁶⁴	GG-46
K SERIES	V8 5.0L FI	GP-3980 ¹⁶ GP-205 ⁹	GA-673R ¹⁶³ GA-732R ¹⁶⁴	GG-46
K SERIES	V8 5.7L FI	GP-3980 ¹⁶ GP-205 ⁹	GA-673R ¹⁶³ GA-732R ¹⁶⁴	GG-46

Marca - Año - Modelo Make-Year-Model	Motor Engine	Aceite Oil	Aire Air	Combustible Fuel
CHEVROLET (continuación)				
K SERIES	V8 6.5L TURBO DIESEL	GP-205	GA-673R	
K SERIES	V8 7.4L FI	GP-205	GA-673R ¹⁶³ GA-732R ¹⁶⁴	GG-46
KODIAK	V8 6.0L FI	GP-23	GA-59	GG-46
KODIAK	V8 7.0L FI	GP-23	GA-59	GG-46
LUMINA	V6 3.1L FI	GP-46	GA-164	GG-66
LUMINA	V6 3.4L FI 24 VALV.	GP-46	GA-164	GG-66
LUV	L4 2.3L FI	GP-6811	GA-139	GG-46
MALIBU	L4 2.4L FI 16 VALV.	GP-44	GA-279	GG-66
MALIBU	V6 3.1L FI	GP-46	GA-279	GG-66
MOTOR 3500 (con conversion a gas)	6 CIL.		GA-250	
MOTOR 3500 (con conversion a gas)	V8		GA-259	
P SERIES	V6 4.3L SFI	GP-3980		GG-46
P SERIES	V8 5.7L SFI	GP-3980		GG-46
P SERIES	V8 6.5L DIESEL	GP-205		
P SERIES	V8 6.5L TURBO DIESEL	GP-205		
P SERIES	V8 7.4L FI	GP-205		GG-46
P SERIES	V8 7.4L TBI	GP-205	GA-59	GG-46
ROADMASTER	V8 5.7L FI	GP-46	GA-6479	GG-581
ROYALE LS	V6 3.8L FI	GP-46	GA-6479	GG-66
S10	L4 2.2L FI	GP-46	GA-165	GG-46
S15/T15 JIMMY	V6 4.3L FI	GP-3980	GA-165	
SAFARI	V6 4.3L FI	GP-3980	GA-165	GG-46
SILVERADO	V8 5.7L FI	GP-205	GA-59	GG-46
SUBURBAN	V6 4.3L SFI	GP-3980	GA-673R ⁷⁷ GA-732R ¹⁰	GG-46
SUBURBAN	V8 5.0L SFI	GP-3980 ¹⁶ GP-205 ⁹	GA-673R ⁷⁷ GA-732R ¹⁰	GG-46
SUBURBAN	V8 5.7L FI	GP-3980 ¹⁶ GP-205 ⁹	GA-673R ⁷⁷ GA-732R ¹⁰	GG-46
SUBURBAN	V8 6.5L TURBO DIESEL	GP-205	GA-673R ⁷⁷	
SUBURBAN	V8 7.4L SFI	GP-205	GA-673R ⁷⁷ GA-732R ¹⁰	GG-46
T10 BLAZER	V6 4.3L FI	GP-3980	GA-165	
TAHOE	V8 5.7L FI	GP-3980 ¹⁶ GP-205 ⁹	GA-673R ¹⁶³ GA-732R ¹⁶⁴	GG-46
TAHOE	V8 6.5L TURBO DIESEL	GP-205	GA-673R	
VENTURE	V6 3.4L FI	GP-46	GA-164	GG-290
1996				
400 SS	V8 5.7L FI	GP-3	GA-59	GG-46
400 SS	V8 7.4L FI	GP-205	GA-59	GG-46
ASTRO	V6 4.3L FI	GP-3980	GA-165	GG-255
BLAZER	V6 4.3L FI	GP-3980	GA-165	GG-3728
C SERIES	V6 4.3L SFI	GP-3980	GA-673R ¹⁶³ GA-732R ¹⁶⁴	GG-46
C SERIES	V8 5.0L FI	GP-3980 ¹⁶ GP-205 ⁹	GA-673R ¹⁶³ GA-732R ¹⁶⁴	GG-46
C SERIES	V8 5.7L FI	GP-3980 ¹⁶ GP-205 ⁹	GA-673R ¹⁶³ GA-732R ¹⁶⁴	GG-46
C SERIES	V8 6.5L DIESEL TURBO	GP-205		
C SERIES	V8 7.4L FI	GP-205	GA-673R ¹⁶³ GA-732R ¹⁶⁴	GG-46
CAMARO	V6 3.8L FI	GP-46	GA-165	GG-66
CAMARO	V8 5.7L FI	GP-3	GA-165	GG-66
CAVALIER	L4 2.2L FI	GP-46	GA-3916	GG-66
CAVALIER	L4 2.4L FI 16 VALV.	GP-44	GA-3916	GG-66
CHEVY	L4 1.4L FI	GP-46	GA-134	GG-64
CHEVY	L4 1.6L FI	GP-46	GA-134	GG-64
CHEVY MONZA	L4 1.4L FI	GP-46	GA-134	GG-64
CHEVY MONZA	L4 1.6L FI	GP-46	GA-134	GG-64
CHEVY PICK-UP	L4 1.6L FI	GP-46	GA-134	GG-64
CHEVY VAN	V6 4.1L FI	GP-3980	GA-192	GG-46
CHEVY VAN C-20	V6 4.3L FI	GP-3980		GG-46
CHEYENNE	V8 5.7L FI	GP-3	GA-59	GG-46
CONCOURS	V8 4.6L FI	GP-3675	GA-6479	GG-581
CORVETTE	V8 5.7L FI	GP-3	GA-7007	GG-46

Marca - Año - Modelo Make-Year-Model	Motor Engine	Aceite Oil	Aire Air	Combustible Fuel
CHEVROLET (continuación)				
CUTLASS	V6 3.1L FI	GP-46	GA-253	GG-3728
CUTLASS EUROSPO	V6 3.0L FI	GP-46	GA-153	GG-41
CUTLASS EUROSPO	V6 3.1L FI	GP-46	GA-253	GG-3728
EUROSPORT	V6 3.1L FI	GP-46	GA-153	GG-46
G SERIES	V6 4.3L EFI	GP-3980	GA-192	GG-46
G SERIES	V6 4.3L SFI	GP-3980		GG-581
G SERIES	V8 5.0L FI	GP-205		GG-581
G SERIES	V8 5.7L FI	GP-205	GA-192	GG-46
G SERIES	V8 5.7L SFI	GP-205		GG-581
G SERIES	V8 6.5L DIESEL	GP-205		
G SERIES	V8 6.5L DIESEL TURBO	GP-205		GPP-419
G SERIES	V8 7.4L EFI	GP-205	GA-59	GG-46
G SERIES	V8 7.4L SFI	GP-205		GG-581
GEO TRACKER	L4 1.6L FI	GP-58	GA-166	GG-151
K SERIES	V6 4.3L FI	GP-3980	GA-673R ¹⁶³ GA-732R ¹⁶⁴	GG-46
K SERIES	V8 5.0L FI	GP-3980 ¹⁶ GP-205 ⁹	GA-673R ¹⁶³ GA-732R ¹⁶⁴	GG-46
K SERIES	V8 5.7L FI	GP-3980 ¹⁶ GP-205 ⁹	GA-673R ¹⁶³ GA-732R ¹⁶⁴	GG-46
K SERIES	V8 6.5L TURBO DIESEL	GP-205		
K SERIES	V8 7.4L FI	GP-205	GA-673R ¹⁶³ GA-732R ¹⁶⁴	GG-46
KODIAK	V8 6.0L FI	GP-23	GA-59	GG-46
KODIAK	V8 7.0L FI	GP-23	GA-59	GG-46
LUMINA	V6 3.4L FI	GP-46	GA-3916	GG-581
P SERIES	V6 4.3L SFI	GP-3980		GG-46
P SERIES	V8 5.7L SFI	GP-3980		GG-46
P SERIES	V8 6.5L DIESEL	GP-205		
P SERIES	V8 6.5L TURBO DIESEL	GP-205		
P SERIES	V8 7.4L EFI	GP-205	GA-59	GG-46
P SERIES	V8 7.4L SFI	GP-205		GG-46
ROADMASTER	V8 5.7L FI	GP-46	GA-6479	GG-581
ROYALE LS	V6 3.8L FI	GP-46	GA-6479	GG-66
S10	L4 2.2L FI	GP-46	GA-165	GG-46
S15/T15 JIMMY	L4 2.2L FI (4)	GP-46	GA-165	GG-46
S15/T15 JIMMY	V6 4.3L FI	GP-3980	GA-165	GG-46
SAFARI	V6 4.3L FI	GP-3980	GA-165	GG-255
SILVERADO	V8 5.7L FI	GP-205	GA-59	GG-46
SUBURBAN	V8 5.7L FI	GP-3980 ¹⁶ GP-205 ⁹	GA-673R ⁷⁷ GA-732R ¹¹⁰	GG-46
SUBURBAN	V8 6.5L TURBO DIESEL	GP-205		
SUBURBAN	V8 7.4L SFI	GP-205	GA-673R ⁷⁷ GA-732R ¹¹⁰	GG-46
T10 BLAZER	L4 2.2L FI	GP-46	GA-165	GG-46
T10 BLAZER	V6 4.3L FI	GP-3980	GA-165	GG-46
TAHOE	V8 5.7L FI	GP-3980 ¹⁶ GP-205 ⁹	GA-673R ¹⁶³ GA-732R ¹⁶⁴	GG-46
TAHOE	V8 6.5L TURBO DIESEL	GP-205		
1995				
400 SS	V8 5.7L FI	GP-3	GA-59	GG-46
400 SS	V8 7.4L	GP-205	GA-59	GG-46
ASTRO	V6 4.3L	GP-3980	GA-165	GG-255
BLAZER	V6 4.3L FI	GP-3980	GA-165	GG-3728
C SERIES	V6 4.3L EFI	GP-3980	GA-192	GG-46
C SERIES	V8 5.0L FI	GP-3980 ¹⁶ GP-205 ⁹	GA-59	GG-46
C SERIES	V8 5.7L FI	GP-3980 ¹⁶ GP-205 ⁹	GA-59	GG-46
C SERIES	V8 6.5L DIESEL	GP-205		
C SERIES	V8 6.5L DIESEL TURBO	GP-205		
C SERIES	V8 7.4L FI	GP-205	GA-59	GG-46
CAMARO	V6 3.4L FI	GP-46	GA-165	GG-66
CAMARO	V8 5.7L FI	GP-3	GA-165	GG-66
CAVALIER	L4 2.2L FI	GP-46	GA-3916	GG-66
CAVALIER	L4 2.3L FI 16 VALV.	GP-46	GA-3916	GG-66
CAVALIER Z-24	L4 2.4L FI 16 VALV.	GP-46	GA-3916	GG-66
CHEVY	L4 1.4L FI	GP-46	GA-134	GG-64

Marca - Año - Modelo Make-Year-Model	Motor Engine	Aceite Oil	Aire Air	Combustible Fuel
CHEVROLET (continuación)				
CHEVY MONZA	L4 1.4L FI	GP-46	GA-134	GG-64
CHEVY VAN	V6 4.1L	GP-3980	GA-192	GG-46
CHEVY VAN C-20	V6 4.3L	GP-3980		GG-46
CHEYENNE	V8 5.7L FI	GP-3	GA-59	GG-46
CONCOURS	V8 4.6L FI	GP-3675	GA-6479	GG-581
CORVETTE	V8 5.7L FI	GP-3	GA-7007	GG-46
CUTLASS	V6 3.1L FI	GP-46	GA-253	GG-3728
CUTLASS EUROSPO	V6 3.0L FI	GP-46	GA-153	GG-41
CUTLASS EUROSPO	V6 3.1L FI	GP-46	GA-253	GG-3728
EUROSPORT	V6 3.1L FI	GP-46	GA-153	GG-46
G SERIES	V6 4.3L EFI	GP-3980	GA-192	GG-46
G SERIES	V8 5.0L FI	GP-205	GA-192	GG-46
G SERIES	V8 5.7L FI	GP-205	GA-192	GG-46
G SERIES	V8 6.5L DIESEL	GP-205		
G SERIES	V8 7.4L FI	GP-205	GA-59	GG-46
GEO TRACKER	L4 1.6L FI	GP-58	GA-166	GG-151
K SERIES	V6 4.3L FI	GP-3980	GA-192	GG-46
K SERIES	V8 5.0L FI	GP-3980 ¹⁶ GP-205 ⁹	GA-59	GG-46
K SERIES	V8 5.7L FI	GP-3980 ¹⁶ GP-205 ⁹	GA-59	GG-46
K SERIES	V8 6.5L DIESEL	GP-205		
K SERIES	V8 6.5L TURBO DIESEL	GP-205		
K SERIES	V8 7.4L FI	GP-205	GA-59	GG-46
K SERIES	V8 7.4L SFI	GP-205		GG-46
KODIAK	V8 6.0L FI	GP-23	GA-59	GG-46
KODIAK	V8 7.0L FI	GP-23	GA-59	GG-46
LUMINA	V6 3.8L FI	GP-46	GA-3916	GG-177
P SERIES	V6 4.3L EFI	GP-3980	GA-192	GG-46
P SERIES	V8 5.0L EFI	GP-205	GA-192	GG-46
P SERIES	V8 5.7L EFI	GP-205	GA-192	GG-46
P SERIES	V8 6.5L DIESEL	GP-205		
P SERIES	V8 6.5L TURBO DIESEL	GP-205		
P SERIES	V8 7.4L EFI	GP-205	GA-59	GG-46
ROADMASTER	V8 5.7L	GP-46	GA-6479	GG-581
ROYALE LS	V6 3.8L	GP-46	GA-6479	GG-66
S10	L4 2.2L FI	GP-46	GA-165	GG-46
S15/T15 JIMMY	L4 2.2L FI (4)	GP-46	GA-165	GG-46
S15/T15 JIMMY	V6 4.3L	GP-3980	GA-165	GG-46
S15/T15 JIMMY	V6 4.3L FI	GP-3980	GA-3588	GG-46
SAFARI	V6 4.3L	GP-3980	GA-165	GG-255
SILVERADO	V8 5.7L FI	GP-205	GA-59	GG-46
SUBURBAN	V8 5.7L FI	GP-3980 ¹⁶ GP-205 ⁹	GA-59	GG-46
SUBURBAN	V8 6.5L TURBO DIESEL	GP-205		
SUBURBAN	V8 7.4L EFI	GP-205	GA-59	GG-46
T10 BLAZER	L4 2.2L FI	GP-46	GA-165	GG-46
T10 BLAZER	V6 4.3L	GP-3980	GA-165	GG-46
T10 BLAZER	V6 4.3L FI	GP-3980	GA-3588	GG-46
TAHOE	V8 5.7L FI	GP-3980 ¹⁶ GP-205 ⁹	GA-59	GG-46
TAHOE	V8 6.5L TURBO DIESEL	GP-205		
TRACKER	L4 1.6L FI	GP-58	GA-166	GG-151
1994				
400 SS	V8 5.7L FI	GP-3	GA-59	GG-46
400 SS	V8 7.4L	GP-205	GA-59	GG-46
ASTRO	V6 4.3L	GP-3980	GA-165	GG-255
BLAZER	V6 3.0L		GA-3588	GG-3728
BLAZER	V6 3.1L	GP-46	GA-3588	GG-3728
BLAZER	V8 5.7L FI	GP-3980 ¹⁶ GP-205 ⁹	GA-59	GG-46
BLAZER	V8 6.5L DIESEL	GP-205		
BLAZER	V8 6.5L TURBO DIESEL	GP-205		
C SERIES	V6 4.3L EFI	GP-3980	GA-192	GG-46
C SERIES	V8 5.0L FI	GP-3980 ¹⁶ GP-205 ⁹	GA-59	GG-46
C SERIES	V8 5.7L FI	GP-3980 ¹⁶ GP-205 ⁹	GA-59	GG-46

Marca - Año - Modelo Make-Year-Model	Motor Engine	Aceite Oil	Aire Air	Combustible Fuel
CHEVROLET (continuación)				
C SERIES	V8 6.5L DIESEL	GP-205		
C SERIES	V8 6.5L DIESEL TURBO	GP-205		
C SERIES	V8 7.4L FI	GP-205	GA-59	GG-46
CAMARO	V6 3.4L SFI	GP-46	GA-165	GG-66
CAMARO	V8 5.7L SFI	GP-3	GA-165	GG-66
CAVALIER	L4 2.2L FI	GP-46	GA-3916	GG-66
CAVALIER	V6 2.8L FI	GP-46	GA-153	GG-46
CAVALIER Z-24	V6 3.1L FI	GP-46	GA-253	GG-66
CHEVY	L4 1.4L FI	GP-46	GA-134	GG-64
CHEVY MONZA	L4 1.4L FI	GP-46	GA-134	GG-64
CHEYENNE	V8 5.7L FI	GP-3	GA-59	GG-46
CONCOURS	V8 4.6L FI	GP-3675	GA-6479	GG-581
CORVETTE	V8 5.7L FI	GP-3	GA-7007	GG-46
CUTLASS	L4 2.2L	GP-46	GA-153	GG-256
CUTLASS	V6 3.1L	GP-48	GA-153	GG-3728
CUTLASS EUROSPO	V6 3.0L FI	GP-46	GA-153	GG-41
CUTLASS EUROSPO	V6 3.1L	GP-48	GA-153	GG-3728
EUROSPO	V6 3.1L FI	GP-46	GA-153	GG-46
G SERIES	V6 4.3L EFI	GP-3980	GA-192	GG-46
G SERIES	V8 5.0L FI	GP-205	GA-192	GG-46
G SERIES	V8 5.7L FI	GP-205	GA-192	GG-46
G SERIES	V8 6.2L DIESEL	GP-205		G-294
G SERIES	V8 6.5L DIESEL	GP-205		
G SERIES	V8 7.4L FI	GP-205	GA-59	GG-46
GEO TRACKER	L4 1.6L FI	GP-58	GA-166	GG-151
K SERIES	V6 4.3L FI	GP-3980	GA-192	GG-46
K SERIES	V8 5.0L FI	GP-3980 ¹⁶ GP-205 ⁹	GA-59	GG-46
K SERIES	V8 5.7L FI	GP-3980 ¹⁶ GP-205 ⁹	GA-59	GG-46
K SERIES	V8 6.5L DIESEL	GP-205		
K SERIES	V8 6.5L TURBO DIESEL	GP-205		
K SERIES	V8 7.4L FI	GP-205	GA-59	GG-46
LUMINA	V6 3.1L FI	GP-46	GA-3588	GG-177
LUMINA	V6 3.8L FI	GP-46	GA-3916	GG-177
P SERIES	V6 4.3L EFI	GP-3980	GA-192	GG-46
P SERIES	V8 5.0L EFI	GP-205	GA-192	GG-46
P SERIES	V8 5.7L EFI	GP-205	GA-59	GG-46
P SERIES	V8 6.5L DIESEL	GP-205		
P SERIES	V8 6.5L TURBO DIESEL	GP-205		
P SERIES	V8 7.4L EFI	GP-205	GA-59	GG-46
ROADMASTER	V8 5.7L	GP-46	GA-6479	GG-581
ROYALE LS	V6 3.8L	GP-46	GA-6479	GG-66
S10	L4 2.2L FI	GP-46	GA-165	GG-46
S10	V6 3.1L FI	GP-46	GA-3588	GG-3728
S10	V6 3.4L FI	GP-3980	GA-3588	GG-3728
S15/T15 JIMMY	L4 2.2L FI (4)	GP-46	GA-165	GG-46
S15/T15 JIMMY	V6 4.3L	GP-3980	GA-165	GG-46
S15/T15 JIMMY	V6 4.3L FI	GP-3980	GA-3588	GG-46
SAFARI	V6 4.3L CPI (W)	GP-3980	GA-165	GG-46
SAFARI	V6 4.3L EFI (Z)	GP-3980	GA-3588	GG-46
SILVERADO	V8 5.7L FI	GP-205	GA-59	GG-46
SUBURBAN	V8 5.7L FI	GP-3980 ¹⁶ GP-205 ⁹	GA-59	GG-46
SUBURBAN	V8 6.5L DIESEL	GP-205		
SUBURBAN	V8 6.5L TURBO DIESEL	GP-205		
SUBURBAN	V8 7.4L FI	GP-205	GA-59	GG-46
T10 BLAZER	L4 2.2L FI	GP-46	GA-165	GG-46
T10 BLAZER	V6 4.3L	GP-3980	GA-165	GG-46
T10 BLAZER	V6 4.3L FI	GP-3980	GA-3588	GG-46
TRACKER	L4 1.6L FI	GP-58	GA-166	GG-151
1993				
400 SS	V8 5.7L FI			
400 SS	V8 7.4L	GP-205	GA-59	GG-46
ASTRO	V6 4.3L	GP-3980	GA-165	GG-255
BERETTA	L4 2.2L FI	GP-46	GA-3916	GG-66

Marca - Año - Modelo Make-Year-Model	Motor Engine	Aceite Oil	Aire Air	Combustible Fuel
CHEVROLET (continuación)				
BERETTA	L4 2.3L FI	GP-46	GA-3916	GG-66
BLAZER	V6 3.0L		GA-3588	GG-3728
BLAZER	V6 3.1L	GP-46	GA-3588	GG-3728
BLAZER	V8 5.7L FI	GP-3980 ¹⁶ GP-205 ⁹	GA-59	GG-46
C SERIES	V6 4.3L EFI	GP-3980	GA-192	GG-46
C SERIES	V8 5.0L FI	GP-3980 ¹⁶ GP-205 ⁹	GA-59	GG-46
C SERIES	V8 5.7L FI	GP-3980 ¹⁶ GP-205 ⁹	GA-59	GG-46
C SERIES	V8 6.2L DIESEL	GP-205		G-294
C SERIES	V8 6.5L DIESEL TURBO	GP-205		
C SERIES	V8 7.4L FI	GP-205	GA-59	GG-46
CAMARO	V6 3.4L SFI	GP-46	GA-165	GG-66
CAMARO	V8 5.7L MFI	GP-3	GA-165	GG-66
CAPRICE	V6 4.3L FI	GP-3980	GA-7017	GG-581
CAPRICE	V8 5.0L EFI	GP-46	GA-7017	GG-581
CAPRICE	V8 5.7L EFI	GP-46	GA-7017	GG-581
CAVALIER	L4 2.2L FI	GP-46	GA-3916	GG-66
CAVALIER	V6 2.8L FI	GP-46	GA-153	GG-46
CAVALIER Z-24	V6 3.1L FI	GP-46	GA-253	GG-66
CHEYENNE	V8 5.7L			
CORSICA	L4 2.2L	GP-46	GA-3916	GG-177
CORSICA	L4 3.1L	GP-46	GA-3916	GG-177
CORVETTE	V8 5.7L FI	GP-3	GA-7007	GG-46
CUTLASS	L4 2.2L	GP-46	GA-153	GG-256
CUTLASS	V6 3.1L	GP-48	GA-153	GG-3728
CUTLASS	V6 3.3L	GP-46	GA-3916	GG-256
CUTLASS EUROSPO	V6 3.0L FI	GP-46	GA-153	GG-41
CUTLASS EUROSPO	V6 3.1L	GP-48	GA-153	GG-3728
EUROSPO	V6 3.1L FI	GP-46	GA-153	GG-46
G SERIES	V6 4.3L EFI	GP-3980	GA-192	GG-46
G SERIES	V8 5.0L FI	GP-205	GA-192	GG-46
G SERIES	V8 5.7L FI	GP-205	GA-192	GG-46
G SERIES	V8 6.2L DIESEL	GP-205		G-294
G SERIES	V8 7.4L FI	GP-205	GA-59	GG-46
GEO TRACKER	L4 1.6L FI	GP-58	GA-166	GG-151
K SERIES	V6 4.3L FI	GP-3980	GA-192	GG-46
K SERIES	V8 5.0L FI	GP-3980 ¹⁶ GP-205 ⁹	GA-59	GG-46
K SERIES	V8 5.7L FI	GP-3980 ¹⁶ GP-205 ⁹	GA-59	GG-46
K SERIES	V8 6.5L DIESEL	GP-205		
K SERIES	V8 6.5L TURBO DIESEL	GP-205		
K SERIES	V8 7.4L FI	GP-205	GA-59	GG-46
LUMINA	V6 3.1L FI	GP-46	GA-3588	GG-177
LUMINA	V6 3.8L FI	GP-46	GA-3916	GG-177
P SERIES	V6 4.3L EFI	GP-3980	GA-192	GG-46
P SERIES	V8 5.0L EFI	GP-205	GA-192	GG-46
P SERIES	V8 5.7L FI	GP-205	GA-192	GG-46
P SERIES	V8 6.2L DIESEL	GP-205		G-294
P SERIES	V8 7.4L FI	GP-205	GA-59	GG-46
GEO TRACKER	L4 1.6L FI	GP-58	GA-166	GG-151
K SERIES	V6 4.3L FI	GP-3980	GA-192	GG-46
K SERIES	V8 5.0L FI	GP-3980 ¹⁶ GP-205 ⁹	GA-59	GG-46
K SERIES	V8 5.7L FI	GP-3980 ¹⁶ GP-205 ⁹	GA-59	GG-46
K SERIES	V8 6.2L DIESEL	GP-205		G-294
K SERIES	V8 6.5L TURBO DIESEL	GP-205		
K SERIES	V8 7.4L FI	GP-205	GA-59	GG-46
LUMINA	V6 3.1L FI	GP-46	GA-6626	GG-66
LUMINA	V6 3.4L MFI	GP-3980	GA-6626	GG-66
LUMINA	V6 3.8L FI	GP-46	GA-3916	GG-581
P SERIES	V6 4.3L EFI	GP-3980	GA-192	GG-46
P SERIES	V8 5.0L EFI	GP-205	GA-192	GG-46
P SERIES	V8 5.7L EFI	GP-205	GA-59	GG-46
P SERIES	V8 6.2L DIESEL	GP-205		G-294
P SERIES	V8 7.4L EFI	GP-205	GA-59	GG-46
ROADMASTER	V8 5.7L	GP-46	GA-6479	GG-581
S10	V6 3.1L FI	GP-46	GA-3588	GG-3728
S10	V6 3.4L FI	GP-3980	GA-3588	GG-3728
S15/T15 JIMMY	L4 2.5L FI (A)	GP-46	GA-3647	GG-46
S15/T15 JIMMY	V6 2.8L (R)	GP-3980	GA-3588	GG-46
S15/T15 JIMMY	V6 4.3L	GP-3980	GA-165	GG-46
S15/T15 JIMMY	V6 4.3L FI	GP-3980	GA-3588	GG-46
S15/T15 JIMMY	V6 4.3L FI (Z) TURBO	GP-3980	GA-165	GG-46
SAFARI	V6 4.3L CPI (W)	GP-3980	GA-165	GG-46
SAFARI	V6 4.3L EFI (Z)	GP-3980	GA-3588	GG-46
SUBURBAN	V8 5.7L FI	GP-3980 ¹⁶ GP-205 ⁹	GA-59	GG-46
SUBURBAN	V8 6.2L DIESEL	GP-205		G-294
SUBURBAN	V8 6.5L DIESEL	GP-205		
SUBURBAN	V8 7.4L EFI	GP-205	GA-59	GG-46

Marca - Año - Modelo Make-Year-Model	Motor Engine	Aceite Oil	Aire Air	Combustible Fuel
CHEVROLET (continuación)				
T10 BLAZER	L4 2.5L FI	GP-46	GA-3647	GG-46
T10 BLAZER	V6 2.8L	GP-3980	GA-3588	GG-46
T10 BLAZER	V6 4.3L	GP-3980	GA-165	GG-46
T10 BLAZER	V6 4.3L FI	GP-3980	GA-3588	GG-46
T10 BLAZER	V6 4.3L FI TURBO	GP-3980	GA-165	GG-46
TRACKER	L4 1.6L FI	GP-58	GA-166	GG-151
1992				
400 SS	V8 5.7L			
400 SS	V8 7.4L	GP-205	GA-59	GG-46
ASTRO	V6 4.3L FI	GP-3980	GA-165	GG-46
BERETTA	L4 2.2L FI	GP-46	GA-3916	GG-66
BERETTA	L4 2.3L FI	GP-46	GA-3916	GG-66
BLAZER	V6 3.0L		GA-3588	GG-3728
BLAZER	V6 3.1L	GP-46	GA-3588	GG-3728
BLAZER	V8 5.7L FI	GP-3980 ¹⁶ GP-205 ⁹	GA-59	GG-46
C SERIES	V6 4.3L EFI	GP-3980	GA-192	GG-46
C SERIES	V8 5.0L FI	GP-3980 ¹⁶ GP-205 ⁹	GA-59	GG-46
C SERIES	V8 5.7L FI	GP-3980 ¹⁶ GP-205 ⁹	GA-59	GG-46
C SERIES	V8 6.2L DIESEL	GP-205		G-294
C SERIES	V8 6.5L DIESEL TURBO	GP-205		
C SERIES	V8 7.4L FI	GP-205	GA-59	GG-46
CAMARO	V6 3.1L MFI	GP-3980	GA-253	GG-46
CAMARO	V8 5.0L EFI	GP-3	GA-3915 ¹²⁸	GG-46
CAMARO	V8 5.0L TPI	GP-3	GA-57 GA-100 ⁴⁵	GG-46
CAMARO	V8 5.7L TPI	GP-3	GA-3915 ¹²⁸	GG-46
CAPRICE	V6 4.3L EFI	GP-3980	GA-7017	GG-581
CAPRICE	V8 5.0L EFI	GP-3	GA-7017 GA-100 ¹⁶⁵	GG-581
CAPRICE	V8 5.7L EFI	GP-3	GA-7017	GG-581
CAVALIER	L4 2.2L FI	GP-46	GA-3916	GG-66
CAVALIER	V6 2.8L FI	GP-46	GA-153	GG-46
CAVALIER Z-24	V6 3.1L FI	GP-46	GA-253	GG-46
CHEYENNE	V8 5.7L			
CORSICA	L4 2.2L	GP-46	GA-3916	GG-177
CORSICA	L4 3.1L	GP-46	GA-3916	GG-177
CORVETTE	V8 5.7L FI	GP-3	GA-7007	GG-46
CUTLASS	V6 3.1L	GP-48	GA-153	GG-3728
CUTLASS	V6 3.3L	GP-46	GA-3916	GG-256
CUTLASS EUROSPORT	V6 3.0L FI	GP-46	GA-153	GG-41
CUTLASS EUROSPORT	V6 3.1L	GP-48	GA-153	GG-3728
EUROSPORT	V6 3.1L FI	GP-46	GA-153	GG-46
G SERIES	V6 4.3L EFI	GP-3980	GA-192	GG-46
G SERIES	V8 5.0L FI	GP-205	GA-192	GG-46
G SERIES	V8 5.7L FI	GP-205	GA-192	GG-46
G SERIES	V8 6.2L DIESEL	GP-205		G-294
G SERIES	V8 7.4L FI	GP-205	GA-59	GG-46
GEO TRACKER	L4 1.6L FI	GP-171	GA-166	GG-151
K SERIES	V6 4.3L FI	GP-3980	GA-192	GG-46
K SERIES	V8 5.0L FI	GP-3980 ¹⁶ GP-205 ⁹	GA-59	GG-46
K SERIES	V8 5.7L FI	GP-3980 ¹⁶ GP-205 ⁹	GA-59	GG-46
K SERIES	V8 6.2L DIESEL	GP-205		G-294
K SERIES	V8 6.5L TURBO DIESEL	GP-205		
K SERIES	V8 7.4L FI	GP-205	GA-59	GG-46
LUMINA	V6 3.1L FI	GP-3980	GA-6626	GG-66
LUMINA	V6 3.4L MFI	GP-3980	GA-6626	GG-66
LUMINA	V6 3.8L FI	GP-46	GA-3916	GG-581
P SERIES	V6 4.3L EFI	GP-3980	GA-192	GG-46
P SERIES	V8 5.0L EFI	GP-205	GA-192	GG-46
P SERIES	V8 5.7L EFI	GP-205	GA-59	GG-46
P SERIES	V8 6.2L DIESEL	GP-205		G-294
P SERIES	V8 7.4L EFI	GP-205	GA-59	GG-46

Marca - Año - Modelo Make-Year-Model	Motor Engine	Aceite Oil	Aire Air	Combustible Fuel
CHEVROLET (continuación)				
ROADMASTER	V8 5.7L	GP-46	GA-6479	GG-581
S10	V6 3.1L FI	GP-46	GA-3588	GG-3728
S10	V6 3.4L FI	GP-3980	GA-3588	GG-3728
S15/T15 JIMMY	L4 2.5L FI (A)	GP-46	GA-3647	GG-46
S15/T15 JIMMY	V6 2.8L (R)	GP-3980	GA-3588	GG-46
S15/T15 JIMMY	V6 4.3L	GP-3980	GA-165	GG-46
S15/T15 JIMMY	V6 4.3L FI	GP-3980	GA-3588	GG-46
S15/T15 JIMMY	V6 4.3L FI (Z) TURBO	GP-3980	GA-165	GG-46
SAFARI	V6 4.3L EFI (Z)	GP-3980	GA-3588	GG-46
SAFARI	V6 4.3L TBI (W)	GP-3980	GA-165	GG-46
SUBURBAN	V8 5.7L FI	GP-3980 ¹⁶ GP-205 ⁹	GA-59	GG-46
SUBURBAN	V8 7.4L EFI	GP-205	GA-59	GG-46
T10 BLAZER	L4 2.5L FI	GP-46	GA-3647	GG-46
T10 BLAZER	V6 2.8L	GP-3980	GA-3588	GG-46
T10 BLAZER	V6 4.3L	GP-3980	GA-165	GG-46
T10 BLAZER	V6 4.3L FI	GP-3980	GA-3588	GG-46
T10 BLAZER	V6 4.3L FI TURBO	GP-3980	GA-165	GG-46
1991				
400 SS	V8 5.7L	GP-13	GA-59	GG-4
ASTRO	L4 2.5L FI	GP-46	GA-3647	GG-46
ASTRO	V6 4.3L FI	GP-3980	GA-3588	GG-46
BERETTA	L4 2.2L EFI	GP-3980	GA-3647	
BERETTA	L4 2.3L MFI HIGH OUTPUT	GP-46	GA-3916	
BERETTA	V6 3.1L MFI	GP-3980		
BLAZER	V6 3.0L		GA-3588	GG-3728
BLAZER	V6 3.1L	GP-46	GA-3588	GG-3728
BLAZER	V8 5.7L FI	GP-3980 ¹⁶ GP-205 ⁹	GA-59	GG-46
BLAZER	V8 6.2L DIESEL	GP-205		G-294
BLAZER	V8 7.4L EFI	GP-205	GA-89	GG-46
C SERIES	V6 4.3L EFI	GP-3980	GA-192	GG-46
C SERIES	V8 5.0L FI	GP-3980 ¹⁶ GP-205 ⁹	GA-59	GG-46
C SERIES	V8 5.7L FI	GP-3980 ¹⁶ GP-205 ⁹	GA-59	GG-46
C SERIES	V8 6.2L DIESEL	GP-205		G-294
C SERIES	V8 7.4L FI	GP-205	GA-59	GG-46
CAMARO	V6 3.1L MFI	GP-3980	GA-253	GG-46
CAMARO	V8 5.0L EFI	GP-3	GA-57 GA-100 ⁴⁵	GG-46
CAMARO	V8 5.0L TPI	GP-3	GA-3915 ¹²⁸	GG-46
CAMARO	V8 5.7L TPI	GP-3	GA-3915 ¹²⁸	GG-46
CAMIONETAS REATTA	V6 3.8L			GG-167
CAPRICE	V8 5.0L EFI	GP-3	GA-7017	GG-580 ⁵⁹ GG-581 ¹⁴⁷
CAPRICE	V8 5.7L TBI	GP-3	GA-7017	GG-580 ⁵⁹ GG-581 ¹⁴⁷
CAVALIER	L4 2.2L FI	GP-3980	GA-3647	GG-46
CAVALIER	V6 2.8L FI	GP-46	GA-153	GG-46
CAVALIER Z-24	V6 3.1L FI	GP-46	GA-253	GG-46
CHEYENNE	V8 5.7L			
CORSICA	L4 2.2L	GP-46	GA-3916	GG-177
CORSICA	L4 3.1L	GP-46	GA-3916	GG-177
CORVETTE	V8 5.7L FI	GP-3	GA-7007	GG-46
CUTLASS	V6 3.1L	GP-48	GA-153	GG-3728
CUTLASS	V6 3.3L	GP-46	GA-3916	GG-256
CUTLASS EUROSPORT	V6 3.0L FI	GP-46	GA-153	GG-41
CUTLASS EUROSPORT	V6 3.1L	GP-48	GA-153	GG-3728
EUROSPORT	V6 3.1L FI	GP-46	GA-153	GG-46
G SERIES	V6 4.3L EFI	GP-3980	GA-192	GG-46
G SERIES	V8 5.0L FI	GP-205	GA-192	GG-46
G SERIES	V8 5.7L FI	GP-205	GA-192	GG-46
G SERIES	V8 6.2L DIESEL	GP-205		G-294
G SERIES	V8 7.4L FI	GP-205	GA-59	GG-46
K SERIES	V6 4.3L FI	GP-3980	GA-192	GG-46
K SERIES	V8 5.0L FI	GP-3980 ¹⁶ GP-205 ⁹	GA-59	GG-46

Para números Gonher con Superíndice vea página 38
For Gonher with Superscript numbers see page 38

Marca - Año - Modelo Make-Year-Model	Motor Engine	Aceite Oil	Aire Air	Combustible Fuel
CHEVROLET (continuación)				
K SERIES	V8 5.7L FI	GP-3980 ¹⁶ GP-205 ⁹	GA-59	GG-46
K SERIES	V8 6.2L DIESEL	GP-205		G-294
K SERIES	V8 7.4L FI	GP-205	GA-59	GG-46
LUMINA	V6 3.1L FI	GP-3980	GA-6626	GG-46
LUMINA	V6 3.4L MFI	GP-3980	GA-6626	GG-46
MOTORES 292	6 CIL. 4.1L	GP-3	GA-90	GG-5 ¹²⁰
MOTORES 292	6 CIL. 4.8L	GP-3	GA-90	GG-5 ¹²⁰
P SERIES	V6 4.3L EFI	GP-3980	GA-192	GG-46
P SERIES	V8 5.0L EFI	GP-205	GA-192	GG-46
P SERIES	V8 5.7L EFI	GP-205	GA-59	GG-46
P SERIES	V8 6.2L DIESEL	GP-205		G-294
P SERIES	V8 7.4L EFI	GP-205	GA-59	GG-46
PICK UP V1500	V8 5.7L	GP-205	GA-59	GG-46
PICK UP V1500	V8 7.4L	GP-205	GA-89	GG-46
R3500	V8 5.7L	GP-205	GA-59	GG-46
R3500	V8 7.4L	GP-205		GG-46
ROADMASTER	V8 5.7L	GP-46	GA-6479	GG-581
S10	V6 3.1L FI	GP-46	GA-3588	GG-3728
S10	V6 3.4L FI	GP-3980	GA-3588	GG-3728
S15/T15 JIMMY	L4 2.5L FI	GP-46	GA-3647	GG-46
S15/T15 JIMMY	L4 2.5L FI (A)	GP-46	GA-3647	GG-46
S15/T15 JIMMY	V6 2.8L FI (R)	GP-46	GA-3588	GG-3728
S15/T15 JIMMY	V6 4.3L FI	GP-3980	GA-3588	GG-46
S15/T15 JIMMY	V6 4.3L FI (Z) TURBO	GP-3980	GA-165	GG-46
SPRINT	3 CIL. 1.0L FI	GP-58	GA-142	GG-207
SPRINT	3 CIL. 1.0L FI TURBO	GP-58		GG-146
SUBURBAN	V8 5.7L FI	GP-3980 ¹⁶ GP-205 ⁹	GA-59	GG-46
SUBURBAN	V8 6.2L DIESEL	GP-205		G-294
SUBURBAN	V8 7.4L FI	GP-205	GA-89	GG-46
T10 BLAZER	L4 2.5L FI	GP-46	GA-3647	GG-46
T10 BLAZER	V6 2.8L FI	GP-46	GA-3588	GG-3728
T10 BLAZER	V6 4.3L FI	GP-3980	GA-3588	GG-46
T10 BLAZER	V6 4.3L FI TURBO	GP-3980	GA-165	GG-46
1990				
400 SS	V8 5.7L	GP-13	GA-59	GG-4
ASTRO	L4 2.5L FI	GP-46	GA-3647	GG-46
ASTRO	V6 4.3L FI	GP-3980	GA-3588	GG-46
BERETTA	L4 2.2L EFI	GP-3980	GA-3647	
BERETTA	L4 2.3L MFI HIGH OUTPUT	GP-46	GA-3916	
BERETTA	V6 3.1L MFI	GP-3980		
BLAZER	V8 5.7L FI	GP-205	GA-59	GG-46
BLAZER	V8 6.2L DIESEL	GP-205		G-294
C SERIES	V6 4.3L EFI	GP-3980	GA-192	GG-46
C SERIES	V8 5.0L FI	GP-3980 ¹⁶ GP-205 ⁹	GA-59	GG-46
C SERIES	V8 5.7L FI	GP-3980 ¹⁶ GP-205 ⁹	GA-59	GG-46
C SERIES	V8 6.2L DIESEL	GP-205		G-294
C SERIES	V8 7.4L FI	GP-205	GA-59	GG-46
CAMARO	V6 3.1L MFI	GP-3980	GA-253	GG-46
CAMARO	V8 5.0L EFI	GP-3	GA-57 GA-100 ⁴⁵	GG-46
CAMARO	V8 5.0L TPI	GP-3	GA-3915 ¹²⁸	GG-46
CAMARO	V8 5.7L FI	GP-3	GA-3915 ¹²⁸	GG-46
CAMIONETAS REATTA	V6 3.8L			GG-167
CAPRICE	V6 4.3L FI	GP-3980	GA-57	GG-580 ⁵⁹ GG-581 ¹⁴⁷
CAPRICE	V8 5.0L 4BBL	GP-3429	GA-59	GG-7 ¹⁵⁰ GG-17 ⁶¹
CAPRICE	V8 5.0L EFI	GP-3	GA-59 GA-100 ⁴⁵	GG-580 ⁵⁹ GG-581 ¹⁴⁷
CAPRICE	V8 5.7L FI	GP-3 ⁵⁶ GP-205 ¹⁴⁴	GA-59 GA-100 ⁴⁵	GG-580 ⁵⁹ GG-581 ¹⁴⁷
CAVALIER	L4 2.2L FI	GP-3980	GA-3647	GG-46
CAVALIER	V6 2.8L FI	GP-46	GA-153	GG-46
CAVALIER	V6 3.1L MFI	GP-3980	GA-153	GG-46

Marca - Año - Modelo Make-Year-Model	Motor Engine	Aceite Oil	Aire Air	Combustible Fuel
CHEVROLET (continuación)				
CAVALIER Z-24	V6 3.1L FI	GP-46	GA-253	GG-46
CELEBRITY	L4 2.5L FI		GA-3647	GG-256
CELEBRITY	V6 3.1L MFI	GP-3980	GA-153	GG-256
CHEYENNE	L6 4.8L			
CORSICA	L4 2.2L	GP-46	GA-3916	GG-177
CORSICA	L4 3.1L	GP-46	GA-3916	GG-177
CORVETTE	V8 5.7L FI	GP-3	GA-3915	GG-46
CUTLASS	V6 2.8L	GP-46	GA-153	GG-46
CUTLASS	V6 3.3L	GP-46	GA-3916	GG-256
CUTLASS EUROSPORT	V6 3.1L	GP-48	GA-153	GG-3728
EUROSPORT	V6 3.1L FI	GP-46	GA-153	GG-46
G SERIES	V6 4.3L EFI	GP-3980	GA-192	GG-46
G SERIES	V8 5.0L FI	GP-205	GA-192	GG-46
G SERIES	V8 5.7L FI	GP-205	GA-192	GG-46
G SERIES	V8 6.2L DIESEL	GP-205		G-294
G SERIES	V8 7.4L FI	GP-205	GA-59	GG-46
K SERIES	V6 4.3L FI	GP-3980	GA-192	GG-46
K SERIES	V8 5.0L FI	GP-3980 ¹⁶ GP-205 ⁹	GA-59	GG-46
K SERIES	V8 5.7L FI	GP-3980 ¹⁶ GP-205 ⁹	GA-59	GG-46
K SERIES	V8 6.2L DIESEL	GP-205		G-294
K SERIES	V8 7.4L FI	GP-205	GA-59	GG-46
LUMINA	V6 3.1L FI	GP-3980	GA-6626	GG-46
MOTORES 292	6 CIL. 4.1L	GP-3	GA-90	GG-5 ¹²⁰
MOTORES 292	6 CIL. 4.8L	GP-3	GA-90	GG-5 ¹²⁰
P SERIES	V6 4.3L EFI	GP-3980	GA-192	GG-46
P SERIES	V8 5.0L EFI	GP-205	GA-192	GG-46
P SERIES	V8 5.7L EFI	GP-205	GA-59	GG-46
P SERIES	V8 6.2L DIESEL	GP-205		G-294
P SERIES	V8 7.4L EFI	GP-205	GA-59	GG-46
PICK UP V1500	V8 5.7L	GP-205	GA-59	GG-46
PICK UP V1500	V8 7.4L	GP-205	GA-89	GG-46
R1500	V8 5.7L	GP-13	GA-59	GG-46
R2500	V8 5.7L	GP-13	GA-59	GG-46
R3500	V8 5.7L	GP-13	GA-59	GG-46
S10	L4 2.5L FI	GP-46	GA-3647	GG-46
S10	V6 2.8L FI (R)	GP-46	GA-3588	GG-3728
S10	V6 4.3L FI	GP-3980	GA-3588	GG-46
S10	V8 5.7L FI	GP-13 GP-205	GA-59	GG-46
S10	V8 7.4L FI	GP-205	GA-89	GG-46
S15/T15 JIMMY	L4 2.5L FI	GP-46	GA-3647	GG-46
S15/T15 JIMMY	V6 2.8L FI (R)	GP-46	GA-3588	GG-3728
S15/T15 JIMMY	V6 4.3L FI	GP-3980	GA-3588	GG-46
SPRINT	3 CIL. 1.0L FI	GP-58	GA-142	GG-207
SPRINT	3 CIL. 1.0L FI TURBO	GP-58		
SUBURBAN	V8 5.7L FI	GP-205	GA-59	GG-46
SUBURBAN	V8 6.2L DIESEL	GP-205		G-294
SUBURBAN	V8 7.4L FI	GP-205	GA-89	GG-46
T10 BLAZER	L4 2.5L FI	GP-46	GA-3647	GG-46
T10 BLAZER	V6 2.8L FI	GP-46	GA-3588	GG-3728
T10 BLAZER	V6 4.3L FI	GP-3980	GA-3588	GG-46
CHRYSLER				
2010				
300	V6 2.7L FI	GP-406	GA-289	
300	V6 3.5L FI	GP-68	GA-289	
2010				
300C	V8 5.7L FI HEMI	GP-68	GA-289	
300C	V8 6.1L FI HEMI	GP-68		
PT CRUISER	L4 2.4L FI		GA-492	
SEBRING	L4 2.4L FI 16 VALV. DOHC	GP-406	GA-248	
SEBRING	V6 2.7L FI 24 VALV. DOHC	GP-406	GA-248	
SEBRING	V6 3.5L FI 24 VALV.	GP-406	GA-248	
TOWN & COUNTRY	V6 3.3L FI FLEX FUEL		GA-248	

Marca - Año - Modelo Make-Year-Model	Motor Engine	Aceite Oil	Aire Air	Combustible Fuel
CHRYSLER (continuación)				
TOWN & COUNTRY	V6 3.8L FI		GA-248	
TOWN & COUNTRY	V6 4.0L FI		GA-248	
2009				
300C	V6 2.7L FI 24 VALV. DOHC	GP-406	GA-289	
300C	V6 3.5L FI 24 VALV.	GP-68	GA-289	
300C	V8 5.7L FI HEMI MAGNUM	GP-68	GA-289	
300C	V8 6.1L FI HEMI MAGNUM	GP-68	GA-289	
ASPEN	V8 4.7L FI FLEX FUEL	GP-68 ¹³³	GA-249	
ASPEN	V8 5.7L FI HEMI MAGNUM	GP-68 ¹³³	GA-249	
ASPEN HYBRID	V8 5.7L FI HEMI	GP-68	GA-249	
PT CRUISER	L4 2.4L FI 16 VALV. DOHC	GP-58	GA-492	
PT CRUISER	L4 2.4L FI 16 VALV. DOHC TURBO	GP-3600	GA-492	
SEBRING	L4 2.4L FI 16 VALV. DOHC	GP-406	GA-248	
SEBRING	V6 2.7L FI 24 VALV. DOHC FLEX FUEL	GP-68	GA-248	
SEBRING	V6 3.5L FI 24 VALV. SOHC	GP-68	GA-248	
TOWN & COUNTRY	V6 3.3L FI	GP-58	GA-248	
TOWN & COUNTRY	V6 3.3L FI FLEX FUEL	GP-58	GA-248	
TOWN & COUNTRY	V6 3.8L FI	GP-58	GA-248	
TOWN & COUNTRY	V6 4.0L FI 24 VALV. SOHC	GP-58	GA-248	
2008				
300C	V6 2.7L FI 24 VALV. DOHC	GP-68 ¹³³ GP-81 ¹³²	GA-289	
300C	V6 3.5L FI 24 VALV. DOHC	GP-68 ¹³³ GP-81 ¹³²	GA-289	
300C	V8 5.7L FI HEMI	GP-68 ¹³³ GP-81 ¹³²	GA-289	
300C	V8 6.1L FI HEMI	GP-68 ¹³³ GP-81 ¹³²	GA-289	
ASPEN	V8 4.7L SFI	GP-68 ¹³³ GP-81 ¹³²	GA-249	
ASPEN	V8 5.7L FI HEMI	GP-68 ¹³³ GP-81 ¹³²	GA-249	
CROSSFIRE	V6 3.2L FI	G-180 ¹⁶⁶ G-918 ¹⁶⁶	GA-2161 ¹²⁸	
PACIFICA	V6 3.8L FI	GP-58	GA-510 GAC-2 ²⁴	
PACIFICA	V6 4.0L FI	GP-81	GA-510 GAC-2 ²⁴	
PT CRUISER	L4 2.4L SFI	GP-58	GA-492	
PT CRUISER	L4 2.4L TURBO	GP-3600	GA-492	
SEBRING	L4 2.4L FI 16 VALV. DOHC	GP-406	GA-248	
SEBRING	V6 2.7L FI 24 VALV. DOHC	GP-68 ¹³³ GP-81 ¹³²	GA-248	
SEBRING	V6 3.5L FI	GP-68 ¹³³ GP-81 ¹³²	GA-248	
TOWN & COUNTRY	V6 3.3L SFI	GP-58	GA-248 GAC-2 ²⁴	
TOWN & COUNTRY	V6 3.8L SFI	GP-58	GA-248 GAC-2 ²⁴	
TOWN & COUNTRY	V6 4.0L SFI	GP-81	GA-248 GAC-2 ²⁴	
VOYAGER	V6 3.3L FI	GP-58	GA-248 GAC-2 ²⁴	
VOYAGER	V6 3.8L FI	GP-58	GA-248 GAC-2 ²⁴	
VOYAGER	V6 4.0L FI	GP-81	GA-248	
2007				
300C	V6 2.7L SFI 24 VALV.	GP-81	GA-289	
300C	V6 3.5L SFI	GP-81	GA-289	
300C	V8 5.7L FI HEMI	GP-81	GA-289	
300C	V8 6.1L FI HEMI	GP-81	GA-289	
ASPEN	V8 4.7L SFI	GP-81	GA-249	
ASPEN	V8 5.7L FI HEMI 16 VALV.	GP-81	GA-249	
CIRRUS	L4 2.4L 16 VALV.	GP-406	GA-183R	
CIRRUS	V6 3.5L 24 VALV.	GP-81		
CROSSFIRE	V6 3.2L FI 18 VALV.	G-180 G-918	GA-2161 ¹²⁹	

Marca - Año - Modelo Make-Year-Model	Motor Engine	Aceite Oil	Aire Air	Combustible Fuel
CHRYSLER (continuación)				
PACIFICA	V6 3.8L SFI 12 VALV.	GP-81	GA-510 GAC-2 ²⁴	
PACIFICA	V6 4.0L SFI 24 VALV.	GP-81	GA-510 GAC-2 ²⁴	
PT CRUISER	L4 2.4L SFI 16 VALV.	GP-58	GA-492	
PT CRUISER	L4 2.4L TURBO	GP-3600	GA-492	
SEBRING	L4 2.4L FI	GP-406	GA-248	
SEBRING	V6 2.7L FI 24 VALV. DOHC	GP-81	GA-248	
SEBRING	V6 3.5L FI	GP-81	GA-248	
TOWN & COUNTRY	V6 3.3L SFI	GP-81	GA-248 GAC-2 ²⁴	
TOWN & COUNTRY	V6 3.8L SFI	GP-81	GA-248 GAC-2 ²⁴	
VOYAGER	V6 3.3L	GP-81	GA-248 GAC-2 ²⁴	
2006				
300C	V6 2.7L SFI 24 VALV.	GP-81	GA-289	
300C	V6 3.5L SFI 24 VALV.	GP-81	GA-289	
300C	V8 5.7L FI HEMI	GP-81	GA-289	
300C	V8 6.1L FI HEMI	GP-81	GA-289	
CIRRUS	L4 2.4L FI 16 VALV. TURBO	GP-58	GA-183R	GG-104
CROSSFIRE	V6 3.2L FI 18 VALV.	G-180 ¹⁵³ G-918	GA-2161 ¹²⁹	
PACIFICA	V6 3.5L FI 24 VALV.	GP-81	GA-510 GAC-2 ²⁴	
PACIFICA	V6 3.8L FI	GP-81	GA-510 GAC-2 ²⁴	
PT CRUISER	L4 2.4L FI 16 VALV.	GP-58	GA-492	
SEBRING	L4 2.4L FI 16 VALV. DOHC	GP-58	GA-183R	
SEBRING	V6 2.7L FI 24 VALV. DOHC	GP-81	GA-183R	
TOWN & COUNTRY	L4 2.4L FI	GP-58	GA-248 GAC-2 ²⁴	
TOWN & COUNTRY	V6 3.3L FI	GP-81	GA-248 GAC-2 ²⁴	
TOWN & COUNTRY	V6 3.8L FI	GP-81	GA-248 GAC-2 ²⁴	
VOYAGER	V6 3.3L FI	GP-81	GA-248 GAC-2 ²⁴	
2005				
300C	V6 2.7L MFI	GP-81	GA-289	
300C	V6 3.5L MFI	GP-81	GA-289	
300C	V8 5.7L FI HEMI	GP-81	GA-289	
300C	V8 6.1L FI HEMI	GP-81	GA-289	
CIRRUS	L4 2.4L FI 16 VALV. TURBO	GP-58	GA-183R	GG-104
CIRRUS	V6 3.0L FI	GP-6811	GA-7344	
CROSSFIRE	V6 3.2L FI 18 VALV.	G-180 ¹⁵³ G-918	GA-2161 ¹²⁹	
PACIFICA	V6 3.5L FI 24 VALV.	GP-81	GA-510 GAC-2 ²⁴	
PACIFICA	V6 3.8L FI	GP-81	GA-510 GAC-2 ²⁴	
PT CRUISER	L4 2.4L FI 16 VALV.	GP-58	GA-258	
SEBRING	L4 2.4L SFI VIN B,G	GP-149	GA-7344	
SEBRING	L4 2.4L SFI VIN X	GP-58	GA-183R	
SEBRING	V6 2.7L SFI	GP-81	GA-183R	
SEBRING	V6 3.0L SFI	GP-6811	GA-7344	
TOWN & COUNTRY	V6 3.3L FI	GP-81	GA-248 GAC-2 ²⁴	GG-265
TOWN & COUNTRY	V6 3.3L FI FLEX FUEL	GP-81	GA-248 GAC-2 ²⁴	GG-265
TOWN & COUNTRY	V6 3.8L FI	GP-81	GA-248 GAC-2 ²⁴	
VOYAGER	V6 3.3L FI	GP-81	GA-248 GAC-2 ²⁴	
VOYAGER	V6 3.8L FI	GP-81	GA-248 GAC-2 ²⁴	GG-265
2004				
300M	V6 3.5L FI 24 VALV.	GP-81	GA-8606	
CIRRUS	L4 2.4L FI 16 VALV. TURBO	GP-58	GA-183R	GG-104

Para números Gonher con Superíndice vea página 38
For Gonher with Superscript numbers see page 38

Marca - Año - Modelo Make-Year-Model	Motor Engine	Aceite Oil	Aire Air	Combustible Fuel
CHRYSLER (continuación)				
CIRRUS	V6 3.0L FI	GP-6811	GA-7344	
CONCORDE	V6 2.7L FI 24 VALV.	GP-81	GA-8606	
CONCORDE	V6 3.5L FI 24 VALV.	GP-81	GA-8606	
CROSSFIRE	V6 3.2L FI 18 VALV.	G-180 ¹⁵³ G-918	GA-2161	
PACIFICA	V6 3.5L FI 24 VALV.	GP-81	GA-510 GAC-2 ²⁴	
PT CRUISER	L4 2.4L FI 16 VALV.	GP-58	GA-258	
SEBRING	L4 2.4L SFI DOHC	GP-58	GA-183R	
SEBRING	L4 2.4L SFI SOHC	GP-149	GA-7344	
SEBRING	V6 2.7L SFI	GP-81	GA-183R	
SEBRING	V6 3.0L SFI 24 VALV.	GP-6811	GA-7344	
TOWN & COUNTRY	V6 3.3L FI	GP-81	GA-248 GAC-2 ²⁴	GG-265
TOWN & COUNTRY	V6 3.3L FI FLEX FUEL	GP-81	GA-248 GAC-2 ²⁴	GG-265
TOWN & COUNTRY	V6 3.8L FI	GP-81	GA-248 GAC-2 ²⁴	GG-265
VOYAGER	V6 3.3L FI	GP-81	GA-248 GAC-2 ²⁴	
VOYAGER	V6 3.8L FI	GP-81	GA-248 GAC-2 ²⁴	GG-265
2003				
300M	V6 3.5L FI 24 VALV.	GP-81	GA-8606	
CIRRUS	L4 2.4L FI 16 VALV. TURBO	GP-58	GA-183R	GG-104
CIRRUS	V6 3.0L FI	GP-6811	GA-7344	
CONCORDE	V6 2.7L FI 24 VALV.	GP-81	GA-8606	
CONCORDE	V6 3.5L FI 24 VALV.	GP-81	GA-8606	
PT CRUISER	L4 2.4L FI 16 VALV.	GP-58	GA-258	
SEBRING	L4 2.4L SFI DOHC	GP-58	GA-183R	
SEBRING	L4 2.4L SFI SOHC	GP-149	GA-7344	
SEBRING	V6 2.7L MFI	GP-81	GA-183R	
SEBRING	V6 3.0L SFI 24 VALV.	GP-6811	GA-7344	
TOWN & COUNTRY	V6 3.3L FI	GP-81	GA-248 GAC-2 ²⁴	GG-265
TOWN & COUNTRY	V6 3.3L FI FLEX FUEL	GP-81	GA-248 GAC-2 ²⁴	GG-265
TOWN & COUNTRY	V6 3.8L FI	GP-81	GA-248 GAC-2 ²⁴	GG-265
VOYAGER	L4 2.4L FI 16 VALV.	GP-58	GA-248 GAC-2 ²⁴	
VOYAGER	V6 3.3L FI	GP-81	GA-248 GAC-2 ²⁴	GG-265
VOYAGER	V6 3.8L FI	GP-81	GA-248 GAC-2 ²⁴	GG-265
2002				
300M	V6 3.5L FI 24 VALV.	GP-81	GA-8606	
CIRRUS	L4 2.4L FI 16 VALV. TURBO	GP-58	GA-183R	GG-104
CONCORDE	V6 3.5L FI 24 VALV.	GP-81	GA-8606	
PT CRUISER	L4 2.4L FI 16 VALV.	GP-58	GA-258	
SEBRING	L4 2.4L SFI DOHC	GP-58	GA-183R	
SEBRING	L4 2.4L SFI SOHC	GP-149	GA-7344	
SEBRING	V6 2.7L SFI	GP-81	GA-183R	
SEBRING	V6 3.0L SFI 24 VALV.	GP-6811	GA-7344	
TOWN & COUNTRY	V6 3.3L FI	GP-81	GA-248 GAC-2 ²⁴	GG-265
TOWN & COUNTRY	V6 3.3L FI FLEX FUEL	GP-81	GA-248 GAC-2 ²⁴	GG-265
TOWN & COUNTRY	V6 3.8L FI	GP-81	GA-248 GAC-2 ²⁴	GG-265
VOYAGER	L4 2.4L FI 16 VALV.	GP-58	GA-248 GAC-2 ²⁴	
VOYAGER	V6 3.3L FI	GP-81	GA-248 GAC-2 ²⁴	GG-265
VOYAGER	V6 3.8L FI	GP-81	GA-248 GAC-2 ²⁴	GG-265
2001				
300M	V6 3.5L FI 24 VALV.	GP-81	GA-8606	
CIRRUS	L4 2.4L FI 16 VALV. TURBO	GP-58	GA-183R	GG-104

Marca - Año - Modelo Make-Year-Model	Motor Engine	Aceite Oil	Aire Air	Combustible Fuel
CHRYSLER (continuación)				
CONCORDE	V6 3.5L FI 24 VALV.	GP-81	GA-8606	
PT CRUISER	L4 2.4L FI 16 VALV.	GP-58	GA-258	
SEBRING	L4 2.4L SFI 16 VALV. VIN G	GP-149	GA-7344	
SEBRING	L4 2.4L SFI 16 VALV. VIN X	GP-58	GA-183R	
SEBRING	V6 2.7L SFI 24 VALV.	GP-81	GA-183R	
SEBRING	V6 3.0L SFI 24 VALV.	GP-6811	GA-7344	
TOWN & COUNTRY	V6 3.3L FI	GP-81	GA-248 GAC-2 ²⁴	GG-265
TOWN & COUNTRY	V6 3.3L FI FLEX FUEL	GP-81	GA-248 GAC-2 ²⁴	GG-265
TOWN & COUNTRY	V6 3.8L FI	GP-81	GA-248 GAC-2 ²⁴	GG-265
VOYAGER	L4 2.4L FI 16 VALV.	GP-58	GA-248 GAC-2 ²⁴	
VOYAGER	V6 3.0L FI	GP-81	GA-248 GAC-2 ²⁴	GG-265 ⁷¹ GG-267 ⁷²
VOYAGER	V6 3.3L FI	GP-81	GA-248 GAC-2 ²⁴	GG-265
VOYAGER	V6 3.8L FI	GP-81	GA-248 GAC-2 ²⁴	
2000				
300M	V6 3.5L FI 24 VALV.	GP-81	GA-8606	
CIRRUS	L4 2.4L FI 16 VALV. TURBO	GP-58	GA-183R	GG-104
CIRRUS	V6 2.5L FI 24 VALV.	GP-81	GA-132	GG-104
CONCORDE	V6 3.2L FI	GP-81	GA-8606	
CONCORDE	V6 3.5L FI	GP-81	GA-8606	
SEBRING	V6 2.5L SFI 24 VALV. CON- VERTIBLE	GP-81	GA-132	
SEBRING	V6 2.5L SFI 24 VALV. COUPE	GP-81	GA-7344	
TOWN & COUNTRY	V6 3.3L FI	GP-81	GA-277 GAC-2 ²⁴	GG-265 ⁷¹ GG-267 ⁷²
TOWN & COUNTRY	V6 3.3L FI FLEX FUEL	GP-81	GA-277 GAC-2 ²⁴	GG-265 ⁷¹ GG-267 ⁷²
TOWN & COUNTRY	V6 3.8L FI	GP-81	GA-277 GAC-2 ²⁴	GG-265
VOYAGER	L4 2.4L FI	GP-58	GA-277	GG-265
VOYAGER	V6 3.3L FI	GP-81	GA-277 GAC-2 ²⁴	GG-265
VOYAGER	V6 3.8L FI	GP-81	GA-277	GG-265
1999				
300M	V6 3.5L FI 24 VALV.	GP-81	GA-8606	
CIRRUS	L4 2.4L FI 16 VALV. TURBO	GP-58	GA-132	GG-104
CIRRUS	V6 2.5L FI 24 VALV.	GP-81	GA-132	GG-104
CONCORDE	V6 3.2L FI	GP-81	GA-8606	
CONCORDE	V6 3.5L FI	GP-81	GA-141	GG-84
SEBRING	L4 2.0L SFI 16 VALV.	GP-81	GA-7344	
SEBRING	L4 2.4L SFI 16 VALV.	GP-58	GA-132	GG-104
SEBRING	V6 2.5L SFI 24 VALV. CON- VERTIBLE	GP-81	GA-132	GG-104
SEBRING	V6 2.5L SFI 24 VALV. COUPE	GP-81	GA-7344	
TOWN & COUNTRY	V6 3.8L FI	GP-81	GA-277	GG-265
1998				
CIRRUS	L4 2.4L FI 16 VALV. TURBO	GP-58	GA-132	GG-104
CIRRUS	V6 2.5L FI 24 VALV.	GP-81	GA-132	GG-104
CONCORDE	V6 3.2L FI	GP-81	GA-8606	
CONCORDE	V6 3.5L FI	GP-81	GA-141	GG-84
SEBRING	L4 2.0L SFI 16 VALV.	GP-81	GA-7344	
SEBRING	L4 2.4L SFI 16 VALV.	GP-58	GA-132	GG-104
SEBRING	V6 2.5L SFI CONVERTIBLE	GP-81	GA-132	GG-104
SEBRING	V6 2.5L SFI COUPE	GP-81	GA-7344	
TOWN & COUNTRY	V6 3.8L FI	GP-81	GA-277	GG-265
1997				
CIRRUS	L4 2.4L FI 16 VALV. TURBO	GP-58	GA-132	GG-104
CIRRUS	V6 2.5L FI 24 VALV.	GP-81	GA-132	GG-104
CONCORDE	V6 3.5L FI 24 VALV.	GP-81	GA-141	GG-84
INTREPID	V6 3.3L FI CANADA	GP-81	GA-141	GG-84

Marca - Año - Modelo Motor Aceite Aire Combustible
Make-Year-Model Engine Oil Air Fuel

CHRYSLER (continuación)				
INTREPID	V6 3.5L FI CANADA	GP-81	GA-141	GG-84
LHS	V6 3.5L SFI 24 VALV.	GP-81	GA-141	GG-84
NEW YORKER	V6 3.5L FI	GP-81	GA-141	GG-84
SEBRING	L4 2.0L SFI 16 VALV.	GP-81	GA-7344	
SEBRING	L4 2.4L SFI 16 VALV.	GP-58	GA-132	GG-104
SEBRING	V6 2.5L SFI CONVERTIBLE	GP-81	GA-132	GG-104
SEBRING	V6 2.5L SFI COUPE	GP-81	GA-7344	
TOWN & COUNTRY	V6 3.8L FI	GP-81	GA-277	GG-265

1996				
CIRRUS	V6 2.5L FI 24 VALV.	GP-81	GA-132	GG-104
CONCORDE	V6 3.3L FI	GP-81	GA-141	GG-84
CONCORDE	V6 3.3L FI FLEX FUEL	GP-81	GA-141	
CONCORDE	V6 3.5L FI 24 VALV.	GP-81	GA-141	GG-84
CRUSIER	L4 2.2L FI	GP-46	GA-3916	GG-256
CRUSIER	L4 3.3L FI	GP-46	GA-3916	GG-256
CRUSIER	V6 2.2L FI	GP-46	GA-3916	GG-256
CRUSIER	V6 3.3L FI	GP-46	GA-3916	GG-256
INTREPID	V6 3.3L FI CANADA	GP-81	GA-141	GG-84
INTREPID	V6 3.3L FLEX FUEL CANADA	GP-81	GA-141	
INTREPID	V6 3.5L FI CANADA	GP-81	GA-141	GG-84
LHS	V6 3.5L SFI	GP-81	GA-141	GG-84
NEW YORKER	V6 3.5L FI	GP-81	GA-141	GG-84
SEBRING	L4 2.0L SFI	GP-81	GA-7344	
SEBRING	L4 2.4L SFI	GP-58	GA-132	GG-104
SEBRING	V6 2.5L SFI CONVERTIBLE	GP-81	GA-132	GG-104
SEBRING	V6 2.5L SFI COUPE	GP-81	GA-7344	
TOWN & COUNTRY	V6 3.8L FI	GP-81	GA-277	GG-65

1995				
CIRRUS	L4 2.4L FI	GP-81	GA-132	GG-104
CIRRUS	V6 2.5L SFI	GP-81	GA-132	GG-104
CONCORDE	V6 3.3L FI FLEX FUEL	GP-81	GA-141	
CONCORDE	V6 3.3L SFI	GP-81	GA-141	GG-84
CONCORDE	V6 3.5L FI 24 VALV.	GP-81	GA-141	GG-84
CRUSIER	L4 2.2L	GP-46	GA-3916	GG-256
CRUSIER	L4 3.3L	GP-46	GA-3916	GG-256
CRUSIER	V6 2.2L	GP-46	GA-3916	GG-256
CRUSIER	V6 3.3L	GP-46	GA-3916	GG-256
IMPERIAL	V6 3.8L	GP-81	GA-271	GG-7018
INTREPID	V6 3.3L FI CANADA	GP-81	GA-141	GG-84
INTREPID	V6 3.3L FLEX FUEL CANADA	GP-81	GA-141	
INTREPID	V6 3.5L FI CANADA	GP-81	GA-141	GG-84
LE BARON	L4 2.5L FI	GP-81	GA-277	GG-7018
LHS	V6 3.5L SFI	GP-81	GA-141	GG-84
NEW YORKER	V6 3.5L FI	GP-81	GA-141	GG-84
SEBRING	L4 2.0L FI	GP-81	GA-7344	GG-185
SEBRING	V6 2.5L SFI	GP-81	GA-7344	GG-185
TOWN & COUNTRY	V6 3.8L FI	GP-81	GA-277	GG-65

1994				
CONCORDE	V6 3.3L FI FLEX FUEL	GP-81	GA-141	
CONCORDE	V6 3.3L MFI	GP-81	GA-141	GG-84
CONCORDE	V6 3.5L FI 24 VALV.	GP-81	GA-141	GG-84
CRUSIER	L4 2.2L	GP-46	GA-3916	GG-256
CRUSIER	L4 3.3L	GP-46	GA-3916	GG-256
CRUSIER	V6 2.2L	GP-46	GA-3916	GG-256
CRUSIER	V6 3.3L	GP-46	GA-3916	GG-256
IMPERIAL	V6 3.8L	GP-81	GA-271	GG-7018
INTREPID	V6 3.3L FI CANADA	GP-81	GA-141	GG-84
INTREPID	V6 3.3L FI FLEX FUEL CANADA	GP-81	GA-141	
INTREPID	V6 3.5L FI CANADA	GP-81	GA-141	GG-84
LE BARON	L4 2.5L FI	GP-81	GA-277	GG-7018
LHS	V6 3.5L MFI	GP-81	GA-141	GG-84

Marca - Año - Modelo Motor Aceite Aire Combustible
Make-Year-Model Engine Oil Air Fuel

CHRYSLER (continuación)				
NEW YORKER	L4 2.5L TURBO	GP-58	GA-276 GA-277	GG-7019
NEW YORKER	V6 3.3L			
NEW YORKER	V6 3.5L FI	GP-81	GA-141	GG-84
PHANTOM	L4 2.5L FI TURBO	GP-81	GA-277	GG-7020
TOWN & COUNTRY	V6 3.3L FI	GP-81	GA-277	GG-65
TOWN & COUNTRY	V6 3.8L FI	GP-81	GA-277	GG-65

1993				
ADVENTURE 150	V6 3.9 FI	GP-58	GA-129	GG-67
CONCORDE	V6 3.3L MFI	GP-81	GA-141	GG-84
CONCORDE	V6 3.5L FI 24 VALV.	GP-81	GA-141	GG-84
CRUSIER	L4 2.2L	GP-46	GA-3916	GG-256
CRUSIER	L4 3.3L	GP-46	GA-3916	GG-256
CRUSIER	V6 2.2L	GP-46	GA-3916	GG-256
CRUSIER	V6 3.3L	GP-46	GA-3916	GG-256
IMPERIAL	V6 3.8L	GP-81	GA-271	GG-7018
INTREPID	V6 3.3L FI CANADA	GP-81	GA-141	GG-84
INTREPID	V6 3.5L FI CANADA	GP-81	GA-141	GG-84
LE BARON	L4 2.5L FI	GP-58	GA-276 GA-277	GG-7019
NEW YORKER	L4 2.5L TURBO	GP-58	GA-276 GA-277	GG-7019
NEW YORKER	V6 3.0L FI	GP-81	GA-277	GG-7018
NEW YORKER	V6 3.3L FI	GP-81	GA-271	GG-7020
PHANTOM	L4 2.5L TURBO 16 VALV.	GP-58	GA-277	GG-61
PROSPECTOR	V8 5.9L	GP-81	GA-70	GG-72
TOWN & COUNTRY	V6 3.3L FI	GP-81	GA-277	GG-65

1992				
ADVENTURE 150	6 CIL. 3.9L	GP-58	GA-129	GG-67
CRUSIER	L4 2.2L	GP-46	GA-3916	GG-256
CRUSIER	L4 3.3L	GP-46	GA-3916	GG-256
CRUSIER	V6 2.2L	GP-46	GA-3916	GG-256
CRUSIER	V6 3.3L	GP-46	GA-3916	GG-256
IMPERIAL	V6 3.8L	GP-81	GA-271	GG-7018
LE BARON	L4 2.5L FI	GP-81	GA-276 GA-277	GG-7019
NEW YORKER	L4 2.5L TURBO	GP-58	GA-276 GA-277	GG-7019
NEW YORKER	V6 3.0L FI	GP-81	GA-277	GG-7018
NEW YORKER	V6 3.3L FI	GP-81	GA-271	GG-7020
PHANTOM	L4 2.5L TURBO 16 VALV.	GP-58	GA-277	GG-61
PROSPECTOR	V8 5.9L	GP-81	GA-70	GG-72
TOWN & COUNTRY	V6 3.3L MFI	GP-81	GA-271	GG-65

1991				
ADVENTURE 150	V6 3.9 FI	GP-58	GA-129	GG-67
CRUSIER	L4 2.2L	GP-46	GA-3916	GG-256
CRUSIER	L4 3.3L	GP-46	GA-3916	GG-256
CRUSIER	V6 2.2L	GP-46	GA-3916	GG-256
CRUSIER	V6 3.3L	GP-46	GA-3916	GG-256
IMPERIAL	V6 3.3L FI	GP-81	GA-271	GG-7020
NEW YORKER	L4 2.2L TURBO			
NEW YORKER	L4 2.5L	GP-58	GA-276	GG-7019
NEW YORKER	V6 3.0L FI	GP-81	GA-277	GG-7018
PHANTOM	L4 2.5L TURBO	GP-58	GA-277	GG-61
PROSPECTOR	V8 5.7L			
TOWN & COUNTRY	V6 3.3L MFI	GP-81	GA-271	GG-65

1990				
CRUSIER	L4 2.2L	GP-46	GA-3916	GG-256
CRUSIER	L4 3.3L	GP-46	GA-3916	GG-256
CRUSIER	V6 2.2L	GP-46	GA-3916	GG-256
CRUSIER	V6 3.3L	GP-46	GA-3916	GG-256
IMPERIAL	V6 3.3L FI	GP-58	GA-271	GG-61
NEW YORKER	L4 2.2L TURBO			

Marca - Año - Modelo Make-Year-Model	Motor Engine	Aceite Oil	Aire Air	Combustible Fuel
CHRYSLER (continuación)				
NEW YORKER	L4 2.5L	GP-58	GA-276	GG-7019
PHANTOM	L4 2.5L TURBO	GP-58	GA-277	GG-61
PROSPECTOR	V8 5.7L			
TOWN & COUNTRY	V6 3.0L FI	GP-58	GA-277	GG-61
TOWN & COUNTRY	V6 3.3L MFI	GP-58	GA-271	GG-65

DODGE				
2010				
AVENGER	L4 2.4L FI	GP-406		
AVENGER	V6 3.5L FI	GP-406	GA-248	
CALIBER	L4 1.8L FI	GP-406	GA-489	
CALIBER	L4 2.0L FI	GP-406	GA-489	
CALIBER	L4 2.4L FI	GP-406	GA-489	
CHALLENGER	V6 3.5L FI	GP-406		
CHALLENGER	V8 5.7L FI HEMI	GP-68		
CHALLENGER	V8 6.1L FI HEMI	GP-68		
CHARGER	V6 2.7L FI	GP-406		
CHARGER	V6 3.5L FI	GP-68		
CHARGER	V8 5.7L FI HEMI	GP-68		
CHARGER	V8 6.1L FI HEMI	GP-68		
DAKOTA	V6 3.7L FI			
DAKOTA	V8 4.7L FI FLEX FUEL	GP-68		
GRAND CARAVAN	V6 3.3L FI FLEX FUEL		GA-248	
GRAND CARAVAN	V6 3.8L FI		GA-248	
GRAND CARAVAN	V6 4.0L FI		GA-248	
JOURNEY	L4 2.4L FI	GP-406	GA-248	
JOURNEY	V6 3.5L FI	GP-406	GA-248	
NITRO	V6 3.7L FI			
NITRO	V6 4.0L FI			
RAM	6 CIL. 5.9L FI TURBO DIESEL	GP-178	GA-488	
RAM	6 CIL. 6.7L FI TURBO DIESEL	GP-178		
RAM	V6 3.7L FI		GA-490	
RAM	V8 4.7L FI FLEX FUEL	GP-68	GA-490	
RAM	V8 5.7L FI HEMI	GP-68	GA-490	
VIPER	V10 8.4L FI			

2009				
ATOS BY DODGE	L4 1.1L FI	GP-6811	GA-302	GG-369
ATTITUDE	L4 1.4L FI	GP-6811	GA-363	
ATTITUDE	L4 1.6L FI	GP-6811	GA-363	
AVENGER	L4 2.4L FI 16 VALV. DOHC	GP-406	GA-248	
AVENGER	V6 2.7L FI 24 VALV. DOHC FLEX FUEL	GP-68	GA-248	
AVENGER	V6 3.5L FI 24 VALV. SOHC	GP-68	GA-248	
CALIBER	L4 1.8L FI 16 VALV. DOHC	GP-406	GA-489	
CALIBER	L4 2.0L FI 16 VALV. DOHC	GP-406	GA-489	
CALIBER	L4 2.4L FI 16 VALV. DOHC	GP-406	GA-489	
CARAVAN	V6 3.3L FI	GP-58	GA-248	
CARAVAN	V6 3.3L FI FLEX FUEL	GP-58	GA-248	
CARAVAN	V6 3.8L FI 24 VALV. SOHC	GP-58	GA-248	
CARAVAN	V6 4.0L FI 24 VALV. SOHC	GP-58	GA-248	
CHALLENGER	V6 3.5L FI	GP-68	GA-289	
CHALLENGER	V8 5.7L FI HEMI MAGNUM	GP-68	GA-289	
CHALLENGER	V8 6.1L FI HEMI MAGNUM	GP-68	GA-289	
CHARGER	V6 2.7L FI 24 VALV. DOHC	GP-406	GA-289	
CHARGER	V6 3.5L FI 24 VALV.	GP-68	GA-289	
CHARGER	V8 5.7L FI HEMI MAGNUM	GP-68	GA-289	
CHARGER	V8 6.1L FI HEMI	GP-68	GA-289	
DAKOTA	V6 3.7L FI	GP-406		
DAKOTA	V8 4.7L FI SOHC FLEX FUEL	GP-68		
DURANGO	V6 3.7L FI	GP-406	GA-249	
DURANGO	V8 4.7L FI FLEX FUEL	GP-68 ¹³³	GA-249	
DURANGO	V8 5.7L FI HEMI MAGNUM	GP-68 ¹³³	GA-249	
DURANGO HYBRID	V8 5.7L FI HEMI MAGNUM	GP-68 ¹³³	GA-249	
GRAND CARAVAN	V6 3.3L FI	GP-58	GA-248	
GRAND CARAVAN	V6 3.3L FI FLEX FUEL	GP-58	GA-248	

Marca - Año - Modelo Make-Year-Model	Motor Engine	Aceite Oil	Aire Air	Combustible Fuel
DODGE (continuación)				
GRAND CARAVAN	V6 3.8L FI	GP-58	GA-248	
GRAND CARAVAN	V6 4.0L FI 24 VALV. SOHC	GP-406	GA-248	
H100 BY DODGE	L4 2.5L DIESEL	GP-112	GA-110	GPP-111 GPP-524 ¹³⁵
JOURNEY	L4 2.4L FI	GP-406	GA-248	
JOURNEY	V6 2.7L FLEX FUEL	GP-68	GA-248	
JOURNEY	V6 3.5L FI	GP-406	GA-248	
MAGNUM	V6 2.7L FI 24 VALV. DOHC	GP-406	GA-289	
MAGNUM	V8 5.7L FI HEMI MAGNUM	GP-68	GA-289	
NITRO	V6 3.7L FI	GP-406	GA-143	
NITRO	V6 4.0L FI 24 VALV. SOHC	GP-406	GA-143	
RAM	6 CIL. 5.9L DIESEL TURBO	GP-178	GA-488	GS-1261
RAM	6 CIL. 6.7L DIESEL TURBO	GP-178		
RAM	V6 3.7L FI	GP-406	GA-490	
RAM	V8 4.7L FI FLEX FUEL	GP-68	GA-490	
RAM	V8 5.7L FI HEMI MAGNUM	GP-68	GA-490	
VIPER	V10 8.4L FI	GP-68		

2008				
ATOS BY DODGE	L4 1.1L FI	GP-6811	GA-302	GG-369
ATTITUDE	L4 1.4L FI	GP-6811	GA-363	
ATTITUDE	L4 1.6L FI	GP-6811	GA-363	
AVENGER	L4 2.0L FI	GP-406		
AVENGER	L4 2.4L FI	GP-406	GA-248	
AVENGER	V6 2.7L FLEX FUEL	GP-68 ¹³³ GP-81 ¹³²	GA-248	
AVENGER	V6 3.5L FI HIGH OUTPUT	GP-68 ¹³³ GP-81 ¹³²	GA-248	
CALIBER	L4 1.8L SFI	GP-406	GA-489	
CALIBER	L4 2.0L SFI	GP-406	GA-489	
CALIBER	L4 2.4L SFI	GP-406	GA-489 ⁹⁰	
CARAVAN	V6 3.3L FI	GP-58	GA-248 GAC-2 ²⁴	
CARAVAN	V6 3.3L FI FLEX FUEL	GP-58	GA-248 GAC-2 ²⁴	
CARAVAN	V6 3.8L FI	GP-58	GA-248 GAC-2 ²⁴	
CARAVAN	V6 4.0L FI	GP-81	GA-248 GAC-2 ²⁴	
CHALLENGER	V8 5.7L FI HEMI			
CHALLENGER	V8 6.1L FI HEMI			
CHARGER	V6 2.7L FI	GP-68 ¹³³ GP-81 ¹³²	GA-289	
CHARGER	V6 3.5L MFI	GP-68 ¹³³ GP-81 ¹³²	GA-289	
CHARGER	V8 5.7L SFI HEMI	GP-68 ¹³³ GP-81 ¹³²	GA-289	
CHARGER	V8 6.1L SFI HEMI	GP-68 ¹³³ GP-81 ¹³²	GA-289	
DAKOTA	V6 3.7L FI	GP-3600	GA-3901	
DAKOTA	V8 4.7L FLEX FUEL	GP-68 ¹³³ GP-81 ¹³²	GA-3901	
DURANGO	V6 3.7L SFI	GP-3600	GA-249	
DURANGO	V8 4.7L FLEX FUEL	GP-68 ¹³³ GP-81 ¹³²	GA-249	
DURANGO	V8 5.7L FI HEMI	GP-68 ¹³³ GP-81 ¹³²	GA-249	
GRAND CARAVAN	V6 3.3L FI FLEX FUEL	GP-58	GA-248 GAC-2 ²⁴	
GRAND CARAVAN	V6 3.8L FI	GP-58	GA-248 GAC-2 ²⁴	
GRAND CARAVAN	V6 4.0L FI	GP-81	GA-248 GAC-2 ²⁴	
H100 BY DODGE	L4 2.5L DIESEL	GP-112	GA-110	GPP-111 GPP-524 ¹³⁵
MAGNUM	V6 2.7L MFI	GP-68 ¹³³ GP-81 ¹³²	GA-289	
MAGNUM	V6 3.5L MFI HO	GP-68 ¹³³ GP-81 ¹³²	GA-289	
MAGNUM	V8 5.7L MFI HEMI	GP-68 ¹³³ GP-81 ¹³²	GA-289	
MAGNUM	V8 6.1L SFI HEMI	GP-68 ¹³³ GP-81 ¹³²	GA-289	

Marca - Año - Modelo Make-Year-Model	Motor Engine	Aceite Oil	Aire Air	Combustible Fuel
DODGE (continuación)				
NITRO	V6 3.7L SFI	GP-3600	GA-143	
NITRO	V6 4.0L SFI	GP-81	GA-143	
RAM	6 CIL. 5.9L TURBO DIESEL	GP-178	GA-488	GS-1261
RAM	6 CIL. 6.7L FI TURBO DIESEL	GP-178		
RAM	V6 3.7L FI	GP-3600	GA-490	
RAM	V8 4.7L FI	GP-68 ¹³³ GP-81 ¹³²	GA-490	
RAM	V8 5.7L FI HEMI	GP-68 ¹³³ GP-81 ¹³²	GA-490	
VAN 1000	L4 2.4L FI	GP-6811	GA-362	GG-187
VIPER	V10 8.4L SFI			

2007				
ATOS BY DODGE	L4 1.1L FI	GP-6811	GA-302	GG-369
ATTITUDE	L4 1.4L FI	GP-6811	GA-363	
ATTITUDE	L4 1.6L FI	GP-6811	GA-363	
CALIBER	L4 1.8L 16 VALV.	GP-406	GA-489	
CALIBER	L4 2.0L 16 VALV.	GP-406	GA-489	
CALIBER	L4 2.4L 16 VALV.	GP-406	GA-489	
CARAVAN	L4 2.4L SFI	GP-58	GA-248 GAC-2 ²⁴	
CARAVAN	V6 3.3L FI	GP-81	GA-248 GAC-2 ²⁴	
CARAVAN	V6 3.8L SFI	GP-81	GA-248 GAC-2 ²⁴	
CHARGER	V6 2.7L MFI 24 VALV.	GP-81	GA-289	
CHARGER	V6 3.5L MFI	GP-81	GA-289	
CHARGER	V8 5.7L FI HEMI	GP-81	GA-289	
CHARGER	V8 6.1L SFI HEMI	GP-81	GA-289	
DAKOTA	V6 3.7L MFI 12 VALV.	GP-3600	GA-3901	
DAKOTA	V8 4.7L MFI	GP-81	GA-3901	
DURANGO	V6 3.7L FI	GP-3600	GA-249	
DURANGO	V6 3.7L SFI	GP-3600		
DURANGO	V8 4.7L SFI	GP-81	GA-249	
DURANGO	V8 5.7L FI HEMI	GP-81	GA-249	
GRAND CARAVAN	L4 2.4L SFI	GP-58	GA-248 GAC-2 ²⁴	
GRAND CARAVAN	V6 3.3L FI	GP-58	GA-248 GAC-2 ²⁴	
GRAND CARAVAN	V6 3.3L FLEX FUEL	GP-58	GA-248 GAC-2 ²⁴	
GRAND CARAVAN	V6 3.8L SFI	GP-58	GA-248 GAC-2 ²⁴	
H100 BY DODGE	L4 2.5L DIESEL	GP-112	GA-110	GPP-111 GPP-524 ¹³⁵
NITRO	V6 3.7L SFI	GP-3600	GA-143	
NITRO	V6 4.0L SFI	GP-81	GA-143	
RAM	6 CIL. 5.9L TURBO DIESEL	GP-178	GA-488	GS-1261
RAM	6 CIL. 6.7L FI TURBO DIESEL	GP-178		
RAM	V6 3.7L FI	GP-3600	GA-490	
RAM	V8 4.7L SFI	GP-81	GA-490	
RAM	V8 5.7L FI HEMI	GP-81	GA-490	
VIPER	V10 8.3L FI 20 VALV.	GP-81		

2006				
ATOS BY DODGE	L4 1.1L FI	GP-6811	GA-302	GG-369
ATTITUDE	L4 1.4L FI	GP-6811	GA-363	
ATTITUDE	L4 1.6L FI	GP-6811	GA-363	
CALIBER	L4 1.8L 16 VALV.	GP-406	GA-489	
CALIBER	L4 2.0L 16 VALV.	GP-406	GA-489	
CALIBER	L4 2.4L 16 VALV.	GP-406	GA-489	
CARAVAN	L4 2.4L SFI	GP-58	GA-248 GAC-2 ²⁴	
CARAVAN	V6 3.3L FI 12 VALV.	GP-81	GA-248 GAC-2 ²⁴	
CARAVAN	V6 3.8L SFI 12 VALV.	GP-81	GA-248 GAC-2 ²⁴	
CHARGER	V6 2.7L MFI 24 VALV.	GP-81	GA-289	
CHARGER	V6 3.5L SFI 24 VALV.	GP-81	GA-289	
CHARGER	V8 5.7L FI HEMI	GP-81	GA-289	

Marca - Año - Modelo Make-Year-Model	Motor Engine	Aceite Oil	Aire Air	Combustible Fuel
DODGE (continuación)				
CHARGER	V8 6.1L SFI HEMI	GP-81	GA-289	
DAKOTA	V6 3.7L FI	GP-3600	GA-3901	
DURANGO	V6 3.7L FI	GP-3600	GA-249	
DURANGO	V8 4.7L FI	GP-81	GA-249	
DURANGO	V8 5.7L FI	GP-81	GA-249	
DURANGO	V8 5.9L FI			
GRAND CARAVAN	L4 2.4L SFI	GP-58	GA-248 GAC-2 ²⁴	
GRAND CARAVAN	V6 3.3L FI FLEX FUEL	GP-81	GA-248 GAC-2 ²⁴	
GRAND CARAVAN	V6 3.3L SFI	GP-81	GA-248 GAC-2 ²⁴	
GRAND CARAVAN	V6 3.8L SFI	GP-81	GA-248 GAC-2 ²⁴	
H100 BY DODGE	L4 2.4L FI	GP-6811	GA-362	GG-237
NEON	L4 2.0L FI SOHC	GP-58	GA-278R	
NEON	L4 2.4L FI DOHC TURBO	GP-3600	GA-278R	
RAM	6 CIL. 5.9L TURBO DIESEL	GP-178	GA-488	GS-1261
RAM	V10 8.3L FI	GP-81	GA-488	
RAM	V6 3.7L FI	GP-3600	GA-490	
RAM	V8 4.7L SFI 16 VALV.	GP-81	GA-490	
RAM	V8 5.7L FI HEMI	GP-81	GA-490	
STRATUS	L4 2.0L FI 16 VALV.			
STRATUS	L4 2.4L FI 16 VALV.	GP-58 ¹³⁴ GP-149 ⁶⁴	GA-7344 ⁶⁴ GA-183R ¹³⁴	
VERNA BY DODGE	L4 1.5L FI 12 VALV.	GP-6811	GA-216	GG-182
VERNA BY DODGE	L4 1.6L FI 16 VALV.	GP-6811	GA-216	GG-182
VIPER	V10 8.3L FI 20 VALV.	GP-81		

2005				
ATOS BY DODGE	L4 1.1L FI	GP-6811	GA-302	GG-369
CARAVAN	L4 2.4L SFI 16 VALV.	GP-58	GA-248 GAC-2 ²⁴	
CARAVAN	V6 3.3L SFI 12 VALV.	GP-81	GA-248 GAC-2 ²⁴	
CARAVAN	V6 3.8L SFI	GP-81	GA-248 GAC-2 ²⁴	
DAKOTA	V8 4.7L FI	GP-81	GA-3901	
DAKOTA	V8 5.7L FI	GP-81		
DURANGO	V6 3.7L FI	GP-3600	GA-249	
DURANGO	V8 4.7L FI	GP-81	GA-249	
DURANGO	V8 5.7L FI HEMI MAGNUM	GP-81	GA-249	
DURANGO	V8 5.9L FI			
GRAND CARAVAN	L4 2.4L SFI	GP-58	GA-248 GAC-2 ²⁴	
GRAND CARAVAN	V6 3.3L SFI	GP-81	GA-248 GAC-2 ²⁴	
GRAND CARAVAN	V6 3.8L SFI	GP-81	GA-248 GAC-2 ²⁴	
H100 BY DODGE	L4 2.4L FI	GP-6811	GA-362	GG-237
NEON	L4 2.0L FI 16 VALV.	GP-58	GA-278R	
NEON	L4 2.5L FI	GP-3600	GA-278R	
RAM	6 CIL. 5.9L TURBO DIESEL	GP-178	GA-488	GS-1261
RAM	V10 8.3L FI	GP-81	GA-488	
RAM	V6 3.7L SFI	GP-3600	GA-490	
RAM	V8 4.7L SFI	GP-81	GA-490	GG-111
RAM	V8 5.7L SFI HEMI	GP-81	GA-490	GG-111
STRATUS	L4 2.4L FI 16 VALV.	GP-58 ¹³⁴ GP-149 ⁶⁴	GA-7344 ⁶⁴ GA-183R ¹³⁴	
VERNA BY DODGE	L4 1.5L FI 12 VALV.	GP-6811	GA-216	GG-182
VERNA BY DODGE	L4 1.6L FI 16 VALV.	GP-6811	GA-216	GG-182
VIPER	V10 8.3L FI	GP-81		

2004				
ATOS BY DODGE	L4 1.0L FI	GP-91	GA-281	GG-169
CARAVAN	L4 2.4L SFI 16 VALV.	GP-81	GA-248 GAC-2 ²⁴	GG-265
CARAVAN	V6 3.3L SFI	GP-81	GA-248 GAC-2 ²⁴	GG-265

Marca - Año - Modelo Make-Year-Model	Motor Engine	Aceite Oil	Aire Air	Combustible Fuel
DODGE (continuación)				
CARAVAN	V6 3.8L SFI 12 VALV.	GP-81	GA-248 GAC-2 ²⁴	GG-265
DAKOTA	V6 3.7L MFI 12 VALV.	GP-3600	GA-3901	
DAKOTA	V8 4.7L SFI 16 VALV.	GP-81	GA-3901	
DURANGO	V6 3.7L FI	GP-3600	GA-249	
DURANGO	V8 4.7L FI	GP-81	GA-249	
DURANGO	V8 5.7L FI HEMI MAGNUM	GP-81	GA-249	
DURANGO	V8 5.9L FI			
GRAND CARAVAN	L4 2.4L SFI	GP-58	GA-248 GAC-2 ²⁴	GG-265
GRAND CARAVAN	V6 3.3L FLEX FUEL	GP-81	GA-248 GAC-2 ²⁴	GG-265
GRAND CARAVAN	V6 3.3L SFI	GP-81	GA-248 GAC-2 ²⁴	GG-265
GRAND CARAVAN	V6 3.8L SFI	GP-81	GA-248 GAC-2 ²⁴	GG-265
H100 BY DODGE	L4 2.4L FI	GP-6811	GA-362	GG-237
INTREPID	V6 2.7L SFI	GP-81	GA-8606	
INTREPID	V6 3.5L SFI	GP-81	GA-8606	
NEON	L4 2.0L FI 16 VALV.	GP-58	GA-278R	
NEON	L4 2.5L FI	GP-3600	GA-278R	
RAM	6 CIL. 5.9L TURBO DIESEL	GP-178	GA-488	GS-1261
RAM	V10 8.0L FI	GP-81	GA-488	
RAM	V10 8.3L FI	GP-81	GA-488	
RAM	V6 3.7L SFI 12 VALV.	GP-3600	GA-490	
RAM	V8 4.7L SFI	GP-81	GA-490	GG-111
RAM	V8 5.7L SFI HEMI	GP-81	GA-490	GG-111
STRATUS	L4 2.0L FI 16 VALV.	GP-58	GA-132	
STRATUS	L4 2.4L FI 16 VALV.	GP-58	GA-183R	
VERNA BY DODGE	L4 1.5L FI 12 VALV.	GP-6811	GA-216	GG-182
VERNA BY DODGE	L4 1.6L FI 16 VALV.	GP-6811	GA-216	GG-182
VIPER	V10 8.0L FI	GP-81		GG-98
VIPER	V10 8.3L FI	GP-81		
2003				
ATOS BY DODGE	L4 1.0L FI	GP-91	GA-281	GG-169
CARAVAN	L4 2.4L SFI 16 VALV.	GP-58	GA-248 GAC-2 ²⁴	GG-265
CARAVAN	V6 3.3L SFI	GP-81	GA-248 GAC-2 ²⁴	GG-265
CARAVAN	V6 3.8L SFI	GP-81	GA-248 GAC-2 ²⁴	GG-265
DAKOTA	V6 3.9L SFI	GP-81	GA-3901	
DAKOTA	V8 4.7L SFI 16 VALV.	GP-81	GA-3901	
DAKOTA	V8 5.9L SFI 16 VALV.	GP-81	GA-3901	
DURANGO	V8 4.7L FI	GP-81	GA-3901	
DURANGO	V8 5.9L FI	GP-81	GA-3901	
GRAND CARAVAN	L4 2.4L SFI	GP-58	GA-248 GAC-2 ²⁴	GG-265
GRAND CARAVAN	V6 3.3L FLEX FUEL	GP-81	GA-248 GAC-2 ²⁴	GG-265
GRAND CARAVAN	V6 3.3L SFI	GP-81	GA-248 GAC-2 ²⁴	GG-265
GRAND CARAVAN	V6 3.8L SFI	GP-81	GA-248 GAC-2 ²⁴	GG-265
H100 BY DODGE	L4 2.4L FI	GP-6811	GA-362	GG-237
INTREPID	V6 2.7L FI 24 VALV.	GP-81	GA-8606	
INTREPID	V6 3.5L FI 24 VALV.	GP-81	GA-8606	
NEON	L4 2.0L FI 16 VALV.	GP-58	GA-278R	
RAM	6 CIL. 5.9L TURBO DIESEL	GP-178	GA-488	GS-1261
RAM	V10 8.0L SFI	GP-81	GA-490	
RAM	V6 3.7L SFI	GP-3600	GA-490	
RAM	V8 4.7L SFI	GP-81	GA-490	GG-111
RAM	V8 5.7L SFI HEMI	GP-81	GA-490	GG-111
RAM	V8 5.9L SFI	GP-81	GA-490	
RAM VAN	V6 3.9L SFI	GP-81	GA-70	
RAM VAN	V8 5.2L SFI	GP-81	GA-70	
RAM VAN	V8 5.9L SFI	GP-81	GA-70	
STRATUS	L4 2.0L FI 16 VALV.	GP-58	GA-132	
STRATUS	L4 2.4L FI 16 VALV.	GP-58	GA-183R	

Marca - Año - Modelo Make-Year-Model	Motor Engine	Aceite Oil	Aire Air	Combustible Fuel
DODGE (continuación)				
VIPER	V10 8.3L FI	GP-81		
2002				
ATOS BY DODGE	L4 1.0L FI	GP-91	GA-281	GG-169
CARAVAN	L4 2.4L SFI 16 VALV.	GP-58	GA-248 GAC-2 ²⁴	GG-265
CARAVAN	V6 3.3L SFI FLEX FUEL	GP-81	GA-248 GAC-2 ²⁴	GG-265
CARAVAN	V6 3.8L SFI	GP-81	GA-248 GAC-2 ²⁴	GG-265
DAKOTA	L4 2.5L SFI	GP-81	GA-3901	
DAKOTA	V6 3.9L SFI	GP-81	GA-3901	
DAKOTA	V8 4.7L SFI 16 VALV.	GP-81	GA-3901	
DAKOTA	V8 5.9L SFI 16 VALV.	GP-81	GA-3901	
DURANGO	V8 4.7L FI	GP-81	GA-3901	GG-111
DURANGO	V8 5.9L FI	GP-81	GA-3901	GG-111
GRAND CARAVAN	L4 2.4L SFI	GP-58	GA-248 GAC-2 ²⁴	GG-265
GRAND CARAVAN	V6 3.3L SFI FLEX FUEL	GP-81	GA-248 GAC-2 ²⁴	GG-265
GRAND CARAVAN	V6 3.8L SFI	GP-81	GA-248 GAC-2 ²⁴	GG-265
INTREPID	V6 2.7L FI 24 VALV.	GP-81	GA-8606	
INTREPID	V6 3.5L FI 24 VALV.	GP-81	GA-8606	
NEON	L4 2.0L FI 16 VALV.	GP-58	GA-278R	
RAM	6 CIL. 5.9L TURBO DIESEL	GP-178	GA-488	GS-1261
RAM	V10 8.0L SFI	GP-81	GA-438	GG-111
RAM	V6 3.7L FI	GP-3600	GA-490	GG-111
RAM	V8 4.7L FI	GP-81	GA-490	
RAM	V8 5.2L FI	GP-81	GA-490	GG-111
RAM	V8 5.9L FI	GP-81	GA-3901 ⁸⁶ GA-490 ¹²⁴	GG-111
RAM VAN	V6 3.9L SFI	GP-81	GA-70	
RAM VAN	V8 5.2L SFI	GP-81	GA-70	
RAM VAN	V8 5.9L SFI	GP-81	GA-70	
STRATUS	L4 2.0L FI 16 VALV.	GP-58	GA-132	
STRATUS	L4 2.4L FI 16 VALV.	GP-58	GA-183R	
VIPER	V10 8.0L FI	GP-81		
2001				
ATOS BY DODGE	L4 1.0L FI	GP-91	GA-281	GG-169
CARAVAN	L4 2.4L SFI 16 VALV.	GP-58	GA-248 GAC-2 ²⁴	GG-265
CARAVAN	V6 3.3L SFI	GP-81	GA-248 GAC-2 ²⁴	GG-265
CARAVAN	V6 3.5L FI	GP-81	GA-248	GG-265
CARAVAN	V6 3.8L SFI	GP-81	GA-248 GAC-2 ²⁴	GG-265
DAKOTA	L4 2.5L SFI	GP-81	GA-3901	
DAKOTA	V6 3.9L SFI	GP-81	GA-3901	
DAKOTA	V8 4.7L SFI 16 VALV.	GP-81	GA-3901	
DAKOTA	V8 5.2L SFI	GP-81	GA-3901	
DAKOTA	V8 5.9L SFI 16 VALV.	GP-81	GA-3901	
DURANGO	V8 4.7L FI	GP-81	GA-3901	GG-111
DURANGO	V8 5.9L FI	GP-81	GA-3901	GG-111
GRAND CARAVAN	L4 2.4L SFI	GP-58	GA-248 GAC-2 ²⁴	GG-265
GRAND CARAVAN	V6 3.3L FLEX FUEL	GP-81	GA-248 GAC-2 ²⁴	GG-265
GRAND CARAVAN	V6 3.3L SFI	GP-81	GA-248 GAC-2 ²⁴	GG-265
GRAND CARAVAN	V6 3.5L FI	GP-81	GA-248	GG-265
GRAND CARAVAN	V6 3.8L SFI	GP-81	GA-248 GAC-2 ²⁴	GG-265
INTREPID	V6 3.5L FI 24 VALV.	GP-81	GA-8606	
NEON	L4 2.0L FI 16 VALV.	GP-58	GA-278R	
RAM	6 CIL. 5.9L TURBO DIESEL	GP-178	GA-240	GS-1261
RAM	V10 8.0L SFI	GP-81	GA-438	GG-111
RAM	V6 3.9L SFI	GP-81	GA-3901	
RAM	V8 5.2L SFI	GP-81	GA-3901	GG-111

Marca - Año - Modelo Make-Year-Model	Motor Engine	Aceite Oil	Aire Air	Combustible Fuel
DODGE (continuación)				
RAM	V8 5.9L FI	GP-81	GA-3901	GG-111
RAM VAN	V6 3.9L SFI	GP-81	GA-70	
RAM VAN	V8 5.2L SFI	GP-81	GA-70	
RAM VAN	V8 5.9L SFI	GP-81	GA-70	
STRATUS	L4 2.0L FI 16 VALV.	GP-58	GA-132	GG-104
STRATUS	L4 2.4L FI 16 VALV.	GP-58	GA-183R	GG-104
VIPER	V10 8.0L FI	GP-81		GG-98
2000				
CARAVAN	L4 2.4L SFI 16 VALV.	GP-58	GA-277 GAC-2 ²⁴	GG-265
CARAVAN	V6 3.0L SFI	GP-81	GA-277 GAC-2 ²⁴	GG-265 ⁷¹ GG-267 ⁷²
CARAVAN	V6 3.3 SFI	GP-81	GA-277 GAC-2 ²⁴	GG-265 ⁷¹ GG-267 ⁷²
CARAVAN	V6 3.3L SFI FLEX FUEL	GP-81	GA-277 GAC-2 ²⁴	
CARAVAN	V6 3.8L SFI	GP-81	GA-277 GAC-2 ²⁴	GG-265 ⁷¹ GG-267 ⁷²
DAKOTA	L4 2.5L SFI	GP-81	GA-3901	
DAKOTA	V6 3.9L SFI	GP-81	GA-3901	
DAKOTA	V8 4.7L SFI	GP-81	GA-3901	
DAKOTA	V8 5.2L SFI	GP-81	GA-3901	
DAKOTA	V8 5.9L SFI	GP-81	GA-3901	
DURANGO	V8 5.2L FI	GP-81	GA-3901	GG-111
DURANGO	V8 5.9L FI	GP-81	GA-3901	GG-111
GRAND CARAVAN	L4 2.4L SFI	GP-58	GA-277 GAC-2 ²⁴	GG-265
GRAND CARAVAN	V6 3.0L SFI	GP-81	GA-277	GG-265 ⁷¹ GG-267 ⁷²
GRAND CARAVAN	V6 3.3L SFI	GP-81	GA-277 GAC-2 ²⁴	GG-265 ⁷¹ GG-267 ⁷²
GRAND CARAVAN	V6 3.3L SFI FLEX FUEL	GP-81	GA-277 GAC-2 ²⁴	GG-265 ⁷¹ GG-267 ⁷²
GRAND CARAVAN	V6 3.8L SFI	GP-81	GA-277 GAC-2 ²⁴	GG-265 ⁷¹ GG-267 ⁷²
INTREPID	V6 3.2L FI 24 VALV.	GP-81	GA-8606	
INTREPID	V6 3.5L FI	GP-81	GA-8606	
NEON	L4 2.0L FI 16 VALV.	GP-58	GA-278R	
RAM	6 CIL. 5.9L TURBO DIESEL	GP-178	GA-240	GS-1261
RAM	V10 8.0L SFI	GP-81	GA-438	
RAM	V6 3.9L SFI	GP-81	GA-3901	
RAM	V8 4.7L FI	GP-81	GA-3901	
RAM	V8 5.2L SFI	GP-81	GA-3901	GG-111
RAM	V8 5.9L FI	GP-81	GA-3901	GG-111
RAM VAN	V6 3.9L SFI	GP-81	GA-70	
RAM VAN	V8 5.2L SFI	GP-81	GA-70	
RAM VAN	V8 5.9L SFI	GP-81	GA-70	
STRATUS	L4 2.0L FI 16 VALV.	GP-58	GA-132	GG-104
STRATUS	L4 2.4L FI 16 VALV.	GP-58	GA-132	GG-104
VIPER	V10 8.0L FI	GP-81		GG-98
1999				
B100	6 / 8 CIL. 3.9 Y 5.2L FI	GP-81	GA-70	
B150	6 / 8 CIL. 3.9 Y 5.2L FI	GP-81	GA-70	
B250	V8 3.9, 5.2 Y 5.9L FI	GP-81	GA-70	GG-67
B350	V8 3.9, 5.2 Y 5.9L FI	GP-81	GA-70	GG-67
CARAVAN	L4 2.4L SFI 16 VALV.	GP-58	GA-277	GG-265
CARAVAN	V6 3.0L SFI	GP-81	GA-277	GG-265 ⁷¹ GG-267 ⁷²
CARAVAN	V6 3.3L SFI	GP-81	GA-277	GG-265 ⁷¹ GG-267 ⁷²
CARAVAN	V6 3.3L SFI FLEX FUEL	GP-81	GA-277	
CARAVAN	V6 3.8L SFI	GP-81	GA-277	GG-265 ⁷¹ GG-267 ⁷²
D600	V8 5.9L FI	GP-81	GA-3901	
DAKOTA	6 CIL. 3.9L FI	GP-81	GA-3901	
DAKOTA	L4 2.5L FI	GP-81	GA-3901	
DAKOTA	V8 5.2L FI	GP-81	GA-3901	
DAKOTA	V8 5.9L FI	GP-81	GA-3901	

Marca - Año - Modelo Make-Year-Model	Motor Engine	Aceite Oil	Aire Air	Combustible Fuel
DODGE (continuación)				
DURANGO	V8 5.2L FI	GP-81	GA-3901	GG-111
DURANGO	V8 5.9L FI	GP-81	GA-3901	GG-111
GRAND CARAVAN	L4 2.4L SFI	GP-58	GA-277	GG-265
GRAND CARAVAN	V6 3.0L SFI	GP-81	GA-277	GG-265 ⁷¹ GG-267 ⁷²
GRAND CARAVAN	V6 3.3L SFI	GP-81	GA-277	GG-265 ⁷¹ GG-267 ⁷²
GRAND CARAVAN	V6 3.3L SFI FLEX FUEL	GP-81	GA-277	GG-265 ⁷¹ GG-267 ⁷²
GRAND CARAVAN	V6 3.8L SFI	GP-81	GA-277	GG-265 ⁷¹ GG-267 ⁷²
INTREPID	V6 3.2L FI 24 VALV.	GP-81	GA-8606	
NEON	L4 2.0L FI 16 VALV.	GP-58	GA-277	GG-195
RAM	6 CIL. 5.9L TURBO DIESEL	GP-178	GA-240	
RAM	V10 8.0L SFI	GP-81	GA-438	
RAM	V6 3.9L SFI	GP-81	GA-3901	
RAM	V8 5.2L SFI	GP-81	GA-3901	GG-111
RAM	V8 5.9L SFI	GP-81	GA-3901	GG-111
RAM VAN	V6 3.9L SFI	GP-81	GA-70	
RAM VAN	V8 5.2L SFI	GP-81	GA-70	
RAM VAN	V8 5.9L SFI	GP-81	GA-70	
STRATUS	L4 2.0L FI 16 VALV.	GP-58	GA-132	GG-104
STRATUS	L4 2.4L FI 16 VALV.	GP-58	GA-132	GG-104
TRUCK 200- VAN 3/4 TON.	V8 3.9, 5.2 Y 5.9L FI	GP-81	GA-70	GG-67
TRUCK 300-VAN 1 TON.	V8 3.9, 5.2 Y 5.9L FI	GP-81	GA-70	GG-67
VIPER	V10 8.0L FI	GP-81		GG-98
1998				
B100	6 / 8 CIL. 3.9 Y 5.2L FI	GP-81	GA-70	
B150	6 / 8 CIL. 3.9 Y 5.2L FI	GP-81	GA-70	
B250	V8 3.9, 5.2 Y 5.9L FI	GP-81	GA-70	GG-67
B350	V8 3.9, 5.2 Y 5.9L FI	GP-81	GA-70	GG-67
CARAVAN	L4 2.4L SFI 16 VALV.	GP-58	GA-277	GG-265
CARAVAN	V6 3.0L SFI	GP-81	GA-277	GG-265 ⁷¹ GG-267 ⁷²
CARAVAN	V6 3.3L SFI	GP-81	GA-277	GG-265 ⁷¹ GG-267 ⁷²
CARAVAN	V6 3.8L SFI	GP-81	GA-277	GG-265 ⁷¹ GG-267 ⁷²
D600	V8 5.9L FI	GP-81	GA-240	GG-111
DAKOTA	6 CIL. 3.9L FI	GP-81	GA-3901	
DAKOTA	L4 2.5L FI	GP-81	GA-3901	GG-72
DAKOTA	V8 5.2L FI	GP-81	GA-3901	
DAKOTA	V8 5.9L FI	GP-81	GA-3901	
DURANGO	V8 5.2L FI	GP-81	GA-3901	GG-111
GRAND CARAVAN	L4 2.4L SFI	GP-58	GA-277	GG-265
GRAND CARAVAN	V6 3.0L SFI	GP-81	GA-277	GG-265 ⁷¹ GG-267 ⁷²
GRAND CARAVAN	V6 3.3L SFI	GP-81	GA-277	GG-265 ⁷¹ GG-267 ⁷²
GRAND CARAVAN	V6 3.8L SFI	GP-81	GA-277	GG-265 ⁷¹ GG-267 ⁷²
INTREPID	V6 2.7L FI 24 VALV.	GP-81	GA-8606	
INTREPID	V6 3.2L FI 24 VALV.	GP-81	GA-8606	
NEON	L4 2.0L FI 16 VALV.	GP-58	GA-277	GG-195
RAM	6 CIL. 5.9L TURBO DIESEL	GP-178	GA-240	
RAM	V10 8.0L FI	GP-81	GA-438	GG-111
RAM	V6 3.9L SFI	GP-81	GA-3901	
RAM	V8 5.2L SFI	GP-81	GA-3901	GG-111
RAM	V8 5.9L SFI	GP-81	GA-3901	GG-111
RAM VAN	V6 3.9L SFI	GP-81	GA-70	
RAM VAN	V8 5.2L SFI	GP-81	GA-70	
RAM VAN	V8 5.9L SFI	GP-81	GA-70	
STRATUS	L4 2.0L FI	GP-58	GA-132	GG-104
STRATUS	L4 2.4L FI	GP-58	GA-132	GG-104
TRUCK 200- VAN 3/4 TON.	V8 3.9, 5.2 Y 5.9L FI	GP-81	GA-70	GG-67

Marca - Año - Modelo Make-Year-Model	Motor Engine	Aceite Oil	Aire Air	Combustible Fuel
DODGE (continuación)				
TRUCK 300-VAN 1 TON.	V8 3.9, 5.2 Y 5.9L FI	GP-81	GA-70	GG-67
VIPER	V10 8.0L FI	GP-81		GG-249
1997				
B100	6 / 8 CIL. 3.9 Y 5.2L FI	GP-81	GA-70	
B150	6 / 8 CIL. 3.9 Y 5.2L FI	GP-81	GA-70	
B250	V8 3.9, 5.2 Y 5.9L FI	GP-81	GA-70	GG-67
B350	V8 3.9, 5.2 Y 5.9L FI	GP-81	GA-70	GG-67
CARAVAN	L4 2.4L SFI 16 VALV.	GP-58	GA-277	GG-265
CARAVAN	V6 3.0L SFI	GP-81	GA-277	GG-265 ⁷¹ GG-267 ⁷²
CARAVAN	V6 3.3L SFI	GP-81	GA-277	GG-265 ⁷¹ GG-267 ⁷²
CARAVAN	V6 3.8L SFI	GP-81	GA-277	GG-265 ⁷¹ GG-267 ⁷²
D600	V8 5.9L FI	GP-81	GA-240	GG-111
DAKOTA	6 CIL. 3.9L FI	GP-81	GA-3901	
DAKOTA	L4 2.5L FI	GP-81	GA-3901	GG-72
DAKOTA	V8 5.2L FI	GP-81	GA-3901	
DAKOTA	V8 5.9L FI	GP-81	GA-3901	
GRAND CARAVAN	L4 2.4L SFI	GP-58	GA-277	GG-265
GRAND CARAVAN	V6 3.0L SFI	GP-81	GA-277	GG-265 ⁷¹ GG-267 ⁷²
GRAND CARAVAN	V6 3.3L SFI	GP-81	GA-277	GG-265 ⁷¹ GG-267 ⁷²
GRAND CARAVAN	V6 3.8L SFI	GP-81	GA-277	GG-265 ⁷¹ GG-267 ⁷²
INTREPID	V6 3.3L FI FLEX FUEL	GP-81	GA-141	GG-84
INTREPID	V6 3.3L SFI	GP-81	GA-141	GG-84
INTREPID	V6 3.5L FI 24 VALV.	GP-81	GA-141	GG-84
NEON	L4 2.0L FI 16 VALV.	GP-58	GA-277	GG-95
RAM	6 CIL. 5.9L TURBO DIESEL	GP-178	GA-240	
RAM	V10 8.0L SFI	GP-81	GA-438	GG-111
RAM	V6 3.9L SFI	GP-81	GA-3901	
RAM	V8 5.2L SFI	GP-81	GA-3901	GG-111
RAM	V8 5.9L SFI	GP-81	GA-3901	
RAM VAN	V6 3.9L SFI	GP-81	GA-70	GG-111
RAM VAN	V8 5.2L SFI	GP-81	GA-70	GG-111
RAM VAN	V8 5.9L SFI	GP-81	GA-70	GG-111
STRATUS	L4 2.0L FI	GP-58	GA-132	GG-104
STRATUS	L4 2.4L FI	GP-58	GA-132	GG-104
TRUCK 200- VAN 3/4 TON.	V8 3.9, 5.2 Y 5.9L FI	GP-81	GA-70	GG-67
TRUCK 300-VAN 1 TON.	V8 3.9, 5.2 Y 5.9L FI	GP-81	GA-70	GG-67
VIPER	V10 8.0L FI	GP-81		GG-249
1996				
B100	6 / 8 CIL. 3.9 Y 5.2L FI	GP-81	GA-70	
B150	6 / 8 CIL. 3.9 Y 5.2L FI	GP-81	GA-70	
B250	V8 3.9, 5.2 Y 5.9L FI	GP-81	GA-70	GG-67
B350	V8 3.9, 5.2 Y 5.9L FI	GP-81	GA-70	GG-67
CARAVAN	L4 2.4L SFI	GP-58	GA-277	GG-265 ⁷¹ GG-267 ⁷²
CARAVAN	V6 3.0L SFI	GP-81	GA-277	GG-265 ⁷¹ GG-267 ⁷²
CARAVAN	V6 3.3L FI GAS NATURAL	GP-81	GA-277	
CARAVAN	V6 3.3L SFI	GP-81	GA-277	GG-265 ⁷¹ GG-267 ⁷²
CARAVAN	V6 3.8L SFI	GP-81	GA-277	GG-265 ⁷¹ GG-267 ⁷²
D600	V8 5.9L FI	GP-81	GA-3901	
DAKOTA	6 CIL. 3.9L FI	GP-81	GA-70	GG-72
DAKOTA	8 CIL. 5.2L FI	GP-81	GA-70	GG-72
DAKOTA	L4 2.5L FI	GP-81	GA-271	GG-72
GRAND CARAVAN	L4 2.4L SFI	GP-58	GA-277	GG-265 ⁷¹ GG-267 ⁷²
GRAND CARAVAN	V6 3.0L SFI	GP-81	GA-277	GG-265 ⁷¹ GG-267 ⁷²
GRAND CARAVAN	V6 3.3L SFI	GP-81	GA-277	GG-265 ⁷¹ GG-267 ⁷²

Marca - Año - Modelo Make-Year-Model	Motor Engine	Aceite Oil	Aire Air	Combustible Fuel
DODGE (continuación)				
GRAND CARAVAN	V6 3.3L FI GAS NATURAL	GP-81	GA-277	
GRAND CARAVAN	V6 3.3L SFI	GP-81	GA-277	GG-265 ⁷¹ GG-267 ⁷²
GRAND CARAVAN	V6 3.8L SFI	GP-81	GA-277	GG-265 ⁷¹ GG-267 ⁷²
INTREPID	V6 3.3L FI	GP-81	GA-141	GG-84
INTREPID	V6 3.5L FI 24 VALV.	GP-81	GA-141	GG-84
NEON	L4 2.0L FI 16 VALV.	GP-58	GA-277	GG-95
RAM	6 CIL. 5.9L TURBO DIESEL	GP-178	GA-240	
RAM	V10 8.0L SFI	GP-81	GA-438	GG-111
RAM	V6 3.9L SFI	GP-81	GA-3901	
RAM	V8 5.2L FI	GP-81	GA-3901	GG-111
RAM	V8 5.9L SFI	GP-81	GA-3901	GG-111
RAM CHARGER	V8 5.9L SFI	GP-81	GA-3901	
RAM VAN	V6 3.9L SFI	GP-81	GA-70	GG-111
RAM VAN	V8 5.2L SFI	GP-81	GA-70	GG-111
RAM VAN	V8 5.9L SFI	GP-81	GA-70	GG-111
STRATUS	L4 2.0L FI	GP-58	GA-132	GG-104
STRATUS	L4 2.4L FI	GP-58	GA-132	GG-104
TRUCK 200- VAN 3/4 TON.	V8 3.9, 5.2 Y 5.9L FI	GP-81	GA-70	GG-67
TRUCK 300-VAN 1 TON.	V8 3.9, 5.2 Y 5.9L FI	GP-81	GA-70	GG-67
VIPER	V10 8.0L FI	GP-81		GG-249
1995				
B100	6 / 8 CIL. 3.9 Y 5.2L FI	GP-81	GA-70	
B150	6 / 8 CIL. 3.9 Y 5.2L FI	GP-81	GA-70	
B250	V8 3.9, 5.2 Y 5.9L FI	GP-81	GA-70	GG-67
B350	V8 3.9, 5.2 Y 5.9L FI	GP-81	GA-70	GG-67
CARAVAN	L4 2.5L FI	GP-58	GA-271	GG-65
CARAVAN	V6 3.0L FI	GP-81	GA-277	GG-65
CARAVAN	V6 3.3L FI	GP-81	GA-271	GG-65
CARAVAN	V6 3.3L FI GAS NATURAL	GP-81	GA-271	
CARAVAN	V6 3.8L FI	GP-81	GA-271	GG-65
D600	V8 5.9L FI	GP-81	GA-3901	
DAKOTA	6 CIL. 3.9L	GP-81	GA-70	GG-72
DAKOTA	8 CIL. 5.2L	GP-81	GA-70	GG-72
DAKOTA	L4 2.5L	GP-81	GA-271	GG-72
GRAND CARAVAN	L4 2.5L FI	GP-81	GA-271	GG-65
GRAND CARAVAN	V6 3.0L FI	GP-81	GA-277	GG-65
GRAND CARAVAN	V6 3.3L FI	GP-81	GA-271	GG-65
GRAND CARAVAN	V6 3.3L FI GAS NATURAL	GP-81	GA-271	
GRAND CARAVAN	V6 3.8L FI	GP-81	GA-271	GG-65
INTREPID	V6 3.3L FI	GP-81	GA-141	GG-84
INTREPID	V6 3.5L FI 24 VALV.	GP-81	GA-141	GG-84
NEON	L4 2.0L FI 16 VALV.	GP-58	GA-277	GG-95
RAM	6 CIL. 5.9L TURBO DIESEL	GP-178	GA-240	
RAM	V10 8.0L SFI	GP-81	GA-438	GG-111
RAM	V6 3.9L SFI	GP-81	GA-3901	
RAM	V8 5.2L SFI	GP-81	GA-3901	GG-111
RAM	V8 5.9L SFI	GP-81	GA-3901	GG-111
RAM CHARGER	V8 5.9L SFI	GP-81	GA-3901	
RAM VAN	V6 3.9L SFI	GP-81	GA-70	
RAM VAN	V8 5.2L SFI	GP-81	GA-70	
RAM VAN	V8 5.9L SFI	GP-81	GA-70	
SHADOW	L4 2.5L TURBO	GP-58	GA-277	GG-61
SPIRIT	L4 2.5L	GP-81	GA-3814	GG-7020
STRATUS	L4 2.0L FI	GP-58	GA-132	GG-104
STRATUS	L4 2.4L FI	GP-58	GA-132	GG-104
TRUCK 200- VAN 3/4 TON.	V8 3.9, 5.2 Y 5.9L FI	GP-81	GA-70	GG-67
TRUCK 300-VAN 1 TON.	V8 3.9, 5.2 Y 5.9L FI	GP-81	GA-70	GG-67
VIPER	V10 8.0L	GP-81		GG-249

Marca - Año - Modelo Make-Year-Model	Motor Engine	Aceite Oil	Aire Air	Combustible Fuel
DODGE (continuación)				
1994				
B100	6 / 8 CIL. 3.9 Y 5.2L FI	GP-81	GA-70	
B150	6 / 8 CIL. 3.9 Y 5.2L FI	GP-81	GA-70	
B250	V8 3.9, 5.2 Y 5.9L FI	GP-81	GA-70	GG-67
B350	V8 3.9, 5.2 Y 5.9L FI	GP-81	GA-70	GG-67
CARAVAN	L4 2.5L EFI	GP-81	GA-271	GG-65
CARAVAN	V6 3.0L MFI	GP-81	GA-277	GG-65
CARAVAN	V6 3.3L MFI	GP-81	GA-271	GG-65
CARAVAN	V6 3.8L MFI	GP-81	GA-271	GG-65
D600	V8 5.9L FI	GP-81	GA-240	GG-111
DAKOTA	L4 2.5L FI	GP-81	GA-271	GG-72
DAKOTA	V6 3.9L	GP-81	GA-70	GG-72
DAKOTA	V8 5.2L	GP-81	GA-70	GG-72
GRAND CARAVAN	L4 2.5L EFI	GP-81	GA-271	GG-65
GRAND CARAVAN	V6 3.0L MFI	GP-81	GA-277	GG-65
GRAND CARAVAN	V6 3.3L MFI	GP-81	GA-271	GG-65
GRAND CARAVAN	V6 3.8L MFI	GP-81	GA-271	GG-65
INTREPID	V6 3.3L FI	GP-81	GA-141	GG-84
INTREPID	V6 3.5L FI 24 VALV.	GP-81	GA-141	GG-84
NEON	L4 2.0L FI 16 VALV.	GP-58	GA-277	GG-95
PICK UP	V6 3.8L FI	GP-81	GA-129	GG-249
RAM	6 CIL. 5.9L TURBO DIESEL	GP-178	GA-240	
RAM	V10 8.0L SFI	GP-81	GA-438	GG-111
RAM	V6 3.9L SFI	GP-81	GA-3901	
RAM	V8 5.2L SFI	GP-81	GA-3901	
RAM	V8 5.9L SFI	GP-81	GA-3901	
RAM CHARGER	V8 5.9L SFI	GP-81	GA-3901	
RAM VAN	V6 3.9L SFI	GP-81	GA-70	GG-98
RAM VAN	V8 5.2L SFI	GP-81	GA-70	
RAM VAN	V8 5.9L SFI	GP-81	GA-70	
SHADOW	L4 2.5L TURBO	GP-58	GA-277	GG-61
SPIRIT	L4 2.5L	GP-81	GA-277 GA-3814	GG-7020
TRUCK 200- VAN 3/4 TON.	V8 3.9, 5.2 Y 5.9L FI	GP-81	GA-70	GG-67
TRUCK 300-VAN 1 TON.	V8 3.9, 5.2 Y 5.9L FI	GP-81	GA-70	GG-67
VIPER	V10 8.0L	GP-81		GG-249

1993				
B100	6 / 8 CIL. 3.9 Y 5.2L FI	GP-81	GA-70	
B150	6 / 8 CIL. 3.9 Y 5.2L FI	GP-81	GA-70	
B250	V8 3.9, 5.2 Y 5.9L FI	GP-81	GA-70	GG-67
B350	V8 3.9, 5.2 Y 5.9L FI	GP-81	GA-70	GG-67
CARAVAN	L4 2.5L EFI	GP-81	GA-271	GG-65
CARAVAN	V6 3.0L MFI	GP-81	GA-277	GG-65
CARAVAN	V6 3.3L FI	GP-81	GA-271	GG-65
D100	V6 3.9L FI	GP-81	GA-129	GG-67
D100	V8 5.2L Y 5.9L FI	GP-81	GA-70	GG-67
D150	V6 3.7L	GP-1	GA-77	GG-8 ¹²⁰
D150	V6 3.9L	GP-58	GA-70	GG-3
D250	V6 3.7L	GP-1	GA-77	GG-8 ¹²⁰
D250	V8 5.7L			
D300	6 / 8 CIL. 5.9L FI	GP-81	GA-70	GG-67
D350	V6 3.7L	GP-1	GA-77	GG-8 ¹²⁰
D350	V8 5.7L			
D50	L4 2.4 Y 2.6L FI			GG-196
D600	V8 5.9L FI	GP-81	GA-70	GG-111
DAKOTA	L4 2.5L FI	GP-81	GA-271	GG-72
DAKOTA	V6 3.9L	GP-81	GA-70	GG-72
DAKOTA	V8 5.2L	GP-81	GA-70	GG-72
GRAND CARAVAN	L4 2.5L EFI	GP-81	GA-271	GG-65
GRAND CARAVAN	V6 3.0L MFI	GP-81	GA-277	GG-65
GRAND CARAVAN	V6 3.3L FI	GP-81	GA-271	GG-65
INTREPID	V6 3.3L MFI	GP-81	GA-141	GG-84
INTREPID	V6 3.5L MFI 24 VALV.	GP-81	GA-141	GG-84
PICK UP	6 CIL. 5.9L TURBO DIESEL	GP-178		

Marca - Año - Modelo Make-Year-Model	Motor Engine	Aceite Oil	Aire Air	Combustible Fuel
DODGE (continuación)				
PICK UP	V6 3.8L FI	GP-81	GA-129	GG-249
PICK UP	V6 3.9L FI	GP-81	GA-129	GG-72
PICK UP	V8 5.2L FI	GP-81	GA-70	GG-72
PICK UP	V8 5.9L FI	GP-81	GA-70	GG-72
RAM 50	L4 2.4L MFI	GP-3985	GA-7142	GG-151 ¹⁶
RAM CHARGER	6 CIL. 5.9L TURBO DIESEL	GP-178		GP-1232
RAM CHARGER	V6 3.9L MFI	GP-81	GA-129	GG-67
RAM CHARGER	V8 5.2L MFI	GP-81	GA-70	GG-72
RAM CHARGER	V8 5.9L MFI	GP-81	GA-70	GG-72
RAM VAN	V6 3.9L MFI	GP-81	GA-70	GG-98
RAM VAN	V8 5.2L MFI	GP-81	GA-70	GG-98
RAM VAN	V8 5.9L MFI	GP-81	GA-70	GG-98
SHADOW	L4 2.5L TURBO	GP-58	GA-277	GG-61
SPIRIT	L4 2.5L	GP-81	GA-277 GA-3814	GG-7020
TRUCK 200- VAN 3/4 TON.	V8 3.9, 5.2 Y 5.9L FI	GP-81	GA-70	GG-67
TRUCK 300-VAN 1 TON.	V8 3.9, 5.2 Y 5.9L FI	GP-81	GA-70	GG-67
VANS B	6 CIL. 5.9L (8) TURBO DIESEL	GP-178		
VANS B	V6 3.9L FI (X)	GP-81	GA-129	GG-72
VANS B	V8 5.2L FI (Y)	GP-81	GA-70	GG-72
VANS B	V8 5.9 (Z,5) L FI	GP-81	GA-70	GG-72
VIPER	V10 8.0L	GP-81		GG-249
W150	V6 3.9L FI	GP-81	GA-129	GG-67
W150	V8 5.2L Y 5.9L FI	GP-81	GA-70	GG-67
W350	V8 5.9L FI	GP-81	GA-70	GG-67

1992				
B100	6 / 8 CIL. 3.9 Y 5.2L FI	GP-81	GA-70	
B150	6 / 8 CIL. 3.9 Y 5.2L FI	GP-81	GA-70	
B250	V8 3.9, 5.2 Y 5.9L FI	GP-81	GA-70	GG-67
B350	V8 3.9, 5.2 Y 5.9L FI	GP-81	GA-70	GG-67
CARAVAN	L4 2.5L EFI	GP-81	GA-271	GG-65
CARAVAN	V6 3.0L MFI	GP-81	GA-277	GG-65
CARAVAN	V6 3.3L EFI	GP-81	GA-271	GG-65
COLT	L4 1.5L MFI	GP-149	GA-362	GG-185
COLT	L4 1.8L MPI	GP-149	GA-7344	GG-185
COLT	L4 2.4L FI	GP-40	GA-7344	GG-185
D100	V6 3.9L FI	GP-81	GA-129	GG-67
D100	V8 5.2L Y 5.9L FI	GP-81	GA-70	GG-67
D150	6 CIL. 3.7L	GP-1	GA-77	GG-8 ¹²⁰
D150	6 CIL. 3.9L	GP-58	GA-70	GG-3
D250	V6 3.7L	GP-1	GA-77	GG-8 ¹²⁰
D250	V8 5.7L			
D300	6 / 8 CIL. 5.9L FI	GP-81	GA-70	GG-67
D350	V6 3.7L	GP-1	GA-77	GG-8 ¹²⁰
D350	V8 5.7L			
D50	L4 2.4 Y 2.6L FI			GG-196
D600	V8 5.9L FI	GP-81	GA-70	GG-111
DAKOTA	L4 2.5L FI	GP-81	GA-271	GG-72
DAKOTA	V6 3.9L	GP-81	GA-70	GG-72
DAKOTA	V8 5.2L	GP-81	GA-70	GG-72
GRAND CARAVAN	L4 2.5L EFI	GP-81	GA-271	GG-65
GRAND CARAVAN	V6 3.0L MFI	GP-81	GA-277	GG-65
GRAND CARAVAN	V6 3.3L EFI	GP-81	GA-271	GG-65
MONACO	V6 3.0L	GP-3985	GAVW-2	
PICK UP	6 CIL. 5.9L TURBO DIESEL	GP-178		
PICK UP	V6 3.9L FI	GP-81	GA-70	GG-249
PICK UP	V8 5.2L FI	GP-81	GA-70	GG-67
PICK UP	V8 5.9L FI	GP-81	GA-70	GG-67
RAM 50	L4 2.4L MFI	GP-3985	GA-7142	GG-151 ¹⁶
RAM CHARGER	V8 5.2L EFI	GP-81	GA-70	GG-72
RAM CHARGER	V8 5.9L EFI	GP-81	GA-70	GG-72
SHADOW	L4 2.5L TURBO	GP-58	GA-277	GG-61
SPIRIT	L4 2.5L	GP-81	GA-276 GA-3814	GG-7020

Para números Gonher con Superíndice vea página 38
For Gonher with Superscript numbers see page 38

Para modelos anteriores a 1990 visite nuestro sitio en internet www.grupogonher.com
For pre-1990 models, visit our Web site www.grupogonher.com

Marca - Año - Modelo Make-Year-Model	Motor Engine	Aceite Oil	Aire Air	Combustible Fuel
DODGE (continuación)				
TRUCK 200- VAN 3/4 TON.	V8 3.9, 5.2 Y 5.9L FI	GP-81	GA-70	GG-67
TRUCK 300-VAN 1 TON.	V8 3.9, 5.2 Y 5.9L FI	GP-81	GA-70	GG-67
VANS B	6 CIL. 5.9L (8) TURBO DIESEL	GP-178		
VANS B	V6 3.9L FI (X)	GP-81	GA-70	GG-249
VANS B	V8 5.2L FI (Y)	GP-81	GA-70	GG-67
VANS B	V8 5.9 (Z,5) L FI	GP-81	GA-70	GG-67
VIPER	V10 8.0L	GP-81		GG-249
W100	V8 5.2L FI (Y)		GA-70	GG-67
W100	V8 5.9 (Z,5) L FI	GP-81	GA-70	GG-67
W150	V6 3.9L FI	GP-81	GA-129	GG-67
W150	V8 5.2L Y 5.9L FI	GP-81	GA-70	GG-67
W350	V8 5.9L FI	GP-81	GA-70	GG-67

1991				
B100	6 / 8 CIL. 3.9 Y 5.2L FI	GP-81	GA-70	
B150	6 / 8 CIL. 3.9 Y 5.2L FI	GP-81	GA-70	
B250	V8 3.9, 5.2 Y 5.9L FI	GP-81	GA-70	GG-67
B350	V8 3.9, 5.2 Y 5.9L FI	GP-81	GA-70	GG-67
CARAVAN	L4 2.5L EFI	GP-81	GA-271	GG-65
CARAVAN	V6 3.0L FI	GP-81	GA-277	GG-65
CARAVAN	V6 3.3L MFI	GP-81	GA-271	GG-65
COLT	L4 1.5L MFI	GP-40	GA-362	
COLT	L4 2.0L MFI	GP-40	GA-362	GG-185 ¹⁵⁹
D100	V6 3.9L FI	GP-81	GA-129	GG-67
D100	V8 5.2L	GP-81	GA-429	GG-5 ¹²⁰
D100	V8 5.9L	GP-81	GA-429	GG-5 ¹²⁰
D150	L6 3.7L	GP-1	GA-77	GG-8 ¹²⁰
D150	V8 5.2L	GP-81	GA-429	GG-5 ¹²⁰
D150	V8 5.9L	GP-81	GA-429	GG-5 ¹²⁰
D250	V8 5.2L	GP-81	GA-429	GG-5 ¹²⁰
D250	V8 5.7L			
D250	V8 5.9L	GP-81	GA-429	GG-5 ¹²⁰
D300	V8 5.2L	GP-81	GA-429	GG-5 ¹²⁰
D300	V8 5.9L	GP-81	GA-429	GG-5 ¹²⁰
D350	V6 3.7L	GP-1	GA-77	GG-8 ¹²⁰
D350	V8 5.2L	GP-81	GA-70	GG-5 ¹²⁰
D350	V8 5.7L			
D350	V8 5.9L	GP-81	GA-70	GG-5 ¹²⁰
D351	V8 5.9L	GP-81	GA-429	GG-67
D50	L4 2.4 Y 2.6L FI			GG-196
D600	V8 5.9L	GP-81	GA-70	GG-67
DAKOTA	L4 2.5L FI	GP-81	GA-271	GG-72
DAKOTA	V6 3.9L	GP-81	GA-70	GG-72
DAKOTA	V8 5.2L	GP-81	GA-70	GG-72
GRAND CARAVAN	L4 2.5L EFI	GP-81	GA-271	GG-65
GRAND CARAVAN	V6 3.0L FI	GP-81	GA-277	GG-65
GRAND CARAVAN	V6 3.3L MFI	GP-81	GA-271	GG-65
MONACO	V6 3.0L	GP-3985	GAVW-2	
PICK UP	6 CIL. 5.9L TURBO DIESEL	GP-178		
PICK UP	V6 3.9L FI	GP-81	GA-70	GG-249
PICK UP	V8 5.2L FI	GP-81	GA-70	GG-67
PICK UP	V8 5.9L FI	GP-81	GA-70	GG-67
RAM 50	L4 2.4L EFI	GP-40	GA-7142	GG-151 ¹⁶
RAM 50	V6 3.0L EFI	GP-40	GA-7142	GG-151 ¹⁶
RAM CHARGER	V8 5.9L EFI	GP-81	GA-70	GG-67
SHADOW	L4 2.5L TURBO	GP-58	GA-277	GG-61
SPIRIT	L4 2.5L	GP-81	GA-276 GA-3814	GG-7020
TRUCK 200- VAN 3/4 TON.	V8 3.9, 5.2 Y 5.9L FI	GP-81	GA-70	GG-67
TRUCK 300-VAN 1 TON.	V8 3.9, 5.2 Y 5.9L FI	GP-81	GA-70	GG-67
VANS B	6 CIL. 5.9L (8) TURBO DIESEL	GP-178		
VANS B	V6 3.9L FI (X)	GP-81	GA-70	GG-249

Marca - Año - Modelo Make-Year-Model	Motor Engine	Aceite Oil	Aire Air	Combustible Fuel
DODGE (continuación)				
VANS B	V8 5.2L FI (Y)	GP-81	GA-70	GG-67
VANS B	V8 5.9 (Z,5) L FI	GP-81	GA-70	GG-67
W100	6 CIL. 5.9L (8) TURBO DIESEL	GP-178		
W100	V6 3.9L FI (X)	GP-81	GA-70	GG-249
W100	V8 5.2L FI (Y)	GP-81	GA-70	GG-67
W100	V8 5.9 (Z,5) L FI	GP-81	GA-70	GG-67
W150	V6 3.9L FI	GP-81	GA-129	GG-67
W150	V8 5.2L Y 5.9L FI	GP-81	GA-70	GG-67
W350	V8 5.9L FI	GP-81	GA-70	GG-67

1990				
2000 GTX	L4 2.0L FI CANADA	GP-40	GA-362	
CARAVAN	L4 2.5L EFI	GP-58	GA-271	GG-65
CARAVAN	V6 3.0L FI	GP-58	GA-277	GG-65
CARAVAN	V6 3.3L MFI	GP-58	GA-271	GG-65
COLT	L4 1.5L MFI	GP-40	GA-362	
COLT	L4 1.6L MFI TURBO	GP-40	GA-362	
COLT	L4 1.8L MFI	GP-40	GA-362	
COLT	L4 2.0L MFI	GP-40	GA-362	GG-185 ¹⁵⁹
D100	V8 5.2L	GP-81	GA-429	GG-5 ¹²⁰
D100	V8 5.9L	GP-81	GA-429	GG-5 ¹²⁰
D150	L6 3.7L	GP-1 GP-9	GA-70 GA-429	GG-3
D150	V8 5.2L	GP-81	GA-429	GG-5 ¹²⁰
D150	V8 5.9L	GP-81	GA-429	GG-5 ¹²⁰
D200	V8 5.2L	GP-81	GA-70	GG-5 ¹²⁰
D200	V8 5.9L	GP-81	GA-70	GG-5 ¹²⁰
D250	V8 5.2L	GP-81	GA-429	GG-5 ¹²⁰
D250	V8 5.7L			
D250	V8 5.9L	GP-81	GA-429	GG-5 ¹²⁰
D300	V8 5.2L	GP-81	GA-429	GG-5 ¹²⁰
D300	V8 5.9L	GP-81	GA-429	GG-5 ¹²⁰
D350	V8 5.2L	GP-81	GA-70	GG-5 ¹²⁰
D350	V8 5.7L			
D350	V8 5.9L	GP-81	GA-70	GG-5 ¹²⁰
D351	V8 5.9L	GP-81	GA-429	GG-67
D50	L4 2.4L FI	GP-40		
D50	L4 2.6L 2 BBL	GP-40	GA-4325	
D50	V6 3.0L FI	GP-40	GA-362	
DAKOTA	L4 2.5L EFI	GP-58	GA-271	GG-67 ⁴⁸ GG-72 ⁴⁹
DAKOTA	V6 3.9L EFI	GP-58	GA-70	GG-67 ⁴⁸ GG-72 ⁴⁹
DAKOTA	V8 5.2L FI	GP-81		GG-67 ⁴⁸ GG-72 ⁴⁹
MINI RAM VAN	L4 2.5L EFI	GP-58	GA-271	GG-65
MINI RAM VAN	L4 2.5L EFI TURBO	GP-58	GA-271	GG-65
MINI RAM VAN	V6 3.0L FI	GP-58	GA-277	GG-65
MINI RAM VAN	V6 3.3L MFI	GP-58	GA-271	GG-65
MONACO	V6 3.0L	GP-3985	GAVW-2	GG-243
PICK UP	6 CIL. 5.9L TURBO DIESEL	GP-178		
PICK UP	V6 3.9L FI	GP-58	GA-129	GG-67
PICK UP	V8 5.2L FI	GP-81	GA-70	GG-67
PICK UP	V8 5.9L FI	GP-81	GA-70	GG-67
RAM 50	L4 2.4L FI	GP-40	GA-7142	GG-151 ¹⁶
RAM 50	V6 3.0L FI	GP-40	GA-362 ¹¹⁹	
RAM CHARGER	V8 5.9L FI	GP-81	GA-70	GG-67
SHADOW	L4 2.2L TURBO	GP-58	GA-271	GG-62
SHADOW	L4 2.5L TURBO	GP-58	GA-276	GG-61
SPIRIT	L4 2.5L	GP-58	GA-276 GA-3814	GG-61
VANS B	6 CIL. 5.9L (8) TURBO DIESEL	GP-178		
VANS B	V6 3.9L FI (X)	GP-58	GA-129	GG-67
VANS B	V8 5.2L FI (Y)	GP-81	GA-70	GG-67
VANS B	V8 5.9 (Z,5) L FI	GP-81	GA-70	GG-67
W100	6 CIL. 5.9L (8) TURBO DIESEL	GP-178		

Marca - Año - Modelo Make-Year-Model	Motor Engine	Aceite Oil	Aire Air	Combustible Fuel
DODGE (continuación)				
W100	V6 3.9L FI (X)	GP-58	GA-129	GG-67
W100	V8 5.2L FI (Y)	GP-81	GA-70	GG-67
W100	V8 5.9 (Z,5) L FI	GP-81	GA-70	GG-67

EAGLE				
1997				
VISION	V6 3.3L SFI	GP-81	GA-141	GG-84
VISION	V6 3.3L SFI FLEX FUEL	GP-81	GA-141	
VISION	V6 3.5L SFI	GP-81	GA-141	GG-84

1996				
VISION	V6 3.3L SFI	GP-81	GA-141	GG-84
VISION	V6 3.5L SFI	GP-81	GA-141	GG-84

1995				
VISION	V6 3.3L SFI	GP-81	GA-141	GG-84
VISION	V6 3.3L SFI FLEX FUEL	GP-81	GA-141	
VISION	V6 3.5L SFI	GP-81	GA-141	GG-84

1994				
2000GTX	L4 2.0L FI CANADA	GP-40	GA-362	GG-185
TALON	L4 1.8L MFI	GP-149	GA-362	GG-185
TALON	L4 2.0L FI TURBO	GP-149	GA-362	GG-185
TALON	L4 2.0L MFI	GP-149	GA-362	GG-185
VISION	V6 3.3L MFI	GP-81	GA-141	GG-84
VISION	V6 3.3L MFI FLEX FUEL	GP-81	GA-141	
VISION	V6 3.5L MFI SOHC	GP-81	GA-141	GG-84

1993				
2000GTX	L4 2.0L FI CANADA	GP-40	GA-362	GG-185
TALON	L4 1.8L MFI	GP-149	GA-362	GG-185
TALON	L4 2.0L MFI	GP-40	GA-362	GG-185
TALON	L4 2.0L MFI TURBO	GP-40	GA-362	GG-185
VISION	V6 3.3L MFI	GP-81	GA-141	GG-84
VISION	V6 3.5L MFI	GP-81	GA-141	GG-84

1992				
2000GTX	L4 2.0L FI CANADA	GP-40	GA-362	GG-185
PREMIER	L4 2.5L	GP-3985	GAVW-2	GG-243
SUMMIT	L4 1.5L MFI	GP-149	GA-362	GG-185
SUMMIT	L4 1.6L FI TURBO	GP-40	GA-362	GG-185
SUMMIT	L4 1.8L MFI	GP-149	GA-7344	GG-185
SUMMIT	L4 2.4L MFI	GP-40	GA-7344	GG-185
TALON	L4 2.0L MFI	GP-40	GA-362	GG-185
TALON	L4 2.0L MFI TURBO	GP-40	GA-362	GG-185

1991				
2000GTX	L4 2.0L FI CANADA	GP-40	GA-362	GG-185
PREMIER	L4 2.5L	GP-3985	GAVW-2	GG-243
SUMMIT	L4 1.5L MFI	GP-40	GA-362	GG-185
SUMMIT	L4 1.6L FI TURBO	GP-40	GA-362	GG-185
TALON	L4 2.0L MFI	GP-40	GA-362	GG-185

1990				
PREMIER	L4 2.5L	GP-3985	GAVW-2	GG-243
SUMMIT	L4 1.5L MFI	GP-40	GA-362	
SUMMIT	L4 1.6L MFI	GP-40	GA-362	
TALON	L4 2.0L MFI	GP-40	GA-362	GG-185
VISTA	L4 1.5L CANADA	GP-40	GA-78	

FERRARI				
2002				
360 MODENA	V8 3.6L FI 40 VALV. (MOTOR CENTRAL)			

Marca - Año - Modelo Make-Year-Model	Motor Engine	Aceite Oil	Aire Air	Combustible Fuel
FERRARI (continuación)				
456 GT	V12 5.5L FI 32 VALV. (MOTOR DELANTERO)			
456 GTA	V12 5.5L FI 32 VALV. (MOTOR DELANTERO)			
550 MARANELLO	V12 5.5L FI			GG-408
550 MARANELLO	V12 5.7L FI 32 VALV. (MOTOR DELANTERO)			

2001				
360 MODENA	V8 3.6L FI 40 VALV. (MOTOR CENTRAL)			
456 GT	V12 5.5L FI 32 VALV. (MOTOR DELANTERO)			
456 GTA	V12 5.5L FI 32 VALV. (MOTOR DELANTERO)			
550 BARCHETTA PININFARINA	V12 5.5L FI			GG-408
550 MARANELLO	V12 5.5L FI			GG-408
550 MARANELLO	V12 5.7L FI 32 VALV. (MOTOR DELANTERO)			
F355 SPIDER	V8 3.5L FI			

2000				
360 MODENA	V8 3.6L FI 40 VALV. (MOTOR CENTRAL)			
456 GT	V12 5.5L FI 32 VALV. (MOTOR DELANTERO)			
456 GTA	V12 5.5L FI 32 VALV. (MOTOR DELANTERO)			
550 BARCHETTA PININFARINA	V12 5.5L FI			GG-408
550 MARANELLO	V12 5.5L FI			GG-408
550 MARANELLO	V12 5.7L FI 32 VALV. (MOTOR DELANTERO)			
F355 SPIDER	V8 3.5L FI			

1999				
550 MARANELLO	V12 5.5L FI			GG-408
550 MARANELLO	V12 5.5L FI			GG-408
550 MARANELLO	V12 5.7L FI 32 VALV. (MOTOR DELANTERO)			
F355 SPIDER	V8 3.5L FI			

1998				
456 GT	V12 5.5L FI			GG-408
550 MARANELLO	V12 5.5L FI			GG-408
GTA	V12 5.5L FI			GG-408

1997				
456 GT	V12 5.5L FI			GG-408
550 MARANELLO	V12 5.5L FI			GG-408
GTA	V12 5.5L FI			GG-408

1996				
456 GT	V12 5.5L FI			GG-408

1995				
456 GT	V12 5.5L FI			GG-408

FIAT				
2008				
DUCATO	L4 2.3L FI DOHC			
DUCATO	L4 3.0L FI DOHC			
GRANDE PUNTO	L4 1.4L STARJET			
GRANDE PUNTO	L4 1.4L TURBO T-JET			
IDEA ADVENTURE	L4 1.8L FI		GP-46	
PALIO 1.8R	L4 1.8L			
PALIO ADVENTURE	L4 1.8L SOHC			
PALIO HATCHBACK	L4 1.8L SOHC			
PALIO SEDAN	L4 1.8L SOHC			
PANDA	L4 1.2L FI			
STILO SCHUMACHER	L5 2.4L DOHC 20 VALV.			

Marca - Año - Modelo Make-Year-Model	Motor Engine	Aceite Oil	Aire Air	Combustible Fuel
FIAT (continuación)				
STRADA ADVENTURE	L4 1.8L	GP-46		
2007				
GRANDE PUNTO	L4 1.4L DOHC 16 VALV.			
PALIO 1.8R	L4 1.8L	GP-46		
PALIO ADVENTURE	L4 1.8L SOHC	GP-46		
PALIO HATCHBACK	L4 1.8L SOHC	GP-46		
PALIO SEDAN	L4 1.8L SOHC	GP-46		
PANDA	L4 1.2L			
STILO SCHUMACHER	L5 2.4L DOHC 20 VALV.			
STRADA ADVENTURE	L4 1.8L	GP-46		

2006				
PALIO ADVENTURE	L4 1.8L SOHC	GP-46		
PALIO HATCHBACK	L4 1.8L SOHC	GP-46		
PALIO SEDAN	L4 1.8L SOHC	GP-46		

FORD				
2010				
CROWN VICTORIA	V8 4.6L FI FLEX FUEL	GP-68	GA-5056	
E SERIES (VANS)	V10 6.8L FI	GP-68	GA-1615	GG-986
E SERIES (VANS)	V8 4.6L FI	GP-68	GA-1615	GG-986
E SERIES (VANS)	V8 5.4L FI FLEX FUEL	GP-68	GA-1615	GG-986
E SERIES (VANS)	V8 6.0L DI TURBO DIESEL	G-3752		
EDGE	V6 3.5L FI		GA-1542	
ESCAPE	L4 2.5L FI	GP-58		GG-1872
ESCAPE	V6 3.0L FI			GG-1872
ESCAPE HYBRID	L4 2.5L FI	GP-58		GG-1872
EXPEDITION	V8 5.4L FI 24 VALV.	GP-68	GA-437	GG-308
EXPLORER	L4 2.0L TURBO DOHC			
EXPLORER	V6 3.5L DOHC TWIN-TURBO			
EXPLORER	V6 4.0L FI	GP-68	GA-395	GG-101
EXPLORER	V8 4.6L FI	GP-68	GA-1540	GG-101
EXPLORER SPORT TRAC	V6 4.0L FI	GP-68	GA-395	GG-101
EXPLORER SPORT TRAC	V8 4.6L FI	GP-68	GA-1540	GG-101
F SERIES	V6 4.6L FI 16 VALV.	GP-68	GA-437	GG-101
F SERIES	V6 4.6L FI 24 VALV.	GP-68	GA-437	GG-101
F SERIES	V8 5.4L FI 24 VALV.	GP-68	GA-437	GG-101
F SERIES	V8 5.4L FI 24 VALV. FLEX FUEL	GP-68	GA-437	GG-101
F SERIES SUPER DUTY	V10 6.8L FI 30 VALV.	GP-68	GA-437	GG-101
F SERIES SUPER DUTY	V8 5.4L FI 24 VALV.	GP-68	GA-437	GG-101
F SERIES SUPER DUTY	V8 6.4L DI TURBO DIESEL	G-3752		
FLEX	V6 3.5L DI TWIN-TURBO		GA-1542 GA-437	
FLEX	V6 3.5L FI		GA-1542 GA-437	
FOCUS	L4 2.0L FI DURATEC20	GP-58	GAC-7 ²⁴	GG-308
FOCUS	L4 2.0L FI DURATEC20E	GP-58	GAC-7 ²⁴	GG-308
FUSION	L4 2.5L FI	GP-58		
FUSION	V6 3.0L FI FLEX FUEL			
FUSION	V6 3.5L FI		GA-1542	
FUSION HYBRID	L4 2.5L FI	GP-58		
MUSTANG	V6 4.0L FI SOHC	GP-68		GG-101
MUSTANG	V8 4.6L FI 24 VALV.	GP-68		GG-101
MUSTANG	V8 5.4L FI SUPER CARGADO	GP-68		GG-101
RANGER	L4 2.3L FI	GP-58	GA-158	GG-308
RANGER	V6 4.0L FI SOHC	GP-68	GA-158	GG-308
TAURUS	V6 3.5L DI TWIN-TURBO		GA-1542	
TAURUS	V6 3.5L FI		GA-1542	
TRANSIT CONNECT	L4 2.0L FI	GP-58		

2009				
CROWN VICTORIA	V8 4.6L FI 16 VALV. SOHC	GP-68	GA-5056	GG-986
E SERIES (VANS)	V10 6.8L SFI	GP-68	GA-437	GG-986
E SERIES (VANS)	V8 4.6L EFI	GP-68	GA-1615	GG-986

Marca - Año - Modelo Make-Year-Model	Motor Engine	Aceite Oil	Aire Air	Combustible Fuel
FORD (continuación)				
E SERIES (VANS)	V8 5.4L EFI	GP-68	GA-1615 GA-1572 ¹⁵⁴	GG-986
E SERIES (VANS)	V8 5.4L FLEX FUEL	GP-68	GA-1615	GG-986
E SERIES (VANS)	V8 6.0L TURBO DIESEL	G-3752		
ECOSPORT	L4 2.0L FI 16 VALV.			
EDGE	V6 3.5L FI 24 VALV. DOHC	GP-3600	GA-1542	
ESCAPE	L4 2.5L FI 16 VALV. DOHC	G-70		
ESCAPE	V6 3.0L FI 24 VALV. DOHC	GP-406		GG-1872
ESCAPE HYBRID	L4 2.5L FI 16 VALV. DOHC	G-70 ²² GP-58 ¹³⁶		GG-1872
EXPEDITION	V8 5.4L FI 24 VALV. SOHC	GP-68	GA-437	GG-308
EXPLORER	V6 4.0L FI 12 VALV. SOHC	GP-68	GA-395	GG-101 ⁸
EXPLORER	V8 4.6L FI 24 VALV. SOHC	GP-68	GA-1540	GG-101 ⁸
EXPLORER SPORT TRAC	V6 4.0L FI	GP-68	GA-395	GG-101 ⁸
EXPLORER SPORT TRAC	V8 4.6L FI 24 VALV. SOHC	GP-68	GA-1540	GG-101 ⁸
F SERIES	V10 6.8L EFI	GP-68	GA-437	GG-101
F SERIES	V8 4.6L EFI	GP-68	GA-437	GG-101
F SERIES	V8 5.4L EFI	GP-68	GA-437	GG-101
F SERIES	V8 5.4L FLEX FUEL	GP-68	GA-437	GG-101
F SERIES	V8 6.4L DI TURBO DIESEL	G-3752		
F SERIES SUPER DUTY	V10 6.8L EFI	GP-68	GA-437	GG-101
F SERIES SUPER DUTY	V8 5.4L EFI	GP-68	GA-1572	GG-101
F SERIES SUPER DUTY	V8 6.4L DI TURBO DIESEL	G-3752		
FIESTA SEDAN	L4 1.6L FI			
FLEX	V6 3.5L FI 24 VALV. DOHC	GP-406 ¹³³ GP-3600 ¹³²	GA-437	
FOCUS	L4 2.0L FI 16 VALV. DOHC	GP-58		GG-308
FUSION	L4 2.3L FI 16 VALV. DOHC	G-70	GA-1572	
FUSION	V6 3.0L FI 24 VALV. DOHC	GP-406 ⁶⁸ GP-68 ⁴⁴		
GRAND MARQUIS	V8 4.6L FI 16 VALV. SOHC (CANADA)	GP-68	GA-5056	GG-986
MUSTANG	V6 4.0L FI SOHC	GP-68		GG-101
MUSTANG	V8 4.6L FI 24 VALV.	GP-68		GG-101
MUSTANG	V8 5.4L FI	GP-68		GG-101
RANGER	L4 2.3L FI 16 VALV. DOHC	GP-58	GA-158	GG-308
RANGER	V6 3.0L FI 12 VALV. SOHC	GP-3600	GA-158	
RANGER	V6 4.0L FI 12 VALV. SOHC	GP-68 ¹³³	GA-158	GG-308
TAURUS	V6 3.5L FI 24 VALV. DOHC	GP-3600	GA-1542	
TAURUS X	V6 3.5L FI 24 VALV. DOHC			

2008				
CROWN VICTORIA	V8 4.6L SFI O FLEX FUEL	GP-68	GA-5056	GG-986
E SERIES (VANS)	V10 6.8L SFI	GP-68	GA-1615 ⁵³ GA-1571 ¹²⁵	GG-986
E SERIES (VANS)	V8 4.6L EFI	GP-68	GA-1615	GG-986
E SERIES (VANS)	V8 5.4L EFI	GP-68	GA-437	GG-986
E SERIES (VANS)	V8 6.0L TURBO DIESEL	G-3752		
ECOSPORT	L4 2.0L FI 16 VALV.	GP-58	GA-288R	
EDGE	V6 3.5L FI	GP-3600	GA-1542	
ESCAPE	L4 2.3L SFI	G-70 ²² GP-58 ¹³⁷	GA-224	GG-47
ESCAPE	V6 3.0L SFI	GP-68	GA-224	GG-47
ESCAPE HYBRID	L4 2.3L FI	G-70		GG-47
EXPEDITION	V8 5.4L SFI	GP-68	GA-437	GG-308
EXPLORER	V6 4.0L SFI	GP-68	GA-395	GG-101
EXPLORER	V8 4.6L SFI	GP-68	GA-1540	GG-101
EXPLORER SPORT TRAC	V6 4.0L SFI	GP-68	GA-395	GG-101
EXPLORER SPORT TRAC	V8 4.6L SFI	GP-68	GA-1540	GG-101
F SERIES	V10 6.8L FI 30 VALV. SOHC	GP-68	GA-437	GG-101
F SERIES	V6 4.2L EFI	GP-3600	GA-1615 GAC-1 ²⁴	GG-101
F SERIES	V8 4.6L EFI	GP-3600 ¹³² GP-68 ¹³³	GA-1615 GAC-1 ²⁴	GG-101
F SERIES	V8 5.4L EFI	GP-68	GA-437 ¹⁵⁴ GA-1617 ¹¹²	GG-101
F SERIES	V8 5.4L FI FLEX FUEL	GP-68	GA-1617	GG-986
F SERIES	V8 6.4L TURBO DIESEL	G-3752		
F SERIES SUPER DUTY	V10 6.8L EFI	GP-68	GA-1571	GG-101

Marca - Año - Modelo Make-Year-Model	Motor Engine	Aceite Oil	Aire Air	Combustible Fuel
FORD (continuación)				
F SERIES SUPER DUTY	V8 5.4L MFI	GP-68	GA-437	GG-101
F SERIES SUPER DUTY	V8 6.4L TURBO DIESEL	G-3752		
FIESTA HATCHBACK	L4 2.0L FI			
FIESTA SEDAN	L4 1.6L FI	GP-58	GA-284	GG-986
FIVE HUNDRED	V6 3.5L FI 24 VALV.	GP-3600	GA-1542	GG-986
FOCUS	L4 2.0L SFI	GP-58 ²⁰	GAC-7 ²⁴	GG-986
FUSION	L4 2.3L SFI	G-70 ⁵² GP-58 ¹³⁷	GA-1572	
FUSION	V6 3.0L SFI	GP-68		
GRAND MARQUIS	V8 4.6L FI 16 VALV. SOHC (CANADA)	GP-68	GA-5056	GG-986
GRAND MARQUIS	V8 4.6L FI 16 VALV. SOHC FLEX FUEL (CANADA)	GP-68	GA-5056	GG-986
KA	L4 1.6L FI	GP-128	GA-280 GAC-1 ²⁴	GG-986
MUSTANG	V6 4.0L SFI	GP-68		GG-101
MUSTANG	V8 4.6L SFI	GP-68		GG-101
MUSTANG	V8 5.4L SFI SUPER CAR-GADO	GP-68		GG-101
RANGER	L4 2.3L FI	GP-58 ²⁰	GA-158	GG-308
RANGER	V6 3.0L FI	GP-3600	GA-158	GG-308
RANGER	V6 4.0L FI	GP-68	GA-158	GG-308
TAURUS	V6 3.5L SFI	GP-3600	GA-1542	
TAURUS X	V6 3.5L FI 24 VALV. DOHC	GP-3600	GA-1542	
TRANSIT	L4 2.2L DIESEL DURATORQ		GA-27161	
2007				
COURIER	L4 1.6L FI		GAC-1 ²⁴	
CROWN VICTORIA	V8 4.6L SFI O FLEX FUEL	GP-68	GA-5056	GG-986
E SERIES (VANS)	V10 6.8L FI	GP-68	GA-1615 ⁵³ GA-1571 ¹²⁵	GG-986
E SERIES (VANS)	V8 4.6L FI	GP-68	GA-1615	GG-986
E SERIES (VANS)	V8 5.4L FI	GP-68	GA-1615 ¹¹² GA-1617 ¹⁵⁴	
E SERIES (VANS)	V8 6.0L TURBO DIESEL	G-3752	GA-4999	
ECOSPORT	L4 2.0L FI MOTOR TRANSVERSAL 16 VALV.	GP-58	GA-288R	GG-986
EDGE	V6 3.5L DURATEC	GP-3600	GA-1542	
ESCAPE	L4 2.3L SFI	G-70 ⁵² GP-58 ¹³⁶	GA-224	GG-47
ESCAPE	V6 3.0L SFI	GP-68	GA-224	GG-47
ESCAPE HYBRID	L4 2.3L FI	G-70		GG-47
EXPEDITION	V8 5.4L SFI	GP-68	GA-437	GG-308
EXPLORER	V6 4.0L FI	GP-68	GA-395	GG-101
EXPLORER	V8 4.6L FI	GP-68	GA-1540	GG-101
EXPLORER SPORT TRAC	V6 4.0L SFI	GP-68	GA-395	GG-101
EXPLORER SPORT TRAC	V8 4.6L SFI	GP-68	GA-1540	GG-101
F SERIES	V6 4.2L EFI	GP-3600	GA-1615 GAC-1 ²⁴	GG-101
F SERIES	V8 4.6L EFI	GP-3600 ¹³² GP-68 ¹³³	GA-1615 GAC-1 ²⁴	GG-101
F SERIES	V8 5.4L EFI	GP-68	GA-1617 GAC-1 ²⁴	GG-101
F SERIES	V8 5.4L FI FLEX FUEL	GP-68	GA-1617	GG-986
F SERIES	V8 6.0L FI TURBO DIESEL	G-3752	GA-4999	G-1047
F SERIES SUPER DUTY	V10 6.8L EFI	GP-68	GA-1571	GG-101
F SERIES SUPER DUTY	V8 5.4L EFI	GP-68	GA-1617 GAC-1 ²⁴	GG-101
F SERIES SUPER DUTY	V8 6.0L FI TURBO DIESEL	G-3752	GA-4999	G-1047
FIESTA HATCHBACK	L4 1.6L FI	GP-58	GA-284	GG-986
FIESTA SEDAN	L4 1.6L FI	GP-58	GA-284	GG-986
FIVE HUNDRED	V6 3.0L SFI 24 VALV.	GP-68		GG-986
FOCUS	L4 2.0L FI	GP-58	GAC-7 ²⁴	GG-986
FOCUS	L4 2.3L FI	GP-58	GAC-7 ²⁴	GG-986
FOCUS	L5 2.5L FI 20 VALV.			
FREESTAR	V6 3.8L FI	GP-3600	GA-479	GG-308
FREESTAR	V6 3.9L SFI	GP-3600	GA-479	
FREESTAR	V6 4.2L SFI	GP-3600	GA-479	
FUSION	L4 2.3L FI	G-70 ⁵² GP-58 ¹³⁶	GA-1572	

Marca - Año - Modelo Make-Year-Model	Motor Engine	Aceite Oil	Aire Air	Combustible Fuel
FORD (continuación)				
FUSION	V6 3.0L FI	GP-68		
GRAND MARQUIS	V8 4.6L FI (CANADA)	GP-68	GA-5056	GG-986
IKON	L4 1.6L FI	GP-3600	GA-179	GG-82
KA	L4 1.6L FI	GP-128	GA-280 GAC-1 ²⁴	GG-986
LOBO	V8 4.6L EFI	GP-3600 ¹³² GP-68 ¹³³	GA-1615	GG-101
LOBO	V8 5.4L EFI	GP-3600 ¹³² GP-68 ¹³³	GA-1617	GG-101
MONDEO	L4 2.0L FI	G-70	GA-196 GAC-9 ²⁴	GG-915
MONDEO	V6 2.5L FI	G-70	GA-196 GAC-9 ²⁴	GG-915
MUSTANG	V6 4.0L SFI	GP-68		GG-101
MUSTANG	V8 4.6L SFI	GP-68		GG-101
MUSTANG	V8 5.4L SFI SUPER CAR-GADO	GP-68		GG-101
RANGER	L4 2.3L FI 16 VALV.	GP-58 ¹¹⁸	GA-158	GG-308
RANGER	V6 3.0L MFI 12 VALV.	GP-3600	GA-158	GG-308
RANGER	V6 4.0L MFI	GP-68	GA-158	GG-308
TAURUS	V6 3.0L FI	GP-3600	GA-224	GG-47
TRANSIT	L4 2.2L DIESEL DURATORQ		GA-27161	
2006				
COURIER	L4 1.6L FI	GP-3600	GAC-1 ²⁴	GG-1872
CROWN VICTORIA	V8 4.6L SFI	GP-68	GA-5056	GG-986
CROWN VICTORIA	V8 4.6L SFI FLEX FUEL	GP-68	GA-5056	
CROWN VICTORIA	V8 4.6L SFI GAS NATURAL	GP-68	GA-5056	
E SERIES (VANS)	V10 6.8L EFI 20 VALV.	GP-68	GA-1615 ⁵³ GA-1571 ¹²⁵	GG-986
E SERIES (VANS)	V8 4.6L EFI 16 VALV.	GP-68	GA-1615	GG-986
E SERIES (VANS)	V8 5.4L EFI 16 VALV.	GP-68	GA-1615 ¹¹² GA-1617 ¹⁵⁴ GAC-1 ²⁴	GG-986
E SERIES (VANS)	V8 6.0L DI TURBO DIESEL	G-3752	GA-4999	
ECOSPORT	L4 2.0L FI MOTOR TRANSVERSAL 16 VALV.	GP-58	GA-288R	GG-986
ESCAPE	L4 2.3L SFI	G-70 ⁵² GP-58 ¹³⁶	GA-224	GG-47
ESCAPE	V6 3.0L FI	GP-68	GA-224	GG-47
ESCAPE HYBRID	L4 2.3L FI	G-70		GG-47
EXPEDITION	V8 4.6L FI 16 VALV.	GP-68	GA-1617 GAC-1 ²⁴	GG-986
EXPEDITION	V8 5.4L FI	GP-1 ¹³² GP-68 ¹³³	GA-1617	
EXPLORER	V6 4.0L FI	GP-68	GA-395	GG-101
EXPLORER	V8 4.6L FI	GP-68	GA-1540	GG-101
F SERIES	V6 4.2L EFI	GP-3600	GA-1615 GAC-1 ²⁴	GG-986
F SERIES	V8 4.6L EFI 16 VALV.	GP-3600 ¹³² GP-68 ¹³³	GA-1615 GAC-1 ²⁴	GG-986
F SERIES	V8 5.4L EFI 24 VALV.	GP-68	GA-1617 GAC-1 ²⁴	GG-986
F SERIES	V8 5.4L FI FLEX FUEL	GP-68	GA-1617	GG-986
F SERIES	V8 6.0L FI TURBO DIESEL	G-3752	GA-4999	G-1047
F SERIES SUPER DUTY	V10 6.8L EFI 30 VALV.	GP-68	GA-1571	GG-101
F SERIES SUPER DUTY	V8 5.4L EFI 16 VALV.	GP-68	GA-1617 GAC-1 ²⁴	GG-101
F SERIES SUPER DUTY	V8 6.0L FI TURBO DIESEL	G-3752	GA-4999	G-1047
FIESTA HATCHBACK	L4 1.6L FI	GP-58	GA-284	GG-986
FIESTA SEDAN	L4 1.6L FI	GP-58	GA-284	GG-986
FIVE HUNDRED	V6 3.0L FI	GP-68		GG-986
FOCUS	L4 2.0L FI	GP-58	GAC-7 ²⁴	GG-986
FOCUS	L4 2.3L FI	GP-58	GAC-7 ²⁴	GG-986
FREESTAR	V6 3.9L SFI	GP-3600		GG-308
FREESTAR	V6 4.2L SFI	GP-3600	GA-479	GG-308
FUSION	L4 2.3L FI	G-70 ⁵² GP-58 ¹³⁶	GA-1572	
FUSION	V6 3.0L 24 VALV.	GP-68		
GRAND MARQUIS	V8 4.6L FI (CANADA)	GP-68	GA-5056	GG-986
IKON	L4 1.6L FI	GP-3600	GA-179	GG-82

Para números Gonher con Superíndice vea página 38
For Gonher with Superscript numbers see page 38

Marca - Año - Modelo Make-Year-Model	Motor Engine	Aceite Oil	Aire Air	Combustible Fuel
FORD (continuación)				
KA	L4 1.6L FI	GP-128	GA-280 GAC-1 ²⁴	GG-986
LOBO	V8 4.6L FI	GP-3600 ¹³² GP-68 ¹³³	GA-1615	GG-986
LOBO	V8 5.4L FI	GP-3600 ¹³² GP-68 ¹³³	GA-1617	GG-101
MONDEO	L4 2.0L FI	G-70	GA-196 GAC-9 ²⁴	GG-915
MONDEO	V6 2.5L FI	G-70	GA-196 GAC-9 ²⁴	GG-915
MUSTANG	V6 4.0L FI	GP-68		GG-101
MUSTANG	V8 4.6L FI	GP-68		GG-101
RANGER	L4 2.3L FI	GP-58 ¹¹⁸	GA-158	GG-308
RANGER	V6 3.0L FI	GP-3600	GA-158	GG-308
RANGER	V6 4.0L FI 12 VALV. SOHC	GP-68 ¹³³	GA-158	GG-308
TAURUS	V6 3.0L FI 12 VALV.	GP-3600	GA-224	GG-47
TAURUS	V6 3.0L FI 24 VALV.	GP-68	GA-224	GG-47
TAURUS	V6 3.0L SFI FLEX FUEL	GP-3600	GA-224	GG-47

2005

COURIER	L4 1.6L FI	GP-3600	GA-179 GAC-1 ²⁴	GG-1872
CROWN VICTORIA	V8 4.6L FI	GP-68	GA-5056	GG-986
CROWN VICTORIA	V8 4.6L SFI GAS NATURAL	GP-68	GA-5056	
E SERIES (VANS)	V10 6.8L EFI TRITON	GP-68	GA-1615 ⁵³ GA-1571 ¹²⁵	GG-986
E SERIES (VANS)	V6 4.2L FI 12 VALV. SOHC	GP-3600	GA-1615 GAC-1 ²⁴	GG-986
E SERIES (VANS)	V8 4.6L EFI	GP-68	GA-1615	GG-986
E SERIES (VANS)	V8 5.4L EFI	GP-68	GA-1615 ¹¹² GA-1617 ¹⁵⁴ GAC-1 ²⁴	GG-986
E SERIES (VANS)	V8 6.0L EFI DIESEL	G-3752	GA-4999	
ECOSPORT	L4 2.0L FI MOTOR TRANS-VERSAL 16 VALV.	GP-58	GA-288R	GG-986
ESCAPE	L4 2.0L SFI 16 VALV.	GP-58 ¹¹⁸	GA-224	GG-47
ESCAPE	L4 2.3L SFI	GP-58 ¹¹⁸	GA-224	GG-47
ESCAPE	V6 3.0L FI	GP-68	GA-224	GG-47
ESCAPE HYBRID	L4 2.3L FI	G-70		GG-47
EXCURSION	V10 6.8L FI TRITON	GP-68	GA-1615	
EXCURSION	V8 6.0L FI TURBO DIESEL	G-3752	GA-4999	G-1047
EXPEDITION	V8 4.6L FI	GP-68	GA-1617 GAC-1 ²⁴	GG-101
EXPEDITION	V8 5.4L FI	GP-68	GA-1617 GAC-1 ²⁴	GG-986
EXPLORER	V6 4.0L FI	GP-68		GG-101
EXPLORER	V8 4.6L FI	GP-68		GG-101
F SERIES	V6 4.2L EFI	GP-3600	GA-1615 GAC-1 ²⁴	GG-986
F SERIES	V8 4.6L EFI	GP-3600 ¹³² GP-68 ¹³³	GA-1615 GAC-1 ²⁴	GG-986
F SERIES	V8 5.4L EFI	GP-68	GA-1617 GAC-1 ²⁴	GG-986
F SERIES	V8 6.0L FI TURBO DIESEL	G-3752	GA-4999	G-1047
F SERIES SUPER DUTY	V10 6.8L EFI TRITON	GP-68	GA-1571	GG-101
F SERIES SUPER DUTY	V8 5.4L EFI TRITON	GP-68	GA-1617 GAC-1 ²⁴	GG-101
F SERIES SUPER DUTY	V8 6.0L FI TURBO DIESEL	G-3752	GA-4999	G-1047
FIESTA HATCHBACK	L4 1.6L FI	GP-58	GA-284 ¹¹⁸	GG-986
FIESTA SEDAN	L4 1.6L FI	GP-58	GA-284	GG-986
FIVE HUNDRED	V6 3.0L FI	GP-68		GG-986
FOCUS	L4 2.0L FI	GP-58 ¹⁹ GP-128 ⁶	GA-168 GAC-7 ²⁴	GG-986
FOCUS	L4 2.3L FI	GP-58	GAC-7 ²⁴	GG-986
FREESTAR	V6 3.9L SFI	GP-3600		GG-986
FREESTAR	V6 4.2L SFI	GP-3600	GA-479	GG-986
GRAND MARQUIS	V8 4.6L FI (CANADA)	GP-68	GA-5056	GG-986
GT	V8 5.4L FI 32 VALV. DOHC SUPER CARGADO		GA-433	
IKON	L4 1.6L FI	GP-3600	GA-179	GG-82
KA	L4 1.6L FI	GP-128	GA-280 GAC-1 ²⁴	GG-986

Marca - Año - Modelo Make-Year-Model	Motor Engine	Aceite Oil	Aire Air	Combustible Fuel
FORD (continuación)				
LOBO	V8 4.6L FI	GP-3600 ¹³² GP-68 ¹³³	GA-1615	GG-986
LOBO	V8 5.4L FI	GP-3600 ¹³² GP-68 ¹³³	GA-1617	GG-986
MONDEO	L4 2.0L FI	G-70	GA-196 GAC-9 ²⁴	GG-915
MONDEO	V6 2.5L FI	G-70	GA-196 GAC-9 ²⁴	GG-915
MUSTANG	V8 4.6L FI	GP-68	GA-1615	GG-986
RANGER	L4 2.3L FI	GP-3600	GA-158	GG-308
RANGER	V6 3.0L FI	GP-3600	GA-158	GG-308
RANGER	V6 4.0L FI 12 VALV. SOHC	GP-68 ¹³³	GA-158	GG-308
TAURUS	V6 3.0L SFI 12 VALV.	GP-3600	GA-224	GG-47
TAURUS	V6 3.0L SFI 24 VALV.	GP-68	GA-224	GG-47
TAURUS	V6 3.0L SFI FLEX FUEL	GP-3600	GA-224	GG-47

2004

COURIER	L4 1.6L FI	GP-3600	GA-179 GAC-1 ²⁴	GG-1872
CROWN VICTORIA	V8 4.6L FI	GP-68	GA-5056	GG-986
E SERIES (VANS)	V10 6.8L EFI	GP-68	GA-1615 ⁵³ GA-1571 ¹²⁵ GAC-1 ²⁴	GG-986
E SERIES (VANS)	V8 4.6L EFI	GP-68	GA-1615	GG-986
E SERIES (VANS)	V8 5.4L EFI TRITON	GP-68	GA-1615 GAC-1 ²⁴	GG-986
E SERIES (VANS)	V8 6.0L FI TURBO DIESEL	G-3752	GA-4999 GAC-1 ²⁴	
E SERIES (VANS)	V8 7.3L DIESEL TURBO	GP-562	GAVW-620 ¹²⁸ GAC-1 ²⁴	G-862
ECOSPORT	L4 2.0L FI MOTOR TRANS-VERSAL 16 VALV.	GP-58	GA-288R	GG-986
ESCAPE	L4 2.0L SFI 16 VALV. ZETEC	GP-128	GA-224	GG-47
ESCAPE	V6 3.0L SFI 24 VALV. DURATEC	GP-68	GA-224	GG-47
EXCURSION	V10 6.8L FI TRITON	GP-68	GA-1615	GG-1872
EXCURSION	V8 6.0L FI TURBO DIESEL 32 VALV.	G-3752	GA-4999	G-1047
EXPEDITION	V8 4.6L FI	GP-68	GA-1615 GAC-1 ²⁴	GG-1872
EXPEDITION	V8 5.4L FI	GP-68	GA-1617 GAC-1 ²⁴	
EXPLORER	V6 4.0L FI	GP-68	GA-395	GG-101
EXPLORER	V8 4.6L SFI	GP-68	GA-395	GG-1872
F SERIES	V6 4.2L EFI 12 VALV.	GP-3600	GA-1615 GAC-1 ²⁴	GG-986
F SERIES	V8 4.6L EFI	GP-3600 ¹³² GP-68 ¹³³	GA-1615 GAC-1 ²⁴	GG-986
F SERIES	V8 5.4L EFI 24 VALV.	GP-68	GA-1615 ⁶² GA-433 ¹²⁷ GA-1617 ¹²⁶ GAC-1 ²⁴	GG-986
F SERIES	V8 6.0L FI TURBO DIESEL	G-3752	GA-4999 GAC-1 ²⁴	G-1047
F SERIES SUPER DUTY	V10 6.8L EFI	GP-68	GA-1615 ⁵³ GA-1571 ¹²⁵ GAC-1 ²⁴	GG-1872
F SERIES SUPER DUTY	V8 5.4L EFI	GP-68	GA-1615 GAC-1 ²⁴	GG-1872
F SERIES SUPER DUTY	V8 6.0L FI TURBO DIESEL	G-3752	GA-4999 GAC-1 ²⁴	G-1047
FIESTA HATCHBACK	L4 1.6L FI	GP-58	GA-284	GG-986
FOCUS	L4 2.0L FI	GP-58 ¹⁹ GP-128 ⁶	GA-168 GAC-7 ²⁴	GG-986
FOCUS	L4 2.3L FI	GP-58	GAC-7 ²⁴	GG-986
FREESTAR	V6 3.9L SFI	GP-3600		GG-986
FREESTAR	V6 4.2L FI	GP-3600	GA-479	GG-986
GRAND MARQUIS	V8 4.6L FI	GP-68	GA-5056	GG-986
IKON	L4 1.6L FI	GP-3600	GA-179	GG-82
KA	L4 1.6L FI	GP-128	GA-280 GAC-1 ²⁴	GG-986
LOBO	V8 4.6L FI	GP-3600 ¹³² GP-68 ¹³³	GA-1615	GG-986
LOBO	V8 5.4L FI	GP-3600 ¹³² GP-68 ¹³³	GA-1617	GG-986

Marca - Año - Modelo Make-Year-Model	Motor Engine	Aceite Oil	Aire Air	Combustible Fuel
FORD (continuación)				
MONDEO	L4 2.0L FI	G-70	GA-196 GAC-9 ²⁴	GG-915
MONDEO	V6 2.5L FI	G-70	GA-196 GAC-9 ²⁴	GG-915
MUSTANG	V8 4.6L FI	GP-68	GA-1615	GG-986
RANGER	L4 2.3L FI	GP-3600	GA-158	GG-986 ¹⁴⁶ GG-308 ⁵⁸
RANGER	V6 3.0L FI	GP-3600	GA-158	GG-308
RANGER	V6 4.0L FI 12 VALV. SOHC	GP-68 ¹³³	GA-158	GG-308
TAURUS	V6 3.0L SFI 12 VALV.	GP-3600	GA-224	GG-47
TAURUS	V6 3.0L SFI 24 VALV. DURATEC	GP-68	GA-224	GG-47
TAURUS	V6 3.0L SFI FLEX FUEL	GP-3600	GA-224	GG-47
THUNDERBIRD	V8 3.9L FI 32 VALV.	GP-457	GA-1615	GG-101

2003				
CLUB WAGON	V6 4.2L FI	GP-3600	GA-1615	GG-1872
COURIER	L4 1.6L FI	GP-3600	GA-179 GAC-1 ²⁴	GG-1872
CROWN VICTORIA	V8 4.6L FI	GP-68	GA-5056	GG-986
E SERIES (VANS)	V10 6.8L EFI	GP-68	GA-1615 GAC-1 ²⁴	GG-986
E SERIES (VANS)	V6 4.2L EFI	GP-3600	GA-1615	GG-986
E SERIES (VANS)	V8 4.6L EFI	GP-68	GA-1615	GG-986
E SERIES (VANS)	V8 5.4L EFI	GP-68	GA-1615 GAC-1 ²⁴	GG-986
E SERIES (VANS)	V8 7.3L TURBO DIESEL	GP-562	GAVW-620 GAC-1 ²⁴	G-862
ECOSPORT	L4 2.0L FI MOTOR TRANSVERSAL 16 VALV.	GP-58	GA-288R	GG-986
ESCAPE	L4 2.0L SFI 16 VALV.	GP-128	GA-224	GG-47
ESCAPE	V6 3.0L SFI 24 VALV.	GP-68	GA-224	GG-47
ESCORT	L4 2.0L FI 16 VALV. DOHC ZETEC	GP-128	GA-130	GG-1872
ESCORT	L4 2.0L FI 8 VALV. SOHC	GP-3600	GA-130	GG-30
EXCURSION	V10 6.8L FI TRITON	GP-68	GA-1615	GG-1872
EXCURSION	V8 6.0L SFI TURBO DIESEL	G-3752	GA-4999	G-1047
EXPEDITION	V8 4.6L FI	GP-68	GA-1615 GAC-1 ²⁴	GG-1872
EXPEDITION	V8 5.4L FI	GP-68	GA-1615 GAC-1 ²⁴	GG-986
EXPLORER	V6 4.0L FI	GP-68	GA-395	GG-1872 ¹⁴⁶ GG-308 ⁵⁸
EXPLORER	V8 4.6L SFI	GP-68	GA-395	GG-101
EXPLORER	V8 5.0L FI			
F SERIES	V6 4.2L EFI	GP-3600	GA-1615 GAC-1 ²⁴	GG-986
F SERIES	V8 4.6L EFI	GP-68	GA-1615 GAC-1 ²⁴	GG-986
F SERIES	V8 5.4L EFI	GP-68	GA-1615 ⁶² GA-433 ¹²⁵ GAC-1 ²⁴	GG-986
F SERIES	V8 6.0L FI TURBO DIESEL	G-3752	GA-4999 GAC-1 ²⁴	G-1047
F SERIES SUPER DUTY	V10 6.8L EFI	GP-68	GA-1615 GAC-1 ²⁴	GG-1872
F SERIES SUPER DUTY	V8 5.4L EFI	GP-68	GA-1615 GAC-1 ²⁴	GG-1872
F SERIES SUPER DUTY	V8 6.0L FI TURBO DIESEL	G-3752	GA-4999 GAC-1 ²⁴	G-1047
F SERIES SUPER DUTY	V8 7.3L DI TURBO DIESEL	GP-562	GA-780 GAC-1 ²⁴	G-862
FIESTA HATCHBACK	L4 1.6L FI	GP-58	GA-284	GG-986
FOCUS	L4 2.0L FI	GP-58 ¹⁹ GP-128 ⁶	GA-168 GAC-7 ²⁴	GG-986
FOCUS	L4 2.3L FI	GP-58	GA-168 GAC-7 ²⁴	GG-986
GRAND MARQUIS	V8 4.6L FI	GP-68	GA-5056	GG-986
IKON	L4 1.6L FI	GP-3600	GA-179	GG-82
KA	L4 1.6L FI	GP-128	GA-280 GAC-1 ²⁴	GG-986
LOBO	V8 4.6L FI	GP-3600 ¹³² GP-68 ¹³³	GA-1615	GG-986

Marca - Año - Modelo Make-Year-Model	Motor Engine	Aceite Oil	Aire Air	Combustible Fuel
FORD (continuación)				
LOBO	V8 5.4L FI	GP-3600 ¹³² GP-68 ¹³³	GA-1617	GG-986
MONDEO	L4 2.0L FI	G-70	GA-196 GAC-9 ²⁴	GG-915
MONDEO	V6 2.5L FI	G-70	GA-196 GAC-9 ²⁴	GG-915
MUSTANG	V8 4.6L FI	GP-68	GA-1615	GG-986
RANGER	L4 / V6 2.3L FI Y 3.0L FI	GP-3600	GA-158	GG-986
TAURUS	V6 3.0L SFI 12 VALV.	GP-3600	GA-224	GG-47
TAURUS	V6 3.0L SFI 24 VALV.	GP-68	GA-224	GG-47
TAURUS	V6 3.0L SFI FLEX FUEL	GP-3600	GA-224	GG-47
THUNDERBIRD	V8 3.9L FI 32 VALV.	GP-457	GA-1615	GG-101
WINDSTAR	V6 3.8L FI	GP-3600	GA-1616	GG-986

2002				
CLUB WAGON	V6 4.2L FI	GP-3600	GA-1615	GG-1872
CONTOUR	L4 2.0L FI 16 VALV.	GP-128	GA-127	GG-47
CONTOUR	V6 2.5L FI 24 VALV.	GP-68	GA-128	GG-47
COURIER	L4 1.6L FI	GP-3600	GA-179 GAC-1 ²⁴	GG-1872
CROWN VICTORIA	V8 4.6L FI	GP-68	GA-5056	GG-986
E SERIES (VANS)	V10 6.8L EFI	GP-68	GA-1615 GAC-1 ²⁴	GG-1872
E SERIES (VANS)	V6 4.2L EFI	GP-3600	GA-1615	GG-986
E SERIES (VANS)	V8 4.6L EFI	GP-68	GA-1615	GG-1872
E SERIES (VANS)	V8 5.4L EFI	GP-68	GA-1615 GAC-1 ²⁴	GG-1872
E SERIES (VANS)	V8 7.3L TURBO DIESEL	GP-562	GAVW-620 GAC-1 ²⁴	G-862
ESCAPE	L4 2.0L SFI 16 VALV.	GP-128	GA-224	GG-47
ESCAPE	V6 3.0L SFI 24 VALV.	GP-68	GA-224	GG-47
ESCORT	L4 2.0L SFI	GP-128	GA-130 GAC-7 ²⁴	GG-30
EXCURSION	V10 6.8L FI TRITON	GP-68	GA-1615	GG-1872
EXPEDITION	V8 4.6L FI	GP-68	GA-1615 GAC-1 ²⁴	GG-1872
EXPEDITION	V8 5.4L FI	GP-68	GA-1615 GAC-1 ²⁴	GG-986
EXPLORER	V6 4.0L FI	GP-68	GA-395	GG-308
EXPLORER	V8 4.6L SFI	GP-68	GA-395	GG-308
EXPLORER	V8 5.0L FI			
F SERIES	V6 4.2L EFI	GP-3600	GA-1615 GAC-1 ²⁴	GG-986
F SERIES	V8 4.6L FI	GP-68	GA-1615 GAC-1 ²⁴	GG-986
F SERIES	V8 5.4L EFI	GP-68	GA-1615 ⁶² GA-433 ¹²⁵ GAC-1 ²⁴	GG-1872
F SERIES SUPER DUTY	V10 6.8L EFI	GP-68	GA-1615 GAC-1 ²⁴	GG-1872
F SERIES SUPER DUTY	V8 5.4L EFI	GP-68	GA-1615 GAC-1 ²⁴	GG-1872
F SERIES SUPER DUTY	V8 7.3L TURBO DIESEL	GP-562	GA-780 GAC-1 ²⁴	G-862
FIESTA HATCHBACK	L4 1.3L FI	GP-58	GA-179 GAC-11 ²⁴	GG-82
FOCUS	L4 2.0L FI	GP-58 ¹⁹ GP-128 ⁶	GA-168 GAC-7 ²⁴	GG-986
GRAND MARQUIS	V8 4.6L FI	GP-68	GA-5056	GG-986
IKON	L4 1.6L FI	GP-3600	GA-179	GG-82
KA	L4 1.6L FI	GP-128	GA-280 GAC-1 ²⁴	GG-986
LOBO	V8 4.6L FI	GP-3600 ¹³² GP-68 ¹³³	GA-1615	GG-986
LOBO	V8 5.4L FI	GP-68	GA-1615	GG-986
MONDEO	L4 2.0L FI	G-70	GA-196 GAC-9 ²⁴	GG-915
MONDEO	V6 2.5L FI	G-70	GA-196 GAC-9 ²⁴	GG-915
MUSTANG	V8 4.6L FI	GP-68	GA-1615	GG-986
RANGER	L4 / V6 2.3L FI Y 3.0L FI	GP-3600	GA-158	GG-986
TAURUS	V6 3.0L SFI 12 VALV.	GP-3600	GA-224	GG-47
TAURUS	V6 3.0L SFI 24 VALV.	GP-68	GA-224	GG-47

Marca - Año - Modelo Make-Year-Model	Motor Engine	Aceite Oil	Aire Air	Combustible Fuel
FORD (continuación)				
TAURUS	V6 3.0L SFI FLEX FUEL	GP-3600	GA-224	GG-47
WINDSTAR	V6 3.8L FI	GP-3600	GA-1616	GG-986
2001				
CLUB WAGON	V6 4.2L FI	GP-3600	GA-1615	GG-1872
CONTOUR	L4 2.0L FI 16 VALV.	GP-128	GA-127	GG-47
CONTOUR	V6 2.5L FI 24 VALV.	GP-68	GA-128	GG-47
COURIER	L4 1.6L FI	GP-3600	GA-179 GAC-1 ²⁴	GG-1872
CROWN VICTORIA	V8 4.6L FI	GP-68	GA-5056	GG-986
E SERIES (VANS)	V10 6.8L EFI	GP-68	GA-1615 GAC-1 ²⁴	GG-1872
E SERIES (VANS)	V6 4.2L EFI	GP-3600	GA-1615	GG-1872
E SERIES (VANS)	V8 4.6L EFI	GP-68	GA-1615	GG-1872
E SERIES (VANS)	V8 5.4L EFI	GP-68	GA-1615 ⁵² GA-433 ¹²⁵ GAC-1 ²⁴	GG-1872
E SERIES (VANS)	V8 7.3L TURBO DIESEL	GP-562	GAVW-620 GAC-1 ²⁴	G-862
ESCAPE	L4 2.0L SFI 16 VALV.	GP-128	GA-224	GG-47
ESCAPE	V6 3.0L SFI 24 VALV.	GP-68	GA-224	GG-47
ESCORT	L4 2.0L SFI 16 VALV.	GP-128	GA-130 GAC-7 ²⁴	GG-30
ESCORT	L4 2.0L SPI	GP-3600	GA-130 GAC-7 ²⁴	GG-30
EXCURSION	V10 6.8L FI TRITON	GP-68	GA-1615	GG-1872
EXCURSION	V8 7.3L DIESEL TURBO	GP-562	GA-780	G-862
EXPEDITION	V8 4.6L FI	GP-68	GA-1615 GAC-1 ²⁴	GG-1872
EXPEDITION	V8 5.4L FI	GP-68	GA-1615 GAC-1 ²⁴	GG-986
EXPLORER	V6 4.0L FI	GP-1	GA-158	GG-986
EXPLORER	V8 5.0L FI	GP-68	GA-158	GG-986
F SERIES	V6 4.2L EFI	GP-3600	GA-1615 GAC-1 ²⁴	GG-986
F SERIES	V8 4.6L EFI	GP-68	GA-1615 GAC-1 ²⁴	GG-986
F SERIES	V8 5.4L EFI	GP-68	GA-1615 ⁵² GA-433 ¹²⁵ GAC-1 ²⁴	GG-986
F SERIES SUPER DUTY	V10 6.8L EFI	GP-68	GA-1615 GAC-1 ²⁴	GG-1872
F SERIES SUPER DUTY	V8 5.4L EFI	GP-68	GA-1615 ⁵² GA-433 ¹²⁵ GAC-1 ²⁴	GG-1872
F SERIES SUPER DUTY	V8 7.3L TURBO DIESEL	GP-562	GA-780 GAC-1 ²⁴	G-862
FIESTA HATCHBACK	L4 1.3L FI	GP-58	GA-179 GAC-11 ²⁴	GG-82
FIESTA HATCHBACK	L4 1.6L FI	GP-58	GA-179 GAC-11 ²⁴	GG-82
FOCUS	L4 2.0L FI	GP-58 ¹⁹ GP-128 ⁶	GA-168 GAC-7 ²⁴	GG-986
GRAND MARQUIS	V8 4.6L FI	GP-68	GA-5056	GG-986
IKON	L4 1.3L FI	GP-58		GG-82
IKON	L4 1.6L FI	GP-3600	GA-179	GG-82
KA	L4 1.6L FI	GP-128	GA-280 GAC-1 ²⁴	GG-986
LOBO	V8 4.6L FI	GP-3600 ¹³² GP-68 ¹³³	GA-1615	GG-986
LOBO	V8 5.4L FI	GP-68	GA-1615	GG-986
MONDEO	L4 2.0L FI	G-70	GA-196 GAC-9 ²⁴	GG-915
MONDEO	V6 2.5L FI	GP-68	GAC-9 ²⁴	GG-915
MUSTANG	V8 4.6L FI	GP-68	GA-1615	GG-986
RANGER	L4 2.3L FI	GP-3600	GA-158	GG-986
RANGER	V6 3.0L FI	GP-3600	GA-158	GG-986
TAURUS	V6 3.0L SFI 12 VALV.	GP-3600	GA-224	GG-307
TAURUS	V6 3.0L SFI 24 VALV.	GP-68	GA-224	GG-307
TAURUS	V6 3.0L SFI FLEX FUEL	GP-3600	GA-224	
WINDSTAR	V6 3.8L FI	GP-3600	GA-1616	GG-986

Marca - Año - Modelo Make-Year-Model	Motor Engine	Aceite Oil	Aire Air	Combustible Fuel
FORD (continuación)				
2000				
CLUB WAGON	V6 4.2L FI	GP-3600	GA-1615	GG-1872
CONTOUR	L4 2.0L FI 16 VALV.	GP-128	GA-127 GAC-9 ²⁴	GG-47
CONTOUR	V6 2.5L FI 24 VALV.	GP-68	GA-128 GAC-9 ²⁴	GG-47
CROWN VICTORIA	V8 4.6L FI	GP-68	GA-5056	GG-986
E SERIES (VANS)	V10 6.8L SFI	GP-68	GA-1615 GAC-1 ²⁴	GG-1872
E SERIES (VANS)	V6 4.2L EFI	GP-3600	GA-1615	GG-986
E SERIES (VANS)	V8 4.6L EFI	GP-68	GA-1615	GG-1872
E SERIES (VANS)	V8 5.4L EFI	GP-68	GA-1615 GAC-1 ²⁴	GG-1872
E SERIES (VANS)	V8 7.3L TURBO DIESEL	GP-562	GAVW-620 GAC-1 ²⁴	G-862
ESCORT	L4 2.0L SFI DOHC	GP-128	GA-130 GAC-7 ²⁴	GG-30
ESCORT	L4 2.0L SPI SOHC	GP-3600	GA-130 GAC-7 ²⁴	GG-30
EXCURSION	V10 6.8L FI	GP-68	GA-1615	GG-1872
EXCURSION	V8 7.3L DIESEL TURBO	GP-562	GA-780	G-862
EXPEDITION	V8 4.6L FI	GP-68	GAC-1 ²⁴	GG-986
EXPEDITION	V8 5.4L FI	GP-68	GA-1615 GAC-1 ²⁴	GG-986
EXPLORER	V6 4.0L FI	GP-1	GA-158	GG-1872
EXPLORER	V6 4.8L FI			
EXPLORER	V8 5.0L FI	GP-68	GA-158	GG-986
F SERIES	V10 6.8L FI	GP-68	GA-1615 GAC-1 ²⁴	GG-1872
F SERIES	V6 4.2L SFI	GP-3600	GA-1615 GAC-1 ²⁴	GG-986
F SERIES	V8 4.6L SFI	GP-68	GA-1615 GAC-1 ²⁴	GG-986
F SERIES	V8 5.4L SFI	GP-68	GA-1615 ⁵² GA-433 ¹²⁵ GAC-1 ²⁴	GG-986
F SERIES	V8 7.3L FI TURBO DIESEL	GP-562	GA-780 GAC-1 ²⁴	G-862
FIESTA HATCHBACK	L4 1.3L FI	GP-58	GA-179 GAC-11 ²⁴	GG-82
FIESTA HATCHBACK	L4 1.4L FI	GP-58	GAC-11 ²⁴	GG-82
FOCUS	L4 2.0L FI	GP-58 ¹⁹ GP-128 ⁶	GA-168 GAC-7 ²⁴	GG-986
GRAND MARQUIS	V8 4.6L FI	GP-68	GA-5056	GG-986
IKON	L4 1.6L FI	GP-3600	GA-179	GG-82
KA	L4 1.6L FI	GP-128	GA-280 GAC-1 ²⁴	GG-986
LOBO	V8 4.6L FI	GP-3600 ¹³² GP-68 ¹³³	GA-1615	GG-986
LOBO	V8 5.4L FI	GP-68	GA-1615	GG-986
MUSTANG	V8 4.6L FI	GP-68	GA-1615	GG-986
RANGER	L4 2.3L FI			
RANGER	L4 2.5L FI	GP-3600	GA-158	
RANGER	V6 3.0L FI	GP-3600	GA-158	GG-986
RANGER	V6 4.0L FI	GP-1	GA-158	
TAURUS	V6 3.0L SFI 12 VALV.	GP-3600	GA-224	GG-47
TAURUS	V6 3.0L SFI 24 VALV.	GP-68	GA-224	GG-47
TAURUS	V6 3.0L SFI FLEX FUEL	GP-3600	GA-224	
WINDSTAR	V6 3.0L SFI	GP-3600	GA-273	GG-986
WINDSTAR	V6 3.8L FI	GP-3600	GA-1616	GG-986
1999				
B-800	6 CIL. 5.9L DIESEL	GP-178		GPP-1122
CLUB WAGON	V6 4.2L FI	GP-3600	GA-1615	GG-1872
CONTOUR	L4 2.0L FI 16 VALV.	GP-128	GA-127 GAC-9 ²⁴	GG-47
CONTOUR	V6 2.5L FI 24 VALV.	GP-68	GA-128 GAC-9 ²⁴	GG-47
CROWN VICTORIA	V8 4.6L FI	GP-68	GA-5056	GG-986
E SERIES (VANS)	V10 6.8L SFI	GP-68	GA-1615 GAC-1 ²⁴	GG-1872
E SERIES (VANS)	V6 4.2L EFI	GP-3600	GA-1615	GG-1872

Marca - Año - Modelo Make-Year-Model	Motor Engine	Aceite Oil	Aire Air	Combustible Fuel
FORD (continuación)				
E SERIES (VANS)	V8 4.6L EFI	GP-68	GA-1615	GG-1872
E SERIES (VANS)	V8 5.4L EFI	GP-68	GA-1615 GAC-1 ²⁴	GG-1872
E SERIES (VANS)	V8 7.3L TURBO DIESEL	GP-562	GAVW-620 GAC-1 ²⁴	G-862
ESCORT	L4 2.0L SFI DOHC	GP-128	GA-130	GG-30
ESCORT	L4 2.0L SPI	GP-3600	GA-130	GG-30
EXCURSION	V10 6.8L FI	GP-68	GA-1615	GG-1872
EXCURSION	V8 5.4L	GP-68	GA-1615	GG-986
EXCURSION	V8 7.3L DIESEL TURBO	GP-562		G-862
EXPEDITION	V8 4.6L FI	GP-68	GA-1615 GAC-1 ²⁴	GG-1872
EXPEDITION	V8 5.4L FI	GP-68	GA-1615 GAC-1 ²⁴	GG-986
EXPLORER	V6 4.0L FI	GP-1	GA-158	GG-1872
EXPLORER	V6 4.8L FI			
EXPLORER	V8 5.0L FI	GP-68	GA-158	GG-986
F SERIES	V10 6.8L SFI	GP-68	GA-1615 GAC-1 ²⁴	GG-1872
F SERIES	V6 4.2L SFI	GP-3600	GA-1615 GAC-1 ²⁴	GG-986
F SERIES	V8 4.6L FI	GP-68	GA-1615 GAC-1 ²⁴	GG-1872
F SERIES	V8 5.4L FI	GP-68	GA-1615 ⁶² GA-433 ¹²⁵ GAC-1 ²⁴	GG-1872
F SERIES	V8 7.3L FI TURBO DIESEL	GP-562	GA-472 ⁸⁸ GA-780 ⁵ AC-1 ²⁴	G-862
FIESTA HATCHBACK	L4 1.3L FI	GP-58	GA-179 GAC-11 ²⁴	GG-82
FIESTA HATCHBACK	L4 1.4L FI	GP-58	GA-179 GAC-11 ²⁴	GG-82
GRAND MARQUIS	V8 4.6L FI	GP-68	GA-5056	GG-986
LOBO	V8 4.6L FI	GP-3600 ¹³² GP-68 ¹³³	GA-1615	GG-986
LOBO	V8 5.4L FI	GP-68	GA-1615	GG-986
MUSTANG	V6 3.8L SFI	GP-3600	GA-175	GG-986
MUSTANG	V8 4.6L FI	GP-68	GA-1615	GG-47
RANGER	L4 2.3L FI			
RANGER	L4 2.5L FI	GP-3600	GA-158	GG-986
RANGER	V6 3.0L FI	GP-3600	GA-158	GG-986
RANGER	V6 4.0L FI	GP-1	GA-158	GG-986
WINDSTAR	V6 3.0L SFI	GP-3600	GA-273	GG-986
WINDSTAR	V6 3.8L FI	GP-3600	GA-1616	GG-986
1998				
B-800	6 CIL. 5.9L DIESEL	GP-178		GPP-1122
CLUB WAGON	V6 4.2L FI	GP-3600	GA-1615	GG-1872
CLUB WAGON	V8 5.0L FI			
CLUB WAGON	V8 5.4L FI	GP-1 GP-68	GA-1615	GG-1872
CONTOUR	L4 2.0L FI 16 VALV.	GP-128	GA-127 GAC-9 ²⁴	GG-47
CONTOUR	V6 2.5L FI 24 VALV.	GP-68	GA-128 GAC-9 ²⁴	GG-47
CROWN VICTORIA	V8 4.6L FI	GP-68	GA-5056	GG-986
E SERIES (VANS)	V10 6.8L SFI	GP-68	GA-1615	GG-1872
E SERIES (VANS)	V6 4.2L SFI	GP-3600	GA-1615	GG-1872
E SERIES (VANS)	V8 5.4L SFI	GP-68	GA-1615 GAC-1 ²⁴	GG-1872
E SERIES (VANS)	V8 7.3L TURBO DIESEL	GP-562	GAVW-620	G-862 ³ G-178 ⁸⁶
ESCORT	L4 2.0L SFI DOHC	GP-128	GA-130	GG-30
ESCORT	L4 2.0L SPI SOHC	GP-3600	GA-130	GG-30
EXPEDITION	V8 4.6L FI	GP-68	GA-1615 GAC-1 ²⁴	GG-1872
EXPEDITION	V8 5.4L FI	GP-68	GA-1615 GAC-1 ²⁴	GG-986
EXPLORER	V6 4.0L FI	GP-1	GA-158 ¹²⁵	GG-1872
EXPLORER	V6 4.8L FI			
EXPLORER	V8 5.0L FI	GP-68	GA-158 ¹²⁵ GA-1614 ⁵³	GG-1872
F SERIES	V6 4.2L EFI	GP-3600	GA-1615 GAC-1 ²⁴	GG-1872
F SERIES	V8 4.6L SFI	GP-68	GA-1615 GAC-1 ²⁴	GG-1872
F SERIES	V8 5.4L EFI	GP-68	GA-1615 GAC-1 ²⁴	GG-1872
F SERIES	V8 5.8L EFI	GP-68	GA-174 GAC-1 ²⁴	GG-1872
F SERIES	V8 7.3L TURBO DIESEL	GP-562	GA-442 GAC-1 ²⁴	G-178
F SERIES	V8 7.5L EFI	GP-1	GA-174 GAC-1 ²⁴	GG-1872
FORD 250	V8 5.8L FI	GP-9	GA-174	GG-1872
FORD 350	V8 5.8L FI	GP-9	GA-174	GG-1872
GRAND MARQUIS	V8 4.6L FI	GP-68	GA-5056	GG-47
LOBO	V8 4.6L FI	GP-3600 ¹³² GP-68 ¹³³	GA-1615	GG-986
MUSTANG	V8 4.6L FI	GP-68	GA-1615	GG-47
P-350	V8 5.8L FI			

Marca - Año - Modelo Make-Year-Model	Motor Engine	Aceite Oil	Aire Air	Combustible Fuel
FORD (continuación)				
F SERIES	V6 4.2L FI	GP-3600	GA-1615 GAC-1 ²⁴	GG-1872
F SERIES	V8 4.6L SFI	GP-68	GA-1615 GAC-1 ²⁴	GG-1872
F SERIES	V8 5.4L FI	GP-68	GA-1615 GAC-1 ²⁴	GG-1872
F SERIES	V8 7.3L TURBO DIESEL	GP-562	GA-442 GAC-1 ²⁴	G-178
FIESTA HATCHBACK	L4 1.3L FI	GP-58	GA-179 GAC-11 ²⁴	GG-82
FIESTA HATCHBACK	L4 1.4L FI	GP-58	GA-179 GAC-11 ²⁴	GG-82
GRAND MARQUIS	V8 4.6L FI	GP-68	GA-5056	GG-986
LOBO	V8 4.6L FI	GP-3600 ¹³² GP-68 ¹³³	GA-1615	GG-1872
LOBO	V8 5.4L FI	GP-68	GA-1615	GG-1872
MUSTANG	V8 4.6L FI	GP-68	GA-1615	GG-47
RANGER	L4 2.3L FI			
RANGER	L4 2.5L FI	GP-1	GA-158	GG-986
RANGER	V6 3.0L FI	GP-3600	GA-158	GG-986
RANGER	V6 4.0L FI	GP-1	GA-158	GG-986
WINDSTAR	V6 3.0L SFI	GP-3600	GA-273	GG-1872
WINDSTAR	V6 3.8L FI	GP-3600	GA-1616	GG-1872
1997				
AEROSTAR	V6 3.0L FI	GP-3600	GA-273	GG-47
B-800	6 CIL. 5.9L DIESEL	GP-178		GPP-1122
CLUB WAGON	V6 4.2L FI	GP-3600	GA-1615	GG-1872
CLUB WAGON	V8 5.0L FI			
CLUB WAGON	V8 5.4L FI	GP-68	GA-1615	GG-1872
CONTOUR	L4 2.0L FI 16 VALV.	GP-9	GA-127 GAC-9 ²⁴	GG-47
CONTOUR	L4 2.0L FI 16 VALV. DOHC BI-FUEL	GP-128	GA-127	GG-47
CONTOUR	V6 2.5L FI 24 VALV.	GP-68	GA-128 GAC-9 ²⁴	GG-47
CROWN VICTORIA	V8 4.6L FI	GP-68	GA-5056	GG-47
E SERIES (VANS)	V6 4.2L FI	GP-3600	GA-1615	GG-1872
E SERIES (VANS)	V8 5.4L EFI	GP-68	GA-1615 GAC-1 ²⁴	GG-1872
E SERIES (VANS)	V8 7.3L TURBO DIESEL	GP-562	GAVW-620 ⁸⁷ GA-442 ¹⁵⁴	G-178
ESCORT	L4 2.0L SFI DOHC	GP-128	GA-130	GG-30
ESCORT	L4 2.0L SPI SOHC	GP-3600	GA-130	GG-30
EXPEDITION	V8 4.6L FI	GP-68	GA-1615 GAC-1 ²⁴	GG-1872
EXPEDITION	V8 5.4L FI	GP-68	GA-1615 GAC-1 ²⁴	GG-986
EXPLORER	V6 4.0L FI	GP-1	GA-158 ¹²⁵ GA-1614 ⁵³	GG-1872
EXPLORER	V6 4.8L FI			
EXPLORER	V8 5.0L FI	GP-68	GA-158 ¹²⁵ GA-1614 ⁵³	GG-1872
F SERIES	V6 4.2L EFI	GP-3600	GA-1615 GAC-1 ²⁴	GG-1872
F SERIES	V8 4.6L SFI	GP-68	GA-1615 GAC-1 ²⁴	GG-1872
F SERIES	V8 5.4L EFI	GP-68	GA-1615 GAC-1 ²⁴	GG-1872
F SERIES	V8 5.8L EFI	GP-68	GA-174 GAC-1 ²⁴	GG-1872
F SERIES	V8 7.3L TURBO DIESEL	GP-562	GA-442 GAC-1 ²⁴	G-178
F SERIES	V8 7.5L EFI	GP-1	GA-174 GAC-1 ²⁴	GG-1872
FORD 250	V8 5.8L FI	GP-9	GA-174	GG-1872
FORD 350	V8 5.8L FI	GP-9	GA-174	GG-1872
GRAND MARQUIS	V8 4.6L FI	GP-68	GA-5056	GG-47
LOBO	V8 4.6L FI	GP-3600 ¹³² GP-68 ¹³³	GA-1615	GG-986
MUSTANG	V8 4.6L FI	GP-68	GA-1615	GG-47
P-350	V8 5.8L FI			

Para números Gonher con Superíndice vea página 38
For Gonher with Superscript numbers see page 38

Marca - Año - Modelo Make-Year-Model	Motor Engine	Aceite Oil	Aire Air	Combustible Fuel
FORD (continuación)				
PROBE	L4 2.0L FI DOHC		GA-432	GG-94 ¹⁶¹ GG-268 ¹⁶²
PROBE	V6 2.5L FI	GP-149	GA-432	GG-268
RANGER	L4 2.3L FI	GP-1	GA-1616	GG-1872
RANGER	V6 3.0L FI	GP-1	GA-1616	GG-1872
RANGER	V6 4.0L FI	GP-1	GA-1616	GG-1872
THUNDERBIRD	V6 3.8L SFI	GP-3600	GA-275 GA-176 ⁴⁵	GG-92
THUNDERBIRD	V8 4.6L SFI	GP-68	GA-275	GG-92
WINDSTAR	V6 3.0L SFI	GP-3600	GA-273	GG-1872
WINDSTAR	V6 3.8L FI	GP-3600	GA-1616	GG-1872
1996				
AEROSTAR	V6 3.0L FI	GP-3600	GA-273	GG-47
AEROSTAR	V6 4.0L FI	GP-1 GP-3600	GA-273	GG-47
B-800	6 CIL. 5.9L DIESEL	GP-178		GPP-1122
BRONCO	V8 5.0L FI	GP-1	GA-174	GG-1872
BRONCO	V8 5.8L FI	GP-1 GP-68	GA-174	GG-1872
CLUB WAGON	V6 4.9L FI	GP-1	GA-1615	GG-1872
CLUB WAGON	V8 5.0L FI	GP-1	GA-174	GG-1872
CLUB WAGON	V8 5.8L FI	GP-1	GA-174	GG-1872
CONTOUR	L4 2.0L FI 16 VALV.	GP-9	GA-127 GAC-9 ²⁴	GG-47
CONTOUR	V6 2.5L FI 24 VALV.	GP-68	GA-128 GAC-9 ²⁴	GG-47
CROWN VICTORIA	V8 4.6L FI	GP-68	GA-5056	GG-47
E SERIES (VANS)	6 CIL. 4.9L SFI	GP-1	GA-174	GG-1872
E SERIES (VANS)	V8 5.0L SFI	GP-1	GA-174	GG-1872
E SERIES (VANS)	V8 5.8L EFI O SFI	GP-1	GA-174	GG-1872
E SERIES (VANS)	V8 7.3L TURBO DIESEL	GP-562	GAVW-620 ⁸⁷ GA-442 ¹⁵⁴	G-178
ESCORT	L4 1.8L EFI	GP-91	GA-133	GG-47
ESCORT	L4 1.9L SFI	GP-3600	GA-277	GG-47
EXPLORER	V6 4.0L FI	GP-1	GA-1616	GG-1872
EXPLORER	V6 4.8L FI			
EXPLORER	V8 5.0L FI	GP-68	GA-1614	GG-1872
F SERIES	L6 4.9L SFI	GP-1	GA-174	GG-1872
F SERIES	V8 5.0L SFI	GP-1	GA-174	GG-1872
F SERIES	V8 5.8L SFI	GP-68	GA-174	GG-1872
F SERIES	V8 7.3L TURBO DIESEL	GP-562	GA-442	G-178
F SERIES	V8 7.5L EFI	GP-1	GA-174	GG-1872
F59 STRIPPED CHASSIS	V8 7.3L FI DIESEL		GA-442	
FORD 250	V8 5.8L FI	GP-9	GA-174	GG-1872
FORD 350	V8 5.8L FI	GP-9	GA-174	GG-1872
GRAND MARQUIS	V8 4.6L FI	GP-68	GA-5056	GG-47
MUSTANG	V8 4.6L FI	GP-68	GA-1615	GG-47
MUSTANG	V8 5.0L FI	GP-1	GA-175	GG-47
P-350	V8 5.8L FI			
PROBE	L4 2.0L FI DOHC		GA-432	GG-94 ¹⁶¹ GG-268 ¹⁶²
PROBE	V6 2.5L FI	GP-149	GA-432	GG-268
RANGER	L4 2.3L FI	GP-1	GA-1616	GG-1872
RANGER	V6 3.0L FI	GP-1	GA-1616	GG-1872
RANGER	V6 4.0L FI	GP-1	GA-1616	GG-1872
THUNDERBIRD	V6 3.8L SFI	GP-3600	GA-275 GA-176 ⁴⁵	GG-92
THUNDERBIRD	V8 4.6L FI	GP-68	GA-275	GG-92
WINDSTAR	V6 3.0L SFI	GP-3600	GA-273	GG-1872
WINDSTAR	V6 3.8L FI	GP-3600	GA-1616	GG-1872
1995				
AEROSTAR	V6 3.0L FI	GP-3600	GA-273	GG-47
AEROSTAR	V6 3.3L FI	GP-3600	GA-273	GG-47
AEROSTAR	V6 4.0L	GP-1 GP-3600	GA-273	GG-47
B-800	6 CIL. 5.9L DIESEL	GP-178		GPP-1122
BRONCO	V8 5.0L FI	GP-1	GA-174	GG-1872
BRONCO	V8 5.8L FI	GP-1	GA-174	GG-1872
CLUB WAGON	V6 4.9L FI	GP-1	GA-1615	GG-1872
CLUB WAGON	V8 5.8L	GP-1	GA-174	GG-1872
CROWN VICTORIA	V8 4.6L	GP-68	GA-5056	GG-47
E SERIES (VANS)	6 CIL. 4.9L EFI	GP-1	GA-174	GG-1872
E SERIES (VANS)	V8 5.0L EFI	GP-1	GA-174	GG-1872
E SERIES (VANS)	V8 5.8L EFI	GP-1	GA-174	GG-1872
E SERIES (VANS)	V8 7.3L DIESEL	GP-3766		
E SERIES (VANS)	V8 7.5L EFI	GP-1 ⁶³	GA-174	GG-1872

Marca - Año - Modelo Make-Year-Model	Motor Engine	Aceite Oil	Aire Air	Combustible Fuel
FORD (continuación)				
BRONCO	V8 5.8L FI	GP-1 GP-68	GA-174	GG-1872
CLUB WAGON	L6 4.2L FI			
CLUB WAGON	V6 4.9L FI	GP-1	GA-1615	GG-1872
CLUB WAGON	V8 5.0L FI	GP-1	GA-174	GG-1872
CLUB WAGON	V8 5.8L	GP-1	GA-174	GG-1872
CONTOUR	L4 2.0L FI	GP-9	GA-127 GAC-9 ²⁴	GG-47
CONTOUR	V6 2.5L SFI	GP-68	GA-128 GAC-9 ²⁴	GG-47
CROWN VICTORIA	V8 4.6L	GP-68	GA-5056	GG-47
E SERIES (VANS)	6 CIL. 4.9L EFI	GP-1	GA-174	GG-1872
E SERIES (VANS)	V8 5.0L EFI	GP-1	GA-174	GG-1872
E SERIES (VANS)	V8 5.8L EFI	GP-1	GA-174	GG-1872
E SERIES (VANS)	V8 7.3L TURBO DIESEL	GP-562	GAVW-620 ⁸⁷ GA-442 ¹⁵⁴	G-178
ESCORT	L4 1.8L EFI	GP-91	GA-133	GG-47
ESCORT	L4 1.9L SFI	GP-3600	GA-277	GG-47
EXPLORER	V6 4.0L FI	GP-1	GA-1616	GG-1872
EXPLORER	V6 4.8L FI			
F SERIES	L6 4.9L EFI	GP-1	GA-174	GG-1872
F SERIES	V8 5.0L EFI	GP-1	GA-174	GG-1872
F SERIES	V8 5.8L EFI	GP-68	GA-174 GA-176 ⁴⁵	GG-1872
F SERIES	V8 7.3L DIESEL	GP-3766	GA-3501	
F SERIES	V8 7.3L TURBO DIESEL	GP-562	GA-442	G-178
F SERIES	V8 7.5L EFI	GP-1	GA-174	GG-1872
F59 STRIPPED CHASSIS	V8 7.3L DIESEL		GA-442	
FORD 250	V8 5.8L FI	GP-9	GA-174	GG-1872
FORD 350	V8 5.8L FI	GP-9	GA-174	GG-1872
GRAND MARQUIS	V8 4.6L FI	GP-68	GA-5056	GG-47
M-450	8 CIL. 7.3L DIESEL	GP-3766	GA-1615	
M-450	8 CIL. 7.5L GASOLINA	GP-1	GA-174	GG-1872
MUSTANG	V8 5.0L FI	GP-1	GA-175	GG-47
P-350	V8 5.8L FI			
PROBE	L4 2.0L FI DOHC		GA-432	GG-94 ¹⁶¹ GG-268 ¹⁶²
PROBE	V6 2.5L	GP-149	GA-432	GG-268
RANGER	L4 2.3L FI	GP-1	GA-1616	GG-1872
RANGER	V6 3.0L FI	GP-1	GA-1616	GG-1872
RANGER	V6 4.0L FI	GP-1	GA-1616	GG-1872
TAURUS	V6 3.0L EFI	GP-3600	GA-273	GG-47
TAURUS	V6 3.0L EFI SHO 24 VALV.	GP-3600		GG-47
TAURUS	V6 3.0L FLEX FUEL	GP-3600	GA-273	GG-47
TAURUS	V6 3.2L EFI	GP-3600		GG-47
TAURUS	V6 3.8L EFI	GP-3600	GA-273 GA-176 ⁴⁵	GG-47
THUNDERBIRD	V6 3.8L EFI	GP-3600	GA-275 GA-176 ⁴⁵	GG-92
THUNDERBIRD	V8 4.6L FI	GP-68	GA-275	GG-92
WINDSTAR	V6 3.0L SFI	GP-3600	GA-273	GG-1872
WINDSTAR	V6 3.8L FI	GP-3600	GA-273	GG-1872
1994				
AEROSTAR	V6 3.0L FI	GP-3600	GA-273	GG-47
AEROSTAR	V6 3.3L FI	GP-3600	GA-273	GG-47
AEROSTAR	V6 4.0L FI	GP-1 GP-3600	GA-273	GG-47
B-800	6 CIL. 5.9L DIESEL	GP-178		GPP-1122
BRONCO	V8 5.0L FI	GP-1	GA-174	GG-1872
BRONCO	V8 5.8L FI	GP-1	GA-174	GG-1872
CLUB WAGON	V6 4.9L FI	GP-1	GA-1615	GG-1872
CLUB WAGON	V8 5.8L	GP-1	GA-174	GG-1872
CROWN VICTORIA	V8 4.6L	GP-68	GA-5056	GG-47
E SERIES (VANS)	6 CIL. 4.9L EFI	GP-1	GA-174	GG-1872
E SERIES (VANS)	V8 5.0L EFI	GP-1	GA-174	GG-1872
E SERIES (VANS)	V8 5.8L EFI	GP-1	GA-174	GG-1872
E SERIES (VANS)	V8 7.3L DIESEL	GP-3766		
E SERIES (VANS)	V8 7.5L EFI	GP-1 ⁶³	GA-174	GG-1872

Marca - Año - Modelo Make-Year-Model	Motor Engine	Aceite Oil	Aire Air	Combustible Fuel
FORD (continuación)				
ESCORT	L4 1.8L EFI DOHC	GP-91	GA-133	GG-47
ESCORT	L4 1.9L EFI	GP-3600	GA-277	GG-47
EXPLORER	V6 4.0L FI	GP-1	GA-273	GG-1872
F SERIES	L6 4.9L EFI	GP-1	GA-174	GG-1872
F SERIES	V8 5.0L EFI	GP-1	GA-174	GG-1872
F SERIES	V8 5.8L EFI	GP-68	GA-174 GA-176 ⁴⁵	GG-1872
F SERIES	V8 7.3L DI TURBO DIESEL	GP-562	GA-442	G-178
F SERIES	V8 7.3L DIESEL	GP-3766	GA-3501	
F SERIES	V8 7.3L TURBO DIESEL	GP-3766		
F SERIES	V8 7.5L EFI	GP-1	GA-174	GG-1872
F59 STRIPPED CHASSIS	V8 7.3L DIESEL		GA-442	
FORD 250	V8 5.8L FI	GP-9	GA-174	GG-1872
FORD 350	V8 5.8L FI	GP-9	GA-174	GG-1872
GHIA	V6 3.0L	GP-3600	GA-217	GG-47
GRAND MARQUIS	V8 4.6L FI	GP-68	GA-5056	GG-47
M-450	8 CIL. 7.3L DIESEL	GP-3766	GA-1615	
M-450	8 CIL. 7.5L GASOLINA	GP-1	GA-174	GG-1872
MUSTANG	V8 5.0L FI	GP-1	GA-175	GG-47
P-350	V8 5.8L	GP-9	GA-174	GG-1872
PROBE	L4 2.0L FI DOHC	GP-149	GA-432	GG-94 ¹⁶¹ GG-268 ¹⁶²
PROBE	V6 2.5L	GP-149	GA-432	GG-268
RANGER	L4 2.3L FI (A)	GP-1	GA-273	GG-47
RANGER	V6 3.0L (U) FI	GP-3600	GA-273	GG-47
RANGER	V6 4.0L FI (X)	GP-1	GA-273	GG-47
TAURUS	V6 3.0L FI	GP-3600	GA-273	GG-47
TAURUS	V6 3.0L FI FLEX FUEL	GP-3600	GA-273	GG-239
TAURUS	V6 3.0L FI SHO (SUPER HIGH OUTPUT)	GP-3600	GA-5057	GG-47
TAURUS	V6 3.2L FI SHO (SUPER HIGH OUTPUT)	GP-3600	GA-5057	GG-47
TAURUS	V6 3.8L FI	GP-3600	GA-273 GA-176 ⁴⁵	GG-47
TEMPO	L4 2.3L EFI	GP-9	GA-217	GG-47
TEMPO	V6 3.0L EFI	GP-3600	GA-217	GG-47
THUNDERBIRD	V6 3.8L EFI	GP-3600	GA-275 GA-176 ⁴⁵	GG-92
THUNDERBIRD	V6 3.8L FI SUPER CARGADO	GP-3600	GA-275	GG-92
THUNDERBIRD	V8 4.6L FI	GP-68	GA-275	GG-92
THUNDERBIRD	V8 5.0L FI	GP-1	GA-275	GG-30
TOPAZ	L4 2.3L FI	GP-9	GA-217	GG-47
1993				
AEROSTAR	V6 3.0L FI	GP-3600	GA-273	GG-47
AEROSTAR	V6 4.0L	GP-1 GP-3600	GA-273	GG-47
BRONCO	6 CIL. 4.9L FI	GP-1	GA-174 GA-176 ⁴⁵	GG-1872
BRONCO	V8 5.0L FI	GP-1	GA-174 GA-176 ⁴⁵	GG-1872
BRONCO	V8 5.8L FI	GP-1	GA-174 GA-176 ⁴⁵	GG-1872
CROWN VICTORIA	V8 4.6L	GP-68	GA-5056	GG-47
E SERIES (VANS)	6 CIL. 4.9L EFI	GP-1	GA-174 GA-176 ⁴⁵	GG-1872
E SERIES (VANS)	V8 5.0L EFI	GP-1	GA-174 GA-176 ⁴⁵	GG-1872
E SERIES (VANS)	V8 5.8L EFI	GP-1	GA-174 GA-176 ⁴⁵	GG-1872
E SERIES (VANS)	V8 7.3L DIESEL	GP-3766		
E SERIES (VANS)	V8 7.5L FI	GP-1 ¹⁶³	GA-174 GA-176 ⁴⁵	GG-1872
ESCORT	L4 1.8L EFI 16 VALV.	GP-91	GA-133	GG-47
ESCORT	L4 1.9L EFI	GP-3600	GA-277	GG-47
EXPLORER	V6 4.0L FI	GP-1	GA-273	GG-1872
F SERIES	L6 4.9L EFI	GP-1	GA-174 GA-176 ⁴⁵	GG-1872
F SERIES	V8 5.0L EFI	GP-1	GA-174 GA-176 ⁴⁵	GG-1872

Marca - Año - Modelo Make-Year-Model	Motor Engine	Aceite Oil	Aire Air	Combustible Fuel
FORD (continuación)				
F SERIES	V8 5.8L EFI	GP-1	GA-174 GA-176 ⁴⁵	GG-1872
F SERIES	V8 7.3L DIESEL	GP-3766	GA-3501	
F SERIES	V8 7.3L TURBO DIESEL	GP-3766		
F SERIES	V8 7.5L EFI	GP-1	GA-174 GA-176 ⁴⁵	GG-1872
FORD 250	V8 5.8L FI	GP-9	GA-174	GG-1872
FORD 350	V8 5.8L FI	GP-9	GA-174	GG-1872
GHIA	V6 3.0L	GP-3600	GA-217	GG-47
GRAND MARQUIS	V8 4.6L FI	GP-68	GA-5056	GG-47
MUSTANG	L4 2.3L FI	GP-1	GA-274	GG-47
MUSTANG	V8 5.0L FI	GP-1		GG-47
P-350	V8 5.8L	GP-9	GA-174	GG-1872
PROBE	L4 2.0L EFI	GP-149	GA-432	GG-268
PROBE	V6 2.5L	GP-149	GA-432	GG-268
RANGER	L4 2.3L FI (A)	GP-1	GA-273	GG-47
RANGER	V6 2.9L (T) FI	GP-1	GA-273	GG-47
RANGER	V6 3.0L (U) FI	GP-3600	GA-273	GG-47
RANGER	V6 4.0L FI (X)	GP-1	GA-273	GG-47
TAURUS	L4 2.5L FI	GP-3600	GA-273	GG-47
TAURUS	V6 3.0L FI	GP-3600	GA-273	GG-47
TAURUS	V6 3.0L FI FLEX FUEL	GP-3600	GA-273	GG-239
TAURUS	V6 3.0L FI SHO (SUPER HIGH OUTPUT)	GP-3600	GA-5057	GG-47
TAURUS	V6 3.2L FI	GP-3600	GA-5057	GG-47
TAURUS	V6 3.8L	GP-3600	GA-273 GA-176 ⁴⁵	GG-47
TEMPO	L4 2.3L EFI	GP-9	GA-217	GG-47
TEMPO	V6 3.0L EFI	GP-3600	GA-217	GG-47
THUNDERBIRD	V6 3.8L EFI	GP-3600	GA-275 GA-176 ⁴⁵	GG-92
THUNDERBIRD	V6 3.8L FI SUPER CARGADO	GP-3600	GA-275	GG-92
THUNDERBIRD	V8 4.6L FI	GP-3600	GA-275	GG-92
THUNDERBIRD	V8 5.0L FI	GP-1	GA-275	GG-30
TOPAZ	L4 2.3L FI	GP-9	GA-217	GG-47
1992				
AEROSTAR	V6 3.0L FI	GP-3600	GA-273	GG-47
AEROSTAR	V6 4.0L	GP-1	GA-273	GG-47 GG-1872
B200	V8 5.0L	GP-1	GA-74	GG-25
BRONCO	6 CIL. 4.9L FI	GP-1	GA-174 GA-176 ⁴⁵	GG-1872
BRONCO	V8 5.0L FI	GP-1	GA-174 GA-176 ⁴⁵	GG-1872
BRONCO	V8 5.8L FI	GP-1	GA-174 GA-176 ⁴⁵	GG-1872
CROWN VICTORIA	V8 4.6L	GP-68	GA-5056	GG-47
E SERIES (VANS)	6 CIL. 4.9L EFI	GP-1 ¹⁶³	GA-174 GA-176 ⁴⁵	GG-1872
E SERIES (VANS)	V8 5.0L EFI	GP-1	GA-174 GA-176 ⁴⁵	GG-1872
E SERIES (VANS)	V8 5.8L EFI	GP-1	GA-174 GA-176 ⁴⁵	GG-1872
E SERIES (VANS)	V8 7.3L DIESEL	GP-3766		
E SERIES (VANS)	V8 7.5L EFI	GP-1 ¹⁶³	GA-174 GA-176 ⁴⁵	GG-47
ESCORT	L4 1.8L EFI	GP-91	GA-133	GG-47
ESCORT	L4 1.9L SFI	GP-3600	GA-277	GG-47
EXPLORER	V6 4.0L FI	GP-1	GA-273	GG-1872
F SERIES	L6 4.9L EFI	GP-1	GA-174 GA-176 ⁴⁵	GG-1872
F SERIES	V8 5.0L EFI	GP-1	GA-174 GA-176 ⁴⁵	GG-1872
F SERIES	V8 5.8L EFI	GP-1	GA-174 GA-176 ⁴⁵	GG-1872
F SERIES	V8 7.3L DIESEL	GP-3766	GA-3501	
F SERIES	V8 7.5L EFI	GP-1	GA-174 GA-176 ⁴⁵	GG-1872
FORD 250	V8 5.8L FI	GP-9	GA-174	GG-1872
FORD 350	V8 5.8L FI	GP-9	GA-174	GG-1872

Para números Gonher con Superíndice vea página 38
For Gonher with Superscript numbers see page 38

Para modelos anteriores a 1990 visite nuestro sitio en internet www.grupogonher.com
For pre-1990 models, visit our Web site www.grupogonher.com

Marca - Año - Modelo Make-Year-Model	Motor Engine	Aceite Oil	Aire Air	Combustible Fuel
FORD (continuación)				
GHIA	V6 3.0L	GP-3600	GA-217	GG-47
GRAND MARQUIS	V8 4.6L FI	GP-68	GA-5056	GG-47
MUSTANG	L4 2.3L FI	GP-1	GA-274	GG-47
MUSTANG	V8 5.0L FI	GP-1		GG-47
P-350	V8 5.8L	GP-9	GA-174	GG-1872
PROBE	L4 2.2L EFI	GP-149		GG-142
RANGER	L4 2.3L FI (A)	GP-1	GA-273	GG-47
RANGER	V6 2.9L (T) FI	GP-1	GA-273	GG-47
RANGER	V6 3.0L (U) FI	GP-3600	GA-273	GG-47
RANGER	V6 4.0L FI (X)	GP-1	GA-273	GG-47
TAURUS	L4 2.5L FI	GP-3600	GA-273	GG-47
TAURUS	V6 3.0L FI	GP-3600	GA-273 GA-5057 ¹³⁸	GG-47
TAURUS	V6 3.8L	GP-3600	GA-273 GA-176 ⁴⁵	GG-47
TEMPO	L4 2.3L FI	GP-1	GA-217	GG-47
TEMPO	V6 3.0L SFI	GP-3600	GA-217	GG-47
THUNDERBIRD	V6 3.8L FI SUPER CARGADO	GP-3600	GA-275	GG-92
THUNDERBIRD	V6 3.8L SFI	GP-3600	GA-275 GA-176 ⁴⁵	GG-92
THUNDERBIRD	V8 4.6L FI	GP-3600	GA-275	GG-92
THUNDERBIRD	V8 5.0L FI	GP-1	GA-275	GG-30
TOPAZ	L4 2.3L FI	GP-9	GA-274	GG-47
1991				
AEROSTAR	V6 3.0L FI	GP-3600	GA-273	GG-47
AEROSTAR	V6 4.0L	GP-1	GA-273	GG-47 GG-1872
B200	V8 5.0L	GP-1	GA-74	GG-25
BRONCO	6 CIL. 4.9L FI	GP-1	GA-174 GA-176 ⁴⁵	GG-47
BRONCO	V8 5.0L FI	GP-1	GA-174 GA-176 ⁴⁵	GG-47
BRONCO	V8 5.8L FI	GP-1	GA-174 GA-176 ⁴⁵	GG-47
CROWN VICTORIA	V8 5.0L	GP-1	GA-5056	GG-47
CROWN VICTORIA	V8 5.8L	GP-9	GA-75	
E SERIES (VANS)	6 CIL. 4.9L EFI	GP-1	GA-174 GA-176 ⁴⁵	GG-47
E SERIES (VANS)	V8 5.0L EFI	GP-1	GA-174 GA-176 ⁴⁵	GG-47
E SERIES (VANS)	V8 5.8L EFI	GP-1	GA-174 GA-176 ⁴⁵	GG-47
E SERIES (VANS)	V8 7.3L DIESEL	GP-3766	GA-3501 ¹⁰⁴	
E SERIES (VANS)	V8 7.5L EFI	GP-1 ¹⁶³	GA-174 GA-176 ⁴⁵	GG-47
ESCORT	L4 1.8L MFI	GP-91	GA-133	GG-47
ESCORT	L4 1.9L SFI	GP-3600	GA-277	GG-47
EXPLORER	V6 4.0L FI	GP-1	GA-273	GG-1872
F SERIES	L6 4.9L EFI	GP-1	GA-174 GA-176 ⁴⁵	GG-47
F SERIES	V8 5.0L EFI	GP-1	GA-174 GA-176 ⁴⁵	GG-47
F SERIES	V8 5.8L EFI	GP-1	GA-174 GA-176 ⁴⁵	GG-47
F SERIES	V8 7.3L DIESEL	GP-3766	GA-3501	
F SERIES	V8 7.5L EFI	GP-1	GA-174 GA-176 ⁴⁵	GG-47
GHIA	L4 2.3L	GP-3600	GA-274	GG-47
GHIA	V6 3.0L	GP-3600	GA-217	GG-47
GRAND MARQUIS	V8 5.0L SFI	GP-1	GA-5056	GG-47
MUSTANG	L4 2.3L FI	GP-1	GA-274 GA-176 ⁴⁵	GG-47
MUSTANG	V8 5.0L FI	GP-1		GG-47
P-350	V8 5.8L	GP-9	GA-174	GG-1872
PROBE	L4 2.2L EFI	GP-149		GG-142
RANGER	L4 2.3L FI (A)	GP-1	GA-273	GG-47
RANGER	V6 2.9L (T) FI	GP-1	GA-273	GG-47
RANGER	V6 4.0L FI (X)	GP-1	GA-273	GG-47
TAURUS	L4 2.5L EFI	GP-9	GA-273	GG-47
TAURUS	V6 3.0L EFI	GP-3600	GA-273 GA-176 ⁴⁵	GG-47
TAURUS	V6 3.0L SFI SHO	GP-3600	GA-176 ⁴⁵	GG-47
TAURUS	V6 3.8L FI	GP-3600	GA-273 GA-176 ⁴⁵	GG-47
TEMPO	L4 2.3L EFI	GP-1	GA-274	GG-47
THUNDERBIRD	V6 3.8L EFI	GP-3600	GA-275 GA-176 ⁴⁵	GG-30
THUNDERBIRD	V6 3.8L FI SUPER CARGADO	GP-3600	GA-275 GA-176 ⁴⁵	GG-30
THUNDERBIRD	V8 4.6L FI	GP-3600	GA-275	GG-92

Marca - Año - Modelo Make-Year-Model	Motor Engine	Aceite Oil	Aire Air	Combustible Fuel
FORD (continuación)				
TAURUS	L4 2.5L FI	GP-9	GA-273 GA-176 ⁴⁵	GG-47
TAURUS	V6 3.0L SFI	GP-3600	GA-273 GA-176 ⁴⁵	GG-47
TAURUS	V6 3.0L SFI SHO	GP-3600 ⁴⁵		GG-47
TAURUS	V6 3.8L FI	GP-3600	GA-273 GA-176 ⁴⁵	GG-47
TEMPO	L4 2.3L EFI	GP-1	GA-274	GG-47
THUNDERBIRD	V6 3.8L EFI	GP-3600	GA-275 GA-176 ⁴⁵	GG-30
THUNDERBIRD	V6 3.8L FI SUPER CARGADO	GP-3600	GA-275 GA-176 ⁴⁵	GG-30
THUNDERBIRD	V8 4.6L FI	GP-3600	GA-275	GG-92
THUNDERBIRD	V8 5.0L FI	GP-1	GA-275	GG-30
TOPAZ	L4 2.3L FI	GP-9	GA-274	GG-47
1990				
AEROSTAR	V6 3.0L	GP-3600	GA-273	GG-47
AEROSTAR	V6 4.0L	GP-1	GA-273	GG-47
B200	V8 5.0L	GP-1	GA-74	GG-25
BRONCO	6 CIL. 4.9L FI	GP-1	GA-174 GA-176 ⁴⁵	GG-47
BRONCO	V6 2.9L	GP-1	GA-273	GG-47
BRONCO	V6 4.0L	GP-1	GA-273	GG-47
BRONCO	V8 5.0L FI	GP-1	GA-174 GA-176 ⁴⁵	GG-47
BRONCO	V8 5.8L FI	GP-1	GA-174 GA-176 ⁴⁵	GG-47
BRONCO II	V6 2.9L EFI	GP-1	GA-273	GG-47
CROWN VICTORIA	V8 5.0L	GP-1	GA-5056	GG-47
CROWN VICTORIA	V8 5.8L	GP-9	GA-75	
E SERIES (VANS)	6 CIL. 4.9L EFI	GP-1	GA-174 GA-176 ⁴⁵	GG-47
E SERIES (VANS)	V8 5.0L EFI	GP-1	GA-174 GA-176 ⁴⁵	GG-47
E SERIES (VANS)	V8 5.8L EFI	GP-1	GA-174 GA-176 ⁴⁵	GG-47
E SERIES (VANS)	V8 7.3L DIESEL	GP-3766	GA-3501	
E SERIES (VANS)	V8 7.5L FI	GP-1	GA-3501 GA-176 ⁴⁵	GG-47
ESCORT	L4 1.9L EFI	GP-3600	GA-277	GG-47
ESCORT	L4 1.9L EFI HIGH OUTPUT	GP-3600		GG-47
F SERIES	L6 4.9L EFI	GP-1	GA-174 GA-176 ⁴⁵	GG-47
F SERIES	V8 5.0L EFI	GP-1	GA-174 GA-176 ⁴⁵	GG-47
F SERIES	V8 5.8L EFI	GP-1	GA-174 GA-176 ⁴⁵	GG-47
F SERIES	V8 7.3L DIESEL	GP-3766	GA-3501	
F SERIES	V8 7.5L EFI	GP-1	GA-174 GA-176 ⁴⁵	GG-47
GRAND MARQUIS	V8 5.0L EFI	GP-1	GA-5056	GG-47
MUSTANG	L4 2.3L FI	GP-1	GA-274 GA-176 ⁴⁵	GG-47
MUSTANG	V8 5.0L FI	GP-1		GG-47
P-350	V8 5.7L	GP-1	GA-74	GG-25
PROBE	L4 2.2L EFI	GP-149	GA-273 ¹⁴	GG-142
RANGER	L4 2.3L FI (A)	GP-1	GA-273	GG-47
RANGER	V6 2.9L (T) FI	GP-1	GA-273	GG-47
RANGER	V6 4.0L FI (X)	GP-1	GA-273	GG-47
TAURUS	L4 2.5L EFI	GP-9	GA-273	GG-47
TAURUS	V6 3.0L EFI	GP-3600	GA-273 GA-176 ⁴⁵	GG-47
TAURUS	V6 3.0L SFI SHO	GP-3600	GA-176 ⁴⁵	GG-47
TAURUS	V6 3.8L FI	GP-3600	GA-273 GA-176 ⁴⁵	GG-47
TEMPO	L4 2.3L EFI	GP-1	GA-274	GG-47
THUNDERBIRD	V6 3.8L EFI	GP-3600	GA-275 GA-176 ⁴⁵	GG-30
THUNDERBIRD	V6 3.8L FI SUPER CARGADO	GP-3600	GA-275 GA-176 ⁴⁵	GG-30
THUNDERBIRD	V8 4.6L FI	GP-3600	GA-275	GG-92

Marca - Año - Modelo Make-Year-Model	Motor Engine	Aceite Oil	Aire Air	Combustible Fuel
FORD (continuación)				
TOPAZ	L4 2.3L FI	GP-9	GA-274	GG-47
GEO				
1997				
METRO	3 CIL. 1.0L EFI	GP-58	GA-142	GG-146
METRO	L4 1.3L EFI	GP-58	GA-142	GG-146
PRIZM	L4 1.6L SFI	GP-157		
PRIZM	L4 1.8L SFI	GP-157		
TRACKER	L4 1.6L MFI	GP-157		
1996				
METRO	3 CIL. 1.0L EFI	GP-58	GA-142	GG-146
METRO	L4 1.3L EFI	GP-58	GA-142	GG-146
PRIZM	L4 1.6L MFI	GP-157		
PRIZM	L4 1.8L SFI	GP-157		
TRACKER	L4 1.6L MFI	GP-58		
1995				
METRO	3 CIL. 1.0L EFI	GP-58	GA-142	GG-146
METRO	L4 1.3L EFI	GP-58	GA-142	GG-146
PRIZM	L4 1.6L MFI	GP-157		
PRIZM	L4 1.8L MFI	GP-157		
TRACKER	L4 1.6L MFI	GP-58	GA-166	
1994				
METRO	3 CIL. 1.0L EFI	GP-58	GA-142	GG-146
METRO	L4 1.3L	GP-58	GA-142	GG-146
PRIZM	L4 1.6L MFI	GP-157		
PRIZM	L4 1.8L MFI	GP-157		
TRACKER	L4 1.6L MFI		GA-166	
1993				
METRO	3 CIL. 1.0L EFI	GP-58	GA-142	GG-146
METRO	L4 1.3L	GP-58	GA-142	GG-146
PRIZM	L4 1.6L MFI	GP-157		
PRIZM	L4 1.8L MFI	GP-157		
STORM	L4 1.6L MFI		GA-6690	GG-260
STORM	L4 1.8L MFI	GP-91	GA-6690	GG-260
SUNFIRE (CANADA)	L4 1.6L FI 16 VALV. DOHC		GA-6690	GG-260
SUNFIRE (CANADA)	L4 1.8L FI 16 VALV. DOHC		GA-6690	GG-260
TRACKER	L4 1.6L EFI		GA-166	
1992				
METRO	3 CIL. 1.0L EFI	GP-58	GA-142	GG-146
METRO	L4 1.3L	GP-58	GA-142	GG-146
PRIZM	L4 1.6L MFI VIN 5	GP-156		GG-220
PRIZM	L4 1.6L MFI VIN 6	GP-157	GA-195	GG-220
STORM	L4 1.6L MFI		GA-6690	GG-260
STORM	L4 1.8L MFI	GP-91	GA-6690	GG-260
TRACKER	L4 1.6L EFI		GA-166	
1991				
METRO	3 CIL. 1.0L EFI	GP-58	GA-142	GG-146
METRO	3 CIL. 1.0L FI CANADA	GP-58		GG-146
PRIZM	L4 1.6L MFI VIN 5	GP-156		GG-220
PRIZM	L4 1.6L MFI VIN 6	GP-157	GA-195	GG-220
STORM	L4 1.6L MFI 16 VALV. GSI VIN 5	GP-91	GA-6690	GG-260
STORM	L4 1.6L MFI VIN 6		GA-6690	GG-260
TRACKER	L4 1.6L EFI	GP-2951	GA-166	
1990				
METRO	3 CIL. 1.0L EFI	GP-58	GA-142	GG-146
METRO	3 CIL. 1.0L EFI TURBO CANADA	GP-58		GG-146

Marca - Año - Modelo Make-Year-Model	Motor Engine	Aceite Oil	Aire Air	Combustible Fuel
GEO (continuación)				
PRIZM	L4 1.6L MFI VIN 5	GP-156		GG-220
PRIZM	L4 1.6L MFI VIN 6	GP-157	GA-195	GG-220
SPRINT	3 CIL. 1.0L FI VIN 2	GP-58		GG-146
SPRINT	3 CIL. 1.0L FI VIN 6	GP-58	GA-142	GG-146
STORM	L4 1.6L MFI		GA-6690	GG-260
STORM	L4 1.6L MFI HO GSI	GP-91	GA-6690	GG-260
TRACKER	L4 1.6L EFI	GP-2951	GA-166	
GIANT				
2008				
GF-3600	L4 3.168L DIESEL TURBO (FAW SUPER DIESEL CA4DC2-1DE3)	GP-205		
GF-6000	L4 4.752L DIESEL TURBO (FAW SUPER DIESEL CA4DF3-13E3)	GP-205		
GF-900	L4 1.0L FI (LJ465QE1)	GP-157		GG-243
GMC				
2010				
ACADIA	V6 3.6L FI	GP-406	GA-3083	
CANYON	5 CIL. 3.7L FI	GP-3675	GA-266	
CANYON	L4 2.9L FI	GP-44	GA-266	
CANYON	V8 5.3L FI	GP-406	GA-266	
SAVANA	V6 4.3L FI	GP-46		
SAVANA	V8 4.8L FI FLEX FUEL	GP-406		
SAVANA	V8 5.3L FI FLEX FUEL	GP-406		
SAVANA	V8 6.0L FI FLEX FUEL	GP-406		
SAVANA	V8 6.6L FI TURBO DIESEL			
SIERRA	V6 4.3L FI	GP-46	GA-348	
SIERRA	V8 4.8L FI FLEX FUEL	GP-406	GA-348	
SIERRA	V8 5.3L FI FLEX FUEL	GP-406	GA-348	
SIERRA	V8 6.0L FI FLEX FUEL	GP-406	GA-348	
SIERRA	V8 6.2L FI FLEX FUEL	GP-406	GA-348	
SIERRA	V8 6.6L FI TURBO DIESEL			
SIERRA HYBRID	V8 6.0L FI	GP-406	GA-348	
TERRAIN	L4 2.4L DI	G-49		
TERRAIN	V6 3.0L DI	GP-406		
YUKON	V8 5.3L FI FLEX FUEL	GP-406	GA-348	
YUKON	V8 6.0L FI FLEX FUEL	GP-406	GA-348	
YUKON	V8 6.2L FI FLEX FUEL	GP-406	GA-348	
YUKON HYBRID	V8 6.0L FI	GP-406	GA-348	
2009				
ACADIA	V6 3.6L FI 24 VALV. DOHC	GP-406	GA-3083	
CANYON	5 CIL. 3.7L FI	GP-3675	GA-266	
CANYON	L4 2.9L FI	GP-44	GA-266	
CANYON	V8 5.3L FI	GP-406	GA-266	
ENVOY	6 CIL. 4.2L FI 24 VALV. DOHC	GP-3675	GA-414R	
ENVOY	V8 5.3L FI	GP-406	GA-414R	
ENVOY	V8 6.0L FI			
SAVANA	V6 4.3L FI	GP-46	GA-413R	
SAVANA	V8 4.8L FI	GP-406	GA-413R	
SAVANA	V8 5.3L FI FLEX FUEL	GP-406	GA-413R	
SAVANA	V8 6.0L FI	GP-406	GA-413R	
SAVANA	V8 6.6L DIESEL TURBO			
SIERRA	V6 4.3L FI	GP-46	GA-348	
SIERRA	V8 4.8L FI	GP-406	GA-348	
SIERRA	V8 5.3L FI	GP-406	GA-348	
SIERRA	V8 5.3L FI FLEX FUEL	GP-406	GA-348	
SIERRA	V8 6.0L FI	GP-406	GA-348	
SIERRA	V8 6.2L FI	GP-406	GA-348	
SIERRA	V8 6.2L FI FLEX FUEL	GP-406	GA-348	
SIERRA	V8 6.6L DIESEL TURBO			
SIERRA HYBRID	V8 6.0L FI	GP-406	GA-348	

Marca - Año - Modelo Make-Year-Model	Motor Engine	Aceite Oil	Aire Air	Combustible Fuel
GMC (continuación)				
YUKON	V6 4.3L FI	GP-46	GA-348	
YUKON	V8 4.8L FI	GP-406	GA-348	
YUKON	V8 5.3L FI	GP-406	GA-348	
YUKON	V8 5.3L FI FLEX FUEL	GP-406	GA-348	
YUKON	V8 6.0L FI	GP-406	GA-348	
YUKON	V8 6.2L FI	GP-406	GA-348	
YUKON	V8 6.2L FI FLEX FUEL	GP-406	GA-348	
YUKON	V8 6.6L DIESEL TURBO			
YUKON HYBRID	V8 6.0L FI	GP-406	GA-348	
2008				
ACADIA	V6 3.6L MFI	GP-406	GA-3083	
CANYON	L4 2.9L MFI	GP-44	GA-266	
CANYON	L5 3.7L MFI	GP-3675	GA-266	
CANYON	V8 5.3L FI	GP-406	GA-266	
ENVOY	6 CIL. 4.2L FI 24 VALV. DOHC	GP-3675	GA-414R	
ENVOY	V8 5.3L FI	GP-406	GA-414R	
ENVOY	V8 6.0L FI	GP-406	GA-414R	
SAVANA	V6 4.3L FI	GP-46	GA-413R	
SAVANA	V8 4.8L FI	GP-406	GA-413R	
SAVANA	V8 5.3L FI FLEX FUEL	GP-406	GA-413R	
SAVANA	V8 6.0L FI	GP-406	GA-413R	
SAVANA	V8 6.6L DIESEL TURBO			
SIERRA	V6 4.3L FI	GP-46	GA-348	
SIERRA	V8 4.8L FI	GP-406	GA-348	
SIERRA	V8 5.3L FI	GP-406	GA-348	
SIERRA	V8 5.3L FI FLEX FUEL	GP-406	GA-348	
SIERRA	V8 6.0L FI	GP-406	GA-348	
SIERRA	V8 6.2L FI	GP-406	GA-348	
SIERRA	V8 6.6L TURBO DIESEL			
YUKON	V8 4.8L SFI	GP-406	GA-348	
YUKON	V8 5.3L SFI	GP-406	GA-348	
YUKON	V8 5.3L SFI FLEX FUEL	GP-406	GA-348	
YUKON	V8 6.2L SFI	GP-406	GA-348	
YUKON HYBRID	V8 6.0L FI	GP-406	GA-348	
2007				
ACADIA	V6 3.6L FI	GP-406	GA-3083	
CANYON	L4 2.9L MFI	GP-44	GA-415	
CANYON	L5 3.7L MFI VORTEC DOHC	GP-3675	GA-415	
ENVOY	6 CIL. 4.2L FI 24 VALV. DOHC	GP-3675	GA-414R	
ENVOY	V8 5.3L FI	GP-406	GA-414R	
SAVANA	V6 4.3L FI	GP-46	GA-413R	
SAVANA	V8 4.8L FI	GP-406	GA-413R	
SAVANA	V8 5.3L FI	GP-406	GA-413R	
SAVANA	V8 6.0L FI	GP-406	GA-413R	
SAVANA	V8 6.6L DIESEL TURBO			
SIERRA	V6 4.3L MFI	GP-46	GA-348	
SIERRA	V8 4.8L SFI	GP-406	GA-348	
SIERRA	V8 5.3L FI FLEX FUEL	GP-406	GA-348	
SIERRA	V8 5.3L SFI	GP-406	GA-348	
SIERRA	V8 6.0L SFI	GP-406	GA-348	
SIERRA	V8 6.2L SFI	GP-406	GA-348	
SIERRA	V8 6.6L TURBO DIESEL			
SIERRA	V8 8.1L FI		GA-348	
SIERRA HYBRID	V8 5.3L FI	GP-406 GP-46		
YUKON	V8 4.8L SFI	GP-406	GA-348	
YUKON	V8 5.3L FI	GP-406	GA-348	
YUKON	V8 5.3L FI FLEX FUEL	GP-406	GA-348	
YUKON	V8 6.0L SFI	GP-406	GA-348	
YUKON	V8 6.2L SFI	GP-406	GA-348	
2006				
CANYON	5 CIL. 3.5L MFI	GP-3675	GA-415	
CANYON	L4 2.8L MFI	GP-44	GA-415	

Marca - Año - Modelo Make-Year-Model	Motor Engine	Aceite Oil	Aire Air	Combustible Fuel
GMC (continuación)				
ENVOY	L6 4.2L SFI VORTEC	GP-3675	GA-414R	
ENVOY	V8 5.3L SFI	GP-44	GA-414R	
SAVANA	V6 4.3L FI	GP-46	GA-413R	
SAVANA	V8 4.8L FI	GP-44	GA-413R	
SAVANA	V8 5.3L FI	GP-44	GA-413R	
SAVANA	V8 6.0L FI	GP-44	GA-413R	
SAVANA	V8 6.6L DIESEL TURBO			
2005				
CANYON	5 CIL. 3.5L MFI	GP-3675	GA-415	GG-581
CANYON	L4 2.8L FI	GP-44	GA-415	
CANYON	L4 2.8L MFI	GP-44	GA-415	GG-581
ENVOY	L6 4.2L SFI	GP-3675	GA-414R	GG-209
ENVOY	V8 5.3L SFI	GP-44	GA-348 ¹²⁵ GA-414R ¹²³	GG-46
SAFARI	V6 4.3L FI	GP-46	GA-165	GG-46
SAVANA	V6 4.3L FI	GP-46	GA-413R	
SAVANA	V8 4.8L FI	GP-44	GA-413R	
SAVANA	V8 5.3L FI	GP-44	GA-413R	
SAVANA	V8 5.3L FI FLEX FUEL	GP-44	GA-413R	GG-66 ¹³¹
SAVANA	V8 6.0L FI	GP-44	GA-413R	
SAVANA	V8 6.0L FI FLEX FUEL	GP-44	GA-413R	GG-66 ¹³¹
SAVANA	V8 6.0L FI HO			GG-46 ¹³⁰ GG-66 ¹³¹
2004				
CANYON	5 CIL. 3.5L MFI	GP-3675 ¹⁶ GP-44 ⁹	GA-415	GG-581
CANYON	L4 2.8L MFI	GP-44	GA-415	GG-581
ENVOY	L6 4.2L SFI	GP-3675	GA-414R	GG-209
ENVOY	V8 5.3L SFI	GP-44	GA-414R	GG-209
JIMMY	V6 4.3L FI OHC (CANADA)	GP-46 ⁹ GP-3980 ¹⁶	GA-165	GG-266
SAFARI	V6 4.3L FI	GP-46	GA-165	GG-46
SAVANA	V6 4.3L FI	GP-46	GA-413R	GG-46
SAVANA	V8 4.8L FI	GP-44	GA-413R	
SAVANA	V8 5.3L FI	GP-44	GA-413R	
SAVANA	V8 5.3L FI FLEX FUEL	GP-44	GA-413R	GG-66 ¹³¹
SAVANA	V8 6.0L FI	GP-44	GA-413R	
SONOMA	V6 4.3L FI	GP-3980	GA-165	GG-266
2003				
ENVOY	L6 4.2L SFI	GP-3675	GA-414R	GG-209
ENVOY	V8 5.3L FI	GP-44	GA-414R	GG-209
JIMMY	V6 4.3L FI OHV (CANADA)	GP-46 ⁹ GP-3980 ¹⁶	GA-165	GG-266
SAFARI	V6 4.3L FI	GP-46	GA-165	GG-46
SAVANA	V6 4.3L FI	GP-46	GA-413R	GG-46
SAVANA	V8 4.8L FI	GP-44	GA-413R	GG-66 ¹³¹
SAVANA	V8 5.3L FI	GP-44	GA-413R	GG-66 ¹³¹
SAVANA	V8 6.0L FI	GP-44	GA-413R	GG-66 ¹³¹
SAVANA	V8 8.1L FI	GP-408	GA-413R	GG-46
SONOMA	L4 2.2L FI (L43) FLEX FUEL	GP-46 ⁹ GP-3980 ¹⁶	GA-165	
SONOMA	V6 4.3L FI	GP-46 ⁹ GP-3980 ¹⁶	GA-165	GG-266
2002				
ENVOY	L6 4.2L SFI	GP-3675	GA-414R	GG-209
JIMMY	V6 4.3L FI OHV	GP-46 ⁹ GP-3980 ¹⁶	GA-165	GG-266
SAFARI	V6 4.3L FI	GP-46	GA-165	GG-46
SAVANA	V6 4.3L FI	GP-46	GA-413R	GG-581
SAVANA	V8 5.0L FI	GP-205	GA-413R	GG-581
SAVANA	V8 5.7L FI	GP-205	GA-413R	GG-581
SAVANA	V8 5.7L FI BI-FUEL	GP-205	GA-413R	GG-581
SAVANA	V8 6.0L FI	GP-3675	GA-413R	GG-46
SAVANA	V8 6.5L DIESEL TURBO	GP-205	GA-392	GPP-419

Marca - Año - Modelo Make-Year-Model	Motor Engine	Aceite Oil	Aire Air	Combustible Fuel
GMC (continuación)				
SAVANA	V8 8.1L FI	GP-408	GA-413R	GG-46
SONOMA	L4 2.2L FI (L43) FLEX FUEL	GP-46	GA-165	
SONOMA	L6 4.2L FI DOHC (LL8)	GP-3675	GA-414R	GG-209
SONOMA	V6 4.3L FI OHV (L35)	GP-46	GA-165	GG-266
2001				
ENVOY	L4 2.2L FI (L43) FLEX FUEL	GP-46	GA-165	
ENVOY	V6 4.3L FI	GP-46 ⁹ P-3980 ¹⁶	GA-165	GG-266
JIMMY	L4 2.2L FI (L43) FLEX FUEL	GP-46	GA-165	
JIMMY	V6 4.3L FI	GP-46 ⁹ P-3980 ¹⁶	GA-165	GG-266
SAFARI	V6 4.3L FI	GP-46 ⁹ P-3980 ¹⁶	GA-165	GG-46
SAVANA	V6 4.3L FI	GP-46	GA-413R	GG-581
SAVANA	V8 5.0L FI	GP-205	GA-413R	GG-581
SAVANA	V8 5.7L FI	GP-205	GA-413R	GG-581
SAVANA	V8 5.7L FI BI-FUEL	GP-205	GA-413R	GG-581
SAVANA	V8 6.5L DIESEL TURBO	GP-205	GA-392	GPP-419
SAVANA	V8 8.1L FI	GP-408	GA-413R	GG-581
SONOMA	L4 2.2L FI	GP-46	GA-165	GG-266
SONOMA	L4 2.2L FI (L43) FLEX FUEL	GP-46	GA-165	
SONOMA	V6 4.3L FI	GP-46 ⁹ P-3980 ¹⁶	GA-165	GG-266
2000				
ENVOY	L4 2.2L FI	GP-46	GA-165	GG-266
ENVOY	V6 4.3L FI	GP-46 ⁹ P-3980 ¹⁶	GA-165	
JIMMY	V6 4.3L FI	GP-46 ⁹ P-3980 ¹⁶	GA-165	GG-206
SAFARI	V6 4.3L FI	GP-46	GA-165	GG-46
SONOMA	L4 2.2L FI	GP-46	GA-165	GG-266
SONOMA	L4 2.2L FI (L43) FLEX FUEL	GP-46	GA-165	
SONOMA	V6 4.3L FI	GP-46 ⁹ P-3980 ¹⁶	GA-165	GG-266
1999				
SONOMA	L4 2.2L FI	GP-46	GA-165	GG-266
SONOMA	V6 4.3L FI	GP-3980	GA-165	GG-266
1998				
SONOMA	L4 2.2L FI	GP-46	GA-165	GG-266
SONOMA	V6 4.3L FI	GP-3980	GA-165	GG-266
1997				
SONOMA	L4 2.2L FI	GP-46	GA-165	GG-266
SONOMA	V6 4.3L FI	GP-3980	GA-165	GG-266
1996				
SONOMA	L4 2.2L FI	GP-46	GA-165	GG-46
SONOMA	V6 4.3L FI	GP-3980	GA-165	GG-46
1995				
SONOMA	L4 2.2L FI	GP-46	GA-165	GG-46
SONOMA	V6 4.3L FI (W)	GP-3980	GA-165	GG-46
SONOMA	V6 4.3L FI (Z)	GP-3980	GA-3588	GG-46
1994				
JIMMY	V8 5.7L FI	GP-3980 ¹⁶ GP-205 ⁹	GA-59	GG-46
JIMMY	V8 6.5L TURBO DIESEL	GP-205		
SONOMA	L4 2.2L FI	GP-46	GA-165	GG-46
SONOMA	V6 4.3L FI (W)	GP-3980	GA-165	GG-46
SONOMA	V6 4.3L FI (Z)	GP-3980	GA-3588	GG-46

Marca - Año - Modelo Make-Year-Model	Motor Engine	Aceite Oil	Aire Air	Combustible Fuel
GMC (continuación)				
1993				
JIMMY	V8 5.7L FI	GP-3980 ¹⁶ GP-205 ⁹	GA-59	GG-46
SONOMA	L4 2.5L FI	GP-46	GA-3647	GG-46
SONOMA	V6 2.8L	GP-3980	GA-3588	GG-46
SONOMA	V6 4.3L FI (W)	GP-3980	GA-165	GG-46
SONOMA	V6 4.3L FI (Z)	GP-3980	GA-3588	GG-46
SONOMA	V6 4.3L FI TURBO (Z)	GP-3980	GA-165	GG-46
1992				
JIMMY	V8 5.7L FI	GP-3980 ¹⁶ GP-205 ⁹	GA-59	GG-46
SONOMA	L4 2.5L FI	GP-46	GA-3647	GG-46
SONOMA	V6 2.8L FI	GP-3980	GA-3588	GG-46
SONOMA	V6 4.3L (W)	GP-3980	GA-165	GG-46
SONOMA	V6 4.3L (Z)	GP-3980	GA-3588	GG-46
SONOMA	V6 4.3L TURBO (Z)	GP-3980	GA-165	GG-46
1991				
JIMMY	V8 5.7L FI	GP-205	GA-59	GG-46
JIMMY	V8 6.2L DIESEL	GP-205		G-294
JIMMY	V8 7.4L FI	GP-205	GA-89	GG-46
SONOMA	L4 2.5L FI	GP-46	GA-3647	GG-46
SONOMA	V6 2.8L FI	GP-3980	GA-3588	GG-3728
SONOMA	V6 4.3L FI	GP-3980	GA-3588	GG-46
SONOMA	V6 4.3L FI TURBO	GP-3980	GA-165	GG-46
1990				
JIMMY	V8 5.7L FI	GP-205	GA-59	GG-46
JIMMY	V8 6.2L DIESEL	GP-205		G-294
HONDA				
2010				
ACCORD	L4 2.4L FI I-VTEC	GP-149	GA-193	
ACCORD	V6 3.5L FI SOHC	GP-149	GA-171	
ACCORD CROSSTOUR	L4 2.4L FI DOHC			
ACCORD CROSSTOUR	V6 3.5L FI DOHC			
CIVIC	L4 1.8L FI I-VTEC	GP-149	GA-340	
CIVIC	L4 2.0L FI I-VTEC	GP-149		
CIVIC HYBRID	3 CIL. 1.3L I-VTEC	GP-149		
CR-V	L4 2.4L FI I-VTEC	GP-149		
CR-Z	L4 1.8L SOHC			
ELEMENT	L4 2.4L FI I-VTEC	GP-149	GA-6 ²⁴	
FIT	L4 1.5L FI VTEC	GP-149		
INSIGHT	L4 1.3L FI	GP-149		
ODYSSEY	V6 3.5L FI VTEC	GP-149		
PILOT	V6 3.5L FI VTEC	GP-149		
RIDGELINE	V6 3.5L FI VTEC 24 VALV.	GP-149		
2009				
ACCORD	L4 2.4L FI 16 VALV. DOHC V-TEC	GP-149	GA-193	
ACCORD	V6 3.5L FI 24 VALV. SOHC V-TEC	GP-149	GA-171	
CIVIC	L4 1.8L FI 16 VALV. SOHC V-TEC	GP-149	GA-340	
CIVIC HYBRID	L4 1.3L FI SOHC V-TEC	GP-149		
CR-V	L4 2.4L FI 16 VALV. DOHC V-TEC	GP-149	GA-341	
ELEMENT	L4 2.4L FI DOHC V-TEC	GP-149	GA-6 ²⁴	
FIT	L4 1.5L FI 16 VALV. SOHC V-TEC	GP-149		
ODYSSEY	V6 3.5L FI 24 VALV. SOHC V-TEC	GP-149	GA-383	
PILOT	V6 3.5L FI 24 VALV. SOHC	GP-149		
RIDGELINE	V6 3.5L FI 24 VALV. SOHC V-TEC	GP-149		

Marca - Año - Modelo Make-Year-Model	Motor Engine	Aceite Oil	Aire Air	Combustible Fuel
HONDA (continuación)				
S2000	L4 2.2L FI 16 VALV. DOHC V-TEC	GP-91		
2008				
ACCORD	L4 2.4L FI	GP-149	GA-193	
ACCORD	V6 3.5L FI	GP-149	GA-171	
CIVIC	L4 1.8L FI	GP-149	GA-340	
CIVIC	L4 2.0L FI	GP-149		
CIVIC HYBRID	L4 1.3L FI	GP-149		
CR-V	L4 2.4L FI 16 VALV. DOHC (K24Z1) I-V-TEC	GP-149	GA-341	
ELEMENT	L4 2.4L MFI I-VTEC	GP-149	GAC-6 ²⁴	
FIT	L4 1.5L FI	GP-149	GA-182	
FIT	L4 1.8L FI	GP-149	GA-182	
ODYSSEY	V6 3.5L EFI	GP-149	GA-383	
PILOT	V6 3.5L MFI VTEC	GP-149		
RIDGELINE	V6 3.5L MFI VTEC	GP-149		
S2000	L4 2.2L FI 16 VALV. DOHC V-TEC	GP-91		
2007				
ACCORD	L4 2.4L FI VTEC 16 VALV.	GP-149	GA-138	
ACCORD	V6 3.0L FI VTEC 24 VALV.	GP-149	GAC-13 ²⁴ GA-269	
CIVIC	L4 1.8L FI I-VTEC	GP-149	GA-340	
CIVIC	L4 2.0L FI I-VTEC	GP-149		
CIVIC HYBRID	L4 1.3L FI	GP-149		
CR-V	L4 2.0L FI SOHC	GP-149	GA-341	
CR-V	L4 2.3L FI 16 VALV. DOHC	GP-149	GA-341	
CR-V	L4 2.4L FI 16 VALV. DOHC (K24Z1) I-V-TEC	GP-149	GA-341	
ELEMENT	L4 2.4L FI I-VTEC	GP-149	GAC-6 ²⁴	
FIT	L4 1.5L FI VTEC 16 VALV.	GP-149	GA-182	
ODYSSEY	V6 3.5L MFI VTEC 24 VALV.	GP-149	GA-383	
PILOT	V6 3.5L MFI VTEC 24 VALV.	GP-149		
RIDGELINE	V6 3.5L MFI VTEC 24 VALV.	GP-149		
2006				
ACCORD	L4 2.4L FI VTEC 16 VALV.	GP-149	GA-138	
ACCORD	V6 3.0L FI VTEC 24 VALV.	GP-149	GAC-13 ²⁴ GA-269	
CIVIC	L4 1.8L FI 16 VALV.	GP-149	GA-340	
CIVIC HYBRID	L4 1.3L FI	GP-149		
CR-V	L4 2.4L FI 16 VALV.	GP-149	GA-184 GAC-6 ²⁴	
ELEMENT	L4 2.4L FI I-VTEC	GP-149	GA-184 GAC-6 ²⁴	
FIT	L4 1.5L FI	GP-149		
ODYSSEY	V6 3.5L FI 24 VALV.	GP-149	GA-383	
PILOT	V6 3.5L FI 24 VALV.	GP-149		
2005				
ACCORD	L4 2.4L FI VTEC 16 VALV.	GP-149	GA-138	
ACCORD	V6 3.0L FI VTEC 24 VALV.	GP-149	GAC-13 ²⁴ GA-269	
CIVIC	L4 1.7L FI VTEC 16 VALV.	GP-149	GA-194 GAC-6 ²⁴	
CIVIC	L4 2.0L MFI I-VTEC	GP-149	GA-184	
CIVIC HYBRID	L4 1.3L FI	GP-149	GAC-6 ²⁴	
CR-V	L4 2.4L FI 16 VALV.	GP-149	GA-184 GAC-6 ²⁴	
ELEMENT	L4 2.4L FI I-VTEC	GP-149	GA-184 GAC-6 ²⁴	
ODYSSEY	V6 3.5L FI 24 VALV.	GP-149	GA-383	
PILOT	V6 3.5L FI 24 VALV.	GP-149		
2004				
ACCORD	L4 2.4L FI VTEC 16 VALV.	GP-149	GA-138	
ACCORD	V6 3.0L FI VTEC 24 VALV.	GP-149	GAC-13 ²⁴ GA-269	

Marca - Año - Modelo Make-Year-Model	Motor Engine	Aceite Oil	Aire Air	Combustible Fuel
HONDA (continuación)				
CIVIC	L4 1.7L FI VTEC 16 VALV.	GP-149	GA-194 GAC-6 ²⁴	
CIVIC	L4 2.0L MFI VTEC	GP-149	GA-184	
CIVIC HYBRID	L4 1.3L FI	GP-149	GAC-6 ²⁴	
CR-V	L4 2.4L FI 16 VALV.	GP-6811	GA-184 GAC-6 ²⁴	GG-160
ELEMENT	L4 2.4L PFI I-VTEC	GP-149	GA-184 GAC-6 ²⁴	
ODYSSEY	V6 3.5L FI 24 VALV.	GP-6811	GA-183	GG-160
PILOT	V6 3.5L FI 24 VALV.	GP-6811		
2003				
ACCORD	L4 2.4L FI VTEC 16 VALV.	GP-149	GA-138	
ACCORD	V6 3.0L FI VTEC 24 VALV.	GP-149	GAC-13 ²⁴ GA-269	
CIVIC	L4 1.7L FI VTEC 16 VALV.	GP-149	GA-194 GAC-6 ²⁴	
CIVIC	L4 2.0L MFI VTEC	GP-149	GA-184	
CIVIC HYBRID	L4 1.3L FI	GP-149	GAC-6 ²⁴	
CR-V	L4 2.4L FI 16 VALV.	GP-6811	GA-184 GAC-6 ²⁴	GG-160
ELEMENT	L4 2.4L MFI	GP-149	GA-184 GAC-6 ²⁴	
ODYSSEY	V6 3.5L FI 24 VALV.	GP-6811	GA-183	GG-160
PILOT	V6 3.5L FI 24 VALV.	GP-6811		
2002				
ACCORD	L4 2.3L FI VTEC 16 VALV.	GP-6811	GA-163 GAC-13 ²⁴	GG-160
ACCORD	V6 3.0L FI VTEC 24 VALV.	GP-6811	GA-170 GAC-13 ²⁴	GG-161
CIVIC	L4 1.7L FI VTEC 16 VALV.	GP-149	GA-194 GAC-6 ²⁴	
CIVIC	L4 2.0L FI	GP-149	GA-194	
CIVIC HYBRID	L4 1.3L FI	GP-149	GAC-6 ²⁴	
CR-V	L4 2.4L FI 16 VALV.	GP-6811	GA-184 GAC-6 ²⁴	GG-160
ODYSSEY	V6 3.5L FI 24 VALV.	GP-6811	GA-183	GG-160
2001				
ACCORD	L4 2.3L FI VTEC 16 VALV.	GP-6811	GA-163 GAC-13 ²⁴	GG-160
ACCORD	V6 3.0L FI VTEC 24 VALV.	GP-6811	GA-170 GAC-13 ²⁴	GG-161
CIVIC	L4 1.7L FI VTEC 16 VALV.	GP-91	GA-194 GAC-6 ²⁴	
CR-V	L4 2.0L MFI DOHC 16 VALV.	GP-91	GA-172	GG-160
ODYSSEY	V6 3.5L FI 24 VALV.	GP-6811	GA-183	GG-160
2000				
ACCORD	L4 2.3L FI VTEC 16 VALV.	GP-6811	GA-163 GAC-13 ²⁴	GG-160
ACCORD	V6 3.0L FI VTEC 24 VALV.	GP-6811	GA-170 GAC-13 ²⁴	GG-161
CIVIC	L4 1.6L FI SOHC D16Y7		GA-384	GG-160
CIVIC	L4 1.6L FI VTEC 16 VALV.		GA-172	GG-160
CR-V	L4 2.0L MFI 16 VALV.	GP-91	GA-172	GG-160
ODYSSEY	V6 3.5L FI 24 VALV.	GP-6811	GA-183	GG-160
1999				
ACCORD	L4 2.3L FI VTEC 16 VALV.	GP-6811	GA-163 GAC-13 ²⁴	GG-160
ACCORD	V6 3.0L FI VTEC 24 VALV.	GP-6811	GA-170 GAC-13 ²⁴	GG-161
CIVIC	L4 1.6L FI SOHC D16Y7		GA-384	GG-160
CIVIC	L4 1.6L FI VTEC 16 VALV.		GA-172	GG-160
CR-V	L4 2.0L MFI DOHC	GP-91	GA-172	GG-160
EXI	L4 2.0L 2BBL		GA-390	GG-208 ²¹
EXI	L4 2.0L FI			GG-190
ODYSSEY	V6 3.5L FI (VTEC) 24 VALV.		GA-183	

Marca - Año - Modelo Make-Year-Model	Motor Engine	Aceite Oil	Aire Air	Combustible Fuel
HONDA (continuación)				
1998				
ACCORD	L4 2.3L FI VTEC 16 VALV.	GP-6811	GA-163 GAC-13 ²⁴	GG-160
ACCORD	V6 3.0L FI VTEC 24 VALV.	GP-6811	GA-170 GAC-13 ²⁴	GG-161
CIVIC	L4 1.6L FI SOHC D16Y7		GA-384	GG-160
CIVIC	L4 1.6L FI VTEC 16 VALV.		GA-172	GG-160
CR-V	L4 2.0L MFI DOHC	GP-91	GA-172	GG-160
ODYSSEY	L4 2.3L MFI		GA-514	GG-160
1997				
ACCORD	L4 2.2L FI 16 VALV. SOHC. VTEC		GA-514	GG-160
CIVIC	L4 1.6L FI SOHC D16Y7		GA-384	GG-160
CIVIC	L4 1.6L FI VTEC 16 VALV.		GA-172	GG-160
CR-V	L4 2.0L MFI DOHC	GP-91	GA-172	GG-160
DEL SOL	L4 1.6L FI DOHC B16A2		GA-381	GG-160
DEL SOL	L4 1.6L FI SOHC D16Y7		GA-384	GG-160
DEL SOL	L4 1.6L FI SOHC D16Y8		GA-381	GG-160
EX-R	L4 2.2L FI SOHC		GA-514	GG-160
EX-R	V6 2.7L FI SOHC			GG-160
ODYSSEY	L4 2.2L MFI		GA-514	GG-160
PRELUDE	L4 2.2L PFI VTEC	GP-149		GG-214
1996				
ACCORD	L4 2.2L FI 16 VALV. SOHC. VTEC		GA-514	GG-160
CIVIC	L4 1.6L FI		GA-172	GG-160
CIVIC	L4 1.6L FI SOHC D16Y7		GA-384	GG-160
DEL SOL	L4 1.6L FI DOHC B16A2		GA-381	GG-160
DEL SOL	L4 1.6L FI SOHC D16Y7		GA-384	GG-160
DEL SOL	L4 1.6L FI SOHC D16Y8		GA-381	GG-160
EX-R	L4 2.2L FI SOHC		GA-514	GG-160
EX-R	V6 2.7L FI SOHC			GG-160
ODYSSEY	L4 2.2L MFI		GA-514	GG-160
PRELUDE	L4 2.2L PFI VTEC	GP-149		GG-214
PRELUDE	L4 2.3L PFI	GP-149		GG-214
1995				
ACCORD	L4 2.2L		GA-514	GG-160
ACCORD	V6 2.7L FI			GG-160
CIVIC	L4 1.5L FI		GA-381	GG-160
CIVIC	L4 1.6L FI		GA-381	GG-160
DEL SOL	L4 1.5L FI SOHC		GA-381	GG-160
DEL SOL	L4 1.6L FI DOHC		GA-381	GG-160
DEL SOL	L4 1.6L FI SOHC		GA-381	GG-160
EX-R	L4 2.2L FI SOHC		GA-514	GG-160
EX-R	V6 2.7L FI SOHC			GG-160
ODYSSEY	L4 2.2L MFI		GA-514	GG-160
PRELUDE	L4 2.2L MFI	GP-149		GG-214
PRELUDE	L4 2.3L PFI	GP-149		GG-214
1994				
ACCORD	L4 2.2L FI		GA-514	GG-160
CIVIC	L4 1.5L FI		GA-381	GG-160
CIVIC	L4 1.6L FI		GA-381	GG-160
DEL SOL	L4 1.5L FI SOHC		GA-381	GG-184
DEL SOL	L4 1.6L FI DOHC		GA-381	GG-184
DEL SOL	L4 1.6L FI SOHC		GA-381	GG-184
PRELUDE	L4 2.2L MFI	GP-149		GG-214
PRELUDE	L4 2.3L PFI	GP-149		GG-214
1993				
ACCORD	L4 2.2L	GP-6811	GA-386	GG-184
CIVIC	L4 1.5L FI		GA-381	GG-184
CIVIC	L4 1.6L FI		GA-381	GG-184
DEL SOL	L4 1.5L FI SOHC		GA-381	GG-184

Marca - Año - Modelo Make-Year-Model	Motor Engine	Aceite Oil	Aire Air	Combustible Fuel
HONDA (continuación)				
DEL SOL	L4 1.6L FI SOHC		GA-381	GG-184
PRELUDE	L4 2.2L MFI	GP-149		GG-214
PRELUDE	L4 2.3L PFI	GP-149		GG-214
1992				
ACCORD	L4 2.2L	GP-6811	GA-386	GG-184
CIVIC	L4 1.5L FI		GA-381	GG-184
CIVIC	L4 1.6L FI		GA-381	GG-184
PRELUDE	L4 2.2L MFI	GP-149		GG-214
PRELUDE	L4 2.3L PFI	GP-149		GG-214
1991				
ACCORD	L4 2.2L	GP-6811	GA-386	GG-184
CIVIC	L4 1.5L FI		GA-382	GG-190
CIVIC	L4 1.6L MFI		GA-382	GG-190
CRX	L4 1.5L FI	GP-149	GA-382	GG-190
CRX	L4 1.6L MFI	GP-149	GA-382	GG-190
CX	L4 1.5L FI SOHC D15B1		GA-382	GG-190
CX	L4 1.5L FI SOHC D15B2		GA-382	GG-190
CX	L4 1.6L FI SOHC D16A6		GA-382	GG-190
EX-R	L4 2.2L FI		GA-386	GG-184
1990				
ACCORD	L4 2.2L MFI	GP-91	GA-386	GG-184
CIVIC	L4 1.5L FI		GA-382	GG-190
CIVIC	L4 1.6L MFI		GA-382	GG-190
CRX	L4 1.5L FI	GP-149	GA-382	GG-190
CRX	L4 1.6L MFI	GP-149	GA-382	GG-190
CX	L4 1.5L FI SOHC D15B1		GA-382	GG-190
CX	L4 1.5L FI SOHC D15B2		GA-382	GG-190
CX	L4 1.6L FI SOHC D16A6		GA-382	GG-190
HUMMER				
2010				
H3	5 CIL. 3.7L FI	GP-3675	GA-266	
H3	V8 5.3L FI	GP-406	GA-266	
2009				
H2	V8 6.2L FI	GP-406		
H3	5 CIL. 3.7L FI	GP-3675	GA-266	
H3	V8 5.3L FI	GP-406	GA-266	
2008				
H2	V8 6.2L SFI	GP-406		
H3	L5 3.7L MFI	GP-3675	GA-266	
H3	V8 5.3L MFI	GP-406	GA-266	
2007				
H2	V8 6.0L SFI	GP-406		
H3	L5 3.7L MFI VORTEC	GP-3675	GA-415	
2006				
H1 ALPHA	V8 6.6L TURBO DIESEL			
H2	V8 6.0L SFI	GP-44		
H3	L5 3.5L FI	GP-3675	GA-415	
H3	V8 6.0L FI	GP-3675		
2005				
H2	V8 6.0L FI	GP-44		GG-209
2004				
H2	V8 6.0L SFI	GP-44		GG-209

Para números Gonher con Superíndice vea página 38
For Gonher with Superscript numbers see page 38

Para modelos anteriores a 1990 visite nuestro sitio en internet www.grupogonher.com
For pre-1990 models, visit our Web site www.grupogonher.com

Marca - Año - Modelo Make-Year-Model	Motor Engine	Aceite Oil	Aire Air	Combustible Fuel
---	-----------------	---------------	-------------	---------------------

HUMMER (continuación)				
2003				
H2	V8 6.0L SFI	GP-44		GG-209

HYUNDAI

2010

ACCENT	L4 1.6L FI		GA-363	
AZERA	V6 3.3L FI 24 VALV.			
AZERA	V6 3.8L FI 24 VALV.			
ELANTRA	L4 2.0L FI 16 VALV.			
GENESIS	L4 2.0L FI TURBO			
GENESIS	V6 3.8L FI 24 VALV.			
GENESIS	V8 4.6L FI 32 VALV.			
SANTA FE	L4 2.4L FI DOHC			
SANTA FE	V6 3.5L FI DOHC			
SONATA	L4 2.4L FI 16 VALV.			
SONATA	V6 3.3L FI 24 VALV.			
TUCSON	L4 2.4L FI DOHC			
VERACRUZ	V6 3.8L FI 24 VALV.			

2009

ACCENT	L4 1.6L FI 16 VALV. DOHC	GP-6811	GA-363	
AZERA	V6 3.3L FI			
AZERA	V6 3.8L FI 24 VALV. DOHC			
ELANTRA	L4 2.0L FI	GP-6811		
ENTOURAGE	V6 3.8L FI 24 VALV. DOHC			
GENESIS	V6 3.8L FI			
GENESIS	V8 4.6L FI			
SANTA FE	V6 2.7L FI 24 VALV. DOHC	GP-6811		
SANTA FE	V6 3.3L FI 24 VALV. DOHC			
SONATA	L4 2.4L FI 16 VALV. DOHC	GP-6811		
SONATA	V6 3.3L FI 24 VALV. DOHC			
TUCSON	L4 2.0L FI 16 VALV. DOHC	GP-6811		
TUCSON	V6 2.7L FI 24 VALV. DOHC	GP-6811		
VERACRUZ	V6 3.8L FI 24 VALV. DOHC			

2008

ACCENT	L4 1.6L FI 16 VALV. DOHC	GP-6811	GA-363	
AZERA	V6 3.3L FI 24 VALV. DOHC			
AZERA	V6 3.8L FI 24 VALV. DOHC			
ELANTRA	L4 2.0L FI	GP-6811		
ENTOURAGE	V6 3.8L FI 24 VALV. DOHC			
SANTA FE	V6 2.7L FI 24 VALV. DOHC	GP-6811		
SANTA FE	V6 3.3L FI 24 VALV. DOHC			
SONATA	L4 2.4L FI 16 VALV. DOHC	GP-6811		
SONATA	V6 3.3L FI 24 VALV. DOHC			
TIBURON	L4 2.0L FI 16 VALV. DOHC	GP-6811		
TIBURON	V6 2.7L FI 24 VALV. DOHC	GP-6811		
TUCSON	L4 2.0L FI 16 VALV. DOHC	GP-6811		
TUCSON	V6 2.7L FI 24 VALV. DOHC	GP-6811		
VERACRUZ	V6 3.8L FI 24 VALV. DOHC			

2007

ACCENT	L4 1.6L FI 16 VALV. DOHC	GP-6811	GA-363	
SONATA	L4 2.4L FI 16 VALV. DOHC	GP-6811		
SONATA	V6 3.3L FI 24 VALV. DOHC			

2006

ACCENT	L4 1.6L FI 16 VALV. DOHC	GP-6811	GA-363	
SONATA	L4 2.4L FI 16 VALV. DOHC	GP-6811		

2005

ACCENT	L4 1.6L	GP-6811	GA-216	
SONATA	L4 2.4L FI 16 VALV. DOHC	GP-6811	GA-491	
SONATA	V6 2.7L FI 24 VALV. DOHC	GP-6811	GA-491	

Marca - Año - Modelo Make-Year-Model	Motor Engine	Aceite Oil	Aire Air	Combustible Fuel
---	-----------------	---------------	-------------	---------------------

HYUNDAI (continuación)				
2004				
ACCENT	L4 1.6L	GP-6811	GA-216	
SONATA	L4 2.4L FI 16 VALV. DOHC	GP-6811	GA-491	
SONATA	V6 2.7L FI 24 VALV. DOHC	GP-6811	GA-491	

2003

ACCENT	L4 1.5L	GP-6811	GA-216	
ACCENT	L4 1.6L	GP-6811	GA-216	
SONATA	L4 2.4L FI 16 VALV. DOHC	GP-6811	GA-491	
SONATA	V6 2.7L FI 24 VALV. DOHC	GP-6811	GA-491	

2002

ACCENT	L4 1.5L	GP-6811	GA-216	
ACCENT	L4 1.6L	GP-6811	GA-216	
SONATA	L4 2.4L FI 16 VALV. DOHC	GP-6811	GA-491	GG-187
SONATA	V6 2.7L FI 24 VALV. DOHC	GP-6811	GA-491	GG-187

2001

ACCENT	L4 1.5L	GP-6811	GA-216	
ACCENT	L4 1.6L	GP-6811	GA-216	
SONATA	L4 2.4L FI 16 VALV. DOHC	GP-6811	GA-491	GG-187
SONATA	V6 2.5L FI DOHC	GP-6811	GA-491	GG-187

2000

ACCENT	L4 1.5L	GP-6811	GA-216	
SONATA	L4 2.4L FI 16 VALV. DOHC	GP-6811	GA-491	GG-187
SONATA	V6 2.5L FI DOHC	GP-6811	GA-491	GG-187

1999

SONATA	L4 2.4L FI 16 VALV. DOHC	GP-6811	GA-491	GG-187
SONATA	V6 2.5L FI DOHC	GP-6811	GA-491	GG-187

1997

ACCENT	L4 1.5L FI		GA-476	GG-114
--------	------------	--	--------	--------

1996

ACCENT	L4 1.5L FI		GA-476	GG-114
--------	------------	--	--------	--------

1995

ACCENT	L4 1.5L		GA-476	GG-114
--------	---------	--	--------	--------

1993

SONATA	L4 2.0L FI DOHC	GP-149	GA-362	GG-223
SONATA	V6 3.0L FI SOHC	GP-149	GA-362	

1992

AUTOMOVILES	L4 1.5L	GP-40	GA-362	GG-237
AUTOMOVILES	L4 1.6L	GP-40	GA-362	GG-237
AUTOMOVILES	L4 2.0L	GP-40	GA-362	GG-237
SONATA	L4 2.0L FI DOHC	GP-40	GA-362	
SONATA	V6 3.0L FI SOHC	GP-149	GA-362	

1991

AUTOMOVILES	L4 1.5L	GP-40	GA-362	GG-237
AUTOMOVILES	L4 1.6L	GP-40	GA-362	GG-237
AUTOMOVILES	L4 2.0L	GP-40	GA-362	GG-237
SONATA	L4 2.4L FI SOHC	GP-40	GA-362	
SONATA	V6 3.0L FI SOHC	GP-149	GA-362	

1990

AUTOMOVILES	L4 1.5L	GP-40	GA-362	GG-237
AUTOMOVILES	L4 1.6L	GP-40	GA-362	GG-237
AUTOMOVILES	L4 2.0L	GP-40	GA-362	GG-237
SONATA	L4 2.4L FI SOHC	GP-40	GA-362	
SONATA	V6 3.0L FI SOHC	GP-149	GA-362	

Marca - Año - Modelo Make-Year-Model	Motor Engine	Aceite Oil	Aire Air	Combustible Fuel
INFINITI				
2010				
EX35	V6 3.5L FI 24 VALV.	GP-91		
FX35	V6 3.5L FI 24 VALV.	GP-91	GAD-15	
FX50	V8 5.0L FI	GP-149	GAD-117	
G37	V6 3.7L FI	GP-91		
M35	V6 3.5L FI	GP-91		
M45	V8 4.5L FI	GP-149		
QX56	V8 5.6L FI	GP-149		
2009				
EX35	V6 3.5L FI	GP-91		
FX35	V6 3.5L FI 24 VALV. DOHC	GP-91	GAD-15	
FX50	V8 5.0L FI	GP-149	GAD-117	
G37	V6 3.7L FI	GP-91		
M35	V6 3.5L FI 24 VALV. DOHC	GP-91		
M45	V8 4.5L FI 32 VALV. DOHC	GP-149		
QX56	V8 5.6L FI 32 VALV. DOHC	GP-149	GA-300	
2008				
EX35	V6 3.5L FI	GP-91		
FX35	V6 3.5L FI 24 VALV. DOHC	GP-91	GAD-15	
FX45	V8 4.5L FI 32 VALV. DOHC	GP-149	GAD-129	
G35	V6 3.5L FI 24 VALV. DOHC	GP-91		
G37	V6 3.7L FI 24 VALV. DOHC	GP-91		
M35	V6 3.5L FI 24 VALV. DOHC	GP-91		
M45	V8 4.5L FI 32 VALV. DOHC	GP-149		
QX56	V8 5.6L FI 32 VALV. DOHC	GP-149	GA-300	
2007				
Q45	V8 4.5L FI	GP-149	GAD-129	
QX56	V8 5.6L FI	GP-149	GA-300	
2006				
Q45	V8 4.5L FI 32 VALV.	GP-149	GAD-129	GG-63
QX56	V8 5.6L FI	GP-149	GA-300	
2005				
Q45	V8 4.5L FI 32 VALV.	GP-149	GAD-129	
QX56	V8 5.6L FI	GP-149	GA-300	
2004				
Q45	V8 4.5L FI 32 VALV.	GP-149	GAD-129	GG-63
QX56	V8 5.6L FI	GP-149	GA-300	
2003				
I35	V6 3.0L FI 24 VALV.			
I35	V6 3.5L FI	GP-149	GAD-15	
Q45	V8 4.5L FI 32 VALV.	GP-149	GAD-129	GG-63
2002				
I35	V6 3.0L FI 24 VALV.			
I35	V6 3.5L FI	GP-91	GAD-15	
Q45	V8 4.5L FI 32 VALV.	GP-149	GAD-129	GG-63
2001				
I30	V6 3.0L FI 24 VALV.	GP-149	GAD-15	
Q45	V8 4.2L FI 32 VALV.	GP-149	GAD-129	
2000				
I30	V6 3.0L FI 24 VALV.	GP-149	GAD-15	
Q45	V8 4.2L FI 32 VALV.	GP-149	GAD-129	GG-63
1999				
I30	V6 3.0L FI 24 VALV.	GP-149	GAD-15	GG-63
Q45	V8 4.2L FI 32 VALV.	GP-149	GAD-129	GG-63

Marca - Año - Modelo Make-Year-Model	Motor Engine	Aceite Oil	Aire Air	Combustible Fuel
INFINITI (continuación)				
1998				
I30	V6 3.0L FI 24 VALV.	GP-149	GAD-15	GG-63
Q45	V8 4.2L FI 32 VALV.	GP-149	GAD-129	GG-63
1997				
Q45	V8 4.1L FI	GP-149	GAD-129	GG-63
Q45	V8 4.5L FI 32 VALV.			
1996				
G20	L4 2.0L FI 16 VALV. DOHC (SR20DE)	GP-156	GAD-15	GG-63
Q45	V8 4.5L FI 32 VALV.	GP-37	GAD-129	GG-63
1995				
G20	L4 2.0L FI 16 VALV. DOHC (SR20DE)	GP-156	GAD-15	GG-63
Q45	V8 4.5L FI 32 VALV.	GP-37	GAD-129	GG-63
1994				
G20	L4 2.0L FI 16 VALV. DOHC (SR20DE)	GP-156	GAD-15	GG-63
Q45	V8 4.5L FI 32 VALV.	GP-3682	GAD-129	GG-98
1993				
G20	L4 2.0L FI 16 VALV. DOHC (SR20DE)	GP-156	GAD-15	GG-63
1992				
G20	L4 2.0L FI 16 VALV. DOHC (SR20DE)	GP-156	GAD-15	GG-63
1991				
G20	L4 2.0L FI 16 VALV. DOHC (SR20DE)	GP-156	GAD-15	GG-63
ISUZU				
2008				
ASCENDER	6 CIL. 4.2L FI 24 VALV. DOHC	GP-3675	GA-414R	
I-290	L4 2.9L SFI	GP-44	GA-266	
I-370	5 CIL. 3.7L SFI	GP-3675	GA-266	
2007				
ASCENDER	6 CIL. 4.2L MFI 24 VALV.	GP-3675	GA-414R	GG-209
ASCENDER	V8 5.3L FI	GP-44	GA-414R	GG-209
I-290	L4 2.9L SFI 16 VALV.	GP-44	GA-415	
I-370	5 CIL. 3.7L SFI 24 VALV.	GP-3675	GA-415	
2006				
ASCENDER	6 CIL. 4.2L FI 24 VALV.	GP-3675	GA-414R	GG-209
ASCENDER	V8 5.3L FI 16 VALV.	GP-44	GA-414R	GG-209
I-280	L4 2.8L SFI 16 VALV.	GP-44	GA-415	
I-350	5 CIL. 3.5L SFI 20 VALV.	GP-3675	GA-415	
2005				
ASCENDER	L6 4.2L FI	GP-3675	GA-414R	GG-209
ASCENDER	V8 5.3L FI	GP-44	GA-414R	GG-209
2004				
ASCENDER	L6 4.2L FI	GP-3675	GA-414R	GG-209
ASCENDER	V8 5.3L FI	GP-44	GA-414R	GG-209
2003				
ASCENDER	L6 4.2L FI	GP-3675	GA-414R	GG-209
ASCENDER	V8 5.3L FI	GP-44	GA-414R	GG-209

Marca - Año - Modelo Make-Year-Model	Motor Engine	Aceite Oil	Aire Air	Combustible Fuel
ISUZU (continuación)				
2001				
OASIS	L4 2.3L FI VTEC		GA-514	GG-160
2000				
AMIGO	L4 2.2L SFI	GP-46	GA-198	GG-255
AMIGO	V6 3.2L SFI	GP-149	GA-198	GG-255
HOMBRE	L4 2.2L FI (DOHC)	GP-46	GA-198	GG-255
HOMBRE	V6 4.3L FI	GP-3980	GA-165	
OASIS	L4 2.3L FI VTEC		GA-514	GG-160
RODEO	L4 2.2L FI (DOHC)	GP-46	GA-198	GG-255
RODEO	V6 3.2L FI (SOHC)	GP-149	GA-198	GG-255
1999				
AMIGO	L4 2.2L SFI	GP-46	GA-198	GG-255
AMIGO	V6 3.2L SFI	GP-149	GA-198	GG-255
HOMBRE	L4 2.2L FI (DOHC)	GP-46	GA-198	GG-255
HOMBRE	V6 4.3L FI	GP-3980	GA-165	
OASIS	L4 2.3L FI VTEC		GA-514	GG-160
RODEO	L4 2.2L FI (DOHC)	GP-46	GA-198	GG-255
RODEO	V6 3.2L FI (SOHC)	GP-149	GA-198	GG-255
TROOPER	V6 3.5L FI (HOHC)	GP-149		GG-255
1998				
AMIGO	L4 2.2L SFI	GP-46	GA-198	GG-255
AMIGO	V6 3.2L SFI	GP-149	GA-198	GG-255
HOMBRE	L4 2.2L FI (DOHC)	GP-46	GA-198	GG-255
HOMBRE	V6 4.3L FI	GP-3980	GA-165	
OASIS	L4 2.3L FI VTEC		GA-514	GG-160
RODEO	L4 2.2L FI (DOHC)	GP-46	GA-198	GG-255
RODEO	V6 3.2L FI (SOHC)	GP-149	GA-198	GG-255
TROOPER	V6 3.5L FI (HOHC)	GP-149		GG-255
1997				
HOMBRE	L4 2.2L FI	GP-46	GA-165	
HOMBRE	V6 4.3L FI	GP-3980	GA-165	
OASIS	L4 2.2L SFI		GA-514	GG-160
RODEO	V6 3.2L FI (SOHC)	GP-149	GA-198	GG-255
TROOPER	V6 3.2L FI (SOHC)	GP-149		GG-255
1996				
HOMBRE	L4 2.2L FI	GP-46	GA-165	
HOMBRE	V6 4.3L FI	GP-3980	GA-165	
OASIS	L4 2.2L SFI		GA-514	GG-160
RODEO	L4 2.2L FI			GG-255
RODEO	L4 2.6L FI (4ZEI)	GP-149		GG-255
RODEO	V6 3.2L FI (GVDI)	GP-149		GG-255
TROOPER	V6 3.2L FI (SOHC)	GP-149		GG-255
1995				
PICK-UPS	L4 2.3L MFI	GP-149	GA-139	GG-63
PICK-UPS	L4 2.6L MFI	GP-149	GA-139	GG-63
RODEO	L4 2.2L			GG-255
RODEO	L4 2.6L FI (4ZEI)	GP-149		GG-255
RODEO	L4 2.6L FI (4ZEI)	GP-149		GG-63
RODEO	V6 3.2L FI (GVDI)	GP-149		GG-255
1994				
AMIGO	L4 2.6L FI	GP-149	GA-139	GG-63
PICK-UPS	L4 2.3L	GP-149	GAD-1	GG-5 L
PICK-UPS	L4 2.6L MFI	GP-149	GA-139	GG-255
PICK-UPS	V6 3.1L TBI	GP-46	GA-3588	GG-255
RODEO	L4 2.2L			GG-255
RODEO	L4 2.6L FI (4ZEI)	GP-149		GG-63
RODEO	V6 3.2L FI (GVDI)	GP-149		GG-255
STYLUS	L4 1.8L FI 16 VALV. DOHC		GA-6690	GG-260
TROOPER	V6 3.2L FI	GP-149		GG-255

Marca - Año - Modelo Make-Year-Model	Motor Engine	Aceite Oil	Aire Air	Combustible Fuel
ISUZU (continuación)				
1993				
AMIGO	L4 2.3L SOHC	GP-91	GAD-1	GG-5 L
AMIGO	L4 2.6L FI SOHC	GP-91	GA-139	GG-63
PICK-UPS	L4 2.3L	GP-91	GAD-1	GG-5 L
PICK-UPS	L4 2.6L MFI SOHC	GP-91	GA-139	GG-63
PICK-UPS	V6 3.1L MFI	GP-46	GA-3588	GG-63 ⁹⁷ GG-255 ⁴
RODEO	L4 2.2L			GG-255
RODEO	L4 2.6L FI (4ZEI)	GP-149		GG-63
RODEO	V6 3.2L FI (GVDI)	GP-149		GG-255
STYLUS	L4 1.6L FI SOHC		GA-6690	GG-260
STYLUS	L4 1.8L FI 16 VALV. DOHC		GA-6690	GG-260
TROOPER	V6 3.2L FI	GP-149		GG-255
1992				
AMIGO	L4 2.3L	GP-91	GAD-1	GG-5 L
AMIGO	L4 2.6L MFI	GP-91	GA-139	GG-63
IMPULSE	L4 1.6L	GP-149	GA-6690	GG-260
IMPULSE	L4 1.8L	GP-149	GA-6690	GG-260
PICK-UPS	L4 2.3L	GP-91	GAD-1	GG-5 L
PICK-UPS	L4 2.6L	GP-91	GA-139	GG-63
PICK-UPS	V6 3.1L FI	GP-46	GA-3588	GG-63
RODEO	L4 2.6L FI (4ZEI)	GP-149		GG-63
RODEO	V6 3.1L FI	GP-46	GA-3588	GG-63
STYLUS	L4 1.6L FI SOHC		GA-6690	GG-260
STYLUS	L4 1.8L FI 16 VALV. DOHC		GA-6690	GG-260
TROOPER	V6 3.2L FI	GP-149		GG-255
1991				
AMIGO	L4 2.3L	GP-91	GAD-1	GG-5 L
AMIGO	L4 2.6L MFI	GP-91	GA-139	GG-63
IMPULSE	L4 1.6L	GP-149	GA-6690	GG-260
IMPULSE	L4 1.8L	GP-149		GG-260
PICK-UPS	L4 2.3L	GP-91	GAD-1	GG-5 L
PICK-UPS	L4 2.6L MFI	GP-91	GA-139	GG-63
PICK-UPS	V6 3.1L FI	GP-46	GA-3588	GG-63
RODEO	L4 2.6L FI (4ZEI)	GP-149		GG-63
RODEO	V6 3.1L FI	GP-46	GA-3588	GG-63
STYLUS	L4 1.6L FI 16 VALV. DOHC		GA-6690	GG-260
STYLUS	L4 1.6L FI SOHC		GA-6690	GG-260
TROOPER	V6 2.8L FI	GP-46	GA-3588	GG-63
1990				
AMIGO	L4 2.3L	GP-91	GAD-1	GG-5 L
AMIGO	L4 2.6L MFI	GP-91	GA-139	GG-63
IMPULSE	L4 1.6L	GP-149	GA-6690	GG-260
IMPULSE	L4 1.8L	GP-149		GG-260
PICK-UPS	L4 2.3L	GP-91		
PICK-UPS	L4 2.6L MFI	GP-91	GA-139	
TROOPER	V6 2.8L FI	GP-46	GA-3588	GG-63
JAGUAR				
2010				
XF	V8 4.2L FI 32 VALV.	GP-457		GG-986
XF	V8 5.0L DI 32 VALV.			GG-986
XFR	V8 5.0L DI 32 VALV. SUPER CARGADO			GG-986
XJ SERIES	V8 5.0L DI 32 VALV.			
XJ SERIES	V8 5.0L DI 32 VALV. SUPER CARGADO			
XK SERIES	V8 5.0L DI 32 VALV.			
XK SERIES	V8 5.0L DI 32 VALV. SUPER CARGADO			

Marca - Año - Modelo Make-Year-Model	Motor Engine	Aceite Oil	Aire Air	Combustible Fuel
JAGUAR (continuación)				
2009				
VANDEN PLAS	V8 4.2L DI 32 VALV. DOHC	GP-457		
XF	V6 3.0L FI 24 VALV.			
XF	V8 4.2L FI 32 VALV.	GP-457		GG-986
XJ SERIES	V8 4.2L DI 32 VALV. DOHC	GP-457		GG-986
XK SERIES	V8 4.2L FI 32 VALV. DOHC	GP-457		
2008				
S-TYPE	V6 2.5L FI 24 VALV. DOHC	GP-3600		
S-TYPE	V6 3.0L FI	GP-3600		GG-986
S-TYPE	V8 4.2L FI	GP-457		GG-986
VANDEN PLAS	V8 4.2L DI 32 VALV. DOHC			
XJ SERIES	V8 4.2L FI	GP-457		GG-46 ⁹³
XK SERIES	V8 4.2L EFI	GP-457		
X-TYPE	V6 3.0L FI	GP-3600		
2007				
S-TYPE	V6 3.0L FI	GP-3600		GG-986
S-TYPE	V8 4.2L FI	GP-457		GG-986
XJ SERIES	V8 4.2L MFI 32 VALV. O SUPER CARGADO	GP-457		GG-46
XK SERIES	V8 4.2L EFI SUPER CARGADO	GP-457		
X-TYPE	V6 3.0L FI 24 VALV.	GP-3600		
2006				
S-TYPE	V6 3.0L FI 24 VALV.	GP-3600	GA-479	GG-986
S-TYPE	V8 4.2L FI 32 VALV.		GA-479 ⁸⁸	GG-986
VANDEN PLAS	V8 4.2L FI 32 VALV. SUPER CARGADO		GA-2130	
XJ SERIES	V8 4.2L FI 32 VALV.		GA-2130	
XK SERIES	V8 4.2L FI 32 VALV.		GA-2130	
X-TYPE	V6 3.0L FI 24 VALV.	GP-3600		
2005				
S-TYPE	V6 3.0L FI 24 VALV.	GP-3600	GA-479	GG-986
S-TYPE	V8 4.2L FI 32 VALV.	GP-457	GA-479 ⁸⁸ GA-2130 ¹⁵⁶	GG-986
VANDEN PLAS	V8 4.2L FI 32 VALV.	GP-457	GA-2130	
XJ SERIES	V8 4.2L FI 32 VALV.	GP-457	GA-2130	
XK SERIES	V8 4.2L FI 32 VALV. SUPER CARGADO	GP-457	GA-2130	
X-TYPE	V6 2.5L FI 24 VALV.	GP-3600		GG-64
X-TYPE	V6 3.0L FI 24 VALV.	GP-3600		GG-64
2004				
S-TYPE	V6 3.0L FI 24 VALV.	GP-3600	GA-479	GG-986
S-TYPE	V8 4.0L FI 32 VALV.	GP-457	GA-479 ¹⁵⁶ GA-2130 ⁸⁸	GG-986
VANDEN PLAS	V8 4.2L FI 32 VALV.	GP-457	GA-2130	
XJ SERIES	V8 4.2L MFI DOHC 32 VALV.	GP-457	GA-2130	GG-46
XK SERIES	V8 4.0L FI 32 VALV.	GP-457	GA-2130	GG-46
X-TYPE	V6 2.5L FI 24 VALV.	GP-3600		GG-64
X-TYPE	V6 3.0L FI 24 VALV.	GP-3600		GG-64
2003				
P6	V6 3.0L FI 24 VALV.	GP-3600	GA-479	GG-116
S-TYPE	V6 3.0L FI 24 VALV.	GP-3600	GA-479	GG-986
S-TYPE	V8 4.2L SFI O SPUERCARGADO 32 VALV.	GP-457	GA-479	GG-986
VANDEN PLAS	V8 4.0L SFI 32 VALV. O SUPER CARGADO	GP-457	GA-2130	GG-46
XJ SERIES	V8 4.0L SFI 32 VALV. O SUPER CARGADO	GP-457	GA-2130	GG-46
XK SERIES	V8 4.2L EFI O SUPER CARGADO 32 VALV.	GP-457	GA-2130	GG-46
X-TYPE	V6 2.5L FI 24 VALV.	GP-3600		GG-64
X-TYPE	V6 3.0L FI 24 VALV.	GP-3600		GG-64

Marca - Año - Modelo Make-Year-Model	Motor Engine	Aceite Oil	Aire Air	Combustible Fuel
JAGUAR (continuación)				
2002				
P6	V6 3.0L FI	GP-3600	GA-479	GG-116
P6	V8 4.0L FI 32 VALV.	GP-457	GA-479	GG-116
S-TYPE	V6 3.0L FI	GP-3600	GA-479	GG-986
S-TYPE	V8 4.0L FI 32 VALV.	GP-457	GA-479	GG-986
VANDEN PLAS	V8 4.0L SFI 32 VALV. O SUPER CARGADO	GP-457	GA-2130	GG-46
XJ SERIES	V8 4.0L SFI 32 VALV. O SUPER CARGADO	GP-457	GA-2130	GG-46
XK SERIES	V8 4.0L SFI 32 VALV. O SUPER CARGADO	GP-457	GA-2130	GG-46
X-TYPE	V6 2.5L FI 24 VALV.	GP-3600		GG-64
X-TYPE	V6 3.0L FI	GP-3600		GG-64
2001				
P6	V6 3.0L FI	GP-3600	GA-479	GG-116
P6	V8 4.0L FI 32 VALV.	GP-457	GA-479	GG-116
S-TYPE	V6 3.0L FI	GP-3600	GA-479	GG-986
S-TYPE	V8 4.0L FI 32 VALV.	GP-457	GA-479	GG-46
VANDEN PLAS	V8 4.0L FI 32 VALV.	GP-457	GA-2130	GG-46
XJ SERIES	V8 4.0L SFI 32 VALV. O SUPER CARGADO	GP-457	GA-2130	GG-46
XK SERIES	V8 4.0L SFI 32 VALV. O SUPER CARGADO	GP-457	GA-2130	GG-46
X-TYPE	V6 3.0L FI	GP-454		
2000				
P6	V6 3.0L FI	GP-3600	GA-479	GG-116
P6	V8 4.0L FI 32 VALV.	GP-457	GA-479	GG-116
S-TYPE	V6 3.0L FI	GP-3600	GA-479	GG-986
S-TYPE	V8 4.0L FI 32 VALV.	GP-457	GA-479	GG-46
VANDEN PLAS	V8 4.0L FI 32 VALV.	GP-457	GA-2130	GG-46
XJ SERIES	V8 4.0L FI 32 VALV.	GP-457	GA-2130	GG-46
XK SERIES	V8 4.0L FI 32 VALV.	GP-457	GA-2130	GG-46
1999				
VANDEN PLAS	V8 4.0L FI 32 VALV.	GP-457	GA-2130	GG-46
XJ SERIES	V8 4.0L FI 32 VALV.	GP-457	GA-2130	GG-46
XK SERIES	V8 4.0L FI 32 VALV.	GP-457	GA-2130	GG-46
1998				
VANDEN PLAS	V8 4.0L FI 32 VALV.	GP-457	GA-2130	GG-46
XJ SERIES	V8 4.0L FI 32 VALV.	GP-457	GA-2130	GG-46
XK SERIES	V8 4.0L FI 32 VALV.	GP-457	GA-2130	GG-46
1997				
VANDEN PLAS	L6 4.0L FI	GP-36	GAVW-4	GG-46
XJ SERIES	L6 4.0L FI	GP-36	GAVW-4	GG-46
XJ SERIES	V12 6.0L FI	GP-36	GAVW-4	GG-46
XK SERIES	V8 4.0L SFI	GP-457	GA-2130	GG-46
1996				
VANDEN PLAS	L6 4.0L FI	GP-36	GAVW-4	GG-46
XJ SERIES	L6 4.0L FI	GP-36	GAVW-4	GG-46
XJ SERIES	V12 6.0L FI	GP-36	GAVW-4 ⁹⁴	GG-46
1995				
VANDEN PLAS	L6 4.0L FI	GP-36	GAVW-4	GG-46
XJ SERIES	L6 4.0L FI	GP-36	GAVW-4	GG-46
XJ SERIES	V12 6.0L FI	GP-36	GAVW-4 ⁹⁴	GG-46
1994				
VANDEN PLAS	L6 4.0L FI	GP-36	GAVW-4	GG-46
XJ SERIES	L6 4.0L FI	GP-36	GAVW-4	GG-46
XJ SERIES	V12 6.0L FI	GP-36	GAVW-4 ⁹⁴	GG-46

Para números Gonher con Superíndice vea página 38
For Gonher with Superscript numbers see page 38

Marca - Año - Modelo	Motor	Aceite	Aire	Combustible
Make-Year-Model	Engine	Oil	Air	Fuel

JAGUAR (continuación)

1993

VANDEN PLAS	L6 4.0L FI	GP-36	GAVW-4	GG-46
XJ SERIES	L6 4.0L FI	GP-36	GAVW-4	GG-46
XJ SERIES	V12 6.0L FI	GP-36	GAVW-4	GG-46

1992

VANDEN PLAS	L6 4.0L FI	GP-36	GAVW-4	GG-46
XJ SERIES	L6 4.0L FI	GP-36	GAVW-4	GG-46
XJ SERIES	V12 5.3L FI	GP-36		GG-46

1991

VANDEN PLAS	L6 4.0L FI	GP-36	GAVW-4	GG-46
XJ SERIES	L6 4.0L FI	GP-36	GAVW-4	GG-46
XJ SERIES	V12 5.3L FI	GP-36		GG-46 ¹⁶⁷ GG-251 ¹⁶⁸

1990

VANDEN PLAS	L6 4.0L FI	GP-36	GAVW-4	GG-46
XJ SERIES	L6 4.0L FI	GP-36	GAVW-4	GG-408
XJ SERIES	V12 5.3L FI	GP-36		GG-46 ¹⁶⁷ GG-251 ¹⁶⁸

JEEP

2010

COMMANDER	V6 3.7L FI			
COMMANDER	V8 5.7L FI HEMI	GP-68		
COMPASS	L4 2.0L FI	GP-406	GA-489	
COMPASS	L4 2.4L FI	GP-406	GA-489	
GRAND CHEROKEE	V6 3.7L FI			
GRAND CHEROKEE	V8 5.7L FI HEMI	GP-68		
GRAND CHEROKEE	V8 6.1L FI HEMI	GP-68		
LIBERTY	V6 3.7L FI			
PATRIOT	L4 2.0L FI	GP-406	GA-489	
PATRIOT	L4 2.4L FI	GP-406	GA-489	
WRANGLER	V6 3.8L FI			

2009

COMMANDER	V6 3.7L FI	GP-406	GA-477	
COMMANDER	V8 4.7L FI SOHC FLEX FUEL	GP-68 ¹³³	GA-477	
COMMANDER	V8 5.7L FI HEMI MAGNUM	GP-68 ¹³³	GA-477	
COMPASS	L4 2.0L FI 16 VALV. DOHC	GP-406	GA-489	
COMPASS	L4 2.4L FI 16 VALV. DOHC	GP-406	GA-489	
GRAND CHEROKEE	V6 3.0L DIESEL 24 VALV. DOHC TURBO		GA-477	
GRAND CHEROKEE	V6 3.7L FI	GP-406	GA-477	
GRAND CHEROKEE	V8 4.7L FI SOHC FLEX FUEL	GP-68	GA-477	
GRAND CHEROKEE	V8 5.7L FI HEMI MAGNUM	GP-68	GA-477	
GRAND CHEROKEE	V8 6.1L FI HEMI	GP-68	GA-477	
LIBERTY	V6 3.7L FI	GP-406	GA-143	
PATRIOT	L4 2.0L FI 16 VALV. DOHC	GP-406	GA-489	
PATRIOT	L4 2.4L FI 16 VALV. DOHC	GP-406	GA-489	
TJ (CANADA)	V6 3.8L FI	GP-58		
WRANGLER	V6 3.8L FI	GP-58		
YJ	V6 3.8L FI	GP-58		

2008

COMMANDER	V6 3.7L FI	GP-3600	GA-477	
COMMANDER	V8 4.7L FI	GP-68 ¹³³ GP-81 ¹³²	GA-477	
COMMANDER	V8 5.7L FI HEMI	GP-68 ¹³³ GP-81 ¹³²	GA-477	
COMPASS	L4 2.0L FI	GP-406	GA-489	
COMPASS	L4 2.4L FI	GP-406	GA-489	
GRAND CHEROKEE	V6 3.0L DI TURBO DIESEL		GA-477	
GRAND CHEROKEE	V6 3.7L FI	GP-3600	GA-477	
GRAND CHEROKEE	V8 4.7L FLEX FUEL		GA-477	

Marca - Año - Modelo	Motor	Aceite	Aire	Combustible
Make-Year-Model	Engine	Oil	Air	Fuel

JEEP (continuación)

GRAND CHEROKEE	V8 5.7L FI HEMI	GP-81	GA-477	
GRAND CHEROKEE	V8 6.1L FI HEMI	GP-81	GA-477	
LIBERTY	V6 3.7L SFI	GP-3600	GA-143	
LIBERTY	V6 4.0L FI SOHC	GP-81	GA-143	
PATRIOT	L4 2.0L FI	GP-406	GA-489	
PATRIOT	L4 2.4L FI	GP-406	GA-489	
TJ (CANADA)	V6 3.8L FI	GP-58		
WRANGLER	V6 3.8L SFI	GP-58		
YJ	V6 3.8L FI	GP-58		

2007

COMMANDER	V6 3.7L SFI	GP-3600	GA-477	
COMMANDER	V8 4.7L SFI 16 VALV.	GP-81	GA-477	
COMMANDER	V8 5.7L FI HEMI	GP-81	GA-477	
COMPASS	L4 2.0L FI	GP-406	GA-489	
COMPASS	L4 2.4L FI	GP-406	GA-489	
GRAND CHEROKEE	V6 3.0L TURBO DIESEL		GA-477	
GRAND CHEROKEE	V6 3.7L SFI 12 VALV.	GP-3600	GA-477	
GRAND CHEROKEE	V8 4.7L SFI 16 VALV.	GP-81	GA-477	
GRAND CHEROKEE	V8 5.7L FI HEMI	GP-81	GA-477	
GRAND CHEROKEE	V8 6.1L FI HEMI	GP-81	GA-477	
LIBERTY	V6 3.7L FI	GP-3600	GA-477	GG-97
PATRIOT	L4 2.0L FI	GP-406	GA-489	
PATRIOT	L4 2.4L FI	GP-406	GA-489	
WRANGLER	V6 3.8L SFI 12 VALV.	GP-58		

2006

COMMANDER	V6 3.7L FI	GP-3600	GA-477	
COMMANDER	V8 4.7L FI 16 VALV.	GP-81	GA-477	
COMMANDER	V8 5.7L FI HEMI	GP-81	GA-477	
GRAND CHEROKEE	6 CIL. 4.0L FI	GP-81	GA-301	
GRAND CHEROKEE	V6 3.7L SFI	GP-3600	GA-477	
GRAND CHEROKEE	V8 4.7L SFI	GP-81	GA-477	
GRAND CHEROKEE	V8 5.7L FI HEMI	GP-81	GA-477	
GRAND CHEROKEE	V8 6.1L FI HEMI	GP-81	GA-477	
LIBERTY	L4 2.4L FI	GP-58		
LIBERTY	L4 2.8L DIESEL TURBO	GP-128	GA-477	
LIBERTY	V6 3.7L FI	GP-3600	GA-477	GG-97
TJ (CANADA)	6 CIL. 4.0L FI	GP-81	GA-301	
TJ (CANADA)	L4 2.4L FI	GP-58		
WRANGLER	6 CIL. 4.0L SFI	GP-81	GA-301	
WRANGLER	L4 2.4L SFI	GP-58		

2005

GRAND CHEROKEE	V6 3.7L FI	GP-3600	GA-477	
GRAND CHEROKEE	V8 4.7L FI	GP-81	GA-477	
GRAND CHEROKEE	V8 5.7L FI HEMI	GP-81	GA-477	
LIBERTY	L4 2.4L FI	GP-58		
LIBERTY	L4 2.8L DIESEL TURBO	GP-128	GA-477	
LIBERTY	V6 3.7L FI	GP-3600	GA-477	GG-97
TJ (CANADA)	6 CIL. 4.0L FI	GP-81	GA-301	
TJ (CANADA)	L4 2.4L SFI	GP-58		
WRANGLER	6 CIL. 4.0L SFI	GP-81	GA-301	
WRANGLER	L4 2.5L FI	GP-58	GA-3901	

2004

GRAND CHEROKEE	L6 4.0L FI	GP-81	GA-300	
GRAND CHEROKEE	V8 4.7L FI	GP-81	GA-300 GA-448 ⁴²	
LIBERTY	L4 2.4L FI	GP-58		
LIBERTY	V6 3.7L FI	GP-3600	GA-477	GG-97
RUBICON	6 CIL. 4.0L FI	GP-81	GA-301	GG-283
RUBICON	L4 2.5L FI	GP-81	GA-301	GG-283
TJ (CANADA)	6 CIL. 4.0L SFI	GP-81	GA-301	
TJ (CANADA)	L4 2.4L SFI	GP-58		
WRANGLER	6 CIL. 4.0L SFI	GP-81	GA-301	

Marca - Año - Modelo Make-Year-Model	Motor Engine	Aceite Oil	Aire Air	Combustible Fuel
JEEP (continuación)				
WRANGLER	L4 2.5L FI	GP-58		
2003				
GRAND CHEROKEE	L6 4.0L SFI	GP-81	GA-300	
GRAND CHEROKEE	V8 4.7L FI	GP-81	GA-300 GA-448 ⁴²	
LIBERTY	L4 2.4L FI	GP-58		
LIBERTY	V6 3.7L FI	GP-3600	GA-477	GG-97
TJ (CANADA)	6 CIL. 4.0L SFI	GP-81	GA-301	
TJ (CANADA)	L4 2.4L SFI	GP-58		
WRANGLER	6 CIL. 4.0L SFI	GP-81	GA-301	
WRANGLER	L4 2.5L FI	GP-58		
2002				
GRAND CHEROKEE	L6 4.0L FI	GP-81	GA-300	
GRAND CHEROKEE	V8 4.7L FI	GP-81	GA-300 GA-448 ⁴²	GG-283
LIBERTY	L4 2.4L	GP-58		GG-97
LIBERTY	L4 2.5L FI TURBO DIESEL		GA-477	
LIBERTY	V6 3.7L FI	GP-3600	GA-477	GG-97
TJ (CANADA)	6 CIL. 4.0L SFI	GP-81	GA-301	
TJ (CANADA)	L4 2.5L SFI	GP-81	GA-301	
WRANGLER	6 CIL. 4.0L SFI	GP-81	GA-301	
WRANGLER	L4 2.5L FI	GP-81	GA-301	
2001				
CHEROKEE	L6 4.0L FI	GP-81	GA-300	GG-283
GRAND CHEROKEE	L6 4.0L FI	GP-81	GA-300	GG-283
GRAND CHEROKEE	V8 4.7L FI	GP-81	GA-300	GG-283
TJ (CANADA)	6 CIL. 4.0L SFI	GP-81	GA-301	
TJ (CANADA)	L4 2.5L SFI	GP-81	GA-301	
WRANGLER	6 CIL. 4.0L SFI	GP-81	GA-301	
WRANGLER	L4 2.5L FI	GP-81	GA-301	
2000				
CHEROKEE	L6 4.0L FI	GP-81	GA-3901	GG-283
GRAND CHEROKEE	L6 4.0L FI	GP-81	GA-300	
GRAND CHEROKEE	V8 4.7L FI	GP-81	GA-300	
TJ (CANADA)	6 CIL. 4.0L SFI	GP-81	GA-301	
TJ (CANADA)	L4 2.5L SFI	GP-81	GA-301	
WRANGLER	6 CIL. 4.0L SFI	GP-81	GA-301	
WRANGLER	L4 2.5L FI	GP-81	GA-301	
1999				
CHEROKEE	L6 4.0L FI	GP-81	GA-3901	GG-283
GRAND CHEROKEE	L6 4.0L FI	GP-81	GA-300	
GRAND CHEROKEE	V8 4.7L FI	GP-81	GA-300	
GRAND CHEROKEE	V8 5.2L FI	GP-81	GA-300	
TJ (CANADA)	6 CIL. 4.0L SFI	GP-81	GA-301	
TJ (CANADA)	L4 2.5L SFI	GP-81	GA-301	
WRANGLER	6 CIL. 4.0L SFI	GP-81	GA-301	
WRANGLER	L4 2.5L FI	GP-81	GA-301	
1998				
CHEROKEE	L6 4.0L FI	GP-81	GA-3901	GG-283
GRAND CHEROKEE	L6 4.0L FI	GP-81	GA-300	
GRAND CHEROKEE	V8 5.2L FI	GP-81	GA-300	
GRAND CHEROKEE	V8 5.9L FI	GP-81	GA-300	
TJ (CANADA)	6 CIL. 4.0L SFI	GP-81	GA-301	
TJ (CANADA)	L4 2.5L SFI	GP-81	GA-301	
WRANGLER	6 CIL. 4.0L SFI	GP-81	GA-301	
WRANGLER	L4 2.5L FI	GP-81	GA-301	
1997				
CHEROKEE	L4 2.5L FI	GP-81	GA-3901	
CHEROKEE	L6 4.0L FI	GP-81	GA-3901	

Marca - Año - Modelo Make-Year-Model	Motor Engine	Aceite Oil	Aire Air	Combustible Fuel
JEEP (continuación)				
GRAND CHEROKEE	L6 4.0L FI	GP-81	GA-300	GG-99
GRAND CHEROKEE	V8 5.2L FI	GP-81	GA-300	GG-99
GRAND CHEROKEE	V8 5.9L FI	GP-81	GA-300	
TJ (CANADA)	6 CIL. 4.0L SFI	GP-81	GA-301	
TJ (CANADA)	L4 2.5L SFI	GP-81	GA-301	
WRANGLER	6 CIL. 4.0L SFI	GP-81	GA-301	
WRANGLER	L4 2.5L FI	GP-81	GA-301	
1996				
CHEROKEE	L4 2.5L FI	GP-81	GA-3901	GG-79
CHEROKEE	L6 4.0L FI	GP-81	GA-3901	GG-79
GRAND CHEROKEE	L6 4.0L FI	GP-81	GA-300	GG-99
GRAND CHEROKEE	V8 5.2L FI	GP-81	GA-300	GG-99
WRANGLER	6 CIL. 4.0L SFI	GP-81	GA-301	GG-79
WRANGLER	L4 2.5L FI	GP-81	GA-301	GG-79
1995				
CHEROKEE	L4 2.5L FI	GP-81	GA-3901	GG-79
CHEROKEE	L6 4.0L FI	GP-81	GA-3901	GG-79
GRAND CHEROKEE	L6 4.0L FI	GP-81	GA-300	GG-99
GRAND CHEROKEE	V8 5.2L FI	GP-81	GA-300	GG-99
WRANGLER	6 CIL. 4.0L SFI	GP-81	GAVW-2	GG-79
WRANGLER	L4 2.5L FI	GP-81	GAVW-2	GG-79
1994				
CHEROKEE	L6 4.0L FI	GP-81	GA-3901	GG-79
GRAND CHEROKEE	L4 2.5L FI	GP-81	GA-77	GG-79
GRAND CHEROKEE	L6 4.0L FI	GP-81	GA-300	GG-99 GG-243
GRAND CHEROKEE	V8 5.2L FI	GP-81	GA-300	GG-99 GG-243
GRAND CHEROKEE	V8 5.9L FI	GP-81	GA-300	GG-99
WRANGLER	6 CIL. 4.0L SFI	GP-81	GAVW-2	GG-79
WRANGLER	L4 2.5L FI	GP-81	GAVW-2	GG-79
1993				
CHEROKEE	L6 4.0L FI	GP-81	GA-3901	
GRAND CHEROKEE	L4 2.5L FI	GP-81	GA-77	GG-79
GRAND CHEROKEE	L6 4.0L FI	GP-81	GA-300	GG-99
GRAND CHEROKEE	V8 5.2L FI	GP-81	GA-300	GG-99 GG-243
GRAND CHEROKEE	V8 5.9L FI	GP-81	GA-300	GG-99
GRAND WAGONEER	V8 5.2L FI	GP-81	GA-300	GG-99
WRANGLER	6 CIL. 4.0L SFI	GP-81	GAVW-2	GG-79
WRANGLER	L4 2.5L FI	GP-81	GAVW-2	GG-79
1992				
CHEROKEE	L4 2.5L FI	GP-81	GA-3901	GG-79
CHEROKEE	V6 4.0L FI	GP-81	GA-3901	GG-79
COMANCHE	L4 2.5L FI (P)	GP-81	GA-3901	GG-79
COMANCHE	V6 4.0L FI (S)	GP-81	GA-3901	GG-79
EAGLE	V6 3.0L			GG-247
GRAND CHEROKEE	L4 2.5L FI	GP-81	GA-77	GG-79
GRAND CHEROKEE	V6 4.0L FI	GP-81	GAVW-2	GG-79
WRANGLER	6 CIL. 4.0L MFI	GP-81	GAVW-2	GG-79
WRANGLER	L4 2.5L	GP-81	GA-70	
1991				
CHEROKEE	L4 2.5L FI	GP-81	GA-3901	GG-79
CHEROKEE	V6 4.0L FI	GP-81	GA-3901	GG-79
COMANCHE	L4 2.5L FI (P)	GP-81	GA-3901	GG-79
COMANCHE	V6 4.0L FI (S)	GP-81	GA-3901	GG-79
EAGLE	V6 3.0L			GG-247
GRAND CHEROKEE	L4 2.5L FI	GP-81	GA-77	GG-79
GRAND CHEROKEE	V6 4.0L FI	GP-81	GAVW-2	GG-79
GRAND WAGONEER	V8 5.9L FI	GP-81	GA-70	
WRANGLER	6 CIL. 4.0L MFI	GP-81	GAVW-2	GG-79
WRANGLER	L4 2.5L	GP-81	GAVW-2	GG-79

Para números Gonher con Superíndice vea página 38
For Gonher with Superscript numbers see page 38

Marca - Año - Modelo Make-Year-Model	Motor Engine	Aceite Oil	Aire Air	Combustible Fuel
JEEP (continuación)				
1990				
CHEROKEE	L4 2.5L FI	GP-3985	GA-3901	GG-79
CHEROKEE	V6 4.0L FI	GP-3985	GA-3901	GG-79
CHEROKEE	V6 4.2L FI	GP-3985	GA-77	
COMANCHE	V6 2.5L (E) FI	GP-3985	GA-3901	GG-79
COMANCHE	V6 4.0L (L) FI	GP-3985	GA-3901	GG-79
COMANCHE	V6 4.2L FI (T)	GP-3985	GA-77	
EAGLE	V6 3.0L			GG-247
GRAND CHEROKEE	L4 2.5L FI	GP-3985	GA-77	GG-79
GRAND CHEROKEE	V6 4.2L 2 BBL	GP-3985	GA-77	
GRAND WAGONEER	V8 5.9L FI	GP-81	GA-70	
WRANGLER	6 CIL. 4.0L	GP-3985	GA-77	
WRANGLER	L4 2.5L	GP-3985	GA-77	

Marca - Año - Modelo Make-Year-Model	Motor Engine	Aceite Oil	Aire Air	Combustible Fuel
KIA				
2010				
BORREGO	V6 3.8L FI 24 VALV.			
BORREGO	V8 4.6L FI 32 VALV.			
FORTE	L4 2.0L FI 16 VALV.			
FORTE	L4 2.4L FI 16 VALV.			
MAGENTIS (CANADA)	L4 2.4L FI 16 VALV. DOHC		GA-149	
MAGENTIS (CANADA)	V6 2.7L FI 24 VALV. DOHC		GA-149	
OPTIMA	L4 2.4L FI 16 VALV.		GA-149	
OPTIMA	V6 2.7L FI 24 VALV.		GA-149	
RIO	L4 1.6L FI		GA-363	
RIO5	L4 1.6L FI		GA-363	
RONDO	L4 2.4L FI 16 VALV.		GA-149	
RONDO	V6 2.7L FI 24 VALV.		GA-149	
SEDONA	V6 3.8L FI 24 VALV.			
SORENTO	L4 2.4L FI DOHC			
SORENTO	V6 3.5L FI DOHC 24 VALV.			
SOUL	L4 1.6L FI 16 VALV.			
SOUL	L4 2.0L FI 16 VALV.			
SPORTAGE	L4 2.0L FI 16 VALV.			
SPORTAGE	V6 2.7L FI 24 VALV.			

2009				
AMANTI	V6 3.8L FI 24 VALV. DOHC			
BORREGO	V6 3.8L FI 24 VALV. DOHC			
BORREGO	V8 4.6L FI			
MAGENTIS (CANADA)	L4 2.4L FI 16 VALV. DOHC	GP-6811	GA-149	
MAGENTIS (CANADA)	V6 2.7L FI 24 VALV. DOHC	GP-149	GA-149	
OPTIMA	L4 2.4L FI 16 VALV. DOHC	GP-6811	GA-149	
OPTIMA	V6 2.7L FI 24 VALV. DOHC	GP-6811	GA-149	
RIO	L4 1.6L FI 16 VALV. DOHC	GP-6811	GA-363	
RIO5	L4 1.6L FI 16 VALV. DOHC	GP-6811	GA-363	
RONDO	L4 2.4L FI 16 VALV. DOHC	GP-6811	GA-149	
RONDO	V6 2.7L FI 24 VALV. DOHC	GP-6811	GA-149	
SEDONA	V6 3.8L FI 24 VALV. DOHC			
SORENTO	V6 3.3L FI 24 VALV. DOHC			
SORENTO	V6 3.8L FI 24 VALV. DOHC			
SPECTRA	L4 2.0L FI 16 VALV. DOHC	GP-6811	GA-363	
SPECTRA5	L4 2.0L FI 16 VALV. DOHC	GP-6811		
SPORTAGE	L4 2.0L FI 16 VALV. DOHC	GP-6811		
SPORTAGE	V6 2.7L FI 24 VALV. DOHC	GP-6811		

2008				
AMANTI	V6 3.8L FI 24 VALV. DOHC			
BORREGO	V6 3.8L FI 24 VALV. DOHC TWIN-TURBO			
BORREGO	V8 4.6L FI			
MAGENTIS (CANADA)	L4 2.4L FI 16 VALV. DOHC	GP-6811	GA-149	
MAGENTIS (CANADA)	V6 2.7L FI 24 VALV. DOHC	GP-6811	GA-149	
OPTIMA	L4 2.4L FI 16 VALV. DOHC	GP-6811	GA-149	

Marca - Año - Modelo Make-Year-Model	Motor Engine	Aceite Oil	Aire Air	Combustible Fuel
KIA (continuación)				
OPTIMA	V6 2.7L FI 24 VALV. DOHC	GP-6811	GA-149	
RIO	L4 1.6L FI 16 VALV. DOHC	GP-6811	GA-363	
RIO5	L4 1.6L FI 16 VALV. DOHC	GP-6811	GA-363	
RONDO	L4 2.4L FI 16 VALV. DOHC	GP-6811	GA-149	
RONDO	V6 2.7L FI 24 VALV. DOHC	GP-6811	GA-149	
SEDONA	V6 3.8L FI 24 VALV. DOHC TWIN-TURBO			
SORENTO	V6 3.3L FI 24 VALV. DOHC			
SORENTO	V6 3.8L FI 24 VALV. DOHC TWIN-TURBO			
SPECTRA	L4 2.0L FI 16 VALV. DOHC	GP-6811		
SPECTRA5	L4 2.0L FI 16 VALV. DOHC	GP-6811		
SPORTAGE	L4 2.0L FI 16 VALV. DOHC	GP-6811		
SPORTAGE	V6 2.7L FI 24 VALV. DOHC	GP-6811		

2007				
MAGENTIS (CANADA)	L4 2.4L FI 16 VALV. DOHC	GP-6811	GA-149	
MAGENTIS (CANADA)	V6 2.7L FI 24 VALV. DOHC	GP-6811	GA-149	
OPTIMA	L4 2.4L FI 16 VALV. DOHC	GP-6811	GA-149	
OPTIMA	V6 2.7L FI 24 VALV. DOHC	GP-6811	GA-149	
RIO	L4 1.6L FI 16 VALV. DOHC	GP-6811	GA-363	
RONDO	L4 2.4L FI 16 VALV. DOHC	GP-6811	GA-149	
RONDO	V6 2.7L FI 24 VALV. DOHC	GP-6811	GA-149	

2006				
MAGENTIS (CANADA)	L4 2.4L FI 16 VALV. DOHC	GP-6811	GA-491	
MAGENTIS (CANADA)	V6 2.7L FI 24 VALV. DOHC	GP-6811	GA-491	
OPTIMA	L4 2.4L FI 16 VALV. DOHC	GP-6811	GA-149	
OPTIMA	V6 2.7L FI 24 VALV. DOHC	GP-6811	GA-491	
RIO	L4 1.6L FI 16 VALV. DOHC	GP-6811	GA-363	
RX-V	L4 1.6L FI 16 VALV. DOHC	GP-6811	GA-363	

2005				
MAGENTIS (CANADA)	L4 2.4L FI 16 VALV. DOHC	GP-6811	GA-491	
MAGENTIS (CANADA)	V6 2.7L FI 24 VALV. DOHC	GP-6811	GA-491	
OPTIMA	L4 2.4L FI 16 VALV. DOHC	GP-6811	GA-491	
OPTIMA	V6 2.7L FI 24 VALV. DOHC	GP-6811	GA-491	

2004				
MAGENTIS (CANADA)	L4 2.4L FI 16 VALV. DOHC	GP-6811	GA-491	
MAGENTIS (CANADA)	V6 2.7L FI 24 VALV. DOHC	GP-6811	GA-491	
OPTIMA	L4 2.4L FI 16 VALV. DOHC	GP-6811	GA-491	GG-187
OPTIMA	V6 2.7L FI 24 VALV. DOHC	GP-6811	GA-491	GG-187
SPECTRA	L4 1.8L FI 16 VALV. DOHC	GP-6811	GA-304	

2003				
MAGENTIS (CANADA)	L4 2.4L FI 16 VALV. DOHC	GP-6811	GA-491	GG-187
MAGENTIS (CANADA)	V6 2.7L FI 24 VALV. DOHC	GP-6811	GA-491	GG-187
OPTIMA	L4 2.4L FI 16 VALV. DOHC	GP-6811	GA-491	GG-187
OPTIMA	V6 2.7L FI 24 VALV. DOHC	GP-6811	GA-491	GG-187
SPECTRA	L4 1.8L FI 16 VALV. DOHC	GP-6811	GA-304	

2002				
MAGENTIS (CANADA)	L4 2.4L FI 16 VALV. DOHC	GP-6811	GA-491	GG-187
MAGENTIS (CANADA)	V6 2.5L FI 24 VALV. DOHC	GP-6811	GA-491	
MAGENTIS (CANADA)	V6 2.7L FI 24 VALV. DOHC	GP-6811	GA-491	GG-187
OPTIMA	L4 2.4L FI 16 VALV. DOHC	GP-6811	GA-491	GG-187
OPTIMA	V6 2.5L FI 24 VALV. DOHC	GP-6811	GA-491	
OPTIMA	V6 2.7L FI 24 VALV. DOHC	GP-6811	GA-491	GG-187
SPECTRA	L4 1.8L FI 16 VALV. DOHC	GP-91	GA-304	

2001				
MAGENTIS (CANADA)	L4 2.4L FI 16 VALV. DOHC	GP-6811	GA-491	GG-187
MAGENTIS (CANADA)	V6 2.5L FI 24 VALV. DOHC	GP-6811	GA-491	GG-187
OPTIMA	L4 2.4L FI 16 VALV. DOHC	GP-6811	GA-491	GG-187
OPTIMA	V6 2.5L FI 24 VALV. DOHC	GP-6811	GA-491	GG-187

Marca - Año - Modelo Motor Aceite Aire Combustible
Make-Year-Model Engine Oil Air Fuel

KIA (continuación)

SEPHIA	L4 1.8L FI 16 VALV. DOHC	GP-91	GA-304	
SPECTRA	L4 1.8L FI 16 VALV. DOHC	GP-91	GA-304	

2000

SEPHIA	L4 1.8L FI 16 VALV. DOHC	GP-91	GA-304	
SPECTRA	L4 1.8L FI 16 VALV. DOHC	GP-91	GA-304	

1999

SEPHIA	L4 1.8L FI 16 VALV. DOHC	GP-91	GA-304	
--------	--------------------------	-------	--------	--

1998

SEPHIA	L4 1.8L FI 16 VALV. DOHC	GP-91	GA-304	
--------	--------------------------	-------	--------	--

1997

SEPHIA	L4 1.6L FI	GP-91	GA-434	GG-150
SEPHIA	L4 1.8L FI	GP-91	GA-434	GG-150

1996

SEPHIA	L4 1.6L FI	GP-91	GA-434	GG-150
SEPHIA	L4 1.8L FI	GP-91	GA-434	GG-150

1995

SEPHIA	L4 1.6L FI	GP-91	GA-434	GG-150
SEPHIA	L4 1.8L FI	GP-91	GA-434	GG-150

1994

SEPHIA	L4 1.6L FI	GP-91	GA-434	GG-150
--------	------------	-------	--------	--------

1993

SEPHIA	L4 1.6L FI	GP-91	GA-434	GG-150
--------	------------	-------	--------	--------

LADA

1995

NIVA	L4			GG-5 ¹²⁰ GG-5 L ¹¹⁵
------	----	--	--	--

LAMBORGHINI

2010

GALLARDO	V10 5.2L FI 40 VALV. DOHC			
MURCIELAGO	V12 6.5L FI 48 VALV. DOHC			

LAND ROVER

2010

LR2	6 CIL. 3.2L FI 24 VALV.			
LR4	V8 5.0L FI 32 VALV.			
RANGE ROVER	V8 5.0L FI 32 VALV.			
RANGE ROVER	V8 5.0L FI 32 VALV. SUPER CARGADO			

2009

LR2	6 CIL. 3.2L FI 24 VALV. DOHC			
LR3	V6 4.0L FI	GP-68		
LR3	V8 4.4L FI 32 VALV. DOHC	GP-457		
RANGE ROVER	V8 4.2L FI 32 VALV. DOHC SC	GP-457		
RANGE ROVER	V8 4.4L FI 32 VALV. DOHC	GP-457		

2008

LR2	L6 3.2L FI			
LR3	V6 4.0L FI	GP-68		
LR3	V8 4.4L FI	GP-457		
RANGE ROVER	V8 4.2L SFI SUPER CARGADO	GP-457		
RANGE ROVER	V8 4.4L FI	GP-457		

Marca - Año - Modelo Motor Aceite Aire Combustible
Make-Year-Model Engine Oil Air Fuel

LAND ROVER (continuación)

2007

FREELANDER	V6 2.5L SFI DOHC 24 VALV.	GP-455	GA-2146	
LR2	8 CIL.			
LR2	L6 3.2L			
LR3	V8 4.0L FI	GP-68		
LR3	V8 4.4L FI 32 VALV.	GP-457		
RANGE ROVER	V8 4.2L FI SUPER CARGADO	GP-457		
RANGE ROVER	V8 4.4L FI	GP-457		

2006

FREELANDER	V6 2.5L SFI DOHC 24 VALV.	GP-455	GA-2146	
LR3	V8 4.4L SFI 32 VALV.	GP-457		
RANGE ROVER	V8 4.2L FI SUPER CARGADO	G-984 ⁵² GP-457 ¹³⁶		
RANGE ROVER	V8 4.4L FI 32 VALV.	G-984 ⁵² GP-457 ¹³⁶		

2005

FREELANDER	V6 2.5L SFI DOHC 24 VALV.	GP-455	GA-2146	
LR3	V8 4.5L FI	GP-457		
RANGE ROVER	V8 4.5L FI	G-984		

2004

DISCOVERY	V8 4.0L FI	GP-432	GA-2146	
DISCOVERY	V8 4.6L SFI 16 VALV.	GP-81	GA-2146	GG-46
FREELANDER	V6 2.5L SFI DOHC 24 VALV.	GP-455	GA-2146	
RANGE ROVER	V8 4.5L FI	G-984		

2003

DISCOVERY	V6 2.5L FI 24 VALV.	GP-455		
DISCOVERY	V8 4.0L FI	GP-432	GA-2146	
DISCOVERY	V8 4.6L SFI 16 VALV.	GP-81	GA-2146	GG-46
FREELANDER	V6 2.5L SFI DOHC 24 VALV.	GP-455	GA-2146	
RANGE ROVER	V8 4.5L FI	G-984		

2002

DISCOVERY	V8 4.0L SFI	GP-432	GA-2146	GG-46
DISCOVERY	V8 4.6L FI		GA-2146	
FREELANDER	V6 2.5L SFI DOHC 24 VALV.	GP-455	GA-2146	
RANGE ROVER	L6 2.5L DSL		GA-2146	
RANGE ROVER	V8 4.0L FI		GA-2146 ⁹¹	
RANGE ROVER	V8 4.6L SFI	GP-81	GA-2146	GG-46

2001

DISCOVERY	V8 4.0L SFI	GP-432	GA-2146	GG-46
FREELANDER	L4 1.8L FI	GP-455	GA-2174	
FREELANDER	V6 2.5L FI 24 VALV.	GP-455	GA-2146	
RANGE ROVER	L6 2.5L DSL		GA-2146	
RANGE ROVER	V8 4.0L FI		GA-2146	
RANGE ROVER	V8 4.6L FI	GP-432	GA-2146	GG-46

2000

DISCOVERY	V8 4.0L SFI	GP-432	GA-2146	GG-46
FREELANDER	L4 1.8L FI	GP-455	GA-2174	
FREELANDER	V6 2.5L FI		GA-2146	
RANGE ROVER	L6 2.5L DSL		GA-2146	
RANGE ROVER	V8 4.0L SFI	GP-81	GA-2146	GG-46
RANGE ROVER	V8 4.6L SFI	GP-432	GA-2146	GG-46

1999

DISCOVERY	V8 4.0L SFI	GP-81	GA-2146	GG-46
FREELANDER	L4 1.8L FI	GP-455	GA-2174	
FREELANDER	V6 2.5L FI	GP-455	GA-2146	
RANGE ROVER	L6 2.5L DSL		GA-2146	
RANGE ROVER	V8 4.0L SFI	GP-81	GA-2146	GG-46

Marca - Año - Modelo Make-Year-Model	Motor Engine	Aceite Oil	Aire Air	Combustible Fuel
---	-----------------	---------------	-------------	---------------------

LAND ROVER (continuación)

RANGE ROVER	V8 4.6L SFI	GP-432	GA-2146	GG-46
-------------	-------------	--------	---------	-------

1998

DISCOVERY	V8 4.0L SFI	GP-81	GA-2146	GG-46
RANGE ROVER	L6 2.5L DSL		GA-2146	
RANGE ROVER	V8 4.0L SFI	GP-81	GA-2146	GG-46
RANGE ROVER	V8 4.6L SFI	GP-432	GA-2146	GG-46

1997

DISCOVERY	V8 4.0L SFI	GP-81	GA-2146	GG-46
RANGE ROVER	L6 2.5L DSL		GA-2146	
RANGE ROVER	V8 4.0L SFI	GP-81	GA-2146	GG-46
RANGE ROVER	V8 4.6L SFI	GP-432	GA-2146	GG-46

1996

DISCOVERY	V8 4.0L SFI	GP-81	GA-2146	GG-46
RANGE ROVER	L6 2.5L DSL		GA-2146 ¹⁰⁷	

1995

DISCOVERY	V8 3.9L MFI	GP-81	GA-2146	GG-46
-----------	-------------	-------	---------	-------

1994

DISCOVERY	V8 3.9L MFI	GP-81	GA-2146	GG-46
-----------	-------------	-------	---------	-------

LEXUS

2010

ES350	V6 3.5L FI	G-912	GA-320	
GS350	V6 3.5L FI			
GS450H HYBRID	V6 3.5L FI			
GS460	V8 4.6L FI			
GX460	V8 4.6L FI			
HS250H	L4 2.4L FI	GP-156		
IS250	V6 2.5L DI			
IS350	V6 3.5L DI			
IS-F	V8 5.0L FI			
LF-A	V10 4.8L FI DOHC			
LS460	V8 4.6L FI			
LS600H	V8 5.0L FI			
LX570	V8 5.7L DI			
RX350	V6 3.5L DI 24 VALV. QOHC	G-912		
RX450H HYBRID	V6 3.5L	G-912		
SC430	V8 4.3L FI	GP-58		

2009

ES350	V6 3.5L FI	G-912	GA-320	
GS350	V6 3.5L DI 24 VALV. QOHC			
GS450H HYBRID	V6 3.5L DI 24 VALV. QOHC			
GS460	V8 4.6L FI 32 VALV. QOHC			
GX470	V8 4.7L FI 32 VALV. QOHC	GP-58	GA-286	
IS250	V6 2.5L DI 24 VALV. QOHC			
IS350	V6 3.5L DI 24 VALV. QOHC			
IS-F	V8 5.0L DI 32 VALV. DOHC			
LS460	V8 4.6L FI 32 VALV. QOHC			
LS600H	V8 5.0L FI 32 VALV. QOHC			
LX570	V8 5.7L FI 32 VALV. DOHC			
RX350	V6 3.5L DI 24 VALV. QOHC	G-912	GA-264	
RX400H HYBRID	V6 3.3L DI 24 VALV. QOHC	GP-58		
SC430	V8 4.3L FI 32 VALV. QOHC	GP-58		

2008

ES350	V6 3.5L DI 24 VALV.	G-912	GA-320	
GS350	V6 3.5L DI 24 VALV.			
GS450H HYBRID	V6 3.5L DI 24 VALV.			
GS460	V8 4.6L FI 32 VALV.			
GX470	V8 4.7L FI 32 VALV.	GP-58	GA-286	

Marca - Año - Modelo Make-Year-Model	Motor Engine	Aceite Oil	Aire Air	Combustible Fuel
---	-----------------	---------------	-------------	---------------------

LEXUS (continuación)

IS250	V6 2.5L DI 24 VALV.			
-------	---------------------	--	--	--

IS350	V6 3.5L DI 24 VALV.			
-------	---------------------	--	--	--

LS460	V8 4.6L FI 32 VALV.			
-------	---------------------	--	--	--

LS600H	V8 5.0L FI 32 VALV.			
--------	---------------------	--	--	--

LX570	V8 5.7L FI 32 VALV.		GA-264	
-------	---------------------	--	--------	--

RX350	V6 3.5L DI 24 VALV.	G-912	GA-264	
-------	---------------------	-------	--------	--

RX400H HYBRID	V6 3.3L DI 24 VALV.	GP-58		
---------------	---------------------	-------	--	--

SC430	V8 4.3L FI 32 VALV.	GP-58		
-------	---------------------	-------	--	--

2007

ES350	V6 3.5L DI 24 VALV.	G-912	GA-320	
-------	---------------------	-------	--------	--

GS350	V6 3.5L DI 24 VALV.			
-------	---------------------	--	--	--

GS430	V8 4.3L FI 32 VALV.	GP-58		
-------	---------------------	-------	--	--

GS450H HYBRID	V6 3.5L DI 24 VALV.			
---------------	---------------------	--	--	--

GX470	V8 4.7L FI 32 VALV.	GP-58	GA-286	
-------	---------------------	-------	--------	--

IS250	V6 2.5L DI 24 VALV.			
-------	---------------------	--	--	--

IS350	V6 3.5L DI 24 VALV.			
-------	---------------------	--	--	--

LS460	V8 4.6L FI 32 VALV.			
-------	---------------------	--	--	--

LX470	V8 4.7L FI 32 VALV.	GP-58	GA-286	
-------	---------------------	-------	--------	--

RX350	V6 3.5 DI 24 VALV.	G-912	GA-264	
-------	--------------------	-------	--------	--

RX400H HYBRID	V6 3.3 DI 24 VALV.	GP-58		
---------------	--------------------	-------	--	--

SC430	V8 4.3L FI 32 VALV.	GP-58		
-------	---------------------	-------	--	--

2003

ES300	V6 3.0L FI 24 VALV. QOHC	GP-58	GA-264	
-------	--------------------------	-------	--------	--

RX300	V6 3.0L FI 24 VALV. QOHC	GP-58	GA-322	
-------	--------------------------	-------	--------	--

2002

ES300	V6 3.0L FI 24 VALV. QOHC	GP-58	GA-264	
-------	--------------------------	-------	--------	--

RX300	V6 3.0L FI 24 VALV. QOHC	GP-58	GA-322	
-------	--------------------------	-------	--------	--

2001

ES300	V6 3.0L FI 24 VALV. QOHC	GP-58	GA-322	
-------	--------------------------	-------	--------	--

RX300	V6 3.0L FI 24 VALV. QOHC	GP-58	GA-322	
-------	--------------------------	-------	--------	--

2000

ES300	V6 3.0L FI 24 VALV. DOHC	GP-58	GA-322	
-------	--------------------------	-------	--------	--

RX300	V6 3.0L FI 24 VALV. QOHC	GP-58	GA-322	
-------	--------------------------	-------	--------	--

1999

ES300	V6 3.0L FI 24 VALV. DOHC	GP-58	GA-322	
-------	--------------------------	-------	--------	--

RX300	V6 3.0L FI 24 VALV. DOHC	GP-58	GA-322	
-------	--------------------------	-------	--------	--

1998

ES300	V6 3.0L FI 24 VALV. DOHC	GP-58	GA-322	
-------	--------------------------	-------	--------	--

RX300	V6 3.0L FI 24 VALV. DOHC	GP-58	GA-322	
-------	--------------------------	-------	--------	--

1997

ES300	V6 3.0L FI 24 VALV. DOHC	GP-58	GA-322	
-------	--------------------------	-------	--------	--

1996

ES300	V6 3.0L FI 24 VALV. DOHC	GP-58	GA-322	GG-185
-------	--------------------------	-------	--------	--------

1995

ES300	V6 3.0L FI 24 VALV. DOHC	GP-58	GA-322	GG-185
-------	--------------------------	-------	--------	--------

1994

ES300	V6 3.0L FI 24 VALV. DOHC	GP-58	GA-322	GG-185
-------	--------------------------	-------	--------	--------

1993

ES300	V6 3.0L FI 24 VALV. DOHC	GP-58	GA-322	GG-185
-------	--------------------------	-------	--------	--------

1992

ES300	V6 3.0L FI 24 VALV. DOHC	GP-58	GA-322	GG-185
-------	--------------------------	-------	--------	--------

Marca - Año - Modelo Motor Aceite Aire Combustible
Make-Year-Model Engine Oil Air Fuel

LEXUS (continuación)

1991
ES250 V6 2.5L MFI GP-58 GA-195 GG-185

1990
ES250 V6 2.5L MFI GP-58 GA-195 GG-185

LINCOLN

2010

MKS V6 3.5L DI TWIN-TURBO GA-1542
MKS V6 3.7L FI GA-1542
MKT V6 3.5L DI TWIN-TURBO GA-1542
MKT V6 3.7L FI GA-1542
MKX V6 3.5L FI GA-1542
MKZ V6 3.5L FI GA-1542
NAVIGATOR V8 5.4L FI 24 VALV. GP-68 GA-437 GG-308
TOWN CAR V8 4.6L FI FLEX FUEL GP-68 GA-5056

2009

MKS V6 3.7L FI 24 VALV. DOHC GP-3600 GA-1542
MKX V6 3.5L FI 24 VALV. DOHC GP-406¹³³
GP-3600¹³² GA-1542
MKZ V6 3.5L FI 24 VALV. DOHC GP-3600 GA-1542
NAVIGATOR V8 5.4L FI 24 VALV. SOHC GP-68 GA-437 GG-308
TOWN CAR V8 4.6L FI 16 VALV. SOHC GP-68 GA-5056
TOWN CAR V8 4.6L FI FLEX FUEL GP-68 GA-5056

2008

MARK LT V8 5.4L FI GP-68 GA-1617 GG-101
MKX V6 3.5L FI GP-3600 GA-1542
MKZ V6 3.5L SFI GP-3600 GA-1542
NAVIGATOR V8 5.4L SFI GP-68 GA-437 GG-308
TOWN CAR V8 4.6L FI GP-68 GA-5056

2007

MARK LT V8 5.4L EFI 24 VALV. SOHC GP-68 GA-1617 GG-101
MKX V6 3.5L FI 24 VALV. GP-3600 GA-1542
MKZ V6 3.5L FI GP-3600 GA-1542
NAVIGATOR V8 5.4L SFI 24 VALV. GP-68 GA-1617 GG-986
TOWN CAR V8 4.6L FI GP-68 GA-5056
ZEPHYR V6 3.0L FI 24 VALV. GP-68

2006

LS V8 3.9L EFI O FLEX FUEL 32 VALV. GP-457 GA-479 GG-101
MARK LT V8 5.4L FI GP-68 GA-1617 GG-986
NAVIGATOR V8 5.4L FI GP-68 GA-1617
GAC-1²⁴ GG-986
TOWN CAR V8 4.6L FI GP-68 GA-5056
ZEPHYR V6 3.0L FI 24 VALV. GP-68

2005

AVIATOR V8 4.6L FI GP-68 GA-395 GG-101
LS V6 3.0L FI GP-3600 GG-101
LS V8 3.9L EFI GP-457 GA-479 GG-101
MARK LT V8 5.4L FI 24 VALV. SOHC GP-68 GA-1617 GG-986
NAVIGATOR V8 5.4L FI GP-68 GA-1617
GAC-1²⁴ GG-986
TOWN CAR V8 4.6L FI GP-68 GG-986

2004

AVIATOR V8 4.6L FI GP-68 GA-395
LS V6 3.0L FI GP-3600 GA-479 GG-986
LS V8 3.9L SFI 32 VALV. GP-457 GA-479 GG-101
NAVIGATOR V8 5.4L FI GP-68 GA-395
GAC-1²⁴ GG-986
TOWN CAR V8 4.6L FI GP-68 GA-5056 GG-986

Marca - Año - Modelo Motor Aceite Aire Combustible
Make-Year-Model Engine Oil Air Fuel

LINCOLN (continuación)

2003

AVIATOR V8 4.6L FI GP-68 GA-395
BLACKWOOD V8 5.4L FI GP-68 GA-1615
GAC-1²⁴ GG-986
LS V6 3.0L FI 24 VALV. GP-3600 GG-986
LS V8 3.9L SFI GP-457 GA-479 GG-101
NAVIGATOR V8 4.6L FI 16 VALV. SOHC GP-68 GA-395
GAC-1²⁴
NAVIGATOR V8 5.4L FI GP-68 GA-1615
GAC-1²⁴ GG-986
TOWN CAR V8 4.6L FI GP-68 GA-5056 GG-986

2002

BLACKWOOD V8 5.4L FI GP-68 GA-1615
GAC-1²⁴ GG-986
LS V6 3.0L FI 24 VALV. GP-3600 GG-986
LS V8 3.9L SFI GP-457 GA-479 GG-986
NAVIGATOR V8 5.4L FI GP-68 GA-1615
GAC-1²⁴ GG-986
TOWN CAR V8 4.6L FI GP-68 GA-5056 GG-986

2001

LS V6 3.0L FI 24 VALV. GP-3600 GG-986
LS V8 3.9L SFI 32 VALV. GP-457 GA-479 GG-986
NAVIGATOR V8 5.4L FI GP-68 GA-1615
GAC-1²⁴ GG-986
TOWN CAR V8 4.6L FI GP-68 GA-5056 GG-986

2000

LS V8 3.9L SFI 32 VALV. GP-457 GA-479 GG-986
NAVIGATOR V8 5.4L FI GP-68 GA-1615
GAC-1²⁴ GG-986
TOWN CAR V8 4.6L FI GP-68 GA-5056 GG-986

1999

CONTINENTAL V8 4.6L FI 32 VALV. GP-68 GA-1615 GG-47
NAVIGATOR V8 5.4L FI GP-68 GA-1615
GAC-1²⁴ GG-986
TOWN CAR V8 4.6L FI GP-68 GA-5056 GG-986

1998

CONTINENTAL V8 4.6L FI 32 VALV. GP-68 GA-1615 GG-47
NAVIGATOR V8 5.4L FI GP-68 GA-1615
GAC-1²⁴ GG-986
TOWN CAR V8 4.6L FI GP-68 GA-5056 GG-986

1997

CONTINENTAL V8 4.6L FI 32 VALV. GP-68 GA-1615 GG-47
TOWN CAR V8 4.6L FI GP-68 GA-5056 GG-47

1996

CONTINENTAL V8 4.6L FI 32 VALV. GP-68 GA-1615 GG-47
MARK VIII V8 4.6L FI 32 VALV. GP-68 GG-92
TOWN CAR V8 4.6L FI GP-68 GA-5056 GG-47

1995

CONTINENTAL V8 4.6L FI 32 VALV. GP-68 GA-1615 GG-47
MARK VIII V8 4.6L FI 32 VALV. GP-68 GG-92
TOWN CAR V8 4.6L FI GP-68 GA-5056 GG-47

1994

CONTINENTAL V6 3.8L EFI GP-3600 GA-273
GA-176⁴⁵ GG-47
MARK VIII V8 4.6L FI GP-68 GG-92
TOWN CAR V8 4.6L FI GP-68 GA-5056 GG-47

Marca - Año - Modelo Motor Aceite Aire Combustible
Make-Year-Model Engine Oil Air Fuel

LINCOLN (continuación)

1993

CONTINENTAL	V6 3.8L EFI	GP-3600	GA-273 GA-176 ⁴⁵	GG-47
TOWN CAR	V8 4.6L FI	GP-68	GA-5056	GG-47

1992

CONTINENTAL	V6 3.8L EFI	GP-3600	GA-273 GA-176 ⁴⁵	GG-47
TOWN CAR	V8 4.6L FI	GP-68	GA-5056 GA-176 ⁴⁵	GG-47

1991

CONTINENTAL	V6 3.8L EFI	GP-3600	GA-273 GA-176 ⁴⁵	GG-47
TOWN CAR	V8 4.6L FI	GP-68	GA-5056 GA-176 ⁴⁵	GG-47
TOWN CAR	V8 5.0L FI	GP-1	GA-5056 GA-176 ⁴⁵	GG-47

1990

CONTINENTAL	V6 3.8L EFI	GP-3600	GA-273 GA-176 ⁴⁵	GG-47
TOWN CAR	V8 5.0L EFI	GP-1	GA-5056	GG-47

M.G.

2006

ZT	L4 1.8L FI		GA-2135	
ZT160	L4 2.5L FI		GA-2135	
ZT180	L4 2.5L FI		GA-2135	
ZT190	V6 2.5L FI		GA-2135	
ZT-T	V6 2.5L FI		GA-2135	

2005

TF	L4 1.8L FI 16 VALV.			
ZR	TODOS			
ZT	L4 1.8L FI		GA-2135	
ZT160	L4 2.5L FI		GA-2135	
ZT180	L4 2.5L FI		GA-2135	
ZT190	V6 2.5L FI		GA-2135	
ZT-T	V6 2.5L FI		GA-2135	

2004

TF	L4 1.8L FI 16 VALV.			
ZR	TODOS			
ZT	L4 1.8L FI		GA-2135	
ZT160	L4 2.5L FI		GA-2135	
ZT180	L4 2.5L FI		GA-2135	
ZT190	V6 2.5L FI		GA-2135	
ZT-T	V6 2.5L FI		GA-2135	

2003

TF	L4 1.8L FI 16 VALV.			
ZR	TODOS			
ZT	L4 1.8L FI		GA-2135 ¹⁰⁶	
ZT160	L4 2.5L FI		GA-2135	
ZT180	L4 2.5L FI		GA-2135	
ZT190	V6 2.5L FI		GA-2135	
ZT-T	V6 2.5L FI		GA-2135	

2002

ZT160	L4 2.5L FI		GA-2135	
ZT180	L4 2.5L FI		GA-2135 ⁹⁹	
ZT190	V6 2.5L FI		GA-2135	
ZT-T	V6 2.5L FI		GA-2135	

Marca - Año - Modelo Motor Aceite Aire Combustible
Make-Year-Model Engine Oil Air Fuel

M.G. (continuación)

2001

ZT160	L4 2.5L FI			GA-2135 ¹⁰³
ZT190	V6 2.5L FI			GA-2135 ¹⁰⁵
ZT-T	V6 2.5L FI			GA-2135

2000

MINI 75 CONNOISSEUR	V6 2.5L FI	GP-453		GA-2135
---------------------	------------	--------	--	---------

MAYBACH

2010

57	V12 5.5L FI 36 VALV. SOHC BI-TURBO			GA-438
62	V12 5.5L FI 36 VALV. SOHC BI-TURBO			GA-438
57S	V12 6.0L FI 36 VALV. SOHC BI-TURBO			GA-438
62S	V12 6.0L FI 36 VALV. SOHC BI-TURBO			GA-438
LANDAULET	V12 6.0L FI 36 VALV. SOHC BI-TURBO			GA-438

MAZDA

2010

CX-7	L4 2.3L DI TURBO	GP-58		
CX-7	L4 2.5L FI	GP-58		
CX-9	V6 3.7L FI			GA-1542
MAZDA 3	L4 2.0L FI	GP-58		GA-596
MAZDA 3	L4 2.5L FI	GP-58		GA-596
MAZDA 5	L4 2.3L FI 16 VALV. DOHC	G-70		GA-596
MAZDA 6	L4 2.5L FI 16 VALV.	G-70 ⁹² GP-58 ¹³⁶		
MAZDA 6	V6 3.7L FI 24 VALV.			GA-1542
MAZDASPEED3	L4 2.3L DI TURBO	GP-58		GA-596
MX-5	L4 2.0L FI 16 VALV.	GP-58		
RX-8	ROTARY 1.3L FI	GP-91		
TRIBUTE	L4 2.5L FI 16 VALV.	G-70		
TRIBUTE	V6 3.0L FI 24 VALV.			
TRIBUTE HYBRID	L4 2.5L FI	G-70 ⁹²		

2009

B-2300	L4 2.3L FI 16 VALV. DOHC	GP-58		GA-158
B-4000	V6 4.0L FI 12 VALV. SOHC	GP-68		GA-158
CX-7	L4 2.3L DI 16 VALV. DOHC TURBO	G-70		GA-597
CX-9	V6 3.7L FI 24 VALV. DOHC	GP-3600		GA-1542
MAZDA 3	L4 2.0L FI	GP-58		GA-596
MAZDA 3	L4 2.3L DI TURBO	G-70		GA-596
MAZDA 3	L4 2.3L FI	G-70		GA-596
MAZDA 5	L4 2.3L FI 16 VALV. DOHC	G-70		GA-596
MAZDA 6	L4 2.5L FI 16 VALV.	G-70		GA-1572
MAZDA 6	V6 3.7L FI 24 VALV.	GP-68		GA-1542
MAZDASPEED	L4 2.0L FI 16 VALV. DOHC	GP-58		
MAZDASPEED3	L4 2.0L FI	GP-58		GA-596
MAZDASPEED3	L4 2.3L DI TURBO	G-70		GA-596
MAZDASPEED3	L4 2.3L FI	G-70		GA-596
MIATA	L4 2.0L FI 16 VALV. DOHC	GP-58		
MX-5	L4 2.0L FI 16 VALV. DOHC	GP-58		
RX-8	ROTARY 1.3L FI			
TRIBUTE	L4 2.5L FI 16 VALV. DOHC	G-70		GA-224
TRIBUTE	V6 3.0L FI 24 VALV. DOHC	GP-406		GA-224
TRIBUTE HYBRID	L4 2.5L FI 16 VALV. DOHC	G-70		GA-224

2008

B-2300	L4 2.3L FI 16 VALV. DOHC	GP-58		GA-158
B-4000	V6 4.0L FI 12 VALV. SOHC	GP-68		GA-158
CX-7	L4 2.3L DI TURBO	G-70		GA-597

Marca - Año - Modelo Make-Year-Model	Motor Engine	Aceite Oil	Aire Air	Combustible Fuel
MAZDA (continuación)				
CX-9	V6 3.7L EFI	GP-3600	GA-1542	
MAZDA 3	L4 2.0L MFI	GP-58	GA-596	
MAZDA 3	L4 2.3L MFI	G-70	GA-596	
MAZDA 5	L4 2.3L FI	G-70	GA-596	
MAZDA 6	L4 2.3L MFI	G-70		
MAZDA 6	V6 3.0L MFI	GP-68	GA-597	
MAZDASPEED	L4 2.0L FI 16 VALV. DOHC	GP-58		
MAZDASPEED3	L4 2.0L FI	GP-58	GA-596	
MAZDASPEED3	L4 2.3L	G-70	GA-596	
MIATA	L4 2.0L FI 16 VALV. DOHC	GP-58		
MX-5	L4 2.0L MFI	GP-58		
RX-8	ROTARY 1.3L FI	GP-91		
TRIBUTE	6 CIL. 3.0L MFI	GP-68	GA-224	GG-47
TRIBUTE	L4 2.3L MFI	GP-58	GA-224	GG-47
TRIBUTE HYBRID	L4 2.3L MFI	G-70	GA-224	GG-47
2007				
B-2300	L4 2.3L FI 16 VALV. DOHC	GP-58	GA-158	GG-308
B-3000	V6 3.0L FI	GP-3600	GA-158	GG-308
B-4000	V6 4.0L FI SOHC	GP-68	GA-158	GG-308
CX-7	L4 2.3L DI TURBO	G-70	GA-597	
CX-9	V6 3.5L EFI	GP-3600	GA-1542	
CX-9	V6 3.7L 24 VALV. DOHC			
MAZDA 3	L4 2.0L MFI 16 VALV.	GP-58	GA-596	
MAZDA 3	L4 2.3L MFI 16 VALV.	G-70	GA-596	
MAZDA 5	L4 2.3L MFI 16 VALV.	G-70	GA-596	
MAZDA 6	L4 2.3L MFI 16 VALV.	G-70	GA-597	
MAZDA 6	V6 3.0L MFI 24 VALV.	GP-68	GA-597	
MX-5	L4 2.0L MFI 16 VALV.	GP-58		
TRIBUTE	L4 2.3L SFI	GP-58	GA-224	GG-47
TRIBUTE	V6 3.0L FI	GP-68	GA-224	GG-47
2006				
B-2300	L4 2.3L FI 16 VALV. DOHC	GP-58	GA-158	GG-308
B-3000	V6 3.0L FI	GP-128	GA-158	GG-308
B-4000	V6 4.0L FI SOHC	GP-68	GA-158	GG-308
MAZDA 3	L4 2.0L FI 16 VALV.	GP-58	GA-596	
MAZDA 3	L4 2.3L MFI 16 VALV.	G-70	GA-596	
MAZDA 5	L4 2.3L MFI 16 VALV.	G-70	GA-596	
MAZDA 6	L4 2.3L FI 16 VALV.	G-70	GA-597	
MAZDA 6	V6 3.0L FI 24 VALV.	GP-68	GA-597	
MX-5	L4 2.0L FI 16 VALV.			
TRIBUTE	L4 2.3L SFI	GP-58	GA-224	GG-47
TRIBUTE	V6 3.0L SFI	GP-68	GA-224	GG-47
2005				
B-2300	L4 2.3L FI	GP-3600		GG-308
B-3000	V6 3.0L FI	GP-3600		
B-4000	V6 4.0L FI	GP-68		
MAZDA 3	L4 2.0L FI 16 VALV.	GP-58	GA-596	
MAZDA 3	L4 2.3L MFI 16 VALV.	G-70	GA-596	
MAZDA 6	L4 2.3L FI 16 VALV.	G-70		
MAZDA 6	V6 3.0L FI 24 VALV. DOHC	GP-68	GA-597	
TRIBUTE	L4 2.3L SFI	GP-58	GA-224	GG-47
TRIBUTE	V6 3.0L SFI	GP-68	GA-224	GG-47
2004				
B-2300	L4 2.3L FI	GP-3600	GA-158	
B-3000	V6 3.0L FI	GP-3600	GA-158	
B-4000	V6 4.0L FI	GP-68	GA-158	
MAZDA 3	L4 2.0L FI 16 VALV. DOHC		GA-596	
MAZDA 3	L4 2.3L MFI 16 VALV.	G-70	GA-596	
MAZDA 6	L4 2.3L FI 16 VALV.	G-70		
MAZDA 6	V6 3.0L FI 24 VALV. DOHC	GP-68	GA-597	
TRIBUTE	L4 2.0L SFI	GP-128	GA-224	GG-47
TRIBUTE	V6 3.0L SFI	GP-68	GA-224	GG-47

Marca - Año - Modelo Make-Year-Model	Motor Engine	Aceite Oil	Aire Air	Combustible Fuel
MAZDA (continuación)				
2003				
B-2300	L4 2.3L FI	GP-3600	GA-158	
B-3000	V6 3.0L FI	GP-3600	GA-158	
B-4000	V6 4.0L FI	GP-68	GA-158	
MAZDA 6	L4 2.3L FI 16 VALV.	G-70		
MAZDA 6	V6 3.0L FI 24 VALV. DOHC	GP-68	GA-597	
PROTEGE	L4 2.0L FI	GP-91	GA-595	
TRIBUTE	L4 2.0L SFI	GP-128	GA-224	GG-47
TRIBUTE	V6 3.0L SFI	GP-68	GA-224	GG-47
2002				
B-2300	L4 2.3L FI	GP-3600	GA-158	
B-3000	V6 3.0L FI	GP-3600	GA-158	
B-4000	V6 4.0L FI	GP-68	GA-158	
MILLENNIA	V6 2.3L MFI	GP-149	GA-5466	GG-136
MILLENNIA	V6 2.5L MFI	GP-149	GA-7344	GG-136
PROTEGE	L4 2.0L FI	GP-91	GA-595	
TRIBUTE	L4 2.0L SFI	GP-128	GA-224	GG-47
TRIBUTE	V6 3.0L SFI	GP-68	GA-224	GG-47
2001				
B-2300	L4 2.3L FI	GP-3600	GA-158	
B-2500	L4 2.5L MFI	GP-3600	GA-158	
B-3000	V6 3.0L FI	GP-3600	GA-158	
B-4000	V6 4.0L FI	GP-68	GA-158	
MILLENNIA	V6 2.3L MFI DOHC SUPER CARGADO 24 VALV.	GP-149	GA-5466	GG-136
MILLENNIA	V6 2.5L MFI DOHC 24 VALV.	GP-149	GA-7344	GG-136
PROTEGE	L4 1.6L FI	GP-91	GA-595	
PROTEGE	L4 2.0L FI	GP-91	GA-595	
TRIBUTE	L4 2.0L SFI	GP-128	GA-224	GG-47
TRIBUTE	V6 3.0L SFI	GP-68	GA-224	GG-47
2000				
626-4	L4 2.0L FI	GP-91		GG-268
B-2500	L4 2.5L FI	GP-3600	GA-158	
B-3000	V6 3.0L FI	GP-3600	GA-158	
B-4000	V6 4.0L FI	GP-1	GA-158	
MILLENNIA	V6 2.3L MFI	GP-149	GA-5466	GG-136
MILLENNIA	V6 2.5L MFI	GP-149	GA-7344	GG-136
PROTEGE	L4 1.6L FI	GP-91	GA-595	
PROTEGE	L4 1.8L FI	GP-91	GA-595	GG-150
1999				
626-4	L4 2.0L FI	GP-91		GG-268
B-2500	L4 2.5L FI	GP-3600	GA-158	
B-3000	V6 3.0L FI	GP-3600	GA-158	
B-4000	V6 4.0L FI	GP-1	GA-158	
MILLENNIA	V6 2.3L MFI	GP-149	GA-5466	GG-136
MILLENNIA	V6 2.5L MFI	GP-149	GA-7344	GG-136
PROTEGE	L4 1.6L FI	GP-91	GA-595	
PROTEGE	L4 1.8L FI	GP-91	GA-595	GG-150
1998				
626	L4 2.0L FI DOHC	GP-91	GA-432	GG-94 ¹⁶¹ GG-268 ¹⁶²
626	V6 2.5L FI DOHC	GP-149	GA-432	GG-268
B-3000	V6 3.0L FI	GP-3600	GA-158	
B-4000	V6 4.0L FI	GP-1	GA-158	
MILLENNIA	V6 2.3L MFI	GP-149	GA-5466	GG-136
MILLENNIA	V6 2.5L MFI	GP-149	GA-7344	GG-136
PROTEGE	L4 1.5L FI	GP-91	GA-595	GG-150
PROTEGE	L4 1.8L FI	GP-91	GA-595	GG-150

Marca - Año - Modelo Make-Year-Model	Motor Engine	Aceite Oil	Aire Air	Combustible Fuel
MAZDA (continuación)				
1997				
626	L4 2.0L FI DOHC	GP-91	GA-432	GG-94 ¹⁶¹ GG-268 ¹⁶²
626	V6 2.5L FI DOHC	GP-149	GA-432	GG-268
626-4	L4 2.0L FI	GP-91		GG-268
B-3000	V8 3.0L (U) FI	GP-3600	GA-1616	GG-1872
B-4000	V6 4.0L FI	GP-1	GA-1616	GG-1872
MILLENNIA	V6 2.3L MFI	GP-149	GA-5466	GG-136
MILLENNIA	V6 2.5L MFI	GP-149	GA-7344	GG-136
MX-6	L4 2.0L FI DOHC	GP-91	GA-432	GG-94 ¹⁶¹ GG-268 ¹⁶²
MX-6	V6 2.5L FI	GP-149	GA-432	GG-268
PROTEGE	L4 1.5L FI	GP-91	GA-595	GG-150
PROTEGE	L4 1.8L FI	GP-91	GA-595	GG-150
1996				
626	L4 2.0L FI DOHC	GP-91	GA-432	GG-94 ¹⁶¹ GG-268 ¹⁶²
626	V6 2.5L FI DOHC	GP-149	GA-432	GG-268
626-4	L4 2.0L FI	GP-91		GG-268
929	V6 3.0L MFI	GP-149	GA-6690	GG-136
B-3000	V8 3.0L (U) FI	GP-3600	GA-1616	GG-1872
B-4000	V6 4.0L FI	GP-1	GA-1616	GG-1872
MILLENNIA	V6 2.3L MFI	GP-149	GA-5466	GG-136
MILLENNIA	V6 2.5L MFI	GP-149	GA-7344	GG-136
MX-6	L4 2.0L FI DOHC	GP-91	GA-432	GG-94 ¹⁶¹ GG-268 ¹⁶²
MX-6	V6 2.5L FI	GP-149	GA-432	GG-268
PROTEGE	L4 1.5L FI	GP-91	GA-595	GG-150
PROTEGE	L4 1.8L FI	GP-91	GA-595	GG-150
323	L4 1.6L MFI	GP-91		GG-150
1995				
323	L4 1.6L MFI	GP-91	GA-133	GG-150
323	L4 1.8L	GP-91	GA-183	GG-150
626	L4 2.0L FI DOHC		GA-432	GG-94 ¹⁶¹ GG-268 ¹⁶²
626	V6 2.5L FI DOHC	GP-149	GA-432	GG-268
626-4	L4 2.0L	GP-91		GG-268
929	V6 3.0L MFI DOHC	GP-149	GA-6690	GG-136
B-3000	V8 3.0L (U) FI	GP-3600	GA-1616	GG-1872
B-4000	V6 4.0L	GP-1	GA-1616	GG-1872
MILLENNIA	V6 2.3L MFI	GP-149	GA-5466	GG-136
MILLENNIA	V6 2.5L MFI	GP-149	GA-7344	GG-136
MX-3	L4 1.6L MFI	GP-91		GG-150
MX-6	L4 2.0L FI DOHC	GP-91	GA-432	GG-94 ¹⁶¹ GG-268 ¹⁶²
MX-6	V6 2.5L FI	GP-149	GA-432	GG-268
PROTEGE	L4 1.5L	GP-91	GA-595	GG-150
PROTEGE	L4 1.8L	GP-91	GA-595	GG-150
1994				
323	L4 1.6L MFI	GP-91	GA-133	GG-150
323	L4 1.8L EFI	GP-91	GA-133	GG-150
626	L4 2.0L FI DOHC		GA-432	GG-268
626	V6 2.5L FI DOHC	GP-149	GA-432	GG-268
929	V6 3.0L MFI DOHC	GP-149	GA-6690	GG-136
B-3000	V8 3.0L (U) FI	GP-3600	GA-273	GG-47
B-4000	V6 4.0L	GP-1	GA-1616	GG-1872
MX-3	L4 1.6L MFI	GP-91		GG-150
MX-6	L4 2.0L FI DOHC		GA-432	GG-94 ¹⁶¹ GG-268 ¹⁶²
MX-6	V6 2.5L FI	GP-149	GA-432	GG-268
NAVAJO	V6 4.0L MFI	GP-1	GA-273	GG-1872
PROTEGE	L4 1.8L MFI	GP-91	GA-133	GG-150

Marca - Año - Modelo Make-Year-Model	Motor Engine	Aceite Oil	Aire Air	Combustible Fuel
MAZDA (continuación)				
1993				
323	L4 1.6L MFI	GP-91	GA-133	GG-150
323	L4 1.8L MFI	GP-91	GA-133	GG-150
626	L4 2.0L	GP-149	GA-273	GG-142
626	L4 2.2L MFI CON O SIN TURBO	GP-91		GG-142 ¹³⁹
929	V6 3.0L MFI	GP-149	GA-6690	GG-136
B-2200	L4 2.2L 2 BBL	GP-91	GA-2740	
B-2200	L4 2.2L FI	GP-149	GA-2106	GG-115
B-2600	L4 2.6L FI	GP-149	GA-2106	GG-115
B-2600	V6 3.0L FI	GP-149		GG-115
MX-3	L4 1.6L MFI	GP-91		GG-150
MX-6	V6 2.5L FI	GP-149	GA-432	GG-268
NAVAJO	V6 4.0L MFI	GP-1	GA-273	GG-1872
PROTEGE	L4 1.6L MFI	GP-91	GA-133	GG-150
PROTEGE	L4 1.8L EFI	GP-91	GA-133	GG-150
1992				
323	L4 1.6L EFI	GP-91	GA-133	GG-150
323	L4 1.8L MFI	GP-91	GA-133	GG-150
626	L4 2.0L	GP-149	GA-273	GG-142
626	L4 2.2L EFI CON O SIN TURBO	GP-91		GG-142 ¹³⁹
929	V6 3.0L MFI	GP-149	GA-2106	GG-148
B-2200	L4 2.2L 2 BBL	GP-91	GA-2740	GG-208
B-2200	L4 2.2L FI	GP-149	GA-2106	GG-115
B-2600	L4 2.6L FI	GP-149	GA-2106	GG-115
B-2600	V6 3.0L FI	GP-149		GG-115
MX-3	L4 1.6L MFI	GP-91		GG-150
MX-6	L4 2.2L MFI CON O SIN TURBO	GP-91		GG-142 ¹³⁹
NAVAJO	V6 4.0L MFI	GP-1	GA-273	GG-1872
PROTEGE	L4 1.6L MFI	GP-91	GA-133	GG-150
PROTEGE	L4 1.8L MFI	GP-91	GA-133	GG-150
RX-7	1.3L FI	GP-91		GG-217
1991				
323	L4 1.6L EFI	GP-91	GA-133	GG-150
323	L4 1.8L	GP-91	GA-183	GG-150
626	L4 2.0L	GP-149	GA-273	GG-142
626	L4 2.2L EFI CON O SIN TURBO	GP-91		GG-142 ¹³⁹
929	V6 3.0L MFI	GP-149	GA-2106	GG-148
B-2200	L4 2.2L 2 BBL	GP-91	GA-2740	GG-208
B-2200	L4 2.2L FI	GP-149	GA-2106	GG-115
B-2600	L4 2.6L FI	GP-149	GA-2106	GG-115
B-2600	V6 3.0L FI	GP-149		GG-115
MX-6	L4 2.2L EFI CON O SIN TURBO	GP-91		GG-142 ¹³⁹
NAVAJO	V6 4.0L MFI	GP-1	GA-273	GG-1872
PROTEGE	L4 1.6L EFI	GP-91	GA-133	GG-150
PROTEGE	L4 1.8L MFI	GP-91	GA-133	GG-150 ⁹
RX-7	1.3L FI	GP-91		GG-217
1990				
B-2200	L4 2.2L 2 BBL	GP-91	GA-2740	GG-208
B-2200	L4 2.2L FI	GP-149	GA-2106	GG-115
B-2600	L4 2.6L FI	GP-149	GA-2106	GG-115
B-2600	V6 3.0L FI	GP-149		GG-115
MX-6	L4 2.2L EFI CON O SIN TURBO	GP-91		GG-142 ¹³⁹
PROTEGE	L4 1.8L MFI	GP-91	GA-133	GG-150 ⁹
RX-7	1.3L FI	GP-91		GG-217

Marca - Año - Modelo Make-Year-Model	Motor Engine	Aceite Oil	Aire Air	Combustible Fuel
MERCEDES BENZ				
2010				
B SERIES	L4 2.0L FI			
B SERIES	L4 2.0L FI TURBO			
C SERIES	V6 2.5L FI	G-180 ¹⁶⁶ G-918 ¹⁶⁶	GA-438	
C SERIES	V6 3.0L FI 24 VALV.	G-180 ¹⁶⁶ G-918 ¹⁶⁶	GA-438 ¹²⁸	GG-420
C SERIES	V6 3.5L FI 24 VALV.	G-180 ¹⁶⁶ G-918 ¹⁶⁶	GA-438 ¹²⁸	GG-420
C SERIES	V8 6.3L FI 32 VALV.			
CL SERIES	V12 5.5L FI 36 VALV. TWIN-TURBO		GA-438	
CL SERIES	V12 6.0L FI 36 VALV. TWIN-TURBO		GA-438	
CL SERIES	V8 5.5L FI 32 VALV.	G-180 ¹⁶⁶ G-918 ¹⁶⁶	GA-438	
CL SERIES	V8 6.3L FI 32 VALV.			
CLK SERIES	V6 3.5L FI 24 VALV.			
CLK SERIES	V8 5.5L FI 32 VALV.			
CLS SERIES	V8 5.5L FI 32 VALV.	G-180 ¹⁶⁶ G-918 ¹⁶⁶		
CLS SERIES	V8 6.3L FI 32 VALV.			
E SERIES	V6 3.5L FI 24 VALV.	G-180 ¹⁶⁶ G-918 ¹⁶⁶	GA-438 ¹²⁸	
E SERIES	V8 5.5L FI 32 VALV.	G-180 ¹⁶⁶ G-918 ¹⁶⁶	GA-438 ¹²⁸	
E SERIES	V8 6.3L FI 32 VALV.			
G SERIES	V8 5.5L FI 24 VALV. SUPER CARGADO	G-180 ¹⁶⁶ G-918 ¹⁶⁶	GA-438 ¹²⁸	GG-420
G SERIES	V8 5.5L FI 32 VALV.	G-180 ¹⁶⁶ G-918 ¹⁶⁶	GA-438	
GL SERIES	V6 3.0L DI 24 VALV. DIESEL			
GL SERIES	V8 4.5L FI 32 VALV.	G-180 ¹⁶⁶ G-918 ¹⁶⁶	GA-438 ¹²⁸	
GL SERIES	V8 5.5L FI 32 VALV.	G-180 ¹⁶⁶ G-918 ¹⁶⁶	GA-438 ¹²⁸	
GLK SERIES	V6 3.5L FI 24 VALV.	G-180 ¹⁶⁶ G-918 ¹⁶⁶	GA-438 ¹²⁸	
ML SERIES	V6 3.0L FI 24 VALV. TURBO DIESEL			
ML SERIES	V6 3.5L FI 24 VALV.	G-180 ¹⁶⁶ G-918 ¹⁶⁶	GA-438 ¹²⁸	
ML SERIES	V6 3.5L FI 24 VALV. HYBRID	G-180 ¹⁶⁶ G-918 ¹⁶⁶	GA-438 ¹²⁸	
ML SERIES	V8 5.5L FI 32 VALV.	G-180 ¹⁶⁶ G-918 ¹⁶⁶	GA-438 ¹²⁸	
ML SERIES	V8 6.3L FI 32 VALV.			
R SERIES	V6 3.0L DI 24 VALV. TURBO DIESEL			
R SERIES	V6 3.5L DI 24 VALV.	G-180 ¹⁶⁶ G-918 ¹⁶⁶	GA-438 ¹²⁸	
S SERIES	V12 5.5L FI 36 VALV. TWIN-TURBO		GA-438 ¹²⁸	
S SERIES	V12 6.0L FI 36 VALV. TWIN-TURBO		GA-438 ¹²⁸	
S SERIES	V6 3.5L FI 24 VALV. HYBRID	G-180 ¹⁶⁶ G-918 ¹⁶⁶	GA-438 ¹²⁸	
S SERIES	V8 5.5L FI 32 VALV.	G-180 ¹⁶⁶ G-918 ¹⁶⁶	GA-438 ¹²⁸	
S SERIES	V8 6.3L FI 32 VALV.			
SL SERIES	V12 5.5L FI 36 VALV. TWIN-TURBO		GA-438 ¹²⁸	
SL SERIES	V12 6.0L FI 36 VALV. TWIN-TURBO		GA-438 ¹²⁸	
SL SERIES	V8 5.5L FI 32 VALV.	G-180 ¹⁶⁶ G-918 ¹⁶⁶	GA-438 ¹²⁸	GG-420
SL SERIES	V8 6.3L FI 32 VALV.			
SLK SERIES	V6 3.0L FI 24 VALV.	G-180 ¹⁶⁶ G-918 ¹⁶⁶	GA-438	
SLK SERIES	V6 3.5L FI 24 VALV.	G-180 ¹⁶⁶ G-918 ¹⁶⁶	GA-438 ¹²⁸	
SLK SERIES	V8 5.5L FI 24 VALV.		GA-438 ¹²⁸	

Marca - Año - Modelo Make-Year-Model	Motor Engine	Aceite Oil	Aire Air	Combustible Fuel
MERCEDES BENZ (continuación)				
2009				
B SERIES	L4 2.0L FI			
B SERIES	L4 2.0L FI TURBO			
C SERIES	V6 3.0L FI 24 VALV. DOHC	G-180 ¹⁶⁶ G-918 ¹⁶⁶	GA-2198	
C SERIES	V6 3.5L FI 24 VALV. DOHC	G-180 ¹⁶⁶ G-918 ¹⁶⁶	GA-438 ¹²⁸	
C SERIES	V8 6.3L FI 32 VALV. DOHC			
CL SERIES	V12 5.5L FI 36 VALV. SOHC TWIN-TURBO			
CL SERIES	V12 6.0L FI 36 VALV. SOHC TWIN-TURBO			
CL SERIES	V8 5.5L FI 32 VALV. DOHC	G-180 ¹⁶⁶ G-918 ¹⁶⁶	GA-438 ¹²⁸	
CL SERIES	V8 6.3L FI 32 VALV. DOHC			
CLK SERIES	V6 3.5L FI 24 VALV. DOHC	G-180 ¹⁶⁶ G-918 ¹⁶⁶	GA-438 ¹²⁸	
CLK SERIES	V8 5.5L FI 32 VALV. DOHC	G-180 ¹⁶⁶ G-918 ¹⁶⁶	GA-438 ¹²⁸	
CLS SERIES	V8 5.5L FI 32 VALV. DOHC	G-180 ¹⁶⁶ G-918 ¹⁶⁶	GA-438 ¹²⁸	
CLS SERIES	V8 6.3L FI 32 VALV. DOHC			
E SERIES	V6 3.0L DI DOHC DIESEL TURBO			
E SERIES	V6 3.5L FI 24 VALV. DOHC	G-180 ¹⁶⁶ G-918 ¹⁶⁶	GA-2198	
E SERIES	V8 5.5L FI 32 VALV. DOHC	G-180 ¹⁶⁶ G-918 ¹⁶⁶	GA-438 ¹²⁸	
E SERIES	V8 6.3L FI 32 VALV. DOHC			
G SERIES	V8 5.0L FI 24 VALV. SOHC	G-180	GA-438 ¹²⁸	
G SERIES	V8 5.5L FI 24 VALV. SOHC SC	G-180 ¹⁶⁶ G-918 ¹⁶⁶	GA-2198 ⁸⁸	
GL SERIES	V6 3.0L DI 24 VALV. DOHC DIESEL TURBO			
GL SERIES	V8 4.6L FI 32 VALV. DOHC	G-180 ¹⁶⁶ G-918 ¹⁶⁶	GA-438 ¹²⁸	
GL SERIES	V8 5.5L FI 32 VALV. DOHC	G-180 ¹⁶⁶ G-918 ¹⁶⁶	GA-438 ¹²⁸	
ML SERIES	V6 3.0L DI 24 VALV. DOHC DIESEL TURBO			
ML SERIES	V6 3.5L FI 24 VALV. DOHC	G-180 ¹⁶⁶ G-918 ¹⁶⁶	GA-2198 ¹²⁸	
ML SERIES	V8 5.5L FI 32 VALV. DOHC	G-180 ¹⁶⁶ G-918 ¹⁶⁶	GA-438 ¹²⁸	
ML SERIES	V8 6.3L FI 32 VALV. DOHC			
R SERIES	V6 3.0L DIESEL 24 VALV. DOHC TURBO			
R SERIES	V6 3.5L FI 24 VALV. DOHC	G-180 ¹⁶⁶ G-918 ¹⁶⁶	GA-438 ¹²⁸	
S SERIES	V12 5.5L FI 36 VALV. SOHC TWIN-TURBO			
S SERIES	V12 6.0L FI 36 VALV. SOHC TWIN-TURBO			
S SERIES	V8 5.5L FI 32 VALV. DOHC	G-180 ¹⁶⁶ G-918 ¹⁶⁶	GA-438 ¹²⁸	
S SERIES	V8 6.3L FI 32 VALV. DOHC			
SL SERIES	V12 5.5L FI 36 VALV. SOHC TWIN-TURBO			
SL SERIES	V12 6.0L FI 36 VALV. SOHC TWIN-TURBO			
SL SERIES	V8 5.5L FI 32 VALV. DOHC	G-180 ¹⁶⁶ G-918 ¹⁶⁶	GA-2198	
SL SERIES	V8 6.3L FI			
SLK SERIES	V6 3.0L FI 24 VALV. DOHC	G-180 ¹⁶⁶ G-918 ¹⁶⁶	GA-438 ¹²⁸	
SLK SERIES	V6 3.5L FI 24 VALV. DOHC	G-180 ¹⁶⁶ G-918 ¹⁶⁶	GA-2198 ¹²⁸	
SLK SERIES	V8 5.5L FI 24 VALV. SOHC		GA-438 ¹²⁸	
SLR SERIES	V8 5.5L FI 24 VALV. SOHC SC		GA-2195	
2008				
B SERIES	L4 2.0L FI			
B SERIES	L4 2.0L FI TURBO			
C SERIES	V6 3.0L FI	G-180 ¹⁶⁶ G-918 ¹⁶⁶	GA-2198 ¹²⁸	

Para números Gonher con Superíndice vea página 38
For Gonher with Superscript numbers see page 38

Marca - Año - Modelo Make-Year-Model	Motor Engine	Aceite Oil	Aire Air	Combustible Fuel
MERCEDES BENZ (continuación)				
C SERIES	V6 3.5L FI	G-180 ¹⁶⁶ G-918 ¹⁶⁶	GA-2198 ¹²⁸	
CL SERIES	V12 5.5L FI 36 VALV. SOHC TWIN-TURBO			
CL SERIES	V12 6.0L FI 36 VALV. TWIN TURBO			
CL SERIES	V8 5.5L FI	G-180 ¹⁶⁶ G-918 ¹⁶⁶	GA-2198 ¹²⁸	
CL SERIES	V8 6.3L FI			
CLK SERIES	V6 3.5L FI	G-180 ¹⁶⁶ G-918 ¹⁶⁶	GA-2198 ¹²⁸	
CLK SERIES	V8 5.5L FI	G-180 ¹⁶⁶ G-918 ¹⁶⁶	GA-2198 ¹²⁸	
CLK SERIES	V8 6.3L FI			
CLS SERIES	V8 5.5L FI	G-180 ¹⁶⁶ G-918 ¹⁶⁶	GA-2198 ¹²⁸	
CLS SERIES	V8 6.3L FI			
E SERIES	V6 3.0L DI 24 VALV. DOHC DIESEL TURBO			
E SERIES	V6 3.5L FI	G-180 ¹⁶⁶ G-918 ¹⁶⁶	GA-2198 ¹²⁸	
E SERIES	V8 5.5L FI	G-180 ¹⁶⁶ G-918 ¹⁶⁶	GA-2198 ¹²⁸	
E SERIES	V8 6.3L FI			
G SERIES	V8 5.0L FI 24 VALV. SOHC	G-180 ¹⁶⁶ G-918 ¹⁶⁶	GA-2198 ¹²⁸	
G SERIES	V8 5.5L FI 24 VALV. SOHC	G-180 ¹⁶⁶ G-918 ¹⁶⁶	GA-2198 ¹²⁸	
GL SERIES	V6 3.0L DI 24 VALV. DOHC DIESEL TURBO			
GL SERIES	V8 4.5L FI 32 VALV. DOHC	G-180 ¹⁶⁶ G-918 ¹⁶⁶	GA-2198 ¹²⁸	
GL SERIES	V8 4.6L FI 32 VALV. DOHC	G-180 ¹⁶⁶ G-918 ¹⁶⁶	GA-2198 ¹²⁸	
GL SERIES	V8 5.5L FI	G-180 ¹⁶⁶ G-918 ¹⁶⁶	GA-2198 ¹²⁸	
ML SERIES	V6 3.0L DIESEL DOHC TURBO			
ML SERIES	V6 3.5L FI	G-180 ¹⁶⁶ G-918 ¹⁶⁶	GA-2198 ¹²⁸	
ML SERIES	V8 5.5L FI	G-180 ¹⁶⁶ G-918 ¹⁶⁶	GA-2198 ¹²⁸	
ML SERIES	V8 6.3L FI			
R SERIES	V12 5.5L FI 36 VALV. TWIN- TURBO			
R SERIES	V6 3.0L DIESEL 24 VALV. TURBO			
R SERIES	V6 3.5L FI	G-180 ¹⁶⁶ G-918 ¹⁶⁶	GA-2198 ¹²⁸	
R SERIES	V8 6.3L FI			
S SERIES	V12 5.5L FI 36 VALV. SOHC TWIN-TURBO			
S SERIES	V12 6.0L FI			
S SERIES	V12 6.5L FI			
S SERIES	V8 5.5L FI	G-180 ¹⁶⁶ G-918 ¹⁶⁶	GA-2198 ¹²⁸	
S SERIES	V8 6.3L FI			
SL SERIES	V12 5.5L FI 36 VALV. SOHC TWIN-TURBO			
SL SERIES	V12 6.0L FI			
SL SERIES	V12 6.5L FI			
SL SERIES	V8 5.5L FI 24 VALV. SOHC	G-180 ¹⁶⁶ G-918 ¹⁶⁶		GG-251
SL SERIES	V8 5.5L FI 32 VALV. DOHC	G-180 ¹⁶⁶ G-918 ¹⁶⁶	GA-2198 ¹²⁸	
SLK SERIES	V6 3.0L FI	G-180 ¹⁶⁶ G-918 ¹⁶⁶	GA-2198 ¹²⁸	
SLK SERIES	V6 3.5L FI	G-180 ¹⁶⁶ G-918 ¹⁶⁶	GA-2198 ¹²⁸	
SLK SERIES	V8 5.5L FI		GA-2198 ¹²⁸	
SLR SERIES	V8 5.5L FI 24 VALV. SOHC		GA-2195	

Marca - Año - Modelo Make-Year-Model	Motor Engine	Aceite Oil	Aire Air	Combustible Fuel
MERCEDES BENZ (continuación)				
2007				
B SERIES	L4 2.0L FI			
C SERIES	V6 2.5L FI	G-180 ¹⁶⁶ G-918 ¹⁶⁶	GA-2198	
C SERIES	V6 3.0L FI	G-180 ¹⁶⁶ G-918 ¹⁶⁶	GA-2198	
C SERIES	V6 3.5L FI	G-180 ¹⁶⁶ G-918 ¹⁶⁶	GA-2198	
CL SERIES	V12 5.5L FI			
CL SERIES	V12 6.0L FI			
CL SERIES	V8 5.5L FI	G-180 ¹⁶⁶ G-918 ¹⁶⁶	GA-2198	
CL SERIES	V8 6.3L FI			
CLK SERIES	V6 3.5L FI	G-180	GA-2198	
CLK SERIES	V8 5.5L FI	G-180		
CLK SERIES	V8 6.3L FI			
CLS SERIES	V8 5.5L FI	G-180 ¹⁶⁶ G-918 ¹⁶⁶	GA-2198	
CLS SERIES	V8 6.3L FI			
E SERIES	V6 3.5L FI	G-180	GA-2198	
E SERIES	V8 5.0L FI	G-180 ¹⁶⁶ G-918 ¹⁶⁶	GA-2198	
E SERIES	V8 5.5L FI	G-180		
E SERIES	V8 6.3L FI			
G SERIES	V8 5.0L FI	G-180 ¹⁶⁶ G-918 ¹⁶⁶	GA-2198	
G SERIES	V8 5.5L FI	G-180 ¹⁶⁶ G-918 ¹⁶⁶	GA-2198	
GL SERIES	V8 4.6L FI	G-180 ¹⁶⁶ G-918 ¹⁶⁶	GA-2198	
ML SERIES	V6 3.5L FI	G-180 ¹⁶⁶ G-918 ¹⁶⁶	GA-2198	
ML SERIES	V8 5.0L FI	G-180 ¹⁶⁶ G-918 ¹⁶⁶	GA-2198	
ML SERIES	V8 6.3L FI		GA-2198	
R SERIES	V6 3.5L FI	G-180 ¹⁶⁶ G-918 ¹⁶⁶	GA-2198	
R SERIES	V8 5.0L FI	G-180 ¹⁶⁶ G-918 ¹⁶⁶	GA-2198	
R SERIES	V8 6.3L FI			
S SERIES	V12 5.5L FI			
S SERIES	V12 6.0L FI			
S SERIES	V8 5.5L FI	G-180 ¹⁶⁶ G-918 ¹⁶⁶	GA-2198	
SL SERIES	V12 5.5L FI			
SL SERIES	V12 6.0L FI			
SL SERIES	V8 5.5L FI 24 VALV. SOHC	G-180 ¹⁶⁶ G-918 ¹⁶⁶		
SL SERIES	V8 5.5L FI 32 VALV. DOHC	G-180 ¹⁶⁶ G-918 ¹⁶⁶	GA-2198	
SLK SERIES	V6 3.0L FI	G-180 ¹⁶⁶ G-918 ¹⁶⁶	GA-2198 ¹²⁸	
SLK SERIES	V6 3.5L FI	G-180 ¹⁶⁶ G-918 ¹⁶⁶	GA-2198 ¹²⁸	
SLK SERIES	V8 5.5L FI		GA-2198 ¹²⁸	
SLR SERIES	V8 5.5L FI		GA-2195	
SPRINTER	L5 2.7L (OM647)	G-918	GA-5876 ⁵⁵ GA-475 ¹⁴⁰	
2006				
B SERIES	L4 2.0L FI			
C SERIES	V6 2.5L FI	G-180 ¹⁶⁶ G-918 ¹⁶⁶	GA-2198	
C SERIES	V6 3.0L FI	G-180 ¹⁶⁶ G-918 ¹⁶⁶	GA-2198	
C SERIES	V6 3.5L FI	G-180 ¹⁶⁶ G-918 ¹⁶⁶	GA-2198	
C SERIES	V8 5.5L FI	G-180 ¹⁶⁶ G-918 ¹⁶⁶	GA-2198	
CL SERIES	V12 5.5L FI			
CL SERIES	V12 6.0L FI			
CL SERIES	V12 6.5L FI			

Marca - Año - Modelo Make-Year-Model	Motor Engine	Aceite Oil	Aire Air	Combustible Fuel
MERCEDES BENZ (continuación)				
CL SERIES	V8 5.0L FI	G-180 ¹⁶⁶ G-918 ¹⁶⁶	GA-2198	
CL SERIES	V8 5.5L FI	G-180 ¹⁶⁶ G-918 ¹⁶⁶		GG-251
CLK SERIES	V6 3.5L FI	G-180 ¹⁶⁶ G-918 ¹⁶⁶	GA-2198	
CLK SERIES	V8 5.0L FI	G-180 ¹⁶⁶ G-918 ¹⁶⁶	GA-2198	
CLK SERIES	V8 5.5L FI	G-180 ¹⁶⁶ G-918 ¹⁶⁶		
CLS SERIES	V8 5.0L FI	G-180 ¹⁶⁶ G-918 ¹⁶⁶	GA-2198	
CLS SERIES	V8 5.5L FI	G-180 ¹⁶⁶ G-918 ¹⁶⁶		
E SERIES	6 CIL. 3.2L DIESEL			
E SERIES	V6 3.5L FI	G-180 ¹⁶⁶ G-918 ¹⁶⁶	GA-2198	
E SERIES	V8 5.0L FI	G-180 ¹⁶⁶ G-918 ¹⁶⁶	GA-2198	
E SERIES	V8 5.5L FI	G-180 ¹⁶⁶ G-918 ¹⁶⁶		
G SERIES	V8 5.0L FI	G-180 ¹⁶⁶ G-918 ¹⁶⁶	GA-2198	
G SERIES	V8 5.5L FI	G-180 ¹⁶⁶ G-918 ¹⁶⁶	GA-2198	
ML SERIES	V6 3.5L FI	G-180 ¹⁶⁶ G-918 ¹⁶⁶	GA-2195	
ML SERIES	V8 5.0L FI	G-180 ¹⁶⁶ G-918 ¹⁶⁶	GA-2195	
R SERIES	V6 3.5L FI	G-180 ¹⁶⁶ G-918 ¹⁶⁶	GA-2198	
R SERIES	V8 5.0L FI	G-180 ¹⁶⁶ G-918 ¹⁶⁶	GA-2198	
S SERIES	V12 5.5L FI			
S SERIES	V12 6.0L FI			
S SERIES	V6 3.7L FI	G-180 ¹⁶⁶ G-918 ¹⁶⁶	GA-2198	
S SERIES	V8 4.3L FI	G-180 ¹⁶⁶ G-918 ¹⁶⁶	GA-2198	
S SERIES	V8 5.0L FI	G-180 ¹⁶⁶ G-918 ¹⁶⁶	GA-2198	
S SERIES	V8 5.5L FI	G-180 ¹⁶⁶ G-918 ¹⁶⁶		GG-251
SL SERIES	V12 5.5L FI			
SL SERIES	V12 6.0L FI			
SL SERIES	V12 6.5L FI			
SL SERIES	V8 5.0L FI	G-180 ¹⁶⁶ G-918 ¹⁶⁶	GA-2198	
SL SERIES	V8 5.5L FI	G-180 ¹⁶⁶ G-918 ¹⁶⁶		GG-431
SLK SERIES	V6 3.0L FI	G-180 ¹⁶⁶ G-918 ¹⁶⁶	GA-2198 ¹²⁸	
SLK SERIES	V6 3.5L FI	G-180 ¹⁶⁶ G-918 ¹⁶⁶	GA-2198 ¹²⁸	
SLK SERIES	V6 5.5L FI	G-180 ¹⁶⁶ G-918 ¹⁶⁶	GA-2198 ¹²⁸	
SLR SERIES	V8 5.4L FI		GA-2195	
SPRINTER	L5 2.7L (OM647)	G-918	GA-5876 ⁵⁵ GA-475 ¹⁴⁰	
2005				
A SERIES	L4 1.6L FI			
A SERIES	L4 1.9L FI			
C SERIES	L4 1.8L FI			
C SERIES	V6 2.6L FI	G-180 ¹⁶⁶ G-918 ¹⁶⁶	GA-2198	
C SERIES	V6 3.2L FI	G-180 ¹⁶⁶ G-918 ¹⁶⁶	GA-2198	
C SERIES	V8 5.4L FI	G-180 ¹⁶⁶ G-918 ¹⁶⁶	GA-2198	
CL SERIES	V12 5.5L FI			
CL SERIES	V12 6.0L FI			
CL SERIES	V8 5.0L FI	G-180 ¹⁶⁶ G-918 ¹⁶⁶	GA-2198	

Marca - Año - Modelo Make-Year-Model	Motor Engine	Aceite Oil	Aire Air	Combustible Fuel
MERCEDES BENZ (continuación)				
CL SERIES	V8 5.5L FI	G-180 ¹⁶⁶ G-918 ¹⁶⁶		
CLK SERIES	V6 3.2L FI	G-180 ¹⁵³	GA-2198	
CLK SERIES	V8 5.0L FI	G-180 ¹⁵³	GA-2198	
CLK SERIES	V8 5.5L FI	G-180 ¹⁵³		
E SERIES	V6 3.2L DIESEL		GA-2198	
E SERIES	V6 3.2L FI	G-180 ¹⁵³	GA-2198	
E SERIES	V8 5.0L FI	G-180 ¹⁵³	GA-2198	
E SERIES	V8 5.5L FI	G-180 ¹⁵³		
G SERIES	V8 5.0L FI	G-180 ¹⁵³	GA-2198	
G SERIES	V8 5.5L FI	G-180 ¹⁵³	GA-2198	
ML SERIES	V6 3.7L FI	G-180 ¹⁶⁶ G-918 ¹⁶⁶	GA-2195	
ML SERIES	V8 5.0L FI	G-180 ¹⁶⁶ G-918 ¹⁶⁶	GA-2195	
S SERIES	V12 5.5L FI			
S SERIES	V8 4.3L FI	G-180 ¹⁵³	GA-2198	
S SERIES	V8 5.0L FI	G-180 ¹⁵³	GA-2198	
S SERIES	V8 5.5L FI	G-180 ¹⁵³		
SL SERIES	V12 5.5L FI			
SL SERIES	V8 5.0L FI	G-180 ¹⁶⁶ G-918 ¹⁶⁶	GA-2198	
SL SERIES	V8 5.5L FI	G-180 ¹⁶⁶ G-918 ¹⁶⁶		GG-431
SLK SERIES	V6 3.5L FI	G-180 ¹⁶⁶ G-918 ¹⁶⁶	GA-2198 ¹²⁸	
SLK SERIES	V8 5.5L FI	G-180 ¹⁶⁶ G-918 ¹⁶⁶	GA-2198 ¹²⁸	
SLR SERIES	V8 5.4L FI 36 VALV.		GA-2195	
SPRINTER	L5 2.7L (OM647)	G-918	GA-5876 ⁵⁵ GA-475 ¹⁴⁰	
2004				
A SERIES	L4 1.6L FI			
A SERIES	L4 1.9L FI			
C SERIES	L4 1.8L FI			
C SERIES	V6 2.6L FI	G-180 ¹⁵³	GA-2198	
C SERIES	V6 3.2L FI	G-180 ¹⁵³	GA-2198	
CL SERIES	V12 5.5L FI	G-180 ¹⁵³		
CL SERIES	V8 5.0L FI	G-180 ¹⁵³	GA-2198	
CL SERIES	V8 5.5L FI	G-180 ¹⁵³	GA-2198	
CLK SERIES	V6 3.2L FI	G-180 ¹⁵³	GA-2195	
CLK SERIES	V8 5.0L FI	G-180 ¹⁵³	GA-2198	
CLK SERIES	V8 5.5L FI	G-180 ¹⁵³	GA-2198	
E SERIES	V6 3.2L DIESEL		GA-2198	
E SERIES	V6 3.2L FI	G-180 ¹⁵³	GA-2198	
E SERIES	V8 5.0L FI	G-180 ¹⁵³	GA-2198	
E SERIES	V8 5.5L FI	G-180 ¹⁵³	GA-2198	
G SERIES	V8 5.0L FI	G-180 ¹⁵³	GA-2198	
G SERIES	V8 5.5L FI	G-180 ¹⁵³	GA-2198	
ML SERIES	V6 3.7L FI	G-180 ¹⁵³	GA-2195	
ML SERIES	V8 5.0L FI	G-180 ¹⁵³	GA-2195	
S SERIES	V12 5.5L FI			
S SERIES	V8 4.3L FI	G-180 ¹⁵³	GA-2198	
S SERIES	V8 5.0L FI	G-180 ¹⁵³	GA-2198	
S SERIES	V8 5.5L FI	G-180 ¹⁵³	GA-2198	
SL SERIES	V8 5.0L FI	G-180 ¹⁵³	GA-2198	
SL SERIES	V8 5.5L FI	G-180 ¹⁵³	GA-2198	GG-431
SLK SERIES	L4 2.0L FI	G-971	GA-2106	GG-431
SLK SERIES	L4 2.3L FI	G-971	GA-2106	GG-431
SLK SERIES	V6 3.2L FI	G-180 ¹⁵³	GA-2161 ⁸⁸	
SPRINTER	L5 2.7L (OM612)	G-918	GA-5876 ⁵⁵ GA-475 ¹⁴⁰	GPP-612
2003				
C SERIES	L4 1.8L SFI	G-971		
C SERIES	L4 2.3L FI	G-971		
C SERIES	V6 2.6L FI	G-180 ¹⁵³	GA-2198	
C SERIES	V6 3.2L FI	G-180 ¹⁵³	GA-2198	

Para números Gonher con Superíndice vea página 38
For Gonher with Superscript numbers see page 38

Marca - Año - Modelo Make-Year-Model	Motor Engine	Aceite Oil	Aire Air	Combustible Fuel
MERCEDES BENZ (continuación)				
CL SERIES	V12 5.5L FI	G-180 ¹⁵³		
CL SERIES	V8 5.0L FI	G-180 ¹⁵³	GA-2198	
CL SERIES	V8 5.5L FI	G-180 ¹⁵³	GA-2198	
CLK SERIES	V6 3.2L FI	G-180 ¹⁵³	GA-2198	
CLK SERIES	V8 4.3L FI	G-180 ¹⁵³		
CLK SERIES	V8 5.0L FI	G-180 ¹⁵³	GA-2198	
CLK SERIES	V8 5.5L FI	G-180 ¹⁵³	GA-2198	
E SERIES	V6 3.2L FI	G-180 ¹⁵³	GA-2198	
E SERIES	V8 5.0L FI	G-180 ¹⁵³	GA-2198	
E SERIES	V8 5.5L FI	G-180 ¹⁵³	GA-2198	
G SERIES	V8 5.0L FI	G-180 ¹⁵³	GA-2198	
G SERIES	V8 5.5L FI	G-180 ¹⁵³	GA-2198	
ML SERIES	V6 3.2L FI	G-180 ¹⁵³	GA-2195	
ML SERIES	V6 3.7L FI	G-180 ¹⁵³	GA-2195	
ML SERIES	V8 5.0L FI	G-180 ¹⁵³	GA-2195	
ML SERIES	V8 5.5L FI	G-180 ¹⁵³	GA-2198	
S SERIES	V12 5.5L FI	G-180 ¹⁵³		
S SERIES	V8 4.3L FI	G-180 ¹⁵³	GA-2198	
S SERIES	V8 5.0L FI	G-180 ¹⁵³	GA-2198	
S SERIES	V8 5.5L FI	G-180 ¹⁵³	GA-2198	
SL SERIES	V12 6.0L FI		GA-2184	
SL SERIES	V8 5.0L FI	G-180 ¹⁵³	GA-2198	
SL SERIES	V8 5.5L FI	G-180 ¹⁵³	GA-2198	GG-431
SLK SERIES	L4 2.0L FI	G-971	GA-2106	GG-431
SLK SERIES	L4 2.3L FI	G-971	GA-2106	GG-431
SLK SERIES	V6 3.2L FI	G-180 ¹⁵³	GA-2161 ⁸⁸	
SPRINTER	L5 2.7L (OM612)	G-918	GA-5876 ⁵⁵ GA-475 ¹⁴⁰	GPP-612
2002				
C SERIES	L4 1.8L FI	G-971	GA-2109	GG-420
C SERIES	L4 2.3L FI	G-971		
C SERIES	V6 2.6L FI	G-180 ¹⁵³	GA-2198	
C SERIES	V6 3.1L FI (C32 AMG)	G-180 ¹⁵³	GA-2170 ¹⁷	GG-420 ¹⁷
C SERIES	V6 3.2L FI	G-180 ¹⁵³	GA-2198	
CL SERIES	V12 6.0L FI	G-180 ¹⁵³		
CL SERIES	V8 5.0L FI	G-180 ¹⁵³	GA-2198	
CL SERIES	V8 5.5L FI	G-180 ¹⁵³	GA-2198	
CLK SERIES	V6 3.2L FI	G-180 ¹⁵³	GA-2195	
CLK SERIES	V8 4.3L FI	G-180 ¹⁵³	GA-2179 ¹²⁸	
CLK SERIES	V8 5.5L SFI	G-180 ¹⁵³	GA-2179 ⁷⁶	
E SERIES	V6 3.2L FI	G-180 ¹⁵³	GA-2198 ¹²⁸	
E SERIES	V8 4.3L FI	G-180 ¹⁵³	GA-2175	
E SERIES	V8 5.5L FI	G-180 ¹⁵³	GA-2179 ¹²⁸	
G SERIES	V8 5.0L FI	G-180 ¹⁵³	GA-2198	
ML SERIES	V6 3.2L FI	G-180 ¹⁵³	GA-2195	
ML SERIES	V8 5.0L FI	G-180 ¹⁵³	GA-2195	
ML SERIES	V8 5.5L FI	G-180 ¹⁵³	GA-2198	
S SERIES	V12 6.0L FI	G-180 ¹⁵³		
S SERIES	V8 4.3L FI	G-180 ¹⁵³	GA-2198	
S SERIES	V8 5.0L FI	G-180 ¹⁵³	GA-2198	
S SERIES	V8 5.5L FI	G-180 ¹⁵³	GA-2198	
SL SERIES	V12 6.0L FI		GA-2184	
SL SERIES	V8 5.0L FI	G-180 ¹⁵³	GA-2198	
SL SERIES	V8 5.5L FI	G-180 ¹⁶⁶ G-918 ¹⁶⁶		GG-431
SLK SERIES	L4 2.0L FI	G-971	GA-2106	GG-431
SLK SERIES	L4 2.3L FI	G-971	GA-2106	GG-431
SLK SERIES	V6 3.2L FI	G-180 ¹⁵³	GA-2161 ¹⁵¹	
2001				
A SERIES	L4 1.6L FI	G-910	GA-2181	GG-411
A SERIES	L4 1.9L FI	G-910	GA-2181	GG-411
C SERIES	L4 1.8L FI	G-971	GA-2109	GG-420
C SERIES	V6 2.6L FI	G-180 ¹⁵³	GA-2198	
C SERIES	V6 3.2L FI	G-180 ¹⁵³	GA-2198	
C SERIES	V8 4.3L FI	G-180 ¹⁵³		
S SERIES	V12 6.0L FI		GA-2184 ¹²⁸	GG-251 ¹¹⁸
CL SERIES	V8 5.0L FI	G-180 ¹⁵³	GA-2198	
CLK SERIES	V6 3.2L FI	G-180 ¹⁵³	GA-2195	
CLK SERIES	V8 4.3L FI	G-180 ¹⁵³	GA-2179 ¹²⁸	
E SERIES	6 CIL. 3.0L DIESEL		GA-2175	
E SERIES	V6 2.8L FI	G-918	GA-2164	GG-420
E SERIES	V6 3.2L FI	G-180 ¹⁵³	GA-2175	
E SERIES	V8 4.3L FI	G-180 ¹⁵³	GA-2175	
E SERIES	V8 5.5L FI	G-180 ¹⁵³	GA-2179 ¹²⁸	
G SERIES	V8 5.0L FI	G-918		GG-420
ML SERIES	V6 3.2L FI	G-180 ¹⁵³	GA-2195	
ML SERIES	V8 4.3L FI	G-180 ¹⁵³	GA-2195	
S SERIES	6 CIL. 3.2L FI	G-971		GG-251 ¹¹⁸
S SERIES	V12 6.0L FI		GA-2184 ¹²⁸	GG-420

Marca - Año - Modelo Make-Year-Model	Motor Engine	Aceite Oil	Aire Air	Combustible Fuel
MERCEDES BENZ (continuación)				
CL SERIES	V12 6.0L FI	G-180 ¹⁵³		
CL SERIES	V8 5.0L FI	G-180 ¹⁵³	GA-2198	
CL SERIES	V8 5.5L FI	G-180 ¹⁵³	GA-2198	
CLK SERIES	V6 3.2L FI	G-180 ¹⁵³	GA-2195	
CLK SERIES	V8 4.3L FI	G-180 ¹⁵³	GA-2179 ⁹¹	
CLK SERIES	V8 5.5L SFI	G-180 ¹⁵³	GA-2179 ⁹¹	
E SERIES	V6 3.2L FI	G-180 ¹⁵³		
E SERIES	V8 4.3L FI	G-180 ¹⁵³	GA-2175	
E SERIES	V8 5.5L FI	G-180 ¹⁵³	GA-2179 ⁹¹	
ML SERIES	V6 3.2L FI	G-180 ¹⁵³	GA-2195	
ML SERIES	V8 4.3L FI	G-180 ¹⁵³	GA-2195	
ML SERIES	V8 5.5L FI	G-180 ¹⁵³	GA-2198	
S SERIES	V12 6.0L FI	G-180 ¹⁵³		
S SERIES	V8 4.3L FI	G-180 ¹⁵³	GA-2198	
S SERIES	V8 5.0L FI	G-180 ¹⁵³	GA-2198	
S SERIES	V8 5.5L FI	G-180 ¹⁵³	GA-2198	
SL SERIES	V12 6.0L FI		GA-2184	
SL SERIES	V8 5.0L FI	G-180 ¹⁵³	GA-2198	
SLK SERIES	L4 2.0L FI	G-971	GA-2106	GG-431
SLK SERIES	L4 2.3L FI	G-971	GA-2106	GG-431
SLK SERIES	V6 3.2L FI	G-180 ¹⁵³	GA-2161	
2000				
A SERIES	L4 1.6L FI	G-910	GA-2181	GG-411
A SERIES	L4 1.9L FI	G-910	GA-2181	GG-411
C SERIES	L4 1.8L FI	G-971	GA-2109	GG-420
C SERIES	L4 2.3L FI	G-971		
C SERIES	V6 2.8L FI	G-180 ¹⁵³	GA-2195	
C SERIES	V8 4.3L FI	G-180 ¹⁵³	GA-2179 ⁹¹	GG-251
CL SERIES	V12 6.0L FI		GA-2184 ¹²⁸	GG-251 ¹¹⁸
CL SERIES	V8 5.0L FI	G-180 ¹⁵³	GA-2198	
CLK SERIES	V6 3.2L FI	G-180 ¹⁵³	GA-2195	
CLK SERIES	V8 4.3L FI	G-180 ¹⁵³	GA-2179 ⁹¹	
E SERIES	V6 3.2L FI	G-180 ¹⁵³	GA-2195	
E SERIES	V8 4.3L FI	G-180 ¹⁵³	GA-2175	
E SERIES	V8 5.5L FI	G-180 ¹⁵³	GA-2179 ⁹¹	
G SERIES	V8 5.0L FI	G-918		GG-420
ML SERIES	V6 3.2L FI	G-180 ¹⁵³	GA-2195	
ML SERIES	V8 4.3L FI	G-180 ¹⁵³	GA-2195	
ML SERIES	V8 5.5L FI	G-180 ¹⁵³	GA-2198	
S SERIES	L6 3.2L FI	G-971		GG-251 ¹¹⁸
S SERIES	V8 4.3L FI	G-180 ¹⁵³	GA-2198	
S SERIES	V8 5.0L FI	G-180 ¹⁵³	GA-2198	
SL SERIES	V12 6.0L FI		GA-2184	
SL SERIES	V8 5.0L FI	G-180 ¹⁵³		
SLK SERIES	L4 2.0L FI	G-971	GA-2106	GG-431
SLK SERIES	L4 2.3L FI	G-971	GA-2106	GG-431
1999				
C SERIES	L4 2.3L FI	G-971	GA-2195 ¹¹⁸	GG-251
C SERIES	V6 2.8L FI	G-180 ¹⁵³	GA-2195	
C SERIES	V8 4.3L SFI	G-180 ¹⁵³	GA-2179 ¹²⁸	
CL SERIES	V12 6.0L FI		GA-2184 ¹²⁸	GG-251 ¹¹⁸
CL SERIES	V8 5.0L FI	G-180 ¹⁵³	GA-2198	
CLK SERIES	V6 3.2L FI	G-180 ¹⁵³	GA-2195	
CLK SERIES	V8 4.3L FI	G-180 ¹⁵³	GA-2179 ¹²⁸	
E SERIES	6 CIL. 3.0L DIESEL		GA-2175	
E SERIES	V6 2.8L FI	G-918	GA-2164	GG-420
E SERIES	V6 3.2L FI	G-180 ¹⁵³	GA-2175	
E SERIES	V8 4.3L FI	G-180 ¹⁵³	GA-2175	
E SERIES	V8 5.5L FI	G-180 ¹⁵³	GA-2179 ¹²⁸	
G SERIES	V8 5.0L FI	G-918		GG-420
ML SERIES	V6 3.2L FI	G-180 ¹⁵³	GA-2195	
ML SERIES	V8 4.3L FI	G-180 ¹⁵³	GA-2195	
S SERIES	6 CIL. 3.2L FI	G-971		GG-251 ¹¹⁸
S SERIES	V12 6.0L FI		GA-2184 ¹²⁸	GG-420

Marca - Año - Modelo Motor Aceite Aire Combustible
Make-Year-Model Engine Oil Air Fuel

MERCEDES BENZ (continuación)

S SERIES	V8 4.2L FI			GG-251 ¹¹⁸
S SERIES	V8 5.0L FI			GG-251 ¹¹⁸
SL SERIES	V12 6.0L FI		GA-2184 ¹²⁸	GG-251 ¹¹⁸
SL SERIES	V8 5.0L FI	G-180 ¹⁵³		GG-251 ¹¹⁸
SLK SERIES	L4 2.3L FI	G-971	GA-2106	GG-251

1998

C SERIES	L4 2.3L FI	G-971	GA-2195 ¹¹⁸	
C SERIES	L6 2.8L FI	G-180 ¹⁵³	GA-2195	
C SERIES	V8 4.3L SFI	G-180 ¹⁵³	GA-2179 ¹²⁸	
CL SERIES	V12 6.0L FI		GA-2184	GG-189
CL SERIES	V8 5.0L FI	G-180 ¹⁵³	GA-2198	GG-189
CLK SERIES	V6 3.2L FI	G-180 ¹⁵³	GA-2195	
E SERIES	6 CIL. 3.0L DIESEL		GA-2175	
E SERIES	L6 3.2L FI	G-180 ¹⁵³	GA-2175	
E SERIES	V8 4.3L FI	G-180 ¹⁵³	GA-2175	
ML SERIES	V6 3.2L FI	G-180 ¹⁵³	GA-2195	
S SERIES	L6 3.2L FI	G-971		GG-189
S SERIES	V12 6.0L FI		GA-2184	GG-189
S SERIES	V8 4.2L FI			GG-189
S SERIES	V8 5.0L FI			GG-189
SL SERIES	V12 6.0L FI		GA-2184	GG-189
SL SERIES	V8 5.0L FI			GG-189
SLK SERIES	L4 2.3L FI	G-971	GA-2106	GG-251

1997

C SERIES	L4 2.3L FI	G-971		GG-251
C SERIES	L6 2.8L FI	G-971	GA-2195	
C SERIES	L6 3.6L FI	G-971		GG-189
E SERIES	6 CIL. 3.0L DIESEL		GA-2175	
E SERIES	L6 3.2L FI	G-971	GA-2175	
E SERIES	V8 4.2L FI		GA-2175	
S SERIES	L6 3.2L FI	G-971		GG-189
S SERIES	V12 6.0L FI		GA-2184	GG-189
S SERIES	V8 4.2L FI			GG-189
S SERIES	V8 5.0L FI			GG-189
SL SERIES	L6 3.2L FI	G-971		GG-189
SL SERIES	V12 6.0L FI		GA-2184	GG-189
SL SERIES	V8 5.0L FI			

1996

C SERIES	L4 2.2L FI	G-971	GA-2195	GG-189
C SERIES	L6 2.8L FI	G-971	GA-2195	GG-189
C SERIES	L6 3.6L FI	G-971	GA-2195	GG-189
E SERIES	6 CIL. 3.0L DIESEL		GA-2175	
E SERIES	L6 3.2L FI	G-971	GA-2175	GG-251
E SERIES	V6 3.2L FI (E320)	G-918 ⁷³	GA-2164 ⁷³	GG-420 ⁷³
E SERIES	V8 4.2L FI			GG-189
S SERIES	L6 3.2L FI	G-971		GG-189
S SERIES	V12 6.0L FI		GA-2184 ¹²⁸	GG-251
S SERIES	V8 4.2L FI			GG-189
S SERIES	V8 5.0L FI			GG-189
SL SERIES	L6 3.2L FI	G-971		GG-189
SL SERIES	V12 6.0L FI		GA-2184 ¹²⁸	GG-251
SL SERIES	V8 5.0L FI			GG-189

1995

C SERIES	L4 2.2L FI	G-971	GA-2195	GG-189
C SERIES	L6 2.8L FI	G-971	GA-2195	GG-189
C SERIES	L6 3.6L FI	G-971	GA-2195	GG-189
E SERIES	6 CIL. 3.0L DIESEL			
E SERIES	L6 3.2L FI	G-971		GG-251
E SERIES	V8 4.2L FI			GG-189
S SERIES	6 CIL. 3.5L DIESEL			GG-3 ²¹
S SERIES	L6 3.2L FI	G-971		GG-189
S SERIES	V12 6.0L FI		GA-2184 ¹²⁸	GG-189

Marca - Año - Modelo Motor Aceite Aire Combustible
Make-Year-Model Engine Oil Air Fuel

MERCEDES BENZ (continuación)

S SERIES	V8 4.2L FI			GG-189
S SERIES	V8 5.0L FI			GG-189
SL SERIES	L6 3.2L FI	G-971		GG-189
SL SERIES	V12 6.0L FI		GA-2184	GG-189
SL SERIES	V8 5.0L FI			GG-189

1994

C SERIES	L4 2.2L FI	G-971	GA-2195	GG-189
C SERIES	L6 2.8L FI	G-971	GA-2195	GG-189
E SERIES	L6 3.2L FI	G-971		GG-189
E SERIES	V8 4.2L FI			GG-189
E SERIES	V8 5.0L FI			GG-189
S SERIES	6 CIL. 3.5L DIESEL			GG-3 ²¹
S SERIES	L6 3.2L FI	G-971		GG-189
S SERIES	V12 6.0L FI		GA-2184 ¹²⁸	GG-189
S SERIES	V8 4.2L FI			GG-189
S SERIES	V8 5.0L FI			GG-189
SL SERIES	L6 3.2L FI	G-971		GG-189
SL SERIES	V12 6.0L FI		GA-2184 ¹²⁸	GG-189
SL SERIES	V8 5.0L FI			GG-189

1993

400E	V8 4.2L FI			GG-189
------	------------	--	--	--------

MERCURY

2010

GRAND MARQUIS	V8 4.6L FI FLEX FUEL	GP-68	GA-5056	
MARINER	L4 2.5L FI	G-70 ⁵² GP-58 ¹³⁶		GG-1872
MARINER	V6 3.0L FI			GG-1872
MARINER HYBRID	L4 2.5L	G-70 ⁵² GP-58 ¹³⁶		GG-1872
MILAN	L4 2.5L FI	GP-58		
MILAN	V6 3.0L FI FLEX FUEL			
MILAN HYBRID	L4 2.5L FI	GP-58		
MOUNTAINEER	V6 4.0L FI	GP-68	GA-395	GG-101
MOUNTAINEER	V8 4.6L FI	GP-68	GA-1540	GG-101

2009

GRAND MARQUIS	V8 4.6L FI 16 VALV. SOHC	GP-68	GA-5056	GG-986
GRAND MARQUIS	V8 4.6L FI 16 VALV. SOHC FLEX FUEL	GP-68	GA-5056	GG-986
MARINER	L4 2.5L FI 16 VALV. DOHC	G-70 ⁵² GP-58 ¹³⁶		
MARINER	V6 3.0L FI 24 VALV. DOHC	GP-406		
MARINER HYBRID	L4 2.5L FI 16 VALV. DOHC	G-70		GG-1872
MILAN	L4 2.3L FI 16 VALV. DOHC	G-70	GA-1572	
MILAN	V6 3.0L FI 24 VALV. DOHC	GP-68		
MOUNTAINEER	V6 4.0L FI 12 VALV. SOHC	GP-68	GA-395	GG-101 ⁸
MOUNTAINEER	V8 4.6L FI 24 VALV. SOHC	GP-68	GA-1540	GG-101 ⁸
SABLE	V6 3.5L FI 24 VALV. DOHC	GP-406 ⁶⁷ GP-3600 ⁴³	GA-1542	

2008

MARINER	L4 2.3L SFI	G-70 ⁵² GP-58 ¹³⁷	GA-224	GG-47
MARINER	V6 3.0L SFI	GP-68	GA-224	GG-47
MARINER HYBRID	L4 2.3L FI	G-70		GG-47
MILAN	L4 2.3L SFI	G-70 ⁵² GP-58 ¹³⁷	GA-1572	
MILAN	V6 3.0L SFI	GP-68		
MOUNTAINEER	V6 4.0L FI	GP-68	GA-395	GG-101
MOUNTAINEER	V8 4.6L SFI	GP-68	GA-1540	GG-101
SABLE	V6 3.5L FI 24 VALV. DOHC	GP-3600	GA-1542	

Marca - Año - Modelo Make-Year-Model	Motor Engine	Aceite Oil	Aire Air	Combustible Fuel
MERCURY (continuación)				
2007				
MARINER	L4 2.3L SFI	G-70 ⁵² GP-58 ¹³⁶	GA-224	GG-47
MARINER	V6 3.0L DURATEC	GP-68	GA-224	GG-47
MARINER HYBRID	L4 2.3L FI	G-70		GG-47
MILAN	L4 2.3L SFI 16 VALV.	G-70 ⁵² GP-58 ¹³⁶	GA-1572	
MILAN	V6 3.0L SFI DURATEC 24 VALV.	GP-68		
MONTEGO	V6 3.0L DURATEC 24 VALV.	GP-68		GG-986
MONTEREY	V6 3.8L FI	GP-3600	GA-479	GG-308
MONTEREY	V6 3.9L FI	GP-3600	GA-479	GG-986 ¹⁴⁶ GG-308 ⁵⁸
MONTEREY	V6 4.2L FI 12 VALV. SOHC	GP-3600	GA-479	GG-308
MOUNTAINEER	V6 4.0L FI	GP-68	GA-395	GG-101
MOUNTAINEER	V8 4.6L SFI	GP-68	GA-1540	GG-101
2006				
MARINER	V6 3.0L FI	GP-68	GA-224	GG-47
MARINER HYBRID	L4 2.3L FI	G-70		GG-47
MILAN	L4 2.3L SFI 16 VALV.	G-70 ⁵² GP-58 ¹³⁶	GA-1572	
MONTEGO	V6 3.0L FI	GP-68		GG-986
MONTEREY	V6 3.9L FI	GP-3600	GA-479	GG-986
MONTEREY	V6 4.2L FI 12 VALV. SOHC	GP-3600	GA-479	GG-308
MOUNTAINEER	V6 4.0L FI FLEX FUEL	GP-68	GA-395	GG-101
MOUNTAINEER	V6 4.0L SFI	GP-68	GA-395	GG-101
MOUNTAINEER	V8 4.6L SFI	GP-68	GA-1540	GG-101
2005				
MARINER	V6 3.0L FI	GP-68		GG-47
MONTEGO	V6 3.0L FI	GP-68		GG-986
MOUNTAINEER	V6 4.0L SFI	GP-68	GA-395	GG-101
MOUNTAINEER	V6 4.0L SFI FLEX FUEL	GP-68	GA-395	GG-101
MOUNTAINEER	V8 4.6L SFI	GP-68	GA-395	GG-101
SABLE	V6 3.0L FI 24 VALV.	GP-68	GA-224	GG-47
2004				
GRAND MARQUIS	V8 4.6L FI	GP-68	GA-5056	GG-986
MOUNTAINEER	V6 4.0L SFI FLEX FUEL	GP-68	GA-395	GG-308
MOUNTAINEER	V8 4.6L SFI	GP-68	GA-395	GG-101
SABLE	V6 3.0L FI 24 VALV.	GP-68	GA-224	GG-47
2003				
GRAND MARQUIS	V8 4.6L FI	GP-68	GA-5056	GG-986
MOUNTAINEER	V6 4.0L SFI FLEX FUEL	GP-68	GA-395	GG-308
MOUNTAINEER	V6 4.0L SFI SOHC	GP-68	GA-395	GG-101 ¹⁴⁶ GG-308 ⁵⁸
MOUNTAINEER	V8 4.6L SFI	GP-68	GA-395	GG-308
SABLE	V6 3.0L FI 24 VALV.	GP-68	GA-224	GG-307
2002				
COUGAR	L4 2.0L MFI ZETEC	GP-128	GA-127 GAC-9 ²⁴	GG-47
COUGAR	V6 2.5L MFI	GP-68	GA-128 GAC-9 ²⁴	GG-47
GRAND MARQUIS	V8 4.6L FI	GP-68	GA-5056	GG-986
MOUNTAINEER	V6 4.0L SFI FLEX FUEL	GP-68	GA-395	GG-308
MOUNTAINEER	V6 4.0L SFI SOHC	GP-68	GA-395	GG-308
MOUNTAINEER	V8 4.6L SFI	GP-68	GA-395	GG-308
SABLE	V6 3.0L FI 24 VALV.	GP-68	GA-224	GG-307
VILLAGER	V6 3.3L SFI SOHC	GP-149	GAD-118	GG-63
2001				
COUGAR	L4 2.0L SFI ZETEC	GP-128	GA-127 GAC-9 ²⁴	GG-47
COUGAR	V6 2.5L SFI HO	GP-68	GA-128 GAC-9 ²⁴	GG-47

Marca - Año - Modelo Make-Year-Model	Motor Engine	Aceite Oil	Aire Air	Combustible Fuel
MERCURY (continuación)				
GRAND MARQUIS	V8 4.6L FI	GP-68	GA-5056	GG-986
MOUNTAINEER	V6 4.0L SFI	GP-1	GA-158	GG-986
MOUNTAINEER	V8 5.0L SFI	GP-68	GA-158	GG-986
SABLE	V6 3.0L FI 24 VALV.	GP-68	GA-224	GG-307
VILLAGER	V6 3.3L SFI SOHC	GP-149	GAD-118	GG-63
2000				
COUGAR	L4 2.0L SFI ZETEC	GP-128	GA-127 GAC-9 ²⁴	GG-47
COUGAR	V6 2.5L SFI DURATEC	GP-68	GA-128 GAC-9 ²⁴	GG-47
GRAND MARQUIS	V8 4.6L FI	GP-68	GA-5056	GG-986
MOUNTAINEER	V6 4.0L SFI	GP-1	GA-158	GG-986
MOUNTAINEER	V8 5.0L SFI	GP-68	GA-158	GG-986
MYSTIQUE	L4 2.0L SFI ZETEC	GP-128	GA-127 GAC-9 ²⁴	GG-47
MYSTIQUE	V6 2.5L FI 24 VALV.	GP-68	GA-128 GAC-9 ²⁴	GG-47
SABLE	V6 3.0L FI 24 VALV.	GP-68	GA-224	GG-307
VILLAGER	V6 3.3L SFI	GP-149	GAD-118	GG-63
1999				
COUGAR	L4 2.0L SFI	GP-128	GA-127 GAC-9 ²⁴	GG-47
COUGAR	V6 2.5L SFI	GP-68	GA-128 GAC-9 ²⁴	GG-47
GRAND MARQUIS	V8 4.6L FI	GP-68	GA-5056	GG-986
MOUNTAINEER	V6 4.0L EFI	GP-1	GA-158 GAC-1 ²⁴	GG-1872
MOUNTAINEER	V8 5.0L EFI	GP-68	GA-158 GAC-1 ²⁴	GG-1872
MYSTIQUE	L4 2.0L SFI	GP-128	GA-127 GAC-9 ²⁴	GG-47
MYSTIQUE	V6 2.5L FI 24 VALV.	GP-68	GA-128 GAC-9 ²⁴	GG-47
SABLE	V6 3.0L FI 24 VALV.	GP-3600	GA-217	GG-47
VILLAGER	V6 3.3L SFI	GP-149	GAD-118	GG-63
1998				
GRAND MARQUIS	V8 4.6L FI	GP-68	GA-5056	GG-986
MOUNTAINEER	V6 4.0L EFI	GP-1	GA-158	GG-1872
MOUNTAINEER	V8 5.0L EFI	GP-68	GA-158	GG-1872
MYSTIQUE	L4 2.0L SFI	GP-128	GA-127 GAC-9 ²⁴	GG-47
MYSTIQUE	V6 2.5L FI 24 VALV.	GP-68	GA-128 GAC-9 ²⁴	GG-47
SABLE	V6 3.0L FI 24 VALV.	GP-3600	GA-217	GG-47
VILLAGER	V6 3.0L EFI	GP-3775 GP-3682 ⁷⁴	GAD-118	GG-94
1997				
COUGAR	V6 3.8L SFI	GP-3600	GA-275 GA-176 ⁴⁵	GG-92
COUGAR	V8 4.6L SFI	GP-68	GA-275	GG-92
GRAND MARQUIS	V8 4.6L FI	GP-68	GA-5056	GG-47
MOUNTAINEER	V8 5.0L EFI	GP-1 ¹³² GP-68 ¹³³	GA-158 ¹²⁵ GA-1614 ⁵³	GG-1872
MYSTIQUE	L4 2.0L SFI	GP-9	GA-127 GAC-9 ²⁴	GG-47
MYSTIQUE	V6 2.5L FI 24 VALV.	GP-68	GA-128 GAC-9 ²⁴	GG-47
SABLE	V6 3.0L FI 24 VALV.	GP-3600	GA-217	GG-47
VILLAGER	V6 3.0L EFI	GP-3775 GP-3682 ⁷⁴	GAD-118	GG-94
1996				
COUGAR	V6 3.8L SFI	GP-3600	GA-275 GA-176 ⁴⁵	GG-92
COUGAR	V8 4.6L SFI	GP-68	GA-275	GG-92
GRAND MARQUIS	V8 4.6L FI	GP-68	GA-5056	GG-47
MYSTIQUE	L4 2.0L SFI	GP-9	GA-127 GAC-9 ²⁴	GG-47

Marca - Año - Modelo Make-Year-Model	Motor Engine	Aceite Oil	Aire Air	Combustible Fuel
MERCURY (continuación)				
MYSTIQUE	V6 2.5L FI 24 VALV.	GP-68	GA-128 GAC-9 ²⁴	GG-47
SABLE	V6 3.0L FI 24 VALV.	GP-3600	GA-217	GG-47
VILLAGER	V6 3.0L SFI	GP-37 ⁷⁵ GP-3682 ⁷⁴	GAD-118	GG-94
1995				
COUGAR	V6 3.8L SFI	GP-3600	GA-275 GA-176 ⁴⁵	GG-92
COUGAR	V8 4.6L SFI	GP-68	GA-275	GG-92
GRAND MARQUIS	V8 4.6L FI	GP-68	GA-5056	GG-47
MYSTIQUE	L4 2.0L FI 16 VALV.	GP-9	GA-128 GAC-9 ²⁴	GG-47
MYSTIQUE	V6 2.5L FI 24 VALV.	GP-68	GA-128 GAC-9 ²⁴	GG-47
SABLE	V6 3.0L SFI 24 VALV.	GP-3600	GA-273	GG-47
SABLE	V6 3.8L FI	GP-3600	GA-273	GG-47
VILLAGER	V6 3.0L EFI	GP-37 ⁷⁵ GP-3682 ⁷⁴	GAD-118	GG-94
1994				
COUGAR	V6 3.8L FI	GP-3600	GA-275 GA-176 ⁴⁵	GG-92
COUGAR	V8 4.6L SFI SOHC	GP-68	GA-275	GG-92
GRAND MARQUIS	V8 4.6L FI	GP-68	GA-5056	GG-47
SABLE	V6 3.0L EFI OHV	GP-3600	GA-273	GG-47
SABLE	V6 3.8L FI	GP-3600	GA-273 GA-176 ⁴⁵	GG-47
TOPAZ	L4 2.3L FI	GP-9	GA-217	GG-47
TOPAZ	V6 3.0L SFI	GP-3600	GA-217	GG-47
VILLAGER	V6 3.0L EFI SOHC	GP-37 ⁷⁵ GP-3682 ⁷⁴	GAD-118	GG-94
1993				
COUGAR	V6 3.8L SFI	GP-3600	GA-275 GA-176 ⁴⁵	GG-92
COUGAR	V8 5.0L SFI HO	GP-1	GA-275	GG-92
GRAND MARQUIS	V8 4.6L FI	GP-68	GA-5056	GG-47
SABLE	V6 3.0L EFI	GP-3600	GA-273	GG-47
SABLE	V6 3.8L EFI	GP-3600	GA-273 GA-176 ⁴⁵	GG-47
TOPAZ	L4 2.3L FI	GP-9	GA-217	GG-47
TOPAZ	V6 3.0L EFI	GP-3600	GA-217	GG-47
VILLAGER	V6 3.0L EFI	GP-37 ⁷⁵ GP-3682 ⁷⁴	GAD-118	GG-94
1992				
COUGAR	V6 3.8L SFI	GP-3600	GA-275 GA-176 ⁴⁵	GG-92
COUGAR	V8 5.0L SFI HO	GP-1	GA-275	GG-92
GRAND MARQUIS	V8 4.6L FI	GP-68	GA-5056	GG-47
SABLE	V6 3.0L SFI	GP-3600	GA-273 GA-176 ⁴⁵	GG-47
SABLE	V6 3.8L SFI	GP-3600	GA-273 GA-176 ⁴⁵	GG-47
TOPAZ	L4 2.3L FI	GP-1	GA-217	GG-47
TOPAZ	V6 3.0L SFI	GP-3600	GA-217	GG-47
1991				
COUGAR	V6 3.8L SFI	GP-3600	GA-275 GA-176 ⁴⁵	GG-30
COUGAR	V8 5.0L SFI	GP-1	GA-275	GG-47
GRAND MARQUIS	V8 5.0L SFI	GP-1	GA-5056	GG-47
SABLE	V6 3.0L SFI	GP-3600	GA-273 GA-176 ⁴⁵	GG-47
SABLE	V6 3.8L SFI	GP-3600	GA-273 GA-176 ⁴⁵	GG-47
TOPAZ	L4 2.3L FI	GP-1	GA-274 GA-176 ⁴⁵	GG-47

Marca - Año - Modelo Make-Year-Model	Motor Engine	Aceite Oil	Aire Air	Combustible Fuel
MERCURY (continuación)				
1990				
COUGAR	V6 3.8L	GP-3600	GA-275 GA-176 ⁴⁵	GG-30
GRAND MARQUIS	V8 5.0L EFI	GP-1	GA-5056	GG-47
SABLE	V6 3.0L EFI	GP-3600	GA-273 GA-176 ⁴⁵	GG-47
SABLE	V6 3.8L EFI	GP-3600	GA-273 GA-176 ⁴⁵	GG-47
TOPAZ	L4 2.3L FI	GP-1	GA-274	GG-47
MINI				
2010				
CLUBMAN	L4 1.6L FI 16 VALV. SOHC	G-341		
CLUBMAN	L4 1.6L FI 16 VALV. SOHC TURBO	G-341		
COOPER	L4 1.6L FI 16 VALV. SOHC	G-341		
COOPER	L4 1.6L FI 16 VALV. SOHC TURBO	G-341		
COOPER S	L4 1.6L FI 16 VALV. SOHC TURBO	G-341		
CROSSMAN	L4 1.6L FI 16 VALV. SOHC TURBO			
2009				
CLUBMAN	L4 1.6L FI SOHC			
CLUBMAN	L4 1.6L FI SOHC TURBO			
COOPER	L4 1.6L FI 16 VALV. DOHC			
COOPER S	L4 1.6L FI 16 VALV.			
2008				
CLUBMAN	L4 1.6L FI			
COOPER	L4 1.6L FI			
COOPER S	L4 1.6L FI			
2007				
COOPER	L4 1.6L FI Y/O TURBO			
COOPER S	L4 1.6L FI Y/O TURBO			
2006				
COOPER	L4 1.6L FI 16 VALV.			
COOPER S	L4 1.6L FI 16 VALV.			
2005				
COOPER	L4 1.6L FI 16 VALV.			
COOPER S	L4 1.6L FI 16 VALV.			
2004				
COOPER	L4 1.6L FI 16 VALV.			
COOPER S	L4 1.6L FI 16 VALV.			
2003				
COOPER	L4 1.6L FI 16 VALV.			
COOPER S	L4 1.6L FI 16 VALV.			
2002				
COOPER	L4 1.6L FI 16 VALV.			
COOPER S	L4 1.6L FI 16 VALV.			
2000				
COOPER	L4 1.3L FI	GP-3682	GA-2122	
MITSUBISHI				
2010				
ECLIPSE	L4 2.4L FI 16 VALV.	GP-6811	GA-606	
ECLIPSE	V6 3.8L FI 24 VALV.	GP-149	GA-606	

Marca - Año - Modelo Make-Year-Model	Motor Engine	Aceite Oil	Aire Air	Combustible Fuel
MITSUBISHI (continuación)				
ENDEAVOR	V6 3.8L FI 24 VALV.	GP-149	GA-606	
GALANT	L4 2.4L FI 16 VALV.	GP-6811	GA-606	
LANCER	L4 2.0L FI 16 VALV.	GP-149		
LANCER	L4 2.0L FI TURBO	GP-6811	GA-607 ⁸⁴	
LANCER	L4 2.4L FI	GP-6811 ¹¹¹ GP-149		
OUTLANDER	L4 2.4L FI 16 VALV.			
OUTLANDER	V6 3.0L FI 24 VALV.			
RAIDER	V6 3.7L FI			
2009				
ECLIPSE	L4 2.4L FI 16 VALV. SOHC	GP-6811	GA-606	
ECLIPSE	V6 3.8L FI 24 VALV. SOHC	GP-149	GA-606	
ENDEAVOR	V6 3.8L FI 24 VALV. SOHC	GP-149	GA-606	
GALANT	L4 2.4L MFI	GP-6811	GA-606	
GALANT	V6 3.8L MFI	GP-149	GA-606	
LANCER	L4 2.0L FI 16 VALV. DOHC TURBO	GP-6811		
LANCER	L4 2.0L MFI	GP-149		
LANCER	L4 2.4L EFI	GP-149		
OUTLANDER	L4 2.4L FI 16 VALV. DOHC	GP-149		
OUTLANDER	V6 3.0L FI 24 VALV. SOHC	GP-91		
RAIDER	V6 3.7L FI 12 VALV. SOHC	GP-406		
RAIDER	V8 4.7L FI 16 VALV. SOHC	GP-68		
2008				
ECLIPSE	L4 2.4L MFI	GP-6811	GA-606	
ECLIPSE	V6 3.8L MFI	GP-149	GA-606	
ENDEAVOR	V6 3.8L MFI	GP-149	GA-606	
GALANT	L4 2.4L MFI	GP-6811	GA-606	
GALANT	V6 3.8L MFI	GP-149	GA-606	
GRANDIS	L4 2.4L FI SOHC 16 VALV.			
L200	2.4L GASOLINA			
L200	2.5L DIESEL			
LANCER	L4 2.0L FI TURBO	GP-6811		
LANCER	L4 2.0L MFI	GP-149		
OUTLANDER	L4 2.4L FI	GP-6811		
OUTLANDER	V6 3.0L FI	GP-91		
RAIDER	V6 3.7L FI 12 VALV. SOHC	GP-3600		
2007				
ECLIPSE	L4 2.4L MFI 16 VALV.	GP-6811	GA-606	
ECLIPSE	V6 3.8L MFI 24 VALV.	GP-145 ³⁷ GP-149 ³³	GA-606	
ENDEAVOR	V6 3.8L FI 24 VALV.	GP-145 ³⁷ GP-6811 GP-149 ³³		
GALANT	L4 2.4L 16 VALV.	GP-6811	GA-606	
GALANT	V6 3.8L 24 VALV.	GP-145 ³⁷ GP-149 ³³	GA-606	
GRANDIS	L4 2.4L MVEC 16 VALV.			
LANCER	L4 2.0L FI TURBO	GP-6811 ³⁰ GP-91 ²⁹	GA-607	
LANCER	L4 2.0L MFI 16 VALV.	GP-149	GA-607	
LANCER	L4 2.4L MFI 16 VALV.	GP-6811 ³⁰ GP-91 ²⁹	GA-607	
MONTERO	V6 3.5L MPFI 24 VALV.	GP-6811	GA-605	
OUTLANDER	V6 3.0L FI	GP-91	GA-607	
2006				
ECLIPSE	L4 2.4L FI 16 VALV.	GP-6811	GA-606	
ECLIPSE	V6 3.0L FI 24 VALV.	GP-149	GA-7344	
ECLIPSE	V6 3.8L FI	GP-145 ³⁷ GP-149 ³³	GA-606	
ENDEAVOR	V6 3.8L FI 24 VALV.	GP-145 ³⁷ GP-149 ³³	GA-606	
GALANT	L4 2.4L FI 16 VALV.	GP-6811	GA-606	
GALANT	V6 3.0L FI 24 VALV.	GP-6811	GA-7344	

Marca - Año - Modelo Make-Year-Model	Motor Engine	Aceite Oil	Aire Air	Combustible Fuel
MITSUBISHI (continuación)				
GALANT	V6 3.8L FI 24 VALV.	GP-145 ³⁷ GP-149 ³³	GA-606	
LANCER	L4 2.0L FI 16 VALV.	GP-149	GA-607	
LANCER	L4 2.0L FI TURBO 16 VALV.	GP-6811 ⁴⁰ GP-91 ³¹	GA-607	
LANCER	L4 2.4L MFI 16 VALV.	GP-6811 ³⁰ GP-91 ²⁹	GA-607	
MONTERO	V6 3.5L FI 24 VALV.	GP-149	GA-605	
MONTERO	V6 3.8L FI	GP-149		
OUTLANDER	L4 2.4L FI	GP-6811 ³⁰ GP-91 ²⁹	GA-607	
2005				
ECLIPSE	V6 3.0L FI 24 VALV.	GP-149	GA-7344	
ENDEAVOR	V6 3.8L FI 24 VALV.	GP-149	GA-606	
GALANT	L4 2.4L FI 16 VALV.	GP-149	GA-606	
GALANT	V6 3.0L FI 24 VALV.	GP-6811	GA-7344	
GALANT	V6 3.8L FI 24 VALV.	GP-149	GA-606	
LANCER	L4 2.0L FI 16 VALV.	GP-149	GA-607	
LANCER	L4 2.0L MFI TURBO 16 VALV.	GP-6811	GA-607 ⁸³	
LANCER	L4 2.4L MFI 16 VALV.	GP-6811	GA-607	
MONTERO	V6 3.8L FI	GP-149		
OUTLANDER	L4 2.4L FI	GP-149	GA-607	
2004				
ECLIPSE	V6 3.0L FI 24 VALV.	GP-6811	GA-7344	
ENDEAVOR	V6 3.8L FI 24 VALV.	GP-149	GA-606	
GALANT	L4 2.4L 16 VALV. SOHC	GP-149	GA-606	
GALANT	V6 3.0L FI 24 VALV.	GP-6811	GA-7344	
GALANT	V6 3.8L FI 24 VALV.	GP-149	GA-606	
LANCER	L4 2.0L EFI TURBO 16 VALV.	GP-6811	GA-607	
LANCER	L4 2.0L FI 16 VALV.	GP-149	GA-607	
LANCER	L4 2.4L MFI 16 VALV.	GP-6811	GA-607	
MONTERO	V6 3.5L FI 24 VALV.	GP-149	GA-605	
OUTLANDER	L4 2.4L FI	GP-6811	GA-607	
SPACE STAR	L4 1.6L FI		GA-283	
SPACE STAR	L4 1.8L FI			
2003				
DIAMANTE	V6 3.5L MFI 24 VALV.	GP-145		
ECLIPSE	V6 3.0L FI 24 VALV.	GP-6811	GA-7344	
ENDEAVOR	V6 3.8L FI 24 VALV.	GP-149	GA-606	
GALANT	V6 3.0L FI 24 VALV.	GP-6811	GA-7344	
LANCER	L4 2.0L FI CON O SIN TURBO	GP-149	GA-607	
MONTERO	V6 3.5L FI 24 VALV.	GP-149	GA-605	
OUTLANDER	L4 2.4L MFI	GP-6811	GA-607	
SPACE STAR	L4 1.6L FI		GA-283	
SPACE STAR	L4 1.8L FI			
2002				
DIAMANTE	V6 3.5L SFI 24 VALV.	GP-145		
LANCER	L4 2.0L MFI 16 VALV.	GP-149	GA-607	
2001				
DIAMANTE	V6 3.5L MFI 24 VALV.	GP-145		
2000				
DIAMANTE	V6 3.5L MFI	GP-145		
1999				
DIAMANTE	V6 3.5L MFI	GP-145		
1998				
DIAMANTE	V6 3.5L SFI	GP-145		

Marca - Año - Modelo Make-Year-Model	Motor Engine	Aceite Oil	Aire Air	Combustible Fuel
MITSUBISHI (continuación)				
1997				
DIAMANTE	V6 3.5L SFI	GP-145		
1996				
MIGHTY MAX	L4 2.4L MFI 2WD	GP-149	GA-7142	
PICK-UP	L4 2.4L FI SOHC	GP-149	GA-7142	
1995				
MIGHTY MAX	L4 2.4L MFI 2WD	GP-149	GA-7142	
PICK-UP	L4 2.4L FI SOHC	GP-149	GA-7142	
PICK-UP	V6 3.0L FI SOHC	GP-149	GA-7142	
1994				
MIGHTY MAX	L4 2.4L MFI 2WD	GP-149	GA-7142	
MIGHTY MAX	V6 3.0L MFI 4WD	GP-149	GA-7142	
PICK-UP	L4 2.4L FI SOHC	GP-149	GA-7142	
PICK-UP	V6 3.0L FI SOHC	GP-149	GA-7142	
3000	V6 3.0L FI DOHC	GP-149	GA-7142	
1993				
DIAMANTE	V6 3.0L FI	GP-149	GA-7142	GG-185
ECLIPSE	L4 1.8L FI SOHC	GP-149	GA-362	GG-185
ECLIPSE	L4 2.0 FI 16 VALV. DOHC	GP-149	GA-362	GG-185
EXPO	L4 1.8L FI	GP-149	GA-7344	GG-185
EXPO	L4 2.4L FI	GP-40	GA-7344	GG-185
GALANT	L4 2.0L FI	GP-40	GA-362	GG-185
MIGHTY MAX	L4 2.4L MFI 2WD	GP-40	GA-7142	
MIGHTY MAX	V6 3.0L MFI 4WD	GP-149	GA-7142	
MIRAGE	L4 1.5L FI	GP-149		GG-185
MIRAGE	L4 1.8L FI	GP-149		GG-185
MONTERO	V6 3.0L FI	GP-149	GA-7142	GG-232
PICK-UP	L4 2.4L FI SOHC	GP-149	GA-7142	
PICK-UP	V6 3.0L FI SOHC	GP-149	GA-7142	
PRECIS	L4 1.5L FI	GP-149	GA-362	
3000	V6 3.0L FI DOHC	GP-149	GA-7142	
1992				
DIAMANTE	V6 3.0L FI	GP-149	GA-7142	GG-185
ECLIPSE	L4 1.8L FI SOHC	GP-40	GA-362	GG-185
ECLIPSE	L4 2.0 FI 16 VALV. DOHC	GP-40	GA-362	GG-185
EXPO	L4 1.8L FI	GP-149	GA-7344	GG-185
EXPO	L4 2.4L FI	GP-40	GA-7344	GG-185
GALANT	L4 2.0L FI	GP-40	GA-362	GG-185
MIGHTY MAX	L4 2.4L MFI	GP-40	GA-7142	
MIGHTY MAX	V6 3.0L MFI 4WD	GP-40	GA-7142	
MIRAGE	L4 1.5L FI	GP-149	GA-362	GG-185
MIRAGE	L4 1.6L FI TURBO	GP-149	GA-362	GG-185
MONTERO	V6 3.0L FI	GP-149	GA-7142	GG-232
PICK-UP	L4 2.4L FI SOHC	GP-40	GA-7142	
PICK-UP	V6 3.0L FI SOHC	GP-40	GA-7142	
PRECIS	L4 1.5L FI	GP-40	GA-362	
1991				
MIGHTY MAX	L4 2.4L MFI	GP-40	GA-7142	
MIGHTY MAX	V6 3.0L MFI	GP-40	GA-7142	
MONTERO	V6 3.0L MFI SOHC	GP-40	GA-362	
PICK-UP	L4 2.4L FI SOHC	GP-40	GA-7142	
PICK-UP	V6 3.0L FI SOHC	GP-40	GA-7142	
1990				
MIGHTY MAX	L4 2.4L FI	GP-40	GA-7142	
MIGHTY MAX	V6 3.0L FI	GP-40	GA-362	
MONTERO	V6 3.0L MFI SOHC	GP-40	GA-362	
PICK-UP	L4 2.4L FI SOHC	GP-40		
PICK-UP	V6 3.0L FI SOHC	GP-40		

Marca - Año - Modelo Make-Year-Model	Motor Engine	Aceite Oil	Aire Air	Combustible Fuel
MITSUBISHI (continuación)				
VAN/WAGON	L4 2.4L FI	GP-40		GG-232
NISSAN				
2010				
370Z	V6 3.7L DI	GP-91		
ALTIMA	L4 2.5L DI 16 VALV.	GP-91	GA-1530	
ALTIMA	V6 3.5L DI 24 VALV.	GP-91	GAD-15	
ALTIMA HYBRID	L4 2.5L DI	GP-91	GA-1530	
ARMADA	V6 5.6L DI	GP-91		
ARMADA	V6 5.6L DI FLEX FUEL	GP-91		
CUBE	L4 1.8L FI 16 VALV. DOHC (MR18DE)	GP-91	GAD-116	
FRONTIER	L4 2.5L DI	GP-91	GA-1546	
FRONTIER	V6 4.0L DI	GP-91		GG-63
GT-R	V6 3.8L DI TWIN-TURBO			
MAXIMA	V6 3.5L DI	GP-91	GAD-15	
MURANO	V6 3.5L DI	GP-91	GAD-15	
PATHFINDER	V6 4.0L DI	GP-91		
PATHFINDER	V8 5.6L DI FLEX FUEL	GP-91		
PLATINA	L4 1.6L FI	GP-291	GA-291	GG-291
ROGUE	L4 2.5L DI	GP-91	GAD-117	
SENTRA	L4 2.0L DI	GP-91	GA-1529	
SENTRA	L4 2.5L DI	GP-91	GAD-117	
TITAN	V8 5.6L DI	GP-91		
TITAN	V8 5.6L DI FLEX FUEL	GP-91		
VERSA	L4 1.6L DI	GP-91	GAD-116	
VERSA	L4 1.8L FI 16 VALV. DOHC (MR18DE)	GP-91	GAD-116	
X-TERRA	V6 4.0L DI	GP-91		
2009				
350Z	V6 3.5L FI 24 VALV. DOHC	GP-91		
370Z	V6 3.7L FI 24 VALV. DOHC	GP-91		
ALTIMA	L4 2.5L FI 16 VALV. DOHC (QR25DE)	GP-91	GA-1530	
ALTIMA	V6 3.5L FI 24 VALV. DOHC (VQ35DE)	GP-91	GAD-15	
ALTIMA HYBRID	L4 2.5L FI 16 VALV. DOHC (QR25DE)	GP-91	GA-1530	
APRIO	L4 1.6L FI 16 VALV.	GP-291	GA-2158	
ARMADA	V8 5.6L FI 32 VALV. DOHC	GP-149	GA-300	
ARMADA	V8 5.6L FI 32 VALV. DOHC FLEX FUEL	GP-149	GA-300	
CUBE	L4 1.8L FI 16 VALV. DOHC (MR18DE)	GP-91	GAD-116	
D22 (FRONTIER)	L4 2.5L DIESEL TURBO (YD25)	G-25	GAD-36	GPP-523
FRONTIER	L4 2.5L FI 16 VALV. DOHC (QR25DE)	GP-91	GA-1546	
FRONTIER	V6 4.0L FI 24 VALV. DOHC (VQ40DE)	GP-149	GA-300	
GT-R	V6 3.8L TWIN TURBO	GP-91	GA-1530	
MAXIMA	V6 3.5L FI 24 VALV. DOHC	GP-91	GAD-15	
MURANO	V6 3.5L FI 24 VALV. DOHC	GP-91	GAD-15	
PATHFINDER	V6 4.0L FI 24 VALV. DOHC	GP-149	GA-300	
PATHFINDER	V8 5.6L FI 32 VALV. DOHC FLEX FUEL	GP-149	GA-300	
PICK-UP	L4 2.4L (KA24DE)	GP-149	GAD-294	GG-137
PICK-UP	L4 2.5L DIESEL TURBO (YD25)	G-25		
PLATINA	L4 1.6L FI	GP-291	GA-291	GG-291
QUEST	V6 3.5L FI 24 VALV. DOHC	GP-91	GAD-15	
ROGUE	L4 2.5L DI 16 VALV. DOHC	GP-91	GAD-117	
SENTRA	L4 2.0L FI 16 VALV. DOHC	GP-91	GA-1529	
SENTRA	L4 2.5L FI	GP-91	GAD-117	
TIIDA	L4 1.8L FI 16 VALV. (MR18DE)	GP-91	GAD-116	
TITAN	V8 5.6L FI 32 VALV. DOHC	GP-149	GA-300	

Marca - Año - Modelo Make-Year-Model	Motor Engine	Aceite Oil	Aire Air	Combustible Fuel
NISSAN (continuación)				
TITAN	V8 5.6L FI 32 VALV. DOHC FLEX FUEL	GP-149	GA-300	
TSURU	L4 1.6L FI 16 VALV. DOHC (GA16DNE)	GP-3682	GAD-117	GG-137
URVAN	L4 2.5L FI 16 VALV. (QR25DE)	GP-149	GAK-16	
URVAN	L4 3.0L FI 16 VALV. TURBO DIESEL (ZD30DDTI)		GAK-16	
VERSA	L4 1.8L FI 16 VALV. DOHC	GP-91	GAD-116	
X-TERRA	V6 4.0L FI 24 VALV. DOHC	GP-149	GA-300	
X-TRAIL	L4 2.5L FI	GP-149	GAD-15	

2008

350Z	V6 3.5L FI	GP-91		
ALTIMA	L4 2.5L FI	GP-149	GA-1530	
ALTIMA	V6 3.5L FI	GP-149	GAD-15	
ALTIMA HYBRID	L4 2.5L FI 16 VALV. DOHC	GP-91	GA-1530	
APRIO	L4 1.6L (K4M) 16 VALV.	GP-291	GA-2158	
ARMADA	V8 5.6L FI	GP-149	GA-300	
CABSTAR	L4 2.5L (YD25DDTI) DIESEL	GP-171		
D22 (FRONTIER)	L4 2.5L DIESEL TURBO (YD25)	G-25	GAD-36	GPP-523
FRONTIER	L4 2.5L FI 16 VALV. DOHC (QR25DE)	GP-91	GA-1546	
FRONTIER	V6 4.0L FI	GP-149	GA-300	GG-63
MAXIMA	V6 3.5L FI	GP-91	GAD-15	
MICRA	L4 1.4L FI (CR14DE) 16 VALV.	GP-156	GAD-315	
MURANO	V6 3.5L FI	GP-91	GAD-15	
PATHFINDER	V6 4.0L SFI	GP-149	GA-300	
PATHFINDER	V8 5.6L FI	GP-149	GA-300	
PICK-UP	L4 2.4L (KA24DE)	GP-149	GAD-294	GG-137
PICK-UP	L4 2.5L DIESEL TURBO (YD25)	G-25		
PLATINA	L4 1.6L FI (K4M) 16 VALV. DOHC	GP-291	GA-291	GG-291
QUEST	V6 3.5L SFI	GP-91	GAD-15	
ROGUE	L4 2.5L (QR25DE) SFI	GP-91	GAD-117	
SENTRA	L4 2.0L FI	GP-91	GA-1529	
SENTRA	L4 2.5L FI	GP-91	GAD-117	
TIIDA	L4 1.8L SFI	GP-91	GAD-116	
TITAN	V8 5.6L FI	GP-149	GA-300	
TSURU	L4 1.6L FI 16 VALV. DOHC (GA16DNE)	GP-3682	GAD-117	GG-137
URVAN	L4 2.5L FI 16 VALV. (QR25DE)	GP-149	GAK-16	
URVAN	L4 3.0L FI 16 VALV. TURBO DIESEL (ZD30DDTI)		GAK-16	
VERSA	L4 1.8L FI 16 VALV. DOHC (MR18DE)	GP-91	GAD-116	
VERSA	L4 2.5L FI (QR25DE)	GP-91	GAD-117	
X-TERRA	V6 4.0L FI	GP-149	GA-300	
X-TRAIL	L4 2.5L FI	GP-149	GAD-15	

2007

350Z	V6 3.5L (VQ35DE) 24 VALV.	GP-91	GAD-15	
ALTIMA	L4 2.5L (QR25) 16 VALV.	GP-149	GA-1530	
ALTIMA	V6 3.5L (VQ35) 24 VALV.	GP-149	GAD-15	
ALTIMA HYBRID	L4 2.5L FI 16 VALV. DOHC (QR25DE)	GP-91	GA-1530	
ARMADA	V8 5.6L (ENDURANCE) 32 VALV.	GP-149	GA-300	
D22 (FRONTIER)	L4 2.5L DIESEL TURBO (YD25)	G-25	GAD-36	GPP-523
FRONTIER	L4 2.4L (KA24DE) 16 VALV.	GP-149		
FRONTIER	L4 2.5L FI 16 VALV. DOHC (QR25DE)	GP-91	GA-1546	
FRONTIER	V6 4.0L FI 24 VALV.	GP-149	GA-300	GG-63
MAXIMA	V6 3.5L (VQ35) MPFI 24 VALV.	GP-91	GAD-15	
MICRA	L4 1.4L (CR14DE) 16 VALV.	GP-156	GAD-315	

Marca - Año - Modelo Make-Year-Model	Motor Engine	Aceite Oil	Aire Air	Combustible Fuel
NISSAN (continuación)				
MURANO	V6 3.5L (VQ35) 24 VALV.	GP-149	GAD-15	
PATHFINDER	V6 4.0L (VQ40) 24 VALV.	GP-149	GA-300	
PICK-UP	L4 2.4L (KA24DE)	GP-149	GAD-294	GG-137
PICK-UP	L4 2.4L (KA24E)	GP-3682	GAD-294	GG-137
PLATINA	L4 1.6L (K4M) 16 VALV.	GP-291	GA-291	GG-291
QUEST	V6 3.5L (VQ35) SFI 24 VALV.	GP-91	GAD-15	
SENTRA	L4 2.0L 16 VALV.	GP-91	GA-1529	
SENTRA	L4 2.5L FI	GP-91	GAD-117	
TIIDA	L4 1.8L (MR18DE) 16 VALV.	GP-91	GAD-116	
TITAN	V8 5.6L (VK56DE) 32 VALV.	GP-149	GA-300	
TSURU	L4 1.6L (GA16DNE) 16 VALV.	GP-3682	GAD-117	GG-137
URVAN	L4 2.4L (KA24DE) 16 VALV.			
VERSA	L4 1.8L FI 16 VALV. DOHC (MR18DE)	GP-91	GAD-116	
X-TERRA	V6 4.0L (VQ40) 24 VALV.	GP-149	GA-300	
X-TRAIL	L4 2.5L (QR25DE) 16 VALV.	GP-91	GAD-15	GG-63

2006

350Z	V6 3.5L FI 24 VALV.	GP-91	GAD-15	
ALTIMA	L4 2.5L FI 16 VALV.	GP-149	GAD-15	
ALTIMA	V6 3.5L FI 24 VALV.	GP-149	GAD-15	
ARMADA	V8 5.6L FI 32 VALV.	GP-149	GA-300	
FRONTIER	L4 2.4L FI 16 VALV.	GP-91		
FRONTIER	L4 2.5L FI 16 VALV. DOHC (QR25DE)	GP-91	GA-1546	
FRONTIER	V6 3.3L FI 24 VALV.	GP-149	GAD-15	GG-63
FRONTIER	V6 4.0L FI	GP-149	GA-300	
MAXIMA	V6 3.5L FI 24 VALV.	GP-91	GAD-15	
MICRA	L4 1.4L FI	GP-156	GAD-315	
MURANO	V6 3.5L FI 24 VALV.	GP-91	GAD-15	
PATHFINDER	V6 4.0L FI	GP-149	GA-300	
PICK-UP	L4 2.4L (KA24DE)	GP-149	GAD-294	GG-137
PICK-UP	L4 2.4L (KA24E)	GP-3682	GAD-294	GG-137
PLATINA	L4 1.6L FI	GP-291	GA-291	GG-291
QUEST	V6 3.3L FI	GP-91	GAD-15	
SENTRA	L4 1.8L FI	GP-149	GAD-15	GG-137
SENTRA	L4 2.5L FI	GP-149	GAD-15	GG-137
TITAN	V8 5.6L FI	GP-149	GA-300	
TSURU	L4 1.6L FI	GP-3682	GAD-117	GG-137
URVAN	L4 2.4L (KA24DE) 16 VALV.	GP-149	GAD-294	GG-63
X-TERRA	L4 2.4L FI 16 VALV.	GP-149	GAD-294	GG-63
X-TERRA	V6 3.3L FI	GP-91	GAD-15	GG-63
X-TERRA	V6 4.0L FI 24 VALV. DOHC (VQ40DE)	GP-149	GA-300	
X-TRAIL	L4 2.5L FI 16 VALV.	GP-91	GAD-15	GG-63

2005

350Z	V6 3.5L FI 24 VALV.	GP-149	GAD-15	
ALMERA	L4 1.8L FI 16 VALV.	GP-91	GAD-15	GG-137
ALTIMA	L4 2.5L FI 16 VALV.	GP-149	GAD-15	
ALTIMA	V6 3.5L FI 24 VALV.	GP-149	GAD-15	
ARMADA	V8 5.6L FI	GP-149	GA-300	
FRONTIER	L4 2.4L FI	GP-91		
FRONTIER	L4 2.5L FI 16 VALV. DOHC (QR25DE)	GP-91	GA-1546	
FRONTIER	V6 4.0L FI	GP-149	GA-300	GG-63
MAXIMA	V6 3.5L FI 24 VALV.	GP-149	GAD-15	
MICRA	L4 1.4L FI	GP-156	GAD-315	
MURANO	V6 3.5L FI 24 VALV.	GP-149	GAD-15	
PATHFINDER	V6 4.0L FI	GP-149	GA-300	
PICK-UP	L4 2.4L (KA24DE)	GP-149	GAD-294	GG-137
PICK-UP	L4 2.4L (KA24E)	GP-3682	GAD-294	GG-137
PLATINA	L4 1.6L FI	GP-291	GA-291	GG-291
QUEST	V6 3.3L FI	GP-149	GAD-15	
SENTRA	L4 1.8L FI	GP-149	GAD-15	GG-137
SENTRA	L4 2.5L FI	GP-149	GAD-15	GG-137
TITAN	V8 5.6L FI	GP-149	GA-300	

Marca - Año - Modelo Make-Year-Model	Motor Engine	Aceite Oil	Aire Air	Combustible Fuel
NISSAN (continuación)				
TSURU	L4 1.6L FI	GP-3682	GAD-117	GG-137
URVAN	L4 2.4L (KA24DE) 16 VALV.	GP-149		GG-63
URVAN II	L4 2.4L FI 16 VALV.	GP-149	GAD-34	GG-63
X-TERRA	L4 2.4L FI 16 VALV.	GP-149	GAD-294	GG-63
X-TERRA	V6 3.3L FI	GP-91	GAD-15	GG-63
X-TERRA	V6 4.0L FI 24 VALV. DOHC (VQ40DE)	GP-149	GA-300	
X-TRAIL	L4 2.5L FI 16 VALV.	GP-91	GAD-15	GG-63
2004				
350Z	V6 3.5L FI 24 VALV.	GP-91	GAD-15	
ALMERA	L4 1.8L FI 16 VALV.	GP-91	GAD-15	GG-137
ALTIMA	L4 2.5L FI 16 VALV.	GP-149	GAD-15	GG-137
ALTIMA	V6 3.5L FI 24 VALV.	GP-91	GAD-15	GG-137
ARMADA	V8 5.6L SFI	GP-149	GA-300	
FRONTIER	L4 2.4L FI	GP-91	GAD-294	
FRONTIER	V6 3.3L FI	GP-91	GAD-15	
MAXIMA	V6 3.5L FI 24 VALV.	GP-149	GAD-15	GG-63
MICRA	L4 1.4L FI	GP-156	GAD-315	
MURANO	V6 3.5L FI 24 VALV.	GP-149	GAD-15	
PATHFINDER	V6 3.5L FI	GP-91	GAD-15	GG-63
PATHFINDER	V8 5.6L SFI	GP-149	GA-300	
PICK-UP	L4 2.4L (KA24DE)	GP-149	GAD-294	GG-137
PICK-UP	L4 2.4L (KA24E)	GP-3682	GAD-294	GG-137
PLATINA	L4 1.6L FI	GP-291	GA-291	GG-291
QUEST	V6 3.3L FI	GP-91	GAD-15	
SENTRA	L4 1.8L FI	GP-149	GAD-15	GG-137
SENTRA	L4 2.5L FI	GP-149	GAD-15	GG-137
TITAN	V8 5.6L FI	GP-149	GA-300	
TSUBAME	L4 1.6L FI 16 VALV.	GP-37	GAD-15	GG-63
TSURU	L4 1.6L FI	GP-37	GAD-117	GG-137
URVAN	L4 2.4L FI 16 VALV.	GP-149	GAD-29	GG-63
URVAN II	L4 2.4L FI 16 VALV.	GP-149	GAD-34	GG-63
X-TERRA	L4 2.4L FI 16 VALV.	GP-149	GAD-294	GG-63
X-TERRA	V6 3.3L FI	GP-91	GAD-15	GG-63
X-TRAIL	L4 2.5L FI 16 VALV.	GP-91	GAD-15	GG-63
2003				
350Z	V6 3.5L FI 24 VALV.	GP-91	GAD-15	
ALMERA	L4 1.8L FI 16 VALV.	GP-91	GAD-15	GG-137
ALTIMA	L4 2.5L FI 16 VALV.	GP-149	GAD-15	GG-137
ALTIMA	V6 3.5L FI 24 VALV.	GP-91	GAD-15	GG-137
FRONTIER	L4 2.4L FI	GP-91	GAD-294	
FRONTIER	V6 3.3L FI	GP-91	GAD-15	
MAXIMA	V6 3.0L FI 24 VALV.	GP-149	GAD-15	GG-63
MURANO	V6 3.5L FI (VQ35DE)	GP-149	GAD-15	
PATHFINDER	V6 3.5L FI 24 VALV.	GP-91	GAD-15	GG-63
PICK-UP	L4 2.4L (KA24E)	GP-3682	GAD-294	GG-137
PLATINA	L4 1.6L FI	GP-291	GA-291	GG-291
QUEST	V6 3.0L FI	GP-3682	GAD-118	GG-94
QUEST	V6 3.3L FI	GP-149	GAD-118	GG-63
SENTRA	L4 1.8L FI	GP-149	GAD-15	GG-137
SENTRA	L4 2.5L FI	GP-149	GAD-15	GG-137
TSUBAME	L4 1.6L FI 16 VALV.	GP-37	GAD-15	GG-63
TSURU	L4 1.6L FI	GP-37	GAD-117	GG-137
URVAN	L4 2.4L FI 16 VALV.	GP-149	GAD-29	GG-63
URVAN II	L4 2.4L FI 16 VALV.	GP-149	GAD-34	GG-63
X-TERRA	L4 2.4L FI 16 VALV.	GP-149	GAD-294	GG-63
X-TERRA	V6 3.3L FI	GP-91	GAD-15	GG-63
X-TRAIL	L4 2.5L FI 16 VALV.	GP-91	GAD-15	GG-63
2002				
ALMERA	L4 1.8L FI 16 VALV.	GP-91	GAD-15	GG-137
ALTIMA	L4 2.5L FI 16 VALV.	GP-149	GAD-15	GG-137
ALTIMA	V6 3.5L FI 24 VALV.	GP-91	GAD-15	GG-137
FRONTIER	L4 2.4L FI	GP-91	GAD-294	

Marca - Año - Modelo Make-Year-Model	Motor Engine	Aceite Oil	Aire Air	Combustible Fuel
NISSAN (continuación)				
FRONTIER	V6 3.3L FI	GP-91	GAD-15	
MAXIMA	V6 3.0L FI 24 VALV.	GP-149	GAD-15	GG-63
PATHFINDER	V6 3.5L FI 24 VALV.	GP-91	GAD-15	GG-63
PICK-UP	L4 2.4L (KA24E)	GP-3682	GAD-294	GG-137
PLATINA	L4 1.6L FI	GP-291	GA-291	GG-291
QUEST	V6 3.3L FI	GP-149	GAD-118	GG-63
SENTRA	L4 1.8L FI	GP-149	GAD-15	GG-137
SENTRA	L4 2.5L FI	GP-91	GAD-15	
TSUBAME	L4 1.6L FI 16 VALV.	GP-37	GAD-15	GG-63
TSURU	L4 1.6L FI	GP-37	GAD-117	GG-137
URVAN	L4 2.4L FI 16 VALV.	GP-149	GAD-29	GG-63
URVAN II	L4 2.4L FI 16 VALV.	GP-149	GAD-34	GG-63
X-TERRA	L4 2.4L FI 16 VALV.	GP-149	GAD-294	GG-63
X-TERRA	V6 3.3L FI	GP-91	GAD-15	GG-63
X-TRAIL	L4 2.5L FI 16 VALV.	GP-91	GAD-15	GG-63
2001				
ALMERA	L4 1.8L FI 16 VALV.	GP-91	GAD-15	GG-137
ALTIMA	L4 2.4L FI 16 VALV.	GP-149	GAD-15	GG-137
FRONTIER	L4 2.4L FI	GP-91	GAD-294	
FRONTIER	V6 3.3L FI	GP-91	GAD-15	
LUCINO	L4 1.6L FI (GA16)	GP-37	GAD-15	
LUCINO	L4 2.0L FI (SR20)	GP-149	GAD-117	GG-137
MAXIMA	V6 3.0L FI 24 VALV.	GP-149	GAD-15	GG-63
PATHFINDER	V6 3.5L FI 24 VALV.	GP-149	GAD-15	GG-63
PICK-UP	L4 2.4L (KA24E)	GP-3682	GAD-294	GG-137
QUEST	V6 3.3L FI	GP-149	GAD-118	GG-94
SENTRA	L4 1.8L FI	GP-149	GAD-15	GG-137
SENTRA	L4 2.0L FI	GP-149	GAD-15	GG-137
TSUBAME	L4 1.6L FI 16 VALV.	GP-37	GAD-15	GG-63
TSURU	L4 1.6L FI	GP-37	GAD-117	GG-137
URVAN	L4 2.4L FI 16 VALV.	GP-149	GAD-294	GG-63
URVAN II	L4 2.4L FI 16 VALV.	GP-149	GAD-294	GG-63
X-TERRA	L4 2.4L FI 16 VALV.	GP-149	GAD-294	GG-63
X-TERRA	V6 3.3L FI	GP-91	GAD-15	GG-63
2000				
ALTIMA	L4 2.4L FI 16 VALV.	GP-149	GAD-15	GG-137
FRONTIER	L4 2.4L FI	GP-91	GAD-294	
FRONTIER	V6 3.3L FI	GP-91	GAD-15	
LUCINO	L4 1.6L FI		GAD-15	
LUCINO	L4 2.0L FI	GP-91	GAD-117	GG-137
MAXIMA	V6 3.0L FI 24 VALV.	GP-149	GAD-15	GG-63
PATHFINDER	V6 3.3L FI	GP-149	GAD-15	GG-63
PICK-UP	L4 2.4L (KA24E)	GP-3682	GAD-294	GG-137
QUEST	V6 3.3L FI	GP-149	GAD-118	GG-94
SENTRA	L4 1.6L FI	GP-3682	GAD-117	GG-137
SENTRA	L4 2.0L FI	GP-91	GAD-15	
TSUBAME	L4 1.6L FI 16 VALV.	GP-37	GAD-15	GG-63
TSURU	L4 1.6L FI	GP-37	GAD-117	GG-137
URVAN	L4 2.4L FI 16 VALV.	GP-149	GAD-294	GG-63
X-TERRA	L4 2.4L FI 16 VALV.	GP-149	GAD-294	GG-63
X-TERRA	V6 3.3L FI	GP-91	GAD-15	GG-63
1999				
ALTIMA	L4 2.4L FI 16 VALV.	GP-149	GAD-15	GG-137
FRONTIER	L4 2.4L FI	GP-149	GAD-294	
FRONTIER	V6 3.3L FI (E)	GP-149	GAD-15	GG-63
LUCINO	L4 1.6L FI		GAD-15	
LUCINO	L4 2.0L FI	GP-91	GAD-15	GG-63
MAXIMA	V6 3.0L FI 24 VALV.	GP-149	GAD-15	GG-63
PATHFINDER	V6 3.3L FI	GP-149	GAD-15	GG-63
PATHFINDER	V6 3.5L FI	GP-149	GAD-15	GG-63
PICK-UP	L4 2.4L (KA24E)	GP-3682	GAD-294	GG-137
QUEST	V6 3.3L FI	GP-149	GAD-118	GG-94
SENTRA	L4 1.6L FI	GP-3682	GAD-15	GG-63

Marca - Año - Modelo Make-Year-Model	Motor Engine	Aceite Oil	Aire Air	Combustible Fuel
NISSAN (continuación)				
SENTRA	L4 2.0L FI	GP-91	GAD-15	GG-63
TSUBAME	L4 1.6L FI 16 VALV.	GP-37	GAD-15	GG-63
TSURU	L4 1.6L FI	GP-37	GAD-117	GG-137
1998				
240SX	L4 2.4L FI 16 VALV.	GP-37	GAD-15	GG-63
ALTIMA	L4 2.4L FI 16 VALV.	GP-149	GAD-15	GG-137
FRONTIER	L4 2.4L FI	GP-149	GAD-294	
LUCINO	L4 1.6L FI	GP-37	GAD-15	GG-63
LUCINO	L4 2.0L FI	GP-91	GAD-15	GG-63
MAXIMA	V6 3.0L FI 24 VALV.	GP-149	GAD-15	GG-63
PATHFINDER	V6 3.3L FI	GP-149	GAD-15	GG-63
PATHFINDER	V6 3.5L FI	GP-149	GAD-15	GG-63
PICK-UP	L4 2.4L (KA24E)	GP-3682	GAD-294	GG-137
QUEST	V6 3.0L FI	GP-3682	GAD-118	GG-94
SENTRA	L4 1.6L FI	GP-3682	GAD-15	GG-63
SENTRA	L4 2.0L FI	GP-91	GAD-15	GG-63
TSUBAME	L4 1.6L FI 16 VALV.	GP-37	GAD-15	GG-63
TSURU	L4 1.6L FI	GP-37	GAD-117	GG-137
TSURU	L4 2.0L FI	GP-156	GAD-15	GG-63
1997				
240SX	L4 2.4L FI	GP-37	GAD-15	GG-63
ALTIMA	L4 2.4L FI 16 VALV.	GP-37	GAD-15	GG-137
LUCINO	L4 1.6L FI	GP-37	GAD-15	GG-63
LUCINO	L4 2.0L FI	GP-91	GAD-15	GG-63
MAXIMA	V6 3.0L FI 24 VALV.	GP-149	GAD-15	GG-63
PATHFINDER	L4 2.4L SFI	GP-3682	GAD-294	GG-137
PATHFINDER	V6 3.3L FI	GP-149	GAD-15	GG-63
PATHFINDER	V6 3.5L FI	GP-149	GAD-15	GG-63
PICK-UP	L4 2.4L (KA24E)	GP-3682	GAD-294	GG-137
QUEST	V6 3.0L FI	GP-3682	GAD-118	GG-94
SENTRA	L4 2.0L FI	GP-91	GAD-15	GG-63
TSUBAME	L4 1.6L FI 16 VALV.	GP-37	GAD-15	GG-63
TSURU	L4 1.6L FI	GP-37	GAD-117	GG-137
TSURU	L4 2.0L FI	GP-156	GAD-15	GG-63
1996				
300ZX	V6 3.0L FI TURBO	GP-37	GAD-17 ²⁸	GG-94
ALTIMA	L4 2.4L FI 16 VALV.	GP-37	GAD-15	GG-137
LUCINO	L4 1.6L FI	GP-37	GAD-15	GG-63
LUCINO	L4 2.0L FI	GP-91	GAD-15	GG-63
MAXIMA	V6 3.0L FI 24 VALV.	GP-149	GAD-15	GG-63
PATHFINDER	L4 2.4L SFI	GP-3682	GAD-294	GG-137
PATHFINDER	V6 3.0L SFI	GP-3682	GAD-15	GG-94
PATHFINDER	V6 3.3L FI (VG33E)	GP-149	GAD-15	GG-98
PICK-UP	L4 2.4L (KA24E)	GP-3682	GAD-294	GG-137
SENTRA	L4 1.6L FI	GP-3682	GAD-15	GG-63
SENTRA	L4 2.0L FI	GP-91	GAD-15	GG-63
TSUBAME	L4 1.6L FI 16 VALV.	GP-37	GAD-15	GG-63
TSURU	L4 1.6L FI	GP-37	GAD-15	GG-63
TSURU	L4 2.0L FI 16 VALV.	GP-156	GAD-15	GG-63
1995				
300ZX	V6 3.0L FI TURBO	GP-37	GAD-17 ²⁸	GG-94
ALTIMA	L4 2.4L F.I. (KA24DE)	GP-37	GAD-15	GG-137
MAXIMA	V6 3.0L FI 24 VALV.	GP-149	GAD-15	GG-63
PATHFINDER	L4 2.4L SFI	GP-3682	GAD-294	GG-137
PATHFINDER	V6 3.0L SFI	GP-3682	GAD-15	GG-94
PICK-UP	L4 2.4L (KA24E)	GP-3682	GAD-294	GG-137
SENTRA	L4 1.6L FI (GA16DE)	GP-3682	GAD-15	GG-63
TSUBAME	L4 1.6L FI 16 VALV.	GP-37	GAD-15	GG-63
TSURU	L4 1.6L FI	GP-37	GAD-15	GG-63
TSURU	L4 2.0L FI 16 VALV.	GP-156	GAD-15	GG-63

Marca - Año - Modelo Make-Year-Model	Motor Engine	Aceite Oil	Aire Air	Combustible Fuel
NISSAN (continuación)				
1994				
300ZX	V6 3.0L FI TURBO	GP-37	GAD-17 ²⁸	GG-94
ALTIMA	L4 2.4L SFI DOHC	GP-3682	GAD-15	GG-137
ICHI VAN	L4 2.4L FI	GP-3682	GAD-15	
MAXIMA	V6 3.0L FI	GP-37	GAD-15	GG-63
PATHFINDER	L4 2.4L SFI	GP-3682	GAD-294	GG-137
PATHFINDER	V6 3.0L SFI SOHC	GP-3682	GAD-15	GG-94
PICK-UP	L4 2.4L (KA24E)	GP-3682	GAD-294	GG-137
SENTRA	L4 1.6L SFI	GP-3682	GAD-15	GG-63
SENTRA	L4 2.0L SFI DOHC	GP-156	GAD-15	GG-63
TSUBAME	L4 1.6L FI 16 VALV.	GP-37	GAD-15	GG-63
TSURU	L4 1.6L (GA16DE)	GP-37	GAD-15	GG-63
TSURU	L4 2.0L FI 16 VALV.	GP-156	GAD-15	GG-63
1993				
240SX	L4 2.4L FI (KA24DE) 16 VALV.	GP-3682	GAD-15	GG-98
300ZX	V6 3.0L FI	GP-37	GAD-17 ²⁸	GG-94
ALTIMA	L4 2.4L SFI 12 VALV.	GP-3682	GAD-15	GG-137
ICHI VAN	L4 2.4L FI	GP-3682	GAD-15	
MAXIMA	V6 3.0L FI	GP-37	GAD-15	GG-63
NX1600	L4 1.6L SFI	GP-3682	GAD-15	GG-63
NX2000	L4 2.0L SFI	GP-156	GAD-15	GG-63
PATHFINDER	V6 3.0L SFI	GP-3682	GAD-15	GG-94
PICK-UP	L4 2.4L (KA24E)	GP-3682	GAD-294	GG-137
SENTRA	L4 1.6L SFI	GP-3682	GAD-15	GG-63
SENTRA	L4 2.0L SFI	GP-156	GAD-15	GG-63
TSUBAME	L4 1.6L 16 VALV.	GP-37	GAD-15	GG-63
TSURU	L4 1.6L (GA16DE) CON 16 VALV.	GP-37	GAD-15	GG-63
TSURU	L4 2.0L	GP-156	GAD-15	GG-63
1992				
240SX	L4 2.4L FI (KA24DE)	GP-37	GAD-15	GG-98
300ZX	V6 3.0L FI	GP-37	GAD-17 ²⁸	GG-94
HIKARI	L4 1.6L	GP-37	GAD-15	GG-39
ICHI VAN	L4 1.8L	GP-38	GAD-30	GG-45
ICHI VAN	L4 2.4L FI	GP-3682	GAD-15	
MAXIMA	V6 3.0L FI	GP-37	GAD-15	GG-63
NX1600	L4 1.6L SFI	GP-3682	GAD-15	GG-63
NX2000	L4 2.0L SFI	GP-156	GAD-15	GG-63
PATHFINDER	V6 3.0L SFI	GP-3682	GAD-15	GG-94
PICK-UP	L4 1.6L Y 1.8L	GP-38	GAD-3	GG-45
PICK-UP	L4 2.4L	GP-3682	GA-4325	GG-45
SENTRA	L4 1.6L FI (GA16DE) 16 VALV.	GP-3682	GAD-15	GG-63
SENTRA	L4 2.0L SFI	GP-156	GAD-15	GG-63
TSURU	L4 1.6L FI	GP-37	GA-6620 ⁷ 9A-6619 ²	GG-63
1991				
300ZX	V6 3.0L FI	GP-37	GAD-17 ²⁸	GG-94
HIKARI	L4 1.6L	GP-37	GAD-15	GG-39
ICHI VAN	L4 1.8L	GP-38	GAD-15	GG-39
MAXIMA	V6 3.0L FI	GP-37	GAD-15	GG-63
NX1600	L4 1.6L SFI	GP-3682	GAD-15	GG-63
NX2000	L4 2.0L SFI	GP-156	GAD-15	GG-63
PATHFINDER	V6 3.0L MFI	GP-3682	GAD-15	GG-94
PICK-UP	L4 1.6L Y 1.8L	GP-38	GAD-3	GG-45
PICK-UP	L4 2.4L	GP-3682	GA-4325	GG-45
SENTRA	L4 1.6L SFI	GP-3682	GAD-15	GG-63
SENTRA	L4 2.0L SFI	GP-156	GAD-15	GG-63
TSURU	L4 1.6L FI	GP-37	GAD-3	GG-39
1990				
300ZX	V6 3.0L FI	GP-37	GAD-17 ²⁸	GG-94
HIKARI	L4 1.6L	GP-37	GAD-15	GG-39

Marca - Año - Modelo Make-Year-Model	Motor Engine	Aceite Oil	Aire Air	Combustible Fuel
NISSAN (continuación)				
ICHI VAN	L4 1.8L	GP-38	GAD-15	GG-39
MAXIMA	V6 3.0L FI	GP-37	GAD-15	GG-63
PATHFINDER	V6 3.0L MFI	GP-37	GAD-15	GG-94
PICK-UP	L4 1.6L Y 1.8L	GP-38	GAD-3	GG-45
PULSAR	L4 1.6L EFI	GP-3682	GA-6619	GG-63
PULSAR	L4 1.8L FI	GP-3682	GAD-15	GG-63 GG-94 ⁵¹
SENTRA	L4 1.6L EFI	GP-37		GG-63
TSURU	L4 1.6L FI TURBO	GP-37	GAD-3	GG-39

OLDSMOBILE				
2004				
ALERO	L4 2.2L SFI	G-49	GA-279	GG-66
ALERO	V6 3.4L SFI	GP-46	GA-279	GG-66
BRAVADA	L6 4.2L SFI 24 VALV. VORTEC	GP-3675	GA-414R	GG-209
BRAVADA	V8 5.3L FI	GP-44	GA-414R	GG-209
SILHOUETTE	V6 3.4L SFI 12 VALV.	GP-46	GA-164	

2003				
ALERO	L4 2.2L SFI	G-49	GA-279	GG-66
ALERO	V6 3.4L SFI	GP-46	GA-279	GG-66
AURORA	V8 4.0L SFI	GP-3675	GA-164	GG-66
BRAVADA	L6 4.2L SFI	GP-3675	GA-414R	GG-209
SILHOUETTE	V6 3.4L SFI	GP-46	GA-164	GG-290

2002				
ALERO	L4 2.2L SFI	G-49	GA-279	GG-66
ALERO	V6 3.4L SFI	GP-46	GA-279	GG-66
AURORA	V6 3.5L SFI	G-765	GA-164	GG-66
AURORA	V8 4.0L SFI	GP-3675	GA-164	GG-66
BRAVADA	L6 4.2L SFI	GP-3675	GA-414R	GG-209
INTRIGUE	V6 3.5L SFI 24 VALV.	G-765	GA-6479	GG-66
SILHOUETTE	V6 3.4L SFI	GP-46	GA-164	GG-290

2001				
ALERO	L4 2.4L SFI	GP-44	GA-279	GG-66
ALERO	V6 3.4L SFI	GP-46	GA-279	GG-66
AURORA	V6 3.5L SFI	G-765	GA-164	GG-66
AURORA	V8 4.0L SFI	GP-3675	GA-164	GG-66
BRAVADA	V6 4.3L SFI	GP-3980	GA-165	GG-266
INTRIGUE	V6 3.5L SFI 24 VALV.	G-765	GA-6479	GG-66
SILHOUETTE	V6 3.4L SFI	GP-46	GA-164	GG-290

2000				
ALERO	L4 2.4L SFI	GP-44	GA-279	GG-66
ALERO	V6 3.4L SFI	GP-46	GA-279	GG-66
BRAVADA	V6 4.3L SFI	GP-3980	GA-165	GG-266
INTRIGUE	V6 3.5L SFI	G-765	GA-6479	GG-66
SILHOUETTE	V6 3.4L SFI	GP-46	GA-164	GG-290

1999				
ALERO	L4 2.4L SFI	GP-44	GA-279	GG-66
ALERO	V6 3.4L SFI	GP-46	GA-279	GG-66
BRAVADA	V6 4.3L SFI	GP-3980	GA-165	GG-266
CUTLASS	V6 3.1L SFI	GP-46	GA-279	GG-66
INTRIGUE	V6 3.5L SFI	G-765	GA-6479	GG-66
INTRIGUE	V6 3.8L SFI	GP-46	GA-164	GG-66
SILHOUETTE	V6 3.4L SFI	GP-46	GA-164	

1998				
BRAVADA	V6 4.3L SFI	GP-3980	GA-165	GG-266
CUTLASS	V6 3.1L SFI	GP-46	GA-279	GG-66
INTRIGUE	V6 3.8L SFI	GP-46	GA-164	GG-66
SILHOUETTE	V6 3.4L SFI	GP-46	GA-164	

Marca - Año - Modelo Make-Year-Model	Motor Engine	Aceite Oil	Aire Air	Combustible Fuel
OLDSMOBILE (continuación)				
1997				
BRAVADA	V6 4.3L SFI	GP-3980	GA-165	GG-266
CUTLASS	V6 3.1L SFI	GP-46	GA-164 ¹⁵⁷ GA-279 ⁸⁹	GG-66
SILHOUETTE	V6 3.4L SFI	GP-46	GA-164	
1996				
BRAVADA	V6 4.3L SFI	GP-3980	GA-165	GG-46
CUTLASS CIERA	L4 2.2L SFI	GP-46	GA-153	GG-256
CUTLASS CIERA	V6 3.1L SFI	GP-46	GA-253	GG-256
SILHOUETTE	V6 3.8L	GP-3980	GA-3916	GG-177

1995				
BRAVADA	V6 4.3L FI	GP-3980	GA-165	GG-46
CUTLASS CIERA	L4 2.2L MFI	GP-46	GA-153	GG-256
CUTLASS CIERA	V6 3.1L SFI	GP-46	GA-253	GG-256
EIGHTY EIGHT (88)	V6 3.8L	GP-46	GA-6479	GG-66
SILHOUETTE	V6 3.8L	GP-3980	GA-3916	GG-177

1994				
BRAVADA	V6 4.3L CPI	GP-3980	GA-165	GG-46
CUTLASS CIERA	L4 2.2L MFI	GP-46	GA-153	GG-256
CUTLASS CIERA	V6 3.1L SFI	GP-46	GA-253	GG-256
EIGHTY EIGHT (88)	V6 3.8L	GP-46	GA-6479	GG-290
SILHOUETTE	V6 3.1L FI	GP-3980	GA-3588	GG-177
SILHOUETTE	V6 3.8L	GP-3980	GA-3916	GG-177

1993				
BRAVADA	V6 4.3L FI	GP-3980	GA-3588 ⁹ GA-165 ¹⁶	GG-46
EIGHTY EIGHT (88)	V6 3.8L TPI	GP-46	GA-6479	GG-581
SILHOUETTE	V6 3.1L	GP-3980	GA-3588	GG-177

1992				
BRAVADA	V6 4.3L CPI	GP-3980	GA-165	GG-46
BRAVADA	V6 4.3L EFI	GP-3980	GA-3588	GG-46
CUSTOM CRUISER	V8 5.0L FI	GP-3	GA-7017	GG-581
CUSTOM CRUISER	V8 5.7L FI	GP-3	GA-7017	GG-581
EIGHTY EIGHT (88)	V6 3.8L	GP-46	GA-6479	GG-290
SILHOUETTE	V6 3.1L	GP-3980	GA-3588	GG-177

1991				
BRAVADA	V6 4.3L EFI	GP-3980	GA-3588	GG-46
CUSTOM CRUISER	V8 5.0L FI	GP-3	GA-7017	GG-581
SILHOUETTE	V6 3.1L	GP-3980	GA-3588	GG-177

1990				
SILHOUETTE	V6 3.1L FI	GP-3980	GA-3588	GG-177

OPEL				
1997				
KADETT	10 CIL. 1.8L FI			GG-263
KADETT	10 CIL. 2.0L FI			GG-263
1996				
KADETT	9 CIL. 1.8L FI			GG-263
KADETT	9 CIL. 2.0L FI			GG-263

1995				
KADETT	8 CIL. 1.8L			GG-263
KADETT	8 CIL. 2.0L			GG-263

1994				
KADETT	7 CIL. 1.8L			GG-263
KADETT	7 CIL. 2.0L			GG-263

Marca - Año - Modelo Make-Year-Model	Motor Engine	Aceite Oil	Aire Air	Combustible Fuel
---	-----------------	---------------	-------------	---------------------

OPEL (continuación)

1993				
KADETT	6 CIL. 1.8L			GG-263
KADETT	6 CIL. 2.0L			GG-263

1992				
KADETT	5 CIL. 1.8L			GG-263
KADETT	5 CIL. 2.0L			GG-263

1991				
KADETT	L4 1.8L			GG-263
KADETT	L4 2.0L			GG-263

PASSPORT

1991				
I-MARK	L4 1.6L FI (VIN 5)	GP-156		GG-220
I-MARK	L4 1.6L FI (VIN 6)	GP-157	GA-195	GG-220

PEUGEOT

2009				
207	L4 1.4L FI			
207	L4 1.6L FI 16 VALV.			GG-291
307	L4 1.6L FI			
307	L4 2.0L FI			GG-291
407	L4 2.2L FI			
EXPERT	2.0L HDI (DIESEL)			
GRAND RAID	L4 1.6L FI	G-141	GA-2184	GG-291
MANAGER	3.0L HDI (DIESEL)	G-141		
PARTNER	L4 1.6L FI (GASOLINA)	G-141	GA-114	GG-291
PARTNER	L4 1.6L HDI (DIESEL)			

2008				
206	L4 1.4L FI		GA-2159 GAC-5 ²⁴	GG-291
206	L4 1.6L FI	G-141	GA-2159 GAC-5 ²⁴	GG-291
307	L4 2.0L 16 VALV.			GG-291
407	L4 2.2L			
407	V6 3.0L	GP-462 GP-461		
607	V6 3.0L	GP-462 GP-461	GA-2156	GG-291
EXPERT	2.0L HDI (DIESEL)			
GRAND RAID	L4 1.6L FI	G-141	GA-2184	GG-291
PARTNER	L4 1.6L FI	G-141	GA-114	GG-291

2007				
206	L4 1.4L FI	GP-461	GA-2159 GAC-5 ²⁴	GG-291
206	L4 1.6L FI	G-141 G-341 ¹⁵²	GA-2159 GAC-5 ²⁴	GG-291
307	L4 2.0L FI	GP-462 GP-461 ¹¹⁸	GA-215	GG-291
407	V6 3.0L FI 24 VALV.	GP-462 GP-461		
607	V6 3.0L FI 24 VALV.	GP-462 GP-461	GA-2156	GG-291
GRAND RAID	L4 1.6L	G-141	GA-2184	GG-291
PARTNER	L4 1.6L FI	G-141	GA-114	GG-291

2006				
206	L4 1.4L FI	GP-461	GA-2159 GAC-5 ²⁴	GG-291
206	L4 1.6L FI	G-141 G-341 ¹⁵²	GA-2159 GAC-5 ²⁴	GG-291
307	L4 2.0L FI	GP-462 GP-461 ¹¹⁸	GA-215	GG-291

Marca - Año - Modelo Make-Year-Model	Motor Engine	Aceite Oil	Aire Air	Combustible Fuel
---	-----------------	---------------	-------------	---------------------

PEUGEOT (continuación)

406	L4 2.0L FI	GP-462 GP-461	GA-2156	GG-291
406	V6 3.0L FI 24 VALV.	GP-462 GP-461	GA-2156	GG-291
607	V6 3.0L FI 24 VALV.	GP-462 GP-461	GA-2156	GG-291
PARTNER	L4 1.6L FI	G-141	GA-114	GG-291

2005				
206	L4 1.4L FI	GP-461	GA-2159 GAC-5 ²⁴	GG-291
206	L4 1.6L FI	G-141	GA-2159 GAC-5 ²⁴	GG-291
307	L4 2.0L FI	GP-462 GP-461 ¹¹⁸	GA-215	GG-291
406	L4 2.0L FI	GP-462 GP-461	GA-2156	GG-291
406	V6 3.0L FI 24 VALV.	GP-462 GP-461	GA-2156	GG-291
607	V6 3.0L FI 24 VALV.	GP-462 GP-461	GA-2156	GG-291
PARTNER	L4 1.6L FI	G-141	GA-114	GG-291

2004				
206	L4 1.4L FI	GP-461	GA-2159 GAC-5 ²⁴	GG-291
206	L4 1.6L FI	G-141	GA-2159 GAC-5 ²⁴	GG-291
306	L4 1.8L FI	GP-462 GP-461	GA-2123	GG-291
307	L4 2.0L FI	GP-462 GP-461 ¹¹⁸	GA-215	GG-291
406	L4 2.0L FI	GP-462 GP-461	GA-2156	GG-291
406	V6 3.0L FI 24 VALV.	GP-462 GP-461	GA-2156	GG-291
607	V6 3.0L FI 24 VALV.	GP-462 GP-461	GA-2156	GG-291
PARTNER	L4 1.6L FI	G-141	GA-114	GG-291

2003				
206	L4 1.4L FI	GP-461	GA-2159 GAC-5 ²⁴	GG-291
206	L4 1.6L FI	G-141	GA-2159 GAC-5 ²⁴	GG-291
306	L4 1.8L FI	GP-462 GP-461	GA-2123	GG-291
306	L4 2.0L FI			
406	V6 3.0L FI 24 VALV.	GP-462 GP-461	GA-2156	GG-291
607	V6 3.0L FI 24 VALV.		GA-2156	GG-291
PARTNER	L4 1.6L FI	G-141	GA-114	GG-291

2002				
PARTNER	L4 1.8L FI		GA-2173	
206	L4 1.4L FI	GP-461	GA-2159 GAC-5 ²⁴	GG-291
206	L4 1.6L FI		GA-2159 GAC-5 ²⁴	GG-291
306	L4 1.8L FI	GP-462 GP-461	GA-2123	GG-291
306	L4 2.0L FI			
406	L4 2.0L FI	GP-462 GP-461	GA-2156	GG-291
406	V6 3.0L FI 24 VALV.	GP-462 GP-461	GA-2156	GG-291

2001				
206	L4 1.4L FI	GP-461	GA-2159 GAC-5 ²⁴	GG-291
206	L4 1.6L FI	GP-461	GA-2159 GAC-5 ²⁴	GG-291

Marca - Año - Modelo Make-Year-Model	Motor Engine	Aceite Oil	Aire Air	Combustible Fuel
PEUGEOT (continuación)				
306	L4 1.8L FI	GP-462 GP-461	GA-2123	GG-291
406	L4 2.0L FI	GP-462 GP-461	GA-2156	GG-291
406	V6 3.0L FI	GP-462 GP-461	GA-2156	GG-291
PARTNER	L4 1.8L FI		GA-2173	
2000				
306	L4 1.8L FI	GP-461	GA-2123	GG-291
405	L4 2.0L FI		GA-2173	GG-251
PARTNER	L4 1.8L FI		GA-2173	
1999				
306	L4 1.8L FI	GP-461	GA-2123	GG-291
405	L4 2.0L FI		GA-2173	GG-251
PARTNER	L4 1.8L FI		GA-2173	
1998				
306	L4 1.6L FI	GP-461	GA-2160	GG-291
306	L4 1.8L FI		GA-2173	
306	L4 2.0L FI		GA-2173	
405	L4 2.0L FI		GA-2173	GG-251
406	L4 1.6L FI		GA-2173	
PARTNER	L4 1.8L FI		GA-2173	
1997				
306	L4 1.8L FI		GA-2173	
306	L4 2.0L FI		GA-2173	
405	L4 1.8L FI		GA-2173	
405	L4 2.0L FI		GA-2173	
406	L4 1.6L FI		GA-2173	
PARTNER	L4 1.8L FI		GA-2173	
1996				
306	L4 1.8L FI		GA-2173	
306	L4 2.0L FI		GA-2173	
405	L4 1.8L FI		GA-2173	
405	L4 2.0L FI		GA-2173	
406	L4 1.6L FI		GA-2173	
1995				
306	L4 1.8L FI		GA-2173	
306	L4 2.0L FI		GA-2173	
405	L4 1.8L FI		GA-2173	
405	L4 2.0L FI		GA-2173	
1994				
306	L4 1.6L FI		GA-2173	
306	L4 1.8L FI		GA-2173	
306	L4 2.0L FI		GA-2173	
405	L4 1.8L FI		GA-2173	
405	L4 2.0L FI		GA-2173	
1993				
405	L4 1.8L FI		GA-2173	
405	L4 1.9L EFI	GP-3985	GA-215	GG-251
405	L4 2.0L FI		GA-2173	
505	L4 2.2L FI	GP-3985		GG-408
505	L4 2.2L FI TURBO	GP-3985		GG-408
1992				
405	L4 1.9L EFI	GP-3985	GA-215	GG-251
405	L4 2.0L FI		GA-2173	
505	L4 2.2L FI	GP-3985		GG-408
505	L4 2.2L FI TURBO	GP-3985		GG-408

Marca - Año - Modelo Make-Year-Model	Motor Engine	Aceite Oil	Aire Air	Combustible Fuel
PEUGEOT (continuación)				
505	V6 2.8L FI	GP-24		GG-408
1991				
405	L4 1.9L EFI	GP-3985	GA-215	GG-251
405	L4 2.0L FI		GA-2173	
505	L4 2.2L FI	GP-3985		GG-408
505	L4 2.2L FI TURBO	GP-3985		GG-408
505	V6 2.8L FI	GP-24		GG-408
PLYMOUTH				
2001				
NEON	L4 2.0L FI 16 VALV. SOHC	GP-58	GA-278R	
2000				
BREEZE	L4 2.0L SFI	GP-58	GA-132	
BREEZE	L4 2.4L SFI	GP-58	GA-132	
NEON	L4 2.0L FI 16 VALV. SOHC	GP-58	GA-278R	
VOYAGER	L4 2.4L SFI	GP-58	GA-277	GG-265
VOYAGER	V6 3.0L SFI	GP-81	GA-277	GG-265 ⁷¹ GG-267 ⁷²
VOYAGER	V6 3.3L SFI	GP-81	GA-277 GAC-2 ²⁴	GG-265 ⁷¹ GG-267 ⁷²
VOYAGER	V6 3.3L SFI FLEX FUEL	GP-81	GA-277 GAC-2 ²⁴	
1999				
BREEZE	L4 2.0L SFI	GP-58	GA-132	
BREEZE	L4 2.4L SFI	GP-58	GA-132	
NEON	L4 2.0L FI 16 VALV. DOHC	GP-58	GA-277	
NEON	L4 2.0L FI 16 VALV. SOHC	GP-58	GA-277	
VOYAGER	L4 2.4L SFI	GP-58	GA-277	GG-265
VOYAGER	V6 3.0L SFI	GP-81	GA-277	GG-265 ⁷¹ GG-267 ⁷²
VOYAGER	V6 3.3L SFI	GP-81	GA-277	GG-265 ⁷¹ GG-267 ⁷²
VOYAGER	V6 3.3L SFI FLEX FUEL	GP-81	GA-277	
1998				
BREEZE	L4 2.0L SFI	GP-58	GA-132	
BREEZE	L4 2.4L SFI	GP-58	GA-132	
NEON	L4 2.0L FI 16 VALV. DOHC	GP-58	GA-277	
NEON	L4 2.0L FI 16 VALV. SOHC	GP-58	GA-277	
VOYAGER	L4 2.4L SFI	GP-58	GA-277	GG-265
VOYAGER	V6 3.0L SFI	GP-81	GA-277	GG-265 ⁷¹ GG-267 ⁷²
VOYAGER	V6 3.3L SFI	GP-81	GA-277	GG-265 ⁷¹ GG-267 ⁷²
VOYAGER	V6 3.8L FI	GP-81	GA-277	GG-265 ⁷¹ GG-267 ⁷²
1997				
BREEZE	L4 2.0L SFI	GP-58	GA-132	GG-104
NEON	L4 2.0L FI 16 VALV. DOHC	GP-58	GA-277	GG-95
NEON	L4 2.0L FI 16 VALV. SOHC	GP-58	GA-277	GG-95
VOYAGER	L4 2.4L SFI	GP-58	GA-277	GG-265
VOYAGER	V6 3.0L SFI	GP-81	GA-277	GG-265 ⁷¹ GG-267 ⁷²
VOYAGER	V6 3.3L SFI	GP-81	GA-277	GG-265 ⁷¹ GG-267 ⁷²
VOYAGER	V6 3.8L SFI	GP-81	GA-277	GG-265 ⁷¹ GG-267 ⁷²
1996				
BREEZE	L4 2.0L SFI	GP-58	GA-132	GG-104
BREEZE	L4 2.4L SFI	GP-58	GA-132	GG-104
NEON	L4 2.0L FI 16 VALV. DOHC	GP-58	GA-277	GG-95
NEON	L4 2.0L FI 16 VALV. SOHC	GP-58	GA-277	GG-95
VOYAGER	L4 2.4L SFI	GP-58	GA-277	GG-265

Marca - Año - Modelo Make-Year-Model	Motor Engine	Aceite Oil	Aire Air	Combustible Fuel
PLYMOUTH (continuación)				
VOYAGER	V6 3.0L SFI	GP-81	GA-277	GG-265 ⁷¹ GG-267 ⁷²
VOYAGER	V6 3.3L GAS NATURAL	GP-81	GA-277	
VOYAGER	V6 3.3L SFI	GP-81	GA-277	GG-265 ⁷¹ GG-267 ⁷²
1995				
ACCLAIM	L4 2.5L EFI	GP-81	GA-3814	GG-7018 ¹³⁴ GG-7019 ¹³³ GG-7020 ¹⁴³
ACCLAIM	V6 3.0L MFI	GP-81	GA-277	GG-7018 ¹³⁴ GG-7019 ¹³³ GG-7020 ¹⁴³
NEON	L4 2.0L FI 16 VALV. DOHC	GP-58	GA-277	GG-95
NEON	L4 2.0L FI 16 VALV. SOHC	GP-58	GA-277	GG-95
VOYAGER	L4 2.5L EFI	GP-81	GA-271	GG-65
VOYAGER	V6 3.0L MFI	GP-81	GA-277	GG-65
VOYAGER	V6 3.3L MFI	GP-81	GA-271	GG-65
VOYAGER	V6 3.8L MFI	GP-81	GA-271	GG-65
1994				
ACCLAIM	L4 2.5L EFI	GP-81	GA-3814	GG-7018 ¹³⁴ GG-7019 ¹³³ GG-7020 ¹⁴³
ACCLAIM	L4 2.5L EFI FLEX FUEL	GP-81	GA-277	GG-7018 ¹³⁴ GG-7019 ¹³³ GG-7020 ¹⁴³
ACCLAIM	V6 3.0L MFI	GP-81	GA-277	GG-7018 ¹³⁴ GG-7019 ¹³³ GG-7020 ¹⁴³
NEON	L4 2.0L FI 16 VALV. SOHC	GP-58	GA-277	GG-95
SUNDANCE	L4 2.2L EFI SOHC	GP-81	GA-3814	GG-7018 ¹³⁴ GG-7019 ¹³³ GG-7020 ¹⁴³
SUNDANCE	L4 2.5L EFI SOHC	GP-81	GA-3814	GG-7018 ¹³⁴ GG-7019 ¹³³ GG-7020 ¹⁴³
SUNDANCE	V6 3.0L MFI SOHC	GP-81	GA-277	GG-7018 ¹³⁴ GG-7019 ¹³³ GG-7020 ¹⁴³
VOYAGER	L4 2.5L EFI SOHC	GP-81	GA-271	GG-65
VOYAGER	V6 3.0L MFI	GP-81	GA-277	GG-65
VOYAGER	V6 3.3L MFI	GP-81	GA-271	GG-65
VOYAGER	V6 3.8L MFI OHV	GP-81	GA-271	GG-65
1993				
ACCLAIM	L4 2.5L EFI	GP-81	GA-3814	GG-7018 ¹³⁴ GG-7019 ¹³³ GG-7020 ¹⁴³
ACCLAIM	L4 2.5L EFI FLEX FUEL	GP-81	GA-277	
ACCLAIM	V6 3.0L MFI	GP-81	GA-277	GG-7018 ¹³⁴ GG-7019 ¹³³ GG-7020 ¹⁴³
SUNDANCE	L4 2.2L EFI	GP-81	GA-3814	GG-7018 ¹³⁴ GG-7019 ¹³³ GG-7020 ¹⁴³
SUNDANCE	L4 2.5L EFI	GP-81	GA-3814	GG-7018 ¹³⁴ GG-7019 ¹³³ GG-7020 ¹⁴³
SUNDANCE	V6 3.0L MFI	GP-81	GA-277	GG-7018 ¹³⁴ GG-7019 ¹³³ GG-7020 ¹⁴³
VOYAGER	L4 2.5L EFI	GP-81	GA-271	GG-65
VOYAGER	V6 3.0L MFI	GP-81	GA-277	GG-65
VOYAGER	V6 3.3L SFI	GP-81	GA-271	GG-65
1992				
ACCLAIM	L4 2.5L EFI	GP-81	GA-3814	GG-7018 ¹³⁴ GG-7019 ¹³³ GG-7020 ¹⁴³
ACCLAIM	V6 3.0L MFI	GP-81	GA-277	GG-7018 ¹³⁴ GG-7019 ¹³³ GG-7020 ¹⁴³
SUNDANCE	L4 2.2L EFI	GP-81	GA-3814	GG-7018 ¹³⁴ GG-7019 ¹³³ GG-7020 ¹⁴³

Marca - Año - Modelo Make-Year-Model	Motor Engine	Aceite Oil	Aire Air	Combustible Fuel
PLYMOUTH (continuación)				
SUNDANCE	L4 2.5L EFI	GP-81	GA-3814	GG-7018 ¹³⁴ GG-7019 ¹³³ GG-7020 ¹⁴³
SUNDANCE	L4 2.5L EFI TURBO	GP-81	GA-276	GG-7018 ¹³⁴ GG-7019 ¹³³ GG-7020 ¹⁴³
SUNDANCE	V6 3.0L MFI	GP-81	GA-277	GG-7018 ¹³⁴ GG-7019 ¹³³ GG-7020 ¹⁴³
VOYAGER	L4 2.5L EFI	GP-81	GA-271	GG-65
VOYAGER	V6 3.0L MFI	GP-81	GA-277	GG-65
VOYAGER	V6 3.3L MFI	GP-81	GA-271	GG-65
1991				
ACCLAIM	L4 2.5L EFI	GP-81	GA-3814	GG-7018 ¹³⁴ GG-7019 ¹³³ GG-7020 ¹⁴³
ACCLAIM	L4 2.5L FI TURBO	GP-81	GA-276	GG-7018 ¹³⁴ GG-7019 ¹³³ GG-7020 ¹⁴³
ACCLAIM	V6 3.0L MFI	GP-81	GA-277	GG-7018 ¹³⁴ GG-7019 ¹³³ GG-7020 ¹⁴³
SUNDANCE	L4 2.2L EFI	GP-81	GA-3814	GG-7018 ¹³⁴ GG-7019 ¹³³ GG-7020 ¹⁴³
SUNDANCE	L4 2.5L EFI	GP-81	GA-276	GG-7018 ¹³⁴ GG-7019 ¹³³ GG-7020 ¹⁴³
SUNDANCE	L4 2.5L MFI TURBO	GP-81	GA-3814	GG-7018 ¹³⁴ GG-7019 ¹³³ GG-7020 ¹⁴³
VOYAGER	L4 2.5L EFI	GP-81	GA-271	GG-65
VOYAGER	V6 3.0L MFI	GP-81	GA-277	GG-65
VOYAGER	V6 3.3L MFI	GP-81	GA-271	GG-65
1990				
ACCLAIM	L4 2.5L EFI	GP-81	GA-3814	GG-61
ACCLAIM	L4 2.5L MFI TURBO	GP-81	GA-276	GG-61
ACCLAIM	V6 3.0L MFI	GP-81	GA-277	GG-61
SUNDANCE	L4 2.2L EFI	GP-81	GA-3814	GG-61
SUNDANCE	L4 2.5L EFI	GP-81	GA-3814	GG-61
SUNDANCE	L4 2.5L EFI TURBO	GP-81	GA-276	GG-61
VOYAGER	L4 2.5L EFI	GP-58	GA-271	GG-65
VOYAGER	L4 2.5L EFI TURBO	GP-58	GA-276	GG-65
VOYAGER	V6 3.0L MFI	GP-58	GA-277	GG-65
VOYAGER	V6 3.3L MFI	GP-58	GA-271	GG-65
PONTIAC				
2010				
G-3	L4 1.6L FI		GA-324	
G-5	L4 2.2L FI			
G-6	L4 2.4L FI			
G-6	V6 3.5L FI	GP-3675		
G-6	V6 3.6L FI	GP-406		
G-6	V6 3.9L FI	GP-3675		
G-8	V8 6.2L FI	GP-406		
SOLSTICE	L4 2.0L DI TURBO			
SOLSTICE	L4 2.4L FI			
VIBE	L4 1.8L FI 16 VALV. DOHC	G-911		
VIBE	L4 2.4L FI 16 VALV. DOHC	GP-156		
2009				
G-3	L4 1.6L FI 16 VALV.	GP-46	GA-324	
G-5	L4 2.2L FI 16 VALV. DOHC	G-49		
G-5	L4 2.4L FI 16 VALV. DOHC	G-49		
G-6	L4 2.4L FI 16 VALV. DOHC	G-49	GA-367	
G-6	V6 3.5L FI	GP-3675		
G-6	V6 3.6L FI 24 VALV. DOHC	GP-406	GA-367 ²¹	
G-6	V6 3.9L FI	GP-3675	GA-1546	

Marca - Año - Modelo Make-Year-Model	Motor Engine	Aceite Oil	Aire Air	Combustible Fuel
PONTIAC (continuación)				
G-8	V6 3.6L FI 24 VALV. DOHC	G-765		
G-8	V8 6.0L FI	GP-406		
G-8	V8 6.2L FI	GP-406		
MATIZ G2	L4 1.0L MFI	GP-157	GA-323	GG-419
MONTANA	V6 3.9L FI	GP-3675	GA-164	
SOLSTICE	L4 2.0L DI 16 VALV. DOHC TURBO	G-49		
SOLSTICE	L4 2.4L FI 16 VALV. DOHC	G-49		
SV-6	V6 3.9L FI	GP-3675	GA-164	
SV-6	V6 3.9L FI FLEX FUEL	GP-3675	GA-164	
TORRENT	V6 3.4L FI	GP-46	GA-367	
TORRENT	V6 3.6L FI 24 VALV. DOHC	GP-406	GA-367	
VIBE	L4 1.8L FI	G-911	GA-265	
VIBE	L4 2.4L FI	GP-156	GA-320	
WAVE (CANADA)	L4 1.6L FI	GP-46	GA-324	

2008				
G-3	L4 1.6L FI 16 VALV.	GP-46	GA-324	
G-5	L4 2.2L SFI	G-49		
G-5	L4 2.4L SFI	G-49		
G-6	L4 2.4L MFI	G-49		
G-6	V6 3.5L SFI	GP-3675		
G-6	V6 3.6L SFI	GP-406	GA-367	
G-6	V6 3.9L SFI	GP-3675		
G-8	V6 3.6L FI 24 VALV. DOHC	G-765		
G-8	V8 6.0L FI	GP-406		
GRAND PRIX	V6 3.8L FI	GP-46	GA-6479	
GRAND PRIX	V8 5.3L FI	GP-406		
GRAND PRIX	V8 6.0L FI	GP-406		
MATIZ G2	L4 1.0L MFI	GP-157	GA-323	GG-419
MONTANA	V6 3.9L FI	GP-3675	GA-164	
PURSUIT	L4 2.0L FI	G-49	GA-414R	
PURSUIT	L4 2.2L FI	G-49	GA-414R	
PURSUIT	L4 2.4L FI	G-49	GA-414R	
SOLSTICE	L4 2.0L TURBO	G-49		
SOLSTICE	L4 2.4L SFI	G-49		
TORRENT	V6 3.4L FI	GP-46	GA-367	
TORRENT	V6 3.6L FI	GP-406	GA-367	
VIBE	L4 1.8L FI 16 VALV. DOHC	GP-157	GA-263	
WAVE (CANADA)	L4 1.6L FI 16 VALV. DOHC	GP-46	GA-324	

2007				
G-3	L4 1.6L MPI 16 VALV.	GP-46	GA-324	
G-5	L4 2.2L MFI 16 VALV.	G-49		
G-5	L4 2.4L ECOTEC MFI 16 VALV.	G-49		
G-6	L4 2.4L FI 16 VALV. DOHC	G-49		
G-6	V6 3.5L SFI	GP-3675		
G-6	V6 3.6L SFI	GP-406	GA-367	
G-6	V6 3.9L FI	GP-3675		
GRAND PRIX	V6 3.8L SFI O SUPER CARGADO	GP-46	GA-6479	
GRAND PRIX	V8 5.3L SFI 16 VALV.	GP-406		
MATIZ G2	L4 1.0L MFI	GP-157	GA-323	GG-419
MONTANA	V6 3.9L SFI	GP-3675	GA-164	
PURSUIT	L4 2.0L FI	G-49	GA-414R	
PURSUIT	L4 2.2L FI	G-49		
PURSUIT	L4 2.4L FI	G-49		
SOLSTICE	L4 2.0L DI TURBO	G-49		
SOLSTICE	L4 2.4L MFI	G-49		
TORRENT	V6 3.4L SFI	GP-46	GA-367	GG-581

2006				
G-3	L4 1.6L MPI 16 VALV.	GP-46	GA-324	
G-4	L4 2.2L FI 16 VALV.	GP-46	GA-164	
G-6	L4 2.4L FI 16 VALV. DOHC	G-49		
G-6	V6 3.5L FI	GP-46		

Marca - Año - Modelo Make-Year-Model	Motor Engine	Aceite Oil	Aire Air	Combustible Fuel
PONTIAC (continuación)				
G-6	V6 3.9L FI	GP-3675		
GRAND PRIX	V6 3.8L SFI O SUPER CARGADO	GP-46	GA-6479	
GRAND PRIX	V8 5.3L SFI 16 VALV.	GP-44		
MATIZ G2	L4 1.0L FI	GP-157	GA-323	GG-419
MONTANA	V6 3.5L FI	GP-46	GA-164	
PURSUIT	L4 2.0L FI	G-49	GA-414R	
PURSUIT	L4 2.2L FI	G-49		
PURSUIT	L4 2.4L FI	G-49		
SOLSTICE	L4 2.4L FI	G-49		
TORRENT	V6 3.4L FI	GP-46		
VIBE	L4 1.8L FI 16 VALV. DOHC (1ZZ-FE) VIN 8	GP-157	GA-263	
VIBE	L4 1.8L FI 16 VALV. DOHC (2ZZ-GE) VIN L	GP-156	GA-263	

2005				
AZTEK	V6 3.4L FI	GP-46	GA-164	GG-290
BONNEVILLE	V6 3.8L FI	GP-46	GA-6479	GG-66
BONNEVILLE	V8 4.6L FI	GP-3675	GA-164	GG-66
G-4	L4 2.2L FI 16 VALV.	GP-46	GA-164	
G-6	V6 3.5L FI	GP-46		
GRAND AM	L4 2.2L FI	G-49	GA-279	GG-66
GRAND PRIX	V6 3.8L SFI O SUPER CARGADO	GP-46	GA-6479	
GRAND PRIX	V8 5.3L FI	GP-44		
MATIZ	L4 1.0L FI	GP-157	GA-314	GG-419
MONTANA	V6 3.5L FI	GP-46	GA-164	GG-290
PURSUIT	L4 2.0L FI	G-49	GA-414R	
PURSUIT	L4 2.2L FI	G-49		
PURSUIT	L4 2.4L FI	G-49		
SUNFIRE	L4 2.2L FI	G-49	GA-3916	GG-66

2004				
AZTEK	V6 3.4L FI	GP-46	GA-164	GG-290
BONNEVILLE	V6 3.8L FI	GP-46	GA-6479	GG-66
BONNEVILLE	V8 4.6L FI	GP-3675	GA-164	GG-66
GRAND AM	L4 2.2L FI	G-49	GA-279	GG-66
GRAND AM	V6 3.4L FI	GP-46	GA-279	GG-66
GRAND PRIX	V6 3.8L SFI O SUPER CARGADO	GP-46	GA-6479	
MATIZ	L4 1.0L FI	GP-157	GA-314	GG-419
MONTANA	V6 3.4L FI	GP-46	GA-164	GG-290
SUNFIRE	L4 2.2L FI	G-49	GA-3916	GG-66

2003				
AZTEK	V6 3.4L FI	GP-46	GA-164	GG-290
BONNEVILLE	V6 3.8L FI	GP-46	GA-6479	GG-66
GRAND AM	L4 2.2L FI	G-49	GA-279	GG-66
GRAND AM	V6 3.4L FI	GP-46	GA-279	GG-66
GRAND PRIX	V6 3.1L SFI	GP-46	GA-6479	GG-66
GRAND PRIX	V6 3.8L SFI O SUPER CARGADO	GP-46	GA-6479	GG-66
MONTANA	V6 3.4L FI	GP-46	GA-164	GG-290
SUNFIRE	L4 2.2L FI	G-49	GA-3916	GG-66

2002				
AZTEK	V6 3.4L FI	GP-46	GA-164	GG-290
BONNEVILLE	V6 3.8L FI	GP-46	GA-6479	GG-66
FIREBIRD	V6 3.8L SFI	GP-46	GA-392	GG-66
FIREBIRD	V8 5.7L SFI	GP-44	GA-392	GG-66
GRAND AM	L4 2.2L FI	G-49	GA-279	GG-66
GRAND AM	V6 3.4L FI	GP-46	GA-279	GG-66
GRAND PRIX	V6 3.1L FI	GP-46	GA-6479	GG-66
GRAND PRIX	V6 3.8L FI	GP-46	GA-6479	GG-66
MONTANA	V6 3.4L SFI	GP-46	GA-164	GG-290
SUNFIRE	L4 2.2L FI	G-49 GP-46 ¹³⁶	GA-3916	GG-66

Marca - Año - Modelo Make-Year-Model	Motor Engine	Aceite Oil	Aire Air	Combustible Fuel
PONTIAC (continuación)				
SUNFIRE	L4 2.4L FI 16 VALV.	GP-44	GA-3916	GG-66
2001				
AZTEK	V6 3.4L FI	GP-46	GA-164	GG-290
BONNEVILLE	V6 3.8L FI	GP-46	GA-6479	GG-66
FIREBIRD	V6 3.8L SFI	GP-46	GA-392	GG-66
FIREBIRD	V8 5.7L SFI	GP-44	GA-392	GG-66
FIREBIRD TRANS AM	V8 5.7L FI	GP-44	GA-392	GG-66
GRAND AM	L4 2.4L FI	GP-44	GA-279	GG-66
GRAND AM	V6 3.4L FI	GP-46	GA-279	GG-66
GRAND PRIX	V6 3.1L FI	GP-46	GA-6479	GG-66
GRAND PRIX	V6 3.8L FI	GP-46	GA-6479	GG-66
MONTANA	V6 3.4L SFI	GP-46	GA-164	GG-290
SUNFIRE	L4 2.2L FI	GP-46	GA-3916	GG-66
SUNFIRE	L4 2.4L FI 16 VALV.	GP-44	GA-3916	GG-66
2000				
BONNEVILLE	V6 3.8L FI	GP-46	GA-6479	GG-66
FIREBIRD	V6 3.8L SFI	GP-46	GA-392	GG-66
FIREBIRD	V8 5.7L SFI	GP-44	GA-392	GG-66
FIREBIRD TRANS AM	V8 5.7L FI	GP-44	GA-392	GG-66
FIREFLY	3 CIL. 1.0L FI CANADA	GP-58	GA-142	GG-146
FIREFLY	L4 1.3L FI CANADA	GP-58	GA-142	GG-146
GRAND AM	L4 2.4L FI	GP-44	GA-279	GG-66
GRAND AM	V6 3.4L FI	GP-46	GA-279	GG-66
GRAND PRIX	V6 3.1L FI	GP-46	GA-6479	GG-66
GRAND PRIX	V6 3.8L FI	GP-46	GA-6479	GG-66
MONTANA	V6 3.4L SFI	GP-46	GA-164	GG-290
SUNFIRE	L4 2.2L FI	GP-46	GA-3916	GG-66
SUNFIRE	L4 2.4L FI 16 VALV.	GP-44	GA-3916	GG-66
1999				
BONNEVILLE	V6 3.8L FI	GP-46	GA-6479	GG-66
FIREBIRD	V6 3.8L SFI	GP-46	GA-392	GG-66
FIREBIRD	V8 5.7L FI	GP-44	GA-392 ²⁷ GA-165 ¹⁴⁵	GG-66
FIREFLY	3 CIL. 1.0L FI CANADA	GP-58	GA-142	GG-146
FIREFLY	L4 1.3L FI CANADA	GP-58	GA-142	GG-146
GRAND AM	L4 2.4L FI	GP-44	GA-279	GG-66
GRAND AM	V6 3.4L FI	GP-46	GA-279	GG-66
GRAND PRIX	V6 3.1L FI	GP-46	GA-6479	GG-66
GRAND PRIX	V6 3.8L FI	GP-46	GA-6479	GG-66
MONTANA	V6 3.4L SFI	GP-46	GA-164	GG-66
SUNFIRE	L4 2.2L FI	GP-46	GA-3916	GG-66
SUNFIRE	L4 2.4L FI 16 VALV.	GP-44	GA-3916	GG-66
1998				
BONNEVILLE	V6 3.8L FI	GP-46	GA-6479	GG-66
FIREBIRD	V6 3.8L SFI	GP-46	GA-392	GG-66
FIREBIRD	V8 5.7L FI	GP-44	GA-392	GG-66
FIREFLY	3 CIL. 1.0L FI CANADA	GP-58	GA-142	GG-146
FIREFLY	L4 1.3L FI CANADA	GP-58	GA-142	GG-146
GRAND AM	L4 2.4L SFI	GP-44		GG-66
GRAND AM	V6 3.1L SFI	GP-46		GG-66
GRAND PRIX	V6 3.8L FI	GP-46	GA-164	GG-66
SUNFIRE	L4 2.2L FI	GP-46	GA-3916	GG-66
SUNFIRE	L4 2.4L FI 16 VALV.	GP-44	GA-3916	GG-66
TRANS SPORT	V6 3.4L FI	GP-46	GA-164	
1997				
BONNEVILLE	V6 3.8L FI	GP-46	GA-6479	GG-66
FIREBIRD	V8 5.7L FI	GP-3	GA-165	GG-66
FIREFLY	3 CIL. 1.0L FI CANADA	GP-58	GA-142	GG-146
FIREFLY	L4 1.3L FI CANADA	GP-58	GA-142	GG-146
GRAND AM	L4 2.4L SFI	GP-44		GG-66
GRAND AM	V6 3.1L SFI	GP-46		GG-66
GRAND PRIX	V6 3.8L FI	GP-46	GA-164	GG-66
SUNFIRE	L4 2.2L FI	GP-46	GA-3916	GG-66
SUNFIRE	L4 2.4L FI 16 VALV.	GP-44	GA-3916	GG-66
TRANS SPORT	V6 3.4L FI	GP-46	GA-164	

Marca - Año - Modelo Make-Year-Model	Motor Engine	Aceite Oil	Aire Air	Combustible Fuel
PONTIAC (continuación)				
GRAND PRIX	V6 3.8L FI	GP-46	GA-164	GG-66
SUNFIRE	L4 2.2L FI	GP-46	GA-3916	GG-66
SUNFIRE	L4 2.4L FI 16 VALV.	GP-44	GA-3916	GG-66
TRANS SPORT	V6 3.4L FI	GP-46	GA-164	
1996				
BONNEVILLE	V6 3.8L FI	GP-46	GA-6479	GG-66
FIREBIRD	V6 3.8L FI	GP-46	GA-165	GG-66
FIREBIRD	V8 5.7L FI	GP-3	GA-165 ²² GA-7007 ¹⁶⁴	GG-66
FIREFLY	3 CIL. 1.0L FI CANADA	GP-58	GA-142	GG-146
FIREFLY	L4 1.3L FI CANADA	GP-58	GA-142	GG-146
GRAND AM	L4 2.4L SFI	GP-44		GG-66
GRAND AM	V6 3.1L SFI	GP-46		GG-66
GRAND PRIX	V6 3.1L FI	GP-46	GA-164	GG-66
GRAND PRIX	V6 3.4L FI	GP-46	GA-164	GG-66
SUNFIRE	L4 2.2L SFI	GP-46	GA-3916	GG-66
SUNFIRE	L4 2.4L SFI	GP-44	GA-3916	GG-66
TRANS AM	V8 5.7L FI	GP-3	GA-165	GG-66
TRANS SPORT	V6 3.4L FI	GP-46	GA-3916	GG-177
1995				
BONNEVILLE	V6 3.8L FI	GP-46	GA-6479	GG-66
FIREBIRD	V6 3.4L FI	GP-46	GA-165	GG-66
FIREBIRD	V6 3.8L FI	GP-46	GA-165	GG-66
FIREBIRD	V8 5.7L FI	GP-3	GA-165	GG-66
FIREFLY	3 CIL. 1.0L FI CANADA	GP-58	GA-142	GG-146
FIREFLY	L4 1.3L FI CANADA	GP-58	GA-142	GG-146
GRAND AM	L4 2.3L MFI	GP-46		GG-66
GRAND AM	V6 3.1L SFI	GP-46		GG-66
GRAND PRIX	V6 3.1L SFI	GP-46	GA-164	GG-66
GRAND PRIX	V6 3.4L SFI	GP-3980	GA-164	GG-66
SUNFIRE	L4 2.2L MFI	GP-46	GA-3916	GG-66
SUNFIRE	L4 2.3L MFI	GP-46	GA-3916	GG-66
TRANS AM	V8 5.7L FI	GP-3	GA-165	GG-66
TRANS SPORT	V6 3.1L FI	GP-46	GA-3588	GG-177
TRANS SPORT	V6 3.8L FI	GP-46	GA-3916	GG-177
1994				
ASUNA SUNRUNNER (CANADA)	L4 1.6L FI	GP-2951	GA-216	GG-260
BONNEVILLE	V6 3.8L FI	GP-46	GA-6479	GG-66
FIREBIRD	V6 3.4L FI	GP-46	GA-165	GG-66
FIREBIRD	V8 5.7L FI	GP-3	GA-165	GG-66
FIREFLY	1.3L FI CANADA	GP-58	GA-142	GG-146
FIREFLY	3 CIL. 1.0L FI CANADA	GP-58	GA-142	GG-146
GRAND AM	L4 2.3L MFI	GP-46		GG-66
GRAND AM	V6 3.1L MFI	GP-46		GG-66
GRAND PRIX	V6 3.1L SFI	GP-46	GA-164	GG-66
GRAND PRIX	V6 3.4L SFI	GP-3980	GA-164	GG-66
SUNBIRD	L4 2.0L MFI	GP-46	GA-3916	GG-66
SUNBIRD	V6 3.1L MFI	GP-46	GA-153	GG-66
TRANS AM	V8 5.7L FI	GP-3	GA-165	GG-66
TRANS SPORT	V6 3.1L FI	GP-3980	GA-3588	GG-177
TRANS SPORT	V6 3.8L FI	GP-46	GA-3916	GG-177
1993				
ASUNA SUNFIRE	L4 1.6L FI			GG-46
ASUNA SUNFIRE	L4 1.8L FI		GA-216	GG-260
ASUNA SUNRUNNER (CANADA)	L4 1.6L FI	GP-2951	GA-216	GG-260
FIREBIRD	V6 3.4L FI	GP-46	GA-165	GG-66
FIREBIRD	V8 5.7L FI	GP-3	GA-165	GG-66
GRAND AM	L4 2.3L MFI	GP-46	GA-3916	GG-66
GRAND AM	V6 3.3L MFI	GP-46	GA-3916	GG-66
GRAND PRIX	V6 3.1L MFI	GP-3980	GA-6626	GG-66
GRAND PRIX	V6 3.4L FI	GP-3980	GA-6626	GG-66
SE/GT (CANADA)	L4 1.6L FI			GG-46

Marca - Año - Modelo Motor Aceite Aire Combustible
Make-Year-Model Engine Oil Air Fuel

PONTIAC (continuación)

SE/GT (CANADA)	L4 1.8L FI		GA-216	GG-260
SUNBIRD	L4 2.0L MFI	GP-46	GA-3916	GG-66
SUNBIRD	V6 3.1L MFI	GP-46	GA-153	GG-66
TRANS SPORT	V6 3.1L FI	GP-3980	GA-3588	GG-177
TRANS SPORT	V6 3.8L FI	GP-46	GA-3916	GG-177

1992

ASUNA (CANADA)	L4 1.6L FI			GG-46
ASUNA (CANADA)	L4 1.8L FI		GA-216	GG-260
ASUNA SUNRUNNER (CANADA)	L4 1.6L FI	GP-2951	GA-216	GG-260
FIREBIRD	V8 5.0L EFI	GP-3	GA-57 GA-100 ⁴⁵	GG-46
GRAND AM	L4 2.3L MFI	GP-46	GA-3916	GG-66
GRAND AM	V6 3.3L MFI	GP-46	GA-3916	GG-66
GRAND PRIX	V6 3.1L EFI	GP-3980	GA-6626	GG-66
GRAND PRIX	V6 3.4L FI 24 VALV.	GP-3980	GA-6626	GG-66
SUNBIRD	L4 2.0L MFI		GA-3916	GG-46 GG-66
SUNBIRD	V6 3.1L MFI	GP-3980	GA-153	GG-66
TRANS SPORT	V6 3.1L FI	GP-3980	GA-3588	GG-177
TRANS SPORT	V6 3.8L FI	GP-46	GA-3916	GG-177

1991

FIREBIRD	V8 5.0L EFI	GP-3	GA-57 GA-100 ⁴⁵	GG-46
FIREFLY	3 CIL. 1.0L FI CANADA	GP-58	GA-142	GG-146
FIREFLY	3 CIL. 1.0L FI TURBO CANADA	GP-58		GG-146
GRAND AM	L4 2.3L MFI	GP-46	GA-3916	GG-46
GRAND AM	L4 2.5L EFI		GA-3647	GG-46
GRAND PRIX	V6 3.1L MFI	GP-3980	GA-6626	GG-46
GRAND PRIX	V6 3.4L MFI	GP-3980	GA-6626	GG-46
SUNBIRD	L4 2.0L EFI	GP-46	GA-3647	GG-46
SUNBIRD	L4 3.1L MFI	GP-3980	GA-153	GG-46
TRANS SPORT	V6 3.1L FI	GP-3980	GA-3588	GG-177

1990

FIREBIRD	V8 5.0L EFI	GP-3	GA-57 GA-100 ⁴⁵	GG-46
FIREFLY	3 CIL. 1.0L CANADA	GP-58	GA-142	
FIREFLY	3 CIL. 1.0L FI TURBO CANADA	GP-58		GG-146
GRAND AM	L4 2.3L MFI	GP-46	GA-3916	GG-46
GRAND AM	L4 2.5L EFI		GA-3647	GG-46
GRAND PRIX	V6 3.1L FI	GP-3980	GA-6626	GG-46
SUNBIRD	L4 2.0L EFI	GP-46	GA-3647	GG-46
SUNBIRD	L4 2.0L MFI TURBO	GP-46	GA-153	GG-46
TRANS SPORT	V6 3.1L FI	GP-3980	GA-3588	GG-177

PORSCHE

2010

911	6 CIL. 3.6L FI 24 VALV.			
911	6 CIL. 3.6L FI 24 VALV. TURBO			
911	6 CIL. 3.8L FI 24 VALV.			
BOXTER	6 CIL. 2.9L FI 24 VALV.			
BOXTER	6 CIL. 3.4L FI 24 VALV.			
CAYENNE	V6 3.6L DI 24 VALV.		GAVW-616	
CAYENNE	V8 4.8L DI 32 VALV.		GAVW-616	
CAYENNE	V8 4.8L DI 32 VALV. TWIN-TURBO		GAVW-616	
CAYENNE HYBRID	V6 3.0L DI			
CAYMAN	6 CIL. 2.9L FI 24 VALV.			
CAYMAN	6 CIL. 3.4L FI 24 VALV.			
PANAMERA	6 CIL. 3.6L FI 24 VALV. DOHC		GAVW-616	
PANAMERA	V8 4.8L DI			
PANAMERA	V8 4.8L DI TWIN-TURBO			

Marca - Año - Modelo Motor Aceite Aire Combustible
Make-Year-Model Engine Oil Air Fuel

PORSCHE (continuación)

2009

911	BOXER 6 CIL. 3.6L FI			
911	BOXER 6 CIL. 3.8L FI			
BOXTER	6 CIL. 2.7L FI 24 VALV. DOHC		GAVW-616	
BOXTER	6 CIL. 3.4L FI 24 VALV. DOHC		GAVW-616	
BOXTER S	6 CIL. 2.7L FI 24 VALV. DOHC		GAVW-616	
BOXTER S	6 CIL. 2.9L FI		GAVW-616	
BOXTER S	6 CIL. 3.4L FI 24 VALV. DOHC		GAVW-616	
CAYENNE	V6 3.6L DI 24 VALV. DOHC	G-112	GAVW-616	
CAYENNE	V8 4.8L DI 32 VALV.		GAVW-616	
CAYENNE	V8 4.8L DI 32 VALV. TWIN-TURBO		GAVW-616	
CAYMAN	6 CIL. 2.7L FI 24 VALV. DOHC		GAVW-616	
CAYMAN	6 CIL. 2.9L FI		GAVW-616	
CAYMAN	6 CIL. 3.4L FI 24 VALV. DOHC		GAVW-616	

2008

911	BOXER 6 CIL. 3.6L			
911	BOXER 6 CIL. 3.8L			
BOXTER	BOXER 6 CIL. 2.7L FI			
BOXTER S	BOXER 6 CIL. 3.4L FI			
CAYENNE	V6 3.6L FI	G-112	GAVW-616	
CAYENNE	V8 4.8L DI		GAVW-616	
CAYMAN	BOXER 6 CIL. 2.7L FI			
CAYMAN	BOXER 6 CIL. 3.4L FI			

2007

911	BOXER 6 CIL. 3.6L			
911	BOXER 6 CIL. 3.8L			
BOXTER	BOXER 6 CIL. 2.7L			
BOXTER S	BOXER 6 CIL. 3.4L			
CAYENNE	V6 3.2L FI 24 VALV.	G-112	GAVW-616	
CAYENNE	V8 4.8L FI O TWIN TURBO			
CAYMAN	BOXER 6 CIL. 2.7L			
CAYMAN	BOXER 6 CIL. 3.4L			

2006

911	BOXER 6 CIL. 3.4L FI 24 VALV.			
911	BOXER 6 CIL. 3.6L FI 24 VALV.			
BOXTER	BOXER 6 CIL. 2.7L			
BOXTER S	BOXER 6 CIL. 3.4L			
CAYENNE	V6 3.2L FI	G-112	GAVW-616	
CAYENNE	V8 4.5L FI 32 VALV. DOHC		GAVW-616	
CAYENNE	V8 4.5L FI 32 VALV. DOHC TWIN-TURBO		GAVW-616	
CAYMAN	6 CIL. 3.4L FI 24 VALV. DOHC		GAVW-616	

2005

911	BOXER 6 CIL. 3.4L FI 24 VALV.			
911	BOXER 6 CIL. 3.6L FI 24 VALV.			
BOXTER	BOXER 6 CIL. 2.7L			
BOXTER S	BOXER 6 CIL. 3.2L FI			
CAYENNE	V6 3.2L FI	G-112	GAVW-616	
TURBO 996	BOXER 6 CIL. 3.6L FI			
TURBO S996	BOXER 6 CIL. 3.6L FI			

2004

911	BOXER 6 CIL. 3.4L FI 24 VALV.			
911	BOXER 6 CIL. 3.6L FI 24 VALV.			
BOXTER	BOXER 6 CIL. 2.7L FI			
BOXTER S	BOXER 6 CIL. 3.2L FI			

Marca - Año - Modelo Make-Year-Model	Motor Engine	Aceite Oil	Aire Air	Combustible Fuel
PORSCHE (continuación)				
CAYENNE	V6 3.2L FI	G-112	GAVW-616	
2003				
911	BOXER 6 CIL. 3.4L FI 24 VALV.			
911	BOXER 6 CIL. 3.6L FI 24 VALV.			
BOXTER	BOXER 6 CIL. 2.7L FI			
BOXTER S	BOXER 6 CIL. 3.2L FI			
CAYENNE	V8 4.5L FI TURBO		GAVW-616	
2002				
911	BOXER 6 CIL. 3.4L FI 24 VALV.			
911	BOXER 6 CIL. 3.6L FI 24 VALV.			
BOXTER	BOXER 6 CIL. 2.7L FI			
BOXTER S	BOXER 6 CIL. 3.2L FI			
2001				
911	BOXER 6 CIL. 3.4L FI 24 VALV.			
911	BOXER 6 CIL. 3.6L FI 24 VALV.			
BOXTER	BOXER 6 CIL. 2.7L FI			
BOXTER S	BOXER 6 CIL. 3.2L FI			
2000				
911	BOXER 6 CIL. 3.4L FI 24 VALV.			
911	BOXER 6 CIL. 3.6L FI 24 VALV.			
BOXTER	BOXER 6 CIL. 2.7L FI			
BOXTER S	BOXER 6 CIL. 3.2L FI			
RENAULT				
2009				
CLIO	L4 1.6L FI 16 VALV. DOHC	GP-291	GA-291 GAC-4 ²⁴	GG-291
EURO CLIO	L4 1.6L FI 16 VALV. DOHC (K4M)			
KANGOO	L4 1.5L FI DIESEL			
KANGOO	L4 1.6L FI 16 VALV.	GP-291	GA-291 GAC-4 ²⁴	GG-291
KOLEOS	L4 2.5L FI 16 VALV. (TR25)			
MEGANE	L4 1.6L FI 16 VALV.			
MEGANE	L4 2.0L FI 16 VALV.			
MEGANE	L4 2.0L FI 16 VALV. (F4R TURBO)			
TRAFIC	L4 1.9L DIESEL	GP-291	GA-4319	
2008				
CLIO	L4 1.6L FI 16 VALV. DOHC	GP-291	GA-291 GAC-4 ²⁴	GG-291
EURO CLIO	L4 1.6L FI 16 VALV. DOHC (K4M)			
KANGOO	L4 1.6L FI 16 VALV.	GP-291	GA-291 GAC-4 ²⁴	GG-291
MEGANE	L4 2.0L FI 16 VALV.			
SCENIC	L4 2.0L FI 16 VALV.	GP-291	GA-391	GG-291
TRAFIC	L4 1.9L DIESEL	GP-291	GA-4319	
2007				
CLIO	L4 1.6L (KM41.6) MPFI 16 VALV.	GP-291	GA-291 GAC-4 ²⁴	GG-291
KANGOO	L4 1.6L FI 16 VALV.	GP-291	GA-291 GAC-4 ²⁴	GG-291
LAGUNA	L4 2.0L FI 16 VALV.	GP-291	GA-391	GG-291
LAGUNA	V6 3.0L 24 VALV.	GP-462 ³⁵ GP-461 ³²		GG-291

Marca - Año - Modelo Make-Year-Model	Motor Engine	Aceite Oil	Aire Air	Combustible Fuel
RENAULT (continuación)				
MEGANE	L4 2.0L FI 16 VALV.			
SCENIC	L4 2.0L FI 16 VALV.	GP-291	GA-391	GG-291
TRAFIC	L4 1.9L DIESEL	GP-291	GA-4319	
2006				
CLIO	L4 1.6L FI	GP-291	GA-291 GAC-4 ²⁴	GG-291
CLIO	L4 2.0L FI 16 VALV.	GP-291	GA-391 GAC-4 ²⁴	GG-291
KANGOO	L4 1.6L FI	GP-291	GA-291 GAC-4 ²⁴	GG-291
LAGUNA	V6 3.0L FI 24 VALV.	GP-462 ³⁵ GP-461 ³²		GG-291
MEGANE	L4 2.0L FI 16 VALV.	GP-291	GA-292	GG-291
SCENIC	L4 2.0L FI 16 VALV.	GP-291	GA-391	GG-291
2005				
CLIO	L4 1.6L FI	GP-291	GA-291 GAC-4 ²⁴	GG-291
CLIO	L4 2.0L FI 16 VALV.	GP-291	GA-391 GAC-4 ²⁴	GG-291
KANGOO	L4 1.6L FI	GP-291	GA-291 GAC-4 ²⁴	GG-291
LAGUNA	V6 3.0L FI 24 VALV.	GP-462 ³⁵ GP-461 ³²		GG-291
MEGANE	L4 2.0L FI 16 VALV.	GP-291	GA-292	GG-291
SCENIC	L4 2.0L FI 16 VALV.	GP-291	GA-391	GG-291
2004				
CLIO	L4 1.6L FI	GP-291	GA-291 GAC-4 ²⁴	GG-291
CLIO	L4 2.0L FI 16 VALV.	GP-291	GA-391 GAC-4 ²⁴	GG-291
KANGOO	L4 1.6L FI	GP-291	GA-291 GAC-4 ²⁴	GG-291
LAGUNA	V6 3.0L FI 24 VALV.	GP-462 ³⁵ GP-461 ³²		GG-291
MEGANE	L4 2.0L FI 16 VALV.	GP-291	GA-292	GG-291
SCENIC	L4 2.0L FI 16 VALV.	GP-291	GA-291	GG-291
2003				
CLIO	L4 1.6L FI	GP-291	GA-291 GAC-4 ²⁴	GG-291
CLIO	L4 2.0L FI 16 VALV.	GP-291	GA-391 GAC-4 ²⁴	GG-291
KANGOO	L4 1.4L FI		GA-2173 ¹⁸	
LAGUNA	V6 3.0L FI 24 VALV.	GP-462 ³⁵ GP-461 ³²		GG-291
MEGANE	L4 2.0L FI 16 VALV.	GP-291	GA-292	GG-291
SCENIC	L4 2.0L FI 16 VALV.	GP-291	GA-291	GG-291
2002				
CLIO	L4 1.6L FI	GP-291	GA-291 GAC-4 ²⁴	GG-291
CLIO	L4 2.0L FI 16 VALV.	GP-291	GA-391 GAC-4 ²⁴	GG-291
KANGOO	L4 1.4L FI		GA-2173 ¹⁸	
MEGANE	L4 2.0L FI 16 VALV.	GP-291	GA-2121 GAC-4 ²⁴	GG-291
SCENIC	L4 2.0L FI 16 VALV.	GP-291	GA-291	GG-291
2001				
CLIO	L4 1.6L FI	GP-291	GA-2173 GAC-4 ²⁴	GG-291
KANGOO	L4 1.4L FI		GA-2173 ¹⁸	
LAGUNA	L4 2.0L FI	GP-3562	GA-2182	GG-291
MEGANE	L4 2.0L FI 16 VALV.	GP-291	GA-2121 GAC-4 ²⁴	GG-291
SCENIC	L4 2.0L FI 16 VALV.	GP-291	GA-291	GG-291
2000				
CLIO	L4 1.6L FI		GA-2173 ⁹⁵	
KANGOO	L4 1.4L FI		GA-2173 ¹⁸	

Marca - Año - Modelo Motor Aceite Aire Combustible
Make-Year-Model Engine Oil Air Fuel

RENAULT (continuación)				
1999				
CLIO	L4 1.6L FI		GA-2173	
KANGOO	L4 1.4L FI		GA-2173 ¹⁸	
1998				
CLIO	L4 1.4L FI		GA-2173	
CLIO	L4 1.6L FI		GA-2173 ⁶⁶	
KANGOO	L4 1.4L FI		GA-2173 ¹⁸	
1997				
KANGOO	L4 1.4L FI		GA-2173 ¹⁸	

ROLLS ROYCE

2010				
GHOST	V12 6.6L FI 48 VALV. DOHC TWIN-TURBO			
PHANTOM	V12 6.7L FI 48 VALV. DOHC			
2009				
PHANTOM	V12 6.7L FI 48 VALV.		GA-241	
2008				
PHANTOM	V12 6.7L FI 48 VALV.		GA-241	
2007				
PHANTOM	V12 6.7L 48 VALV.		GA-241	
2006				
PHANTOM	V12 6.7L FI 48 VALV.		GA-241	
2005				
PHANTOM	V12 6.7L FI 48 VALV.		GA-241	
2004				
PHANTOM	V12 6.7L FI 48 VALV.		GA-241	

ROVER

2006				
75	L4 1.8L FI		GA-2135	
75	L4 2.0L FI		GA-2135	
2005				
75	L4 1.8L FI		GA-2135	
75	L4 2.0L FI		GA-2135	
75	V6 2.5L FI 24 VALV.			
2004				
75	L4 1.8L FI		GA-2135	
75	L4 2.0L FI		GA-2135	
75	V6 2.5L FI 24 VALV.			
2003				
75	L4 1.8L FI		GA-2135 ¹⁰⁶	
75	L4 2.0L FI		GA-2135	
75	V6 2.5L FI 24 VALV.			
2002				
ROVER VAGONETA	V6 2.5L FI 24 VALV.			
75	L4 2.0L FI		GA-2135	
75	V6 2.5L FI		GA-2135	

Marca - Año - Modelo Motor Aceite Aire Combustible
Make-Year-Model Engine Oil Air Fuel

ROVER (continuación)				
2001				
75	L4 2.0L FI		GA-2135	
75	V6 2.5L FI		GA-2135	
2000				
75	L4 2.0L FI		GA-2135	
75	V6 2.5L FI		GA-2135	
1999				
75	L4 2.0L FI		GA-2135 ¹⁰¹	
75	V6 2.5L FI		GA-2135 ¹⁰¹	

SAAB

2010				
9-3	L4 2.0L FI TURBO			
9-5	L4 2.0L FI TURBO			
9-4X	L4 2.0L FI TURBO			
2009				
9-3	L4 2.0L FI 16 VALV. DOHC TURBO	G-49	GA-646	
9-3	V6 2.8L FI 24 VALV. DOHC TWIN-TURBO	G-765	GA-646	
9-5	L4 2.3L FI 16 VALV. DOHC TURBO	GP-58	GA-2147	GG-261
9-7X	6 CIL. 4.2L FI 24 VALV. DOHC	GP-3675	GA-414R	
9-7X	V8 5.3L FI	GP-406	GA-414R	
9-7X	V8 6.0L FI	GP-406	GA-414R	
2008				
9-3	L4 2.0L FI 16 VALV. DOHC TURBO	G-49	GA-646	
9-3	V6 2.8L FI 24 VALV. DOHC TWIN-TURBO	G-765	GA-646	
9-5	L4 2.0L FI TURBO	G-49		
9-5	L4 2.3L FI TURBO	GP-58	GA-2147	GG-261
9-5	V6 2.8L TWIN TURBO			
9-7X	6 CIL. 4.2L SFI 24 VALV. DOHC	GP-3675	GA-414R	
9-7X	V8 5.3L FI	GP-406	GA-414R	
9-7X	V8 6.0L FI		GA-414R	
2007				
9-3	L4 2.0L FI TURBO	G-49	GA-646	
9-3	V6 2.8L FI 24 VALV. DOHC TWIN-TURBO	G-765	GA-646	
9-5	L4 2.3L FI TURBO		GA-2147	GG-64
9-5	V6 2.8L FI TWIN TURBO			
9-7X	6 CIL. 4.2L SFI 24 VALV.	GP-3675	GA-414R	
9-7X	V8 5.3L SFI 16 VALV.	GP-406	GA-414R	
2006				
9-3	L4 2.0L FI	G-49	GA-646	GG-246
9-3	V6 2.8L FI 24 VALV. DOHC TWIN-TURBO	G-765	GA-646	
9-5	L4 2.3L FI		GA-2147	
9-7X	6 CIL. 4.2L FI	GP-3675	GA-414R	
9-7X	V8 5.3L FI	GP-44	GA-414R	
2005				
9-3	L4 2.0L FI	G-49	GA-646	
9-5	L4 2.3L FI			GG-246
9-2X	L4 2.0L FI	GP-91	GAD-15	
9-2X	L4 2.5L FI	GP-91	GAD-15	
9-7X	6 CIL. 4.2L FI	GP-3675	GA-414R	
9-7X	V8 5.3L FI	GP-44	GA-414R	

Marca - Año - Modelo Make-Year-Model	Motor Engine	Aceite Oil	Aire Air	Combustible Fuel
SAAB (continuación)				
2004				
9-3	L4 2.0L FI TURBO	G-49	GA-646	
9-5	L4 2.3L FI TURBO		GA-2147	GG-246
2003				
9-3	L4 2.0L FI TURBO	G-49	GA-2118	GG-246
9-5	L4 2.3L FI TURBO		GA-2147	GG-246
9-5	V6 3.0L FI TURBO		GA-2147	GG-246
2002				
9-3	L4 2.0L FI TURBO	GP-58	GA-2118	GG-246
9-3	L4 2.3L FI TURBO	GP-58		GG-246
9-5	L4 2.3L FI TURBO		GA-2147	GG-246
9-5	V6 3.0L FI TURBO		GA-2147	GG-246
2001				
9-3	L4 2.0L FI TURBO	GP-58	GA-2118	GG-246
9-3	L4 2.3L FI TURBO	GP-58	GA-2147	GG-246
9-5	L4 2.3L FI TURBO		GA-2147	
9-5	V6 3.0L FI TURBO		GA-2147	GG-246
2000				
9-3	L4 2.0L FI	GP-58	GA-2118	GG-246
9-3	L4 2.3L FI	GP-58		GG-246
9-5	L4 2.3L FI		GA-2147	GG-246
9-5	V6 3.0L FI		GA-2147	GG-246
1999				
9-3	L4 2.0L EFI TURBO 16 VALV.	GP-58	GA-2118	GG-246
9-3	L4 2.3L EFI TURBO 16 VALV.	GP-58	GA-2118	GG-246
9-5	L4 2.3L FI		GA-2147	GG-246
9-5	V6 3.0L FI		GA-2147	GG-246
1998				
900	L4 2.0L EFI TURBO	GP-58	GA-2118	GG-246
900	L4 2.3L EFI	GP-58	GA-2118	GG-246
9000	L4 2.3L FI			GG-246
1997				
900	L4 2.0L EFI TURBO	GP-58	GA-2118	GG-246
900	L4 2.3L EFI	GP-58	GA-2118	GG-246
900	V6 3.0L EFI	GP-46		GG-246
9000	L4 2.3L FI			GG-246
9000	V6 3.0L FI	GP-46		GG-246
1996				
900	L4 2.0L EFI TURBO	GP-58	GA-2118	GG-246
900	L4 2.3L EFI	GP-58	GA-2118	GG-246
900	V6 3.0L EFI	GP-46		GG-246
9000	L4 2.3L FI			GG-246
9000	V6 2.5L FI			GG-246
1995				
900	L4 2.0L EFI TURBO	GP-58	GA-2118	GG-246
900	L4 2.3L EFI	GP-58	GA-2118	GG-246
900	V6 3.0L EFI	GP-46		GG-246
9000	L4 2.3L			GG-246
9000	V6 3.0L			GG-246
1994				
900	L4 2.0L EFI TURBO	GP-58	GA-2118	GG-246
900	L4 2.1L EFI	GP-58		GG-246
900	L4 2.3L EFI	GP-58	GA-2118	GG-246
9000	L4 2.3L			GG-246
9005	L4 2.1L			GG-246

Marca - Año - Modelo Make-Year-Model	Motor Engine	Aceite Oil	Aire Air	Combustible Fuel
SAAB (continuación)				
9005	L4 2.3L			GG-246
900SE	L4 2.0L			GG-246
900SE	V6 2.5L			GG-246
1993				
900	L4 2.0L			GG-246
900	L4 2.1L			GG-246
9000	L4 2.1L			GG-246
1992				
900	L4 2.0L			GG-246
900	L4 2.1L			GG-246
9000	L4 2.3L			GG-246
1991				
900	L4 2.0L			GG-246
900	L4 2.1L			GG-246
9000	L4 2.3L			GG-246
1990				
900	L4 2.0L			GG-246
9000	L4 2.0L			GG-246
9000	L4 2.3L			GG-246
SATURN				
2010				
AURA	L4 2.4L FI			
AURA	L4 2.4L FI FLEX FUEL			
AURA	V6 3.6L FI	GP-406		
OUTLOOK	V6 3.6L DI	GP-406		GA-3083
VUE	L4 2.4L FI			GA-290
VUE	V6 3.5L FI	GP-406		GA-290
VUE	V6 3.6L FI	GP-406		GA-290
VUE HYBRID	L4 2.4L FI			
2009				
ASTRA	L4 1.8L FI 16 VALV. DOHC			
AURA	L4 2.4L FI 16 VALV. DOHC ECOTEC	G-49		GA-367
AURA	V6 3.6L FI 24 VALV. DOHC	GP-406		GA-367
AURA HYBRID	L4 2.4L FI 16 VALV. DOHC	G-49		GA-367
GREEN LINE	L4 2.4L FI 16 VALV. DOHC	G-49		GA-367
OUTLOOK	V6 3.6L DI 24 VALV.	GP-406		GA-3083
RED LINE	L4 2.0L DI 16 VALV. DOHC TURBO	G-49		
RED LINE	L4 2.4L FI 16 VALV. DOHC ECOTEC	G-49		GA-290
RED LINE	V6 3.5L FI	GP-3675		GA-290
RED LINE	V6 3.6L FI 24 VALV. DOHC	GP-406		GA-290
SKY	L4 2.0L DI 16 VALV. DOHC TURBO	G-49		
SKY	L4 2.4L FI 16 VALV. DOHC ECOTEC	G-49		
VUE	L4 2.4L FI 16 VALV. DOHC	G-49		GA-290
VUE	V6 3.5L FI	GP-3675		GA-290
VUE	V6 3.6L FI 24 VALV. DOHC	GP-406		GA-290
VUE HYBRID	L4 2.4L FI	G-49		GA-367
2008				
ASTRA	L4 1.8L FI			
AURA	L4 2.4L FI	G-49		GA-367
AURA	V6 3.5L FI	GP-3675		GA-367
AURA	V6 3.6L FI	GP-406		GA-367
AURA HYBRID	L4 2.4L FI 16 VALV. DOHC	G-49		GA-367
GREEN LINE	L4 2.4L FI 16 VALV. DOHC	G-49		GA-367 ²²
OUTLOOK	V6 3.6L FI	GP-406		GA-3083

Marca - Año - Modelo Make-Year-Model	Motor Engine	Aceite Oil	Aire Air	Combustible Fuel
SATURN (continuación)				
RED LINE	L4 2.0L DI 16 VALV. DOHC TURBO	G-49		
RED LINE	L4 2.4L FI 16 VALV. DOHC ECOTEC	G-49	GA-290	
RED LINE	V6 3.5L FI	GP-3675	GA-290	
RED LINE	V6 3.6L FI 24 VALV. DOHC	GP-406	GA-290	
SKY	L4 2.0L TURBO	G-49		
SKY	L4 2.4L FI	G-49		
VUE	L4 2.4L FI HYBRID	G-49	GA-290	
VUE	L4 2.4L SFI		GA-290	
VUE	V6 3.5L SFI	GP-3675	GA-290	
VUE	V6 3.6L SFI	GP-406	GA-290	
VUE HYBRID	L4 2.4L FI 16 VALV. DOHC	G-49	GA-290	
2007				
AURA	V6 3.5L FI	GP-3675	GA-367	
AURA	V6 3.6L FI DOHC	GP-406	GA-367	
AURA HYBRID	L4 2.4L FI 16 VALV. DOHC	G-49	GA-367	
GREEN LINE	L4 2.4L FI 16 VALV. DOHC	G-49	GA-367	
ION	L4 2.0L SFI SUPER CARGADO	G-49	GA-414R	
ION	L4 2.2L MFI 16 VALV.	G-49	GA-486	
ION	L4 2.4L FI	G-49	GA-486	
OUTLOOK	V6 3.6L FI SOHC	GP-406	GA-3083	
RED LINE	L4 2.0L DI 16 VALV. DOHC TURBO	G-49		
RED LINE	L4 2.0L FI 16 VALV. DOHC SUPER CARGADO	G-49		
RED LINE	L4 2.2L FI 16 VALV. DOHC ECOTEC	G-49	GA-486	
RED LINE	L4 2.4L FI 16 VALV. DOHC	G-49	GA-486	
RED LINE	L4 2.4L FI 16 VALV. DOHC ECOTEC	G-49		
RELAY	V6 3.9L SFI	GP-3675	GA-164	
SKY	L4 2.0L TURBO	G-49		
SKY	L4 2.4L SFI ECOTEC	G-49		
VUE	L4 2.2L SFI 16 VALV.	G-49		
VUE	L4 2.4L HYBRID	G-49	GA-367	
VUE	V6 3.5L FI	G-49	GA-367	
VUE HYBRID	L4 2.4L FI 16 VALV. DOHC	G-49		
2006				
ION	L4 2.0L SFI SUPER CARGADO	G-49	GA-414R	
ION	L4 2.2L SFI 16 VALV.	G-49	GA-486	
ION	L4 2.4L MFI	G-49	GA-486	
L300	V6 3.0L FI DOHC	G-45		GG-581
RED LINE	L4 2.0L FI 16 VALV. DOHC	G-49	GA-414R	
RED LINE	L4 2.2L FI 16 VALV. DOHC ECOTEC	G-49	GA-486	
RED LINE	L4 2.4L FI 16 VALV. DOHC	G-49	GA-486	
RELAY	V6 3.5L SFI	GP-46	GA-164	
RELAY	V6 3.9L SFI	GP-46	GA-164	
SKY	L4 2.4L FI 16 VALV. DOHC	G-49		
VUE	L4 2.2L SFI 16 VALV. DOHC	G-49	GA-367	
VUE	V6 3.5L MFI 24 VALV. DOHC	GP-149	GA-367	
2005				
ION	L4 2.0L SFI SUPER CARGADO	G-49	GA-414R	
ION	L4 2.2L SFI DOHC	G-49		
L SERIES	L4 2.2L FI 16 VALV. DOHC	G-49		GG-581
L SERIES	V6 3.0L FI 24 VALV. DOHC	G-45		GG-581
L300	L4 2.2L FI	G-49		GG-581
L300	V6 3.0L SFI	G-45		GG-581
RED LINE	L4 2.0L FI 16 VALV. DOHC	G-49	GA-414R	
RED LINE	L4 2.2L FI 16 VALV. DOHC	G-49		
RELAY	V6 3.5L FI	GP-46	GA-164	
VUE	L4 2.2L SFI DOHC	G-49	GA-367	

Marca - Año - Modelo Make-Year-Model	Motor Engine	Aceite Oil	Aire Air	Combustible Fuel
VUE	V6 3.5L SFI	GP-149	GA-367	
2004				
ION	L4 2.0L FI DOHC SUPER CARGADO	G-49	GA-414R	
ION	L4 2.2L FI DOHC	G-49		
L SERIES	L4 2.2L FI 16 VALV. DOHC	G-49		GG-581
L SERIES	V6 3.0L FI 24 VALV. DOHC	G-45		GG-581
L300	L4 2.2L SFI DOHC 16 VALV.	G-49		GG-581
L300	V6 3.0L SFI DOHC 24 VALV.	G-45		GG-581
LW SERIES	L4 2.2L FI 16 VALV. DOHC	G-49		GG-581
LW SERIES	V6 3.0L FI DOHC	G-45		GG-581
RED LINE	L4 2.0L FI 16 VALV. DOHC	G-49	GA-414R	
RED LINE	L4 2.2L FI 16 VALV. DOHC	G-49		
VUE	L4 2.2L FI DOHC 16 VALV.	G-49	GA-367	
VUE	V6 3.5L FI	GP-149	GA-367	
2003				
ION	L4 2.2L FI 16 VALV. DOHC	G-49		
L SERIES	L4 2.2L FI 16 VALV. DOHC	G-49		GG-581
L SERIES	V6 3.0L FI 24 VALV. DOHC	G-45		GG-581
LW SERIES	L4 2.2L FI 16 VALV. DOHC	G-49		GG-581
LW SERIES	V6 3.0L FI 24 VALV. DOHC	G-45		GG-581
VUE	L4 2.2L FI 16 VALV. DOHC	G-49	GA-367	
VUE	V6 3.0L FI 24 VALV. DOHC	G-45	GA-367	
2002				
L SERIES	L4 2.2L FI 16 VALV. DOHC	G-49		GG-581
L SERIES	V6 3.0L FI 24 VALV. DOHC	G-45		GG-581
LW SERIES	L4 2.2L FI 16 VALV. DOHC	G-49		GG-581
LW SERIES	V6 3.0L FI 24 VALV. DOHC	G-45		GG-581
SC SERIES	L4 1.9L FI 16 VALV. DOHC	GP-58	GA-604	
SC SERIES	L4 1.9L FI 8 VALV. SOHC	GP-58	GA-604	
SL SERIES	L4 1.9L FI 16 VALV. DOHC	GP-58	GA-604	
SL SERIES	L4 1.9L FI 8 VALV. SOHC	GP-58	GA-604	
SW SERIES	L4 1.9L FI 16 VALV. DOHC	GP-58	GA-604	
SW SERIES	L4 1.9L FI 8 VALV. SOHC	GP-58	GA-604	
VUE	L4 2.2L FI 16 VALV. DOHC	G-49	GA-367	
VUE	V6 3.0L FI 24 VALV. DOHC	G-45	GA-367	
2001				
LS SERIES	L4 2.2L FI 16 VALV. DOHC	G-49		GG-581
LS SERIES	V6 3.0L FI 24 VALV. DOHC	G-45		GG-581
LW SERIES	L4 2.2L FI 16 VALV. DOHC	G-49		GG-581
LW SERIES	V6 3.0L FI 24 VALV. DOHC	G-45		GG-581
SC SERIES	L4 1.9L FI 16 VALV. DOHC	GP-58	GA-604	
SC SERIES	L4 1.9L FI 16 VALV. SOHC	GP-58	GA-604	
SL SERIES	L4 1.9L FI 16 VALV. DOHC	GP-58	GA-604	
SL SERIES	L4 1.9L FI 16 VALV. SOHC	GP-58	GA-604	
SW SERIES	L4 1.9L FI 16 VALV. DOHC	GP-58	GA-604	
SW SERIES	L4 1.9L FI 16 VALV. SOHC	GP-58	GA-604	
2000				
LS SERIES	L4 2.2L FI 16 VALV. DOHC	G-49		GG-581
LS SERIES	V6 3.0L FI 24 VALV. DOHC	G-45		GG-581
LW SERIES	L4 2.2L FI 16 VALV. DOHC	G-49		GG-581
LW SERIES	V6 3.0L FI 24 VALV. DOHC	G-45		GG-581
SC SERIES	L4 1.9 FI DOHC	GP-58	GA-604	
SC SERIES	L4 1.9 FI SOHC	GP-58	GA-604	
SL SERIES	L4 1.9 FI DOHC	GP-58	GA-604	
SL SERIES	L4 1.9 FI SOHC	GP-58	GA-604	
SW SERIES	L4 1.9 FI DOHC	GP-58	GA-604	
SW SERIES	L4 1.9 FI SOHC	GP-58	GA-604	
1999				
SC SERIES	L4 1.9 FI DOHC	GP-58	GA-604	
SC SERIES	L4 1.9 FI SOHC	GP-58	GA-604	
SL SERIES	L4 1.9 FI DOHC	GP-58	GA-604	

Marca - Año - Modelo Make-Year-Model	Motor Engine	Aceite Oil	Aire Air	Combustible Fuel
SATURN (continuación)				
SL SERIES	L4 1.9 FI SOHC	GP-58	GA-604	
SW SERIES	L4 1.9 FI DOHC	GP-58	GA-604	
SW SERIES	L4 1.9 FI SOHC	GP-58	GA-604	
1998				
SC SERIES	L4 1.9 FI DOHC	GP-58	GA-604	
SC SERIES	L4 1.9 FI SOHC	GP-58	GA-604	
SL SERIES	L4 1.9 FI DOHC	GP-58	GA-604	
SL SERIES	L4 1.9 FI SOHC	GP-58	GA-604	
SW SERIES	L4 1.9 FI DOHC	GP-58	GA-604	
SW SERIES	L4 1.9 FI SOHC	GP-58	GA-604	
1997				
SC SERIES	L4 1.9 FI DOHC	GP-58	GA-604	
SC SERIES	L4 1.9 FI SOHC	GP-58	GA-604	
SL SERIES	L4 1.9 FI DOHC	GP-58	GA-604	
SL SERIES	L4 1.9 FI SOHC	GP-58	GA-604	
SW SERIES	L4 1.9 FI DOHC	GP-58	GA-604	
SW SERIES	L4 1.9 FI SOHC	GP-58	GA-604	
1996				
SC SERIES	L4 1.9 FI DOHC	GP-58	GA-604	
SC SERIES	L4 1.9 FI SOHC	GP-58	GA-604	
SL SERIES	L4 1.9 FI DOHC	GP-58	GA-604	
SL SERIES	L4 1.9 FI SOHC	GP-58	GA-604	
SW SERIES	L4 1.9 FI DOHC	GP-58	GA-604	
SW SERIES	L4 1.9 FI SOHC	GP-58	GA-604	
1995				
SC SERIES	L4 1.9 FI DOHC	GP-58	GA-604	
SC SERIES	L4 1.9 FI SOHC	GP-58	GA-604	
SL SERIES	L4 1.9 FI DOHC	GP-58	GA-604	
SL SERIES	L4 1.9 FI SOHC	GP-58	GA-604	
SW SERIES	L4 1.9 FI DOHC	GP-58	GA-604	
SW SERIES	L4 1.9 FI SOHC	GP-58	GA-604	
1994				
SC SERIES	L4 1.9 FI DOHC	GP-58	GA-604	
SC SERIES	L4 1.9 FI SOHC	GP-58	GA-604	
SL SERIES	L4 1.9 FI DOHC	GP-58	GA-604	
SL SERIES	L4 1.9 FI SOHC	GP-58	GA-604	
SW SERIES	L4 1.9 FI DOHC	GP-58	GA-604	
SW SERIES	L4 1.9 FI SOHC	GP-58	GA-604	
1993				
SC SERIES	L4 1.9 FI DOHC	GP-58	GA-604	
SC SERIES	L4 1.9 FI SOHC	GP-58	GA-604	
SL SERIES	L4 1.9 FI DOHC	GP-58	GA-604	
SL SERIES	L4 1.9 FI SOHC	GP-58	GA-604	
SW SERIES	L4 1.9 FI DOHC	GP-58	GA-604	
SW SERIES	L4 1.9 FI SOHC	GP-58	GA-604	
1992				
SC SERIES	L4 1.9 FI DOHC	GP-58	GA-604	
SC SERIES	L4 1.9 FI SOHC	GP-58	GA-604	
SL SERIES	L4 1.9 FI DOHC	GP-58	GA-604	
SL SERIES	L4 1.9 FI SOHC	GP-58	GA-604	
SW SERIES	L4 1.9 FI DOHC	GP-58	GA-604	
SW SERIES	L4 1.9 FI SOHC	GP-58	GA-604	
1991				
SC SERIES	L4 1.9 FI DOHC	GP-58	GA-604	
SC SERIES	L4 1.9 FI SOHC	GP-58	GA-604	
SL SERIES	L4 1.9 FI DOHC	GP-58	GA-604	
SL SERIES	L4 1.9 FI SOHC	GP-58	GA-604	

Marca - Año - Modelo Make-Year-Model	Motor Engine	Aceite Oil	Aire Air	Combustible Fuel
SATURN (continuación)				
SW SERIES	L4 1.9 FI DOHC	GP-58	GA-604	
SW SERIES	L4 1.9 FI SOHC	GP-58	GA-604	
SCION				
2010				
TC SPORT COUPE	L4 2.4L FI	GP-156	GA-263	
XB	L4 2.4L FI	GP-156	GA-320	
XD	L4 1.8L FI	G-911	GA-265	
2009				
TC SPORT COUPE	L4 2.4L FI 16 VALV. DOHC	GP-156	GA-263	
XB	L4 2.4L FI 16 VALV. DOHC	GP-156	GA-320	
XD	L4 1.8L FI 16 VALV. DOHC	G-911	GA-265	
2008				
TC SPORT COUPE	L4 2.4L FI 16 VALV. DOHC	GP-157	GA-263	
XB	L4 2.4L FI 16 VALV. DOHC	GP-156	GA-320	
XD	L4 1.8L FI 16 VALV. DOHC	G-911	GA-265	
SEAT				
2009				
FREETRACK	L4 2.0L FI			
2008				
ALTEA	L4 2.0L DI			
CORDOBA	L4 1.6L FI	GP-428	GAVW-623	
CORDOBA	L4 2.0L FI	GP-430	GAVW-624 GAC-3 ²⁴	
FREETRACK	L4 2.0L FI			
IBIZA	L4 1.6L FI	GP-430	GAVW-623	
IBIZA	L4 1.8L FI TURBO	G-70 ³² GP-430 ¹³⁶	GAVW-624 GAC-3 ²⁴	
IBIZA	L4 2.0L FI	GP-430	GAVW-624 GAC-3 ²⁴	
LEON	L4 1.4L FI			
LEON	L4 1.8L FI			
LEON	L4 2.0L FI			
2007				
ALHAMBRA	L4 1.8L FI			
ALTEA	L4 2.0L DI			
CORDOBA	L4 1.6L FI	GP-428	GAVW-623	
CORDOBA	L4 2.0L FI	GP-430	GAVW-624 GAC-3 ²⁴	
IBIZA	L4 1.6L FI	GP-430	GAVW-623	
IBIZA	L4 1.8L FI TURBO	G-70 ³² GP-430 ¹³⁶	GAVW-624 GAC-3 ²⁴	
IBIZA	L4 2.0L FI	GP-430	GAVW-624 GAC-3 ²⁴	
LEON	L4 2.0L DI Y	G-313		
TOLEDO	L4 2.0L DI			
2006				
ALHAMBRA	L4 1.8L FI TURBO			
ALHAMBRA	V6 2.8L FI			
ALTEA	L4 2.0L FI			
CORDOBA	L4 1.6L FI	GP-428	GAVW-623	
CORDOBA	L4 2.0L FI	GP-430	GAVW-624 GAC-3 ²⁴	
IBIZA	L4 1.6L FI	GP-430	GAVW-623	
IBIZA	L4 1.8L FI TURBO	GP-430	GAC-3 ²⁴	
IBIZA	L4 2.0L FI	GP-430	GAVW-624 GAC-3 ²⁴	
LEON	L4 1.8L FI 20 VALV. TURBO			
TOLEDO	L4 1.8L FI 20 VALV.	GP-28	GAVW-621	GG-261

Marca - Año - Modelo Make-Year-Model	Motor Engine	Aceite Oil	Aire Air	Combustible Fuel
SEAT (continuación)				
2005				
ALHAMBRA	L4 1.8L FI TURBO	GP-430		GG-251
ALTEA	L4 2.0L FI			
CORDOBA	L4 1.6L FI	GP-428	GAVW-623	GG-355
CORDOBA	L4 2.0L FI	GP-430	GAVW-624 GAC-3 ²⁴	GG-355
IBIZA	L4 1.6L FI	GP-430	GAVW-623	GG-355
IBIZA	L4 2.0L FI	GP-430	GAVW-624 GAC-3 ²⁴	GG-355
LEON	L4 1.8L FI 20 VALV. TURBO	GP-430	GAVW-621 GAC-10 ²⁶ GAC-3 ²⁷ GAC-8 ²⁵	GG-102
TOLEDO	L4 1.8L FI 20 VALV.	GP-430	GAVW-621 GAC-10 ²⁸ GAC-8 ²⁴	GG-261
2004				
ALHAMBRA	L4 1.8L FI TURBO	GP-430		GG-251
CORDOBA	L4 1.6L FI	GP-428	GAVW-623	GG-355
CORDOBA	L4 2.0L FI	GP-430	GAVW-624 GAC-3 ²⁴	GG-355
IBIZA	L4 1.6L FI	GP-430	GAVW-623	GG-355
IBIZA	L4 2.0L FI	GP-430	GAVW-624 GAC-3 ²⁴	GG-355
LEON	L4 1.8L FI 20 VALV. TURBO	GP-430	GAVW-621 GAC-10 ²⁶ GAC-3 ²⁷ GAC-8 ²⁵	GG-102
TOLEDO	L4 1.8L FI 20 VALV.	GP-430	GAVW-621 GAC-10 ²⁸ GAC-8 ²⁴	GG-261
2003				
CORDOBA	L4 1.6L FI	GP-428	GAVW-623	GG-355
CORDOBA	L4 2.0L FI	GP-430	GAVW-624 GAC-3 ²⁴	GG-355
IBIZA	L4 1.6L FI	GP-430	GAC-10 ²⁸ GAVW-623 GAC-8 ²⁴	GG-355
IBIZA	L4 2.0L FI	GP-430	GAVW-624 GAC-3 ²⁴	GG-355
LEON	L4 1.8L FI 20 VALV. TURBO	GP-430	GAVW-621 GAC-10 ²⁶ GAC-3 ²⁷ GAC-8 ²⁵	GG-102
TOLEDO	L4 1.8L FI 20 VALV.	GP-430	GAVW-621 GAC-10 ²⁸ GAC-8 ²⁴	GG-261
2002				
CORDOBA	L4 1.6L FI	GP-430	GAC-10 ²⁸ GA-285 GAC-8 ²⁴	GG-355
IBIZA	L4 1.6L FI	GP-430	GAC-10 ²⁸ GA-285 GAC-8 ²⁴	GG-355
LEON	L4 1.8L FI 20 VALV. TURBO	GP-430	GAVW-621 GAC-10 ²⁶ GAC-3 ²⁷ GAC-8 ²⁵	GG-102
TOLEDO	L4 1.8L FI 20 VALV. TURBO	GP-430	GAVW-621 GAC-10 ²⁸ GAC-8 ²⁴	GG-261
2001				
CORDOBA	L4 1.6L FI	GP-430	GAC-10 ²⁸ GA-285 GAC-8 ²⁴	GG-355
IBIZA	L4 1.6L FI	GP-430	GAC-10 ²⁸ GA-285 GAC-8 ²⁴	GG-355
LEON	L4 1.8L FI 20 VALV. TURBO	GP-430	GAVW-621 GAC-10 ²⁶ GAC-3 ²⁷ GAC-8 ²⁵	GG-102

Marca - Año - Modelo Make-Year-Model	Motor Engine	Aceite Oil	Aire Air	Combustible Fuel
SEAT (continuación)				
TOLEDO	L4 1.8L FI 20 VALV. TURBO	GP-430	GAVW-621 GAC-10 ²⁸ GAC-8 ²⁴	GG-261
2000				
CORDOBA	L4 1.6L FI	GP-430	GAC-10 ²⁸ GA-285 GAC-8 ²⁴	GG-355
IBIZA	L4 1.6L FI	GP-430	GAC-10 ²⁸ GA-285 GAC-8 ²⁴	GG-355
LEON	L4 1.8L FI 20 VALV. TURBO	GP-430	GAVW-621 GAC-10 ²⁶ GAC-3 ²⁷ GAC-8 ²⁵	GG-102
TOLEDO	L4 1.8L FI	GP-430	GAVW-621 GAC-10 ²⁸ GAC-8 ²⁴	GG-261
SMART				
2010				
FORTWO	3 CIL. 0.8L TURBO DIESEL			
FORTWO	3 CIL. 1.0L FI			
2009				
FORTWO	3 CIL. 0.8L FI TURBO DIESEL			
FORTWO	3 CIL. 1.0L FI	GP-91		
FORTWO	3 CIL. 1.0L FI TURBO			
2008				
FORTWO	3 CIL. 0.8L FI TURBO DIESEL			
FORTWO	3 CIL. 1.0L FI	GP-91		
2007				
FORFOUR	L4 1.5L FI TURBO			
FORTWO	L3 0.7L FI TURBO Y		GA-2136	
SMART	L3 0.7L FI TURBO Y		GA-2136	
SMART	L4 1.5L FI TURBO			
2006				
FORFOUR	L4 1.5L FI TURBO			
FORTWO	L3 0.7L FI TURBO		GA-2136	
SMART	L3 0.7L FI TURBO		GA-2136	
SMART	L4 1.5L FI TURBO			
2005				
FORFOUR	L4 1.5L FI TURBO			
FORTWO	L3 0.7L FI TURBO		GA-2136	GG-291
SMART	L3 0.7L FI TURBO		GA-2136	
SMART	L4 1.5L FI TURBO			
2004				
CROSSBLADE	L3 0.6L FI		GA-2136	
FORTWO	L3 0.6L FI		GA-2136	GG-291
ROADSTER	L3 0.6L FI		GA-2136	GG-291
SMART	L3 0.6L FI		GA-2136	
2003				
CABRIO	L3 0.6L FI		GA-2136	
COUPE	L3 0.6L FI		GA-2136	
SMART	L3 0.6L FI		GA-2136	
2002				
CABRIO	L3 0.6L FI		GA-2136	
COUPE	L3 0.6L FI		GA-2136	
SMART	L3 0.6L FI		GA-2136	

Marca - Año - Modelo **Motor** **Aceite** **Aire** **Combustible**
Make-Year-Model Engine Oil Air Fuel

SMART (continuación)				
2001				
CABRIO	L3 0.6L FI		GA-2136	GG-291
COUPE	L3 0.6L FI		GA-2136	GG-291
SMART	L3 0.6L FI		GA-2136	GG-291

STERLING

2009				
BULLET	6 CIL. 6.7L DIESEL TURBO	GP-178		

1991				
825	V6 2.7L FI	GP-212		
827	V6 2.7L FI	GP-212		

1990				
825	V6 2.7L FI	GP-212		
827	V6 2.7L FI	GP-212		

SUBARU

2010				
FORESTER	L4 2.5L FI	GP-91		
FORESTER	L4 2.5L FI TURBO	GP-91		
IMPREZA	L4 2.5L FI	GP-91		
IMPREZA	L4 2.5L FI TURBO	GP-91		
LEGACY	H6 3.6L DI			
LEGACY	L4 2.5L DI TURBO	GP-91		
LEGACY	L4 2.5L FI	GP-91		
OUTBACK	H6 3.6L FI			
OUTBACK	L4 2.5L DI TURBO			
OUTBACK	L4 2.5L FI			
TRIBECA	H6 3.6L FI			

2009				
FORESTER	L4 2.5L FI 16 VALV. SOHC	GP-91		
IMPREZA	L4 2.5L FI 16 VALV. DOHC TURBO	GP-91		
IMPREZA	L4 2.5L FI 16 VALV. SOHC	GP-91		
LEGACY	H6 3.0L FI 24 VALV. DOHC			
LEGACY	L4 2.5L FI 16 VALV. DOHC TURBO	GP-91		
LEGACY	L4 2.5L FI 16VALV. SOHC	GP-91		
OUTBACK	H6 3.0L FI 24 VALV. DOHC			
OUTBACK	L4 2.5L FI 16 VALV. DOHC TURBO	GP-91		
OUTBACK	L4 2.5L FI 16 VALV. SOHC	GP-91		
TRIBECA	H6 3.0L FI 24 VALV. DOHC			

2008				
FORESTER	H4 2.5L EFI O TURBO	GP-91	GAD-15	
IMPREZA	4 CIL. 2.5L FI	GP-91		
LEGACY	4 CIL. 2.5L SFI O TURBO	GP-91		
LEGACY	H6 3.0L SFI			
OUTBACK	H6 3.0L SFI			
OUTBACK	L4 2.5L SFI O TURBO	GP-91		
TRIBECA	H6 3.6L FI			

2007				
FORESTER	H4 2.5L MFI O TURBO	GP-91	GAD-15	
IMPREZA	4 CIL. 2.5L TURBO	GP-91	GAD-15	
LEGACY	BOXER 4 CIL. 2.5L	GP-91		
OUTBACK	4 CIL. 2.5L FI	GP-91		
OUTBACK	6 CIL. 3.0 SFI			
TRIBECA	6 CIL. 3.0L SFI			
TRIBECA	BOXER H6 3.6L			

2006				
BAJA	4 CIL. 2.5L FI	GP-91	GAD-15	

Marca - Año - Modelo **Motor** **Aceite** **Aire** **Combustible**
Make-Year-Model Engine Oil Air Fuel

SUBARU (continuación)				
FORESTER	4 CIL. 2.5L FI	GP-91	GAD-15	
IMPREZA	4 CIL. 2.0L FI	GP-91	GAD-15	
IMPREZA	4 CIL. 2.5L FI	GP-91	GAD-15	
LEGACY	BOXER 4 CIL. 2.5L	GP-91		
OUTBACK	4 CIL. 2.5L FI	GP-91		

2005				
BAJA	4 CIL. 2.5L FI	GP-91	GAD-15	
FORESTER	4 CIL. 2.5L FI	GP-91	GAD-15	
IMPREZA	4 CIL. 2.0L FI	GP-91	GAD-15	
IMPREZA	4 CIL. 2.5L FI	GP-91	GAD-15	
LEGACY	BOXER 4 CIL. 2.5L	GP-91		
OUTBACK	4 CIL. 2.5L FI	GP-91		

1992				
JUSTY	L4 1.2L	GP-91	GAD-3	GG-203

1991				
JUSTY	L4 1.2L	GP-91	GAD-3	GG-203

1990				
JUSTY	L4 1.2L	GP-91	GAD-3	GG-203

SUZUKI

2010				
EQUATOR	L4 2.5L FI (QR25DE)	GP-91	GA-1546	GG-63
EQUATOR	V6 4.0L FI 24 VALV. DOHC (VQ40DE)	GP-149	GA-300	GG-63
GRAND VITARA	L4 2.4L FI			
GRAND VITARA	V6 3.2L FI			
KIZASHI	L4 2.4L FI DOHC			
KIZASHI	V6 3.6L FI DOHC			
SWIFT	L4 1.6L FI			
SX4	L4 2.0L FI			

2009				
EQUATOR	L4 2.5L FI (QR25DE)	GP-91	GA-1546	
EQUATOR	V6 4.0L FI 24 VALV. DOHC (VQ40DE)	GP-149	GA-300	
GRAND VITARA	L4 2.4L FI 16 VALV. DOHC	GP-157		
GRAND VITARA	V6 2.7L FI 24 VALV. DOHC	GP-2951		
GRAND VITARA	V6 3.2L FI 24 VALV. DOHC	GP-406		
SWIFT	L4 1.6L FI 16 VALV. DOHC	GP-46	GA-324	
SX4	L4 2.0L FI 16 VALV. DOHC	GP-156		
XL-7	V6 3.6L FI 24 VALV. DOHC	GP-406	GA-367	

2008				
FORENZA	L4 2.0L FI 16 VALV. DOHC	GP-46	GA-328	
GRAND VITARA	V6 2.7L FI	GP-2951		
RENO	L4 2.0L FI 16 VALV. DOHC	GP-46	GA-328	
SWIFT	L4 1.6L FI CANADA	GP-46	GA-324	
SX4	L4 2.0L MFI	GP-156		
XL-7	V6 3.6L MFI	GP-406	GA-367	

2007				
AERIO	L4 2.3L FI	GP-156		
FORENZA	L4 2.0L FI 16 VALV. DOHC	GP-46	GA-328	
GRAND VITARA	V6 2.7L FI 24 VALV.	GP-2951		
RENO	L4 2.0L FI 16 VALV. DOHC	GP-46	GA-328	
SWIFT	L4 1.5L VVT			
SWIFT	L4 1.6L FI CANADA	GP-46		
SX4	L4 2.0L FI	GP-156		
XL-7	V6 3.6L MFI	GP-406		

Marca - Año - Modelo Make-Year-Model	Motor Engine	Aceite Oil	Aire Air	Combustible Fuel
SUZUKI (continuación)				
2006				
AERIO	L4 2.3L FI 16 VALV.	GP-156		
FORENZA	L4 2.0L FI 16 VALV. DOHC	GP-46	GA-328	
GRAND VITARA	L4 2.3L FI 16 VALV.			
GRAND VITARA	V6 2.7L FI 24 VALV.	GP-2951		
GRAND VITARA	V6 2.8L FI 16 VALV.	GP-2951		
RENO	L4 2.0L FI 16 VALV. DOHC	GP-46	GA-328	
VERONA	6 CIL. 2.5L MFI	GP-461		
XL-7	V6 2.7L FI	GP-2951		
2005				
AERIO	L4 2.3L FI 16 VALV.	GP-156		
FORENZA	L4 2.0L FI 16 VALV. DOHC	GP-46	GA-328	
GRAND VITARA	V6 2.5L FI 24 VALV.	GP-2951	GA-244	GG-206
RENO	L4 2.0L FI 16 VALV. DOHC	GP-46	GA-328	
SWIFT	L4 1.6L FI	GP-46		
VERONA	6 CIL. 2.5L MFI	GP-461		
VITARA	V6 2.5L MFI	GP-2951	GA-244	GG-206
XL-7	V6 2.7L FI	GP-2951		
2004				
AERIO	L4 2.3L MFI	GP-156		
FORENZA	L4 2.0L FI 16 VALV. DOHC	GP-46	GA-328	
GRAND VITARA	V6 2.5L FI 24 VALV.	GP-2951	GA-244	GG-206
GRAND VITARA	V6 2.7L FI 24 VALV.	GP-2951	GA-244	
SWIFT	L4 1.6L FI	GP-46		
VERONA	6 CIL. 2.5L MFI	GP-461		
VITARA	V6 2.5L MFI	GP-2951	GA-244	GG-206
XL-7	V6 2.7L MFI	GP-2951	GA-244	
2003				
AERIO	L4 2.0L MFI	GP-156		
GRAND VITARA	L4 2.0L MFI	GP-156	GA-244	
GRAND VITARA	V6 2.5L FI 24 VALV.	GP-2951	GA-244	GG-206
GRAND VITARA	V6 2.7L FI 24 VALV.	GP-2951	GA-244	
VITARA	L4 2.0L MFI	GP-156	GA-244	GG-206
VITARA	V6 2.5L MFI	GP-2951	GA-244	
XL-7	V6 2.7L MFI	GP-2951	GA-244	
2002				
AERIO	L4 2.0L FI	GP-156		
ESTEEM	L4 1.8L MFI	GP-156		
GRAND VITARA	L4 2.0L MFI	GP-156		
GRAND VITARA	V6 2.5L FI 24 VALV.	GP-2951	GA-244	GG-206
GRAND VITARA	V6 2.7L FI 24 VALV.	GP-2951	GA-244	
VITARA	L4 1.6L FI	GP-156	GA-244	GG-206
VITARA	L4 2.0L MFI	GP-156	GA-244	
VITARA	V6 2.5L MFI	GP-2951	GA-244	
VITARA	V6 2.7L MFI	GP-2951	GA-244	
XL-7	V6 2.7L FI 24 VALV. DOHC	GP-2951	GA-244	
2001				
ESTEEM	L4 1.6L MFI	GP-58		
ESTEEM	L4 1.8L MFI	GP-156		
GRAND VITARA	L4 1.6L MFI	GP-156	GA-244	
GRAND VITARA	L4 2.0L MFI	GP-156	GA-244	
GRAND VITARA	V6 2.5L FI 24 VALV.	GP-2951	GA-244	GG-206
GRAND VITARA	V6 2.7L FI 24 VALV.	GP-2951	GA-244	
SWIFT	L4 1.3L MFI	GP-156		
VITARA	L4 1.6L MFI	GP-156	GA-244	GG-206
VITARA	L4 2.0L MFI	GP-156	GA-244	GG-206
VITARA	V6 2.5L MFI	GP-2951	GA-244	
VITARA	V6 2.7L MFI	GP-2951	GA-244	
XL-7	V6 2.7L FI 24 VALV. DOHC	GP-2951	GA-244	

Marca - Año - Modelo Make-Year-Model	Motor Engine	Aceite Oil	Aire Air	Combustible Fuel
SUZUKI (continuación)				
2000				
ESTEEM	L4 1.6L MFI	GP-58		
ESTEEM	L4 1.8L MFI	GP-156		
GRAND VITARA	L4 1.6L MFI	GP-156	GA-244	
GRAND VITARA	L4 2.0L MFI	GP-156	GA-244	
GRAND VITARA	V6 2.5L FI 24 VALV.	GP-2951	GA-244	GG-206
SWIFT	L4 1.3L MFI	GP-58		
VITARA	L4 1.6L FI	GP-156	GA-244	GG-206
VITARA	L4 2.0L FI SOHC	GP-156	GA-244	GG-206
VITARA	V6 2.5L MFI	GP-2951	GA-244	
1999				
ESTEEM	L4 1.6L MFI	GP-58		
ESTEEM	L4 1.8L MFI	GP-156		
GRAND VITARA	L4 1.6L FI	GP-156	GA-244	
GRAND VITARA	L4 2.0L FI	GP-156	GA-244	
GRAND VITARA	V6 2.5L FI 24 VALV.	GP-2951	GA-244	GG-206
SWIFT	L4 1.3L MFI	GP-58		GG-146
VITARA	L4 1.6L FI	GP-156	GA-244	GG-206
VITARA	L4 2.0L FI SOHC	GP-156	GA-244	GG-206
VITARA	V6 2.5L FI	GP-2951	GA-244	
1998				
ESTEEM	L4 1.6L MFI	GP-58		
SIDEKICK	L4 1.6L FI DOHC	GP-58		GG-151
SIDEKICK	L4 1.8L FI DOHC	GP-156	GA-244	GG-151
SWIFT	L4 1.3L MFI	GP-58	GA-142	
X-90	L4 1.6L FI SOHC	GP-58		GG-151
1997				
ESTEEM	L4 1.6L MFI	GP-58		
SIDEKICK	L4 1.6L FI DOHC	GP-156		GG-151
SIDEKICK	L4 1.8L FI DOHC	GP-156	GA-244	GG-151
SWIFT	L4 1.3L MFI	GP-58	GA-142	GG-146
X-90	L4 1.6L FI SOHC	GP-58		GG-151
1996				
ESTEEM	L4 1.6L MFI	GP-58		
SIDEKICK	L4 1.6L FI DOHC	GP-156	GA-166 ⁶³	GG-151
SIDEKICK	L4 1.8L FI DOHC	GP-156	GA-244	GG-151
SWIFT	L4 1.3L EFI 16 VALV.	GP-58		GG-146
SWIFT	L4 1.3L EFI 8 VALV.	GP-58	GA-142	GG-146
X-90	L4 1.6L FI SOHC	GP-58		GG-151
1995				
ESTEEM	L4 1.6L MFI	GP-58		
SAMURAI	L4 1.3L FI	GP-156		
SIDEKICK	L4 1.6L FI 16 VALV.	GP-156		GG-151
SIDEKICK	L4 1.6L FI 8 VALV.	GP-156	GA-166	GG-151
SWIFT	L4 1.3L EFI	GP-58	GA-142	GG-146
1994				
L	L4 1.0L SOHC	GP-58		
L	L4 1.3L FI DOHC	GP-2951		GG-146
L	L4 1.3L FI SOHC	GP-2951	GA-142	GG-146
L	L4 1.6L DOHC	GP-2951		GG-151
L	L4 1.6L SOHC	GP-2951	GA-166	
SAMURAI	L4 1.3L FI	GP-156		
SIDEKICK	L4 1.6L FI 16 VALV.	GP-2951		GG-151
SIDEKICK	L4 1.6L FI 8 VALV.	GP-2951	GA-166	GG-151
SWIFT	L4 1.3L EFI SOHC	GP-2951	GA-142	GG-146
SWIFT	L4 1.3L MFI DOHC 16 VALV.	GP-2951		GG-146
1993				
GL	L4 1.0L SOHC	GP-58		

Marca - Año - Modelo Make-Year-Model	Motor Engine	Aceite Oil	Aire Air	Combustible Fuel
SUZUKI (continuación)				
GL	L4 1.3L FI DOHC	GP-2951		GG-46
GL	L4 1.3L FI SOHC	GP-2951	GA-142	GG-46
GL	L4 1.6L DOHC	GP-58		GG-46
GL	L4 1.6L SOHC	GP-58		GG-46
GLX	L4 1.0L SOHC	GP-58		
GLX	L4 1.3L FI DOHC	GP-2951		GG-46
GLX	L4 1.3L FI SOHC	GP-2951	GA-142	GG-46
GLX	L4 1.6L DOHC	GP-58		GG-46
GLX	L4 1.6L SOHC	GP-58		GG-46
L	L4 1.0L SOHC	GP-58		
L	L4 1.3L FI DOHC	GP-2951		GG-46
L	L4 1.3L FI SOHC	GP-2951	GA-142	GG-46
L	L4 1.6L DOHC	GP-58		GG-46
L	L4 1.6L SOHC	GP-58		GG-46
SAMURAI	L4 1.3L FI	GP-156		
SIDEKICK	L4 1.6L FI 16 VALV.	GP-2951		GG-151
SIDEKICK	L4 1.6L FI 8 VALV.	GP-2951	GA-166	GG-151
SWIFT	L4 1.3L EFI SOHC	GP-2951	GA-142	GG-146
SWIFT	L4 1.3L FI DOHC	GP-2951		GG-146
1992				
GL	L4 1.0L SOHC	GP-58		
GL	L4 1.3L FI DOHC	GP-2951		GG-46
GL	L4 1.3L FI SOHC	GP-2951	GA-142	GG-46
GL	L4 1.6L DOHC	GP-58		GG-46
GL	L4 1.6L SOHC	GP-58		GG-46
GLX	L4 1.0L SOHC	GP-58		
GLX	L4 1.3L FI DOHC	GP-2951		GG-46
GLX	L4 1.3L FI SOHC	GP-2951	GA-142	GG-46
GLX	L4 1.6L DOHC	GP-58		GG-46
GLX	L4 1.6L SOHC	GP-58		GG-46
L	L4 1.0L SOHC	GP-58		
L	L4 1.3L FI DOHC	GP-2951		GG-46
L	L4 1.3L FI SOHC	GP-2951	GA-142	GG-46
L	L4 1.6L DOHC	GP-58		GG-46
L	L4 1.6L SOHC	GP-58		GG-46
SAMURAI	L4 1.3L FI	GP-156		
SIDEKICK	L4 1.6L FI 16 VALV.	GP-2951		GG-151
SIDEKICK	L4 1.6L FI 8 VALV.	GP-2951	GA-166	GG-151
SWIFT	L4 1.3L FI DOHC	GP-2951		GG-146
SWIFT	L4 1.3L MFI SOHC	GP-2951	GA-142	GG-146
1991				
GL	L4 1.0L SOHC	GP-58		
GL	L4 1.3L FI DOHC	GP-2951		GG-146
GL	L4 1.3L FI SOHC	GP-2951	GA-142	GG-146
GLX	L4 1.0L SOHC	GP-58		
GLX	L4 1.3L FI DOHC	GP-2951		GG-146
GLX	L4 1.3L FI SOHC	GP-2951	GA-142	GG-146
L	L4 1.0L SOHC	GP-58		
L	L4 1.3L FI DOHC	GP-2951		GG-146
L	L4 1.3L FI SOHC	GP-2951	GA-142	GG-146
SAMURAI	L4 1.3L FI	GP-156		
SIDEKICK	L4 1.6L FI	GP-2951	GA-166	GG-151
SWIFT	L4 1.3L EFI SOHC	GP-2951	GA-142	GG-146
SWIFT	L4 1.3L FI DOHC	GP-2951		GG-146
1990				
SAMURAI	L4 1.3L FI	GP-156		
SIDEKICK	L4 1.6L FI	GP-2951	GA-166	GG-151
SWIFT	L4 1.3L EFI SOHC	GP-2951	GA-142	GG-146
SWIFT	L4 1.3L FI DOHC	GP-2951		GG-146

Marca - Año - Modelo Make-Year-Model	Motor Engine	Aceite Oil	Aire Air	Combustible Fuel
TOYOTA				
2010				
4 RUNNER	L4 2.7L FI	GP-58		
4 RUNNER	V6 4.0L FI	GP-58	GA-380	
AVALON	V6 3.5L FI	G-912	GA-320	
CAMRY	L4 2.5L FI 16 VALV. DOHC	G-912	GA-464	
CAMRY	V6 3.5L FI 24 VALV. DOHC	G-912	GA-320 ¹⁶	
CAMRY HYBRID	L4 2.4L FI 16 VALV. DOHC		GA-264	
COROLLA	L4 1.8L FI 16 VALV. DOHC	G-911	GA-320 ¹⁶	GA-265 ¹⁷
COROLLA	L4 2.4L FI 16 VALV. DOHC	GP-156	GA-320	
FJ CRUISER	V6 4.0L FI	GP-58	GA-380	
HIGHLANDER	L4 2.7L FI	G-912	GA-264	
HIGHLANDER	V6 3.5L FI	G-912	GA-264	
HIGHLANDER HYBRID	V6 3.3L FI	GP-58		
LAND CRUISER	V8 5.7L FI			
MATRIX	L4 1.8L FI 16 VALV. DOHC	G-911	GA-265	
MATRIX	L4 2.4L FI 16 VALV. DOHC	GP-156	GA-320	
PRIUS HYBRID	L4 1.8L	G-911		
RAV 4	L4 2.5L FI	G-912	GA-320	
RAV 4	V6 3.5L FI	G-912	GA-320	
SEQUOIA	V8 4.6L FI			
SEQUOIA	V8 5.7L FI			
SEQUOIA	V8 5.7L FI FLEX FUEL			
SIENNA	V6 3.5L FI	G-912	GA-264	
TACOMA	L4 2.7L FI	GP-58		
TACOMA	V6 4.0L FI	GP-58	GA-380	
TUNDRA	V6 4.0L FI	GP-58	GA-380	
TUNDRA	V8 4.6L FI			
TUNDRA	V8 5.7L FI			
TUNDRA	V8 5.7L FI FLEX FUEL			
VENZA	L4 2.7L FI	G-912	GA-464	
VENZA	V6 3.5L FI	G-912	GA-320	
YARIS	L4 1.5L FI	GP-157	GA-265	
2009				
4 RUNNER	V6 4.0L FI 24 VALV. DOHC	GP-58	GA-380	
4 RUNNER	V8 4.7L FI 32 VALV. DOHC	GP-58	GA-286	
ACE	V6 3.5L FI			
AVALON	V6 3.5L FI 24 VALV. DOHC	G-912	GA-320	
CAMRY	L4 2.4L EFI	GP-156	GA-464	
CAMRY	V6 3.5L EFI	G-912	GA-320	
CAMRY HYBRID	L4 2.4L FI	GP-156	GA-264	
COROLLA	L4 1.8L EFI	G-911	GA-265	
COROLLA	L4 2.4L EFI	GP-156	GA-320	
FJ CRUISER	V6 4.0L FI 24 VALV. DOHC	GP-58	GA-380	
HIGHLANDER	L4 2.7L FI 16 VALV. DOHC	G-912	GA-264	
HIGHLANDER	V6 3.5L FI 24 VALV. DOHC	G-912	GA-264	
HIGHLANDER HYBRID	V6 3.3L FI 24 VALV. DOHC	GP-58		
LAND CRUISER	V8 5.7L FI 32 VALV. DOHC			
MATRIX	L4 1.8L EFI	G-911	GA-265	
MATRIX	L4 2.4L EFI	GP-156	GA-320	
PRIUS HYBRID	L4 1.5L FI 16 VALV. DOHC	GP-157		
RAV 4	L4 2.5L FI	G-912	GA-320	
RAV 4	V6 3.5L FI 24 VALV. DOHC	G-912	GA-320	
SEQUOIA	V8 4.7L FI 32 VALV. DOHC	GP-58		
SEQUOIA	V8 5.7L FI 32 VALV. DOHC			
SIENNA	V6 3.5L FI 24 VALV. DOHC	G-912	GA-264	
SOLARA	L4 2.4L FI 16 VALV. DOHC	GP-156	GA-264	
SOLARA	V6 3.3L FI 24 VALV. DOHC	GP-58	GA-264	
TACOMA	L4 2.7L FI 16 VALV. DOHC	GP-58		
TACOMA	V6 4.0L FI 24 VALV. DOHC	GP-58	GA-380	
TUNDRA	V6 4.0L FI 24 VALV. DOHC	GP-58	GA-380	
TUNDRA	V8 4.7L FI 32 VALV. DOHC	GP-58		
TUNDRA	V8 5.7L FI 32 VALV. DOHC			
VENZA	L4 2.7L FI 16 VALV. DOHC	G-912	GA-464	
VENZA	V6 3.5L FI 24 VALV. DOHC	G-912	GA-320	

Marca - Año - Modelo Make-Year-Model	Motor Engine	Aceite Oil	Aire Air	Combustible Fuel
TOYOTA (continuación)				
YARIS	L4 1.5L FI 16 VALV. DOHC	GP-157	GA-265	
2008				
4 RUNNER	V6 4.0L EFI	GP-58	GA-380	
4 RUNNER	V8 4.7L EFI	GP-58	GA-286	
AVALON	V6 3.5L FI 24 VALV. DOHC	G-912	GA-320	
AVANZA	L4 1.5L FI			
CAMRY	L4 2.4L EFI	GP-156	GA-464	
CAMRY	V6 3.5L EFI	G-912	GA-320	
CAMRY HYBRID	L4 2.4L FI 16 VALV. DOHC	GP-156	GA-264	
COROLLA	L4 1.8L FI	GP-157	GA-263	
FJ CRUISER	V6 4.0L FI 24 VALV. DOHC	GP-58	GA-380	
HIACE	L4 2.7L FI 16 VALV.	GP-58	GA-410	
HIGHLANDER	V6 3.5L FI 24 VALV. DOHC	G-912	GA-264	
HIGHLANDER HYBRID	V6 3.3L FI 24 VALV. DOHC	GP-58		
LAND CRUISER	V8 5.7L EFI			
MATRIX	L4 1.8L FI	G-911 ¹² GP-157 ¹³⁶	GA-263	
MATRIX HYBRID	L4 1.8L FI 16 VALV. DOHC	G-911 ¹² GP-157 ¹³⁶	GA-263	
PRIUS HYBRID	L4 1.5L FI 16 VALV. DOHC	GP-157		
RAV 4	L4 2.4L SFI	GP-156	GA-320	
RAV 4	V6 3.5L SFI	G-912	GA-320	
SEQUOIA	V8 4.7L FI 32 VALV. I-FORCE VVT-I	GP-58		
SEQUOIA	V8 5.7L FI 32 VALV. I-FORCE VVT-I			
SIENNA	V6 3.5L FI	G-912	GA-264	
SOLARA	L4 2.4L FI 16 VALV. DOHC	GP-156	GA-264	
SOLARA	V6 3.3L FI 24 VALV. DOHC	GP-58	GA-264	
TACOMA	L4 2.7L EFI	GP-58		
TACOMA	V6 4.0L EFI	GP-58	GA-380	
TUNDRA	V6 4.0L FI	GP-58	GA-380	
TUNDRA	V8 4.7L FI	GP-58	GG-187 ¹⁴⁷	
TUNDRA	V8 5.7L FI			
YARIS	L4 1.5L SFI	GP-157	GA-265	
2007				
4 RUNNER	V6 4.0L EFI 24 VALV.	GP-58	GA-380	
4 RUNNER	V8 4.7L EFI 32 VALV.	GP-58	GA-286	
AVALON	V6 3.5L FI 24 VALV. DOHC	G-912	GA-320	
AVANZA	L4 1.5L FI			
AVANZA	L4 1.8L			
CAMRY	L4 2.4L EFI 16 VALV.	GP-156	GA-464	
CAMRY	V6 3.5L EFI 24 VALV.	G-912	GA-320	
CAMRY HYBRID	L4 2.4L FI 16 VALV. DOHC	GP-156	GA-264	
COROLLA	L4 1.8L FI 16 VALV.	GP-157	GA-263	
FJ CRUISER	V6 4.0L SFI	GP-3600 ²⁰	GA-380	
HIACE	L4 2.7L FI 16 VALV.	GP-58	GA-410	
HIGHLANDER	L4 2.4L SFI	GP-156	GA-264	
HIGHLANDER	V6 3.3L SFI	GP-58	GA-264	
HILUX	L4 2.7L FI 16 VALV.		GA-412R	
LAND CRUISER	V8 4.7L EFI 32 VALV.	GP-3600	GA-286	
MATRIX	L4 1.8L SFI 16 VALV.	GP-157	GA-263	
RAV 4	L4 2.4L SFI 16 VALV.	GP-156	GA-320	
RAV 4	V6 3.5L SFI	G-912	GA-320	
SIENNA	V6 3.3L FI	GP-58	GA-264	
SIENNA	V6 3.5L FI 24 VALV. DOHC	G-912	GA-264	
SOLARA	L4 2.4L FI 16 VALV. DOHC	GP-156	GA-264	
SOLARA	V6 3.3L SFI 24 VALV.	GP-58	GA-264	
TACOMA	L4 2.7L EFI	GP-58		
TACOMA	V6 4.0L EFI 24 VALV.	GP-58	GA-380	
TUNDRA	V6 4.0L	GP-3600 ¹⁸	GA-380	
TUNDRA	V8 4.7L	GP-3600 ¹⁸	GA-286	GG-187 ¹⁴⁷
YARIS	L4 1.5L 16 VALV.	GP-157	GA-265	

Marca - Año - Modelo Make-Year-Model	Motor Engine	Aceite Oil	Aire Air	Combustible Fuel
TOYOTA (continuación)				
2006				
4 RUNNER	V6 4.0L EFI 24 VALV.	GP-58	GA-380	
4 RUNNER	V8 4.7L FI 32 VALV.	GP-58	GA-286	
AVALON	V6 3.5L FI 24 VALV. DOHC	G-912	GA-320	
CAMRY	L4 2.4L FI 16 VALV.	GP-156	GA-264	
CAMRY	V6 3.0L FI 24 VALV.	GP-58	GA-264	
COROLLA	L4 1.8L FI 1ZZ-FE	GP-157	GA-263	
COROLLA	L4 1.8L FI 2ZZ-GE	GP-156	GA-263	
HIACE	L4 2.7L FI 16 VALV.	GP-58	GA-410	
HIGHLANDER	L4 2.4L FI 16 VALV. DOHC	GP-156	GA-264	
HILUX	L4 2.7L FI 16 VALV.	GP-58	GA-412R	
LAND CRUISER	V8 4.7L FI 32 VALV.	GP-58	GA-286	
MATRIX	L4 1.8L FI 16 VALV.	GP-157	GA-263	
RAV 4	L4 2.4L EFI	GP-156	GA-320	
RAV 4	V6 3.5L FI 24 VALV. DOHC	G-912	GA-320	
SIENNA	V6 3.3L FI	GP-58	GA-264	
SOLARA	L4 2.4L FI 16 VALV. DOHC	GP-156	GA-264	
SOLARA	V6 3.3L FI	GP-58	GA-264	
TACOMA	V6 4.0L EFI 24 VALV.	GP-3600	GA-380	
TUNDRA	V6 4.0L FI (1GR-FE)	GP-58	GA-380	
TUNDRA	V8 4.7L FI 32 VALV. DOHC (2UZ-FE)	GP-58	GA-286	GG-187
YARIS	L4 1.5L 16 VALV.	GP-157	GA-265	
2005				
4 RUNNER	V6 4.0L EFI 24 VALV.	GP-58	GA-380	
4 RUNNER	V8 4.7L FI 32 VALV.	GP-58	GA-286	
AVALON	V6 3.5L FI 24 VALV. DOHC	G-912	GA-320	
CAMRY	L4 2.4L FI 16 VALV.	GP-156	GA-264	
CAMRY	V6 3.0L FI 24 VALV.	GP-58	GA-264	
COROLLA	L4 1.8L EFI 1ZZ-FE	GP-157	GA-263	
COROLLA	L4 1.8L EFI 2ZZ-GE	GP-156	GA-263	
HIGHLANDER	L4 2.4L FI 16 VALV. DOHC	GP-156	GA-264	
HILUX	L4 2.7L FI 16 VALV.	GP-58	GA-412R	
LAND CRUISER	V8 4.7L FI 32 VALV.	GP-58	GA-286	
MATRIX	L4 1.8L FI 16 VALV.	GP-157	GA-263	
MR2 SPYDER	L4 1.8L FI 16 VALV.	GP-157		
RAV 4	L4 2.4L FI 16 VALV.	GP-156	GA-293	
SIENNA	V6 3.3L FI	GP-58	GA-264	
SOLARA	L4 2.4L FI 16 VALV. DOHC	GP-156	GA-264	
SOLARA	V6 3.3L FI	GP-58	GA-264	
TACOMA	V6 4.0L FI	GP-58	GA-380	
TACOMA	V8 4.7L EFI	GP-3600	GA-380	
TUNDRA	V6 4.0L FI (1GR-FE)	GP-58	GA-380	
TUNDRA	V8 4.7L FI 32 VALV. DOHC (2UZ-FE)	GP-58	GA-286	GG-187
YARIS	L4 1.3L FI 16 VALV.	GP-157	GA-364	
2004				
4 RUNNER	V6 4.0L EFI 24 VALV.	GP-58	GA-380	
4 RUNNER	V8 4.7L FI 32 VALV.	GP-58	GA-286	
AVALON	V6 3.0L FI 24 VALV. DOHC	GP-58	GA-322	
CAMRY	L4 2.4L FI 16 VALV.	GP-156	GA-264	
CAMRY	V6 3.0L FI 24 VALV.	GP-58	GA-264	
COROLLA	L4 1.8L FI 16 VALV.	GP-157	GA-263	
HIGHLANDER	L4 2.4L FI 16 VALV. DOHC	GP-156	GA-264	
HILUX	L4 2.7L FI 16 VALV.	GP-58		
LAND CRUISER	V8 4.7L FI 32 VALV.	GP-58	GA-286	
MATRIX	L4 1.8L FI 16 VALV.	GP-157	GA-263	
MR2 SPYDER	L4 1.8L FI	GP-157		
RAV 4	L4 2.4L FI 16 VALV.	GP-156	GA-293	
SIENNA	V6 3.3L FI	GP-58	GA-264	
SOLARA	L4 2.4L FI 16 VALV. DOHC	GP-156	GA-264	
SOLARA	V6 3.3L FI	GP-58	GA-264	
TACOMA	L4 2.4L FI 16 VALV. DOHC	GP-58	GA-6690	
TACOMA	L4 2.7L FI 16 VALV. DOHC	GP-58	GA-6690	
TACOMA	V6 3.4L FI 24 VALV. DOHC	GP-58		GG-187

Marca - Año - Modelo	Motor	Aceite	Aire	Combustible
Make-Year-Model	Engine	Oil	Air	Fuel

TOYOTA (continuación)

TUNDRA	V6 3.4L FI 24 VALV. DOHC (5VZ-FE)	GP-58	GA-286	GG-187
TUNDRA	V8 4.7L FI 32 VALV. DOHC (2UZ-FE)	GP-58	GA-286	GG-187
YARIS	L4 1.3L FI 16 VALV.	GP-157	GA-364	

2003

4 RUNNER	V6 4.0L EFI 24 VALV.	GP-58	GA-380	
4 RUNNER	V8 4.7L FI 32 VALV.	GP-58	GA-286	
AVALON	V6 3.0L FI 24 VALV. DOHC	GP-58	GA-322	
CAMRY	L4 2.4L FI 16 VALV.	GP-156	GA-264	
CAMRY	V6 3.0L FI 24 VALV.	GP-58	GA-264	
COROLLA	L4 1.8L FI 16 VALV.	GP-157		
HIGHLANDER	L4 2.4L FI 16 VALV. DOHC	GP-156	GA-264	
LAND CRUISER	V8 4.7L FI	GP-58	GA-286	
MATRIX	L4 1.8L FI 16 VALV.	GP-157	GA-263	
RAV 4	L4 2.0L FI	GP-157	GA-293	
SIENNA	V6 3.0L FI	GP-58	GA-322	
SOLARA	L4 2.4L FI DOHC	GP-156	GA-322	GG-185
SOLARA	V6 3.0L FI DOHC	GP-58	GA-322	
TACOMA	L4 2.4L FI 16 VALV. DOHC	GP-58	GA-6690	
TACOMA	L4 2.7L FI 16 VALV. DOHC	GP-58	GA-6690	
TACOMA	V6 3.4L FI 24 VALV. DOHC	GP-58		GG-187
TUNDRA	V6 3.4L FI 24 VALV. DOHC (5VZ-FE)	GP-58	GA-286	GG-187
TUNDRA	V8 4.7L FI 32 VALV. DOHC (2UZ-FE)	GP-58	GA-286	GG-187
YARIS	L4 1.3L FI 16 VALV.	GP-157	GA-364	

2002

4 RUNNER	V6 3.4L SFI 24 VALV.	GP-58		GG-187
AVALON	V6 3.0L FI 24 VALV. DOHC	GP-58	GA-322	
CAMRY	L4 2.4L FI 16 VALV.	GP-156	GA-264	
CAMRY	V6 3.0L FI 24 VALV.	GP-58	GA-264	
CELICA	L4 1.8L FI 16 VALV. DOHC (1ZZ-FE)	GP-157		
CELICA	L4 1.8L FI 16 VALV. DOHC (2ZZ-GE)	GP-58		
COROLLA	L4 1.8L FI	GP-157	GA-5466	
HIGHLANDER	L4 2.4L FI 16 VALV. DOHC	GP-156	GA-264	
LAND CRUISER	V8 4.7L FI 32 VALV.	GP-58	GA-286	
RAV 4	L4 2.0L FI 16 VALV.	GP-157	GA-293	
SIENNA	V6 3.0L EFI 24 VALV.	GP-58	GA-322	
SOLARA	L4 2.4L FI DOHC	GP-156	GA-322	
SOLARA	V6 3.0L FI QOHC	GP-58	GA-322	
TACOMA	L4 2.4L FI 16 VALV. DOHC	GP-58	GA-6690	
TACOMA	L4 2.7L FI 16 VALV. DOHC	GP-58	GA-6690	
TACOMA	V6 3.4L FI 24 VALV. DOHC	GP-58		GG-187
TUNDRA	V6 3.4L FI 24 VALV. DOHC (5VZ-FE)	GP-58	GA-286	GG-187
TUNDRA	V8 4.7L FI 32 VALV. DOHC (2UZ-FE)	GP-58	GA-286	GG-187

2001

4 RUNNER	V6 3.4L EFI 24 VALV.	GP-58		GG-187
AVALON	V6 3.0L MFI 24 VALV.	GP-58	GA-322	
CAMRY	L4 2.2L MFI 16 VALV.	GP-157	GA-322	GG-185
CAMRY	V6 3.0L MFI 24 VALV.	GP-58	GA-322	
CELICA	L4 1.8L FI 16 VALV. DOHC (1ZZ-FE)	GP-157		
CELICA	L4 1.8L FI 16 VALV. DOHC (2ZZ-GE)	GP-156		
COROLLA	L4 1.8L EFI	GP-157	GA-5466	
LAND CRUISER	V8 4.7L FI 32 VALV.	GP-58	GA-286	
RAV 4	L4 2.0L FI 16 VALV.	GP-157	GA-293	
SIENNA	V6 3.0L MFI 24 VALV.	GP-58	GA-322	
SOLARA	L4 2.2L FI DOHC	GP-157	GA-322	GG-185
SOLARA	V6 3.0L FI DOHC	GP-58	GA-322	
TACOMA	L4 2.4L FI 16 VALV. DOHC	GP-58	GA-6690	

Marca - Año - Modelo	Motor	Aceite	Aire	Combustible
Make-Year-Model	Engine	Oil	Air	Fuel

TOYOTA (continuación)

TACOMA	L4 2.7L FI 16 VALV. DOHC	GP-58	GA-6690	
TACOMA	V6 3.4L FI 24 VALV. DOHC	GP-58		GG-187
TUNDRA	V6 3.4L FI 24 VALV. DOHC (5VZ-FE)	GP-58	GA-286	GG-187
TUNDRA	V8 4.7L FI 32 VALV. DOHC (2UZ-FE)	GP-58	GA-286	GG-187

2000

4 RUNNER	L4 2.7L EFI	GP-58	GA-6690	
4 RUNNER	V6 3.4L EFI	GP-58		GG-187
AVALON	V6 3.0L MFI	GP-58	GA-322	
CAMRY	L4 2.2L MFI	GP-157	GA-322	GG-185
CAMRY	V6 3.0L MFI	GP-58	GA-322	
CELICA	L4 1.8L FI 16 VALV. DOHC (1ZZ-FE)	GP-157		
CELICA	L4 1.8L FI 16 VALV. DOHC (2ZZ-GE)	GP-156		
COROLLA	L4 1.8L EFI	GP-157	GA-5466	
LAND CRUISER	V8 4.7L FI	GP-58	GA-286	
RAV 4	L4 2.0L EFI	GP-157	GA-195	GG-164
SIENNA	V6 3.0L MFI	GP-58	GA-322	
SOLARA	L4 2.2L FI DOHC	GP-157	GA-322	GG-185
SOLARA	V6 3.0L FI DOHC	GP-58	GA-322	
TACOMA	L4 2.4L FI 16 VALV. DOHC	GP-58	GA-6690	
TACOMA	L4 2.7L FI 16 VALV. DOHC	GP-58	GA-6690	
TACOMA	V6 3.4L FI 24 VALV. DOHC	GP-58		GG-187
TUNDRA	V6 3.4L FI DOHC (5VZ-FE)	GP-58	GA-286	GG-187
TUNDRA	V8 4.7L FI DOHC (2UZ-FE)	GP-58	GA-286	GG-187

1999

4 RUNNER	L4 2.7L EFI	GP-58	GA-6690	
4 RUNNER	V6 3.4L EFI	GP-58		GG-187
AVALON	V6 3.0L MFI	GP-58	GA-322	
CAMRY	L4 2.2L MFI	GP-157	GA-322	GG-185
CAMRY	V6 3.0L MFI	GP-58	GA-322	
CELICA	L4 2.2L FI DOHC	GP-157	GA-322	GG-164
COROLLA	L4 1.8L EFI	GP-157	GA-5466	
LAND CRUISER	V8 4.7L FI DOHC	GP-58	GA-286	
PASEO	L4 1.5L FI 16 VALV. DOHC CANADA	GP-157		GG-164
RAV 4	L4 2.0L EFI	GP-157	GA-195	GG-164
SIENNA	V6 3.0L MFI	GP-58	GA-322	
SOLARA	L4 2.2L FI DOHC	GP-157	GA-322	GG-185
SOLARA	V6 3.0L FI DOHC	GP-58	GA-322	
TACOMA	L4 2.4L FI 16 VALV. DOHC	GP-58	GA-6690	
TACOMA	L4 2.7L FI 16 VALV. DOHC	GP-58	GA-6690	
TACOMA	V6 3.4L FI 24 VALV. DOHC	GP-58		GG-187
TERCEL	L4 1.5L FI 16 VALV. DOHC CANADA	GP-157		GG-164
TUNDRA	V6 3.4L FI DOHC (5VZ-FE)	GP-58	GA-286	GG-187
TUNDRA	V8 4.7L FI DOHC (2UZ-FE)	GP-58	GA-286	GG-187

1998

4 RUNNER	L4 2.7L EFI	GP-58	GA-6690	
4 RUNNER	V6 3.4L EFI	GP-58		GG-187
AVALON	V6 3.0L EFI	GP-58	GA-322	
CAMRY	L4 2.2L EFI	GP-157	GA-322	GG-185
CAMRY	V6 3.0L EFI	GP-58	GA-322	
CELICA	L4 1.8L FI DOHC	GP-157	GA-322	GG-185
CELICA	L4 2.2L FI DOHC	GP-157	GA-322	GG-164
COROLLA	L4 1.8L EFI	GP-157	GA-5466	
LAND CRUISER	V8 4.7L FI DOHC	GP-58	GA-286	
PASEO	L4 1.5L FI 16 VALV. DOHC	GP-157		GG-164
RAV 4	L4 2.0L EFI	GP-157	GA-195	GG-164
SIENNA	V6 3.0L MFI	GP-58	GA-322	
TACOMA	L4 2.4L FI 16 VALV. DOHC	GP-58	GA-6690	
TACOMA	L4 2.7L FI 16 VALV. DOHC	GP-58	GA-6690	
TACOMA	V6 3.4L FI 24 VALV. DOHC	GP-58		GG-187

Marca - Año - Modelo Make-Year-Model	Motor Engine	Aceite Oil	Aire Air	Combustible Fuel
TOYOTA (continuación)				
TERCEL	L4 1.5L FI 16 VALV. DOHC	GP-157		GG-164
1997				
4 RUNNER	L4 2.7L SFI	GP-58	GA-6690	
4 RUNNER	V6 3.4L EFI	GP-58		GG-187
AVALON	V6 3.0L MFI	GP-58	GA-322	GG-185
CAMRY	L4 2.2L MFI	GP-157	GA-322	GG-185
CAMRY	V6 3.0L MFI	GP-58	GA-322	GG-185
CELICA	L4 1.8L FI DOHC	GP-157	GA-322	GG-185
CELICA	L4 2.2L FI DOHC	GP-157	GA-322	GG-164
COROLLA	L4 1.6L EFI	GP-157	GA-5466	
COROLLA	L4 1.8L EFI	GP-157		
LAND CRUISER	L6 4.5L FI DOHC	GP-58		
PASEO	L4 1.5L FI 16 VALV. DOHC	GP-157		GG-164
PREVIA	L4 2.4L FI 16 VALV. DOHC	GP-58	GA-6690	GG-227
RAV 4	L4 2.0L EFI	GP-157	GA-195	GG-164
TACOMA	L4 2.4L FI 16 VALV. DOHC	GP-58	GA-6690	
TACOMA	L4 2.7L FI 16 VALV. DOHC	GP-58	GA-6690	
TACOMA	V6 3.4L FI 24 VALV. DOHC	GP-58		GG-187
TERCEL	L4 1.5L FI 16 VALV. DOHC	GP-157		GG-164
1996				
4 RUNNER	L4 2.7L EFI	GP-58	GA-6690	
4 RUNNER	V6 3.4L EFI	GP-58		GG-187
AVALON	V6 3.0L FI DOHC	GP-58	GA-322	GG-185
CAMRY	L4 2.2L MFI	GP-157	GA-322	GG-185
CAMRY	V6 3.0L MFI	GP-58	GA-322	GG-185
CELICA	L4 1.8L FI DOHC	GP-157	GA-322	GG-185
CELICA	L4 2.2L FI DOHC	GP-157	GA-322	GG-164
COROLLA	L4 1.6L EFI	GP-157	GA-5466	
COROLLA	L4 1.8L EFI	GP-157		
LAND CRUISER	L6 4.5L FI DOHC	GP-1 ¹⁰⁰ GP-58 ¹⁵		
PASEO	L4 1.5L FI 16 VALV. DOHC	GP-157		GG-164 ⁵⁰ GG-185 ⁵¹
PREVIA	L4 2.4L FI 16 VALV. DOHC	GP-58	GA-6690	GG-227
RAV 4	L4 2.0L EFI	GP-157	GA-195	GG-164
TACOMA	L4 2.4L FI 16 VALV. DOHC	GP-58	GA-6690	
TACOMA	L4 2.7L FI 16 VALV. DOHC	GP-58	GA-6690	
TACOMA	V6 3.4L FI 24 VALV. DOHC	GP-58		GG-187
TERCEL	L4 1.5L FI 16 VALV. DOHC	GP-157		GG-164
1995				
4 RUNNER	L4 2.4L EFI	GP-58	GA-6690	
4 RUNNER	V6 3.0L EFI	GP-58	GA-139	GG-187
AVALON	V6 3.0L FI DOHC	GP-58	GA-322	GG-185
CAMRY	L4 2.2L EFI	GP-157	GA-322	GG-185
CAMRY	V6 3.0L EFI	GP-58	GA-322	GG-185
CELICA	L4 1.8L FI DOHC	GP-157	GA-322	GG-185
CELICA	L4 2.2L FI DOHC	GP-157	GA-322	GG-164
COROLLA	L4 1.6L EFI	GP-157	GA-5466	
COROLLA	L4 1.8L EFI	GP-157		
LAND CRUISER	L6 4.5L FI DOHC	GP-1		
MR2	L4 2.0L FI 16 VALV. DOHC TURBO	GP-156	GA-195	
MR2	L4 2.2L FI 16 VALV. DOHC	GP-157	GA-195	
PASEO	L4 1.5L FI 16 VALV. DOHC	GP-157		GG-164 ⁵⁰ GG-185 ⁵¹
PICK UP	L4 2.4L EFI	GP-58	GA-6690	
PICK UP	V6 3.0L FI	GP-58	GA-139	GG-137
PREVIA	L4 2.2L FI	GP-58		
PREVIA	L4 2.4L FI 16 VALV. DOHC	GP-58	GA-6690	GG-227
PREVIA	V6 3.0L FI	GP-58		
TACOMA	L4 2.4L FI 16 VALV. DOHC	GP-58	GA-6690	
TACOMA	L4 2.7L FI 16 VALV. DOHC	GP-58	GA-6690	
TACOMA	V6 3.4L FI 24 VALV. DOHC	GP-58		GG-187
TERCEL	L4 1.5L FI 16 VALV. DOHC	GP-157		GG-164

Marca - Año - Modelo Make-Year-Model	Motor Engine	Aceite Oil	Aire Air	Combustible Fuel
TOYOTA (continuación)				
1994				
4 RUNNER	L4 2.4L EFI	GP-58	GA-6690	
4 RUNNER	V6 3.0L EFI	GP-58	GA-139	GG-187
CAMRY	L4 2.2L EFI DOHC	GP-157	GA-322	GG-185
CAMRY	V6 3.0L EFI DOHC	GP-58	GA-322	GG-185
CELICA	L4 1.6L FI DOHC	GP-157	GA-322	GG-185
CELICA	L4 1.8L FI DOHC	GP-157	GA-322	GG-164
COROLLA	L4 1.6L EFI DOHC	GP-157	GA-5466	
COROLLA	L4 1.8L EFI DOHC	GP-157		
LAND CRUISER	L6 4.5L FI DOHC	GP-1		
MR2	L4 2.0L FI 16 VALV. DOHC TURBO	GP-156	GA-195	
MR2	L4 2.2L FI 16 VALV. DOHC	GP-157	GA-195	
PICK UP	L4 2.4L FI	GP-58	GA-6690	
PICK UP	V6 3.0L FI	GP-58		GG-187
PREVIA	L4 2.2L FI	GP-58		
PREVIA	L4 2.4L FI 16 VALV. DOHC	GP-58	GA-6690	GG-227
PREVIA	V6 3.0L FI	GP-58		
1993				
4 RUNNER	L4 2.4L EFI SOHC	GP-58	GA-6690	
4 RUNNER	V6 3.0L EFI SOHC	GP-58	GA-139	GG-187
ALL TRAC	L4 1.6L FI 16 VALV. DOHC	GP-157	GA-5466	GG-220
ALL TRAC	L4 1.8L FI 16 VALV. DOHC	GP-157	GA-5466	GG-220
CAMRY	L4 2.2L EFI DOHC	GP-157	GA-322	GG-185
CAMRY	V6 3.0L EFI DOHC	GP-58	GA-322	GG-185
CELICA	L4 1.6L FI	GP-157		GG-185
CELICA	L4 2.0L FI TURBO	GP-156	GA-195	GG-185
CELICA	L4 2.2L DOHC	GP-157	GA-195	GG-185
COROLLA	L4 1.6L EFI DOHC	GP-157	GA-5466	
COROLLA	L4 1.8L EFI DOHC	GP-157		
LAND CRUISER	L6 4.5L FI DOHC	GP-1		
MR2	L4 2.0L FI 16 VALV. DOHC TURBO	GP-156	GA-195	
MR2	L4 2.2L FI 16 VALV. DOHC	GP-157	GA-195	
PICK UP	L4 2.4L FI	GP-58	GA-6690	
PICK UP	V6 3.0L FI	GP-58		GG-187
PREVIA	L4 2.4L FI ZTZ-FE	GP-58	GA-6690	GG-227
1992				
4 RUNNER	L4 2.4L EFI	GP-58	GA-6690	
4 RUNNER	V6 3.0L EFI	GP-58	GA-139	GG-187
CAMRY	L4 2.2L EFI	GP-157	GA-322	GG-185
CAMRY	V6 3.0L EFI	GP-58	GA-322	GG-185
CELICA	L4 1.6L FI	GP-157		GG-185
CELICA	L4 2.0L FI TURBO	GP-156	GA-195	GG-185
CELICA	L4 2.2L FI DOHC	GP-157	GA-195	GG-185
COROLLA	L4 1.6L EFI	GP-157	GA-195	GG-220
GTS	L4 2.0L FI 16 VALV. DOHC TURBO	GP-156	GA-195	GG-185
GTS	L4 2.2L FI 16 VALV. DOHC	GP-157	GA-195	GG-185
LAND CRUISER	L6 4.0L FI	GP-1		
LSX	L4 1.6L FI 16 VALV. DOHC	GP-157	GA-195	GG-220
MR2	L4 2.0L FI 16 VALV. DOHC TURBO	GP-156	GA-195	
MR2	L4 2.2L FI 16 VALV. DOHC	GP-157	GA-195	
PICK UP	L4 2.4L FI	GP-58	GA-6690	
PICK UP	V6 3.0L FI	GP-58		GG-187
PREVIA	L4 2.4L FI ZTZ-FE	GP-58	GA-6690	GG-227
SR5	L4 1.6L FI 16 VALV. DOHC	GP-157	GA-195	GG-220
1991				
4 RUNNER	L4 2.4L EFI	GP-58	GA-6690	
4 RUNNER	V6 3.0L EFI	GP-58	GA-139	GG-187
ALL TRAC	V6 2.5L FI 24 VALV. DOHC (2VZ-FE)	GP-58	GA-195	GG-185

Marca - Año - Modelo Make-Year-Model	Motor Engine	Aceite Oil	Aire Air	Combustible Fuel
TOYOTA (continuación)				
CAMRY	L4 2.0L EFI	GP-157		GG-185
CAMRY	V6 2.5L EFI (2V5FE)	GP-58	GA-195	GG-185
CELICA	L4 1.6L FI	GP-157		GG-185
CELICA	L4 2.0L FI TURBO	GP-156	GA-195	GG-185
CELICA	L4 2.2L FI DOHC	GP-157		GG-185
COROLLA	L4 1.6L EFI DOHC	GP-156	GA-195	GG-220
COROLLA	L4 1.6L EFI SOHC	GP-157		
GTS	L4 2.0L FI 16 VALV. DOHC TURBO	GP-156	GA-195	GG-185
LAND CRUISER	L6 4.0L FI	GP-1		
MR2	L4 2.0L FI 16 VALV. DOHC TURBO	GP-156	GA-195	
MR2	L4 2.2L FI 16 VALV. DOHC	GP-157	GA-195	
PICK UP	L4 2.4L FI	GP-58	GA-6690	
PICK UP	V6 3.0L FI	GP-58		GG-187
PREVIA	L4 2.4L FI ZTZ-FE	GP-58	GA-6690	GG-227

1990

4 RUNNER	L4 2.4L EFI	GP-58	GA-6690	
4 RUNNER	V6 3.0L EFI	GP-58	GA-139	GG-187
ALL TRAC	V6 2.5L FI 24 VALV. DOHC (2VZ-FE)	GP-58	GA-195	GG-185
CAMRY	L4 2.0L EFI	GP-157		GG-185
CAMRY	V6 2.5L EFI	GP-58	GA-195	GG-185
CELICA	L4 1.6L FI	GP-157		GG-185
CELICA	L4 2.0L FI	GP-156	GA-195	GG-185
CELICA	L4 2.2L FI	GP-157		GG-185
COROLLA	L4 1.6L EFI 4AFE	GP-157	GA-195	GG-220
COROLLA	L4 1.6L EFI 4AGE	GP-156		GG-220
GTS	L4 2.0L FI 16 VALV. DOHC	GP-156	GA-195	GG-185
LAND CRUISER	L6 4.0L FI	GP-1		
MR2	L4 1.6L FI 16 VALV.	GP-156	GA-139	
PICK UP	L4 2.4L 2 BBL.	GP-58	GA-2719B	GG-203
PICK UP	L4 2.4L EFI	GP-58	GA-6690	
PICK UP	V6 3.0L FI	GP-58		GG-187
PREVIA	L4 2.4L FI ZTZ-FE	GP-58	GA-6690	GG-227

VOLKSWAGEN

2010

BEETLE	5 CIL. 2.5L FI		GAVW-621 GAC-8 ²⁴	
CC	L4 2.0L DI 16 VALV. TURBO		GAVW-619	
CC	V6 3.6L DI 24 VALV.		GAVW-618	
EOS	L4 2.0L DI TURBO		GAVW-619	
GLI	L4 2.0L DI TURBO		GAVW-619	
GOLF	5 CIL. 2.5L FI	G-313	GAVW-625	
GOLF	L4 2.0L DI TURBO DIESEL		GAVW-619	
GTI	L4 2.0L DI TURBO		GAVW-619	
JETTA	5 CIL. 2.5L DI	G-313	GAVW-625	
JETTA	L4 2.0L DI TURBO		GAVW-619	
JETTA	L4 2.0L DI TURBO DIESEL		GAVW-619	
PASSAT	L4 2.0L DI TURBO		GAVW-619	
ROUTAN	V6 3.8L FI	GP-58	GA-248	
ROUTAN	V6 4.0L FI 24 VALV. SOHC	GP-406	GA-248	
TIGUAN	L4 2.0L DI TURBO		GAVW-619	
TOUAREG 2	V6 3.0L DI TURBO DIESEL		GAVW-616	
TOUAREG 2	V6 3.6L FI	G-112	GAVW-616	
TOUAREG 2	V8 4.2L FI		GAVW-616	

2009

BEETLE	5 CIL. 2.5L FI 20 VALV. DOHC	G-313	GAVW-621 GAC-10 ²⁸ GAC-8 ²⁴	GG-102
BEETLE	L4 1.9L DIESEL TURBO		GAVW-621 GAC-10 ²⁸ GAC-8 ²⁴	
BORA	L4 1.9L TDI DIESEL 16 VALV.	G-466	GAVW-621	

Marca - Año - Modelo Make-Year-Model	Motor Engine	Aceite Oil	Aire Air	Combustible Fuel
VOLKSWAGEN (continuación)				
BORA	L5 2.5L FI 20 VALV.	G-313		GAVW-625
CC	L4 2.0L DI 16 VALV. DOHC TURBO			
CC	V6 3.6L DI 24 VALV. DOHC	G-466		GAVW-618
CROSSFOX	L4 1.6L FI	GP-428		GAVW-623 GAC-3 ²⁴
DERBY	L4 1.8L FI	GP-28		GAVW-212 GG-106
EOS	L4 2.0L DI 16 VALV. DOHC BPY TURBO	G-313		GAVW-617
EOS	L4 2.0L DI 16 VALV. DOHC CCTA TURBO			GAVW-617
EUROVAN	L4 1.9L TDI DIESEL	G-466		GAVW-627
GLI	L4 2.0L DI 16 VALV. DOHC TURBO			GAVW-618
GOL	L4 1.6L FI	GP-428		
GOLF	L4 1.8L FI	GP-28		GAVW-621
GOLF	L4 2.0L FI	GP-28		GAVW-621
GTI	L4 2.0L DI 16 VALV. DOHC TURBO	G-313		GAVW-619
JETTA	L4 2.0L DI 16 VALV. DOHC TURBO			GAVW-618
JETTA	L4 2.0L DI DIESEL TURBO	G-466		GAVW-619
JETTA	L4 2.0L FI	GP-28		GAVW-621
JETTA	L5 2.5L DI 20 VALV. DOHC	G-313		GAVW-625
LUPO	L4 1.6L FI	GP-428		GAVW-623 GG-252
PASSAT	L4 2.0L DI 16 VALV. DOHC BPY TURBO	G-313		GAVW-617
PASSAT	L4 2.0L DI 16 VALV. DOHC CCTA TURBO			
POINTER	L4 1.8L FI	GP-28		GAVW-620 GG-252
RABBIT	5 CIL. 2.5L FI 20 VALV. DOHC	G-313		GAVW-625
RABBIT	L4 2.0L DI 16 VALV. DOHC TURBO	G-313		GAVW-617
RABBIT	V6 3.2L DI 24 VALV. DOHC	G-466		GAVW-618
ROUTAN	V6 3.8L FI	GP-58		GA-248
ROUTAN	V6 4.0L FI	GP-406		GA-248
SPORT VAN	L4 1.6L FI			
TIGUAN	L4 2.0L DI TURBO			GAVW-619
TOUAREG	V6 3.0L DIESEL TURBO			GAVW-616
TOUAREG	V6 3.6L DI DOHC	G-112		GAVW-616
TOUAREG	V8 4.2L FI 32 VALV. DOHC			GAVW-616

2008

BEETLE	L5 2.5L FI	G-313		GAVW-621 GAC-10 ²⁸ GAC-8 ²⁴
BORA	L4 1.9L TDI DIESEL 16 VALV.	G-466		GAVW-621
BORA	L5 2.5L FI 20 VALV.	G-313		GAVW-625
CRAFTER	L5 2.5L TDI DIESEL			
CROSSFOX	L4 1.6L FI	GP-428		GAVW-623 GAC-3 ²⁴
DERBY	L4 1.8L FI	GP-28		GAVW-212 GG-106
EOS	L4 2.0L DI 16 VALV. DOHC TURBO	G-313		GAVW-617
EOS	L4 2.0L DI DIESEL TURBO	G-313		GAVW-617
EOS	V6 3.2L DI 24 VALV. DOHC	G-466		GAVW-621
EUROVAN	L4 1.9L TDI DIESEL	G-466		GAVW-627
GLI	L4 2.0L DI 16 VALV. DOHC TURBO	G-313		GAVW-617
GOLF	L4 2.0L FI	GP-28		GAVW-621
GTI	L4 2.0L DI 16 VALV. DOHC TURBO	G-313		GAVW-617
JETTA	5 CIL. 2.5L DI 20 VALV. DOHC	G-313		GAVW-625
JETTA	L4 2.0L DI 16 VALV. DOHC TURBO	G-313		GAVW-617
JETTA	L4 2.0L DIESEL TURBO	G-466		GAVW-618
JETTA	L4 2.0L FI	GP-28		GAVW-621
LUPO	L4 1.6L FI	GP-428		GAVW-623 GG-252
PASSAT	L4 2.0L DI TURBO	G-313		GAVW-617
PASSAT	V6 3.6L DI	G-466		GAVW-618
POINTER	L4 1.8L FI	GP-28		GAVW-620 GG-252

Marca - Año - Modelo Make-Year-Model	Motor Engine	Aceite Oil	Aire Air	Combustible Fuel
VOLKSWAGEN (continuación)				
R32	V6 3.2L FI 24 VALV. DOHC	G-466	GAVW-618	
RABBIT	5 CIL. 2.5L FI 20 VALV. DOHC	G-313	GAVW-625	
SHARAN	L4 1.8L FI TURBO	GP-430		
SPORT VAN	L4 1.6L FI			
TIGUAN	L4 2.0L DI 16 VALV. DOHC TURBO	G-466	GAVW-619	
TOUAREG	V10 5.0L DIESEL TURBO			
TOUAREG	V6 3.6L DI 24 VALV. DOHC	G-112		
TOUAREG	V8 4.2L FI 32 VALV. DOHC			
VAN	L4 1.8L FI	GP-28	GAC-10 ²⁸ GAC-8 ²⁴	GG-106
2007				
BEETLE	5 CIL. 2.5L SFI		GAVW-621 GAC-10 ²⁸ GAC-8 ²⁴	GG-102
BEETLE	L4 2.0L DI			
BORA	L4 1.9L TDI DIESEL 16 VALV.	G-466	GAVW-621	
BORA	L5 2.5L DI 20 VALV.	G-313	GAVW-625	
CABRIO	5 CIL. 2.5L SFI		GAVW-621	GG-102
CROSSFOX	L4 1.6L FI	GP-428	GAVW-623 GAC-3 ²⁴	GG-252
DERBY	L4 1.8L FI	GP-28	GAVW-212	GG-106
EOS	L4 2.0L DI 16 VALV. DOHC TURBO	G-313	GAVW-617	
EOS	L4 2.0L DI DIESEL TURBO	G-313	GAVW-617	
EOS	V6 3.2L DI 24 VALV. DOHC	G-466	GAVW-621	
EUROVAN	L4 1.9L TDI DIESEL	G-466	GAVW-627	
GLI	5 CIL. 2.5L DI 20 VALV.	G-313	GAVW-625	
GLI	L4 2.0L DI 16 VALV. DOHC TURBO	G-313		
GOLF	5 CIL. 2.5L FI 20 VALV. DOHC	G-313	GAVW-625	
GOLF	L4 1.9L DIESEL TURBO	G-466	GAVW-621	
GOLF	L4 2.0L DI 16 VALV. DOHC TURBO	G-313		
GTI	5 CIL. 2.5L FI 20 VALV. DOHC	G-313	GAVW-625	
GTI	L4 1.9L DIESEL TURBO	G-466	GAVW-621	
GTI	L4 2.0L DI 16 VALV. DOHC TURBO	G-313	GAVW-617	
JETTA	5 CIL. 2.5L DI 20 VALV.	G-313	GAVW-625	
JETTA	L4 1.9L TDI DIESEL	G-466	GAVW-621	
JETTA	L4 2.0L DI 16 VALV. DOHC TURBO	G-313	GAVW-617	
JETTA	L4 2.0L EFI	GP-28	GAVW-621	GG-102
LUPO	L4 1.6L FI	GP-428	GAVW-623	GG-252
PASSAT	L4 1.9L FSI TURBO 16 VALV.	G-313		
PASSAT	L4 2.0L DI 16 VALV. DOHC TURBO	G-313	GAVW-617	
PASSAT	V6 3.6L FSI 24 VALV.	G-466	GAVW-618	
POINTER	L4 1.8L FI	GP-28	GAVW-620	GG-252
POINTER	L4 2.0L FI	GP-28	GAVW-620	GG-252
POINTER PICK-UP	L4 1.8L FI	GP-28	GAVW-620	GG-252
POLO	L4 1.6L FI	GP-428	GAVW-623	GG-102
POLO	L4 2.0L MPFI	GP-28	GAVW-624	GG-102
R32	V6 3.2L FI 24 VALV.	G-466	GAVW-621	
RABBIT	5 CIL. 2.5L FI 20 VALV. DOHC	G-313	GAVW-625	
RABBIT	L4 2.0L DI 16 VALV. DOHC TURBO	G-313	GAVW-617	
SHARAN	L4 1.8L TURBO	GP-430		
SPORT VAN	L4 1.6L MPFI			
TOUAREG	V10 5.0L DIESEL TURBO		GAVW-616	
TOUAREG	V6 3.2L SFI 24 VALV.	G-466		
TOUAREG	V6 3.6L DI	G-112		
TOUAREG	V6 3.6L FI	G-112	GAVW-616	
TOUAREG	V8 4.2L FI 32 VALV. DOHC		GAVW-616	
TOUAREG	V8 4.2L FI 40 VALV. DOHC		GAVW-616	
VAN	L4 1.8L FI	GP-28	GAC-10 ²⁸ GAC-8 ²⁴	GG-106

Marca - Año - Modelo Make-Year-Model	Motor Engine	Aceite Oil	Aire Air	Combustible Fuel
VOLKSWAGEN (continuación)				
2006				
BEETLE	5 CIL. 2.5L SFI 20 VALV.		GAVW-621 GAC-10 ²⁸ GAC-8 ²⁴	GG-102
BEETLE	L4 1.9L DI TURBO DIESEL		GAVW-621 GAC-10 ²⁸ GAC-8 ²⁴	
BORA	L4 1.9L TDI DIESEL 16 VALV.	G-466	GAVW-621	
BORA	L5 2.5L DI 20 VALV.	G-313	GAVW-625	
CABRIO	4 CIL. 1.9L DI TURBO DIESEL		GAVW-621	
CABRIO	5 CIL. 2.5L SFI DOHC 20 VALV.		GAVW-621	GG-102
DERBY	L4 1.8L FI	GP-28	GAVW-212	GG-106
EUROVAN	L4 1.9L TDI DIESEL	G-466	GAVW-627	
GOLF	5 CIL. 2.5L FI 20 VALV. DOHC	G-313	GAVW-625	
GOLF	L4 1.8L FI 20 VALV. DOHC TURBO	GP-28	GAVW-621 GAC-10 ²⁸ GAC-8 ²⁴	GG-102
GOLF	L4 1.9L DIESEL TURBO	G-466	GAVW-621	
GOLF	L4 2.0L DI 16 VALV. DOHC TURBO	G-313	GAVW-617	
GOLF	L4 2.0L FI 8 VALV. SOHC AVH	GP-28	GAVW-621 GAC-10 ²⁸ GAC-8 ²⁴	GG-102
GOLF	L4 2.0L FI 8 VALV. SOHC BEV	GP-28	GAC-10 ²⁸ GAC-8 ²⁴	
GTI	5 CIL. 2.5L FI 20 VALV. DOHC	G-313	GAVW-625	
GTI	L4 1.8L FI 20 VALV. DOHC TURBO	GP-28	GAVW-621 GAC-10 ²⁸ GAC-8 ²⁴	GG-102
GTI	L4 1.9L DIESEL TURBO	G-466	GAVW-621	
GTI	L4 2.0L DI 16 VALV. DOHC TURBO	G-313	GAVW-617	
GTI	L4 2.0L FI 8 VALV. SOHC AVH	GP-28	GAVW-621 GAC-10 ²⁸ GAC-8 ²⁴	GG-102
GTI	L4 2.0L FI 8 VALV. SOHC BEV	GP-28		
JETTA	5 CIL. 2.5L FI 20 VALV. DOHC	G-313	GAVW-625	
JETTA	L4 1.9L DIESEL	G-466	GAVW-621	
JETTA	L4 2.0L DI 16 VALV. DOHC TURBO	G-313	GAVW-617	
JETTA	L4 2.0L FI	GP-28	GAVW-621	GG-251
LUPO	L4 1.6L FI	GP-428	GAVW-623	GG-252
PASSAT	L4 1.9L FSI TURBO 16 VALV.	G-313		
PASSAT	L4 2.0L DI 16 VALV. DOHC TURBO	G-313	GAVW-617	
PASSAT	V6 3.6L FSI 24 VALV.	G-466	GAVW-618	
POINTER	L4 1.8L FI	GP-28	GAVW-620	GG-252
POINTER	L4 2.0L FI	GP-28	GAVW-620	GG-252
POINTER PICK-UP	L4 1.8L FI	GP-28	GAVW-620	GG-252
POLO	L4 1.6L FI	GP-428	GAVW-623	GG-102
POLO	L4 2.0L MPFI	GP-28	GAVW-624	GG-102
SHARAN	L4 1.8L FI TURBO	GP-430		GG-251
TOUAREG	V10 5.0L FI 20 VALV. TURBO DIESEL		GAVW-616	
TOUAREG	V6 3.2L FI 24 VALV.	G-466	GAVW-616	
TOUAREG	V8 4.2L FI 40 VALV.		GAVW-616	
VAN	L4 1.8L FI	GP-28	GAC-10 ²⁸ GAC-8 ²⁴	GG-106
2005				
BEETLE	L4 1.8L FI	GP-430	GAVW-621 GAC-10 ²⁸ GAC-8 ²⁴	GG-102
BEETLE	L4 1.9L DI TURBO DIESEL		GAVW-621 GAC-10 ²⁸ GAC-8 ²⁴	
BEETLE	L4 2.0L FI TURBO	GP-430	GAVW-621 GAC-10 ²⁸ GAC-8 ²⁴	GG-102
CABRIO	4 CIL. 1.9L DI TURBO DIESEL		GAVW-621	
CABRIO	L4 1.8L SFI TURBO 20 VALV.	GP-28	GAVW-621	GG-102
CABRIO	L4 2.0L SFI	GP-28	GAVW-621	GG-102
DERBY	L4 1.8L FI	GP-28	GAVW-212	GG-106

Para números Gonher con Superíndice vea página 38
For Gonher with Superscript numbers see page 38

Marca - Año - Modelo Make-Year-Model	Motor Engine	Aceite Oil	Aire Air	Combustible Fuel
VOLKSWAGEN (continuación)				
DERBY	L4 2.0L FI	GP-28	GAC-10 ²⁸ GAC-8 ²⁴	GG-106
EUROVAN	L5 2.5L FI	GP-310	GAVW-626	GG-251
GOLF	L4 1.8L SFI TURBO	GP-28	GAVW-621 GAC-10 ²⁸ GAC-8 ²⁴	GG-102
GOLF	L4 2.0L FI TURBO	GP-430	GAVW-621 GAC-10 ²⁸ GAC-8 ²⁴	GG-102
GOLF	V6 2.8L SFI		GAVW-621 GAC-10 ²⁸ GAC-8 ²⁴	GG-102
JETTA	5 CIL. 2.5L FI 20 VALV. DOHC	G-313	GAVW-625	
JETTA	L4 1.8L FI TURBO	GP-28	GAVW-621 GAC-10 ²⁸ GAC-8 ²⁴	GG-102
JETTA	L4 1.9L DIESEL	G-466	GAVW-621 GAC-10 ²⁸ GAC-8 ²⁴	
JETTA	L4 2.0L FI	GP-28	GAVW-621 GAC-10 ²⁸ GAC-8 ²⁴	GG-102
LUPO	L4 1.6L FI	GP-428	GAVW-623	GG-252
PASSAT	L4 1.8L FI 20 VALV. TURBO	GP-430	GAC-10 ²⁸ GAVW-622 GAC-8 ²⁴	GG-251
PASSAT	L4 2.0L FI TURBO DIESEL		GAC-10 ²⁸ GAVW-622 GAC-8 ²⁴	
PASSAT	V6 2.8L FI 30 VALV.	GP-171	GAC-10 ²⁸ GAVW-622 GAC-8 ²⁴	GG-251
PASSAT	W8 4.0L FI	G-112	GAVW-622	GG-246
POINTER	L4 1.8L FI	GP-28	GAVW-620	GG-252
POINTER	L4 2.0L FI	GP-28	GAVW-620	GG-252
POINTER PICK-UP	L4 1.8L FI	GP-28	GAVW-620	GG-252
POLO	L4 1.6L FI	GP-428	GAVW-623	GG-102
POLO	L4 2.0L MPFI	GP-28	GAVW-624	GG-102
R32	V6 3.2L FI 24 VALV. DOHC		GAVW-621 GAC-10 ²⁸ GAC-8 ²⁴	GG-102
SHARAN	L4 1.8L FI TURBO	GP-430		GG-251
TOUAREG	V10 5.0L FI 20 VALV. TURBO DIESEL		GAVW-616	
TOUAREG	V6 3.2L FI	G-112	GAVW-616	
TOUAREG	V8 4.2L FI		GAVW-616	
VAN	L4 1.8L FI	GP-28	GAC-10 ²⁸ GAC-8 ²⁴	GG-106
2004				
BEETLE	L4 1.8L FI	GP-430	GAVW-621 GAC-10 ²⁸ GAC-8 ²⁴	GG-102
BEETLE	L4 1.9L DI TURBO DIESEL		GAVW-621 GAC-10 ²⁸ GAC-8 ²⁴	
BEETLE	L4 2.0L FI TURBO	GP-430	GAVW-621 GAC-10 ²⁸ GAC-8 ²⁴	GG-102
CABRIO	4 CIL. 1.9L DI TURBO DIESEL		GAVW-621	
CABRIO	L4 1.8L SFI TURBO 20 VALV.	GP-28	GAVW-621	GG-102
CABRIO	L4 2.0L SFI SOHC	GP-28	GAVW-621	GG-102
DERBY	L4 1.8L FI	GP-28	GAVW-212	GG-106
DERBY	L4 2.0L FI	GP-28	GAVW-212 GAC-10 ²⁸ GAC-8 ²⁴	GG-106
EUROVAN	L5 2.5L FI	GP-310	GAVW-626	GG-251
GOLF	L4 1.8L FI	GP-430	GAVW-621 GAC-10 ²⁸ GAC-8 ²⁴	GG-102
GOLF	L4 1.9L FI TURBO DIESEL		GAVW-621 GAC-10 ²⁸ GAC-8 ²⁴	
GOLF	L4 2.0L FI	GP-430	GAVW-621 GAC-10 ²⁸ GAC-8 ²⁴	GG-102
GOLF	L4 1.9L FI TURBO DIESEL		GAVW-621 GAC-10 ²⁸ GAC-8 ²⁴	
GOLF	V6 2.8L SFI		GAVW-621 GAC-10 ²⁸ GAC-8 ²⁴	GG-102
JETTA	L4 1.8L FI TURBO	GP-430	GAVW-621 GAC-10 ²⁸ GAC-8 ²⁴	GG-102

Marca - Año - Modelo Make-Year-Model	Motor Engine	Aceite Oil	Aire Air	Combustible Fuel
VOLKSWAGEN (continuación)				
GOLF	V6 2.8L SFI		GAVW-621 GAC-10 ²⁸ GAC-8 ²⁴	GG-102
JETTA	L4 1.8L FI TURBO	GP-430	GAVW-621 GAC-10 ²⁸ GAC-8 ²⁴	GG-102
JETTA	L4 1.9L DI TURBO DIESEL		GAVW-621 GAC-10 ²⁸ GAC-8 ²⁴	
JETTA	L4 2.0L FI	GP-28	GAVW-621 GAC-10 ²⁸ GAC-8 ²⁴	GG-102
JETTA	V6 2.8L FI		GAVW-621 GAC-10 ²⁸ GAC-8 ²⁴	GG-102
PASSAT	L4 1.8L FI 20 VALV. TURBO	GP-430	GAC-10 ²⁸ GAVW-622 GAC-8 ²⁴	GG-251
PASSAT	L4 2.0L FI TURBO DIESEL		GAC-10 ²⁸ GAVW-622 GAC-8 ²⁴	
PASSAT	V6 2.8L FI 30 VALV.	GP-171	GAC-10 ²⁸ GAVW-622 GAC-8 ²⁴	GG-251 ¹⁵⁹ GG-408 ⁴⁶
PASSAT	W8 4.0L FI	G-112	GAC-10 ²⁸ GAVW-622 GAC-8 ²⁴	GG-408
POINTER	L4 1.8L FI	GP-28	GAVW-620	GG-252
POINTER	L4 2.0L FI	GP-28	GAVW-620	GG-252
POINTER PICK-UP	L4 1.8L FI	GP-28	GAVW-620	GG-252
POLO	L4 1.6L FI	GP-428	GAVW-623	GG-102
POLO	L4 2.0L FI	GP-28	GAVW-624	GG-102
R32	V6 3.2L FI 24 VALV. DOHC		GAVW-621 GAC-10 ²⁸ GAC-8 ²⁴	GG-102
SEDAN	L4 1.6L FI MOTOR TRASERO, ENFRIADO POR AIRE	GP-28	GAVW-2	GG-251
SHARAN	L4 1.8L FI TURBO	GP-430		GG-251
TOUAREG	V10 5.0L FI 20 VALV. TURBO DIESEL		GAVW-616	
TOUAREG	V6 3.2L FI	G-112	GAVW-616	GG-102
TOUAREG	V8 4.2L FI		GAVW-616	GG-102
VAN	L4 1.8L FI	GP-28	GAC-10 ²⁸ GAC-8 ²⁴	GG-106
2003				
BEETLE	L4 1.8L FI	GP-430	GAVW-621 GAC-10 ²⁸ GAC-8 ²⁴	GG-102
BEETLE	L4 1.9L DI TURBO DIESEL		GAVW-621 GAC-10 ²⁸ GAC-8 ²⁴	
BEETLE	L4 2.0L FI TURBO	GP-430	GAVW-621 GAC-10 ²⁸ GAC-8 ²⁴	GG-102
CABRIO	L4 1.8L SFI TURBO 20 VALV.	GP-28	GAVW-121	GG-251
CABRIO	L4 2.0L SFI SOHC	GP-28	GAVW-121	GG-102
DERBY	L4 1.8L FI	GP-28	GAVW-212	GG-106
DERBY	L4 2.0L FI	GP-28	GAVW-212 GAC-10 ²⁸ GAC-8 ²⁴	GG-106
EUROVAN	L5 2.5L FI	GP-310	GAVW-626	GG-251
GOLF	L4 1.8L FI TURBO	GP-430	GAVW-621 GAC-10 ²⁸ GAC-8 ²⁴	GG-102
GOLF	L4 1.9L FI TURBO DIESEL		GAVW-621 GAC-10 ²⁸ GAC-8 ²⁴	
GOLF	L4 2.0L FI	GP-430	GAVW-621 GAC-10 ²⁸ GAC-8 ²⁴	GG-102
GOLF	V6 2.8L SFI		GAVW-621 GAC-10 ²⁸ GAC-8 ²⁴	GG-102
JETTA	L4 1.8L FI TURBO	GP-430	GAVW-621 GAC-10 ²⁸ GAC-8 ²⁴	GG-102

Marca - Año - Modelo Make-Year-Model	Motor Engine	Aceite Oil	Aire Air	Combustible Fuel
VOLKSWAGEN (continuación)				
JETTA	L4 1.9L TURBO DIESEL			GAVW-621 GAC-10 ²⁸ GAC-8 ²⁴
JETTA	L4 2.0L FI	GP-28		GAVW-621 GAC-10 ²⁸ GAC-8 ²⁴
JETTA	V6 2.8L FI	G-112		GAVW-621 GAC-10 ²⁸ GAC-8 ²⁴
PASSAT	L4 1.8L FI 20 VALV. TURBO	GP-3569		GAC-10 ²⁸ GAVW-622 GAC-8 ²⁴
PASSAT	V6 2.8L FI 30 VALV.	GP-171		GAC-10 ²⁸ GAVW-622 GAC-8 ²⁴
PASSAT	W8 4.0L FI	G-112		GAC-10 ²⁸ GAVW-622 GAC-8 ²⁴
POINTER	L4 1.8L FI	GP-28		GAVW-620
POINTER	L4 2.0L FI	GP-28		GAVW-620
POINTER PICK-UP	L4 1.8L FI	GP-28		GAVW-620
POLO	L4 1.6L FI	GP-428		GAVW-623
POLO	L4 2.0L FI	GP-28		GAVW-624
SEDAN	L4 1.6L FI MOTOR TRASERO, ENFRIADO POR AIRE	GP-28		GAVW-2
SHARAN	L4 1.8L FI TURBO	GP-430		
TOUAREG	V8 4.2L FI			GG-102
VAN	L4 1.8L FI	GP-28		GAC-10 ²⁸ GAC-8 ²⁴
2002				
BEETLE	L4 1.8L FI	GP-430		GAVW-621 GAC-10 ²⁸ GAC-8 ²⁴
BEETLE	L4 1.9L DI TURBO DIESEL			GAVW-621 GAC-10 ²⁸ GAC-8 ²⁴
BEETLE	L4 2.0L FI TURBO	GP-430		GAVW-621 GAC-10 ²⁸ GAC-8 ²⁴
CABRIO	L4 2.0L SFI SOHC	GP-28		GAVW-121
COMBI	L4 1.8L FI MOTOR TRASERO	GP-28		GA-49
DERBY	L4 1.8L FI	GP-430		GAVW-212 GAC-10 ²⁸ GAC-8 ²⁴
DERBY	L4 2.0L FI	GP-28		GAVW-212 GAC-10 ²⁸ GAC-8 ²⁴
EUROVAN	L5 2.5L FI	GP-310		GAVW-626
EUROVAN	V6 2.8L FI	G-112		GAVW-626
GOLF	L4 1.8L FI TURBO	GP-430		GAVW-621 GAC-10 ²⁸ GAC-8 ²⁴
GOLF	L4 1.9L FI TURBO DIESEL			GAVW-621 GAC-10 ²⁸ GAC-8 ²⁴
GOLF	L4 2.0L FI	GP-430		GAVW-621 GAC-10 ²⁸ GAC-8 ²⁴
GOLF	V6 2.8L SFI			GAVW-621 GAC-10 ²⁸ GAC-8 ²⁴
JETTA	L4 1.8L FI TURBO	GP-430		GAVW-621 GAC-10 ²⁸ GAC-8 ²⁴
JETTA	L4 1.8L FI TURBO	GP-430		GAVW-621 GAC-10 ²⁸ GAC-8 ²⁴
JETTA	L4 1.9L DI TURBO DIESEL			GAVW-621 GAC-10 ²⁸ GAC-8 ²⁴
JETTA	L4 2.0L FI	GP-28		GAVW-621 GAC-10 ²⁸ GAC-8 ²⁴
JETTA	V6 2.8L FI	G-112		GAVW-621 GAC-10 ²⁸ GAC-8 ²⁴
PASSAT	L4 1.8L FI 20 VALV. TURBO	GP-3569		GAVW-622
PASSAT	V6 2.8L FI 30 VALV.	G-112		GAVW-622
POINTER	L4 1.8L FI	GP-28		GAVW-620
POINTER	L4 2.0L FI	GP-28		GAVW-620
POINTER PICK-UP	L4 1.8L FI	GP-28		GAVW-620
SEDAN	L4 1.6L FI MOTOR TRASERO, ENFRIADO POR AIRE	GP-28		GAVW-2
2000				
BEETLE	L4 1.8L FI	GP-430		GAVW-621 GAC-10 ²⁸ GAC-8 ²⁴
BEETLE	L4 1.9L TURBO DIESEL			GAVW-621 GAC-10 ²⁸ GAC-8 ²⁴
BEETLE	L4 2.0L FI TURBO	GP-430		GAVW-621 GAC-10 ²⁸ GAC-8 ²⁴
CABRIO	L4 2.0L SFI	GP-28		GAVW-121
COMBI	L4 1.8L FI MOTOR TRASERO	GP-28		GA-49

Marca - Año - Modelo Make-Year-Model	Motor Engine	Aceite Oil	Aire Air	Combustible Fuel
VOLKSWAGEN (continuación)				
PASSAT	V6 2.8L FI 30 VALV.	G-112		GAC-10 ²⁸ GAVW-622 GAC-8 ²⁴
PASSAT	W8 4.0L FI	G-112		GAC-10 ²⁸ GAVW-622 GAC-8 ²⁴
POINTER	L4 1.8L FI	GP-28		GAVW-620
POINTER	L4 2.0L FI	GP-28		GAVW-620
POINTER PICK-UP	L4 1.8L FI	GP-28		GAVW-620
SEDAN	L4 1.6L FI MOTOR TRASERO, ENFRIADO POR AIRE	GP-28		GAVW-2
SHARAN	L4 1.8L FI TURBO	GP-430		
VAN	L4 1.8L FI	GP-28		GAC-10 ²⁸ GAC-8 ²⁴
2001				
BEETLE	L4 1.8L FI	GP-430		GAVW-621 GAC-10 ²⁸ GAC-8 ²⁴
BEETLE	L4 1.9L DI TURBO DIESEL			GAVW-621 GAC-10 ²⁸ GAC-8 ²⁴
BEETLE	L4 2.0L FI TURBO	GP-430		GAVW-621 GAC-10 ²⁸ GAC-8 ²⁴
CABRIO	L4 2.0L SFI SOHC	GP-28		GAVW-121
COMBI	L4 1.8L FI MOTOR TRASERO	GP-28		GA-49
DERBY	L4 1.8L FI	GP-430		GAVW-212 GAC-10 ²⁸ GAC-8 ²⁴
EUROVAN	L5 2.5L FI	GP-310		GAVW-626
EUROVAN	V6 2.8L FI	G-112		GAVW-626
GOLF	L4 1.8L FI TURBO	GP-430		GAVW-621 GAC-10 ²⁸ GAC-8 ²⁴
GOLF	L4 1.9L FI TURBO DIESEL			GAVW-621 GAC-10 ²⁸ GAC-8 ²⁴
GOLF	L4 2.0L FI	GP-430		GAVW-621 GAC-10 ²⁸ GAC-8 ²⁴
GOLF	V6 2.8L SFI			GAVW-621 GAC-10 ²⁸ GAC-8 ²⁴
JETTA	L4 1.8L FI TURBO	GP-430		GAVW-621 GAC-10 ²⁸ GAC-8 ²⁴
JETTA	L4 1.9L DI TURBO DIESEL			GAVW-621 GAC-10 ²⁸ GAC-8 ²⁴
JETTA	L4 2.0L FI	GP-28		GAVW-621 GAC-10 ²⁸ GAC-8 ²⁴
JETTA	V6 2.8L FI	G-112		GAVW-621 GAC-10 ²⁸ GAC-8 ²⁴
PASSAT	L4 1.8L FI 20 VALV. TURBO	GP-3569		GAVW-622
PASSAT	V6 2.8L FI 30 VALV.	G-112		GAVW-622
POINTER	L4 1.8L FI	GP-28		GAVW-620
POINTER	L4 2.0L FI	GP-28		GAVW-620
POINTER PICK-UP	L4 1.8L FI	GP-28		GAVW-620
SEDAN	L4 1.6L FI MOTOR TRASERO, ENFRIADO POR AIRE	GP-28		GAVW-2
2000				
BEETLE	L4 1.8L FI	GP-430		GAVW-621 GAC-10 ²⁸ GAC-8 ²⁴
BEETLE	L4 1.9L TURBO DIESEL			GAVW-621 GAC-10 ²⁸ GAC-8 ²⁴
BEETLE	L4 2.0L FI TURBO	GP-430		GAVW-621 GAC-10 ²⁸ GAC-8 ²⁴
CABRIO	L4 2.0L SFI	GP-28		GAVW-121
COMBI	L4 1.8L FI MOTOR TRASERO	GP-28		GA-49

Marca - Año - Modelo Make-Year-Model	Motor Engine	Aceite Oil	Aire Air	Combustible Fuel
VOLKSWAGEN (continuación)				
DERBY	L4 1.8L FI	GP-430	GAVW-212 GAC-10 ²⁸ GAC-8 ²⁴	GG-106
EUROVAN	V6 2.8L FI	G-112	GAVW-626	GG-251
GOLF	L4 1.8L FI TURBO	GP-430	GAVW-621 GAC-10 ²⁸ GAC-8 ²⁴	GG-102
GOLF	L4 1.9L FI TURBO DIESEL		GAVW-621 GAC-10 ²⁸ GAC-8 ²⁴	
GOLF	L4 2.0L FI	GP-430	GAVW-621 GAC-10 ²⁸ GAC-8 ²⁴	GG-102
GOLF	V6 2.8L SFI		GAVW-121 GAC-10 ²⁸ GAC-8 ²⁴	GG-102
JETTA	L4 1.8L FI TURBO	GP-430	GAVW-621 GAC-10 ²⁸ GAC-8 ²⁴	GG-102
JETTA	L4 1.9L TURBO DIESEL		GAVW-621 GAC-10 ²⁸ GAC-8 ²⁴	
JETTA	L4 2.0L FI	GP-28	GAVW-621 GAC-10 ²⁸ GAC-8 ²⁴	GG-102
JETTA	V6 2.8L FI	G-112	GAVW-621 GAC-10 ²⁸ GAC-8 ²⁴	GG-102
PASSAT	L4 1.8L FI 20 VALV. TURBO	GP-3569	GAVW-622	GG-251
PASSAT	V6 2.8L FI 30 VALV.	G-112	GAVW-622	GG-251
POINTER	L4 1.8L FI	GP-28	GAVW-620	GG-252
POINTER	L4 2.0L FI	GP-28	GAVW-620	GG-252
POINTER PICK-UP	L4 1.8L FI	GP-28	GAVW-620	GG-252
SEDAN	L4 1.6L FI MOTOR TRASERO, ENFRIADO POR AIRE	GP-28	GAVW-2	GG-251
1999				
BEETLE	L4 1.8L FI	GP-430	GAVW-621 GAC-10 ²⁸ GAC-8 ²⁴	GG-102
BEETLE	L4 1.9L TURBO DIESEL		GAVW-621 GAC-10 ²⁸ GAC-8 ²⁴	
BEETLE	L4 2.0L FI	GP-430	GAVW-621 GAC-10 ²⁸ GAC-8 ²⁴	GG-102
CABRIO	L4 2.0L SFI	GP-28	GAVW-121	GG-251
COMBI	L4 1.8L FI MOTOR TRASERO	GP-28	GA-49	GG-251
DERBY	L4 1.8L FI	GP-430	GAVW-212 GAC-10 ²⁸ GAC-8 ²⁴	GG-106
GOLF	L4 1.8L FI	GP-28	GAVW-121	GG-251
GOLF	L4 2.0L FI	GP-430	GAVW-121 GAC-10 ²⁸ GAC-8 ²⁴	GG-251
GOLF	V6 2.8L FI	G-112	GAVW-121 GAC-10 ²⁸ GAC-8 ²⁴	GG-251
JETTA	L4 1.8L FI	GP-28	GAVW-121	GG-251
JETTA	L4 1.9L TURBO DIESEL		GAVW-121 GAC-10 ²⁸ GAC-8 ²⁴	
JETTA	L4 2.0L FI	GP-28	GAVW-121 GAC-10 ²⁸ GAC-8 ²⁴	GG-251
JETTA	V6 2.8L FI	G-112	GAVW-120 GAC-10 ²⁸ GAC-8 ²⁴	GG-246
PASSAT	L4 1.8L FI 20 VALV. TURBO	GP-3569	GAVW-622	GG-251
PASSAT	V6 2.8L FI 30 VALV.	G-112	GAVW-622	GG-102
POINTER	L4 1.8L FI	GP-28	GAVW-620	GG-252
POINTER PICK-UP	L4 1.8L FI	GP-28	GAVW-620	GG-252
SEDAN	L4 1.6L FI MOTOR TRASERO, ENFRIADO POR AIRE	GP-28	GAVW-2	GG-251

Marca - Año - Modelo Make-Year-Model	Motor Engine	Aceite Oil	Aire Air	Combustible Fuel
VOLKSWAGEN (continuación)				
1998				
BEETLE	L4 1.9L TURBO DIESEL		GAVW-621 GAC-10 ²⁸ GAC-8 ²⁴	
BEETLE	L4 2.0L FI	GP-430	GAVW-621 GAC-10 ²⁸ GAC-8 ²⁴	GG-102
CABRIO	L4 2.0L SFI	GP-28	GAVW-121	GG-251
COMBI	L4 1.8L FI MOTOR TRASERO	GP-28	GA-49	GG-251
DERBY	L4 1.8L FI	GP-430	GAVW-212 GAC-10 ²⁸ GAC-8 ²⁴	GG-251
GOLF	L4 1.8L FI	GP-28	GAVW-121	GG-251
GOLF	L4 1.9L FI TURBO DIESEL CANADA	GP-3569	GAVW-121	
GOLF	L4 2.0L FI	GP-430	GAVW-121 GAC-10 ²⁸ GAC-8 ²⁴	GG-251
GOLF	V6 2.8L FI	G-112	GAVW-120 GAC-10 ²⁸ GAC-8 ²⁴	GG-246
JETTA	L4 1.8L FI	GP-28	GAVW-121	GG-251
JETTA	L4 1.9L FI TURBO DIESEL	GP-3569	GAVW-121 GAC-10 ²⁸ GAC-8 ²⁴	
JETTA	L4 2.0L FI	GP-28	GAVW-121 GAC-10 ²⁸ GAC-8 ²⁴	GG-251
JETTA	V6 2.8L FI	G-112	GAVW-120 GAC-10 ²⁸ GAC-8 ²⁴	GG-246
PASSAT	L4 1.8L MFI TURBO	GP-3569	GAVW-622	GG-251
PASSAT	V6 2.8L FI	G-112	GAVW-120	GG-251
POINTER	L4 1.8L FI	GP-28	GAVW-620	GG-251
SEDAN	L4 1.6L FI MOTOR TRASERO, ENFRIADO POR AIRE	GP-28	GAVW-2	GG-251
1997				
CABRIO	L4 2.0L SFI	GP-28	GAVW-121	GG-251
COMBI	L4 1.8L FI MOTOR TRASERO	GP-28	GA-49	GG-251
DERBY	L4 1.8L FI	GP-430	GAVW-212 GAC-10 ²⁸ GAC-8 ²⁴	GG-251
GOLF	L4 1.8L FI	GP-28	GAVW-121 GAC-10 ²⁸ GAC-8 ²⁴	GG-251
GOLF	L4 1.9L TURBO DIESEL	GP-3569	GAVW-121 GAC-10 ²⁸ GAC-8 ²⁴	
GOLF	L4 2.0L FI	GP-430	GAVW-121 GAC-10 ²⁸ GAC-8 ²⁴	GG-251
GOLF	V6 2.8L FI	G-112	GAVW-120 GAC-10 ²⁸ GAC-8 ²⁴	GG-246
JETTA	4 CIL. 1.9L DIESEL	GP-3569	GAVW-121 GAC-10 ²⁸ GAC-8 ²⁴	
JETTA	L4 1.8L FI	GP-28	GAVW-121	GG-251
JETTA	L4 2.0L FI	GP-28	GAVW-121 GAC-10 ²⁸ GAC-8 ²⁴	GG-251
JETTA	V6 2.8L FI	G-112	GAVW-120 GAC-10 ²⁸ GAC-8 ²⁴	GG-246
PASSAT	L4 1.9L TURBO DIESEL	GP-3569		
PASSAT	V6 2.8L FI	G-112	GAVW-120	GG-251
SEDAN	L4 1.6L FI MOTOR TRASERO, ENFRIADO POR AIRE	GP-28	GAVW-2	GG-251
1996				
CABRIO	L4 2.0L SFI	GP-28	GAVW-121	GG-251
COMBI	L4 1.8L FI MOTOR TRASERO	GP-28	GA-49	GG-251
DERBY	L4 1.8L FI	GP-430	GAVW-212 GAC-10 ²⁸ GAC-8 ²⁴	GG-251

Marca - Año - Modelo Make-Year-Model	Motor Engine	Aceite Oil	Aire Air	Combustible Fuel
VOLKSWAGEN (continuación)				
GOLF	L4 1.8L FI	GP-28	GAVW-121 GAC-10 ²⁸ GAC-8 ²⁴	GG-251
GOLF	L4 1.9L FI DIESEL	GP-3569	GAVW-121 GAC-10 ²⁸ GAC-8 ²⁴	
GOLF	L4 2.0L FI	GP-430	GAVW-121 GAC-10 ²⁸ GAC-8 ²⁴	GG-251
GOLF	V6 2.8L SFI		GAVW-121 GAC-10 ²⁸ GAC-8 ²⁴	GG-251
JETTA	L4 1.8L FI	GP-28	GAVW-121 GAC-10 ²⁸ GAC-8 ²⁴	GG-251
JETTA	L4 1.9L FI TURBO DIESEL	GP-3569	GAVW-121 GAC-10 ²⁸ GAC-8 ²⁴	
JETTA	L4 2.0L FI	GP-28	GAVW-121 GAC-10 ²⁸ GAC-8 ²⁴	GG-251
JETTA	V6 2.8L FI	G-112	GAVW-120 GAC-10 ²⁸ GAC-8 ²⁴	GG-246
PASSAT	L4 1.9L TURBO DIESEL	GP-3569		
PASSAT	V6 2.8L FI	G-112	GAVW-121	GG-251
SEDAN	L4 1.6L FI MOTOR TRASERO, ENFRIADO POR AIRE	GP-28	GAVW-2	GG-251
1995				
CABRIO	L4 2.0L SFI	GP-28	GAVW-121	GG-251
COMBI	L4 1.8L FI MOTOR TRASERO	GP-28	GA-49	GG-251
DERBY	L4 1.8L FI	GP-430	GAVW-212 GAC-10 ²⁸ GAC-8 ²⁴	GG-251
GOLF	L4 1.8L FI	GP-28	GAVW-121 GAC-10 ²⁸ GAC-8 ²⁴	GG-251
GOLF	L4 1.9L FI DIESEL	GP-3569	GAVW-121 GAC-10 ²⁸ GAC-8 ²⁴	
GOLF	L4 2.0L FI	GP-430	GAVW-121 GAC-10 ²⁸ GAC-8 ²⁴	GG-251
GOLF	V6 2.8L FI	GP-28	GAVW-121 GAC-10 ²⁸ GAC-8 ²⁴	GG-251
JETTA	L4 1.8L FI	GP-28	GAVW-121 GAC-10 ²⁸ GAC-8 ²⁴	GG-251
JETTA	L4 1.9L FI DIESEL	GP-3569	GAVW-121 GAC-10 ²⁸ GAC-8 ²⁴	
JETTA	L4 2.0L FI	GP-28	GAVW-121 GAC-10 ²⁸ GAC-8 ²⁴	GG-251
JETTA	V6 2.8L FI	G-112	GAVW-120 GAC-10 ²⁸ GAC-8 ²⁴	GG-246
PASSAT	V6 2.8L FI	G-112	GAVW-121	GG-251
SEDAN	L4 1.6L FI MOTOR TRASERO, ENFRIADO POR AIRE	GP-28	GAVW-2	GG-251
1994				
COMBI	L4 1.8L FI MOTOR TRASERO	GP-28	GA-49	GG-251
GOLF	L4 1.8L FI	GP-28	GAVW-121 GAC-10 ²⁸ GAC-8 ²⁴	GG-239
GOLF	L4 1.9L TURBO DIESEL	GP-3569	GAVW-121 GAC-10 ²⁸ GAC-8 ²⁴	
GOLF	L4 2.0L FI	GP-430	GAVW-121 GAC-10 ²⁸ GAC-8 ²⁴	GG-251
GOLF	V6 2.8L FI DOHC		GAVW-121 GAC-10 ²⁸ GAC-8 ²⁴	GG-251
JETTA	L4 1.8L FI	GP-28	GAVW-121 GAC-10 ²⁸ GAC-8 ²⁴	GG-251

Marca - Año - Modelo Make-Year-Model	Motor Engine	Aceite Oil	Aire Air	Combustible Fuel
VOLKSWAGEN (continuación)				
JETTA	L4 1.9L FI TURBO DIESEL	GP-3569	GAVW-121 GAC-10 ²⁸ GAC-8 ²⁴	
JETTA	L4 2.0L FI	GP-28	GAVW-121 GAC-10 ²⁸ GAC-8 ²⁴	GG-251
JETTA	V6 2.8L FI		GAVW-121 GAC-10 ²⁸ GAC-8 ²⁴	GG-251
PASSAT	L4 1.9L FI DIESEL CANADA	GP-3569		
PASSAT	L4 2.0L	GP-28	GAVW-120	GG-226
SEDAN	4 CIL. 1.6L	GP-28	GAVW-2	GG-251
1993				
CABRIOLET	L4 1.8L FI	GP-28	GA-277 GAC-10 ²⁸ GAC-8 ²⁴	GG-251
COMBI	L4 1.8L FI MOTOR TRASERO	GP-28	GA-49	GG-251
FOX	L4 1.8L FI	GP-28	GA-277 GAC-10 ²⁸ GAC-8 ²⁴	GG-226
GOLF	L4 1.8L FI	GP-28	GAVW-121 GAC-10 ²⁸ GAC-8 ²⁴	GG-251
GOLF	L4 1.9L TURBO DIESEL	GP-3569	GAVW-121 GAC-10 ²⁸ GAC-8 ²⁴	
GOLF	L4 2.0L CON 16 VALV.	GP-430	GAVW-121 GAC-10 ²⁸ GAC-8 ²⁴	GG-251
JETTA	L4 1.8L FI	GP-28	GAVW-121 GAC-10 ²⁸ GAC-8 ²⁴	GG-251
JETTA	L4 1.9L FI TURBO DIESEL	GP-28	GAVW-121 GAC-10 ²⁸ GAC-8 ²⁴	
JETTA	L4 2.0L FI	GP-28	GAVW-121 GAC-10 ²⁸ GAC-8 ²⁴	GG-251
JETTA	V6 2.8L FI		GAVW-121 GAC-10 ²⁸ GAC-8 ²⁴	GG-251
PASSAT	L4 1.9L FI DIESEL CANADA	GP-3569		
PASSAT	L4 2.0L	GP-430	GAVW-120	GG-226
SEDAN	4 CIL. 1.6L	GP-28	GAVW-2	GG-251
1992				
ATLANTIC	L4 1.6L	GP-28	GAVW-10	GG-4
CABRIOLET	L4 1.8L FI	GP-28	GA-277	GG-251
COMBI	L4 1.8L FI MOTOR TRASERO	GP-28	GA-49	GG-251
GOLF	L4 1.6L DIESEL	GP-3569	GAVW-2	
GOLF	L4 1.8L FI	GP-28	GAVW-120	GG-251
GOLF	L4 2.0L CON 16 VALV.	GP-430	GAVW-120	GG-251
JETTA	L4 1.6L DIESEL	GP-3569		
JETTA	L4 1.8L FI	GP-28	GAVW-120	GG-251
JETTA	L4 2.0L FI	GP-28		
PASSAT	L4 2.0L	GP-430	GAVW-120	GG-226
SEDAN	4 CIL. 1.6L		GAVW-2	GG-4
1991				
ATLANTIC	L4 1.6L	GP-28	GAVW-10	GG-4
CABRIOLET	L4 1.8L FI 2H	GP-28	GA-277	GG-251
COMBI	L4 1.8L FI MOTOR TRASERO	GP-28	GA-49	GG-251
GOLF	L4 1.6L DIESEL	GP-3569	GAVW-2	
GOLF	L4 1.8L FI	GP-28	GAVW-10	GG-251
GOLF	L4 2.0L 16 VALV.	GP-28	GAVW-120	
JETTA	L4 1.6L DIESEL	GP-3569	GAVW-2	
JETTA	L4 1.8L FI	GP-28	GAVW-10	GG-298
JETTA	L4 2.0L FI	GP-28		
PASSAT	L4 2.0L	GP-430	GAVW-120	GG-226
SEDAN	4 CIL. 1.6L		GAVW-2	GG-4

Para números Gonher con Superíndice vea página 38
For Gonher with Superscript numbers see page 38

Para modelos anteriores a 1990 visite nuestro sitio en internet www.grupogonher.com
For pre-1990 models, visit our Web site www.grupogonher.com

Marca - Año - Modelo Make-Year-Model	Motor Engine	Aceite Oil	Aire Air	Combustible Fuel
VOLKSWAGEN (continuación)				
1990				
ATLANTIC	L4 1.6L	GP-28	GAVW-10	GG-4
CABRIOLET	L4 1.8L FI 2H	GP-28	GA-277	GG-251
COMBI	L4 1.8L MOTOR TRASERO	GP-28	GA-49	GG-251
GOLF	L4 1.6L DIESEL	GP-3569	GAVW-2	
GOLF	L4 1.8L FI	GP-28	GAVW-10	GG-251
JETTA	L4 1.6L DIESEL	GP-3569	GAVW-2	
JETTA	L4 1.8L FI	GP-28	GAVW-10	GG-298
JETTA	L4 2.0L FI	GP-28		
PASSAT	L4 2.0L	GP-28	GAVW-120	GG-226
SEDAN	4 CIL. 1.6L		GAVW-2	GG-4

VOLVO				
2010				
C30	5 CIL. 2.4L FI 20 VALV.			
C30	5 CIL. 2.5L FI 20 VALV. TURBO			
C70	5 CIL. 2.5L FI 20 VALV. TURBO			
S40	5 CIL. 2.4L FI 20 VALV.			
S40	5 CIL. 2.5L FI 20 VALV. TURBO			
S60	L4 2.6L DI DOHC TURBO			
S80	6 CIL. 3.0L FI 24 VALV. TURBO			
S80	6 CIL. 3.2L FI 24 VALV. DOHC			
S80	V8 4.4L FI DOHC 32 VALV.	G-72		
V50	5 CIL. 2.4L FI 20 VALV.			
V50	5 CIL. 2.5L FI 20 VALV. TURBO			
V70	6 CIL. 3.2L FI 24 VALV. DOHC			
XC60	6 CIL. 3.0L FI 24 VALV. TURBO			
XC60	6 CIL. 3.2L FI 24 VALV.			
XC70	6 CIL. 3.0L FI 24 VALV. TURBO			
XC70	6 CIL. 3.2L FI 24 VALV. DOHC			
XC90	6 CIL. 3.2L FI 24 VALV. DOHC			
XC90	V8 4.4L FI 32 VALV. DOHC	G-72		

2009				
C30	5 CIL. 2.4L FI 20 VALV. DOHC			
C30	5 CIL. 2.5L FI 20 VALV. DOHC TURBO			
C70	5 CIL. 2.5L FI 20 VALV. DOHC TURBO			
S40	5 CIL. 2.4L FI 20 VALV. DOHC			
S40	5 CIL. 2.5L FI 20 VALV. DOHC TURBO			
S60	L5 2.4L FI 20 VALV. TURBO	G-72	GA-305	
S60	L5 2.5L FI 20 VALV. TURBO	G-72	GA-305	
S80	V8 4.4L FI	G-72		
V50	5 CIL. 2.4L FI 20 VALV. DOHC			
V50	5 CIL. 2.5L FI 20 VALV. DOHC TURBO			
XC70	6 CIL. 3.0L FI TURBO			
XC70	6 CIL. 3.2L FI 24 VALV. DOHC			
XC90	6 CIL. 3.2L FI 24 VALV. DOHC			
XC90	V8 4.4L FI	G-72		

2008				
C30	5 CIL. 2.5L FI TURBO			
C70	5 CIL. 2.5L FI TURBO			
S40	5 CIL. 2.4L FI			
S40	5 CIL. 2.5L FI TURBO			
S60	5 CIL. 2.4L FI TURBO	G-72	GA-305	
S60	5 CIL. 2.5L FI TURBO	G-72	GA-305	
S80	6 CIL. 3.0L FI			

Marca - Año - Modelo Make-Year-Model	Motor Engine	Aceite Oil	Aire Air	Combustible Fuel
VOLVO (continuación)				
S80	6 CIL. 3.2L FI			
S80	V8 4.4L FI	G-72		
V50	5 CIL. 2.4 FI			
V50	5 CIL. 2.5L FI TURBO			
V70	6 CIL. 3.2L FI			
XC70	6 CIL. 3.2L FI			
XC90	6 CIL. 3.2L FI			
XC90	V8 4.4L FI	G-72		

2007				
C70	L5 2.5L BAJA PRESION DHOC 20 VALV.			
S40	5 CIL. 2.4L 20 VALV.			
S40	5 CIL. 2.5L TURBO			
S60	L5 2.4L FI TURBO	G-72	GA-305	
S60	L5 2.5L FI TURBO	G-72	GA-305	
S80	L6 3.2L FI			
S80	V8 4.4L FI 32 VALV.	G-72		
V50	L5 2.5L 20 VALV.			
V70	L5 2.4L FI 20 VALV. DOHC	G-72	GA-305	
V70	L5 2.5L FI 20 VALV. DOHC	G-72	GA-305	
XC70	L5 2.5L FI TURBO	G-72	GA-305	
XC90	L5 2.5L 20 VALV. TURBO			
XC90	L6 3.2L FI			
XC90	V8 4.4L FI 32 VALV.	G-72		

2006				
C70	L5 2.5L FI TURBO BAJA PRESION 20 VALV.	G-72		
S40	L4 2.0L FI 16 VALV.			
S40	L5 2.5L FI			
S60	L5 2.4L FI 20 VALV. DOHC TURBO	G-72	GA-305	
S60	L5 2.5L FI 20 VALV. TURBO	G-72	GA-305	
S80	L5 2.5L FI 20 VALV. DOHC TURBO	G-72		
S80	L6 2.9L FI 24 VALV.			
V50	L5 2.5L FI			
V70	L5 2.4L FI 20 VALV. DOHC	G-72	GA-305	
V70	L5 2.5L FI 20 VALV. TURBO	G-72	GA-305	
XC70	L5 2.5L FI 20 VALV. TURBO	G-72	GA-305	
XC90	L5 2.5L FI 20 VALV. TURBO	G-72		
XC90	L6 2.9L FI 24 VALV. DOHC TWIN-TURBO			
XC90	V8 4.4L FI 32 VALV.	G-72		

2005				
S40	L5 2.4L FI 20 VALV. DOHC			
S40	L5 2.5L FI 20 VALV. DOHC TURBO			
S60	L5 2.4L FI 20 VALV.	G-72	GA-305	
S60	L5 2.5L FI 20 VALV. DOHC TURBO	G-72	GA-305	
S80	L5 2.5L FI 20 VALV. DOHC TURBO	G-72		
S80	L6 2.9L FI 24 VALV.	G-72		
V50	L5 2.5L FI			
V70	L5 2.3L FI TURBO	G-72		
V70	L5 2.4L FI 20 VALV. DOHC	G-72	GA-305	
V70	L5 2.4L FI 20 VALV. DOHC TURBO		GA-305	
V70	L5 2.5L FI 20 VALV. DOHC TURBO	G-72	GA-305	
XC70	L5 2.5L FI 20 VALV. TURBO	G-72	GA-305	
XC90	L5 2.5L FI TURBO	G-72		
XC90	L6 2.9L FI 24 VALV. DOHC TWIN-TURBO	G-72		
XC90	V8 4.4L FI 32 VALV. DOHC	G-72		

Marca - Año - Modelo Make-Year-Model	Motor Engine	Aceite Oil	Aire Air	Combustible Fuel
VOLVO (continuación)				
2004				
C70	L5 2.3L FI 20 VALV. TURBO	G-72		
C70	L5 2.4L FI 20 VALV. TURBO	G-72		
S40	L4 1.9L FI 16 VALV. DOHC TWIN-TURBO	G-72		
S40	L5 2.5L FI			
S60	L5 2.3L FI 20 VALV. DOHC TURBO	G-72	GA-305	
S60	L5 2.4L FI	G-72		
S60	L5 2.5L FI 20 VALV. DOHC TURBO	G-72	GA-305	
S80	L5 2.5L FI TURBO	G-72		
S80	L6 2.8L FI 20 VALV.			
S80	L6 2.9L FI 24 VALV. DOHC TWIN-TURBO	G-72		
V40	L4 1.9L FI 16 VALV. DOHC TWIN-TURBO	G-72		
V40	L4 2.0L FI 16 VALV.			
V40	L4 2.5L FI 16 VALV.			
V70	L5 2.3L FI 20 VALV. DOHC TURBO	G-72	GA-305	
V70	L5 2.4L FI 20 VALV. DOHC	G-72	GA-305	
V70	L5 2.4L FI 20 VALV. DOHC TURBO		GA-305	
V70	L5 2.5L FI 20 VALV. DOHC TURBO	G-72	GA-305	
XC70	L5 2.5L FI 20 VALV. TURBO	G-72	GA-305	
XC90	L5 2.5L FI TURBO	G-72		
XC90	L6 2.9L FI 24 VALV. DOHC TWIN-TURBO	G-72		
2003				
C70	L5 2.3L FI 20 VALV. DOHC TURBO	G-72	GA-305	
C70	L5 2.4L FI 20 VALV. DOHC			
C70	L5 2.4L FI 20 VALV. DOHC TURBO	G-72		
S40	L4 1.9L FI DOHC TURBO	G-72		
S40	L4 2.0L FI 16 VALV.			
S60	L5 2.3L TURBO	G-72	GA-305	
S60	L5 2.4L FI 20 VALV. TURBO	G-72	GA-305	
S60	L5 2.5L FI 20 VALV. DOHC TURBO	G-72	GA-305	
S70	L5 2.3L FI 20 VALV. DOHC TURBO	G-72	GA-305	
S70	L5 2.4L FI 20 VALV. DOHC	G-72		
S70	L5 2.4L FI 20 VALV. DOHC TURBO	G-72		
S80	L6 2.8L FI 24 VALV. DOHC TWIN-TURBO			
S80	L6 2.9L FI 24 VALV.	G-72		
V40	L4 1.9L FI DOHC TURBO	G-72		
V40	L4 2.0L FI 16 VALV.			
V70	L5 2.3L FI 20 VALV. TURBO	G-72	GA-305	
V70	L5 2.4L FI 20 VALV. DOHC	G-72	GA-305	
V70	L5 2.4L FI 20 VALV. TURBO	G-72	GA-305	
V70	L5 2.5L FI 20 VALV. DOHC TURBO	G-72	GA-305	
V70	L5 2.5L FI TWIN-TURBO	G-72	GA-305	
XC70	L5 2.5L FI 20 VALV. DOHC TURBO	G-72		
XC90	L5 2.5L FI TURBO	G-72		
XC90	L6 2.9L FI 24 VALV. BI TURBO	G-72		
2002				
C70	L5 2.3L FI 20 VALV. DOHC TURBO	G-72		
C70	L5 2.4L FI 20 VALV. DOHC TURBO	G-72		
S40	L4 1.9L FI DOHC TURBO	G-72		
S60	L5 2.3L FI DOHC TURBO	G-72	GA-305	

Marca - Año - Modelo Make-Year-Model	Motor Engine	Aceite Oil	Aire Air	Combustible Fuel
VOLVO (continuación)				
S60	L5 2.4L FI 20 VALV. TURBO	G-72		
S60	L5 2.4L FI DOHC	G-72		
S70	L5 2.3L FI 20 VALV. DOHC TURBO	G-72		
S70	L5 2.4L FI 20 VALV. DOHC TURBO	G-72		
S80	L6 2.8L FI 24 VALV. DOHC TWIN-TURBO	G-72		
S80	L6 2.9L FI 24 VALV. DOHC	G-72		
V40	L4 1.9L FI DOHC TURBO	G-72		
V70	L5 2.3L FI 20 VALV. TURBO	G-72	GA-305	
V70	L5 2.4L FI 20 VALV. DOHC		GA-305	
V70	L5 2.4L FI 20 VALV. TURBO	G-72	GA-305	
2001				
C70	L5 2.3L FI DOHC TURBO	G-72		
C70	L5 2.4L FI DOHC	G-72		
C70	L5 2.4L FI DOHC TURBO	G-72		
S40	L4 1.9L FI DOHC TURBO	G-72		
S60	L5 2.3L FI 20 VALV. DOHC TURBO	G-72	GA-305	
S60	L5 2.4L FI 20 VALV. DOHC	G-72		
S60	L5 2.4L FI 20 VALV. DOHC TURBO	G-72		
S70	L5 2.3L FI DOHC TURBO	G-72		
S70	L5 2.4L FI DOHC	G-72		
S70	L5 2.4L FI DOHC TURBO	G-72		
S70	L6 2.9L FI DOHC	G-72		
S80	L6 2.8L FI DOHC B6284T TWIN-TURBO	G-72		
S80	L6 2.9L FI DOHC B6304S	G-72		
V40	L4 1.9L FI DOHC TURBO	G-72		
V70	L5 2.3L FI DOHC TURBO	G-72	GA-305	
V70	L5 2.4L FI DOHC	G-72	GA-305	
V70	L5 2.4L FI DOHC TURBO	G-72	GA-305	
V70	L6 2.9L FI DOHC			
2000				
C70	L5 2.3L FI TURBO	G-72		
C70	L5 2.4L FI	G-72		
C70	L5 2.4L FI TURBO	G-72		
S40	L4 1.9L FI DOHC TURBO	G-72		
S70	L4 2.3L FI TURBO	G-72		
S70	L4 2.4L FI	G-72		
S70	L4 2.4L FI TURBO	G-72		
S80	L6 2.8L FI TURBO	G-72		
S80	L6 2.9L FI	G-72		
V40	L4 1.9L FI DOHC TURBO	G-72		
V70	L4 2.3L FI TURBO	G-72		
V70	L4 2.4L FI	G-72		
V70	L4 2.4L FI TURBO	G-72		
1999				
C70	L5 2.3L FI TURBO	G-72		
C70	L5 2.4L FI	G-72		
C70	L5 2.4L FI TURBO	G-72		
S70	L5 2.3L FI TURBO	G-72		
S70	L5 2.4L FI	G-72		
S70	L5 2.4L FI TURBO	G-72		
S80	L6 2.8L FI TURBO	G-72		
S80	L6 2.9L FI	G-72		
V70	L5 2.3L FI TURBO	G-72		
V70	L5 2.4L FI	G-72		
V70	L5 2.4L FI TURBO	G-72		
1994				
850 SERIES	5 CIL. 2.4L MFI	GP-171		
940 SERIES	L4 2.3L EFI	GP-171		

Marca - Año - Modelo Make-Year-Model	Motor Engine	Aceite Oil	Aire Air	Combustible Fuel	Marca - Año - Modelo Make-Year-Model	Motor Engine	Aceite Oil	Aire Air	Combustible Fuel
VOLVO (continuación)									
940 SERIES	L4 2.3L EFI TURBO	GP-171							
960 SERIES	6 CIL. 2.9L EFI	GP-171							
1993									
240 SERIES	L4 2.3L EFI	GP-171	GA-4365						
850 SERIES	5 CIL. 2.4 MFI	GP-171							
940 SERIES	L4 2.3L EFI	GP-171							
940 SERIES	L4 2.3L EFI TURBO	GP-171							
960 SERIES	V6 2.9L EFI	GP-171							
1992									
240 SERIES	L4 2.3L EFI	GP-171	GA-4365						
740 SERIES	L4 2.3L EFI	GP-171							
740 SERIES	L4 2.3L EFI TURBO	GP-171							
940 SERIES	L4 2.3L EFI	GP-171							
940 SERIES	L4 2.3L EFI TURBO	GP-171							
960 SERIES	6 CIL. 2.9L EFI	GP-171							
1991									
240 SERIES	L4 2.3L EFI	GP-171	GA-4365						
740 SERIES	L4 2.3L EFI	GP-171							
740 SERIES	L4 2.3L EFI TURBO	GP-171							
780 SERIES	L4 2.3L EFI TURBO	GP-171							
940 SERIES	L4 2.3L EFI	GP-171							
940 SERIES	L4 2.3L EFI TURBO	GP-171							
1990									
240 SERIES	L4 2.3L EFI	GP-171	GA-4365						
740 SERIES	L4 2.3L EFI	GP-171							
740 SERIES	L4 2.3L EFI TURBO	GP-171							
760 SERIES	L4 2.3L EFI TURBO	GP-171							
760 SERIES	V6 2.8L EFI	GP-171							
780 SERIES	L4 2.3L EFI TURBO	GP-171							
780 SERIES	V6 2.8L EFI	GP-171							

Aplicaciones Servicio Pesado

Heavy Duty Applications

MARCA-MODELO-MOTOR	GONHER	OEM
MAKE-MODEL-ENGINE	GONHER	OEM

ADVANCE MIXER, INC.

MOTORES

MODELOS CON CUMMINS L10		
ACEITE	GP-3000	3318853
MODELOS CON CUMMINS M11		
ACEITE	GP-3000	3318853

AGCO

COMBINADAS

8780XP con motor/CUMMINS 8.3L		
ACEITE	GP-3000	72501533
C62, R42, R52, R55, R62 con motor/CUMMINS 6CTA8.3		
ACEITE	GP-3000	72501533
R72 con motor/CUMMINS LTA10		
ACEITE	GP-3000	72501533

AGCO

TRACTORES

8360, 8425 AGCOSTAR con motor/CUMMINS N14		
ACEITE	GP-3000	72501533
RT100 (AUTO QUADRASHIFT), RT120 (POWER MAXX CVT), RT100 (POWER MAXX CVT), RT120 (AUTO QUADRASHIFT) con motor/CUMMINS 6.7L		
ACEITE	GP-737	4897898
RT100A (AUTO 6), RT120A (POWER MAX CVT), RT100A (POWER MAX CVT), RT120A (AUTO 6) con motor/SISU 6.6L		
AIRE, PRIMARIO	GA-697R	4271467M1

AKSA

GENERADORES

AC150, AC200 con motores/CUMMINS 6CT8.3, CUMMINS 6CTA8.3		
ACEITE	GP-3000	3318853
AC250, AC275 con motor/CUMMINS LTA10		
ACEITE	GP-3000	3318853
AC350, AC400 con motor/CUMMINS NTA855		
ACEITE	GP-3000	3318853

ALLIS CHALMERS

APLANADORAS

145 con motores/ALLIS CHALMERS 10000, ALLIS CHALMERS AD5516		
ACEITE	G-6	4372517
COMBUSTIBLE, SECUNDARIO	G-1173	74056633
COMBUSTIBLE, PRIMARIO	G-1174	74055563
145T con motor/ALLIS CHALMERS 6000		
ACEITE	G-6	4372517
COMBUSTIBLE, SECUNDARIO	G-1173	74056633
COMBUSTIBLE, PRIMARIO	G-1174	74055563
145T con motor/ALLIS CHALMERS 7000		
ACEITE	G-6	4372517
COMBUSTIBLE, SECUNDARIO	G-1173	74056633
COMBUSTIBLE, PRIMARIO	G-1174	74055563
ACEITE, DERIVACION (BY PASS)	G-500	91540
45 con motores/ALLIS CHALMERS 10000, ALLIS CHALMERS AD5516		
TRANSMISION	G-6	197121

MARCA-MODELO-MOTOR	GONHER	OEM
MAKE-MODEL-ENGINE	GONHER	OEM

ALLIS CHALMERS (continuación)

APLANADORAS

ACEITE	G-33	4395889
COMBUSTIBLE, SECUNDARIO	G-1173	74056633
COMBUSTIBLE, PRIMARIO	G-1174	74055563
ACEITE, DERIVACION (BY PASS)	G-500	91540
AD SERIES3238, AD-3 SERIES3238, AD-4 SERIES3238 con motor/CASE		
COMBUSTIBLE, SECUNDARIO	G-1173	74056633
AD-30 SERIES3239 con motor/CASE		
ACEITE	G-33	4395889
AD-40 SERIES3239 con motor/CASE		
COMBUSTIBLE, SECUNDARIO	G-1173	74056633
DD con motores/ALLIS CHALMERS D230, ALLIS CHALMERS D262		
COMBUSTIBLE, SECUNDARIO	G-1173	74056633
M100 con motores/ALLIS CHALMERS 10000, ALLIS CHALMERS 11000		
ACEITE	G-33	4395889
COMBUSTIBLE	G-1173	74056633
COMBUSTIBLE	G-1174	74055563
AIRE, PRIMARIO	GA-360	684733
AIRE, SECUNDARIO	GA-361	662608
M70 con motor/ALLIS CHALMERS 7000		
ACEITE	G-6	4372517
COMBUSTIBLE	G-1173	74056633
COMBUSTIBLE	G-1174	74055563

ALLIS CHALMERS

BOMBAS

4PTD con motor/ALLIS CHALMERS 2000		
ACEITE	GP-50	4512207
6PT con motor/CASE		
GASOLINA	GG-5 L	417917C91

ALLIS CHALMERS

CAMIONES, TRACTOCAMIONES Y AUTOBUSES

150C DE VOLTEO con motor/A DIESEL		
ACEITE	G-33	4395889
150C DE VOLTEO con motor/CASE		
COMBUSTIBLE, SECUNDARIO	G-1173	74056633
AIRE, PRIMARIO	GA-360	70684733
AIRE, SECUNDARIO	GA-361	70662609
161 DE VOLTEO con motor/CUMMINS		
ACEITE, FLUJO TOTAL (FULL FLOW)	G-566	70658126
HIDRAULICO	G-222	70664000
COMBUSTIBLE	GPP-14	4006995
ACEITE, SELLADO PARA FLUJO TOTAL (FULL FLOW)	GP-53	70697634
ACEITE, DERIVACION (BY PASS)	GP-57	73124135
AGUA, PRE-CHARGE	GP-1011Q	74393504
AGUA, MANTENIMIENTO	GP-2071W	4734562
AIRE, SECUNDARIO	GA-6127	70197588
AIRE, PRIMARIO	GA-6129	70659387
ACEITE, DERIVACION (BY PASS)	G-750	74059343

MARCA-MODELO-MOTOR	GONHER	OEM
MAKE-MODEL-ENGINE	GONHER	OEM

ALLIS CHALMERS (continuación)

CAMIONES, TRACTOCAMIONES Y AUTOBUSES

260 DE VOLTEO con motores/ALLIS CHALMERS 16000, ALLIS CHALMERS 19000		
ACEITE, FLUJO TOTAL (FULL FLOW)	G-33	74395889
COMBUSTIBLE, SECUNDARIO	G-1176	74056632
AIRE	GA-5648	70620717
ACEITE, DERIVACION (BY PASS)	G-500	70091540
ACEITE, DERIVACION (BY PASS)	G-750	74059343
260 HASTA S/N 4001 DE VOLTEO con motor/CASE		
ACEITE, FLUJO TOTAL (FULL FLOW)	G-33	74395889
COMBUSTIBLE, SECUNDARIO	G-1176	74056632
ACEITE, DERIVACION (BY PASS)	G-500	70091540
260A DE VOLTEO con motor/CASE		
ACEITE, FLUJO TOTAL (FULL FLOW)	G-33	74395889
COMBUSTIBLE, SECUNDARIO	G-1176	4056632
AGUA	GP-1011Q	74393504
AIRE, SECUNDARIO	GA-6127	70197588
AIRE, PRIMARIO	GA-6129	70659387
ACEITE, DERIVACION (BY PASS)	G-750	4059343
260B DE VOLTEO, 261B DE VOLTEO con motor/CASE		
ACEITE, FLUJO TOTAL (FULL FLOW)	G-33	74395889
HIDRAULICO	G-222	70666421
ACEITE, SELLADO PARA FLUJO TOTAL (FULL FLOW)	GP-53	70697634
AGUA	GP-1011Q	74393504
COMBUSTIBLE, SEPARADOR DE AGUA	GPP-1000	74394407
AIRE, SECUNDARIO	GA-6127	70197588
AIRE, PRIMARIO	GA-6129	70659387
ACEITE, DERIVACION (BY PASS)	G-750	74059343
260E HASTA S/N 8001 DE VOLTEO con motor/CASE		
ACEITE, FLUJO TOTAL (FULL FLOW)	G-33	74395889
COMBUSTIBLE, SECUNDARIO	G-1176	74056632
AIRE, SECUNDARIO	GA-6127	70197588
AIRE, PRIMARIO	GA-6129	70659387
ACEITE, DERIVACION (BY PASS)	G-750	74059343
260E SERIES A S/N 8001-UP DE VOLTEO con motor/CASE		
ACEITE, FLUJO TOTAL (FULL FLOW)	G-33	74395889
COMBUSTIBLE, SECUNDARIO	G-1176	74056632
AIRE, SECUNDARIO	GA-6127	70197588
AIRE, PRIMARIO	GA-6129	70659387
ACEITE, DERIVACION (BY PASS)	G-750	74059343
262B DE VOLTEO, 263B DE VOLTEO con motor/DOS MOTORES CASE		
ACEITE, CARTUCHO PARA FLUJO TOTAL (FULL FLOW) MOTOR FRONTAL	G-33	74395889
ACEITE, CARTUCHO PARA FLUJO TOTAL (FULL FLOW) MOTOR TRASERO	G-33	74395889
HIDRAULICO	G-222	7066421
ACEITE, SELLADO PARA FLUJO TOTAL (FULL FLOW) MOTOR FRONTAL	GP-53	70697634
AGUA	GP-1011Q	74393504
COMBUSTIBLE, MOTOR TRASERO	GPP-19	74321716
AIRE, SECUNDARIO	GA-6127	70197588
AIRE, PRIMARIO	GA-6129	70659387
ACEITE, DERIVACION (BY PASS) MOTOR FRONTAL	G-750	74059343

MARCA-MODELO-MOTOR	GONHER	OEM
MAKE-MODEL-ENGINE	GONHER	OEM

MARCA-MODELO-MOTOR	GONHER	OEM
MAKE-MODEL-ENGINE	GONHER	OEM

MARCA-MODELO-MOTOR	GONHER	OEM
MAKE-MODEL-ENGINE	GONHER	OEM

ALLIS CHALMERS (continuación)		
CAMIONES, TRACTOCAMIONES Y AUTOBUSES		
440 DE VOLTEO con motor/CUMMINS 555		
ACEITE	G-566	70658126
ACEITE	G-613	173174
COMBUSTIBLE	GP-110	3300901
AIRE	GA-361	662609
ACEITE, DERIVACION (BY PASS)	G-500	91540
TR160 DE VOLTEO, TS160 DE VOLTEO con motores/ALLIS CHALMERS 11000, ALLIS CHALMERS TDS516		
ACEITE, FLUJO TOTAL (FULL FLOW)	G-33	4395889
COMBUSTIBLE, SECUNDARIO	G-1173	74056633
ACEITE, DERIVACION (BY PASS)	G-500	91540
TR200 DE VOLTEO, TW-300 DE VOLTEO, TS200 DE VOLTEO, TS300 DE VOLTEO con motor/BUDA		
COMBUSTIBLE, SECUNDARIO	G-1173	74056633
TR200 DE VOLTEO, TW300 DE VOLTEO, TS200 DE VOLTEO, TS300 DE VOLTEO con motor/CUMMINS		
ACEITE, FLUJO TOTAL (FULL FLOW)	G-566	70658126
ACEITE, TURBOCARGADOR	GP-14	152499
COMBUSTIBLE, 5 47/64 IN	GPP-14	4006995
COMBUSTIBLE, 4 11/32 IN	GP-1101	158172
ACEITE, SELLADO PARA FLUJO TOTAL (FULL FLOW)	GP-53	70697634
COMBUSTIBLE, 11 1/2 IN	GP-55	73111946
COMBUSTIBLE, SEPARADOR DE AGUA	GPP-11	3308638
AIRE	GA-39	255963
ACEITE, DERIVACION (BY PASS)	G-750	4059343
TS360 DE VOLTEO, TW360 DE VOLTEO con motor/ALLIS CHALMERS 21000		
ACEITE	G-33	4395889

ALLIS CHALMERS		
CARGADORAS		
653 SOBRE ORUGAS con motor/CASE		
AIRE	GA-18	237395
840B SOBRE ORUGAS con motor/ALLIS CHALMERS 2800		
COMBUSTIBLE	G-295	4024232
940 SOBRE ORUGAS con motor/ALLIS CHALMERS 2900		
COMBUSTIBLE	G-295	4024232
945 SOBRE ORUGAS con motor/CASE		
ACEITE	G-33	4395889
AGUA	GP-2071W	4393504
AIRE, SECUNDARIO	GA-6127	197588
AIRE, PRIMARIO	GA-6129	659387
ACEITE	G-750	4059343
SERIES 1101 CON TURBOCARGADORA con motor/A DIESEL		
ACEITE	G-6	4372517
T-16 SOBRE ORUGAS con motor/ALLIS CHALMERS 10000		
ACEITE	G-33	4395889
HIDRAULICO	G-33	74371021
TRANSMISION	G-33	4335348
COMBUSTIBLE, SECUNDARIO	G-1173	4056633
COMBUSTIBLE, PRIMARIO	G-1174	4055563

ALLIS CHALMERS (continuación)		
CARGADORAS		
TL-10 SOBRE ORUGAS, TL-10D SOBRE ORUGAS, TL-11 SOBRE ORUGAS, TL-12 SOBRE ORUGAS con motores/ALLIS CHALMERS G226, ALLIS CHALMERS G262		
ACEITE	G-33	4395889
TL-11 SOBRE ORUGAS con motor/ALLIS CHALMERS W226		
ACEITE	G-33	74371021
COMBUSTIBLE, SECUNDARIO	G-1173	4348149
ACEITE	GP-1	237000
TL-11D SOBRE ORUGAS con motor/ALLIS CHALMERS 6DA273		
COMBUSTIBLE, SECUNDARIO	G-1173	74056633
TL-12A SOBRE ORUGAS con motores/ALLIS CHALMERS D262, ALLIS CHALMERS G262		
ACEITE	G-33	4395889
TL-12D SOBRE ORUGAS con motor/ALLIS CHALMERS 6DA273		
COMBUSTIBLE, SECUNDARIO	G-1173	74056633
TL-12D SOBRE ORUGAS con motor/ALLIS CHALMERS D262		
TRANSMISION	G-33	4395889
TL-12D SOBRE ORUGAS con motor/ALLIS CHALMERS G262		
ACEITE	G-33	4395889
TL-14 SOBRE ORUGAS con motor/ALLIS CHALMERS 17000		
ACEITE	G-33	4395889
TL-14 SOBRE ORUGAS con motor/ALLIS CHALMERS G262		
ACEITE, CONVERTIDOR DE TORSION	G-33	4395889
TL-14 SOBRE ORUGAS, TL-14A SOBRE ORUGAS con motor/ALLIS CHALMERS 6000		
ACEITE	G-33	4395889
COMBUSTIBLE, SECUNDARIO	G-1173	74056633
COMBUSTIBLE, PRIMARIO	G-1174	74055563
TL-14A SOBRE ORUGAS con motor/ALLIS CHALMERS G262		
ACEITE	G-33	4395889
TL-14D SOBRE ORUGAS con motor/ALLIS CHALMERS 6DA237		
ACEITE	GP-1	4511629
TL-14DA SOBRE ORUGAS con motor/ALLIS CHALMERS 6DA238		
ACEITE	GP-1	4511629
TL-16D SOBRE ORUGAS con motor/ALLIS CHALMERS 3500		
ACEITE, CONVERTIDOR DE TORSION	G-33	74371021
TRANSMISION	G-33	74371021
COMBUSTIBLE, SECUNDARIO	G-1173	4056633
COMBUSTIBLE, PRIMARIO	G-1174	4055563
TL-16D SOBRE ORUGAS con motor/ALLIS CHALMERS DD339		
TRANSMISION	G-33	4395889
COMBUSTIBLE, SECUNDARIO	G-1176	4367714
ACEITE	GP-1	4511629
TL-16D SOBRE ORUGAS con motor/ALLIS CHALMERS DD344		
TRANSMISION	G-33	4395889
TL-16D SOBRE ORUGAS con motor/ALLIS CHALMERS G3400		
TRANSMISION	G-33	4335348

ALLIS CHALMERS (continuación)		
CARGADORAS		
TL-16D SOBRE ORUGAS con motor/ALLIS CHALMERS HD344		
ACEITE, CONVERTIDOR DE TORSION	G-33	74371021
COMBUSTIBLE, PRIMARIO	G-1174	4055563
COMBUSTIBLE, SECUNDARIO	G-1176	4367714
TL-16D SOBRE ORUGAS con motor/HERCULES GO-339		
COMBUSTIBLE, SECUNDARIO	G-1176	4367714
TL-16D SOBRE ORUGAS con motores/ALLIS CHALMERS 6000, ALLIS CHALMERS 7000		
ACEITE	G-33	74371021
COMBUSTIBLE, PRIMARIO	G-1174	4055563
COMBUSTIBLE, SECUNDARIO	G-1176	4367714
TL-20 SOBRE ORUGAS con motor/ALLIS CHALMERS 10000		
ACEITE	G-33	4395889
HIDRAULICO	G-33	4395889
COMBUSTIBLE, SECUNDARIO	G-1173	74056633
COMBUSTIBLE, PRIMARIO	G-1174	74055563
TL-20D SOBRE ORUGAS con motor/ALLIS CHALMERS 4D1344		
COMBUSTIBLE, SECUNDARIO	G-1173	4056633
TL-20D SOBRE ORUGAS con motor/ALLIS CHALMERS HD516		
ACEITE	G-33	4395889
COMBUSTIBLE, SECUNDARIO	G-1173	4056633
COMBUSTIBLE, PRIMARIO	G-1174	4055563
TL-30 SOBRE ORUGAS con motor/ALLIS CHALMERS 11000		
ACEITE	G-6	4372517
ACEITE	G-33	4395889
TRANSMISION	G-33	4395889
COMBUSTIBLE, PRIMARIO	G-1173	74056633
COMBUSTIBLE, SECUNDARIO	G-1173	74056633
COMBUSTIBLE, PRIMARIO	G-1174	74055563
TL-40 SOBRE ORUGAS con motor/ALLIS CHALMERS 21000		
ACEITE	G-6	4372517
ACEITE	G-33	4395889
COMBUSTIBLE, SECUNDARIO	G-1176	4056632
TL-545 SERIES B SOBRE ORUGAS con motor/ALLIS CHALMERS 2900 MKII		
HIDRAULICO	G-238	6664213
TL-545 SOBRE ORUGAS con motor/ALLIS CHALMERS 2900		
TRANSMISION	G-33	4395889
ACEITE	G-238	70666421
AIRE	GAK-20	3045583
TL-545 SOBRE ORUGAS con motor/ALLIS CHALMERS G2800		
ACEITE	G-238	70666421
TL-545H SOBRE ORUGAS con motor/ALLIS CHALMERS 2900		
ACEITE	G-33	4395889
ACEITE	G-238	70666421
AIRE	GAK-20	3045583
TL-605 SERIE B SOBRE ORUGAS con motor/ALLIS CHALMERS 2900 MKII		
ACEITE	G-238	70666421
TL-645 SERIE B SOBRE ORUGAS con motor/ALLIS CHALMERS 3500 MKII		
ACEITE	G-33	4395889
ACEITE	G-238	70666421

SERVICIO PESADO

MARCA-MODELO-MOTOR MAKE-MODEL-ENGINE	GONHER GONHER	OEM OEM	MARCA-MODELO-MOTOR MAKE-MODEL-ENGINE	GONHER GONHER	OEM OEM	MARCA-MODELO-MOTOR MAKE-MODEL-ENGINE	GONHER GONHER	OEM OEM
ALLIS CHALMERS (continuación)			ALLIS CHALMERS (continuación)			ALLIS CHALMERS (continuación)		
CARGADORAS			COMBINADAS			COMBINADAS		
AGUA	GP-2071W	4029120	F con motores/ALLIS CHALMERS G226, ALLIS CHALMERS G262			ACEITE	GP-13	114687-3
AIRE	GA-360	660360	ACEITE	GP-1	45116290	ACEITE	GP-205	114687-3
AIRE	GA-361	662609				AIRE	GAK-403	3046858
TL-6D SOBRE ORUGAS con motor/ALLIS CHALMERS 4DA153			F con motores/CHEVROLET 250, CHEVROLET 292			L2 con motor/ALLIS CHALMERS 2900		
COMBUSTIBLE, SECUNDARIO	G-1173	74056633	ACEITE	GP-13	114687-3	COMBUSTIBLE	G-295	4024232
TL-745 SOBRE ORUGAS, TL-745B SOBRE ORUGAS, TL-745C SOBRE ORUGAS, TL-745HB SOBRE ORUGAS con motor/ALLIS CHALMERS 11000 MKII			F2 con motor/CASE			ACEITE	GP-390	40235483
ACEITE	G-6	4372517	COMBUSTIBLE	GPP-1000	4394407	AIRE	GAK-20	244728
ACEITE	G-33	4395889	AIRE, S/N 39200	GAK-16	243163	AIRE	GAK-625	266787
COMBUSTIBLE, SECUNDARIO	G-1173	74056633	AIRE, S/N 39200 EN ADELANTE	GAK-403	3046858	L2 con motor/ALLIS CHALMERS 3500		
COMBUSTIBLE, PRIMARIO	G-1174	74055563	F2 con motor/GMC 6-292			COMBUSTIBLE	G-295	4024232
AIRE	GA-106	659533	ACEITE	GP-3	1146873	ACEITE	GP-390	40235482
AIRE	GA-326	659533	F3 con motor/ALLIS CHALMERS 433I			AIRE	GAK-625	266787
AIRE	GA-206	662477	HIDRAULICO	GP-66	921999	L2 con motor/ALLIS CHALMERS 670		
			AGUA	GP-2071W	4393504	AGUA	GP-2071W	4393504
			AIRE	GAK-403	3046858	ACEITE	GP-390	40235483
			G con motor/A GASOLINA			COMBUSTIBLE	G-270	71367687
			ACEITE	GP-3	1146873	L2 con motor/ALLIS CHALMERS D3500		
			G con motor/ALLIS CHALMERS G301			COMBUSTIBLE	G-295	4024232
			AIRE	GAK-20	4056630	AGUA	GP-2071W	4393504
			G, GH con motor/CASE			ACEITE	GP-390	40235483
			AIRE	GAK-20	244728	AIRE, PRIMARIO	GAK-625	266787
			GH con motores/A GASOLINA, GMC V8 350			L2 con motores/ALLIS CHALMERS D2900, ALLIS CHALMERS D649		
			ACEITE	GP-3	1146873	HIDRAULICO	GP-66	921999
			K con motor/CASE			AGUA	GP-2071W	4393504
			AIRE	GAK-403	3046858	ACEITE	GP-390	40235483
			K con motor/GMC 6-292			AIRE, PRIMARIO	GAK-625	266787
			ACEITE	GP-3	1146873	L3 con motor/CASE		
			K con motores/A GASOLINA, GMC 6-250			HIDRAULICO	GP-66	921999
			ACEITE	GP-3	1146873	COMBUSTIBLE	GP-1107	74036711
			K-2 con motor/CASE			COMBUSTIBLE, SEPARADOR DE AGUA	GPP-1000	4394407
			COMBUSTIBLE	GPP-1000	4394407	M con motor/A GASOLINA		
			K-2 con motor/GMC 6-250			ACEITE	GP-3	1146873
			ACEITE	GP-3	1146873	M con motor/ALLIS CHALMERS 2900		
			K-2 con motor/GMC 6-292			COMBUSTIBLE	G-295	4024232
			ACEITE	GP-3	1146873	ACEITE	GP-390	40235483
			K-2 con motores/ALLIS CHALMERS 433I, ALLIS CHALMERS 433T			AIRE	GAK-20	244728
			AIRE	GAK-16	1167808	AIRE	GAK-625	266787
			L con motor/ALLIS CHALMERS D2900			M con motor/CASE		
			COMBUSTIBLE	G-295	4024232	GASOLINA, SEPARADOR DE AGUA	G-293	4024223
			ACEITE	GP-390	40235483	COMBUSTIBLE	G-295	4024232
			AIRE	GAK-20	244728	AGUA	GP-2071W	4393504
			AIRE	GAK-625	266787	ACEITE	GP-390	40235483
			L con motor/ALLIS CHALMERS D3500			AIRE	GAK-16	243163
			COMBUSTIBLE	G-295	4024232	AIRE, PRIMARIO	GAK-625	266787
			AGUA	GP-2071W	4393504	M2 con motores/ALLIS CHALMERS 2900, ALLIS CHALMERS 649T		
			ACEITE	GP-390	40235483	AGUA	GP-2071W	4393504
			AIRE	GAK-20	244728	ACEITE	GP-390	40235483
			AIRE	GAK-625	266787	AIRE	GAK-625	266787
			L con motor/ALLIS CHALMERS D3500			M2 con motores/ALLIS CHALMERS 670, ALLIS CHALMERS D3500		
			COMBUSTIBLE	G-295	4024232	AGUA	GP-2071W	4393504
			AGUA	GP-2071W	4393504	ACEITE	GP-390	40235483
			ACEITE	GP-390	40235483	COMBUSTIBLE	G-270	71367687
			L con motor/GMC V8 350					
			ACEITE	GP-3	1146873			

MARCA-MODELO-MOTOR MAKE-MODEL-ENGINE	GONHER GONHER	OEM OEM
ALLIS CHALMERS (continuación)		
COMBINADAS		
M3 con motor/CASE		
ACEITE	GP-390	40235483
COMBUSTIBLE, SEPARADOR DE AGUA	GPP-1000	4394407
AIRE	GAK-625	266787
MH con motores/ALLIS CHALMERS 3500, ALLIS CHALMERS 670T		
COMBUSTIBLE, VIDRIO	G-295	4024232
AGUA	GP-2071W	4393504
ACEITE	GP-390	40235483
COMBUSTIBLE	G-270	71367687
MH2 con motor/ALLIS CHALMERS 2900		
COMBUSTIBLE	G-295	4024232
ACEITE	GP-390	40235483
AIRE	GAK-20	244728
AIRE	GAK-625	266787
MH2 con motor/ALLIS CHALMERS 3500		
COMBUSTIBLE	G-295	4024232
ACEITE	GP-390	40235483
AIRE	GAK-625	266787
MH2 con motor/ALLIS CHALMERS 649T		
AGUA	GP-2071W	4393504
ACEITE	GP-390	40235483
AIRE	GAK-625	266787
MH2 con motor/ALLIS CHALMERS 670T		
COMBUSTIBLE, VIDRIO	G-295	4024232
AGUA	GP-2071W	4393504
ACEITE	GP-390	40235483
COMBUSTIBLE	G-270	71367687
MM2 con motor/ALLIS CHALMERS 2900		
COMBUSTIBLE	G-295	4024232
ACEITE	GP-390	40235483
AIRE	GAK-20	244728
AIRE	GAK-625	266787
N con motor/CASE		
ACEITE	GP-390	40235483
N2 con motor/CASE		
ACEITE	GP-53	70697634
N5 con motor/ALLIS CHALMERS 6701		
COMBUSTIBLE	GPP-1000	4394407
N5, N6 con motor/CASE		
ACEITE	GP-51	74036791
AGUA	GP-2071W	4393504
COMBUSTIBLE	GPP-19	74321716
N7 con motor/ALLIS CHALMERS 6 Cyl.		
GASOLINA	G-293	4024223
ACEITE, FLUJO TOTAL (FULL FLOW)	GP-53	70697634
AGUA	GP-1011Q	74393504
COMBUSTIBLE, SEPARADOR DE AGUA	GPP-1000	4394407
ACEITE, DERIVACION (BY PASS)	G-500	91540
N7 con motor/CASE		
GASOLINA	G-293	4024223
ACEITE, SELLADO	GP-53	70697634

MARCA-MODELO-MOTOR MAKE-MODEL-ENGINE	GONHER GONHER	OEM OEM
ALLIS CHALMERS (continuación)		
COMBINADAS		
ACEITE, CARTUCHO	G-500	91540
R con motor/A GASOLINA		
ACEITE	GP-1	45116290
R con motor/ALLIS CHALMERS D262		
ACEITE	GP-1	4511629
R, T con motor/ALLIS CHALMERS G230		
ACEITE	GP-1	45116290
R1 con motor/A GASOLINA		
ACEITE	GP-1	45116290
R5, R6 con motor/CASE		
ACEITE	GP-51	74036791
COMBUSTIBLE	GP-1107	74036711
COMBUSTIBLE, SEPARADOR DE AGUA	GPP-1000	4394407
R7 con motor/CASE		
ACEITE, FLUJO TOTAL (FULL FLOW)	GP-53	70697634
ACEITE, DERIVACION (BY PASS)	GP-57	73124135
AGUA	GP-1011Q	74393504
COMBUSTIBLE, SEPARADOR DE AGUA	GPP-1000	4394407
ALLIS CHALMERS		
EQUIPO FORESTAL		
TP103 con motor/A GASOLINA		
ACEITE	GP-1	2370005
TP103 con motor/CASE		
AIRE	GA-18	237395
ALLIS CHALMERS		
EXCAVADORAS		
540 RETROEXCAVADORA con motor/FORD 172 DIESEL		
ACEITE	GP-81	4356575
540 RETROEXCAVADORA con motor/FORD 172 GASOLINA		
ACEITE	GP-81	4356575
555 RETROEXCAVADORA con motor/ALLIS CHALMERS 25000		
ACEITE	G-6	4372517
ACEITE	G-33	74371021
COMBUSTIBLE, PRIMARIO	G-1176	4056632
562 RETROEXCAVADORA con motor/ALLIS CHALMERS 25000		
ACEITE	G-6	4372517
ACEITE	G-33	4395889
COMBUSTIBLE, PRIMARIO	G-1176	4056632
562 RETROEXCAVADORA con motor/ALLIS CHALMERS 25000 MKII		
ACEITE	G-6	4372517
ACEITE	G-33	4395889
TRANSMISION	G-33	4395889
COMBUSTIBLE, PRIMARIO	G-1176	4056632
AIRE, PRIMARIO	GA-6127	197588
AIRE, SECUNDARIO	GA-6129	659387
ACEITE, PARCIAL	G-750	4059343

MARCA-MODELO-MOTOR MAKE-MODEL-ENGINE	GONHER GONHER	OEM OEM
ALLIS CHALMERS (continuación)		
EXCAVADORAS		
615 RETROEXCAVADORA con motor/A GASOLINA		
ACEITE	GP-1	237000
615 RETROEXCAVADORA con motor/CASE		
DIRECCION	GP-1	4511629
640 RETROEXCAVADORA con motor/CASE		
ACEITE	GP-3600	1014120
653 RETROEXCAVADORA con motor/CASE		
HIDRAULICO	GP-5	234774
714B RETROEXCAVADORA, 715D RETROEXCAVADORA, 715 RETROEXCAVADORA, 715B RETROEXCAVADORA con motor/CASE		
ACEITE	GP-1	2370005
TRANSMISION	GP-1	45116290
COMBUSTIBLE	G-296	2513976
AGUA	GP-2071W	4029120
COMBUSTIBLE	G-296-B	2513976
AIRE	GAK-16	11678083
816 RETROEXCAVADORA con motor/PERKINS 4.248		
ACEITE	GP-1	2513810
COMBUSTIBLE	G-296	2513976
COMBUSTIBLE	G-296-B	2513976
AIRE	GAK-403	4059292
816B RETROEXCAVADORA con motor/PERKINS 4.248		
ACEITE	GP-1	4511629
TRANSMISION	GP-1	2370005
COMBUSTIBLE	G-296	2513976
COMBUSTIBLE	G-296-B	2513976
AIRE	GAK-403	4059292
840 RETROEXCAVADORA, 840B RETROEXCAVADORA con motor/PERKINS		
ACEITE	GP-1	237000
COMBUSTIBLE	G-296	251397
COMBUSTIBLE	G-296-B	251397
AIRE	GAK-403	4004652
918 RETROEXCAVADORA con motor/ALLIS CHALMERS 2800		
HIDRAULICO	GP-5	234774
940 RETROEXCAVADORA con motor/ALLIS CHALMERS 2900		
COMBUSTIBLE	G-295	4024232
ALLIS CHALMERS		
GENERADORES		
DES-100 con motores/ALLIS CHALMERS 2800, ALLIS CHALMERS 2900, ALLIS CHALMERS 3500		
COMBUSTIBLE	G-295	4024232
DES125, DES135 con motor/ALLIS CHALMERS 11000		
ACEITE	G-6	4372517
DES125, DES135 con motor/ALLIS CHALMERS 17000		
ACEITE	G-33	4395889
DES175 con motor/ALLIS CHALMERS 11000		
ACEITE	G-33	4395889
DES175 con motor/ALLIS CHALMERS 17000		
ACEITE	G-6	4372517

SERVICIO PESADO

MARCA-MODELO-MOTOR MAKE-MODEL-ENGINE	GONHER GONHER	OEM OEM	MARCA-MODELO-MOTOR MAKE-MODEL-ENGINE	GONHER GONHER	OEM OEM	MARCA-MODELO-MOTOR MAKE-MODEL-ENGINE	GONHER GONHER	OEM OEM
ALLIS CHALMERS (continuación)			ALLIS CHALMERS (continuación)			ALLIS CHALMERS (continuación)		
GENERADORES			MONTACARGAS			MONTACARGAS		
DES200, DES275, DES220, DES250 con motores/ALLIS CHALMERS 21000, ALLIS CHALMERS 25000 C/TURBOCARGADOR			ACC35, ACC40, ACC45, ACC55 con motores/A GASOLINA, LPG			F60-24, F70-24, F80-24 con motor/ALLIS CHALMERS G230		
ACEITE, TURBO	G-6	4372517	ACEITE	GP-1	45116290	ACEITE	GP-1	4511629
ACEITE	G-33	4395889	ACC60, ACC70 con motores/CONTINENTAL A GASOLINA, CONTINENTAL LPG			FD100-24, FD120-24 con motor/ALLIS CHALMERS G262		
COMBUSTIBLE, SECUNDARIO	G-1176	4056632	ACEITE	GP-1	45116290	DIRECCION	GP-1	4511629
AGUA	GP-2071W	4393504	ACC60, ACC70, ACC80 con motor/ALLIS CHALMERS D262			TRANSMISION	GP-1	4511629
COMBUSTIBLE, SECUNDARIO	GPP-1000	4394407	TRANSMISION	GP-1	45116290	ACEITE, DERIVACION (BY PASS)	GP-50	45122074
AIRE, SIN ASPAS	GA-27	P101240	ACC80 con motor/CONTINENTAL A GASOLINA			FD60-24 con motor/ALLIS CHALMERS G230		
ACEITE, DERIVACION (BY PASS)	G-500	91540	ACEITE	GP-1	45116290	DIRECCION	GP-1	4511629
DES45, DES90 con motores/ALLIS CHALMERS 2800, ALLIS CHALMERS 2900, ALLIS CHALMERS 3500			ACP20 con motores/CONTINENTAL A GASOLINA, CONTINENTAL LPG			FD60-24, FD70-24, FD80-24 con motor/ALLIS CHALMERS D262		
COMBUSTIBLE	G-295	4024232	TRANSMISION	GP-1	45116290	DIRECCION	GP-1	4511629
DES500 con motor/ALLIS CHALMERS 61000			ACEITE	GP-50	45122074	TRANSMISION	GP-1	4511629
ACEITE	G-33	4395889	AIRE	GA-105	49975683	AIRE	GA-105	49975683
DES550 con motor/ALLIS CHALMERS 65000			ACP225 con motor/ALLIS CHALMERS 2900			FD70-24, FD80-24 con motor/ALLIS CHALMERS G262		
ACEITE	G-33	4395889	COMBUSTIBLE	G-295	40242323	DIRECCION	GP-1	4511629
DES60 con motores/ALLIS CHALMERS 3500, ALLIS CHALMERS 2800, ALLIS CHALMERS 2900			ACEITE	GP-390	40235483	TRANSMISION	GP-1	4511629
COMBUSTIBLE	G-295	4024232	AIRE	GAK-403	4909733	AIRE	GA-105	49975683
ALLIS CHALMERS			ACP225 con motor/FORD 300 A GASOLINA			FL100-24, FL120-24 con motor/ALLIS CHALMERS G230		
MONTACARGAS			ACEITE	GP-1	C1A26731A	ACEITE	GP-1	4511629
500 con motor/A GASOLINA			TRANSMISION	GP-1	4855745	FL30-24, FP40-24, FL40-24, FL50-24 con motor/ALLIS CHALMERS G153		
ACEITE	GP-1	2370005	AIRE	GAK-403	4909733	ACEITE, CONVERTIDOR DE TORSION	G-6	4372517
500 con motor/CASE			ACP25, ACP30 con motores/CONTINENTAL A GASOLINA, CONTINENTAL LPG			ACEITE, DERIVACION (BY PASS)	GP-50	4512207
AIRE	GA-18	237395	TRANSMISION	GP-1	45116290	AIRE	GA-105	49975683
510 con motor/CASE			ACEITE	GP-50	45122074	FL60-24, FL70-24, FL80-24 con motor/ALLIS CHALMERS G230		
ACEITE	GP-1	45116290	AIRE	GA-105	49975683	ACEITE	GP-1	45116290
600 con motor/A GASOLINA			ACP40 con motor/PERKINS 4.203 DIESEL			FP50-24 con motor/ALLIS CHALMERS D175		
ACEITE	GP-1	2370005	TRANSMISION	GP-1	45116290	ACEITE, DERIVACION (BY PASS)	GP-50	4512207
600 con motor/CASE			COMBUSTIBLE	G-296	2513976	FP50-24 con motor/ALLIS CHALMERS G153		
AIRE	GA-18	237395	ACEITE	GP-3600	1014120	ACEITE, CONVERTIDOR DE TORSION	G-6	4372517
705 SERIES C con motor/CASE			COMBUSTIBLE	G-296-B	2513976	ACEITE, DERIVACION (BY PASS)	GP-50	45122074
COMBUSTIBLE	G-296	7111/296	ACP40, ACP50 con motores/CONTINENTAL A GASOLINA, CONTINENTAL LPG			AIRE	GA-105	49975683
COMBUSTIBLE	G-296-B	7111/296	TRANSMISION	GP-1	45116290	FP50-24 con motor/ALLIS CHALMERS G230		
AIRE	GAK-16	1167808	ACP50 con motor/PERKINS 4.203 DIESEL			ACEITE	GP-1	4511629
706 con motor/PERKINS			TRANSMISION	GP-1	4511629	FP60-24, FP70-24, FP80-24 con motor/ALLIS CHALMERS G230		
HIDRAULICO	GP-5	234774	COMBUSTIBLE	G-296	2513976	ACEITE	GP-1	4511629
706 SERIES C con motor/CASE			ACEITE	GP-3600	1014120	FPD40-24, FPD50-24 con motor/ALLIS CHALMERS D175		
COMBUSTIBLE	G-296	7111/296	COMBUSTIBLE	G-296-B	2513976	ACEITE, DERIVACION (BY PASS)	GP-50	45122074
COMBUSTIBLE	G-296-B	7111/296	C50XLPS con motor/MITSUBISHI			ACEITE	GP-1	4511629
AIRE	GAK-16	11678083	ACEITE	GP-462	MD162326	FPD60-24, FPD70-24, FPD80-24 con motor/ALLIS CHALMERS D262		
ACC100, ACC120 con motor/ALLIS CHALMERS D262			F100-24, F120-24 con motor/ALLIS CHALMERS G230			DIRECCION	GP-1	4511629
ACEITE	GP-1	45116290	ACEITE	GP-1	4511629	TRANSMISION	GP-1	4511629
ACC100, ACC120 con motores/CONTINENTAL A GASOLINA, CONTINENTAL LPG			F30-24, F40-24 con motor/ALLIS CHALMERS G153			AIRE	GA-105	49975683
ACEITE	GP-1	45116290	ACEITE, CONVERTIDOR DE TORSION	G-6	4372517	FP40-24 con motor/ALLIS CHALMERS 4B153		
ACC30, ACC20, ACC25 con motores/A GASOLINA, LPG			ACEITE, DERIVACION (BY PASS)	GP-50	45122074	ACEITE	GP-1	4511629
ACEITE	GP-1	45116290	AIRE	GA-105	49975683	DIRECCION	GP-1	4511629
ACEITE	GP-50	45122074	F-4 con motor/CASE			TRANSMISION	GP-1	4511629
AIRE	GA-105	49975683	ACEITE	GP-1	45116290	FP40-24, FPL50-24 con motor/ALLIS CHALMERS G153		
						ACEITE, CONVERTIDOR DE TORSION	G-6	4372517

APLICACIONES SERVICIO PESADO
HEAVY DUTY APPLICATIONS



MARCA-MODELO-MOTOR MAKE-MODEL-ENGINE	GONHER GONHER	OEM OEM	MARCA-MODELO-MOTOR MAKE-MODEL-ENGINE	GONHER GONHER	OEM OEM	MARCA-MODELO-MOTOR MAKE-MODEL-ENGINE	GONHER GONHER	OEM OEM
ALLIS CHALMERS (continuación)			ALLIS CHALMERS (continuación)			ALLIS CHALMERS (continuación)		
MONTACARGAS			MOTORES			MOTORES		
ACEITE, DERIVACION (BY PASS)	GP-50	4512207	AGUA	GP-2071W	4393504	1BD38 CASE		
AIRE	GA-105	49975683	AIRE	GA-37	4052677	COMBUSTIBLE, PRIMARIO	GC-1133	74507143
FS70-24, FS80-24, FSL60-24, FSL70-24, FSL80-24, FPL60-24, FPL70-24, FPL80-24, FS60-24 con motor/ALLIS CHALMERS G230			10000 MARINO			COMBUSTIBLE, SECUNDARIO	GS-1133	74055345
ACEITE	GP-1	45116290	ACEITE	G-33	4395889	COMBUSTIBLE, SECUNDARIO	G-1173	74056633
FSD60-24, FSD70-24, FSD80-24 con motor/ALLIS CHALMERS D262			COMBUSTIBLE, SECUNDARIO	G-1173	74056633	21000 CASE		
DIRECCION	GP-1	4511629	COMBUSTIBLE, PRIMARIO	G-1174	4055563	ACEITE	G-6	4372517
TRANSMISION	GP-1	4511629	11000 A DIESEL			ACEITE, FLUJO TOTAL (FULL FLOW)	G-33	74371021
AIRE	GA-105	49975683	ACEITE	G-33	74371021	COMBUSTIBLE, SECUNDARIO OPCIONAL	G-1173	74056633
FSL60-24, FSL70-24 con motor/ALLIS CHALMERS D230			COMBUSTIBLE, SECUNDARIO	G-1173	74056633	COMBUSTIBLE, SECUNDARIO	G-1176	4056632
ACEITE	GP-1	4511629	COMBUSTIBLE, PRIMARIO	G-1174	74055563	ACEITE, SELLADO PARA FLUJO TOTAL (FULL FLOW)	GP-53	70697634
FSL80-24 con motor/ALLIS CHALMERS D230			AGUA	GP-2071W	4393504	AGUA	GP-2071W	4393504
ACEITE	GP-1	4511629	AIRE	GA-37	4052677	AIRE, SIN ASPAS	GA-27	P101240
FT100-24, FT60-24, FT70-24, FT80-24, FTD100-24, FTD60-24, FTD70-24, FTD75-24 con motor/ALLIS CHALMERS 6BD230			11000 MARINO			ACEITE, DERIVACION (BY PASS)	G-500	91540
ACEITE	GP-1	4511629	ACEITE	G-33	4395889	ACEITE, DERIVACION (BY PASS)	G-750	4059343
FT20 con motor/CASE			COMBUSTIBLE, SECUNDARIO	G-1173	74056633	21000 MARINO		
ACEITE	GP-1	45116290	COMBUSTIBLE, PRIMARIO	G-1174	74055563	ACEITE	G-33	4395889
FT20-24, FT25-24, FTB30-15, FTB30-24, FTBL30-15, FTBL30-24 con motor/WAUKESHA FC-133			AGUA	GP-2071W	4393504	21000 MK II CASE		
ACEITE	GP-1	4511629	16000 CASE			ACEITE, FLUJO TOTAL (FULL FLOW)	G-33	4395889
FTD20, FTD30, FTD40 con motor/A DIESEL			ACEITE	G-33	74371021	COMBUSTIBLE, SECUNDARIO OPCIONAL	G-1173	4056633
COMBUSTIBLE, SECUNDARIO	G-1173	74056633	COMBUSTIBLE, SECUNDARIO OPCIONAL	G-1173	74056633	COMBUSTIBLE, SECUNDARIO	G-1176	4052172
FTD80-24, FTL100-24 con motor/ALLIS CHALMERS 6BD230			COMBUSTIBLE, SECUNDARIO	G-1176	74056632	ACEITE, SELLADO PARA FLUJO TOTAL (FULL FLOW)	GP-53	70697634
ACEITE	GP-1	4511629	AGUA	GP-2071W	4393504	ACEITE, DERIVACION (BY PASS)	G-500	91540
FTL20-24, FTL25-24, FTP20-24 con motor/WAUKESHA FC-133			COMBUSTIBLE, SEPARADOR DE AGUA	GPP-1000	4394407	ACEITE, DERIVACION (BY PASS)	G-750	4059343
ACEITE	GP-1	45116290	AIRE	GA-37	4051918	21000H CASE		
FTP30-24, FTP40-24, FTPL30-24, FTPL40-24 con motor/ALLIS CHALMERS 4B153			ACEITE, DERIVACION (BY PASS)	G-500	70091540	ACEITE, FLUJO TOTAL (FULL FLOW)	G-33	4395889
ACEITE	GP-1	45116290	16000 MARINO			COMBUSTIBLE, SECUNDARIO OPCIONAL	G-1173	4056633
DIRECCION	GP-1	4511629	ACEITE	G-33	4395889	COMBUSTIBLE, SECUNDARIO	G-1176	4052172
TRANSMISION	GP-1	4511629	16000H CASE			ACEITE, SELLADO PARA FLUJO TOTAL (FULL FLOW)	GP-53	70697634
FTPD30-24, FTPD40-24 con motor/ALLIS CHALMERS 4BD153			ACEITE	G-33	4395889	ACEITE, DERIVACION (BY PASS)	G-500	91540
COMBUSTIBLE	G-1173	74056633	COMBUSTIBLE, SECUNDARIO OPCIONAL	G-1173	4056633	ACEITE, DERIVACION (BY PASS)	G-750	4059343
FTPL20-24 con motor/WAUKESHA FC-133			COMBUSTIBLE, SECUNDARIO	G-1176	4052172	21000H MARINO		
ACEITE	GP-1	45116290	COMBUSTIBLE, SECUNDARIO	G-1176	4052172	ACEITE	G-33	4395889
FTPL60-24, FTL60-24, FTL70-24, FTL80-24, FTP60-24 con motor/ALLIS CHALMERS 6B230			COMBUSTIBLE, SEPARADOR DE AGUA	GPP-1000	4394407	25000 CASE		
ACEITE	GP-1	45116290	ACEITE, DERIVACION (BY PASS)	G-500	91540	ACEITE	G-6	4372517
RT-40 con motor/ALLIS CHALMERS G149			17000 CASE			ACEITE, FLUJO TOTAL (FULL FLOW)	G-33	74371021
ACEITE	GP-1	4511629	ACEITE	G-33	74371021	COMBUSTIBLE, SECUNDARIO OPCIONAL	G-1173	74056633
RTD-40 con motor/ALLIS CHALMERS D175			COMBUSTIBLE, SECUNDARIO OPCIONAL	G-1173	74056633	COMBUSTIBLE, SECUNDARIO	G-1176	4056632
ACEITE	GP-50	45122074	COMBUSTIBLE, SECUNDARIO	G-1176	74056632	ACEITE, SELLADO PARA FLUJO TOTAL (FULL FLOW)	GP-53	70697634
			AGUA	GP-2071W	4393504	AGUA	GP-2071W	4393504
			COMBUSTIBLE, SEPARADOR DE AGUA	GPP-1000	4394407	AIRE, SIN ASPAS	GA-27	P101240
			AIRE	GA-37	4051918	ACEITE, DERIVACION (BY PASS)	G-500	91540
			ACEITE, DERIVACION (BY PASS)	G-500	70091540	ACEITE, DERIVACION (BY PASS)	G-750	4059343
			19000 CASE			25000 MARINO		
			ACEITE	G-33	74371021	ACEITE	G-33	4395889
			COMBUSTIBLE, SECUNDARIO OPCIONAL	G-1173	74056633	2800 MK II CASE		
			COMBUSTIBLE, SECUNDARIO	G-1176	74056632	COMBUSTIBLE	G-295	74024232
			AGUA	GP-2071W	4393504	ACEITE	GP-390	40235483
						AIRE	GAK-403	3046858
						AIRE	GAK-20	244728

SERVICIO PESADO

MARCA-MODELO-MOTOR MAKE-MODEL-ENGINE	GONHER GONHER	OEM OEM	MARCA-MODELO-MOTOR MAKE-MODEL-ENGINE	GONHER GONHER	OEM OEM	MARCA-MODELO-MOTOR MAKE-MODEL-ENGINE	GONHER GONHER	OEM OEM
ALLIS CHALMERS (continuación)			ALLIS CHALMERS (continuación)			ALLIS CHALMERS (continuación)		
MOTORES			MOTORES			MOTORES		
2900 CASE			4DA153 CASE			COMBUSTIBLE, SEPARADOR DE AGUA	GPP-1000	4394407
COMBUSTIBLE	G-295	74024232	COMBUSTIBLE, SECUNDARIO	G-1173	74056633	ACEITE, CARTUCHO	G-500	91540
2900 MK II CASE			4DA182 CASE			6B CASE		
COMBUSTIBLE	G-295	74024232	COMBUSTIBLE, SECUNDARIO	G-1173	74056633	COMBUSTIBLE, SECUNDARIO	G-1174	74055563
ACEITE	GP-390	40235483	4DA482 CASE			6BD230 CASE		
AIRE	GAK-403	3046858	COMBUSTIBLE, SECUNDARIO	G-1173	74056633	COMBUSTIBLE, SECUNDARIO	G-1173	74056633
AIRE	GAK-20	244728	4DAMR182 CASE			6BD273 CASE		
2BD77 CASE			COMBUSTIBLE, SECUNDARIO	G-1173	74056633	COMBUSTIBLE, SECUNDARIO	G-1173	74056633
COMBUSTIBLE	G-1173	74056633	4DC645 CASE			6BDMR230 CASE		
2BDMR77 CASE			COMBUSTIBLE, SECUNDARIO	G-1173	74056633	COMBUSTIBLE, SECUNDARIO	G-1173	74056633
COMBUSTIBLE	G-1173	74056633	6000 CASE			6D CASE		
3400 MK II CASE			COMBUSTIBLE	GS-1133	74055345	COMBUSTIBLE, SECUNDARIO	G-1174	74055563
GASOLINA, SEPARADOR DE AGUA	G-293	4024223	COMBUSTIBLE	G-1173	74056633	COMBUSTIBLE, SECUNDARIO	G-1174	74055563
COMBUSTIBLE	G-295	74024232	COMBUSTIBLE, PRIMARIO	G-1174	74353268	6D1-516 CASE		
ACEITE	GP-390	40235483	61000 CASE			ACEITE	G-33	74371021
ACEITE, DERIVACION (BY PASS)	G-500	4059373	ACEITE, CARTUCHO	G-33	74371021	COMBUSTIBLE, SECUNDARIO	G-1173	74056633
3500 CASE			COMBUSTIBLE, SECUNDARIO	G-1176	4056632	COMBUSTIBLE, PRIMARIO	G-1174	74055563
ACEITE	GP-390	40235483	AGUA	GP-2071W	4393504	6D317 CASE		
3500 MK II CASE			ACEITE	G-500	91540	COMBUSTIBLE, SECUNDARIO	G-1173	74056633
GASOLINA, SEPARADOR DE AGUA	G-293	4024223	6-120T CASE			6DA230 CASE		
COMBUSTIBLE	G-295	74024232	ACEITE, SELLADO	GP-53	70697634	COMBUSTIBLE, SECUNDARIO	G-1173	74056633
ACEITE	GP-390	4023548	AGUA	GP-1013Q	P552055	6DA273 CASE		
ACEITE, DERIVACION (BY PASS)	G-500	4059373	COMBUSTIBLE, SECUNDARIO	GP-1108	P551712	ACEITE	G-33	74371021
3700 CASE			ACEITE, CARTUCHO	G-750	4059343	6DA779 CASE		
GASOLINA, SEPARADOR DE AGUA	G-293	4024223	6-138I CASE			ACEITE	G-33	74371021
COMBUSTIBLE	G-295	74024232	ACEITE, CARTUCHO	G-33	74371021	6DA844 CASE		
ACEITE	GP-390	40235483	ACEITE, SELLADO	GP-53	70697634	ACEITE	G-33	74371021
ACEITE, DERIVACION (BY PASS)	G-500	4059373	AGUA	GP-1013Q	P552055	COMBUSTIBLE, SECUNDARIO	G-1173	4056633
3700 MK II CASE			ACEITE	G-750	4059343	COMBUSTIBLE, PRIMARIO	G-1175	70059898
GASOLINA, SEPARADOR DE AGUA	G-293	4024223	649I CASE			COMBUSTIBLE, SECUNDARIO	G-1176	74371499
COMBUSTIBLE	G-295	74024232	COMBUSTIBLE, VIDRIO	G-295	4024232	6DA970 CASE		
ACEITE	GP-390	40235483	COMBUSTIBLE	GPP-19	74321716	ACEITE	G-33	74371021
ACEITE, DERIVACION (BY PASS)	G-500	4059373	ACEITE	GP-390	40235483	6DAM844 CASE		
3750 CASE			COMBUSTIBLE	G-270	71367687	COMBUSTIBLE, SECUNDARIO	G-1173	74056633
GASOLINA, SEPARADOR DE AGUA	G-293	4024223	6-49T CASE			6DAMR273 CASE		
COMBUSTIBLE	G-295	74024232	COMBUSTIBLE, SECUNDARIO	GP-1108	P551712	COMBUSTIBLE, SECUNDARIO	G-1173	74056633
ACEITE	GP-390	40235483	ACEITE	GP-390	40235483	6DAMR779 CASE		
4B153 A GASOLINA			COMBUSTIBLE	G-270	71367687	COMBUSTIBLE, SECUNDARIO	G-1173	74056633
ACEITE	GP-1	45116290	65000 CASE			6DAMR844 CASE		
4BD175 CASE			ACEITE, CARTUCHO	G-33	74371021	COMBUSTIBLE, SECUNDARIO	G-1173	74056633
COMBUSTIBLE, SECUNDARIO	G-1173	74056633	COMBUSTIBLE, SECUNDARIO	G-1176	4056632	6DAMR779 CASE		
4BD182 CASE			AGUA	GP-2071W	4393504	COMBUSTIBLE, SECUNDARIO	G-1173	74056633
COMBUSTIBLE, SECUNDARIO	G-1173	74056633	ACEITE	G-500	91540	6DAMR844 CASE		
4BDMR153 CASE			6-70T CASE			COMBUSTIBLE, SECUNDARIO	G-1173	74056633
COMBUSTIBLE, SECUNDARIO	G-1173	74056633	COMBUSTIBLE	GP-1101	158172	6DAS844 CASE		
4D1344 CASE			ACEITE	GP-390	40235483	ACEITE	G-33	74371021
COMBUSTIBLE, SECUNDARIO	G-1173	74056633	COMBUSTIBLE	G-270	71367687	COMBUSTIBLE, SECUNDARIO	G-1173	4056633
			6-85I CASE			COMBUSTIBLE, PRIMARIO	G-1175	70059898
			GASOLINA	G-293	4024223	COMBUSTIBLE, SECUNDARIO	G-1176	74371499
			ACEITE, SELLADO	GP-53	70697634	6DASM844 CASE		
			AGUA	GP-1013Q	P552055	ACEITE	G-33	74371021

MARCA-MODELO-MOTOR MAKE-MODEL-ENGINE	GONHER GONHER	OEM OEM	MARCA-MODELO-MOTOR MAKE-MODEL-ENGINE	GONHER GONHER	OEM OEM	MARCA-MODELO-MOTOR MAKE-MODEL-ENGINE	GONHER GONHER	OEM OEM
ALLIS CHALMERS (continuación)			ALLIS CHALMERS (continuación)			ALLIS CHALMERS (continuación)		
MOTORES			MOTORES			MOTORES		
COMBUSTIBLE, SECUNDARIO	G-1173	4056633	8DC1290 CASE			DAS516 CASE		
COMBUSTIBLE, PRIMARIO	G-1175	70059898	COMBUSTIBLE, SECUNDARIO	G-1176	74367714	ACEITE	G-33	4395889
COMBUSTIBLE, SECUNDARIO	G-1176	74371499						
			8DC2505 CASE			G-138 A GASOLINA		
6DAT779 CASE			ACEITE	G-33	4395889	ACEITE	GP-1	4511629
COMBUSTIBLE, SECUNDARIO	G-1173	74056633						
			8DCMR2505 CASE			G-149 A GASOLINA		
6DC CAS			COMBUSTIBLE, SECUNDARIO	G-1173	74056633	ACEITE	GP-1	4511629
COMBUSTIBLE, SECUNDARIO	G-1174	74055563						
			8DCMSR2505 CASE			G-153 A GASOLINA		
6DC844 CASE			COMBUSTIBLE, SECUNDARIO	G-1173	74056633	ACEITE	GP-1	4511629
ACEITE	G-33	4395889						
			8DCS1125 CASE			G-160 A GASOLINA		
6DC970 CASE			ACEITE	G-33	4395889	ACEITE	GP-1	4511629
COMBUSTIBLE, PRIMARIO	G-1175	70059898						
			8DCS2505 CASE			G-226 A GASOLINA		
6DCS844 CASE			COMBUSTIBLE, SECUNDARIO	G-1176	74367714	ACEITE	GP-1	4511629
COMBUSTIBLE, PRIMARIO	G-1175	70059898						
			8DCSMR2505 CASE			G-262 A GASOLINA		
6DS844 CASE			COMBUSTIBLE, SECUNDARIO	G-1173	74056633	ACEITE	GP-1	4511629
COMBUSTIBLE, PRIMARIO	G-1175	70059898						
			AD5516 CASE			G2800 A GASOLINA		
6DT317 CASE			ACEITE	G-33	74371021	ACEITE	GP-390	4035556
COMBUSTIBLE, SECUNDARIO	G-1173	74056633	COMBUSTIBLE, SECUNDARIO	G-1173	74056633			
			COMBUSTIBLE, PRIMARIO	G-1174	74055563	HD516 CASE		
6DT468 CASE						ACEITE	G-33	74371021
COMBUSTIBLE, SECUNDARIO	G-1173	74056633	AS516 CASE			COMBUSTIBLE, SECUNDARIO	G-1173	74056633
			ACEITE	G-33	74371021	COMBUSTIBLE, PRIMARIO	G-1174	74055563
6DTM317 CASE			COMBUSTIBLE, SECUNDARIO	G-1173	74056633			
COMBUSTIBLE, SECUNDARIO	G-1173	74056633	COMBUSTIBLE, PRIMARIO	G-1174	74055563	HD844 CASE		
						ACEITE	G-33	74371021
6DTM468 CASE			D-175 CASE			COMBUSTIBLE, SECUNDARIO	G-1173	4056633
COMBUSTIBLE, SECUNDARIO	G-1173	74056633	ACEITE	GP-50	74512207	COMBUSTIBLE, PRIMARIO	G-1175	70059898
						COMBUSTIBLE, SECUNDARIO	G-1176	74371499
6DTMR317 CASE			D230 CASE					
COMBUSTIBLE, SECUNDARIO	G-1173	74056633	ACEITE	GP-1	45116290	HDS-844 CASE		
						ACEITE	G-33	74371021
6DTMR468 CASE			D273 CASE			COMBUSTIBLE, SECUNDARIO	G-1173	4056633
COMBUSTIBLE, SECUNDARIO	G-1173	74056633	ACEITE	G-33	4395889	COMBUSTIBLE, PRIMARIO	G-1175	70059898
						COMBUSTIBLE, SECUNDARIO	G-1176	74371499
6MO779 CASE			D344 CASE					
COMBUSTIBLE, PRIMARIO	G-1173	74056633	COMBUSTIBLE, SECUNDARIO	G-1173	74056633	HDT-844 CASE		
						ACEITE	G-33	74371021
7000 CASE			D516 CASE			COMBUSTIBLE, SECUNDARIO	G-1173	4056633
COMBUSTIBLE	GS-1133	74055345	ACEITE	G-33	74371021	COMBUSTIBLE, PRIMARIO	G-1175	70059898
COMBUSTIBLE, SECUNDARIO	G-1173	74056633	COMBUSTIBLE, SECUNDARIO	G-1173	74056633	COMBUSTIBLE, SECUNDARIO	G-1176	74371499
COMBUSTIBLE, PRIMARIO	G-1174	74353268	COMBUSTIBLE, PRIMARIO	G-1174	74055563			
						SERIE 10000 MARINO		
8DA1125 CASE			D716 CASE			ACEITE	G-33	4395889
ACEITE	G-33	4395889	ACEITE	G-33	74371021	COMBUSTIBLE, SECUNDARIO	G-1173	74056633
			COMBUSTIBLE, SECUNDARIO	G-1173	74056633	COMBUSTIBLE, PRIMARIO	G-1174	74055563
8DAS1125 CASE			COMBUSTIBLE, PRIMARIO	G-1174	74055563			
ACEITE	G-33	4395889				SERIE 11000 MARINO		
			D844 CASE			ACEITE	G-33	4395889
8DAT1125 CASE			ACEITE	G-33	74371021	COMBUSTIBLE, SECUNDARIO	G-1173	74056633
ACEITE	G-33	4395889	COMBUSTIBLE, SECUNDARIO	G-1173	4056633	COMBUSTIBLE, PRIMARIO	G-1174	74055563
			COMBUSTIBLE, PRIMARIO	G-1175	70059898			
8DC1125 CASE			COMBUSTIBLE, SECUNDARIO	G-1176	74371499	SERIE 19000 DIESEL		
ACEITE	G-33	74371021				ACEITE	G-33	4395889
COMBUSTIBLE, SECUNDARIO	G-1173	74056633	DA516 CASE			COMBUSTIBLE, SECUNDARIO	G-1173	74056633
COMBUSTIBLE, PRIMARIO	G-1176	74367714	ACEITE	G-33	4395889	AGUA	GP-1010Q	4393504
COMBUSTIBLE, SECUNDARIO	G-1176	74367714	COMBUSTIBLE, SECUNDARIO	G-1173	74056633			
1955 EN ADELANTE			COMBUSTIBLE, PRIMARIO	G-1174	74055563			
			AIRE, PRIMARIO	GA-6127	197588			
			AIRE, SECUNDARIO	GA-6129	659387			

SERVICIO PESADO

MARCA-MODELO-MOTOR MAKE-MODEL-ENGINE	GONHER GONHER	OEM OEM	MARCA-MODELO-MOTOR MAKE-MODEL-ENGINE	GONHER GONHER	OEM OEM	MARCA-MODELO-MOTOR MAKE-MODEL-ENGINE	GONHER GONHER	OEM OEM
ALLIS CHALMERS (continuación)			ALLIS CHALMERS (continuación)			ALLIS CHALMERS (continuación)		
MOTORES			MOTORES			MOTOTRAILLA		
SERIE 21000 CASE			SERIE 1700 DIESEL			180, 185 con motor/CASE		
ACEITE	G-6	4372517	ACEITE	G-33	4395889	HIDRAULICO	GP-5	239930
ACEITE	G-33	4395889	COMBUSTIBLE, SECUNDARIO	G-1173	74056633	COMBUSTIBLE	G-295	4024232
COMBUSTIBLE, SECUNDARIO	G-1173	74056633	AGUA	GP-1010Q	4029120	AIRE	GAK-16	243163
AGUA	GP-1010Q	4393504	SERIE 17000 DIESEL			260 con motores/ALLIS CHALMERS 16000, ALLIS CHALMERS 19000		
ACEITE	GP-53	4396645	ACEITE	G-33	4395889	ACEITE, FLUJO TOTAL (FULL FLOW)	G-33	74395889
AIRE, SIN ASPAS	GA-27	P101240	COMBUSTIBLE, PRIMARIO	G-1174	74055563	COMBUSTIBLE, SECUNDARIO	G-1176	74056632
ACEITE, DERIVACION (BY PASS)	G-500	91540	SERIE 19000 DIESEL			AIRE	GA-5648	70620717
ACEITE, DERIVACION (BY PASS)	G-750	40593436	ACEITE	G-33	4395889	ACEITE, DERIVACION (BY PASS)	G-500	70091540
SERIE 25000 MKII CASE			COMBUSTIBLE, SECUNDARIO	G-1173	74056633	ACEITE, DERIVACION (BY PASS)	G-750	74059343
ACEITE	G-6	4372517	COMBUSTIBLE, PRIMARIO	G-1174	74055563	260 HASTA S/N 4001 con motor/CASE		
ACEITE	G-33	4395889	AGUA	GP-1010Q	4393504	ACEITE, FLUJO TOTAL (FULL FLOW)	G-33	74395889
COMBUSTIBLE, SECUNDARIO	G-1173	74056633	SERIE 25000 (6138LT) CASE			COMBUSTIBLE, SECUNDARIO	G-1176	74056632
AGUA	GP-1010Q	74059979	ACEITE	G-6	4372517	ACEITE, DERIVACION (BY PASS)	G-500	70091540
ACEITE	GP-53	4396645	ACEITE	G-33	4395889	260 SERIE A con motor/ALLIS CHALMERS 21000 MKII		
AIRE	GA-27	P101240	COMBUSTIBLE, SECUNDARIO	G-1173	74056633	ACEITE	G-33	4395889
ACEITE, DERIVACION (BY PASS)	G-500	91540	AGUA	GP-1010Q	4029120	COMBUSTIBLE, SECUNDARIO	G-1176	4056632
ACEITE, DERIVACION (BY PASS)	G-750	40593436	ACEITE	GP-53	4396645	AGUA	GP-2071W	4393504
SERIE 2800MKII CASE			AIRE, SIN ASPAS	GA-27	P101240	AIRE, SECUNDARIO	GA-6127	197588
COMBUSTIBLE	G-295	40242323	ACEITE, DERIVACION (BY PASS)	G-500	91540	AIRE, PRIMARIO	GA-6129	659387
AIRE	GAK-403	3046858	ACEITE, DERIVACION (BY PASS)	G-750	40593436	ACEITE, DERIVACION (BY PASS)	G-750	4059343
AIRE	GAK-20	244728	TD844 CASE			260A con motor/CASE		
SERIE 2900MKII CASE			ACEITE	G-33	74371021	ACEITE, FLUJO TOTAL (FULL FLOW)	G-33	74395889
COMBUSTIBLE	G-295	40242323	COMBUSTIBLE, SECUNDARIO	G-1173	4056633	COMBUSTIBLE, SECUNDARIO	G-1176	4056632
AIRE, SIN ASPAS	GA-403	3046858	COMBUSTIBLE, PRIMARIO	G-1175	70059898	AGUA	GP-1011Q	74393504
AIRE	GAK-20	244728	COMBUSTIBLE, SECUNDARIO	G-1176	74371499	AIRE, SECUNDARIO	GA-6127	70197588
SERIE 3400 MKII CASE			TDS516 CASE			AIRE, PRIMARIO	GA-6129	70659387
COMBUSTIBLE	G-295	40242323	ACEITE	G-33	74371021	ACEITE, DERIVACION (BY PASS)	G-750	4059343
SERIE 61000 CASE			COMBUSTIBLE, SECUNDARIO	G-1173	74056633	260B con motor/ALLIS CHALMERS 25000 MKII		
ACEITE	G-33	4395889	COMBUSTIBLE, PRIMARIO	G-1174	74055563	ACEITE	G-33	4395889
AGUA	GP-1010Q	4393504	TDS844 CASE			COMBUSTIBLE, SECUNDARIO	G-1176	4056632
ACEITE, DERIVACION (BY PASS)	G-500	91540	ACEITE	G-33	74371021	AGUA	GP-2071W	4393504
SERIE 61000 DIESEL			COMBUSTIBLE, SECUNDARIO	G-1173	4056633	AIRE, PRIMARIO	GA-6127	197588
ACEITE	G-33	4395889	COMBUSTIBLE, PRIMARIO	G-1175	70059898	AIRE, SECUNDARIO	GA-6129	659387
AGUA	GP-1010Q	4029120	COMBUSTIBLE, SECUNDARIO	G-1176	74371499	ACEITE, DERIVACION (BY PASS)	G-750	40592635
ACEITE, DERIVACION (BY PASS)	G-500	91540	ALLIS CHALMERS			260B, 261B con motor/CASE		
SERIE 65000 DIESEL			MOTOTRAILLA			ACEITE, FLUJO TOTAL (FULL FLOW)	G-33	74395889
ACEITE	G-33	4395889	150C con motor/CASE			HIDRAULICO	G-222	70666421
AGUA	GP-1010Q	4029120	ACEITE	G-33	4395889	ACEITE, SELLADO PARA FLUJO TOTAL (FULL FLOW)	GP-53	70697634
ACEITE, DERIVACION (BY PASS)	G-500	91540	COMBUSTIBLE, SECUNDARIO	G-1173	74056633	AGUA	GP-1011Q	74393504
SERIES 10000 DIESEL			AIRE, PRIMARIO	GA-360	70684733	COMBUSTIBLE, SEPARADOR DE AGUA	GPP-1000	74394407
ACEITE	G-33	4395889	AIRE, SECUNDARIO	GA-361	70662609	AIRE, SECUNDARIO	GA-6127	70197588
COMBUSTIBLE, SECUNDARIO	G-1173	74056633	161 con motor/CUMMINS			AIRE, PRIMARIO	GA-6129	70659387
COMBUSTIBLE, PRIMARIO	G-1174	74055563	ACEITE, FLUJO TOTAL (FULL FLOW)	G-566	70658126	ACEITE, DERIVACION (BY PASS)	G-750	74059343
AGUA	GP-1010Q	4393504	HIDRAULICO	G-222	70664000	260E HASTA S/N 8001 con motor/CASE		
SERIES 11000 DIESEL			COMBUSTIBLE	GPP-14	4006995	ACEITE, FLUJO TOTAL (FULL FLOW)	G-33	74395889
ACEITE	G-33	4395889	ACEITE, SELLADO PARA FLUJO TOTAL (FULL FLOW)	GP-53	70697634	COMBUSTIBLE, SECUNDARIO	G-1176	74056632
COMBUSTIBLE, SECUNDARIO	G-1173	74056633	ACEITE, DERIVACION (BY PASS)	GP-57	73124135	ACEITE, DERIVACION (BY PASS)	G-500	91540
COMBUSTIBLE, PRIMARIO	G-1174	74055563	AGUA, PRE-CHARGE	GP-1011Q	74393504	ACEITE, DERIVACION (BY PASS)	G-750	4059343
AGUA	GP-1010Q	4393504	AGUA, MANTENIMIENTO	GP-2071W	4734562			
SERIES 15000 CASE			AIRE, SECUNDARIO	GA-6127	70197588			
ACEITE	G-33	4395889	AIRE, PRIMARIO	GA-6129	70659387			
COMBUSTIBLE, SECUNDARIO	G-1173	74056633	ACEITE, DERIVACION (BY PASS)	G-750	74059343			
COMBUSTIBLE, PRIMARIO	G-1174	74055563						
AGUA	GP-1010Q	4393504						

MARCA-MODELO-MOTOR	GONHER	OEM	MARCA-MODELO-MOTOR	GONHER	OEM	MARCA-MODELO-MOTOR	GONHER	OEM
MAKE-MODEL-ENGINE	GONHER	OEM	MAKE-MODEL-ENGINE	GONHER	OEM	MAKE-MODEL-ENGINE	GONHER	OEM
ALLIS CHALMERS (continuación)			ALLIS CHALMERS (continuación)			ALLIS CHALMERS (continuación)		
MOTOTRAILLA			MOTOTRAILLA			MOTOTRAILLA		
260E SERIE A con motor/ALLIS CHALMERS 21000 MKII			562 SERIES C con motores/ALLIS CHALMERS 25000, ALLIS CHALMERS 25000 MKII			TS-160 con motores/ALLIS CHALMERS 11000, ALLIS CHALMERS TDS516		
ACEITE	G-33	4395889	TRANSMISION	G-6	4372517	ACEITE	G-6	4372517
COMBUSTIBLE, SECUNDARIO	G-1176	4056632	ACEITE	G-33	4395889	ACEITE	G-33	4395889
AGUA	GP-2071W	4393504	TRANSMISION	G-33	197121	COMBUSTIBLE	G-1173	74056633
AIRE, PRIMARIO	GA-6127	197588	COMBUSTIBLE, SECUNDARIO	G-1176	4056632	COMBUSTIBLE	G-1174	4055563
AIRE, SECUNDARIO	GA-6129	659387	AIRE, SECUNDARIO	GA-6127	197588	ACEITE	G-500	91540
ACEITE, DERIVACION (BY PASS)	G-750	4059343	AIRE, PRIMARIO	GA-6129	659387	TS-260 con motores/ALLIS CHALMERS 16000, ALLIS CHALMERS 19000		
260E SERIES A S/N 8001-UP con motor/CASE			D-560 con motores/ALLIS CHALMERS 21000, ALLIS CHALMERS 25000 C/TURBOCARGADOR			ACEITE		
ACEITE, FLUJO TOTAL (FULL FLOW)	G-33	74395889	ACEITE	G-6	4372517	ACEITE	G-33	4395889
COMBUSTIBLE, SECUNDARIO	G-1176	74056632	TRANSMISION	G-6	4372517	COMBUSTIBLE, SECUNDARIO	G-1176	4056632
AIRE, SECUNDARIO	GA-6127	70197588	ACEITE	G-33	4395889	AIRE	GA-5648	620717
AIRE, PRIMARIO	GA-6129	70659387	TRANSMISION	G-33	197121	ACEITE, DERIVACION (BY PASS)	G-750	40593436
ACEITE, DERIVACION (BY PASS)	G-750	74059343	COMBUSTIBLE, SECUNDARIO	G-1176	4056632	TS-260E con motor/SERIES 8000 EN ADELANTE		
261B con motor/ALLIS CHALMERS 25000 MKII			AIRE			ACEITE		
ACEITE	G-33	4395889	AIRE	GA-6127	197588	COMBUSTIBLE, SECUNDARIO	G-1176	4056632
COMBUSTIBLE, SECUNDARIO	G-1176	4056632	AIRE	GA-6129	659387	ACEITE, DERIVACION (BY PASS)	G-500	91540
AGUA	GP-2071W	4393504	T-260 SERIE A con motor/ALLIS CHALMERS 25000			ACEITE, DERIVACION (BY PASS)	G-750	4059343
AIRE, PRIMARIO	GA-6127	197588	ACEITE	G-33	4395889	TS-360, TW-360 con motores/ALLIS CHALMERS 21000, ALLIS CHALMERS TDS844		
AIRE, SECUNDARIO	GA-6129	659387	COMBUSTIBLE, SECUNDARIO	G-1176	4056632	TRANSMISION	G-6	4372517
ACEITE, DERIVACION (BY PASS)	G-750	40592635	ACEITE, DERIVACION (BY PASS)	G-750	4059343	ACEITE, TURBO	G-6	4372517
262B, 263B con motor/DOS MOTORES CASE			T-260 SERIE A, T-260E SERIE A con motor/ALLIS CHALMERS 21000			ACEITE	G-33	4395889
ACEITE, CARTUCHO PARA FLUJO TOTAL (FULL FLOW) MOTOR FRONTAL	G-33	74395889	ACEITE	G-33	4395889	COMBUSTIBLE, SECUNDARIO	G-1176	4056632
ACEITE, CARTUCHO PARA FLUJO TOTAL (FULL FLOW) MOTOR TRASERO	G-33	74395889	COMBUSTIBLE, SECUNDARIO	G-1176	4056632	ACEITE, TURBO	G-6	4372517
HIDRAULICO	G-222	7066421	ACEITE, DERIVACION (BY PASS)	G-750	4059343	ACEITE	G-33	4395889
ACEITE, SELLADO PARA FLUJO TOTAL (FULL FLOW) MOTOR FRONTAL	GP-53	70697634	T-460, T-560 con motores/ALLIS CHALMERS 21000, ALLIS CHALMERS 25000			COMBUSTIBLE, SECUNDARIO	G-1176	4056632
AGUA	GP-1011Q	74393504	ACEITE	G-6	4372517	AIRE	GA-6127	197588
COMBUSTIBLE, MOTOR TRASERO	GPP-19	74321716	TRANSMISION	G-6	4372517	AIRE	GA-6129	659387
AIRE, SECUNDARIO	GA-6127	70197588	ACEITE	G-33	4395889	TR-160 con motores/ALLIS CHALMERS 11000, ALLIS CHALMERS TDS516		
AIRE, PRIMARIO	GA-6129	70659387	TRANSMISION	G-33	197121	ACEITE, TURBO	G-6	4372517
ACEITE, DERIVACION (BY PASS) MOTOR FRONTAL	G-750	74059343	COMBUSTIBLE, SECUNDARIO	G-1176	4056632	ACEITE	G-33	4395889
440 con motor/CUMMINS 555			AIRE	GA-6127	197588	TRANSMISION	G-33	197121
ACEITE	G-566	70658126	AIRE	GA-6129	659387	COMBUSTIBLE, SECUNDARIO	G-1176	4056632
ACEITE	G-613	173174	TR-200, TS-200, TS-300, TW300 con motor/CUMMINS			COMBUSTIBLE, PRIMARIO	G-1174	4055563
COMBUSTIBLE	GP-110	3300901	ACEITE, FLUJO TOTAL (FULL FLOW)	G-566	70658126	ACEITE, DERIVACION (BY PASS)	G-500	91540
AIRE	GA-361	662609	ACEITE, TURBOCARGADOR	GP-14	152499	145 con motor/ALLIS CHALMERS G226		
ACEITE, DERIVACION (BY PASS)	G-500	91540	COMBUSTIBLE, 5 47/64 IN	GPP-14	4006995	COMBUSTIBLE, SECUNDARIO	G-1173	4056633
460 SERIES CS con motor/DETROIT DIESEL 12V-71			COMBUSTIBLE, 4 11/32 IN	GP-1101	158172	COMBUSTIBLE, PRIMARIO	G-1174	4055563
ACEITE	G-33	197121	ACEITE, SELLADO PARA FLUJO TOTAL (FULL FLOW)	GP-53	70697634	AIRE	GAK-16	243163
AIRE, PRIMARIO	GA-6127	197588	COMBUSTIBLE, 11 1/2 IN	GP-55	73111946	145 con motores/ALLIS CHALMERS 6000, ALLIS CHALMERS 7000, ALLIS CHALMERS AD344		
AIRE, SECUNDARIO	GA-6129	659378	COMBUSTIBLE, SEPARADOR DE AGUA	GPP-11	3308638	ACEITE	G-6	4372517
460, 460 SERIES BS con motores/ALLIS CHALMERS 25000, ALLIS CHALMERS 25000 MKII			AIRE	GA-39	255963	COMBUSTIBLE, SECUNDARIO	G-1173	4056633
ACEITE	G-6	4372517	ACEITE, DERIVACION (BY PASS)	G-750	4059343	COMBUSTIBLE, PRIMARIO	G-1174	4055563
ACEITE	G-33	4395889	TR-200, TW-300, TS-200, TS-300 con motor/BUDA			ACEITE	G-500	4059373
COMBUSTIBLE, SECUNDARIO	G-1176	4056632	COMBUSTIBLE, SECUNDARIO	G-1173	74056633	145T con motor/ALLIS CHALMERS 6000		
ACEITE, PARCIAL	G-750	4059343	TR-260 con motores/ALLIS CHALMERS 16000, ALLIS CHALMERS 19000			ACEITE	G-6	4372517
555, 562 con motor/ALLIS CHALMERS 25000			TR-200, TS-200, TS-300 con motor/CUMMINS			COMBUSTIBLE, SECUNDARIO	G-1173	4056633
TRANSMISION	G-6	4372517	ACEITE, FLUJO TOTAL (FULL FLOW)	G-566	70658126	COMBUSTIBLE, PRIMARIO	G-1174	4055563
ACEITE, TURBO	G-6	4372517	ACEITE, TURBOCARGADOR	GP-14	152499	AIRE	GAK-16	243163
ACEITE	G-33	4395889	COMBUSTIBLE, 5 47/64 IN	GPP-14	4006995	145T con motor/ALLIS CHALMERS G226		
COMBUSTIBLE, SECUNDARIO	G-1176	4056632	COMBUSTIBLE, 4 11/32 IN	GP-1101	158172	COMBUSTIBLE, SECUNDARIO	G-1173	4056633
555, 562 con motor/ALLIS CHALMERS 25000			ACEITE, SELLADO PARA FLUJO TOTAL (FULL FLOW)	GP-53	70697634	COMBUSTIBLE, PRIMARIO	G-1174	4055563
TRANSMISION	G-6	4372517	COMBUSTIBLE, 11 1/2 IN	GP-55	73111946	ACEITE	G-500	4059373
ACEITE, TURBO	G-6	4372517	COMBUSTIBLE, SEPARADOR DE AGUA	GPP-11	3308638	145T con motor/ALLIS CHALMERS 6000		
ACEITE	G-33	4395889	AIRE	GA-39	255963	ACEITE	G-6	4372517
COMBUSTIBLE, SECUNDARIO	G-1176	4056632	ACEITE, DERIVACION (BY PASS)	G-750	4059343	COMBUSTIBLE, SECUNDARIO	G-1173	4056633
555, 562 con motor/ALLIS CHALMERS 25000			TR-200, TW-300, TS-200, TS-300 con motor/BUDA			COMBUSTIBLE, PRIMARIO	G-1174	4055563
TRANSMISION	G-6	4372517	COMBUSTIBLE, SECUNDARIO	G-1173	74056633	145T con motor/ALLIS CHALMERS G226		
ACEITE, TURBO	G-6	4372517	TR-260 con motores/ALLIS CHALMERS 16000, ALLIS CHALMERS 19000			COMBUSTIBLE, SECUNDARIO	G-1173	4056633
ACEITE	G-33	4395889	TR-260 con motores/ALLIS CHALMERS 16000, ALLIS CHALMERS 19000	TR-200, TS-200, TS-300 con motor/CUMMINS			COMBUSTIBLE, PRIMARIO	G-1174
COMBUSTIBLE, SECUNDARIO	G-1176	4056632	ACEITE	G-33	4395889	ACEITE, FLUJO TOTAL (FULL FLOW)	G-566	70658126
555, 562 con motor/ALLIS CHALMERS 25000			COMBUSTIBLE, SECUNDARIO	G-1176	4056632	ACEITE, TURBOCARGADOR	GP-14	152499
TRANSMISION	G-6	4372517	ACEITE, DERIVACION (BY PASS)	G-750	4059343	COMBUSTIBLE, 5 47/64 IN	GPP-14	4006995
ACEITE, TURBO	G-6	4372517	TR-200, TW-300, TS-200, TS-300 con motor/BUDA			COMBUSTIBLE, 4 11/32 IN	GP-1101	158172
ACEITE	G-33	4395889	COMBUSTIBLE, SECUNDARIO	G-1173	74056633	ACEITE, SELLADO PARA FLUJO TOTAL (FULL FLOW)	GP-53	70697634
COMBUSTIBLE, SECUNDARIO	G-1176	4056632	TR-260 con motores/ALLIS CHALMERS 16000, ALLIS CHALMERS 19000			COMBUSTIBLE, 11 1/2 IN	GP-55	73111946
555, 562 con motor/ALLIS CHALMERS 25000			TR-200, TS-200, TS-300 con motor/CUMMINS			COMBUSTIBLE, SEPARADOR DE AGUA	GPP-11	3308638
TRANSMISION	G-6	4372517	ACEITE, FLUJO TOTAL (FULL FLOW)	G-566	70658126	AIRE	GA-39	255963
ACEITE, TURBO	G-6	4372517	ACEITE, TURBOCARGADOR	GP-14	152499	ACEITE, DERIVACION (BY PASS)	G-750	4059343
ACEITE	G-33	4395889	COMBUSTIBLE, 5 47/64 IN	GPP-14	4006995	145T con motor/ALLIS CHALMERS 6000		
COMBUSTIBLE, SECUNDARIO	G-1176	4056632	COMBUSTIBLE, 4 11/32 IN	GP-1101	158172	ACEITE	G-6	4372517
555, 562 con motor/ALLIS CHALMERS 25000			ACEITE, SELLADO PARA FLUJO TOTAL (FULL FLOW)	GP-53	70697634	COMBUSTIBLE, SECUNDARIO	G-1173	4056633
TRANSMISION	G-6	4372517	COMBUSTIBLE, 11 1/2 IN	GP-55	73111946	COMBUSTIBLE, PRIMARIO	G-1174	4055563
ACEITE, TURBO	G-6	4372517	COMBUSTIBLE, SEPARADOR DE AGUA	GPP-11	3308638	ACEITE	G-500	4059373
ACEITE	G-33	4395889	AIRE	GA-39	255963	145T con motor/ALLIS CHALMERS G226		
COMBUSTIBLE, SECUNDARIO	G-1176	4056632	ACEITE, DERIVACION (BY PASS)	G-750	4059343	COMBUSTIBLE, SECUNDARIO	G-1173	4056633
555, 562 con motor/ALLIS CHALMERS 25000			TR-200, TW-300, TS-200, TS-300 con motor/BUDA			COMBUSTIBLE, PRIMARIO	G-1174	4055563
TRANSMISION	G-6	4372517	COMBUSTIBLE, SECUNDARIO	G-1173	74056633	AIRE	GAK-16	243163
ACEITE, TURBO	G-6	4372517	TR-260 con motores/ALLIS CHALMERS 16000, ALLIS CHALMERS 19000			145T con motor/ALLIS CHALMERS 6000		
ACEITE	G-33	4395889	TR-260 con motores/ALLIS CHALMERS 16000, ALLIS CHALMERS 19000	TR-200, TS-200, TS-300 con motor/CUMMINS			ACEITE	G-6
COMBUSTIBLE, SECUNDARIO	G-1176	4056632	ACEITE	G-33	4395889	ACEITE, FLUJO TOTAL (FULL FLOW)	G-566	70658126
555, 562 con motor/ALLIS CHALMERS 25000			COMBUSTIBLE, SECUNDARIO	G-1176	4056632	ACEITE, TURBOCARGADOR	GP-14	152499
TRANSMISION	G-6	4372517	ACEITE, DERIVACION (BY PASS)	G-750	4059343	COMBUSTIBLE, 5 47/64 IN	GPP-14	4006995
ACEITE, TURBO	G-6	4372517	TR-200, TW-300, TS-200, TS-300 con motor/BUDA			COMBUSTIBLE, 4 11/32 IN	GP-1101	158172
ACEITE	G-33	4395889	COMBUSTIBLE, SECUNDARIO	G-1173	74056633	ACEITE, SELLADO PARA FLUJO TOTAL (FULL FLOW)	GP-53	70697634
COMBUSTIBLE, SECUNDARIO	G-1176	4056632	TR-260 con motores/ALLIS CHALMERS 16000, ALLIS CHALMERS 19000			COMBUSTIBLE, 11 1/2 IN	GP-55	73111946
555, 562 con motor/ALLIS CHALMERS 25000			TR-200, TS-200, TS-300 con motor/CUMMINS			COMBUSTIBLE, SEPARADOR DE AGUA	GPP-11	3308638
TRANSMISION	G-6	4372517	ACEITE, FLUJO TOTAL (FULL FLOW)	G-566	70658126	AIRE	GA-39	255963
ACEITE, TURBO	G-6	4372517	ACEITE, TURBOCARGADOR	GP-14	152499	ACEITE, DERIVACION (BY PASS)	G-750	4059343
ACEITE	G-33	4395889	COMBUSTIBLE, 5 47/64 IN	GPP-14	4006995	145T con motor/ALLIS CHALMERS 6000		
COMBUSTIBLE, SECUNDARIO	G-1176	4056632	COMBUSTIBLE, 4 11/32 IN	GP-1101	158172	ACEITE	G-6	4372517
555, 562 con motor/ALLIS CHALMERS 25000			ACEITE, SELLADO PARA FLUJO TOTAL (FULL FLOW)	GP-53	70697634	COMBUSTIBLE, SECUNDARIO	G-1173	4056633
TRANSMISION	G-6	4372517	COMBUSTIBLE, 11 1/2 IN	GP-55	73111946	COMBUSTIBLE, PRIMARIO	G-1174	4055563
ACEITE, TURBO	G-6	4372517	COMBUSTIBLE, SEPARADOR DE AGUA	GPP-11	3308638	ACEITE	G-500	4059373
ACEITE	G-33	4395889	AIRE	GA-39	255963	145T con motor/ALLIS CHALMERS G226		
COMBUSTIBLE, SECUNDARIO	G-1176	4056632	ACEITE, DERIVACION (BY PASS)	G-750	4059343	COMBUSTIBLE, SECUNDARIO	G-1173	4056633
555, 562 con motor/ALLIS CHALMERS 25000			TR-200, TW-300, TS-200, TS-300 con motor/BUDA			COMBUSTIBLE, PRIMARIO	G-1174	4055563
TRANSMISION	G-6	4372517	COMBUSTIBLE, SECUNDARIO	G-1173	74056633	AIRE	GAK-16	243163
ACEITE, TURBO	G-6	4372517	TR-260 con motores/ALLIS CHALMERS 16000, ALLIS CHALMERS 19000			145T con motor/ALLIS CHALMERS 6000		
ACEITE	G-33	4395889	TR-260 con motores/ALLIS CHALMERS 16000, ALLIS CHALMERS 19000	TR-200, TS-200, TS-300 con motor/CUMMINS			ACEITE	G-6
COMBUSTIBLE, SECUNDARIO	G-1176	4056632	ACEITE	G-33	4395889	ACEITE, FLUJO TOTAL (FULL FLOW)	G-566	70658126
555, 562 con motor/ALLIS CHALMERS 25000			COMBUSTIBLE, SECUNDARIO	G-1176	4056632	ACEITE, TURBOCARGADOR	GP-14	152499
TRANSMISION	G-6	4372517	ACEITE, DERIVACION (BY PASS)	G-750	4059343	COMBUSTIBLE, 5 47/64 IN	GPP-14	4006995
ACEITE, TURBO	G-6	4372517	TR-200, TW-300, TS-200, TS-300 con motor/BUDA			COMBUSTIBLE, 4 11/32 IN	GP-1101	158172
ACEITE	G-33	4395889	COMBUSTIBLE, SECUNDARIO	G-1173	74056633	ACEITE, SELLADO PARA FLUJO TOTAL (FULL FLOW)	GP-53	70697634
COMBUSTIBLE, SECUNDARIO	G-1176	4056632	TR-260 con motores/ALLIS CHALMERS 16000, ALLIS CHALMERS 19000			COMBUSTIBLE, 11 1/2 IN	GP-55	73111946
555, 562 con motor/ALLIS CHALMERS 25000			TR-200, TS-200, TS-300 con motor/CUMMINS			COMBUSTIBLE, SEPARADOR DE AGUA	GPP-1	

MARCA-MODELO-MOTOR MAKE-MODEL-ENGINE	GONHER GONHER	OEM OEM	MARCA-MODELO-MOTOR MAKE-MODEL-ENGINE	GONHER GONHER	OEM OEM	MARCA-MODELO-MOTOR MAKE-MODEL-ENGINE	GONHER GONHER	OEM OEM
ALLIS CHALMERS (continuación)			ALLIS CHALMERS (continuación)			ALLIS CHALMERS (continuación)		
NIVELADORAS			NIVELADORAS			NIVELADORAS		
145T con motores/ALLIS CHALMERS 7000, ALLIS CHALMERS AD344			260E HASTA S/N 8001 con motor/CASE			D-30 PALA con motor/ALLIS CHALMERS 11000		
ACEITE	G-6	4372517	ACEITE, FLUJO TOTAL (FULL FLOW)	G-33	74395889	ACEITE	G-33	4395889
COMBUSTIBLE, SECUNDARIO	G-1173	4056633	COMBUSTIBLE, SECUNDARIO	G-1176	74056632	TRANSMISION	G-33	4395889
COMBUSTIBLE, PRIMARIO	G-1174	4055563	ACEITE, DERIVACION (BY PASS)	G-500	91540	COMBUSTIBLE, SECUNDARIO	G-1173	4056633
ACEITE	G-500	4059373	ACEITE, DERIVACION (BY PASS)	G-750	4059343	COMBUSTIBLE, PRIMARIO	G-1174	4055563
150C con motor/CASE			260E SERIES A S/N 8001-UP con motor/CASE			DD con motores/ALLIS CHALMERS D230, ALLIS CHALMERS D262		
ACEITE	G-33	4395889	ACEITE, FLUJO TOTAL (FULL FLOW)	G-33	74395889	COMBUSTIBLE, SECUNDARIO	G-1173	74056633
COMBUSTIBLE, SECUNDARIO	G-1173	74056633	COMBUSTIBLE, SECUNDARIO	G-1176	74056632	M-100 con motores/ALLIS CHALMERS 10000, ALLIS CHALMERS 11000		
AIRE, PRIMARIO	GA-360	70684733	AIRE, SECUNDARIO	GA-6127	70197588	ACEITE	G-33	4395889
AIRE, SECUNDARIO	GA-361	70662609	AIRE, PRIMARIO	GA-6129	70659387	COMBUSTIBLE, SECUNDARIO	G-1173	74056633
150-C, 200-C con motor/ALLIS CHALMERS 11000 MKII			ACEITE, DERIVACION (BY PASS)			COMBUSTIBLE, PRIMARIO		
ACEITE	G-33	4395889	262B, 263B con motor/DOS MOTORES CASE			AIRE, PRIMARIO	GA-360	684733
AIRE, PRIMARIO	GA-360	684733	ACEITE, CARTUCHO PARA FLUJO TOTAL (FULL FLOW) MOTOR FRONTAL	G-33	74395889	AIRE, SECUNDARIO	GA-361	662609
AIRE, SECUNDARIO	GA-361	662609	ACEITE, CARTUCHO PARA FLUJO TOTAL (FULL FLOW) MOTOR TRASERO	G-33	74395889	ACEITE, DERIVACION (BY PASS)	G-750	4059343
ACEITE, DERIVACION (BY PASS)	G-750	4059343	HIDRAULICO	G-222	7066421	M-100 SERIES B con motores/ALLIS CHALMERS 10000, ALLIS CHALMERS 11000		
161 con motor/CUMMINS			ACEITE, SELLADO PARA FLUJO TOTAL (FULL FLOW) MOTOR FRONTAL			ACEITE	G-6	4372517
ACEITE, FLUJO TOTAL (FULL FLOW)	G-566	70658126	AGUA	GP-1011Q	74393504	ACEITE	G-33	4395889
HIDRAULICO	G-222	70664000	COMBUSTIBLE, MOTOR TRASERO	GPP-19	74321716	COMBUSTIBLE, SECUNDARIO	G-1173	74056633
COMBUSTIBLE	GPP-14	4006995	AIRE, SECUNDARIO	GA-6127	70197588	COMBUSTIBLE, PRIMARIO	G-1174	74055563
ACEITE, SELLADO PARA FLUJO TOTAL (FULL FLOW)	GP-53	70697634	AIRE, PRIMARIO	GA-6129	70659387	M-60 con motor/CASE		
ACEITE, DERIVACION (BY PASS)	GP-57	73124135	ACEITE, DERIVACION (BY PASS) MOTOR FRONTAL	G-750	74059343	COMBUSTIBLE, SECUNDARIO	G-1173	4056633
AGUA, PRE-CHARGE	GP-1011Q	74393504	440 con motor/CUMMINS 555			M-65 con motor/ALLIS CHALMERS D262		
AGUA, MANTENIMIENTO	GP-2071W	4734562	ACEITE	G-566	70658126	ACEITE	GP-1	45116290
AIRE, SECUNDARIO	GA-6127	70197588	ACEITE	G-613	173174	M-65 con motor/ALLIS CHALMERS G226		
AIRE, PRIMARIO	GA-6129	70659387	COMBUSTIBLE	GP-110	3300901	COMBUSTIBLE, SECUNDARIO	G-1173	74056633
ACEITE, DERIVACION (BY PASS)	G-750	74059343	AIRE	GA-361	662609	COMBUSTIBLE, PRIMARIO	G-1174	74055563
260 con motores/ALLIS CHALMERS 16000, ALLIS CHALMERS 19000			ACEITE, DERIVACION (BY PASS)			ACEITE		
ACEITE, FLUJO TOTAL (FULL FLOW)	G-33	74395889	45 con motores/ALLIS CHALMERS 10000, ALLIS CHALMERS AD5516			HIDRAULICO	GP-1	45116290
COMBUSTIBLE, SECUNDARIO	G-1176	74056632	TRANSMISION	G-6	4372517	AIRE	GAK-16	243163
AIRE	GA-5648	70620717	ACEITE	G-33	4395889	M-70 con motor/ALLIS CHALMERS 7000		
ACEITE, DERIVACION (BY PASS)	G-500	70091540	COMBUSTIBLE, SECUNDARIO	G-1173	4056633	ACEITE	G-6	4372517
ACEITE, DERIVACION (BY PASS)	G-750	74059343	COMBUSTIBLE, PRIMARIO	G-1174	4055563	COMBUSTIBLE, SECUNDARIO	G-1173	4056633
260 HASTA S/N 4001 con motor/CASE			ACEITE, DERIVACION (BY PASS)			COMBUSTIBLE, PRIMARIO		
ACEITE, FLUJO TOTAL (FULL FLOW)	G-33	74395889	555 PALA con motores/ALLIS CHALMERS 21000, ALLIS CHALMERS 25000			TR160, TS160 con motores/ALLIS CHALMERS 11000, ALLIS CHALMERS TD5516		
COMBUSTIBLE, SECUNDARIO	G-1176	74056632	ACEITE, TURBO	G-6	4372517	ACEITE, FLUJO TOTAL (FULL FLOW)	G-33	4395889
ACEITE, DERIVACION (BY PASS)	G-500	70091540	ACEITE	G-33	4395889	COMBUSTIBLE, SECUNDARIO	G-1173	74056633
260A con motor/CASE			COMBUSTIBLE, SECUNDARIO			ACEITE, DERIVACION (BY PASS)	G-500	91540
ACEITE, FLUJO TOTAL (FULL FLOW)	G-33	74395889	AD, AD-3, AD-4 con motor/CASE			TR200, TW300, TS200, TS-300 con motor/BUDA		
COMBUSTIBLE, SECUNDARIO	G-1176	4056632	COMBUSTIBLE, SECUNDARIO	G-1176	4056632	COMBUSTIBLE, SECUNDARIO		
AGUA	GP-1011Q	74393504	AD-30, AD-40 con motor/CASE			TR200, TW300, TS200, TS300 con motor/CUMMINS		
AIRE, SECUNDARIO	GA-6127	70197588	ACEITE	G-33	4395889	ACEITE, FLUJO TOTAL (FULL FLOW)	G-566	70658126
AIRE, PRIMARIO	GA-6129	70659387	COMBUSTIBLE, SECUNDARIO	G-1173	74056633	ACEITE, TURBOCARGADOR	GP-14	152499
ACEITE, DERIVACION (BY PASS)	G-750	4059343	ACEITE	G-500	91540	COMBUSTIBLE, 5 47/64 IN	GPP-14	4006995
260B, 261B con motor/CASE			BD-3 con motor/CASE			COMBUSTIBLE, 4 11/32 IN	GP-1101	158172
ACEITE, FLUJO TOTAL (FULL FLOW)	G-33	74395889	ACEITE	G-33	4395889	ACEITE, SELLADO PARA FLUJO TOTAL (FULL FLOW)	GP-53	70697634
HIDRAULICO	G-222	70666421	COMBUSTIBLE, SECUNDARIO	G-1173	74056633	COMBUSTIBLE, 11 1/2 IN	GP-55	73111946
ACEITE, SELLADO PARA FLUJO TOTAL (FULL FLOW)	GP-53	70697634	ACEITE	G-500	91540	COMBUSTIBLE, SEPARADOR DE AGUA	GPP-11	3308638
AGUA	GP-1011Q	74393504	D SPEED PATROL, W SPEED PATROL con motor/ALLIS CHALMERS G226			AIRE	GA-39	255963
COMBUSTIBLE, SEPARADOR DE AGUA	GPP-1000	74394407	ACEITE	GP-1	45116290	ACEITE, DERIVACION (BY PASS)	G-750	4059343
AIRE, SECUNDARIO	GA-6127	70197588						
AIRE, PRIMARIO	GA-6129	70659387						
ACEITE, DERIVACION (BY PASS)	G-750	74059343						

MARCA-MODELO-MOTOR MAKE-MODEL-ENGINE	GONHER GONHER	OEM OEM	MARCA-MODELO-MOTOR MAKE-MODEL-ENGINE	GONHER GONHER	OEM OEM	MARCA-MODELO-MOTOR MAKE-MODEL-ENGINE	GONHER GONHER	OEM OEM
ALLIS CHALMERS (continuación)			ALLIS CHALMERS (continuación)			ALLIS CHALMERS (continuación)		
NIVELADORAS			PISCADORAS DE ALGODÓN			TRACTORES		
TS360, TW360 con motor/ALLIS CHALMERS 21000			945 con motor/CASE			AIRE	GAK-16	243163
ACEITE	G-33	4395889	ACEITE	G-33	4395889	190 con motor/ALLIS CHALMERS D2800		
ALLIS CHALMERS			AGUA	GP-1010Q	4393504	HIDRAULICO	GP-5	239930
PISCADORAS DE ALGODÓN			AIRE, PRIMARIO	GA-6127	197588	190 con motor/ALLIS CHALMERS D2900		
616 con motores/ALLIS CHALMERS G226, ALLIS CHALMERS G262			AIRE, SECUNDARIO	GA-6129	659387	HIDRAULICO	GP-5	239930
ACEITE	GP-1	45116290	ACEITE, PARCIAL	G-750	4059343	190 con motores/ALLIS CHALMERS G2500, ALLIS CHALMERS G2800		
622 con motor/ALLIS CHALMERS 622			R, SUPER 100SP con motor/CASE			HIDRAULICO	GP-5	239930
ACEITE	GP-1	4511629	ACEITE	GP-1	45116290	190XT con motor/ALLIS CHALMERS D2800		
622 con motores/ALLIS CHALMERS G226, ALLIS CHALMERS G262			ALLIS CHALMERS			HIDRAULICO	GP-5	239930
ACEITE	GP-1	45116290	TRACTORES			190XT con motor/ALLIS CHALMERS D2900		
707 con motor/A GASOLINA			11 SERIES B SOBRE ORUGAS con motor/A DIESEL			HIDRAULICO	GP-5	239930
COMBUSTIBLE	G-295	4024232	ACEITE, FLUJO TOTAL (FULL FLOW)	G-33	4395889	190XT con motores/ALLIS CHALMERS G2500, ALLIS CHALMERS G2800		
707 con motor/CASE			AGUA, PRE-CHARGE	GP-1011Q	74393504	HIDRAULICO	GP-5	239930
ACEITE	GP-1	45116290	AGUA, MANTENIMIENTO	GP-2071W	4393504	190XT SERIE III con motor/ALLIS CHALMERS D2800		
707XTB con motor/A GASOLINA			AIRE, CUMMINS	GA-106	684734	HIDRAULICO	GP-5	239930
COMBUSTIBLE	G-295	4024232	AIRE, KOMATSU	GA-326	684734	190XT SERIE III con motor/ALLIS CHALMERS D2900		
707XTB con motor/CASE			AIRE	GA-206	662477	HIDRAULICO	GP-5	239930
ACEITE	GP-1	45116290	ACEITE, DERIVACION (BY PASS)	G-750	4059343	190XT SERIE III con motor/ALLIS CHALMERS D2900		
801 con motor/A GASOLINA			12G SERIES B SOBRE ORUGAS, 12G SOBRE ORUGAS con motor/ ALLIS CHALMERS 11000			HIDRAULICO	GP-5	239930
COMBUSTIBLE	G-295	4024232	ACEITE	G-33	4395889	190XT SERIE III con motores/ALLIS CHALMERS G2500, ALLIS CHALMERS G2800		
801 con motor/CASE			AIRE, PRIMARIO PARA CUMMINS	GA-106	684734	HIDRAULICO	GP-5	239930
ACEITE	GP-1	45116290	AIRE, PRIMARIO PARA KOMATSU	GA-326	684734	200 con motor/ALLIS CHALMERS 2900		
802 con motor/A GASOLINA			AIRE, SECUNDARIO	GA-361	662609	HIDRAULICO	GP-5	239930
COMBUSTIBLE	G-295	4024232	160 con motor/CASE			210 con motor/ALLIS CHALMERS 2900		
801 con motor/CASE			ACEITE	G-813	20802054	HIDRAULICO	GP-5	239930
ACEITE	GP-1	45116290	COMBUSTIBLE	G-296	2513976	21B SOBRE ORUGAS con motor/CASE		
802 con motor/A GASOLINA			COMBUSTIBLE	G-296-B	2513976	ACEITE, FLUJO TOTAL (FULL FLOW)	G-33	74395889
COMBUSTIBLE	G-295	4024232	AIRE	GAK-16	243163	COMBUSTIBLE, SECUNDARIO	G-1176	74056632
801 con motor/CASE			1600 con motor/CASE			AIRE, SECUNDARIO	GA-6127	70197588
ACEITE	GP-1	45116290	ACEITE	GP-1	232578	ACEITE, DERIVACION (BY PASS)	G-750	4059343
802 con motor/CASE			1600D con motor/CASE			21C SOBRE ORUGAS con motor/ALLIS CHALMERS 21000 MKII		
ACEITE	GP-1	45116290	ACEITE	GP-50	4512207	ACEITE, FLUJO TOTAL (FULL FLOW)	G-33	74395889
860 con motor/A GASOLINA			16B SOBRE ORUGAS con motor/ALLIS CHALMERS 17000 MKII			HIDRAULICO	G-222	70664000
HIDRAULICO	GP-5	239930	ACEITE, FLUJO TOTAL (FULL FLOW)	G-33	74395889	AGUA, PRE-CHARGE	GP-1011Q	74393504
COMBUSTIBLE	G-295	4024232	170, 175 con motor/A GASOLINA			AGUA, MANTENIMIENTO	GP-2071W	4734562
ACEITE	GP-390	40235483	ACEITE	GP-1	2513810	ACEITE, DERIVACION (BY PASS)	G-750	4059343
AIRE	GAK-403	3046858	HIDRAULICO	GP-5	239930	220 con motor/CASE		
860 con motor/CASE			ACEITE, DERIVACION (BY PASS)	GP-50	45122074	HIDRAULICO	GP-5	239930
HIDRAULICO	GP-5	234774	AIRE	GAK-16	243163	31 SOBRE ORUGAS con motor/CUMMINS		
COMBUSTIBLE	G-295	4024232	170, 175 con motor/CASE			ACEITE, FLUJO TOTAL (FULL FLOW)	G-566	70658126
ACEITE	GP-390	40235483	ACEITE	G-813	20802054	HIDRAULICO	G-222	70664000
AIRE	GAK-403	3046858	ACEITE	GP-1	2513810	COMBUSTIBLE	GPP-14	4006995
860XTB con motores/A GASOLINA, CASE			HIDRAULICO	GP-5	239930	ACEITE, SELLADO PARA FLUJO TOTAL (FULL FLOW)	GP-53	70697634
HIDRAULICO	GP-5	239930	ACEITE, DERIVACION (BY PASS)	GP-50	45122074	AGUA	GP-1011Q	74393504
COMBUSTIBLE	G-295	4024232	AIRE	GAK-16	243163	ACEITE, DERIVACION (BY PASS)	G-750	4059343
ACEITE	GP-390	40235483	180, 185 con motor/CASE					
AIRE	GAK-403	3046858	HIDRAULICO	GP-5	239930			
880 con motor/CASE			COMBUSTIBLE	G-295	4024232			
AIRE	GAK-403	740090782						
940 con motor/ALLIS CHALMERS 2900								
COMBUSTIBLE	G-295	40242323						

SERVICIO PESADO

MARCA-MODELO-MOTOR MAKE-MODEL-ENGINE	GONHER GONHER	OEM OEM	MARCA-MODELO-MOTOR MAKE-MODEL-ENGINE	GONHER GONHER	OEM OEM	MARCA-MODELO-MOTOR MAKE-MODEL-ENGINE	GONHER GONHER	OEM OEM
ALLIS CHALMERS (continuación)			ALLIS CHALMERS (continuación)			ALLIS CHALMERS (continuación)		
TRACTORES			TRACTORES			TRACTORES		
41 SOBRE ORUGAS con motor/CUMMINS V12			COMBUSTIBLE	GPP-1000	4394407	8 SOBRE ORUGAS, 8B SOBRE ORUGAS con motor/CASE		
ACEITE, FLUJO TOTAL (FULL FLOW)	G-566	70658126	AIRE	GAK-625	266787	COMBUSTIBLE	G-296	2513976
COMBUSTIBLE	G-1143	70658128	650 con motor/CASE			8010 con motor/ALLIS CHALMERS 649T		
HIDRAULICO	G-222	70664000	HIDRAULICO	GP-5	234774	ACEITE	GP-390	40235483
AGUA	GP-2071W	4393504	652 con motor/CASE			8550 con motor/ALLIS CHALMERS 6120T		
ACEITE, DERIVACION (BY PASS)	G-750	4059343	HIDRAULICO	GP-5	234774	ACEITE	GP-1	4511629
41B SOBRE ORUGAS con motor/CUMMINS VT1710C			655 con motor/CASE			COMBUSTIBLE	GPP-1000	4394407
ACEITE, FLUJO TOTAL (FULL FLOW)	G-566	70658126	HIDRAULICO	GP-5	234774	ACEITE, PARCIAL	G-750	4059343
COMBUSTIBLE	G-1143	70658128	670T con motor/CASE			920 con motor/CASE		
HIDRAULICO	G-222	70664000	COMBUSTIBLE	GPP-1000	4394407	HIDRAULICO	GP-3816	1650954
COMBUSTIBLE	GP-55	73111946	7000 con motor/ALLIS CHALMERS HD7G			D-10, D-12, D-12 SERIES 3 con motor/ALLIS CHALMERS G138		
AGUA	GP-2071W	4393504	COMBUSTIBLE, SECUNDARIO	G-1173	4056633	HIDRAULICO	GP-1	237000
ACEITE, DERIVACION (BY PASS)	G-750	7409343	7000 con motores/ALLIS CHALMERS 2900, ALLIS CHALMERS 6301TB			D-14, D-15, D-15 SERIE III con motor/ALLIS CHALMERS G149		
440 con motor/CUMMINS			COMBUSTIBLE	G-295	4024232	HIDRAULICO	GP-5	239930
AIRE, PRIMARIO	GA-360	684733	7010, 7020 con motor/ALLIS CHALMERS 6491			ACEITE, DERIVACION (BY PASS)	GP-50	4512207
4W-220 con motor/CASE			COMBUSTIBLE	G-295	4024232	AIRE, SIN ASPAS	GA-33	239518
ACEITE, DERIVACION (BY PASS)	GP-51	74036791	7030, 7040 con motor/ALLIS CHALMERS 3500 MKII			D-15 SERIE IV con motor/ALLIS CHALMERS G149		
COMBUSTIBLE	GP-1107	74036711	HIDRAULICO	GP-5	239930	ACEITE	GP-1	4511629
ACEITE	GP-390	4035556	COMBUSTIBLE	G-295	4024232	HIDRAULICO	GP-5	239930
COMBUSTIBLE	GPP-1000	4394407	AIRE	GAK-625	266787	AIRE, SIN ASPAS	GA-33	239518
AIRE, SECUNDARIO	GA-827	70264740	7045 con motor/ALLIS CHALMERS 3500 MKII			D-15D con motor/ALLIS CHALMERS D175		
4W-305 con motor/CASE			COMBUSTIBLE	G-295	4024232	HIDRAULICO	GP-5	239930
ACEITE	GP-53	4396645	7050 con motor/ALLIS CHALMERS 3500 MKII			D-17 con motor/ALLIS CHALMERS G226		
COMBUSTIBLE	GPP-1000	4394407	AIRE	GAK-625	266787	HIDRAULICO	GP-5	239930
AIRE	GA-758	70259792	7050 con motor/ALLIS CHALMERS 3700			ACEITE	GP-50	4512207
5010 con motor/CASE			COMBUSTIBLE	G-295	4024232	AIRE, PRIMARIO	GA-18	237395
AIRE, SIN ASPAS	GA-33	2097035	7060 con motor/ALLIS CHALMERS 3500 MKII			D-17 con motor/ALLIS CHALMERS W226		
5020 con motor/ALLIS CHALMERS S126			AIRE	GAK-625	266787	HIDRAULICO	GP-5	239930
AIRE, SIN ASPAS	GA-33	2097035	7060 con motor/ALLIS CHALMERS 3700			D-17 SERIE III, D-17 SERIE IV con motor/ALLIS CHALMERS G226 LPG		
5030 con motor/ALLIS CHALMERS S148			COMBUSTIBLE	G-295	4024232	ACEITE	GP-1	4511629
AIRE, SIN ASPAS	GA-33	2097035	7080 con motor/ALLIS CHALMERS 3500 MKII			HIDRAULICO	GP-5	239930
5040 con motor/FIAT D115			COMBUSTIBLE	G-295	4024232	AIRE, PRIMARIO	GA-18	237395
ACEITE	G-813	20802054	7080 con motor/ALLIS CHALMERS 3750			D-17D con motor/ALLIS CHALMERS D262		
COMBUSTIBLE	G-296	26560017	COMBUSTIBLE	G-295	4024232	HIDRAULICO	GP-5	239930
COMBUSTIBLE	G-296-B	26560017	7085, 7110 con motor/CASE			D-19 con motor/ALLIS CHALMERS G262		
AIRE, SIN ASPAS	GA-33	4372517	AIRE, PRIMARIO	GAK-458	4319257	ACEITE	GP-1	4511629
5050 con motor/PERKINS 3.158			7120, 7145 con motor/CASE			HIDRAULICO	GP-1	4511629
COMBUSTIBLE	G-296	26560017	ACEITE	GP-77	1174420	HIDRAULICO	GP-5	239930
COMBUSTIBLE	G-296-B	26560017	7580 con motor/ALLIS CHALMERS 3750			D-19D con motor/ALLIS CHALMERS D262T		
AIRE	GAK-16	4996245	COMBUSTIBLE	G-295	4024232	HIDRAULICO	GP-1	239930
6040 con motor/PERKINS 3.158			7G SERIES B SOBRE ORUGAS con motor/ALLIS CHALMERS 3500			D-21D con motores/ALLIS CHALMERS 3400, ALLIS CHALMERS 3500		
ACEITE	G-813	20802054	AGUA	GP-2071W	4393504	HIDRAULICO	GP-5	239930
COMBUSTIBLE	G-296	251397	7G SOBRE ORUGAS con motor/ALLIS CHALMERS 7000			D-30 con motor/ALLIS CHALMERS 11000		
COMBUSTIBLE	G-296-B	251397	COMBUSTIBLE	G-295	4024232	ACEITE	G-33	4395889
AIRE	GAK-16	243163	7G SERIES B SOBRE ORUGAS con motor/ALLIS CHALMERS 3500			TRANSMISION	G-33	4395889
6120T con motor/CASE			AGUA	GP-2071W	4393504	COMBUSTIBLE, SECUNDARIO	G-1173	4056633
ACEITE	G-33	4395889	7G SOBRE ORUGAS con motor/ALLIS CHALMERS 7000			COMBUSTIBLE, PRIMARIO	G-1174	74055563
6140 con motor/NISSAN			COMBUSTIBLE, SECUNDARIO	G-1173	74056633	FD14E SOBRE ORUGAS con motor/CASE		
COMBUSTIBLE	G-296	2513976				AGUA	GP-2071W	4393504
6491 con motor/CASE								
ACEITE	GP-390	4035556						

APLICACIONES SERVICIO PESADO
HEAVY DUTY APPLICATIONS



MARCA-MODELO-MOTOR MAKE-MODEL-ENGINE	GONHER GONHER	OEM OEM	MARCA-MODELO-MOTOR MAKE-MODEL-ENGINE	GONHER GONHER	OEM OEM	MARCA-MODELO-MOTOR MAKE-MODEL-ENGINE	GONHER GONHER	OEM OEM
ALLIS CHALMERS (continuación)			ALLIS CHALMERS (continuación)			ALLIS CHALMERS (continuación)		
TRACTORES			TRACTORES			TRACTORES		
AIRE, PRIMARIO	GA-360	684733	ACEITE, DERIVACION (BY PASS)	GP-50	4512207	HD11AG SOBRE ORUGAS con motor/CASE		
AIRE, SECUNDARIO	GA-361	662609				ACEITE, FLUJO TOTAL (FULL FLOW)	G-33	4395889
FD20 SOBRE ORUGAS con motor/FIAT 8215			H3 SOBRE ORUGAS con motor/ALLIS CHALMERS G149			AIRE, PRIMARIO PARA CUMMINS S/N 13368 EN ADELANTE	GA-106	684734
AGUA	GP-2071W	4734562	ACEITE	GP-1	45116290	AIRE, PRIMARIO (S/N 1338 EN ADELANTE) SIN TUBO	GA-360	684733
AIRE, PRIMARIO PARA CUMMINS	GA-106	79043780	H3, H3 SOBRE ORUGAS con motor/ALLIS CHALMERS D160			AIRE, PRIMARIO PARA KOMATSU S/N 13368 EN ADELANTE CON TURBO	GA-326	684734
AIRE, PRIMARIO PARA KOMATSU	GA-326	79043780	ACEITE	G-813	20802054	AIRE, SECUNDARIO S/N 13368 EN ADELANTE CON TURBO	GA-206	662477
AIRE, SECUNDARIO	GA-206	70662477	HIDRAULICO	GP-5	239930	AIRE, SECUNDARIO S/N 13368 EN ADELANTE SIN TURBO	GA-361	662609
FD30 SOBRE ORUGAS con motor/CASE			COMBUSTIBLE	G-296	2513976			
HIDRAULICO	G-222	70664000	COMBUSTIBLE	G-296-B	2513976			
FD30B SOBRE ORUGAS con motor/CUMMINS			H4 SOBRE ORUGAS con motor/ALLIS CHALMERS D2200			HD11BD con motores/ALLIS CHALMERS 10000, ALLIS CHALMERS 11000, ALLIS CHALMERS HD516		
HIDRAULICO	G-222	70664000	AIRE	GA-18	237395	ACEITE	G-6	4372517
ACEITE, FLUJO TOTAL (FULL FLOW)	GP-53	70697634	HA-120 TOW con motor/CASE			TRANSMISION	G-6	4372517
ACEITE, DERIVACION (BY PASS)	GP-57	73124135	ACEITE	G-6	4998842	ACEITE	G-33	4395889
AGUA	GP-2071W	4734562	HD-10 con motor/DETROIT DIESEL 4-71			COMBUSTIBLE, SECUNDARIO	G-1173	74056633
FD30B SOBRE ORUGAS con motor/FIAT			COMBUSTIBLE, SECUNDARIO	G-1173	74056633	ACEITE, CONVERTIDOR DE TORSION	GP-1	4511629
HIDRAULICO	G-222	70664000	HD10 SOBRE ORUGAS con motor/DETROIT DIESEL 4-71			AIRE, PRIMARIO PARA CUMMINS	GA-106	684734
FD40 SOBRE ORUGAS con motor/CUMMINS			COMBUSTIBLE, SECUNDARIO	G-1173	74056633	AIRE, PRIMARIO	GA-360	684733
HIDRAULICO	G-222	70664000	HD11 SOBRE ORUGAS con motor/ALLIS CHALMERS 17000			AIRE, PRIMARIO PARA KOMATSU	GA-326	684734
COMBUSTIBLE	GPP-14	4006995	ACEITE	G-33	4395889	AIRE, SECUNDARIO	GA-206	662477
ACEITE, FLUJO TOTAL (FULL FLOW)	GP-53	70697634	HD11 SOBRE ORUGAS, HD11B SOBRE ORUGAS, HD11EC SOBRE ORUGAS con motor/CASE			AIRE, SECUNDARIO	GA-361	662609
ACEITE, DERIVACION (BY PASS)	GP-57	73124135	ACEITE, FLUJO TOTAL (FULL FLOW)	G-33	4395889	ACEITE, DERIVACION (BY PASS)	G-500	91540
FD5 SOBRE ORUGAS, FD5LPG SOBRE ORUGAS con motor/FIAT 8045			COMBUSTIBLE, SECUNDARIO	G-1173	74056633	HD11E SOBRE ORUGAS con motor/CASE		
COMBUSTIBLE	G-296	2513976	ACEITE, DERIVACION (BY PASS)	G-500	91540	ACEITE, FLUJO TOTAL (FULL FLOW)	G-33	4395889
COMBUSTIBLE	G-296-B	2513976	ACEITE, DERIVACION (BY PASS)	G-750	4059343	COMBUSTIBLE, SECUNDARIO	G-1173	74056633
AIRE, PRIMARIO	GAK-216	1909128	HD11, HD11B con motores/ALLIS CHALMERS HD516, ALLIS CHALMERS 10000, ALLIS CHALMERS 11000			AIRE, PRIMARIO PARA CUMMINS S/N 13368 EN ADELANTE	GA-106	684734
AIRE, SECUNDARIO	GA-416	1909129	TRANSMISION	G-6	4372517	AIRE, PRIMARIO (S/N 1338 EN ADELANTE) SIN TUBO	GA-360	684733
FD50 SOBRE ORUGAS con motor/CUMMINS VT1710			ACEITE, TURBO	G-6	4372517	AIRE, PRIMARIO PARA KOMATSU S/N 13368 EN ADELANTE CON TURBO	GA-326	684734
ACEITE, FLUJO TOTAL (FULL FLOW)	G-566	70658126	ACEITE	G-33	4395889	AIRE, SECUNDARIO S/N 13368 EN ADELANTE CON TURBO	GA-206	662477
HIDRAULICO	G-222	70664000	COMBUSTIBLE, SECUNDARIO	G-1173	74056633	AIRE, SECUNDARIO S/N 13368 EN ADELANTE SIN TURBO	GA-361	662609
ACEITE, SELLADO PARA FLUJO TOTAL (FULL FLOW)	GP-53	70697634	ACEITE, CONVERTIDOR DE TORSION	GP-1	4511629	ACEITE, DERIVACION (BY PASS)	G-500	91540
COMBUSTIBLE	GP-55	73111946	AIRE, PRIMARIO PARA CUMMINS	GA-106	684734	ACEITE, DERIVACION (BY PASS)	G-750	4059343
ACEITE, DERIVACION (BY PASS)	GP-57	73124135	AIRE, PRIMARIO	GA-360	684733	HD11E, HD11G con motores/ALLIS CHALMERS 10000, ALLIS CHALMERS 11000, ALLIS CHALMERS HD516		
AGUA	GP-2071W	70681546	AIRE, PRIMARIO PARA KOMATSU	GA-326	684734	TRANSMISION	G-6	4372517
ACEITE, DERIVACION (BY PASS)	G-750	4059343	AIRE, SECUNDARIO	GA-206	662477	ACEITE, TURBO	G-6	4372517
FD7 SOBRE ORUGAS con motor/CASE			AIRE, SECUNDARIO	GA-361	662609	ACEITE	G-33	4395889
COMBUSTIBLE	GPP-1122	P550688	ACEITE, DERIVACION (BY PASS)	G-500	91540	COMBUSTIBLE, SECUNDARIO	G-1173	74056633
FD9 SOBRE ORUGAS con motor/FIAT 8365T			HD11AG con motores/ALLIS CHALMERS 10000, ALLIS CHALMERS 11000, ALLIS CHALMERS HD516			ACEITE, CONVERTIDOR DE TORSION	GP-1	4511629
COMBUSTIBLE	G-296	2513976	TRANSMISION	G-6	4372517	AIRE, PRIMARIO PARA CUMMINS	GA-106	684734
COMBUSTIBLE	GPP-1122	P550688	ACEITE, TURBO	G-6	4372517	AIRE, PRIMARIO	GA-360	684733
COMBUSTIBLE	G-296-B	2513976	ACEITE	G-33	4395889	AIRE, PRIMARIO PARA KOMATSU	GA-326	684734
H3 con motor/ALLIS CHALMERS D149			COMBUSTIBLE, SECUNDARIO	G-1173	74056633	AIRE, SECUNDARIO	GA-206	662477
ACEITE	GP-1	4511629	ACEITE, CONVERTIDOR DE TORSION	GP-1	4511629	AIRE, SECUNDARIO	GA-361	662609
HIDRAULICO	GP-5	239930	AIRE, PRIMARIO PARA CUMMINS	GA-106	684734	ACEITE, DERIVACION (BY PASS)	G-500	91540
ACEITE, DERIVACION (BY PASS)	GP-50	4512207	AIRE, PRIMARIO	GA-360	684733			
H3 con motor/ALLIS CHALMERS D175			AIRE, PRIMARIO PARA KOMATSU	GA-326	684734			
HIDRAULICO	GP-5	239930	AIRE, SECUNDARIO	GA-206	662477			
H3 con motor/ALLIS CHALMERS G149			AIRE, SECUNDARIO	GA-361	662609			
ACEITE	GP-1	45116290	ACEITE, DERIVACION (BY PASS)	G-500	91540			
HIDRAULICO	GP-5	239930						

SERVICIO PESADO

MARCA-MODELO-MOTOR MAKE-MODEL-ENGINE	GONHER GONHER	OEM OEM	MARCA-MODELO-MOTOR MAKE-MODEL-ENGINE	GONHER GONHER	OEM OEM	MARCA-MODELO-MOTOR MAKE-MODEL-ENGINE	GONHER GONHER	OEM OEM
ALLIS CHALMERS (continuación)			ALLIS CHALMERS (continuación)			ALLIS CHALMERS (continuación)		
TRACTORES			TRACTORES			TRACTORES		
HD11EP con motores/ALLIS CHALMERS HD516, ALLIS CHALMERS 10000, ALLIS CHALMERS 11000			ACEITE, DERIVACION (BY PASS)	G-500	91540	HD21 SOBRE ORUGAS (S/N 12801) con motor/CASE		
TRANSMISION	G-6	4372517	HD16 con motores/ALLIS CHALMERS 16000, ALLIS CHALMERS HD844			ACEITE, FLUJO TOTAL (FULL FLOW)	G-33	4395889
ACEITE, TURBO	G-6	4372517	TRANSMISION	G-6	4372517	COMBUSTIBLE, SECUNDARIO	G-1176	4056632
ACEITE	G-33	4395889	ACEITE	G-33	74395889	ACEITE, DERIVACION (BY PASS)	G-500	91540
COMBUSTIBLE, SECUNDARIO	G-1173	74056633	COMBUSTIBLE, SECUNDARIO	G-1176	4056632	HD21A con motores/ALLIS CHALMERS 19000, ALLIS CHALMERS 21000, ALLIS CHALMERS HDT844		
ACEITE, CONVERTIDOR DE TORSION	GP-1	4511629	AIRE, PRIMARIO PARA CUMMINS	GA-106	684734	ACEITE	G-6	4372517
AIRE, PRIMARIO PARA CUMMINS	GA-106	684734	AIRE, PRIMARIO	GA-360	684733	ACEITE	G-33	4395889
AIRE, PRIMARIO	GA-360	684733	AIRE, PRIMARIO PARA KOMATSU	GA-326	684734	AIRE	GA-5648	620717
AIRE, PRIMARIO PARA KOMATSU	GA-326	684734	AIRE, SECUNDARIO	GA-206	662477	AIRE, SECUNDARIO	GA-6127	197588
AIRE, SECUNDARIO	GA-206	662477	AIRE, SECUNDARIO	GA-361	662609	AIRE, PRIMARIO	GA-6129	659387
AIRE, SECUNDARIO	GA-361	662609	ACEITE, DERIVACION (BY PASS)	G-500	91540	ACEITE, DERIVACION (BY PASS)	G-500	91540
ACEITE, DERIVACION (BY PASS)	G-500	91540	HD16 SOBRE ORUGAS con motores/ALLIS CHALMERS 16000, ALLIS CHALMERS HD844			ACEITE, DERIVACION (BY PASS)	G-750	40593436
HD11EP SOBRE ORUGAS con motor/CASE			ACEITE, FLUJO TOTAL (FULL FLOW)	G-33	4395889	HD21B con motor/ALLIS CHALMERS 19000		
ACEITE, FLUJO TOTAL (FULL FLOW)	G-33	4395889	COMBUSTIBLE, SECUNDARIO	G-1176	74056632	ACEITE	G-6	4372517
COMBUSTIBLE, SECUNDARIO HASTA S/N 12201	G-1173	74056633	ACEITE, DERIVACION (BY PASS)	G-500	91540	ACEITE	G-33	4395889
AIRE, PRIMARIO PARA CUMMINS S/N 13367 EN ADELANTE	GA-106	684734	HD16G con motor/ALLIS CHALMERS 16000 SERIES 24L09572			COMBUSTIBLE, SECUNDARIO	G-1176	4056632
AIRE, PRIMARIO PARA KOMATSU S/N 13367 EN ADELANTE	GA-326	684734	AIRE	GA-360	684733	AIRE, SECUNDARIO	GA-6127	197588
AIRE, SECUNDARIO HASTA S/N 13367 EN ADELANTE	GA-206	662477	HD16G, HD16 SERIES B, HD16D, HD16DC, HD16DP con motores/ALLIS CHALMERS 16000, ALLIS CHALMERS HD844			AIRE, PRIMARIO	GA-6129	659387
HD11G SOBRE ORUGAS con motor/CASE			TRANSMISION	G-6	4372517	ACEITE, DERIVACION (BY PASS)	G-500	91540
ACEITE, FLUJO TOTAL (FULL FLOW)	G-33	4395889	ACEITE	G-33	4395889	ACEITE, DERIVACION (BY PASS)	G-750	40593436
COMBUSTIBLE, SECUNDARIO	G-1173	74056633	COMBUSTIBLE, SECUNDARIO	G-1176	4056632	HD21B con motores/ALLIS CHALMERS 21000, ALLIS CHALMERS HDT844		
ACEITE, CLUTCH	GP-1	45116290	AIRE, PRIMARIO PARA CUMMINS	GA-106	684734	ACEITE	G-6	4372517
ACEITE, DERIVACION (BY PASS)	G-500	91540	AIRE, PRIMARIO	GA-360	684733	ACEITE	G-33	4395889
HD11S SOBRE ORUGAS con motor/CASE			AIRE, PRIMARIO PARA KOMATSU	GA-326	684734	AIRE	GA-5648	620717
ACEITE, FLUJO TOTAL (FULL FLOW)	G-33	4395889	AIRE, SECUNDARIO	GA-206	662477	AIRE, SECUNDARIO	GA-6127	197588
COMBUSTIBLE, SECUNDARIO	G-1173	74056633	AIRE, SECUNDARIO	GA-361	662609	AIRE, PRIMARIO	GA-6129	659387
ACEITE, DERIVACION (BY PASS)	G-500	91540	ACEITE, DERIVACION (BY PASS)	G-500	91540	ACEITE, DERIVACION (BY PASS)	G-500	91540
ACEITE, DERIVACION (BY PASS)	G-750	40593436	HD-19 con motor/DETROIT DIESEL 6-71			ACEITE, DERIVACION (BY PASS)	G-750	40593436
HD12G, HD12G SERIES B con motor/ALLIS CHALMERS 11000			ACEITE, DERIVACION (BY PASS)	G-500	91540	HD21C con motores/ALLIS CHALMERS 19000, ALLIS CHALMERS 21000, ALLIS CHALMERS HDT844		
TRANSMISION	G-6	4372517	HD19 SOBRE ORUGAS con motor/GMC 6-71			ACEITE	G-6	4372517
ACEITE	G-33	4395889	ACEITE, FLUJO TOTAL (FULL FLOW)	G-33	4395889	ACEITE	G-33	4395889
COMBUSTIBLE, SECUNDARIO	G-1173	74056633	COMBUSTIBLE, SECUNDARIO	G-1176	59897	AIRE	GA-5648	620717
AIRE, PRIMARIO PARA CUMMINS	GA-106	684734	ACEITE, DERIVACION (BY PASS)	G-500	91540	AIRE, SECUNDARIO	GA-6127	197588
AIRE, PRIMARIO PARA KOMATSU	GA-326	684734	HD20 con motores/DETROIT DIESEL 6-110, DETROIT DIESEL 6-71			AIRE, PRIMARIO	GA-6129	659387
AIRE, SECUNDARIO	GA-206	662477	ACEITE	G-33	4395889	ACEITE, DERIVACION (BY PASS)	G-500	91540
HD12GS con motor/ALLIS CHALMERS 11000			COMBUSTIBLE, SECUNDARIO	G-1176	4056632	ACEITE, DERIVACION (BY PASS)	G-750	40593436
ACEITE	G-6	4372517	ACEITE	G-500	91540	HD21G con motores/ALLIS CHALMERS 19000, ALLIS CHALMERS 21000, ALLIS CHALMERS HDT844		
ACEITE	G-33	4395889	HD20 SOBRE ORUGAS con motor/GMC 6-71			ACEITE, TURBO	G-6	4372517
COMBUSTIBLE, SECUNDARIO	G-1173	74056633	ACEITE, FLUJO TOTAL (FULL FLOW)	G-33	4395889	ACEITE	G-33	4395889
AIRE, PRIMARIO PARA CUMMINS	GA-106	684734	COMBUSTIBLE, SECUNDARIO	G-1176	4056632	COMBUSTIBLE, SECUNDARIO	G-1176	4056632
AIRE, PRIMARIO PARA KOMATSU	GA-326	684734	ACEITE, DERIVACION (BY PASS)	G-500	91540	AIRE, PRIMARIO	GA-5648	620717
AIRE, SECUNDARIO	GA-206	662477	HD21 SOBRE ORUGAS (HASTA S/N 12801), HD21G SOBRE ORUGAS (HASTA S/N 13718) con motor/CASE			AIRE, PRIMARIO	GA-6129	659387
HD14, HD14C con motor/DETROIT DIESEL 6-71			ACEITE, FLUJO TOTAL (FULL FLOW)	G-33	4395889	AIRE, SECUNDARIO	GA-206	197588
ACEITE	G-500	91540	COMBUSTIBLE, SECUNDARIO	G-1176	4056632	ACEITE, DERIVACION (BY PASS)	G-500	91540
HD15 con motor/DETROIT DIESEL 6-71			AIRE	GA-5648	620717	ACEITE, DERIVACION (BY PASS)	G-750	91540
ACEITE	G-33	4395889	ACEITE, DERIVACION (BY PASS)	G-500	91540	HD21G SOBRE ORUGAS (S/N 13718-UP), HD21GS SOBRE ORUGAS (S/N 13718-UP) con motor/CASE		
COMBUSTIBLE, PRIMARIO	G-1174	74055563				ACEITE, FLUJO TOTAL (FULL FLOW)	G-33	4395889
						COMBUSTIBLE, SECUNDARIO	G-1176	4056632
						ACEITE, DERIVACION (BY PASS)	G-750	40593436
						HD21P con motores/ALLIS CHALMERS 19000, ALLIS CHALMERS 21000, ALLIS CHALMERS HDT844		
						ACEITE, TURBO	G-6	4372517
						ACEITE	G-33	4395889
						COMBUSTIBLE, SECUNDARIO	G-1176	4056632

MARCA-MODELO-MOTOR	GONHER	OEM
MAKE-MODEL-ENGINE	GONHER	OEM

ALLIS CHALMERS (continuación)

TRACTORES PEQUEÑOS Y PARA JARDIN

312 con motores/KOHLER K301, KOHLER K330, KOHLER K331		
ACEITE	GP-9	1650954
TRANSMISION	GP-81	4356575
AIRE	GA-7	235116
314 con motor/KOHLER		
ACEITE	GP-9	1650954
410 con motor/KOHLER K2415		
AIRE	GA-7	235116
416 con motor/KOHLER K3415		
TRANSMISION	GP-9	1650954
TRANSMISION	GP-81	4356575
AIRE	GA-86	277138
GASOLINA	GG-5 L	P550012

600 con motor/A GASOLINA		
ACEITE	GP-1	2370005
600 con motor/CASE		
AIRE	GA-18	237395
620 con motor/ONAN CCKB		
TRANSMISION	GP-9	1650954
TRANSMISION	GP-81	4356575
GASOLINA	GG-4	149-2206-01

706 con motor/PERKINS		
HIDRAULICO	GP-5	234774
706 SERIE C con motor/CASE		
AIRE, SIN ASPAS	GA-16	3042922-4

710 con motor/KOHLER		
AIRE	GA-7	235116
720, 723 con motor/ONAN CCKB-M5		
ACEITE	GP-3600	122B-323

AMERICAN

GRÚAS

HC110 con motor/CUMMINS 6CTA8.3		
ACEITE	GP-3000	3318853

AMERICAN LAFRANCE

CAMIONES, TRACTOCAMIONES Y AUTOBUSES

LAF con motor/CUMMINS M11		
ACEITE	GP-3000	3318853

AUTOCAR

CAMIONES, TRACTOCAMIONES Y AUTOBUSES

ACL64FT con motor/CUMMINS N14 PLUS		
ACEITE	GP-3001	3401544
COMBUSTIBLE	GPP-1000	3329289
AIRE	GA-1095	AF1897
S42B con motor/CATERPILLAR 3406		
COMBUSTIBLE	GP-749	1R0712
ACEITE	GP-691	2721788
AGUA	GP-1013Q	1W5518
AIRE	GA-1095	310842

MARCA-MODELO-MOTOR	GONHER	OEM
MAKE-MODEL-ENGINE	GONHER	OEM

AUTOCAR (continuación)

CAMIONES, TRACTOCAMIONES Y AUTOBUSES

S42F con motor/CATERPILLAR 3406		
COMBUSTIBLE	GP-749	1R0712
ACEITE	GP-691	2721788
AGUA	GP-1013Q	1W5518
AIRE	GA-98	310085
S64TF, S42TF, S64B, S64F, S64TB, A42B, A42F, A42TB, A42TF, A64B, A64F, A64TB, A64TF, ACL64F, S42TB con motor/CATERPILLAR 3406		
COMBUSTIBLE	GP-749	1R0712
ACEITE	GP-691	2721788
AGUA	GP-1013Q	1W5518
AIRE	GA-1095	310842

BANDIT INDUSTRIES, INC.

EQUIPO

1900 con motor/CUMMINS N14 (NT855)		
ACEITE	GP-3000	3318853
2400 con motor/CUMMINS QSK19		
ACEITE	GP-3000	3318853
3680 con motor/CUMMINS N14		
ACEITE	GP-3000	3318853

BARKO

EQUIPO

775B con motor/CUMMINS 8.3L		
ACEITE	GP-3000	3318853

BEAVER

MOTORES

SANTAIMHOMES		
ACEITE	GP-3000	LF3000

BELARUS

TRACTORES

D240, D242, D245 con motor/A DIESEL		
COMBUSTIBLE	G-1120	501117030A

BITELLI

EQUIPO PARA CONSTRUCCION VIAL

SF102, SF102C con motor/CUMMINS 6CT8.3L TURBO		
ACEITE	GP-3000	3318853

BLUE BIRD

CAMIONES, TRACTOCAMIONES Y AUTOBUSES

CONVENTIONAL con motor/CATERPILLAR 3116		
ACEITE, SELLADO	GP-51	1R0739
COMBUSTIBLE, SECUNDARIO	GP-110	1R0740
ACEITE, DERIVACION (BY PASS), CARTUCHO	G-750	15525633
CONVENTIONAL con motor/CUMMINS ISB 5.9L		
ACEITE	GP-3937	3937144
CONVENTIONAL con motor/FORD 6.6L DIESEL		
AGUA, SISTEMA DE ENFRIAMIENTO	GP-1010Q	E7HZ-8A424-B
COMBUSTIBLE, SECUNDARIO, REQUIERE 2 PIEZAS	GP-1122	E7HZ-9365-A

MARCA-MODELO-MOTOR	GONHER	OEM
MAKE-MODEL-ENGINE	GONHER	OEM

BLUE BIRD (continuación)

CAMIONES, TRACTOCAMIONES Y AUTOBUSES

ACEITE, REQUIERE 2 PIEZAS, 1986 SOLAMENTE	GP-77	FL781
COMBUSTIBLE, SEPARADOR DE AGUA, PURGADOR	GPP-1287	F1HZ-9365-A
ACEITE, DERIVACION (BY PASS), CARTUCHO	G-750	FL750
COMBUSTIBLE, SEPARADOR DE AGUA, ROSCA PARA TAZON	R 60 P	F1HZ-9365-A
CONVENTIONAL con motor/FORD FD1060 5.9L		
COMBUSTIBLE	GPP-1122	F3HZ-9365-E
AGUA, SISTEMA DE ENFRIAMIENTO	GP-2071W	F3HZ-8A424-C
ACEITE	GP-178	F3HZ-6731-B
CONVENTIONAL con motor/GM 7.4L GASOLINA		
ACEITE	GP-408	25324052
ACEITE	GP-205	25160561
COMBUSTIBLE	GG-46	25121792
CONVENTIONAL con motor/GM V8 366 GASOLINA		
ACEITE	GP-205	25160561
COMBUSTIBLE, CON CARBURADOR	GG-20	5650030
COMBUSTIBLE, CON SISTEMA DE INYECCION DE COMBUSTIBLE	GG-46	25121792
CONVENTIONAL con motor/GM V8 8.1L		
ACEITE	GP-408	25324052
AIRE	GA-348	25313349
COMBUSTIBLE	GG-46	25121792
CONVENTIONAL con motor/INTERNATIONAL 7.3L		
DIRECCION	G-162H	1691121C1
DIRECCION	G-169	279294C92
COMBUSTIBLE	G-293	FSR81205
COMBUSTIBLE, SEPARADOR DE AGUA, PURGADOR	GPP-547	1677004C91
ACEITE, SELLADO	GP-3766	1804442C1
COMBUSTIBLE, SELLADO	GP-155	1804459C1
AIRE	GA-422	588213C1
AIRE, PRIMARIO	GA-209	476741C1
AIRE, SECUNDARIO	GA-210	482644C1
AIRE, RADIAL	GA-197R	1691027C1
COMBUSTIBLE, SEPARADOR DE AGUA, ROSCA PARA TAZON	R 60 P	1677004C91
CONVENTIONAL con motor/INTERNATIONAL DT360		
COMBUSTIBLE	GPP-14	FFR-8105D
COMBUSTIBLE	G-293	FSR-81205
COMBUSTIBLE, SEPARADOR DE AGUA, PURGADOR	GPP-547	1677004C91
ACEITE, SELLADO	GP-88	1811953C1
COMBUSTIBLE	GP-78	1809789C1
COMBUSTIBLE, SEPARADOR DE AGUA, ROSCA PARA TAZON	R 60 P	1677004C91
CONVENTIONAL con motor/INTERNATIONAL DT408		
COMBUSTIBLE, SEPARADOR DE AGUA, PURGADOR	GPP-547	1677004C91
COMBUSTIBLE, SECUNDARIO	GP-1122	FF5052
AGUA, SISTEMA DE ENFRIAMIENTO	GP-2071W	1822313C1
COMBUSTIBLE	GP-78	1822588C1
ACEITE, SELLADO	GP-152	1819452C1
COMBUSTIBLE, SEPARADOR DE AGUA, ROSCA PARA TAZON	R 60 P	1677004C91

MARCA-MODELO-MOTOR MAKE-MODEL-ENGINE	GONHER GONHER	OEM OEM
BLUE BIRD (continuación)		
CAMIONES, TRACTOCAMIONES Y AUTOBUSES		
CONVENTIONAL con motor/INTERNATIONAL DT466		
COMBUSTIBLE	GP-78	1822588C1
CONVENTIONAL con motor/INTERNATIONAL DT466E		
DIRECCION	G-162H	1691121C1
COMBUSTIBLE	GP-78	1822588C1
ACEITE, SELLADO	GP-152	1819452C1
AIRE	GA-209	476741C1
CONVENTIONAL con motor/INTERNATIONAL T444E		
DIRECCION	G-162H	1691121C1
COMBUSTIBLE, SEPARADOR DE AGUA, 1998 EN ADELANTE	G-862	1825864C92
COMBUSTIBLE, SEPARADOR DE AGUA, HASTA 1997	G-178	1822631C91
AIRE	GA-209	476741C1
CONVENTIONAL con motor/INTERNATIONAL VT365		
COMBUSTIBLE, SEPARADOR DE AGUA	G-862	1825864C92
CONVENTIONAL con motores/CATERPILLAR 3126B, CATERPILLAR C7		
ACEITE	GP-51	1R0739
CUT-AWAY CHASSIS con motor/FORD 6.0L TURBO DIESEL		
ACEITE, CARTUCHO	G-3752	3C3Z-6731-AA
CUT-AWAY CHASSIS con motor/FORD V8 5.4L		
ACEITE, SELLADO	GP-68	F2AZ-6731-BD
AIRE	GA-1615	F6ZZ-9601-A
COMBUSTIBLE	GG-986	F89Z-9155-A
CUT-AWAY CHASSIS con motor/GM 5.7L GASOLINA		
ACEITE, SELLADO	GP-205	25160561
AIRE	GA-392	25042562
AIRE	GA-192	6419892
AIRE	GA-413R	15153904
COMBUSTIBLE	GG-46	25121792
COMBUSTIBLE	GG-581	25121801
CUT-AWAY CHASSIS con motor/GM 6.5L DIESEL		
ACEITE, SELLADO	GP-205	25160561
COMBUSTIBLE	GPP-419	12552214
AIRE	GA-392	25042562
CUT-AWAY CHASSIS con motores/GM V8 4.8L VORTEC, GM V8 6.0L VORTEC		
ACEITE, SELLADO	GP-44	88984215
AIRE	GA-413R	15153904
COMBUSTIBLE, ROSCA EN AMBOS EXTREMOS	GG-46	25171792
COMBUSTIBLE, ROSCA EN UN EXTREMO	GG-66	25121293
TRANSIT FE con motor/CUMMINS ISB		
ACEITE, SELLADO	GP-3937	3937144
TRANSIT FE, TRANSIT RE con motor/CATERPILLAR C7		
ACEITE, SELLADO	GP-51	1R0739
TRANSIT RE con motor/CUMMINS ISC		
ACEITE	GP-3001	3401544
SEPARADOR DE COMBUSTIBLE	GPP-1003S	3800394
SEPARADOR DE COMBUSTIBLE	GPP-1022S	3800394
ULTRA LF TRANSIT con motor/CUMMINS ISB		
ACEITE, SELLADO	GP-3937	3937144

MARCA-MODELO-MOTOR MAKE-MODEL-ENGINE	GONHER GONHER	OEM OEM
BLUE BIRD (continuación)		
CAMIONES, TRACTOCAMIONES Y AUTOBUSES		
ULTRA LF TRANSIT con motor/CUMMINS ISB CNG		
ACEITE, SELLADO	GP-3937	3937144
ULTRA LMB TRANSIT con motor/CUMMINS ISB		
ACEITE, SELLADO	GP-3937	3937144
XCEL 102 TRANSIT con motor/CATERPILLAR C7		
ACEITE, SELLADO	GP-51	1R0739
XCEL 102 TRANSIT con motor/CUMMINS ISC		
ACEITE	GP-3001	3401544
XPRESS 4000/4500 COACH con motor/CATERPILLAR C13		
COMBUSTIBLE, SECUNDARIO	GP-749	1R0749
XPRESS 4000/4500 COACH con motor/DETROIT DIESEL SERIES 60		
COMBUSTIBLE, PRIMARIO	GP-26	25014274
COMBUSTIBLE, SECUNDARIO	GP-27	25014342
ACEITE, SELLADO	GP-193	23527033
BOBCAT		
CARGADORAS		
653 con motor/A DIESEL		
COMBUSTIBLE, SEPARADOR DE AGUA	GPP-1122	6667352
751 con motor/PEUGEOT		
COMBUSTIBLE, SEPARADOR DE AGUA	GPP-1122	6667352
BOMAG		
APLANADORAS		
BW10 con motores/DEUTZ F3L912, DEUTZ F4L912		
ACEITE	GP-36	5710639
BW100AC, BW100AD con motores/DEUTZ F1L511, DEUTZ F2L511		
ACEITE	GP-28	5710632
BW100AD, BW100ADL con motor/DEUTZ F6L912		
ACEITE	GP-9	3357461
BW100AD, BW100ADL con motores/HATZ E950, HATZ Z790		
ACEITE	GP-28	5710632
BW100AD-3, BW120AD-3 con motor/DEUTZ F2L1011		
ACEITE	GP-28	5710632
BW1014A con motor/DEUTZ F5L912		
ACEITE	GP-54	5710634
BW10A, BW10S con motores/DEUTZ F3L912, DEUTZ F4L912		
ACEITE	GP-36	5710639
BW10AS con motor/CUMMINS 4BT3.9		
COMBUSTIBLE, SECUNDARIO	GP-1122	5711730
COMBUSTIBLE, PRIMARIO	GPP-18	3925274
ACEITE	GP-390	3908616
BW120AC, BW120AD con motor/DEUTZ F2L511		
ACEITE	GP-28	5710632
BW124DH-3, BW124PDH-3 con motor/DEUTZ F3L1011		
COMBUSTIBLE	GPP-1122	WK842

MARCA-MODELO-MOTOR MAKE-MODEL-ENGINE	GONHER GONHER	OEM OEM
BOMAG (continuación)		
APLANADORAS		
BW124PDB con motor/DEUTZ F3L1011		
ACEITE	GP-28	5710632
BW12R con motor/CUMMINS 4B3.9		
COMBUSTIBLE, SECUNDARIO	GP-1122	5711730
COMBUSTIBLE, SEPARADOR DE AGUA	GPP-1122	WK842
AGUA	GP-2071W	31701010
COMBUSTIBLE, PRIMARIO	GPP-18	3925274
ACEITE	GP-390	3908616
BW130AC, BW130AD con motor/DEUTZ F2L511		
ACEITE	GP-28	5710632
BW135AD, BW138AD con motor/DEUTZ F3L1011		
ACEITE	GP-28	5710632
BW141AC, BW141AD con motor/DEUTZ F4L912		
ACEITE	GP-36	5710639
COMBUSTIBLE	GP-1122	5711730
TRANSMISION	GP-66	5821212
BW141AD-2, BW142D-2 con motores/DEUTZ BF4L1011, DEUTZ F4L1011		
ACEITE	GP-28	5710632
BW142, BW142D, BW142PD con motor/DEUTZ F3L912		
ACEITE	GP-36	5710639
COMBUSTIBLE	GP-1122	5711730
HIDRAULICO	GP-66	5821220
BW142PDB, BW160ADMK3, BW154, BW160-66ADMK1, BW160A, BW160AD, BW160ADMK1, BW160ADMK2 con motor/DEUTZ F4L912		
ACEITE	GP-36	5710639
COMBUSTIBLE	GP-1122	5711730
TRANSMISION	GP-66	5821212
BW144ADMK1, BW144ADMK2 con motor/CASE		
ACEITE	GP-54	5710634
BW15 con motor/DEUTZ F6L912		
ACEITE	GP-54	1173430
BW151AC, BW151AD, BW154AC, BW154AD con motor/CASE		
ACEITE	GP-54	5710634
BW151AD-2, BW172PDB-2, BW172D-2, BW172PD-2 con motor/DEUTZ BF4L1011		
ACEITE	GP-28	5710632
BW156D-3, BW156DH-3, BW156PDH-3 con motor/CUMMINS 4B3.9		
COMBUSTIBLE, SECUNDARIO	GP-1122	5711730
COMBUSTIBLE, SEPARADOR DE AGUA	GPP-1122	WK842
COMBUSTIBLE, PRIMARIO	GPP-18	3925274
ACEITE	GP-390	3908616
BW15A con motor/DEUTZ F6L912		
ACEITE	GP-54	1173430
BW15R con motor/DEUTZ F6L912		
ACEITE	GP-54	5710634
BW15S con motor/DEUTZ F6L912		
ACEITE	GP-54	1173430

SERVICIO PESADO

MARCA-MODELO-MOTOR MAKE-MODEL-ENGINE	GONHER GONHER	OEM OEM	MARCA-MODELO-MOTOR MAKE-MODEL-ENGINE	GONHER GONHER	OEM OEM	MARCA-MODELO-MOTOR MAKE-MODEL-ENGINE	GONHER GONHER	OEM OEM
BOMAG (continuación)			BOMAG (continuación)			BOMAG (continuación)		
APLANADORAS			APLANADORAS			APLANADORAS		
BW160AS con motor/DEUTZ F4L912			COMBUSTIBLE, SEPARADOR DE AGUA	GPP-1122	WK842	BW213D con motores/DEUTZ F6L912, DEUTZ F6L913		
ACEITE	GP-36	A1H4123	COMBUSTIBLE, PRIMARIO	GPP-18	3925274	ACEITE	GP-54	5710634
COMBUSTIBLE	GP-1122	5711730	ACEITE	GP-390	3908616	BW213PD, BW213PDB con motor/DEUTZ BF6L913		
TRANSMISION	GP-66	5821212	BW20, BW20R con motor/CUMMINS 4B3.9			COMBUSTIBLE	GP-1122	5711730
BW161AC con motor/DEUTZ F4L913			COMBUSTIBLE, SECUNDARIO	GP-1122	5711730	BW213PDB-3 con motor/CUMMINS 5.9L		
ACEITE	GP-36	5710639	COMBUSTIBLE, PRIMARIO	GPP-18	3925274	COMBUSTIBLE, SECUNDARIO	GP-1122	5711730
BW161AD con motor/DEUTZ BF4L913			ACEITE	GP-390	3908616	COMBUSTIBLE, SEPARADOR DE AGUA	GPP-1122	WK842
ACEITE	GP-54	5710634	BW200, BW200E con motores/DEUTZ F3L912, DEUTZ F4L912			COMBUSTIBLE, PRIMARIO	GPP-18	3925274
BW161AD con motor/DEUTZ F4L913			ACEITE	GP-36	5710639	ACEITE	GP-178	3914395
ACEITE	GP-36	5710639	BW201AD con motor/DEUTZ BF4L913			BW214 con motor/DETROIT DIESEL 4-53		
BW161AD2 con motor/DEUTZ BF4L913			ACEITE	GP-54	5710640	ACEITE	G-33	23518666
ACEITE	GP-54	5710634	BW201AD con motores/DEUTZ F3L912, DEUTZ F4L912			COMBUSTIBLE, SECUNDARIO	G-1173	23519162
BW162A con motor/CASE			ACEITE	GP-36	5710639	COMBUSTIBLE, PRIMARIO	G-1174	23519454
ACEITE	GP-54	5710640	BW202, BW202ADH, BW202ADH-2 con motor/DEUTZ BF4L913			COMBUSTIBLE, SECUNDARIO	G-1175	5574508
COMBUSTIBLE	GP-1122	5711730	ACEITE	GP-54	5710640	BW214D con motor/DEUTZ		
HIDRAULICO	GP-66	5821212	BW20R con motor/DEUTZ F6L912			ACEITE	GP-54	5710634
BW164AC, BW164AD con motor/DEUTZ F4L913			ACEITE	GP-54	5710634	BW215D, BW215PD, BW217D, BW217PD con motor/DEUTZ F6L413		
ACEITE	GP-36	5710639	BW210 con motor/ALLIS CHALMERS 2900 MKII			ACEITE	GP-54	5710634
BW16R con motor/CUMMINS 4BT3.9			AGUA	GP-2071W	31701010	COMBUSTIBLE, PRIMARIO	GP-1122	5711732
COMBUSTIBLE, SECUNDARIO	GP-1122	5711730	ACEITE	GP-390	3908616	COMBUSTIBLE, SECUNDARIO	GP-1122	5711730
COMBUSTIBLE, SEPARADOR DE AGUA	GPP-1122	WK842	AIRE	GAK-20	70244622	TRANSMISION	GP-66	5821212
COMBUSTIBLE, PRIMARIO	GPP-18	3925274	BW210, BW212D, BW210A, BW210D, BW210DP, BW211, BW211A, BW211AB, BW211AD, BW211B, BW212, BW212B con motor/DEUTZ F6L912			BW219PDH-3, BW225D-3, BW225PD-3, BW216D-3, BW216DH-3, BW-216PDH-3, BW219DH-3 con motor/DEUTZ BF6M1013		
ACEITE	GP-390	3908616	ACEITE	GP-54	5710634	ACEITE	GP-54	5710634
BW170 con motor/DETROIT DIESEL 3-53			BW210A, BW213 con motor/DETROIT DIESEL 4-53			BW220A, BW220AD con motor/DETROIT DIESEL 6V-53		
ACEITE, CARTUCHO	G-119	5574978	ACEITE	G-33	23518666	ACEITE, CARTUCHO	G-33	23518666
COMBUSTIBLE, PRIMARIO	GP-92	23518527	COMBUSTIBLE, SECUNDARIO	G-1173	23519162	COMBUSTIBLE, PRIMARIO	GP-26	8423132
COMBUSTIBLE, SECUNDARIO	GP-93	23518526	COMBUSTIBLE, PRIMARIO	G-1174	23519454	COMBUSTIBLE, SECUNDARIO	GP-27	23518482
ACEITE, SELLADO	GP-43	25313733	COMBUSTIBLE, SECUNDARIO	G-1175	5574508	ACEITE, SELLADO	GP-53	31701670
BW170 con motor/DEUTZ F4L412			BW211D-3 con motor/PERKINS			BW220AD con motor/DEUTZ BF6L913		
ACEITE	GP-36	5710639	ACEITE	GP-1	7023700-0	COMBUSTIBLE, PRIMARIO	GP-1122	5711730
COMBUSTIBLE, PRIMARIO	GP-1122	5711730	BW212D-3 con motor/DEUTZ BF6M1012			COMBUSTIBLE, SECUNDARIO	GP-1122	5711730
COMBUSTIBLE, SECUNDARIO	GP-1122	5711730	ACEITE	GP-54	5710634	COMBUSTIBLE, SIMPLE	GP-1122	5711730
COMBUSTIBLE, SIMPLE	GP-1122	5711730	BW212DH, BW212PD con motor/DEUTZ F6L912			COMBUSTIBLE, PRIMARIO	GPP-1122	WK842
COMBUSTIBLE, PRIMARIO	GPP-1122	WK842	ACEITE	GP-54	5710634	COMBUSTIBLE, SECUNDARIO	GPP-1122	WK842
COMBUSTIBLE, SECUNDARIO	GPP-1122	WK842	BW212PL-3 con motor/DEUTZ BF6M1012			ACEITE	GP-77	5710634
BW170 con motor/DEUTZ F4L912			ACEITE	GP-54	5710634	BW222CA con motor/DEUTZ BF6L913		
ACEITE	GP-36	5710639	BW212SB con motor/DEUTZ F6L912			COMBUSTIBLE	GP-1122	5711730
COMBUSTIBLE	GP-1122	5711730	ACEITE	GP-54	5710634	BW222CA con motor/GMC 6V-53		
HIDRAULICO	GP-66	5821212	BW213, BW213A, BW213AD con motores/DEUTZ F6L912, DEUTZ F6L913			ACEITE	G-33	23518666
BW172, BW172D, BW172PD con motor/DEUTZ F4L912			ACEITE	GP-54	5710634	BW24R con motor/CUMMINS 4BT3.9		
ACEITE	GP-36	5710639	BW213AD-3, BW213D-3, BW213DH-3, BW213PDH-3, BW214DH-3, BW214PDH-3 con motor/PERKINS 1006.60T			COMBUSTIBLE, SECUNDARIO	GP-1122	5711730
COMBUSTIBLE	GP-1122	5711730	ACEITE	GP-1	7023700-0	COMBUSTIBLE, SEPARADOR DE AGUA	GPP-1122	WK842
TRANSMISION	GP-66	5821220	BW213D con motor/DEUTZ BF6L913			COMBUSTIBLE, PRIMARIO	GPP-18	3925274
BW178D-3, BW179PHD-3, BW178DH-3, BW178PHD-3, BW179D-3, BW179DH-3 con motor/CUMMINS 4BT3.9			COMBUSTIBLE	GP-1122	5711730	ACEITE	GP-390	3908616
COMBUSTIBLE, SECUNDARIO	GPP-1122	WK842	BW213D con motor/DEUTZ BF6L913			BW38, BW6, BW6A, BW6S, BW38S, BW4, BW4A, BW4S, BW58, BW58S con motores/DEUTZ F3L912, DEUTZ F4L912		
COMBUSTIBLE, PRIMARIO	GPP-18	3925274	COMBUSTIBLE	GP-1122	5711730	ACEITE	GP-36	5710639
ACEITE	GP-390	3908616	BW213D con motor/DEUTZ BF6L913			BW75AD, BW75ADL con motor/DEUTZ F1L210D		
BW180AD, BW177AD-3, BW177D-3, BW177DH-3, BW177PDB-3 con motor/CUMMINS 3.9L			COMBUSTIBLE	GP-1122	5711730	ACEITE	GP-9	3357461
COMBUSTIBLE, SECUNDARIO	GP-1122	5711730						

MARCA-MODELO-MOTOR MAKE-MODEL-ENGINE	GONHER GONHER	OEM OEM
BOMAG (continuación)		
APLANADORAS		
BW812, BW812A con motor/DEUTZ F5L912		
ACEITE	GP-54	5710634
BW82, BW82S con motor/DEUTZ F6L912		
ACEITE	GP-54	5710634
BW90A, BW90AD con motores/HATZ E950, HATZ Z790		
ACEITE	GP-9	5727381
BW90ADL con motor/DEUTZ F1L210D		
ACEITE	GP-9	3357461

MARCA-MODELO-MOTOR MAKE-MODEL-ENGINE	GONHER GONHER	OEM OEM
BOMAG		
EQUIPO PARA CONSTRUCCION VIAL		
BC671RB, BC671RS, BC771RB, BC771RS con motor/CUMMINS M11		
COMBUSTIBLE, SEPARADOR DE AGUA	GPP-11	3308638
K300 con motor/DEUTZ BF6L913		
COMBUSTIBLE	GP-1122	5711730
K300, K301 con motor/CUMMINS V504C		
ACEITE, CARTUCHO	G-613	173174
COMBUSTIBLE	GP-1101	154711
ACEITE, SELLADO PARA DERIVACION (BY PASS)	GP-57	31780104
COMBUSTIBLE, SEPARADOR DE AGUA	GPP-11	3308638
ACEITE, SELLADO	GP-43	3313281
AGUA	GP-2071W	31701010
ACEITE, CARTUCHO PARA DERIVACION (BY PASS)	G-500	213527
K301 con motor/CATERPILLAR 3145		
ACEITE	GP-36	9N5680
K301 con motor/CUMMINS NT855C		
COMBUSTIBLE	GPP-14	3315847
ACEITE	GP-53	31701670
ACEITE, DERIVACION (BY PASS)	GP-57	31780104
AGUA	GP-2071W	31701010
AIRE	GA-39	257014
K301 SERIES II con motor/CUMMINS V504C		
ACEITE	G-613	173174
COMBUSTIBLE	GP-1101	154711
ACEITE, DERIVACION (BY PASS)	G-500	213527
K350, K350P, K351, K401 con motor/CUMMINS NT855		
ACEITE, CARTUCHO	G-566	136551
COMBUSTIBLE	GP-1101	154711
ACEITE, SELLADO	GP-53	31701670
ACEITE, SELLADO PARA DERIVACION (BY PASS)	GP-57	31780104
AGUA	GP-2071W	31701010
AIRE	GA-39	257014
ACEITE, CARTUCHO PARA DERIVACION (BY PASS)	G-750	256345
K350, K350P, K351, K451 con motor/DETROIT DIESEL 6-71		
ACEITE, CARTUCHO	G-33	23518666
COMBUSTIBLE, PRIMARIO	GP-26	8423132
COMBUSTIBLE, SECUNDARIO	GP-27	23518482
ACEITE, SELLADO	GP-53	31701670

MARCA-MODELO-MOTOR MAKE-MODEL-ENGINE	GONHER GONHER	OEM OEM
BOMAG (continuación)		
EQUIPO PARA CONSTRUCCION VIAL		
K401 con motor/CUMMINS V504C		
ACEITE, CARTUCHO	G-613	173174
COMBUSTIBLE	GP-1101	154711
ACEITE, SELLADO PARA DERIVACION (BY PASS)	GP-57	31780104
COMBUSTIBLE, SEPARADOR DE AGUA	GPP-11	3308638
ACEITE, SELLADO	GP-43	3313281
AGUA	GP-2071W	31701010
ACEITE, CARTUCHO PARA DERIVACION (BY PASS)	G-500	213527
K451 con motor/CUMMINS NT855		
ACEITE, CARTUCHO	G-566	136551
COMBUSTIBLE	GP-1101	154711
ACEITE, SELLADO	GP-53	31701670
ACEITE, SELLADO PARA DERIVACION (BY PASS)	GP-57	31780104
AGUA	GP-2071W	31701010
AIRE	GA-39	257014
ACEITE, CARTUCHO PARA DERIVACION (BY PASS)	G-750	256345
K701 con motor/CATERPILLAR 3408		
ACEITE, CUMPLE CON MEDIDAS ORIGINALES	GP-691	1R0716
ACEITE, SEGUNDA OPCION	GP-52	1R0716
COMBUSTIBLE	GP-110	1P2299
K701 con motor/CUMMINS KT1150		
COMBUSTIBLE	GP-1101	154711
ACEITE	GP-53	31701670
ACEITE, SELLADO PARA DERIVACION (BY PASS)	GP-57	31780104
ACEITE, CARTUCHO PARA DERIVACION (BY PASS)	G-750	256345
K701 con motor/DETROIT DIESEL 8V-92		
ACEITE, CARTUCHO	G-33	23518666
COMBUSTIBLE, PRIMARIO	GP-26	8423132
COMBUSTIBLE, SECUNDARIO	GP-27	23518482
ACEITE, SELLADO	GP-53	31701670
K84 con motor/CUMMINS 6V352		
AIRE	GA-27	299351
LA107, LA88 con motor/DOS MOTORES GMC 6-71		
ACEITE	G-33	23518666
MPH121 con motor/DEUTZ		
COMBUSTIBLE	GPP-1122	WK842
MPH454R con motor/CUMMINS N14 PLUS		
ACEITE	GP-3001	LF9009
S1014, S1014A con motor/DEUTZ F5L912		
ACEITE	GP-54	5710634
COMBUSTIBLE	GP-1122	5711730
AIRE	GAK-403	P118160
S1014A, S812A con motor/DETROIT DIESEL 3-53		
ACEITE	G-33	23518666
BOMAG		
NIVELADORAS		
BG110T con motores/PERKINS 1004.40T, PERKINS 1004.40TW		
ACEITE	GP-1	7023700-0

MARCA-MODELO-MOTOR MAKE-MODEL-ENGINE	GONHER GONHER	OEM OEM
BOMAG (continuación)		
NIVELADORAS		
BG160TA con motor/PERKINS 1006.60T		
ACEITE	GP-1	7023700-0
BG160TA con motor/PERKINS 1006.6T		
ACEITE	GP-1	7023700-0
COMBUSTIBLE	G-296	868014
COMBUSTIBLE	G-296-B	868014
BG190T con motor/PERKINS 1006.60TW		
ACEITE	GP-1	7023700-0

MARCA-MODELO-MOTOR MAKE-MODEL-ENGINE	GONHER GONHER	OEM OEM
BRUCE		
EQUIPO		
PQ300 con motor/CUMMINS LTA10		
ACEITE	GP-3000	3318853
PQ600, PQ450, PQ500 con motor/CUMMINS N14		
ACEITE	GP-3000	3318853

MARCA-MODELO-MOTOR MAKE-MODEL-ENGINE	GONHER GONHER	OEM OEM
CARPENTER		
CAMIONES, TRACTOCAMIONES Y AUTOBUSES		
CONVENTIONAL con motor/FORD FD1060 5.9L		
COMBUSTIBLE	GPP-1122	F3HZ-9365-E
AGUA, SISTEMA DE ENFRIAMIENTO	GP-2071W	F3HZ-8A424-C
ACEITE, SELLADO	GP-178	F3HZ-6731-B
CONVENTIONAL con motor/GM V8 366 GASOLINA		
ACEITE	GP-23	PF832
ACEITE	GP-205	25160561
COMBUSTIBLE, CON CARBURADOR	GG-20	5650030
COMBUSTIBLE, CON SISTEMA DE INYECCION DE COMBUSTIBLE	GG-46	25121792
CONVENTIONAL con motor/INTERNATIONAL 7.3L		
DIRECCION	G-162H	1691121C1
DIRECCION	G-169	279294C92
COMBUSTIBLE	G-293	FSR81205
SEPARADOR DE COMBUSTIBLE, CON PURGADOR	GPP-547	1677004C91
ACEITE	GP-3766	1804442c1
COMBUSTIBLE, PRIMARIO	GP-155	1804456C1
AIRE	GA-422	588213C1
AIRE, PRIMARIO	GA-209	476741C1
AIRE, SECUNDARIO	GA-210	482644C1
AIRE	GA-197R	1691027C1
SEPARADOR DE COMBUSTIBLE, ROSCA PARA TAZON	R 60 P	1677004C91
CONVENTIONAL con motor/INTERNATIONAL DT360		
COMBUSTIBLE	GPP-14	FFR8105D
COMBUSTIBLE	G-293	FSR81205
SEPARADOR DE COMBUSTIBLE, CON PURGADOR	GPP-547	1677004C91
ACEITE	GP-88	1811953C1
COMBUSTIBLE	GP-78	1809789C1
SEPARADOR DE COMBUSTIBLE, ROSCA PARA TAZON	R 60 P	1677004C91

SERVICIO PESADO

MARCA-MODELO-MOTOR	GONHER	OEM
MAKE-MODEL-ENGINE	GONHER	OEM

CARPENTER (continuación)

CAMIONES, TRACTOCAMIONES Y AUTOBUSES

CONVENTIONAL con motor/INTERNATIONAL DT408		
COMBUSTIBLE, SEPARADOR DE SOMBUSTIBLE, CON PURGADOR	GPP-547	1677004C91
COMBUSTIBLE, SECUNDARIO	GP-1122	FF5052
AGUA, SISTEMA DE ENFRIAMIENTO	GP-2071W	1822313C1
COMBUSTIBLE	GP-78	1822588C1
ACEITE	GP-152	1819452C1
COMBUSTIBLE, SEPARADOR DE SOMBUSTIBLE, ROSCA PARA TAZON	R 60 P	1677004C91
CONVENTIONAL con motor/INTERNATIONAL DT466		
COMBUSTIBLE	GP-78	1822588C1
CONVENTIONAL con motor/INTERNATIONAL T444E		
COMBUSTIBLE, SEPARADOR DE AGUA, 1998 EN ADELANTE	G-862	1825864C92
COMBUSTIBLE, SEPARADOR DE AGUA, HASTA 1997	G-178	1822631C91
ACEITE	GP-562	1814562C1
CUT-AWAY CHASSIS con motor/GM 5.7L GASOLINA		
ACEITE	GP-205	25160561
AIRE	GA-392	25042562
AIRE	GA-192	6419892
AIRE	GA-413R	15153904
COMBUSTIBLE	GG-46	25121792
COMBUSTIBLE	GG-581	25121801

CARRIER

CAMIONES, TRACTOCAMIONES Y AUTOBUSES

1003 con motor/MERCEDES BENZ OM636		
ACEITE	GP-54	30.00303
COMBUSTIBLE, SECUNDARIO	GP-110	30.00302
COMBUSTIBLE, PRIMARIO	GPP-18	30.00301
1003 con motor/PERKINS 4.108		
ACEITE	G-31	30.00323
ACEITE	GP-54	30.00303
COMBUSTIBLE, SECUNDARIO	GP-110	30.00302
COMBUSTIBLE, PRIMARIO	GPP-18	30.00301
2005A, 6007A con motor/MERCEDES BENZ OM636		
ACEITE	G-31	30.00087
2005A-3 con motor/MERCEDES BENZ OM636		
ACEITE	GP-54	30.00303
COMBUSTIBLE, SECUNDARIO	GP-110	30.00302
COMBUSTIBLE, PRIMARIO	GPP-18	30.00301
230B, 250C, 400C-1 con motor/PERKINS 4.99		
ACEITE	G-31	30.00087
ACEITE	G-836	30.21026
COMBUSTIBLE, PRIMARIO	G-11816	30232
234, 250, 260, 640, 650, 230, 231 con motor/PERKINS 4.99		
ACEITE	G-31	30.00087
ACEITE	G-836	30.21026
COMBUSTIBLE, PRIMARIO	G-11816	30232
250CM con motor/MERCEDES BENZ OM636		
COMBUSTIBLE, PRIMARIO	G-1174	30.00133-01

MARCA-MODELO-MOTOR	GONHER	OEM
MAKE-MODEL-ENGINE	GONHER	OEM

CARRIER (continuación)

CAMIONES, TRACTOCAMIONES Y AUTOBUSES

6000A-3, 6007A-3 con motor/MERCEDES BENZ OM636		
ACEITE	GP-54	30.00303
COMBUSTIBLE, SECUNDARIO	GP-110	30.00302
COMBUSTIBLE, PRIMARIO	GPP-18	30.00301
6008A con motor/KOHLER		
AIRE	GA-7	25.32004
EAGLE PLUS con motor/CARRIER CT4-114		
ACEITE	GP-31	30.00323
COMBUSTIBLE, SECUNDARIO	GP-110	30.00302
COMBUSTIBLE, PRIMARIO	GPP-18	30.00301
EXTRA con motor/CARRIER CT4-114		
ACEITE	GP-31	30.00323.00
COMBUSTIBLE	GP-458	30.01090.01
COMBUSTIBLE, SEPARADOR DE AGUA	GPP-1287	30.01079.01
GENESIS TM 1000/900 con motor/CARRIER CT4-134		
ACEITE	GP-31	30.00323.00
COMBUSTIBLE	GP-458	30.01090.01
COMBUSTIBLE, SEPARADOR DE AGUA	GPP-1287	30.01079.01
HAWK-TGB14 con motor/CASE		
AIRE	GA-7	25.32004
METROBIRD con motor/CARRIER CT1-19		
COMBUSTIBLE	GP-110	30.00302
NDB-40 EAGLE con motor/MERCEDES BENZ OM636		
ACEITE	GP-54	30.00303
COMBUSTIBLE, SECUNDARIO	GP-110	30.00302
COMBUSTIBLE, PRIMARIO	GPP-18	30.00301
NDB-40 EAGLE, NDE-40 GOLDEN EAGLE, NDS-40 FALCON con motor/PERKINS 4.108		
ACEITE	GP-31	30.00323
ACEITE	GP-54	30.00303
COMBUSTIBLE, SECUNDARIO	GP-110	30.00302
COMBUSTIBLE, PRIMARIO	GPP-18	30.00301
PHOENIX con motor/CARRIER CT4-134		
ACEITE	GP-31	30.00323
COMBUSTIBLE, SECUNDARIO	GP-110	30.00302
COMBUSTIBLE, PRIMARIO	GPP-18	30.00301
AIRE, SIN ASPAS	GA-33	P181050
PHOENIX ULTRA con motor/CARRIER CT4-134		
ACEITE, (ALT. 5 13/32 IN)	GP-50	30-00304
PHOENIX XL con motor/CARRIER CT4-134		
ACEITE	GP-31	30.00323.00
COMBUSTIBLE	GP-458	30.01090.01
COMBUSTIBLE, SEPARADOR DE AGUA	GPP-1287	30.01079.01
SPACESAVER con motor/PERKINS 4.108		
ACEITE	GP-31	30.00323
ACEITE	GP-54	30.00303
COMBUSTIBLE, SECUNDARIO	GP-110	30.00302
COMBUSTIBLE, PRIMARIO	GPP-18	30.00301
SUNBIRD con motor/CARRIER CT2-35		
COMBUSTIBLE	GP-110	30.00302

MARCA-MODELO-MOTOR	GONHER	OEM
MAKE-MODEL-ENGINE	GONHER	OEM

CARRIER (continuación)

CAMIONES, TRACTOCAMIONES Y AUTOBUSES

SUPRA 622/644 con motor/CARRIER CT3-44		
COMBUSTIBLE, SECUNDARIO	GP-110	30.00302
ACEITE	GP-490	941172
COMBUSTIBLE	GP-458	30.01090.01
SUPRA 922/944 con motor/CARRIER CT3-69		
ACEITE	GP-31	30.00323.00
COMBUSTIBLE, SECUNDARIO	GP-110	30.00302
COMBUSTIBLE	GP-458	30.01090.01
THUNDERBIRD con motor/CARRIER CT4-114		
ACEITE	GP-31	30.00323
COMBUSTIBLE, SECUNDARIO	GP-110	30.00302
COMBUSTIBLE, PRIMARIO	GPP-18	30.00301
AIRE, SIN ASPAS	GA-33	P181050
UDE ROAD RUNNER con motor/MERCEDES BENZ OM636		
ACEITE	GP-54	30.00303
COMBUSTIBLE, SECUNDARIO	GP-110	30.00302
COMBUSTIBLE, PRIMARIO	GPP-18	30.00301
UDE ROAD RUNNER, 2005A, 6000A, 6000A-2, 6004A-1, 6004A-2, EAGLE con motor/PERKINS 4.108		
ACEITE	GP-31	30.00323
ACEITE	GP-54	30.00303
COMBUSTIBLE, SECUNDARIO	GP-110	30.00302
COMBUSTIBLE, PRIMARIO	GPP-18	30.00301
ULTIMA 53 con motor/CARRIER CT4-134		
ACEITE	GP-31	30.00323.00
COMBUSTIBLE	GP-458	30.01090.01
COMBUSTIBLE, SEPARADOR DE AGUA	GPP-1287	30.01079.01
CARRIER		
GENERADORES		
UDG-AL con motor/MERCEDES BENZ OM636		
ACEITE	GP-54	30.00303
COMBUSTIBLE, SECUNDARIO	GP-110	30.00302
COMBUSTIBLE, PRIMARIO	GPP-18	30.00301
UDG-AL con motor/PERKINS 4.108 DIESEL		
ACEITE	GP-31	30.00323
COMBUSTIBLE, SECUNDARIO	GP-110	30.00302
COMBUSTIBLE, PRIMARIO	GPP-18	30.00301
UDG-BL con motor/MERCEDES BENZ OM636		
ACEITE	GP-54	30.00303
COMBUSTIBLE, SECUNDARIO	GP-110	30.00302
COMBUSTIBLE, PRIMARIO	GPP-18	30.00301
UDG-BL con motor/PERKINS 4.108 DIESEL		
ACEITE	GP-31	30.00323
COMBUSTIBLE, SECUNDARIO	GP-110	30.00302
COMBUSTIBLE, PRIMARIO	GPP-18	30.00301

CARRIER

MOTORES

CT2-29TV		
ACEITE, FLUJO TOTAL (FULL FLOW)	GP-490	941172

MARCA-MODELO-MOTOR MAKE-MODEL-ENGINE	GONHER GONHER	OEM OEM
CARRIER (continuación)		
MOTORES		
CT3-37 con motor/CARRIER CT3-37		
ACEITE	GP-490	941172
CT3-44TV con motor/CARRIER CARRIER CT3-44TV		
COMBUSTIBLE	GP-110	30-00302-00
MODELOS CON PERKINS 4.99 con motor/PERKINS 4.99		
ACEITE	G-836	32578
COMBUSTIBLE, CARTUCHO	G-11816	30232
COMBUSTIBLE	G-296	26560017
COMBUSTIBLE	G-296-B	26560017

CARRIER		
UNIDADES DE REFRIGERACIÓN		
250CM con motor/MERCEDES BENZ OM636		
COMBUSTIBLE, SENCILLO	G-1121	926901
620 con motor/CASE		
COMBUSTIBLE, SECUNDARIO	G-11816	30232
ACEITE, FORD	GP-9	111836
ACEITE	GP-81	111836
640M con motor/MERCEDES BENZ		
COMBUSTIBLE, SECUNDARIO	G-1123	4773515
ADVANTAGE con motores/CARRIER CT4-114, CARRIER CT4-134DI, CARRIER CT4-134TV		
ACEITE, FLUJO TOTAL DEL MOTOR (ENGINE FULL FLOW)	GP-31	30-00323-00
COMBUSTIBLE	GP-110	30-00302-00
COMBUSTIBLE	GP-458	30-01079-01
AIRE, SIN ASPAS	GA-33	66U12155
AIRE	GA-888R	30-00430-22
EAGLE con motores/CARRIER CT4-114, CARRIER CT4114DI, CARRIER CT4-134DI, CARRIER CT4-134TV		
ACEITE, FLUJO TOTAL DEL MOTOR (ENGINE FULL FLOW)	GP-31	30-00323-00
COMBUSTIBLE	GP-110	30-00302-00
COMBUSTIBLE	GP-458	30-01079-01
AIRE, SIN ASPAS	GA-33	66U12155
EXTRA con motor/CARRIER CT4-114TV		
ACEITE, (ALT. 5 13/32 IN)	GP-50	30-00304
COMBUSTIBLE, SEPARADOR DE AGUA	GP-1224	30-01090-00
AIRE	GA-888R	30-00430-22
AIRE	GA-2803T	30-01077-01
EXTRA XT con motor/CARRIER CT4-114TV		
AIRE, RADIAL	GA-880R	30-00426-20
GEN SET 69UG con motor/GEN SET 69UG		
ACEITE	GP-31	30-00323-00
GENESIS R90 MULTI-TEMP con motor/CARRIER CT3-69		
ACEITE, LUBRICACION DEL MOTOR	GP-31	30-00323-00
COMBUSTIBLE	GP-110	30-00302-00
COMBUSTIBLE	GP-458	30-01079-01
KING BIRD TDS295N4 con motor/CASE		
ACEITE	GP-490	941172

MARCA-MODELO-MOTOR MAKE-MODEL-ENGINE	GONHER GONHER	OEM OEM
CARRIER (continuación)		
UNIDADES DE REFRIGERACIÓN		
MAXIMA con motor/MAXIMA		
ACEITE, LUBRICACION DEL MOTOR	GP-462	30-50327-00
ACEITE, LUBRICACION DEL MOTOR	GP-31	30-00323-00
COMBUSTIBLE	GP-110	30-00302-00
OPTIMA con motor/CARRIER CT4-911TV		
ACEITE, (ALT. 5 13/32 IN)	GP-50	30-00304
COMBUSTIBLE, SEPARADOR DE AGUA	GP-1224	30-01090-00
AIRE	GA-888R	30-00430-22
AIRE	GA-2803T	30-01077-01
PHOENIX ADVANTAGE con motor/CASE		
ACEITE	GP-31	30.00323
SUPRA 322 con motor/CARRIER CT2-29TV		
ACEITE, FLUJO TOTAL (FULL FLOW)	GP-490	941172
SUPRA 422 con motor/CARRIER CT2-29TV		
ACEITE, DERIVACION (BY-PASS) (ALT. 5 13/32 IN)	GP-50	30-00304-00
COMBUSTIBLE, SEPARADOR DE AGUA	GP-1224	30-01090-05
ACEITE, FLUJO TOTAL (FULL FLOW)	GP-490	941172
DIESEL	GP-458	30-01079-01
SUPRA 622, SUPRA 644, SUPRA 722, SUPRA 744 con motor/CARRIER CT3-44TV		
ACEITE, FLUJO TOTAL DEL MOTOR (ENGINE FULL FLOW)	GP-31	30-00323-00
COMBUSTIBLE	GP-110	30-00302-00
ACEITE, FLUJO TOTAL DEL MOTOR (ENGINE FULL FLOW)	GP-490	941172
COMBUSTIBLE	GP-458	30-01079-01
SUPRA 622, SUPRA 722 con motor/KUBOTA D722		
COMBUSTIBLE, SEPARADOR DE AGUA	GP-1224	30-01090-00
SUPRA 922 con motor/CARRIER CT3-69TV		
ACEITE, MOTOR	GP-31	30-00323-00
DIESEL	GP-110	30-00302-00
COMBUSTIBLE, SEPARADOR DE AGUA	GP-1224	30-01090-05
DIESEL	GP-458	30-01079-01
SUPRA 944 con motor/CARRIER CT3-69TV		
ACEITE, LUBRICACION DEL MOTOR	GP-31	30-00323-00
COMBUSTIBLE	GP-110	30-00302-00
COMBUSTIBLE	GP-458	30-01079-01
THUNDERBIRD NDJ con motor/KUBOTA 4 CYL		
ACEITE	GP-31	30.00323
COMBUSTIBLE, SECUNDARIO	GP-110	30.00302
COMBUSTIBLE, PRIMARIO	GPP-18	30.00301
TM 1000 MULTI-TEMP, TM 900 MULTI-TEMP con motor/CARRIER CT4-134DI		
ACEITE, LUBRICACION DEL MOTOR	GP-31	30-00450-00
ULTIMA 53-STEALTH con motor/KUBOTA		
COMBUSTIBLE	GP-458	30.01090.01

MARCA-MODELO-MOTOR MAKE-MODEL-ENGINE	GONHER GONHER	OEM OEM
CARRIER (continuación)		
UNIDADES DE REFRIGERACIÓN		
ULTIMA con motor/CARRIER CT4-13DI		
ACEITE, MOTOR	GP-31	30-00323-00
SEPARADOR DE COMBUSTIBLE	GP-1224	30-01090-05
AIRE	GA-888R	30-00430-22
AIRE	GA-2803T	30-01077-01
ULTIMA XTC RAIL EDITION, VECTOR 1800 MULTI-TEMP, ULTRA XL STANDBY, ULTRA XTC RAIL EDITION con motor/CARRIER CT4-134DI		
ACEITE, LUBRICACION DEL MOTOR	GP-31	30-00450-00
ULTIMA XTC, ULTRA XT, ULTRA XTC con motor/CARRIER CT4-134DI		
ACEITE, LUBRICACION DEL MOTOR	GP-31	30-00450-00
ULTRA con motores/CARRIER CT4-134DI, CARRIER CT4-134TV		
ACEITE, FLUJO TOTAL (FULL FLOW)	GP-31	30-00323-00
ACEITE, DERIVACION (BY PASS) (ALT. 5 13/32 IN)	GP-50	30-00304-00
COMBUSTIBLE, SEPARADOR DE AGUA	GP-1224	30-01090-05
DIESEL	GP-458	30-01079-01
AIRE	GA-888R	30-00430-22
AIRE	GA-2803T	30-01077-01

CASE		
APLANADORAS		
602B con motor/CASE 4-390		
COMBUSTIBLE, SECUNDARIO	GP-1122	J903640
COMBUSTIBLE, PRIMARIO	GPP-18	J903410
ACEITE	GP-390	J908616
AIRE, PRIMARIO	GAK-1532	A173290
865 con motor/CUMMINS		
COMBUSTIBLE, SECUNDARIO	GP-1122	J903640
AGUA	GP-1011Q	3315115
ACEITE	GP-3000	J919562
COMBUSTIBLE, PRIMARIO	GPP-18	A58712

CASE		
BOMBAS		
P-336 PARA CONCRETO con motor/A DIESEL		
ACEITE	GP-1	A146696
COMBUSTIBLE, PRIMARIO	GPP-18	A58712
AIRE	GA-20	D50938
AIRE	GAK-20	D50938
P504 PARA CONCRETO con motor/CASE 504		
ACEITE	GP-69	A75294
T-336 PARA CONCRETO con motor/CASE 336		
ACEITE	GP-1	A146696
ACEITE	GP-69	A75294
COMBUSTIBLE, PRIMARIO	GPP-18	A58712
AIRE	GA-403	D37975
AIRE	GAK-403	D37975
T-50 PARA CONCRETO, TB-50 PARA CONCRETO con motor/A DIESEL		
ACEITE	GP-1	A146696
COMBUSTIBLE, PRIMARIO	GPP-18	A39868
COMBUSTIBLE, SECUNDARIO	GPP-19	A39867

SERVICIO PESADO

MARCA-MODELO-MOTOR MAKE-MODEL-ENGINE	GONHER GONHER	OEM OEM	MARCA-MODELO-MOTOR MAKE-MODEL-ENGINE	GONHER GONHER	OEM OEM	MARCA-MODELO-MOTOR MAKE-MODEL-ENGINE	GONHER GONHER	OEM OEM
CASE (continuación)			CASE (continuación)			CASE (continuación)		
BOMBAS			CARGADORAS			CARGADORAS		
T-604 PARA CONCRETO, TB-604 PARA CONCRETO con motor/A DIESEL			1150 con motor/CASE A451D			1187 DE TRONCOS CON ORUGAS, 1187B DE TRONCOS CON ORUGAS con motor/DETROIT DIESEL		
ACEITE	GP-69	A75294	COMBUSTIBLE, SECUNDARIO	G-1173	A7627	ACEITE	G-33	L31230
T-80 PARA CONCRETO con motor/A DIESEL			ACEITE	GP-69	A58672	COMBUSTIBLE	G-1174	A19578
ACEITE	GP-5	A64453	COMBUSTIBLE, PRIMARIO	GPP-18	A58712	AIRE, PRIMARIO	GA-360	S231996
ACEITE	GP-54	A58672	AIRE	GA-403	D37975	AIRE, SECUNDARIO	GA-361	N6660
ACEITE	GP-69	A75294	AIRE	GAK-403	D37975	1187C DE TRONCOS CON ORUGAS con motor/CASE 8.3L SERIE 44487829 EN ADELANTE		
COMBUSTIBLE, PRIMARIO	GPP-18	A58712	1150 E con motor/CASE 6-830			COMBUSTIBLE, PRIMARIO	GP-1122	P150564
AIRE	GA-24	L30937	COMBUSTIBLE	GP-1122	V37545	ACEITE	GP-43	A77537
TB-336 PARA CONCRETO con motor/CASE 336			ACEITE	GP-43	A77537	COMBUSTIBLE, PRIMARIO	GPP-18	A58712
ACEITE	GP-1	A146696	AGUA	GP-2071W	A77544	AIRE, PRIMARIO	GA-360	S231996
ACEITE	GP-69	A75294	COMBUSTIBLE, PRIMARIO	GPP-18	A58712	AIRE, SECUNDARIO	GA-361	N6660
COMBUSTIBLE, PRIMARIO	GPP-18	A58712	1150B con motor/CASE 451BD			1450 con motor/CASE 504		
AIRE	GA-403	D37975	ACEITE	GP-69	A75294	ACEITE	GP-69	A75294
AIRE	GAK-403	D37975	COMBUSTIBLE, PRIMARIO	GPP-18	A58712	COMBUSTIBLE, PRIMARIO	GPP-18	A58712
TB-80 PARA CONCRETO con motor/A DIESEL			AIRE	GA-20	L 33913	AIRE	GA-20	L33913
ACEITE	GP-5	A64453	AIRE	GAK-20	L 33913	AIRE	GAK-20	L33913
ACEITE	GP-54	A58672	1150C SOBRE ORUGAS con motor/A DIESEL			1450B, 1455B con motor/CASE A504BDT		
ACEITE	GP-69	A75294	ACEITE	GP-69	A75294	HIDRAULICO	GP-66	A44081
COMBUSTIBLE, PRIMARIO	GPP-18	A58712	1150D con motor/A DIESEL			COMBUSTIBLE, PRIMARIO	GPP-18	A58712
AIRE	GA-24	L30937	ACEITE	GP-54	A44081	AIRE, PRIMARIO	GA-360	S231996
CASE			1150G con motor/A DIESEL			AIRE, SECUNDARIO	GA-361	N6660
CAMIONES, TRACTOCAMIONES Y AUTOBUSES			COMBUSTIBLE, SECUNDARIO	GP-1122	J903640	1455B SOBRE ORUGAS con motor/CASE 504		
330 ARTICULADO con motor/CUMMINS MTA11			1155D con motor/A DIESEL			ACEITE	GP-54	A44081
COMBUSTIBLE	GPP-1000	A184776	ACEITE	GP-54	A44081	COMBUSTIBLE, PRIMARIO	GPP-18	A58712
CASE			1155D SOBRE ORUGA con motor/CASE 830			AIRE, PRIMARIO	GA-360	S231996
CARGADORAS			COMBUSTIBLE	GP-1122	V37545	AIRE, SECUNDARIO	GA-361	P850561
1000 RETROEXCAVADORA con motor/CASE 301			ACEITE	GP-43	A77537	150 UNI-CARGADORAS, 150M UNI-CARGADORAS con motor/A DIESEL		
ACEITE	G-6	A42274	AGUA	GP-2071W	A77544	AIRE	GA-33	D48198
COMBUSTIBLE	G-1173	A7627	COMBUSTIBLE, PRIMARIO	GPP-18	A58712	1530 UNI-CARGADORAS, 1530B UNI-CARGADORAS, 1537 UNI-CARGADORAS con motor/WISCONSIN VG4D		
AIRE	GA-403	D36261	1155E con motor/CASE 4-390			AIRE, PRIMARIO SIN ASPAS	GA-24	L30937
AIRE, PRIMARIO	GAK-403	D37975	COMBUSTIBLE	GP-1122	V37545	1700, ARRASTRADOR Y GUIADOR con motor/A DIESEL		
1000 RETROEXCAVADORA con motor/CASE A284			COMBUSTIBLE, PRIMARIO	GPP-18	A58712	ACEITE	GP-1	A29891
ACEITE	G-6	A42274	ACEITE	GP-390	J908616	COMBUSTIBLE, PRIMARIO	GPP-18	A39868
COMBUSTIBLE, SECUNDARIO	G-1173	A7627	1155E con motor/CASE 6-830			COMBUSTIBLE, SECUNDARIO	GPP-19	A39867
AIRE	GA-403	D36261	COMBUSTIBLE	GP-1122	V37545	AIRE, SIN ASPAS	GA-33	D48198
AIRE, PRIMARIO	GAK-403	D37975	ACEITE	GP-43	A77537	1737 UNI-CARGADORAS con motor/A DIESEL		
1000 RETROEXCAVADORA con motor/CHRYSLER V8-318 A GAS			AGUA	GP-2071W	A77544	ACEITE	GP-1	A146696
ACEITE	GP-1	29891	COMBUSTIBLE, PRIMARIO	GPP-18	A58712	1740 UNI-CARGADORAS con motor/A DIESEL		
AIRE	GA-403	36261	1155E con motor/CASE 6T-590			ACEITE	GP-1	A146696
AIRE, PRIMARIO	GAK-403	D37975	COMBUSTIBLE	GP-1122	V37545	COMBUSTIBLE, PRIMARIO	GPP-18	A39868
1000 RETROEXCAVADORA con motores/CASE 709, CASE 719			COMBUSTIBLE, PRIMARIO	GPP-18	A58712	COMBUSTIBLE, SECUNDARIO	GPP-19	A39867
COMBUSTIBLE, SECUNDARIO	G-1173	A7627	ACEITE	GP-178	J908615	AIRE	GA-16	A42274
1000B SOBRE ORUGAS, 1000D SOBRE ORUGAS con motor/A DIESEL			1187 DE TRONCOS CON ORUGAS con motor/CASE 504			AIRE, SIN ASPAS	GA-33	D48198
ACEITE	G-33	L31230	ACEITE	GP-69	A75294	AIRE	GAK-16	A42274
1000C SOBRE ORUGAS con motor/A DIESEL			1187 DE TRONCOS CON ORUGAS, 1187B DE TRONCOS CON ORUGAS con motor/CASE			1816 UNI-CARGADORAS, 1816B UNI-CARGADORAS con motor/A DIESEL		
ACEITE	G-31	010070AB	ACEITE	GP-54	A44081	AIRE	GA-7	D66337
ACEITE	G-33	L31230	AIRE, PRIMARIO	GA-360	S231996	1816C UNI-CARGADORAS con motor/ONAN		
COMBUSTIBLE	G-1173	A7627	AIRE, SECUNDARIO	GA-361	N6660	ACEITE	GP-81	D62845
1086B CRUZ-AIR DE TRONCOS con motor/CASE 6T-590			1187 DE TRONCOS CON ORUGAS con motor/A DIESEL			1818 UNI-CARGADORAS con motor/A DIESEL		
COMBUSTIBLE, SECUNDARIO	GP-1122	V37545	ACEITE	GP-81	D62845	ACEITE	GP-81	D62845
COMBUSTIBLE, PRIMARIO	GPP-18	A58712						
ACEITE	GP-178	J908615						

MARCA-MODELO-MOTOR MAKE-MODEL-ENGINE	GONHER GONHER	OEM OEM	MARCA-MODELO-MOTOR MAKE-MODEL-ENGINE	GONHER GONHER	OEM OEM	MARCA-MODELO-MOTOR MAKE-MODEL-ENGINE	GONHER GONHER	OEM OEM
CASE (continuación)			CASE (continuación)			CASE (continuación)		
CARGADORAS			CARGADORAS			CARGADORAS		
1825 UNI-CARGADORAS con motor/GASOLINA			1845C UNI-CARGADORAS con motor/CASE 4-390			380CK RETROEXCAVADORA, 380GP RETROEXCAVADORA, 380LL RETROEXCAVADORA con motor/DAVID BROWN		
HIDRAULICO	GP-761H	D122562	COMBUSTIBLE, SECUNDARIO	GP-1122	J903640	COMBUSTIBLE, SECUNDARIO	G-296	960911
1825 UNI-CARGADORAS con motor/KUBOTA D1105E			COMBUSTIBLE, SECUNDARIO	GPP-1122	J843760	COMBUSTIBLE, SECUNDARIO	G-296-B	960911
ACEITE	GP-462	1959198-C1	COMBUSTIBLE, PRIMARIO	GPP-18	A39868	ACEITE	GP-171	K200037
1825 UNI-CARGADORAS con motor/KUBOTA V1110			ACEITE	GP-390	J908616	40B DE TRONCOS con motor/CASE		
ACEITE	GP-149	1959198C1	HIDRAULICO	GP-761H	D126922	ACEITE	GP-5	A64453
1825B con motor/KUBOTA V1505			AIRE, PRIMARIO	GAK-1532	A173290	COMBUSTIBLE, SECUNDARIO	GPP-18	A41745
ACEITE	GP-462	125282A1	310 con motor/CASE G148B			AIRE	GA-20	L33913
COMBUSTIBLE, SEPARADOR DE AGUA	GPP-1122	J843760	ACEITE	GP-1	A146696	AIRE	GAK-20	L33913
HIDRAULICO	GP-761H	D122562	310D con motor/CASE G148D			40B DE TRONCOS con motor/DETROIT DIESEL		
1830 UNI-CARGADORAS con motor/A DIESEL			ACEITE	GP-1	A146696	ACEITE	G-33	L31230
ACEITE	GP-81	D62845	310E con motores/CASE G148D, CASE G188D			COMBUSTIBLE, SECUNDARIO	G-1173	A19579
1835 con motor/CASE G188D			ACEITE	GP-1	A146696	COMBUSTIBLE	G-1174	A19578
ACEITE	GP-1	A29891	310F, 310G con motor/CASE G188D			AIRE	GA-24	S221313
COMBUSTIBLE, PRIMARIO	GPP-18	A39868	ACEITE	GP-1	A146696	40XT, ARRASTRADOR Y GUIADOR con motor/CASE 4-390		
COMBUSTIBLE, SECUNDARIO	GPP-19	A39867	AIRE	GA-16	A7627	COMBUSTIBLE	GPP-1122	J931062
AIRE	GA-16	A42274	AIRE	GAK-16	F84998	ACEITE	GP-390	J908616
AIRE	GAK-16	A42274	310G SOBRE ORUGAS con motor/A DIESEL			ACEITE	GP-761H	D122562
1835 UNI-CARGADORAS, 1835B UNI-CARGADORAS, 1845B UNI-CARGADORAS con motor/CASE G188D			ACEITE	GP-1	A146696	410 con motor/CASE 422/M2		
ACEITE	GP-1	A29891	320 con motor/A DIESEL			ACEITE, 8-12 PSI	GP-58	87409203
COMBUSTIBLE, PRIMARIO	GPP-18	A39868	COMBUSTIBLE, SECUNDARIO	G-1173	A7627	COMBUSTIBLE, SEPARADOR DE AGUA	GPP-1122	87039679
COMBUSTIBLE, SECUNDARIO	GPP-19	A39867	320B con motor/A DIESEL			GASOLINA	GG-124	9611973
AIRE	GA-16	A42274	COMBUSTIBLE, SECUNDARIO	G-1173	A7627	4125, 4135 con motor/A GASOLINA		
AIRE	GAK-16	A42274	321D con motor/PERKINS 1004.42			ACEITE	GP-54	73321-C1
1835C UNI-CARGADORAS con motor/CONTINENTAL			ACEITE	GP-1	A146696	4130, 4140 con motor/A GASOLINA		
ACEITE	GP-1	A29891	350 con motor/A DIESEL			ACEITE	GP-54	73321-C1
COMBUSTIBLE	G-295	P779297	ACEITE	GP-1	A146696	ACEITE	GP-3600	75318-C1
ACEITE	GP-761H	D122562	COMBUSTIBLE, PRIMARIO	GPP-18	A58712	AIRE	GA-33	D48198
1835C UNI-CARGADORAS, 1838 UNI-CARGADORAS, 1840 UNI-CARGADORAS con motor/CASE 4-390			COMBUSTIBLE, SECUNDARIO	GPP-19	A151281	4136 con motor/A DIESEL		
COMBUSTIBLE, SECUNDARIO	GP-1122	J903640	AIRE	GA-33	H425256	ACEITE	GP-54	73321-C1
COMBUSTIBLE, SECUNDARIO	GPP-1122	P150564	350B SOBRE ORUGAS con motor/CASE G188			4140 con motor/A DIESEL		
COMBUSTIBLE, PRIMARIO	GPP-18	A58712	ACEITE	GP-1	A146696	ACEITE	GP-54	73321-C1
ACEITE	GP-390	J908616	COMBUSTIBLE, PRIMARIO	GPP-18	A151281	4150 con motores/ISUZU, MAZDA A GASOLINA		
HIDRAULICO	GP-761H	D122562	COMBUSTIBLE, SECUNDARIO	GPP-19	A151281	ACEITE	GP-54	73321-C1
AIRE, PRIMARIO	GAK-1532	A173290	HIDRAULICO	GP-761H	N9025	420 con motor/CASE 422T/M2		
1838 con motor/KUBOTA V2204			350B SOBRE ORUGAS con motor/CASE G188D			ACEITE, 8-12 PSI	GP-58	87409203
COMBUSTIBLE, SECUNDARIO	GPP-1122	J843760	ACEITE	GP-1	A146696	COMBUSTIBLE, SEPARADOR DE AGUA	GPP-1122	87039679
ACEITE	GP-171	K200037	COMBUSTIBLE, PRIMARIO	GPP-18	A151281	GASOLINA	GG-124	9611973
ACEITE	GP-761H	D122562	COMBUSTIBLE, SECUNDARIO	GPP-19	A151281	420C SOBRE ORUGAS con motor/A DIESEL		
1845 UNI-CARGADORAS con motor/CASE G188D			350D con motor/A DIESEL			ACEITE	GP-1	A29891
ACEITE	GP-1	A29891	ACEITE	GP-1	A146696	420CT con motor/CASE 422T/M2		
COMBUSTIBLE, PRIMARIO	GPP-18	A39868	COMBUSTIBLE, PRIMARIO	GPP-18	A58712	ACEITE, 8-12 PSI	GP-58	87409203
COMBUSTIBLE, SECUNDARIO	GPP-19	A39867	COMBUSTIBLE, SECUNDARIO	GPP-19	A151281	COMBUSTIBLE, SEPARADOR DE AGUA	GPP-1122	87039679
HIDRAULICO	GP-761H	D126922	AIRE	GA-33	H425256	GASOLINA	GG-124	9611973
AIRE	GA-16	A42274	380B con motor/A DIESEL			425 con motor/A DIESEL		
AIRE	GAK-16	A42274	COMBUSTIBLE, SECUNDARIO	GPP-1122	1967094-C1	COMBUSTIBLE, SECUNDARIO	G-1173	A7627
1845 UNI-CARGADORAS, 1845S UNI-CARGADORAS con motor/CASE 159G			AIRE	GA-16	1265510-C1	430 con motor/CASE 445/M2		
ACEITE	GP-1	A146696	AIRE	GAK-16	1265510-C1	COMBUSTIBLE, SEPARADOR DE AGUA	GPP-1122	87803194
AIRE	GA-16	A42274						
AIRE	GAK-16	A42274						

SERVICIO PESADO

MARCA-MODELO-MOTOR MAKE-MODEL-ENGINE	GONHER GONHER	OEM OEM	MARCA-MODELO-MOTOR MAKE-MODEL-ENGINE	GONHER GONHER	OEM OEM	MARCA-MODELO-MOTOR MAKE-MODEL-ENGINE	GONHER GONHER	OEM OEM
CASE (continuación)			CASE (continuación)			CASE (continuación)		
CARGADORAS			CARGADORAS			CARGADORAS		
430 SCATBACK con motor/WISCONSIN			480B RETROEXCAVADORA con motores/CASE G148B, CASE G188D			530CK RETROEXCAVADORA con motor/A DIESEL		
AIRE, SIN ASPAS	GA-33	D48198	ACEITE	GP-1	A146696	ACEITE	GP-1	A29891
			HIDRAULICO	GP-761H	N9025	550H con motor/CASE 4-390		
430CK RETROEXCAVADORA con motor/A DIESEL			AIRE	GA-16	F84998	COMBUSTIBLE, SECUNDARIO	GP-1122	J903640
ACEITE	GP-1	A146696	AIRE	GAK-16	F84998	COMBUSTIBLE, SEPARADOR DE AGUA, PRIMARIO	GPP-18	J930942
						ACEITE	GP-390	J934429
440, 445 con motor/CASE 445T/M2			480C RETROEXCAVADORA con motor/A DIESEL			HIDRAULICO	GP-761H	1346028-C1
COMBUSTIBLE, SEPARADOR DE AGUA	GPP-1122	87803194	ACEITE	GP-1	A146696	AIRE, RADIAL PRIMARIO	GA-853R	222421A1
ACEITE	GP-737	87803261	COMBUSTIBLE, PRIMARIO	GPP-18	A58712			
AIRE, RADIAL PRIMARIO	GA-853R	222421A1	COMBUSTIBLE, SECUNDARIO	GPP-19	A39867	570L con motor/CASE 3.9L		
			HIDRAULICO	GP-761H	N9025	COMBUSTIBLE, SECUNDARIO	GP-1122	J903640
440CT con motor/CASE 445T/M2			AIRE	GA-16	F84998	COMBUSTIBLE, SECUNDARIO	GPP-1122	P150564
COMBUSTIBLE, SEPARADOR DE AGUA	GPP-1122	87803194	AIRE	GAK-16	F84998	COMBUSTIBLE, PRIMARIO	GPP-18	A151281
ACEITE	GP-737	87803261				ACEITE	GP-390	J908616
AIRE, RADIAL PRIMARIO	GA-853R	222421A1	480CK RETROEXCAVADORA con motor/CASE G148B			HIDRAULICO	GP-761H	N9025
			ACEITE	GP-1	A146696	GASOLINA, PLASTICO	GG-5	D145357
445CT, 450CT con motor/CASE 445T/M2						GASOLINA, METALICO	GG-5 L	D145357
COMBUSTIBLE, SEPARADOR DE AGUA	GPP-1122	87803194	480CK RETROEXCAVADORA con motor/CASE G188D					
			ACEITE	GP-1	A146696	570L XT con motores/CASE 4-390, CASE 4T-390		
450 con motor/A DIESEL			COMBUSTIBLE, PRIMARIO	GPP-18	A151281	COMBUSTIBLE, SEPARADOR DE AGUA	GPP-1122	87803194
ACEITE	GP-1	A146696	COMBUSTIBLE, SECUNDARIO	GPP-19	A151281	AGUA, REFRIGERANTE	GP-2071W	A151931
COMBUSTIBLE, PRIMARIO	GPP-18	A58712	HIDRAULICO	GP-761H	N9025	ACEITE	GP-390	J934429
COMBUSTIBLE, SECUNDARIO	GPP-19	A39867				HIDRAULICO	GP-761H	N9025
AIRE	GA-16	F84998	480D, 480LL con motor/CASE G188D			AIRE, RADIAL PRIMARIO (CON TURBO)	GA-853R	222421A1
AIRE	GA-33	D48198	ACEITE	GP-1	A146696			
AIRE	GAK-16	F84998	COMBUSTIBLE, PRIMARIO	GPP-18	A151281	570MXT con motores/CASE 4-390, CASE 4T-390		
			COMBUSTIBLE, SECUNDARIO	GPP-19	A151281	COMBUSTIBLE, SEPARADOR DE AGUA	GPP-1122	J286503
450, 465 con motor/CASE 445T/M2			HIDRAULICO	GP-761H	N9025	ACEITE	GP-390	J934429
COMBUSTIBLE, SEPARADOR DE AGUA	GPP-1122	87803194	AIRE	GA-16	A42274	HIDRAULICO	GP-761H	N9025
			AIRE	GAK-16	A42274	AIRE, RADIAL PRIMARIO (CON TURBO)	GA-853R	222421A1
450B con motor/CASE G207D						570XLT SERIE 2 RETROEXCAVADORA con motor/CUMMINS 4T-390		
ACEITE	GP-1	A146696	480E, 480E-LL, 480F, 480F-LL con motor/CASE 4-390			COMBUSTIBLE, SECUNDARIO	GPP-1122	P150564
COMBUSTIBLE, PRIMARIO	GPP-18	A151281	COMBUSTIBLE, SECUNDARIO	GP-1122	J903640			
COMBUSTIBLE, SECUNDARIO	GPP-19	A39867	COMBUSTIBLE, PRIMARIO	GPP-18	A151281	580 CK RETROEXCAVADORA con motor/CASE G188D		
			ACEITE	GP-390	J908616	ACEITE	GP-1	A29891
450B SOBRE ORUGAS con motor/CASE 207			AIRE, PRIMARIO	GAK-1532	A-173290	COMBUSTIBLE, PRIMARIO	GPP-18	A151281
ACEITE	GP-1	A146696				COMBUSTIBLE, SECUNDARIO	GPP-19	A151281
COMBUSTIBLE, PRIMARIO	GPP-18	A151281	500LK con motores/A DIESEL, A GASOLINA			AIRE	GA-16	A42274
COMBUSTIBLE, SECUNDARIO	GPP-19	A151281	ACEITE	GP-1	A29891	AIRE	GAK-16	A42274
455B con motor/CASE G207D			521D con motor/CASE 445TA/M2			580 RETROEXCAVADORA con motor/A DIESEL		
ACEITE	GP-1	A146696	COMBUSTIBLE, SEPARADOR DE AGUA	GPP-1122	87803194	COMBUSTIBLE, SECUNDARIO	G-296	3044506R93
COMBUSTIBLE, PRIMARIO	GPP-18	A151281				ACEITE	GP-34	A41725
COMBUSTIBLE, SECUNDARIO	GPP-19	A39867	521D con motor/CASE 4TAA390			COMBUSTIBLE, SECUNDARIO	G-296-B	3044506R93
			COMBUSTIBLE, SECUNDARIO	GPP-1122	P150564	AIRE	GA-16	F84998
455B SOBRE ORUGAS con motor/CASE 207						AIRE	GA-33	D48198
ACEITE	GP-1	A146696	521DXT con motor/CASE 445TA/M2			AIRE	GAK-16	F84998
COMBUSTIBLE, PRIMARIO	GPP-18	A151281	COMBUSTIBLE, SEPARADOR DE AGUA	GPP-1122	87803194			
COMBUSTIBLE, SECUNDARIO	GPP-19	A151281				580 SUPER D, 580D con motor/CASE G207D		
			521DXT con motor/CASE 4TAA390			ACEITE	GP-1	A29891
455C con motor/CASE 4-390			COMBUSTIBLE, SECUNDARIO	GPP-1122	P150564	COMBUSTIBLE, PRIMARIO	GPP-18	A151281
COMBUSTIBLE, SECUNDARIO	GP-1122	J903640				COMBUSTIBLE, SECUNDARIO	GPP-19	A151281
COMBUSTIBLE, PRIMARIO	GPP-18	A58712	530 SERIES con motor/A DIESEL			HIDRAULICO	GP-761H	N9025
ACEITE	GP-390	J908616	ACEITE	GP-1	A146696	AIRE	GA-16	A42274
AIRE, PRIMARIO	GAK-1532	N6778				AIRE	GAK-16	A42274
			521DXT con motor/CASE 4TAA390			AIRE, PRIMARIO	GAK-1532	A173290
475 RETROEXCAVADORA con motores/CASE 301D, CASE 336D			COMBUSTIBLE, SECUNDARIO	GPP-1122	P150564			
ACEITE	GP-1	A29891				580 SUPER E RETROEXCAVADORA con motor/CUMMINS 4-390		
COMBUSTIBLE, PRIMARIO	GPP-18	A39868	530 SERIES con motor/A DIESEL			COMBUSTIBLE, SECUNDARIO	GP-1122	J931062
AIRE	GA-403	D37975	ACEITE	GP-1	A146696	COMBUSTIBLE, SECUNDARIO	GPP-1122	P150564
AIRE	GAK-403	D37975						

MARCA-MODELO-MOTOR MAKE-MODEL-ENGINE	GONHER GONHER	OEM OEM	MARCA-MODELO-MOTOR MAKE-MODEL-ENGINE	GONHER GONHER	OEM OEM	MARCA-MODELO-MOTOR MAKE-MODEL-ENGINE	GONHER GONHER	OEM OEM
CASE (continuación)			CASE (continuación)			CASE (continuación)		
CARGADORAS			CARGADORAS			CARGADORAS		
COMBUSTIBLE, PRIMARIO	GPP-18	A151281	580C RETROEXCAVADORA con motor/A DIESEL			ACEITE	GP-390	J-908616
ACEITE	GP-390	J908616	ACEITE	GP-1	A37189	AIRE	GAK-1532	A-173290
HIDRAULICO	GP-761H	N9025	COMBUSTIBLE, PRIMARIO	GPP-18	A39868	590 SUPER L con motor/CASE 3.9L		
AIRE	GAK-1532	A-173290	COMBUSTIBLE, SECUNDARIO	GPP-19	A39867	COMBUSTIBLE, SECUNDARIO	GP-1122	J903640
GASOLINA, PLASTICO	GG-5	D139225	HIDRAULICO	GP-761H	N9025	COMBUSTIBLE, SECUNDARIO	GPP-1122	P150564
GASOLINA, METALICO	GG-5 L	D139225	AIRE	GA-16	A42274	COMBUSTIBLE, PRIMARIO	GPP-18	A58712
580 SUPER K con motores/CUMMINS 4B3.9, CUMMINS 4BT3.9			AIRE	GAK-16	A42274	ACEITE	GP-390	J908616
COMBUSTIBLE, SECUNDARIO	GP-1122	J903640	580F RETROEXCAVADORA con motor/A DIESEL			GASOLINA, PLASTICO	GG-5	D145357
COMBUSTIBLE, SECUNDARIO	GPP-1122	P150564	ACEITE	GP-1	G45306	GASOLINA, METALICO	GG-5 L	D145357
COMBUSTIBLE, PRIMARIO	GPP-18	A58712	COMBUSTIBLE, SECUNDARIO	G-296	3044506R93	590 SUPER L RETROEXCAVADORA con motor/CUMMINS 4T-390		
ACEITE	GP-390	J908616	ACEITE	GP-34	A57857	COMBUSTIBLE, PRIMARIO	GPP-18	A151281
HIDRAULICO	GP-761H	N9025	COMBUSTIBLE, SECUNDARIO	G-296-B	3044506R93	590 SUPER L SERIE 2 RETROEXCAVADORA con motor/A DIESEL		
AIRE, PRIMARIO	GAK-1532	N6778	AIRE	GA-16	D72854	COMBUSTIBLE, SECUNDARIO	GPP-1122	J931062
GASOLINA, PLASTICO	GG-5	D145357	AIRE	GA-33	D48198	590 SUPER L SERIES II con motor/CUMMINS 3.9L		
GASOLINA, METALICO	GG-5 L	D145357	AIRE	GAK-16	D72854	COMBUSTIBLE, SEPARADOR DE AGUA	GPP-1122	J931062
580 SUPER L con motor/CASE 4BT3.9			580G RETROEXCAVADORA con motor/A DIESEL			ACEITE	GP-390	J934429
COMBUSTIBLE, SEPARADOR DE AGUA	GPP-1122	J931062	ACEITE	GP-1	G45306	HIDRAULICO	GP-761H	D149921
ACEITE	GP-390	J934429	COMBUSTIBLE, SECUNDARIO	G-296	3044506R93	AIRE, RADIAL PRIMARIO	GA-853R	222421A1
HIDRAULICO	GP-761H	N9025	ACEITE	GP-34	A57857	590 SUPER M con motor/CASE 445T (4.5L)		
AIRE, RADIAL PRIMARIO (CON TURBO)	GA-853R	222421A1	COMBUSTIBLE, SECUNDARIO	G-296-B	3044506R93	COMBUSTIBLE, SEPARADOR DE AGUA	GPP-1122	87803194
580 SUPER L SERIES II con motor/CASE 4BT3.9			ACEITE	GP-171	K200037	ACEITE	GP-737	87803261
COMBUSTIBLE, SECUNDARIO	GPP-1122	J931062	HIDRAULICO	GP-761H	N9025	HIDRAULICO	GP-761H	N9025
ACEITE	GP-390	J908616	AIRE	GA-16	E43790	AIRE, PRIMARIO	GA-853R	87418364
HIDRAULICO	GP-761H	N9025	AIRE	GAK-16	E43790	590 SUPER M RETROEXCAVADORA con motor/CASE 3.9L		
GASOLINA, PLASTICO	GG-5	D145357	580K con motor/A DIESEL			COMBUSTIBLE, SEPARADOR DE AGUA	GPP-1122	J931062
GASOLINA, METALICO	GG-5 L	D145357	COMBUSTIBLE, SECUNDARIO	GP-1122	J903640	ACEITE	GP-390	J934429
580 SUPER M RETROEXCAVADORA con motor/CUMMINS 3.9L			COMBUSTIBLE, SECUNDARIO	GPP-1122	P150564	HIDRAULICO	GP-761H	D149921
COMBUSTIBLE, SEPARADOR DE AGUA	GPP-1122	J931062	COMBUSTIBLE, PRIMARIO	GPP-18	A58712	AIRE, RADIAL PRIMARIO	GA-853R	222421A1
ACEITE	GP-390	J934429	ACEITE	GP-390	J908616	590 TURBO RETROEXCAVADORA con motor/CUMMINS 390		
HIDRAULICO	GP-761H	N9025	HIDRAULICO	GP-761H	N9025	COMBUSTIBLE, SECUNDARIO	GP-1122	J931062
AIRE, RADIAL PRIMARIO (CON TURBO)	GA-853R	222421A1	AIRE, PRIMARIO	GAK-1532	N6778	COMBUSTIBLE, PRIMARIO	GPP-18	A151281
580 SUPER M SERIES 2 con motor/CASE 445T (4.5L) TURBO			GASOLINA, PLASTICO	GG-5	D145357	ACEITE	GP-390	J-908616
COMBUSTIBLE, SEPARADOR DE AGUA	GPP-1122	87803194	GASOLINA, METALICO	GG-5 L	D145357	AIRE	GAK-1532	A-173290
ACEITE	GP-737	87803261	580L con motor/CASE 3.9L			590 TURBO RETROEXCAVADORA con motor/CUMMINS 4T-390		
HIDRAULICO	GP-761H	N9025	COMBUSTIBLE, SECUNDARIO	GP-1122	J903640	COMBUSTIBLE, SECUNDARIO	GP-1122	J931062
AIRE, RADIAL PRIMARIO	GA-853R	87438248	COMBUSTIBLE, SECUNDARIO	GPP-1122	P150564	COMBUSTIBLE, PRIMARIO	GPP-18	A151281
580 SUPER R, 590 SUPER R, 695 SUPER R con motor/CASE 445T (4.5L)			COMBUSTIBLE, PRIMARIO	GPP-18	A151281	ACEITE	GP-390	J-908616
ACEITE	GP-737	87803261	ACEITE	GP-390	J908616	AIRE	GAK-1532	A-173290
580B RETROEXCAVADORA con motor/CASE G188D			HIDRAULICO	GP-761H	N9025	590 TURBO RETROEXCAVADORA con motor/CUMMINS 4T-390		
ACEITE	GP-1	A29891	GASOLINA, PLASTICO	GG-5	D145357	COMBUSTIBLE, SECUNDARIO	GP-1122	J931062
COMBUSTIBLE, PRIMARIO	GPP-18	A151281	GASOLINA, METALICO	GG-5 L	D145357	COMBUSTIBLE, SECUNDARIO	GPP-1122	P150564
COMBUSTIBLE, SECUNDARIO	GPP-19	A151281	580L SERIES 2 con motor/CASE 3.9L			COMBUSTIBLE, PRIMARIO	GPP-18	A151281
AIRE	GA-16	A42274	COMBUSTIBLE, SEPARADOR DE AGUA	GPP-1122	J931062	ACEITE	GP-390	J-908616
AIRE	GAK-16	A42274	ACEITE	GP-390	J934429	HIDRAULICO	GP-761H	N9025
580B RETROEXCAVADORA, 580CK RETROEXCAVADORA con motor/ CASE G159			HIDRAULICO	GP-761H	N9025	AIRE	GAK-1532	A-173290
ACEITE	GP-1	A29891	AIRE, RADIAL PRIMARIO (CON TURBO)	GA-853R	222421A1	GASOLINA, PLASTICO	GG-5	D139225
580B SOBRE ORUGAS con motor/A DIESEL			580M SERIES 2 con motores/CASE 445/M2 (4.5L), CASE 445T/M2 (4.5L)			GASOLINA, METALICO	GG-5 L	D139225
ACEITE	GP-69	A44081	COMBUSTIBLE, SEPARADOR DE AGUA	GPP-1122	87803194	600SK DE TRONCOS con motor/A DIESEL		
AIRE	GA-403	D36261	ACEITE	GP-737	87803261	ACEITE	GP-1	A146696
AIRE	GAK-403	D37975	HIDRAULICO	GP-761H	N9025	COMBUSTIBLE, PRIMARIO	GPP-18	A58712
580B RETROEXCAVADORA, 580CK RETROEXCAVADORA con motor/ CASE G159			AIRE, RADIAL PRIMARIO (CON TURBO)	GA-853R	87438248	AIRE	GA-403	A40866
ACEITE	GP-1	A29891	590 RETROEXCAVADORA con motor/CUMMINS 390			AIRE	GAK-403	A40866
580B SOBRE ORUGAS con motor/A DIESEL			COMBUSTIBLE, SEPARADOR DE AGUA	GPP-1122	87803194	60XT, ARRASTRADOR Y GUIADOR con motor/CASE 4-390		
ACEITE	GP-69	A44081	ACEITE	GP-737	87803261	COMBUSTIBLE	GPP-1122	J931062
AIRE	GA-403	D36261	HIDRAULICO	GP-761H	N9025	ACEITE	GP-390	J908616
AIRE	GAK-403	D37975	AIRE, RADIAL PRIMARIO (CON TURBO)	GA-853R	87438248	ACEITE	GP-761H	N9025
580B SOBRE ORUGAS con motor/A DIESEL			590 RETROEXCAVADORA con motor/CUMMINS 390			60XT, ARRASTRADOR Y GUIADOR con motor/CASE 4-390		
ACEITE	GP-69	A44081	COMBUSTIBLE, SECUNDARIO	GP-1122	J931062	COMBUSTIBLE		
AIRE	GA-403	D36261	COMBUSTIBLE, SECUNDARIO	GPP-1122	J931062	COMBUSTIBLE		
AIRE	GAK-403	D37975	COMBUSTIBLE, PRIMARIO	GPP-18	A151281	COMBUSTIBLE		

SERVICIO PESADO

MARCA-MODELO-MOTOR MAKE-MODEL-ENGINE	GONHER GONHER	OEM OEM	MARCA-MODELO-MOTOR MAKE-MODEL-ENGINE	GONHER GONHER	OEM OEM	MARCA-MODELO-MOTOR MAKE-MODEL-ENGINE	GONHER GONHER	OEM OEM
CASE (continuación)			CASE (continuación)			CASE (continuación)		
CARGADORAS			CARGADORAS			CARGADORAS		
621 con motor/CASE 6T-590			680C RETROEXCAVADORA con motor/CASE A3018D			721C, 721CXT con motor/CASE 6CT8.3		
COMBUSTIBLE, SECUNDARIO	GP-1122	J903640	ACEITE	GP-1	A58758	COMBUSTIBLE, SECUNDARIO	GP-1122	J903640
COMBUSTIBLE, SECUNDARIO	GPP-1122	P150564	COMBUSTIBLE, PRIMARIO	GPP-18	A151281	COMBUSTIBLE, SEPARADOR DE AGUA OPCIONAL	GPP-1122	J931062
COMBUSTIBLE, PRIMARIO	GPP-18	A58712	AIRE	GA-403	A40866	AGUA, SISTEMA DE ENFRIAMIENTO	GP-2071W	A77544
ACEITE	GP-178	J908615	AIRE	GAK-403	A40866	COMBUSTIBLE, SEPARADOR DE AGUA PRIMARIO	GPP-18	J930942
621B con motor/CASE 6T-590			680CK RETROEXCAVADORA con motor/CASE A251			HIDRAULICO (REQUIERE 2)	GP-761H	N9025
COMBUSTIBLE, SECUNDARIO	GP-1122	J903640	ACEITE	G-6	A21475	AIRE, PRIMARIO	GA-966R	249987A1
COMBUSTIBLE, SECUNDARIO	GPP-1122	P150564	AIRE	GA-16	F84998	AIRE, SECUNDARIO	GA-967R	249988A1
COMBUSTIBLE, PRIMARIO	GPP-18	A58712	AIRE	GAK-16	F84998			
ACEITE	GP-178	J908615						
621C con motor/A DIESEL			680CK RETROEXCAVADORA con motor/CASE A267D			721CXR con motor/CASE 8.3L		
COMBUSTIBLE, SECUNDARIO	GPP-1122	J931062	ACEITE	G-6	A21475	COMBUSTIBLE, SECUNDARIO	GP-1122	A77470
			COMBUSTIBLE, SECUNDARIO	G-1173	A7627	COMBUSTIBLE, SECUNDARIO	GPP-1122	P150564
621CXT con motor/CASE 5.9L			AIRE	GA-16	F84998	ACEITE	GP-3000	J919562
COMBUSTIBLE, SECUNDARIO	GPP-1122	P150564	AIRE	GAK-16	F84998	COMBUSTIBLE, PRIMARIO	GPP-18	A77470
621D con motor/5.9L			680E RETROEXCAVADORA con motor/CASE 336BD			721D, 721DXT con motor/IVECO 6TAA6804 (6.8L)		
COMBUSTIBLE, SEPARADOR DE AGUA	GPP-1122	87039679	ACEITE	GP-1	A58758	COMBUSTIBLE	GP-548	87803200
ACEITE	GP-178	J934430	ACEITE	GP-69	A75294	ACEITE	GP-737	87803261
AIRE, PRIMARIO	GA-697R	392120A1	COMBUSTIBLE, PRIMARIO	GPP-18	A58712	HIDRAULICO (REQUIERE 2)	GP-761H	402652A1
621D, 621DXR con motor/CASE 668TA/M2			680G RETROEXCAVADORA, 680H RETROEXCAVADORA con motor/CASE 336BD			750 con motores/CASE A267D, CASE A301D		
COMBUSTIBLE, SEPARADOR DE AGUA	GPP-1122	87803194	ACEITE	GP-54	A44081	ACEITE	G-6	A42274
621DXT con motor/CASE 6TAA3802 (6.8L)			680K RETROEXCAVADORA, 680L RETROEXCAVADORA con motor/CUMMINS 590			750H con motor/CASE 4T-390		
ACEITE	GP-178	J937743	COMBUSTIBLE, SECUNDARIO	GP-1122	J903640	COMBUSTIBLE, SECUNDARIO	GP-1122	J903640
			COMBUSTIBLE, PRIMARIO	GPP-18	J903410	COMBUSTIBLE, SEPARADOR DE AGUA, PRIMARIO	GPP-18	J930942
650G, 650H con motor/CASE 4T-390			ACEITE	GP-178	J908615	ACEITE	GP-390	J934429
COMBUSTIBLE, SECUNDARIO	GP-1122	J903640				HIDRAULICO	GP-761H	1346028-C1
COMBUSTIBLE, SEPARADOR DE AGUA, SECUNDARIO	GPP-1122	J931062	686G, 686GXR con motores/CASE 4-390, CASE 4T-390			AIRE, RADIAL PRIMARIO	GA-853R	222421A1
COMBUSTIBLE, SEPARADOR DE AGUA, PRIMARIO	GPP-18	J930942	COMBUSTIBLE, SEPARADOR DE AGUA	GPP-1122	J286503			
ACEITE	GP-390	J934429	ACEITE	GP-390	J934429	750K con motor/CASE 445T (4.5L)		
HIDRAULICO	GP-761H	1346028-C1	AIRE, RADIAL PRIMARIO (CON TURBO)	GA-853R	222421A1	COMBUSTIBLE, SEPARADOR DE AGUA	GPP-1122	87803194
AIRE, RADIAL PRIMARIO	GA-853R	222421A1				ACEITE	GP-737	87803261
			688G con motor/CASE 4T-390			HIDRAULICO	GP-761H	402652A1
			COMBUSTIBLE, SEPARADOR DE AGUA	GPP-1122	J931062	AIRE, RADIAL PRIMARIO	GA-853R	222421A1
650K con motor/CASE 445T (4.5L)			ACEITE	GP-390	J934429			
COMBUSTIBLE, SEPARADOR DE AGUA	GPP-1122	87803194	AIRE, RADIAL PRIMARIO	GA-853R	222421A1	750K con motor/CUMMINS 4T-390		
ACEITE	GP-737	87803261				COMBUSTIBLE, SECUNDARIO	GP-1122	J931063
HIDRAULICO	GP-761H	402652A1	70XT, ARRASTRADOR Y GUIADOR con motor/CASE 4-390			COMBUSTIBLE, SEPARADOR DE AGUA, PRIMARIO	GPP-18	J930942
AIRE, RADIAL PRIMARIO	GA-853R	222421A1	COMBUSTIBLE, SECUNDARIO	GPP-1122	P150564	ACEITE	GP-390	J934429
			ACEITE	GP-390	J908616	HIDRAULICO	GP-761H	402652A1
			HIDRAULICO	GP-761H	N9025	AIRE, RADIAL PRIMARIO	GA-853R	222421A1
650K con motor/CUMMINS 4T-390								
COMBUSTIBLE, SECUNDARIO	GP-1122	J931063	721 con motor/CASE 6T-830			75XT, ARRASTRADOR Y GUIADOR con motor/CASE 4-390		
COMBUSTIBLE, SEPARADOR DE AGUA, PRIMARIO	GPP-18	J930942	COMBUSTIBLE, SECUNDARIO	GP-1122	J903640	COMBUSTIBLE, SECUNDARIO	GPP-1122	P150564
ACEITE	GP-390	J934429	COMBUSTIBLE, SECUNDARIO	GPP-1122	P150564	ACEITE	GP-390	J908616
HIDRAULICO	GP-761H	402652A1	ACEITE	GP-43	A77537	HIDRAULICO	GP-761H	N9025
AIRE, RADIAL PRIMARIO	GA-853R	222421A1	AGUA	GP-2071W	A77544	AIRE	GA-413R	222425A1
			COMBUSTIBLE, PRIMARIO	GPP-18	A58712	GASOLINA	GG-3	D139225
680B RETROEXCAVADORA con motor/A DIESEL			HIDRAULICO	GP-761H	N9025			
ACEITE	G-6	A21475	AIRE	GA-398	S238647	780B RETROEXCAVADORA con motor/CASE 336BDT		
COMBUSTIBLE, PRIMARIO	GPP-18	A151281				ACEITE	GP-54	A75294
AIRE	GA-403	A40866	721B con motor/CASE 6T-830			HIDRAULICO	GP-66	A44081
AIRE	GAK-403	A40866	COMBUSTIBLE, SECUNDARIO	GP-1122	J903640	COMBUSTIBLE, PRIMARIO	GPP-18	A58712
			COMBUSTIBLE, SECUNDARIO	GPP-1122	P150564			
680C CK RETROEXCAVADORA con motor/CASE 301B			ACEITE	GP-43	A77537	780C RETROEXCAVADORA, 780D RETROEXCAVADORA con motor/CUMMINS 590		
ACEITE	GP-1	A58758	AGUA	GP-2071W	A77544	COMBUSTIBLE, SECUNDARIO	GP-1122	J903640
COMBUSTIBLE, PRIMARIO	GPP-18	A58712	COMBUSTIBLE, PRIMARIO	GPP-18	A58712	COMBUSTIBLE, PRIMARIO	GPP-18	J903410
AIRE	GA-403	D37975	AIRE	GA-398	S238647	ACEITE	GP-178	J908615
AIRE	GAK-403	D37975						

MARCA-MODELO-MOTOR MAKE-MODEL-ENGINE	GONHER GONHER	OEM OEM	MARCA-MODELO-MOTOR MAKE-MODEL-ENGINE	GONHER GONHER	OEM OEM	MARCA-MODELO-MOTOR MAKE-MODEL-ENGINE	GONHER GONHER	OEM OEM
CASE (continuación)			CASE (continuación)			CASE (continuación)		
CARGADORAS			CARGADORAS			CARGADORAS		
780CK RETROEXCAVADORA con motor/CASE 336			855C SOBRE ORUGAS con motor/A DIESEL			W10B con motor/CASE A401D		
ACEITE	GP-1	A146696	ACEITE	GP-54	A44081	COMBUSTIBLE, SECUNDARIO	G-1173	A7627
ACEITE	GP-54	A44081	ACEITE	GP-69	A44081	W10BD SOBRE RUEDAS con motor/CASE A401D		
COMBUSTIBLE, PRIMARIO	GPP-18	J903410	COMBUSTIBLE, PRIMARIO	GPP-18	A41745	COMBUSTIBLE, SECUNDARIO	G-1173	A7627
AIRE	GA-403	D36261	AIRE	GA-403	D36261	W10C SOBRE RUEDAS con motor/A DIESEL		
AIRE	GAK-403	A40866	AIRE	GAK-403	A40866	ACEITE	GP-34	A41725
800 SERIES SOBRE ORUGAS con motor/A DIESEL			855D SOBRE ORUGAS con motor/CASE 6-590			W10C, W10E con motor/CASE A377G		
ACEITE	G-31	010070AB	COMBUSTIBLE, SECUNDARIO	GP-1122	J903640	ACEITE	GP-1	A146696
ACEITE	G-33	L31230	COMBUSTIBLE, PRIMARIO	GPP-18	A58712	W10D SOBRE RUEDAS con motor/CASE A401D		
COMBUSTIBLE, SECUNDARIO	G-1173	A7627	ACEITE	GP-178	J908615	COMBUSTIBLE, SECUNDARIO	G-1173	A7627
821 SOBRE RUEDAS con motor/CASE 6T-830			855E con motor/CASE 6-590			W10E SOBRE RUEDAS con motor/A DIESEL		
COMBUSTIBLE, SECUNDARIO	GP-1122	A77470	COMBUSTIBLE, SECUNDARIO	GP-1122	J903640	ACEITE	GP-1	A146696
COMBUSTIBLE, SECUNDARIO	GPP-1122	P150564	COMBUSTIBLE, PRIMARIO	GPP-18	A58712	W11 SOBRE RUEDAS con motor/CASE G207D		
ACEITE	GP-43	A77537	ACEITE	GP-178	J908615	ACEITE	GP-1	A146696
AGUA	GP-2071W	A77544	HIDRAULICO	GP-761H	N9025	COMBUSTIBLE, PRIMARIO	GPP-18	A151281
COMBUSTIBLE, PRIMARIO	GPP-18	A77470	855E SOBRE ORUGAS con motor/CASE 6-590			COMBUSTIBLE, SECUNDARIO	GPP-19	A151281
AIRE	GA-398	S238647	COMBUSTIBLE, SECUNDARIO	GP-1122	J903640	AIRE	GA-16	A42274
821B SOBRE RUEDAS con motor/CASE 6T-830			COMBUSTIBLE, PRIMARIO	GPP-18	J925274	AIRE	GAK-16	A42274
COMBUSTIBLE, SECUNDARIO	GP-1122	J903640	ACEITE	GP-178	J932217	W11B con motor/CASE 4-390		
COMBUSTIBLE, SECUNDARIO	GPP-1122	P150564	HIDRAULICO	GP-761H	N9025	COMBUSTIBLE, SECUNDARIO	GP-1122	J903640
AGUA	GP-2071W	A77544	85XT, ARRASTRADOR Y GUIADOR con motor/CASE 4-390			COMBUSTIBLE, PRIMARIO	GPP-18	J903410
COMBUSTIBLE, PRIMARIO	GPP-18	J903410	COMBUSTIBLE, SECUNDARIO	GPP-1122	P150564	ACEITE	GP-390	J908616
HIDRAULICO	GP-761H	N9025	ACEITE	GP-390	J908616	COMBUSTIBLE, PRIMARIO	GPP-18	J903410
AIRE	GA-398	S238647	HIDRAULICO	GP-761H	N9025	ACEITE	GP-390	J908616
821C SOBRE RUEDAS, 821CXR SOBRE RUEDAS con motor/CASE 6TAA-830			AIRE	GA-413R	222425A1	AIRE	GAK-1532	A173290
COMBUSTIBLE, SECUNDARIO	GP-1122	J931063	GASOLINA	GG-3	D139225	W11B SOBRE RUEDAS con motor/CUMMINS 4B3.9		
COMBUSTIBLE, SEPARADOR DE AGUA OPCIONAL	GPP-1122	J931062	90XT, 95XT con motor/CASE 4BT3.9			COMBUSTIBLE, SECUNDARIO	GP-1122	J903640
AGUA, SISTEMA DE ENFRIAMIENTO	GP-2071W	J100304	COMBUSTIBLE, SEPARADOR DE AGUA	GPP-1122	J931062	COMBUSTIBLE, PRIMARIO	GPP-18	J903410
COMBUSTIBLE, SEPARADOR DE AGUA PRIMARIO	GPP-18	J930942	ACEITE	GP-390	J934429	AIRE	GAK-1532	N6778
HIDRAULICO (REQUIERE 2)	GP-761H	N9025	ACEITE, CARGADOR HIDRAULICO	GP-761H	222759A1	W12, W12D con motor/CASE A451D		
AIRE, PRIMARIO (HASTA S/N JEE0155001)	GA-966R	249987A1	ACEITE, RETORNO HIDRAULICO	GP-761H	N9025	COMBUSTIBLE, SECUNDARIO	G-1173	A7627
AIRE, SECUNDARIO (HASTA S/N JEE155001)	GA-967R	249988A1	AIRE, RADIAL PRIMARIO	GA-853R	222421A1	W14 con motor/A DIESEL		
850 con motor/CASE A301D			921 SOBRE RUEDAS con motor/CUMMINS LTA10-C			ACEITE	GP-1	A146696
COMBUSTIBLE, SECUNDARIO	G-1173	A7627	COMBUSTIBLE	GPP-11	202893	ACEITE	GP-54	A44081
ACEITE	GP-1	A146696	ACEITE	GP-3000	907101T1	COMBUSTIBLE, PRIMARIO	GPP-18	A58712
COMBUSTIBLE, PRIMARIO	GPP-18	A58712	AGUA	GP-2071W	1329039-C1	W14 SOBRE RUEDAS, W14H SOBRE RUEDAS con motor/A DIESEL		
AIRE	GA-403	D36261	AGUA	GP-1012Q	3315114	ACEITE	GP-69	A75294
AIRE	GAK-403	A40866	921B SOBRE RUEDAS, 921C SOBRE RUEDAS, 921CXR SOBRE RUEDAS con motor/CUMMINS M11			W14B SOBRE RUEDAS, W14C SOBRE RUEDAS con motor/CASE 6-590		
850 con motor/CASE A410BD			ACEITE	GP-3000	907101T1	COMBUSTIBLE, SECUNDARIO	GP-1122	J903640
COMBUSTIBLE, SECUNDARIO	G-1173	A7627	921C SOBRE RUEDAS con motor/CUMMINS QSM11			COMBUSTIBLE, PRIMARIO	GPP-18	A58712
ACEITE	GP-1	A146696	COMBUSTIBLE	GPP-1000	A184776	ACEITE	GP-178	J908615
COMBUSTIBLE, PRIMARIO	GPP-18	A58712	955 C con motor/A DIESEL			W14H con motor/A DIESEL		
AIRE	GA-403	D36261	HIDRAULICO	GP-761H	N9025	ACEITE	GP-1	A146696
AIRE	GAK-403	A40866	G310G con motor/CASE G148B			ACEITE	GP-54	A44081
850E SOBRE ORUGAS con motor/CASE 6-590			ACEITE	GP-1	A146696	COMBUSTIBLE, PRIMARIO	GPP-18	A58712
COMBUSTIBLE, SECUNDARIO	GP-1122	J903640	W10 (MILITAR) con motor/A DIESEL			W18 SOBRE RUEDAS, W20 SOBRE RUEDAS con motor/CASE 401B		
COMBUSTIBLE, PRIMARIO	GPP-18	J925274	COMBUSTIBLE	G-1175	5574508	ACEITE	G-33	L33711
ACEITE	GP-178	J932217	W10 SOBRE RUEDAS con motor/CASE A401D			ACEITE	GP-5	A64453
850K con motor/CASE 668T/M2			COMBUSTIBLE, SECUNDARIO	G-1173	A7627	ACEITE	GP-69	A75294
COMBUSTIBLE, SEPARADOR DE AGUA (REQUIERE 2)	GPP-1122	87803194	W10 SOBRE RUEDAS con motor/CASE A401D			COMBUSTIBLE, PRIMARIO	GPP-18	A58712
ACEITE	GP-737	87803261	COMBUSTIBLE, SECUNDARIO	G-1173	A7627			
HIDRAULICO	GP-761H	402652A1						

MARCA-MODELO-MOTOR MAKE-MODEL-ENGINE	GONHER GONHER	OEM OEM	MARCA-MODELO-MOTOR MAKE-MODEL-ENGINE	GONHER GONHER	OEM OEM	MARCA-MODELO-MOTOR MAKE-MODEL-ENGINE	GONHER GONHER	OEM OEM
CASE (continuación)			CASE (continuación)			CASE (continuación)		
CARGADORAS			CARGADORAS			CARGADORAS		
W18B con motor/CASE A508BD			W4 SOBRE RUEDAS con motor/CASE 1800CC			W9 con motor/CASE A267D		
ACEITE	GP-54	A75294	ACEITE	GP-1	E36534	COMBUSTIBLE, SECUNDARIO	G-1173	A7627
W18B SOBRE RUEDAS con motor/CASE 504			ACEITE	GP-9	1336188C1	W9A con motor/CASE A284		
ACEITE	GP-69	A75294	COMBUSTIBLE, SECUNDARIO	G-296	3044506R93	ACEITE	G-6	A42274
W20B SOBRE RUEDAS con motores/CASE 401BD, CASE 401BDT			COMBUSTIBLE	G-296-B	3044506R93	ACEITE	GP-1	A146696
ACEITE	GP-69	A75294	AIRE	GA-33	D48198	AIRE	GA-29	A14417
W20C con motor/CASE A504BD			W4 SOBRE RUEDAS con motor/CASE 2.1L			W9A SOBRE RUEDAS, W9AD SOBRE RUEDAS con motor/CASE A301D		
ACEITE	GP-54	A44081	ACEITE	GP-36	H411272	ACEITE	G-6	A42274
W20C SOBRE RUEDAS con motor/CASE 504			HIDRAULICO	GP-761H	N9025	COMBUSTIBLE, SECUNDARIO	G-1173	A7627
ACEITE	GP-54	A44081	AIRE	GA-33	D48198	AIRE	GA-29	A15903
W24 SOBRE RUEDAS, W24C SOBRE RUEDAS con motor/CASE 504BD			GASOLINA	GG-5 L	1701232C91	W9AG SOBRE RUEDAS con motor/CASE A284		
ACEITE	GP-69	A75294	W4 SOBRE RUEDAS con motor/CASE 207			ACEITE	GP-1	A146696
W24B SOBRE RUEDAS con motor/CASE A504BD			ACEITE	GP-1	A37189	W9B con motor/A DIESEL		
ACEITE	GP-5	A64453	COMBUSTIBLE, PRIMARIO	GPP-18	A39868	COMBUSTIBLE, SECUNDARIO	G-1173	A7627
ACEITE	GP-69	A75294	COMBUSTIBLE, SECUNDARIO	GPP-19	A39867	W9B con motor/CASE A377G		
COMBUSTIBLE, PRIMARIO	GPP-18	A58712	AIRE	GA-16	A42274	ACEITE	GP-1	A146696
W26 con motor/GMC 6V-53			AIRE	GAK-16	A42274	W9BD SOBRE RUEDAS con motor/CASE A410D		
ACEITE	G-33	L31230	W5 con motor/CASE G188			COMBUSTIBLE, SECUNDARIO	G-1173	A7627
W26B SOBRE RUEDAS, W26LF SOBRE RUEDAS con motor/CASE 504			ACEITE	GP-1	A146696	W9BG SOBRE RUEDAS con motor/CASE A377G		
ACEITE	GP-5	A64453	W5A con motores/CASE G188, CASE G188D			ACEITE	GP-34	A41725
W3 con motores/CASE G159, CASE G188D			ACEITE	GP-1	A146696	W9C con motor/CASE A377G		
ACEITE	GP-1	A146696	W7 SOBRE RUEDAS, W7C SOBRE RUEDAS con motor/CASE A301D			ACEITE	GP-1	A146696
W30 con motor/CASE A504BDT			ACEITE	G-6	A42274	W9C SOBRE RUEDAS con motor/A DIESEL		
ACEITE	GP-54	A44081	COMBUSTIBLE, SECUNDARIO	G-1173	A7627	ACEITE	GP-34	A41725
COMBUSTIBLE, PRIMARIO	GPP-18	A58712	ACEITE	GP-1	A33487	W9D SOBRE RUEDAS con motor/CASE A267		
AIRE	GA-398	S238647	COMBUSTIBLE, PRIMARIO	GPP-18	A39868	ACEITE	G-6	A42274
W30 SOBRE RUEDAS con motor/CASE 504			W7 SOBRE RUEDAS, W7E SOBRE RUEDAS, W7C SOBRE RUEDAS, W7D SOBRE RUEDAS con motor/CASE A284			W9E, W9E SOBRE RUEDAS con motor/A DIESEL		
ACEITE	GP-69	A75294	ACEITE	G-6	A42274	ACEITE	GP-1	A146696
COMBUSTIBLE, PRIMARIO	GPP-18	A58712	W7D SOBRE RUEDAS, W7G SOBRE RUEDAS con motor/CASE A301D			W9G SOBRE RUEDAS con motor/CASE A251		
AIRE	GA-398	S238647	ACEITE	G-6	A42274	ACEITE	G-6	A42274
W36 con motor/CASE 8.3L			W7E SOBRE RUEDAS con motor/CASE A301B			CASE		
COMBUSTIBLE, SECUNDARIO	GP-1122	J903640	ACEITE	GP-1	A146696	COMBINADAS		
ACEITE	GP-43	A77537	W7E SOBRE RUEDAS con motor/CASE A301D			1000 con motor/CASE		
AGUA	GP-2071W	A151931	ACEITE	G-6	A42274	ACEITE	G-6	A42274
COMBUSTIBLE, PRIMARIO	GPP-18	A58712	W7G SOBRE RUEDAS con motor/CASE A284			1000 con motor/CASE 301		
W36 SOBRE RUEDAS con motor/CASE 504			ACEITE	G-6	A42274	COMBUSTIBLE, SECUNDARIO	G-1173	A7627
ACEITE	GP-69	A75294	W8B con motor/CASE A377			AIRE	GA-403	D36261
W3D SOBRE RUEDAS, W5D SOBRE RUEDAS, W5AD SOBRE RUEDAS, W5AG SOBRE RUEDAS con motor/CASE G188D			COMBUSTIBLE, SECUNDARIO	G-1173	A7627	AIRE, PRIMARIO	GAK-403	D37975
ACEITE	GP-1	A146696	ACEITE	GP-34	A41725	1000 con motor/CASE A284		
COMBUSTIBLE, PRIMARIO	GPP-18	A39868	COMBUSTIBLE, PRIMARIO	GPP-18	A58712	ACEITE	G-6	A42274
COMBUSTIBLE, SECUNDARIO	GPP-19	A39867	W8B, W8BD SOBRE RUEDAS con motor/CASE A410D			COMBUSTIBLE, SECUNDARIO	G-1173	A7627
W3G SOBRE RUEDAS con motor/CASE G159			COMBUSTIBLE, SECUNDARIO	G-1173	A7627	AIRE	GA-403	D36261
ACEITE	GP-1	A146696	W8C SOBRE RUEDAS con motor/A DIESEL			AIRE, PRIMARIO	GAK-403	D37975
W4 con motor/MITSUBISHI			ACEITE	GP-34	A41725	1000 con motores/CASE 709, CASE 719		
AIRE	GA-33	D48198	W8E SOBRE RUEDAS con motor/A DIESEL			COMBUSTIBLE, SECUNDARIO	G-1173	A7627
			ACEITE	GP-1	A146696			
			W9 con motor/CASE A251					
			ACEITE	G-6	A42274			

MARCA-MODELO-MOTOR MAKE-MODEL-ENGINE	GONHER GONHER	OEM OEM	MARCA-MODELO-MOTOR MAKE-MODEL-ENGINE	GONHER GONHER	OEM OEM	MARCA-MODELO-MOTOR MAKE-MODEL-ENGINE	GONHER GONHER	OEM OEM
CASE (continuación)			CASE (continuación)			CASE (continuación)		
EQUIPO FORESTAL			EQUIPO FORESTAL			EQUIPO FORESTAL		
1737S con motor/GASOLINA			1835B con motor/A GASOLINA			AIRE	GA-20	L33913
ACEITE	GP-1	A146696	ACEITE	GP-1	A146696	AIRE	GAK-20	L33913
AIRE, SIN ASPAS	GA-33	D48198	AIRE	GA-16	A42274	400 con motor/DETROIT DIESEL		
GASOLINA, PLASTICO	GG-5	D 53599	AIRE	GAK-16	A42274	ACEITE	G-33	L31230
GASOLINA, METALICO	GG-5 L	D 53599	GASOLINA, PLASTICO	GG-5	D53599	400C con motor/CASE 336B		
			GASOLINA, METALICO	GG-5 L	D53599	ACEITE	G-33	L31230
1740 con motor/A DIESEL			1835C con motor/CONTINENTAL DIESEL			ACEITE	GP-1	A146696
ACEITE	GP-1	A29891	ACEITE	GP-1	A29891	AIRE	GA-20	L33913
COMBUSTIBLE, PRIMARIO	GPP-18	A39868	1835C con motor/CONTINENTAL GASOLINA			AIRE	GAK-20	L33913
COMBUSTIBLE, SECUNDARIO	GPP-19	A39867	ACEITE	GP-1	A29891	400SK con motor/GMC 4-53		
AIRE	GA-16	A2274	GASOLINA	GG-5	D53599	ACEITE	G-33	L31230
AIRE, SIN ASPAS	GA-33	D48198	GASOLINA, METALICO	GG-5 L	D53599	TRANSMISION	G-33	L31230
AIRE	GAK-16	A2274	1838 con motor/A DIESEL			COMBUSTIBLE, SECUNDARIO	G-1173	A7627
1816 con motor/TECUMSEH			COMBUSTIBLE, SECUNDARIO	GPP-1122	J843760	COMBUSTIBLE	G-1174	A19578
AIRE	GA-7	D66337	1840 con motor/A DIESEL			600 con motor/A DIESEL		
1816B con motor/TECUMSEH			COMBUSTIBLE, SECUNDARIO	GPP-1122	J843760	ACEITE	GP-1	A146696
AIRE	GA-7	D66337	COMBUSTIBLE, PRIMARIO	GPP-18	A39868	COMBUSTIBLE, PRIMARIO	GPP-18	A58712
1816C con motor/GASOLINA			ACEITE	GP-390	J908616	AIRE	GA-403	A40866
ACEITE	GP-81	D62845	AIRE, PRIMARIO	GAK-1532	A173290	AIRE	GAK-403	A40866
1818 con motor/KUBOTA			1845 con motores/A DIESEL, A GASOLINA			800, 825 con motor/A DIESEL		
ACEITE	GP-149	1959198 C1	ACEITE	GP-1	A29891	ACEITE	GP-1	A146696
1818 con motor/ONAN			AIRE	GA-16	A42274	COMBUSTIBLE, PRIMARIO	GPP-18	A58712
ACEITE	GP-81	D62845	AIRE	GAK-16	A42274	AIRE	GA-20	L33913
1825 con motor/KUBOTA A GASOLINA			1845B con motor/A DIESEL			AIRE	GAK-20	L33913
ACEITE	GP-149	1959198C1	ACEITE	GP-1	A29891	800SK, 825SK con motor/A DIESEL		
1825 con motor/NISSAN A GASOLINA			COMBUSTIBLE, PRIMARIO	GPP-18	A39868	ACEITE	GP-1	A146696
ACEITE	GP-3682	1972202C1	COMBUSTIBLE, SECUNDARIO	GPP-19	A39867	COMBUSTIBLE, PRIMARIO	GPP-18	A58712
1825B con motor/A DIESEL			AIRE	GA-16	A42274	AIRE	GA-20	L33913
COMBUSTIBLE, SECUNDARIO	GPP-1122	J843760	AIRE	GAK-16	A42274	AIRE	GAK-20	L33913
ACEITE	GP-24	125282A1	1845B con motor/A GASOLINA			CASE		
GASOLINA	GG-3	D139225	ACEITE	GP-1	A29891	EXCAVADORAS		
1830 con motor/A DIESEL			AIRE	GA-16	A42274	1000 con motor/DEUTZ SERIE 14030		
ACEITE	GP-81	D62845	AIRE	GAK-16	A42274	ACEITE	GP-54	P1350575
1835 con motor/A DIESEL			GASOLINA, PLASTICO	GG-5	D145357	1080 con motor/CASE 504		
ACEITE	GP-1	A29891	GASOLINA, METALICO	GG-5 L	D145357	ACEITE	GP-69	A75294
COMBUSTIBLE, PRIMARIO	GPP-18	A39868	1845C con motor/CASE 390			COMBUSTIBLE, PRIMARIO	GPP-18	A58712
COMBUSTIBLE, SECUNDARIO	GPP-19	A39867	COMBUSTIBLE, SECUNDARIO	GP-1122	J903640	AIRE, PRIMARIO	GA-360	S231996
AIRE	GA-16	A42274	COMBUSTIBLE, SECUNDARIO	GPP-1122	J843760	AIRE, SECUNDARIO	GA-361	N6660
AIRE	GAK-16	A42274	COMBUSTIBLE, PRIMARIO	GPP-18	A39868	1080 con motor/DETROIT DIESEL 4-71		
1835 con motor/A GASOLINA			ACEITE	GP-390	J908616	ACEITE, DERIVACION (BY PASS)	G-31	010070AB
ACEITE	GP-1	A146696	AIRE, PRIMARIO	GAK-1532	A173290	ACEITE	GP-53	25010449
AIRE	GA-16	A42274	300C con motor/CASE 336B			COMBUSTIBLE, PRIMARIO	GP-92	23518527
AIRE	GAK-16	A42274	ACEITE	GP-1	A146696	COMBUSTIBLE, SECUNDARIO	GP-93	23518526
GASOLINA, PLASTICO	GG-5	D53599	AIRE	GA-20	L33913	AIRE, PRIMARIO	GA-360	S231996
GASOLINA, METALICO	GG-5 L	D53599	AIRE	GAK-20	L33913	AIRE, SECUNDARIO	GA-361	N6660
1835B con motor/A DIESEL			300SK con motor/DETROIT DIESEL 3-53			1080B con motor/CASE 504		
ACEITE	GP-1	A29891	ACEITE	G-33	L31230	ACEITE	GP-69	A75294
COMBUSTIBLE, PRIMARIO	GPP-18	A39868	ACEITE	G-119	5574978	COMBUSTIBLE, PRIMARIO	GPP-18	A58712
COMBUSTIBLE, SECUNDARIO	GPP-19	A39867	COMBUSTIBLE, SECUNDARIO	G-1173	A19579	AIRE, PRIMARIO	GA-360	S231996
AIRE	GA-16	A42274	COMBUSTIBLE	G-1175	5574508	AIRE, SECUNDARIO	GA-361	N6660
AIRE	GAK-16	A42274	COMBUSTIBLE	GP-26	8423132	1080B con motor/DETROIT DIESEL 4-71		
1835B con motor/A GASOLINA			300SK SERIES C con motor/CASE 366BD			ACEITE, DERIVACION (BY PASS)	G-31	010070AB
ACEITE	GP-1	A29891	ACEITE	GP-1	A146696	ACEITE	GP-53	25010449
COMBUSTIBLE, PRIMARIO	GPP-18	A39868	COMBUSTIBLE, PRIMARIO	GPP-18	A58712			
COMBUSTIBLE, SECUNDARIO	GPP-19	A39867						

MARCA-MODELO-MOTOR MAKE-MODEL-ENGINE	GONHER GONHER	OEM OEM	MARCA-MODELO-MOTOR MAKE-MODEL-ENGINE	GONHER GONHER	OEM OEM	MARCA-MODELO-MOTOR MAKE-MODEL-ENGINE	GONHER GONHER	OEM OEM
CASE (continuación)			CASE (continuación)			CASE (continuación)		
EXCAVADORAS			EXCAVADORAS			EXCAVADORAS		
COMBUSTIBLE, PRIMARIO	GP-92	23518527	1188 PLUS con motor/CUMMINS 6TA590			HIDRAULICO	GP-66	A44081
COMBUSTIBLE, SECUNDARIO	GP-93	23518526	COMBUSTIBLE, SECUNDARIO	GP-1122	J903640	220C DE ORUGA con motor/DEUTZ		
AIRE, PRIMARIO	GA-360	S231996	COMBUSTIBLE, SECUNDARIO	GPP-1122	P150564	ACEITE	GP-54	P1350575
AIRE, SECUNDARIO	GA-361	N6660	COMBUSTIBLE, PRIMARIO	GPP-18	A58712	221D con motor/PERKINS 700 SERIES (2.9L)		
1085 SOBRE RUEDAS, 1086 SOBRE RUEDAS con motor/CASE 6T-590			ACEITE	GP-178	J908615	COMBUSTIBLE, SECUNDARIO	G-296	3044506R93
TRANSMISION	G-33	N9960	125B SOBRE ORUGAS con motor/DEUTZ BF6L913			300 CON ORUGA con motor/DEUTZ		
1085B con motor/CASE 590			COMBUSTIBLE, PRIMARIO	GP-1122	P150564	ACEITE	GP-54	P1350575
TRANSMISION	G-33	N9960	ACEITE	GP-77	P172511	30EC-YC CON ORUGA SERIES A, 35EC-YC CON ORUGA SERIES A con motores/IHC UC263, IHC UD282		
COMBUSTIBLE, SECUNDARIO	GP-1122	V37545	AIRE, PRIMARIO	GA-360	S231996	AIRE	GA-16	A7627
COMBUSTIBLE, PRIMARIO	GPP-18	A58712	AIRE, SECUNDARIO	GA-361	P850561	35D CON ORUGA con motor/DETROIT DIESEL		
ACEITE	GP-178	J908615	125CK SOBRE ORUGAS SERIE B, 125P-B SOBRE ORUGAS SERIE B con motor/A DIESEL			COMBUSTIBLE, SECUNDARIO	G-1173	A19579
1085B SOBRE RUEDAS con motor/CASE 6T-590			COMBUSTIBLE, PRIMARIO	GP-1122	P150564	COMBUSTIBLE	G-1174	A19574
TRANSMISION	G-33	N9960	AIRE, PRIMARIO	GA-360	S231996	AIRE	GA-33	L31230
COMBUSTIBLE, SECUNDARIO	GP-1122	V37545	AIRE, SECUNDARIO	GA-361	P850561	35EC-YC CON ORUGA SERIES B con motor/CASE		
COMBUSTIBLE, PRIMARIO	GPP-18	A58712	1280 con motor/DETROIT DIESEL 6-53			AIRE	GA-403	A40866
ACEITE	GP-178	J908615	ACEITE	G-33	L32230	35EC-YC CON ORUGA SERIES B con motor/DETROIT DIESEL		
1085C SOBRE RUEDAS con motor/CASE 6T-590			ACEITE	GP-53	25010449	AIRE	GA-20	L33913
COMBUSTIBLE, SECUNDARIO	GP-1122	V37545	COMBUSTIBLE, PRIMARIO	GP-92	23518527	400 CON ORUGA con motor/DEUTZ		
COMBUSTIBLE, PRIMARIO	GPP-18	A58712	COMBUSTIBLE, SECUNDARIO	GP-93	23518526	ACEITE	GP-54	P1350575
ACEITE	GP-178	J908615	AIRE, CUMMINS	GA-106	L35495	40B SOBRE RUEDAS con motor/CUMMINS		
HIDRAULICO	GP-761H	N9025	AIRE, KOMATSU	GA-326	L35495	AIRE	GA-403	A40866
1086B SOBRE RUEDAS con motor/CASE 6T-590			AIRE, SECUNDARIO	GA-206	L35496	40B SOBRE RUEDAS con motor/DETROIT DIESEL		
TRANSMISION	G-33	N9960	1280 SOBRE ORUGAS, 1280B SOBRE ORUGAS con motor/CASE 504			ACEITE	G-33	L31230
COMBUSTIBLE, SECUNDARIO	GP-1122	V37545	ACEITE	GP-69	A75294	COMBUSTIBLE, SECUNDARIO	G-1173	A19579
COMBUSTIBLE, PRIMARIO	GPP-18	A58712	COMBUSTIBLE, PRIMARIO	GPP-18	A58712	AIRE	GA-20	L33913
ACEITE	GP-178	J908615	AIRE, PRIMARIO	GA-360	S231996	AIRE	GAK-20	L33913
1088 con motor/CASE 6T-590			AIRE, SECUNDARIO	GA-361	P850561	40D SOBRE ORUGAS con motor/DEUTZ		
COMBUSTIBLE, SECUNDARIO	GP-1122	V37545	1285 CON RUEDAS, 1286 CON RUEDAS con motor/CASE			ACEITE	GP-54	A75294
COMBUSTIBLE, SECUNDARIO	GPP-1122	P150564	ACEITE	GP-54	A75294	COMBUSTIBLE, PRIMARIO	GPP-18	A44068
COMBUSTIBLE, PRIMARIO	GPP-18	A58712	COMBUSTIBLE, PRIMARIO	GPP-18	A58712	AIRE, PRIMARIO	GA-360	S231996
ACEITE	GP-178	J908615	AIRE	GA-398	S328647	AIRE, SECUNDARIO	GA-361	P850561
115 con motor/A DIESEL			1286 CON RUEDAS con motor/CASE 6T-830			40D SOBRE ORUGAS con motor/DETROIT DIESEL		
COMBUSTIBLE	GP-1122	V37545	COMBUSTIBLE, PRIMARIO	GP-1122	P150564	ACEITE	G-33	L31230
AIRE, PRIMARIO	GA-360	S231996	1288, 1488 con motor/CUMMINS 6TA830			COMBUSTIBLE, SECUNDARIO	G-1173	A19579
AIRE, SECUNDARIO	GA-361	N6660	COMBUSTIBLE	GP-1122	P150564	AIRE	GA-20	L33913
115P con motor/A DIESEL			AGUA	GP-2071W	A77544	AIRE	GAK-20	L33913
COMBUSTIBLE	GP-1122	V37545	COMBUSTIBLE, PRIMARIO	GPP-18	A58712	40D SOBRE ORUGAS con motor/DETROIT DIESEL		
AIRE, PRIMARIO	GA-360	S231996	1288C con motor/CUMMINS 6TA830			ACEITE	G-33	L31230
AIRE, SECUNDARIO	GA-361	N6660	COMBUSTIBLE	GP-1122	P150564	COMBUSTIBLE, SECUNDARIO	G-1173	A19579
1187 con motor/CASE 504			AGUA	GP-2071W	A77544	COMBUSTIBLE	G-1174	A19578
ACEITE	GP-69	A75294	COMBUSTIBLE, PRIMARIO	GPP-18	A58712	40D SOBRE RUEDAS con motor/DETROIT DIESEL		
COMBUSTIBLE, PRIMARIO	GPP-18	A58712	160CK DE ORUGA con motor/DEUTZ			ACEITE	G-33	L31230
AIRE, PRIMARIO	GA-360	S231996	COMBUSTIBLE, PRIMARIO	GP-1122	P150564	COMBUSTIBLE, SECUNDARIO	G-1173	A19579
AIRE, SECUNDARIO	GA-361	N6660	AIRE, PRIMARIO	GA-360	S231996	AIRE	GA-20	L33913
1187B con motor/CASE 504			AIRE, SECUNDARIO	GA-361	P850561	AIRE	GAK-20	L33913
ACEITE	GP-69	A75294	170B con motor/DEUTZ			40E SOBRE ORUGAS con motor/CASE		
COMBUSTIBLE, PRIMARIO	GPP-18	A58712	COMBUSTIBLE, PRIMARIO	GP-1122	P150564	ACEITE	GP-69	A75294
AIRE, PRIMARIO	GA-360	S231996	ACEITE	GP-77	P172511	COMBUSTIBLE, PRIMARIO	GPP-18	A44068
AIRE, SECUNDARIO	GA-361	N6660	AIRE, PRIMARIO	GA-360	S231996	AIRE	GA-398	S238647
1187B con motor/DETROIT DIESEL			AIRE, SECUNDARIO	GA-361	P850561	40E SOBRE ORUGAS con motor/DETROIT DIESEL		
ACEITE	G-33	L32230	220B con motor/DEUTZ F10L413			ACEITE	G-33	L31230
AIRE, PRIMARIO	GA-360	S231996	ACEITE	GP-54	P1350575	AIRE, PRIMARIO	GA-360	S231996
AIRE, SECUNDARIO	GA-361	N6660	COMBUSTIBLE, PRIMARIO	GP-1122	P150564	AIRE, SECUNDARIO	GA-361	P850561

SERVICIO PESADO

MARCA-MODELO-MOTOR MAKE-MODEL-ENGINE	GONHER GONHER	OEM OEM	MARCA-MODELO-MOTOR MAKE-MODEL-ENGINE	GONHER GONHER	OEM OEM	MARCA-MODELO-MOTOR MAKE-MODEL-ENGINE	GONHER GONHER	OEM OEM
CASE (continuación)			CASE (continuación)			CASE (continuación)		
EXCAVADORAS			EXCAVADORAS			EXCAVADORAS		
40E SOBRE RUEDAS con motor/DETROIT DIESEL			AIRE	GAK-1532	A-173290	880R SOBRE RUEDAS con motor/A DIESEL		
ACEITE	G-33	L31230				ACEITE	GP-69	A75294
40EC-YC SOBRE RUEDAS SERIES B con motor/CASE			588 con motor/CASE 4T-390			COMBUSTIBLE, PRIMARIO	GPP-18	A41745
AIRE	GA-20	L33913	COMBUSTIBLE, SECUNDARIO	GP-1122	J903640	AIRE	GA-403	D36261
40EC-YC SOBRE RUEDAS SERIES B con motor/DETROIT DIESEL			COMBUSTIBLE, SECUNDARIO	GPP-1122	P150564	AIRE	GAK-403	A40866
AIRE, SIN ASPAS	GA-24	L30937	COMBUSTIBLE, PRIMARIO	GPP-18	A58712			
40F SOBRE ORUGAS con motor/DETROIT DIESEL			ACEITE	GP-390	J908616	888 con motor/CASE 6T-590		
ACEITE	G-33	L31230	60 P-PL-B, 60C, 60CK-B, 60P, 70CK-B con motor/DEUTZ			COMBUSTIBLE, SECUNDARIO	GP-1122	J903640
45 SOBRE RUEDAS con motor/A DIESEL			HIDRAULICO	GP-36	P1350576	COMBUSTIBLE, SECUNDARIO	GPP-1122	P150564
ACEITE	GP-69	A75294	COMBUSTIBLE, SECUNDARIO	GP-1122	P150564	COMBUSTIBLE, PRIMARIO	GPP-18	A41745
COMBUSTIBLE, PRIMARIO	GPP-18	A58712	AIRE, SECUNDARIO	GA-892	P250566	ACEITE	GP-178	J908615
AIRE, PRIMARIO SIN ASPAS	GA-24	L30937	AIRE, PRIMARIO	GA-891	P250566	AIRE	GA-680	P2150506
AIRE, PRIMARIO	GA-360	S231996	600 SOBRE ORUGAS con motor/DEUTZ			9010, 9020 con motor/CASE 4T-390		
AIRE, SECUNDARIO	GA-361	P850561	COMBUSTIBLE, SECUNDARIO	GP-1122	P1050595	COMBUSTIBLE, SECUNDARIO	GP-1122	J903640
AIRE	GA-398	S328647	COMBUSTIBLE, SECUNDARIO	GPP-1122	P150564	COMBUSTIBLE, SECUNDARIO	GPP-1122	P150564
45B SOBRE RUEDAS con motor/A DIESEL			COMBUSTIBLE, PRIMARIO	GPP-18	J903410	COMBUSTIBLE, PRIMARIO	GPP-18	J925274
ACEITE	GP-69	A75294	ACEITE	GP-390	J908616	ACEITE	GP-390	J908616
COMBUSTIBLE, PRIMARIO	GPP-18	A58712	75C, 75CK-CKE-B, 75P, 75PB, 85CK-B con motor/A DIESEL			GASOLINA, PLASTICO	GG-5	D139225
AIRE	GA-398	S238647	HIDRAULICO	GP-36	P1350576	GASOLINA, METALICO	GG-5 L	D139225
50D SOBRE ORUGAS con motor/CASE			ACEITE	GP-54	P1350575	9010, 9020 con motor/CASE 4TA-390		
AIRE, PRIMARIO	GA-360	S231996	COMBUSTIBLE, SECUNDARIO	GP-1122	P150564	COMBUSTIBLE, SECUNDARIO	GP-1122	J903640
50D SOBRE ORUGAS con motor/DETROIT DIESEL			788 con motor/CASE 4T-390			COMBUSTIBLE, PRIMARIO	GPP-18	J925274
ACEITE	G-33	L31230	COMBUSTIBLE, SECUNDARIO	GP-1122	J903640	ACEITE	GP-390	J908616
50E SOBRE ORUGAS con motor/CASE			COMBUSTIBLE, SECUNDARIO	GPP-1122	P150564	AIRE	GA-892	150482A1
ACEITE	GP-69	A75294	COMBUSTIBLE, PRIMARIO	GPP-18	A58712	9010B, 9020B con motor/CASE 4T-390		
COMBUSTIBLE, PRIMARIO	GPP-18	A58712	ACEITE	GP-390	J908616	COMBUSTIBLE, SECUNDARIO	GP-1122	J903640
AIRE, PRIMARIO	GA-360	S231996	80 con motor/YANMAR 4TNE98			COMBUSTIBLE, SECUNDARIO	GPP-1122	P150564
AIRE, SECUNDARIO	GA-361	P850561	ACEITE	GP-149	M801209	COMBUSTIBLE, PRIMARIO	GPP-18	J925274
50E SOBRE ORUGAS con motor/DETROIT DIESEL			800R con motor/A DIESEL			ACEITE	GP-390	J908616
ACEITE	G-33	L31230	ACEITE	GP-69	A75294	GASOLINA, PLASTICO	GG-5	D139225
50EC SOBRE ORUGAS SERIES B con motor/CASE			COMBUSTIBLE, PRIMARIO	GPP-18	A58712	GASOLINA, METALICO	GG-5 L	D139225
AIRE	GA-20	L33913	AIRE	GA-403	A40866	9010B, 9020B con motor/CASE 4TA-390		
50EC SOBRE ORUGAS SERIES B con motor/DETROIT DIESEL			AIRE	GAK-403	A40866	COMBUSTIBLE, SECUNDARIO	GP-1122	J903640
AIRE, SIN ASPAS	GA-27	S221347	80B SOBRE RUEDAS con motor/A DIESEL			COMBUSTIBLE, PRIMARIO	GPP-18	J925274
580 SUPER K RETROEXCAVADORA con motor/CUMMINS 390			ACEITE	G-33	L31230	ACEITE	GP-390	J908616
COMBUSTIBLE, SECUNDARIO	GP-1122	J931062	880 con motor/A DIESEL			AIRE	GA-892	150482A1
COMBUSTIBLE, PRIMARIO	GPP-18	A151281	ACEITE	GP-1	A146696	9030 con motor/CASE 6T-590		
ACEITE	GP-390	J-908616	ACEITE	GP-69	A75294	COMBUSTIBLE, SECUNDARIO	GP-1122	J903640
AIRE	GAK-1532	A-173290	COMBUSTIBLE, PRIMARIO	GPP-18	A58712	COMBUSTIBLE, SECUNDARIO	GPP-1122	P150564
580 SUPER L RETROEXCAVADORA con motor/CUMMINS 4T-390			AIRE	GA-403	D36261	COMBUSTIBLE, PRIMARIO	GPP-18	J925274
COMBUSTIBLE, SECUNDARIO	GPP-1122	J931062	AIRE	GAK-403	A40866	ACEITE	GP-178	J932217
580 SUPER L SERIE 2 RETROEXCAVADORA con motor/A DIESEL			880B con motor/A DIESEL			AIRE	GA-361	N6660
COMBUSTIBLE, SECUNDARIO	GPP-1122	J931062	ACEITE	GP-69	A75294	9040 con motor/CASE 6T-830		
COMBUSTIBLE, PRIMARIO	GPP-18	A151281	880C SOBRE ORUGAS con motor/A DIESEL			COMBUSTIBLE, SECUNDARIO	GP-1122	J903640
ACEITE	GP-390	J-908616	ACEITE	GP-69	A75294	COMBUSTIBLE, SECUNDARIO	GPP-1122	P150564
580K RETROEXCAVADORA con motor/CUMMINS 390			COMBUSTIBLE, PRIMARIO	GPP-18	A44068	AGUA	GP-2071W	A77544
COMBUSTIBLE, SECUNDARIO	GP-1122	J931062	AIRE	GAK-625	S117745	COMBUSTIBLE, PRIMARIO	GPP-18	J925274
COMBUSTIBLE, PRIMARIO	GPP-18	A151281	880D con motor/CASE 6T-590			GASOLINA, PLASTICO	GG-5	D139225
ACEITE	GP-390	J-908616	COMBUSTIBLE, SECUNDARIO	GP-1122	J903640	GASOLINA, METALICO	GG-5 L	D139225
580K RETROEXCAVADORA con motor/CUMMINS 390			COMBUSTIBLE, PRIMARIO	GPP-18	A41745	9040B con motor/CASE 6T-830		
COMBUSTIBLE, SECUNDARIO	GPP-1122	P150564	ACEITE	GP-178	J908615	COMBUSTIBLE, SECUNDARIO	GP-1122	J903640
COMBUSTIBLE, PRIMARIO	GPP-18	A151281				COMBUSTIBLE, SECUNDARIO	GPP-1122	P150564
ACEITE	GP-390	J-908616						

MARCA-MODELO-MOTOR MAKE-MODEL-ENGINE	GONHER GONHER	OEM OEM	MARCA-MODELO-MOTOR MAKE-MODEL-ENGINE	GONHER GONHER	OEM OEM	MARCA-MODELO-MOTOR MAKE-MODEL-ENGINE	GONHER GONHER	OEM OEM
CASE (continuación)			CASE (continuación)			CASE (continuación)		
EXCAVADORAS			EXCAVADORAS			MONTACARGAS		
AGUA	GP-2071W	A77544	ACEITE	GP-390	J908616	585, 586 con motor/A DIESEL		
COMBUSTIBLE, PRIMARIO	GPP-18	J925274				ACEITE	GP-1	A37189
GASOLINA, PLASTICO	GG-5	D139225	CX160 con motor/CUMMINS 6TAA-590			COMBUSTIBLE, PRIMARIO	GPP-18	A39868
GASOLINA, METALICO	GG-5 L	D139225	COMBUSTIBLE, SECUNDARIO	GP-1122	J903640	COMBUSTIBLE, SECUNDARIO	GPP-19	A39867
			COMBUSTIBLE, PRIMARIO	GPP-18	A58712	AIRE	GA-16	F84998
9045B con motor/CASE 6T-830			ACEITE	GP-178	J908615	AIRE	GAK-16	F84998
COMBUSTIBLE, SECUNDARIO	GP-1122	J903640						
AGUA	GP-2071W	A77544	D530CB RETROEXCAVADORA con motor/A DIESEL			585C, 586C con motor/CASE 207		
COMBUSTIBLE, PRIMARIO	GPP-18	J925274	ACEITE	GP-1	E36534	ACEITE	GP-1	A146696
						COMBUSTIBLE, PRIMARIO	GPP-18	A39868
9050B con motor/CUMMINS M11			CASE			COMBUSTIBLE, SECUNDARIO	GPP-19	A39867
ACEITE	GP-3001	366700A1	HILERADORAS			AIRE	GA-16	F84998
COMBUSTIBLE	GPP-11	90-3941T1	1075 con motor/CHRYSLER			AIRE	GAK-16	F84998
ACEITE	GP-3000	90-7101T1	ACEITE	GP-1	D29891			
AGUA	GP-2071W	A77544	AIRE	GA-16	L11247	585D con motor/CASE 188D		
			AIRE	GAK-16	L11247	ACEITE	GP-1	A146696
9060B con motor/CUMMINS M11			GASOLINA, PLASTICO	GG-5	D139225	COMBUSTIBLE, PRIMARIO	GPP-18	A39868
ACEITE	GP-3000	907101T1	GASOLINA, METALICO	GG-5 L	D139225	COMBUSTIBLE, SECUNDARIO	GPP-19	A39867
						HIDRAULICO	GP-761H	N9025
90C, 90P-B, 90CK-CKE-B, 90P con motor/A DIESEL			1150, 1155 con motor/A DIESEL			AIRE	GA-16	F84998
HIDRAULICO	GP-36	P1350576	ACEITE	GP-1	A29891	AIRE	GAK-16	F84998
ACEITE	GP-54	P1350575	COMBUSTIBLE, PRIMARIO	GPP-18	A58712			
COMBUSTIBLE, SECUNDARIO	GP-1122	P150564	COMBUSTIBLE, SECUNDARIO	GPP-19	A39867	585E con motor/CASE 390		
						COMBUSTIBLE, SECUNDARIO	GP-1122	J903640
960 TURBO con motor/CASE 3.9L			950 con motor/CASE A126			COMBUSTIBLE, SECUNDARIO	GPP-1122	J931062
ACEITE	GP-390	J908616	ACEITE	GP-1	A146696	COMBUSTIBLE, PRIMARIO	GPP-18	J-925274
						ACEITE	GP-390	J-908616
980 con motor/CASE A504BDT			CASE			HIDRAULICO	GP-761H	N9025
ACEITE	GP-5	A64453	MONTACARGAS			AIRE, PRIMARIO	GAK-1532	A173290
COMBUSTIBLE	GPP-18	A58712	401BD con motor/CASE 6 CILINDROS					
AIRE	GA-20	L33913	COMBUSTIBLE, SECUNDARIO	G-1173	A7627	586D con motor/CASE 188D		
AIRE	GAK-20	L33913	ACEITE	GP-69	A75294	ACEITE	GP-1	A146696
			COMBUSTIBLE, PRIMARIO	GPP-18	A58712	COMBUSTIBLE, PRIMARIO	GPP-18	A39868
980B SOBRE ORUGA con motor/CASE						COMBUSTIBLE, SECUNDARIO	GPP-19	A39867
ACEITE	GP-54	A44081	584 con motor/A DIESEL			HIDRAULICO	GP-761H	N9025
COMBUSTIBLE, PRIMARIO	GPP-18	A41745	ACEITE	GP-1	A29891	AIRE	GA-16	F84998
AIRE, SECUNDARIO	GA-20	L33913	COMBUSTIBLE, PRIMARIO	GPP-18	A39868	AIRE	GAK-16	F84998
AIRE, SECUNDARIO	GAK-20	L33913	COMBUSTIBLE, SECUNDARIO	GPP-19	A39867	586E con motor/CASE 390		
AIRE, PRIMARIO	GA-360	S231996	AIRE	GA-16	F84998	COMBUSTIBLE, SECUNDARIO	GP-1122	J903640
			AIRE	GAK-16	F84998	COMBUSTIBLE, SECUNDARIO	GPP-1122	J931062
980D con motor/CASE A504BDT						COMBUSTIBLE, PRIMARIO	GPP-18	J-925274
ACEITE	GP-5	A64453	584C con motor/CASE 207			ACEITE	GP-390	J-908616
COMBUSTIBLE	GPP-18	A58712	ACEITE	GP-1	A29891	HIDRAULICO	GP-761H	N9025
AIRE	GA-20	L33913	COMBUSTIBLE, PRIMARIO	GPP-18	A39868	AIRE, PRIMARIO	GAK-1532	A173290
AIRE	GAK-20	L33913	COMBUSTIBLE, SECUNDARIO	GPP-19	A39867			
			AIRE	GA-16	F84998	CASE		
988 PLUS con motor/CASE 6T-590			AIRE	GAK-16	F84998	MOTORES		
COMBUSTIBLE, SECUNDARIO	GP-1122	J903640				126, 126B		
COMBUSTIBLE, SECUNDARIO	GPP-1122	P150564	584D con motor/CASE 188D			ACEITE	GP-1	A29891
COMBUSTIBLE, PRIMARIO	GPP-18	A58712	ACEITE	GP-1	A29891			
COMBUSTIBLE, PRIMARIO	GPP-18	A58712	COMBUSTIBLE, PRIMARIO	GPP-18	A39868	207 UNIDADES DE FUERZA		
ACEITE	GP-178	J908615	COMBUSTIBLE, SECUNDARIO	GPP-19	A39867	ACEITE	GP-1	A29891
			HIDRAULICO	GP-761H	N9025	COMBUSTIBLE, PRIMARIO	GPP-18	A39868
CX130 con motor/CUMMINS 4TA-390			AIRE	GA-16	F84998	COMBUSTIBLE, SECUNDARIO	GPP-19	A39867
COMBUSTIBLE, SECUNDARIO	GP-1122	J903640	AIRE	GAK-16	F84998			
COMBUSTIBLE, PRIMARIO	GPP-18	A58712				301BD UNIDADES DE FUERZA		
ACEITE	GP-390	J908616	584E con motor/CASE 390			ACEITE	GP-1	A146696
			COMBUSTIBLE, SECUNDARIO	GP-1122	J903640			
CX130 con motor/CUMMINS 6TAA-590			COMBUSTIBLE, SECUNDARIO	GPP-1122	J931062	3-290 DIESEL		
COMBUSTIBLE, SECUNDARIO	GP-1122	J903640	COMBUSTIBLE, PRIMARIO	GPP-18	J-925274	COMBUSTIBLE, SECUNDARIO	GP-1122	J903640
COMBUSTIBLE, PRIMARIO	GPP-18	A58712	ACEITE	GP-390	J-908616			
ACEITE	GP-178	J908615	HIDRAULICO	GP-761H	N9025			
			AIRE, PRIMARIO	GAK-1532	A173290			

SERVICIO PESADO

MARCA-MODELO-MOTOR MAKE-MODEL-ENGINE	GONHER GONHER	OEM OEM	MARCA-MODELO-MOTOR MAKE-MODEL-ENGINE	GONHER GONHER	OEM OEM	MARCA-MODELO-MOTOR MAKE-MODEL-ENGINE	GONHER GONHER	OEM OEM
CASE (continuación)			CASE (continuación)			CASE		
MOTORES			MOTORES			NIVELADORAS		
336 BD DIESEL, 336B DIESEL			909B DIESEL			1150B SOBRE ORUGA con motor/CASE A451BD		
ACEITE	GP-1	A146696	ACEITE	G-31	010070AB	ACEITE	GP-69	A75294
336BD UNIDADES DE FUERZA, 336BDT UNIDADES DE FUERZA			A301BD DIESEL			COMBUSTIBLE, PRIMARIO	GPP-18	A58712
ACEITE	GP-1	A146696	ACEITE	GP-1	A146696	AIRE	GAK-20	L33913
400 DIESEL, 400D DIESEL			A301D DIESEL			1150C SOBRE ORUGA con motor/CASE A451BD		
COMBUSTIBLE, SECUNDARIO	G-1173	A7627	ACEITE	G-6	A42274	ACEITE	GP-69	A75294
401B UNIDADES DE FUERZA			COMBUSTIBLE, SECUNDARIO	G-1173	A7627	1150D SOBRE ORUGA con motor/CASE 830		
COMBUSTIBLE, SECUNDARIO	G-1173	A7627	ACEITE	GP-1	A146696	COMBUSTIBLE	GP-1122	V37545
ACEITE	GP-69	A75294	A336BDT DIESEL			ACEITE	GP-43	A77537
COMBUSTIBLE, PRIMARIO	GPP-18	A58712	ACEITE	GP-1	A146696	AGUA	GP-2071W	A77544
409 DIESEL			A401BD DIESEL			COMBUSTIBLE, PRIMARIO	GPP-18	A58712
COMBUSTIBLE, SECUNDARIO	G-1173	A7627	ACEITE	GP-69	A184775	1150D SOBRE ORUGA, 1155D SOBRE ORUGA con motor/CASE 504		
4-390 DIESEL			A401D DIESEL			ACEITE	GP-69	A75294
COMBUSTIBLE, SECUNDARIO	GP-1122	J903640	COMBUSTIBLE, SECUNDARIO	G-1173	A7627	1150E SOBRE ORUGA con motor/CASE 6T-590		
COMBUSTIBLE, PRIMARIO	GPP-18	A58712	ACEITE	GP-1	E36534	COMBUSTIBLE	GP-1122	V 37545
ACEITE	GP-390	J908616	ACEITE	GP-34	H341974	COMBUSTIBLE, SECUNDARIO	GPP-1122	P150564
4391 POWER TAKE-OFF			COMBUSTIBLE	GPP-18	A58712	COMBUSTIBLE, PRIMARIO	GPP-18	A58712
ACEITE	GP-390	J934429	A451D DIESEL			ACEITE	GP-178	J908615
451BD UNIDADES DE FUERZA, 451BDT UNIDADES DE FUERZA			COMBUSTIBLE, SECUNDARIO	G-1173	A7627	1150E SOBRE ORUGA con motor/CASE 830		
ACEITE	GP-69	A75294	ACEITE	GP-69	A184775	COMBUSTIBLE	GP-1122	V37545
4T-390 DIESEL, 4TA-390 DIESEL			COMBUSTIBLE	GPP-18	A58712	ACEITE	GP-43	A 77537
COMBUSTIBLE, SECUNDARIO	GP-1122	J903640	A504BDT DIESEL, A504D			AGUA	GP-2071W	A77544
COMBUSTIBLE, PRIMARIO	GPP-18	A58712	ACEITE	GP-5	A64453	COMBUSTIBLE, PRIMARIO	GPP-18	A58712
ACEITE	GP-390	J908616	ACEITE	GP-54	A44081	ACEITE	GP-178	J908615
500 DIESEL con motor/CASE 500			ACEITE	GP-69	A75294	1150G SOBRE ORUGA con motor/CASE 6T-590		
ACEITE	G-31	010070AB	COMBUSTIBLE, PRIMARIO	GPP-18	A58712	COMBUSTIBLE	GP-1122	V37545
504BD UNIDADES DE FUERZA, 504BDT UNIDADES DE FUERZA			G207D DIESEL con motor/CASE G207D			COMBUSTIBLE, PRIMARIO	GPP-18	A58712
ACEITE	GP-5	A64453	ACEITE	GP-1	A146696	ACEITE	GP-178	J908615
509 DIESEL, 609 DIESEL			COMBUSTIBLE, PRIMARIO	GPP-18	A58712	1150K con motor/FAMILY IV 6.7L		
ACEITE	G-31	010070AB	COMBUSTIBLE, SECUNDARIO	GPP-19	A39867	COMBUSTIBLE	GP-548	87803200
6-590 DIESEL, 6590TA UNIDADES DE FUERZA			CASE			ACEITE	GP-737	87803261
COMBUSTIBLE, SECUNDARIO	GP-1122	J903640	MOTOTRAILLA			AIRE, PRIMARIO	GA-697R	392120A1
COMBUSTIBLE, PRIMARIO	GPP-18	A151281	400B con motor/A DIESEL			1155D SOBRE ORUGA con motor/CASE 830		
ACEITE	GP-178	J908615	COMBUSTIBLE, SECUNDARIO	G-1173	A19579	COMBUSTIBLE	GP-1122	V37545
6591 UNIDADES DE FUERZA, 6591T UNIDADES DE FUERZA			420 con motor/A DIESEL			ACEITE	GP-43	A77537
COMBUSTIBLE, SECUNDARIO	GPP-1122	P150564	COMBUSTIBLE, SECUNDARIO	G-1173	A7627	AGUA	GP-2071W	A77544
ACEITE	GP-178	J908615	420B con motor/A DIESEL			COMBUSTIBLE, PRIMARIO	GPP-18	A58712
AIRE	GA-398	S238647	COMBUSTIBLE, SECUNDARIO	G-1173	A7627	1155E SOBRE ORUGA con motor/CASE 590		
6-830 DIESEL, 6T-830 DIESEL, 6TA-830 DIESEL			420C con motor/A DIESEL			COMBUSTIBLE	GP-1122	V 37545
COMBUSTIBLE, SECUNDARIO	GP-1122	J903640	ACEITE	GP-1	A146696	COMBUSTIBLE, PRIMARIO	GPP-18	A58712
ACEITE	GP-43	A77537	COMBUSTIBLE, PRIMARIO	GPP-18	A151281	ACEITE	GP-178	J908615
COMBUSTIBLE, PRIMARIO	GPP-18	J903410	COMBUSTIBLE, SECUNDARIO	GPP-19	A151281	1450 SOBRE ORUGA con motores/CASE A504B, CASE A504DT, CASE A504BDT, CASE A504D		
AIRE	GA-398	S238647	500B con motor/CASE A GASOLINA			ACEITE	GP-69	A75294
6831TA DIESEL			ACEITE	GP-1	A29891	1450B SOBRE ORUGA con motor/CASE A504		
COMBUSTIBLE, SECUNDARIO	GP-1122	J903640	520 con motor/A DIESEL			ACEITE	GP-69	A75294
6T-590 DIESEL, 6TA-590 DIESEL			ACEITE	G-31	010070AB	COMBUSTIBLE, PRIMARIO	GPP-18	A58712
COMBUSTIBLE, SECUNDARIO	GP-1122	J903640	600B con motor/CASE A GASOLINA			AIRE, PRIMARIO	GA-360	S231996
COMBUSTIBLE, PRIMARIO	GPP-18	A151281	ACEITE	GP-1	A146696	AIRE, SECUNDARIO	GA-361	P850561
ACEITE	GP-178	J908615				1550 SOBRE ORUGA con motor/CASE 830		
						COMBUSTIBLE, PRIMARIO	GP-1122	P150564
						ACEITE	GP-43	A77537
						AGUA	GP-2071W	A77544
						COMBUSTIBLE, PRIMARIO	GPP-18	A58712
						AIRE	GA-398	S328647

MARCA-MODELO-MOTOR MAKE-MODEL-ENGINE	GONHER GONHER	OEM OEM	MARCA-MODELO-MOTOR MAKE-MODEL-ENGINE	GONHER GONHER	OEM OEM	MARCA-MODELO-MOTOR MAKE-MODEL-ENGINE	GONHER GONHER	OEM OEM
CASE (continuación)			CASE (continuación)			CASE (continuación)		
NIVELADORAS			NIVELADORAS			TRACTORES		
1650L con motor/FAMILY IV 6.7L			850D SOBRE ORUGA con motor/CASE 6-590			1060 con motor/A DIESEL		
COMBUSTIBLE	GP-548	87803200	COMBUSTIBLE, SECUNDARIO	GP-1122	J903640	COMBUSTIBLE, SECUNDARIO	G-1173	A7627
ACEITE	GP-737	87803261	COMBUSTIBLE, PRIMARIO	GPP-18	A58712	ACEITE	GP-54	A58672
AIRE, PRIMARIO	GA-697R	392120A1	ACEITE	GP-178	J908615	COMBUSTIBLE, PRIMARIO	GPP-18	A58712
450C con motor/CASE 4-390			850G SOBRE ORUGA, 850H SOBRE ORUGA con motor/CASE 6T-590			1060 con motor/A GASOLINA		
COMBUSTIBLE, SECUNDARIO	GP-1122	J903640	COMBUSTIBLE, SECUNDARIO	GP-1122	J903640	ACEITE	G-6	A42274
COMBUSTIBLE, PRIMARIO	GPP-18	A58712	COMBUSTIBLE, PRIMARIO	GPP-18	A58712	1070 con motor/CASE A451BD		
ACEITE	GP-390	J908616	ACEITE	GP-178	J908615	ACEITE	GP-54	A58672
HIDRAULICO	GP-761H	N9025	850K con motor/CUMMINS 6T-590			1070 con motor/CASE A451BD SERIES 8675001 EN ADELANTE		
AIRE, PRIMARIO	GAK-1532	A173290	COMBUSTIBLE, SECUNDARIO	GP-1122	J931063	COMBUSTIBLE, PRIMARIO	GPP-18	A58712
550 SOBRE ORUGA con motor/CASE 4T-390			COMBUSTIBLE, PRIMARIO	GPP-18	J930942	1071 con motor/A DIESEL		
COMBUSTIBLE, SECUNDARIO	GP-1122	J903640	ACEITE	GP-178	J934430	ACEITE	GP-69	A75294
COMBUSTIBLE, SECUNDARIO	GPP-1122	P150564	HIDRAULICO	GP-761H	402652A1	1080B con motor/CASE 504		
COMBUSTIBLE, PRIMARIO	GPP-18	A151281	AIRE, PRIMARIO	GA-697R	392120A1	ACEITE	GP-69	A184775
ACEITE	GP-390	J-908616	850K SERIES 2, 850K SERIES 3 con motor/CASE 668T/M2			COMBUSTIBLE, PRIMARIO	GPP-18	A58712
AIRE	GAK-1532	A-173290	COMBUSTIBLE, SEPARADOR DE AGUA, REQUIERE 2 PIEZAS	GPP-1122	87803194	AIRE, SECUNDARIO	GA-361	P850561
550D SOBRE ORUGA con motor/CASE 4T-390			ACEITE	GP-737	87803261	1085 con motor/CASE 6T-590		
COMBUSTIBLE, SECUNDARIO	GP-1122	J903640	HIDRAULICO	GP-761H	402652A1	TRANSMISION	G-33	N9960
COMBUSTIBLE, SECUNDARIO	GPP-1122	P150564	AIRE, PRIMARIO	GA-697R	392120A1	COMBUSTIBLE, SECUNDARIO	GP-1122	V37545
COMBUSTIBLE, PRIMARIO	GPP-18	A151281	850L con motor/CUMMINS 667TA			COMBUSTIBLE, PRIMARIO	GPP-18	A58712
ACEITE	GP-390	J-908616	COMBUSTIBLE	GP-548	87803200	ACEITE	GP-178	J908615
HIDRAULICO	GP-761H	N9025	ACEITE	GP-737	87803261	1085B con motor/A DIESEL		
550E SOBRE ORUGA con motor/A DIESEL			HIDRAULICO	GP-761H	402652A1	COMBUSTIBLE, SECUNDARIO	GP-1122	V37545
AIRE	GAK-1532	A-173290	AIRE, PRIMARIO	GA-697R	392120A1	COMBUSTIBLE, PRIMARIO	GPP-18	A58712
550E SOBRE ORUGA con motor/CASE 4T-390			855D SOBRE ORUGA con motor/CASE 590			ACEITE	GP-178	J908615
COMBUSTIBLE, SECUNDARIO	GP-1122	J903640	COMBUSTIBLE, SECUNDARIO	GP-1122	J903640	1085B, 1086B con motor/CASE 6T-590		
COMBUSTIBLE, SECUNDARIO	GPP-1122	P150564	COMBUSTIBLE, PRIMARIO	GPP-18	A58712	TRANSMISION	G-33	N9960
COMBUSTIBLE, PRIMARIO	GPP-18	A151281	ACEITE	GP-178	J908615	COMBUSTIBLE, SECUNDARIO	GP-1122	V37545
ACEITE	GP-390	J-908616	CASE			COMBUSTIBLE, PRIMARIO	GPP-18	A58712
550E SOBRE ORUGA con motor/CUMMINS 4T-390			TRACTORES			ACEITE	GP-178	J908615
COMBUSTIBLE, SECUNDARIO	GP-1122	J903640	1000 con motor/CONTINENTAL JD382			1087B con motor/A DIESEL		
COMBUSTIBLE, PRIMARIO	GPP-18	A151281	ACEITE	G-31	010070AB	ACEITE	GP-69	A184775
ACEITE	GP-390	J-908616	ACEITE	G-33	L33711	1090 con motor/CASE A451BD		
AIRE, PRIMARIO	GAK-1532	A-173290	COMBUSTIBLE, SECUNDARIO	G-1173	A7627	COMBUSTIBLE, PRIMARIO	GPP-18	A58712
550G SOBRE ORUGA con motor/CUMMINS 4T-390			1000B, 1000C, 1000D con motor/CONTINENTAL JD382			1120, 1130 con motor/MITSUBISHI		
COMBUSTIBLE, SECUNDARIO	GP-1122	J903640	ACEITE, DERIVACION (BY PASS)	G-31	010070AB	HIDRAULICO	GP-166	H311654
COMBUSTIBLE, PRIMARIO	GPP-18	A151281	ACEITE	G-33	L33711	ACEITE, PARA TRANSMISION	GP-166	H311654
ACEITE	GP-390	J-908616	COMBUSTIBLE, SECUNDARIO	G-1173	A7627	HIDRAULICO	GP-91	A32297
AIRE, PRIMARIO	GAK-1532	A-173290	1010 con motor/CONTINENTAL JD382			1140 con motor/MITSUBISHI		
650 SOBRE ORUGA con motor/CASE 4T-390			ACEITE	G-31	010070AB	ACEITE	GP-149	N13844
COMBUSTIBLE, SECUNDARIO	GP-1122	J903640	ACEITE	G-33	L31230	1150 con motor/CASE A401BD		
COMBUSTIBLE, SECUNDARIO	GPP-1122	P150564	COMBUSTIBLE, SECUNDARIO	G-1173	A7627	ACEITE	GP-34	A41725
COMBUSTIBLE, PRIMARIO	GPP-18	A151281	1030 con motores/CASE A401D, CASE A451D			ACEITE	GP-69	A75294
ACEITE	GP-390	J-908616	COMBUSTIBLE, SECUNDARIO	G-1173	A7627	COMBUSTIBLE, PRIMARIO	GPP-18	A58712
850B SOBRE ORUGA con motor/A DIESEL			ACEITE	GP-34	A41725	1150 con motor/CASE A401D		
ACEITE	GP-69	A44081	AIRE	GA-403	D36261	COMBUSTIBLE, SECUNDARIO	G-1173	A7627
COMBUSTIBLE, PRIMARIO	GPP-18	A58712	AIRE	GAK-403	D37975	ACEITE	GP-1	A29891
AIRE	GA-403	D36261	1030CK con motores/CASE A401D, CASE A451D			ACEITE	GP-54	V37624
AIRE	GAK-403	A40866	COMBUSTIBLE, SECUNDARIO	G-1173	A7627	ACEITE	GP-69	A75294
850C SOBRE ORUGA con motor/A DIESEL			ACEITE	GP-34	A41725	COMBUSTIBLE, PRIMARIO	GPP-18	A58712
ACEITE	GP-54	A44081	AIRE	GA-403	D36261	1150 con motor/CASE A401D		
COMBUSTIBLE, PRIMARIO	GPP-18	A58712	AIRE	GAK-403	D37975	COMBUSTIBLE, SECUNDARIO	G-1173	A7627
AIRE	GA-403	D36261				ACEITE	GP-1	A29891
AIRE	GAK-403	A40866				ACEITE	GP-54	V37624
						ACEITE	GP-69	A75294
						COMBUSTIBLE, PRIMARIO	GPP-18	A58712
						AIRE	GA-16	A2274

SERVICIO PESADO

MARCA-MODELO-MOTOR MAKE-MODEL-ENGINE	GONHER GONHER	OEM OEM	MARCA-MODELO-MOTOR MAKE-MODEL-ENGINE	GONHER GONHER	OEM OEM	MARCA-MODELO-MOTOR MAKE-MODEL-ENGINE	GONHER GONHER	OEM OEM
CASE (continuación)			CASE (continuación)			CASE (continuación)		
TRACTORES			TRACTORES			TRACTORES		
AIRE	GA-403	D36261	1370 con motor/CASE A504BD			COMBUSTIBLE	G-296	K960911
AIRE	GAK-16	A2274	ACEITE	GP-5	A64453	COMBUSTIBLE	G-296-B	K960911
AIRE	GAK-403	D37975	ACEITE	GP-69	A75294	1737 con motor/CASE G148B		
1160T con motor/A DIESEL			AGUA	GP-2071W	A151931	ACEITE	GP-1	A146696
COMBUSTIBLE, SECUNDARIO	G-1173	A7627	COMBUSTIBLE, PRIMARIO	GPP-18	A58712	1740 con motor/CASE G188D		
ACEITE	GP-54	V37624	1390 con motor/CASE 219			ACEITE	GP-1	A37189
COMBUSTIBLE, PRIMARIO	GPP-18	A58712	COMBUSTIBLE	G-296	960911	COMBUSTIBLE, PRIMARIO	GPP-18	A39868
1160T con motor/GASOLINA			COMBUSTIBLE	G-296-B	K960911	COMBUSTIBLE, SECUNDARIO	GPP-19	A39867
ACEITE	G-6	A42274	ACEITE	GP-171	K200037	AIRE	GA-16	A42274
1170 con motor/CASE A451BD			1394 con motor/A DIESEL			AIRE, SIN ASPAS	GA-33	D48198
ACEITE	GP-5	A64453	COMBUSTIBLE	G-296	K960911	AIRE	GAK-16	A42274
1175 con motores/CASE A451BD, CASE A451BDT			COMBUSTIBLE	G-296-B	K960911	1816 con motor/A DIESEL		
ACEITE	GP-5	A64453	ACEITE	GP-171	K200037	AIRE	GA-7	A70090
1190 con motor/CASE 164.4			1410 con motor/A DIESEL			1816C con motor/A DIESEL		
COMBUSTIBLE	G-296	3044506-R93	ACEITE	GP-171	K200037	HIDRAULICO	GP-66	K22001
1190, 1194 con motor/DAVID BROWN			1410, 1412 con motor/DAVID BROWN 455011			1830 con motor/A GASOLINA		
COMBUSTIBLE	G-296	K960911	COMBUSTIBLE	G-296	960911	ACEITE	GP-81	D62845
COMBUSTIBLE	G-296-B	K960911	1412 con motor/A DIESEL			1845 con motor/A DIESEL		
ACEITE	GP-171	K200037	COMBUSTIBLE, SECUNDARIO	G-296	960911	ACEITE	GP-1	A29891
1200 con motor/CASE A451D			COMBUSTIBLE, SECUNDARIO	G-296-B	3044506R93	COMBUSTIBLE, PRIMARIO	GPP-18	A39868
COMBUSTIBLE, SECUNDARIO	G-1173	A7627	ACEITE	GP-171	K200037	COMBUSTIBLE, SECUNDARIO	GPP-19	A39867
COMBUSTIBLE	GPP-18	A58712	1450C con motores/CASE A504DT, CASE A504B, CASE A504BDT, CASE A504C, CASE A504D			AIRE	GA-16	A42274
AIRE, PRIMARIO SIN ASPAS	GA-24	L30937	ACEITE	GP-69	A75294	AIRE	GAK-16	A42274
1200 SELECTAMATIC con motor/A DIESEL			1470 con motores/CASE 504DT, CASE A504BD, CASE A504D			1845 con motor/A GASOLINA		
COMBUSTIBLE, SECUNDARIO	G-296	3044506-R93	COMBUSTIBLE, PRIMARIO	GPP-18	A58712	ACEITE	GP-1	A37189
1210 con motor/DAVID BROWN 455011			1490 con motor/DAVID BROWN			AIRE	GA-16	A42274
COMBUSTIBLE	G-296	3044506-R93	COMBUSTIBLE, SECUNDARIO	G-296	K960911	AIRE	GAK-16	A42274
COMBUSTIBLE	G-296-B	960911	1494 con motor/DAVID BROWN			GASOLINA, PLASTICO	GG-5	D53499
ACEITE	GP-171	K200037	ACEITE	GP-1	K955687	GASOLINA, METALICO	GG-5 L	D53499
1212 con motor/A DIESEL			COMBUSTIBLE, SECUNDARIO	G-296	K960911	1866, 1896 con motor/CASE 6T-590		
COMBUSTIBLE, SECUNDARIO	G-296	3044506-R93	COMBUSTIBLE, SECUNDARIO	G-296-B	K960911	COMBUSTIBLE, SECUNDARIO	GP-1122	J903640
1270 con motor/CASE 451BDT			1530, 1537 con motor/A DIESEL			COMBUSTIBLE, PRIMARIO	GPP-18	A58712
ACEITE	GP-5	A64453	AIRE, SIN ASPAS	GA-33	D48198	ACEITE	GP-178	J908615
1270 con motor/CASE A451BD			1530B con motor/A DIESEL			1896 con motor/CUMMINS 6B-5.9L		
ACEITE	GP-5	A64453	AIRE, SIN ASPAS	GA-33	D48198	COMBUSTIBLE, SECUNDARIO	GPP-1122	J843760
ACEITE	GP-69	A75294	1570 con motor/CASE A504BDT			2090 con motor/CASE 504		
AGUA	GP-2071W	A151931	ACEITE	GP-69	A75294	ACEITE	GP-54	A44081
COMBUSTIBLE, PRIMARIO	GPP-18	A58712	1570 con motor/CASE A504D			2090 con motor/CASE 504BD		
1290 con motor/CASE 195			ACEITE	GP-54	A44081	AGUA	GP-1010Q	A151931
COMBUSTIBLE	G-296	3044506R93	1594 con motor/A DIESEL			2094 con motor/A DIESEL		
COMBUSTIBLE	G-296-B	3044506R93	COMBUSTIBLE, SECUNDARIO	G-296	K960911	ACEITE	GP-54	A44081
ACEITE	GP-171	K200037	COMBUSTIBLE, SECUNDARIO	G-296-B	K960911	AGUA	GP-2071W	A151931
1290 con motor/DAVID BROWN			ACEITE	GP-171	K200037	COMBUSTIBLE, PRIMARIO	GPP-18	A39868
COMBUSTIBLE, SECUNDARIO	G-296	960911	1690 con motor/CASE 329			2094 con motor/CASE 504BD		
COMBUSTIBLE, SECUNDARIO	G-296-B	K960911	COMBUSTIBLE	G-296	K960911	AGUA	GP-1010Q	A151931
ACEITE	GP-171	K200037	1690 con motor/DAVID BROWN			ACEITE	GP-69	A44081
1294 con motor/DAVID BROWN			ACEITE	GP-1	A146696	COMBUSTIBLE, PRIMARIO	GPP-18	A44068
COMBUSTIBLE, SECUNDARIO	G-296	960911				2120, 2150, 2130, 2140 con motor/A DIESEL		
COMBUSTIBLE, SECUNDARIO	G-296-B	K960911				COMBUSTIBLE, SECUNDARIO	G-296	3044506R93
ACEITE	GP-171	K200037				COMBUSTIBLE, SECUNDARIO	G-296-B	3044506R93
						TRANSMISION	GP-81	D62845

MARCA-MODELO-MOTOR MAKE-MODEL-ENGINE	GONHER GONHER	OEM OEM	MARCA-MODELO-MOTOR MAKE-MODEL-ENGINE	GONHER GONHER	OEM OEM	MARCA-MODELO-MOTOR MAKE-MODEL-ENGINE	GONHER GONHER	OEM OEM
CASE (continuación)			CASE (continuación)			CASE (continuación)		
TRACTORES			TRACTORES			TRACTORES		
2290 con motor/CASE 504BD			300B con motor/CONTINENTAL GD157			400 con motor/A DIESEL		
ACEITE	GP-54	A44081	COMBUSTIBLE, SECUNDARIO	G-1173	A7627	ACEITE	GP-1	A146696
AGUA	GP-2071W	A151931	310 con motor/CASE G148B			TRANSMISION	GP-1	A146696
COMBUSTIBLE, PRIMARIO	GPP-18	A44068	ACEITE	GP-1	A146696	COMBUSTIBLE, PRIMARIO	GPP-18	A151281
2294 con motor/A DIESEL			310D, 310E con motor/CASE G148B			COMBUSTIBLE, SECUNDARIO	GPP-19	A151281
ACEITE	GP-54	A44081	ACEITE	GP-1	A146696	400 con motor/CASE G188D		
AGUA	GP-2071W	A151931	310E con motor/CASE G188D			ACEITE	GP-1	A146696
COMBUSTIBLE, PRIMARIO	GPP-18	A39868	COMBUSTIBLE, SECUNDARIO	G-1173	A7627	COMBUSTIBLE, PRIMARIO	GPP-18	A151281
2390 con motor/CASE 504BD			310F con motor/CASE G188D			COMBUSTIBLE, SECUNDARIO	GPP-19	A151281
ACEITE	GP-54	A44081	ACEITE	GP-1	A146696	400 con motor/CONTINENTAL GD157		
AGUA	GP-2071W	A151931	AIRE	GA-16	A7627	COMBUSTIBLE, SECUNDARIO	G-1173	A19579
COMBUSTIBLE, PRIMARIO	GPP-18	A44068	AIRE	GAK-16	F84998	400B, 400D con motor/CONTINENTAL GD157		
AIRE	GA-329	A47145	310G SOBRE ORUGAS con motor/A DIESEL			COMBUSTIBLE, SECUNDARIO	G-1173	A19579
AIRE	GA-239	A47146	ACEITE	GP-1	A146696	403, 401, 402 con motor/CASE		
2394, 2594 con motor/A DIESEL			311B con motores/CASE G148B, CASE G148D			COMBUSTIBLE, SECUNDARIO	G-1173	A19579
ACEITE	GP-54	A44081	ACEITE	GP-1	A146696	411B, 420B con motor/CASE G148B		
AGUA	GP-2071W	A151931	320 con motor/A DIESEL			ACEITE	GP-1	A29891
COMBUSTIBLE, PRIMARIO	GPP-18	A44068	COMBUSTIBLE, SECUNDARIO	G-1173	A7627	420, 425 con motor/A DIESEL		
AIRE	GA-329	A47145	320B con motor/A DIESEL			COMBUSTIBLE, SECUNDARIO	G-1173	A7627
AIRE	GA-239	A47146	COMBUSTIBLE, SECUNDARIO	G-1173	A7627	420C con motor/A GASOLINA		
2470 con motor/CASE 504BDT			3294 con motor/A DIESEL			ACEITE	GP-1	A146696
ACEITE	GP-69	A44081	AGUA	GP-2071W	A151931	420C con motor/DETROIT DIESEL		
2470 con motor/CASE A504BDT			COMBUSTIBLE, PRIMARIO	GPP-18	A58712	ACEITE	GP-1	A146696
ACEITE	GP-54	A44081	AIRE	GA-329	A47145	COMBUSTIBLE, PRIMARIO	GPP-18	A151281
252 con motor/DEUTZ			AIRE	GA-239	A47146	COMBUSTIBLE, SECUNDARIO	GPP-19	A151281
ACEITE	GP-1	A146696	AIRE			430 con motor/CASE G188D		
2590 con motor/CASE 504			3394, 3594 con motor/A DIESEL			COMBUSTIBLE, SECUNDARIO	G-1173	A7627
ACEITE	GP-54	A44081	ACEITE	GP-54	A44081	ACEITE	GP-1	A29891
AGUA	GP-2071W	A151931	AGUA	GP-2071W	A151931	COMBUSTIBLE, PRIMARIO	GPP-18	A39868
COMBUSTIBLE, PRIMARIO	GPP-18	A44068	COMBUSTIBLE, PRIMARIO	GPP-18	A58712	COMBUSTIBLE, SECUNDARIO	GPP-19	A39867
AIRE	GA-329	A47145	AIRE	GA-329	A47145	AIRE, SIN ASPAS	GA-33	D48198
AIRE	GA-239	A47146	AIRE	GA-239	A47146	430, 441, 431, 440 con motor/CASE G148B		
2590 con motor/CASE 504BDT			350 con motor/A DIESEL			ACEITE	GP-1	A29891
ACEITE	GP-69	A44081	ACEITE	GP-1	A146696	430CK, 480CK con motor/A DIESEL		
2670 con motor/CASE 504BDT			COMBUSTIBLE, PRIMARIO	GPP-18	A58712	ACEITE	GP-1	A146696
ACEITE	GP-69	A44081	COMBUSTIBLE, SECUNDARIO	GPP-19	A151281	446 con motor/ONAN BF-MS326-4F		
2670 con motor/CASE A504BDT			AIRE	GA-33	H425256	ACEITE	GP-3600	75318-C1
ACEITE	GP-54	A44081	350D con motor/A DIESEL			4490 con motor/CASE 504		
2870 con motor/SCANIA			ACEITE	GP-1	A146696	ACEITE	GP-54	A44081
ACEITE	GP-171	K200037	COMBUSTIBLE, PRIMARIO	GPP-18	A151281	AGUA	GP-2071W	A151931
30 FLEETHOE, 30+4 con motor/WISCONSIN			COMBUSTIBLE, SECUNDARIO	GPP-19	A151281	COMBUSTIBLE, PRIMARIO	GPP-18	A39868
AIRE	GA-33	D48198	AIRE	GA-33	H425256	ACEITE	GP-761H	D122562
300 con motor/CASE G148B			351 con motor/CASE G164			4490 con motor/CASE 504BDT		
ACEITE	GP-1	A146696	ACEITE	GP-1	A146696	AGUA	GP-1010Q	A151931
300, 301, 302 con motor/CONTINENTAL GD157			COMBUSTIBLE, PRIMARIO	GPP-18	A151281	450 con motor/CASE 207		
COMBUSTIBLE, SECUNDARIO	G-1173	A7627	COMBUSTIBLE, SECUNDARIO	GPP-19	A151281	ACEITE	GP-1	A146696
300B con motor/CASE G148B			360 con motor/A DIESEL			COMBUSTIBLE, PRIMARIO	GPP-18	A151281
ACEITE	GP-1	A146696	AIRE, PRIMARIO	GAK-1532	A173290	COMBUSTIBLE, SECUNDARIO	GPP-19	A151281
380CK, 380GP/LL con motor/DAVID BROWN 355011			COMBUSTIBLE	G-296	960911	AIRE	GA-16	F84998
COMBUSTIBLE						AIRE	GAK-16	F84998

SERVICIO PESADO

MARCA-MODELO-MOTOR MAKE-MODEL-ENGINE	GONHER GONHER	OEM OEM	MARCA-MODELO-MOTOR MAKE-MODEL-ENGINE	GONHER GONHER	OEM OEM	MARCA-MODELO-MOTOR MAKE-MODEL-ENGINE	GONHER GONHER	OEM OEM
CASE (continuación)			CASE (continuación)			CASE (continuación)		
TRACTORES			TRACTORES			TRACTORES		
450 con motor/CASE 336D			480 con motor/CASE G148			530 con motor/CASE G188D		
ACEITE	GP-1	A146696	ACEITE	GP-1	A146696	ACEITE	GP-1	A29891
COMBUSTIBLE, PRIMARIO	GPP-18	A151281				COMBUSTIBLE, PRIMARIO	GPP-18	A151281
AIRE	GA-403	D37975	480 con motor/CASE G188D			COMBUSTIBLE, SECUNDARIO	GPP-19	A151281
AIRE	GAK-403	D37975	ACEITE	GP-1	A146696			
			COMBUSTIBLE, PRIMARIO	GPP-18	A39868	530, 531, 540, 541 con motor/CASE G159		
450 con motor/G188			COMBUSTIBLE, SECUNDARIO	GPP-19	A39867	ACEITE	GP-1	A29891
ACEITE	GP-1	A146696						
			480 SERIE B con motor/CASE G148B			531, 540, 541 con motor/CASE G188D		
450 con motor/G188D			ACEITE	GP-1	A146696	COMBUSTIBLE, SECUNDARIO	G-1173	A7627
ACEITE	GP-1	A146696	AIRE	GA-16	F84998	ACEITE	GP-1	A29891
AIRE	GA-16	F84998	AIRE	GAK-16	F84998	COMBUSTIBLE, SECUNDARIO	G-296	3044506R93
AIRE	GA-403	D37975				COMBUSTIBLE, SECUNDARIO	G-296-B	3044506R93
AIRE	GAK-16	F84998	480 SERIE B con motor/CASE G188D			COMBUSTIBLE, PRIMARIO	GPP-18	A151281
AIRE	GAK-403	D37975	ACEITE	GP-1	A146696	COMBUSTIBLE, SECUNDARIO	GPP-19	A151281
			COMBUSTIBLE, PRIMARIO	GPP-18	A39868			
450 con motor/G188D 5/N 2718490 EN ADELANTE			COMBUSTIBLE, SECUNDARIO	GPP-19	A39867	570 con motor/A DIESEL		
COMBUSTIBLE, PRIMARIO	GPP-18	A151281	AIRE	GA-16	F84998	ACEITE	GP-1	A29891
			AIRE	GAK-16	F84998	COMBUSTIBLE, PRIMARIO	GPP-18	A151281
						COMBUSTIBLE, SECUNDARIO	GPP-19	A151281
450C con motor/CUMMINS 4B 3.9L			480C con motor/A DIESEL			570 con motor/CASE G148B		
COMBUSTIBLE, SECUNDARIO	GP-1122	J903640	COMBUSTIBLE, PRIMARIO	GPP-18	A151281	ACEITE	GP-1	A29891
COMBUSTIBLE, PRIMARIO	GPP-18	A925274	COMBUSTIBLE, SECUNDARIO	GPP-19	A151281			
ACEITE	GP-390	J908616	AIRE	GA-16	F84998	580 con motor/CASE G159		
AIRE, PRIMARIO	GAK-1532	A173290	AIRE	GAK-16	F84998	ACEITE	GP-1	A29891
						COMBUSTIBLE, PRIMARIO	GPP-18	A151281
450D con motor/CASE 207			480D, 480D-LL con motor/A DIESEL			COMBUSTIBLE, SECUNDARIO	GPP-19	A151281
ACEITE	GP-1	A146696	ACEITE	GP-1	A146696	AIRE	GA-16	F84998
COMBUSTIBLE, PRIMARIO	GPP-18	A151281	COMBUSTIBLE, PRIMARIO	GPP-18	A151281	AIRE	GAK-16	F84998
COMBUSTIBLE, SECUNDARIO	GPP-19	A151281	COMBUSTIBLE, SECUNDARIO	GPP-19	A151281			
AIRE	GA-16	F84998	AIRE	GA-16	F84998	580 con motor/CASE G188D		
AIRE	GAK-16	F84998	AIRE	GAK-16	F84998	ACEITE	GP-1	A29891
						COMBUSTIBLE, PRIMARIO	GPP-18	A151281
455C con motor/CUMMINS 4B3.9			4890 con motor/SCANIA			COMBUSTIBLE, SECUNDARIO	GPP-19	A151281
COMBUSTIBLE, SECUNDARIO	GP-1122	J903640	ACEITE	GP-58	9144445	AIRE	GA-16	F84998
COMBUSTIBLE, PRIMARIO	GPP-18	A925274	AGUA	GP-2071W	A151931	AIRE, SIN ASPAS	GA-33	D48198
ACEITE	GP-390	J908616	ACEITE	GP-171	A46158	AIRE	GAK-16	F84998
AIRE, PRIMARIO	GAK-1532	N6778	COMBUSTIBLE	GPP-18	A58712			
						580B con motor/CASE G159		
4690 con motor/CASE 504			4890, 4894 con motor/CASE 674			ACEITE	GP-1	A29891
ACEITE	GP-34	A41725	AGUA	GP-1010Q	A151931	COMBUSTIBLE, PRIMARIO	GPP-18	A151281
AGUA	GP-2071W	A151931	ACEITE	GP-171	A46158	COMBUSTIBLE, SECUNDARIO	GPP-19	A151281
COMBUSTIBLE, PRIMARIO	GPP-18	A58712	COMBUSTIBLE, PRIMARIO	GPP-18	A58712	AIRE	GA-16	F84998
ACEITE	GP-761H	N9025				AIRE	GAK-16	F84998
			500 con motor/CONTINENTAL GD157			AIRE	GAK-16	F84998
4690 con motor/CASE 504BDTI			ACEITE, DERIVACION (BY PASS)	G-31	010070AB			
AGUA	GP-1010Q	A151931				580B con motor/CASE G188D		
			500LK con motor/CASE			ACEITE	GP-1	A29891
470 con motor/CASE G148			ACEITE	GP-1	A29891	COMBUSTIBLE, PRIMARIO	GPP-18	A151281
ACEITE	GP-1	A146696				COMBUSTIBLE, SECUNDARIO	GPP-19	A151281
			500LK con motor/CASE A GASOLINA			AIRE	GA-16	F84998
470 con motor/CASE G148B			ACEITE	GP-1	A29891	AIRE, SIN ASPAS	GA-33	D48198
ACEITE	GP-1	A29891				AIRE	GAK-16	F84998
			510 con motores/A GASOLINA, CASE G159					
470 con motor/CASE G188D			ACEITE	GP-1	A29891	580C con motor/CASE		
ACEITE	GP-1	A29891	COMBUSTIBLE, PRIMARIO	GPP-18	A39868	ACEITE	GP-1	A29891
COMBUSTIBLE, PRIMARIO	GPP-18	A39868	COMBUSTIBLE, SECUNDARIO	GPP-19	A39867	COMBUSTIBLE, PRIMARIO	GPP-18	A151281
COMBUSTIBLE, SECUNDARIO	GPP-19	A39867	511 con motor/A GASOLINA			COMBUSTIBLE, SECUNDARIO	GPP-19	A151281
			ACEITE	GP-1	A29891	AIRE	GA-16	F84998
475 CABLEADOR con motores/CASE 301D, CASE 336D			511B con motor/CASE G159			AIRE	GAK-16	F84998
ACEITE	GP-1	A146696	ACEITE	GP-1	A29891			
ACEITE	GP-54	A44081				580D, 580D TURBO con motor/CASE G207A		
COMBUSTIBLE, PRIMARIO	GPP-18	A39868	520 con motor/A DIESEL			ACEITE	GP-1	A29891
AIRE	GA-403	A40866	ACEITE, DERIVACION (BY PASS)	G-31	010070AB	AIRE	GA-16	F84998
AIRE	GAK-403	A40866						

MARCA-MODELO-MOTOR MAKE-MODEL-ENGINE	GONHER GONHER	OEM OEM	MARCA-MODELO-MOTOR MAKE-MODEL-ENGINE	GONHER GONHER	OEM OEM	MARCA-MODELO-MOTOR MAKE-MODEL-ENGINE	GONHER GONHER	OEM OEM
CASE (continuación)			CASE (continuación)			CASE (continuación)		
TRACTORES			TRACTORES			TRACTORES		
AIRE	GAK-16	F84998	680CK SERIES C con motor/CASE A301BD			COMBUSTIBLE, PRIMARIO	GPP-18	A58712
AIRE	GAK-1532	A-173290	ACEITE	GP-1	A146696	AIRE	GA-403	D36261
580E con motor/CUMMINS 4B3.9			COMBUSTIBLE, PRIMARIO	GPP-18	A58712	AIRE	GAK-403	D37975
COMBUSTIBLE, SECUNDARIO	GP-1122	J903640	AIRE	GA-403	D36261	780CK con motor/CASE 336		
COMBUSTIBLE, PRIMARIO	GPP-18	A58712	AIRE	GAK-403	D36261	ACEITE	GP-1	A146696
ACEITE	GP-390	J-908616	680CK SERIES E con motor/CASE 336B			ACEITE	GP-69	A44081
AIRE	GAK-1532	A-173290	ACEITE	GP-1	A146696	COMBUSTIBLE, PRIMARIO	GPP-18	A58712
584CK, 585CK, 586CK con motor/A DIESEL			ACEITE	GP-69	A75294	AIRE	GA-403	D36261
ACEITE	GP-1	A29891	COMBUSTIBLE, PRIMARIO	GPP-18	A58712	AIRE	GAK-403	D37975
COMBUSTIBLE, PRIMARIO	GPP-18	A39868	700 con motor/CASE A251			801, 810, 802, 803 con motores/CONTINENTAL H227, CONTINENTAL HD227		
COMBUSTIBLE, SECUNDARIO	GPP-19	A39867	COMBUSTIBLE, SECUNDARIO	G-1173	A7627	ACEITE	G-31	010070AB
AIRE	GA-16	F84998	HIDRAULICO	GP-66	A44081	ACEITE	G-33	L33711
AIRE	GAK-16	F84998	700 con motor/CASE A267D			COMBUSTIBLE, SECUNDARIO	G-1173	A7627
600 con motor/CONTINENTAL ED208			ACEITE	G-6	A21475	810, 800, 801, 802, 803 con motor/CASE A251		
ACEITE	G-31	010070AB	COMBUSTIBLE, SECUNDARIO	G-1173	A7627	ACEITE	G-6	A42274
610 DIESEL con motor/CONTINENTAL ED208			HIDRAULICO	GP-66	A44081	ACEITE	G-31	010070AB
ACEITE	G-31	010070AB	700 con motor/CASE A267D S/N 8140136			ACEITE	G-33	L33711
611 con motor/CASE 600 SERIES			COMBUSTIBLE	G-1174	A31222	COMBUSTIBLE, SECUNDARIO	G-1173	A7627
ACEITE	G-31	010070AB	700 DIESEL con motor/CASE A267D			811, 812, 813 con motor/CASE A267D		
611 con motor/CASE G188D			ACEITE	G-6	A21475	ACEITE	G-6	A21475
ACEITE	GP-1	A146696	715, 701, 702, 703, 705, 710, 711, 713, 714 con motores/CASE A251, CASE A267D			830 con motor/CASE A284		
COMBUSTIBLE, PRIMARIO	GPP-18	A58712	ACEITE	G-6	A21475	ACEITE	GP-1	A146696
COMBUSTIBLE, SECUNDARIO	GPP-19	A39867	COMBUSTIBLE, SECUNDARIO	G-1173	A7627	830 con motor/CASE A301D		
611, 630, 641 con motor/CASE G188			HIDRAULICO	GP-66	A44081	ACEITE	G-6	A42274
ACEITE	GP-1	A146696	730 con motor/CASE A251			COMBUSTIBLE, SECUNDARIO	G-1173	A7627
630, 641 con motor/CASE G188D			ACEITE	G-6	A42274	HIDRAULICO	GP-66	A32297
ACEITE	GP-1	A146696	730, 810, 800, 801, 802, 803 con motor/CASE A267D			830C, 841TRACTOR con motor/CASE A284		
COMBUSTIBLE, PRIMARIO	GPP-18	A39868	ACEITE	G-6	A42274	ACEITE	GP-1	A146696
COMBUSTIBLE, SECUNDARIO	GPP-19	A39867	731 DIESEL con motor/CASE A267D			831 DIESEL con motor/CASE A301D		
630C con motor/CASE G188			ACEITE	G-6	A42274	ACEITE	G-6	A42274
ACEITE	GP-1	A146696	740 DIESEL con motor/CASE A251			COMBUSTIBLE, SECUNDARIO	G-1173	A7627
630C, 631 DIESEL con motor/CASE G188D			ACEITE	G-6	A42274	HIDRAULICO	GP-66	A32297
ACEITE	GP-1	A146696	750 DIESEL con motores/CASE A267D, CASE A301D			840 con motor/A DIESEL		
COMBUSTIBLE, PRIMARIO	GPP-18	A39868	ACEITE	G-6	A42274	ACEITE	G-6	A42274
COMBUSTIBLE, SECUNDARIO	GPP-19	A39867	770 con motor/CASE A251			850 DIESEL con motor/CASE A267D		
680 con motor/CASE A251			ACEITE	GP-1	A37189	HIDRAULICO	GP-66	A32297
ACEITE	G-6	A42274	COMBUSTIBLE, PRIMARIO	GPP-18	A58712	850 DIESEL con motor/CASE A267D S/N 8140136		
AIRE	GA-16	F84998	AIRE	GA-16	F84998	COMBUSTIBLE, SECUNDARIO	G-1173	A7627
AIRE	GAK-16	F84998	AIRE	GAK-16	F84998	850 DIESEL con motor/CASE A301D		
680 DIESEL con motor/CASE A267D			770 DIESEL con motor/CASE A267BD			ACEITE	GP-1	A146696
ACEITE	G-6	A21475	ACEITE	GP-1	A37189	COMBUSTIBLE, PRIMARIO	GPP-18	A58712
COMBUSTIBLE, SECUNDARIO	G-1173	A7627	COMBUSTIBLE, PRIMARIO	GPP-18	A58712	AIRE	GA-403	D37975
ACEITE	GP-1	A58758	AIRE	GA-16	F84998	AIRE	GAK-403	D37975
COMBUSTIBLE, PRIMARIO	GPP-18	A58712	AIRE	GAK-16	F84998	850 DIESEL con motor/CASE A401BD		
AIRE	GA-16	A42274	770A, 770B, 780 SELECTAMATIC con motor/A DIESEL			COMBUSTIBLE, PRIMARIO	GPP-18	A58712
AIRE	GAK-16	A42274	COMBUSTIBLE, SECUNDARIO	G-296	3044506R93	850 IMPLMATIC, 880 SERIES, 885 SERIES con motor/A DIESEL		
680CK SERIES B con motor/A DIESEL			780 con motor/CASE 336			COMBUSTIBLE, SECUNDARIO	G-296	3044506R93
ACEITE	G-6	A21475	ACEITE	GP-1	A146696			
ACEITE	GP-1	A58758	ACEITE	GP-69	A44081			
COMBUSTIBLE, PRIMARIO	GPP-18	A58712						
AIRE	GA-403	D36261						
AIRE	GAK-403	A58713						

SERVICIO PESADO

MARCA-MODELO-MOTOR MAKE-MODEL-ENGINE	GONHER GONHER	OEM OEM	MARCA-MODELO-MOTOR MAKE-MODEL-ENGINE	GONHER GONHER	OEM OEM	MARCA-MODELO-MOTOR MAKE-MODEL-ENGINE	GONHER GONHER	OEM OEM
CASE (continuación)			CASE (continuación)			CASE (continuación)		
TRACTORES			TRACTORES			TRACTORES		
850 SERIES B con motor/CASE 336BD			920 DIESEL con motor/A DIESEL			970 con motor/CASE A377D		
ACEITE	GP-69	A75294	ACEITE	G-31	A28008	ACEITE	GP-1	A37189
COMBUSTIBLE, PRIMARIO	GPP-18	A58712	COMBUSTIBLE	G-1173	A7627	ACEITE	GP-54	A58672
AIRE	GA-403	D36261	COMBUSTIBLE, SECUNDARIO	G-1174	A31222	AGUA	GP-2071W	A151931
AIRE	GAK-403	D37975	920 DIESEL con motor/CASE A377D S/N 8140136			COMBUSTIBLE, PRIMARIO	GPP-18	A58712
850 SERIES B con motor/CASE A401BD			COMBUSTIBLE, SECUNDARIO	G-1173	A7627	AIRE	GA-403	D36261
ACEITE	GP-1	A146696	930 con motor/CASE A377			AIRE	GAK-403	A40866
COMBUSTIBLE, PRIMARIO	GPP-18	A58712	ACEITE	GP-34	A41725	970 con motor/CASE A401BD		
AIRE	GA-403	D36261	930 con motor/CASE A401BD			ACEITE	GP-1	A146696
AIRE	GAK-403	D37975	HIDRAULICO	GP-66	A32297	ACEITE	GP-69	A75294
850E SOBRE ORUGAS, 855E SOBRE ORUGAS con motor/CASE 6-590			930 con motor/CASE A401D			COMBUSTIBLE, PRIMARIO	GPP-18	A58712
COMBUSTIBLE, SECUNDARIO	GP-1122	J903640	COMBUSTIBLE, SECUNDARIO	G-1173	A7627	AIRE	GA-403	D36261
COMBUSTIBLE, PRIMARIO	GPP-18	J925274	930CK con motor/A DIESEL			AIRE	GAK-403	A40866
ACEITE	GP-178	J932217	COMBUSTIBLE, SECUNDARIO	G-1173	A7627	980 con motor/CASE 504BD		
855 con motor/DAVID BROWN			930CK con motor/A DIESEL			ACEITE	GP-5	A64453
COMBUSTIBLE	G-296	960911	COMBUSTIBLE, SECUNDARIO	G-1173	A7627	COMBUSTIBLE, PRIMARIO	GPP-18	A58712
870 con motor/CASE A301			ACEITE	GP-34	A41725	AIRE	GA-20	L33913
ACEITE	GP-1	A37189	HIDRAULICO	GP-66	A32297	AIRE	GAK-20	L33913
COMBUSTIBLE, PRIMARIO	GPP-18	A58712	931 con motor/CASE A377			990 con motor/DAVID BROWN 455011		
AIRE	GA-16	F84998	ACEITE	G-31	010070AB	COMBUSTIBLE	G-296-B	960911
AIRE	GAK-16	F84998	ACEITE	GP-34	A41725	990 SELECTAMATICS, 990A SELECTAMATICS con motor/A DIESEL		
870 DIESEL con motor/CASE 336BD			HIDRAULICO	GP-66	A32297	COMBUSTIBLE, SECUNDARIO	G-296	3044506R93
ACEITE	GP-1	A37189	931 con motor/CASE A401D			COMBUSTIBLE, SECUNDARIO	G-296-B	3044506R93
COMBUSTIBLE, PRIMARIO	GPP-18	A58712	COMBUSTIBLE, SECUNDARIO	G-1173	A7627	ACEITE	GP-81	D62845
AIRE	GA-16	A42274	ACEITE	GP-34	A41725	990B con motor/A DIESEL		
AIRE	GAK-16	A42274	HIDRAULICO	GP-66	A32297	ACEITE	GP-69	A44081
880 con motor/CASE 336			931, 932, 933 con motor/CASE A401BD			COMBUSTIBLE, PRIMARIO	GPP-18	A58712
ACEITE	GP-1	A146696	HIDRAULICO	GP-66	A32297	AIRE, SECUNDARIO	GA-361	P850561
COMBUSTIBLE, PRIMARIO	GPP-18	A58712	932 con motor/CASE A377			990B SELECTAMATICS, 995 SELECTAMATICS, 996 SELECTAMATICS con motor/A DIESEL		
AIRE	GA-403	D36261	ACEITE	G-31	010070AB	COMBUSTIBLE, SECUNDARIO	G-296	3044506R93
AIRE	GAK-403	D37975	ACEITE	GP-34	A41725	COMBUSTIBLE, SECUNDARIO	G-296-B	3044506R93
880B con motor/CASE 336			HIDRAULICO	GP-66	A32297	ACEITE	GP-81	D62845
ACEITE	GP-1	A146696	932 con motor/CASE A401D			995 con motor/A DIESEL		
COMBUSTIBLE, PRIMARIO	GPP-18	A58712	COMBUSTIBLE, SECUNDARIO	G-1173	A7627	ACEITE	GP-36	3136046-R93
AIRE	GA-16	F84998	ACEITE	GP-34	A41725	COMBUSTIBLE, SECUNDARIO	GP-1122	J903640
AIRE	GAK-16	F84998	HIDRAULICO	GP-66	A32297	AGUA	GP-2071W	A151931
885LCG con motor/DAVID BROWN 355011			933 con motor/CASE A377			995 con motor/DAVID BROWN 455011		
COMBUSTIBLE	G-296	960911	ACEITE	G-31	010070AB	COMBUSTIBLE, SECUNDARIO	G-296	960911
COMBUSTIBLE	G-296-B	960911	ACEITE	GP-34	A41725	D310G con motor/CASE G188D		
ACEITE	GP-171	K200037	HIDRAULICO	GP-66	A32297	ACEITE	GP-1	A146696
900 con motor/A DIESEL			933 con motor/CASE A401D			AIRE	GA-16	P101222
ACEITE	G-31	A28008	COMBUSTIBLE, SECUNDARIO	G-1173	A7627	AIRE	GAK-16	P101222
COMBUSTIBLE, SECUNDARIO	G-1173	A7627	ACEITE	GP-34	A41725	G310G con motor/CASE G148		
COMBUSTIBLE	G-1174	A31222	HIDRAULICO	GP-66	A32297	ACEITE	GP-1	A146696
900 con motor/CASE A377			940 con motor/CASE A377			CASE		
COMBUSTIBLE	GS-1133	FS1203	ACEITE	G-31	010070AB	TRACTORES PEQUEÑOS Y PARA JARDIN		
900 con motor/CASE A377D S/N 8140136			950 SERIES con motor/A DIESEL			107, 117 con motor/TECUMSEH 7 HP		
COMBUSTIBLE	G-1173	A7627	COMBUSTIBLE, SECUNDARIO	G-296	3044506R93	TRANSMISION	GP-81	D62845
910 con motor/CASE A377D			970 con motor/CASE A377			120 con motores/KOHLER 10 HP, KOHLER 12 HP		
ACEITE	G-31	A28008	ACEITE	GP-1	A37189	AIRE	GA-7	A70090
COMBUSTIBLE	G-1173	A7627	AIRE	GA-403	D36261	CASE		
COMBUSTIBLE, SECUNDARIO	G-1174	A31222	AIRE	GAK-403	A43066	TRACTORES PEQUEÑOS Y PARA JARDIN		

MARCA-MODELO-MOTOR MAKE-MODEL-ENGINE	GONHER GONHER	OEM OEM	MARCA-MODELO-MOTOR MAKE-MODEL-ENGINE	GONHER GONHER	OEM OEM	MARCA-MODELO-MOTOR MAKE-MODEL-ENGINE	GONHER GONHER	OEM OEM
CASE (continuación)			CASE / INTERNATIONAL			CASE/INTERNATIONAL(continuación)		
TRACTORES PEQUEÑOS Y PARA JARDIN			COMBINADAS			COMBINADAS		
150, 155 con motores/KOHLER 10 HP, KOHLER 12 HP			1060 con motor/A DIESEL			COMBUSTIBLE	GPP-1000	A184776
AIRE	GA-7	D66337	ACEITE	G-6	A21475	AIRE	GA-892	150482A1
			COMBUSTIBLE, SECUNDARIO	G-1173	A7627			
190, 195 con motores/KOHLER 10 HP, KOHLER 12 HP			AIRE	GA-403	D37975	1640 con motor/CASE 6TA-590		
AIRE	GA-7	A70090	AIRE	GAK-403	D37975	ACEITE	G-338	528493-R3
						COMBUSTIBLE, SECUNDARIO	GP-1122	J903640
210 con motor/KOHLER K241A			1275 con motor/A DIESEL			AGUA	GP-2071W	A77544
AIRE	GA-7	A70090	AIRE	GA-16	F84998	ACEITE	GP-178	J908615
						COMBUSTIBLE	GPP-1000	A184776
220 con motor/KOHLER 10 HP			1420 con motor/IHC D358			1640 con motor/IHC DT466		
TRANSMISION	GP-81	D62845	ACEITE	G-338	528493-R3	ACEITE	G-338	528493-R3
			ACEITE	GP-36	3136046-R93	ACEITE	GP-69	A184775
222 con motor/KOHLER 12 HP			COMBUSTIBLE, SECUNDARIO	GPP-1122	1967094-C1	COMBUSTIBLE	GP-1108	A184773
AIRE	GA-7	A70090	AGUA	GP-2071W	A77544	ACEITE	GP-88	1811953C1
			COMBUSTIBLE	GPP-1000	A184776	AGUA	GP-2071W	A77544
224 con motor/KOHLER K321A			AIRE	GA-892	529852-R5	COMBUSTIBLE	GP-78	A184774
AIRE	GA-7	A70090				COMBUSTIBLE	GPP-1000	A184776
			1440 con motor/IHC D436			AIRE, SECUNDARIO	GA-361	N6660
235 con motor/MITSUBISHI 18 HP			ACEITE	G-338	528493-R3	GASOLINA	GG-20	405501-C1
ACEITE	GP-149	1275229C1	ACEITE	GP-69	A184775			
			COMBUSTIBLE	GP-1108	A184773	1644 con motor/CASE 5.9L		
245 con motores/MITSUBISHI 18 HP, MITSUBISHI 21 HP			AGUA	GP-2071W	A151931	COMBUSTIBLE, SECUNDARIO	GP-1122	J903640
ACEITE	GP-149	1275229C1	COMBUSTIBLE	GP-78	A184774	AGUA	GP-2071W	A77544
			COMBUSTIBLE	GPP-1000	A184776	ACEITE	GP-178	J908615
2510 con motor/A DIESEL			AIRE, PRIMARIO	GA-360	S231996			
AIRE	GA-7	D66337	AIRE, SECUNDARIO	GA-361	N6660	1660 con motor/CASE 6TA-830		
			GASOLINA	GG-20	405501-C1	ACEITE	G-338	528493-R3
255 con motor/MITSUBISHI 24 HP			1460 con motor/IHC DT436			COMBUSTIBLE, SECUNDARIO	GP-1122	J903640
ACEITE	GP-149	1275229C1	ACEITE	G-338	528493-R3	AGUA	GP-2071W	A77544
			ACEITE	GP-69	A184775	COMBUSTIBLE	GPP-1000	A184776
275 con motor/MITSUBISHI 31 HP			COMBUSTIBLE	GP-1108	A184773			
ACEITE	GP-149	1275229C1	AGUA	GP-2071W	A151931	1660 con motor/CASE 6TA-830 S/N 44489287		
			COMBUSTIBLE	GP-78	A184774	ACEITE	GP-43	A77537
442 con motor/KOHLER 12 HP			COMBUSTIBLE	GPP-1000	A184776			
AIRE	GA-7	A70090	GASOLINA	GG-20	405501-C1	1660, 1670 HILLSIDE con motor/IHC DT466		
						ACEITE	G-338	528493-R3
444 con motor/KOHLER 14 HP			1470 con motor/IHC DT466			ACEITE	GP-69	A184775
TRANSMISION	GP-81	D62845	ACEITE	G-338	528493-R2	COMBUSTIBLE	GP-1108	A184773
			COMBUSTIBLE	GPP-14	702255-C1	ACEITE	GP-88	1811953C1
644 con motor/KOHLER K321A			ACEITE	GP-69	A184775	AGUA	GP-2071W	A77544
AIRE	GA-7	A70090	COMBUSTIBLE	GP-1108	A184773	COMBUSTIBLE	GP-78	A184774
			COMBUSTIBLE	GP-88	1811953C1	COMBUSTIBLE	GPP-1000	A184776
646 con motor/ONAN CCKA-MS			AGUA	GP-2071W	A77544			
AIRE	GA-7	A70090	COMBUSTIBLE	GP-78	A184774	1666, 1688 con motor/CASE 6CTA-830		
						COMBUSTIBLE, SECUNDARIO	GP-1122	J903640
			1480 con motor/IHC DT436			ACEITE	GP-43	A77537
			ACEITE	G-338	528493-R2	AGUA	GP-2071W	A77544
			COMBUSTIBLE	GPP-14	702255-C1	COMBUSTIBLE	GPP-1000	A184776
			ACEITE	GP-69	A184775			
			COMBUSTIBLE	GP-1108	A184773	1670 HILLSIDE con motor/CASE 6TA-830		
			AGUA	GP-2071W	A77544	COMBUSTIBLE	GP-1122	J903640
			COMBUSTIBLE	GP-78	A184774	ACEITE	GP-43	A77537
						AGUA	GP-2071W	A77544
			1620 con motor/CASE 6T-590			COMBUSTIBLE	GPP-1000	A184776
			ACEITE	G-338	528493-R3			
			COMBUSTIBLE, SECUNDARIO	GP-1122	J903640	1680 con motor/CASE 6TA-830		
			COMBUSTIBLE, PRIMARIO	GPP-18	A58712	ACEITE	G-338	528493-R3
			ACEITE	GP-178	J908615	COMBUSTIBLE, SECUNDARIO	GP-1122	J903640
						ACEITE	GP-43	A77537
			1620 con motor/IHC D358			AGUA	GP-2071W	A77544
			ACEITE	G-338	528493-R3	COMBUSTIBLE	GPP-1000	A184776
			ACEITE	GP-36	3136046-R93			
			COMBUSTIBLE, SECUNDARIO	GPP-1122	1967094-C1			
			AGUA	GP-2071W	A77544			

SERVICIO PESADO

MARCA-MODELO-MOTOR	GONHER	OEM
MAKE-MODEL-ENGINE	GONHER	OEM

CASE/INTERNATIONAL(continuación)

COMBINADAS

1680 con motor/IHC DT1466		
ACEITE	G-338	528493-R3
COMBUSTIBLE	GP-1122	J903640
ACEITE, OPCIONAL	GP-66	H371872
ACEITE	GP-69	A1808896-C1
COMBUSTIBLE	GP-1108	A184773
ACEITE	GP-88	1811953C1
AGUA	GP-2071W	A77544
COMBUSTIBLE	GP-78	A184774
COMBUSTIBLE	GPP-1000	A184776

1680 con motor/IHC DT1466 S/N 44489287		
ACEITE	GP-43	A77537

2144 con motor/CUMMINS 6BTA590		
COMBUSTIBLE, SECUNDARIO	GP-1122	J903640
ACEITE	GP-178	J908615
COMBUSTIBLE	GPP-1000	A184776

2166, 2188 con motor/CUMMINS 6CTA830		
COMBUSTIBLE, SECUNDARIO	GP-1122	J903640
ACEITE, OPCIONAL	GP-66	H371872
AGUA	GP-2071W	A77544
COMBUSTIBLE	GPP-1000	A184776

2344 con motor/CUMMINS 5.9L		
COMBUSTIBLE, SECUNDARIO	GP-1122	J903640
ACEITE	GP-178	J908615
COMBUSTIBLE	GPP-1000	A184776

2366, 2388 con motor/CUMMINS 8.3L		
COMBUSTIBLE, SECUNDARIO	GP-1122	J903640
AGUA	GP-2071W	A77544
COMBUSTIBLE	GPP-1000	A184776

815, 915 con motores/IHC D414, IHC DT414		
ACEITE	G-338	528493-R3
ACEITE	GP-69	A184775
COMBUSTIBLE	GP-1108	A184773
COMBUSTIBLE	GP-78	A184774
AIRE, PRIMARIO	GA-360	S231996
AIRE, SECUNDARIO	GA-361	S30270-R2

AFX8010 con motor/IVECO 3VEXL (10.3L)		
ACEITE, RETORNO HIDRAULICO	GP-761H	294721A1

CASE / INTERNATIONAL

HILERADORAS

6000, 6500 con motor/A GASOLINA		
GASOLINA, PLASTICO	GG-5	1701232-C91

6000, 6500 con motor/CUMMINS 3.9L		
COMBUSTIBLE, SECUNDARIO	GP-1122	J903640
COMBUSTIBLE, PRIMARIO	GPP-18	A44068
ACEITE	GP-390	J908616

8820, 8830 con motor/A GASOLINA		
ACEITE	GP-81	D62845
AIRE	GAK-216	924779-C2
AIRE	GA-416	537335-R3
GASOLINA, PLASTICO	GG-5	1701232-C91
GASOLINA, METALICO	GG-5 L	1701232-C91

MARCA-MODELO-MOTOR	GONHER	OEM
MAKE-MODEL-ENGINE	GONHER	OEM

CASE/INTERNATIONAL(continuación)

HILERADORAS

8820, 8830 con motor/CUMMINS 3.9L		
COMBUSTIBLE, SECUNDARIO	GP-1122	J903640
COMBUSTIBLE, SECUNDARIO	GPP-1122	J843760
COMBUSTIBLE, PRIMARIO	GPP-18	A58712
ACEITE	GP-81	D62845
ACEITE	GP-390	J908616
AIRE	GAK-216	924779-C2
AIRE	GA-416	537335-R3
AIRE, PRIMARIO	GAK-1532	A173290

8825, 8825HP con motor/CUMMINS 3.9L		
COMBUSTIBLE, SECUNDARIO	GP-1122	J903640
COMBUSTIBLE, SECUNDARIO	GPP-1122	J843760
COMBUSTIBLE, PRIMARIO	GPP-18	A58712
ACEITE	GP-390	J908616

8840 con motor/CUMMINS 3.9L		
COMBUSTIBLE, SECUNDARIO	GP-1122	J903640
COMBUSTIBLE, PRIMARIO	GPP-18	A58712
ACEITE	GP-81	D62845
ACEITE	GP-390	J908616
AIRE	GAK-216	924779-C2
AIRE	GA-416	537335-R3

8850, 8850HP con motor/CUMMINS 5.9L		
COMBUSTIBLE, SECUNDARIO	GP-1122	J903640
COMBUSTIBLE, PRIMARIO	GPP-18	A58712
ACEITE	GP-178	J908615

WDX1002S con motor/A DIESEL		
ACEITE, AUXILIAR HIDRAULICO	GP-34	86632018
HIDRAULICO (REQUIERE 2)	GP-34	86632018
COMBUSTIBLE, SEPARADOR DE AGUA	GPP-1122	87803194
ACEITE	GP-737	87803261
AIRE, RADIAL PRIMARIO	GA-853R	222421A1

WDX1202 con motor/A DIESEL		
ACEITE, AUXILIAR HIDRAULICO	GP-34	86632018
HIDRAULICO (REQUIERE 2)	GP-34	86632018
COMBUSTIBLE, SEPARADOR DE AGUA	GPP-1122	87803194
AIRE DE CABINA, RADIAL	GA-853R	222421A1
AIRE, RADIAL, PRIMARIO	GA-697R	392120A1

WDX1202S con motor/A DIESEL		
ACEITE, AUXILIAR HIDRAULICO	GP-34	86632018
HIDRAULICO (REQUIERE 2)	GP-34	86632018
COMBUSTIBLE, SEPARADOR DE AGUA	GPP-1122	87803194
AIRE DE CABINA, RADIAL	GA-853R	222421A1
AIRE, RADIAL, PRIMARIO	GA-697R	AF25492

WDX1902, WDX2302 con motor/7.5L		
ACEITE, AUXILIAR HIDRAULICO	GP-34	86632018
HIDRAULICO (REQUIERE 2)	GP-34	86632018
AIRE DE CABINA, RADIAL	GA-853R	222421A1

CASE / INTERNATIONAL

MOTORES

PX215 PTO UNIDADES DE FUERZA con motor/A DIESEL		
COMBUSTIBLE, SECUNDARIO	GP-1122	J903640
ACEITE	GP-3000	J919562
COMBUSTIBLE, PRIMARIO	GPP-18	A39868

MARCA-MODELO-MOTOR	GONHER	OEM
MAKE-MODEL-ENGINE	GONHER	OEM

CASE / INTERNATIONAL

PISCADORAS DE ALGODÓN

1822 con motor/CUMMINS 6BTA590		
COMBUSTIBLE, SECUNDARIO	GP-1122	J903640
ACEITE	GP-69	A184775
AGUA	GP-2071W	A77544
COMBUSTIBLE, PRIMARIO	GPP-18	A58712
COMBUSTIBLE	GP-78	A184774
ACEITE	GP-178	J908615
AIRE	GA-826	67974-C4
AIRE	GA-827	67975-C1

1822, 1844 con motor/IHC		
ACEITE	GP-69	A184775
AGUA	GP-2071W	A151931
COMBUSTIBLE	GP-78	A184774
COMBUSTIBLE	GPP-1000	A184776
AIRE	GA-826	67974-C4
AIRE	GA-827	67975-C1

1844 con motor/CASE 6TA-830		
COMBUSTIBLE, SECUNDARIO	GP-1122	J903640
ACEITE	GP-43	A77537
AGUA	GP-2071W	A77544
COMBUSTIBLE, PRIMARIO	GPP-18	A58712
AIRE	GA-826	67974-C4
AIRE	GA-827	67975-C1

2022 con motor/CUMMINS 6TA590		
COMBUSTIBLE, SECUNDARIO	GP-1122	J903640
COMBUSTIBLE, PRIMARIO	GPP-18	A58712
ACEITE	GP-178	J908615
AIRE	GA-826	67974-C4
AIRE	GA-827	67975-C1

2044, 2055 con motor/CUMMINS 6TA830		
COMBUSTIBLE, SECUNDARIO	GP-1122	J903640
AGUA	GP-2071W	A77544
COMBUSTIBLE, PRIMARIO	GPP-18	A58712
AIRE	GA-826	67974-C4
AIRE	GA-827	67975-C1

2155 con motor/CUMMINS 6CTA830		
COMBUSTIBLE, SECUNDARIO	GP-1122	J903640
AGUA	GP-2071W	A77544
COMBUSTIBLE, PRIMARIO	GPP-18	A58712

2555 con motor/CUMMINS 8.3L		
COMBUSTIBLE, SECUNDARIO	GP-1122	J903640
COMBUSTIBLE, PRIMARIO	GPP-18	A44068
COMBUSTIBLE	GPP-1000	A184776

CPX610 con motor/CUMMINS 8.3L		
COMBUSTIBLE	GPP-1022S	J800394

CASE / INTERNATIONAL

TRACTORES

1394 con motor/A DIESEL		
COMBUSTIBLE	G-296	3044506R93
COMBUSTIBLE	G-296-B	3044506R93
ACEITE	GP-171	K200037

1594 con motor/A DIESEL		
COMBUSTIBLE	G-296	3044506R93
COMBUSTIBLE	G-296-B	3044506R93

MARCA-MODELO-MOTOR MAKE-MODEL-ENGINE	GONHER GONHER	OEM OEM	MARCA-MODELO-MOTOR MAKE-MODEL-ENGINE	GONHER GONHER	OEM OEM	MARCA-MODELO-MOTOR MAKE-MODEL-ENGINE	GONHER GONHER	OEM OEM
CASE/INTERNATIONAL(continuación)			CASE/INTERNATIONAL(continuación)			CASE/INTERNATIONAL(continuación)		
TRACTORES			TRACTORES			TRACTORES		
ACEITE	GP-171	K200037	4694 con motor/CASE 504BDTI			5230, 5240, 5250 con motor/CUMMINS 6BTS.9		
AIRE, PRIMARIO	GA-360	S231996	ACEITE	GP-69	A44081	COMBUSTIBLE, SECUNDARIO	GP-1122	J903640
AIRE, SECUNDARIO	GA-361	N6660	AGUA	GP-2071W	A151931	COMBUSTIBLE, SECUNDARIO	GPP-1122	P150564
			COMBUSTIBLE, PRIMARIO	GPP-18	A44068	AGUA	GP-2071W	A151931
2096 con motor/CASE 590			HIDRAULICO	GP-761H	A165029	COMBUSTIBLE, PRIMARIO	GPP-18	A58712
COMBUSTIBLE, PRIMARIO	GPP-18	A58712				ACEITE	GP-178	J908615
			485 con motor/A DIESEL			585 con motor/A DIESEL		
2096 con motor/CASE 6T-590			ACEITE	GP-36	3136046-R93	ACEITE, OPCIONAL	GP-36	3136046-R93
COMBUSTIBLE, SECUNDARIO	GP-1122	J903640	COMBUSTIBLE, SECUNDARIO	GPP-1122	1967094-C1	COMBUSTIBLE	G-296	3044506R93
COMBUSTIBLE, PRIMARIO	GPP-18	A58712	AIRE	GA-16	1265510-C1	COMBUSTIBLE	G-296-B	3044506R93
ACEITE	GP-178	J908615	AIRE	GAK-16	1265510-C1	AIRE	GA-16	1265510-C1
						AIRE	GAK-16	1265510-C1
2294 con motor/CASE 504BDT			4894 con motor/A DIESEL			595 con motor/A DIESEL DE 3 CILINDROS		
AGUA	GP-1010Q	A151931	AGUA	GP-2071W	A151931	ACEITE	GP-36	3136046-R93
ACEITE	GP-69	A44081	ACEITE	GP-171	K200037	COMBUSTIBLE, SECUNDARIO	GPP-1122	3132428R2
COMBUSTIBLE, PRIMARIO	GPP-18	A44068	COMBUSTIBLE, PRIMARIO	GPP-18	A44068	AGUA	GP-2071W	A151931
			HIDRAULICO	GP-761H	A165029	AIRE	GA-16	1265510-C1
						AIRE	GAK-16	1265510-C1
2394, 2594 con motor/CASE 504BDT			4994 con motor/MERCEDES BENZ 866			685 con motor/A DIESEL DE 4 CILINDROS		
AGUA	GP-1010Q	A151931	AGUA	GP-1010Q	A151931	ACEITE	GP-36	3136046-R93
ACEITE	GP-69	A44081	ACEITE	GP-171	A46158	COMBUSTIBLE, SECUNDARIO	G-296	3044506R93
COMBUSTIBLE, PRIMARIO	GPP-18	A44068	COMBUSTIBLE, PRIMARIO	GPP-18	A44068	ACEITE	GP-54	398080R2
AIRE	GA-329	A47145	AIRE	GA-356	S224637	COMBUSTIBLE, SECUNDARIO	GPP-1122	1967094-C1
AIRE	GA-239	A47146	AIRE	GA-357	A46947	AGUA	GP-2071W	A151931
						COMBUSTIBLE	G-296-B	3044506R93
265 OFF-SET con motor/A DIESEL DE 3 CILINDROS			4994 con motor/SCANIA			AIRE	GA-16	1265510-C1
ACEITE	GP-40	1962769C1	AGUA	GP-2071W	A151931	AIRE	GAK-16	1265510-C1
			ACEITE	GP-171	A46158			
3220 con motor/A DIESEL			COMBUSTIBLE, PRIMARIO	GPP-18	A44068	695 con motor/A DIESEL DE 4 CILINDROS		
ACEITE	GP-36	3136046-R93	AIRE	GA-356	S224637	ACEITE	GP-36	3136046-R93
COMBUSTIBLE, SECUNDARIO	GPP-1122	1967094-C1	AIRE	GA-357	A46947	COMBUSTIBLE, SECUNDARIO	G-296	3044506R93
AGUA	GP-2071W	A77544				ACEITE	GP-54	398080R2
AIRE	GA-16	1265510-C1				COMBUSTIBLE, SECUNDARIO	GPP-1122	1967094-C1
AIRE	GAK-16	1265510-C1				AGUA	GP-2071W	A151931
						COMBUSTIBLE	G-296-B	3044506R93
3294, 3394, 3594 con motor/CASE 504BDT			5120 con motor/CUMMINS 4TA-390			AIRE	GA-16	1265510-C1
AGUA	GP-1010Q	A151931	COMBUSTIBLE, SECUNDARIO	GP-1122	J903640	AIRE	GAK-16	1265510-C1
ACEITE	GP-69	A44081	COMBUSTIBLE, SECUNDARIO	GPP-1122	P150564			
COMBUSTIBLE, PRIMARIO	GPP-18	A44068	AGUA	GP-2071W	A151931	710 MAGNUM, 7120 MAGNUM, 7130 MAGNUM, 7140 MAGNUM, 7150 MAGNUM, 9110 STEIGER SERIES, 9130 STEIGER SERIES con motor/A DIESEL		
AIRE	GA-329	A47145	COMBUSTIBLE, PRIMARIO	GPP-18	A44068	COMBUSTIBLE, SECUNDARIO	GP-1122	J903640
AIRE	GA-239	A47146	ACEITE	GP-390	J908616	ACEITE	GP-43	A77537
						AGUA	GP-2071W	A77544
385 con motor/A DIESEL			5120 MAXXUM con motor/A DIESEL			COMBUSTIBLE, PRIMARIO	GPP-18	A58712
ACEITE	GP-10	398080-R2	COMBUSTIBLE, SECUNDARIO	GP-1122	J903640			
ACEITE	GP-36	3136046-R93	AGUA	GP-2071W	A151931	7110, 7120 con motor/CUMMINS 8.3L		
COMBUSTIBLE	GPP-1122	1967094-C1	COMBUSTIBLE, PRIMARIO	GPP-18	A44068	COMBUSTIBLE, SECUNDARIO	GP-1122	J903640
AIRE	GA-16	F84998	ACEITE	GP-390	J908616	ACEITE	GP-43	A77537
AIRE	GAK-16	F84998				AGUA	GP-2071W	A77544
			5130 MAXXUM, 5140 MAXXUM con motor/A DIESEL			COMBUSTIBLE, PRIMARIO	GPP-18	A58712
395, 495 con motor/A DIESEL DE 3 CILINDROS			COMBUSTIBLE, SECUNDARIO	GP-1122	J903640			
ACEITE	GP-36	3136046-R93	AGUA	GP-2071W	A151931	7110, 7120 con motor/CUMMINS 8.3L		
COMBUSTIBLE, SECUNDARIO	GPP-1122	1967094-C1	COMBUSTIBLE, PRIMARIO	GPP-18	A58712	COMBUSTIBLE, SECUNDARIO	GP-1122	J903640
AGUA	GP-2071W	A151931	ACEITE	GP-178	J908615	ACEITE	GP-43	A77537
AIRE	GA-16	1265510-C1				AGUA	GP-2071W	A77544
AIRE	GAK-16	1265510-C1				COMBUSTIBLE, PRIMARIO	GPP-18	A58712
						HIDRAULICO	GP-761H	1346028-C1
4210, 4230, 4240 con motor/A DIESEL			5130, 5140 con motor/CUMMINS 6BTS.9			7130, 7140, 7150 con motor/CUMMINS 8.3L		
ACEITE	GP-36	3136046-R93	COMBUSTIBLE, SECUNDARIO	GP-1122	J903640	COMBUSTIBLE, SECUNDARIO	GP-1122	J903640
COMBUSTIBLE, SECUNDARIO	GP-1122	1967094-C1	AGUA	GP-2071W	A151931	COMBUSTIBLE, SECUNDARIO	GPP-1122	P150564
AGUA	GP-2071W	A77544	COMBUSTIBLE, PRIMARIO	GPP-18	A58712	ACEITE	GP-43	A77537
AIRE	GA-16	1265510-C1	ACEITE	GP-178	J908615	AGUA	GP-2071W	A77544
AIRE	GAK-16	1265510-C1				COMBUSTIBLE, PRIMARIO	GPP-18	A58712
4494 con motor/CASE 504BDT			5220 con motor/CUMMINS 4TA-390			7230, 7240, 7250, 7210, 7220 con motor/CUMMINS 6CT8.3		
ACEITE	GP-54	A44081	COMBUSTIBLE, SECUNDARIO	GP-1122	J903640	COMBUSTIBLE, SECUNDARIO	GP-1122	J903640
AGUA	GP-2071W	A151931	COMBUSTIBLE, SECUNDARIO	GPP-1122	P150564	AGUA	GP-2071W	A77544
COMBUSTIBLE, PRIMARIO	GPP-18	A44068	AGUA	GP-2071W	A151931	COMBUSTIBLE, PRIMARIO	GPP-18	J930942
HIDRAULICO	GP-761H	A165029	COMBUSTIBLE, PRIMARIO	GPP-18	A44068			
			ACEITE	GP-390	J908616			

SERVICIO PESADO

MARCA-MODELO-MOTOR MAKE-MODEL-ENGINE	GONHER GONHER	OEM OEM	MARCA-MODELO-MOTOR MAKE-MODEL-ENGINE	GONHER GONHER	OEM OEM	MARCA-MODELO-MOTOR MAKE-MODEL-ENGINE	GONHER GONHER	OEM OEM
CASE/INTERNATIONAL(continuación)			CASE/INTERNATIONAL(continuación)			CASE/INTERNATIONAL(continuación)		
TRACTORES			TRACTORES			TRACTORES		
8790 MAMMUT con motor/DEUTZ BF8M1015C			ACEITE	GP-57	901158T1	JX100U con motor/FIAT 3.9L TURBO		
COMBUSTIBLE, SECUNDARIO	GP-1122	J903640	AGUA	GP-2071W	A77544	COMBUSTIBLE	GPP-1122	47135707
			COMBUSTIBLE, SECUNDARIO	GPP-19	A39867			
8910, 8920, 8930, 8940, 8950 con motor/CUMMINS 8.3L			9210, 9230, 9240 con motor/CUMMINS 6CTA830			JX1070U, JX1085C con motor/4.5L		
COMBUSTIBLE, SECUNDARIO	GP-1122	J903640	COMBUSTIBLE, SECUNDARIO	GP-1122	J903640	AIRE, RADIAL PRIMARIO	GA-853R	47132345
AGUA	GP-2071W	A77544	AGUA	GP-2071W	A77544	JX1095C con motor/4.5L		
COMBUSTIBLE, PRIMARIO	GPP-18	J925274	COMBUSTIBLE, PRIMARIO	GPP-18	A44068	AIRE, SECUNDARIO (ALGU- NOS)	GA-459	1909117
			HIDRAULICO	GP-761H	N9025			
9110, 9130 con motor/A DIESEL			GASOLINA, PLASTICO	GG-5	D139225	JX1100U, JX1080U, JX1090U con motor/A DIESEL		
COMBUSTIBLE, SECUNDARIO	GP-1122	J903640	GASOLINA, METALICO	GG-5 L	D139225	AIRE, RADIAL PRIMARIO	GA-853R	47132345
ACEITE	GP-43	A77537						
AGUA	GP-2071W	A77544	9210, 9230, 9240 con motor/CUMMINS 6TA830			JX90U con motor/FIAT 3.9L TURBO		
COMBUSTIBLE, PRIMARIO	GPP-18	A58712	COMBUSTIBLE	GP-1122	J903640	COMBUSTIBLE	GPP-1122	47135707
			AGUA	GP-2071W	A77544			
9150 con motor/CUMMINS LTA10			COMBUSTIBLE, PRIMARIO	GPP-18	A44068	JX95 con motor/3.9L TURBO		
ACEITE	GP-53	12187	AIRE	GAVW-2	P536676	ACEITE	GP-31	3214797-R1
ACEITE	GP-57	901158T1				COMBUSTIBLE	GPP-1122	47135707
COMBUSTIBLE	GPP-11	28035	9250, 9260 con motor/CUMMINS LTA10			AIRE, SECUNDARIO	GA-459	1931169
ACEITE	GP-3000	907101T1	COMBUSTIBLE	GPP-11	28035	AIRE, RADIAL PRIMARIO	GA-853R	222421A1
AGUA	GP-2071W	A77544	ACEITE	GP-3000	J919562			
HIDRAULICO	GP-761H	N9025	AGUA	GP-2071W	A77544	MAXXUM 115 con motor/6.75L		
						COMBUSTIBLE	GP-548	87803200
9150 STEIGER SERIES con motor/CATERPILLAR 3306			9270, 9280 con motor/CUMMINS NTA855A					
ACEITE	GP-51	28036	COMBUSTIBLE	GPP-11	28035	MX100 MAXXUM con motor/CUMMINS 5.9L		
			ACEITE	GP-3000	J919562	COMBUSTIBLE, SECUNDARIO	GPP-1122	J931062
9150 STEIGER SERIES con motor/CUMMINS L-10			AGUA	GP-2071W	A77544			
AGUA	GP-2071W	A77544				MX100C con motor/A DIESEL		
			9330 con motor/CUMMINS 6CTA8.3			ACEITE	GP-31	3214797-R1
9170 STEIGER SERIES con motor/CATERPILLAR 3406			COMBUSTIBLE, SECUNDARIO	GP-1122	J903640			
ACEITE, CUMPLE CON MEDI- DAS ORIGINALES	GP-691	12335	AGUA	GP-2071W	A77544	MX110 MAXXUM, MX120 MAXXUM, MX135 MAXXUM, MX150 MAXXUM, MX170 MAXXUM con motor/CUMMINS 5.9L		
ACEITE, SEGUNDA OPCION	GP-52	12335	COMBUSTIBLE, PRIMARIO	GPP-18	A44068	COMBUSTIBLE, SECUNDARIO	GPP-1122	J931062
COMBUSTIBLE	GP-56	12334						
COMBUSTIBLE	GP-110	3218794-R91	9350 con motor/CUMMINS LTA10					
AGUA	GP-2071W	28031	ACEITE	GP-3000	J919562	MX180 MAGNUM, MX200 MAGNUM, MX220 MAGNUM con motor/CUMMINS 8.3L		
HIDRAULICO	GP-761H	N9025	AGUA	GP-2071W	A77544	COMBUSTIBLE, SECUNDARIO	GP-1122	J903640
			COMBUSTIBLE	GPP-1000	A184776	COMBUSTIBLE, SECUNDARIO	GPP-1122	J931062
9170 STEIGER SERIES con motor/CUMMINS NTA855			HIDRAULICO	GP-761H	N9025	AGUA	GP-2071W	A77544
ACEITE	GP-53	12187				COMBUSTIBLE, PRIMARIO	GPP-18	A39868
ACEITE	GP-57	901158T1	9350 con motor/CUMMINS M11					
COMBUSTIBLE	GPP-11	28035	ACEITE	GP-3001	3401544	MX240 MAGNUM, MX270 MAGNUM con motor/CUMMINS 8.3L TURBO		
ACEITE	GP-3000	907101T1				AGUA	GP-2071W	A77544
AGUA	GP-2071W	A77544	9370, 9380 con motor/CUMMINS N14			COMBUSTIBLE, PRIMARIO	GPP-18	A39868
HIDRAULICO	GP-761H	N9025	ACEITE	GP-3000	J919562			
			AGUA	GP-2071W	A77544	MX80C, MX90C con motor/A DIESEL		
9180 STEIGER SERIES con motor/CATERPILLAR 3406			COMBUSTIBLE	GPP-1000	A184776	ACEITE	GP-31	3214797-R1
ACEITE, CUMPLE CON MEDI- DAS ORIGINALES	GP-691	12335						
ACEITE, SEGUNDA OPCION	GP-52	12335	9390 con motor/CUMMINS N14			MXM120 con motor/7.5L		
COMBUSTIBLE	GP-56	12334	ACEITE	GP-3000	3318853	AIRE, RADIAL, PRIMARIO	GA-697R	AF25492
COMBUSTIBLE	GP-110	3218794-R91						
AGUA	GP-2071W	28031	C100, CX90, C80, C90, CX100, CX80 con motor/PERKINS 1004.40T			MXM155 PRO, MXM120 PRO, MXM130, MXM130 PRO, MXM140, MXM140 PRO, MXM155 con motor/7.5L		
HIDRAULICO	GP-761H	N9025	ACEITE	GP-31	3214797-R1	AIRE, RADIAL, PRIMARIO	GA-697R	82034629
9180 STEIGER SERIES con motor/CUMMINS NTA855			C50, C60, CX50, CX60 con motor/PERKINS 2.7L			MXU110 con motor/CASE-INTERNATIONAL 4.5L TURBO ENG.		
ACEITE	GP-53	12187	ACEITE	GP-1	3118119-R1	COMBUSTIBLE	GP-548	87803200
ACEITE	GP-57	901158T1	COMBUSTIBLE, SECUNDARIO	G-296	218577A1			
COMBUSTIBLE	GPP-11	28035	COMBUSTIBLE, SECUNDARIO	G-296-B	218577A1	MXU115 con motor/6.7L		
ACEITE	GP-3000	907101T1				COMBUSTIBLE	GPP-1122	87803194
AGUA	GP-2071W	A77544	D25, DX45, D33, D35, D40, D45, DX25, DX26, DX29, DX33, DX35, DX40 con motor/A DIESEL					
HIDRAULICO	GP-761H	N9025	ACEITE (8-12 PSI)	GP-58	87409203	MXU125 con motor/CASE-INTERNATIONAL 6.7L ENG.		
						COMBUSTIBLE	GP-548	87803200
9190 con motor/CUMMINS			D29 con motor/A DIESEL					
ACEITE	G-33	1-3984T1	ACEITE	GP-81	86546618			
COMBUSTIBLE	GP-1101	154711						
ACEITE	GP-53	12187						

MARCA-MODELO-MOTOR MAKE-MODEL-ENGINE	GONHER GONHER	OEM OEM	MARCA-MODELO-MOTOR MAKE-MODEL-ENGINE	GONHER GONHER	OEM OEM	MARCA-MODELO-MOTOR MAKE-MODEL-ENGINE	GONHER GONHER	OEM OEM
CASE/INTERNATIONAL (continuación)			CATERPILLAR (continuación)			CATERPILLAR (continuación)		
TRACTORES			APLANADORAS			APLANADORAS		
MXU135 con motor/CASE-INTERNATIONAL 6.7L ENG.			AIRE, PRIMARIO	GA-1008	4M9378	12E con motor/A DIESEL (EXCEPTO S/N 17K)		
COMBUSTIBLE	GP-548	87803200	AIRE, SECUNDARIO	GA-1284	2S1284	ACEITE, CARTUCHO	G-191	5S0484
						COMBUSTIBLE, CARTUCHO	G-1166	9H4729
STX275, STX325 con motor/CUMMINS 8.3L			112F con motor/A DIESEL (S/N 80J, 89J)			COMBUSTIBLE, SELLADO	GP-110	6L7440
ACEITE	GP-3001	366700A1	ACEITE, SELLADO	GP-51	1R0739	AIRE, SECUNDARIO	GA-1285	4M8048
AGUA	GP-2071W	A77544	COMBUSTIBLE	GP-110	6L7440	AIRE, PRIMARIO	GA-8047	4M8047
HIDRAULICO	GP-761H	1346028-C1	AIRE, SECUNDARIO	GA-1285	2S1285			
COMBUSTIBLE	GPP-1022S	J800394	AIRE, PRIMARIO	GA-8047	4M8047	12E, 12F con motor/A DIESEL (S/N 17K)		
						ACEITE, CARTUCHO	G-191	5S0484
STX375, STX500, STX375D, STX425, STX440, STX450 con motor/ CUMMINS QSX15			12 con motor/A DIESEL (S/N 7T)			ACEITE, SELLADO	GP-51	2P4004
ACEITE	GP-9000	324617A1	ACEITE	G-191	9F6428	COMBUSTIBLE	GP-110	1P2299
AGUA	GP-2126Q	324618A1	12 con motor/A DIESEL (S/N 8T, 38E, 70D, 71D, 80C, 94C)			AIRE, SECUNDARIO	GA-1286	2S1286
COMBUSTIBLE	GPP-1007S	419858A1	ACEITE, FLUJO TOTAL	G-191	9F6700	AIRE, PRIMARIO	GA-9334	4M9334
			AIRE, SECUNDARIO	GA-1285	4M8048	12F con motor/A DIESEL (S/N 13K, 33K)		
			AIRE, PRIMARIO	GA-8047	4M8047	ACEITE, CARTUCHO	G-191	5S0484
						ACEITE, SELLADO	GP-51	1R0739
			12 con motor/A DIESEL (S/N 9K)			COMBUSTIBLE, SELLADO	GP-1108	4N5823
			ACEITE, FLUJO TOTAL	G-191	9F6428	COMBUSTIBLE, SELLADO	GP-110	1P2299
						AIRE, SECUNDARIO	GA-1286	2S1286
			120 con motor/CATERPILLAR 3306			AIRE, PRIMARIO	GA-9334	4M9334
			ACEITE, CARTUCHO	G-191	5S0484			
			COMBUSTIBLE, CARTUCHO	G-1166	9H4729	12F con motor/A DIESEL (S/N 59H, 73G)		
			TRANSMISION (S/N 13U, 90R)	G-152	9M9740	ACEITE	G-191	7M3800
			ACEITE, SELLADO	GP-51	2P4004	COMBUSTIBLE	G-1166	9H4729
			COMBUSTIBLE, SELLADO	GP-1108	4N5823	AIRE, SECUNDARIO	GA-1286	2S1286
			COMBUSTIBLE, SELLADO	GP-110	1P2299	AIRE, SECUNDARIO (ACCE- SORIO)	GA-1287	2S1287
			AIRE, SECUNDARIO	GA-1285	2S1285	AIRE, PRIMARIO (ACCESORIO)	GA-9045	7M9045
			AIRE, SECUNDARIO	GA-1286	2S1286	AIRE, PRIMARIO	GA-9334	4M9334
			AIRE, PRIMARIO	GA-8047	4M8047			
			AIRE, PRIMARIO	GA-9334	4M9334	12F con motor/A DIESEL (S/N 89H)		
						ACEITE, CARTUCHO	G-191	5S0484
			120B con motor/CATERPILLAR 3306			ACEITE, SELLADO	GP-51	2P4004
			ACEITE, SELLADO	GP-51	1R0739	COMBUSTIBLE, SELLADO	GP-110	1P2299
			COMBUSTIBLE	GP-110	1P2299	AIRE, SECUNDARIO (OP- CIONAL)	GA-1285	2S1285
			AIRE, SECUNDARIO	GA-1286	2S1286	AIRE, SECUNDARIO	GA-1286	2S1286
			AIRE, PRIMARIO	GA-9334	4M9334	AIRE, PRIMARIO (OPCIONAL)	GA-8047	4M8047
						AIRE, PRIMARIO	GA-9334	4M9334
			120E con motor/A DIESEL					
			ACEITE, CARTUCHO	G-191	1R0659	12G con motor/CATERPILLAR 3306		
			TRANSMISION	G-152	1R0719	ACEITE, TANQUE HIDRAULICO	G-152	1R0719
			ACEITE, SELLADO	GP-51	1R0739	TRANSMISION	G-152	9M9740
			AIRE, SECUNDARIO ESTANDAR	GA-1286	2S1286	GASOLINA, SEPARADOR DE AGUA (S/N 61M3778 EN ADELANTE)	G-293	6N7617
			AIRE, PRIMARIO ESTANDAR	GA-9334	7W5317	ACEITE	GP-51	1R0739
						COMBUSTIBLE	GP-1108	4N5823
			120G con motor/CATERPILLAR 3304			COMBUSTIBLE	GP-110	1P2299
			ACEITE, TANQUE HIDRAULICO	G-152	1R0719	AIRE, SECUNDARIO ESTANDAR	GA-1285	2S1285
			TRANSMISION	G-152	9M9740	AIRE, PRIMARIO ESTANDAR	GA-8047	4M8047
			GASOLINA, SEPARADOR DE AGUA	G-293	8N9803	AIRE, PRIMARIO RADIAL	GA-499R	6I2499
			ACEITE	GP-51	1R0739			
			COMBUSTIBLE, SELLADO	GP-110	1R0750	12H, 12H ES, 12H NA con motor/CATERPILLAR 3306		
			AIRE, SECUNDARIO ESTANDAR	GA-1285	2S1285	TRANSMISION	G-152	1R0719
			AIRE, PRIMARIO ESTANDAR	GA-8047	8N5389	ACEITE	GP-51	1R0739
			AIRE, PRIMARIO RADIAL	GA-499R	6I2499	COMBUSTIBLE, SELLADO	GP-110	1R0750
						AIRE, PRIMARIO RADIAL	GA-499R	6I2499
			120H, 120H ES, 120H NA con motor/CATERPILLAR 3116					
			ACEITE, TANQUE HIDRAULICO	G-152	1R0719	130G con motor/CATERPILLAR 3304		
			ACEITE	GP-51	1R0739	ACEITE, TANQUE HIDRAULICO	G-152	1R0719
			COMBUSTIBLE, 5 13/32 IN	GP-62	1R0751	TRANSMISION	G-152	9M9740
			COMBUSTIBLE, 7 13/32 IN	GP-1109	1R0751	GASOLINA, SEPARADOR DE AGUA (S/N 74V1040-74V1656)	G-293	6N7617
			COMBUSTIBLE, SEPARADOR DE AGUA	GPP-424	117-4089	ACEITE	GP-51	1R0739
			AIRE, PRIMARIO RADIAL	GA-499R	6I2499	COMBUSTIBLE	GP-110	1P2299

SERVICIO PESADO

MARCA-MODELO-MOTOR MAKE-MODEL-ENGINE	GONHER GONHER	OEM OEM	MARCA-MODELO-MOTOR MAKE-MODEL-ENGINE	GONHER GONHER	OEM OEM	MARCA-MODELO-MOTOR MAKE-MODEL-ENGINE	GONHER GONHER	OEM OEM
CATERPILLAR (continuación)			CATERPILLAR (continuación)			CATERPILLAR (continuación)		
APLANADORAS			APLANADORAS			APLANADORAS		
AIRE, SECUNDARIO ESTANDAR	GA-1285	2S1285	140H, 140H ES, 140H NA con motor/CATERPILLAR 3306			AIRE, PRIMARIO	GA-9334	7W5317
AIRE, PRIMARIO ESTANDAR	GA-8047	8N5389	TRANSMISION	G-152	1R0719	160H, 160H ES, 160H NA con motor/CATERPILLAR 3306		
AIRE, PRIMARIO RADIAL	GA-499R	6I2499	ACEITE	GP-51	1R0739	TRANSMISION	G-152	1R0719
			COMBUSTIBLE, SELLADO	GP-110	1R0750	ACEITE	GP-51	1R0739
130H con motor/A DIESEL			COMBUSTIBLE, SELLADO	GP-110	1R0750	COMBUSTIBLE, SELLADO	GP-110	1R0750
ACEITE	G-152	1R0719	143H con motor/A DIESEL			163H con motor/CATERPILLAR 3306		
ACEITE	GP-51	1R0739	TRANSMISION (CARTUCHO)	G-152	1R0719	TRANSMISION (CARTUCHO)	G-152	1R0719
COMBUSTIBLE, SECUNDARIO	GP-62	1R0751	ACEITE	GP-51	1R0739	ACEITE	GP-51	1R0739
COMBUSTIBLE	GP-1109	1R0753	COMBUSTIBLE, SELLADO	GP-110	1R0750	COMBUSTIBLE, SELLADO	GP-110	1R0750
AIRE	GA-1285	2S1285	HIDRAULICO	GP-761H	9T5916	TRANSMISION (SELLADO)	GP-761H	4T3131
AIRE	GA-8047	7W5389	TRANSMISION (SELLADO)	GP-761H	1G8878			
135H, 135H NA con motor/CATERPILLAR 3116			14B con motor/A DIESEL (S/N 64C, 78E)			16G con motor/CATERPILLAR 3406		
TRANSMISION	G-152	1R0719	ACEITE	G-191	9F6700	ACEITE, TANQUE HIDRAULICO	G-152	9M9740
ACEITE	GP-51	1R0739	COMBUSTIBLE	G-1166	9H4729	TRANSMISION	G-152	9M9740
COMBUSTIBLE, 5 13/32 IN	GP-62	1R0751	14D con motor/A DIESEL (S/N 96F)			COMBUSTIBLE, SELLADO	GP-749	1R0749
COMBUSTIBLE, 7 13/32 IN	GP-1109	1R0751	ACEITE	G-191	5S0484	ACEITE, CUMPLE CON MEDI- DAS ORIGINALES	GP-691	2P4005
COMBUSTIBLE, SEPARADOR DE AGUA	GPP-424	117-4089	ACEITE, TURBOCARGADOR	G-191	7M3800	ACEITE, SEGUNDA OPCION	GP-52	2P4005
AIRE, PRIMARIO RADIAL	GA-499R	6I2499	COMBUSTIBLE	G-1166	9H4729	COMBUSTIBLE, SELLADO	GP-1108	4N5823
14 con motor/A DIESEL (S/N 64C, 78E)			14E con motor/A DIESEL (S/N 12K, 72G)			AGUA, PRE-CARGA	GP-1011Q	9N6123
ACEITE	G-191	9F6700	ACEITE, CARTUCHO	G-191	5S0484	AGUA, MANTENIMIENTO	GP-2071W	9N3368
14 con motor/A DIESEL (S/N 96F)			TRANSMISION (S/N 72G1 EN ADELANTE)	G-152	9M9740	AIRE, PRIMARIO	GA-7716	7W5495
ACEITE	G-191	5S0484	ACEITE, SELLADO	GP-51	2P4004	AIRE, SECUNDARIO	GA-7360	1P7360
ACEITE, TURBOCARGADOR	G-191	7M3800	COMBUSTIBLE	GP-1108	4N5823	16H, 16H NA con motor/CATERPILLAR 3406C		
COMBUSTIBLE	G-1166	9H4729	COMBUSTIBLE	GP-110	1P2299	TRANSMISION	G-152	9M9740
14 con motor/A DIESEL (S/N 99G)			AIRE, SECUNDARIO	GA-1286	2S1286	COMBUSTIBLE, SELLADO	GP-749	1R0749
ACEITE	G-191	5S0484	AIRE, PRIMARIO	GA-9334	4M9334	ACEITE, CUMPLE CON MEDI- DAS ORIGINALES	GP-691	1R0716
COMBUSTIBLE	G-1166	9H4729	14E con motor/A DIESEL (S/N 99G)			ACEITE, SEGUNDA OPCION	GP-52	1R0716
ACEITE, CONTROL DE PODER	G-152	5J8877	ACEITE	G-191	5S0484	AGUA	GP-1011Q	9N6123
AIRE, SECUNDARIO	GA-1287	2S1287	COMBUSTIBLE	G-1166	9H4729	212 con motor/A DIESEL		
AIRE, PRIMARIO	GA-9045	7M9045	ACEITE, CONTROL DE PODER	G-152	5J8877	ACEITE, FLUJO TOTAL (FULL FLOW)	G-191	9F6426
14, 14C con motor/A DIESEL (S/N 35F)			AIRE, SECUNDARIO	GA-1287	2S1287	AIRE, PRIMARIO	GA-1008	4M9378
ACEITE	G-191	7M3800	AIRE, PRIMARIO	GA-9045	7M9045	AIRE, SECUNDARIO	GA-1284	2S1284
140 con motor/CATERPILLAR 3306			14G con motor/CATERPILLAR 3306			24H con motor/CATERPILLAR 3412E		
ACEITE, CARTUCHO	G-191	5S0484	ACEITE, TANQUE HIDRAULICO	G-152	9M9740	TRANSMISION	G-222	1R0741
TRANSMISION (S/N 14U1 EN ADELANTE)	G-152	9M9740	TRANSMISION	G-152	9M9740	DIESEL, (REQUIERE 2 PIEZAS)	GP-749	1R0749
ACEITE, SELLADO	GP-51	1R0739	GASOLINA, SEPARADOR DE AGUA (S/N 96U1743 EN ADELANTE)	G-293	8N9803	ACEITE, (REQUIERE 2 PIEZAS)	GP-52	1R0716
COMBUSTIBLE	GP-1108	4N5823	ACEITE	GP-51	1R0739	AIRE RADIAL, PRIMARIO	GA-600R	106-3969
COMBUSTIBLE	GP-110	1P2299	COMBUSTIBLE	GP-1108	4N5823	AG55, AG65 con motor/A DIESEL		
AIRE, SECUNDARIO	GA-1286	2S1286	COMBUSTIBLE	GP-110	1P2299	ACEITE	G-238	5S0485
AIRE, PRIMARIO	GA-9334	4M9334	AIRE, PRIMARIO	GA-9334	7W5317	AG65B con motor/A DIESEL		
140B con motor/CATERPILLAR 3306			14H, 14H NA con motor/CATERPILLAR 3306			ACEITE, CUMPLE CON MEDI- DAS ORIGINALES	GP-691	1R0716
ACEITE	GP-51	1R0739	TRANSMISION	G-152	9M9740	ACEITE, SEGUNDA OPCION	GP-52	1R0716
COMBUSTIBLE	GP-110	1P2299	ACEITE	GP-51	1R0739	COMBUSTIBLE, SELLADO	GP-1108	1R0712
AIRE, SECUNDARIO	GA-1286	2S1286	COMBUSTIBLE, SELLADO	GP-110	1R0750	G65 con motor/A DIESEL		
AIRE, PRIMARIO	GA-9334	4M9334	16 con motor/A DIESEL			ACEITE	G-238	1R0721
140G con motor/CATERPILLAR 3306			ACEITE, CARTUCHO	G-238	5S0485	G65B con motor/A DIESEL		
ACEITE, TANQUE HIDRAULICO	G-152	1R0719	COMBUSTIBLE, CARTUCHO	G-1166	6H5932	ACEITE, CUMPLE CON MEDI- DAS ORIGINALES	GP-691	1R0716
TRANSMISION	G-152	9M9740	TRANSMISION	G-152	9M9740	ACEITE, SEGUNDA OPCION	GP-52	1R0716
GASOLINA, SEPARADOR DE AGUA	G-293	6N7617	COMBUSTIBLE, SELLADO	GP-110	1P2299	COMBUSTIBLE, SELLADO	GP-1108	1R0712
ACEITE	GP-51	1R0739	AIRE, SECUNDARIO	GA-1286	2S1286			
COMBUSTIBLE, SELLADO	GP-1108	4N5823	AIRE, PRIMARIO	GA-9334	4M9334	160G con motor/CATERPILLAR 3306		
COMBUSTIBLE, SELLADO	GP-110	1P2299	160G con motor/CATERPILLAR 3306			ACEITE, TANQUE HIDRAULICO	G-152	1R0719
AIRE, PRIMARIO ESTANDAR	GA-9334	8N5317	ACEITE, TANQUE HIDRAULICO	G-152	1R0719	TRANSMISION	G-152	1R0719
			TRANSMISION	G-152	1R0739	ACEITE	GP-51	1R0739
			ACEITE	GP-51	1R0739	COMBUSTIBLE	GP-110	1R0750
			COMBUSTIBLE	GP-110	1R0750			

MARCA-MODELO-MOTOR MAKE-MODEL-ENGINE	GONHER GONHER	OEM OEM	MARCA-MODELO-MOTOR MAKE-MODEL-ENGINE	GONHER GONHER	OEM OEM	MARCA-MODELO-MOTOR MAKE-MODEL-ENGINE	GONHER GONHER	OEM OEM
CATERPILLAR			CATERPILLAR (continuación)			CATERPILLAR (continuación)		
CAMIONES, TRACTOCAMIONES Y AUTOBUSES			CAMIONES, TRACTOCAMIONES Y AUTOBUSES			CAMIONES, TRACTOCAMIONES Y AUTOBUSES		
725 ARTICULADO con motor/CATERPILLAR 3176C			ACEITE, TANQUE HIDRAULICO G-222 1R0741			ACEITE, SELLADO (CUMPLE CON MEDIDAS ORIGINALES) GP-691 2P4005		
ACEITE, TANQUE HIDRAULICO G-222 1R0741			TRANSMISION G-222 4J6064			ACEITE, SELLADO (SEGUNDA OPCION) GP-52 2P4005		
ACEITE, CUMPLE CON MEDIDAS ORIGINALES GP-691 1R0716			COMBUSTIBLE, SELLADO GP-749 1R0749			COMBUSTIBLE, SELLADO GP-110 1P2299		
ACEITE, SEGUNDA OPCION GP-52 1R0716			ACEITE, CUMPLE CON MEDIDAS ORIGINALES GP-691 1R0716			AIRE, SECUNDARIO GA-1287 2S1287		
HIDRAULICO (SELLADO) GP-761H 144-6691			ACEITE, SEGUNDA OPCION GP-52 1R0716			AIRE, PRIMARIO GA-9045 7M9045		
730 ARTICULADO con motor/CATERPILLAR 3196C			AGUA, PRE-CARGA GP-1013Q 1W5518			773B FUERA DE CARRETERA con motor/CATERPILLAR 3412		
ACEITE, TANQUE HIDRAULICO G-222 1R0741			COMBUSTIBLE, SELLADO GP-1108 4N5823			DIRECCION G-222 4J6064		
ACEITE, CUMPLE CON MEDIDAS ORIGINALES GP-691 1R0716			AGUA, MANTENIMIENTO GP-1011Q 9N3718			ACEITE, TANQUE HIDRAULICO G-222 4J6064		
ACEITE, SEGUNDA OPCION GP-52 1R0716			AIRE, PRIMARIO ESTANDAR GA-483 7W5313			TRANSMISION G-222 4J6064		
HIDRAULICO (SELLADO) GP-761H 144-6691			AIRE, SECUNDARIO ESTANDAR GA-482 1P8482			COMBUSTIBLE, SELLADO GP-749 1R0749		
735 ARTICULADO con motor/CATERPILLAR 3406E			769D FUERA DE CARRETERA con motor/CATERPILLAR 3408			ACEITE, CUMPLE CON MEDIDAS ORIGINALES GP-691 1R0716		
COMBUSTIBLE GP-749 1R0749			HIDRAULICO (CARTUCHO) G-152 1R0719			ACEITE, SEGUNDA OPCION GP-52 1R0716		
ACEITE, CUMPLE CON MEDIDAS ORIGINALES GP-691 1R0716			ACEITE, CONVERTIDOR DE TORSION/ TRANSMISION G-222 1R0741			AGUA, PRE-CARGA GP-1013Q 1W5518		
ACEITE, SEGUNDA OPCION GP-52 1R0716			DIRECCION (CARTUCHO) G-222 4J6064			COMBUSTIBLE, SELLADO GP-1108 4N5823		
740 ARTICULADO con motor/CATERPILLAR 3406E			COMBUSTIBLE, SELLADO GP-749 1R0749			AGUA, MANTENIMIENTO GP-1011Q 9N6123		
TRANSMISION G-152 1R0719			ACEITE, CUMPLE CON MEDIDAS ORIGINALES GP-691 1R0716			AIRE, PRIMARIO ESTANDAR GA-483 8N5313		
COMBUSTIBLE GP-749 1R0749			ACEITE, SEGUNDA OPCION GP-52 1R0716			AIRE, SECUNDARIO ESTANDAR GA-482 1P8482		
ACEITE, CUMPLE CON MEDIDAS ORIGINALES GP-691 1R0716			AGUA GP-1011Q 9N6123			773D FUERA DE CARRETERA con motor/CATERPILLAR 3412E		
ACEITE, SEGUNDA OPCION GP-52 1R0716			ACEITE, TREN DE PODER GP-761H 1G8878			ACEITE, CONVERTIDOR DE TORSION/ TRANSMISION G-222 1R0741		
HIDRAULICO GP-761H 144-6691			771C FUERA DE CARRETERA con motor/CATERPILLAR 3408			DIRECCION (CARTUCHO) G-222 4J6064		
768B FUERA DE CARRETERA con motor/CATERPILLAR D343			ACEITE, FRENOS HIDRAULICOS G-152 1R0719			ACEITE, TANQUE HIDRAULICO G-222 4J6064		
ACEITE G-238 5S0485			DIRECCION G-222 4J6064			COMBUSTIBLE, SELLADO GP-749 1R0749		
DIRECCION G-222 4J6064			TRANSMISION G-222 1R0741			ACEITE, CUMPLE CON MEDIDAS ORIGINALES GP-691 1R0716		
ACEITE, TANQUE HIDRAULICO G-222 4J6064			COMBUSTIBLE, SELLADO GP-749 1R0749			DIRECCION (SELLADO) GP-34 4T6788		
TRANSMISION G-222 4J6064			ACEITE, CUMPLE CON MEDIDAS ORIGINALES GP-691 1R0716			ACEITE, SEGUNDA OPCION GP-52 1R0716		
COMBUSTIBLE GP-110 1P2299			ACEITE, SEGUNDA OPCION GP-52 1R0716			AGUA, PRE-CARGA GP-1011Q 9N3366		
AIRE, SECUNDARIO GA-1287 2S1287			AGUA GP-1011Q 9N6123			AGUA, MANTENIMIENTO GP-2071W 9N3717		
AIRE, PRIMARIO GA-9045 7M9045			AIRE, PRIMARIO ESTANDAR GA-483 7W5313			ACEITE, TREN DE PODER GP-761H 1G8878		
768C FUERA DE CARRETERA con motor/CATERPILLAR 3408			AIRE, SECUNDARIO ESTANDAR GA-482 1P8482			775B FUERA DE CARRETERA con motor/CATERPILLAR 3412		
ACEITE, FRENOS DE POTENCIA G-152 1R0719			771D FUERA DE CARRETERA con motor/CATERPILLAR 3408			DIRECCION G-222 4J6064		
TRANSMISION G-152 1R0719			HIDRAULICO (CARTUCHO) G-152 1R0749			ACEITE, FRENOS/ CONVERTIDOR DE TORSION/ TRANSMISION G-222 1R0741		
DIRECCION G-222 4J6064			ACEITE, CONVERTIDOR DE TORSION/ TRANSMISION G-222 1R0741			COMBUSTIBLE, SELLADO GP-749 1R0749		
ACEITE, TANQUE HIDRAULICO G-222 4J6064			DIRECCION (CARTUCHO) G-222 4J6064			ACEITE, CUMPLE CON MEDIDAS ORIGINALES GP-691 1R0716		
TRANSMISION G-222 4J6064			COMBUSTIBLE GP-749 1R0749			ACEITE, SEGUNDA OPCION GP-52 1R0716		
COMBUSTIBLE, SELLADO GP-749 1R0749			ACEITE, CUMPLE CON MEDIDAS ORIGINALES GP-691 1R0716			AGUA GP-1011Q 9N6123		
ACEITE, CUMPLE CON MEDIDAS ORIGINALES GP-691 1R0716			ACEITE, SEGUNDA OPCION GP-52 1R0716			AIRE, PRIMARIO ESTANDAR GA-483 7W5313		
ACEITE, SEGUNDA OPCION GP-52 1R0716			AGUA GP-1011Q 9N6123			AIRE, SECUNDARIO ESTANDAR GA-482 1P8482		
AGUA, PRE-CARGA GP-1013Q 1W5518			ACEITE, TREN DE PODER GP-761H 1G8878			775D FUERA DE CARRETERA con motor/CATERPILLAR 3412E		
COMBUSTIBLE, SELLADO GP-1108 4N5823			772B FUERA DE CARRETERA con motor/A DIESEL			ACEITE, CONVERTIDOR DE TORSION/ TRANSMISION G-222 1R0741		
AGUA, MANTENIMIENTO GP-1011Q 9N3718			ACEITE, CONVERTIDOR DE TORSION/ TRANSMISION G-222 1R0741			DIRECCION (CARTUCHO) G-222 4J6064		
AIRE, PRIMARIO ESTANDAR GA-483 7W5313			DIRECCION G-222 4J6064			COMBUSTIBLE, SELLADO GP-749 1R0749		
AIRE, SECUNDARIO ESTANDAR GA-482 1P8482			COMBUSTIBLE, SELLADO GP-749 1R0749			ACEITE, CUMPLE CON MEDIDAS ORIGINALES GP-691 1R0716		
769 FUERA DE CARRETERA, 769B FUERA DE CARRETERA con motor/A DIESEL			ACEITE, CUMPLE CON MEDIDAS ORIGINALES GP-691 1R0716			DIRECCION (SELLADO) GP-34 4T6788		
ACEITE G-238 5S0485			ACEITE, SEGUNDA OPCION GP-52 1R0716			ACEITE, SEGUNDA OPCION GP-52 1R0716		
COMBUSTIBLE, CARTUCHO G-1166 8M9641			AGUA, PRE-CARGA GP-1013Q 1W5518			AGUA, PRE-CARGA GP-1011Q 9N3366		
DIRECCION G-222 4J6064			COMBUSTIBLE, SELLADO GP-1108 4N5823			AGUA, MANTENIMIENTO GP-2071W 9N3717		
ACEITE, TANQUE HIDRAULICO G-222 4J6064			AGUA, MANTENIMIENTO GP-1011Q 9N6123			HIDRAULICO GP-761H 1G8878		
TRANSMISION G-222 4J6064			AIRE, PRIMARIO ESTANDAR GA-483 7W5313			776B FUERA DE CARRETERA con motor/CATERPILLAR 3508		
COMBUSTIBLE, SELLADO GP-110 1P2299			AIRE, SECUNDARIO ESTANDAR GA-482 1P8482			ACEITE, FRENOS HIDRAULICOS G-152 1R0719		
AIRE, SECUNDARIO GA-1287 2S1287			773 FUERA DE CARRETERA con motor/CATERPILLAR D346			ACEITE, CONVERTIDOR DE TORSION/TRANSMISION, (REQUIERE 2 PIEZAS) G-222 1R0741		
AIRE, PRIMARIO GA-9045 7M9045			ACEITE, LUBRICACION TRIPLE G-191 5S0484			ACEITE, TANQUE HIDRAULICO G-222 4J6064		
769C FUERA DE CARRETERA con motor/CATERPILLAR 3408			ACEITE, LUBRICACION DUAL G-238 5S0485			TRANSMISION G-222 4J6064		
TRANSMISION G-152 1R0719			DIRECCION G-222 4J6064					
DIRECCION G-222 4J6064			ACEITE, TANQUE HIDRAULICO G-222 4J6064					
			TRANSMISION G-222 4J6064					

SERVICIO PESADO

MARCA-MODELO-MOTOR MAKE-MODEL-ENGINE	GONHER GONHER	OEM OEM	MARCA-MODELO-MOTOR MAKE-MODEL-ENGINE	GONHER GONHER	OEM OEM	MARCA-MODELO-MOTOR MAKE-MODEL-ENGINE	GONHER GONHER	OEM OEM
CATERPILLAR (continuación)			CATERPILLAR (continuación)			CATERPILLAR (continuación)		
CAMIONES, TRACTOCAMIONES Y AUTOBUSES			CAMIONES, TRACTOCAMIONES Y AUTOBUSES			CAMIONES, TRACTOCAMIONES Y AUTOBUSES		
ACEITE, (REQUIERE 2 PIEZAS)	GP-52	2P4005	AIRE RADIAL, PRIMARIO (REQUIERE 2 PIEZAS)	GA-600R	106-3969	DIRECCION	G-222	4J6064
AIRE ESTANDAR, SECUNDARIO	GA-357	6N6072				ACEITE, TANQUE HIDRAULICO	G-222	4J6064
AIRE RADIAL, PRIMARIO	GA-600R	106-3969				ACEITE, CUMPLE CON MEDI- DAS ORIGINALES	GP-691	2P4005
			777D FUERA DE CARRETERA con motor/CATERPILLAR 3508B			ACEITE, SEGUNDA OPCION	GP-52	2P4005
776C FUERA DE CARRETERA con motor/CATERPILLAR 3508			HIDRAULICO	G-152	1R0719			
ACEITE HIDRAULICO	G-152	1R0719	DIRECCION (CARTUCHO)	G-222	1R0741			
ACEITE, CONVERTIDOR DE TORSION/TRANSMISION, (REQUIERE 2 PIEZAS)	G-222	1R0741	TRANSMISION (REQUIERE 2 PIEZAS)	G-222	1R0741	785C FUERA DE CARRETERA con motor/CATERPILLAR 3512B		
DIRECCION	G-222	1R0741	DIRECCION (SELLADO)	GP-34	4T6788	ACEITE, FRENOS HIDRAULICOS	G-152	1R0719
ACEITE, (REQUIERE 2 PIEZAS)	GP-52	2P4005	ACEITE, (REQUIERE 2 PIEZAS)	GP-52	2P4005	ACEITE, CONVERTIDOR DE TORSION/ TRANSMISION	G-222	1R0741
AIRE ESTANDAR, SECUNDARIO	GA-357	6N6072	DIESEL, (ACCESORIO)	GP-110	1R0750	DIRECCION	G-222	1R0741
AIRE RADIAL, PRIMARIO	GA-600R	106-3969	AIRE RADIAL, PRIMARIO (REQUIERE 2 PIEZAS)	GA-600R	106-3969	TRANSMISION	G-222	1R0741
			AIRE DE CABINA	GA-240	107-0266	ACEITE, CUMPLE CON MEDI- DAS ORIGINALES	GP-691	2P4005
						ACEITE	GP-52	2P4005
776D FUERA DE CARRETERA con motor/CATERPILLAR 3508B			777D FUERA DE CARRETERA con motor/CATERPILLAR 3512B			COMBUSTIBLE, ACCESORIO SELLADO	GP-110	1R0750
ACEITE, CONVERTIDOR DE TORSION/TRANSMISION, (REQUIERE 2 PIEZAS)	G-222	1R0741	ACEITE, FRENOS HIDRAULICOS	G-152	1R0719	AIRE, PRIMARIO	GA-879	9Y7662
DIRECCION (CARTUCHO)	G-222	1R0741	TRANSMISION	G-152	1R0719	AIRE ACONDICIONADO	GA-240	107-0266
ACEITE, FRENOS/TRANS- MISION	G-222	1R0719	ACEITE, CONVERTIDOR DE TORSION/ TRANSMISION	G-222	1R0741			
DIRECCION (SELLADO)	GP-34	4T6788	DIRECCION (CARTUCHO)	G-222	1R0741	785C FUERA DE CARRETERA con motor/CATERPILLAR 3516B		
ACEITE, (REQUIERE 2 PIEZAS)	GP-52	2P4005	ACEITE, CUMPLE CON MEDI- DAS ORIGINALES	GP-691	2P4005	ACEITE, FRENOS HIDRAULICOS	G-152	1R0719
AIRE RADIAL, PRIMARIO	GA-600R	106-3969	DIRECCION (SELLADO)	GP-34	4T3132	TRANSMISION	G-152	1R0719
AIRE DE CABINA	GA-240	107-0266	ACEITE, SEGUNDA OPCION	GP-52	2P4005	ACEITE, CONVERTIDOR DE TORSION/ TRANSMISION	G-222	1R0741
						DIRECCION	G-222	1R0741
777 FUERA DE CARRETERA con motor/CATERPILLAR D348			779 FUERA DE CARRETERA con motor/A DIESEL			ACEITE, CUMPLE CON MEDI- DAS ORIGINALES	GP-691	2P4005
ACEITE, CARTUCHO	G-191	5S0484	ACEITE	G-191	5S0484	ACEITE, SEGUNDA OPCION	GP-52	2P4005
TRANSMISION (S/N 84A1284 EN ADELANTE)	G-152	1R0719	ACEITE, ACUMULADOR HIDRAULICO	G-222	4J6064			
DIRECCION	G-222	4J6064	ACEITE, TANQUE HIDRAULICO	G-222	4J6064	789 FUERA DE CARRETERA con motor/CATERPILLAR 3516		
ACEITE, TANQUE HIDRAULICO	G-222	4J6064				ACEITE, FRENOS HIDRAULICOS	G-152	1R0719
TRANSMISION (S/N 84A1-163)	G-222	4J6064	783B FUERA DE CARRETERA con motor/A DIESEL			TRANSMISION	G-152	1R0719
TRANSMISION (S/N 84A164- 1283)	G-153	7J0670	TRANSMISION	G-152	9M9740	ACEITE, CONVERTIDOR DE TORSION	G-222	1R0741
ACEITE, SELLADO (CUMPLE CON MEDIDAS ORIGINALES)	GP-691	2P4005	ACEITE, TANQUE HIDRAULICO	G-222	4J6064	ACEITE, CUMPLE CON MEDI- DAS ORIGINALES	GP-691	2P4005
ACEITE, SELLADO (SEGUNDA OPCION)	GP-52	2P4005	ACEITE, CUMPLE CON MEDI- DAS ORIGINALES	GP-691	2P4005	ACEITE, SEGUNDA OPCION	GP-52	2P4005
AIRE, PRIMARIO	GA-7716	8N5495	ACEITE, SEGUNDA OPCION	GP-52	2P4005	DIRECCION	GP-166	4T6915
AIRE, SECUNDARIO	GA-7360	1P7360						
			784B FUERA DE CARRETERA, 785B FUERA DE CARRETERA con motor/CATERPILLAR 3512			789B FUERA DE CARRETERA con motor/CATERPILLAR 3516		
777A FUERA DE CARRETERA con motor/A DIESEL			TRANSMISION	G-152	1R0719	ACEITE, DIFERENCIAL	G-152	9M9740
HIDRAULICO	G-222	1R0741	ACEITE, CONVERTIDOR DE TORSION	G-222	1R0741	TRANSMISION	G-152	1R0719
TRANSMISION	G-222	1R0741	DIRECCION	G-222	4J6064	ACEITE, CONVERTIDOR DE TORSION	G-222	1R0741
ACEITE, CUMPLE CON MEDI- DAS ORIGINALES	GP-691	1R0716	ACEITE, CUMPLE CON MEDI- DAS ORIGINALES	GP-691	2P4005	ACEITE, CUMPLE CON MEDI- DAS ORIGINALES	GP-691	2P4005
ACEITE, SEGUNDA OPCION	GP-52	1R0716	ACEITE, SEGUNDA OPCION	GP-52	2P4005	ACEITE, SEGUNDA OPCION	GP-52	2P4005
AIRE, PRIMARIO	GA-7716	7W5495				DIRECCION	GP-166	4T6915
AIRE, SECUNDARIO	GA-7360	1P7360	784C FUERA DE CARRETERA con motor/CATERPILLAR 3512					
			TRANSMISION	G-152	1R0719	789C FUERA DE CARRETERA con motor/CATERPILLAR 3516		
777B FUERA DE CARRETERA con motor/CATERPILLAR 3508			ACEITE, CONVERTIDOR DE TORSION/ TRANSMISION	G-222	1R0741	TRANSMISION	G-152	1R0719
ACEITE, CONVERTIDOR DE TORSION/ TRANSMISION	G-222	1R0741	DIRECCION	G-222	1R0741	ACEITE, CONVERTIDOR DE TORSION/ TRANSMISION	G-222	1R0741
ACEITE, TANQUE HIDRAULICO	G-222	4J6064	ACEITE, CUMPLE CON MEDI- DAS ORIGINALES	GP-691	2P4005	ACEITE, CUMPLE CON MEDI- DAS ORIGINALES	GP-691	2P4005
TRANSMISION	G-222	4J6064	ACEITE, SEGUNDA OPCION	GP-52	2P4005	ACEITE, SEGUNDA OPCION	GP-52	2P4005
ACEITE, CUMPLE CON MEDI- DAS ORIGINALES	GP-691	2P4005	COMBUSTIBLE, ACCESORIO	GP-110	1R0750	COMBUSTIBLE, ACCESORIO	GP-110	1R0750
ACEITE, SEGUNDA OPCION	GP-52	2P4005				DIRECCION	GP-166	4T6915
AIRE, SECUNDARIO	GA-357	6N6072	784D FUERA DE CARRETERA con motor/CATERPILLAR 3412TA					
			COMBUSTIBLE, SELLADO	GP-749	1R0749	793 FUERA DE CARRETERA con motor/CATERPILLAR 3516		
777C FUERA DE CARRETERA con motor/CATERPILLAR 3508			ACEITE, CUMPLE CON MEDI- DAS ORIGINALES	GP-691	2P4005	TRANSMISION	G-152	9M9740
HIDRAULICO	G-152	1R0719	ACEITE, SEGUNDA OPCION	GP-52	2P4005	ACEITE, CONVERTIDOR DE TORSION	G-222	1R0741
ACEITE, CONVERTIDOR DE TORSION/TRANSMISION, (REQUIERE 2 PIEZAS)	G-222	1R0741				ACEITE, CUMPLE CON MEDI- DAS ORIGINALES	GP-691	2P4005
DIRECCION	G-222	1R0741	785 FUERA DE CARRETERA con motor/CATERPILLAR 3512			ACEITE, SEGUNDA OPCION	GP-52	2P4005
TRANSMISION	G-222	1R0741	TRANSMISION	G-152	1R0719	DIRECCION	GP-166	4T6915
ACEITE, (REQUIERE 2 PIEZAS)	GP-52	2P4005	ACEITE, CONVERTIDOR DE TORSION	G-222	1R0741	AIRE, PRIMARIO	GA-879	9Y7662

MARCA-MODELO-MOTOR MAKE-MODEL-ENGINE	GONHER GONHER	OEM OEM	MARCA-MODELO-MOTOR MAKE-MODEL-ENGINE	GONHER GONHER	OEM OEM	MARCA-MODELO-MOTOR MAKE-MODEL-ENGINE	GONHER GONHER	OEM OEM
CATERPILLAR (continuación)			CATERPILLAR (continuación)			CATERPILLAR (continuación)		
CAMIONES, TRACTOCAMIONES Y AUTOBUSES			CAMIONES, TRACTOCAMIONES Y AUTOBUSES			CAMIONES, TRACTOCAMIONES Y AUTOBUSES		
793B FUERA DE CARRETERA con motor/CATERPILLAR 3516			AD45 ARTICULADO, AE40 SERIES II ARTICULADO con motor/A DIESEL			D250E DE VOLTEO, D250E SERIES II DE VOLTEO con motor/CATERPILLAR 3306		
TRANSMISION	G-152	1R0719	HIDRAULICO	G-152	1R0719	TRANSMISION	G-152	1R0719
ACEITE, CONVERTIDOR DE TORSION	G-222	1R0741	HIDRAULICO	G-222	1R0741	HIDRAULICO	G-222	1R0741
ACEITE, CUMPLE CON MEDIDAS ORIGINALES	GP-691	2P4005	COMBUSTIBLE	GP-749	1R0749	ACEITE	GP-51	1R0739
ACEITE, SEGUNDA OPCION	GP-52	2P4005	ACEITE, CUMPLE CON MEDIDAS ORIGINALES	GP-691	1R0716	COMBUSTIBLE, SELLADO	GP-110	1R0750
DIRECCION	GP-166	4T6915	ACEITE, SEGUNDA OPCION	GP-52	1R0716	D25C ARTICULADO con motor/CATERPILLAR 3306		
AIRE, PRIMARIO	GA-879	9Y7662	AD55 ARTICULADO con motor/A DIESEL			TRANSMISION	G-152	9M9740
			COMBUSTIBLE	GP-749	1R0749	ACEITE, TANQUE HIDRAULICO	G-222	4J6064
793C FUERA DE CARRETERA con motor/CATERPILLAR 3516			ACEITE, CUMPLE CON MEDIDAS ORIGINALES	GP-691	1R0716	ACEITE	GP-51	2P4004
DIRECCION	G-1166	4T6915	ACEITE, SEGUNDA OPCION	GP-52	1R0716	COMBUSTIBLE	GP-110	1P2299
TRANSMISION	G-152	1R0719	HIDRAULICO	GP-761H	1G8878	AIRE, PRIMARIO	GA-7716	1P7716
ACEITE, CONVERTIDOR DE TORSION/ TRANSMISION	G-222	1R0741				AIRE, SECUNDARIO	GA-7360	1P7360
ACEITE, CUMPLE CON MEDIDAS ORIGINALES	GP-691	2P4005	D20D ARTICULADO con motor/CATERPILLAR 3116			D25D ARTICULADO con motor/CATERPILLAR 3306		
ACEITE, SEGUNDA OPCION	GP-52	2P4005	TRANSMISION	G-152	9M9740	TRANSMISION	G-152	1R0719
COMBUSTIBLE, ACCESORIO SELLADO	GP-110	1R0750	ACEITE, TANQUE HIDRAULICO	G-222	4J6064	ACEITE, TANQUE HIDRAULICO	G-222	1R0741
AIRE, PRIMARIO	GA-879	9Y7662	ACEITE	GP-51	1R0739	ACEITE	GP-51	1R0739
			COMBUSTIBLE, 5 13/32 IN	GP-62	1R0751	COMBUSTIBLE	GP-110	1R0750
793D FUERA DE CARRETERA con motor/CATERPILLAR 3516B			COMBUSTIBLE, 7 13/32 IN	GP-1109	1R0751	AIRE, PRIMARIO ESTANDAR	GA-7716	7W5495
ACEITE	GP-52	275-2604	COMBUSTIBLE	GP-110	1R0740	AIRE, SECUNDARIO ESTANDAR	GA-7360	1P7360
AIRE, PRIMARIO	GA-879	9Y7662	AIRE, SECUNDARIO	GA-1287	2S1287	D300B DE VOLTEO, D300D DE VOLTEO con motor/CATERPILLAR 3306		
AIRE ACONDICIONADO	GA-240	107-0266	AIRE, PRIMARIO	GA-9045	7W5316	TRANSMISION	G-152	9M9740
						ACEITE, TANQUE HIDRAULICO	G-222	4J6064
797 FUERA DE CARRETERA con motor/CATERPILLAR 3524B			D22 ARTICULADO, D250 ARTICULADO, D25B ARTICULADO, D275 ARTICULADO, D275B ARTICULADO, D300 ARTICULADO con motor/A DIESEL			ACEITE	GP-51	1R0739
ACEITE, DIFERENCIAL	G-152	9M9740	TRANSMISION	G-152	9M9740	COMBUSTIBLE, SELLADO	GP-110	1R0740
ACEITE, TRACCION DE TRANSMISION FINAL	G-152	1R0719	HIDRAULICO	G-222	4J6064	AIRE, PRIMARIO	GA-7716	1P7716
ACEITE, CUMPLE CON MEDIDAS ORIGINALES	GP-691	2P4005	ACEITE	GP-51	2P4004	AIRE, SECUNDARIO	GA-7360	1P7360
HIDRAULICO/ DIRECCION/ RESPIRADOR DEL CONVERTIDOR DE TORSION	GP-34	4T6788	COMBUSTIBLE, SEPARADOR DE AGUA	GPP-11	175-2949	D300C DE VOLTEO con motor/A DIESEL		
RESPIRADOR DEL TANQUE DE COMBUSTIBLE	GP-34	4T6788	COMBUSTIBLE	GP-110	1P2299	ACEITE	G-152	1R0750
ACEITE, SEGUNDA OPCION	GP-52	2P4005	AIRE, PRIMARIO	GA-7716	7W5495	ACEITE	G-222	2P4004
			AIRE, SECUNDARIO	GA-7360	1P7360	ACEITE	GP-51	9M9740
797B FUERA DE CARRETERA con motor/CATERPILLAR 3524B			D25 ARTICULADO con motor/CATERPILLAR 3306			COMBUSTIBLE	GP-110	1P2299
ACEITE	GP-52	2P4005	TRANSMISION	G-152	9M9740	AIRE	GA-7360	7W5495
COMBUSTIBLE, SELLADO	GP-110	1R0750	HIDRAULICO	G-222	4J6064	D300E DE VOLTEO con motor/CATERPILLAR 3306		
AIRE, PRIMARIO	GA-879	9Y7662	ACEITE	GP-51	2P4004	TRANSMISION	G-152	1R0719
AIRE ACONDICIONADO	GA-240	107-0266	COMBUSTIBLE, SEPARADOR DE AGUA	GPP-11	175-2949	ACEITE, TANQUE HIDRAULICO	G-222	1R0741
			COMBUSTIBLE	GP-110	1P2299	ACEITE	GP-51	1R0739
AD30 DE VOLTEO con motor/CATERPILLAR 3406E			AIRE, PRIMARIO	GA-7716	7W5495	COMBUSTIBLE, SELLADO	GP-110	1R0750
DIESEL	GP-749	1R0749	AIRE, SECUNDARIO	GA-7360	1P7360	D300E SERIES II DE VOLTEO con motor/CATERPILLAR 3306		
ACEITE	GP-52	2P4005	D250B DE VOLTEO con motor/CATERPILLAR 3306			TRANSMISION	G-152	1R0719
AGUA, REFRIGERANTE	GP-1011Q	9N3718	TRANSMISION	G-152	9M9740	HIDRAULICO	G-222	1R0741
TRANSMISION (REQUIERE 2 PIEZAS)	GP-761H	1G8878	ACEITE, TANQUE HIDRAULICO	G-222	4J6064	ACEITE	GP-51	1R0739
AIRE RADIAL, SECUNDARIO	GA-600R	106-3969	ACEITE	GP-51	1R0739	COMBUSTIBLE, SELLADO	GP-110	1R0750
			COMBUSTIBLE, SELLADO	GP-110	1R0740	D30C ARTICULADO con motor/CATERPILLAR 3306		
AD40 FUERA DE CARRETERA, AE40 ARTICULADO con motor/A DIESEL			AIRE, PRIMARIO	GA-7716	1P7716	TRANSMISION	G-152	9M9740
TRANSMISION	G-152	1R0719	AIRE, SECUNDARIO	GA-7360	1P7360	ACEITE, TANQUE HIDRAULICO	G-222	4J6064
ACEITE, CONVERTIDOR DE TORSION	G-222	1R0741	D250D DE VOLTEO con motor/CATERPILLAR 3116			ACEITE	GP-51	2P4004
DIRECCION	G-222	1R0741	TRANSMISION	G-152	9M9740	COMBUSTIBLE	GP-110	1P2299
COMBUSTIBLE	GP-749	1R0749	ACEITE, TANQUE HIDRAULICO	G-222	4J6064	AIRE, PRIMARIO	GA-7716	1P7716
ACEITE, CUMPLE CON MEDIDAS ORIGINALES	GP-691	1R0716	ACEITE	GP-51	1R0739	AIRE, SECUNDARIO	GA-7360	1P7360
ACEITE, SEGUNDA OPCION	GP-52	1R0716	COMBUSTIBLE, 5 13/32 IN	GP-62	1R0751	D30D ARTICULADO con motor/CATERPILLAR 3306		
AGUA	GP-1011Q	9N3718	COMBUSTIBLE, 7 13/32 IN	GP-1109	1R0751	TRANSMISION	G-152	1R0719
			COMBUSTIBLE, 7 1/8 IN	GP-110	1R0740	ACEITE, TANQUE HIDRAULICO	G-222	1R0741
			AIRE, SECUNDARIO	GA-1287	2S1287	ACEITE	GP-51	1R0739
			AIRE, PRIMARIO	GA-9045	7W5316	COMBUSTIBLE	GP-110	1R0750
						AIRE, PRIMARIO ESTANDAR	GA-7716	7W5495
						AIRE, SECUNDARIO ESTANDAR	GA-7360	1P7360

SERVICIO PESADO

MARCA-MODELO-MOTOR MAKE-MODEL-ENGINE	GONHER GONHER	OEM OEM	MARCA-MODELO-MOTOR MAKE-MODEL-ENGINE	GONHER GONHER	OEM OEM	MARCA-MODELO-MOTOR MAKE-MODEL-ENGINE	GONHER GONHER	OEM OEM
CATERPILLAR (continuación)			CATERPILLAR (continuación)			CATERPILLAR (continuación)		
CAMIONES, TRACTOCAMIONES Y AUTOBUSES			CAMIONES, TRACTOCAMIONES Y AUTOBUSES			CAMIONES, TRACTOCAMIONES Y AUTOBUSES		
D330 ARTICULADO con motor/A DIESEL			ACEITE, CUMPLE CON MEDI-DAS ORIGINALES	GP-691	1R0716	D400E SERIES II DE VOLTEO con motor/CATERPILLAR 3406E		
ACEITE, CARTUCHO	G-191	1R0659	ACEITE, SEGUNDA OPCION	GP-52	1R0716	TRANSMISION	G-152	1R0719
TRANSMISION	G-152	9M9740	D35C ARTICULADO con motor/CATERPILLAR 3306			ACEITE, TANQUE HIDRAULICO (S/N 2YR) (REQUIERE 3 PIEZAS)	G-222	1R0741
HIDRAULICO	G-222	4J6064	TRANSMISION	G-152	9M9740	DIESEL	GP-749	1R0749
ACEITE, SELLADO	GP-51	2P4004	ACEITE, TANQUE HIDRAULICO	G-222	4J6064	ACEITE	GP-52	1R0716
COMBUSTIBLE, SEPARADOR DE AGUA	GPP-11	175-2949	ACEITE	GP-51	2P4004	AIRE RADIAL, PRIMARIO	GA-712R	123-6855
COMBUSTIBLE	GP-110	1P2299	COMBUSTIBLE	GP-110	1P2299	D40D DE VOLTEO con motor/CATERPILLAR 3406		
AIRE, PRIMARIO	GA-7716	7W5495	AIRE, PRIMARIO	GA-7716	1P7716	TRANSMISION	G-152	1R0719
AIRE, SECUNDARIO	GA-7360	1P7360	AIRE, SECUNDARIO	GA-7360	1P7360	ACEITE, TANQUE HIDRAULICO	G-222	1R0741
D330B ARTICULADO con motor/A DIESEL			D35C-HP ARTICULADO con motor/A DIESEL			COMBUSTIBLE, SELLADO	GP-749	1R0749
ACEITE	G-191	550484	TRANSMISION	G-152	9M9740	ACEITE, CUMPLE CON MEDI-DAS ORIGINALES	GP-691	1R0716
D330C ARTICULADO con motor/A DIESEL			HIDRAULICO	G-222	4J6064	ACEITE, SEGUNDA OPCION	GP-52	1R0716
COMBUSTIBLE	GP-110	1R0750	COMBUSTIBLE	GP-749	1R0749	AGUA, PRE-CARGA	GP-1011Q	9N3367
D35 ARTICULADO con motor/A DIESEL			ACEITE, CUMPLE CON MEDI-DAS ORIGINALES	GP-691	2P4005	AGUA, MANTENIMIENTO	GP-2071W	9N3368
TRANSMISION	G-152	9M9740	ACEITE, SEGUNDA OPCION	GP-52	2P4005	AIRE, PRIMARIO	GA-7716	7W5495
HIDRAULICO	G-222	4J6064	COMBUSTIBLE	GP-56	4N5823	AIRE, SECUNDARIO	GA-7360	1P7360
ACEITE	GP-51	2P4004	AIRE, PRIMARIO	GA-7716	7W5495	D44 ARTICULADO con motor/A DIESEL		
COMBUSTIBLE, SEPARADOR DE AGUA	GPP-11	175-2949	AIRE, SECUNDARIO	GA-7360	1P7360	TRANSMISION	G-152	9M9740
COMBUSTIBLE, SECUNDARIO	GP-110	1P2299	D35HP DE VOLTEO con motor/CATERPILLAR 3406B			HIDRAULICO	G-222	4J6064
AIRE, PRIMARIO	GA-7716	7W5495	TRANSMISION	G-152	9M9740	ACEITE, CUMPLE CON MEDI-DAS ORIGINALES	GP-691	2P4005
AIRE, SECUNDARIO	GA-7360	1P7360	ACEITE, TANQUE HIDRAULICO	G-222	4J6064	ACEITE, SEGUNDA OPCION	GP-52	2P4005
D350 DE VOLTEO, D350B DE VOLTEO con motor/A DIESEL			ACEITE, CUMPLE CON MEDI-DAS ORIGINALES	GP-691	2P4005	COMBUSTIBLE	GP-56	4N5823
TRANSMISION	G-152	9M9740	ACEITE, SEGUNDA OPCION	GP-52	2P4005	AIRE, PRIMARIO	GA-483	7W5313
HIDRAULICO	G-222	4J6064	COMBUSTIBLE, SELLADO	GP-1108	4N5823	AIRE, SECUNDARIO	GA-482	1P8482
ACEITE	GP-51	2P4004	AGUA, PRE-CARGA	GP-1011Q	9N3367	D44B DE VOLTEO, D550B DE VOLTEO con motor/CATERPILLAR 3408		
COMBUSTIBLE, SEPARADOR DE AGUA	GPP-11	175-2949	AGUA, MANTENIMIENTO	GP-2071W	9N3368	TRANSMISION	G-152	9M9740
COMBUSTIBLE	GP-110	1P2299	AIRE, PRIMARIO	GA-7716	1P7716	ACEITE, TANQUE HIDRAULICO	G-222	4J6064
AIRE, PRIMARIO	GA-7716	7W5495	AIRE, SECUNDARIO	GA-7360	1P7360	ACEITE, CUMPLE CON MEDI-DAS ORIGINALES	GP-691	2P4005
AIRE, SECUNDARIO	GA-7360	1P7360	D400 DE VOLTEO con motor/CATERPILLAR 3406			ACEITE, SEGUNDA OPCION	GP-52	2P4005
D350C DE VOLTEO con motor/CATERPILLAR 3306			TRANSMISION	G-152	9M9740	COMBUSTIBLE, SELLADO	GP-1108	1R0712
TRANSMISION	G-152	9M9740	ACEITE, TANQUE HIDRAULICO	G-222	4J6064	AGUA, PRE-CARGA	GP-1011Q	9N3367
ACEITE, TANQUE HIDRAULICO	G-222	4J6064	ACEITE, CUMPLE CON MEDI-DAS ORIGINALES	GP-691	2P4005	AGUA, MANTENIMIENTO	GP-2071W	9N3368
ACEITE	GP-51	1R0739	ACEITE, SEGUNDA OPCION	GP-52	2P4005	AIRE, PRIMARIO	GA-483	1P8483
COMBUSTIBLE, SELLADO	GP-110	1P2299	COMBUSTIBLE, SELLADO	GP-1108	4N5823	AIRE, SECUNDARIO	GA-482	1P8482
AIRE, PRIMARIO	GA-7716	1P7716	AGUA, PRE-CARGA	GP-1011Q	9N3367	D550 ARTICULADO con motor/A DIESEL		
AIRE, SECUNDARIO	GA-7360	1P7360	AGUA, MANTENIMIENTO	GP-2071W	9N3368	TRANSMISION	G-152	9M9740
D350D DE VOLTEO con motor/CATERPILLAR 3306			AIRE, PRIMARIO	GA-7716	1P7716	HIDRAULICO	G-222	4J6064
TRANSMISION	G-152	1R0719	AIRE, SECUNDARIO	GA-7360	1P7360	COMBUSTIBLE	GP-749	1R0749
ACEITE, TANQUE HIDRAULICO	G-222	4J6064	D400D DE VOLTEO con motor/CATERPILLAR 3406			ACEITE, CUMPLE CON MEDI-DAS ORIGINALES	GP-691	2P4005
ACEITE	GP-51	1R0739	TRANSMISION	G-152	1R0719	ACEITE, SEGUNDA OPCION	GP-52	2P4005
COMBUSTIBLE, SELLADO	GP-110	1P2299	ACEITE, TANQUE HIDRAULICO	G-222	1R0741	COMBUSTIBLE	GP-56	4N5823
AIRE, PRIMARIO ESTANDAR	GA-7716	1P7716	COMBUSTIBLE, SELLADO	GP-749	1R0749	AIRE, PRIMARIO	GA-483	7W5313
AIRE, SECUNDARIO ESTANDAR	GA-7360	1P7360	ACEITE, CUMPLE CON MEDI-DAS ORIGINALES	GP-691	1R0716	AIRE, SECUNDARIO	GA-482	1P8482
D350E DE VOLTEO con motor/CATERPILLAR 3406			ACEITE, SEGUNDA OPCION	GP-52	1R0716	R1300 FUERA DE CARRETERA con motor/CATERPILLAR 3306		
TRANSMISION	G-152	1R0719	AGUA, PRE-CARGA	GP-1011Q	9N3367	ACEITE	GP-51	1R0739
ACEITE, TANQUE HIDRAULICO	G-222	1R0741	AGUA, MANTENIMIENTO	GP-2071W	9N3368	R1600 FUERA DE CARRETERA con motor/CATERPILLAR 3176		
COMBUSTIBLE, SELLADO	GP-749	1R0749	AIRE, PRIMARIO	GA-7716	1P7716	TRANSMISION	G-152	1R0719
ACEITE, CUMPLE CON MEDI-DAS ORIGINALES	GP-691	1R0716	AIRE, SECUNDARIO	GA-7360	1P7360	COMBUSTIBLE	GP-749	1R0749
ACEITE, SEGUNDA OPCION	GP-52	1R0716	D400E ARTICULADO con motor/CATERPILLAR 3406			ACEITE, CUMPLE CON MEDI-DAS ORIGINALES	GP-691	1R0716
AGUA	GP-2071W	9N3368	TRANSMISION	G-152	1R0719	ACEITE, SEGUNDA OPCION	GP-52	1R0716
D350E SERIES II DE VOLTEO con motor/CATERPILLAR 3406E			ACEITE, TANQUE HIDRAULICO	G-222	1R0741	AGUA	GP-1011Q	9N3718
TRANSMISION	G-152	1R0719	COMBUSTIBLE	GP-749	1R0749			
COMBUSTIBLE, SELLADO	GP-749	1R0749	ACEITE, CUMPLE CON MEDI-DAS ORIGINALES	GP-691	1R0716			
			ACEITE, SEGUNDA OPCION	GP-52	1R0716			
			AGUA	GP-2071W	9N3368			

MARCA-MODELO-MOTOR MAKE-MODEL-ENGINE	GONHER GONHER	OEM OEM	MARCA-MODELO-MOTOR MAKE-MODEL-ENGINE	GONHER GONHER	OEM OEM	MARCA-MODELO-MOTOR MAKE-MODEL-ENGINE	GONHER GONHER	OEM OEM
CATERPILLAR (continuación)			CATERPILLAR (continuación)			CATERPILLAR (continuación)		
CAMIONES, TRACTOCAMIONES Y AUTOBUSES			CARGADORAS			CARGADORAS		
R1700 SERIES II FUERA DE CARRETERA con motor/CATERPILLAR 3176			262, 236, 246, 248, 252 con motor/CATERPILLAR 3034			COMBUSTIBLE, SEPARADOR DE AGUA	GPP-421	131-1812
COMBUSTIBLE, SEPARADOR DE AGUA	G-1143	8N0205	ACEITE	GP-1	7W2327	COMBUSTIBLE	GPP-419	159-6102
TRANSMISION	G-152	1R0719	COMBUSTIBLE, SEPARADOR DE AGUA	GPP-421	131-1812	AIRE, RADIAL PRIMARIO	GA-853R	110-6326
COMBUSTIBLE	GP-749	1R0749	COMBUSTIBLE, SEPARADOR DE AGUA	GPP-425	163-4465	422 RETROEXCAVADORA con motor/PERKINS		
ACEITE, CUMPLE CON MEDI-DAS ORIGINALES	GP-691	1R0716	HIDRAULICO	GP-761H	1G8878	ACEITE	GP-31	7W2326
ACEITE, SEGUNDA OPCION	GP-52	1R0716	COMBUSTIBLE, SECUNDARIO	GPP-419	159-6102	COMBUSTIBLE, SEPARADOR DE AGUA	GPP-421	131-1812
			AIRE, RADIAL PRIMARIO	GA-853R	110-6326	AIRE, RADIAL PRIMARIO	GA-853R	110-6326
R1700G FUERA DE CARRETERA con motor/CATERPILLAR 3176			268B con motor/CATERPILLAR 3044 (3.3L)			424D con motor/CATERPILLAR 3054T		
TRANSMISION	G-152	1R0719	ACEITE	GP-36	1R0734	ACEITE	GP-31	7W2326
COMBUSTIBLE	GP-749	1R0749	268B, 277B, 277C, 287B, 287C, 297C con motor/CATERPILLAR 3044C			COMBUSTIBLE, SEPARADOR DE AGUA	GPP-421	131-1812
ACEITE, CUMPLE CON MEDI-DAS ORIGINALES	GP-691	1R0716	ACEITE	GP-36	1R0734	COMBUSTIBLE	GPP-419	159-6102
ACEITE, SEGUNDA OPCION	GP-52	1R0716	HIDRAULICO	GP-761H	1G8878	AIRE, RADIAL PRIMARIO	GA-853R	110-6326
AGUA	GP-1011Q	9N3718	AIRE, RADIAL PRIMARIO	GA-853R	110-6326	426 RETROEXCAVADORA, 426 SERIES II RETROEXCAVADORA con motores/PERKINS 4.236, PERKINS D4.236		
R2900 FUERA DE CARRETERA con motor/CATERPILLAR 3406			287 con motor/PERKINS 2.9L			ACEITE	GP-1	7W2327
TRANSMISION (CARTUCHO)	G-152	1R0719	ACEITE	GP-1	7W2327	COMBUSTIBLE	G-296	67-6987
COMBUSTIBLE	GP-749	1R0749	375 con motor/A DIESEL			COMBUSTIBLE	G-296-B	67-6987
ACEITE, CUMPLE CON MEDI-DAS ORIGINALES	GP-691	1R0716	ACEITE, CUMPLE CON MEDI-DAS ORIGINALES	GP-691	1R0716	TRANSMISION	GP-761H	90-2900
ACEITE, SEGUNDA OPCION	GP-52	1R0716	ACEITE, SEGUNDA OPCION	GP-52	1R0716	426B RETROEXCAVADORA con motor/CATERPILLAR 3054		
ACEITE, ACCESORIO PARA TRANSMISION (SELLADO)	GP-761H	9T5916	COMBUSTIBLE	GP-1108	1R0712	ACEITE	GP-31	7W2326
			AGUA	GP-1011Q	9N3367	426C con motor/CATERPILLAR 3054		
			416 RETROEXCAVADORA, 416 SERIES II RETROEXCAVADORA con motores/PERKINS 4.236, PERKINS T4.236			ACEITE	GP-31	7W2326
			ACEITE	GP-1	7W2327	COMBUSTIBLE, SEPARADOR DE AGUA	GPP-421	131-1812
			COMBUSTIBLE	G-296	67-6987	COMBUSTIBLE	GPP-419	159-6102
			COMBUSTIBLE, SECUNDARIO	G-296-B	67-6987	AIRE, RADIAL PRIMARIO	GA-853R	110-6326
			TRANSMISION	GP-761H	90-2900	428 RETROEXCAVADORA, 428 SERIES II RETROEXCAVADORA con motores/PERKINS 4.236, PERKINS T4.236		
			416B RETROEXCAVADORA con motor/CATERPILLAR 3054			ACEITE, 5 13/32 IN	GP-1	7W2327
			ACEITE, 5 13/32 IN	GP-1	7W2327	ACEITE, 7 17/32 IN	GP-31	7W2326
			ACEITE, 7 17/32 IN	GP-31	7W2326	COMBUSTIBLE	G-296	67-6987
			COMBUSTIBLE, SEPARADOR DE AGUA	GPP-421	131-1812	COMBUSTIBLE	G-296-B	67-6987
			COMBUSTIBLE	GPP-419	159-6102	TRANSMISION	GP-761H	90-2900
			416C con motor/CATERPILLAR 3054 SERIES			428B RETROEXCAVADORA con motor/CATERPILLAR 3054		
			ACEITE	GP-31	7W2326	ACEITE, 5 13/32 IN	GP-1	7W2327
			COMBUSTIBLE, SEPARADOR DE AGUA	GPP-421	131-1812	ACEITE, 7 17/32 IN	GP-31	7W2326
			COMBUSTIBLE	GPP-419	159-6102	COMBUSTIBLE	G-296	67-6987
			AIRE, RADIAL PRIMARIO	GA-853R	110-6326	COMBUSTIBLE, SEPARADOR DE AGUA	GPP-421	131-1812
			416C RETROEXCAVADORA con motores/PERKINS, CATERPILLAR 3054T			COMBUSTIBLE	GPP-419	100-5593
			ACEITE, 5 13/32 IN	GP-1	7W2327	428C con motor/PERKINS		
			ACEITE, 7 17/32 IN	GP-31	7W2326	ACEITE (5 13/32 IN)	GP-1	7W2327
			COMBUSTIBLE, SEPARADOR DE AGUA	GPP-421	131-1812	ACEITE (7 17/32 IN)	GP-31	7W2326
			COMBUSTIBLE	GPP-419	159-6102	COMBUSTIBLE, SEPARADOR DE AGUA	GPP-421	131-1812
			416D RETROEXCAVADORA, 420D RETROEXCAVADORA con motor/CATERPILLAR 3054T			AIRE, RADIAL PRIMARIO	GA-853R	110-6326
			ACEITE, 5 13/32 IN	GP-1	7W2327	428D con motor/CATERPILLAR 3054T		
			ACEITE, 7 17/32 IN	GP-31	7W2326	ACEITE	GP-31	7W2326
			COMBUSTIBLE, SEPARADOR DE AGUA	GPP-421	131-1812	COMBUSTIBLE, SEPARADOR DE AGUA	GPP-421	131-1812
			COMBUSTIBLE	GPP-419	159-6102	COMBUSTIBLE	GPP-419	159-6102
			AIRE, RADIAL PRIMARIO	GA-853R	110-6326	AIRE, RADIAL PRIMARIO	GA-853R	110-6326
			252B, 262B con motor/CATERPILLAR 3044 (3.3L)			252B, 262B con motor/CATERPILLAR 3044 (3.3L)		
ACEITE	GP-36	1R0734	ACEITE	GP-36	1R0734	ACEITE	GP-36	1R0734
HIDRAULICO	GP-761H	1G8878	HIDRAULICO	GP-761H	1G8878	HIDRAULICO	GP-761H	1G8878
AIRE, RADIAL PRIMARIO	GA-853R	110-6326	AIRE, RADIAL PRIMARIO	GA-853R	110-6326	AIRE, RADIAL PRIMARIO	GA-853R	110-6326
247, 277, 257, 267 con motor/CATERPILLAR 3034			420D RETROEXCAVADORA con motor/CATERPILLAR 3054			ACEITE (5 13/32 IN)	GP-1	7W2327
ACEITE	GP-1	7W2327	ACEITE (5 13/32 IN)	GP-1	7W2327	ACEITE (7 17/32 IN)	GP-31	7W2326
COMBUSTIBLE, SEPARADOR DE AGUA	GPP-421	131-1812	ACEITE (7 17/32 IN)	GP-31	7W2326			
HIDRAULICO	GP-761H	1G8878						
COMBUSTIBLE, PRIMARIO	GPP-419	159-6102						

SERVICIO PESADO

MARCA-MODELO-MOTOR MAKE-MODEL-ENGINE	GONHER GONHER	OEM OEM	MARCA-MODELO-MOTOR MAKE-MODEL-ENGINE	GONHER GONHER	OEM OEM	MARCA-MODELO-MOTOR MAKE-MODEL-ENGINE	GONHER GONHER	OEM OEM
CATERPILLAR (continuación)			CATERPILLAR (continuación)			CATERPILLAR (continuación)		
CARGADORAS			CARGADORAS			CARGADORAS		
430D con motor/CATERPILLAR 3054			446 RETROEXCAVADORA con motor/CATERPILLAR 3114			COMBUSTIBLE	GPP-419	159-6102
ACEITE	GP-31	7W2326	COMBUSTIBLE	GP-110	1R0750	906, 908 con motor/CATERPILLAR 3044C		
COMBUSTIBLE, SEPARADOR DE AGUA	GPP-421	131-1812	ACEITE, TREN DE PODER	GP-761H	9T5916	ACEITE	GP-36	1R0734
COMBUSTIBLE	GPP-419	159-6102	AIRE, PRIMARIO	GA-1008	7W3920	ACEITE, TREN DE PODER	GP-761H	1G8878
AIRE, RADIAL PRIMARIO	GA-853R	110-6326				AIRE, RADIAL PRIMARIO	GA-853R	110-6326
432D RETROEXCAVADORA con motor/CATERPILLAR 3054T			446B RETROEXCAVADORA con motor/CATERPILLAR			908 con motor/CATERPILLAR 3054		
ACEITE	GP-31	7W2326	COMBUSTIBLE, SEPARADOR DE AGUA	GPP-424	117-4089	ACEITE	GP-31	7W2326
COMBUSTIBLE, SEPARADOR DE AGUA	GPP-421	131-1812	COMBUSTIBLE	GP-110	1R0750	COMBUSTIBLE, SEPARADOR DE AGUA	GPP-425	138-3100
COMBUSTIBLE	GPP-419	159-6102	TRANSMISION	GP-761H	1G8878	HIDRAULICO	GP-761H	1G8878
433C RETROEXCAVADORA con motor/A DIESEL			AIRE, PRIMARIO	GA-1008	7W3920	COMBUSTIBLE	GPP-419	159-6102
ACEITE	GP-31	7W2326				AIRE, RADIAL PRIMARIO	GA-853R	110-6326
COMBUSTIBLE, SEPARADOR DE AGUA	GPP-425	100-63-74	446B RETROEXCAVADORA con motor/PERKINS			910 con motor/CATERPILLAR 3024		
HIDRAULICO	GP-761H	1G8878	ACEITE	GP-31	7W2326	ACEITE, TANQUE HIDRAULICO	G-152	9M9740
COMBUSTIBLE	GPP-419	100-5593	539 con motor/CATERPILLAR 3126			ACEITE	GP-36	9L9200
436 RETROEXCAVADORA, 436 SERIES II RETROEXCAVADORA con motor/PERKINS 4.236			ACEITE	GP-51	1R0739	COMBUSTIBLE	GP-110	1P2299
ACEITE	GP-1	7W2327	COMBUSTIBLE, SECUNDARIO (5 13/32 IN)	GP-62	1R0751	ACEITE	GP-9586	1R0713
COMBUSTIBLE	G-296	67-6987	COMBUSTIBLE, SECUNDARIO (7 13/32 IN)	GP-1109	1R0751	910 con motor/CATERPILLAR 3114		
COMBUSTIBLE	G-296-B	67-6987	572 con motor/CATERPILLAR 3126			HIDRAULICO	GP-761H	1G8878
436B RETROEXCAVADORA con motor/CATERPILLAR 3054			ACEITE	GP-51	1R0739	910E con motor/CATERPILLAR 3114		
ACEITE	GP-31	7W2326	574 con motor/CATERPILLAR 3126			COMBUSTIBLE	GP-110	1R0750
COMBUSTIBLE, SEPARADOR DE AGUA	GPP-421	131-1812	ACEITE	GP-51	1R0739	910F con motor/CATERPILLAR 3114		
COMBUSTIBLE	GPP-419	100-5593	COMBUSTIBLE, 5 13/32 IN	GP-62	1R0751	COMBUSTIBLE, 5 13/32 IN	GP-62	1R0751
436C, 438C con motor/CATERPILLAR 3054			COMBUSTIBLE, 7 13/32 IN	GP-1109	1R0751	COMBUSTIBLE, 7 13/32 IN	GP-1109	1R0751
ACEITE	GP-31	7W2326	COMBUSTIBLE, SEPARADOR DE AGUA (S/N 1FM1-260)	GPP-424	117-4089	COMBUSTIBLE, 7 1/8 IN	GP-110	1R0750
COMBUSTIBLE, SEPARADOR DE AGUA	GPP-421	131-1812	ACEITE, RETORNO HIDRAULICO	GP-166	93-7521	TRANSMISION (SELLADO)	GP-761H	9T5916
COMBUSTIBLE	GPP-419	159-6102	ACEITE, TREN DE PODER	GP-761H	1G8878	AIRE, SECUNDARIO	GA-361	616582
AIRE, RADIAL PRIMARIO	GA-853R	110-6326	6 con motor/A DIESEL			910G con motor/CATERPILLAR 3064		
438 RETROEXCAVADORA con motor/PERKINS 4.236			ACEITE	G-191	9F6700	HIDRAULICO (REQUIERE 2)	GP-761H	1G8878
ACEITE	GP-1	7W2327	816 SOBRE RUEDAS con motor/A DIESEL			914 con motor/CATERPILLAR 3054T		
COMBUSTIBLE	G-296	67-6987	ACEITE	G-152	9M9740	ACEITE	GP-31	7W2326
COMBUSTIBLE	G-296-B	67-6987	ACEITE	GP-51	2P4004	COMBUSTIBLE	GPP-421	131-1812
438 SERIES II RETROEXCAVADORA con motor/PERKINS 4.236			COMBUSTIBLE	GP-56	4N5823	HIDRAULICO	GP-761H	1G8878
ACEITE	GP-1	7W2327	AIRE	GA-9334	7W5317	COMBUSTIBLE	GPP-419	159-6102
COMBUSTIBLE	G-296	67-6987	834 SOBRE RUEDAS con motor/A DIESEL			AIRE, RADIAL PRIMARIO	GA-853R	110-6326
COMBUSTIBLE, SECUNDARIO	G-296-B	67-6987	ACEITE	G-153	7J0670	914G con motor/CATERPILLAR 3054T		
438B RETROEXCAVADORA con motor/CATERPILLAR 3054			ACEITE, CUMPLE CON MEDIDAS ORIGINALES	GP-691	1R0716	ACEITE	GP-31	7W2326
ACEITE	GP-31	7W2326	ACEITE, SEGUNDA OPCION	GP-52	1R0716	COMBUSTIBLE, SEPARADOR DE AGUA	GPP-421	131-1812
COMBUSTIBLE, SEPARADOR DE AGUA	GPP-421	131-1812	AIRE	GA-483	7W5313	COMBUSTIBLE, SEPARADOR DE AGUA	GPP-425	163-4465
COMBUSTIBLE	GPP-419	100-5593	902 con motor/CATERPILLAR 3024			TRANSMISION (REQUIERE 2)	GP-761H	1G8878
438C RETROEXCAVADORA con motor/PERKINS			ACEITE	GP-36	1R0734	COMBUSTIBLE	GPP-419	159-6102
ACEITE	GP-31	7W2326	ACEITE	GP-81	150-4140	AIRE, RADIAL PRIMARIO	GA-853R	110-6326
COMBUSTIBLE, SEPARADOR DE AGUA	GPP-421	131-1812	HIDRAULICO (SELLADO)	GP-761H	1G8878	916, 926 con motor/CATERPILLAR 3204		
COMBUSTIBLE	GPP-419	159-6102	COMBUSTIBLE, SEPARADOR DE AGUA	GPP-420	156-1200	COMBUSTIBLE	GP-110	1P2299
438D RETROEXCAVADORA, 442D RETROEXCAVADORA con motor/CATERPILLAR 3054T			904 con motor/CATERPILLAR 3054			918F con motor/CATERPILLAR 3114		
ACEITE	GP-31	7W2326	ACEITE	GP-31	7W2326	COMBUSTIBLE, 5 13/32 IN	GP-62	1R0751
COMBUSTIBLE, SEPARADOR DE AGUA	GPP-421	131-1812	HIDRAULICO	GP-761H	1G8878	COMBUSTIBLE, 7 13/32 IN	GP-1109	1R0751
COMBUSTIBLE	GPP-419	159-6102	COMBUSTIBLE	GPP-419	159-6102	COMBUSTIBLE, 7 1/8 IN	GP-110	1R0750
446 RETROEXCAVADORA con motor/CATERPILLAR 3034			906 con motor/CATERPILLAR 3034			TRANSMISION (SELLADO)	GP-761H	9T5916
ACEITE	GP-31	7W2326	ACEITE	GP-36	1R0734	AIRE, PRIMARIO	GA-499R	612499
COMBUSTIBLE, SEPARADOR DE AGUA	GPP-421	131-1812	COMBUSTIBLE, SEPARADOR DE AGUA	GPP-425	138-3100	920 con motor/CATERPILLAR 3304		
COMBUSTIBLE	GPP-419	159-6102	HIDRAULICO	GP-761H	1G8878	ACEITE, CARTUCHO	G-191	550484

MARCA-MODELO-MOTOR MAKE-MODEL-ENGINE	GONHER GONHER	OEM OEM	MARCA-MODELO-MOTOR MAKE-MODEL-ENGINE	GONHER GONHER	OEM OEM	MARCA-MODELO-MOTOR MAKE-MODEL-ENGINE	GONHER GONHER	OEM OEM
CATERPILLAR (continuación)			CATERPILLAR (continuación)			CATERPILLAR (continuación)		
CARGADORAS			CARGADORAS			CARGADORAS		
DIRECCION	G-152	9M9740	COMBUSTIBLE, SEPARADOR DE AGUA	GPP-421	131-1812	931C, 935C con motor/CATERPILLAR 3204		
TRANSMISION	G-152	9M9740	ACEITE, TREN DE PODER	GP-761H	1G8878	ACEITE, TANQUE HIDRAULICO	G-152	9M9740
ACEITE, TANQUE HIDRAULICO	G-222	4J6064	AIRE, PRIMARIO	GA-697R	152-7217	COMBUSTIBLE	GP-110	1R0740
GASOLINA, SEPARADOR DE AGUA	G-293	8N9803				ACEITE	GP-9586	1R0713
ACEITE, SELLADO	GP-51	2P4004	924GZ con motor/CATERPILLAR 3056					
COMBUSTIBLE	GP-110	1P2299	ACEITE, REQUIERE 2 PIEZAS	GP-1	7W2327	933, 939 con motor/CATERPILLAR 3046		
AIRE, SECUNDARIO	GA-1285	2S1285	COMBUSTIBLE, SEPARADOR DE AGUA	GPP-425	163-4465	ACEITE, TANQUE HIDRAULICO	G-152	9M9740
AIRE, PRIMARIO	GA-8047	4M8047	TRANSMISION	GP-761H	1G8878	933C, 933C LGP con motor/CATERPILLAR 3046		
			AIRE, PRIMARIO	GA-697R	152-7217	ACEITE	GP-36	1R0734
922 SOBRE RUEDAS con motor/A DIESEL								
ACEITE	G-191	1R0659	924GZ, 928G, 930G con motor/CATERPILLAR 3056E			933F, 933G con motor/A DIESEL		
ACEITE	G-222	1R0741	ACEITE	GP-51	1R0739	ACEITE	G-191	550484
COMBUSTIBLE	GP-110	1R0750	COMBUSTIBLE, SEPARADOR DE AGUA	GPP-421	131-1812	COMBUSTIBLE	G-1166	9H4729
AIRE	GA-1284	2S1284	ACEITE, TREN DE PODER	GP-761H	1G8878	HIDRAULICO	G-222	2J1560
AIRE	GA-1285	2S1285	AIRE, PRIMARIO	GA-697R	152-7217	AIRE, PRIMARIO	GA-1008	4M9378
AIRE	GA-8047	4M8047				AIRE, SECUNDARIO	GA-1284	2S1284
922A con motor/A DIESEL (S/N 63A)			926E, 926F con motor/CATERPILLAR 3204			935B con motor/CATERPILLAR 3204		
TRANSMISION	G-191	7M3800	COMBUSTIBLE	GP-110	1P2299	ACEITE, TANQUE HIDRAULICO	G-152	9M9740
HIDRAULICO	G-222	4J0806						
AIRE, PRIMARIO	GA-1008	4M9378	928F con motor/CATERPILLAR 3116			936 con motor/CATERPILLAR 3304		
AIRE, SECUNDARIO	GA-1284	2S1284	ACEITE	GP-51	1R0739	ACEITE	GP-51	1R0739
GASOLINA	GG-20	3K5498	COMBUSTIBLE, 5 13/32 IN	GP-62	1R0751	COMBUSTIBLE	GP-110	1R0740
			COMBUSTIBLE, 7 13/32 IN	GP-1109	1R0751	AIRE, PRIMARIO	GA-9334	7W5317
			COMBUSTIBLE, SEPARADOR DE AGUA	GPP-424	117-4089			
922A, 922B con motor/A DIESEL (S/N 59A)			COMBUSTIBLE, 7 1/8 IN	GP-110	1R0750	936E con motor/CATERPILLAR 3304		
ACEITE	G-191	550484	TRANSMISION	GP-761H	9T5916	ACEITE	GP-51	1R0739
TRANSMISION	G-191	7M3800	AIRE, PRIMARIO	GA-499R	6I2499	COMBUSTIBLE	GP-110	1R0740
COMBUSTIBLE	G-1166	9H4729				AIRE, PRIMARIO	GA-9334	7W5317
HIDRAULICO	G-222	2J1560	928G con motor/CATERPILLAR 3116					
AIRE, PRIMARIO	GA-1008	4M9378	ACEITE	GP-51	1R0739	936F con motor/CATERPILLAR 3304		
AIRE, SECUNDARIO	GA-1284	2S1284	COMBUSTIBLE, 5 13/32 IN	GP-62	1R0751	ACEITE	GP-51	1R0739
			COMBUSTIBLE, 7 13/32 IN	GP-1109	1R0751	COMBUSTIBLE	GP-110	1R0740
			COMBUSTIBLE, SEPARADOR DE AGUA	GPP-424	117-4089	AIRE, PRIMARIO ESTANDAR	GA-9334	7W5317
922B con motores/A DIESEL (S/N 74J), A DIESEL (S/N 88J)			TRANSMISION	GP-761H	1G8878			
HIDRAULICO	G-222	1R0741	AIRE, PRIMARIO	GA-499R	6I2499	938F con motor/CATERPILLAR 3116		
COMBUSTIBLE	GP-110	6L7440				ACEITE	GP-51	1R0739
AIRE, SECUNDARIO	GA-1285	2S1285	930 con motor/CATERPILLAR 3304			COMBUSTIBLE, 5 13/32 IN	GP-62	1R0751
AIRE, PRIMARIO	GA-8047	4M8047	ACEITE, CARTUCHO	G-191	550484	COMBUSTIBLE, 7 13/32 IN	GP-1109	1R0751
			ACEITE, DRENADO HIDRAULICO	G-152	9M9740	COMBUSTIBLE, SEPARADOR DE AGUA	GPP-424	117-4089
			TRANSMISION	G-152	9M9740	TRANSMISION	GP-761H	1G8878
			ACEITE, TANQUE HIDRAULICO	G-222	4J6064			
922B con motores/A DIESEL (S/N 94A), A DIESEL (S/N 97A)			GASOLINA, SEPARADOR DE AGUA	G-293	8N9803	938G con motor/CATERPILLAR 3126		
ACEITE, CARTUCHO	G-191	7M3800	ACEITE, SELLADO	GP-51	1R0739	ACEITE	GP-51	1R0739
COMBUSTIBLE	G-1166	9H4729	COMBUSTIBLE	GP-110	1P2299	COMBUSTIBLE, 5 13/32 IN	GP-62	1R0751
HIDRAULICO	G-222	4J6064	AIRE, SECUNDARIO	GA-1285	2S1285	COMBUSTIBLE, 7 13/32 IN	GP-1109	1R0751
AIRE, PRIMARIO	GA-1008	4M9378	AIRE, PRIMARIO	GA-8047	4M8047	COMBUSTIBLE, SEPARADOR DE AGUA	GPP-424	117-4089
AIRE, SECUNDARIO	GA-1284	2S1284				TRANSMISION	GP-761H	1G8878
			930R, 930T con motor/CATERPILLAR 3304					
924F con motor/CATERPILLAR 3114			ACEITE, TANQUE HIDRAULICO	G-222	4J6064	939C con motor/CATERPILLAR 3046		
ACEITE, FLUJO TOTAL (FULL FLOW)	GP-51	1R0739	ACEITE	GP-51	1R0658	ACEITE	GP-36	1R0734
COMBUSTIBLE, 5 13/32 IN	GP-62	1R0751	AIRE, SECUNDARIO	GA-1285	2S1285			
COMBUSTIBLE, 7 13/32 IN	GP-1109	1R0751	AIRE, PRIMARIO	GA-8047	4M8047	941 con motor/A DIESEL (EXCEPTO S/N 75H)		
ACEITE, DERIVACION (BY PASS)	GP-57	1W8845				ACEITE, CARTUCHO	G-191	550484
COMBUSTIBLE, SEPARADOR DE AGUA	GPP-424	117-4089				CLUTCH/ DIRECCION	G-191	550484
TRANSMISION	GP-761H	9T5916				TRANSMISION	G-152	9M9740
AIRE, PRIMARIO	GA-499R	6I2499				GASOLINA, SEPARADOR DE AGUA	G-293	6N7617
						ACEITE, SELLADO	GP-51	2P4004
924G con motor/CATERPILLAR 3056						COMBUSTIBLE	GP-110	1R0740
ACEITE, REQUIERE 2 PIEZAS	GP-1	7W2327				AIRE, SECUNDARIO	GA-1285	2S1285
COMBUSTIBLE, SEPARADOR DE AGUA	GPP-425	163-4465				AIRE, PRIMARIO	GA-8047	4M8047
TRANSMISION	GP-761H	1G8878						
AIRE, PRIMARIO	GA-697R	152-7217						
924G con motor/CATERPILLAR 3056E			931 con motor/CATERPILLAR 3204					
ACEITE	GP-51	1R0739	HIDRAULICO	G-152	9M9740			
			931B con motor/CATERPILLAR 3204					
			ACEITE, TANQUE HIDRAULICO	G-152	9M9740			
			ACEITE	GP-36	9L9200			
			ACEITE	GP-9586	1R0713			

MARCA-MODELO-MOTOR MAKE-MODEL-ENGINE	GONHER GONHER	OEM OEM	MARCA-MODELO-MOTOR MAKE-MODEL-ENGINE	GONHER GONHER	OEM OEM	MARCA-MODELO-MOTOR MAKE-MODEL-ENGINE	GONHER GONHER	OEM OEM
CATERPILLAR (continuación)			CATERPILLAR (continuación)			CATERPILLAR (continuación)		
CARGADORAS			CARGADORAS			CARGADORAS		
941 con motor/A DIESEL (S/N 75H)			AIRE, PRIMARIO	GA-8047	4M8047	GASOLINA, SEPARADOR DE AGUA	G-293	6N7617
COMBUSTIBLE	GP-110	6L7440	950A SOBRE RUEDAS con motor/A DIESEL			ACEITE, SELLADO	GP-51	2P4004
AIRE, SECUNDARIO	GA-1285	2S1285	ACEITE	G-191	1R0659	COMBUSTIBLE	GP-110	1P2299
AIRE, PRIMARIO	GA-8047	4M8047	ACEITE	G-152	1R0719	AIRE, PRIMARIO (S/N 78J1-78J616, 92A1-1152)	GA-1008	4M9378
941B con motor/A DIESEL (EXCEPTO S/N 75H)			ACEITE	G-222	1R0741	AIRE, SECUNDARIO (S/N 78J1-78J616, 92A1-1152)	GA-1284	2S1284
ACEITE, CARTUCHO	G-191	5S0484	ACEITE	GP-51	1R0739	AIRE, SECUNDARIO	GA-1285	2S1285
CLUTCH/ DIRECCION	G-191	5S0484	AIRE	GA-1285	2S1285	AIRE, PRIMARIO	GA-8047	4M8047
TRANSMISION	G-152	9M9740	AIRE	GA-8047	7W5389	953 con motor/CATERPILLAR 3204		
GASOLINA, SEPARADOR DE AGUA	G-293	6N7617	950B, 950E con motor/CATERPILLAR 3304			TRANSMISION	G-222	4J6064
ACEITE, SELLADO	GP-51	2P4004	ACEITE	GP-51	1R0739	COMBUSTIBLE	GP-110	1P2299
COMBUSTIBLE	GP-110	1R0740	COMBUSTIBLE	GP-110	1R0750	AIRE, PRIMARIO	GA-9334	8N5317
AIRE, SECUNDARIO	GA-1285	2S1285	AIRE, PRIMARIO	GA-9334	8N5317	953B con motor/CATERPILLAR 3116		
AIRE, PRIMARIO	GA-8047	4M8047	950F SERIES II con motor/CATERPILLAR 3116			ACEITE	GP-51	1R0739
943 con motor/CATERPILLAR 3204			ACEITE	GP-51	1R0739	COMBUSTIBLE, SELLADO	GP-110	1R0750
TRANSMISION	G-222	4J6064	COMBUSTIBLE, 5 13/32 IN	GP-62	1R0751	AIRE, PRIMARIO	GA-499R	6I2499
COMBUSTIBLE	GP-110	1P2299	COMBUSTIBLE, 7 13/32 IN	GP-1109	1R0751	953C con motor/CATERPILLAR 3116		
AIRE, PRIMARIO	GA-8047	8N5389	COMBUSTIBLE, SEPARADOR DE AGUA	GPP-424	117-4089	TRANSMISION	GP-34	4T6788
944 con motor/A DIESEL (EXCEPTO S/N 58A)			COMBUSTIBLE, 7 1/8 IN	GP-110	1R0750	ACEITE	GP-51	1R0739
ACEITE	G-191	5S0484	950F SOBRE RUEDAS con motor/CATERPILLAR 3116			COMBUSTIBLE, 5 13/32 IN	GP-62	1R0751
TRANSMISION	G-191	7M3800	ACEITE	GP-51	1R0739	COMBUSTIBLE, 7 13/32 IN	GP-1109	1R0751
COMBUSTIBLE, CARTUCHO (S/N 70A1 EN ADELANTE)	G-1166	9H4729	COMBUSTIBLE, SELLADO	GP-110	1R0740	COMBUSTIBLE, SEPARADOR DE AGUA	GPP-424	117-4089
HIDRAULICO	G-222	4J0806	AIRE, PRIMARIO	GA-9334	7W5317	AIRE, PRIMARIO RADIAL	GA-499R	6I2499
COMBUSTIBLE, SELLADO	GP-110	6L7440	950G con motor/CATERPILLAR 3126B			955 con motor/A DIESEL		
AIRE, SECUNDARIO	GA-1285	2S1285	ACEITE	GP-51	1R0739	ACEITE	G-191	9F6700
AIRE, PRIMARIO	GA-8047	4M8047	950G SOBRE RUEDAS con motor/CATERPILLAR 3126			ACEITE, TREN DE PODER	G-238	5H6886
944 con motor/A DIESEL (S/N 58A)			ACEITE	GP-51	1R0739	ACEITE, TREN DE PODER	G-222	2J1560
TRANSMISION	G-191	9F6700	COMBUSTIBLE, PRIMARIO (5 13/32 IN)	GP-62	1R0751	955C, 955E con motor/A DIESEL		
HIDRAULICO	G-222	4J6064	COMBUSTIBLE, PRIMARIO (7 13/32 IN)	GP-1109	1R0751	ACEITE	G-191	9F6700
AIRE, SECUNDARIO	GA-1285	2S1285	HIDRAULICO	GP-761H	1G8878	ACEITE, TREN DE PODER	G-238	5H6886
AIRE, PRIMARIO	GA-8047	4M8047	TRANSMISION	GP-761H	1G8878	ACEITE, TREN DE PODER	G-222	2J1560
GASOLINA	GG-20	3K5498	AIRE, AUXILIAR	GA-373	156-9328	955F con motor/A DIESEL		
944A con motor/A DIESEL (EXCEPTO S/N 58A)			951 con motor/A DIESEL			ACEITE, CARTUCHO	G-191	1R0659
ACEITE	G-191	5S0484	ACEITE, CARTUCHO	G-191	5S0484	COMBUSTIBLE	G-1166	9H4729
TRANSMISION	G-191	7M3800	CLUTCH/ DIRECCION	G-191	5S0484	HIDRAULICO	G-222	1R0741
COMBUSTIBLE, CARTUCHO (S/N 70A1 EN ADELANTE)	G-1166	9H4729	COMBUSTIBLE, S/N 89A, 92A	G-1166	9H4729	AIRE, PRIMARIO	GA-1008	4M9378
HIDRAULICO	G-222	4J0806	TRANSMISION (S/N 15F1 EN ADELANTE)	G-152	9M9740	AIRE, SECUNDARIO	GA-1284	2S1284
COMBUSTIBLE, SELLADO	GP-110	6L7440	HIDRAULICO (EN ADELANTE S/N 63K1, 89A1, 92A1)	G-222	4J6064	AIRE, SECUNDARIO	GA-1285	2S1285
AIRE, SECUNDARIO	GA-1285	2S1285	GASOLINA, SEPARADOR DE AGUA	G-293	6N7617	AIRE, PRIMARIO	GA-8047	7W5389
AIRE, PRIMARIO	GA-8047	4M8047	ACEITE, SELLADO	GP-51	2P4004	955H con motor/A DIESEL		
950 (EXCEPTO S/N 15J, 58H, 90A, 99A) con motor/CATERPILLAR 3304			COMBUSTIBLE	GP-110	1P2299	ACEITE, CARTUCHO	G-191	5S0484
ACEITE, CARTUCHO	G-191	5S0484	AIRE, PRIMARIO (S/N 78J1-78J616, 92A1-1152)	GA-1008	4M9378	CLUTCH/ DIRECCION	G-191	7M3800
TRANSMISION	G-152	9M9740	AIRE, SECUNDARIO (S/N 78J1-78J616, 92A1-1152)	GA-1284	2S1284	TRANSMISION	G-191	7M3800
ACEITE, TANQUE HIDRAULICO	G-222	4J6064	AIRE, SECUNDARIO	GA-1285	2S1285	COMBUSTIBLE	G-1166	9H4729
GASOLINA, SEPARADOR DE AGUA	G-293	8N9803	AIRE, PRIMARIO	GA-8047	4M8047	HIDRAULICO	G-222	4J0806
ACEITE, SELLADO	GP-51	2P4004	951B, 951C con motor/A DIESEL			TRANSMISION	G-222	4J6064
COMBUSTIBLE	GP-110	1R0740	ACEITE, CARTUCHO	G-191	5S0484	AIRE, SECUNDARIO	GA-1285	4M8048
AIRE, SECUNDARIO	GA-1285	2S1285	CLUTCH/ DIRECCION	G-191	5S0484	AIRE, PRIMARIO	GA-8047	4M8047
AIRE, PRIMARIO	GA-8047	4M8047	COMBUSTIBLE, S/N 89A, 92A	G-1166	9H4729	955K con motor/CATERPILLAR 3304		
950 (S/N 15J, 58H, 90A, 99A) con motor/A DIESEL			TRANSMISION (S/N 15F1 EN ADELANTE)	G-152	9M9740	ACEITE, CARTUCHO	G-191	5S0484
ACEITE	G-191	5S0484	HIDRAULICO (EN ADELANTE S/N 63K1, 89A1, 92A1)	G-222	4J6064	CLUTCH/ DIRECCION	G-191	5S0484
TRANSMISION	G-191	5S0484	951B, 951C con motor/A DIESEL			COMBUSTIBLE, CARTUCHO	G-1166	9H4729
COMBUSTIBLE	G-1166	9H4729	ACEITE, CARTUCHO	G-191	5S0484	TRANSMISION	G-152	9M9740
HIDRAULICO	G-222	4J6064	CLUTCH/ DIRECCION	G-191	5S0484	ACEITE, TANQUE HIDRAULICO	G-222	4J6064
AIRE, SECUNDARIO	GA-1285	2S1285	COMBUSTIBLE, S/N 89A, 92A	G-1166	9H4729	GASOLINA, SEPARADOR DE AGUA	G-293	6N7617

MARCA-MODELO-MOTOR MAKE-MODEL-ENGINE	GONHER GONHER	OEM OEM	MARCA-MODELO-MOTOR MAKE-MODEL-ENGINE	GONHER GONHER	OEM OEM	MARCA-MODELO-MOTOR MAKE-MODEL-ENGINE	GONHER GONHER	OEM OEM
CATERPILLAR (continuación)			CATERPILLAR (continuación)			CATERPILLAR (continuación)		
CARGADORAS			CARGADORAS			CARGADORAS		
ACEITE, SELLADO	GP-51	2P4004	966 con motor/A DIESEL			966R con motor/CATERPILLAR 3306		
COMBUSTIBLE, SELLADO	GP-110	1P2299	ACEITE, CARTUCHO	G-191	5S0484	TRANSMISION	G-152	9M9740
AIRE, SECUNDARIO	GA-1286	2S1286	TRANSMISION	G-191	5S0484	ACEITE, TANQUE HIDRAULICO	G-222	4J6064
AIRE, PRIMARIO	GA-9334	4M9334	COMBUSTIBLE, CARTUCHO	G-1166	9H4729	GASOLINA, SEPARADOR DE AGUA	G-293	8N9803
			HIDRAULICO	G-222	2J1560	ACEITE	GP-51	2P4004
955L con motor/CATERPILLAR 3304			AIRE, SECUNDARIO (S/N 33A1-33A2110)	GA-1286	2S1286	COMBUSTIBLE	GP-110	1P2299
ACEITE, CARTUCHO	G-191	5S0484	AIRE, SECUNDARIO (EXCEPTO S/N 33A)	GA-1287	2S1287	AIRE, SECUNDARIO	GA-1286	2S1286
CLUTCH/ DIRECCION	G-191	5S0484	AIRE, PRIMARIO (EXCEPTO S/N 33A)	GA-9045	7M9045	AIRE, PRIMARIO	GA-9334	4M9334
CLUTCH/ DIRECCION	G-152	9M9740						
TRANSMISION	G-152	9J5461				970F con motor/CATERPILLAR 3306		
ACEITE, TANQUE HIDRAULICO (S/N 64J)	G-222	4J6064	AIRE, PRIMARIO (S/N 33A1-33A2110)	GA-9334	4M9334	TRANSMISION	G-152	1R0719
GASOLINA, SEPARADOR DE AGUA	G-293	8N9803				ACEITE	GP-51	1R0739
ACEITE, SELLADO	GP-51	2P4004	966A, 966B con motor/A DIESEL			COMBUSTIBLE	GP-110	1R0750
COMBUSTIBLE	GP-110	1P2299	ACEITE, CARTUCHO	G-191	5S0484			
AIRE, SECUNDARIO	GA-1286	2S1286	TRANSMISION	G-191	5S0484	972G con motor/CATERPILLAR 3306		
AIRE, PRIMARIO	GA-9334	4M9334	COMBUSTIBLE, CARTUCHO	G-1166	9H4729	TRANSMISION	G-152	1R0719
			HIDRAULICO	G-222	2J1560	ACEITE	GP-51	1R0739
			AIRE, SECUNDARIO (S/N 33A1-33A2110)	GA-1286	2S1286	COMBUSTIBLE	GP-110	1R0750
960F SOBRE RUEDAS con motor/CATERPILLAR 3116			AIRE, SECUNDARIO (EXCEPTO S/N 33A)	GA-1287	2S1287	HIDRAULICO	GP-761H	1G8878
ACEITE, FLUJO TOTAL (FULL FLOW)	GP-51	1R0739	AIRE, PRIMARIO (EXCEPTO S/N 33A)	GA-9045	7M9045			
COMBUSTIBLE, 5 13/32 IN	GP-62	1R0751	AIRE, PRIMARIO (S/N 33A1-33A2110)	GA-9334	4M9334	972G SERIES II con motor/CATERPILLAR 3196		
COMBUSTIBLE, 7 13/32 IN	GP-1109	1R0751				TRANSMISION	G-152	1R0719
ACEITE, DERIVACION (BY PASS)	GP-57	1W8845	966C con motor/CATERPILLAR 3306			ACEITE, CUMPLE CON MEDI-DAS ORIGINALES	GP-691	1R0716
COMBUSTIBLE, SEPARADOR DE AGUA	GPP-424	117-4089	ACEITE, CARTUCHO	G-191	5S0484	ACEITE, SEGUNDA OPCION	GP-52	1R0716
COMBUSTIBLE, 7 1/8 IN	GP-110	1R0750	TRANSMISION	G-152	9M9740	HIDRAULICO	GP-761H	1G8878
			ACEITE, TANQUE HIDRAULICO	G-222	4J6064			
962G con motor/CATERPILLAR 3126			GASOLINA, SEPARADOR DE AGUA	G-293	8N9803	973 con motor/CATERPILLAR 3306		
ACEITE, FLUJO TOTAL (FULL FLOW)	GP-51	1R0739	ACEITE, SELLADO	GP-51	2P4004	TRANSMISION	G-222	4J6064
COMBUSTIBLE, 5 13/32 IN	GP-62	1R0751	COMBUSTIBLE	GP-1108	4N5823	ACEITE	GP-51	1R0739
COMBUSTIBLE, 7 13/32 IN	GP-1109	1R0751	COMBUSTIBLE	GP-110	1R0740	COMBUSTIBLE	GP-110	1R0750
ACEITE, DERIVACION (BY PASS)	GP-57	1W8845	AIRE, SECUNDARIO	GA-1286	2S1286	AIRE, PRIMARIO ESTANDAR	GA-7716	1P7716
COMBUSTIBLE, SEPARADOR DE AGUA	GPP-424	117-4089	AIRE, SECUNDARIO	GA-1287	2S1287	AIRE, SECUNDARIO ESTANDAR	GA-7360	1P7360
HIDRAULICO	GP-761H	1G8878	AIRE, PRIMARIO	GA-9045	7M9045			
TRANSMISION	GP-761H	9T5916	AIRE, PRIMARIO	GA-9334	4M9334	973 LGP con motor/A DIESEL (S/N 86G1 EN ADELANTE)		
AIRE, AUXILIAR	GA-373	156-9328				TRANSMISION	G-222	1R0741
			966D, 966E con motor/CATERPILLAR 3306			ACEITE	GP-51	1R0739
963 con motor/A DIESEL			TRANSMISION	G-152	1R0719	COMBUSTIBLE	GP-110	1R0750
TRANSMISION	G-222	4J6064	ACEITE	GP-51	1R0658	AIRE, PRIMARIO	GA-7716	7W5495
ACEITE	GP-51	2P4004	COMBUSTIBLE	GP-110	1R0740	AIRE, SECUNDARIO	GA-7360	1P7360
COMBUSTIBLE, SELLADO	GP-110	1R0740	AIRE, SECUNDARIO	GA-1287	2S1287			
AIRE, PRIMARIO ESTANDAR	GA-7716	1P7716	AIRE, PRIMARIO	GA-9045	7M9045	973C con motor/CATERPILLAR 3306		
AIRE, SECUNDARIO ESTANDAR	GA-7360	1P7360	AIRE, PRIMARIO	GA-9334	4M9334	ACEITE	GP-51	1R0739
963 LGP con motor/A DIESEL			966F con motor/CATERPILLAR 3306			977 SOBRE RUEDAS con motor/A DIESEL (S/N 10A1 EN ADELANTE)		
TRANSMISION	G-222	4J6064	TRANSMISION	G-152	1R0719	AIRE, SECUNDARIO	GA-1285	2S1285
ACEITE	GP-51	2P4004	ACEITE	GP-51	1R0739			
COMBUSTIBLE, SELLADO	GP-110	1R0740	COMBUSTIBLE	GP-110	1R0740	977 SOBRE RUEDAS con motor/A DIESEL (S/N 10A827 EN ADELANTE)		
AIRE, PRIMARIO ESTANDAR	GA-7716	1P7716	AIRE, PRIMARIO ESTANDAR	GA-9334	7W5317	HIDRAULICO	G-238	5S0485
AIRE, SECUNDARIO ESTANDAR	GA-7360	1P7360						
			966F SERIES II con motor/CATERPILLAR 3306			977 SOBRE RUEDAS con motor/A DIESEL (S/N 11K1 EN ADELANTE)		
			TRANSMISION	G-152	1R0719	COMBUSTIBLE	GP-110	1R0740
963B con motor/CATERPILLAR 3116			ACEITE	GP-51	1R0739			
ACEITE	GP-51	1R0739	COMBUSTIBLE	GP-110	1R0750	977 SOBRE RUEDAS con motor/A DIESEL (S/N 11K4071 EN ADELANTE)		
COMBUSTIBLE, 5 13/32 IN	GP-62	1R0751	AIRE, PRIMARIO ESTANDAR	GA-9334	4M9334	ACEITE	GP-51	2P4004
COMBUSTIBLE, 7 13/32 IN	GP-1109	1R0751						
			966G con motor/CATERPILLAR 3306			977 SOBRE RUEDAS con motor/A DIESEL (S/N 14X1-14X806)		
963C con motor/CATERPILLAR 3116			TRANSMISION	G-152	1R0719	COMBUSTIBLE	GP-110	1R0750
TRANSMISION	GP-34	46788	ACEITE	GP-51	1R0739			
ACEITE	GP-51	1R0739	COMBUSTIBLE, SELLADO	GP-110	1R0750	977 SOBRE RUEDAS con motor/A DIESEL (S/N 46H1 EN ADELANTE)		
COMBUSTIBLE, 5 13/32 IN	GP-62	1R0751	HIDRAULICO	GP-761H	1G8878	ACEITE	G-191	1W7399
COMBUSTIBLE, 7 13/32 IN	GP-1109	1R0751				HIDRAULICO	G-222	4J6064
COMBUSTIBLE, SEPARADOR DE AGUA	GPP-424	117-4089				TRANSMISION	G-222	4J6064

SERVICIO PESADO

MARCA-MODELO-MOTOR MAKE-MODEL-ENGINE	GONHER GONHER	OEM OEM	MARCA-MODELO-MOTOR MAKE-MODEL-ENGINE	GONHER GONHER	OEM OEM	MARCA-MODELO-MOTOR MAKE-MODEL-ENGINE	GONHER GONHER	OEM OEM
CATERPILLAR (continuación)			CATERPILLAR (continuación)			CATERPILLAR (continuación)		
CARGADORAS			CARGADORAS			CARGADORAS		
AIRE, SECUNDARIO	GA-1287	2S1287	ACEITE, CUMPLE CON MEDIDAS ORIGINALES	GP-691	1R0716	988A con motor/A DIESEL (S/N 87A187-5627)		
AIRE, PRIMARIO	GA-9045	7M9045	ACEITE, SEGUNDA OPCION	GP-52	1R0716	COMBUSTIBLE, SEPARADOR DE AGUA	GPP-11	175-2949
977D con motor/A DIESEL			COMBUSTIBLE, SELLADO	GP-1108	1R0712	988A con motor/A DIESEL (S/N 87A1879 EN ADELANTE)		
ACEITE	G-191	9F6700	AGUA, PRE-CARGA	GP-1011Q	9N6123	COMBUSTIBLE	GP-110	1P2299
HIDRAULICO	G-222	4J6064	AGUA, MANTENIMIENTO	GP-2071W	9N3368	988A con motor/A DIESEL (S/N 87A1-87A9074)		
TRANSMISION (S/N 20A614 EN ADELANTE)	G-222	4J6064	AIRE, PRIMARIO	GA-7716	1P7716	AIRE, SECUNDARIO	GA-1287	2S1287
977E con motor/A DIESEL			AIRE, SECUNDARIO	GA-7360	1P7360	988A con motor/A DIESEL (S/N 87A9075 EN ADELANTE)		
ACEITE	G-191	1R0659	980F, 980F SERIES II con motor/CATERPILLAR 3406			AIRE, PRIMARIO	GA-483	8N5313
977H con motor/A DIESEL			TRANSMISION	G-152	1R0719	988B con motor/CATERPILLAR 3408		
ACEITE, CARTUCHO	G-191	5S0484	COMBUSTIBLE	GP-749	1R0749	HIDRAULICO PILOTO	G-152	9M9740
TRANSMISION	G-191	7M3800	ACEITE, CUMPLE CON MEDIDAS ORIGINALES	GP-691	1R0716	TRANSMISION	G-152	1R0719
COMBUSTIBLE	G-1166	9H4729	ACEITE, SEGUNDA OPCION	GP-52	1R0716	ACEITE, TANQUE HIDRAULICO	G-153	7J0670
HIDRAULICO	G-222	4J0806	COMBUSTIBLE	GP-1108	1R0712	COMBUSTIBLE	GP-749	1R0749
TRANSMISION	G-222	4J6064	AGUA, PRE-CARGA	GP-1011Q	9N6123	ACEITE, CUMPLE CON MEDIDAS ORIGINALES	GP-691	1R0716
977K con motor/CATERPILLAR 3306			AGUA, MANTENIMIENTO	GP-2071W	9N3368	ACEITE, SEGUNDA OPCION	GP-52	1R0716
ACEITE, CARTUCHO	G-191	5S0484	AIRE, PRIMARIO ESTANDAR	GA-7716	1P7716	AGUA	GP-1013Q	1W5518
COMBUSTIBLE, CARTUCHO	G-1166	9H4729	AIRE, SECUNDARIO ESTANDAR	GA-7360	1P7360	COMBUSTIBLE	GP-1108	4N5823
ACEITE, TANQUE HIDRAULICO	G-222	4J6064	980G con motores/CATERPILLAR 3406, CATERPILLAR 3406C			AGUA, MANTENIMIENTO	GP-1011Q	9N3718
TRANSMISION	G-222	4J6064	TRANSMISION	G-152	1R0719	AIRE, PRIMARIO ESTANDAR	GA-483	8N5313
COMBUSTIBLE, SELLADO	GP-110	1P2299	COMBUSTIBLE	GP-749	1R0749	AIRE, SECUNDARIO ESTANDAR	GA-482	1P8482
AIRE, SECUNDARIO	GA-1287	2S1287	ACEITE, CUMPLE CON MEDIDAS ORIGINALES	GP-691	1R0716	988F con motor/CATERPILLAR 3408		
AIRE, PRIMARIO	GA-9045	7M9045	ACEITE, SEGUNDA OPCION	GP-52	1R0716	TRANSMISION	G-152	1R0719
977L con motor/CATERPILLAR 3306			COMBUSTIBLE	GP-1108	1R0712	ACEITE, TANQUE HIDRAULICO	G-153	7J0670
ACEITE, CARTUCHO	G-191	5S0484	AGUA, PRE-CARGA	GP-1011Q	9N6123	COMBUSTIBLE, SELLADO	GP-749	1R0749
ACEITE, TANQUE HIDRAULICO (EXCEPTO S/N 11K, 48J)	G-222	4J6064	AGUA, MANTENIMIENTO	GP-2071W	9N3368	ACEITE, CUMPLE CON MEDIDAS ORIGINALES	GP-691	1R0716
TRANSMISION	G-222	4J6064	983 con motor/CATERPILLAR D343			ACEITE, SEGUNDA OPCION	GP-52	1R0716
GASOLINA, SEPARADOR DE AGUA	G-293	6N7617	ACEITE	G-238	5S0485	AGUA	GP-1011Q	9N3718
ACEITE, SELLADO	GP-51	2P4004	ACEITE, TANQUE HIDRAULICO	G-222	4J6064	ACEITE, DRENADO HIDRAULICO	GP-166	4T6915
COMBUSTIBLE	GP-1108	4N5823	TRANSMISION	G-222	4J6064	988F SERIES II con motor/CATERPILLAR 3408E		
COMBUSTIBLE	GP-110	1P2299	COMBUSTIBLE	GP-110	1P2299	TRANSMISION	G-152	1R0719
AIRE, SECUNDARIO	GA-1287	2S1287	AGUA	GP-1011Q	9N3367	COMBUSTIBLE	GP-749	1R0749
AIRE, PRIMARIO	GA-9045	7M9045	983B con motor/CATERPILLAR 3406			ACEITE, CUMPLE CON MEDIDAS ORIGINALES	GP-691	1R0716
980 con motor/A DIESEL			TRANSMISION	G-222	4J6064	ACEITE, SEGUNDA OPCION	GP-52	1R0716
ACEITE, CARTUCHO	G-191	5S0484	ACEITE, CUMPLE CON MEDIDAS ORIGINALES	GP-691	2P4005	AGUA	GP-1011Q	9N3718
COMBUSTIBLE	G-1166	4S5368	ACEITE, SEGUNDA OPCION	GP-52	2P4005	ACEITE, DRENADO HIDRAULICO	GP-166	4T6915
TRANSMISION	G-152	9M9740	COMBUSTIBLE	GP-1108	4N5823	ACEITE, TANQUE HIDRAULICO	GP-761H	1G8878
ACEITE, TANQUE HIDRAULICO	G-222	4J6064	AGUA	GP-1011Q	9N3367	988G SOBRE RUEDAS con motor/CATERPILLAR 3456		
AIRE, SECUNDARIO	GA-1286	2S1286	AIRE, PRIMARIO	GA-7716	8N5495	ACEITE, CUMPLE CON MEDIDAS ORIGINALES	GP-691	1R0716
AIRE, PRIMARIO	GA-9334	4M9334	AIRE, SECUNDARIO	GA-7360	1P7360	ACEITE, SEGUNDA OPCION	GP-52	1R0716
980B con motor/CATERPILLAR 3306			988 con motor/A DIESEL			COMBUSTIBLE	GP-110	1R0749
ACEITE, CARTUCHO	G-191	5S0484	ACEITE	G-238	5S0485	ACEITE, DRENADO HIDRAULICO	GP-761H	1G8878
TRANSMISION	G-152	9M9740	COMBUSTIBLE, CARTUCHO	G-1166	8M9641	988H SOBRE RUEDAS con motor/CATERPILLAR C18		
ACEITE, TANQUE HIDRAULICO	G-222	4J6064	DIRECCION	G-222	4J6064	DIESEL	GP-749	1R0762
GASOLINA, SEPARADOR DE AGUA	G-293	6N7617	ACEITE, TANQUE HIDRAULICO	G-222	4J6064	ACEITE	GP-52	1R0716
ACEITE, SELLADO	GP-51	1R0739	TRANSMISION	G-222	4J6064	ACEITE HIDRAULICO	GP-761H	1G8878
COMBUSTIBLE	GP-1108	4N5823	COMBUSTIBLE, SELLADO	GP-110	1P2299	AIRE RADIAL, PRIMARIO	GA-600R	106-3969
COMBUSTIBLE	GP-110	1P2299	AIRE, SECUNDARIO (DOBLE)	GA-1287	2S1287	AIRE DE CABINA	GA-240	107-0266
AIRE, SECUNDARIO (DOBLE)	GA-1286	2S1286	AIRE, PRIMARIO (DOBLE)	GA-9045	7M9045	990 con motor/CATERPILLAR 3412		
AIRE, PRIMARIO (DOBLE)	GA-9334	4M9334	AIRE, PRIMARIO (SIMPLE)	GA-483	1P8483	COMBUSTIBLE	GP-749	1R0749
AIRE, PRIMARIO (SIMPLE)	GA-7716	1P7716	AIRE, SECUNDARIO (SIMPLE)	GA-482	1P8482	ACEITE, CUMPLE CON MEDIDAS ORIGINALES	GP-691	1R0716
AIRE, SECUNDARIO (SIMPLE)	GA-7360	1P7360	988A con motor/A DIESEL (S/N 87A1309-1878)					
980C con motor/CATERPILLAR 3406			ACEITE	G-238	5S0485			
TRANSMISION	G-152	1R0719	DIRECCION	G-222	4J6064			
COMBUSTIBLE, SELLADO	GP-749	1R0749	HIDRAULICO	G-222	4J6064			
			TRANSMISION	G-222	4J6064			

MARCA-MODELO-MOTOR MAKE-MODEL-ENGINE	GONHER GONHER	OEM OEM	MARCA-MODELO-MOTOR MAKE-MODEL-ENGINE	GONHER GONHER	OEM OEM	MARCA-MODELO-MOTOR MAKE-MODEL-ENGINE	GONHER GONHER	OEM OEM
CATERPILLAR (continuación)			CATERPILLAR (continuación)			CATERPILLAR		
CARGADORAS			CARGADORAS			COMBINADAS		
ACEITE, SEGUNDA OPCION	GP-52	1R0716	992G con motor/CATERPILLAR 3508B			LEXION 460R, LEXION 465, LEXION 470, LEXION 450, LEXION 460 con motor/CATERPILLAR 3126B		
AGUA	GP-1011Q	9N3718	ACEITE, (REQUIERE 2 PIEZAS)	GP-52	2P4005	ACEITE	GP-51	1R0739
			HIDRAULICO	GP-761H	1G8878	COMBUSTIBLE, 5 13/32 IN	GP-62	1R0751
990 SERIES II con motor/CATERPILLAR 3412			AIRE RADIAL, PRIMARIO (REQUIERE 2 PIEZAS)	GA-712R	123-6855	COMBUSTIBLE, 7 13/32 IN	GP-1109	1R0751
COMBUSTIBLE	GP-749	1R0749						
ACEITE, CUMPLE CON MEDIDAS ORIGINALES	GP-691	1R0716	994 con motor/CATERPILLAR 3516			LEXION 470R, LEXION 475R con motor/CATERPILLAR C9		
ACEITE, SEGUNDA OPCION	GP-52	1R0716	PILOTO HIDRAULICO/ DIRECCION	G-152	1R0719	ACEITE, CUMPLE CON MEDIDAS ORIGINALES	GP-691	1R0716
AGUA	GP-1011Q	9N3718	ACEITE, CUMPLE CON MEDIDAS ORIGINALES	GP-691	2P4005			
			ACEITE, SEGUNDA OPCION	GP-52	2P4005	LEXION 480, LEXION 485 con motor/CATERPILLAR 3176		
992 con motor/CATERPILLAR D348			ACEITE, TREN DE PODER (SELLADO)	GP-761H	9T5916	ACEITE, CUMPLE CON MEDIDAS ORIGINALES	GP-691	1R0716
ACEITE	G-191	5S0484	AIRE, PRIMARIO ESTANDAR	GA-483	7W5313			
ACEITE, TANQUE HIDRAULICO (TRASERO)	G-222	4J6064				LEXION 480R, LEXION 485R con motor/CATERPILLAR C121		
TRANSMISION	G-222	4J6064	994D con motor/CATERPILLAR 3516B			ACEITE, CUMPLE CON MEDIDAS ORIGINALES	GP-691	1R0716
ACEITE, TANQUE HIDRAULICO (FRONTAL)	G-153	7J0670	HIDRAULICO (CARTUCHO)	G-152	1R0719			
AIRE, SECUNDARIO (S/N 25K1-1169)	GA-1287	2S1287	ACEITE, CUMPLE CON MEDIDAS ORIGINALES	GP-691	2P4005	LEXION 670 con motor/CUMMINS		
AIRE, PRIMARIO (S/N 25K1-1169)	GA-9045	7M9045	ACEITE, SEGUNDA OPCION	GP-52	2P4005	AIRE	GA-106	8T-8076
AIRE, PRIMARIO (S/N 25K1170 EN ADELANTE)	GA-7716	1P7716	ACEITE, BOMBA HIDRAULICA	GP-761H	1G8878			
AIRE, SECUNDARIO (S/N 25K1170 EN ADELANTE)	GA-7360	1P7360				LEXION 670 con motor/KOMATSU		
			994F con motor/A DIESEL			AIRE	GA-326	8T-8076
			HIDRAULICO	GP-761H	1G8878			
992B con motor/CATERPILLAR D348			G91 Q SOBRE RUEDAS con motor/A DIESEL					
ACEITE	G-191	5S0484	ACEITE	GP-9586	1R0713			
ACEITE, TANQUE HIDRAULICO (TRASERO)	G-222	4J6064						
TRANSMISION	G-222	4J6064	G910 con motor/CATERPILLAR 3204					
ACEITE, TANQUE HIDRAULICO (FRONTAL)	G-153	7J0670	ACEITE, TANQUE HIDRAULICO	G-152	9M9740			
AIRE, SECUNDARIO (S/N 25K1-1169)	GA-1287	2S1287	COMBUSTIBLE	GP-110	1P2299	GASOLINA, SEPARADOR DE AGUA	G-293	8N9803
AIRE, PRIMARIO (S/N 25K1-1169)	GA-9045	7M9045	ACEITE	GP-9586	1R0713	ACEITE, SELLADO	GP-51	2P4004
AIRE, PRIMARIO (S/N 25K1170 EN ADELANTE)	GA-7716	1P7716				COMBUSTIBLE	GP-110	1P2299
AIRE, SECUNDARIO (S/N 25K1170 EN ADELANTE)	GA-7360	1P7360	G916 con motor/CATERPILLAR 3204			AIRE, SECUNDARIO	GA-1286	2S1286
			COMBUSTIBLE	GP-110	1P2299	AIRE, SECUNDARIO	GA-1287	2S1287
			G926 con motor/CATERPILLAR 3204			AIRE, PRIMARIO 16 17/32 IN	GA-9045	7M9045
			ACEITE	GP-36	9L9200	AIRE, PRIMARIO 13 1/2 IN	GA-9334	4M9334
			COMBUSTIBLE	GP-110	1P2299			
			AIRE, PRIMARIO	GA-8047	8N5389			
						815 con motor/CATERPILLAR 3306		
992C con motor/CATERPILLAR 3412			G936 con motor/CATERPILLAR 3304			ACEITE, CARTUCHO	G-191	4W4840
ACEITE, LINEAS HIDRAULICAS	G-152	9M9740	ACEITE	GP-51	1R0739	TRANSMISION	G-152	1R0719
TRANSMISION	G-222	4J6064	COMBUSTIBLE	GP-110	1R0740	ACEITE, TANQUE HIDRAULICO	G-222	1R0741
DIRECCION	G-153	7J0670	AIRE, PRIMARIO	GA-9334	7W5317	GASOLINA, SEPARADOR DE AGUA	G-293	8N9803
COMBUSTIBLE	GP-749	1R0749				ACEITE, SELLADO	GP-51	2P4004
ACEITE, CUMPLE CON MEDIDAS ORIGINALES	GP-691	1R0716	LL229 DE TRONCOS con motor/A DIESEL			COMBUSTIBLE	GP-110	1P2299
ACEITE, SEGUNDA OPCION	GP-52	1R0716	COMBUSTIBLE, SEPARADOR DE AGUA	GS-2033	1R0725	AIRE, SECUNDARIO	GA-1286	2S1286
AGUA, PRE-CARGA	GP-1013Q	1W5518				AIRE, SECUNDARIO	GA-1287	2S1287
COMBUSTIBLE, S/N 41X	GP-56	4N5823	R1600G con motor/CATERPILLAR 3176C			AIRE, PRIMARIO 16 17/32 IN	GA-9045	7M9045
COMBUSTIBLE, SELLADO	GP-1108	4N5823	ACEITE, CUMPLE CON MEDIDAS ORIGINALES	GP-691	1R0716	AIRE, PRIMARIO 13 1/2 IN	GA-9334	4M9334
AGUA, MANTENIMIENTO	GP-1011Q	9N3718						
AIRE, PRIMARIO	GA-483	1P8483	R2900G con motor/CATERPILLAR 3406E			815B con motor/CATERPILLAR 3306		
AIRE, SECUNDARIO	GA-482	1P8482	TRANSMISION	G-152	1R0719	TRANSMISION	G-152	1R0719
			DIESEL	GP-749	1R0749	ACEITE	GP-51	2P4004
			ACEITE	GP-52	1R0716	COMBUSTIBLE	GP-110	1P2299
			AGUA, REFRIGERANTE	GP-1011Q	9N3718	AIRE, PRIMARIO	GA-9334	8N5317
			HIDRAULICO	GP-761H	1G8878			
			AIRE RADIAL, PRIMARIO	GA-600R	106-3969	815F con motor/CATERPILLAR 3306		
						TRANSMISION	G-152	1R0719
						ACEITE	GP-51	1R0739
						COMBUSTIBLE	GP-110	1R0750
						816 con motor/A DIESEL		
						TRANSMISION	G-152	9M9740
						SEPARADOR DE AGUA	G-293	6N7617

SERVICIO PESADO

MARCA-MODELO-MOTOR MAKE-MODEL-ENGINE	GONHER GONHER	OEM OEM	MARCA-MODELO-MOTOR MAKE-MODEL-ENGINE	GONHER GONHER	OEM OEM	MARCA-MODELO-MOTOR MAKE-MODEL-ENGINE	GONHER GONHER	OEM OEM
CATERPILLAR (continuación)			CATERPILLAR (continuación)			CATERPILLAR (continuación)		
COMPACTADORAS			COMPACTADORAS			COMPACTADORAS		
ACEITE	GP-51	2P4004	AIRE, SECUNDARIO SIMPLE	GA-482	1P8482	AIRE, PRIMARIO	GA-9045	7M9045
COMBUSTIBLE	GP-110	1P2299				834C con motor/A DIESEL		
AIRE, SECUNDARIO	GA-1286	2S1286	825C con motor/CATERPILLAR 3406			ACEITE	G-238	5S0485
AIRE, PRIMARIO	GA-9334	4M9334	TRANSMISION	G-152	9M9740	ACEITE, TANQUE HIDRAULICO	G-222	4J6064
			COMBUSTIBLE	GP-749	1R0749	TRANSMISION	G-222	4J6064
816B con motor/CATERPILLAR 3306			ACEITE, CUMPLE CON MEDI- DAS ORIGINALES	GP-691	1R0716	COMBUSTIBLE	GP-110	1P2299
TRANSMISION	G-152	1R0719	AGUA, PRE-CARGA	GP-1010Q	9N3367	AIRE, SECUNDARIO	GA-1287	2S1287
ACEITE	GP-51	1R0739	ACEITE, SEGUNDA OPCION	GP-52	1R0716	AIRE, PRIMARIO	GA-9045	7M9045
COMBUSTIBLE	GP-110	1R0750	COMBUSTIBLE	GP-1108	1R0712			
AIRE, PRIMARIO	GA-9334	7W5317	AGUA, MANTENIMIENTO	GP-2071W	9N3368	836 con motor/CATERPILLAR 3408 SERIES		
			AIRE, PRIMARIO	GA-7716	1P7716	TRANSMISION	G-152	9M9740
816F con motor/A DIESEL			AIRE, SECUNDARIO	GA-7360	1P7360	ACEITE, TANQUE HIDRAULICO	G-153	7J0670
TRANSMISION	G-152	9M9740				COMBUSTIBLE	GP-749	1R0749
ACEITE	GP-51	1R0739	825G con motor/CATERPILLAR 3406			ACEITE, CUMPLE CON MEDI- DAS ORIGINALES	GP-691	1R0716
COMBUSTIBLE	GP-110	1R0750	TRANSMISION	G-152	1R0719	ACEITE, SEGUNDA OPCION	GP-52	1R0716
			COMBUSTIBLE	GP-749	1R0749	AGUA	GP-1011Q	9N6123
824 con motor/A DIESEL			ACEITE, CUMPLE CON MEDI- DAS ORIGINALES	GP-691	1R0716	AIRE, PRIMARIO	GA-483	1P8483
ACEITE	G-238	1R0721	AGUA, PRE-CARGA	GP-1010Q	9N6123	AIRE, SECUNDARIO	GA-482	1P8482
COMBUSTIBLE	G-1166	1R0724	ACEITE, SEGUNDA OPCION	GP-52	1R0716			
ACEITE, TANQUE HIDRAULICO	G-222	1R0741	AGUA, MANTENIMIENTO	GP-2071W	9N3368	836G con motor/CATERPILLAR 3406		
TRANSMISION	G-222	1R0741				ACEITE, CUMPLE CON MEDI- DAS ORIGINALES	GP-691	1R0716
AIRE, SECUNDARIO	GA-1286	2S1286	825H, 826H con motor/CATERPILLAR C15			ACEITE, SEGUNDA OPCION	GP-52	1R0716
AIRE, PRIMARIO	GA-9334	4M9334	DIESEL, SECUNDARIO	GP-749	1R0762	HIDRAULICO	GP-761H	1G8878
			ACEITE	GP-52	1R0716			
824B con motor/A DIESEL			AIRE, PRIMARIO	GA-600R	106-3969	836G con motor/CATERPILLAR 3456		
ACEITE	G-238	1R0721	AIRE, CABINA	GA-240	107-0266	COMBUSTIBLE	GP-749	1R0749
COMBUSTIBLE, CARTUCHO	G-1166	1R0724				ACEITE, CUMPLE CON MEDI- DAS ORIGINALES	GP-691	1R0716
ACEITE, TANQUE HIDRAULICO	G-222	1R0741	826B con motor/CATERPILLAR D343			ACEITE, SEGUNDA OPCION	GP-52	1R0716
TRANSMISION	G-222	1R0741	ACEITE	G-238	1R0721	HIDRAULICO	GP-761H	1G8878
COMBUSTIBLE, SELLADO	GP-110	1R0750	ACEITE, TANQUE HIDRAULICO	G-222	1R0741			
AIRE, SECUNDARIO DOBLE	GA-1287	2S1287	TRANSMISION	G-222	1R0741	836H con motor/CATERPILLAR C18		
AIRE, PRIMARIO DOBLE	GA-9045	7M9045	COMBUSTIBLE	GP-110	1R0750	DIESEL, SECUNDARIO	GP-749	1R0762
AIRE, PRIMARIO SIMPLE	GA-483	1P8483	AIRE, SECUNDARIO DOBLE	GA-1287	2S1287	ACEITE	GP-52	1R0716
AIRE, SECUNDARIO SIMPLE	GA-482	1P8482	AIRE, PRIMARIO DOBLE	GA-9045	7W5316	HIDRAULICO, DRENADO DE LA CAJA	GP-761H	1G8878
			AIRE, PRIMARIO DOBLE	GA-9045	7W5316	AIRE, PRIMARIO	GA-600R	106-3969
824C con motor/A DIESEL (S/N 85X)			AIRE, PRIMARIO SIMPLE	GA-483	1P8483	AIRE, CABINA	GA-240	107-0266
TRANSMISION	G-152	9M9740	AIRE, SECUNDARIO SIMPLE	GA-482	1P8482			
ACEITE, CUMPLE CON MEDI- DAS ORIGINALES	GP-691	1R0716				CB214C, CB224C con motor/HATZ		
ACEITE, SEGUNDA OPCION	GP-52	1R0716	826C con motor/CATERPILLAR 3406			HIDRAULICO	GP-761H	1G8878
COMBUSTIBLE	GP-1108	1R0712	TRANSMISION	G-152	9M9740			
AGUA	GP-2071W	9N3368	COMBUSTIBLE	GP-749	1R0749	CB214D, CB224D, CB225D con motor/CATERPILLAR 3013		
AIRE, PRIMARIO	GA-7716	1P7716	ACEITE, CUMPLE CON MEDI- DAS ORIGINALES	GP-691	1R0716	HIDRAULICO	GP-761H	144-6691
AIRE, SECUNDARIO	GA-7360	1P7360	ACEITE, SEGUNDA OPCION	GP-52	1R0716	COMBUSTIBLE, SEPARADOR DE AGUA	GPP-420	156-1200
			COMBUSTIBLE	GP-1108	4N5823	AIRE, RADIAL PRIMARIO	GA-880R	146-7472
824G con motor/A DIESEL			AGUA, PRE-CARGA	GP-1011Q	9N3367			
COMBUSTIBLE	GP-749	1R0749	AGUA, MANTENIMIENTO	GP-2071W	9N3368	CB214E, CB224B, CB225E con motor/CATERPILLAR 3013C		
			AIRE, PRIMARIO	GA-7716	1P7716	ACEITE	GP-58	220-1523
825, 826 con motor/A DIESEL			AIRE, SECUNDARIO	GA-7360	1P7360	HIDRAULICO	GP-761H	144-6691
ACEITE	G-238	5S0485				COMBUSTIBLE, SEPARADOR DE AGUA	GPP-420	156-1200
HIDRAULICO	G-222	4J6064	826G con motor/CATERPILLAR 3406			AIRE, RADIAL PRIMARIO	GA-880R	146-7472
TRANSMISION	G-222	4J6064	TRANSMISION	G-152	1R0719			
COMBUSTIBLE, SEPARADOR DE AGUA	GPP-11	175-2949	COMBUSTIBLE	GP-749	1R0749	CB334D con motor/CATERPILLAR 3013		
COMBUSTIBLE	GP-110	1P2299	ACEITE, CUMPLE CON MEDI- DAS ORIGINALES	GP-691	1R0716	COMBUSTIBLE, SEPARADOR DE AGUA	GPP-425	138-3100
AIRE, SECUNDARIO	GA-1287	2S1287	ACEITE, SEGUNDA OPCION	GP-52	1R0716	ACEITE	GP-81	150-4140
AIRE, PRIMARIO	GA-9045	7M9045	AGUA, PRE-CARGA	GP-1011Q	9N3718	HIDRAULICO	GP-761H	144-6691
			AGUA, MANTENIMIENTO	GP-2071W	9N3368	AIRE, RADIAL PRIMARIO	GA-880R	146-7472
825B con motor/A DIESEL								
ACEITE	G-238	5S0485	834, 835 con motor/A DIESEL					
ACEITE, TANQUE HIDRAULICO	G-222	4J6064	ACEITE	G-238	5S0485			
TRANSMISION	G-222	4J6064	ACEITE, TANQUE HIDRAULICO	G-222	4J6064			
COMBUSTIBLE	GP-110	1R0750	TRANSMISION	G-222	4J6064			
AIRE, SECUNDARIO DOBLE	GA-1287	2S1287	COMBUSTIBLE	GP-110	1P2299			
AIRE, PRIMARIO DOBLE	GA-9045	7M9045	AIRE, SECUNDARIO	GA-1287	2S1287			
AIRE, PRIMARIO SIMPLE	GA-483	1P8483						

MARCA-MODELO-MOTOR MAKE-MODEL-ENGINE	GONHER GONHER	OEM OEM	MARCA-MODELO-MOTOR MAKE-MODEL-ENGINE	GONHER GONHER	OEM OEM	MARCA-MODELO-MOTOR MAKE-MODEL-ENGINE	GONHER GONHER	OEM OEM
CATERPILLAR (continuación)			CATERPILLAR (continuación)			CATERPILLAR (continuación)		
COMPACTADORAS			COMPACTADORAS			COMPACTADORAS		
CB334E con motor/CATERPILLAR 3024C			CB434D con motor/CATERPILLAR 3054C			COMBUSTIBLE, 7 1/8 IN	GP-110	1R0750
ACEITE	GP-58	220-1523	ACEITE	GP-31	7W2326	DIRECCION	GP-761H	1G8878
HIDRAULICO	GP-761H	144-6691	HIDRAULICO	GP-761H	1G8878	AIRE, PRIMARIO	GA-8047	7W5389
COMBUSTIBLE, SEPARADOR DE AGUA	GPP-420	156-1200	AIRE, RADIAL PRIMARIO	GA-853R	110-6326			
AIRE, RADIAL PRIMARIO	GA-880R	146-7472				CB614 con motor/CATERPILLAR 3208		
			CB514 con motor/DETROIT DIESEL 3-53			GASOLINA, SEPARADOR DE AGUA	G-293	8N9803
CB335D con motor/CATERPILLAR 3013			ACEITE, FLUJO TOTAL (FULL FLOW)	G-119	E380089	COMBUSTIBLE	GP-110	1R0740
COMBUSTIBLE, SEPARADOR DE AGUA	GPP-425	138-3100				ACEITE	GP-9586	1R0713
ACEITE	GP-81	150-4140	CB523B, CB525B con motor/A DIESEL			CB624 con motor/A DIESEL		
HIDRAULICO	GP-761H	144-6691	AIRE, PRIMARIO	GAK-403	81-4648	COMBUSTIBLE	GP-110	1R0740
AIRE, RADIAL PRIMARIO	GA-880R	146-7472				ACEITE	GP-9586	1R0713
			CB525, CB521, CB522, CB523, CB524 con motor/DEUTZ F5L912			AIRE, SECUNDARIO	GA-1286	251286
CB335D con motor/CATERPILLAR 3014			ACEITE	GP-54	665934	AIRE, PRIMARIO	GA-9334	7W5317
ACEITE	GP-81	150-4140	COMBUSTIBLE	GP-1122	5W3394			
HIDRAULICO	GP-761H	144-6691	AIRE, PRIMARIO	GAK-403	81-4648			
AIRE, RADIAL PRIMARIO	GA-880R	146-7472				CB634 con motor/CATERPILLAR 3116		
			CB531 con motor/CATERPILLAR 3116			ACEITE	GP-51	1R0739
CB335E con motor/CATERPILLAR 3024C			ACEITE	GP-51	1R0739	COMBUSTIBLE, 5 13/32 IN	GP-62	1R0751
ACEITE	GP-81	150-4140	COMBUSTIBLE, 5 13/32 IN	GP-62	1R0751	COMBUSTIBLE, 7 13/32 IN	GP-1109	1R0751
HIDRAULICO	GP-761H	144-6691	COMBUSTIBLE, 7 13/32 IN	GP-1109	1R0751	HIDRAULICO AUXILIAR	GP-761H	1G8878
COMBUSTIBLE	GPP-420	156-1200	COMBUSTIBLE, 7 1/8 IN	GP-110	1R0750	AIRE, PRIMARIO	GA-499R	6I2499
AIRE, RADIAL PRIMARIO	GA-880R	146-7472	HIDRAULICO	GP-761H	1G8878			
			AIRE, PRIMARIO	GA-8047	7W5389	CB634C con motor/CATERPILLAR 3116		
CB355D con motor/CATERPILLAR 3013						ACEITE	GP-51	1R0739
COMBUSTIBLE, SEPARADOR DE AGUA	GPP-425	138-3100	CB534 con motor/CATERPILLAR 3304			COMBUSTIBLE, 5 13/32 IN	GP-62	1R0751
ACEITE	GP-81	150-4140	ACEITE	GP-51	1R0739	COMBUSTIBLE, 7 13/32 IN	GP-1109	1R0751
HIDRAULICO	GP-761H	144-6691	COMBUSTIBLE	GP-110	1R0740	COMBUSTIBLE, SEPARADOR DE AGUA	GPP-424	117-4089
			AIRE, PRIMARIO	GA-360	81-3923	COMBUSTIBLE, 7 1/8 IN	GP-110	1R0750
CB355D con motor/CATERPILLAR 3014			AIRE, SECUNDARIO	GA-361	81-3957	HIDRAULICO AUXILIAR	GP-761H	1G8878
ACEITE	GP-81	150-4140				AIRE, PRIMARIO	GA-499R	6I2499
CB414 con motor/JOHN DEERE			CB534B, CB534C con motor/CATERPILLAR 3054					
ACEITE	GP-14	6E-0924	ACEITE	GP-31	7W2326	CB634D con motor/CATERPILLAR 3116T		
			COMBUSTIBLE, SEPARADOR DE AGUA	GPP-425	138-3100	ACEITE	GP-51	1R0739
CB424 con motor/DEUTZ			HIDRAULICO	GP-761H	1G8878			
ACEITE	GP-36	R09505-59	COMBUSTIBLE	GPP-419	100-5593	CP323 con motor/JOHN DEERE 4219D		
						AIRE	GAK-403	67000055
CB424 con motor/PERKINS 4.236			CB534D con motor/CATERPILLAR 3054C					
ACEITE	GP-1	7W2327	ACEITE, 5 13/32 IN	GP-1	7W2327	CP323 con motor/PERKINS 4.236		
COMBUSTIBLE	G-296	67-6987	ACEITE, 7 17/32 IN	GP-31	7W2326	ACEITE	GP-1	7W2327
COMBUSTIBLE	G-296-B	67-6987	COMBUSTIBLE, SEPARADOR DE AGUA	GPP-425	138-3100	COMBUSTIBLE	G-296	67-6987
			COMBUSTIBLE, SECUNDARIO	GPP-419	159-6102	GASOLINA, SEPARADOR DE AGUA	G-293	8N9803
CB434 con motor/CATERPILLAR 3114T						COMBUSTIBLE	G-296-B	67-6987
COMBUSTIBLE	GP-110	1R0740	CB535B con motor/CATERPILLAR 3054					
			ACEITE	GP-31	7W2326	CP323C con motor/CATERPILLAR 3054		
CB434B con motor/CATERPILLAR 3054			COMBUSTIBLE, SEPARADOR DE AGUA	GPP-425	138-3100	ACEITE	GP-1	7W2327
ACEITE	GP-1	7W2327	HIDRAULICO	GP-761H	1G8878	COMBUSTIBLE, SEPARADOR DE AGUA	GPP-425	138-3100
COMBUSTIBLE, SEPARADOR DE AGUA	GPP-425	138-3100	COMBUSTIBLE	GPP-419	100-5593	HIDRAULICO	GP-761H	1G8878
HIDRAULICO	GP-761H	1G8878				COMBUSTIBLE	GPP-419	159-6102
COMBUSTIBLE	GPP-419	159-6102	CB544, CB545 con motor/CATERPILLAR 3054					
			ACEITE	GP-1	7W2327	CP433 con motor/JOHN DEERE 4276D		
CB434B con motor/PERKINS			COMBUSTIBLE, SEPARADOR DE AGUA	GPP-425	138-3100	AIRE	GAK-403	67000055
ACEITE	GP-51	7W2327	HIDRAULICO	GP-761H	1G8878			
HIDRAULICO	GP-761H	1G8878	COMBUSTIBLE	GPP-419	159-6102	CP433B con motor/PERKINS T4.236		
COMBUSTIBLE	GPP-419	100-5593	AIRE, RADIAL PRIMARIO	GA-853R	110-6326	ACEITE	GP-1	7W2327
						COMBUSTIBLE	G-296	67-6987
CB434C con motor/CATERPILLAR 3054			CB545 con motor/PERKINS			GASOLINA, SEPARADOR DE AGUA	G-293	8N9803
ACEITE	GP-1	7W2327	ACEITE	GP-1	7W2327	COMBUSTIBLE	G-296-B	67-6987
COMBUSTIBLE, SEPARADOR DE AGUA	GPP-425	138-3100				TRANSMISION	GP-761H	144-6691
HIDRAULICO	GP-761H	1G8878	CB583 con motor/CATERPILLAR 3116					
COMBUSTIBLE	GPP-419	100-5593	ACEITE	GP-51	1R0739	CP433C con motor/CATERPILLAR 3054		
			COMBUSTIBLE, 5 13/32 IN	GP-62	1R0751	ACEITE (5 13/32 IN)	GP-1	7W2327
			COMBUSTIBLE, 7 13/32 IN	GP-1109	1R0751	ACEITE (7 17/32 IN)	GP-31	7W2326

SERVICIO PESADO

MARCA-MODELO-MOTOR MAKE-MODEL-ENGINE	GONHER GONHER	OEM OEM	MARCA-MODELO-MOTOR MAKE-MODEL-ENGINE	GONHER GONHER	OEM OEM	MARCA-MODELO-MOTOR MAKE-MODEL-ENGINE	GONHER GONHER	OEM OEM
CATERPILLAR (continuación)			CATERPILLAR (continuación)			CATERPILLAR (continuación)		
COMPACTADORAS			COMPACTADORAS			COMPACTADORAS		
COMBUSTIBLE, SEPARADOR DE AGUA	GPP-425	138-3100	AIRE, PRIMARIO	GA-8047	7W5389	HIDRAULICO	GP-761H	1G8878
HIDRAULICO	GP-761H	1G8878	CP563D con motor/CATERPILLAR 3116			COMBUSTIBLE	GPP-419	159-6102
COMBUSTIBLE	GPP-419	159-6102	ACEITE	GP-51	1R0739	AIRE, RADIAL PRIMARIO	GA-853R	110-6326
AIRE, RADIAL PRIMARIO	GA-853R	110-6326	COMBUSTIBLE, 5 13/32 IN	GP-62	1R0751	CS431C, CS433C con motor/PERKINS		
CP433C con motor/PERKINS			COMBUSTIBLE, 7 13/32 IN	GP-1109	1R0751	ACEITE	GP-31	7W2326
ACEITE	GP-31	7W2326	COMBUSTIBLE, SEPARADOR DE AGUA	GPP-424	117-4089	HIDRAULICO	GP-761H	1G8878
HIDRAULICO	GP-761H	1G8878	HIDRAULICO	GP-761H	1G8878	COMBUSTIBLE	GPP-419	100-5593
COMBUSTIBLE	GPP-419	100-5593	CP643, CP653 con motor/CATERPILLAR 3304			CS433 con motor/JOHN DEERE 4276D		
CP433E con motor/CATERPILLAR 3054			HIDRAULICO	G-152	9M9740	AIRE	GAK-403	9Y-6841
ACEITE	GP-31	7W2326	ACEITE	GP-51	1R0739	CS433B con motor/PERKINS T4.236		
COMBUSTIBLE, SEPARADOR DE AGUA	GPP-425	138-3100	COMBUSTIBLE	GP-110	1R0740	ACEITE	GP-1	7W2327
HIDRAULICO	GP-761H	1G8878	AIRE, PRIMARIO	GA-9334	7W5317	COMBUSTIBLE	G-296	67-6987
COMBUSTIBLE	GPP-419	159-6102	CS323 con motor/PERKINS 4.236			GASOLINA, SEPARADOR DE AGUA	G-293	8N9803
AIRE, RADIAL PRIMARIO	GA-853R	110-6326	ACEITE	GP-1	7W2327	COMBUSTIBLE	G-296-B	67-6987
CP433E con motor/CATERPILLAR 3054C			COMBUSTIBLE	G-296	67-6987	TRANSMISION	GP-761H	144-6691
ACEITE	GP-31	7W2326	GASOLINA, SEPARADOR DE AGUA	G-293	8N9803	CS433E con motor/CATERPILLAR 3054		
HIDRAULICO	GP-761H	1G8878	COMBUSTIBLE	G-296-B	67-6987	ACEITE	GP-31	7W2326
AIRE, RADIAL PRIMARIO	GA-853R	110-6326	CS323C con motor/CATERPILLAR 3054			COMBUSTIBLE, SEPARADOR DE AGUA	GPP-425	138-3100
CP533 con motor/CATERPILLAR 3116			ACEITE	GP-1	7W2327	HIDRAULICO	GP-761H	1G8878
ACEITE	GP-51	1R0739	COMBUSTIBLE, SEPARADOR DE AGUA	GPP-425	138-3100	COMBUSTIBLE	GPP-419	159-6102
COMBUSTIBLE, 5 13/32 IN	GP-62	1R0751	HIDRAULICO	GP-761H	1G8878	AIRE, RADIAL PRIMARIO	GA-853R	110-6326
COMBUSTIBLE, 7 13/32 IN	GP-1109	1R0751	COMBUSTIBLE	GPP-419	159-6102	CS433E con motor/CATERPILLAR 3054C		
COMBUSTIBLE	GP-110	1R0750	CS413C con motor/PERKINS			ACEITE	GP-31	7W2326
HIDRAULICO	GP-761H	1G8878	ACEITE	GP-31	7W2326	HIDRAULICO	GP-761H	1G8878
AIRE, PRIMARIO	GA-8047	7W5389	COMBUSTIBLE, SEPARADOR DE AGUA	GPP-425	100-6374	AIRE, RADIAL PRIMARIO	GA-853R	110-6326
CP533 con motor/CATERPILLAR 3208			HIDRAULICO	GP-761H	1G8878	CS531 con motor/CATERPILLAR 3116		
COMBUSTIBLE	GP-110	1R0740	COMBUSTIBLE	GPP-419	100-5593	ACEITE	GP-51	1R0739
ACEITE	GP-9586	1R0713	CS423E con motor/CATERPILLAR 3054B			COMBUSTIBLE, 5 13/32 IN	GP-62	1R0751
AIRE	GA-24	9Y6834	ACEITE	GP-31	7W2326	COMBUSTIBLE, 7 13/32 IN	GP-1109	1R0751
CP533C, CP563C con motor/CATERPILLAR 3116			COMBUSTIBLE, SEPARADOR DE AGUA	GPP-425	138-3100	COMBUSTIBLE, 7 1/8 IN	GP-110	1R0750
ACEITE	GP-51	1R0739	HIDRAULICO	GP-761H	1G8878	HIDRAULICO	GP-761H	1G8878
COMBUSTIBLE, 5 13/32 IN	GP-62	1R0751	COMBUSTIBLE	GPP-419	159-6102	AIRE, PRIMARIO	GA-8047	7W5389
COMBUSTIBLE, 7 13/32 IN	GP-1109	1R0751	AIRE, RADIAL PRIMARIO	GA-853R	110-6326	CS531C con motor/CATERPILLAR 3116		
COMBUSTIBLE, SEPARADOR DE AGUA	GPP-424	117-4089	CS423E con motor/CATERPILLAR 3054C			ACEITE	GP-51	1R0739
HIDRAULICO	GP-761H	1G8878	ACEITE	GP-31	7W2326	COMBUSTIBLE, 5 13/32 IN	GP-62	1R0751
AIRE, PRIMARIO	GA-499R	6I2499	HIDRAULICO	GP-761H	1G8878	COMBUSTIBLE, 7 13/32 IN	GP-1109	1R0751
CP533D con motor/CATERPILLAR 3116			AIRE, RADIAL PRIMARIO	GA-853R	110-6326	COMBUSTIBLE, SEPARADOR DE AGUA	GPP-424	117-4089
ACEITE	GP-51	1R0739	CS431 con motores/JOHN DEERE 4219D, JOHN DEERE 4239D			HIDRAULICO	GP-761H	1G8878
COMBUSTIBLE, 5 13/32 IN	GP-62	1R0751	ACEITE	GP-14	6E-0924	AIRE, PRIMARIO	GA-499R	6I2499
COMBUSTIBLE, 7 13/32 IN	GP-1109	1R0751	COMBUSTIBLE	G-295	3I-1233	CS531D, CS533D con motor/CATERPILLAR 3116		
HIDRAULICO	GP-761H	1G8878	AIRE	GAK-403	67000055	ACEITE	GP-51	1R0739
CP553 con motor/CATERPILLAR 3208			CS431B con motor/PERKINS T4.236			COMBUSTIBLE, 5 13/32 IN	GP-62	1R0751
GASOLINA, SEPARADOR DE AGUA	G-293	8N9803	ACEITE	GP-1	7W2327	COMBUSTIBLE, 7 13/32 IN	GP-1109	1R0751
COMBUSTIBLE	GP-110	1R0740	COMBUSTIBLE	G-296	67-6987	HIDRAULICO	GP-761H	1G8878
ACEITE	GP-9586	1R0713	GASOLINA, SEPARADOR DE AGUA	G-293	8N9803	CS533 con motor/CATERPILLAR 3116		
AIRE, SIN ASPAS	GA-24	9Y6834	COMBUSTIBLE	G-296-B	67-6987	ACEITE	GP-51	1R0739
CP563, CS563 con motor/CATERPILLAR 3116			CS431C, CS433C con motor/CATERPILLAR 3054			COMBUSTIBLE, 5 13/32 IN	GP-62	1R0751
ACEITE	GP-51	1R0739	ACEITE (5 13/32 IN)	GP-1	7W2327	COMBUSTIBLE, 7 13/32 IN	GP-1109	1R0751
COMBUSTIBLE, 5 13/32 IN	GP-62	1R0751	ACEITE (7 17/32 IN)	GP-31	7W2326	COMBUSTIBLE	GP-110	1R0750
COMBUSTIBLE, 7 13/32 IN	GP-1109	1R0751	COMBUSTIBLE, SEPARADOR DE AGUA	GPP-425	138-3100	HIDRAULICO	GP-761H	1G8878
COMBUSTIBLE, 7 1/8 IN	GP-110	1R0740	CS431 con motores/JOHN DEERE 4219D, JOHN DEERE 4239D			AIRE, PRIMARIO	GA-8047	7W5389
DIRECCION SELLADO	GP-761H	1G8878	ACEITE	GP-14	6E-0924	CS533C, CS563C, CS573C con motor/CATERPILLAR 3116		
HIDRAULICO	GP-761H	1G8878	COMBUSTIBLE	G-295	3I-1233	ACEITE	GP-51	1R0739

MARCA-MODELO-MOTOR MAKE-MODEL-ENGINE	GONHER GONHER	OEM OEM	MARCA-MODELO-MOTOR MAKE-MODEL-ENGINE	GONHER GONHER	OEM OEM	MARCA-MODELO-MOTOR MAKE-MODEL-ENGINE	GONHER GONHER	OEM OEM
CATERPILLAR (continuación)			CATERPILLAR (continuación)			CATERPILLAR (continuación)		
COMPACTADORAS			COMPACTADORAS			COMPACTADORAS		
COMBUSTIBLE, 5 13/32 IN	GP-62	1R0751	PF290 con motor/PERKINS			P5500 con motor/CATERPILLAR 3208		
COMBUSTIBLE, 7 13/32 IN	GP-1109	1R0751	ACEITE	GP-1	7W2326	GASOLINA, SEPARADOR DE AGUA	G-293	8N9803
COMBUSTIBLE, SEPARADOR DE AGUA	GPP-424	117-4089	PF290B con motor/CATERPILLAR 3054			COMBUSTIBLE	GP-110	1R0740
HIDRAULICO	GP-761H	1G8878	ACEITE	GP-31	7W2326	ACEITE	GP-9586	1R0713
AIRE, PRIMARIO	GA-499R	6I2499	HIDRAULICO	GP-761H	1G8878	AIRE, SECUNDARIO	GA-1286	2S1286
			COMBUSTIBLE	GPP-419	159-6102	AIRE, PRIMARIO	GA-9334	7W5317
CS551, CS553 con motor/CATERPILLAR 3208			AIRE, RADIAL PRIMARIO	GA-853R	110-6326			
GASOLINA, SEPARADOR DE AGUA	G-293	8N9803	PF300 con motor/DEUTZ F6L912			CATERPILLAR		
COMBUSTIBLE	GP-110	1R0740	ACEITE	GP-54	3I1361	EQUIPO AGRICOLA		
ACEITE	GP-9586	1R0713	COMBUSTIBLE	GP-1122	3I1266	CHALLENGER 35 con motor/CATERPILLAR 3116		
AIRE, SIN ASPAS	GA-24	9Y6834	AIRE, RADIAL PRIMARIO	GA-853R	110-6326	ACEITE	GP-51	1R0739
						COMBUSTIBLE, 5 13/32 IN	GP-62	1R0751
CS563D con motor/CATERPILLAR 3116			PF300B, PS300B con motor/CATERPILLAR 3054			COMBUSTIBLE, 7 13/32 IN	GP-1109	1R0751
ACEITE	GP-51	1R0739	ACEITE (5 13/32 IN)	GP-1	7W2327	COMBUSTIBLE, SEPARADOR DE AGUA	GPP-424	117-4089
COMBUSTIBLE, 5 13/32 IN	GP-62	1R0751	ACEITE (7 17/32 IN)	GP-31	7W2326	DIRECCION (S/N 8DNN 9DF)	GP-761H	1G8878
COMBUSTIBLE, 7 13/32 IN	GP-1109	1R0751	COMBUSTIBLE, SEPARADOR DE AGUA	GPP-425	138-3100	TRANSMISION	GP-761H	1G8878
COMBUSTIBLE, SEPARADOR DE AGUA	GPP-424	117-4089	HIDRAULICO	GP-761H	1G8878			
HIDRAULICO	GP-761H	1G8878	COMBUSTIBLE	GPP-419	159-6102	CHALLENGER 45 con motor/CATERPILLAR 3116		
			AIRE, RADIAL PRIMARIO	GA-853R	110-6326	ACEITE	GP-51	1R0739
CS573 con motor/CATERPILLAR 3116						COMBUSTIBLE, 5 13/32 IN	GP-62	1R0751
ACEITE	GP-51	1R0658	PF300C, PS300C con motor/CATERPILLAR 3054C			COMBUSTIBLE, 7 13/32 IN	GP-1109	1R0751
COMBUSTIBLE, 5 13/32 IN	GP-62	1R0751	ACEITE	GP-31	7W2326	COMBUSTIBLE, SEPARADOR DE AGUA	GPP-424	117-4089
COMBUSTIBLE, 7 13/32 IN	GP-1109	1R0751	PS110, PS130 con motor/PERKINS 4.236			DIRECCION (S/N 1DR, 4DZ)	GP-761H	1G8878
DIRECCION SELLADO	GP-761H	1G8878	ACEITE	GP-1	7W2327	TRANSMISION	GP-761H	1G8878
AIRE, PRIMARIO	GA-8047	7W5389	TRANSMISION	GP-1	E380084			
			COMBUSTIBLE	G-296	67-6987	CHALLENGER 55 con motor/CATERPILLAR 3126		
CS573D con motor/CATERPILLAR 3116			GASOLINA, SEPARADOR DE AGUA	G-293	8N9803	ACEITE	GP-51	1R0739
ACEITE	GP-51	1R0739	COMBUSTIBLE	G-296-B	67-6987	COMBUSTIBLE, 5 13/32 IN	GP-62	1R0751
COMBUSTIBLE, 5 13/32 IN	GP-62	1R0751	PS110, PS130, PS180 con motor/JOHN DEERE 4239D			COMBUSTIBLE, 7 13/32 IN	GP-1109	1R0751
COMBUSTIBLE, 7 13/32 IN	GP-1109	1R0751	TRANSMISION	GP-1	7W2327	COMBUSTIBLE, SEPARADOR DE AGUA	GPP-424	117-4089
HIDRAULICO	GP-761H	1G8878	ACEITE	GP-14	6E-0924	DIRECCION (S/N 5DK, 7DM)	GP-761H	1G8878
			COMBUSTIBLE	G-295	3I-1233	TRANSMISION	GP-761H	1G8878
CS583 con motor/CATERPILLAR 3116			PS150B con motor/CATERPILLAR 3054					
ACEITE	GP-51	1R0739	ACEITE	GP-1	7W2327	CHALLENGER 65, CHALLENGER 65B con motor/CATERPILLAR 3306		
COMBUSTIBLE, 5 13/32 IN	GP-62	1R0751	COMBUSTIBLE, SEPARADOR DE AGUA	GPP-425	138-3100	ACEITE	GP-51	1R0739
COMBUSTIBLE, 7 13/32 IN	GP-1109	1R0751	HIDRAULICO	GP-761H	1G8878	COMBUSTIBLE	GP-110	1R0750
COMBUSTIBLE, 7 1/8 IN	GP-110	1R0750	COMBUSTIBLE	GPP-419	159-6102	AGUA	GP-2071W	9N3368
DIRECCION	GP-761H	1G8878	AIRE, RADIAL PRIMARIO	GA-853R	110-6326	DIRECCION	GP-761H	9T5916
AIRE, PRIMARIO	GA-8047	7W5389				ACEITE, INSTRUMENTOS	GP-761H	9T5916
			PS180 con motor/PERKINS 4.236			AIRE, PRIMARIO ESTANDAR	GA-9045	7W5316
CS583C con motor/A DIESEL			ACEITE	GP-1	7W2327			
ACEITE	GP-51	1R0739	TRANSMISION	GP-1	E380084	CHALLENGER 65C con motor/CATERPILLAR 3306		
COMBUSTIBLE, 5 13/32 IN	GP-62	1R0751	COMBUSTIBLE	G-296	67-6987	ACEITE	GP-51	1R0739
COMBUSTIBLE, 7 13/32 IN	GP-1109	1R0751	GASOLINA, SEPARADOR DE AGUA	G-293	8N9803	COMBUSTIBLE, S/N 8Z84650 EN ADELANTE	GP-110	1R0750
COMBUSTIBLE, SEPARADOR DE AGUA	GPP-424	117-4089	COMBUSTIBLE	G-296-B	67-6987	HIDRAULICO	GP-761H	9T5916
HIDRAULICO	GP-761H	1G8878	PS200B, PS360B con motor/CATERPILLAR 3054					
AIRE, PRIMARIO	GA-499R	6I2499	ACEITE	GP-31	7W2326	CHALLENGER 65D con motor/CATERPILLAR 3306		
			COMBUSTIBLE, SEPARADOR DE AGUA	GPP-425	138-3100	COMBUSTIBLE, S/N 8Z84650 EN ADELANTE	GP-749	1R0749
CS583D con motor/CATERPILLAR 3116			HIDRAULICO	GP-761H	1G8878			
ACEITE	GP-51	1R0739	COMBUSTIBLE	GPP-419	159-6102	CHALLENGER 65E, CHALLENGER 75E con motor/CATERPILLAR 3176		
COMBUSTIBLE, 5 13/32 IN	GP-62	1R0751	AIRE, RADIAL PRIMARIO	GA-853R	110-6326	ACEITE, CUMPLE CON MEDI-DAS ORIGINALES	GP-691	1R0716
COMBUSTIBLE, 7 13/32 IN	GP-1109	1R0751						
COMBUSTIBLE, SEPARADOR DE AGUA	GPP-424	117-4089	PS300 con motor/DEUTZ F6L912			CHALLENGER 70C con motor/CATERPILLAR 3306		
HIDRAULICO	GP-761H	1G8878	ACEITE	GP-54	3I1361	ACEITE	GP-51	1R0739
			COMBUSTIBLE	GP-1122	3I1266	COMBUSTIBLE	GP-110	1R0750
CS643, CS653 con motor/CATERPILLAR 3304			AIRE, RADIAL PRIMARIO	GA-853R	110-6326	HIDRAULICO	GP-761H	9T5916
HIDRAULICO	G-152	9M9740						
ACEITE	GP-51	1R0739						
COMBUSTIBLE	GP-110	1R0740						
AIRE, PRIMARIO	GA-9334	7W5317						

SERVICIO PESADO

MARCA-MODELO-MOTOR MAKE-MODEL-ENGINE	GONHER GONHER	OEM OEM	MARCA-MODELO-MOTOR MAKE-MODEL-ENGINE	GONHER GONHER	OEM OEM	MARCA-MODELO-MOTOR MAKE-MODEL-ENGINE	GONHER GONHER	OEM OEM
CATERPILLAR (continuación)			CATERPILLAR (continuación)			CATERPILLAR (continuación)		
EQUIPO AGRICOLA			EQUIPO AGRICOLA			EQUIPO FORESTAL		
CHALLENGER 75 con motor/CATERPILLAR 3176			CHALLENGER MT835, CHALLENGER MT845 con motor/CATERPILLAR C121 (12.0L)			525 con motor/CATERPILLAR 3304		
ACEITE, CUMPLE CON MEDIDAS ORIGINALES	GP-691	1R0716	ACEITE, CUMPLE CON MEDIDAS ORIGINALES	GP-691	1R0716	ACEITE	GP-51	1R0739
ACEITE, SEGUNDA OPCION	GP-52	1R0716	ACEITE, SEGUNDA OPCION	GP-52	1R0716	COMBUSTIBLE	GP-110	1R0750
COMBUSTIBLE	GP-1108	1R0712	COMBUSTIBLE	GP-110	1R0749	ACEITE, ACCESORIO PARA TORNO	GP-761H	90-2900
AGUA, PRE-CARGA	GP-1011Q	7E6013				ACEITE, TREN DE PODER	GP-761H	1G8878
AGUA, MANTENIMIENTO	GP-2071W	7E6014	CHALLENGER MT855 con motor/CATERPILLAR C15 (14.6L)			AIRE, PRIMARIO RADIAL	GA-499R	6I2499
DIRECCION	GP-761H	9T5916	ACEITE, CUMPLE CON MEDIDAS ORIGINALES	GP-691	1R0716	525B con motor/CATERPILLAR 3126		
ACEITE, INSTRUMENTOS	GP-761H	9T5916				ACEITE	GP-51	1R0739
AIRE, PRIMARIO	GA-7716	7W5495	CHALLENGER MT865 con motor/CATERPILLAR C16 (15.8L)			COMBUSTIBLE, 5 13/32 IN	GP-62	1R0751
AIRE, SECUNDARIO	GA-7360	1P7360	ACEITE, CUMPLE CON MEDIDAS ORIGINALES	GP-691	1R0716	COMBUSTIBLE, 7 13/32 IN	GP-1109	1R0751
CHALLENGER 75B con motor/A DIESEL			CATERPILLAR			527 con motor/CATERPILLAR 3304		
ACEITE, CUMPLE CON MEDIDAS ORIGINALES	GP-691	1R0716	EQUIPO FORESTAL			ACEITE	GP-51	1R0739
ACEITE, SEGUNDA OPCION	GP-52	1R0716	508 con motor/CATERPILLAR 3204			COMBUSTIBLE	GP-110	1R0740
AGUA	GP-1013Q	7E0613	COMBUSTIBLE	GP-110	1P2299	HIDRAULICO (SELLADO)	GP-166	4T6915
COMBUSTIBLE, PRIMARIO	GP-1108	1R0712	TRANSMISION	GP-761H	90-2900	528 con motor/CATERPILLAR 3306		
HIDRAULICO	GP-761H	9T5916	AIRE, PRIMARIO	GA-8047	7W5389	HIDRAULICO	G-152	9M9740
AIRE, PRIMARIO	GA-7716	7W5495	515 con motor/A DIESEL			TRANSMISION	G-152	9M9740
AIRE, SECUNDARIO	GA-7360	1P7360	ACEITE	GP-51	1R0739	HIDRAULICO	G-222	4J6064
CHALLENGER 75C, CHALLENGER 75D con motor/CATERPILLAR 3176			COMBUSTIBLE	GP-110	1R0750	GASOLINA, SEPARADOR DE AGUA	G-293	6N7617
COMBUSTIBLE	GP-749	1R0749	ACEITE, ACCESORIO PARA TORNO	GP-761H	90-2900	ACEITE	GP-51	1R0739
ACEITE, CUMPLE CON MEDIDAS ORIGINALES	GP-691	1R0716	ACEITE, DIFERENCIAL (TREN DE PODER)	GP-761H	1G8878	COMBUSTIBLE	GP-110	1P2299
ACEITE, SEGUNDA OPCION	GP-52	1R0716	AIRE, PRIMARIO RADIAL	GA-499R	6I2499	AIRE, SECUNDARIO ESTANDAR	GA-1286	2S1286
AGUA, PRE-CARGA	GP-1011Q	7E6013	517 con motor/CATERPILLAR 3304			AIRE, PRIMARIO ESTANDAR	GA-9334	4M9334
AGUA, MANTENIMIENTO	GP-2071W	7E6014	ACEITE, TANQUE HIDRAULICO	G-152	1R0719	528B con motor/CATERPILLAR 3306		
CHALLENGER 80C con motor/A DIESEL			ACEITE	GP-51	1R0739	HIDRAULICO	G-152	9M9740
ACEITE, CUMPLE CON MEDIDAS ORIGINALES	GP-691	1R0716	COMBUSTIBLE	GP-110	1R0750	TRANSMISION	G-152	1R0719
ACEITE, SEGUNDA OPCION	GP-52	1R0716	AIRE, PRIMARIO RADIAL	GA-499R	6I2499	ACEITE	GP-51	1R0739
COMBUSTIBLE, PRIMARIO	GP-1108	1R0712	518 con motor/CATERPILLAR 3304			COMBUSTIBLE	GP-110	1R0750
HIDRAULICO	GP-761H	9T5916	ACEITE, CARTUCHO	G-191	5S0484	ACEITE, ACCESORIO PARA TORNO	GP-761H	90-2900
AIRE, PRIMARIO	GA-483	7W5313	TRANSMISION	G-152	9M9740	530B con motor/CATERPILLAR 3306		
AIRE, SECUNDARIO	GA-482	1P8482	GASOLINA, SEPARADOR DE AGUA	G-293	6N7617	HIDRAULICO	G-152	1R0719
CHALLENGER 85C con motor/CATERPILLAR 3176			ACEITE, SELLADO	GP-51	1R0658	TRANSMISION	G-152	1R0719
COMBUSTIBLE	GP-749	1R0749	COMBUSTIBLE	GP-110	1R0740	ACEITE	GP-51	1R0739
ACEITE, CUMPLE CON MEDIDAS ORIGINALES	GP-691	1R0716	AIRE, SECUNDARIO	GA-1285	2S1285	COMBUSTIBLE	GP-110	1R0750
ACEITE, SEGUNDA OPCION	GP-52	1R0716	AIRE, PRIMARIO	GA-8047	7W5389	ACEITE, ACCESORIO PARA TORNO	GP-761H	90-2900
COMBUSTIBLE	GP-1108	1R0712	518 SERIES II con motor/CATERPILLAR 3304			AIRE, SECUNDARIO ESTANDAR	GA-1286	2S1286
AGUA, PRE-CARGA	GP-1011Q	7E6013	ACEITE, CARTUCHO	G-191	5S0484	AIRE, PRIMARIO ESTANDAR	GA-9334	4M9334
AGUA, MANTENIMIENTO	GP-2071W	7E6014	TRANSMISION	G-152	9M9740	535B con motor/CATERPILLAR 3126		
CHALLENGER 85D con motor/CATERPILLAR 3196			GASOLINA, SEPARADOR DE AGUA	G-293	6N7617	ACEITE	GP-51	1R0739
COMBUSTIBLE	GP-749	1R0749	ACEITE, SELLADO	GP-51	1R0658	COMBUSTIBLE, 5 13/32 IN	GP-62	1R0751
ACEITE, CUMPLE CON MEDIDAS ORIGINALES	GP-691	1R0716	COMBUSTIBLE	GP-110	1R0740	COMBUSTIBLE, 7 13/32 IN	GP-1109	1R0751
ACEITE, SEGUNDA OPCION	GP-52	1R0716	AIRE, SECUNDARIO	GA-1285	2S1285	ACEITE, ACCESORIO PARA TORNO	GP-761H	1G8878
CHALLENGER 85E, CHALLENGER 95E con motor/CATERPILLAR 3196			AIRE, PRIMARIO	GA-8047	7W5389	TRANSMISION	GP-761H	1G8878
ACEITE, CUMPLE CON MEDIDAS ORIGINALES	GP-691	1R0716	518C con motor/CATERPILLAR 3304			545 con motor/CATERPILLAR 3306		
CHALLENGER 80C con motor/A DIESEL			TRANSMISION	G-152	1R0719	ACEITE	GP-51	1R0739
ACEITE, CUMPLE CON MEDIDAS ORIGINALES	GP-691	1R0716	ACEITE	GP-51	1R0739	COMBUSTIBLE	GP-110	1R0750
ACEITE, SEGUNDA OPCION	GP-52	1R0716	COMBUSTIBLE	GP-110	1R0750	ACEITE, ACCESORIO PARA TORNO	GP-761H	1G8878
COMBUSTIBLE, PRIMARIO	GP-1108	1R0712	ACEITE, ACCESORIO PARA TORNO	GP-761H	90-2900	TRANSMISION	GP-761H	1G8878
HIDRAULICO	GP-761H	9T5916	AIRE, SECUNDARIO	GA-1285	2S1285	545 con motor/CATERPILLAR 3306		
AIRE, PRIMARIO	GA-483	7W5313	AIRE, PRIMARIO	GA-8047	7W5389	ACEITE	GP-51	1R0739
AIRE, SECUNDARIO	GA-482	1P8482	518C con motor/CATERPILLAR 3304			COMBUSTIBLE	GP-110	1R0750
CHALLENGER 85C con motor/CATERPILLAR 3176			TRANSMISION	G-152	1R0719	ACEITE, ACCESORIO PARA TORNO	GP-761H	1G8878
COMBUSTIBLE	GP-749	1R0749	ACEITE	GP-51	1R0739	TRANSMISION	GP-761H	1G8878
ACEITE, CUMPLE CON MEDIDAS ORIGINALES	GP-691	1R0716	COMBUSTIBLE	GP-110	1R0750	545 con motor/CATERPILLAR 3306		
ACEITE, SEGUNDA OPCION	GP-52	1R0716	ACEITE, ACCESORIO PARA TORNO	GP-761H	90-2900	ACEITE	GP-51	1R0739
COMBUSTIBLE	GP-1108	1R0712	AIRE, SECUNDARIO	GA-1285	2S1285	COMBUSTIBLE	GP-110	1R0750
AGUA, PRE-CARGA	GP-1011Q	7E6013	AIRE, PRIMARIO	GA-8047	7W5389	ACEITE, ACCESORIO PARA TORNO	GP-761H	1G8878
AGUA, MANTENIMIENTO	GP-2071W	7E6014	518C con motor/CATERPILLAR 3304			TRANSMISION	GP-761H	1G8878
CHALLENGER 85D con motor/CATERPILLAR 3196			TRANSMISION	G-152	1R0719	545 con motor/CATERPILLAR 3306		
COMBUSTIBLE	GP-749	1R0749	ACEITE	GP-51	1R0739	ACEITE	GP-51	1R0739
ACEITE, CUMPLE CON MEDIDAS ORIGINALES	GP-691	1R0716	COMBUSTIBLE	GP-110	1R0750	COMBUSTIBLE	GP-110	1R0750
ACEITE, SEGUNDA OPCION	GP-52	1R0716	ACEITE, ACCESORIO PARA TORNO	GP-761H	90-2900	ACEITE, ACCESORIO PARA TORNO	GP-761H	1G8878
CHALLENGER 85E, CHALLENGER 95E con motor/CATERPILLAR 3196			AIRE, SECUNDARIO	GA-1285	2S1285	TRANSMISION	GP-761H	1G8878
ACEITE, CUMPLE CON MEDIDAS ORIGINALES	GP-691	1R0716	AIRE, PRIMARIO	GA-8047	7W5389	545 con motor/CATERPILLAR 3306		
CHALLENGER MT535, CHALLENGER MT545 con motor/CATERPILLAR 3056			518C con motor/CATERPILLAR 3304			ACEITE	GP-51	1R0739
ACEITE	GP-31	7W2326	TRANSMISION	G-152	1R0719	COMBUSTIBLE	GP-110	1R0750
CHALLENGER MT735, CHALLENGER MT745, CHALLENGER MT755, CHALLENGER MT765 con motor/CATERPILLAR C9 (8.8L)			ACEITE	GP-51	1R0739	ACEITE, ACCESORIO PARA TORNO	GP-761H	1G8878
ACEITE, CUMPLE CON MEDIDAS ORIGINALES	GP-691	1R0716	COMBUSTIBLE	GP-110	1R0750	TRANSMISION	GP-761H	1G8878
CHALLENGER MT735, CHALLENGER MT745, CHALLENGER MT755, CHALLENGER MT765 con motor/CATERPILLAR C9 (8.8L)			ACEITE, ACCESORIO PARA TORNO	GP-761H	90-2900	545 con motor/CATERPILLAR 3306		
ACEITE, CUMPLE CON MEDIDAS ORIGINALES	GP-691	1R0716	AIRE, SECUNDARIO	GA-1285	2S1285	ACEITE	GP-51	1R0739
CHALLENGER MT735, CHALLENGER MT745, CHALLENGER MT755, CHALLENGER MT765 con motor/CATERPILLAR C9 (8.8L)			AIRE, PRIMARIO	GA-8047	7W5389	COMBUSTIBLE	GP-110	1R0750
ACEITE, CUMPLE CON MEDIDAS ORIGINALES	GP-691	1R0716	518C con motor/CATERPILLAR 3304			ACEITE, ACCESORIO PARA TORNO	GP-761H	1G8878
CHALLENGER MT735, CHALLENGER MT745, CHALLENGER MT755, CHALLENGER MT765 con motor/CATERPILLAR C9 (8.8L)			TRANSMISION	G-152	1R0719	TRANSMISION	GP-761H	1G8878
ACEITE, CUMPLE CON MEDIDAS ORIGINALES	GP-691	1R0716	ACEITE	GP-51	1R0739	545 con motor/CATERPILLAR 3306		
CHALLENGER MT735, CHALLENGER MT745, CHALLENGER MT755, CHALLENGER MT765 con motor/CATERPILLAR C9 (8.8L)			COMBUSTIBLE	GP-110	1R0750	ACEITE	GP-51	1R0739
ACEITE, CUMPLE CON MEDIDAS ORIGINALES	GP-691	1R0716	ACEITE, ACCESORIO PARA TORNO	GP-761H	90-2900	COMBUSTIBLE	GP-110	1R0750
CHALLENGER MT735, CHALLENGER MT745, CHALLENGER MT755, CHALLENGER MT765 con motor/CATERPILLAR C9 (8.8L)			AIRE, SECUNDARIO	GA-1285	2S1285	ACEITE, ACCESORIO PARA TORNO	GP-761H	1G8878
ACEITE, CUMPLE CON MEDIDAS ORIGINALES	GP-691	1R0716	AIRE, PRIMARIO	GA-8047	7W5389	TRANSMISION	GP-761H	1G8878

MARCA-MODELO-MOTOR MAKE-MODEL-ENGINE	GONHER GONHER	OEM OEM	MARCA-MODELO-MOTOR MAKE-MODEL-ENGINE	GONHER GONHER	OEM OEM	MARCA-MODELO-MOTOR MAKE-MODEL-ENGINE	GONHER GONHER	OEM OEM
CATERPILLAR (continuación)			CATERPILLAR (continuación)			CATERPILLAR (continuación)		
EQUIPO FORESTAL			EQUIPO PARA CONSTRUCCION VIAL			EQUIPO PARA CONSTRUCCION VIAL		
554 con motor/CATERPILLAR 3054			COMBUSTIBLE, 7 1/8 IN	GP-110	1R0750	BG225 C ASFALTADORA con motor/A DIESEL		
ACEITE	GP-31	7W2326	AIRE, PRIMARIO ESTANDAR	GA-8047	7W5389	ACEITE	GP-31	7W2326
COMBUSTIBLE, SEPARADOR DE AGUA	GPP-424	117-4089	AIRE, PRIMARIO RADIAL	GA-499R	6I2499			
ACEITE, RETORNO HIDRAULICO	GP-166	93-7521	AP1000B ASFALTADORA, AP1050B ASFALTADORA, AP1055B ASFALTADORA con motor/CATERPILLAR 3116			BG230 ASFALTADORA con motor/A DIESEL		
TRANSMISION	GP-761H	1G8878	GASOLINA, SEPARADOR DE AGUA	G-293	8N9803	ACEITE	GP-1	7W2327
COMBUSTIBLE	GPP-419	159-6102	ACEITE	GP-51	1R0739	BG2455 ASFALTADORA con motor/A DIESEL		
AIRE, RADIAL PRIMARIO	GA-853R	110-6326	COMBUSTIBLE, 5 13/32 IN	GP-62	1R0751	ACEITE	GP-51	7W2327
			ACEITE, TREN DE PODER	GP-66	77-3492	COMBUSTIBLE, SECUNDARIO	GP-62	1R0751
564 con motor/CATERPILLAR 3056E			COMBUSTIBLE, 7 13/32 IN	GP-1109	1R0751	AIRE	GA-1285	6I-2500
ACEITE, REQUIERE 2 PIEZAS	GP-1	7W2327	HIDRAULICO (SELLADO)	GP-761H	144-6691	AIRE	GA-8047	6I-2499
COMBUSTIBLE, SEPARADOR DE AGUA	GPP-425	138-3100	AIRE, PRIMARIO RADIAL	GA-499R	6I2499			
ACEITE, TREN DE PODER	GP-761H	1G8878	AP1050 ASFALTADORA con motor/CATERPILLAR 3116			BP100 con motor/PERKINS 4.236		
AIRE, PRIMARIO	GA-697R	152-7217	ACEITE	GP-51	1R0739	ACEITE	GP-1	7W2327
AIRE DE CABINA	GA-240	107-0266	COMBUSTIBLE, 5 13/32 IN	GP-62	1R0751	COMBUSTIBLE	G-296	67-6987
			COMBUSTIBLE, 7 13/32 IN	GP-1109	1R0751	COMBUSTIBLE	G-296-B	676987
574 con motor/CATERPILLAR 3126			COMBUSTIBLE, 7 1/8 IN	GP-110	1R0750			
ACEITE	GP-51	1R0739	AIRE, PRIMARIO ESTANDAR	GA-8047	7W5389	PM con motor/A DIESEL		
COMBUSTIBLE, REQUIERE 2 PIEZAS	GP-1109	1R0751	AIRE, PRIMARIO RADIAL	GA-499R	6I2499	COMBUSTIBLE, SELLADO	GP-749	1R0749
COMBUSTIBLE, SEPARADOR DE AGUA, HASTA S/N 1FM261	GPP-424	117-4089	AP1055 ASFALTADORA con motor/CATERPILLAR 3116			ACEITE, CUMPLE CON MEDIDAS ORIGINALES	GP-691	1R0716
ACEITE, TREN DE PODER	GP-761H	1G8878	GASOLINA, SEPARADOR DE AGUA	G-293	8N9803	ACEITE, SEGUNDA OPCION	GP-52	1R0716
AIRE, PRIMARIO	GA-697R	152-7217	ACEITE	GP-51	1R0739	PM465 con motor/CATERPILLAR 3406C		
			COMBUSTIBLE, 5 13/32 IN	GP-62	1R0751	COMBUSTIBLE	GP-749	1R0749
574B con motor/CATERPILLAR 3056E			COMBUSTIBLE, 7 13/32 IN	GP-1109	1R0751	ACEITE, CUMPLE CON MEDIDAS ORIGINALES	GP-691	1R0716
ACEITE, REQUIERE 2 PIEZAS	GP-1	7W2327	AIRE, PRIMARIO RADIAL	GA-499R	6I2499	ACEITE, SEGUNDA OPCION	GP-52	1R0716
COMBUSTIBLE, SEPARADOR DE AGUA	GPP-425	138-3100	AP1200 ASFALTADORA con motor/PERKINS 6.354			HIDRAULICO	GP-761H	1G8878
ACEITE, TREN DE PODER	GP-761H	1G8878	ACEITE	GP-1	7W2327	PM565 con motor/CATERPILLAR 3408		
AIRE, PRIMARIO	GA-697R	152-7217	COMBUSTIBLE	G-296	67-6987	TRANSMISION	G-152	1R0719
AIRE DE CABINA S/N RLS1 EN DELANTE	GA-240	107-0266	COMBUSTIBLE	G-296-B	67-6987	COMBUSTIBLE	GP-749	1R0749
			AP200 ASFALTADORA con motor/DEUTZ F2L511D			ACEITE, CUMPLE CON MEDIDAS ORIGINALES	GP-691	1R0716
950 con motor/A DIESEL			ACEITE	GP-28	1174484	ACEITE, SEGUNDA OPCION	GP-52	1R0716
TRANSMISION	G-152	1R0719	AP650B ASFALTADORA con motor/CATERPILLAR 3054			AGUA, PRE-CARGA	GP-1013Q	1W5518
ACEITE, TANQUE HIDRAULICO	G-222	1R0741	ACEITE	GP-31	7W2326	AGUA, MANTENIMIENTO	GP-1011Q	9N6123
ACEITE	GP-51	1R0739	COMBUSTIBLE, TREN DE PODER	GP-66	77-3492	HIDRAULICO	GP-761H	1G8878
COMBUSTIBLE	GP-110	1R0740	COMBUSTIBLE, SEPARADOR DE AGUA	GPP-424	117-4089	AIRE, SECUNDARIO ESTANDAR	GA-482	7N1308
AIRE, SECUNDARIO	GA-1285	2S1285	HIDRAULICO (SELLADO)	GP-761H	144-6691			
AIRE, PRIMARIO	GA-8047	4M8047	COMBUSTIBLE	GPP-419	159-6102	PM565B con motor/CATERPILLAR 3408C		
			AP800 ASFALTADORA, AP800B ASFALTADORA con motor/PERKINS 4.236			TRANSMISION	G-152	1R0719
FB221 con motor/A DIESEL			ACEITE	GP-1	7W2327	COMBUSTIBLE, SELLADO	GP-749	1R0749
GASOLINA, SEPARADOR DE AGUA	G-293	8N9803	COMBUSTIBLE	G-296	67-6987	ACEITE, CUMPLE CON MEDIDAS ORIGINALES	GP-691	1R0716
			COMBUSTIBLE	G-296-B	67-6987	ACEITE, SEGUNDA OPCION	GP-52	1R0716
FB508 con motor/CATERPILLAR 3204			HIDRAULICO (SELLADO)	GP-761H	144-6691	AGUA, PRE-CARGA	GP-1013Q	1W5518
COMBUSTIBLE	GP-110	1P2299	AP900B ASFALTADORA con motor/CATERPILLAR 3116			AGUA, MANTENIMIENTO	GP-1011Q	9N6123
TRANSMISION	GP-761H	90-2900	ACEITE	GP-51	1R0739	HIDRAULICO	GP-761H	1G8878
AIRE, PRIMARIO	GA-8047	7W5389	COMBUSTIBLE, 5 13/32 IN	GP-62	1R0751	PM800 con motor/A DIESEL		
			COMBUSTIBLE	GP-1109	1R0751	ACEITE, CUMPLE CON MEDIDAS ORIGINALES	GP-691	1R0716
FB518 con motor/A DIESEL			HIDRAULICO (SELLADO)	GP-761H	144-6691	ACEITE, SEGUNDA OPCION	GP-52	1R0716
ACEITE, TANQUE HIDRAULICO	G-152	9M9740	AP800C ASFALTADORA con motor/CATERPILLAR 3054			COMBUSTIBLE	GP-1108	1R0712
TRANSMISION	G-152	9M9740	ACEITE	GP-31	7W2326			
ACEITE	GP-51	2P4004	GASOLINA, SEPARADOR DE AGUA	G-293	8N9803	PR100, PR100DC EQUIPO PARA PAVIMENTACION con motor/A DIESEL		
COMBUSTIBLE	GP-110	1P2299	HIDRAULICO (SELLADO)	GP-761H	144-6691	COMBUSTIBLE	GP-110	1R0740
AIRE, SECUNDARIO	GA-1285	2S1285	COMBUSTIBLE	GPP-419	159-6102			
AIRE, PRIMARIO	GA-8047	7W5389	AP900B ASFALTADORA con motor/CATERPILLAR 3116			PR1000 con motor/CATERPILLAR 3208		
			ACEITE	GP-51	1R0739	GASOLINA, SEPARADOR DE AGUA	G-293	8N9803
			COMBUSTIBLE, 5 13/32 IN	GP-62	1R0751	COMBUSTIBLE	GP-110	1P2299
			COMBUSTIBLE, 7 13/32 IN	GP-1109	1R0751	AGUA, PRE-CARGA	GP-1011Q	9N3367
			HIDRAULICO (SELLADO)	GP-761H	144-6691	AGUA, MANTENIMIENTO	GP-2071W	9N3368
			AIRE, PRIMARIO RADIAL	GA-499R	6I2499			

SERVICIO PESADO

MARCA-MODELO-MOTOR MAKE-MODEL-ENGINE	GONHER GONHER	OEM OEM	MARCA-MODELO-MOTOR MAKE-MODEL-ENGINE	GONHER GONHER	OEM OEM	MARCA-MODELO-MOTOR MAKE-MODEL-ENGINE	GONHER GONHER	OEM OEM
CATERPILLAR (continuación)			CATERPILLAR (continuación)			CATERPILLAR (continuación)		
EQUIPO PARA CONSTRUCCION VIAL			EQUIPO PARA CONSTRUCCION VIAL			EQUIPO PARA CONSTRUCCION VIAL		
AIRE, PRIMARIO	GA-356	6N6071	PR750C con motor/A DIESEL			SF250 ASFALTADORA con motor/KOMATSU		
AIRE, PRIMARIO	GA-360	8T5600	COMBUSTIBLE	GP-749	1R0749	AIRE	GA-326	8T-8076
AIRE, SECUNDARIO	GA-357	6N6072				SF250 con motor/A DIESEL		
PR1000 con motor/CATERPILLAR 3412			PST300 con motor/A DIESEL			ACEITE	GP-36	9L9200
COMBUSTIBLE, SELLADO	GP-749	1R0749	ACEITE	GP-51	1R0739	COMBUSTIBLE	GP-110	1R0750
ACEITE, CUMPLE CON MEDIDAS ORIGINALES	GP-691	1R0716	RL200 con motor/A DIESEL			ACEITE	GP-9586	8N9586
GASOLINA, SEPARADOR DE AGUA	G-293	8N9803	ACEITE	GP-36	4-99129-200	SF250B con motor/CATERPILLAR 3208		
ACEITE, SEGUNDA OPCION	GP-52	1R0716	RM250C con motor/CATERPILLAR 3406C			GASOLINA, SEPARADOR DE AGUA	G-293	8N9803
AGUA, PRE-CARGA	GP-1011Q	9N3367	COMBUSTIBLE, SELLADO	GP-749	1R0749	COMBUSTIBLE	GP-110	1P2299
AGUA, MANTENIMIENTO	GP-2071W	9N3368	ACEITE, CUMPLE CON MEDIDAS ORIGINALES	GP-691	1R0716	AIRE, PRIMARIO	GA-106	8T8076
AIRE, PRIMARIO	GA-356	6N6074	ACEITE, SEGUNDA OPCION	GP-52	1R0716	SF350 con motor/A DIESEL		
AIRE, PRIMARIO	GA-360	8T5600	ACEITE, ACCESORIO HIDRAULICO (SELLADO)	GP-761H	144-6691	ACEITE	GP-51	1R0739
AIRE, SECUNDARIO	GA-357	6N6072	RM350 con motor/CATERPILLAR 3406E			COMBUSTIBLE, SELLADO	GP-110	1R0740
PR1000C con motor/CATERPILLAR 3208			COMBUSTIBLE, SELLADO	GP-749	1R0749	AIRE	GA-5648	255648
GASOLINA, SEPARADOR DE AGUA	G-293	8N9803	ACEITE, CUMPLE CON MEDIDAS ORIGINALES	GP-691	1R0716	SF360 ASFALTADORA con motor/A DIESEL		
COMBUSTIBLE, SELLADO	GP-110	1R0750	ACEITE, SEGUNDA OPCION	GP-52	1R0716	ACEITE	GP-51	1R0739
AGUA, PRE-CARGA	GP-1011Q	9N3367	AGUA	GP-1011Q	9N6123	SF450 con motor/A DIESEL		
AGUA, MANTENIMIENTO	GP-2071W	9N3368	HIDRAULICO (SELLADO)	GP-761H	144-6691	ACEITE	GP-51	1R0739
AIRE, PRIMARIO	GA-106	8T8076	AIRE, PRIMARIO ESTANDAR	GA-483	7W5313	COMBUSTIBLE	GP-110	1R0740
AIRE, PRIMARIO	GA-356	6N6071	AIRE, SECUNDARIO ESTANDAR	GA-482	1P8482	AIRE	GA-5648	255648
AIRE, SECUNDARIO	GA-206	8C3047	RM350B con motor/A DIESEL			SF500 ASFALTADORA con motor/A DIESEL		
AIRE, SECUNDARIO	GA-357	6N6072	COMBUSTIBLE, SELLADO	GP-749	1R0749	ACEITE	G-238	4-95190-485
PR105 con motor/A DIESEL			ACEITE, CUMPLE CON MEDIDAS ORIGINALES	GP-691	1R0716	SF550 con motor/CATERPILLAR 3406		
ACEITE	GP-36	1R0734	ACEITE, SEGUNDA OPCION	GP-52	1R0716	ACEITE, CUMPLE CON MEDIDAS ORIGINALES	GP-691	1R0716
PR275 con motor/A DIESEL			AGUA, PRE-CARGA	GP-1011Q	9N3367	ACEITE, SEGUNDA OPCION	GP-52	1R0716
ACEITE	GP-51	1R0739	AGUA, MANTENIMIENTO	GP-2071W	9N3368	COMBUSTIBLE, SELLADO	GP-1108	1R0712
PR450 con motor/DETROIT DIESEL			HIDRAULICO (SELLADO)	GP-761H	144-6691	SM350 con motor/A DIESEL		
COMBUSTIBLE, PRIMARIO	GP-26	6438839	RR250 con motor/CATERPILLAR 3406B			COMBUSTIBLE, SELLADO	GP-749	1R0749
COMBUSTIBLE, SECUNDARIO	GP-27	23518482	COMBUSTIBLE	GP-749	1R0749	ACEITE, CUMPLE CON MEDIDAS ORIGINALES	GP-691	1R0716
ACEITE	GP-43	25010495	ACEITE, CUMPLE CON MEDIDAS ORIGINALES	GP-691	1R0716	ACEITE, SEGUNDA OPCION	GP-52	1R0716
PR450, PR450C con motor/CATERPILLAR 3408			ACEITE, SEGUNDA OPCION	GP-52	1R0716	AGUA	GP-1011Q	9N6123
COMBUSTIBLE, SELLADO	GP-749	1R0749	AGUA	GP-1011Q	9N3718	HIDRAULICO (SELLADO)	GP-761H	144-6691
ACEITE, CUMPLE CON MEDIDAS ORIGINALES	GP-691	1R0716	AIRE, PRIMARIO	GA-356	6N6071	AIRE, PRIMARIO ESTANDAR	GA-483	7W5313
ACEITE, SEGUNDA OPCION	GP-52	1R0716	AIRE, SECUNDARIO	GA-357	6N6072	AIRE, SECUNDARIO ESTANDAR	GA-482	1P8482
AGUA, PRE-CARGA	GP-1011Q	9N3367	AIRE, PRIMARIO	GA-483	7W5313	SS250 con motor/CATERPILLAR 3406B		
AGUA, MANTENIMIENTO	GP-2071W	9N3368	AIRE, SECUNDARIO	GA-482	1P8482	COMBUSTIBLE, SELLADO	GP-749	1R0749
PR75 con motor/JOHN DEERE 4219			RR250B, SS250B con motor/CATERPILLAR 3406C			ACEITE, CUMPLE CON MEDIDAS ORIGINALES	GP-691	1R0716
ACEITE	GP-14	6E-0924	COMBUSTIBLE, SELLADO	GP-749	1R0749	ACEITE, SEGUNDA OPCION	GP-52	1R0716
PR75 con motor/PERKINS 4.236			ACEITE, CUMPLE CON MEDIDAS ORIGINALES	GP-691	1R0716	AGUA	GP-1011Q	9N3718
ACEITE	GP-1	7W2327	ACEITE, SEGUNDA OPCION	GP-52	1R0716	AIRE, PRIMARIO	GA-356	6N6071
COMBUSTIBLE	G-296	67-6987	AGUA	GP-1011Q	9N3367	AIRE, SECUNDARIO	GA-357	6N6072
COMBUSTIBLE	G-296-B	67-6987	HIDRAULICO (SELLADO)	GP-761H	144-6691	AIRE, PRIMARIO	GA-483	7W5313
PR750B con motor/CATERPILLAR 3412			SF175 con motor/A DIESEL			AIRE, SECUNDARIO	GA-482	1P8482
COMBUSTIBLE, SELLADO	GP-749	1R0749	COMBUSTIBLE	GP-110	1R0750	TC250, TF250 con motor/JOHN DEERE		
ACEITE, CUMPLE CON MEDIDAS ORIGINALES	GP-691	1R0716	SF176 ASFALTADORA con motor/A DIESEL			ACEITE	GP-14	6E-0924
ACEITE, SEGUNDA OPCION	GP-52	1R0716	COMBUSTIBLE	GP-110	1R0740	COMBUSTIBLE	G-296	67-6987
AGUA, PRE-CARGA	GP-1011Q	9N3367	SF250 ASFALTADORA con motor/CATERPILLAR 3208			COMBUSTIBLE	G-295	3I-1233
AGUA, MANTENIMIENTO	GP-2071W	9N3368	ACEITE	GP-51	1R0739	COMBUSTIBLE	G-296-B	67-6987
AIRE, PRIMARIO	GA-356	6N6071	SF250 ASFALTADORA con motor/CUMMINS			TR225B con motor/CATERPILLAR 3208		
AIRE, PRIMARIO	GA-360	8T5600	AIRE	GA-106	8T-8076	COMBUSTIBLE	GP-110	1R0740
AIRE, SECUNDARIO	GA-357	6N6072						

MARCA-MODELO-MOTOR MAKE-MODEL-ENGINE	GONHER GONHER	OEM OEM	MARCA-MODELO-MOTOR MAKE-MODEL-ENGINE	GONHER GONHER	OEM OEM	MARCA-MODELO-MOTOR MAKE-MODEL-ENGINE	GONHER GONHER	OEM OEM
CATERPILLAR (continuación)			CATERPILLAR (continuación)			CATERPILLAR (continuación)		
EXCAVADORAS			EXCAVADORAS			EXCAVADORAS		
225D con motor/CATERPILLAR 3208			231D, 231D LC con motor/CATERPILLAR 3208			ACEITE, FLUJO TOTAL (FULL FLOW) (SEGUNDA OPCION)		
ACEITE, BOMBA HIDRAULICA	G-152	9M9740	ACEITE, BOMBA HIDRAULICA	G-152	9M9740	AGUA, PRE-CARGA	GP-52	1R0716
ACEITE, CONTROL HIDRAULICO	G-222	4J6064	ACEITE, CONTROL HIDRAULICO	G-222	4J6064	AGUA, MANTENIMIENTO	GP-1013Q	1W5518
ACEITE, RETORNO HIDRAULICO	G-153	7J0670	ACEITE, RETORNO HIDRAULICO	G-153	7J0670	COMBUSTIBLE	GP-1108	1R0712
ACEITE	GP-36	9L9200	GASOLINA, SEPARADOR DE AGUA	G-293	8N9803	ACEITE, DERIVACION (BY PASS)	GP-57	1W8845
COMBUSTIBLE	GP-110	1P2299	COMBUSTIBLE	GP-110	1P2299	AGUA, MANTENIMIENTO	GP-1011Q	9N3718
ACEITE	GP-9586	1R0713	AIRE, SECUNDARIO	GA-1287	2S1287	AIRE, PRIMARIO	GA-483	7W5313
AIRE, SECUNDARIO	GA-1287	2S1287	AIRE, PRIMARIO	GA-9045	7W5316	AIRE, SECUNDARIO	GA-482	1P8482
AIRE, PRIMARIO	GA-9045	7W5316	235 con motor/CATERPILLAR 3306			301.5, 301.6, 301.8 con motor/CATERPILLAR 3003		
225D con motor/CATERPILLAR 3304			235 con motor/CATERPILLAR 3306			ACEITE		
ACEITE, BOMBA HIDRAULICA	G-152	9M9740	ACEITE, BOMBA HIDRAULICA	G-152	9M9740	COMBUSTIBLE, SEPARADOR DE AGUA	GPP-420	156-1200
ACEITE, ACCESORIO HIDRAULICO	G-222	4J6064	ACEITE, CONTROL HIDRAULICO	G-222	4J6064	AIRE, RADIAL	GA-880R	146-7472
ACEITE, LINEA DE RETORNO HIDRAULICO	G-153	7J0670	ACEITE, RETORNO HIDRAULICO	G-153	7J0670	302.5 con motor/CATERPILLAR 3013		
GASOLINA, SEPARADOR DE AGUA	G-293	6N7617	GASOLINA, SEPARADOR DE AGUA	G-293	8N9803	ACEITE	GP-81	150-4140
ACEITE	GP-51	2P4004	ACEITE	GP-51	2P4004	HIDRAULICO	GP-864H	9T8578
COMBUSTIBLE	GP-110	1P2299	COMBUSTIBLE	GP-1108	4N5823	COMBUSTIBLE, SEPARADOR DE AGUA	GPP-420	156-1200
AIRE, SECUNDARIO	GA-1286	2S1286	COMBUSTIBLE	GP-110	1P2299	AIRE, RADIAL PRIMARIO	GA-880R	146-7472
AIRE, PRIMARIO	GA-9334	4M9334	AIRE, SECUNDARIO	GA-1287	2S1287	303.5 con motor/CATERPILLAR 3013		
225D LC SERIES con motor/CATERPILLAR 3304			235B, 235C, 235D con motor/CATERPILLAR 3306			ACEITE		
HIDRAULICO VERTICAL	G-152	9M9740	ACEITE, BOMBA HIDRAULICA	G-152	9M9740	COMBUSTIBLE, SEPARADOR DE AGUA	GPP-420	156-1200
TRANSMISION	G-222	4J6064	ACEITE, ACCESORIO PARA CONTROLES HIDRAULICOS	G-222	4J6064	AIRE, RADIAL PRIMARIO	GA-880R	121-3661
ACEITE	GP-51	1W3300	ACEITE, RETORNO HIDRAULICO	G-153	7J0670	303C CR con motor/MITSUBISHI S3Q2		
COMBUSTIBLE	GP-110	1R0740	ACEITE	GP-51	1R0658	COMBUSTIBLE, SEPARADOR DE AGUA	GPP-420	156-1200
AIRE, SECUNDARIO	GA-1286	2S1286	COMBUSTIBLE	GP-110	1R0750	303CR con motor/CATERPILLAR 3013		
AIRE, PRIMARIO	GA-9334	7W5317	AIRE, SECUNDARIO	GA-1287	2S1287	ACEITE	GP-81	150-4140
227 con motor/A DIESEL (S/N 10W1 EN ADELANTE)			245 con motor/CATERPILLAR 3406			304.5 con motor/CATERPILLAR 3024		
HIDRAULICO	G-153	7J0670	ACEITE, BOMBA HIDRAULICA	G-153	7J0670	ACEITE	GP-81	150-4140
COMBUSTIBLE, SEPARADOR DE AGUA	GPP-11	175-2949	ACEITE, RETORNO HIDRAULICO	G-153	7J0670	COMBUSTIBLE, SEPARADOR DE AGUA	GPP-420	156-1200
COMBUSTIBLE	GP-110	1P2299	ACEITE, FLUJO TOTAL (FULL FLOW) (CUMPLE CON MEDIDAS ORIGINALES)	GP-691	2P4005	AIRE, RADIAL PRIMARIO	GA-880R	121-3661
ACEITE	GP-9586	8N9586	ACEITE, FLUJO TOTAL (FULL FLOW) (SEGUNDA OPCION)	GP-52	2P4005	305C CR con motor/MITSUBISHI S4Q2T		
AIRE, SECUNDARIO	GA-1286	2S1286	AGUA, PRE-CARGA	GP-1013Q	1W5518	COMBUSTIBLE, SEPARADOR DE AGUA	GPP-420	156-1200
AIRE, PRIMARIO	GA-9334	7W5317	COMBUSTIBLE	GP-1108	4N5823	305CR con motor/MITSUBISHI K4N		
229 con motor/CATERPILLAR 3208			245B SERIES II con motor/A DIESEL			COMBUSTIBLE		
ACEITE, BOMBA HIDRAULICA	G-152	9M9740	HIDRAULICO	G-153	1R0732	ACEITE, FLUJO TOTAL (FULL FLOW)	GP-3985	94-7207
ACEITE, ACCESORIO HIDRAULICO	G-222	4J6064	COMBUSTIBLE, SECUNDARIO	GP-749	1R0749	307 con motor/CATERPILLAR 3054		
ACEITE, RETORNO HIDRAULICO	G-153	7J0670	ACEITE, CUMPLE CON MEDIDAS ORIGINALES	GP-691	1R0716	ACEITE	GP-1	7W2327
COMBUSTIBLE	GP-110	1P2299	ACEITE, SEGUNDA OPCION	GP-52	1R0716	COMBUSTIBLE, SEPARADOR DE AGUA	GPP-425	100-6374
ACEITE	GP-9586	1R0713	ACEITE, DERIVACION (BY PASS)	GP-57	1W8845	COMBUSTIBLE	GPP-419	100-5593
AIRE, SECUNDARIO	GA-1286	2S1286	AGUA, MANTENIMIENTO	GP-1011Q	9N3367	AIRE, RADIAL PRIMARIO	GA-853R	110-6326
AIRE, PRIMARIO	GA-9334	4M9334	AGUA, MANTENIMIENTO	GP-2071W	9N3368	307 con motor/MITSUBISHI 4D32		
229 con motor/CATERPILLAR 3304			245B, 245D con motor/CATERPILLAR 3406			ACEITE, FLUJO TOTAL (FULL FLOW)		
ACEITE, RETORNO HIDRAULICO	G-153	7J0670	ACEITE, BOMBA HIDRAULICA	G-153	7J0670	ACEITE, FLUJO TOTAL (FULL FLOW)	GP-3985	94-7207
ACEITE	GP-51	1W3300	ACEITE, RETORNO HIDRAULICO	G-153	7J0670	307L con motor/A DIESEL		
COMBUSTIBLE	GP-110	1P2299	COMBUSTIBLE	GP-749	1R0749	ACEITE	GP-3985	947207
AIRE, SECUNDARIO	GA-1286	2S1286	ACEITE, CUMPLE CON MEDIDAS ORIGINALES	GP-691	1R0716	311, 312 con motor/CATERPILLAR 3064		
AIRE, PRIMARIO	GA-9334	7W5317	ACEITE, SEGUNDA OPCION	GP-52	1R0716	ACEITE	GP-51	1R0739
229D con motor/CATERPILLAR 3304			245B, 245D con motor/CATERPILLAR 3406			311B con motor/CATERPILLAR 3064		
ACEITE, RETORNO HIDRAULICO	G-153	7J0670	ACEITE, BOMBA HIDRAULICA	G-153	7J0670	ACEITE	GP-51	1R0739
ACEITE	GP-51	1W3300	ACEITE, RETORNO HIDRAULICO	G-153	7J0670	ACEITE, TANQUE HIDRAULICO	GP-166	93-7521
COMBUSTIBLE	GP-110	1P2299	COMBUSTIBLE	GP-749	1R0749			
AIRE, SECUNDARIO	GA-1286	2S1286	ACEITE, FLUJO TOTAL (FULL FLOW) (CUMPLE CON MEDIDAS ORIGINALES)	GP-691	1R0716			
AIRE, PRIMARIO	GA-9334	7W5317						

MARCA-MODELO-MOTOR MAKE-MODEL-ENGINE	GONHER GONHER	OEM OEM	MARCA-MODELO-MOTOR MAKE-MODEL-ENGINE	GONHER GONHER	OEM OEM	MARCA-MODELO-MOTOR MAKE-MODEL-ENGINE	GONHER GONHER	OEM OEM
CATERPILLAR (continuación)			CATERPILLAR (continuación)			CATERPILLAR (continuación)		
EXCAVADORAS			EXCAVADORAS			EXCAVADORAS		
AIRE, RADIAL PRIMARIO	GA-853R	131-8902	314C CR, 314C LCR con motor/CATERPILLAR 3064T			318C, 318C L, 318C LN con motor/CATERPILLAR 3066		
311CU con motor/A DIESEL			ACEITE	GP-51	1R0739	ACEITE	GP-51	1R0739
ACEITE	GP-51	1R0739	COMBUSTIBLE	GP-1109	1R0751	COMBUSTIBLE	GP-1109	1R0751
COMBUSTIBLE	GPP-424	117-4089	ACEITE, DRENADO DE LA CAJA HIDRAULICA	GP-166	93-7521	COMBUSTIBLE, SEPARADOR DE AGUA	GPP-424	117-4089
HIDRAULICO	GP-166	93-7521	AIRE, RADIAL PRIMARIO	GA-853R	131-8902	AIRE, RADIAL, PRIMARIO	GA-697R	152-7217
312 con motor/CATERPILLAR 3054			315 con motor/CATERPILLAR 3046			319C LN con motor/CATERPILLAR 3066		
ACEITE	GP-31	7W2326	ACEITE	GP-36	1R0734	ACEITE	GP-51	1R0739
COMBUSTIBLE	GPP-419	138-3098	315 con motor/CATERPILLAR 3054			COMBUSTIBLE	GP-1109	1R0751
AIRE, RADIAL PRIMARIO	GA-853R	110-6326	ACEITE	GP-31	7W2326	COMBUSTIBLE, SEPARADOR DE AGUA	GPP-424	117-4089
312B con motor/CATERPILLAR 3064			COMBUSTIBLE, SEPARADOR DE AGUA	GPP-425	138-3100	AIRE, PRIMARIO	GA-697R	152-7217
ACEITE	GP-51	1R0739	COMBUSTIBLE	GPP-419	138-3098	320 con motor/CATERPILLAR 3066		
ACEITE, TANQUE HIDRAULICO	GP-166	93-7521	AIRE, RADIAL PRIMARIO	GA-853R	110-6326	ACEITE	GP-51	1R0739
AIRE, RADIAL PRIMARIO	GA-853R	110-6326	315B L con motor/CATERPILLAR 3054			320 con motor/CATERPILLAR 3116		
312B L con motor/CATERPILLAR 3064			ACEITE	GP-31	7W2326	ACEITE	GP-51	1R0658
ACEITE	GP-51	1R0739	COMBUSTIBLE, SEPARADOR DE AGUA	GPP-425	138-3100	COMBUSTIBLE, 5 13/32 IN	GP-62	1R0751
ACEITE, TANQUE HIDRAULICO	GP-166	93-7521	ACEITE, RETORNO HIDRAULICO	GP-166	93-7521	COMBUSTIBLE, 7 13/32 IN	GP-1109	1R0751
AIRE, RADIAL PRIMARIO	GA-853R	110-6326	COMBUSTIBLE	GPP-419	159-6102	320B con motor/CATERPILLAR 3066		
312B L con motor/PERKINS			AIRE, RADIAL PRIMARIO	GA-853R	110-6326	ACEITE	GP-51	1R0739
ACEITE	GP-31	7W2326	315B, 315B L con motor/CATERPILLAR 3046			COMBUSTIBLE, 5 13/32 IN	GP-62	1R0751
ACEITE	GP-166	93-7521	ACEITE	GP-36	1R0734	COMBUSTIBLE, 7 13/32 IN	GP-1109	1R0751
COMBUSTIBLE	GPP-419	138-3098	315C con motor/CATERPILLAR 3046			COMBUSTIBLE, SEPARADOR DE AGUA	GPP-424	117-4089
312B, 312B L con motor/CATERPILLAR 3054			ACEITE	GP-51	1R0739	HIDRAULICO PILOTO	GP-166	93-7521
ACEITE	GP-31	7W2326	COMBUSTIBLE, 5 13/32 IN	GP-62	1R0751	320B con motor/CATERPILLAR 3116		
COMBUSTIBLE, SEPARADOR DE AGUA	GPP-425	138-3100	COMBUSTIBLE, 7 13/32 IN	GP-1109	1R0751	ACEITE	GP-51	1R0739
ACEITE, TANQUE HIDRAULICO	GP-166	93-7521	COMBUSTIBLE, SEPARADOR DE AGUA	GPP-424	117-4089	COMBUSTIBLE, 5 13/32 IN	GP-62	1R0751
COMBUSTIBLE	GPP-419	159-6102	AIRE, RADIAL, PRIMARIO	GA-697R	152-7217	COMBUSTIBLE, 7 13/32 IN	GP-1109	1R0751
AIRE, RADIAL PRIMARIO	GA-853R	110-6326	315C L con motor/CATERPILLAR 3046			COMBUSTIBLE, SEPARADOR DE AGUA	GPP-424	117-4089
312C con motor/CATERPILLAR 3054			ACEITE	GP-51	1R0739	ACEITE, RETORNO HIDRAULICO	GP-166	93-7521
ACEITE	GP-31	7W2326	COMBUSTIBLE, 5 13/32 IN	GP-62	1R0751	320B L con motor/CATERPILLAR 3066		
COMBUSTIBLE, SEPARADOR DE AGUA	GPP-424	117-4089	COMBUSTIBLE, 7 13/32 IN	GP-1109	1R0751	ACEITE	GP-51	1R0739
ACEITE, TANQUE HIDRAULICO	GP-166	93-7521	COMBUSTIBLE, SEPARADOR DE AGUA	GPP-424	117-4089	COMBUSTIBLE, 5 13/32 IN	GP-62	1R0751
COMBUSTIBLE	GPP-419	159-6102	AIRE, RADIAL, PRIMARIO	GA-697R	130-4678	COMBUSTIBLE, 7 13/32 IN	GP-1109	1R0751
AIRE, RADIAL PRIMARIO	GA-853R	110-6326	315D L con motor/CATERPILLAR C4.2			COMBUSTIBLE, SEPARADOR DE AGUA	GPP-424	117-4089
312C con motor/CATERPILLAR 3064T			ACEITE	GP-51	1R0739	HIDRAULICO PILOTO	GP-166	93-7521
ACEITE	GP-51	1R0739	COMBUSTIBLE, REQUIERE 2 PIEZAS	GP-110	1R0750	320B L, 320B LN con motor/CATERPILLAR 3116		
COMBUSTIBLE	GP-1109	1R0751	AIRE, RADIAL, PRIMARIO, EXC. S/N NCM	GA-697R	152-7217	ACEITE	GP-51	1R0739
COMBUSTIBLE, SEPARADOR DE AGUA	GPP-424	117-4089	315L con motor/CATERPILLAR 3046			COMBUSTIBLE, 5 13/32 IN	GP-62	1R0751
ACEITE, TANQUE HIDRAULICO	GP-166	93-7521	ACEITE, SECUNDARIO	GP-36	1R0734	COMBUSTIBLE, 7 13/32 IN	GP-1109	1R0751
AIRE, RADIAL PRIMARIO	GA-853R	110-6326	317 con motor/PERKINS			COMBUSTIBLE, SEPARADOR DE AGUA	GPP-424	117-4089
312C L con motor/CATERPILLAR 3054			ACEITE	GP-31	7W2326	ACEITE, RETORNO HIDRAULICO	GP-166	93-7521
ACEITE	GP-31	7W2326	317B L, 317B LN, 318B L, 318B LN con motor/CATERPILLAR 3046			320B LU, 320B N con motor/CATERPILLAR 3066		
COMBUSTIBLE, SEPARADOR DE AGUA	GPP-424	117-4089	ACEITE	GP-36	1R0734	ACEITE	GP-51	1R0739
ACEITE, TANQUE HIDRAULICO	GP-166	93-7521	317N con motor/CATERPILLAR 3054			COMBUSTIBLE, 5 13/32 IN	GP-62	1R0751
COMBUSTIBLE	GPP-419	159-6102	ACEITE	GP-31	7W2326	COMBUSTIBLE, 7 13/32 IN	GP-1109	1R0751
AIRE, RADIAL PRIMARIO	GA-853R	110-6326	COMBUSTIBLE, SEPARADOR DE AGUA	GPP-425	100-6374	COMBUSTIBLE, SEPARADOR DE AGUA	GPP-424	117-4089
312C L con motor/CATERPILLAR 3064T			COMBUSTIBLE	GPP-419	138-3098	HIDRAULICO PILOTO	GP-166	93-7521
ACEITE	GP-51	1R0739	AIRE, RADIAL PRIMARIO	GA-853R	110-6326	320B N, 320B S con motor/CATERPILLAR 3116		
COMBUSTIBLE	GP-1109	1R0751				ACEITE	GP-51	1R0739
COMBUSTIBLE, SEPARADOR DE AGUA	GPP-424	117-4089				COMBUSTIBLE, 5 13/32 IN	GP-62	1R0751
ACEITE, TANQUE HIDRAULICO	GP-166	93-7521				COMBUSTIBLE, 7 13/32 IN	GP-1109	1R0751
AIRE, RADIAL PRIMARIO	GA-853R	110-6326						

SERVICIO PESADO

MARCA-MODELO-MOTOR MAKE-MODEL-ENGINE	GONHER GONHER	OEM OEM	MARCA-MODELO-MOTOR MAKE-MODEL-ENGINE	GONHER GONHER	OEM OEM	MARCA-MODELO-MOTOR MAKE-MODEL-ENGINE	GONHER GONHER	OEM OEM
CATERPILLAR (continuación)			CATERPILLAR (continuación)			CATERPILLAR (continuación)		
EXCAVADORAS			EXCAVADORAS			EXCAVADORAS		
COMBUSTIBLE, SEPARADOR DE AGUA	GPP-424	117-4089	325 con motor/CATERPILLAR 3116			350L con motor/CATERPILLAR 3306		
ACEITE, RETORNO HIDRAULICO	GP-166	93-7521	ACEITE	GP-51	1R0739	ACEITE, TANQUE HIDRAULICO (SELLADO)	GP-34	4T6788
			COMBUSTIBLE, 5 13/32 IN	GP-62	1R0751	ACEITE	GP-52	1R0716
320B U con motor/CATERPILLAR 3066			COMBUSTIBLE, 7 13/32 IN	GP-1109	1R0751	DIESEL	GP-110	1R0750
ACEITE	GP-51	1R0739	COMBUSTIBLE, ACCESORIO	GP-110	1P2299	AIRE, PRIMARIO	GA-758	102-3765
COMBUSTIBLE, 5 13/32 IN	GP-62	1R0751				AIRE RADIAL, PRIMARIO	GA-600R	106-3969
COMBUSTIBLE, 7 13/32 IN	GP-1109	1R0751	325B, 325B L, 325B LN con motor/CATERPILLAR 3116			365 BL con motor/CATERPILLAR 3196		
COMBUSTIBLE, SEPARADOR DE AGUA	GPP-424	117-4089	ACEITE	GP-51	1R0739	ACEITE, CUMPLE CON MEDIDAS ORIGINALES	GP-691	1R0716
HIDRAULICO PILOTO	GP-166	93-7521	COMBUSTIBLE, 5 13/32 IN	GP-62	1R0751	ACEITE, TANQUE HIDRAULICO (SELLADO)	GP-34	31664
			COMBUSTIBLE, 7 13/32 IN	GP-1109	1R0751	ACEITE, SEGUNDA OPCION	GP-52	1R0716
320C, 320C L, 320C N con motor/CATERPILLAR 3066			COMBUSTIBLE, SEPARADOR DE AGUA	GPP-424	117-4089	COMBUSTIBLE	GP-110	1R0750
ACEITE	GP-51	1R0739	HIDRAULICO PILOTO	GP-166	93-7521	AIRE RADIAL, PRIMARIO	GA-600R	106-3969
COMBUSTIBLE, 5 13/32 IN	GP-62	1R0751				365 BLME con motor/CATERPILLAR 3196		
COMBUSTIBLE, 7 13/32 IN	GP-1109	1R0751	325L, 325LN con motor/CATERPILLAR 3116			ACEITE, CUMPLE CON MEDIDAS ORIGINALES	GP-691	1R0716
COMBUSTIBLE, SEPARADOR DE AGUA	GPP-424	117-4089	ACEITE	GP-51	1R0739	ACEITE, TANQUE HIDRAULICO (SELLADO)	GP-34	4T6788
ACEITE, RETORNO HIDRAULICO	GP-166	93-7521	COMBUSTIBLE, 5 13/32 IN	GP-62	1R0751	ACEITE, SEGUNDA OPCION	GP-52	1R0716
			COMBUSTIBLE, 7 13/32 IN	GP-1109	1R0751	COMBUSTIBLE	GP-110	1R0750
320L, 320N con motor/CATERPILLAR 3066			COMBUSTIBLE, ACCESORIO	GP-110	1P2299	AIRE RADIAL, PRIMARIO	GA-600R	106-3969
ACEITE	GP-51	1R0739				365B con motor/CATERPILLAR 3196		
			325N con motor/A DIESEL			DIESEL	GP-749	1R0762
320L, 320N, 320S con motor/CATERPILLAR 3116			ACEITE	GP-51	1R0739	ACEITE, TANQUE HIDRAULICO (SELLADO)	GP-34	4T6788
ACEITE	GP-51	1R0658	325W con motor/A DIESEL			ACEITE	GP-52	1R0716
COMBUSTIBLE, 5 13/32 IN	GP-62	1R0751	ACEITE	GP-51	1R0739	COMBUSTIBLE	GP-110	1R0750
COMBUSTIBLE, 7 13/32 IN	GP-1109	1R0751	330 con motor/CATERPILLAR 3306			AIRE RADIAL, PRIMARIO	GA-600R	106-3969
			ACEITE	GP-51	1R0739	365B SERIES II con motor/CATERPILLAR 3196		
321D LC con motor/A DIESEL						DIESEL	GP-749	1R0762
HIDRAULICO	G-152	1R0719	330B, 330BL con motor/CATERPILLAR 3306			ACEITE, TANQUE HIDRAULICO (SELLADO)	GP-34	4T6788
HIDRAULICO	G-222	1R0741	ACEITE	GP-51	1R0739	ACEITE	GP-52	1R0716
HIDRAULICO	G-153	1R0732	COMBUSTIBLE, SEPARADOR DE AGUA	GPP-424	117-4089	AIRE RADIAL, PRIMARIO	GA-600R	106-3969
GASOLINA	G-293	8N9803	COMBUSTIBLE	GP-110	1R0750	365B SERIES II con motor/CATERPILLAR 3196		
COMBUSTIBLE, SECUNDARIO	GP-110	1R0750	HIDRAULICO PILOTO	GP-166	93-7521	DIESEL	GP-749	1R0762
ACEITE	GP-9586	1R0713				ACEITE, TANQUE HIDRAULICO	GP-34	4T6788
AIRE, SECUNDARIO	GA-1286	2S1286	330L, 330LN con motor/CATERPILLAR 3306			ACEITE	GP-52	1R0716
AIRE, PRIMARIO	GA-9334	7W5317	ACEITE	GP-51	1R0739	AIRE RADIAL, PRIMARIO	GA-600R	106-3969
						365C, 365C L con motor/CATERPILLAR C15		
322 con motor/CATERPILLAR 3116			330N con motor/A DIESEL			ACEITE, TANQUE HIDRAULICO	GP-34	4T6788
ACEITE	GP-51	1R0739	ACEITE	GP-51	1R0739	ACEITE	GP-52	1R0716
COMBUSTIBLE, 5 13/32 IN	GP-62	1R0751				AIRE RADIAL, PRIMARIO	GA-600R	106-3969
COMBUSTIBLE, 7 13/32 IN	GP-1109	1R0751	345 L SERIES II, 345B, 345B L, 345B LC, 345B SERIES II con motor/CATERPILLAR 3176C			375 con motor/CATERPILLAR 3406		
			ACEITE, CUMPLE CON MEDIDAS ORIGINALES	GP-691	1R0716	COMBUSTIBLE	GP-749	1R0749
322B L, 322B LN con motor/CATERPILLAR 3116			ACEITE, SEGUNDA OPCION	GP-52	1R0716	ACEITE, CUMPLE CON MEDIDAS ORIGINALES	GP-691	1R0716
ACEITE	GP-51	1R0739	ACEITE, RETORNO HIDRAULICO	GP-166	93-7521	ACEITE, TANQUE HIDRAULICO (SELLADO)	GP-34	4T6788
COMBUSTIBLE, 5 13/32 IN	GP-62	1R0751	AIRE, PRIMARIO	GA-600R	106-3969	ACEITE, SEGUNDA OPCION	GP-52	1R0716
COMBUSTIBLE, 7 13/32 IN	GP-1109	1R0751				COMBUSTIBLE	GP-1108	1R0712
COMBUSTIBLE, SEPARADOR DE AGUA	GPP-424	117-4089	345C, 345C L con motor/CATERPILLAR C13			AGUA	GP-1011Q	9N3718
HIDRAULICO PILOTO	GP-166	93-7521	ACEITE	GP-52	1R1808	375L con motor/CATERPILLAR 3406		
						COMBUSTIBLE	GP-749	1R0749
322C con motor/CATERPILLAR 3126			350 con motor/CATERPILLAR 3306			ACEITE, CUMPLE CON MEDIDAS ORIGINALES	GP-691	1R0716
ACEITE	GP-51	1R0739	ACEITE, TANQUE HIDRAULICO (SELLADO)	GP-34	4T6788	ACEITE, TANQUE HIDRAULICO (SELLADO)	GP-34	4T6788
COMBUSTIBLE, 5 13/32 IN	GP-62	1R0751	ACEITE	GP-52	1R0716	ACEITE, SEGUNDA OPCION	GP-52	1R0716
COMBUSTIBLE, 7 13/32 IN	GP-1109	1R0751	DIESEL	GP-110	1R0750	COMBUSTIBLE	GP-1108	1R0712
COMBUSTIBLE, SEPARADOR DE AGUA	GPP-424	117-4089	AIRE, PRIMARIO	GA-758	102-3765	AGUA	GP-1011Q	9N3718
ACEITE, RETORNO HIDRAULICO	GP-166	93-7521	AIRE RADIAL, PRIMARIO	GA-600R	106-3969	385C, 385C L con motor/CATERPILLAR C18		
						ACEITE, TANQUE HIDRAULICO	GP-34	4T6788
322L, 322LN, 322N con motor/CATERPILLAR 3116			350B, 350BL con motor/A DIESEL			ACEITE	GP-52	1R1808
ACEITE	GP-51	1R0739	ACEITE, CUMPLE CON MEDIDAS ORIGINALES	GP-691	1R0716	AIRE RADIAL, PRIMARIO	GA-600R	106-3969
COMBUSTIBLE, 5 13/32 IN	GP-62	1R0751	ACEITE, SEGUNDA OPCION	GP-52	1R0716			
COMBUSTIBLE, 7 13/32 IN	GP-1109	1R0751	COMBUSTIBLE	GP-110	1R0750			

MARCA-MODELO-MOTOR MAKE-MODEL-ENGINE	GONHER GONHER	OEM OEM	MARCA-MODELO-MOTOR MAKE-MODEL-ENGINE	GONHER GONHER	OEM OEM	MARCA-MODELO-MOTOR MAKE-MODEL-ENGINE	GONHER GONHER	OEM OEM
CATERPILLAR (continuación)			CATERPILLAR (continuación)			CATERPILLAR (continuación)		
EXCAVADORAS			EXCAVADORAS			EXCAVADORAS		
5080 con motor/CATERPILLAR 3406			E180 con motor/CATERPILLAR 3204			HIDRAULICO (SELLADO)	GP-166	93-7521
COMBUSTIBLE	GP-749	1R0749	COMBUSTIBLE	GP-110	1R0750	AIRE, SECUNDARIO	GA-1285	2S1285
ACEITE, CUMPLE CON MEDI-DAS ORIGINALES	GP-691	1R0716	HIDRAULICO (SELLADO)	GP-166	93-7521	AIRE, PRIMARIO	GA-8047	7W5389
ACEITE, TANQUE HIDRAULICO (SELLADO)	GP-34	4T6788	AIRE, SECUNDARIO	GA-1285	1C6394			
ACEITE, SEGUNDA OPCION	GP-52	1R0716	AIRE, PRIMARIO	GA-8047	1C6391	EL200B con motor/MITSUBISHI S6KT		
COMBUSTIBLE	GP-1108	1R0712	E200B con motor/MITSUBISHI S6KT			HIDRAULICO (SELLADO)	GP-166	93-7521
AGUA	GP-1011Q	9N3718	HIDRAULICO (SELLADO)	GP-166	93-7521	EL240 con motor/CATERPILLAR 3304		
						ACEITE	GP-51	1W3300
5090B con motor/CATERPILLAR 3456			E200B, EL200B con motor/CATERPILLAR 3116T			COMBUSTIBLE	GP-110	1P2299
DIESEL (REQUIERE 2 PIEZAS)	GP-749	1R0762	ACEITE	GP-51	2P4004	HIDRAULICO (SELLADO)	GP-166	93-7521
ACEITE, TANQUE HIDRAULICO	GP-34	4T6788	COMBUSTIBLE, 5 13/32 IN	GP-62	1R0751	AIRE, SECUNDARIO	GA-1286	2S1286
ACEITE	GP-52	1R0716	COMBUSTIBLE, 7 13/32 IN	GP-1109	1R0751	AIRE, PRIMARIO	GA-9334	7W5317
AIRE RADIAL, PRIMARIO	GA-600R	106-3969	COMBUSTIBLE, 7 1/8 IN	GP-110	1R0750			
			HIDRAULICO (SELLADO)	GP-166	93-7521	EL240B, EL240C con motor/CATERPILLAR 3116T		
			AIRE, SECUNDARIO	GA-361	94-6352	ACEITE	GP-51	1R0739
						COMBUSTIBLE, 5 13/32 IN	GP-62	1R0751
5110 con motor/CATERPILLAR 3412			E240 con motor/CATERPILLAR 3304			COMBUSTIBLE, 7 13/32 IN	GP-1109	1R0751
COMBUSTIBLE	GP-749	1R0749	ACEITE	GP-51	1W3300	COMBUSTIBLE, 7 1/8 IN	GP-110	1R0750
ACEITE, CUMPLE CON MEDI-DAS ORIGINALES	GP-691	1R0716	COMBUSTIBLE	GP-110	1P2299	HIDRAULICO (SELLADO)	GP-166	93-7521
ACEITE, SEGUNDA OPCION	GP-52	1R0716	HIDRAULICO (SELLADO)	GP-166	93-7521			
AGUA	GP-1011Q	9N3718	AIRE, SECUNDARIO	GA-1286	2S1286	EL300 con motor/CATERPILLAR 3306		
			AIRE, PRIMARIO	GA-9334	7W5317	ACEITE	GP-51	1W3300
						COMBUSTIBLE	GP-110	1R0750
5110B con motor/CATERPILLAR 3412E			E240B, E240C con motor/CATERPILLAR 3116T			HIDRAULICO (SELLADO)	GP-166	93-7521
COMBUSTIBLE	GP-749	1R0749	ACEITE	GP-51	1R0739	AIRE, SECUNDARIO	GA-1286	2S1286
ACEITE, CUMPLE CON MEDI-DAS ORIGINALES	GP-691	1R0716	COMBUSTIBLE, 5 13/32 IN	GP-62	1R0751	AIRE, PRIMARIO	GA-9334	7W5317
ACEITE, SEGUNDA OPCION	GP-52	1R0716	COMBUSTIBLE, 7 13/32 IN	GP-1109	1R0751			
			COMBUSTIBLE, 7 1/8 IN	GP-110	1R0750	EL300B con motor/CATERPILLAR 3306T		
5130 con motor/CATERPILLAR 3508			HIDRAULICO (SELLADO)	GP-166	93-7521	ACEITE	GP-51	2P4004
ACEITE, CUMPLE CON MEDI-DAS ORIGINALES	GP-691	2P4005				COMBUSTIBLE	GP-110	1R0750
ACEITE, SEGUNDA OPCION	GP-52	2P4005	E300 con motor/CATERPILLAR 3306			HIDRAULICO (SELLADO)	GP-166	93-7521
AIRE, SECUNDARIO ESTANDAR	GA-482	7N1308	ACEITE	GP-51	1W3300	AIRE, SECUNDARIO	GA-398	99-5800
			COMBUSTIBLE	GP-110	1P2299			
			HIDRAULICO (SELLADO)	GP-166	93-7521	EL325 con motor/A DIESEL		
5130B con motor/CATERPILLAR 3508B			AIRE, SECUNDARIO	GA-1286	2S1286	ACEITE	GP-51	1R0739
ACEITE, CUMPLE CON MEDI-DAS ORIGINALES	GP-691	2P4005	AIRE, PRIMARIO	GA-9334	4M9334	COMBUSTIBLE, 5 13/32 IN	GP-62	1R0751
						COMBUSTIBLE, 7 13/32 IN	GP-1109	1R0751
5230 con motor/CATERPILLAR 3516			E300B con motor/CATERPILLAR 3306T					
ACEITE, CUMPLE CON MEDI-DAS ORIGINALES	GP-691	1R0716	ACEITE	GP-51	2P4004	EL330 con motor/A DIESEL		
			COMBUSTIBLE	GP-110	1R0750	ACEITE	GP-51	1R0739
E100 con motor/CATERPILLAR 3204			HIDRAULICO (SELLADO)	GP-166	93-7521			
COMBUSTIBLE	GP-110	1R0750	AIRE, SECUNDARIO	GA-398	99-5800	M312, M315 con motor/CATERPILLAR 3054		
AIRE, SECUNDARIO	GA-1285	1C6394				ACEITE	GP-31	7W2326
AIRE, PRIMARIO	GA-8047	1C6391	E450 con motores/MITSUBISHI 6D22T, MITSUBISHI 6D22TC			COMBUSTIBLE, SEPARADOR DE AGUA	GPP-425	138-3100
			HIDRAULICO (SELLADO)	GP-166	93-7521	COMBUSTIBLE	GPP-419	159-6102
			AIRE, PRIMARIO	GA-106	96-9624	AIRE, RADIAL PRIMARIO	GA-853R	110-6326
			AIRE, SECUNDARIO	GA-206	94-6081			
E110 con motores/MITSUBISHI 4D31, MITSUBISHI 4D31T								
ACEITE, FLUJO TOTAL (FULL FLOW)	GP-3985	94-7207	E650 con motor/MITSUBISHI S6B-TA			M318, M320 con motor/CATERPILLAR 3116		
HIDRAULICO (SELLADO)	GP-166	93-7521	HIDRAULICO (SELLADO)	GP-166	93-7521	ACEITE	GP-51	1R0739
AIRE	GAK-403	93-8717				COMBUSTIBLE, 5 13/32 IN	GP-62	1R0751
			E70 con motores/MITSUBISHI 4D31, MITSUBISHI 4D31T			COMBUSTIBLE, 7 13/32 IN	GP-1109	1R0751
E110B, E120B con motor/CATERPILLAR 3114T			ACEITE, FLUJO TOTAL (FULL FLOW)	GP-3985	94-7207	COMBUSTIBLE, SEPARADOR DE AGUA	GPP-424	117-4089
COMBUSTIBLE, 5 13/32 IN	GP-62	1R0751						
COMBUSTIBLE, 7 13/32 IN	GP-1109	1R0751	E70B con motor/MITSUBISHI 4D32			MM15T con motor/MITSUBISHI L3E		
COMBUSTIBLE, 7 1/8 IN	GP-110	1R0750	ACEITE, FLUJO TOTAL (FULL FLOW) S/N 5TG1 EN ADELANTE	GP-3985	94-7207	HIDRAULICO	G-152	1R0719
HIDRAULICO (SELLADO)	GP-166	93-7521						
AIRE, SECUNDARIO	GA-361	94-6352	EL120B con motor/A DIESEL			MM30T con motor/MITSUBISHI S3L2		
			COMBUSTIBLE	GP-1109	1R0751	HIDRAULICO	G-152	1R0719
E110B, E120B con motor/MITSUBISHI S4K-T								
HIDRAULICO (SELLADO)	GP-166	93-7521	EL180 con motor/CATERPILLAR 3204			MM35T con motor/MITSUBISHI S4L		
			COMBUSTIBLE	GP-110	1P2299	HIDRAULICO	G-152	1R0719
E120, E140 con motor/MITSUBISHI 6D14								
HIDRAULICO (SELLADO)	GP-166	93-7521						

SERVICIO PESADO

MARCA-MODELO-MOTOR MAKE-MODEL-ENGINE	GONHER GONHER	OEM OEM	MARCA-MODELO-MOTOR MAKE-MODEL-ENGINE	GONHER GONHER	OEM OEM	MARCA-MODELO-MOTOR MAKE-MODEL-ENGINE	GONHER GONHER	OEM OEM
CATERPILLAR (continuación)			CATERPILLAR (continuación)			CATERPILLAR (continuación)		
EXCAVADORAS			GENERADORES			GENERADORES		
X345B con motor/CATERPILLAR 3176C			GASOLINA, SEPARADOR DE AGUA	G-293	8N9803	3408C con motor/CATERPILLAR 3408C		
ACEITE, CUMPLE CON MEDIDAS ORIGINALES	GP-691	1R0716	ACEITE	GP-51	1R0739	COMBUSTIBLE, SEPARADOR DE AGUA	G-1143	8N0205
CATERPILLAR			ACEITE, ACCESORIO DE LUBRICACION (SEGUNDA OPCION)	GP-52	1R0716	COMBUSTIBLE	GP-749	1R0749
GENERADORES			COMBUSTIBLE	GP-110	1R0750	ACEITE, CUMPLE CON MEDIDAS ORIGINALES	GP-691	1R0716
3056 con motor/CATERPILLAR 3056			3306B con motor/CATERPILLAR 3306B			ACEITE, SEGUNDA OPCION	GP-52	1R0716
ACEITE, REQUIERE 2 PIEZAS	GP-1	7W2327	COMBUSTIBLE, DUPLEX	GP-749	1R0749	COMBUSTIBLE, SEPARADOR DE AGUA	G-1143	8N0205
COMBUSTIBLE, SEPARADOR DE AGUA	GPP-425	138-3100	ACEITE, ACCESORIO DE LUBRICACION (CUMPLE CON MEDIDAS ORIGINALES)	GP-691	1R0716	COMBUSTIBLE	GP-749	1R0749
COMBUSTIBLE	GPP-419	159-6102	GASOLINA, SEPARADOR DE AGUA	G-293	8N9803	ACEITE, CUMPLE CON MEDIDAS ORIGINALES	GP-691	1R0716
AIRE, PRIMARIO	GA-697R	130-4678	ACEITE	GP-51	1R0739	ACEITE, SEGUNDA OPCION	GP-52	1R0716
3114 con motor/CATERPILLAR 3114			ACEITE, ACCESORIO DE LUBRICACION (SEGUNDA OPCION)	GP-52	1R0716	COMBUSTIBLE, ACCESORIO PARA FILTRACION DUPLEX	GP-1108	1R0712
GASOLINA, SEPARADOR DE AGUA	G-293	8N9803	COMBUSTIBLE	GP-110	1R0750	AIRE	GAP-381	4N0015
COMBUSTIBLE	GP-110	1R0750	3406 con motor/CATERPILLAR 3406			3412C con motor/CATERPILLAR 3412C		
AIRE, PRIMARIO ESTANDAR	GA-8047	7W5389	COMBUSTIBLE, SEPARADOR DE AGUA	G-1143	8N0205	COMBUSTIBLE	GP-749	1R0749
AIRE, PRIMARIO RADIAL	GA-499R	612499	ACEITE, CUMPLE CON MEDIDAS ORIGINALES	GP-691	2P4005	ACEITE, CUMPLE CON MEDIDAS ORIGINALES	GP-691	1R0716
3116 con motor/CATERPILLAR 3116			ACEITE, SEGUNDA OPCION	GP-52	2P4005	ACEITE, SEGUNDA OPCION	GP-52	1R0716
GASOLINA, SEPARADOR DE AGUA	G-293	8N9803	COMBUSTIBLE	GP-1108	4N5823	3456 con motor/CATERPILLAR 3456		
ACEITE	GP-51	1R0739	AIRE, PRIMARIO	GA-356	6N6071	COMBUSTIBLE	GP-749	1R0749
COMBUSTIBLE	GP-110	1R0750	AIRE, ACCESORIO	GAP-381	4N0015	ACEITE, CUMPLE CON MEDIDAS ORIGINALES	GP-691	1R0716
AIRE, PRIMARIO ESTANDAR	GA-8047	7W5389	AIRE, SECUNDARIO	GA-357	6N6072	ACEITE, SEGUNDA OPCION	GP-52	1R0716
AIRE, PRIMARIO RADIAL	GA-499R	612499	AIRE, PRIMARIO	GA-483	8N5313	3508 con motor/CATERPILLAR 3508		
3145 con motor/CATERPILLAR 3145			3406B con motor/CATERPILLAR 3406B			COMBUSTIBLE	GP-749	1R0749
ACEITE	GP-36	9L9200	COMBUSTIBLE, SEPARADOR DE AGUA	G-1143	8N0205	ACEITE, SELLADO (CUMPLE CON MEDIDAS ORIGINALES)	GP-691	2P4005
3150 con motor/CATERPILLAR 3150			COMBUSTIBLE	GP-749	1R0749	ACEITE, SELLADO (SEGUNDA OPCION)	GP-52	2P4005
ACEITE	GP-36	9L9200	ACEITE, CUMPLE CON MEDIDAS ORIGINALES	GP-691	1R0716	COMBUSTIBLE	GP-1108	1R0712
3160 con motor/CATERPILLAR 3160			ACEITE, SEGUNDA OPCION	GP-52	1R0716	3508B con motor/CATERPILLAR 3508B		
ACEITE	GP-36	9L9200	AIRE, ACCESORIO	GAP-381	4N0015	COMBUSTIBLE	GP-749	1R0749
3208 con motor/CATERPILLAR 3208			AIRE, PRIMARIO	GA-483	8N5313	ACEITE, SELLADO (CUMPLE CON MEDIDAS ORIGINALES)	GP-691	2P4005
GASOLINA, SEPARADOR DE AGUA	G-293	8N9803	3406C con motor/CATERPILLAR 3406C			ACEITE, SELLADO (SEGUNDA OPCION)	GP-52	2P4005
COMBUSTIBLE	GP-110	1P2299	COMBUSTIBLE, SEPARADOR DE AGUA	G-1143	8N0205	3512 con motor/CATERPILLAR 3512		
ACEITE	GP-9586	1R0713	COMBUSTIBLE	GP-749	1R0749	COMBUSTIBLE, SEPARADOR DE AGUA	GS-2033	4P7384
AIRE, PRIMARIO ESTANDAR	GA-9334	7W5317	ACEITE, CUMPLE CON MEDIDAS ORIGINALES	GP-691	1R0716	COMBUSTIBLE, SELLADO	GP-749	1R0712
3304 con motor/CATERPILLAR 3304			ACEITE, SEGUNDA OPCION	GP-52	1R0716	ACEITE, SELLADO (CUMPLE CON MEDIDAS ORIGINALES)	GP-691	2P4005
COMBUSTIBLE, DUPLEX	GP-749	1R0749	AIRE, ACCESORIO	GAP-381	4N0015	ACEITE, SELLADO (SEGUNDA OPCION)	GP-52	2P4005
ACEITE, ACCESORIO DE LUBRICACION (CUMPLE CON MEDIDAS ORIGINALES)	GP-691	1R0716	AIRE, PRIMARIO	GA-483	8N5313	AIRE, PRIMARIO	GA-879	9Y7662
GASOLINA, SEPARADOR DE AGUA	G-293	8N9803	3408 con motor/CATERPILLAR 3408			3512B con motor/CATERPILLAR 3512B		
ACEITE	GP-51	1R0739	COMBUSTIBLE, SEPARADOR DE AGUA	G-1143	8N0205	COMBUSTIBLE, SELLADO	GP-749	1R0712
ACEITE, ACCESORIO DE LUBRICACION (SEGUNDA OPCION)	GP-52	1R0716	ACEITE, CUMPLE CON MEDIDAS ORIGINALES	GP-691	1R0716	ACEITE, SELLADO (CUMPLE CON MEDIDAS ORIGINALES)	GP-691	2P4005
COMBUSTIBLE	GP-110	1P2299	ACEITE, SEGUNDA OPCION	GP-52	1R0716	ACEITE, SELLADO (SEGUNDA OPCION)	GP-52	2P4005
3304B con motor/CATERPILLAR 3304B			COMBUSTIBLE	GP-1108	4N5823	AIRE, PRIMARIO	GA-879	9Y7662
ACEITE	GP-51	1R0739	AIRE, ACCESORIO	GAP-381	4N0015	3516 con motor/CATERPILLAR 3516		
COMBUSTIBLE	GP-110	1R0740	AIRE, PRIMARIO	GA-483	1P8483	COMBUSTIBLE	GP-749	1R0749
AIRE, SECUNDARIO ESTANDAR	GA-1285	2S1285	AIRE, SECUNDARIO	GA-482	1P8482	ACEITE, SELLADO (CUMPLE CON MEDIDAS ORIGINALES)	GP-691	2P4005
AIRE, PRIMARIO ESTANDAR	GA-8047	7W5389	3408B con motor/CATERPILLAR 3408B			ACEITE, SELLADO (SEGUNDA OPCION)	GP-52	2P4005
AIRE, PRIMARIO RADIAL	GA-499R	612499	COMBUSTIBLE, SEPARADOR DE AGUA	G-1143	8N0205	COMBUSTIBLE	GP-1108	1R0712
3306 con motor/CATERPILLAR 3306			COMBUSTIBLE	GP-749	1R0749	3516 con motor/CATERPILLAR 3516		
COMBUSTIBLE, DUPLEX	GP-749	1R0749	ACEITE, CUMPLE CON MEDIDAS ORIGINALES	GP-691	1R0716	COMBUSTIBLE	GP-749	1R0749
ACEITE, ACCESORIO DE LUBRICACION (CUMPLE CON MEDIDAS ORIGINALES)	GP-691	1R0716	ACEITE, SEGUNDA OPCION	GP-52	1R0716	ACEITE, SELLADO (CUMPLE CON MEDIDAS ORIGINALES)	GP-691	2P4005

MARCA-MODELO-MOTOR MAKE-MODEL-ENGINE	GONHER GONHER	OEM OEM	MARCA-MODELO-MOTOR MAKE-MODEL-ENGINE	GONHER GONHER	OEM OEM	MARCA-MODELO-MOTOR MAKE-MODEL-ENGINE	GONHER GONHER	OEM OEM
CATERPILLAR (continuación)			CATERPILLAR (continuación)			CATERPILLAR (continuación)		
GENERADORES			GENERADORES			MONTACARGAS		
3516B con motor/CATERPILLAR 3516B			D399 con motor/CATERPILLAR D399			441 con motor/A DIESEL		
COMBUSTIBLE	GP-749	1R0749	ACEITE	G-191	4W4840	ACEITE, DERIVACION (BY PASS)	GP-50	68147
ACEITE, SELLADO (CUMPLE CON MEDIDAS ORIGINALES)	GP-691	2P4005	AIRE, PRIMARIO	GA-356	6N6071			
ACEITE, SELLADO (SEGUNDA OPCION)	GP-52	2P4005	AIRE, PANEL	GAP-379	6L4714	460, 461 con motor/A DIESEL		
			AIRE, SECUNDARIO	GA-357	6N6072	ACEITE, DERIVACION (BY PASS) SELLADO	GP-50	68147
3612 con motor/CATERPILLAR 3612			D4400 con motor/CATERPILLAR D4400			540D, 680PD, 600D, 670D con motor/CONTINENTAL HD260		
AIRE, PRIMARIO	GA-483	8N5313	ACEITE, FLUJO TOTAL (FULL FLOW)	G-191	1R0659	ACEITE	G-31	636372
C4.4 con motor/CATERPILLAR C4.4			D8800 con motor/CATERPILLAR D8800			850 S con motor/A DIESEL		
ACEITE	GP-31	7W2326	ACEITE, FLUJO TOTAL (FULL FLOW)	G-191	9F6700	ACEITE	GP-166	82-261
D13000 con motor/CATERPILLAR D13000			E624 con motor/CATERPILLAR E624			860P, 960P con motor/A DIESEL		
ACEITE, FLUJO COMPLETO (FULL FLOW)	G-191	5S0484	COMBUSTIBLE	GP-749	1R0749	ACEITE, DERIVACION (BY PASS) SELLADO	GP-50	68147
			ACEITE, CUMPLE CON MEDIDAS ORIGINALES	GP-691	1R0716			
D17000 con motor/CATERPILLAR D17000			ACEITE, SEGUNDA OPCION	GP-52	1R0716	A15 con motor/A DIESEL		
ACEITE, FLUJO COMPLETO (FULL FLOW)	G-191	5S0484				ACEITE	G-31	636372
			G3412 con motor/CATERPILLAR G3412					
D311 con motor/CATERPILLAR D311			ACEITE, CUMPLE CON MEDIDAS ORIGINALES	GP-691	1R0716	A24 con motor/A DIESEL		
ACEITE	G-191	9F6700				ACEITE, DERIVACION (BY PASS)	G-31	636372
D315 con motor/CATERPILLAR D315			CATERPILLAR			AH40 con motor/A DIESEL		
ACEITE, FLUJO TOTAL (FULL FLOW)	G-191	9F6700	HILERADORAS			ACEITE, FLUJO TOTAL (FULL FLOW) CARTUCHO	G-191	5S0484
			SP 110, SP 80 con motor/CUMMINS 3.9L			ACEITE, DERIVACION (BY PASS)	GP-31	636372
D318 con motor/CATERPILLAR D318			ACEITE	GP-390	3903224	ACEITE, FLUJO TOTAL (FULL FLOW) SELLADO	GP-36	9L9200
ACEITE, FLUJO TOTAL (FULL FLOW)	G-191	9F6700	WE601, WE651 con motor/JOHN DEERE 4239T			COMBUSTIBLE, 7 1/8 IN	GP-110	1R0740
			ACEITE	GP-14	6E-0924			
D320 con motor/CATERPILLAR D320			WE601B con motor/PERKINS 4.236			AH46 con motor/A DIESEL		
ACEITE, FLUJO TOTAL (FULL FLOW)	G-191	7M3800	ACEITE	GP-1	7W2327	ACEITE	G-191	5S0484
			COMBUSTIBLE	G-296	67-6987	ACEITE	GP-36	9L9200
D320A con motor/CATERPILLAR D320A			COMBUSTIBLE	G-296-B	67-6987	COMBUSTIBLE	GP-110	1R0740
ACEITE, FLUJO TOTAL (FULL FLOW)	G-191	7M3800	WE851 con motores/JOHN DEERE 6414D, JOHN DEERE 6539T			AH52 con motor/A DIESEL		
			ACEITE	GP-14	6E-0924	ACEITE, CARTUCHO	G-191	5S0484
D326 con motor/CATERPILLAR D326			WE851B con motor/PERKINS 6.354			ACEITE, SELLADO	GP-36	9L9200
ACEITE	G-238	8F1151	ACEITE	GP-1	7W2327	COMBUSTIBLE, 7 1/8 IN	GP-110	1R0740
			COMBUSTIBLE	G-296	67-6987			
D326F con motor/CATERPILLAR D326F			COMBUSTIBLE	G-296-B	67-6987	AH60 con motor/A DIESEL		
ACEITE	G-238	8F1151				ACEITE, FLUJO TOTAL (FULL FLOW) CARTUCHO	G-191	5S0484
						ACEITE, FLUJO TOTAL (FULL FLOW) SELLADO	GP-36	9L9200
D3400 con motor/CATERPILLAR D3400			CATERPILLAR			COMBUSTIBLE, 7 1/8 IN	GP-110	1R0740
ACEITE, FLUJO TOTAL (FULL FLOW)	G-191	5S0484	MONTACARGAS			AM25 con motor/A DIESEL		
			3515, 3535 con motor/A DIESEL			ACEITE	GP-36	9L9200
D364 con motor/CATERPILLAR D364			ACEITE, DERIVACION (BY PASS) SELLADO	GP-50	68147	AM30, AM36, AM40 con motor/A DIESEL		
ACEITE	G-238	5S0485				ACEITE, DERIVACION (BY PASS)	G-31	636372
			392S con motor/A DIESEL			AM46, AMP25, AM52, AM60 con motor/A DIESEL		
D375 con motor/CATERPILLAR D375			ACEITE, DERIVACION (BY PASS)	GP-50	68147	ACEITE, DERIVACION (BY PASS)	G-31	636372
ACEITE	G-238	6H9999						
D379B con motor/CATERPILLAR D379B			400P, 462S, 502P, 502S, 510P, 540S, 590S, 600S, 601P, 670S, 680P, 750S, 760P con motor/A DIESEL			B10, B12 con motor/A DIESEL		
ACEITE	G-191	1R0659	ACEITE, DERIVACION (BY PASS) SELLADO	GP-50	68147	ACEITE, FLUJO TOTAL (FULL FLOW)	G-870	676944
D386 con motor/CATERPILLAR D386			410, 411 con motor/A DIESEL			B15, B16 con motor/A DIESEL		
ACEITE	G-238	8F1151	ACEITE, DERIVACION (BY PASS) SELLADO	GP-50	68147	ACEITE, FLUJO TOTAL (FULL FLOW) CARTUCHO	G-834	676228
						ACEITE, DERIVACION (BY PASS)	GP-31	636372
D397 con motor/CATERPILLAR D397			422S con motor/A DIESEL			ACEITE, FLUJO TOTAL (FULL FLOW) SELLADO	GP-36	9L9200
ACEITE	G-238	1R0721	ACEITE, DERIVACION (BY PASS)	GP-50	68147	ACEITE, CLUTCH	GP-66	665934
D398B con motor/CATERPILLAR D398B								
ACEITE	G-191	1R0659						

SERVICIO PESADO

MARCA-MODELO-MOTOR MAKE-MODEL-ENGINE	GONHER GONHER	OEM OEM	MARCA-MODELO-MOTOR MAKE-MODEL-ENGINE	GONHER GONHER	OEM OEM	MARCA-MODELO-MOTOR MAKE-MODEL-ENGINE	GONHER GONHER	OEM OEM
CATERPILLAR (continuación)			CATERPILLAR (continuación)			CATERPILLAR (continuación)		
MONTACARGAS			MONTACARGAS			MONTACARGAS		
B18 con motor/A DIESEL			T100D, T150D con motor/PERKINS			T40D con motor/PEUGEOT		
ACEITE, FLUJO TOTAL (FULL FLOW) CARTUCHO	G-834	676228	ACEITE	GP-1	7W2327	HIDRAULICO	GP-166	917336
ACEITE, DERIVACION (BY PASS)	GP-31	636372	COMBUSTIBLE	G-296	67-6987			
ACEITE, FLUJO TOTAL (FULL FLOW) SELLADO	GP-36	9L9200	COMBUSTIBLE	G-296-B	67-6987	T45B con motor/CATERPILLAR 1404		
ACEITE, CLUTCH (SELLADO)	GP-66	665934				ACEITE	GP-1	364464
B20 con motor/A DIESEL			T120C con motor/CONTINENTAL			T45B con motor/CONTINENTAL F163		
ACEITE, DERIVACION (BY PASS)	G-31	636372	ACEITE	GP-1	364464	ACEITE	GP-1	364464
ACEITE, FLUJO TOTAL (FULL FLOW) CARTUCHO	G-834	676228	ACEITE PARA CLUTCH	GP-1	364464			
COMBUSTIBLE, CARTUCHO	G-1176	632315	ACEITE	GP-50	68147	T50 con motor/CONTINENTAL F163		
ACEITE, FLUJO TOTAL (FULL FLOW) SELLADO	GP-36	9L9200	AIRE	GA-18	369136	TRANSMISION	GP-1	364464
ACEITE, CLUTCH (SELLADO)	GP-66	665934				T50 con motor/PERKINS 3.152		
B25 con motor/A DIESEL			T220, T221, T300, T33 C con motor/A DIESEL			ACEITE	G-813	337778
ACEITE, DERIVACION (BY PASS)	G-31	636372	ACEITE	GP-166	85-261	TRANSMISION	GP-1	364464
ACEITE, FLUJO TOTAL (FULL FLOW) CARTUCHO	G-834	676228	T25 con motor/CONTINENTAL F163			COMBUSTIBLE	G-296	67-6987
COMBUSTIBLE, CARTUCHO	G-1176	632315	ACEITE PARA CLUTCH	GP-1	364464	COMBUSTIBLE	G-296-B	67-6987
ACEITE, FLUJO TOTAL (FULL FLOW) SELLADO	GP-36	9L9200	ACEITE, EXCEPTO S/N 11X, 12X LPG	GP-1	364464			
ACEITE, CLUTCH (SELLADO)	GP-66	665934	ACEITE, S/N 11X, 12X LPG	GP-50	68147	T50B con motor/CATERPILLAR 1404		
B25 con motor/A DIESEL						TRANSMISION	GP-1	364464
ACEITE, DERIVACION (BY PASS)	G-31	636372	T25D con motor/PEUGEOT XN1P			T50B con motor/CONTINENTAL F163		
ACEITE, FLUJO TOTAL (FULL FLOW) CARTUCHO	G-834	676228	HIDRAULICO	GP-166	917336	TRANSMISION	GP-1	364464
COMBUSTIBLE, CARTUCHO	G-1176	632315				T50B con motor/PERKINS 3.152		
ACEITE, FLUJO TOTAL (FULL FLOW) SELLADO	GP-36	9L9200	T30, T30B con motor/CONTINENTAL			TRANSMISION	GP-1	364464
ACEITE, CLUTCH	GP-66	665934	ACEITE PARA CLUTCH	GP-1	364464	COMBUSTIBLE	G-296	67-6987
DP20, DP25, DP30, DP35 con motor/MITSUBISHI DIESEL	GPP-111	104-1296	ACEITE	GP-50	68147	COMBUSTIBLE	G-296-B	67-6987
			AIRE	GA-18	369136	COMBUSTIBLE	G-296-B	67-6987
DP40 con motor/MITSUBISHI S6E								
ACEITE	GP-54	103-2977	T30, T30B, T30C con motor/PERKINS			T55B con motor/CATERPILLAR 1404 GASOLINA		
DPL40 con motor/A DIESEL			ACEITE, CARTUCHO	G-813	337778	ACEITE, FLUJO TOTAL (FULL FLOW)	GP-36	9L9200
COMBUSTIBLE	G-296	130-3496	ACEITE PARA CLUTCH	GP-1	364464			
DPL40 con motor/MITSUBISHI S6E			ACEITE, SELLADO	GP-1	7W2317	T60 con motor/CONTINENTAL		
ACEITE	GP-54	103-2977	COMBUSTIBLE	G-296	67-6987	ACEITE PARA CLUTCH	GP-1	364464
F40D, F50D, F60D SA con motor/A DIESEL			COMBUSTIBLE	G-296-B	67-6987	TRANSMISION	GP-1	364464
HIDRAULICO	GP-166	917336	AIRE	GA-18	369136	ACEITE	GP-50	68147
GPL40, GPL40S con motor/MITSUBISHI						T60B con motor/CATERPILLAR 1404 GASOLINA		
ACEITE	GP-149	30A4000103	T30B, T30C con motor/CATERPILLAR 1404 GASOLINA			ACEITE PARA CLUTCH	GP-1	364464
M40D, M50D, MC40D, MC60D SA con motor/A DIESEL			ACEITE PARA CLUTCH	GP-1	364464	T60B, T60C con motor/CONTINENTAL		
HIDRAULICO	GP-166	917336				ACEITE PARA CLUTCH	GP-1	364464
R60, R70, R80, R40, R50 con motor/PERKINS 4.236			T35B con motor/CATERPILLAR 1404			T60D, T70D, T90D, TC1000 con motor/PERKINS 4.236 GASOLINA		
ACEITE	GP-1	7W2327	ACEITE	GP-1	364464	ACEITE	GP-1	7W2327
COMBUSTIBLE, S/N 1KK, 2PJ, 4BJ, 4XG, 5PF, 21A, 31A	G-296	67-6987	T35B con motor/PERKINS 3.152			T60D, TC60C, V60, V60B, V60D, V60E, VC60C, T60, T60B con motor/PERKINS		
COMBUSTIBLE, S/N 1KK, 2PJ, 4BJ, 4XG, 5PF, 21A, 31A	G-296-B	67-6987	ACEITE	GP-1	364464	ACEITE, CARTUCHO	G-813	337778
RC60 con motor/PERKINS 4.236						ACEITE PARA CLUTCH	GP-1	364464
ACEITE	GP-1	7W2327	T400 con motor/A DIESEL			ACEITE, SELLADO	GP-1	364464
COMBUSTIBLE, S/N 2PJ, 4BJ, 4XG, 21A, 31A	G-296	67-6987	ACEITE	GP-166	85-261	ACEITE, VELOCIDADES HIDRAULICAS	GP-1	364464
COMBUSTIBLE, S/N 2PJ, 4BJ, 4XG, 21A, 31A	G-296-B	67-6987				COMBUSTIBLE	G-296	67-6987
RT40, RT50, RT60, RTC60 con motor/PERKINS 4.236			T40B con motor/CATERPILLAR 1404			COMBUSTIBLE	G-296-B	67-6987
ACEITE	GP-1	7W2327	ACEITE	GP-1	364464	AIRE	GA-18	369136
COMBUSTIBLE, S/N 1KK, 2PJ, 4BJ, 4XG, 5PF, 21A, 31A	G-296	67-6987				T80D con motor/PERKINS 4.236		
COMBUSTIBLE, S/N 1KK, 2PJ, 4BJ, 4XG, 5PF, 21A, 31A	G-296-B	67-6987	T40B con motor/CONTINENTAL F163			ACEITE	GP-1	7W2327
			ACEITE	GP-1	364464	TC120D con motor/PERKINS		
						ACEITE	GP-1	7W2327
			T40B, T45B con motor/PERKINS 3.152			COMBUSTIBLE	G-296	67-6987
			ACEITE	GP-1	364464	COMBUSTIBLE	G-296-B	67-6987
			COMBUSTIBLE	G-296	67-6987			
			COMBUSTIBLE	G-296-B	67-6987			

APLICACIONES SERVICIO PESADO
HEAVY DUTY APPLICATIONS



MARCA-MODELO-MOTOR MAKE-MODEL-ENGINE	GONHER GONHER	OEM OEM	MARCA-MODELO-MOTOR MAKE-MODEL-ENGINE	GONHER GONHER	OEM OEM	MARCA-MODELO-MOTOR MAKE-MODEL-ENGINE	GONHER GONHER	OEM OEM
CATERPILLAR (continuación)			CATERPILLAR (continuación)			CATERPILLAR (continuación)		
MONTACARGAS			MONTACARGAS			MONTACARGAS		
TC30 con motor/CONTINENTAL F163			V160 con motor/PERKINS 6.354			V30, V30B, V30C con motor/PERKINS		
ACEITE PARA CLUTCH	GP-1	364464	ACEITE	GP-1	7W2327	ACEITE, CARTUCHO	G-813	337778
ACEITE, EXCEPTO S/N 11X, 12X LPG	GP-1	364464	COMBUSTIBLE	G-296	67-6987	ACEITE PARA CLUTCH	GP-1	364464
ACEITE, S/N 11X, 12X LPG	GP-50	68147	ACEITE PARA CLUTCH	GP-66	665934	ACEITE, SELLADO	GP-1	7W2317
TC40 con motor/PEUGEOT			COMBUSTIBLE	G-296-B	67-6987	COMBUSTIBLE	G-296	67-6987
ACEITE	GP-14	6E-0924	AIRE	GAK-20	687743	COMBUSTIBLE	G-296-B	67-6987
TC40D con motor/PEUGEOT XN1P			V160, V180, V200, V225, V250 con motor/CATERPILLAR 3145			V300 con motor/CATERPILLAR 3145		
HIDRAULICO	GP-166	917336	ACEITE	GP-36	1R0734	ACEITE	GP-36	1R0734
TC60 con motor/CATERPILLAR 1404 GASOLINA			ACEITE PARA CLUTCH	GP-66	665934	ACEITE PARA CLUTCH	GP-66	665934
ACEITE	GP-1	364464	AIRE	GAK-20	687743	AIRE	GAK-20	687743
ACEITE	GP-14	6E-0924	V160B con motor/CATERPILLAR 3208			V300 con motor/CATERPILLAR 3208		
ACEITE	GP-36	1R0734	ACEITE, VELOCIDADES HIDRAULICAS	G-152	1R0719	ACEITE	GP-36	9L9200
TC60 con motor/PERKINS			ACEITE PARA CLUTCH	GP-66	665934	COMBUSTIBLE	GP-110	1R0750
ACEITE	G-813	337778	COMBUSTIBLE	GP-110	1R0740	AIRE	GAK-20	687743
ACEITE	GP-1	364464	ACEITE	GP-9586	8N9586	V300B con motor/CATERPILLAR 3208		
ACEITE	GP-14	6E-0924	AIRE, PRIMARIO	GA-8047	7W5389	COMBUSTIBLE	GP-110	1R0750
COMBUSTIBLE	G-296	67-6987	V180, V200 con motor/PERKINS 6.354			V30B con motor/CONTINENTAL		
COMBUSTIBLE	G-296-B	67-6987	ACEITE	GP-1	7W2327	ACEITE PARA CLUTCH	GP-1	364464
AIRE	GA-18	369136	COMBUSTIBLE	G-296	67-6987	ACEITE	GP-50	68147
TC60C con motor/CATERPILLAR 1404 GASOLINA			ACEITE PARA CLUTCH	GP-66	665934	AIRE	GA-18	369136
ACEITE PARA CLUTCH	GP-1	364464	COMBUSTIBLE	G-296-B	67-6987	V30C con motor/CATERPILLAR 1404 GASOLINA		
TC60D con motor/CATERPILLAR 1404 GASOLINA			AIRE	GAK-20	687743	ACEITE PARA CLUTCH	GP-1	364464
ACEITE	GP-14	6E-0924	V200B con motor/CATERPILLAR 3208			V30C con motor/CONTINENTAL F227		
ACEITE	GP-36	1R0734	ACEITE, VELOCIDADES HIDRAULICAS	G-152	1R0719	ACEITE	GP-1	364464
ACEITE	GP-3937	917336	ACEITE PARA CLUTCH	GP-66	665934	V330B con motor/CATERPILLAR 3208		
TC60D con motor/PEUGEOT			COMBUSTIBLE	GP-110	1R0740	ACEITE, VELOCIDADES HIDRAULICAS	G-152	1R0719
HIDRAULICO	GP-166	917336	ACEITE	GP-9586	8N9586	ACEITE PARA CLUTCH	GP-66	665934
TC60D SA con motor/CATERPILLAR 1404 GASOLINA			AIRE, PRIMARIO	GA-8047	7W5389	COMBUSTIBLE	GP-110	1R0750
ACEITE	GP-36	1R0734	V225 con motor/PERKINS 6.354			ACEITE	GP-9586	8N9586
HIDRAULICO	GP-166	917336	ACEITE	GP-1	7W2327	AIRE, SECUNDARIO	GA-8047	7W5389
HIDRAULICO	GP-761H	90-2900	COMBUSTIBLE	G-296	67-6987	V35B con motor/A DIESEL		
V100, V100F con motor/PERKINS			ACEITE PARA CLUTCH	GP-66	665934	ACEITE, DERIVACION (BY PASS)	GP-50	68147
ACEITE, CARTUCHO	G-870	676944	COMBUSTIBLE	G-296-B	67-6987	V35C, V45C con motor/CATERPILLAR 1404 GASOLINA		
ACEITE, SELLADO	GP-1	364464	AIRE	GAK-20	687743	ACEITE, FLUJO TOTAL (FULL FLOW)	GP-36	9L9200
COMBUSTIBLE	G-296	67-6987	V225B, V250B con motor/CATERPILLAR 3208			V40, V40B, V50 con motor/A DIESEL		
ACEITE PARA CLUTCH	GP-66	665934	ACEITE, VELOCIDADES HIDRAULICAS	G-152	1R0719	ACEITE, CLUTCH	GP-1	314361
COMBUSTIBLE	G-296-B	67-6987	ACEITE PARA CLUTCH	GP-66	665934	ACEITE, DERIVACION (BY PASS)	GP-50	68147
V1100 CTH con motor/CATERPILLAR 3208			COMBUSTIBLE	GP-110	1R0740	ACEITE, FLUJO TOTAL (FULL FLOW)	GP-36	9L9200
ACEITE, VELOCIDADES HIDRAULICAS	G-152	1R0719	ACEITE	GP-9586	8N9586	TRANSMISION (SELLADO)	GP-34	342449
HIDRAULICO	G-222	1R0720	AIRE, PRIMARIO	GA-8047	7W5389	AIRE, HOUSING FRAM FA100PL	GA-105	333660
COMBUSTIBLE	GP-110	1R0750	V250, V300 con motor/PERKINS 6.354			V40C, V40D con motor/CATERPILLAR 1404		
AIRE, PRIMARIO	GA-8047	7W5389	ACEITE	GP-1	7W2327	ACEITE, FLUJO TOTAL (FULL FLOW)	GP-36	9L9200
V110B con motor/PERKINS			COMBUSTIBLE	G-296	67-6987	HIDRAULICO (LPG)	GP-166	917336
ACEITE	GP-1	7W2327	ACEITE PARA CLUTCH	GP-66	665934	HIDRAULICO (DIESEL)	GP-761H	90-2900
COMBUSTIBLE	G-296	67-6987	COMBUSTIBLE	G-296-B	67-6987	V40D con motor/PERKINS		
COMBUSTIBLE	G-296-B	67-6987	V25D con motor/PEUGEOT XN1P			COMBUSTIBLE	G-296	67-6987
V150, V155B con motor/PERKINS			HIDRAULICO	GP-166	917336	COMBUSTIBLE	G-296-B	67-6987
ACEITE, CARTUCHO	G-870	676944	V30 con motor/CONTINENTAL			HIDRAULICO	GP-166	917336
ACEITE, SELLADO	GP-1	364464	ACEITE PARA CLUTCH	GP-1	364464	HIDRAULICO	GP-761H	90-2900
COMBUSTIBLE	G-296	2W-3236	ACEITE	GP-50	68147	V40D con motor/PERKINS		
ACEITE PARA CLUTCH	GP-66	665934	AIRE	GA-18	369136	COMBUSTIBLE	G-296	67-6987
COMBUSTIBLE	G-296-B	2W-3236				COMBUSTIBLE	G-296-B	67-6987

SERVICIO PESADO

MARCA-MODELO-MOTOR MAKE-MODEL-ENGINE	GONHER GONHER	OEM OEM	MARCA-MODELO-MOTOR MAKE-MODEL-ENGINE	GONHER GONHER	OEM OEM	MARCA-MODELO-MOTOR MAKE-MODEL-ENGINE	GONHER GONHER	OEM OEM
CATERPILLAR (continuación)			CATERPILLAR (continuación)			CATERPILLAR (continuación)		
MONTACARGAS			MONTACARGAS			MONTACARGAS		
V40D con motor/PEUGEOT			COMBUSTIBLE	G-296	67-6987	VC60D con motor/PEUGEOT		
HIDRAULICO	GP-166	917336	COMBUSTIBLE	G-296-B	67-6987	HIDRAULICO	GP-166	917336
			AIRE	GA-18	369136			
V41, V41B, V51, V51B con motor/A DIESEL			V80D con motor/PERKINS			VC60D SA con motor/CATERPILLAR 1404		
ACEITE, CLUTCH	GP-1	314361	ACEITE	GP-1	7W2327	ACEITE PARA CLUTCH	GP-1	364464
ACEITE, FLUJO TOTAL (FULL FLOW)	GP-1	329060	ACEITE, VELOCIDADES HIDRAULICAS	GP-1	7W2327	ACEITE	GP-36	1R0734
ACEITE, DERIVACION (BY PASS)	GP-50	68147	COMBUSTIBLE	G-296	67-6987	HIDRAULICO (MOTORES A GASOLINA)	GP-166	917336
AIRE, HOUSING FRAM FA100PL	GA-105	333660	COMBUSTIBLE	G-296-B	67-6987	HIDRAULICO (MOTORES A GAS LPG)	GP-761H	90-2900
			V80E con motor/PERKINS					
V45B con motor/A DIESEL			ACEITE	GP-1	7W2327	VC60D SA con motor/PERKINS 4.2032		
ACEITE, DERIVACION (BY PASS)	GP-50	68147				COMBUSTIBLE	G-296	67-6987
			V900CH con motor/CATERPILLAR 3208			COMBUSTIBLE	G-296-B	67-6987
V550, V620 con motor/CATERPILLAR 3208			ACEITE, VELOCIDADES HIDRAULICAS	G-152	1R0719	HIDRAULICO	GP-166	917336
ACEITE, VELOCIDADES HIDRAULICAS	G-152	1R0719	HIDRAULICO	G-222	1R0720	HIDRAULICO	GP-761H	90-2900
HIDRAULICO	G-222	1R0720	COMBUSTIBLE	GP-110	1R0740			
COMBUSTIBLE	GP-110	1R0750	AIRE, PRIMARIO	GA-8047	7W5389			
ACEITE	GP-9586	8N9586						
AIRE, PRIMARIO	GA-8047	7W5389	V90E con motor/PERKINS					
			ACEITE	GP-1	364464			
V55B con motor/A DIESEL			ACEITE, VELOCIDADES HIDRAULICAS	GP-1	364464			
ACEITE, CLUTCH	GP-1	314361	COMBUSTIBLE	G-296	67-6987	1100 A DIESEL		
ACEITE, FLUJO TOTAL (FULL FLOW)	GP-1	329060	COMBUSTIBLE	G-296-B	67-6987	ACEITE	GP-36	1R0734
ACEITE, DERIVACION (BY PASS)	GP-50	68147						
			V90F con motor/PERKINS			1140 A DIESEL		
V60, V60B con motor/CONTINENTAL			ACEITE	GP-1	364464	ACEITE	GP-36	1R0734
ACEITE	GP-1	364464	COMBUSTIBLE	G-296	67-6987			
ACEITE PARA CLUTCH	GP-1	364464	COMBUSTIBLE	G-296-B	67-6987	1145 A DIESEL		
ACEITE	GP-50	68147				ACEITE	GP-36	1R0734
			V925, V925 LH con motor/CATERPILLAR 3208			1150 A DIESEL		
V60C con motor/PERKINS 4.236 DIESEL			ACEITE, VELOCIDADES HIDRAULICAS	G-152	1R0719	ACEITE	GP-36	1R0734
ACEITE	GP-1	364464	HIDRAULICO	G-222	1R0720			
COMBUSTIBLE	G-296	679987	COMBUSTIBLE	GP-110	1R0740	1160 A DIESEL		
COMBUSTIBLE	G-296-B	679987	AIRE, PRIMARIO	GA-8047	7W5389	ACEITE	GP-36	1R0734
AIRE, PRIMARIO	GA-18	369136						
			VC110F con motor/PERKINS			1404 A DIESEL		
V60C con motores/PERKINS 4.236 GASOLINA, PERKINS 4.236 LPG			ACEITE	GP-1	7W2327	ACEITE	GP-36	9L200
ACEITE	GP-1	364464	COMBUSTIBLE	G-296	67-6987			
			COMBUSTIBLE	G-296-B	67-6987	1670 A DIESEL PARA CAMION		
V670 con motor/CONTINENTAL HD260						ACEITE, S/N 6181 EN ADELANTE	G-238	1R0721
ACEITE	G-31	636372	VC40D con motor/PEUGEOT XN1P					
			HIDRAULICO	GP-166	917336	1673 A DIESEL PARA CAMION		
V700, V800 con motor/CATERPILLAR 3208			VC60C con motor/CATERPILLAR 1404			ACEITE	G-191	550484
ACEITE, VELOCIDADES HIDRAULICAS	G-152	1R0719	ACEITE PARA CLUTCH	GP-1	364464	ACEITE	G-238	550485
HIDRAULICO	G-222	1R0720	ACEITE	GP-36	1R0734	COMBUSTIBLE	G-1166	9H4729
COMBUSTIBLE	GP-110	1R0750	HIDRAULICO (MOTORES A GASOLINA)	GP-166	917336	AIRE	GA-5648	2M7941
AIRE, PRIMARIO	GA-8047	7W5389	HIDRAULICO (MOTORES A GAS LPG)	GP-761H	90-2900	AIRE	GA-9334	4M9334
V70C con motor/A DIESEL			VC60C con motor/CONTINENTAL			1673B A DIESEL PARA CAMION		
ACEITE	GP-1	364464	ACEITE	GP-1	364464	ACEITE	G-238	550485
			ACEITE PARA CLUTCH	GP-1	364464	COMBUSTIBLE	G-1166	9H4729
V70F, V80F con motor/PERKINS			ACEITE	GP-50	68147	AIRE	GA-5648	2M7941
ACEITE	GP-1	7W2327				AIRE	GA-9334	4M9334
COMBUSTIBLE	G-296	67-6987	VC60D con motor/PERKINS			1673C A DIESEL PARA CAMION		
COMBUSTIBLE	G-296-B	67-6987	ACEITE	GP-1	364464	ACEITE	G-191	550484
			ACEITE PARA CLUTCH	GP-1	364464	GASOLINA, SEPARADOR DE AGUA	G-293	6N7617
V80 con motor/A DIESEL			ACEITE	GP-50	68147	COMBUSTIBLE	GP-110	1P2299
ACEITE, DERIVACION (BY PASS)	GP-50	68147				AIRE, COMPRESOR	GA-135	9L2169
			VC60D con motor/PERKINS			AIRE	GA-9334	4M9334
V80C con motor/PERKINS			ACEITE	GP-1	364464			
ACEITE	GP-1	7W2327	ACEITE, VELOCIDADES HIDRAULICAS	GP-1	364464	1674 A DIESEL PARA CAMION		
ACEITE, VELOCIDADES HIDRAULICAS	GP-1	7W2327	COMBUSTIBLE	G-296	67-6987	ACEITE	G-191	550484
			COMBUSTIBLE	G-296-B	67-6987			

MARCA-MODELO-MOTOR MAKE-MODEL-ENGINE	GONHER GONHER	OEM OEM	MARCA-MODELO-MOTOR MAKE-MODEL-ENGINE	GONHER GONHER	OEM OEM	MARCA-MODELO-MOTOR MAKE-MODEL-ENGINE	GONHER GONHER	OEM OEM
CATERPILLAR (continuación)			CATERPILLAR (continuación)			CATERPILLAR (continuación)		
MOTORES			MOTORES			MOTORES		
COMBUSTIBLE	GP-110	1R0740	COMBUSTIBLE, SEPARADOR DE AGUA	GPP-425	138-3100	COMBUSTIBLE, 7 1/8 IN	GP-110	1R0750
AIRE, COMPRESOR	GA-135	9L2169	COMBUSTIBLE	GPP-419	138-3098	AIRE, PRIMARIO ESTANDAR	GA-8047	7W5389
AIRE	GA-375	4L9853	3054B INDUSTRIAL A DIESEL			AIRE, PRIMARIO RADIAL	GA-499R	6I2499
1676 A DIESEL PARA CAMION			ACEITE, 5 13/32 IN	GP-1	7W2327	3116 A DIESEL (EQUIPO CATERPILLAR)		
ACEITE	G-238	5S0485	ACEITE, 7 17/32 IN	GP-31	7W2326	ACEITE	GP-51	1R0739
COMBUSTIBLE	GP-110	6L7440	COMBUSTIBLE, SEPARADOR DE AGUA	GPP-425	138-3100	COMBUSTIBLE, 5 13/32 IN	GP-62	1R0751
AIRE, COMPRESOR	GA-135	9L2169	COMBUSTIBLE	GPP-419	138-3098	COMBUSTIBLE, 7 13/32 IN	GP-1109	1R0751
AIRE	GA-375	4L9853	3054C INDUSTRIAL			COMBUSTIBLE	GPP-424	117-4089
1693 A DIESEL PARA CAMION			ACEITE	GP-31	7W2326	COMBUSTIBLE, 7 1/8 IN	GP-110	1R0750
ACEITE, CARTUCHO	G-238	5S0485	3054E INDUSTRIAL			3116 A DIESEL PARA CAMION		
COMBUSTIBLE, CARTUCHO	G-1166	6H5932	ACEITE	GP-31	7W2326	GASOLINA, SEPARADOR DE AGUA	G-293	8N9803
ACEITE, SELLADO (CUMPLE CON MEDIDAS ORIGINALES)	GP-691	2P4005	3056 A DIESEL (EQUIPO CATERPILLAR)			ACEITE	GP-51	1R0739
ACEITE, SELLADO (SEGUNDA OPCION)	GP-52	2P4005	ACEITE	GP-31	7W2326	COMBUSTIBLE, 5 13/32 IN	GP-62	1R0751
COMBUSTIBLE, SELLADO	GP-110	1P2299	COMBUSTIBLE	GPP-423	145-4501	COMBUSTIBLE, 7 13/32 IN	GP-1109	1R0751
AIRE, COMPRESOR	GA-135	9L2169	COMBUSTIBLE, SEPARADOR DE AGUA	GPP-425	163-4465	COMBUSTIBLE, SEPARADOR DE AGUA	GPP-424	117-4089
AIRE	GA-375	4L9853	3056 INDUSTRIAL A DIESEL			AIRE, COMPRESOR	GA-135	9L2169
3003 A DIESEL (EQUIPO CATERPILLAR)			ACEITE, 5 13/32 IN	GP-1	7W2327	AIRE, PRIMARIO	GA-499R	6I2499
ACEITE	GP-81	150-4140	ACEITE, 7 17/32 IN	GP-31	7W2326	3116 INDUSTRIAL A DIESEL		
3003 INDUSTRIAL A DIESEL			COMBUSTIBLE, S/N 7MS	GPP-423	145-4501	COMBUSTIBLE, SEPARADOR DE AGUA (CARTUCHO)	G-1143	8N0205
ACEITE	GP-81	150-4140	COMBUSTIBLE, SEPARADOR DE AGUA	GPP-425	138-3100	GASOLINA, SEPARADOR DE AGUA	G-293	8N9803
3013 INDUSTRIAL A DIESEL			COMBUSTIBLE, EXCEPTO S/N 7MS	GPP-419	159-6102	ACEITE	GP-51	1R0739
ACEITE	GP-81	150-4140	3056 MARINO A DIESEL			COMBUSTIBLE, 5 13/32 IN	GP-62	1R0751
3014 A DIESEL (EQUIPO CATERPILLAR), 3014 MARINO A DIESEL			ACEITE	GP-1	7W2327	COMBUSTIBLE, 7 13/32 IN	GP-1109	1R0751
ACEITE	GP-81	150-4140	3064 A DIESEL (EQUIPO CATERPILLAR)			COMBUSTIBLE, SEPARADOR DE AGUA	GPP-424	117-4089
3024 A DIESEL (EQUIPO CATERPILLAR)			ACEITE, FLUJO TOTAL (FULL FLOW)	GP-51	1R0739	COMBUSTIBLE, 7 1/8 IN	GP-110	1R0740
ACEITE	GP-36	1R0734	COMBUSTIBLE, 5 13/32 IN	GP-62	1R0751	3116 MARINO A DIESEL		
ACEITE	GP-81	150-4140	COMBUSTIBLE, 7 13/32 IN	GP-1109	1R0751	COMBUSTIBLE, SEPARADOR DE AGUA	G-1143	8N0205
COMBUSTIBLE	GPP-420	156-1200	3066 A DIESEL (EQUIPO CATERPILLAR)			ACEITE	GP-51	1R0739
3024 INDUSTRIAL A DIESEL			ACEITE	GP-51	1R0739	COMBUSTIBLE, 5 13/32 IN	GP-62	1R0751
ACEITE	GP-81	150-4140	COMBUSTIBLE, 5 13/32 IN	GP-62	1R0751	COMBUSTIBLE, 7 13/32 IN	GP-1109	1R0751
3034 A DIESEL (EQUIPO CATERPILLAR)			COMBUSTIBLE, 7 13/32 IN	GP-1109	1R0751	COMBUSTIBLE, 7 1/8 IN	GP-110	1R0740
ACEITE	GP-1	7W2327	3114 A DIESEL (EQUIPO CATERPILLAR)			AIRE, ESTANDAR	GA-119	8N5006
COMBUSTIBLE, SEPARADOR DE AGUA	GPP-421	131-1812	ACEITE, FLUJO TOTAL (FULL FLOW)	GP-51	1R0739	3116 TA MARINO A DIESEL		
COMBUSTIBLE, SEPARADOR DE AGUA	GPP-425	163-4465	COMBUSTIBLE, 5 13/32 IN	GP-62	1R0751	COMBUSTIBLE	G-1143	8N0205
COMBUSTIBLE	GPP-419	159-6102	COMBUSTIBLE, 7 13/32 IN	GP-1109	1R0751	ACEITE	GP-51	1R0739
3034D INDUSTRIAL A DIESEL			ACEITE, DERIVACION (BY PASS)	GP-57	1W8845	COMBUSTIBLE, 5 13/32 IN	GP-62	1R0751
ACEITE	GP-1	7W2327	COMBUSTIBLE, SEPARADOR DE AGUA	GPP-424	117-4089	AIRE	GA-119	8N-5006
COMBUSTIBLE, SEPARADOR DE AGUA	GPP-425	163-4465	COMBUSTIBLE, 7 1/8 IN	GP-110	1R0750	3126 (7.2L) A DIESEL PARA CAMION		
COMBUSTIBLE	GPP-419	159-6102	3114 A DIESEL PARA CAMION			ACEITE	GP-51	1R0739
3046 A DIESEL (EQUIPO CATERPILLAR)			ACEITE	GP-51	1R0739	COMBUSTIBLE, 5 13/32 IN	GP-62	1R0751
ACEITE	GP-36	1R0734	COMBUSTIBLE, 5 13/32 IN	GP-62	1R0751	COMBUSTIBLE, 7 13/32 IN	GP-1109	1R0751
3054 A DIESEL PARA CAMION			COMBUSTIBLE, 7 13/32 IN	GP-1109	1R0751	3126 (7.2L) INDUSTRIAL A DIESEL		
ACEITE	GP-31	7W2326	3114 INDUSTRIAL A DIESEL			ACEITE, CUMPLE CON MEDIDAS ORIGINALES	GP-691	1R0716
COMBUSTIBLE	G-296	67-6987	GASOLINA, SEPARADOR DE AGUA	G-293	8N9803	ACEITE	GP-51	1R0739
COMBUSTIBLE	G-296-B	67-6987	COMBUSTIBLE, 5 13/32 IN	GP-62	1R0751	ACEITE, SEGUNDA OPCION	GP-52	1R0716
3054 INDUSTRIAL A DIESEL			COMBUSTIBLE, 7 13/32 IN	GP-1109	1R0751	COMBUSTIBLE, 5 13/32 IN	GP-62	1R0751
ACEITE, 5 13/32 IN	GP-1	7W2327	COMBUSTIBLE, SEPARADOR DE AGUA	GPP-424	117-4089	COMBUSTIBLE, 7 13/32 IN	GP-1109	1R0751
ACEITE, 7 17/32 IN	GP-31	7W2326				COMBUSTIBLE, SEPARADOR DE AGUA	GPP-424	117-4089

SERVICIO PESADO

MARCA-MODELO-MOTOR MAKE-MODEL-ENGINE	GONHER GONHER	OEM OEM	MARCA-MODELO-MOTOR MAKE-MODEL-ENGINE	GONHER GONHER	OEM OEM	MARCA-MODELO-MOTOR MAKE-MODEL-ENGINE	GONHER GONHER	OEM OEM
CATERPILLAR (continuación)			CATERPILLAR (continuación)			CATERPILLAR (continuación)		
MOTORES			MOTORES			MOTORES		
3126 A DIESEL (EQUIPO CATERPILLAR)			3176 INDUSTRIAL A DIESEL			3196 A DIESEL (EQUIPO CATERPILLAR)		
ACEITE, FLUJO TOTAL (FULL FLOW)	GP-51	1R0739	COMBUSTIBLE, SEPARADOR DE AGUA (CARTUCHO)	G-1143	8N0205	COMBUSTIBLE	GP-749	1R0749
COMBUSTIBLE, 5 13/32 IN	GP-62	1R0751	COMBUSTIBLE, TRACTORES CHALLENGER	GP-749	1R0749	ACEITE, CUMPLE CON MEDIDAS ORIGINALES	GP-691	1R0716
COMBUSTIBLE, 7 13/32 IN	GP-1109	1R0751	ACEITE, FLUJO TOTAL (FULL FLOW) (CUMPLE CON MEDIDAS ORIGINALES)	GP-691	1R0716	ACEITE, SEGUNDA OPCION	GP-52	1R0716
ACEITE, DERIVACION (BY PASS)	GP-57	1W8845	ACEITE, FLUJO TOTAL (FULL FLOW) (SEGUNDA OPCION)	GP-52	1R0716	3196 INDUSTRIAL A DIESEL		
COMBUSTIBLE, SEPARADOR DE AGUA	GPP-424	117-4089	COMBUSTIBLE	GP-1108	1R0712	COMBUSTIBLE, SEPARADOR DE AGUA	G-1143	8N0205
			ACEITE, DERIVACION (BY PASS)	GP-57	1W8845	COMBUSTIBLE	GP-749	1R0749
3126 MARINO A DIESEL			COMBUSTIBLE, SEPARADOR DE AGUA (SELLADO)	GPP-11	175-2949	ACEITE, FLUJO TOTAL (FULL FLOW) (CUMPLE CON MEDIDAS ORIGINALES)	GP-691	1R0716
COMBUSTIBLE, SEPARADOR DE AGUA	G-1143	8N0205				ACEITE, FLUJO TOTAL (FULL FLOW) (SEGUNDA OPCION)	GP-52	1R0716
COMBUSTIBLE, 5 13/32 IN	GP-62	1R0751	3176B A DIESEL PARA CAMION			ACEITE, DERIVACION (BY PASS)	GP-57	1W8845
COMBUSTIBLE, 7 13/32 IN	GP-1109	1R0751	COMBUSTIBLE, SEPARADOR DE AGUA	G-1143	8N0205			
			COMBUSTIBLE	GP-749	1R0749	3196 MARINO A DIESEL		
3126B (7.2L) A DIESEL PARA CAMION			ACEITE, FLUJO TOTAL (FULL FLOW) (CUMPLE CON MEDIDAS ORIGINALES)	GP-691	1R0716	COMBUSTIBLE, SEPARADOR DE AGUA (CARTUCHO)	G-1143	8N0205
ACEITE	GP-51	1R0739	ACEITE, FLUJO TOTAL (FULL FLOW) (SEGUNDA OPCION)	GP-52	1R0716	COMBUSTIBLE	GP-749	1R0749
COMBUSTIBLE, 5 13/32 IN	GP-62	1R0751	ACEITE, DERIVACION (BY PASS)	GP-57	1W8845	ACEITE, CUMPLE CON MEDIDAS ORIGINALES	GP-691	1R0716
COMBUSTIBLE, 7 13/32 IN	GP-1109	1R0751				ACEITE, SEGUNDA OPCION	GP-52	1R0716
			3176B INDUSTRIAL A DIESEL					
3126B (7.2L) INDUSTRIAL A DIESEL			COMBUSTIBLE, SEPARADOR DE AGUA (CARTUCHO)	G-1143	8N0205	3204 A DIESEL (EQUIPO CATERPILLAR)		
ACEITE, CUMPLE CON MEDIDAS ORIGINALES	GP-691	1R0716	COMBUSTIBLE	GP-749	1R0749	ACEITE	GP-36	9L9200
ACEITE	GP-51	1R0739	ACEITE, FLUJO TOTAL (FULL FLOW) (CUMPLE CON MEDIDAS ORIGINALES)	GP-691	1R0716	COMBUSTIBLE	GP-110	1P2299
ACEITE, SEGUNDA OPCION	GP-52	1R0716	ACEITE, FLUJO TOTAL (FULL FLOW) (SEGUNDA OPCION)	GP-52	1R0716	ACEITE	GP-9586	1R0713
COMBUSTIBLE, 5 13/32 IN	GP-62	1R0751	COMBUSTIBLE	GP-1108	1R0712	3204 INDUSTRIAL A DIESEL		
COMBUSTIBLE, 7 13/32 IN	GP-1109	1R0751	ACEITE, DERIVACION (BY PASS)	GP-57	1W8845	COMBUSTIBLE	GP-110	1R0750
COMBUSTIBLE, SEPARADOR DE AGUA	GPP-424	117-4089				3208 A DIESEL		
			3176B MARINO A DIESEL			ACEITE	GP-36	9L9200
3126B MARINO A DIESEL			COMBUSTIBLE, SEPARADOR DE AGUA	G-1143	8N0205	GASOLINA, SEPARADOR DE AGUA	G-293	8N9803
ACEITE	GP-51	1R0739	COMBUSTIBLE	GP-749	1R0749	COMBUSTIBLE	GP-110	1R0740
COMBUSTIBLE, 5 13/32 IN	GP-62	1R0751	ACEITE, CUMPLE CON MEDIDAS ORIGINALES	GP-691	1R0716	ACEITE	GP-9586	1R0713
COMBUSTIBLE, 7 13/32 IN	GP-1109	1R0751	ACEITE, SEGUNDA OPCION	GP-52	1R0716	3208 MARINO A DIESEL		
COMBUSTIBLE, SEPARADOR DE AGUA	GPP-11	198-6378	COMBUSTIBLE, INSTALACION EN EL CAMPO	GP-1108	1R0712	COMBUSTIBLE, SEPARADOR DE AGUA	G-1143	8N0205
						ACEITE	GP-36	9L9200
3126E (7.2L) A DIESEL			3176C INDUSTRIAL A DIESEL			GASOLINA, SEPARADOR DE AGUA	G-293	8N9803
ACEITE	GP-51	1R0739	COMBUSTIBLE, SEPARADOR DE AGUA	G-1143	8N0205	COMBUSTIBLE	GP-110	1R0740
COMBUSTIBLE, 5 13/32 IN	GP-62	1R0751	COMBUSTIBLE	GP-749	1R0749	ACEITE	GP-9586	1R0713
COMBUSTIBLE, 7 13/32 IN	GP-1109	1R0751	ACEITE, FLUJO TOTAL (FULL FLOW) (CUMPLE CON MEDIDAS ORIGINALES)	GP-691	1R0716	3204 INDUSTRIAL A DIESEL		
COMBUSTIBLE, SEPARADOR DE AGUA	GPP-11	198-6378	ACEITE, FLUJO TOTAL (FULL FLOW) (SEGUNDA OPCION)	GP-52	1R0716	COMBUSTIBLE, SEPARADOR DE AGUA (CARTUCHO)	G-1143	8N0205
			COMBUSTIBLE	GP-1108	1R0712	ACEITE, ACCESORIO DE LUBRICACION (CUMPLE CON MEDIDAS ORIGINALES)	GP-691	1R0716
3160 MARINO A DIESEL			ACEITE, DERIVACION (BY PASS)	GP-57	1W8845	GASOLINA, SEPARADOR DE AGUA	G-293	8N9803
ACEITE	GP-36	9L9200				COMBUSTIBLE	GP-110	1R0750
			3176C MARINO A DIESEL			ACEITE	GP-9586	1R0713
3176 A DIESEL (EQUIPO CATERPILLAR)			COMBUSTIBLE	GP-749	1R0749	3304 A DIESEL (EQUIPO CATERPILLAR)		
COMBUSTIBLE, TRACTORES CHALLENGER	GP-749	1R0749	ACEITE, CUMPLE CON MEDIDAS ORIGINALES	GP-691	1R0716	ACEITE, CARTUCHO	G-191	550484
ACEITE, CUMPLE CON MEDIDAS ORIGINALES	GP-691	1R0716	ACEITE, FLUJO TOTAL (FULL FLOW) (CUMPLE CON MEDIDAS ORIGINALES)	GP-691	1R0716	COMBUSTIBLE, DUPLEX	GP-749	1R0749
ACEITE, SEGUNDA OPCION	GP-52	1R0716	ACEITE, FLUJO TOTAL (FULL FLOW) (SEGUNDA OPCION)	GP-52	1R0716	GASOLINA, SEPARADOR DE AGUA	G-293	8N9803
COMBUSTIBLE	GP-1108	1R0712	COMBUSTIBLE	GP-1108	1R0712	ACEITE, SELLADO	GP-51	1R0739
			ACEITE, DERIVACION (BY PASS)	GP-57	1W8845	COMBUSTIBLE	GP-110	1P2299
3176 A DIESEL PARA CAMION						3304 INDUSTRIAL A DIESEL		
COMBUSTIBLE, SEPARADOR DE AGUA	G-1143	8N0205	3181 CON MECANISMO REDUCTOR			COMBUSTIBLE, SEPARADOR DE AGUA (CARTUCHO)	G-1143	8N0205
COMBUSTIBLE, INSTALACION EN EL CAMPO	GP-749	1R0749	TRANSMISION	G-238	550485	ACEITE, ACCESORIO DE LUBRICACION (CUMPLE CON MEDIDAS ORIGINALES)	GP-691	1R0716
ACEITE, CUMPLE CON MEDIDAS ORIGINALES	GP-691	1R0716				GASOLINA, SEPARADOR DE AGUA	G-293	8N9803
ACEITE, SEGUNDA OPCION	GP-52	1R0716	3192 CON MECANISMO REDUCTOR			ACEITE	GP-51	1R0739
COMBUSTIBLE, MONTAJE REMOTO	GP-1108	1R0712	TRANSMISION	G-238	550485	ACEITE, ACCESORIO DE LUBRICACION (SEGUNDA OPCION)	GP-52	1R0716
ACEITE, DERIVACION (BY PASS)	GP-57	1W8845				COMBUSTIBLE	GP-110	1R0740
AIRE, PRIMARIO	GA-9334	7W5310						

MARCA-MODELO-MOTOR MAKE-MODEL-ENGINE	GONHER GONHER	OEM OEM	MARCA-MODELO-MOTOR MAKE-MODEL-ENGINE	GONHER GONHER	OEM OEM	MARCA-MODELO-MOTOR MAKE-MODEL-ENGINE	GONHER GONHER	OEM OEM
CATERPILLAR (continuación)			CATERPILLAR (continuación)			CATERPILLAR (continuación)		
MOTORES			MOTORES			MOTORES		
3304 INDUSTRIAL A GAS NATURAL			3306 INDUSTRIAL A DIESEL			3306C A DIESEL PARA CAMION		
ACEITE	GP-51	1R0739	COMBUSTIBLE, SEPARADOR DE AGUA (CARTUCHO)	G-1143	8N0205	ACEITE, ACCESORIO DE LUBRICACION (CUMPLE CON MEDIDAS ORIGINALES)	GP-691	1R0716
3304 MARINO A DIESEL			ACEITE, ACCESORIO DE LUBRICACION (CUMPLE CON MEDIDAS ORIGINALES)	GP-691	1R0716	ACEITE	GP-51	1R0739
COMBUSTIBLE, SEPARADOR DE AGUA	G-1143	8N0205	GASOLINA, SEPARADOR DE AGUA	G-293	8N9803	ACEITE, ACCESORIO DE LUBRICACION (SEGUNDA OPCION)	GP-52	1R0716
COMBUSTIBLE, DUPLEX	GP-749	1R0749	ACEITE	GP-51	1R0739	COMBUSTIBLE	GP-110	1R0740
ACEITE, ACCESORIO DE LUBRICACION (CUMPLE CON MEDIDAS ORIGINALES)	GP-691	1R0716	ACEITE, ACCESORIO DE LUBRICACION (SEGUNDA OPCION)	GP-52	1R0716	AIRE ESTANDAR	GA-9334	7W5317
GASOLINA, SEPARADOR DE AGUA	G-293	6N7617	COMBUSTIBLE	GP-110	1R0750			
ACEITE	GP-51	1R0739	AIRE, COMPRESOR	GA-135	9L2169	3406 A DIESEL (EQUIPO CATERPILLAR)		
ACEITE, ACCESORIO DE LUBRICACION (SEGUNDA OPCION)	GP-52	1R0716	3306 INDUSTRIAL A GAS NATURAL			COMBUSTIBLE, SEPARADOR DE AGUA (CARTUCHO)	G-1143	8N0205
COMBUSTIBLE	GP-110	1R0740	ACEITE	G-191	5S0484	COMBUSTIBLE	GP-749	1R0749
3304B INDUSTRIAL A DIESEL			3306 MARINO A DIESEL			ACEITE, FLUJO TOTAL (FULL FLOW) (CUMPLE CON MEDIDAS ORIGINALES)	GP-691	1R0716
COMBUSTIBLE, SEPARADOR DE AGUA (CARTUCHO)	G-1143	8N0205	COMBUSTIBLE, SEPARADOR DE AGUA	G-1143	8N0205	ACEITE, FLUJO TOTAL (FULL FLOW) (SEGUNDA OPCION)	GP-52	1R0716
ACEITE, ACCESORIO DE LUBRICACION (CUMPLE CON MEDIDAS ORIGINALES)	GP-691	1R0716	COMBUSTIBLE	GP-749	1R0749	COMBUSTIBLE	GP-1108	1R0712
GASOLINA, SEPARADOR DE AGUA	G-293	8N9803	ACEITE, ACCESORIO DE LUBRICACION (CUMPLE CON MEDIDAS ORIGINALES)	GP-691	1R0716	ACEITE, DERIVACION (BY PASS)	GP-57	1W8845
ACEITE	GP-51	1R0739	GASOLINA, SEPARADOR DE AGUA	G-293	8N9803	COMBUSTIBLE	GP-110	1R0750
ACEITE, ACCESORIO DE LUBRICACION (SEGUNDA OPCION)	GP-52	1R0716	ACEITE	GP-51	1R0739	3406 A DIESEL PARA CAMION		
COMBUSTIBLE	GP-110	1R0740	ACEITE, ACCESORIO DE LUBRICACION (SEGUNDA OPCION)	GP-52	1R0716	ACEITE, CUMPLE CON MEDIDAS ORIGINALES	GP-691	2P4005
3304B MARINO A DIESEL			COMBUSTIBLE	GP-110	1R0750	ACEITE, SEGUNDA OPCION	GP-52	2P4005
COMBUSTIBLE, SEPARADOR DE AGUA	G-1143	8N0205	3306B A DIESEL PARA CAMION			COMBUSTIBLE	GP-1108	4N5823
COMBUSTIBLE, DUPLEX	GP-749	1R0749	ACEITE, CARTUCHO	G-191	5S0484	AIRE, ACCESORIO DE AIRE	GA-375	4L9853
ACEITE, ACCESORIO DE LUBRICACION (CUMPLE CON MEDIDAS ORIGINALES)	GP-691	1R0716	COMBUSTIBLE, SEPARADOR DE AGUA	G-1143	8N0205	3406 INDUSTRIAL A DIESEL		
GASOLINA, SEPARADOR DE AGUA	G-293	6N7617	ACEITE, SELLADO (CUMPLE CON MEDIDAS ORIGINALES)	GP-691	1R0716	COMBUSTIBLE	GP-749	1R0749
ACEITE	GP-51	1R0739	GASOLINA, SEPARADOR DE AGUA	G-293	6N7617	ACEITE, CUMPLE CON MEDIDAS ORIGINALES	GP-691	1R0716
ACEITE, ACCESORIO DE LUBRICACION (SEGUNDA OPCION)	GP-52	1R0716	ACEITE, SELLADO	GP-51	1R0739	ACEITE, SEGUNDA OPCION	GP-52	1R0716
COMBUSTIBLE	GP-110	1R0740	ACEITE, SELLADO (SEGUNDA OPCION)	GP-52	1R0716	COMBUSTIBLE	GP-1108	4N5823
3306 A DIESEL (EQUIPO CATERPILLAR)			COMBUSTIBLE	GP-110	1R0740	3406 INDUSTRIAL A GAS NATURAL		
ACEITE, CARTUCHO	G-191	5S0484	AIRE ESTANDAR	GA-9334	7W5317	ACEITE, CUMPLE CON MEDIDAS ORIGINALES	GP-691	1R0716
ACEITE, SELLADO (CUMPLE CON MEDIDAS ORIGINALES)	GP-691	1R0716	3306B INDUSTRIAL A DIESEL			3406 MARINO A DIESEL		
GASOLINA, SEPARADOR DE AGUA	G-293	8N9803	COMBUSTIBLE, SEPARADOR DE AGUA (CARTUCHO)	G-1143	8N0205	ACEITE	G-191	5S0484
ACEITE, SELLADO	GP-51	1R0739	ACEITE, ACCESORIO DE LUBRICACION (CUMPLE CON MEDIDAS ORIGINALES)	GP-691	1R0716	COMBUSTIBLE, SEPARADOR DE AGUA	G-1143	8N0205
ACEITE, SELLADO (SEGUNDA OPCION)	GP-52	1R0716	GASOLINA, SEPARADOR DE AGUA	G-293	8N9803	ACEITE, CUMPLE CON MEDIDAS ORIGINALES	GP-691	2P4005
COMBUSTIBLE	GP-1108	1R0712	ACEITE	GP-51	1R0739	ACEITE, SEGUNDA OPCION	GP-52	2P4005
COMBUSTIBLE	GP-110	1R0740	ACEITE, ACCESORIO DE LUBRICACION (SEGUNDA OPCION)	GP-52	1R0716	COMBUSTIBLE	GP-1108	4N5823
3306 A DIESEL PARA CAMION			COMBUSTIBLE	GP-110	1R0750	AIRE	GAP-381	4N0015
ACEITE, CARTUCHO	G-191	5S0484	AIRE, COMPRESOR	GA-135	9L2169	3406B A DIESEL (EQUIPO CATERPILLAR)		
COMBUSTIBLE, SEPARADOR DE AGUA	G-1143	8N0205	3306B MARINO A DIESEL			COMBUSTIBLE, SEPARADOR DE AGUA (CARTUCHO)	G-1143	8N0205
ACEITE, SELLADO (CUMPLE CON MEDIDAS ORIGINALES)	GP-691	1R0716	COMBUSTIBLE, SEPARADOR DE AGUA	G-1143	8N0205	COMBUSTIBLE	GP-749	1R0749
GASOLINA, SEPARADOR DE AGUA	G-293	6N7617	COMBUSTIBLE	GP-749	1R0749	ACEITE, FLUJO TOTAL (FULL FLOW) (CUMPLE CON MEDIDAS ORIGINALES)	GP-691	1R0716
ACEITE, SELLADO	GP-51	1R0739	ACEITE, ACCESORIO DE LUBRICACION (CUMPLE CON MEDIDAS ORIGINALES)	GP-691	1R0716	ACEITE, FLUJO TOTAL (FULL FLOW) (SEGUNDA OPCION)	GP-52	1R0716
ACEITE, SELLADO (SEGUNDA OPCION)	GP-52	1R0716	GASOLINA, SEPARADOR DE AGUA	G-293	8N9803	COMBUSTIBLE	GP-1108	1R0712
COMBUSTIBLE	GP-110	1R0740	ACEITE	GP-51	1R0739	ACEITE, DERIVACION (BY PASS)	GP-57	1W8845
AIRE ESTANDAR	GA-9334	7W5317	ACEITE, ACCESORIO DE LUBRICACION (SEGUNDA OPCION)	GP-52	1R0716	COMBUSTIBLE	GP-110	1R0750
			COMBUSTIBLE	GP-110	1R0750	3406B A DIESEL PARA CAMION		
						COMBUSTIBLE	GP-749	1R0749
						ACEITE, CUMPLE CON MEDIDAS ORIGINALES	GP-691	1R0716
						ACEITE, SEGUNDA OPCION	GP-52	1R0716

SERVICIO PESADO

MARCA-MODELO-MOTOR MAKE-MODEL-ENGINE	GONHER GONHER	OEM OEM	MARCA-MODELO-MOTOR MAKE-MODEL-ENGINE	GONHER GONHER	OEM OEM	MARCA-MODELO-MOTOR MAKE-MODEL-ENGINE	GONHER GONHER	OEM OEM
CATERPILLAR (continuación)			CATERPILLAR (continuación)			CATERPILLAR (continuación)		
MOTORES			MOTORES			MOTORES		
COMBUSTIBLE	GP-1108	1R0712	3406E A DIESEL PARA CAMION			COMBUSTIBLE	GP-1108	4N5823
3406B INDUSTRIAL A DIESEL			COMBUSTIBLE	GP-749	1R0749	AIRE	GA-1203	5L1203
COMBUSTIBLE	GP-749	1R0749	ACEITE, CUMPLE CON MEDIDAS ORIGINALES	GP-691	1R0716	3408B INDUSTRIAL A DIESEL		
ACEITE, CUMPLE CON MEDIDAS ORIGINALES	GP-691	1R0716	ACEITE, SEGUNDA OPCION	GP-52	1R0716	COMBUSTIBLE	GP-749	1R0749
ACEITE, SEGUNDA OPCION	GP-52	1R0716	COMBUSTIBLE	GP-1108	1R0712	ACEITE, CUMPLE CON MEDIDAS ORIGINALES	GP-691	1R0716
COMBUSTIBLE	GP-1108	4N5823	3406E INDUSTRIAL A DIESEL			ACEITE, SEGUNDA OPCION	GP-52	1R0716
3406B MARINO A DIESEL			COMBUSTIBLE	GP-749	1R0749	3408B INDUSTRIAL A GAS NATURAL		
ACEITE	G-191	9G6420	ACEITE, CUMPLE CON MEDIDAS ORIGINALES	GP-691	1R0716	ACEITE, CUMPLE CON MEDIDAS ORIGINALES	GP-691	1R0716
COMBUSTIBLE, SEPARADOR DE AGUA	G-1143	8N0205	ACEITE, SEGUNDA OPCION	GP-52	1R0716	COMBUSTIBLE, SEPARADOR DE AGUA	G-1143	8N0205
COMBUSTIBLE	GP-749	1R0749	COMBUSTIBLE	GP-1108	4N5823	COMBUSTIBLE	GP-749	1R0749
ACEITE, CUMPLE CON MEDIDAS ORIGINALES	GP-691	1R0716	3406E MARINO A DIESEL			ACEITE, CUMPLE CON MEDIDAS ORIGINALES	GP-691	1R0716
ACEITE, SEGUNDA OPCION	GP-52	1R0716	COMBUSTIBLE	GP-749	1R0749	ACEITE, SEGUNDA OPCION	GP-52	1R0716
AIRE	GAP-381	4N0015	ACEITE, CUMPLE CON MEDIDAS ORIGINALES	GP-691	1R0716	AIRE, ACCESORIO	GAP-381	4N0015
3406C A DIESEL (EQUIPO CATERPILLAR)			ACEITE, SEGUNDA OPCION	GP-52	1R0716	AIRE	GA-483	7W5313
COMBUSTIBLE, SEPARADOR DE AGUA (CARTUCHO)	G-1143	8N0205	AIRE, PANEL	GAP-381	4N0015	3408C INDUSTRIAL A DIESEL		
COMBUSTIBLE	GP-749	1R0749	3408 A DIESEL (EQUIPO CATERPILLAR)			COMBUSTIBLE	GP-749	1R0749
ACEITE, FLUJO TOTAL (FULL FLOW) (CUMPLE CON MEDIDAS ORIGINALES)	GP-691	1R0716	COMBUSTIBLE	GP-749	1R0749	ACEITE, CUMPLE CON MEDIDAS ORIGINALES	GP-691	1R0716
ACEITE, FLUJO TOTAL (FULL FLOW) (SEGUNDA OPCION)	GP-52	1R0716	ACEITE, CUMPLE CON MEDIDAS ORIGINALES	GP-691	1R0716	ACEITE, SEGUNDA OPCION	GP-52	1R0716
COMBUSTIBLE	GP-1108	1R0712	ACEITE, SEGUNDA OPCION	GP-52	1R0716	AIRE, ACCESORIO	GAP-381	4N0015
ACEITE, DERIVACION (BY PASS)	GP-57	1W8845	3408 A DIESEL PARA CAMION			AIRE	GA-483	7W5313
COMBUSTIBLE	GP-110	1R0750	COMBUSTIBLE	GP-749	1R0749	3408C MARINO A DIESEL		
3406C A DIESEL PARA CAMION			ACEITE, CUMPLE CON MEDIDAS ORIGINALES	GP-691	1R0716	ACEITE	G-191	9G6420
COMBUSTIBLE	GP-749	1R0749	ACEITE, SEGUNDA OPCION	GP-52	1R0716	COMBUSTIBLE, SEPARADOR DE AGUA	G-1143	8N0205
ACEITE, CUMPLE CON MEDIDAS ORIGINALES	GP-691	1R0716	COMBUSTIBLE	GP-1108	4N5823	COMBUSTIBLE	GP-749	1R0749
ACEITE, SEGUNDA OPCION	GP-52	1R0716	AIRE	GA-1203	5L1203	ACEITE, CUMPLE CON MEDIDAS ORIGINALES	GP-691	1R0716
COMBUSTIBLE	GP-1108	1R0712	3408 INDUSTRIAL A DIESEL			ACEITE, SEGUNDA OPCION	GP-52	1R0716
3406C INDUSTRIAL A DIESEL			ACEITE, CUMPLE CON MEDIDAS ORIGINALES	GP-691	1R0716	AIRE, ACCESORIO	GAP-381	4N0015
COMBUSTIBLE	GP-749	1R0749	ACEITE, SEGUNDA OPCION	GP-52	1R0716	AIRE	GA-483	7W5313
ACEITE, CUMPLE CON MEDIDAS ORIGINALES	GP-691	1R0716	COMBUSTIBLE	GP-1108	1R0712	3408E INDUSTRIAL A DIESEL		
ACEITE, SEGUNDA OPCION	GP-52	1R0716	AGUA	GP-2071W	9N3368	COMBUSTIBLE	GP-749	1R0749
COMBUSTIBLE	GP-1108	4N5823	AIRE, PRIMARIO	GA-356	6N6071	ACEITE, CUMPLE CON MEDIDAS ORIGINALES	GP-691	1R0716
3406C MARINO A DIESEL			AIRE, ACCESORIO	GAP-381	4N0015	ACEITE, SEGUNDA OPCION	GP-52	1R0716
ACEITE	G-191	9G6420	AIRE, SECUNDARIO	GA-357	6N6072	AIRE, ACCESORIO	GAP-381	4N0015
COMBUSTIBLE, SEPARADOR DE AGUA	G-1143	8N0205	AIRE, PRIMARIO	GA-483	1P8483	AIRE	GA-483	7W5313
COMBUSTIBLE	GP-749	1R0749	AIRE, SECUNDARIO	GA-482	1P8482	3412 A DIESEL (EQUIPO CATERPILLAR)		
ACEITE, CUMPLE CON MEDIDAS ORIGINALES	GP-691	1R0716	3408 INDUSTRIAL A GAS NATURAL			COMBUSTIBLE	GP-749	1R0749
ACEITE, SEGUNDA OPCION	GP-52	1R0716	ACEITE, CUMPLE CON MEDIDAS ORIGINALES	GP-691	1R0716	ACEITE, CUMPLE CON MEDIDAS ORIGINALES	GP-691	1R0716
COMBUSTIBLE	GP-1108	4N5823	ACEITE, SEGUNDA OPCION	GP-52	1R0716	ACEITE, SEGUNDA OPCION	GP-52	1R0716
3406C MARINO A DIESEL			COMBUSTIBLE	GP-1108	4N5823	COMBUSTIBLE	GP-1108	2W2134
ACEITE	G-191	9G6420	AIRE	GAP-381	4N0015	3412 INDUSTRIAL A DIESEL		
COMBUSTIBLE, SEPARADOR DE AGUA	G-1143	8N0205	3408 MARINO A DIESEL			COMBUSTIBLE	GP-749	1R0749
COMBUSTIBLE	GP-749	1R0749	ACEITE	G-191	9G6420	ACEITE, CUMPLE CON MEDIDAS ORIGINALES	GP-691	1R0716
ACEITE, CUMPLE CON MEDIDAS ORIGINALES	GP-691	1R0716	COMBUSTIBLE, SEPARADOR DE AGUA	G-1143	8N0205	ACEITE, SEGUNDA OPCION	GP-52	1R0716
ACEITE, SEGUNDA OPCION	GP-52	1R0716	ACEITE, CUMPLE CON MEDIDAS ORIGINALES	GP-691	1R0716	COMBUSTIBLE	GP-1108	4N5823
COMBUSTIBLE	GP-1108	4N5823	ACEITE, SEGUNDA OPCION	GP-52	1R0716	3412 INDUSTRIAL A GAS NATURAL		
3406C MARINO A DIESEL			COMBUSTIBLE	GP-1108	4N5823	ACEITE, CUMPLE CON MEDIDAS ORIGINALES	GP-691	1R0716
ACEITE	G-191	9G6420	AIRE	GAP-381	4N0015	COMBUSTIBLE, SEPARADOR DE AGUA	G-1143	8N0805
COMBUSTIBLE, SEPARADOR DE AGUA	G-1143	8N0205	3408B A DIESEL PARA CAMION			COMBUSTIBLE	GP-749	1R0749
COMBUSTIBLE	GP-749	1R0749	COMBUSTIBLE	GP-749	1R0749			
ACEITE, FLUJO TOTAL (FULL FLOW) (CUMPLE CON MEDIDAS ORIGINALES)	GP-691	1R0716	ACEITE, CUMPLE CON MEDIDAS ORIGINALES	GP-691	1R0716			
ACEITE, FLUJO TOTAL (FULL FLOW) (SEGUNDA OPCION)	GP-52	1R0716	ACEITE, SEGUNDA OPCION	GP-52	1R0716			
COMBUSTIBLE	GP-1108	1R0712	COMBUSTIBLE	GP-1108	4N5823			
ACEITE, DERIVACION (BY PASS)	GP-57	1W8845	AIRE	GAP-381	4N0015			
COMBUSTIBLE	GP-110	1R0750	3408B A DIESEL PARA CAMION					
			COMBUSTIBLE	GP-749	1R0749			
			ACEITE, CUMPLE CON MEDIDAS ORIGINALES	GP-691	1R0716			
			ACEITE, SEGUNDA OPCION	GP-52	1R0716			

MARCA-MODELO-MOTOR MAKE-MODEL-ENGINE	GONHER GONHER	OEM OEM	MARCA-MODELO-MOTOR MAKE-MODEL-ENGINE	GONHER GONHER	OEM OEM	MARCA-MODELO-MOTOR MAKE-MODEL-ENGINE	GONHER GONHER	OEM OEM
CATERPILLAR (continuación)			CATERPILLAR (continuación)			CATERPILLAR (continuación)		
MOTORES			MOTORES			MOTORES		
ACEITE, CUMPLE CON MEDIDAS ORIGINALES	GP-691	1R0716	3508 A DIESEL (EQUIPO CATERPILLAR)			3516B INDUSTRIAL A DIESEL, 3516B MARINO A DIESEL		
ACEITE, SEGUNDA OPCION	GP-52	1R0716	ACEITE, CUMPLE CON MEDIDAS ORIGINALES	GP-691	1R0716	ACEITE, SELLADO (CUMPLE CON MEDIDAS ORIGINALES)	GP-691	2P4005
COMBUSTIBLE	GP-1108	4N5823						
AIRE	GAP-381	4N0015	3508 INDUSTRIAL A GAS NATURAL			3524B A DIESEL (EQUIPO CATERPILLAR)		
			AIRE, PRIMARIO	GA-483	7W5313	ACEITE, CUMPLE CON MEDIDAS ORIGINALES	GP-691	2P4005
3412B MARINO A DIESEL								
COMBUSTIBLE, SEPARADOR DE AGUA	G-1143	8N0805	3508B INDUSTRIAL A DIESEL, 3508B MARINO A DIESEL			3612 MARINO A DIESEL		
COMBUSTIBLE	GP-749	1R0749	ACEITE, SELLADO (CUMPLE CON MEDIDAS ORIGINALES)	GP-691	2P4005	COMBUSTIBLE	GS-2033	1R0725
ACEITE, CUMPLE CON MEDIDAS ORIGINALES	GP-691	1R0716						
ACEITE, SEGUNDA OPCION	GP-52	1R0716	3512 A DIESEL (EQUIPO CATERPILLAR)			7211 CON MECANISMO REDUCTOR		
COMBUSTIBLE	GP-1108	4N5823	ACEITE, SELLADO (CUMPLE CON MEDIDAS ORIGINALES)	GP-691	2P4005	TRANSMISION	G-152	9M9740
AIRE	GAP-381	4N0015	ACEITE, SELLADO (SEGUNDA OPCION)	GP-52	2P4005			
			ACCESORIO (RENOVACION DE ACEITE)	GP-110	1R0750	7221 CON MECANISMO REDUCTOR		
3412C A DIESEL (EQUIPO CATERPILLAR)						TRANSMISION	G-152	9M9740
COMBUSTIBLE	GP-749	1R0749	3512 INDUSTRIAL A DIESEL					
ACEITE, CUMPLE CON MEDIDAS ORIGINALES	GP-691	1R0716	ACEITE, SELLADO (CUMPLE CON MEDIDAS ORIGINALES)	GP-691	2P4005	7231 CON MECANISMO REDUCTOR		
ACEITE, SEGUNDA OPCION	GP-52	1R0716				TRANSMISION	G-152	9M9740
COMBUSTIBLE	GP-1108	2W2134	3512 INDUSTRIAL A GAS NATURAL					
			AIRE, PRIMARIO	GA-483	7W5313	7251 CON MECANISMO REDUCTOR		
3412C INDUSTRIAL A DIESEL						ACEITE, S/N 74E1246 EN ADELANTE	G-238	550485
COMBUSTIBLE	GP-749	1R0749	3512B A DIESEL (EQUIPO CATERPILLAR)					
ACEITE, CUMPLE CON MEDIDAS ORIGINALES	GP-691	1R0716	ACEITE, SELLADO (CUMPLE CON MEDIDAS ORIGINALES)	GP-691	2P4005	7261 CON MECANISMO REDUCTOR		
ACEITE, SEGUNDA OPCION	GP-52	1R0716				TRANSMISION	G-152	9M9740
COMBUSTIBLE	GP-1108	2W2134	ACEITE, SELLADO (SEGUNDA OPCION)	GP-52	2P4005			
			ACCESORIO (RENOVACION DE ACEITE)	GP-110	1R0750	7271 CON MECANISMO REDUCTOR		
3412C MARINO A DIESEL						TRANSMISION	G-152	9M9740
COMBUSTIBLE, SEPARADOR DE AGUA	G-1143	8N0805	3512B INDUSTRIAL A DIESEL					
COMBUSTIBLE	GP-749	1R0749	ACEITE, SELLADO (CUMPLE CON MEDIDAS ORIGINALES)	GP-691	1R0716	C10 (10.3L) A DIESEL		
ACEITE, CUMPLE CON MEDIDAS ORIGINALES	GP-691	1R0716				COMBUSTIBLE, SEPARADOR DE AGUA	G-1143	8N0205
ACEITE, SEGUNDA OPCION	GP-52	1R0716	3512B MARINO A DIESEL			COMBUSTIBLE	GP-749	1R0749
COMBUSTIBLE	GP-1108	4N5823	ACEITE, SELLADO (CUMPLE CON MEDIDAS ORIGINALES)	GP-691	2P4005	ACEITE, FLUJO TOTAL (FULL FLOW) (CUMPLE CON MEDIDAS ORIGINALES)	GP-691	1R0716
AIRE	GAP-381	4N0015				ACEITE, FLUJO TOTAL (FULL FLOW) (SEGUNDA OPCION)	GP-52	1R0716
			3516 A DIESEL (EQUIPO CATERPILLAR)			ACEITE, DERIVACION (BY PASS)	GP-57	1W8845
3412E A DIESEL (EQUIPO CATERPILLAR)			ACEITE, SELLADO (CUMPLE CON MEDIDAS ORIGINALES)	GP-691	2P4005			
COMBUSTIBLE	GP-749	1R0749				C11 (11.1L) A DIESEL PARA CAMION		
ACEITE, CUMPLE CON MEDIDAS ORIGINALES	GP-691	1R0716	ACCESORIO (RENOVACION DE ACEITE)	GP-110	1R0750	COMBUSTIBLE	GP-749	1R0749
ACEITE, SEGUNDA OPCION	GP-52	1R0716				ACEITE, CUMPLE CON MEDIDAS ORIGINALES	GP-691	1R0716
COMBUSTIBLE	GP-1108	2W2134	3516 INDUSTRIAL A DIESEL			ACEITE, SEGUNDA OPCION	GP-52	1R0716
			ACEITE, SELLADO (CUMPLE CON MEDIDAS ORIGINALES)	GP-691	2P4005			
3412E INDUSTRIAL A DIESEL						C12 (12.0L) A DIESEL		
COMBUSTIBLE	GP-749	1R0749	3516 INDUSTRIAL A GAS NATURAL			COMBUSTIBLE, SEPARADOR DE AGUA	G-1143	8N0205
ACEITE, CUMPLE CON MEDIDAS ORIGINALES	GP-691	1R0716	AIRE, PRIMARIO	GA-483	7W5313	COMBUSTIBLE	GP-749	1R0749
ACEITE, SEGUNDA OPCION	GP-52	1R0716				ACEITE, FLUJO TOTAL (FULL FLOW) (CUMPLE CON MEDIDAS ORIGINALES)	GP-691	1R0716
			3516 MARINO A DIESEL			ACEITE, FLUJO TOTAL (FULL FLOW) (SEGUNDA OPCION)	GP-52	1R0716
3412E MARINO A DIESEL			ACEITE, SELLADO (CUMPLE CON MEDIDAS ORIGINALES)	GP-691	1R0716	ACEITE, DERIVACION (BY PASS)	GP-57	1W8845
COMBUSTIBLE, SEPARADOR DE AGUA	G-1143	8N0805						
COMBUSTIBLE	GP-749	1R0749	3516B A DIESEL (EQUIPO CATERPILLAR)			C13 (12.5L) A DIESEL PARA CAMION		
ACEITE, CUMPLE CON MEDIDAS ORIGINALES	GP-691	1R0716	ACEITE, SELLADO (CUMPLE CON MEDIDAS ORIGINALES)	GP-691	2P4005	COMBUSTIBLE	GP-749	1R0749
ACEITE, SEGUNDA OPCION	GP-52	1R0716				ACEITE, CUMPLE CON MEDIDAS ORIGINALES	GP-691	1R0716
COMBUSTIBLE	GP-1108	4N5823	ACCESORIO (RENOVACION DE ACEITE)	GP-110	1R0750	ACEITE, SEGUNDA OPCION	GP-52	1R0716
AIRE	GAP-381	4N0015						
			3456 A DIESEL (EQUIPO CATERPILLAR), 3456 INDUSTRIAL A DIESEL					
COMBUSTIBLE	GP-749	1R0749	COMBUSTIBLE	GP-749	1R0749			
ACEITE, CUMPLE CON MEDIDAS ORIGINALES	GP-691	1R0716	ACEITE, CUMPLE CON MEDIDAS ORIGINALES	GP-691	1R0716			
ACEITE, SEGUNDA OPCION	GP-52	1R0716	ACEITE, SEGUNDA OPCION	GP-52	1R0716			

MARCA-MODELO-MOTOR MAKE-MODEL-ENGINE	GONHER GONHER	OEM OEM	MARCA-MODELO-MOTOR MAKE-MODEL-ENGINE	GONHER GONHER	OEM OEM	MARCA-MODELO-MOTOR MAKE-MODEL-ENGINE	GONHER GONHER	OEM OEM
CATERPILLAR (continuación)			CATERPILLAR (continuación)			CATERPILLAR (continuación)		
MOTORES			MOTORES			MOTORES		
C15 (14.6L) A DIESEL PARA CAMION			D311 MARINO A DIESEL			D333 A DIESEL		
COMBUSTIBLE	GP-749	1R0749	ACEITE, FLUJO TOTAL (FULL FLOW)	G-191	1R0659	ACEITE	G-191	1R0659
ACEITE, CUMPLE CON MEDIDAS ORIGINALES	GP-691	1R0716				ACEITE	GP-51	2P4004
ACEITE, SEGUNDA OPCION	GP-52	1R0716	D311H INDUSTRIAL A DIESEL			COMBUSTIBLE, SECUNDARIO	GP-110	1R0740
			ACEITE	G-191	5S0484	AIRE	GA-29	4L9851
C15 (14.6L) INDUSTRIAL A DIESEL			D312 AUTOMOTRIZ			D333A INDUSTRIAL A DIESEL		
COMBUSTIBLE, SEPARADOR DE AGUA (CARTUCHO)	G-128	P176160	ACEITE, CONVERSION EN EL CAMPO A FLUJO TOTAL	G-191	9F6426	ACEITE	G-191	7M3800
COMBUSTIBLE	GP-749	1R0749				COMBUSTIBLE	G-1166	9H4729
ACEITE, CUMPLE CON MEDIDAS ORIGINALES	GP-691	1R0716	D315 MARINO A DIESEL			AIRE	GA-5648	2M7941
ACEITE, SEGUNDA OPCION	GP-52	1R0716	ACEITE, FLUJO TOTAL (FULL FLOW)	G-191	1R0659	D333A MARINO A DIESEL		
COMBUSTIBLE, SEPARADOR DE AGUA (SELLADO)	GPP-1000	133-5673				ACEITE	G-191	5S0484
			D315G INDUSTRIAL A DIESEL			D333B INDUSTRIAL A DIESEL, D333B MARINO A DIESEL		
C15 (15.2L) INDUSTRIAL A DIESEL			ACEITE, FLUJO TOTAL (FULL FLOW)	G-191	9F6426	ACEITE	G-191	5S0484
COMBUSTIBLE	GP-749	1R0749				D333C INDUSTRIAL A DIESEL		
ACEITE, CUMPLE CON MEDIDAS ORIGINALES	GP-691	1R0716	D318 MARINO A DIESEL			ACEITE	G-191	5S0484
ACEITE, SEGUNDA OPCION	GP-52	1R0716	ACEITE, FLUJO TOTAL (FULL FLOW)	G-191	1R0659	GASOLINA, SEPARADOR DE AGUA	G-293	6N7617
						COMBUSTIBLE, SECUNDARIO	GP-110	1P2299
C16 (15.8L) A DIESEL PARA CAMION			D318G INDUSTRIAL A DIESEL			AIRE, COMPRESOR	GA-135	9L2169
COMBUSTIBLE	GP-749	1R0749	ACEITE, FLUJO TOTAL (FULL FLOW)	G-191	1C6406	AIRE, ACCESORIO 2-STAGE	GA-5648	2S5648
ACEITE, CUMPLE CON MEDIDAS ORIGINALES	GP-691	1R0716				AIRE, ESTANDAR (S/N 9A)	GA-9334	4M9334
ACEITE, SEGUNDA OPCION	GP-52	1R0716	D326 MARINO A DIESEL					
			ACEITE	G-238	6H9937	D333C MARINO A DIESEL		
C16 (15.8L) INDUSTRIAL A DIESEL			D326F MARINO A DIESEL			ACEITE	G-191	5S0484
COMBUSTIBLE, SEPARADOR DE AGUA (CARTUCHO)	G-128	P176160	ACEITE	G-238	6H9999	COMBUSTIBLE	G-1166	1P2299
COMBUSTIBLE	GP-749	1R0749				GASOLINA, SEPARADOR DE AGUA	G-293	8N9803
ACEITE, CUMPLE CON MEDIDAS ORIGINALES	GP-691	1R0716	D330 A DIESEL			D334 INDUSTRIAL A DIESEL, D334 MARINO A DIESEL		
ACEITE, SEGUNDA OPCION	GP-52	1R0716	ACEITE, CARTUCHO (S/N 2B1 HASTA 2B4363)	G-191	1R0659	ACEITE	G-191	5S0484
COMBUSTIBLE, SEPARADOR DE AGUA (SELLADO)	GPP-1000	133-5673	COMBUSTIBLE, CARTUCHO (S/N 2B1 EN ADELANTE, 4B1 EN ADELANTE)	G-1166	9H4729	D336 INDUSTRIAL A DIESEL		
			ACEITE, SELLADO (S/N 2B1 HASTA 2B4363)	GP-51	2P4004	ACEITE	G-191	5S0484
C6.6 INDUSTRIAL			COMBUSTIBLE, SEPARADOR DE AGUA (S/N 2B1 EN ADELANTE, 4B1 EN ADELANTE)	GPP-11	175-2949	ACEITE	G-238	5S0485
COMBUSTIBLE	GP-1109	1R0751	COMBUSTIBLE, SELLADO (S/N 2B1 EN ADELANTE, 4B1 EN ADELANTE)	GP-110	1R0740	COMBUSTIBLE	GP-110	6L7440
						AIRE	GA-375	4L9853
C7 (7.2L) A DIESEL PARA CAMION			D330 MARINO A DIESEL			D336 MARINO A DIESEL		
ACEITE	GP-51	1R0739	ACEITE	G-191	1R0659	ACEITE	G-238	6H9999
COMBUSTIBLE, 5 13/32 IN	GP-62	1R0751	D330A INDUSTRIAL A DIESEL, D330A MARINO A DIESEL					
COMBUSTIBLE, 7 13/32 IN	GP-1109	1R0751	ACEITE	G-191	5S0484	D337 INDUSTRIAL A DIESEL		
COMBUSTIBLE, SEPARADOR DE AGUA	GPP-1000	133-5673				ACEITE	G-238	8F1151
			D330B INDUSTRIAL A DIESEL, D330B MARINO A DIESEL					
C9 (8.8L) A DIESEL			ACEITE	G-191	1R0659	D337 MARINO A DIESEL		
ACEITE, CUMPLE CON MEDIDAS ORIGINALES	GP-691	1R0716				ACEITE	G-238	6H9999
ACEITE, SEGUNDA OPCION	GP-52	1R0716	D330C INDUSTRIAL A DIESEL					
COMBUSTIBLE, 5 13/32 IN	GP-62	1R0751	ACEITE	G-191	5S0484	D337F INDUSTRIAL A DIESEL		
COMBUSTIBLE, 7 13/32 IN	GP-1109	1R0751				ACEITE	G-238	8F1151
			D330C MARINO A DIESEL			COMBUSTIBLE	G-1166	6H5932
D11000 MARINO A DIESEL			ACEITE, FLUJO COMPLETO (FULL FLOW)	G-191	9F6430	AIRE, INSTALACION EN EL CAMPO	GA-5648	2S5648
ACEITE, FLUJO COMPLETO (FULL FLOW)	G-191	9F6430						
D13000 MARINO A DIESEL			D330C INDUSTRIAL A DIESEL			D337F MARINO A DIESEL		
ACEITE, FLUJO COMPLETO (FULL FLOW)	G-191	5S0484	ACEITE	G-191	5S0484	ACEITE	G-191	9F6700
			GASOLINA, SEPARADOR DE AGUA	G-293	6N7617	ACEITE	G-238	6H9999
D17000 MARINO A DIESEL			COMBUSTIBLE, SECUNDARIO	GP-110	1P2299	COMBUSTIBLE	G-1166	6H5932
ACEITE, FLUJO COMPLETO (FULL FLOW)	G-191	5S0484						
			D330C MARINO A DIESEL			D339 INDUSTRIAL A DIESEL		
D275 INDUSTRIAL A DIESEL			ACEITE	G-191	5S0484	ACEITE	G-191	5S0484
ACEITE	GP-51	1R0739	GASOLINA, SEPARADOR DE AGUA	G-293	6N7617			
			COMBUSTIBLE	GP-110	1P2299	D3400 MARINO A DIESEL		
						ACEITE, FLUJO TOTAL (FULL FLOW)	G-191	5S0484

MARCA-MODELO-MOTOR MAKE-MODEL-ENGINE	GONHER GONHER	OEM OEM	MARCA-MODELO-MOTOR MAKE-MODEL-ENGINE	GONHER GONHER	OEM OEM	MARCA-MODELO-MOTOR MAKE-MODEL-ENGINE	GONHER GONHER	OEM OEM
CATERPILLAR (continuación)			CATERPILLAR (continuación)			CATERPILLAR (continuación)		
MOTORES			MOTORES			MOTORES		
D342 A DIESEL (EQUIPO CATERPILLAR)			D346 INDUSTRIAL A DIESEL			ACEITE, SELLADO (SEGUNDA OPCION)		
ACEITE, CARTUCHO	G-191	550484	ACEITE, S/N RESTANTES	G-191	550484	COMBUSTIBLE	GP-52	2P4005
ACEITE, SELLADO (CUMPLE CON MEDIDAS ORIGINALES)	GP-691	2P4005	ACEITE, S/N 39J1-39J521	G-238	550485	AIRE, PRIMARIO	GP-110	1P2299
ACEITE, SELLADO (SEGUNDA OPCION)	GP-52	2P4005	AIRE	GAP-379	6L4714	AIRE, SECUNDARIO	GA-483	1P8483
COMBUSTIBLE	GP-110	1P2299	D346 MARINO A DIESEL				GA-482	1P8482
AIRE, PRIMARIO	GA-7716	1P7716	ACEITE	G-191	550484	D353C INDUSTRIAL A DIESEL, D353C MARINO A DIESEL		
AIRE, SECUNDARIO	GA-7360	1P7360	ACEITE	G-238	550485	ACEITE	G-238	550485
			AIRE, PANEL	GAP-379	6L4714	COMBUSTIBLE, CARTUCHO	G-1166	6H5932
						COMBUSTIBLE, SELLADO	GP-110	1P2299
D342 INDUSTRIAL A DIESEL			D346 VEHICULAR			AIRE	GA-375	4L9853
ACEITE	G-191	550484	ACEITE	G-191	550484	AIRE	GA-1203	5L1203
COMBUSTIBLE	G-1166	6H5931	D348 A DIESEL (EQUIPO CATERPILLAR S/N 2S)					
AIRE, S/N 5A8403-8462	GA-375	4L9853	ACEITE	G-238	6H9999	D353D INDUSTRIAL A DIESEL, D353D MARINO A DIESEL		
AIRE, ACCESORIO S/N 5A	GA-1203	5L1203				ACEITE	G-238	550485
			D348 A DIESEL (EQUIPO CATERPILLAR S/N 57K)			COMBUSTIBLE, CARTUCHO	G-1166	6H5932
			ACEITE	G-191	1R0659	COMBUSTIBLE, SELLADO	GP-110	1P2299
D342C INDUSTRIAL A DIESEL			ACEITE, LUBRICACION OPCIONAL	G-238	6H9999	AIRE	GA-375	4L9853
ACEITE	G-191	550484	COMBUSTIBLE, SELLADO	GP-110	1R0750	AIRE	GA-1203	5L1203
COMBUSTIBLE	G-1166	9H1252				D353E INDUSTRIAL A DIESEL, D353E MARINO A DIESEL		
AIRE	GA-375	4L9853	D348 A DIESEL (EQUIPO CATERPILLAR S/N 98S)			ACEITE	G-238	550485
AIRE	GA-1203	5L1203	ACEITE, CARTUCHO	G-191	550484	COMBUSTIBLE, CARTUCHO	G-1166	6H5932
AIRE	GA-5648	2M7941	ACEITE, SELLADO (CUMPLE CON MEDIDAS ORIGINALES)	GP-691	2P4005	COMBUSTIBLE, SELLADO	GP-110	1P2299
			ACEITE, SELLADO (SEGUNDA OPCION)	GP-52	2P4005	AIRE	GA-375	4L9853
			COMBUSTIBLE, SELLADO	GP-1108	4N5823	AIRE	GA-1203	5L1203
D342C MARINO A DIESEL			AIRE, PRIMARIO	GA-7716	1P7716	D364 MARINO A DIESEL		
ACEITE	G-191	9F6700	AIRE, PRIMARIO	GA-483	8N5313	ACEITE, FLUJO TOTAL (FULL FLOW)	G-238	6H9999
COMBUSTIBLE	G-1166	6H5931	AIRE, SECUNDARIO	GA-7360	1P7360	D375 MARINO A DIESEL		
AIRE	GA-375	4L9853				ACEITE, FLUJO TOTAL (FULL FLOW)	G-238	6H9999
AIRE	GA-1203	5L1203	D348 INDUSTRIAL A DIESEL					
			ACEITE	G-191	550484	D375D INDUSTRIAL A DIESEL, D375D MARINO A DIESEL		
D343 A DIESEL (EQUIPO CATERPILLAR)			ACEITE	G-238	550485	ACEITE, FLUJO TOTAL (FULL FLOW)	G-238	6H9999
ACEITE	G-238	550485	AIRE	GAP-379	6L4714	D379 INDUSTRIAL A DIESEL		
						ACEITE	G-191	550484
D343 INDUSTRIAL A DIESEL			D348 VEHICULAR			ACEITE	G-238	550485
ACEITE, CARTUCHO	G-238	550485	ACEITE	G-191	550484	COMBUSTIBLE	G-1166	5L7564
COMBUSTIBLE, CARTUCHO	G-1166	6H5932	AIRE, PANEL	GAP-379	6L4714	AIRE, CIRCULAR	GA-375	4L9853
ACEITE, SELLADO (CUMPLE CON MEDIDAS ORIGINALES)	GP-691	2P4005				AIRE, ACCESORIO	GA-1203	5L1203
ACEITE, SELLADO (SEGUNDA OPCION)	GP-52	2P4005	D348 A DIESEL (EQUIPO CATERPILLAR)			AIRE, PANEL	GAP-379	6L4714
COMBUSTIBLE, SELLADO	GP-110	1P2299	ACEITE	G-191	550484	D379A INDUSTRIAL A DIESEL		
AIRE	GA-375	4L9853	ACEITE	G-238	550485	ACEITE	G-191	550484
AIRE	GA-1203	5L1203	AIRE	GAP-379	6L4714	ACEITE	G-238	550485
						COMBUSTIBLE	G-1166	5L7564
D343 MARINO A DIESEL			D349 A DIESEL (EQUIPO CATERPILLAR)			AIRE, CIRCULAR	GA-375	4L9853
ACEITE	G-191	550484	ACEITE	G-191	1R0659	AIRE, ACCESORIO	GA-1203	5L1203
ACEITE	G-238	550485				AIRE, PANEL	GAP-379	6L4714
COMBUSTIBLE, CARTUCHO	G-1166	6H5932	D349 INDUSTRIAL A DIESEL			D379A MARINO A DIESEL		
COMBUSTIBLE, SELLADO	GP-110	1P2299	ACEITE	G-191	1W7399	ACEITE	G-191	4W4840
AIRE, ESTANDAR	GA-375	4L9853	AIRE, PRIMARIO	GA-356	1N8165	ACEITE	G-238	6H9999
AIRE	GA-1203	5L1203	AIRE, PANEL	GAP-379	6L4714	COMBUSTIBLE	G-1166	5L7564
			AIRE, SECUNDARIO	GA-357	1N8164	AIRE, CIRCULAR	GA-375	4L9853
						AIRE, ACCESORIO (CIRCULAR)	GA-1203	5L1203
D343A A DIESEL			D349 MARINO A DIESEL			AIRE, PANEL	GAP-379	6L4714
ACEITE	G-238	1R0721	ACEITE	G-191	1W7399	D379B INDUSTRIAL A DIESEL		
COMBUSTIBLE	GP-110	1R0740				ACEITE	G-191	550484
AIRE	GA-375	4L9853	D349 VEHICULAR			ACEITE	G-238	550485
			ACEITE	G-191	1W7399	COMBUSTIBLE	G-1166	5L7564
						AIRE, CIRCULAR	GA-375	4L9853
D346 A DIESEL (EQUIPO CATERPILLAR)			D349 A DIESEL (EQUIPO CATERPILLAR)			AIRE, ACCESORIO (CIRCULAR)	GA-1203	5L1203
ACEITE, CARTUCHO PARA LUBRICACION TRIPLE	G-191	550484	ACEITE	G-191	1R0659	AIRE, PANEL	GAP-379	6L4714
ACEITE, CARTUCHO PARA LUBRICACION DOBLE	G-238	550485				D379B MARINO A DIESEL		
ACEITE, CUMPLE CON MEDIDAS ORIGINALES	GP-691	2P4005	D353 A DIESEL (EQUIPO CATERPILLAR)			ACEITE	G-191	550484
ACEITE, SEGUNDA OPCION	GP-52	2P4005	ACEITE, CARTUCHO	G-238	550485	ACEITE	G-238	550485
COMBUSTIBLE	GP-110	1P2299	ACEITE, SELLADO (CUMPLE CON MEDIDAS ORIGINALES)	GP-691	2P4005			
AIRE, SECUNDARIO	GA-1287	251287						
AIRE, PRIMARIO	GA-9045	7M9045						

SERVICIO PESADO

MARCA-MODELO-MOTOR MAKE-MODEL-ENGINE	GONHER GONHER	OEM OEM	MARCA-MODELO-MOTOR MAKE-MODEL-ENGINE	GONHER GONHER	OEM OEM	MARCA-MODELO-MOTOR MAKE-MODEL-ENGINE	GONHER GONHER	OEM OEM
CATERPILLAR (continuación)			CATERPILLAR (continuación)			CATERPILLAR (continuación)		
MOTORES			MOTORES			MOTORES		
COMBUSTIBLE	G-1166	5L7564	D399 INDUSTRIAL A DIESEL			G342F INDUSTRIAL A GAS NATURAL		
AIRE, CIRCULAR	GA-375	4L9853	ACEITE	G-191	5S0484	ACEITE	G-191	9F6700
AIRE, ACCESORIO	GA-1203	5L1203	ACEITE	G-238	5S0485	COMBUSTIBLE	G-1166	6H5931
AIRE, PANEL	GAP-379	6L4714	COMBUSTIBLE	G-1166	5L7564	AIRE	GA-375	4L9853
D379B MARINO A DIESEL			AIRE, PRIMARIO	GA-356	6N6071	AIRE	GA-1203	5L1203
ACEITE	G-191	4W4840	AIRE, PANEL	GAP-379	6L714	AIRE	GA-5648	255648
ACEITE	G-238	6H9999	AIRE, SECUNDARIO	GA-357	6N6072	G343 INDUSTRIAL A GAS NATURAL		
COMBUSTIBLE	G-1166	5L7564	D399 MARINO A DIESEL			ACEITE	G-238	5S0485
AIRE, CIRCULAR	GA-375	4L9853	ACEITE	G-191	5S0484	G348 INDUSTRIAL A GAS NATURAL		
AIRE, ACCESORIO (CIRCULAR)	GA-1203	5L1203	ACEITE	G-238	5S0485	ACEITE	G-191	5S0484
AIRE, PANEL	GAP-379	6L4714	COMBUSTIBLE, S/N 91B-91B386	G-1166	5L7564	G349 INDUSTRIAL A GAS NATURAL		
D386 MARINO A DIESEL			AIRE, PANEL	GAP-379	6L4714	ACEITE	G-191	5S0484
ACEITE, FLUJO TOTAL (FULL FLOW)	G-238	6H9999	D4400 MARINO A DIESEL			G3512 INDUSTRIAL A GAS NATURAL		
D397 MARINO A DIESEL			ACEITE, FLUJO TOTAL (FULL FLOW)	G-191	1R0659	AIRE, PRIMARIO	GA-483	7W5313
ACEITE, FLUJO TOTAL (FULL FLOW)	G-238	6H9999	D4600 A DIESEL			G3516 INDUSTRIAL A GAS NATURAL		
D397D INDUSTRIAL A DIESEL			ACEITE	G-191	1R0659	HIDRAULICO	GP-761H	144-6691
ACCESORIO PARA EL DEPOSITO DE ACEITE	G-191	9F6700	D8800 INDUSTRIAL A DIESEL, D8800 MARINO A DIESEL			G353 INDUSTRIAL A GAS NATURAL		
D397D MARINO A DIESEL			ACEITE, FLUJO TOTAL (FULL FLOW)	G-191	9F6700	ACEITE	G-238	5S0485
ACEITE, S/N 42B332, 368-458	G-191	9F6700	G3306 A DIESEL PARA CAMION			AIRE	GA-375	4L9853
D398 INDUSTRIAL A DIESEL			ACEITE	GP-51	1R0739	AIRE	GA-1203	5L1203
ACEITE	G-191	5S0484	G3306 INDUSTRIAL A GAS NATURAL			G353D INDUSTRIAL A GAS NATURAL		
ACEITE	G-238	6H9999	ACEITE	GP-51	1R0739	ACEITE	G-238	5S0485
COMBUSTIBLE	G-1166	5L7564	G333 INDUSTRIAL A GAS NATURAL			AIRE	GA-375	4L9853
AIRE, CIRCULAR	GA-375	4L9853	ACEITE	G-191	5S0484	AIRE	GA-1203	5L1203
AIRE, ACCESORIO CIRCULAR	GA-1203	5L1203	G333A INDUSTRIAL A GAS NATURAL			G3606 INDUSTRIAL A GAS NATURAL		
AIRE, PANEL	GAP-379	6L4714	ACEITE	G-191	5S0484	ACEITE, LINEAS DE LUBRICACION	GP-761H	1G8878
D398A INDUSTRIAL A DIESEL			G333B INDUSTRIAL A GAS NATURAL			G3608 INDUSTRIAL A GAS NATURAL		
ACEITE	G-191	5S0484	ACEITE	G-191	5S0484	ACEITE, LINEAS DE LUBRICACION	GP-761H	1G8878
ACEITE	G-238	6H9999	G333C INDUSTRIAL A GAS NATURAL			G3612 INDUSTRIAL A GAS NATURAL		
COMBUSTIBLE	G-1166	5L7564	ACEITE	G-191	5S0484	ACEITE, LINEAS DE LUBRICACION	GP-761H	1G8878
AIRE, CIRCULAR	GA-375	4L9853	G3406 INDUSTRIAL A GAS NATURAL			G3616 INDUSTRIAL A GAS NATURAL		
AIRE, ACCESORIO CIRCULAR	GA-1203	5L1203	ACEITE, CUMPLE CON MEDI-DAS ORIGINALES	GP-691	1R0716	ACEITE, LINEAS DE LUBRICACION	GP-761H	1G8878
AIRE, PANEL	GAP-379	6L4714	ACEITE, SEGUNDA OPCION	GP-52	1R0716	G379 INDUSTRIAL A GAS NATURAL		
D398A MARINO A DIESEL			AIRE, PRIMARIO	GA-483	1P8483	ACEITE	G-191	5S0484
ACEITE, S/N 67B1391 EN ADELANTE	G-191	5S0484	AIRE, SECUNDARIO	GA-482	1P8482	ACEITE	G-238	5S0485
ACEITE, S/N 67B1-1390	G-238	5S0485	G3408 INDUSTRIAL A GAS NATURAL			AIRE, CIRCULAR	GA-375	4L9853
COMBUSTIBLE, S/N 67B1-1390	G-1166	5L7564	ACEITE, CUMPLE CON MEDI-DAS ORIGINALES	GP-691	1R0716	AIRE, PANEL	GAP-379	6L4714
AIRE, CIRCULAR	GA-1203	5L1203	G342 INDUSTRIAL A GAS NATURAL			G398 INDUSTRIAL A GAS NATURAL		
AIRE, PANEL	GAP-379	6L4714	ACEITE	G-191	9F6700	ACEITE	G-191	5S0484
D398B INDUSTRIAL A DIESEL			COMBUSTIBLE	G-1166	6H5931	ACEITE	G-238	5S0485
ACEITE	G-191	5S0484	AIRE	GA-375	4L9853	AIRE, CIRCULAR	GA-375	4L9853
ACEITE	G-238	6H9999	AIRE	GA-1203	5L1203	AIRE, CIRCULAR	GA-1203	5L1203
COMBUSTIBLE	G-1166	5L7564	AIRE	GA-5648	255648	AIRE, PANEL	GAP-379	6L4714
AIRE, CIRCULAR	GA-375	4L9853	G342C INDUSTRIAL A GAS NATURAL			G398A INDUSTRIAL A GAS NATURAL		
AIRE, ACCESORIO CIRCULAR	GA-1203	5L1203	ACEITE	G-191	4W4840	ACEITE	G-191	5S0484
AIRE, PANEL	GAP-379	6L4714				ACEITE	G-238	5S0485
D398B MARINO A DIESEL						AIRE, CIRCULAR	GA-375	4L9853
ACEITE, S/N 67B1391 EN ADELANTE	G-191	5S0484				AIRE, CIRCULAR	GA-1203	5L1203
ACEITE, S/N 67B1-1390	G-238	5S0485				AIRE, CIRCULAR	GA-1203	5L1203
COMBUSTIBLE, S/N 67B1-1390	G-1166	5L7564						
AIRE, CIRCULAR	GA-1203	5L1203						
AIRE, PANEL	GAP-379	6L4714						

MARCA-MODELO-MOTOR MAKE-MODEL-ENGINE	GONHER GONHER	OEM OEM
CATERPILLAR (continuación)		
MOTORES		
AIRE, PANEL	GAP-379	6L4714
G399 INDUSTRIAL A GAS NATURAL		
ACEITE	G-191	4W4840
ACEITE	G-238	5S0485
AIRE, CIRCULAR	GA-1203	5L1203
AIRE, PANEL	GAP-379	6L4714

CATERPILLAR		
NIVELADORAS		
824H SOBRE RUEDAS con motor/CATERPILLAR C15		
DIESEL	GP-749	1R0762
ACEITE	GP-52	1R0716
AIRE RADIAL, PRIMARIO	GA-600R	106-3969
AIRE DE CABINA	GA-240	107-0266
834H SOBRE RUEDAS con motor/CATERPILLAR C18		
DIESEL	GP-749	1R0762
ACEITE	GP-52	1R0716
HIDRAULICO	GP-761H	1G8878
AIRE RADIAL, PRIMARIO	GA-600R	106-3969
AIRE DE CABINA	GA-240	107-0266
D10 SOBRE ORUGAS con motor/CATERPILLAR D348		
ACEITE, TREN DE PODER	G-222	4J6064
ACEITE, TANQUE HIDRAULICO	G-153	7J0670
ACEITE, CUMPLE CON MEDIDAS ORIGINALES	GP-691	2P4005
ACEITE, SEGUNDA OPCION	GP-52	2P4005
COMBUSTIBLE	GP-1108	4N5823
AIRE, PRIMARIO	GA-7716	1P7716
AIRE, PRIMARIO	GA-483	8N5313
AIRE, SECUNDARIO	GA-7360	1P7360

D10N SOBRE ORUGAS con motor/CATERPILLAR 3412		
TRANSMISION	G-152	1R0719
ACEITE, TANQUE HIDRAULICO	G-153	7J0670
COMBUSTIBLE	GP-749	1R0749
ACEITE, CUMPLE CON MEDIDAS ORIGINALES	GP-691	1R0716
ACEITE, SEGUNDA OPCION	GP-52	1R0716
AGUA	GP-1011Q	9N3718
AIRE, PRIMARIO	GA-600R	106-3969
D10R SOBRE ORUGAS con motor/CATERPILLAR 3412		
COMBUSTIBLE	GP-749	1R0749
ACEITE, CUMPLE CON MEDIDAS ORIGINALES	GP-691	1R0716
ACEITE, SEGUNDA OPCION	GP-52	1R0716
AGUA	GP-1011Q	9Y1022
AIRE, PRIMARIO	GA-600R	106-3969

D11N SOBRE ORUGAS con motor/CATERPILLAR 3508		
ACEITE, TANQUE HIDRAULICO (REQUIERE 2 PIEZAS)	G-152	4T3131
TRANSMISION (REQUIERE 2 PIEZAS)	G-222	4J6064
ACEITE, TANQUE HIDRAULICO (REQUIERE 2 PIEZAS)	G-153	7J0670
ACEITE, (REQUIERE 2 PIEZAS)	GP-52	2P4005
AIRE ESTANDAR, PRIMARIO (REQUIERE 2 PIEZAS)	GA-483	7W5313
AIRE ESTANDAR, SECUNDARIO (REQUIERE 2 PIEZAS)	GA-482	1P8482
AIRE RADIAL, PRIMARIO (REQUIERE 2 PIEZAS)	GA-712R	123-6855

MARCA-MODELO-MOTOR MAKE-MODEL-ENGINE	GONHER GONHER	OEM OEM
CATERPILLAR (continuación)		
NIVELADORAS		
D11R SOBRE ORUGAS con motores/CATERPILLAR 3508, CATERPILLAR 3508B		
ACEITE, TANQUE HIDRAULICO (REQUIERE 2 PIEZAS)	G-153	7J0670
ACEITE, (REQUIERE 2 PIEZAS)	GP-52	2P4005
AIRE RADIAL, PRIMARIO	GA-712R	123-6855
AIRE DE CABINA	GA-240	107-0266

D2 SOBRE ORUGAS con motor/A DIESEL		
ACEITE	G-191	1R0659
D3 SOBRE ORUGAS con motor/CATERPILLAR 3204		
ACEITE, TANQUE HIDRAULICO	G-152	9M9740
D3B SOBRE ORUGAS con motor/CATERPILLAR 3204		
ACEITE, TANQUE HIDRAULICO	G-152	9M9740
ACEITE, EXCEPTO. S/N 2PC	GP-36	9L9200
COMBUSTIBLE, SECUNDARIO	GP-110	1P2299
ACEITE, EXCEPTO. S/N 2PC	GP-9586	1R0713
AIRE, PRIMARIO (S/N 2PC)	GA-9334	8N5317

D3C SERIES II SOBRE ORUGAS, D3C SOBRE ORUGAS con motor/CATERPILLAR 3204		
ACEITE, TANQUE HIDRAULICO	G-152	1R0719
ACEITE, EXCEPTO. S/N 7JF	GP-36	9L9200
COMBUSTIBLE	GP-110	1P2299
ACEITE, EXCEPTO. S/N 7JF	GP-9586	1R0713
AIRE, PRIMARIO (S/N 7JF)	GA-9334	8N5317
D3C SERIES III SOBRE ORUGAS con motor/CATERPILLAR 3046		
ACEITE, TANQUE HIDRAULICO	G-152	1R0719
ACEITE	GP-36	1R0734
TRANSMISION SELLADO	GP-761H	1G8878

D4 SOBRE ORUGAS con motor/A DIESEL (S/N 28X1726 EN ADELANTE)		
ACEITE, SELLADO	GP-51	1R0739
D4 SOBRE ORUGAS con motor/A DIESEL (S/N 29X1 EN ADELANTE)		
ACEITE	G-152	9M9740
D4 SOBRE ORUGAS con motor/A DIESEL (S/N 39A1 EN ADELANTE)		
ACEITE, CARTUCHO	G-191	1W7399
AIRE, PRIMARIO	GA-1008	4M9378
AIRE, SECUNDARIO	GA-1284	2S1284

D4 SOBRE ORUGAS con motor/A DIESEL (S/N 4G1 EN ADELANTE)		
ACEITE, CARTUCHO	G-333	3I1301
D4 SOBRE ORUGAS con motor/A DIESEL (S/N 82J1 EN ADELANTE)		
COMBUSTIBLE, SEPARADOR DE AGUA	GPP-11	175-2949
COMBUSTIBLE	GP-110	1R0740
AIRE, SECUNDARIO ESTANDAR	GA-1285	2S1285
AIRE, PRIMARIO ESTANDAR	GA-8047	4M8047
AIRE, PRIMARIO RADIAL	GA-499R	6I2499

D4B SOBRE ORUGAS con motor/A DIESEL		
TRANSMISION	G-152	9M9740
COMBUSTIBLE	GP-110	1R0740
ACEITE	GP-9586	8N9586
D4C LGP SERIES II SOBRE ORUGAS, D5C LGP SOBRE ORUGAS, D4C SERIES II SOBRE ORUGAS, D4C XL SERIES II SOBRE ORUGAS con motor/CATERPILLAR 3204		
ACEITE, TANQUE HIDRAULICO	G-152	9M9740
COMBUSTIBLE	GP-110	1R0740

MARCA-MODELO-MOTOR MAKE-MODEL-ENGINE	GONHER GONHER	OEM OEM
CATERPILLAR (continuación)		
NIVELADORAS		
ACEITE	GP-9586	1R0713
D4C SOBRE ORUGAS con motor/A DIESEL		
ACEITE	G-191	1R0659
COMBUSTIBLE	G-1166	1R0724
AIRE	GA-1008	4M9378
AIRE	GA-1284	2S1284

D4C SOBRE ORUGAS con motor/CATERPILLAR 3046		
ACEITE, TANQUE HIDRAULICO	G-152	9M9740
D4D SOBRE ORUGAS con motor/CATERPILLAR 3304		
ACEITE, CARTUCHO	G-191	5S0484
COMBUSTIBLE, CARTUCHO	G-1166	9H4729
TRANSMISION	G-152	9M9740
GASOLINA, ACCESORIO SEPARADOR DE AGUA	G-293	6N7617
ACEITE, SELLADO	GP-51	1R0739
COMBUSTIBLE, SELLADO	GP-110	1P2299
AIRE, PRIMARIO	GA-1008	4M9378
AIRE, SECUNDARIO	GA-1284	2S1284
AIRE, SECUNDARIO	GA-1285	2S1285
AIRE, PRIMARIO	GA-8047	4M8047

D4E SOBRE ORUGAS, D4E SR SOBRE ORUGAS con motor/CATERPILLAR 3304		
CLUTCH/ DIRECCION/ TRANSMISION	G-152	9M9740
RETORNO DE ACEITE HIDRAULICO	G-152	9M9740
GASOLINA, ACCESORIO SEPARADOR DE AGUA	G-293	8N9803
ACEITE	GP-51	1R0739
COMBUSTIBLE	GP-110	1R0740
AIRE, SECUNDARIO	GA-1285	2S1285
AIRE, SECUNDARIO	GA-1286	2S1286
AIRE, PRIMARIO	GA-8047	8N5389
AIRE, PRIMARIO	GA-9334	4M9334

D4H SERIES XL III SOBRE ORUGAS, D4H SOBRE ORUGAS con motor/CATERPILLAR 3304		
ACEITE, TANQUE HIDRAULICO	G-152	1R0719
ACEITE, TREN DE PODER	G-152	9M9740
ACEITE	GP-51	1R0739
COMBUSTIBLE	GP-110	1R0740
AIRE, PRIMARIO ESTANDAR	GA-8047	7W5389
AIRE, PRIMARIO RADIAL	GA-499R	6I2499
D4H SOBRE ORUGAS con motor/CATERPILLAR 3204		
ACEITE, TANQUE HIDRAULICO	G-152	9M9740
TRANSMISION	G-152	1R0719
COMBUSTIBLE	GP-110	1R0740
AIRE, PRIMARIO	GA-8047	7W5389

D4HTSK SERIES III SOBRE ORUGAS con motor/CATERPILLAR 3304		
ACEITE, TANQUE HIDRAULICO	G-152	1R0719
ACEITE	GP-51	1R0739
COMBUSTIBLE	GP-110	1R0750
AIRE, PRIMARIO ESTANDAR	GA-8047	7W5389
AIRE, PRIMARIO RADIAL	GA-499R	6I2499

D5 SOBRE ORUGAS con motor/CATERPILLAR 3306		
ACEITE, CARTUCHO	G-191	5S0484
CLUTCH/ DIRECCION/ TRANSMISION	G-152	9M9740
GASOLINA, ACCESORIO SEPARADOR DE AGUA	G-293	6N7617
ACEITE, SELLADO	GP-51	1R0739

SERVICIO PESADO

MARCA-MODELO-MOTOR MAKE-MODEL-ENGINE	GONHER GONHER	OEM OEM	MARCA-MODELO-MOTOR MAKE-MODEL-ENGINE	GONHER GONHER	OEM OEM	MARCA-MODELO-MOTOR MAKE-MODEL-ENGINE	GONHER GONHER	OEM OEM
CATERPILLAR (continuación)			CATERPILLAR (continuación)			CATERPILLAR (continuación)		
NIVELADORAS			NIVELADORAS			NIVELADORAS		
COMBUSTIBLE	GP-1108	4N5823	D5H XL SOBRE ORUGAS con motor/A DIESEL			D6C TURBO SOBRE ORUGAS con motor/CON DOBLE CARTUCHO DE LUBRICACION		
COMBUSTIBLE	GP-110	1P2299	TRANSMISION	G-152	1R0719	ACEITE	G-191	5S0484
AIRE, SECUNDARIO	GA-1286	2S1286	ACEITE	GP-51	1R0739	COMBUSTIBLE	G-1166	9H4729
AIRE, PRIMARIO	GA-9334	4M9334	COMBUSTIBLE	GP-110	1R0750	TRANSMISION (3 27/32 IN DIAM. EXT.)	G-152	9M9740
			AIRE, PRIMARIO	GA-9334	7W5317	TRANSMISION (4 63/64 IN DIAM. EXT.)	G-222	4J6064
D5 SOBRE ORUGAS con motor/CON DOBLE CARTUCHO DE LUBRICACION			D5HSTK SOBRE ORUGAS con motor/CATERPILLAR 3304			AIRE, SECUNDARIO	GA-1286	2S1286
ACEITE	G-191	5S0484	ACEITE	GP-51	1R0739	AIRE, PRIMARIO	GA-9334	4M9334
COMBUSTIBLE	G-1166	9H4729	COMBUSTIBLE	GP-110	1P2299			
DIRECCION	G-152	1R0719	HIDRAULICO SELLADO	GP-166	4T6915	D6D SOBRE ORUGAS, D6D SR SOBRE ORUGAS con motor/CATERPILLAR 3306		
TRANSMISION	G-152	1R0719	AIRE, PRIMARIO ESTANDAR	GA-9334	7W5317	ACEITE, CARTUCHO	G-191	4W4840
ACEITE, ACCESORIO PARA TANQUE HIDRAULICO (S/N 37J, 81H, 83H, 87H)	G-222	4J6064	DSM LPG SOBRE ORUGAS, DSM LPG XL SERIES SOBRE ORUGAS, DSM SOBRE ORUGAS con motor/CATERPILLAR 3116			ACEITE, BOMBA HIDRAULICA	G-152	9M9740
AIRE, SECUNDARIO (EXCEPTO S/N 21J)	GA-1285	2S1285	ACEITE, TANQUE HIDRAULICO	G-152	1R0719	TRANSMISION	G-222	4J6064
AIRE, SECUNDARIO (S/N 21J)	GA-1286	2S1286	ACEITE	GP-51	1R0739	GASOLINA, SEPARADOR DE AGUA	G-293	8N9803
AIRE, PRIMARIO (EXCEPTO S/N 21J)	GA-8047	4M8047	COMBUSTIBLE, 5 13/32 IN	GP-62	1R0751	ACEITE, SELLADO	GP-51	1R0739
AIRE, PRIMARIO (S/N 21J)	GA-9334	4M9334	COMBUSTIBLE, 7 13/32 IN	GP-1109	1R0751	COMBUSTIBLE	GP-110	1R0740
			COMBUSTIBLE, SEPARADOR DE AGUA	GPP-424	117-4089	AIRE, SECUNDARIO	GA-1286	2S1286
D5B SOBRE ORUGAS con motor/CATERPILLAR 3306			ACEITE, ACCESORIO PARA TORNO	GP-761H	118-6322	AIRE, PRIMARIO	GA-9334	4M9334
ACEITE, ACCESORIO PARA BOMBA HIDRAULICA	G-191	4W4840	AIRE, PRIMARIO	GA-499R	6I2499	AIRE, PRIMARIO	GA-7716	1P7716
ACEITE, CARTUCHO	G-191	5S0484	D6 SOBRE ORUGAS con motor/A DIESEL (S/N 10K1-10K6290)			AIRE, SECUNDARIO	GA-7360	1P7360
ACEITE, BOMBA HIDRAULICA	G-152	1R0719	ACEITE	G-191	1W7399			
CLUTCH/ DIRECCION/ TRANSMISION	G-152	9M9740	D6 SOBRE ORUGAS con motor/A DIESEL (S/N 17R465 EN ADELANTE)			D6E SOBRE ORUGAS con motor/CATERPILLAR 3306		
GASOLINA, SEPARADOR DE AGUA	G-293	8N9803	AIRE, PRIMARIO	GA-7716	1P7716	CLUTCH/ DIRECCION/ TRANSMISION	G-222	1R0741
ACEITE, SELLADO	GP-51	2P4004	D6 SOBRE ORUGAS con motor/A DIESEL (S/N 1Y1 EN ADELANTE)			ACEITE	GP-51	1R0739
COMBUSTIBLE	GP-110	1P2299	TRANSMISION	G-222	1R0741	COMBUSTIBLE	GP-110	1R0750
AIRE, SECUNDARIO	GA-1286	2S1286	ACEITE	GP-51	1R0739	AIRE, PRIMARIO	GA-7716	7W5495
AIRE, PRIMARIO	GA-9334	4M9334	COMBUSTIBLE, SEPARADOR DE AGUA	GPP-11	175-2949	AIRE, SECUNDARIO	GA-7360	1P7360
			COMBUSTIBLE	GP-110	1R0740	D6E SR SOBRE ORUGAS con motor/CATERPILLAR 3306		
D5C LPG SOBRE ORUGAS, D5C SOBRE ORUGAS con motor/CATERPILLAR 3046			AIRE, SECUNDARIO	GA-1286	2S1286	CLUTCH/ DIRECCION/ TRANSMISION	G-222	1R0741
ACEITE, TANQUE HIDRAULICO	G-152	1R0719	AIRE, PRIMARIO	GA-9334	4M9334	ACEITE	GP-51	1R0739
ACEITE	GP-36	1R0734	D6 SOBRE ORUGAS con motor/A DIESEL (S/N 37A1 EN ADELANTE)			COMBUSTIBLE	GP-110	1R0750
ACEITE, TREN DE PODER	GP-761H	1G8878	TRANSMISION	G-152	9M9740	AIRE, SECUNDARIO	GA-1286	2S1286
			AIRE, SECUNDARIO ESTANDAR	GA-1285	2S1285	AIRE, PRIMARIO	GA-9334	4M9334
D5C SOBRE ORUGAS con motor/CATERPILLAR 3204			AIRE, PRIMARIO ESTANDAR	GA-8047	4M8047	D6F SR SOBRE ORUGAS, D6G SR SOBRE ORUGAS con motor/CATERPILLAR 3306		
ACEITE, TANQUE HIDRAULICO	G-152	9M9740	AIRE, PRIMARIO RADIAL	GA-499R	6I2499	TRANSMISION	G-222	1R0741
COMBUSTIBLE	GP-110	1R0740	D6 SOBRE ORUGAS con motor/A DIESEL (S/N 74A1 EN ADELANTE)			ACEITE	GP-51	1R0739
ACEITE	GP-9586	1R0713	COMBUSTIBLE	G-1166	6H5932	COMBUSTIBLE	GP-110	1R0750
			D6B SOBRE ORUGAS con motor/A DIESEL			D6H LS SERIES II SOBRE ORUGAS, D6H SERIES II SOBRE ORUGAS con motor/CATERPILLAR 3306		
D5E DD SOBRE ORUGAS con motor/A DIESEL			ACEITE	G-191	5S0484	TRANSMISION	G-222	4J6064
TRANSMISION	G-152	1R0719	COMBUSTIBLE	G-1166	9H4729	ACEITE, ACCESORIO PARA TANQUE HIDRAULICO	GP-34	4T6788
ACEITE	GP-51	1R0739	AIRE, SECUNDARIO	GA-1285	2S1285	ACEITE	GP-51	1R0739
COMBUSTIBLE	GP-110	1R0750	AIRE, PRIMARIO	GA-8047	4M8047	COMBUSTIBLE	GP-110	1R0750
AIRE, SECUNDARIO	GA-1286	2S1286	D6C SOBRE ORUGAS con motor/CATERPILLAR 3306			ACEITE, BOMBA HIDRAULICA	GP-864H	9T8578
AIRE, PRIMARIO	GA-9334	7W5317	ACEITE, CARTUCHO	G-191	1R0659	AIRE, PRIMARIO ESTANDAR	GA-9334	7W5317
			CLUTCH/ DIRECCION/ TRANSMISION	G-222	1R0741			
D5E SOBRE ORUGAS con motor/A DIESEL			GASOLINA, SEPARADOR DE AGUA	G-293	6N7617	D6H SOBRE ORUGAS con motor/CATERPILLAR 3306		
TRANSMISION	G-152	9M9740	ACEITE, SELLADO	GP-51	1R0739	TRANSMISION	G-222	4J6064
ACEITE	GP-51	1R0739	COMBUSTIBLE	GP-110	1R0750	ACEITE, ACCESORIO PARA TANQUE HIDRAULICO	GP-34	4T6788
COMBUSTIBLE	GP-110	1R0750	AIRE, SECUNDARIO	GA-1286	2S1286	ACEITE	GP-51	1R0739
AIRE, SECUNDARIO	GA-1286	2S1286	AIRE, PRIMARIO (11 3/32 DIAM. EXT.)	GA-9334	4M9334	COMBUSTIBLE	GP-110	1P2299
AIRE, PRIMARIO	GA-9334	7W5317	AIRE, PRIMARIO (11 1/2 DIAM. EXT.)	GA-7716	1P7716	ACEITE, BOMBA HIDRAULICA	GP-864H	9T8578
			AIRE, SECUNDARIO	GA-7360	1P7360	AIRE, PRIMARIO	GA-9334	4M9334
D5H LGP SERIES II SOBRE ORUGAS, D5H SOBRE ORUGAS con motor/CATERPILLAR 3304								
TRANSMISION	G-152	9M9740						
ACEITE	GP-51	2P4004						
COMBUSTIBLE	GP-110	1P2299						
HIDRAULICO SELLADO	GP-166	4T6915						
AIRE, PRIMARIO ESTANDAR	GA-9334	7W5317						

MARCA-MODELO-MOTOR MAKE-MODEL-ENGINE	GONHER GONHER	OEM OEM	MARCA-MODELO-MOTOR MAKE-MODEL-ENGINE	GONHER GONHER	OEM OEM	MARCA-MODELO-MOTOR MAKE-MODEL-ENGINE	GONHER GONHER	OEM OEM
CATERPILLAR (continuación)			CATERPILLAR (continuación)			CATERPILLAR (continuación)		
NIVELADORAS			NIVELADORAS			NIVELADORAS		
D6H XL SERIES II DS SOBRE ORUGAS, D6H XL SERIES II SOBRE ORUGAS, D6H XR SERIES II SOBRE ORUGAS con motor/CATERPILLAR 3306			D7A SOBRE ORUGAS con motor/A DIESEL			D7R SOBRE ORUGAS con motor/CATERPILLAR 3306		
TRANSMISION	G-222	4J6064	ACEITE	G-191	1C6406	ACEITE, TANQUE HIDRAULICO (CARTUCHO)	G-222	1R0741
ACEITE, ACCESORIO PARA TANQUE HIDRAULICO	GP-34	4T6788	D7C SOBRE ORUGAS, D7D SOBRE ORUGAS con motor/A DIESEL			ACEITE, TANQUE HIDRAULICO (SELLADO)	GP-34	4T6788
ACEITE	GP-51	1R0739	ACEITE	G-191	7M3800	ACEITE	GP-51	1R0739
COMBUSTIBLE	GP-110	1R0750	TRANSMISION	G-191	7M3800	COMBUSTIBLE, PRIMARIO SELLADO	GP-1108	1T1712
ACEITE, BOMBA HIDRAULICA	GP-864H	9T8578	COMBUSTIBLE	G-1166	6H5931	COMBUSTIBLE	GP-110	1R0750
AIRE, PRIMARIO ESTANDAR	GA-9334	7W5317	D7E SOBRE ORUGAS con motor/A DIESEL			D8 SOBRE ORUGAS con motor/A DIESEL (EXCEPTO S/N 1H, 2U, 13A)		
D6H XR SOBRE ORUGAS con motor/CATERPILLAR 3306			ACEITE	G-238	6H9999	ACEITE	G-191	7M3800
TRANSMISION	G-222	4J6064	COMBUSTIBLE	G-1166	9H1252	COMBUSTIBLE	G-1166	9H1252
ACEITE, ACCESORIO PARA TANQUE HIDRAULICO	GP-34	4T6788	DIRECCION (S/N 47A1-47A3395, 48A1-48A6392)	G-152	1R0719	CLUTCH/ DIRECCION/ TRANSMISION	G-152	9M9740
ACEITE	GP-51	1R0739	TRANSMISION (S/N 47A1-47A3395, 48A1-48A6392)	G-152	1R0719	CLUTCH/ DIRECCION/ TRANSMISION	G-222	4J6064
COMBUSTIBLE	GP-110	1P2299	DIRECCION (S/N RESTANTES)	G-222	1R0741	AIRE, SIMPLE	GA-5648	2M7941
ACEITE, BOMBA HIDRAULICA	GP-864H	9T8578	TRANSMISION (S/N RESTANTES)	G-222	1R0741	D8 SOBRE ORUGAS con motor/A DIESEL (S/N 1H, 2U, 13A)		
AIRE, PRIMARIO	GA-9334	4M9334	AIRE, PRIMARIO	GA-287	4S8833	ACEITE, FLUJO TOTAL (FULL FLOW)	G-191	5S0484
D6M LGP SOBRE ORUGAS, D6M SOBRE ORUGAS, D6M XL SOBRE ORUGAS con motor/CATERPILLAR 3116			D7F SOBRE ORUGAS con motor/CATERPILLAR 3306			D8D SOBRE ORUGAS, D8G SOBRE ORUGAS con motor/A DIESEL		
ACEITE	GP-51	1R0739	ACEITE, CARTUCHO	G-191	5S0484	ACEITE	G-191	5S0484
COMBUSTIBLE, 5 13/32 IN	GP-62	1R0751	ACEITE, TANQUE HIDRAULICO	G-222	1R0741	ACEITE, CONVERTIDOR DE TORSION	G-191	5S0484
COMBUSTIBLE, 7 13/32 IN	GP-1109	1R0751	TRANSMISION	G-222	1R0741	FRENO/ DIRECCION	G-191	5S0484
COMBUSTIBLE, SEPARADOR DE AGUA	GPP-424	117-4089	ACEITE, SELLADO	GP-51	1R0739	TRANSMISION	G-191	5S0484
HIDRAULICO	GP-166	4T6915	COMBUSTIBLE	GP-1108	4N5823	COMBUSTIBLE	G-1166	6H5931
ACEITE, ACCESORIO PARA TORNO	GP-761H	118-6322	COMBUSTIBLE	GP-110	1P2299	ACEITE, ACCESORIO RIPPER HIDRAULICO	G-152	1R0719
D6R LGP SOBRE ORUGAS, D6R XR SERIES SOBRE ORUGAS, D6R SOBRE ORUGAS, D6R XL SERIES SOBRE ORUGAS con motor/CATERPILLAR 3306			AIRE, PRIMARIO	GA-9334	4M9334	ACEITE, ACCESORIO HIDRAULICO	G-222	1R0741
ACEITE, TANQUE HIDRAULICO (SELLADO)	GP-34	4T6788	D7G SOBRE ORUGAS con motor/CATERPILLAR 3306			D8E SOBRE ORUGAS, D8F SOBRE ORUGAS con motor/A DIESEL		
ACEITE	GP-51	1R0739	TRANSMISION	G-222	4J6064	ACEITE	G-191	5S0484
COMBUSTIBLE, PRIMARIO (SELLADO)	GP-1108	1R1712	GASOLINA, SEPARADOR DE AGUA	G-293	8N9803	FRENO/ DIRECCION	G-191	9F6700
COMBUSTIBLE	GP-110	1R0750	ACEITE	GP-51	1R0739	TRANSMISION	G-191	9F6700
ACEITE, ACCESORIO PARA TORNO	GP-761H	118-6322	COMBUSTIBLE	GP-1108	4N5823	COMBUSTIBLE	G-1166	6H5931
D7 SOBRE ORUGAS con motor/A DIESEL (S/N 17A1-17A10692)			AIRE, SECUNDARIO ESTANDAR	GA-1286	2S1286	ACEITE, ACCESORIO RIPPER HIDRAULICO	G-152	1R0719
COMBUSTIBLE	G-1166	6H5932	AIRE, PRIMARIO ESTANDAR	GA-9334	8N5317	D8H SOBRE ORUGAS con motor/CATERPILLAR D342T		
D7 SOBRE ORUGAS con motor/A DIESEL (S/N 3T23647-3T28058)			D7H SERIES II SOBRE ORUGAS, D7H SOBRE ORUGAS con motor/CATERPILLAR 3306			ACEITE, CARTUCHO	G-191	5S0484
TRANSMISION	G-191	5S0484	ACEITE, TANQUE HIDRAULICO (CARTUCHO) RETORNO	G-222	4J6064	ACEITE, CONVERTIDOR DE TORSION	G-191	7M3800
D7 SOBRE ORUGAS con motor/A DIESEL (S/N 47A1 EN ADELANTE)			TRANSMISION	G-222	4J6064	COMBUSTIBLE	G-1166	9H1252
ACEITE	G-238	5S0485	ACEITE, TANQUE HIDRAULICO (SELLADO)	GP-34	9T0522	CLUTCH/ DIRECCION/ TRANSMISION	G-152	9M9740
D7 SOBRE ORUGAS con motor/A DIESEL (S/N 48A1-48A6392)			ACEITE	GP-51	1R0739	CLUTCH/ DIRECCION/ TRANSMISION	G-222	4J6064
DIRECCION	G-152	1R0719	COMBUSTIBLE	GP-110	1R0750	ACEITE, SELLADO (CUMPLE CON MEDIDAS ORIGINALES)	GP-691	2P4005
D7 SOBRE ORUGAS con motor/A DIESEL (S/N 72W1 EN ADELANTE)			AIRE, PRIMARIO ESTANDAR	GA-9334	7W5317	ACEITE, SELLADO (SEGUNDA OPCION)	GP-52	2P4005
TRANSMISION	G-222	4J6064	D7R LGP SOBRE ORUGAS con motor/CATERPILLAR 3306			COMBUSTIBLE, SELLADO	GP-110	1P2299
ACEITE	GP-51	2P4004	ACEITE, TANQUE HIDRAULICO (CARTUCHO)	G-222	1R0741	AIRE, SIMPLE	GA-5648	2M7941
COMBUSTIBLE, SEPARADOR DE AGUA	GPP-11	175-2949	ACEITE, TANQUE HIDRAULICO (SELLADO)	GP-34	4T6788	AIRE, PRIMARIO	GA-7716	1P7716
AIRE, PRIMARIO	GA-9334	4M9334	ACEITE	GP-51	1R0739	AIRE, SECUNDARIO	GA-7360	1P7360
D7 SOBRE ORUGAS con motor/A DIESEL (S/N 7M1-7M9999)			COMBUSTIBLE, PRIMARIO SELLADO	GP-1108	1T1712	D8K SOBRE ORUGAS con motor/CATERPILLAR D342		
AIRE, SECUNDARIO	GA-1285	2S1285	COMBUSTIBLE	GP-110	1R0750	ACEITE, CARTUCHO	G-191	5S0484
D7 SOBRE ORUGAS con motor/A DIESEL (S/N 93N1-93N961)			D7R SERIES II SOBRE ORUGAS con motor/CATERPILLAR 3176C			TRANSMISION	G-222	4J6064
ACEITE	G-191	1W7399	ACEITE, TANQUE HIDRAULICO (CARTUCHO)	G-222	1R0741	ACEITE, SELLADO (CUMPLE CON MEDIDAS ORIGINALES)	GP-691	2P4005
			COMBUSTIBLE	GP-749	1R0749	ACEITE, SELLADO (SEGUNDA OPCION)	GP-52	2P4005
			ACEITE, CUMPLE CON MEDIDAS ORIGINALES	GP-691	1R0716	COMBUSTIBLE	GP-110	1P2299
			ACEITE, TANQUE HIDRAULICO (SELLADO)	GP-34	4T6788	AIRE, PRIMARIO	GA-7716	1P7716
			ACEITE, SEGUNDA OPCION	GP-52	1R0716			

SERVICIO PESADO

MARCA-MODELO-MOTOR MAKE-MODEL-ENGINE	GONHER GONHER	OEM OEM	MARCA-MODELO-MOTOR MAKE-MODEL-ENGINE	GONHER GONHER	OEM OEM	MARCA-MODELO-MOTOR MAKE-MODEL-ENGINE	GONHER GONHER	OEM OEM
CATERPILLAR (continuación)			CATERPILLAR (continuación)			CATERPILLAR (continuación)		
NIVELADORAS			NIVELADORAS			NIVELADORAS		
AIRE, SECUNDARIO	GA-7360	1P7360	COMBUSTIBLE, SEPARADOR DE AGUA	GPP-11	175-2949	ACEITE, SEGUNDA OPCION	GP-52	1R0716
D8L SOBRE ORUGAS con motor/CATERPILLAR 3408			COMBUSTIBLE	GP-110	1P2299	AGUA, PRE-CARGA	GP-1013Q	1W5518
TRANSMISION	G-152	9M9740	D9 SOBRE ORUGAS con motor/A DIESEL (S/N 9V4939)			AGUA, MANTENIMIENTO	GP-1011Q	9N3718
ACEITE, TANQUE HIDRAULICO	G-153	7J0670	ACEITE, CONVERTIDOR DE TORSION	G-191	5S0484	AIRE, PRIMARIO	GA-483	7W5313
COMBUSTIBLE	GP-749	1R0749	ACEITE, CUMPLE CON MEDIDAS ORIGINALES	GP-691	2P4005	D9R SOBRE ORUGAS con motor/CATERPILLAR 3408		
ACEITE, CUMPLE CON MEDIDAS ORIGINALES	GP-691	2P4005	ACEITE, SEGUNDA OPCION	GP-52	2P4005	ACEITE, TANQUE HIDRAULICO (FLUJO INVERSO)	G-152	1R0719
ACEITE, SEGUNDA OPCION	GP-52	2P4005	D9D SOBRE ORUGAS con motor/A DIESEL			TRANSMISION	G-152	1R0719
AGUA, PRE-CARGA	GP-1013Q	1W5518	ACEITE, CONVERTIDOR DE TORSION	G-191	9F6700	COMBUSTIBLE	GP-749	1R0749
AGUA, MANTENIMIENTO	GP-1011Q	9N3718	ACEITE, CONVERSION EN EL CAMPO	G-238	6H9999	ACEITE, CUMPLE CON MEDIDAS ORIGINALES	GP-691	1R0716
HIDRAULICO SELLADO	GP-166	4T6915	ACEITE, LUBRICACION EXTERIOR O PRIMARIA	G-238	8F1151	TRANSMISION	GP-749	1R0749
AIRE, PRIMARIO	GA-483	7W5313	TRANSMISION	G-238	8F1151	COMBUSTIBLE	GP-691	1R0716
D8N SOBRE ORUGAS con motor/CATERPILLAR 3406			COMBUSTIBLE	G-1166	6H5932	ACEITE, SEGUNDA OPCION	GP-52	1R0716
ACEITE, TANQUE HIDRAULICO (CARTUCHO) EXCEPTO S/N 5TJ, 7TK	G-222	4J6064	D9E SOBRE ORUGAS con motor/A DIESEL			AGUA	GP-1011Q	9N6123
TRANSMISION (S/N 9TC)	G-222	4J6064	ACEITE, CONVERTIDOR DE TORSION	G-191	9F6700	PF300B SOBRE ORUGAS con motor/A DIESEL (43E1 EN ADELANTE)		
COMBUSTIBLE	GP-749	1R0749	ACEITE	G-238	6H9999	ACEITE	GP-1	7W2327
ACEITE, CUMPLE CON MEDIDAS ORIGINALES	GP-691	1R0716	TRANSMISION (EXCEPTO S/N 34A)	G-238	8F1151	CATERPILLAR		
ACEITE, TANQUE HIDRAULICO (SELLADO)	GP-34	9T5664	COMBUSTIBLE	G-1166	6H5932	PORTA-HERRAMIENTAS		
ACEITE, SEGUNDA OPCION	GP-52	1R0716	TRANSMISION (S/N 34A)	G-152	9M9740	IT12 con motor/CATERPILLAR 3204		
AGUA, PRE-CARGA	GP-1011Q	9N3367	ACEITE, CONTROLES HIDRAULICOS	G-222	4J6064	ACEITE, TANQUE HIDRAULICO	G-152	9M9740
AGUA, MANTENIMIENTO	GP-2071W	9N3368	D9G SOBRE ORUGAS con motor/CATERPILLAR D353			COMBUSTIBLE, S/N 45V72916 EN ADELANTE	GP-110	1P2299
AIRE, PRIMARIO ESTANDAR	GA-7716	7W5495	ACEITE	G-238	6H9999	ACEITE	GP-9586	1R0713
AIRE, SECUNDARIO ESTANDAR	GA-7360	1P7360	COMBUSTIBLE, CARTUCHO	G-1166	1R0724	IT12B con motor/CATERPILLAR 3204		
D8R SOBRE ORUGAS con motor/CATERPILLAR 3406			CLUTCH/ DIRECCION/ TRANSMISION	G-152	1R0719	COMBUSTIBLE	GP-110	1R0750
TRANSMISION	G-222	1R0741	CLUTCH/ DIRECCION/ TRANSMISION	G-222	1R0741	IT12F con motor/CATERPILLAR 3204		
COMBUSTIBLE	GP-749	1R0749	HIDRAULICO	G-222	1R0741	COMBUSTIBLE, 5 13/32 IN	GP-62	1R0751
ACEITE, CUMPLE CON MEDIDAS ORIGINALES	GP-691	1R0716	COMBUSTIBLE, SELLADO	GP-110	1R0750	COMBUSTIBLE, 7 13/32 IN	GP-1109	1R0751
ACEITE, SEGUNDA OPCION	GP-52	1R0716	AIRE, PRIMARIO	GA-483	1P8483	COMBUSTIBLE, 7 1/8 IN	GP-110	1R0750
AGUA	GP-1011Q	9N6123	AIRE, SECUNDARIO	GA-482	1P8482	TRANSMISION (S/N 1KF1005 EN ADELANTE)	GP-761H	9T5916
D9 SOBRE ORUGAS con motor/A DIESEL (S/N 18A1 EN ADELANTE)			D9H SOBRE ORUGAS con motor/CATERPILLAR D353			AIRE, SECUNDARIO	GA-361	6I6582
ACEITE, CONVERTIDOR DE TORSION	G-191	5S0484	TRANSMISION	G-222	4J6064	IT14B con motor/CATERPILLAR 3114		
D9 SOBRE ORUGAS con motor/A DIESEL (S/N 34A1 EN ADELANTE)			ACEITE, CUMPLE CON MEDIDAS ORIGINALES	GP-691	2P4005	COMBUSTIBLE	GP-110	1R0750
ACEITE	G-238	5S0485	ACEITE, SEGUNDA OPCION	GP-52	2P4005	IT14F con motor/CATERPILLAR 3114T		
D9 SOBRE ORUGAS con motor/A DIESEL (S/N 49A1 EN ADELANTE)			COMBUSTIBLE	GP-110	1P2299	COMBUSTIBLE, 5 13/32 IN	GP-62	1R0751
ACEITE, CONVERTIDOR DE TORSION	G-191	5S0484	AIRE, PRIMARIO	GA-483	1P8443	COMBUSTIBLE, 7 13/32 IN	GP-1109	1R0751
DIRECCION	G-222	4J6064	AIRE, SECUNDARIO	GA-482	1P8482	COMBUSTIBLE, 7 1/8 IN	GP-110	1R0750
TRANSMISION	G-222	4J6064	D9I SOBRE ORUGAS con motor/CATERPILLAR 3412			TRANSMISION (S/N 1KF1005 EN ADELANTE)	GP-761H	9T5916
D9 SOBRE ORUGAS con motor/A DIESEL (S/N 66A11908 EN ADELANTE)			TRANSMISION	G-152	9M9740	AIRE, SECUNDARIO	GA-361	6I6582
ACEITE, CONVERTIDOR DE TORSION	G-191	5S0484	ACEITE, ACCESORIO PARA TANQUE HIDRAULICO	G-153	7J0670	IT14G con motor/CATERPILLAR 3054		
AIRE, PRIMARIO	GA-483	1P8483	ACEITE, CUMPLE CON MEDIDAS ORIGINALES	GP-691	2P4005	ACEITE	GP-31	7W2326
AIRE, SECUNDARIO	GA-482	1P8482	ACEITE, SEGUNDA OPCION	GP-52	2P4005	COMBUSTIBLE, SEPARADOR DE AGUA	GPP-421	131-1812
D9 SOBRE ORUGAS con motor/A DIESEL (S/N 66A1-66A3074)			AGUA	GP-1013Q	1W5518	COMBUSTIBLE, SEPARADOR DE AGUA	GPP-425	163-4465
ACEITE, CONVERTIDOR DE TORSION	G-191	5S0484	COMBUSTIBLE	GP-1108	2W2134	ACEITE, TREN DE PODER (REQUIERE 2)	GP-761H	1G8878
DIRECCION	G-152	9M9740	AIRE, SECUNDARIO	GA-482	7N1308	COMBUSTIBLE	GPP-419	159-6102
HIDRAULICO	G-152	9M9740	D9N SOBRE ORUGAS con motor/CATERPILLAR 3408			AIRE, RADIAL PRIMARIO	GA-853R	110-6326
TRANSMISION	G-152	9M9740	TRANSMISION	G-152	1R0719	IT14G con motor/CATERPILLAR 3054C		
D9 SOBRE ORUGAS con motor/A DIESEL (S/N 9V1 EN ADELANTE)			ACEITE, TANQUE HIDRAULICO	G-153	7J0670	ACEITE	GP-31	7W2326
ACEITE, CONVERTIDOR DE TORSION	G-191	5S0484	COMBUSTIBLE	GP-749	1R0749	ACEITE, TREN DE PODER (REQUIERE 2)	GP-761H	1G8878
ACEITE, CUMPLE CON MEDIDAS ORIGINALES	GP-691	2P4005	ACEITE, CUMPLE CON MEDIDAS ORIGINALES	GP-691	1R0716	AIRE, RADIAL PRIMARIO	GA-853R	110-6326

MARCA-MODELO-MOTOR MAKE-MODEL-ENGINE	GONHER GONHER	OEM OEM	MARCA-MODELO-MOTOR MAKE-MODEL-ENGINE	GONHER GONHER	OEM OEM	MARCA-MODELO-MOTOR MAKE-MODEL-ENGINE	GONHER GONHER	OEM OEM
CATERPILLAR (continuación)			CATERPILLAR (continuación)			CATERPILLAR (continuación)		
PORTA-HERRAMIENTAS			PORTA-HERRAMIENTAS			RASPADORAS		
COMBUSTIBLE, SEPARADOR DE AGUA	GPP-421	131-1812	TRANSMISION	GP-761H	1G8878	HIDRAULICO	G-222	4J6064
ACEITE, TREN DE PODER	GP-761H	1G8878	IT62G con motor/A DIESEL			AIRE, SECUNDARIO	GA-1286	2S1286
COMBUSTIBLE	GPP-419	159-6102	ACEITE, FLUJO TOTAL (FULL FLOW)	GP-51	1R0739	AIRE, PRIMARIO	GA-9334	4M9334
IT18 con motor/CATERPILLAR 3204			COMBUSTIBLE, PRIMARIO (5 13/32 IN)	GP-62	1R0751	619C con motor/A DIESEL		
COMBUSTIBLE	GP-110	1P2299	COMBUSTIBLE, PRIMARIO (7 13/32 IN)	GP-1109	1R0751	ACEITE	G-238	1R0721
IT18B, IT28, IT28B con motor/CATERPILLAR 3204			ACEITE, DERIVACION (BY PASS)	GP-57	1W8845	TRANSMISION	G-238	1R0721
COMBUSTIBLE	GP-110	1P2299	TRANSMISION	GP-761H	1G8878	HIDRAULICO	G-222	1R0741
IT18F con motor/CATERPILLAR 3114						AIRE	GA-1286	2S1286
COMBUSTIBLE, 5 13/32 IN	GP-62	1R0751	CATERPILLAR			AIRE	GA-9334	7W5317
COMBUSTIBLE, 7 13/32 IN	GP-1109	1R0751	RASPADORAS			621 con motor/A DIESEL (S/N 23H1 EN ADELANTE)		
COMBUSTIBLE, 7 1/8 IN	GP-110	1R0750	611 con motor/CATERPILLAR 3306			ACEITE	G-191	5S0484
TRANSMISION	GP-761H	9T5916	TRANSMISION	G-152	1R0719	TRANSMISION	G-152	1R0719
AIRE, PRIMARIO	GA-499R	6I2499	HIDRAULICO	G-153	7J0670	HIDRAULICO	G-222	4J6064
IT24F con motor/CATERPILLAR 3114			ACEITE	GP-51	1R0739	AIRE, SECUNDARIO	GA-1287	2S1287
ACEITE	GP-51	1R0739	COMBUSTIBLE, SELLADO	GP-110	1R0750	AIRE, PRIMARIO	GA-9045	7M9045
COMBUSTIBLE, 5 13/32 IN	GP-62	1R0751	613 con motor/A DIESEL (S/N 38W1 EN ADELANTE)			621 con motor/A DIESEL (S/N 45P1 EN ADELANTE)		
COMBUSTIBLE, 7 13/32 IN	GP-1109	1R0751	TRANSMISION	G-152	9M9740	HIDRAULICO	G-153	7J670
COMBUSTIBLE, SEPARADOR DE AGUA	GPP-424	117-4089	ACEITE	GP-36	9N5680	ACEITE, CUMPLE CON MEDIDAS ORIGINALES	GP-691	2P4005
TRANSMISION	GP-761H	1G8878	COMBUSTIBLE, SEPARADOR DE AGUA	GPP-11	175-2949	ACEITE, SEGUNDA OPCION	GP-52	2P4005
AIRE, PRIMARIO	GA-499R	6I2499	COMBUSTIBLE	GP-110	1P2299	COMBUSTIBLE	GP-56	4N5823
IT28F con motor/CATERPILLAR 3116			AIRE, SECUNDARIO	GA-1286	2S1286	AIRE, PRIMARIO	GA-7716	1P7716
ACEITE	GP-51	1R0739	AIRE, PRIMARIO	GA-9334	4M9334	AIRE, SECUNDARIO	GA-7360	1P7360
COMBUSTIBLE, 5 13/32 IN	GP-62	1R0751	613 con motor/A DIESEL (S/N 71M1-71M1377)			621B con motor/A DIESEL		
COMBUSTIBLE, 7 13/32 IN	GP-1109	1R0751	HIDRAULICO	G-222	4J6064	COMBUSTIBLE, CARTUCHO	G-1166	4S2341
COMBUSTIBLE, SEPARADOR DE AGUA	GPP-424	117-4089	ACEITE	GP-36	9N5680	TRANSMISION	G-152	9M9740
COMBUSTIBLE, 7 1/8 IN	GP-110	1R0750	COMBUSTIBLE	GP-110	1P2299	ACEITE, TANQUE HIDRAULICO	G-153	7J0670
TRANSMISION	GP-761H	1G8878	613B, 613C, 613C SERIES II con motor/CATERPILLAR 3116			ACEITE, SELLADO (CUMPLE CON MEDIDAS ORIGINALES)	GP-691	2P4005
AIRE, PRIMARIO	GA-499R	6I2499	TRANSMISION	G-152	1R0719	ACEITE, SELLADO (SEGUNDA OPCION)	GP-52	2P4005
IT28G con motor/CATERPILLAR 3056E			HIDRAULICO	G-222	4J6064	COMBUSTIBLE, SELLADO	GP-1108	2W2134
ACEITE	GP-51	1R0739	ACEITE, TANQUE HIDRAULICO	G-222	4J6064	AIRE, PRIMARIO	GA-7716	8N5495
COMBUSTIBLE, SEPARADOR DE AGUA	GPP-421	131-1812	GASOLINA, SEPARADOR DE AGUA	G-293	8N9803	AIRE, SECUNDARIO	GA-7360	1P7360
ACEITE, TREN DE PODER	GP-761H	1G8878	ACEITE	GP-51	1R0739	621E con motor/CATERPILLAR 3406		
AIRE, RADIAL, PRIMARIO	GA-697R	152-7217	COMBUSTIBLE, 5 13/32 IN	GP-62	1R0751	TRANSMISION	G-152	9M9740
IT28G con motor/CATERPILLAR 3116			COMBUSTIBLE, 7 13/32 IN	GP-1109	1R0751	ACEITE, TANQUE HIDRAULICO	G-153	7J0670
ACEITE	GP-51	1R0739	COMBUSTIBLE, SEPARADOR DE AGUA	GPP-424	117-4089	COMBUSTIBLE, SELLADO	GP-749	1R0749
COMBUSTIBLE, 5 13/32 IN	GP-62	1R0751	COMBUSTIBLE, 7 1/8 IN	GP-110	1R0750	ACEITE, CUMPLE CON MEDIDAS ORIGINALES	GP-691	2P4005
COMBUSTIBLE, 7 13/32 IN	GP-1109	1R0751	AIRE, SECUNDARIO ESTANDAR	GA-1287	2S1287	ACEITE, SEGUNDA OPCION	GP-52	2P4005
COMBUSTIBLE, SEPARADOR DE AGUA	GPP-424	117-4089	613W con motor/A DIESEL			AIRE, PRIMARIO	GA-7716	7W5495
TRANSMISION	GP-761H	1G8878	TRANSMISION	G-152	1R0719	AIRE, SECUNDARIO	GA-7360	1P7360
AIRE, PRIMARIO	GA-499R	6I2499	HIDRAULICO	G-222	1R0741	621F con motores/CATERPILLAR 3406, CATERPILLAR 3406C		
IT38F con motor/CATERPILLAR 3116			ACEITE	GP-36	9L9200	TRANSMISION	G-152	1R0719
ACEITE	GP-51	1R0739	COMBUSTIBLE	GP-110	1R0740	ACEITE, TANQUE HIDRAULICO	G-153	7J0670
COMBUSTIBLE, 5 13/32 IN	GP-62	1R0751	AIRE, SECUNDARIO	GA-1286	2S1286	COMBUSTIBLE, SELLADO	GP-749	1R0749
COMBUSTIBLE, 7 13/32 IN	GP-1109	1R0751	AIRE, PRIMARIO	GA-9334	7W5317	ACEITE, CUMPLE CON MEDIDAS ORIGINALES	GP-691	1R0716
COMBUSTIBLE, SEPARADOR DE AGUA	GPP-424	117-4089	615C con motor/CATERPILLAR 3306			ACEITE, SEGUNDA OPCION	GP-52	1R0716
TRANSMISION	GP-761H	1G8878	TRANSMISION	G-152	1R0719	AGUA	GP-1011Q	9N6123
IT38G con motor/CATERPILLAR 3126			ACEITE, TANQUE HIDRAULICO	G-153	7J0670	621R con motor/A DIESEL		
ACEITE	GP-51	1R0739	ACEITE	GP-51	1R0739	COMBUSTIBLE	GP-110	1R0750
COMBUSTIBLE, 5 13/32 IN	GP-62	1R0751	COMBUSTIBLE, SELLADO	GP-110	1R0750	621S con motor/CATERPILLAR 3306		
COMBUSTIBLE, 7 13/32 IN	GP-1109	1R0751	619 con motor/A DIESEL			TRANSMISION	G-152	9M9740
COMBUSTIBLE, SEPARADOR DE AGUA	GPP-424	117-4089	ACEITE	G-238	5S0485	ACEITE, TANQUE HIDRAULICO	G-153	7J0670
TRANSMISION	GP-761H	1G8878	TRANSMISION	G-238	5S0485	ACEITE	GP-51	2Y8096
AIRE, PRIMARIO	GA-499R	6I2499	COMBUSTIBLE	G-1166	6H5932	COMBUSTIBLE, SELLADO	GP-110	2Y8670
IT38F con motor/CATERPILLAR 3116						AIRE, PRIMARIO	GA-7716	7W5495

SERVICIO PESADO

MARCA-MODELO-MOTOR MAKE-MODEL-ENGINE	GONHER GONHER	OEM OEM	MARCA-MODELO-MOTOR MAKE-MODEL-ENGINE	GONHER GONHER	OEM OEM	MARCA-MODELO-MOTOR MAKE-MODEL-ENGINE	GONHER GONHER	OEM OEM
CATERPILLAR (continuación)			CATERPILLAR (continuación)			CATERPILLAR (continuación)		
RASPADORAS			RASPADORAS			RASPADORAS		
AIRE, SECUNDARIO	GA-7360	1P7360	AIRE, SECUNDARIO	GA-7360	1P7360	630B con motor/A DIESEL		
623 con motor/A DIESEL (S/N 46P1 EN ADELANTE)			627E con motor/CATERPILLAR 3306			ACEITE	G-238	1R0721
ACEITE, CUMPLE CON MEDIDAS ORIGINALES	GP-691	2P4005	TRANSMISION	G-152	1R0719	HIDRAULICO	G-222	1R0741
ACEITE, SEGUNDA OPCION	GP-52	2P4005	ACEITE, TANQUE HIDRAULICO	G-153	7J0670	TRANSMISION	G-222	1R0741
COMBUSTIBLE	GP-56	4N5823	COMBUSTIBLE, SELLADO	GP-749	1R0749	AIRE	GA-1287	2S1287
AIRE, PRIMARIO	GA-7716	1P7716	ACEITE, CUMPLE CON MEDIDAS ORIGINALES	GP-691	1R0716	AIRE	GA-9045	7W5316
AIRE, SECUNDARIO	GA-7360	1P7360	ACEITE	GP-51	1R0739	631 con motor/A DIESEL (S/N 13G1 EN ADELANTE)		
623 con motor/A DIESEL (S/N 52S1 EN ADELANTE)			ACEITE, SEGUNDA OPCION	GP-52	1R0716	DIRECCION	G-222	1R0741
ACEITE	G-191	1W7399	AGUA	GP-1013Q	1W5518	HIDRAULICO	G-222	1R0741
TRANSMISION	G-152	9M9740	COMBUSTIBLE, SELLADO	GP-110	1P2299	TRANSMISION	G-222	4J6064
HIDRAULICO	G-222	4J6064	AIRE, PRIMARIO ESTANDAR	GA-9045	7W5316	AIRE, SECUNDARIO	GA-1287	2S1287
HIDRAULICO	G-153	7J0670	AIRE, PRIMARIO ESTANDAR	GA-7716	7W5495	AIRE, PRIMARIO	GA-9045	7M9045
AIRE, SECUNDARIO	GA-1287	2S1287	AIRE, SECUNDARIO ESTANDAR	GA-7360	1P7360	631 con motor/A DIESEL (S/N 24W1 EN ADELANTE)		
AIRE, PRIMARIO	GA-9045	7M9045	627E con motor/CATERPILLAR 3406			HIDRAULICO	G-153	7J0670
623B con motor/A DIESEL			TRANSMISION	G-152	1R0719	631 con motor/A DIESEL (S/N 48W1 EN ADELANTE)		
TRANSMISION	G-152	1R0719	ACEITE, TANQUE HIDRAULICO	G-153	7J0670	TRANSMISION	G-152	1R0719
HIDRAULICO	G-153	7J0670	COMBUSTIBLE, SELLADO	GP-749	1R0749	ACEITE, CUMPLE CON MEDIDAS ORIGINALES	GP-691	2P4005
COMBUSTIBLE	GP-749	1R0749	ACEITE, CUMPLE CON MEDIDAS ORIGINALES	GP-691	1R0716	ACEITE, SEGUNDA OPCION	GP-52	2P4005
ACEITE, CUMPLE CON MEDIDAS ORIGINALES	GP-691	1R0716	ACEITE	GP-51	2P4004	COMBUSTIBLE	GP-56	4N5823
ACEITE, SEGUNDA OPCION	GP-52	1R0716	ACEITE, SEGUNDA OPCION	GP-52	1R0716	AIRE, PRIMARIO	GA-483	1P8483
AIRE, PRIMARIO	GA-7716	7W5495	COMBUSTIBLE, SELLADO	GP-110	1R0750	AIRE, SECUNDARIO	GA-482	1P8482
AIRE, SECUNDARIO	GA-7360	1P7360	AGUA	GP-1011Q	9Y1022	631 con motor/A DIESEL (S/N 51F1 EN ADELANTE)		
623E, 623F con motores/CATERPILLAR 3406, CATERPILLAR 3406C			AIRE, PRIMARIO ESTANDAR	GA-9045	7W5316	ACEITE	G-238	5S0485
TRANSMISION	G-152	1R0719	AIRE, PRIMARIO ESTANDAR	GA-7716	7W5495	631 con motor/A DIESEL (S/N 67M1 EN ADELANTE)		
ACEITE, TANQUE HIDRAULICO	G-153	7J0670	AIRE, SECUNDARIO ESTANDAR	GA-7360	1P7360	COMBUSTIBLE, SEPARADOR DE AGUA	GPP-11	175-2949
COMBUSTIBLE, SELLADO	GP-749	1R0749	627F con motor/CATERPILLAR 3406B			631B con motor/A DIESEL (S/N 13G1-3686)		
ACEITE, CUMPLE CON MEDIDAS ORIGINALES	GP-691	1R0716	TRANSMISION	G-152	1R0719	ACEITE	G-238	1R0721
ACEITE, SEGUNDA OPCION	GP-52	1R0716	ACEITE, TANQUE HIDRAULICO	G-153	7J0670	HIDRAULICO	G-222	1R0741
AGUA	GP-1013Q	1W5518	COMBUSTIBLE, SELLADO	GP-749	1R0749	TRANSMISION	G-222	1R0741
AGUA	GP-1011Q	9N6123	ACEITE, CUMPLE CON MEDIDAS ORIGINALES	GP-691	1R0716	AIRE	GA-1287	2S1287
HIDRAULICO (SELLADO)	GP-166	4T6915	ACEITE	GP-51	1R0739	631B con motor/A DIESEL (S/N 13G3687 EN ADELANTE)		
AIRE, PRIMARIO ESTANDAR	GA-7716	7W5495	ACEITE, SEGUNDA OPCION	GP-52	1R0716	COMBUSTIBLE	GP-110	1R0750
AIRE, SECUNDARIO ESTANDAR	GA-7360	1P7360	COMBUSTIBLE, SELLADO	GP-110	1R0750	631C con motor/A DIESEL (S/N 11G3287 EN ADELANTE)		
627 con motor/A DIESEL			AGUA	GP-1011Q	9N6123	HIDRAULICO	G-222	1C6405
ACEITE, CARTUCHO	G-191	5S0484	AIRE, PRIMARIO ESTANDAR	GA-9045	7W5316	631C con motor/A DIESEL (S/N 67M1-4259)		
TRANSMISION	G-152	9M9740	627G con motor/CATERPILLAR 3306			ACEITE	G-238	1R0721
GASOLINA, SEPARADOR DE AGUA	G-293	6N7617	TRANSMISION	G-152	1R0719	631C con motor/A DIESEL (S/N 67M4260 EN ADELANTE)		
ACEITE, SELLADO	GP-51	1R0739	ACEITE	GP-51	1R0739	HIDRAULICO	G-153	7J0670
COMBUSTIBLE, SELLADO	GP-110	1P2299	COMBUSTIBLE, SELLADO	GP-110	1R0750	631E-II con motor/A DIESEL		
AIRE, SECUNDARIO	GA-1287	2S1287	630 con motor/A DIESEL (S/N 14G1 EN ADELANTE)			ACEITE, S/N 1BB1540 EN ADELANTE (CUMPLE CON MEDIDAS ORIGINALES)	GP-691	1R0716
AIRE, PRIMARIO	GA-9045	7M9045	HIDRAULICO	G-222	4J6064	ACEITE, S/N 1BB1540 EN ADELANTE (SEGUNDA OPCION)	GP-52	1R0716
627B con motor/A DIESEL			TRANSMISION	G-222	4J6064	AIRE, S/N 6PC1 EN ADELANTE	GA-483	1P8483
ACEITE, CARTUCHO	G-191	5S0484	COMBUSTIBLE, SELLADO	GP-110	1R0750	631G con motor/CATERPILLAR 3408E		
TRANSMISION	G-152	9M9740	630 con motor/A DIESEL (S/N 14G481 EN ADELANTE)			COMBUSTIBLE	GP-749	1R0749
GASOLINA, SEPARADOR DE AGUA	G-293	6N7617	HIDRAULICO	G-222	4J6064	ACEITE, CUMPLE CON MEDIDAS ORIGINALES	GP-691	1R0716
ACEITE, SELLADO	GP-51	1R0739	TRANSMISION	G-222	4J6064	ACEITE, SEGUNDA OPCION	GP-52	1R0716
COMBUSTIBLE, SELLADO	GP-110	1P2299	COMBUSTIBLE, SEPARADOR DE AGUA	GPP-11	175-2949	632 con motor/A DIESEL		
AIRE, SECUNDARIO	GA-1287	2S1287	COMBUSTIBLE	GP-110	1P2299	ACEITE	G-238	5S0485
AIRE, PRIMARIO	GA-9045	7M9045	630 con motor/A DIESEL (S/N 52F1 EN ADELANTE)					
627BTR con motor/A DIESEL			ACEITE	G-238	5S0485			
TRANSMISION	G-152	1R0719	COMBUSTIBLE	G-1166	1R0724			
HIDRAULICO	G-153	7J0670	HIDRAULICO	G-222	4J6064			
ACEITE	GP-51	1R0739	TRANSMISION	G-222	4J6064			
COMBUSTIBLE	GP-110	1R0750						
AIRE, PRIMARIO	GA-7716	7W5495						

MARCA-MODELO-MOTOR MAKE-MODEL-ENGINE	GONHER GONHER	OEM OEM	MARCA-MODELO-MOTOR MAKE-MODEL-ENGINE	GONHER GONHER	OEM OEM	MARCA-MODELO-MOTOR MAKE-MODEL-ENGINE	GONHER GONHER	OEM OEM
CATERPILLAR (continuación)			CATERPILLAR (continuación)			CATERPILLAR (continuación)		
RASPADORAS			RASPADORAS			TRACTORES		
HIDRAULICO	G-222	1R0741	637G con motor/CATERPILLAR 3306			COMBUSTIBLE, SELLADO	GP-110	1R0750
TRANSMISION	G-222	1R0741	HIDRAULICO	G-152	1R0719	613 con motor/A DIESEL		
COMBUSTIBLE, SEPARADOR DE AGUA	GPP-11	175-2949	ACEITE	GP-51	1R0739	TRANSMISION	G-152	9M9740
COMBUSTIBLE	GP-110	1R0740	COMBUSTIBLE, SECUNDARIO	GP-110	1R0750	ACEITE, TANQUE HIDRAULICO	G-222	4J6064
AIRE, SECUNDARIO	GA-1287	2S1287	639D con motor/CATERPILLAR 3306			ACEITE	GP-36	9L9200
AIRE, PRIMARIO	GA-9045	7M9045	TRANSMISION	G-152	9M9740	AIRE, SECUNDARIO	GA-1286	2S1286
637 con motor/CATERPILLAR 3306			GASOLINA, SEPARADOR DE AGUA	G-293	8N9803	AIRE, PRIMARIO	GA-9334	4M9334
ACEITE, CARTUCHO	G-191	5S0484	ACEITE	GP-51	1R0739	613B con motor/A DIESEL		
TRANSMISION	G-152	9M9740	COMBUSTIBLE, SELLADO	GP-110	1R0750	TRANSMISION	G-152	9M9740
ACEITE, SELLADO	GP-51	2P4004	AIRE, SECUNDARIO	GA-1287	2S1287	ACEITE, TANQUE HIDRAULICO	G-222	4J6064
COMBUSTIBLE, SELLADO	GP-1108	4N5823	AIRE, PRIMARIO	GA-9045	7M9045	ACEITE	GP-36	9L9200
COMBUSTIBLE, SELLADO	GP-110	1R0740	657 con motor/A DIESEL			GASOLINA, SEPARADOR DE AGUA	G-293	8N9803
AIRE, SECUNDARIO	GA-1287	2S1287	ACEITE	G-238	5S0485	COMBUSTIBLE, SELLADO	GP-110	1P2299
AIRE, PRIMARIO	GA-9045	7M9045	COMBUSTIBLE, CARTUCHO	G-1166	8M9641	ACEITE	GP-9586	8N9586
637B con motor/CATERPILLAR 3306			TRANSMISION	G-152	9M9740	AIRE, SECUNDARIO	GA-1286	2S1286
ACEITE, CARTUCHO	G-191	5S0484	HIDRAULICO	G-222	4J6064	AIRE, PRIMARIO	GA-9334	4M9334
TRANSMISION	G-152	9M9740	COMBUSTIBLE, SELLADO	GP-110	1P2299	613C con motor/CATERPILLAR 3116		
ACEITE, SELLADO	GP-51	2P4004	AIRE, SECUNDARIO	GA-1287	2S1287	TRANSMISION	G-152	1R0719
COMBUSTIBLE, SELLADO	GP-1108	4N5823	AIRE, PRIMARIO	GA-9045	8N5316	ACEITE, TANQUE HIDRAULICO	G-222	4J6064
COMBUSTIBLE, SELLADO	GP-110	1R0740	657B con motor/A DIESEL			ACEITE	GP-51	1R0739
AIRE, SECUNDARIO	GA-1287	2S1287	ACEITE	G-238	5S0485	COMBUSTIBLE, 5 13/32 IN	GP-62	1R0751
AIRE, PRIMARIO	GA-9045	7M9045	COMBUSTIBLE, CARTUCHO	G-1166	8M9641	COMBUSTIBLE, 7 13/32 IN	GP-1109	1R0751
637D con motor/CATERPILLAR 3306			TRANSMISION	G-152	9M9740	COMBUSTIBLE, 7 1/8 IN	GP-110	1R0750
TRANSMISION	G-152	9M9740	HIDRAULICO	G-222	4J6064	AIRE, SECUNDARIO ESTANDAR	GA-1287	2S1287
GASOLINA, SEPARADOR DE AGUA	G-293	6N7617	COMBUSTIBLE, SELLADO	GP-110	1P2299	AIRE, PRIMARIO ESTANDAR	GA-9045	8N5316
ACEITE, SELLADO	GP-51	1R0739	AIRE, SECUNDARIO	GA-1287	2S1287	613C con motor/CATERPILLAR 3208		
COMBUSTIBLE, SELLADO	GP-110	1R0750	AIRE, PRIMARIO	GA-9045	8N5316	TRANSMISION	G-152	1R0719
AIRE, SECUNDARIO	GA-1287	2S1287	657E con motores/CATERPILLAR 3408, CATERPILLAR 3408E			ACEITE, TANQUE HIDRAULICO	G-222	4J6064
AIRE, PRIMARIO	GA-9045	7M9045	TRANSMISION	G-152	9M9740	COMBUSTIBLE, SELLADO	GP-110	1R0750
AIRE, PRIMARIO	GA-483	7W5313	COMBUSTIBLE, SELLADO	GP-749	1R0749	ACEITE	GP-9586	1R0713
AIRE, SECUNDARIO	GA-482	1P8482	ACEITE, CUMPLE CON MEDIDAS ORIGINALES	GP-691	1R0716	AIRE, SECUNDARIO	GA-1287	2S1287
637DTR con motor/A DIESEL			ACEITE, SEGUNDA OPCION	GP-52	1R0716	AIRE, PRIMARIO	GA-9045	8N5316
TRANSMISION	G-152	1R0719	AGUA, PRE-CARGA	GP-1013Q	1W5518	615 con motor/CATERPILLAR 3306		
HIDRAULICO	G-153	7J0670	AGUA, MANTENIMIENTO	GP-1011Q	9N6123	TRANSMISION	G-152	9M9740
COMBUSTIBLE	GP-749	1R0749	AIRE, PRIMARIO ESTANDAR	GA-483	8N5313	HIDRAULICO	G-153	7J0670
ACEITE, CUMPLE CON MEDIDAS ORIGINALES	GP-691	1R0716	AIRE, SECUNDARIO ESTANDAR	GA-482	1P8482	ACEITE	GP-51	2P4004
ACEITE, SEGUNDA OPCION	GP-52	1R0716	666 con motor/CATERPILLAR D343			COMBUSTIBLE	GP-110	1P2299
AIRE	GA-483	7W5313	ACEITE	G-238	5S0485	AIRE, PRIMARIO	GA-9045	7W5316
AIRE	GA-482	1P8482	COMBUSTIBLE, CARTUCHO	G-1166	8M9641	615C, 615C SERIES II con motor/CATERPILLAR 3306		
637E con motor/CATERPILLAR 3306			TRANSMISION	G-222	4J6064	TRANSMISION	G-152	1R0719
TRANSMISION	G-152	1R0719	COMBUSTIBLE, SELLADO	GP-110	1P2299	ACEITE, TANQUE HIDRAULICO	G-153	7J0670
ACEITE	GP-51	1R0739	AIRE, SECUNDARIO	GA-1287	2S1287	ACEITE	GP-51	1R0739
AGUA, PRE-CARGA	GP-1013Q	1W5518	AIRE, PRIMARIO	GA-9045	7M9045	COMBUSTIBLE, SELLADO	GP-110	1R0750
COMBUSTIBLE, SELLADO	GP-110	1R0740	666B con motor/CATERPILLAR D343			AIRE, PRIMARIO ESTANDAR	GA-9045	7W5316
AGUA, MANTENIMIENTO	GP-1011Q	9N6123	ACEITE	G-238	5S0485	619 con motor/A DIESEL		
AIRE, PRIMARIO	GA-9045	7W5316	COMBUSTIBLE, CARTUCHO	G-1166	8M9641	ACEITE	G-238	1R0721
AIRE, PRIMARIO ESTANDAR	GA-483	7W5313	TRANSMISION	G-222	4J6064	COMBUSTIBLE	G-1166	1R0724
AIRE, SECUNDARIO ESTANDAR (15 11/32 IN)	GA-482	1P8482	COMBUSTIBLE, SELLADO	GP-110	1P2299	ACEITE	G-222	1R0741
637ETR con motor/A DIESEL			AIRE, SECUNDARIO	GA-1287	2S1287	AIRE	GA-1008	4M9378
TRANSMISION	G-152	1R0719	AIRE, PRIMARIO	GA-9045	7M9045	AIRE	GA-5648	2S-5648
HIDRAULICO	G-153	7J0670	CATERPILLAR			619B con motor/A DIESEL		
COMBUSTIBLE	GP-749	1R0749	TRACTORES			ACEITE	G-238	6H9999
ACEITE, CUMPLE CON MEDIDAS ORIGINALES	GP-691	1R0716	611 con motor/CATERPILLAR 3306			TRANSMISION	G-238	6H9999
ACEITE, SEGUNDA OPCION	GP-52	1R0716	TRANSMISION	G-152	1R0719	COMBUSTIBLE	G-1166	6H5932
AIRE	GA-483	7W5313	HIDRAULICO	G-153	7J0670	HIDRAULICO	G-222	4J0806
			ACEITE	GP-51	1R0739	AIRE	GA-5648	2S5648

SERVICIO PESADO

MARCA-MODELO-MOTOR MAKE-MODEL-ENGINE	GONHER GONHER	OEM OEM	MARCA-MODELO-MOTOR MAKE-MODEL-ENGINE	GONHER GONHER	OEM OEM	MARCA-MODELO-MOTOR MAKE-MODEL-ENGINE	GONHER GONHER	OEM OEM
CATERPILLAR (continuación)			CATERPILLAR (continuación)			CATERPILLAR (continuación)		
TRACTORES			TRACTORES			TRACTORES		
619C con motor/A DIESEL			621R con motor/CATERPILLAR 3306			627B con motor/CATERPILLAR 3306		
ACEITE, CARTUCHO	G-238	6H9999	TRANSMISION	G-152	9M9740	TRANSMISION	G-152	9M9740
TRANSMISION (S/N 62F1-510)	G-238	6H9999	ACEITE, TANQUE HIDRAULICO	G-153	7J0670	HIDRAULICO	G-153	7J0670
COMBUSTIBLE	G-1166	6H5932	ACEITE	GP-51	2P4004	ACEITE, SELLADO (CUMPLE CON MEDIDAS ORIGINALES)	GP-691	2P4005
ACEITE, ACCESORIO HIDRAULICO	G-222	4J6064	COMBUSTIBLE, SELLADO	GP-1108	2W2134	GASOLINA, SEPARADOR DE AGUA	G-293	6N7617
DIRECCION	G-222	4J0806	AIRE, PRIMARIO	GA-7716	1P7716	ACEITE, SELLADO	GP-51	2P4004
TRANSMISION (S/N 61F1-2704)	G-222	4J6064	AIRE, SECUNDARIO	GA-7360	1P7360	ACEITE, SELLADO (SEGUNDA OPCION)	GP-52	2P4005
AIRE	GA-5648	255648	621S con motor/CATERPILLAR 3306			COMBUSTIBLE, SELLADO	GP-110	1P2299
621 con motor/A DIESEL			TRANSMISION	G-152	9M9740	AIRE, PRIMARIO	GA-7716	1P7716
ACEITE, CARTUCHO	G-191	550484	ACEITE, TANQUE HIDRAULICO	G-153	7J0670	AIRE, SECUNDARIO	GA-7360	1P7360
COMBUSTIBLE, CARTUCHO	G-1166	455368	ACEITE	GP-51	2Y8096	627E con motor/CATERPILLAR 3306		
TRANSMISION	G-152	9M9740	COMBUSTIBLE, SELLADO	GP-110	2Y8670	TRANSMISION	G-152	1R0719
ACEITE, TANQUE HIDRAULICO	G-222	4J6064	AIRE, PRIMARIO	GA-7716	7W5495	ACEITE, TANQUE HIDRAULICO	G-153	7J0670
ACEITE, TANQUE HIDRAULICO	G-153	7J0670	AIRE, SECUNDARIO	GA-7360	1P7360	COMBUSTIBLE, SELLADO	GP-749	1R0749
ACEITE, SELLADO (CUMPLE CON MEDIDAS ORIGINALES)	GP-691	2P4005	623 con motor/A DIESEL			ACEITE, CUMPLE CON MEDIDAS ORIGINALES	GP-691	1R0716
ACEITE, SELLADO (SEGUNDA OPCION)	GP-52	2P4005	ACEITE	G-191	550484	ACEITE, CUMPLE CON MEDIDAS ORIGINALES	GP-51	1R0739
COMBUSTIBLE, SELLADO	GP-1108	2W2131	COMBUSTIBLE	G-1166	455368	ACEITE, SEGUNDA OPCION	GP-52	1R0716
AIRE, SECUNDARIO	GA-1287	251287	TRANSMISION	G-152	9M9740	AGUA	GP-1013Q	1W5518
AIRE, PRIMARIO	GA-9045	7M9045	ACEITE, TANQUE HIDRAULICO	G-153	7J0670	COMBUSTIBLE, SELLADO	GP-110	1P2299
AIRE, PRIMARIO	GA-7716	8N5495	AIRE, SECUNDARIO	GA-1287	251287	AIRE, PRIMARIO ESTANDAR	GA-9045	7W5316
AIRE, SECUNDARIO	GA-7360	1P7360	AIRE, PRIMARIO	GA-9045	7M9045	AIRE, PRIMARIO ESTANDAR	GA-7716	7W5495
621B con motor/A DIESEL			623B con motor/A DIESEL			AIRE, SECUNDARIO ESTANDAR	GA-7360	1P7360
TRANSMISION	G-152	9M9740	TRANSMISION	G-152	9M9740	627E con motor/CATERPILLAR 3406		
ACEITE, TANQUE HIDRAULICO	G-153	7J0670	ACEITE, TANQUE HIDRAULICO	G-153	7J0670	TRANSMISION	G-152	1R0719
COMBUSTIBLE, SELLADO	GP-749	1R0749	ACEITE, CUMPLE CON MEDIDAS ORIGINALES	GP-691	2P4005	ACEITE, TANQUE HIDRAULICO	G-153	7J0670
ACEITE, SELLADO (CUMPLE CON MEDIDAS ORIGINALES)	GP-691	1R0716	ACEITE, SEGUNDA OPCION	GP-52	2P4005	COMBUSTIBLE, SELLADO	GP-749	1R0749
ACEITE, SELLADO (SEGUNDA OPCION)	GP-52	1R0716	COMBUSTIBLE, SELLADO	GP-1108	1R0712	ACEITE, CUMPLE CON MEDIDAS ORIGINALES	GP-691	1R0716
COMBUSTIBLE, SELLADO	GP-1108	2W2134	AGUA	GP-1011Q	9N3367	ACEITE	GP-51	2P4004
AGUA	GP-1011Q	9N3367	AIRE, PRIMARIO	GA-7716	1P7716	ACEITE, SEGUNDA OPCION	GP-52	1R0716
AIRE, PRIMARIO	GA-7716	8N5495	AIRE, SECUNDARIO	GA-7360	1P7360	COMBUSTIBLE, SELLADO	GP-110	1R0750
AIRE, SECUNDARIO	GA-7360	1P7360	623E, 623F con motores/CATERPILLAR 3406, CATERPILLAR 3406C			AGUA	GP-1011Q	9Y1022
621E con motor/CATERPILLAR 3406			TRANSMISION	G-152	1R0719	AIRE, PRIMARIO ESTANDAR	GA-9045	7W5316
TRANSMISION	G-152	1R0719	ACEITE, TANQUE HIDRAULICO	G-153	7J0670	AIRE, PRIMARIO ESTANDAR	GA-7716	7W5495
ACEITE, TANQUE HIDRAULICO	G-153	7J0670	COMBUSTIBLE, SELLADO	GP-749	1R0749	AIRE, SECUNDARIO ESTANDAR	GA-7360	1P7360
COMBUSTIBLE, SELLADO	GP-749	1R0749	ACEITE, CUMPLE CON MEDIDAS ORIGINALES	GP-691	1R0716	627F con motor/CATERPILLAR 3406B		
ACEITE, CUMPLE CON MEDIDAS ORIGINALES	GP-691	1R0716	ACEITE, SEGUNDA OPCION	GP-52	1R0716	TRANSMISION	G-152	1R0719
ACEITE, SEGUNDA OPCION	GP-52	1R0716	AGUA	GP-1013Q	1W5518	ACEITE, TANQUE HIDRAULICO	G-153	7J0670
AGUA, PRE-CARGA	GP-1013Q	1W5518	AGUA	GP-1011Q	9N6123	COMBUSTIBLE, SELLADO	GP-749	1R0749
AGUA, MANTENIMIENTO	GP-1011Q	9Y1022	HIDRAULICO (SELLADO)	GP-166	4T6915	ACEITE, CUMPLE CON MEDIDAS ORIGINALES	GP-691	1R0716
AIRE, PRIMARIO ESTANDAR	GA-7716	7W5495	AIRE, PRIMARIO ESTANDAR	GA-7716	7W5495	ACEITE	GP-51	1R0739
AIRE, SECUNDARIO ESTANDAR	GA-7360	1P7360	AIRE, SECUNDARIO ESTANDAR	GA-7360	1P7360	ACEITE, SEGUNDA OPCION	GP-52	1R0716
621F con motores/CATERPILLAR 3406, CATERPILLAR 3406C			623G con motor/CATERPILLAR 3406E			COMBUSTIBLE, SELLADO	GP-110	1R0750
TRANSMISION	G-152	1R0719	TRANSMISION	G-152	1R0719	AGUA	GP-1011Q	9N6123
ACEITE, TANQUE HIDRAULICO	G-153	7J0670	ACEITE, TANQUE HIDRAULICO	G-153	7J0670	AIRE, PRIMARIO ESTANDAR	GA-9045	7W5316
COMBUSTIBLE, SELLADO	GP-749	1R0749	COMBUSTIBLE, SELLADO	GP-749	1R0749	630A con motor/A DIESEL		
ACEITE, CUMPLE CON MEDIDAS ORIGINALES	GP-691	1R0716	ACEITE, CUMPLE CON MEDIDAS ORIGINALES	GP-691	1R0716	ACEITE	G-238	6H9999
ACEITE, SEGUNDA OPCION	GP-52	1R0716	ACEITE, SEGUNDA OPCION	GP-52	1R0716	COMBUSTIBLE	G-1166	6H5932
AGUA	GP-1011Q	9N6123	HIDRAULICO (SELLADO)	GP-166	4T6915	HIDRAULICO	G-222	4J0806
621G, 627G con motor/CATERPILLAR 3406E			627 con motor/CATERPILLAR 3306			TRANSMISION	G-222	4J6064
TRANSMISION	G-152	1R0719	ACEITE, CARTUCHO	G-191	550484	630B con motor/A DIESEL		
ACEITE, TANQUE HIDRAULICO	G-153	7J0670	TRANSMISION	G-152	9M9740	ACEITE, CARTUCHO	G-238	6H9999
COMBUSTIBLE, SELLADO	GP-749	1R0749	HIDRAULICO	G-222	4J6064	COMBUSTIBLE, CARTUCHO	G-1166	8M9641
ACEITE, CUMPLE CON MEDIDAS ORIGINALES	GP-691	1R0716	HIDRAULICO	G-153	7J0670	ACEITE, TANQUE HIDRAULICO	G-222	4J0806
ACEITE, SEGUNDA OPCION	GP-52	1R0716	ACEITE, SELLADO	GP-51	2P4004	TRANSMISION	G-222	4J0806
AGUA	GP-1011Q	9N6123	COMBUSTIBLE, SELLADO	GP-110	1P2299	COMBUSTIBLE, SELLADO	GP-110	6L7440
621H, 627H con motor/CATERPILLAR 3406E			AIRE, SECUNDARIO	GA-1286	251286	AIRE, SECUNDARIO	GA-1287	251287
TRANSMISION	G-152	1R0719	AIRE, PRIMARIO	GA-9334	4M9334			

MARCA-MODELO-MOTOR MAKE-MODEL-ENGINE	GONHER GONHER	OEM OEM	MARCA-MODELO-MOTOR MAKE-MODEL-ENGINE	GONHER GONHER	OEM OEM	MARCA-MODELO-MOTOR MAKE-MODEL-ENGINE	GONHER GONHER	OEM OEM
CATERPILLAR (continuación)			CATERPILLAR (continuación)			CATERPILLAR (continuación)		
TRACTORES			TRACTORES			TRACTORES		
AIRE, PRIMARIO	GA-9045	7M9045	633E SERIES II con motor/A DIESEL			AIRE, SECUNDARIO	GA-1287	2S1287
			TRANSMISION	G-152	1R0719	AIRE, PRIMARIO	GA-9045	7M9045
631A con motor/A DIESEL			ACEITE, TANQUE HIDRAULICO	G-153	7J0670	641B con motor/CATERPILLAR D346		
ACEITE	G-238	6H9999	COMBUSTIBLE, SELLADO	GP-749	1R0749	ACEITE, CARTUCHO	G-191	5S0484
COMBUSTIBLE	G-1166	6H5932	ACEITE, CUMPLE CON MEDIDAS ORIGINALES	GP-691	1R0716	ACEITE, CARTUCHO	G-238	5S0485
DIRECCION	G-222	211560	AGUA, MANTENIMIENTO	GP-1010Q	9N6123	TRANSMISION	G-152	9M9740
TRANSMISION	G-222	4J6064	ACEITE, SEGUNDA OPCION	GP-52	1R0716	DIRECCION (DOBLE)	G-222	4J6064
631B con motor/A DIESEL			AGUA, PRE-CARGA	GP-1011Q	1W5518	DIRECCION (SIMPLE)	G-222	4J6064
ACEITE, CARTUCHO	G-238	5S0485	637 con motor/A DIESEL			ACEITE, TANQUE HIDRAULICO	G-222	4J6064
COMBUSTIBLE, CARTUCHO	G-1166	8M9641	ACEITE	G-238	5S0485	ACEITE, SELLADO (CUMPLE CON MEDIDAS ORIGINALES)	GP-691	2P4005
BOMBA DE DIRECCION	G-222	4J6064	TRANSMISION	G-152	9M9740	ACEITE, SELLADO (SEGUNDA OPCION)	GP-52	2P4005
CILINDRO DE DIRECCION (S/N 13G3489-4639)	G-222	5J6174	ACEITE, TANQUE HIDRAULICO (EXCEPTO S/N 65M353 EN ADELANTE)	G-222	4J6064	COMBUSTIBLE, SELLADO	GP-110	1P2299
ACEITE, TANQUE HIDRAULICO	G-222	4J6064	ACEITE, TANQUE HIDRAULICO (S/N 65M353 EN ADELANTE)	G-153	7J0670	AIRE, SECUNDARIO	GA-1287	2S1287
TRANSMISION	G-222	4J6064	COMBUSTIBLE, SELLADO	GP-110	1P2299	AIRE, PRIMARIO	GA-9045	8N5316
COMBUSTIBLE, SELLADO	GP-110	1P2299	637D con motor/A DIESEL			650 con motor/A DIESEL		
AIRE, SECUNDARIO	GA-1287	2S1287	TRANSMISION	G-152	9M9740	ACEITE	G-238	6H9999
AIRE, PRIMARIO	GA-9045	7M9045	ACEITE, TANQUE HIDRAULICO	G-153	7J0670	COMBUSTIBLE	G-1166	8M5388
631C con motor/A DIESEL			ACEITE, CUMPLE CON MEDIDAS ORIGINALES	GP-691	2P4005	HIDRAULICO (S/N 63F1-F9)	G-222	4J0806
ACEITE	G-238	5S0485	ACEITE, SEGUNDA OPCION	GP-52	2P4005	ACEITE, TANQUE HIDRAULICO (RASPADORA)	G-222	4J6064
TRANSMISION	G-152	9M9740	AGUA, PRE-CARGA	GP-1013Q	1W5518	TRANSMISION	G-222	4J6064
ACEITE, TANQUE HIDRAULICO (S/N 67M1-3647)	G-222	4J6064	COMBUSTIBLE, SELLADO	GP-1108	4N5823	AIRE, SECUNDARIO	GA-1287	2S1287
ACEITE, TANQUE HIDRAULICO (S/N 67M4260 EN ADELANTE)	G-153	7J0670	AGUA, MANTENIMIENTO	GP-1011Q	9N6123	AIRE, PRIMARIO	GA-9045	7M9045
COMBUSTIBLE, SELLADO	GP-110	1P2299	AIRE, PRIMARIO	GA-483	1P8483	650B con motor/A DIESEL		
631D, 633D con motor/CATERPILLAR 3408			AIRE, SECUNDARIO	GA-482	1P8482	ACEITE, CARTUCHO	G-191	5S0484
TRANSMISION	G-152	9M9740	637E con motor/CATERPILLAR 3408			ACEITE, CARTUCHO	G-238	5S0485
ACEITE, TANQUE HIDRAULICO	G-153	7J0670	TRANSMISION	G-152	1R0719	TRANSMISION	G-152	9M9740
ACEITE, CUMPLE CON MEDIDAS ORIGINALES	GP-691	2P4005	ACEITE, TANQUE HIDRAULICO	G-153	7J0670	ACEITE, TANQUE HIDRAULICO	G-222	4J6064
ACEITE, SEGUNDA OPCION	GP-52	2P4005	COMBUSTIBLE, SELLADO	GP-749	1R0749	ACEITE, SELLADO (CUMPLE CON MEDIDAS ORIGINALES)	GP-691	2P4005
COMBUSTIBLE, SELLADO	GP-1108	4N5823	ACEITE, CUMPLE CON MEDIDAS ORIGINALES	GP-691	1R0716	ACEITE, SELLADO (SEGUNDA OPCION)	GP-52	2P4005
AIRE, PRIMARIO	GA-483	8N5313	ACEITE, SEGUNDA OPCION	GP-52	1R0716	COMBUSTIBLE, SELLADO	GP-110	1P2299
AIRE, SECUNDARIO	GA-482	1P8482	AGUA, PRE-CARGA	GP-1013Q	1W5518	AIRE, SECUNDARIO	GA-1287	2S1287
631E con motores/CATERPILLAR 3408, CATERPILLAR 3408C			AGUA, MANTENIMIENTO	GP-1011Q	9N6123	AIRE, PRIMARIO	GA-9045	7M9045
TRANSMISION	G-152	1R0719	AIRE, PRIMARIO ESTANDAR	GA-483	7W5313	651B, 657B con motor/CATERPILLAR D346		
ACEITE, TANQUE HIDRAULICO	G-153	7J0670	637G con motor/CATERPILLAR C18			ACEITE, CARTUCHO	G-191	5S0484
COMBUSTIBLE, SELLADO	GP-749	1R0749	TRANSMISION	G-152	1U2093	ACEITE, CARTUCHO (INSTALACION EN EL CAMPO)	G-238	5S0485
ACEITE, CUMPLE CON MEDIDAS ORIGINALES	GP-691	1R0716	ACEITE, TANQUE HIDRAULICO (REQUIERE 3 PIEZAS)	G-153	1R0732	TRANSMISION	G-152	9M9740
ACEITE, SEGUNDA OPCION	GP-52	1R0716	DIESEL	GP-749	1R0762	DIRECCION (DOBLE)	G-222	4J6064
AGUA, PRE-CARGA	GP-1013Q	1W5518	ACEITE	GP-52	1R1808	DIRECCION (SIMPLE)	G-222	4J6064
AGUA, MANTENIMIENTO	GP-1011Q	9N6123	AIRE RADIAL, PRIMARIO	GA-600R	106-3969	ACEITE, TANQUE HIDRAULICO	G-222	4J6064
AIRE, PRIMARIO ESTANDAR	GA-483	7W5313	639D con motor/CATERPILLAR 3408			ACEITE, SELLADO (CUMPLE CON MEDIDAS ORIGINALES)	GP-691	2P4005
633 con motor/A DIESEL			TRANSMISION	G-152	9M9740	ACEITE, SELLADO (SEGUNDA OPCION)	GP-52	2P4005
ACEITE, CARTUCHO	G-238	5S0485	HIDRAULICO	G-153	7J0670	COMBUSTIBLE, SELLADO	GP-110	1P2299
DIRECCION	G-222	4J6064	ACEITE, CUMPLE CON MEDIDAS ORIGINALES	GP-691	2P4005	AIRE, SECUNDARIO	GA-1287	2S1287
ACEITE, TANQUE HIDRAULICO	G-222	4J6064	ACEITE, SEGUNDA OPCION	GP-52	2P4005	AIRE, PRIMARIO	GA-9045	8N5316
TRANSMISION	G-222	4J6064	COMBUSTIBLE, SELLADO	GP-1108	4N5823	651E con motores/CATERPILLAR 2412, CATERPILLAR 2412E		
COMBUSTIBLE, SELLADO	GP-110	6L7440	AIRE, PRIMARIO	GA-483	8N5313	ACEITE, TANQUE HIDRAULICO	G-222	1R0741
AIRE, SECUNDARIO	GA-1287	2S1287	AIRE, SECUNDARIO	GA-482	1P8482	TRANSMISION	G-222	4J6064
AIRE, PRIMARIO	GA-9045	7M9045	641, 651, 657 con motor/A DIESEL			COMBUSTIBLE, SELLADO	GP-749	1R0749
633C con motor/A DIESEL			ACEITE, CARTUCHO	G-238	5S0485	ACEITE, CUMPLE CON MEDIDAS ORIGINALES	GP-691	1R0716
ACEITE	G-238	5S0485	COMBUSTIBLE	G-1166	8M5388	ACEITE, SEGUNDA OPCION	GP-52	1R0716
TRANSMISION	G-152	9M9740	DIRECCION	G-222	4J6064	AGUA, PRE-CARGA	GP-1013Q	1W5518
ACEITE, TANQUE HIDRAULICO (S/N 66M1-627)	G-222	4J6064	HIDRAULICO (TIRON DE COJIN)	G-222	4J6064	AGUA, MANTENIMIENTO	GP-1011Q	9N6123
ACEITE, TANQUE HIDRAULICO (S/N RESTANTES)	G-153	4J6064	ACEITE, TANQUE HIDRAULICO	G-222	4J6064	AIRE, PRIMARIO	GA-483	7W5313
COMBUSTIBLE, SELLADO	GP-110	1P2299	TRANSMISION	G-222	4J6064	AIRE, SECUNDARIO	GA-482	1P8482

SERVICIO PESADO

MARCA-MODELO-MOTOR MAKE-MODEL-ENGINE	GONHER GONHER	OEM OEM	MARCA-MODELO-MOTOR MAKE-MODEL-ENGINE	GONHER GONHER	OEM OEM	MARCA-MODELO-MOTOR MAKE-MODEL-ENGINE	GONHER GONHER	OEM OEM
CATERPILLAR (continuación)			CATERPILLAR (continuación)			CATERPILLAR (continuación)		
TRACTORES			TRACTORES			TRACTORES		
657E con motores/CATERPILLAR 3412C, CATERPILLAR 3412E			814B con motor/CATERPILLAR 3306			ACEITE, TANQUE HIDRAULICO G-222 4J6064		
ACEITE, TANQUE HIDRAULICO	G-222	1R0741	TRANSMISION	G-152	1R0719	TRANSMISION	G-222	4J6064
TRANSMISION	G-222	4J6064	ACEITE	GP-51	1R0739	COMBUSTIBLE, SELLADO	GP-110	1P2299
COMBUSTIBLE, SELLADO	GP-749	1R0749	COMBUSTIBLE, SELLADO	GP-110	1R0750	AIRE, SECUNDARIO	GA-1287	2S1287
ACEITE, CUMPLE CON MEDIDAS ORIGINALES	GP-691	1R0716	AIRE, PRIMARIO	GA-9334	7W5317	AIRE, PRIMARIO	GA-9045	7M9045
ACEITE, SEGUNDA OPCION	GP-52	1R0716	814F con motor/CATERPILLAR 3306			834B con motor/A DIESEL		
AGUA, PRE-CARGA	GP-1013Q	1W5518	TRANSMISION	G-152	1R0719	TRANSMISION	G-152	1R0719
AGUA, MANTENIMIENTO	GP-1011Q	9N6123	ACEITE	GP-51	1R0739	ACEITE, TANQUE HIDRAULICO	G-153	7J0670
AIRE, PRIMARIO ESTANDAR	GA-483	8N5313	COMBUSTIBLE, SELLADO	GP-110	1R0750	COMBUSTIBLE, SELLADO	GP-749	1R0749
AIRE, SECUNDARIO ESTANDAR	GA-482	1P8482	815F con motor/A DIESEL			ACEITE, CUMPLE CON MEDIDAS ORIGINALES		
660 con motor/A DIESEL			TRANSMISION	G-152	1R0719	ACEITE, SEGUNDA OPCION	GP-52	1R0716
ACEITE	G-238	6H9999	ACEITE	GP-51	1R0739	AGUA	GP-1011Q	9N3718
COMBUSTIBLE	G-1166	8M5388	COMBUSTIBLE, SELLADO	GP-110	1R0750	ACEITE, EJE HIDRAULICO	GP-761H	1G8878
ACEITE, TANQUE HIDRAULICO	G-222	4J6064	824 con motor/A DIESEL			AIRE, PRIMARIO ESTANDAR	GA-483	8N5313
TRANSMISION	G-222	4J6064	ACEITE	G-238	1R0721	AIRE, SECUNDARIO ESTANDAR	GA-482	1P8482
AIRE, SECUNDARIO	GA-1287	2S1287	COMBUSTIBLE	G-1166	1R0724	834G con motor/CATERPILLAR 3456		
AIRE, PRIMARIO	GA-9045	7M9045	ACEITE, TANQUE HIDRAULICO	G-222	1R0741	COMBUSTIBLE	GP-749	1R0749
666 con motor/A DIESEL			TRANSMISION	G-222	1R0741	ACEITE, CUMPLE CON MEDIDAS ORIGINALES	GP-691	1R0716
ACEITE, CARTUCHO	G-238	5S0485	AIRE, SECUNDARIO	GA-1286	2S1286	ACEITE, SEGUNDA OPCION	GP-52	1R0716
COMBUSTIBLE	G-1166	8M5388	AIRE, PRIMARIO	GA-9334	4M9334	HIDRAULICO	GP-761H	1G8878
ACEITE, TANQUE HIDRAULICO	G-222	4J6064	824B con motor/CATERPILLAR D343			844 con motor/CATERPILLAR 3412E		
TRANSMISION	G-222	4J6064	ACEITE	G-238	1R0721	COMBUSTIBLE	GP-749	1R0749
AIRE, SECUNDARIO	GA-1287	2S1287	COMBUSTIBLE, CARTUCHO	G-1166	1R0724	ACEITE, CUMPLE CON MEDIDAS ORIGINALES	GP-691	1R0716
AIRE, PRIMARIO	GA-9045	7M9045	ACEITE, TANQUE HIDRAULICO	G-222	1R0741	ACEITE, SEGUNDA OPCION	GP-52	1R0716
666B con motor/CATERPILLAR D346			TRANSMISION	G-222	1R0741	854G con motor/CATERPILLAR 3508B		
ACEITE, CARTUCHO	G-191	5S0484	COMBUSTIBLE, SELLADO	GP-110	1R0750	ACEITE, (REQUIERE 2 PIEZAS)	GP-52	2P4005
ACEITE, CARTUCHO (INSTALACION EN EL CAMPO)	G-238	5S0485	AIRE, SECUNDARIO DOBLE	GA-1287	2S1287	DIRECCION (S/N AMP274-337)	GP-761H	1G8878
TRANSMISION	G-152	9M9740	AIRE, PRIMARIO DOBLE	GA-9045	7M9045	HIDRAULICO	GP-761H	1G8878
ACEITE, TANQUE HIDRAULICO	G-222	4J6064	AIRE, PRIMARIO SIMPLE	GA-483	1P8483	AIRE RADIAL, PRIMARIO (REQUIERE 2 PIEZAS)	GA-712R	123-6855
ACEITE, SELLADO (CUMPLE CON MEDIDAS ORIGINALES)	GP-691	2P4005	AIRE, SECUNDARIO SIMPLE	GA-482	1P8482	D3C LGP SERIES II SOBRE ORUGAS con motor/CATERPILLAR 3204		
ACEITE, SELLADO (SEGUNDA OPCION)	GP-52	2P4005	824C con motor/CATERPILLAR 3406			ACEITE	G-152	1R0719
COMBUSTIBLE, SELLADO	GP-110	1P2299	TRANSMISION	G-152	9M9740	COMBUSTIBLE, SECUNDARIO	GP-110	1R0750
AIRE, SECUNDARIO	GA-1287	2S1287	COMBUSTIBLE, SELLADO	GP-749	1R0749	ACEITE	GP-9586	8N9586
AIRE, PRIMARIO	GA-9045	7M9045	ACEITE, CUMPLE CON MEDIDAS ORIGINALES	GP-691	1R0716	D3C LGP SERIES III SOBRE ORUGAS, D3C XL SERIES III SOBRE ORUGAS con motor/CATERPILLAR 3046		
772D con motor/CATERPILLAR 3412TA			ACEITE, SEGUNDA OPCION	GP-52	1R0716	ACEITE, TANQUE HIDRAULICO	G-152	1R0719
COMBUSTIBLE	GP-749	1R0749	AGUA, PRE-CARGA	GP-1013Q	1W5518	ACEITE	GP-36	1R0734
ACEITE, CUMPLE CON MEDIDAS ORIGINALES	GP-691	2P4005	COMBUSTIBLE, SELLADO (S/N 85X1-1193)	GP-1108	1R0712	TRANSMISION SELLADO	GP-761H	1G8878
ACEITE, SEGUNDA OPCION	GP-52	2P4005	AGUA, MANTENIMIENTO	GP-2071W	9N3368	D4C XL SERIES III SOBRE ORUGAS con motor/CATERPILLAR 3046		
784C con motor/CATERPILLAR 3512			AIRE, PRIMARIO	GA-7716	1P7716	ACEITE, TANQUE HIDRAULICO	G-152	1R0719
ACEITE	GP-52	275-2604	AIRE, SECUNDARIO	GA-7360	1P7360	ACEITE	GP-36	1R0734
COMBUSTIBLE	GP-110	1R0750	824G con motor/A DIESEL			TRANSMISION (EXCEPTO S/N 1FW)	GP-761H	1G8878
AIRE, PRIMARIO	GA-879	9Y7662	TRANSMISION	G-152	1R0719	D5C SOBRE ORUGAS SERIES III con motor/CATERPILLAR 3046		
AIRE ACONDICIONADO	GA-240	107-0266	COMBUSTIBLE, SELLADO	GP-749	1R0749	ACEITE	GP-36	1R0734
814 con motor/CATERPILLAR 3306			ACEITE, CUMPLE CON MEDIDAS ORIGINALES	GP-691	1R0716	D5C XL SOBRE ORUGAS SERIES III con motor/CATERPILLAR 3046		
ACEITE, CARTUCHO	G-191	4W4840	ACEITE, SEGUNDA OPCION	GP-52	1R0716	ACEITE, TANQUE HIDRAULICO	G-152	1R0719
TRANSMISION	G-152	9M9740	AGUA, PRE-CARGA	GP-1011Q	9N6123	ACEITE	GP-36	1R0734
HIDRAULICO	G-222	4J6064	AGUA, MANTENIMIENTO	GP-2071W	9N3368	TRANSMISION (EXCEPTO S/N 1FW)	GP-761H	1G8878
GASOLINA, SEPARADOR DE AGUA	G-293	8N9803	830M con motor/A DIESEL			D7 LGP SOBRE ORUGAS con motor/A DIESEL		
ACEITE, SELLADO	GP-51	2P4004	ACEITE	G-238	1R0721	ACEITE	G-222	1R0741
COMBUSTIBLE	GP-110	1P2299	HIDRAULICO	G-222	4J0806	ACEITE	GP-51	1R0739
AIRE, SECUNDARIO	GA-1286	2S1286	ACEITE, TANQUE HIDRAULICO	G-222	4J6064	COMBUSTIBLE	GP-110	1R0750
AIRE, SECUNDARIO	GA-1287	2S1287	TRANSMISION	G-222	4J6064			
AIRE, PRIMARIO 16 1/2 IN	GA-9045	7M9045	834 con motor/A DIESEL					
AIRE, PRIMARIO 13 1/2 IN	GA-9334	4M9334	ACEITE	G-238	5S0485			
			COMBUSTIBLE, CARTUCHO	G-1166	8M9641			

MARCA-MODELO-MOTOR MAKE-MODEL-ENGINE	GONHER GONHER	OEM OEM	MARCA-MODELO-MOTOR MAKE-MODEL-ENGINE	GONHER GONHER	OEM OEM	MARCA-MODELO-MOTOR MAKE-MODEL-ENGINE	GONHER GONHER	OEM OEM
CATERPILLAR (continuación)			CHAMPION (continuación)			CHICAGOPNEUMATIC(continuación)		
TRACTORES			NIVELADORAS			COMPRESORES		
D9T SOBRE ORUGAS con motor/CATERPILLAR C18			726A SERIES III, 726A SERIES V, 726A VPH SERIES V, 730 SERIES III, 730 SERIES V, 730 VHP SERIES V, 730A, 730A SERIES III, 730A SERIES V, 730A VHP SERIES V, 736A, 736A SERIES V, 720, 730 con motor/CUMMINS 6CT8.3			600R02 con motor/GMC 6-71		
DIESEL	GP-749	1R0749	ACEITE	GP-3000	54429	ACEITE, DERIVACION (BY PASS)	G-31	F36
ACEITE	GP-52	1R0716				ACEITE	G-33	4PS915
AIRE RADIAL, PRIMARIO	GA-712R	123-6855				COMBUSTIBLE, SECUNDARIO	G-1173	3290851
DW10 con motor/A DIESEL			740A VHP SERIES V, 750 SERIES IV, 750A SERIES V, 750A VHP SERIES V, 780 SERIES IV, 780A SERIES V, 780A VHP SERIES V, 740 SERIES IV, 740 SERIES V, 740 VHP SERIES V, 740A SERIES V con motor/CUMMINS M11			600RSO1 con motor/GMC 6-71		
ACEITE, FLUJO TOTAL (FULL FLOW)	G-191	9F6700	ACEITE	GP-3000	54429	ACEITE	G-33	4PS915
DW15, DW15C con motor/A DIESEL			740A, 740A SERIES III, 750 SERIES III, 750A, 750A SERIES III, 780 SERIES III, 780A, 780A SERIES III, 740, 750, 780, 740 SERIES III con motor/CUMMINS LT10-C			750RSO1 con motor/CATERPILLAR D333CT		
TRANSMISION	G-191	9F6700	ACEITE	GP-3000	54429	ACEITE	G-191	1R0659
ACEITE, LUBRICACION EXTERIOR O PRIMARIA	G-238	6H9999				COMBUSTIBLE	G-1166	6H5931
COMBUSTIBLE, EXCEPTO S/N 45C	G-1166	6H5932				GASOLINA	G-293	9Y4445
DW15E, DW15F con motor/A DIESEL						COMBUSTIBLE	GP-110	1P2299
TRANSMISION	G-191	1R0659	CHANGAN			75PG20 con motor/HERCULES 1XLB		
ACEITE	G-238	6H9999	CAMIONES, TRACTOCAMIONES Y AUTOBUSES			ACEITE	G-6	346246
COMBUSTIBLE	G-1166	6H5932	BRAND TRUCK SC1040D con motor/A DIESEL			825DZ con motor/CATERPILLAR 3306		
DW20 con motor/A DIESEL			COMBUSTIBLE			ACEITE	GP-51	311134
ACEITE, LUBRICACION EXTERIOR O PRIMARIA	G-238	550484				85RGH1 con motor/CONTINENTAL F163		
DW20E con motor/A DIESEL						ACEITE, DERIVACION (BY PASS)	GP-50	F600L4340
ACEITE, LUBRICACION EXTERIOR O PRIMARIA	G-238	550484	CHICAGO PNEUMATIC			900R02 con motor/CUMMINS		
TRANSMISION	G-238	550484	COMPRESORES			ACEITE, CARTUCHO PARA FLUJO TOTAL (FULL FLOW)	G-566	136551
COMBUSTIBLE	G-1166	6H5932	1200RSO1 con motor/GMC 12V-71			ACEITE, TURBOCARGADOR	GP-14	152499
ACEITE, ACCESORIO HIDRAULICO	G-222	4J6064	ACEITE			COMBUSTIBLE, 5 47/64 IN	GPP-14	158172
DW20F, DW20G con motor/A DIESEL			125R02 con motor/FORD 220			COMBUSTIBLE, 5 13/32 IN	GP-1101	140617
ACEITE	G-238	6H9999	ACEITE			ACEITE, SELLADO PARA FLUJO TOTAL (FULL FLOW)	GP-53	3313287
TRANSMISION	G-238	550484	160R01 con motor/GMC 3-53			COMBUSTIBLE, 11 1/2 IN	GP-55	3313306
COMBUSTIBLE	G-1166	6H5932	ACEITE			COMBUSTIBLE, SECUNDARIO	GPP-1122	255963
ACEITE, ACCESORIO HIDRAULICO	G-222	4J6064	175G1 con motor/FORD			COMBUSTIBLE, SEPARADOR DE AGUA	GPP-11	3600980
DW21 con motor/A DIESEL			ACEITE			AIRE, RESPIRADOR	GA-39	255963
HIDRAULICO	G-238	550484	175R01 con motor/GMC 3-53			ACEITE, DERIVACION (BY PASS)	G-750	213428
ACEITE, LUBRICACION EXTERIOR O PRIMARIA	G-238	550484	ACEITE			900R02 con motor/GMC 6-110		
TRANSMISION	G-238	550484	COMBUSTIBLE, SECUNDARIO			ACEITE	G-31	F36
DW21C con motor/A DIESEL			COMBUSTIBLE, SECUNDARIO			ACEITE	G-33	4PS915
ACEITE, LUBRICACION EXTERIOR O PRIMARIA	G-238	550484	17R01 con motores/GMC 3-53, NORMAN			COMBUSTIBLE, SECUNDARIO	G-1173	3290851
TRANSMISION	G-238	550484	ACEITE			185DZ con motor/CHRYSLER-NISSAN CN-4-33		
DW21G con motor/A DIESEL			185DZ con motor/CHRYSLER-NISSAN CN-4-33			COMBUSTIBLE	G-296	711/296
ACEITE, LUBRICACION EXTERIOR O PRIMARIA	G-238	8F1151	COMBUSTIBLE			COMBUSTIBLE	G-296-B	711/296
TRANSMISION (S/N 58C1-767)	G-238	8F1151	AIRE			AIRE	GAK-403	4PS253
COMBUSTIBLE	G-1166	6H5932	210R02 con motor/GMC 4-51			CP8030GS con motor/JOHN DEERE 3179		
HIDRAULICO	G-222	4J0806	COMBUSTIBLE, SECUNDARIO			ACEITE	GP-14	T19044
TRANSMISION (S/N 69C1-2341)	G-222	1R0741	210R02, 250R02 con motor/GMC 4-53			COMBUSTIBLE	GPP-418	RE62418
DW21D, DW21G con motor/A DIESEL			ACEITE			AIRE	GA-16	AF25456K
ACEITE	G-238	6H9999	250RG2 con motor/HERCULES G3400			AIRE, PRIMARIO	GAK-16	N404079
TRANSMISION	G-238	6H9999	ACEITE			CPS130 con motor/DEUTZ B/F3M1011		
COMBUSTIBLE	G-1166	6H5932	ACEITE			ACEITE	GP-28	117434
HIDRAULICO	G-222	4J6064	COMBUSTIBLE, SECUNDARIO			COMBUSTIBLE, SECUNDARIO	GP-1122	2133558
CHAMPION			250R02 con motor/GMC 4-51			COMBUSTIBLE, SECUNDARIO	GPP-1122	1174483
NIVELADORAS			COMBUSTIBLE, SECUNDARIO			CPS130B con motor/DEUTZ F3L1011		
720 SERIES III, 720 VHP, 720A, 720A SERIES III, 720A VHP, 726A con motor/CUMMINS 6CT8.3			365R02 con motor/GMC 4-71			ACEITE	GP-28	117434
ACEITE	GP-3000	54429	ACEITE			COMBUSTIBLE, SECUNDARIO	GP-1122	2133558
			ACEITE			AIRE	GAK-403	4PS253
			COMBUSTIBLE, SECUNDARIO			CPS180A, CPS180B con motor/A DIESEL		
			ACEITE			AIRE	GA-16	AF25456K

SERVICIO PESADO

MARCA-MODELO-MOTOR GONHER OEM
MAKE-MODEL-ENGINE GONHER OEM

CHICAGOPNEUMATIC(continuación)

COMPRESORES

CPS185 con motor/JOHN DEERE 4039D		
ACEITE	GP-14	T19044
COMBUSTIBLE	GPP-418	RE62418
COMBUSTIBLE	GPP-419	RE62419

CPS190 con motor/DEUTZ F4M1011		
ACEITE	GP-28	117434
COMBUSTIBLE, SECUNDARIO	GP-1122	2133558
COMBUSTIBLE, SECUNDARIO	GPP-1122	1174483

CPS270 con motor/JOHN DEERE 4039D		
ACEITE	GP-14	T19044
COMBUSTIBLE	GPP-418	RE62418
COMBUSTIBLE	GPP-419	RE62419
AIRE	GA-403	AT65088
AIRE	GAK-403	4PS253

CPS270 con motor/JOHN DEERE 4045 POWER TECH		
COMBUSTIBLE	GPP-420	RE60021

CPS390D con motor/DEUTZ F6L913		
ACEITE	GP-54	P551205
COMBUSTIBLE, SECUNDARIO	GP-1122	2133558
AIRE	GA-405	1619-2799

CPS75, CPS75/90 con motor/DEUTZ F2L1011		
ACEITE	GP-28	117434
COMBUSTIBLE, SECUNDARIO	GP-1122	2133558
AIRE, SIN ASPAS	GA-33	N403638

CPS90 con motor/DEUTZ F2L1011		
ACEITE	GP-28	117434
COMBUSTIBLE, SECUNDARIO	GP-1122	2133558
COMBUSTIBLE, SECUNDARIO	GPP-1122	1174483
ACEITE	GP-3816	1163420
AIRE, SIN ASPAS	GA-33	N403638

D2000, D3400 con motor/HERCULES		
COMBUSTIBLE, SECUNDARIO	G-296	266537-AS
COMBUSTIBLE, PRIMARIO	G-297	266536-AS
COMBUSTIBLE, SECUNDARIO	G-296-B	266537-AS
COMBUSTIBLE, PRIMARIO	G-297-B	266536-AS

CHICAGO PNEUMATIC

GENERADORES

CP8030GS con motor/JOHN DEERE 3179		
ACEITE	GP-14	T19044

CP8040GS con motor/JOHN DEERE 4039D		
ACEITE	GP-14	T19044
COMBUSTIBLE, 5 3/16 IN	GPP-418	RE62418
COMBUSTIBLE, 5 15/16 IN	GPP-419	RE62419

CP8060GS con motor/JOHN DEERE 4039T		
ACEITE	GP-14	T19044
COMBUSTIBLE, 5 3/16 IN	GPP-418	RE62418
COMBUSTIBLE, 5 15/16 IN	GPP-419	RE62419

CP8110GS con motor/JOHN DEERE 6059T		
ACEITE	GP-14	T19044
COMBUSTIBLE, 5 3/16 IN	GPP-418	RE62418
COMBUSTIBLE, 5 15/16 IN	GPP-419	RE62419

MARCA-MODELO-MOTOR GONHER OEM
MAKE-MODEL-ENGINE GONHER OEM

CHICAGOPNEUMATIC(continuación)

GENERADORES

CP8175GS con motor/JOHN DEERE 6076A		
ACEITE	GP-35	AR98329
COMBUSTIBLE, 5 3/16 IN	GPP-418	RE62418
COMBUSTIBLE, 5 15/16 IN	GPP-419	RE62419

CHRYSLER

CAMIONES, TRACTOCAMIONES Y AUTOBUSES

100 SERIES con motor/DODGE 170 6 CIL.		
ACEITE	G-236	2129023
ACEITE	GP-1	1851658
AIRE	GA-71	2206376
GASOLINA	GG-5 L	2525254

100 SERIES con motor/DODGE 198 6 CIL.		
ACEITE	GP-1	1851658
AIRE	GA-71	2206376
GASOLINA	GG-20	2240546
GASOLINA	GG-5 L	2525254

100 SERIES con motor/DODGE 230 6 CIL.		
GASOLINA	GG-20	2240546

100 SERIES con motor/DODGE 238 V8		
ACEITE	GP-58	P550971

100 SERIES con motor/DODGE 243 6 CIL.		
ACEITE	GP-81	3549957

100 SERIES con motor/DODGE 273A V8		
ACEITE	G-236	2129023
ACEITE	GP-1	1851658
AIRE	GA-70	1739547
GASOLINA	GG-20	2240546
GASOLINA	GG-5 L	2525254

100 SERIES con motor/DODGE 318 V8		
ACEITE	G-236	2129023
ACEITE, SELLADO 5 13/32 IN	GP-1	3549232
ACEITE, SELLADO 3 45/64 IN	GP-81	3549957
AIRE, 1969-79	GA-70	1739547
AIRE, 1980-87	GA-70	1739547
AIRE, HASTA 1979	GA-429	3614353
GASOLINA	GG-20	2240546
GASOLINA	GG-5 L	2525254

100 SERIES con motor/DODGE 360 V8		
ACEITE	G-236	2129023
ACEITE, SELLADO 5 13/32 IN	GP-1	3549232
ACEITE, SELLADO 3 45/64 IN	GP-81	3549957
AIRE, 1979-80 2BBL	GA-70	1739547
AIRE, 1981 EN ADELANTE	GA-70	1739547
AIRE, HASTA 1979	GA-429	3614353
AIRE, 1979-80 4BBL	GA-730	2863349
GASOLINA	GG-5 L	2525254

100 SERIES con motor/DODGE 838 V8		
ACEITE	G-236	2129023
ACEITE	GP-1	1851658
AIRE	GA-730	2863349
GASOLINA	GG-5 L	2525254

100 SERIES, 200 SERIES, 300 SERIES con motor/DODGE 440 V8		
ACEITE, SELLADO 5 13/32 IN	GP-1	1851658
ACEITE, SELLADO 3 45/64 IN	GP-81	3549957

MARCA-MODELO-MOTOR GONHER OEM
MAKE-MODEL-ENGINE GONHER OEM

CHRYSLER (continuación)

CAMIONES, TRACTOCAMIONES Y AUTOBUSES

100 SERIES, 350 SERIES, 150 SERIES, 200 SERIES, 250 SERIES, 300 SERIES con motor/DODGE 225 6 CIL.		
AIRE, 3 1/2 IN	GA-429	3614353
AIRE, 2 51/64 IN	GA-730	2863349
GASOLINA	GG-20	2240546
GASOLINA	GG-5 L	2525254

1000 SERIES con motor/DODGE 273A V8		
ACEITE	G-236	2129023
ACEITE, SELLADO 5 13/32 IN	GP-1	1851658
ACEITE, SELLADO 3 45/64 IN	GP-81	3549957
AIRE, 1977-78 EXCEPTO VANS	GA-70	1739547
AIRE, 1981 EN ADELANTE EXCEPTO VANS	GA-70	1739547
AIRE, 1967-77	GA-71	2206376
AIRE, 1979-80	GA-77	2453346
AIRE, 1981 EN ADELANTE PARA VANS	GA-77	2453346
AIRE, 1977-78 PARA VANS	GA-78	4041252
GASOLINA	GG-20	2240546
GASOLINA	GG-5 L	2525254

1000 SERIES con motor/DODGE 318A V8		
ACEITE	G-236	2129023
ACEITE	GP-1	1851658
GASOLINA	GG-20	2240546
GASOLINA	GG-5 L	2525254

1000 SERIES con motor/DODGE 361 V8		
ACEITE	G-236	2129023
ACEITE, SELLADO 5 13/32 IN	GP-1	1851658
ACEITE, SELLADO 3 45/64 IN	GP-81	676575
GASOLINA	GG-20	2240546
GASOLINA	GG-5 L	2525254

1000 SERIES con motores/DODGE 360 V8, DODGE 440 V8		
ACEITE, SELLADO 5 13/32 IN	GP-1	1851658
ACEITE, SELLADO 3 45/64 IN	GP-81	3549957
GASOLINA	GG-5 L	2525254

150 SERIES con motor/CUMMINS 6BT5.9		
ACEITE	GP-178	3914395

150 SERIES con motor/DODGE 318 V8		
ACEITE	G-236	2129023
ACEITE, SELLADO 5 13/32 IN	GP-1	3549232
ACEITE, SELLADO 3 45/64 IN	GP-81	3549957
AIRE, 1969-79	GA-70	1739547
AIRE, 1980-87	GA-70	1739547
AIRE, HASTA 1979	GA-429	3614353
GASOLINA	GG-20	2240546
GASOLINA	GG-5 L	2525254

150 SERIES con motor/DODGE 360 V8		
ACEITE	G-236	2129023
ACEITE, SELLADO 5 13/32 IN	GP-1	3549232
ACEITE, SELLADO 3 45/64 IN	GP-81	3549957
AIRE, 1969-79	GA-70	1739547
AIRE, 1980-87	GA-70	1739547
AIRE, HASTA 1979	GA-429	3614353
GASOLINA	GG-20	2240546
GASOLINA	GG-5 L	2525254

150 SERIES con motor/DODGE 360 V8		
ACEITE	G-236	2129023
ACEITE, SELLADO 5 13/32 IN	GP-1	3549232
ACEITE, SELLADO 3 45/64 IN	GP-81	3549957
AIRE, 1979-80 2BBL	GA-70	1739547
AIRE, 1981 EN ADELANTE	GA-70	1739547
AIRE, HASTA 1979	GA-429	3614353
AIRE, 1979-80 4BBL	GA-730	2863349
GASOLINA	GG-5 L	2525254

MARCA-MODELO-MOTOR MAKE-MODEL-ENGINE	GONHER GONHER	OEM OEM	MARCA-MODELO-MOTOR MAKE-MODEL-ENGINE	GONHER GONHER	OEM OEM	MARCA-MODELO-MOTOR MAKE-MODEL-ENGINE	GONHER GONHER	OEM OEM
CHRYSLER (continuación)			CHRYSLER (continuación)			CHRYSLER (continuación)		
CAMIONES, TRACTOCAMIONES Y AUTOBUSES			CAMIONES, TRACTOCAMIONES Y AUTOBUSES			CAMIONES, TRACTOCAMIONES Y AUTOBUSES		
200 SERIES con motor/DODGE 170 6 CIL.			250 SERIES con motor/DODGE 360 V8			AIRE, 1980-87	GA-70	1739547
ACEITE	G-236	2129023	ACEITE	G-236	2129023	AIRE, HASTA 1979	GA-429	3614353
ACEITE	GP-1	1851658	ACEITE, SELLADO 5 13/32 IN	GP-1	3549232	GASOLINA	GG-20	2240546
AIRE	GA-71	2206376	ACEITE, SELLADO 3 45/64 IN	GP-81	3549957	GASOLINA	GG-5 L	2525254
GASOLINA	GG-5 L	2525254	AIRE, 1979-80 2BBL	GA-70	1739547	350 SERIES con motor/DODGE 360 V8		
			AIRE, 1981 EN ADELANTE	GA-70	1739547	ACEITE	G-236	2129023
200 SERIES con motor/DODGE 198 6 CIL.			AIRE, HASTA 1979	GA-429	3614353	ACEITE, SELLADO 5 13/32 IN	GP-1	3549232
ACEITE	GP-1	1851658	AIRE, 1979-80 4BBL	GA-730	2863349	ACEITE, SELLADO 3 45/64 IN	GP-81	3549957
AIRE	GA-71	2206376	GASOLINA	GG-5 L	2525254	AIRE, 1979-80 2BBL	GA-70	1739547
GASOLINA	GG-20	2240546	300 SERIES con motor/DODGE 170 6 CIL.			AIRE, 1981 EN ADELANTE	GA-70	1739547
GASOLINA	GG-5 L	2525254	ACEITE	G-236	2129023	AIRE, HASTA 1979	GA-429	3614353
			ACEITE	GP-1	1851658	AIRE, 1979-80 4BBL	GA-730	2863349
200 SERIES con motor/DODGE 230 6 CIL.			ACEITE	GP-1	1851658	GASOLINA	GG-5 L	2525254
GASOLINA	GG-20	2240546	AIRE	GA-71	2206376	300 SERIES con motor/DODGE 198 6 CIL.		
			GASOLINA	GG-5 L	2525254	ACEITE	GP-1	1851658
200 SERIES con motor/DODGE 238 V8			ACEITE	GP-1	1851658	AIRE	GA-71	2206376
ACEITE	GP-58	P550971	AIRE	GA-71	2206376	GASOLINA	GG-20	2240546
			GASOLINA	GG-20	2240546	GASOLINA	GG-5 L	2525254
200 SERIES con motor/DODGE 243 6 CIL.			GASOLINA	GG-5 L	2525254	400 SERIES con motor/DODGE 198 6 CIL.		
ACEITE	GP-81	3549957	300 SERIES con motor/DODGE 198 6 CIL.			ACEITE	GP-1	1851658
			ACEITE	GP-1	1851658	AIRE	GA-71	2206376
200 SERIES con motor/DODGE 318 V8			AIRE	GA-71	2206376	GASOLINA	GG-20	2240546
ACEITE	G-236	2129023	GASOLINA	GG-20	2240546	GASOLINA	GG-5 L	2525254
ACEITE, SELLADO 5 13/32 IN	GP-1	3549232	GASOLINA	GG-5 L	2525254	400 SERIES con motor/DODGE 225 6 CIL.		
ACEITE, SELLADO 3 45/64 IN	GP-81	3549957	300 SERIES con motor/DODGE 230 6 CIL.			ACEITE	G-236	2129023
AIRE, 1969-79	GA-70	1739547	GASOLINA	GG-20	2240546	ACEITE	GP-1	1851658
AIRE, 1980-87	GA-70	1739547	300 SERIES con motor/DODGE 238 V8			ACEITE	GP-81	3549957
AIRE, HASTA 1979	GA-429	3614353	ACEITE	GP-58	P550971	AIRE, 1977 EN ADELANTE	GA-70	1739547
GASOLINA	GG-20	2240546	300 SERIES con motor/DODGE 243 6 CIL.			AIRE, 1967-77	GA-71	2206376
GASOLINA	GG-5 L	2525254	ACEITE	GP-81	3549957	AIRE, 1977 EN ADELANTE PARA VANS	GA-78	4041252
			300 SERIES con motor/DODGE 318 V8			GASOLINA	GG-20	2240546
200 SERIES con motor/DODGE 360 V8			ACEITE	G-236	2129023	GASOLINA	GG-5 L	2525254
ACEITE	G-236	2129023	ACEITE, SELLADO 5 13/32 IN	GP-1	3549232	400 SERIES con motor/DODGE 251 6 CIL.		
ACEITE, SELLADO 5 13/32 IN	GP-1	3549232	ACEITE, SELLADO 3 45/64 IN	GP-81	3549957	ACEITE	G-236	2129023
ACEITE, SELLADO 3 45/64 IN	GP-81	3549957	AIRE, 1969-79	GA-70	1739547	ACEITE	GP-1	1851658
AIRE, 1979-80 2BBL	GA-70	1739547	AIRE, 1980-87	GA-70	1739547	GASOLINA	GG-20	2240546
AIRE, 1981 EN ADELANTE	GA-70	1739547	AIRE, HASTA 1979	GA-429	3614353	GASOLINA	GG-5 L	2525254
AIRE, HASTA 1979	GA-429	3614353	GASOLINA	GG-20	2240546	400 SERIES con motor/DODGE 318A V8		
AIRE, 1979-80 4BBL	GA-730	2863349	GASOLINA	GG-5 L	2525254	ACEITE, CARTUCHO	G-236	2129023
GASOLINA	GG-5 L	2525254	300 SERIES con motor/DODGE 360 V8			ACEITE, SELLADO 5 13/32 IN	GP-1	1851658
			ACEITE	G-236	2129023	ACEITE, SELLADO 3 45/64 IN	GP-81	3549957
200 SERIES con motor/DODGE 838 V8			ACEITE, SELLADO 5 13/32 IN	GP-1	3549232	AIRE, 1978 EN ADELANTE	GA-70	1739547
ACEITE	G-236	2129023	ACEITE, SELLADO 3 45/64 IN	GP-81	3549957	AIRE, HASTA 1974	GA-70	1739547
ACEITE	GP-1	1851658	AIRE, 1979-80 2BBL	GA-70	1739547	AIRE, 1974-78	GA-429	3614353
AIRE	GA-730	2863349	AIRE, 1981 EN ADELANTE	GA-70	1739547	GASOLINA	GG-20	2240546
GASOLINA	GG-5 L	2525254	AIRE, HASTA 1979	GA-429	3614353	GASOLINA	GG-5 L	2525254
			AIRE, 1979-80 4BBL	GA-730	2863349	400 SERIES con motor/DODGE 360 V8		
200 SERIES, 300 SERIES con motor/DODGE 273A V8			GASOLINA	GG-5 L	2525254	ACEITE, SELLADO 5 13/32 IN	GP-1	1851658
ACEITE	G-236	2129023	300 SERIES con motor/DODGE 838 V8			ACEITE, SELLADO 3 45/64 IN	GP-81	3549957
ACEITE	GP-1	1851658	ACEITE	G-236	2129023	AIRE	GA-429	3614353
GASOLINA	GG-20	2240546	ACEITE	GP-1	1851658	GASOLINA	GG-5 L	2525254
			AIRE	GA-730	2863349	400 SERIES, 500 SERIES, 600 SERIES con motor/DODGE 170 6 CIL.		
250 SERIES con motor/CUMMINS 6BT5.9			GASOLINA	GG-5 L	2525254	ACEITE	GP-1	1851658
ACEITE	GP-178	3914395	350 SERIES con motor/CUMMINS 6BT5.9			400 SERIES, 500 SERIES, 600 SERIES con motor/DODGE 273A V8		
			ACEITE	GP-178	3914395	ACEITE	G-236	2129023
250 SERIES con motor/DODGE 318 V8			ACEITE	GP-1	1851658	ACEITE	GP-1	1851658
ACEITE	G-236	2129023	AIRE	GA-730	2863349	AIRE, 1977 EN ADELANTE	GA-70	1739547
ACEITE, SELLADO 5 13/32 IN	GP-1	3549232	GASOLINA	GG-5 L	2525254	GASOLINA	GG-20	2240546
ACEITE, SELLADO 3 45/64 IN	GP-81	3549957	350 SERIES con motor/DODGE 318 V8			GASOLINA	GG-5 L	2525254
AIRE, 1969-79	GA-70	1739547	ACEITE	GP-178	3914395			
AIRE, 1980-87	GA-70	1739547	ACEITE	G-236	2129023			
AIRE, HASTA 1979	GA-429	3614353	ACEITE, SELLADO 5 13/32 IN	GP-1	3549232			
GASOLINA	GG-20	2240546	ACEITE, SELLADO 3 45/64 IN	GP-81	3549957			
GASOLINA	GG-5 L	2525254	AIRE, 1969-79	GA-70	1739547			

SERVICIO PESADO

MARCA-MODELO-MOTOR MAKE-MODEL-ENGINE	GONHER GONHER	OEM OEM	MARCA-MODELO-MOTOR MAKE-MODEL-ENGINE	GONHER GONHER	OEM OEM	MARCA-MODELO-MOTOR MAKE-MODEL-ENGINE	GONHER GONHER	OEM OEM
CHRYSLER (continuación)			CHRYSLER (continuación)			CHRYSLER (continuación)		
CAMIONES, TRACTOCAMIONES Y AUTOBUSES			CAMIONES, TRACTOCAMIONES Y AUTOBUSES			CAMIONES, TRACTOCAMIONES Y AUTOBUSES		
400 SERIES, 500 SERIES, 600 SERIES, 700 SERIES, 800 SERIES, 900 SERIES con motor/DODGE 361 V8			600 SERIES con motor/DODGE 318A V8			COMBUSTIBLE, PRIMARIO SELLADO GP-26 23518481		
GASOLINA	GG-20	2240546	ACEITE, CARTUCHO	G-236	2129023	COMBUSTIBLE, SECUNDARIO SELLADO	GP-27	L305
500 SERIES con motor/DODGE 198 6 CIL.			AIRE, 1978 EN ADELANTE	GA-70	1739547	CNT800 con motor/CATERPILLAR 1100 SERIES		
ACEITE	GP-1	1851658	AIRE, HASTA 1974	GA-70	1739547	ACEITE	GP-36	9N5680
AIRE	GA-71	2206376	AIRE, 1974-78	GA-429	3614353	CNT900 con motor/CUMMINS NHC250		
GASOLINA	GG-20	2240546	GASOLINA	GG-20	2240546	ACEITE	G-566	257528
GASOLINA	GG-5 L	2525254	GASOLINA	GG-5 L	2525254	CT800 con motor/CATERPILLAR 1100 SERIES		
500 SERIES con motor/DODGE 225 6 CIL.			600 SERIES con motor/DODGE 360 V8			ACEITE		
ACEITE	G-236	2129023	ACEITE, SELLADO 5 13/32 IN	GP-1	1851658	ACEITE		
ACEITE	GP-1	1851658	ACEITE, SELLADO 3 45/64 IN	GP-81	3549957	LS1000, LT1000 con motores/GMC 6-71N, GMC 8V-71N		
ACEITE	GP-81	3549957	AIRE	GA-429	3614353	ACEITE, DERIVACION (BY PASS)	G-31	925809
AIRE, 1977 EN ADELANTE	GA-70	1739547	GASOLINA	GG-5 L	2525254	ACEITE	G-33	5573013
AIRE, 1967-77	GA-71	2206376	600 SERIES, 400 SERIES, 500 SERIES con motor/DODGE 400 V8			COMBUSTIBLE, SECUNDARIO CARTUCHO	G-1175	8764949
AIRE, 1977 EN ADELANTE PARA VANS	GA-78	4041252	ACEITE, SELLADO 5 13/32 IN	GP-1	1851658	COMBUSTIBLE, PRIMARIO SELLADO	GP-26	23518481
GASOLINA	GG-20	2240546	ACEITE, SELLADO 3 45/64 IN	GP-81	3549957	COMBUSTIBLE, SECUNDARIO SELLADO	GP-27	L305
GASOLINA	GG-5 L	2525254	GASOLINA	GG-5 L	2525254	MODELOS DE con motor/CUMMINS 5.9L TURBO DIESEL		
500 SERIES con motor/DODGE 251 6 CIL.			700 SERIES, 800 SERIES, 900 SERIES, C850 SERIES con motor/DODGE 318A V8			COMBUSTIBLE, SECUNDARIO		
ACEITE	G-236	2129023	ACEITE	G-236	2129023	COMBUSTIBLE, SEPARADOR DE AGUA	GPP-18	3925274
ACEITE	GP-1	1851658	ACEITE, SELLADO 5 13/32 IN	GP-1	1851658	ACEITE	GP-178	3914395
GASOLINA	GG-20	2240546	ACEITE, SELLADO 3 45/64 IN	GP-81	676575	COMBUSTIBLE	GS-1261	3942470
GASOLINA	GG-5 L	2525254	GASOLINA	GG-20	2240546	PC600, PD500, PD600, L600, PC500 con motor/PERKINS 6.354		
500 SERIES con motor/DODGE 318A V8			GASOLINA	GG-5 L	2525254	ACEITE	G-834	1531639
ACEITE, CARTUCHO	G-236	2129023	700 SERIES, C850 SERIES, 800 SERIES, 900 SERIES con motor/DODGE 273A V8			COMBUSTIBLE	G-296	868014
ACEITE, SELLADO 5 13/32 IN	GP-1	1851658	ACEITE	G-236	2129023	COMBUSTIBLE	G-296-B	868014
ACEITE, SELLADO 3 45/64 IN	GP-81	3549957	ACEITE	GP-1	1851658	S550 SERIES con motor/DODGE 170 6 CIL.		
AIRE, 1978 EN ADELANTE	GA-70	1739547	GASOLINA	GG-20	2240546	ACEITE	GP-1	1851658
AIRE, 1974-78	GA-429	3614353	GASOLINA	GG-5 L	2525254	AIRE	GA-71	2206376
GASOLINA	GG-20	2240546	800 con motor/CATERPILLAR 1100 SERIES			GASOLINA	GG-20	2240546
GASOLINA	GG-5 L	2525254	ACEITE	GP-36	9N5680	GASOLINA	GG-5 L	2525254
500 SERIES con motor/DODGE 360 V8			700 SERIES, C850 SERIES, 800 SERIES, 900 SERIES con motores/DODGE 360 V8, DODGE 440 V8			S550 SERIES con motor/DODGE 225 6 CIL.		
ACEITE, SELLADO 5 13/32 IN	GP-1	1851658	ACEITE, SELLADO 5 13/32 IN	GP-1	1851658	ACEITE	G-236	2129023
ACEITE, SELLADO 3 45/64 IN	GP-81	3549957	ACEITE, SELLADO 3 45/64 IN	GP-81	3549957	ACEITE	GP-1	1851658
AIRE	GA-429	3614353	GASOLINA	GG-5 L	2525254	AIRE, 1977 EN ADELANTE PARA VANS	GA-78	4041252
GASOLINA	GG-5 L	2525254	C800 con motor/CATERPILLAR 1100 SERIES			GASOLINA	GG-20	2240546
600 SERIES con motor/DODGE 198 6 CIL.			ACEITE	GP-36	9N5680	GASOLINA	GG-5 L	2525254
ACEITE	GP-1	1851658	800, CN900, CNT900 con motor/CUMMINS 210 V8			S550 SERIES con motor/DODGE 251 6 CIL.		
AIRE	GA-71	2206376	ACEITE	G-613	173174	ACEITE	G-236	2129023
GASOLINA	GG-20	2240546	COMBUSTIBLE	GP-1101	154711	ACEITE	GP-1	1851658
GASOLINA	GG-5 L	2525254	AGUA	GP-2071W	3315116	ACEITE	GP-81	3549957
600 SERIES con motor/DODGE 225 6 CIL.			AIRE, RESPIRADOR	GA-39	255963	AIRE, 1977 EN ADELANTE	GA-70	1739547
ACEITE	G-236	2129023	AIRE	GA-37	106837	AIRE, 1967-77	GA-71	2206376
ACEITE	GP-1	1851658	ACEITE, DERIVACION (BY PASS)	G-500	256839	AIRE, 1977 EN ADELANTE PARA VANS	GA-78	4041252
ACEITE	GP-81	3549957	C850 SERIES con motor/DODGE 361 V8			GASOLINA	GG-20	2240546
AIRE, 1977 EN ADELANTE	GA-70	1739547	GASOLINA	GG-20	2240546	GASOLINA	GG-5 L	2525254
AIRE, 1967-77	GA-71	2206376	CN800 con motor/CATERPILLAR 1100 SERIES			S550 SERIES con motor/DODGE 273A V8		
AIRE, 1977 EN ADELANTE PARA VANS	GA-78	4041252	ACEITE	GP-36	9N5680	ACEITE	G-236	2129023
GASOLINA	GG-20	2240546	CN900 con motor/CUMMINS NHC250			ACEITE	GP-1	1851658
GASOLINA	GG-5 L	2525254	ACEITE	G-566	257528	GASOLINA	GG-20	2240546
600 SERIES con motor/DODGE 251 6 CIL.			CN900, CNT900 con motor/GMC 6-71N			GASOLINA	GG-5 L	2525254
ACEITE	G-236	2129023	ACEITE, DERIVACION (BY PASS)	G-31	925809	S550 SERIES con motor/DODGE 273A V8		
ACEITE	GP-1	1851658	ACEITE	G-33	5573013	ACEITE	GP-1	1851658
GASOLINA	GG-20	2240546	COMBUSTIBLE, SECUNDARIO CARTUCHO	G-1175	8764949	AIRE, 1977 EN ADELANTE	GA-70	1739547
GASOLINA	GG-5 L	2525254				GASOLINA	GG-20	2240546

MARCA-MODELO-MOTOR	GONHER	OEM	MARCA-MODELO-MOTOR	GONHER	OEM	MARCA-MODELO-MOTOR	GONHER	OEM
MAKE-MODEL-ENGINE	GONHER	OEM	MAKE-MODEL-ENGINE	GONHER	OEM	MAKE-MODEL-ENGINE	GONHER	OEM
CHRYSLER (continuación)			CHRYSLER (continuación)			CHRYSLER (continuación)		
CAMIONES, TRACTOCAMIONES Y AUTOBUSES			MOTORES			MOTORES		
GASOLINA	GG-5 L	2525254	GASOLINA	GG-20	2240546	GASOLINA, 1959-71	GG-20	2240546
S550 SERIES con motor/DODGE 318A V8			GASOLINA	GG-5 L	2525254	GASOLINA, 1968-81	GG-5 L	2525254
ACEITE, CARTUCHO	G-236	2129023	225 6 CIL. A GASOLINA			GASOLINA, 1975 EN ADELANTE	GG-8 L	3870548
ACEITE, SELLADO 5 13/32 IN	GP-1	1851658	ACEITE	GP-1	1851658	318-3 INDUSTRIAL, H170 INDUSTRIAL, H225 INDUSTRIAL, H318 INDUSTRIAL, H361 INDUSTRIAL, H383 INDUSTRIAL, H413 INDUSTRIAL, H426 INDUSTRIAL, H440 INDUSTRIAL, HA225 INDUSTRIAL, HA273 INDUSTRIAL, HB170 INDUSTRIAL, HB225 INDUSTRIAL, HB318 INDUSTRIAL, HB361 INDUSTRIAL, HB383 INDUSTRIAL, HB413 INDUSTRIAL, HB426 INDUSTRIAL, HC170 INDUSTRIAL, HC225 INDUSTRIAL, HC318 INDUSTRIAL, HC361 INDUSTRIAL, HC413 INDUSTRIAL, HC426 INDUSTRIAL, HT318 INDUSTRIAL, HT413 INDUSTRIAL, LH318 INDUSTRIAL		
ACEITE, SELLADO 3 45/64 IN	GP-81	3549957	AIRE, 1977 EN ADELANTE	GA-70	1739547	ACEITE	G-236	2129023
AIRE, 1978 EN ADELANTE	GA-70	1739547	AIRE, 1967-77	GA-71	2206376	360 5.9L V8 A GASOLINA, 360 5.9L V8 A GASOLINA, 360 5.9L V8 A GASOLINA, 360 5.9L V8 A GASOLINA, 360-1 V8 A GASOLINA, 360-1 V8 A GASOLINA, 360-1 V8 A GASOLINA, 360-1 V8 A GASOLINA, 440-1 V8 A GASOLINA, 440-3 V8 A GASOLINA, HEMI MAGNUM V8-537L A GASOLINA	GP-81	3549957
AIRE, HASTA 1974	GA-70	1739547	AIRE, 1979 EN ADELANTE	GA-77	2453346	GASOLINA	GG-67	4443452
AIRE, 1974-78	GA-429	3614353	AIRE, 1977 EN ADELANTE	GA-78	4041252	GASOLINA	GG-67	4443452
GASOLINA	GG-20	2240546	GASOLINA	GG-20	2240546	360-1 V8 A GASOLINA, 360-3 V8 A GASOLINA		
GASOLINA	GG-5 L	2525254	GASOLINA, 1957-81	GG-5 L	2525254	GASOLINA	GG-67	4443452
S550 SERIES con motor/DODGE 360 V8			GASOLINA, 1975-81	GG-8 L	3870548	361-4 INDUSTRIAL, 413-2 INDUSTRIAL, 413-3 INDUSTRIAL, IND13 INDUSTRIAL, IND13A INDUSTRIAL, IND14A INDUSTRIAL, IND15 INDUSTRIAL, IND15A INDUSTRIAL		
ACEITE, SELLADO 5 13/32 IN	GP-1	1851658	225 6 CIL. A GASOLINA, 318 V8 A GASOLINA			GASOLINA	GG-20	2240546
ACEITE, SELLADO 3 45/64 IN	GP-81	3549957	AIRE	GA-70	1739547	383 V8 A GASOLINA		
AIRE	GA-429	3614353	225-1 6 CIL. A GASOLINA, 225-2 6 CIL. A GASOLINA			ACEITE	GP-1	1851658
GASOLINA	GG-5 L	2525254	ACEITE	G-236	2129023	ACEITE	GP-81	3549957
S550 SERIES con motor/DODGE 361 V8			ACEITE	GP-1	1851658	AIRE	GA-730	2863349
GASOLINA	GG-20	2240546	ACEITE	GP-81	3549957	GASOLINA	GG-5 L	2525254
S550 SERIES con motor/DODGE 400 V8			AIRE, 1977 EN ADELANTE	GA-70	1739547	400 V8 A GASOLINA		
ACEITE, SELLADO 5 13/32 IN	GP-1	1851658	AIRE, 1967-77	GA-71	2206376	ACEITE	GP-1	1851658
ACEITE, SELLADO 3 45/64 IN	GP-81	3549957	AIRE, 1979 EN ADELANTE	GA-77	2453346	ACEITE	GP-81	3549957
GASOLINA	GG-5 L	2525254	AIRE, 1977 EN ADELANTE	GA-78	4041252	ACEITE	GP-81	3549957
CHRYSLER			GASOLINA	GG-20	2240546	AIRE	GA-730	2863349
MOTORES			GASOLINA, 1957-81	GG-5 L	2525254	GASOLINA	GG-5 L	2525254
100 MARINO, 110 MARINO, 120 MARINO, 130 MARINO, 165 MARINO, 170 MARINO, 215 MARINO, 230 MARINO, 240 MARINO, 275 MARINO, M239 MARINO			GASOLINA, 1975-81	GG-8 L	3870548	413 V8 A GASOLINA		
ACEITE	GP-81	5281090	230 6 CIL. A GASOLINA, 361 V8 A GASOLINA, 361-2 V8 A GASOLINA, 361-3 V8 A GASOLINA, 361-4 V8 A GASOLINA			ACEITE	GP-1	1851658
120 SUPER CROWN MARINO, 145 SPACE SAVER MARINO, 150 SUPER CROWN MARINO, 215 INDUSTRIAL, 225 INDUSTRIAL			GASOLINA	GG-20	2240546	ACEITE	GP-81	3549957
ACEITE	G-236	2129023	238 V6 A GASOLINA			AIRE	GA-730	2863349
122 MARINO, 125 MARINO, 150 MARINO, 155 MARINO, 170A MARINO, 170AJ JET MARINO, 175 MARINO, 195 MARINO, 200 MARINO, 210 MARINO, 225 MARINO, 235 MARINO, 250 MARINO, 260 MARINO, 280 MARINO, 300 MARINO, 330 MARINO, 335 MARINO, 375 MARINO, 413B MARINO, 413D MARINO, 413E MARINO, 413GL MARINO, 525 MARINO, CM6-55 MARINO, CM6-55A MARINO, CM6-55N MARINO, CM6-55NA MARINO, COMMANDO 175 MARINO, COMMANDO 195 MARINO, COMMANDO 280 MARINO, FURY 190 MARINO, FURY 195 MARINO, FURY 235 MARINO, GOLDEN COMMANDO 280 MARINO, GOLDEN COMMANDO 290 MARINO, GOLDEN LION 300 MARINO, GOLDEN LION 325 MARINO, IMPERIAL 250 MARINO, IMPERIAL 290 MARINO, IMPERIAL 325 MARINO, JET II MARINO, JET III MARINO, JET IV MARINO, JET MARINO, LM318 MARINO, LM318A MARINO, LM318B MARINO, LM318D MARINO, M170 MARINO, M170A MARINO, M225 MARINO, M225A MARINO, M225D MARINO, M273A MARINO, M273B MARINO, M273B-O/D MARINO, M318A MARINO, M318B MARINO, M318C MARINO, M318G MARINO, M383B MARINO, M413B MARINO, M413D MARINO, M413E MARINO, M413GL MARINO, M426 MARINO, M440B MARINO, M440D MARINO, M80 MARINO, M81 MARINO, MARINOS V8 DE 1962 EN ADELANTE, MH225D MARINO, MODELO 340 MARINO, NEWPORT 260 MARINO, SK GOLDEN LION MARINO, SUPER BEE I MARINO, SUPER BEE II MARINO, SUPER BEE III MARINO, SUPER BEE IV MARINO			243 6 CIL. A DIESEL			GASOLINA	GG-8 L	3870548
ACEITE	GP-1	1851658	ACEITE	GP-81	3549957	413 V8 A GASOLINA		
170 6 CIL. A GASOLINA			251 6 CIL. A GASOLINA, 251-1 6 CIL. A GASOLINA, 251-2 6 CIL. A GASOLINA, 251-3 6 CIL. A GASOLINA, 273A V8 A GASOLINA			ACEITE	GP-1	1851658
ACEITE	G-236	2129023	ACEITE	G-236	2129023	440 V8 A GASOLINA		
ACEITE	GP-1	1851658	ACEITE	GP-1	1851658	ACEITE, HASTA 1973	GP-1	1851658
AIRE	GA-71	2206376	AIRE	GA-70	1739547	AIRE	GA-429	3614353
GASOLINA	GG-5 L	2525254	GASOLINA	GG-20	2240546	AIRE	GA-730	2863349
198 6 CIL. A GASOLINA			GASOLINA	GG-5 L	2525254	GASOLINA	GG-20	2240546
ACEITE	GP-1	1851658	318 V8 A GASOLINA			GASOLINA	GG-5 L	2525254
ACEITE	GA-71	2206376	ACEITE	GP-1	1851658	GASOLINA	GG-8 L	3870548
AIRE	GA-71	2206376	AIRE, 1964-73	GA-70	1739547	440-1 V8 A GASOLINA, 440-3 V8 A GASOLINA		
			AIRE, 1974 EN ADELANTE	GA-429	3614353	ACEITE	GP-1	1851658
						IND908A INDUSTRIAL		
						ACEITE	G-31	925809

SERVICIO PESADO

MARCA-MODELO-MOTOR	GONHER	OEM
MAKE-MODEL-ENGINE	GONHER	OEM

CHRYSLER (continuación)		
MOTORES		
M10 MARINO, M11 MARINO, M16ACE MARINO, M26ACE MARINO, M6 MARINO, M7 MARINO, M8 MARINO		
ACEITE	G-31	925809
M44S MARINO, M44SJ MARINO, M45S3 MARINO, M45SP3 MARINO, M46-3 MARINO, M46-4 MARINO, M46-5 MARINO, M47-3 MARINO, M47-4 MARINO		
ACEITE	G-6	1677224

CITROEN		
CAMIONES, TRACTOCAMIONES Y AUTOBUSES		

C25 con motor/1.9D		
COMBUSTIBLE, ALT. 2 49/64 IN	G-296	CAV296
COMBUSTIBLE, ALT.4 25/64 IN	G-297	7111-796
COMBUSTIBLE, ALT. 2 49/64 IN	G-296-B	CAV296
COMBUSTIBLE, ALT.4 25/64 IN	G-297-B	7111-796
ACEITE	GP-461	C2105
C25 con motor/2.5D		
COMBUSTIBLE, ALT. 2 49/64 IN	G-296	CAV296
COMBUSTIBLE, ALT.4 25/64 IN	G-297	7111-796
COMBUSTIBLE, ALT. 2 49/64 IN	G-296-B	CAV296
COMBUSTIBLE, ALT.4 25/64 IN	G-297-B	7111-796
C25 con motores/1.8L, 2.0L		
ACEITE, 1983 EN ADELANTE	GP-461	C2105
JUMPER con motores/2, 1.9D, 1.9TD		
COMBUSTIBLE	G-296	CAV296
COMBUSTIBLE	G-296-B	CAV296
ACEITE	GP-461	C2105

CLARK		
CAMIONES, TRACTOCAMIONES Y AUTOBUSES		

20 REMOLCADOR con motor/FORD 6-240		
ACEITE	GP-1	945928
225 REMOLCADOR con motor/FORD M477		
ACEITE	G-5000	B8QH-6714-A
30 REMOLCADOR con motor/FORD 6-240		
ACEITE	GP-1	945928
300 REMOLCADOR con motor/FORD M477		
ACEITE	G-5000	B8QH-6714-A
40 REMOLCADOR, 50 REMOLCADOR con motor/FORD 6-240		
ACEITE	GP-1	945928
CT40D REMOLCADOR, CT50B REMOLCADOR, CT50D REMOLCADOR, CT640B REMOLCADOR, CT650B REMOLCADOR, CTF40B REMOLCADOR, CTF50B REMOLCADOR, CT1623551 REMOLCADOR, CT40B REMOLCADOR con motor/A DIESEL		
AIRE	GA-16	1803991
CT620B REMOLCADOR, CT630B REMOLCADOR, CTA6 REMOLCADOR, CTF20B REMOLCADOR, CTF6 REMOLCADOR, CT20B REMOLCADOR, CT20D REMOLCADOR, CT30 REMOLCADOR, CT30B REMOLCADOR con motor/A DIESEL		
ACEITE	GP-50	990936
AIRE	GA-16	1803991
AIRE	GAK-16	886525

MARCA-MODELO-MOTOR	GONHER	OEM
MAKE-MODEL-ENGINE	GONHER	OEM

CLARK		
CARGADORAS		
140 con motor/GMC 6V-53		
ACEITE	G-31	5572425
ACEITE	G-33	215502
COMBUSTIBLE, SECUNDARIO	G-1175	5574508
275C con motor/CUMMINS KT1150C		
COMBUSTIBLE	GPP-14	949095
ACEITE	GP-53	961172
ACEITE, SELLADO PARA DERIVACION (BY PASS)	GP-57	963023
COMBUSTIBLE, SEPARADOR DE AGUA	GPP-11	3308638
AGUA	GP-2071W	949418
ACEITE, CARTUCHO PARA DERIVACION (BY PASS)	G-750	947293
340 con motor/WAUKESHA 180 DCL		
ACEITE	G-31	5572425
35C con motor/GMC		
ACEITE	G-33	215502
ACEITE	G-119	5574978
COMBUSTIBLE	G-1173	5573263
AIRE, PRIMARIO	GAK-625	961000
35C con motor/PERKINS		
ACEITE	G-31	5572425
ACEITE	GP-1	945928
COMBUSTIBLE	G-297	961048
COMBUSTIBLE	G-297-B	961048
AIRE, PRIMARIO	GAK-625	961000
45C con motor/GMC		
ACEITE	G-33	215502
ACEITE	G-119	5574978
COMBUSTIBLE	G-1173	5573263

45C con motor/PERKINS		
ACEITE	G-31	5572425
ACEITE	GP-1	945928
COMBUSTIBLE	G-297	961048
COMBUSTIBLE	G-297-B	961048
AIRE, PRIMARIO	GAK-625	961000
475C con motor/CUMMINS 1710		
ACEITE	GP-53	961172
COMBUSTIBLE	GP-55	961657
ACEITE	GP-57	963023
AGUA	GP-1011Q	3315115
50, 60 con motor/GMC 3-53		
ACEITE	G-33	215502
ACEITE	G-119	5574978
COMBUSTIBLE	G-1173	5573263
50, 60 con motor/IHC UD236		
ACEITE	G-335	279994-R91
50, 60 con motor/IHC UD282		
COMBUSTIBLE, SECUNDARIO	G-1163	610309-C91
55C con motor/CUMMINS V378C		
ACEITE, CARTUCHO	G-613	949096
COMBUSTIBLE	GPP-14	949095
COMBUSTIBLE, SEPARADOR DE AGUA	GPP-11	3308638

MARCA-MODELO-MOTOR	GONHER	OEM
MAKE-MODEL-ENGINE	GONHER	OEM

CLARK (continuación)		
CARGADORAS		
ACEITE, SELLADO	GP-43	905575
AGUA	GP-2071W	949418
ACEITE, DERIVACION (BY PASS)	G-500	949098
80 con motor/GMC 4-53		
ACEITE	G-33	215502
COMBUSTIBLE	G-1173	5573263
COMBUSTIBLE, SECUNDARIO OPCIONAL	G-1175	5574508
C440B SOBRE RUEDAS con motor/A DIESEL		
TRANSMISION	GP-1	945928

CLARK		
COMPACTADORAS		

CV 40 con motor/A DIESEL		
COMBUSTIBLE	G-1123	3201438
ACEITE	GP-36	LF3497
COMBUSTIBLE	GP-1122	P779451
RS80, RS80-2, RS80-4, RW80 con motor/A DIESEL		
COMBUSTIBLE, CARTUCHO	G-1123	3201438
ACEITE	GP-36	LF3497
COMBUSTIBLE, SELLADO	GP-1122	P779451
S80-2, SV70 con motor/A DIESEL		
COMBUSTIBLE	G-1123	3201438
ACEITE	GP-36	LF3497
COMBUSTIBLE	GP-1122	P779451
TS80, TS80-1, TV80 con motor/A DIESEL		
COMBUSTIBLE, CARTUCHO	G-1123	3201438
ACEITE	GP-36	LF3497
COMBUSTIBLE, SELLADO	GP-1122	P779451

CLARK		
EQUIPO FORESTAL		

662 con motor/DETROIT DIESEL 3-53		
ACEITE, CONVERTIDOR DE TORSION	G-33	215502
TRANSMISION	G-33	215502
AIRE	GA-20	1644729
AIRE	GA-403	8994216
AIRE	GAK-403	888936
AIRE	GAK-20	944954
662 con motor/FORD 2701		
ACEITE	G-836	C2TZ-6714-A
662 con motor/GMC DIESEL		
ACEITE	G-33	215502
ACEITE	G-119	5574978
AIRE	GA-20	1644729
AIRE	GA-403	8994216
AIRE, PRIMARIO	GAK-403	888936
AIRE	GAK-20	944954
664 con motor/DETROIT DIESEL 3-53		
ACEITE, CONVERTIDOR DE TORSION	G-33	215502
TRANSMISION	G-33	215502
ACEITE	G-119	5574978
COMBUSTIBLE	G-1173	5573263
COMBUSTIBLE	GP-92	1992217

MARCA-MODELO-MOTOR MAKE-MODEL-ENGINE	GONHER GONHER	OEM OEM	MARCA-MODELO-MOTOR MAKE-MODEL-ENGINE	GONHER GONHER	OEM OEM	MARCA-MODELO-MOTOR MAKE-MODEL-ENGINE	GONHER GONHER	OEM OEM
CLARK (continuación)			CLARK (continuación)			CLARK (continuación)		
EQUIPO FORESTAL			EQUIPO FORESTAL			EQUIPO FORESTAL		
COMBUSTIBLE	GP-93	23518526	666B, 666C con motor/CUMMINS V378C			667GS con motor/CUMMINS V378C		
ACEITE	GP-43	905575	ACEITE	G-613	949096	ACEITE	G-613	949096
AIRE	GA-360	1990248	COMBUSTIBLE	GPP-14	949095	COMBUSTIBLE	GP-1101	154711
			COMBUSTIBLE	GP-1101	154711	ACEITE, DERIVACION (BY PASS)	G-500	949098
664 con motor/GMC 3-53			ACEITE, DERIVACION (BY PASS)	G-500	949098	667GS con motor/DETROIT DIESEL 4-53		
ACEITE, 9 IN	G-33	215502	666D con motor/CUMMINS 6B5.9			ACEITE, CONVERTIDOR DE TORSION	G-33	215502
TRANSMISION	G-33	215502	COMBUSTIBLE, SECUNDARIO	GP-1122	P779451	TRANSMISION	G-33	215502
ACEITE, 5 9/16 IN	G-119	5574978	COMBUSTIBLE, PRIMARIO	GPP-18	913556	TRANSMISION	G-33	215502
COMBUSTIBLE, SECUNDARIO	G-1173	945443	ACEITE	GP-178	3937145	AIRE	GA-360	1990248
AIRE	GA-360	1990248						
664C, 664GS, 665D, 664B, 664BGS con motor/DETROIT DIESEL 3-53			666D, 666C, 666CDS, 666CGS, 666CSS con motor/DETROIT DIESEL 4-53			668 con motor/CUMMINS C352		
ACEITE, CARTUCHO	G-119	5574978	ACEITE	G-33	215502	TRANSMISION	G-33	215502
COMBUSTIBLE, PRIMARIO	GP-92	1992217	ACEITE, DERIVACION (BY PASS)	GP-53	961172	ACEITE	G-613	949096
COMBUSTIBLE, SECUNDARIO	GP-93	23518526	COMBUSTIBLE, PRIMARIO	GP-92	1992217	COMBUSTIBLE	GP-1101	154711
ACEITE, SELLADO	GP-43	905575	COMBUSTIBLE, SECUNDARIO	GP-93	23518526	AIRE	GA-360	1990248
						ACEITE, DERIVACION (BY PASS)	G-500	949098
664D con motor/DETROIT DIESEL 3-53			667 con motor/CUMMINS			668 con motor/CUMMINS V504C		
COMBUSTIBLE, PRIMARIO	GP-92	1992217	ACEITE, CARTUCHO	G-566	257528	ACEITE, CONVERTIDOR DE TORSION	G-33	215502
COMBUSTIBLE, SECUNDARIO	GP-93	23518526	ACEITE, TURBOCARGADOR	GP-14	152499	TRANSMISION	G-33	215502
ACEITE	GP-43	905575	COMBUSTIBLE, 5 3/4 IN	GPP-14	949095	AIRE	GA-360	1990248
AIRE	GA-135	1992053	COMBUSTIBLE, 5 17/32 IN	GP-1101	154711			
AIRE, PRIMARIO	GA-360	1990244	ACEITE, SELLADO	GP-53	961172	668 con motor/DETROIT DIESEL 6V-53		
AIRE, SECUNDARIO	GA-361	1993689	COMBUSTIBLE, 11 15/32 IN	GP-55	961657	ACEITE, CONVERTIDOR DE TORSION	G-33	215502
			COMBUSTIBLE, SEPARADOR DE AGUA	GPP-11	3308638	TRANSMISION	G-33	215502
666 con motor/CUMMINS V352C			AIRE, RESPIRADOR	GA-39	255963	AIRE, CUMMINS	GA-106	946897
ACEITE, CONVERTIDOR DE TORSION	G-33	215502	AIRE, SIN ASPAS	GA-27	941089	AIRE, KOMATSU	GA-326	946897
TRANSMISION	G-33	215502	ACEITE, DERIVACION (BY PASS)	G-750	947293			
ACEITE	G-613	949096						
COMBUSTIBLE	GPP-14	949095	667 con motor/CUMMINS V378C			668 con motor/GMC 6V-53		
AGUA	GP-1010Q	949418	AIRE	GA-20	1644729	ACEITE	G-31	869688
AGUA	GP-2071W	949418				ACEITE	G-33	215502
AIRE	GA-360	1990248	667 con motor/DETROIT DIESEL 4-53			TRANSMISION	G-33	215502
			ACEITE	G-33	215502	COMBUSTIBLE	G-1173	5573263
666 con motor/DETROIT DIESEL 4-53			ACEITE	GP-53	961172	AIRE, CUMMINS	GA-106	946897
ACEITE, CONVERTIDOR DE TORSION	G-33	215502	COMBUSTIBLE	GP-92	1992217	AIRE, KOMATSU	GA-326	916897
TRANSMISION	G-33	215502	COMBUSTIBLE	GP-93	23518526			
AIRE	GA-360	1990248	AIRE	GA-360	1990248	668B con motor/CUMMINS V504C		
						ACEITE	G-613	949096
666 con motor/GMC 4-53			667 con motor/GMC 4-53			COMBUSTIBLE	GP-1101	154711
ACEITE	G-33	215502	ACEITE	G-33	215502	ACEITE, DERIVACION (BY PASS)	G-500	949098
TRANSMISION	G-33	215502	TRANSMISION	G-33	215502			
COMBUSTIBLE	G-1173	945443	COMBUSTIBLE, SECUNDARIO	G-1173	5573263	668B con motor/DETROIT DIESEL 6V-53		
AIRE	GA-360	1990248	AIRE, PRIMARIO	GA-360	1990248	ACEITE	G-33	215502
			AIRE, SECUNDARIO	GA-361	1993689	COMBUSTIBLE, PRIMARIO	GP-26	FJ-25
						COMBUSTIBLE, SECUNDARIO	GP-27	3576061
666, 666B con motor/DETROIT DIESEL V-352-C			667C, 667CGS, 667D con motor/CUMMINS V378C			ACEITE	GP-53	961172
ACEITE	G-33	215502	ACEITE	G-613	949096	668C con motor/CUMMINS VT555		
			COMBUSTIBLE	GP-1101	154711	ACEITE	G-566	257528
666B con motor/CUMMINS V352C			ACEITE, DERIVACION (BY PASS)	G-500	949098	COMBUSTIBLE	GP-27	3576061
ACEITE, CONVERTIDOR DE TORSION	G-33	215502				COMBUSTIBLE	GP-1101	154711
TRANSMISION	G-33	215502	667C, 667D, 667DGS con motor/DETROIT DIESEL 4-53			ACEITE	GP-43	905575
AIRE	GA-360	1990248	ACEITE	G-33	215502			
			ACEITE	GP-53	961172	668C con motor/DETROIT DIESEL 6V-53		
666B con motor/DETROIT DIESEL 4-53			COMBUSTIBLE	GP-92	1992217	ACEITE	G-33	215502
ACEITE, CONVERTIDOR DE TORSION	G-33	215502	COMBUSTIBLE	GP-93	23518526	COMBUSTIBLE, PRIMARIO	GP-26	FJ-25
TRANSMISION	G-33	215502	667GS con motor/CUMMINS V352C			COMBUSTIBLE, SECUNDARIO	GP-27	3576061
ACEITE, DERIVACION (BY PASS)	GP-53	961172	ACEITE, CONVERTIDOR DE TORSION	G-33	215502	ACEITE	GP-53	961172
COMBUSTIBLE, PRIMARIO	GP-92	1992217	TRANSMISION	G-33	215502			
COMBUSTIBLE, SECUNDARIO	GP-93	23518526	AIRE	GA-360	1990248	668CGS con motor/CUMMINS VT555		
AIRE	GA-360	1990248				ACEITE	G-566	257528
						COMBUSTIBLE	GP-27	3576061
						COMBUSTIBLE	GP-1101	154711

SERVICIO PESADO

MARCA-MODELO-MOTOR MAKE-MODEL-ENGINE	GONHER GONHER	OEM OEM	MARCA-MODELO-MOTOR MAKE-MODEL-ENGINE	GONHER GONHER	OEM OEM	MARCA-MODELO-MOTOR MAKE-MODEL-ENGINE	GONHER GONHER	OEM OEM
CLARK (continuación)			CLARK (continuación)			CLARK (continuación)		
EQUIPO FORESTAL			EXCAVADORAS			EXCAVADORAS		
ACEITE	GP-43	905575	1250 con motor/GMC 6-110			300 con motor/WAUKESHA 135 GZU		
668CGS con motor/DETROIT DIESEL 6V-53			ACEITE	G-31	5572425	ACEITE	G-31	5572425
ACEITE	G-33	215502	ACEITE	G-33	215502	300, 350, 400 con motor/WAUKESHA 6 WAKD		
COMBUSTIBLE, PRIMARIO	GP-26	FJ-2S	COMBUSTIBLE, SECUNDARIO	G-1173	5573263	ACEITE	G-31	5572425
COMBUSTIBLE, SECUNDARIO	GP-27	3576061	1250 con motor/WAUKESHA 135 GZU			34 SOBRE ORUGAS con motor/CATERPILLAR D318G		
ACEITE	GP-53	961172	ACEITE	G-31	5572425	ACEITE	G-191	550484
668D con motor/CUMMINS VT555			1250 con motor/WAUKESHA 6 WAKD			34 SOBRE ORUGAS con motor/CATERPILLAR D320		
ACEITE	G-566	257528	ACEITE	G-31	5572425	ACEITE	G-191	550484
COMBUSTIBLE	GP-27	3576061	1601 con motor/WAUKESHA 135 GZU			34 SOBRE ORUGAS con motores/ALLIS CHALMERS 10000, ALLIS CHALMERS DT 516		
COMBUSTIBLE	GP-1101	154711	ACEITE	G-31	5572425	ACEITE	G-33	215502
ACEITE	GP-43	905575	1601 con motor/WAUKESHA 6 WAKD			350 DE CABLE con motor/GMC 4-53		
668D con motor/DETROIT DIESEL 6V-53			ACEITE	G-31	5572425	ACEITE, DERIVACION (BY PASS)	G-31	5572425
ACEITE	G-33	215502	1800 con motor/CATERPILLAR D375			ACEITE	G-33	215502
COMBUSTIBLE, PRIMARIO	GP-26	FJ-2S	ACEITE	G-191	550484	COMBUSTIBLE, SECUNDARIO	G-1173	5573263
COMBUSTIBLE, SECUNDARIO	GP-27	3576061	1800SC con motor/CATERPILLAR D375			350 DE CABLE con motor/WAUKESHA 135 GZU		
ACEITE	GP-53	961172	ACEITE	G-191	550484	ACEITE	G-31	5572425
677C con motor/DETROIT DIESEL 4-53			1850 con motor/CATERPILLAR D353			35T DE CABLE con motor/CATERPILLAR		
ACEITE, CARTUCHO	G-33	215502	ACEITE	G-238	550485	ACEITE	G-238	550485
ACEITE, SELLADO	GP-53	961172	1850 con motor/CATERPILLAR D375			35T DE CABLE con motor/GMC 4-53		
COMBUSTIBLE, PRIMARIO	GP-92	1992217	ACEITE	G-238	550485	ACEITE	G-33	215502
COMBUSTIBLE, SECUNDARIO	GP-93	23518526	24 DE CABLE, 24T DE CABLE, 25 DE CABLE con motor/GMC 4-71			400 DE CABLE con motor/GMC 4-71		
677CGS con motor/DETROIT DIESEL 4-53			ACEITE, DERIVACION (BY PASS)	G-31	5572425	ACEITE, DERIVACION (BY PASS)	G-31	5572425
ACEITE	G-33	215502	ACEITE	G-33	215502	ACEITE	G-33	215502
ACEITE	GP-53	961172	COMBUSTIBLE, SECUNDARIO	G-1173	5573263	COMBUSTIBLE, SECUNDARIO	G-1173	5573263
COMBUSTIBLE	GP-92	1992217	3 1/4 IN			400T DE CABLE con motor/WAUKESHA 135 GZU		
COMBUSTIBLE	GP-93	23518526	COMBUSTIBLE, SECUNDARIO	G-1175	5574508	ACEITE	G-31	869688
880 con motor/CUMMINS V903C			7 3/8 IN			400T DE CABLE con motor/WAUKESHA 6 WAKD		
ACEITE, CARTUCHO	G-566	257528	24, 25 con motor/GMC 3-71			ACEITE	G-31	5572425
COMBUSTIBLE	GP-1101	154711	ACEITE, DERIVACION (BY PASS)	G-31	869688	44 SOBRE ORUGAS con motor/CATERPILLAR D318G		
ACEITE, SELLADO	GP-53	961172	ACEITE	G-33	215502	ACEITE	G-191	550484
ACEITE	G-500	949098	COMBUSTIBLE, SECUNDARIO	G-1173	5573263	44 SOBRE ORUGAS con motor/CATERPILLAR D320		
ACEITE, DERIVACION (BY PASS)	G-750	947293	2400 con motor/CATERPILLAR D397			ACEITE	G-191	550484
880 con motor/DETROIT DIESEL 8V-71			ACEITE	G-238	550485	44 SOBRE ORUGAS con motores/ALLIS CHALMERS 10000, ALLIS CHALMERS DT 516		
ACEITE, CARTUCHO	G-33	215502	250 con motor/CATERPILLAR D320			ACEITE	G-33	215502
COMBUSTIBLE, PRIMARIO	GP-26	FJ-2S	ACEITE	G-191	550484	44 SOBRE ORUGAS con motores/GMC 3-71, GMC 4-71		
COMBUSTIBLE, SECUNDARIO	GP-27	3576061	250 con motores/GMC 3-71, GMC 4-71			ACEITE	G-31	5572425
ACEITE, SELLADO	GP-53	961172	ACEITE	G-31	5572425	ACEITE	G-33	215502
			ACEITE	G-33	215502	COMBUSTIBLE	G-1173	5573263
			COMBUSTIBLE	G-1173	5573263	45T DE CABLE con motor/CATERPILLAR		
			250TS con motor/CATERPILLAR D320			ACEITE	G-238	550485
			ACEITE	G-191	550484	45T DE CABLE con motor/GMC 4-53		
			250TS, 34 SOBRE ORUGAS con motores/GMC 3-71, GMC 4-71			ACEITE	G-33	215502
			ACEITE	G-31	5572425	50, 60 con motores/IHC UD236, IHC UD282		
			ACEITE	G-33	215502	ACEITE	G-335	279994-R91
			COMBUSTIBLE	G-1173	5573263			

CLARK

EXCAVADORAS

100 con motor/GMC 4-71		
ACEITE, DERIVACION (BY PASS)	G-31	5572425
ACEITE	G-33	215502
COMBUSTIBLE, SECUNDARIO	G-1173	944408
1201 con motor/WAUKESHA 135 GZU		
ACEITE	G-31	5572425
1201 con motor/WAUKESHA 6 WAKD		
COMBUSTIBLE, SECUNDARIO	G-1176	4367714
1250 con motor/ALLIS CHALMERS 8 DAS 1125		
COMBUSTIBLE, SECUNDARIO	G-1175	DE62633
1250 con motor/CATERPILLAR D353		
ACEITE	G-238	550485

MARCA-MODELO-MOTOR MAKE-MODEL-ENGINE	GONHER GONHER	OEM OEM	MARCA-MODELO-MOTOR MAKE-MODEL-ENGINE	GONHER GONHER	OEM OEM	MARCA-MODELO-MOTOR MAKE-MODEL-ENGINE	GONHER GONHER	OEM OEM
CLARK (continuación)			CLARK (continuación)			CLARK (continuación)		
EXCAVADORAS			EXCAVADORAS			GRÚAS		
500T con motor/WAUKESHA 6 WAKD			703 con motor/WAUKESHA 6 WAKD			510 con motor/GMC 6V-53		
ACEITE	G-31	869688	COMBUSTIBLE, SECUNDARIO	G-1176	4367714	ACEITE, DERIVACION (BY PASS)	G-31	5572425
500T DE CABLE con motor/WAUKESHA 135 GZU			80 con motor/GMC 4-53			TRANSMISION	G-33	215502
ACEITE	G-31	869688	ACEITE	G-33	215502	COMBUSTIBLE, SECUNDARIO	G-1173	5573263
60 RETROEXCAVADORA con motor/CONTINENTAL F244 A GASOLINA			802, 803 con motor/CATERPILLAR D337			54 MOVIL con motores/WAUKESHA 140 GK, WAUKESHA 145 GK, WAUKESHA 148 DB		
AIRE	GA-16	1803991	ACEITE	G-238	550485	COMBUSTIBLE	G-1176	944475
600T con motor/CATERPILLAR D326			802, 803 con motores/GMC 6-110, GMC 6-71			54T MOVIL con motores/WAUKESHA 148 DB, WAUKESHA 140 GK, WAUKESHA 145 GK		
ACEITE	G-238	550485	ACEITE	G-31	869688	COMBUSTIBLE	G-1176	944475
600T con motor/GMC 6-71			ACEITE	G-33	215502	550TC con motores/CUMMINS, DETROIT DIESEL		
ACEITE, DERIVACION (BY PASS)	G-31	869688	COMBUSTIBLE, SECUNDARIO	G-1173	5573263	TRANSMISION	G-33	215502
ACEITE	G-33	215502	85T con motor/ALLIS CHALMERS 16000			55T MOVIL con motores/WAUKESHA 140 GK, WAUKESHA 145 GK, WAUKESHA 148 DB		
COMBUSTIBLE, SECUNDARIO	G-1175	5574508	ACEITE	G-31	869688	COMBUSTIBLE	G-1176	944475
600T con motor/WAUKESHA 135 GZU			ACEITE	G-33	215502	65 con motor/CATERPILLAR D333		
ACEITE	G-31	869688	COMBUSTIBLE, SECUNDARIO	G-1175	5574508	ACEITE	G-191	550484
600T con motor/WAUKESHA 6 WAKD			COMBUSTIBLE, PRIMARIO	G-1176	4367714	700HC, 700TC, 765SCM, 780CM, 990TC con motor/CUMMINS		
ACEITE	G-31	869688	COMBUSTIBLE, DERIVACION (BY PASS)	G-500	949098	TRANSMISION	G-33	215502
604 con motor/WAUKESHA 135 GZU			945 con motor/GMC 6-71			714SP con motor/DETROIT DIESEL 4-53		
ACEITE	G-31	869688	ACEITE	G-33	215502	TRANSMISION	G-33	215502
604 con motor/WAUKESHA 6 WAKD			945 con motor/GMC 8V-71N			714SP con motores/CUMMINS, DETROIT DIESEL, IHC UV345		
COMBUSTIBLE, SECUNDARIO	G-1176	4367714	ACEITE	G-33	215502	TRANSMISION	G-33	215502
604, 703 con motor/CATERPILLAR D326			HV-4 RETROEXCAVADORA con motor/KOHLER K91			AIRE	GA-403	8994216
ACEITE	G-238	550485	AIRE	GA-11	230840	AIRE	GAK-403	888936
604, 85T con motor/GMC 6-71			L1250 con motor/GMC 6-110			720CM, 736CM, 615, 709, 710, 712, 714, 720 con motores/CUMMINS, DETROIT DIESEL		
ACEITE, DERIVACION (BY PASS)	G-31	869688	ACEITE	G-31	5572425	TRANSMISION	G-33	215502
ACEITE	G-33	215502	ACEITE	G-33	215502	72005 con motor/CUMMINS		
COMBUSTIBLE, SECUNDARIO	G-1175	5574508	COMBUSTIBLE	G-1173	5573263	TRANSMISION	G-33	215502
64, 65 con motor/CATERPILLAR D318G			L190 con motor/CUMMINS			72005 con motor/DETROIT DIESEL 6-53		
ACEITE	G-191	550484	COMBUSTIBLE	GPP-14	949095	TRANSMISION	G-33	215502
64, 65 con motor/WAUKESHA 6 WAKD			ACEITE	GP-53	961172	75C con motor/CATERPILLAR D333C		
ACEITE	G-31	869688	ACEITE, DERIVACION (BY PASS)	GP-57	963023	ACEITE	G-191	550484
65 con motor/ALLIS CHALMERS 11000			COMBUSTIBLE, SEPARADOR DE AGUA	GPP-11	3308638	7700, 7707, 1500C, 2400B con motor/CUMMINS		
ACEITE	G-6	4998842	AGUA	GP-2071W	949418	TRANSMISION	G-33	215502
ACEITE	G-33	215502	MODELOS con motor/CUMMINS			75005 con motor/CUMMINS		
COMBUSTIBLE, SECUNDARIO	G-1173	5573263	ACEITE	G-566	257528	TRANSMISION	G-33	215502
65SC, 65T con motor/CATERPILLAR D318G			COMBUSTIBLE	G-1143	139097	7700, 7707, 1500C, 2400B con motor/CUMMINS		
ACEITE	G-191	550484	ACEITE	GP-14	152499	TRANSMISION	G-33	215502
65SC, 65T con motor/WAUKESHA 6 WAKD			COMBUSTIBLE	GPP-14	949095	CLARK		
ACEITE	G-31	869688	COMBUSTIBLE	GP-1101	154711	MONTACARGAS		
700 RETROEXCAVADORA con motor/CONTINENTAL F244-388 A GASOLINA			ACEITE	GP-53	961172	200L con motor/CONTINENTAL		
AIRE	GA-18	896056	COMBUSTIBLE	GP-55	961657	HIDRAULICO	G-6	871077
703 con motor/GMC 6-71			COMBUSTIBLE	GPP-11	3308638	235 con motor/A DIESEL		
ACEITE, DERIVACION (BY PASS)	G-31	869688	AIRE	GA-39	255963	TRANSMISION	GP-1	990937
ACEITE	G-33	215502	ACEITE	G-750	947293	ACEITE, DERIVACION (BY PASS)	GP-50	990936
COMBUSTIBLE, SECUNDARIO OPCIONAL	G-1175	5574508	CLARK			AIRE	GA-33	3493878
703 con motor/WAUKESHA 135 GZU			GRÚAS			310 con motor/GMC		
ACEITE	G-31	869688	3420 con motor/A DIESEL			ACEITE	G-33	215502
			TRANSMISION	G-33	215502			
			450TC con motores/CUMMINS, DETROIT DIESEL					
			TRANSMISION	G-33	215502			

MARCA-MODELO-MOTOR MAKE-MODEL-ENGINE	GONHER GONHER	OEM OEM	MARCA-MODELO-MOTOR MAKE-MODEL-ENGINE	GONHER GONHER	OEM OEM	MARCA-MODELO-MOTOR MAKE-MODEL-ENGINE	GONHER GONHER	OEM OEM
CLARK (continuación)			CLARK (continuación)			CLARK (continuación)		
MONTACARGAS			MONTACARGAS			MONTACARGAS		
355 con motor/A DIESEL			ACEITE	GP-6811	129150-35151	C500-Y355 con motores/WAUKESHA D176 A GASOLINA, WAUKESHA D176 LPG		
TRANSMISION	GP-1	990937				ACEITE	GP-50	990936
ACEITE	GP-50	990936	C25B con motor/A DIESEL					
AIRE	GA-33	3493878	ACEITE	GP-50	990936	C500-Y685 con motores/CONTINENTAL F227 LPG (S/N 2254-5196), CONTINENTAL F227 LPG (S/N 4130-5196), CONTINENTAL F227 S/N 2254-5196		
						ACEITE	GP-50	990936
35A con motor/FORD 220 DIESEL			C25B con motor/CONTINENTAL					
ACEITE	G-813	EPN-6731-B	ACEITE	GP-1	945928	C60 con motor/CONTINENTAL	G-31	869688
						ACEITE		
35A con motor/GMC 3-53			C25B5, C25BP con motor/A DIESEL					
ACEITE, 9 IN	G-33	215502	ACEITE	GP-50	990936	C60B, C60D, CF60, CF60D, CFY60 con motor/A DIESEL		
ACEITE, 5 9/16 IN	G-119	5574978				ACEITE	GP-50	990936
COMBUSTIBLE, SECUNDARIO	G-1173	5573263	C25P con motor/CONTINENTAL			AIRE, SIN ASPAS	GA-33	889098
			ACEITE	GP-1	945928	AIRE	GAK-16	886525
35A con motor/GMC 3-55			C25SY con motor/A DIESEL					
ACEITE	G-33	215502	ACEITE	GP-50	990936	C65RC con motor/A DIESEL		
ACEITE	G-119	5574978				ACEITE	GP-50	990936
COMBUSTIBLE	G-1173	5573263	C30, C30B con motor/A DIESEL					
COMBUSTIBLE	G-1174	5574961	ACEITE	GP-50	990936	C70, C70D, C80, C80D con motor/A DIESEL		
						ACEITE	GP-50	990936
6000 SERIES, 7000 SERIES, 8000 SERIES con motor/A DIESEL			C300-356 con motores/CONTINENTAL F163 LPG, CONTINENTAL F163 S/N 1526-1546					
ACEITE	GP-24	142066	ACEITE	GP-50	990936	CF20, CF25 con motor/CONTINENTAL Y112 A GASOLINA		
						ACEITE	GP-50	990936
665D con motor/DETROIT DIESEL 3-53			C30D con motor/YANMAR 4TNE94					
ACEITE	G-119	5574978	ACEITE	GP-6811	129150-35151	CF30B, CF40 con motor/A DIESEL		
COMBUSTIBLE, PRIMARIO	GP-92	1992217				ACEITE	GP-50	990936
COMBUSTIBLE, SECUNDARIO	GP-93	23518526	C40, C50B con motor/A DIESEL					
ACEITE	GP-43	905575	ACEITE	GP-50	990936	CF30B-50B con motor/CONTINENTAL Y112		
AIRE, PRIMARIO	GA-360	1990248				TRANSMISION	GP-1	990937
AIRE, SECUNDARIO	GA-361	1993689	C430 con motor/A DIESEL					
			TRANSMISION	GP-1	990937	CF70, CF70D, CF80, CF80D con motor/A DIESEL		
665D con motor/DETROIT DIESEL 3-53T						ACEITE	GP-50	990936
COMBUSTIBLE, PRIMARIO	GP-92	1992217	C500 con motor/A DIESEL					
COMBUSTIBLE, SECUNDARIO	GP-93	23518526	TRANSMISION	GP-1	945928	CFY150, CFY200SD, CFY160, CFY180BD, CFY200, CFY200L, CFY200LD, CFY200S con motor/A DIESEL		
ACEITE	GP-43	905575	ACEITE, DERIVACION (BY PASS)	GP-50	990936	ACEITE	G-33	215502
			COMBUSTIBLE	G-296	3995315	CFY20 con motor/A DIESEL		
666D con motor/DETROIT DIESEL 4-53N			COMBUSTIBLE	G-296-B	3995315	ACEITE	GP-50	990936
ACEITE	GP-53	961172	AIRE, SIN ASPAS	GA-33	2353816			
COMBUSTIBLE, PRIMARIO	GP-92	1992217				CFY20B-50B con motor/CONTINENTAL Y112		
COMBUSTIBLE, SECUNDARIO	GP-93	23518526	C500-235 con motores/CONTINENTAL Y112 A GASOLINA, CONTINENTAL Y112 LPG			ACEITE	GP-50	990936
			ACEITE	GP-50	990936			
685 con motor/A DIESEL			C500-335 con motores/WAUKESHA D155 A GASOLINA, WAUKESHA D155 LPG			CFY225D, CFY250D con motor/A DIESEL		
TRANSMISION	GP-1	990937	ACEITE	GP-50	990936	TRANSMISION	G-33	215502
ACEITE, DERIVACION (BY PASS)	GP-50	990936						
AIRE, SIN ASPAS	GA-33	889098	C500-685 con motor/CONTINENTAL F227 A GASOLINA			CFY25B con motor/A DIESEL		
AIRE	GAK-16	886525	ACEITE	GP-50	990936	ACEITE, DERIVACION (BY PASS)	GP-50	990936
915 con motor/A DIESEL			C500-685 con motor/CONTINENTAL F227 LPG			CFY30B, CFY50B, CFYR40B con motor/A DIESEL		
TRANSMISION	GP-1	990937	ACEITE	GP-50	990936	ACEITE	GP-50	990936
C100, C120 con motor/A DIESEL			C500-F235 con motores/CONTINENTAL Y112 LPG (S/N 2244-2830), CONTINENTAL Y112 S/N 2244-2830			CFY70, CFY80 con motor/A DIESEL		
ACEITE	GP-50	990936	ACEITE	GP-50	990936	ACEITE	GP-50	990936
C120 con motor/CONTINENTAL			C500-FY235 con motor/CONTINENTAL F163 LPG (S/N 2267-2336)			CGC25 con motor/MITSUBISHI 4G64		
ACEITE	G-31	869688	ACEITE	GP-50	990936	ACEITE	GP-91	664478
C150 con motor/A DIESEL			C500-H355 con motores/WAUKESHA D176 LPG (S/N 2505-2817), WAUKESHA D176 S/N 2505-2817			CH120, CH60 con motor/CONTINENTAL		
ACEITE	GP-50	990936	ACEITE	GP-50	990936	ACEITE	G-31	869688
C20 con motor/A DIESEL						CH140, CH200 con motor/A DIESEL		
ACEITE	GP-50	990936				ACEITE	GP-50	990936
						ACEITE, DERIVACION (BY PASS)	GP-50	990936
C200 con motor/A DIESEL						AIRE	GAK-16	886525
ACEITE	GP-50	990936						
C20D, C25D con motor/YANMAR 4TNE94								

MARCA-MODELO-MOTOR MAKE-MODEL-ENGINE	GONHER GONHER	OEM OEM	MARCA-MODELO-MOTOR MAKE-MODEL-ENGINE	GONHER GONHER	OEM OEM	MARCA-MODELO-MOTOR MAKE-MODEL-ENGINE	GONHER GONHER	OEM OEM
CLARK (continuación)			CLARK (continuación)			CLARK (continuación)		
MONTACARGAS			MONTACARGAS			MONTACARGAS		
CH60, CH60D con motor/A DIESEL			CMP50DS con motor/PERKINS 1004.42			ET60D con motor/JOHN DEERE		
ACEITE	GP-50	990936	ACEITE	GP-1	992221	ACEITE	GP-14	152499
AIRE, SIN ASPAS	GA-33	889098						
AIRE	GAK-16	886525	CMP50SD con motor/PERKINS 1004.42			F235 con motor/A DIESEL		
			ACEITE	GP-1	990937	TRANSMISION	GP-1	990937
CH65RC con motor/A DIESEL			CMP60D, CMP70D, CMP75D, CPM50D con motor/PERKINS 1004.42			ACEITE, DERIVACION (BY PASS)	GP-50	990936
ACEITE	GP-50	990936	ACEITE	GP-1	992221	AIRE	GA-33	3493878
ACEITE, DERIVACION (BY PASS)	GP-50	990936						
AIRE, SIN ASPAS	GA-33	889098	CS30 con motor/A DIESEL			FY235 con motor/A DIESEL		
			ACEITE, DERIVACION (BY PASS)	GP-50	990936	TRANSMISION	GP-1	990937
CHY120, C100, C120, C60, CH100, CH120, CH60 con motor/GMC 3-53			CY 150 con motor/HERCULES JXC			ACEITE, DERIVACION (BY PASS)	GP-50	990936
ACEITE	G-33	215502	ACEITE	G-33	215502	AIRE	GA-33	3493878
ACEITE	G-119	5574978						
COMBUSTIBLE	G-1173	5573263	CY100, CY100B, CY100D, CY120, CY120B, CY120D con motor/A DIESEL			GCS 20-31 con motores/MITSUBISHI 4G54, WAUKESHA D176		
COMBUSTIBLE, SECUNDARIO OPCIONAL	G-1175	5574508	ACEITE, DERIVACION (BY PASS)	GP-50	990936	ACEITE	GP-40	909213
CHY160 con motor/GMC 4-53			CY120 con motor/GMC 3-53			GCS15-17 con motor/A DIESEL		
ACEITE	G-33	215502	ACEITE	G-33	215502	ACEITE	GP-40	909213
COMBUSTIBLE	G-1173	5573263	ACEITE	G-119	5574978	GCS20-30 con motor/MITSUBISHI 4G54		
COMBUSTIBLE, SECUNDARIO OPCIONAL	G-1175	5574508	COMBUSTIBLE	G-1173	5573263	ACEITE	GP-40	909213
			COMBUSTIBLE, SECUNDARIO OPCIONAL	G-1175	5574508	GCS20-30 con motor/WAUKESHA D176		
CHY180WP con motor/GMC 4-53			CY150, CY160BD, CY180B, CY200L, CY200LD, CY200S, CY200SD, CY225, CY250, CY300 con motor/A DIESEL			ACEITE	GP-50	990936
ACEITE	G-33	215502	TRANSMISION	G-33	215502	GCX25 con motor/A DIESEL		
COMBUSTIBLE	G-1173	5573263				AIRE	GA-26	886525
COMBUSTIBLE	G-1174	5574961	CY160 con motor/GMC 4-53					
COMBUSTIBLE	G-1175	5574508	ACEITE	G-33	215502	GPX 30 con motor/A DIESEL		
			COMBUSTIBLE	G-1173	5573263	ACEITE	GP-1	992221
CHY200, CHY70, CHY70PD, CHY80, CHY80PD, CH100, CH120, CH70, CH70S, CH80, CH80S, CHY100, CHY120 con motor/A DIESEL			COMBUSTIBLE, SECUNDARIO OPCIONAL	G-1175	5574508	AIRE	GA-16	1803991
ACEITE	GP-50	990936				AIRE	GAK-16	886525
			CY165 con motor/HERCULES JXC			GPX30 con motor/A DIESEL		
CHY60, CHY60D, CHY60PD con motor/A DIESEL			TRANSMISION	G-33	215502	TRANSMISION	GP-1	990937
ACEITE	GP-50	990936						
AIRE, SIN ASPAS	GA-33	889098	CY20 con motor/A DIESEL			GPX40 con motor/PERKINS 1004.42		
AIRE	GAK-16	886525	ACEITE, DERIVACION (BY PASS)	GP-50	990936	ACEITE	GP-1	992221
						TRANSMISION	GP-1	990937
CHYWP160, CHYWP180B con motor/A DIESEL			CY200 con motor/HERCULES JXC			AIRE	GA-16	1803991
ACEITE	G-33	215502	ACEITE, DERIVACION (BY PASS)	GP-50	990936	AIRE	GAK-16	886525
CLARKLIFT 20 con motor/A DIESEL			CY20B-50B con motor/CONTINENTAL Y112			GPX50 con motor/A DIESEL		
AIRE	GA-44	1614059	TRANSMISION	GP-1	990937	ACEITE	GP-1	992221
						TRANSMISION	GP-1	990937
CLFR40B con motor/A DIESEL			CY25B, CY25BS con motor/A DIESEL			AIRE	GA-16	1803991
ACEITE	GP-50	990936	ACEITE, DERIVACION (BY PASS)	GP-50	990936	AIRE	GAK-16	886525
CLIPPER 2024 con motor/CONTINENTAL			CY30B, CYR40B, CY40, CY50B con motor/A DIESEL			H355D, H355PD con motor/A DIESEL		
AIRE, SIN ASPAS	GA-33	P122510	ACEITE, DERIVACION (BY PASS)	GP-50	990936	TRANSMISION	GP-1	990937
						ACEITE, DERIVACION (BY PASS)	GP-50	990936
CLR40B con motor/A DIESEL			CY60D, CY60PD con motor/A DIESEL			AIRE, SIN ASPAS	GA-33	3493878
ACEITE, DERIVACION (BY PASS)	GP-50	990936	ACEITE, DERIVACION (BY PASS)	GP-50	990936			
			AIRE, SIN ASPAS	GA-33	889098	H40, H50D, H40D, H50 con motor/A DIESEL		
CMO18D, CMP15D, CMP18D con motor/YANMAR 4TNE88			AIRE	GAK-16	886525	ACEITE, DERIVACION (BY PASS)	GP-50	990936
ACEITE	GP-6811	129150-35151						
			CY70, CY70D, CY80, CY80D con motor/A DIESEL			H685, H685D, HY685 con motor/A DIESEL		
CMP20D, CMP20SD, CMP25D, CMP30D con motor/YANMAR 4TNE94			ACEITE, DERIVACION (BY PASS)	GP-50	990936	TRANSMISION	GP-1	990937
ACEITE	GP-6811	129150-35151				ACEITE, DERIVACION (BY PASS)	GP-50	990936
			CMP40D con motor/PERKINS 1004.42			AIRE, SIN ASPAS	GA-33	889098
ACEITE	GP-1	992221	ACEITE	GP-1	992221	AIRE	GAK-16	886525
CMP45D, CMP50D con motor/PERKINS 1004.42			DCS251 con motor/A DIESEL			H915, HY2030, HY2030D, HY2030DP, HY1015, HY1245D, HY1425, HY1625, HY1830, HY1830D con motor/A DIESEL		
ACEITE	GP-1	990937	ACEITE	GP-40	909213	TRANSMISION	G-33	215502

SERVICIO PESADO

MARCA-MODELO-MOTOR MAKE-MODEL-ENGINE	GONHER GONHER	OEM OEM
CLARK (continuación)		
MONTACARGAS		
HCL con motor/A DIESEL		
ACEITE	G-6	871077
HY 685 con motor/A DIESEL		
ACEITE	GP-50	990936
HY355, HY355D, HY355PD con motor/A DIESEL		
TRANSMISION	GP-1	990937
ACEITE	GP-50	990936
AIRE	GA-33	3493878
HY40, HY50D, HY40D, HY50 con motor/A DIESEL		
ACEITE, DERIVACION (BY PASS)	GP-50	990936
IT30, IT355, IT40B con motor/A DIESEL		
ACEITE	GP-1	992221
ACEITE, DERIVACION (BY PASS)	GP-50	990936
TRANSMISION	GP-171	992221
AIRE, SIN ASPAS	GA-33	889098
IT40 con motor/A DIESEL		
ACEITE	GP-1	992221
ACEITE, DERIVACION (BY PASS)	GP-50	990936
TRANSMISION	GP-171	992221
AIRE	GA-16	1803991
AIRE, SIN ASPAS	GA-33	2353816
AIRE	GAK-16	886525
IT50 con motor/A DIESEL		
ACEITE	GP-1	992221
ACEITE	GP-50	990936
TRANSMISION	GP-171	992221
IT50BD con motor/PERKINS		
ACEITE	G-870	3213711
ACEITE	G-871	26540055
COMBUSTIBLE	G-11816	3725648
AIRE	GA-16	1803991
AIRE	GAK-16	886525
IT581, TFY40, IT60, IT70, IT80, TFY30 con motor/A DIESEL		
ACEITE	GP-1	992221
ACEITE	GP-50	990936
TRANSMISION	GP-171	992221
AIRE, SIN ASPAS	GA-33	889098
R600, R700 con motor/GMC 6057C		
ACEITE	G-33	215502
ACEITE	G-119	5574978
COMBUSTIBLE, SECUNDARIO	G-1175	5574508
R600, R700, RHY SERIES con motor/DETROIT DIESEL		
ACEITE	G-31	869688
RHY SERIES con motor/GMC 4-53		
ACEITE	G-33	215502
ACEITE	G-119	5574978
COMBUSTIBLE	G-1173	5573263
COMBUSTIBLE	G-1174	5574961
COMBUSTIBLE, SECUNDARIO OPCIONAL	G-1175	5574508
SD-UTE con motor/A DIESEL		
ACEITE	G-31	869688

MARCA-MODELO-MOTOR MAKE-MODEL-ENGINE	GONHER GONHER	OEM OEM
CLARK (continuación)		
MONTACARGAS		
UT60 con motor/JOHN DEERE 219		
ACEITE	GP-14	152499
COMBUSTIBLE	G-296	3995315
COMBUSTIBLE	G-295	AR50041
COMBUSTIBLE	G-296-B	3995315
UT60 con motor/JOHN DEERE 4219		
ACEITE	GP-14	152499
UTILITRUCK 120 con motor/CONTINENTAL HD260		
ACEITE	G-31	869688
Y1015 con motor/A DIESEL		
ACEITE	G-33	215502
TRANSMISION	GP-1	990937
ACEITE, DERIVACION (BY PASS)	GP-50	990936
Y1015PD con motor/A DIESEL		
TRANSMISION	G-33	215502
TRANSMISION	GP-1	990937
ACEITE, DERIVACION (BY PASS)	GP-50	990936
Y1425, Y1425D, Y1625, Y1830, Y1830D, Y2030, Y2030D, Y2030DP con motor/A DIESEL		
TRANSMISION	G-33	215502
Y235, Y355, Y355D, Y355PD con motor/A DIESEL		
ACEITE, DERIVACION (BY PASS)	GP-50	990936
Y40, Y40D, Y50, Y50D con motor/A DIESEL		
ACEITE, DERIVACION (BY PASS)	GP-50	990936
Y685 con motor/A DIESEL		
TRANSMISION	GP-1	990937
ACEITE, DERIVACION (BY PASS)	GP-50	990936
AIRE, SIN ASPAS	GA-33	889098
AIRE	GAK-16	886525
YARDLIFT 150, YARDLIFT 6024, YARDLIFT 2024, YARDLIFT 4024 con motor/CONTINENTAL		
AIRE, SIN ASPAS	GA-33	889098
CLARK		
TRACTORES		
20 DE PATIO con motor/FORD INDUSTRIAL 6-240		
ACEITE	GP-1	990937
225 DE PATIO con motor/FORD M477		
ACEITE	G-5000	B8QH-6714-A
30 DE PATIO con motor/FORD 6-240		
ACEITE	GP-1	990937
300 DE PATIO con motor/FORD M477		
ACEITE	G-5000	B8QH-6714-A
375 TRUCTRACTOR MONTACARGAS, 380 TRUCTRACTOR MONTA-CARGAS con motor/GMC		
ACEITE	G-33	215502
40 DE PATIO, 50 DE PATIO con motor/FORD 6-240		
ACEITE	GP-1	945928

MARCA-MODELO-MOTOR MAKE-MODEL-ENGINE	GONHER GONHER	OEM OEM
CLARK (continuación)		
TRACTORES		
CT20B DE PATIO, CT20D DE PATIO, CT30 DE PATIO, CT30B DE PATIO, CT620B DE PATIO, CT630B DE PATIO, CT66 DE PATIO, CTF20B DE PATIO, CTF30B DE PATIO, CTF6 DE PATIO con motor/A DIESEL		
ACEITE, DERIVACION (BY PASS)	GP-50	990936
AIRE	GA-105	889289
AIRE	GAK-16	886525
CT40D DE PATIO, CT50B DE PATIO, CT50D DE PATIO, CT640B DE PATIO, CT650B DE PATIO, CTF40B DE PATIO, CTF50B DE PATIO, CT1623551 DE PATIO, CT40B DE PATIO con motor/A DIESEL		
AIRE	GA-105	889289
CLEVELAND		
NIVELADORAS		
D560, D562, D565, D581, D600, D640, D650, D680 con motor/CUMMINS, DETROIT DIESEL		
TRANSMISION	G-6	FL515
CMI		
COMPACTADORAS		
3-70C con motor/CUMMINS N14		
ACEITE	GP-3000	3318853
COACH & EQUIPMENT		
CAMIONES, TRACTOCAMIONES Y AUTOBUSES		
CONVENTIONAL con motor/INTERNATIONAL DT466E		
COMBUSTIBLE	GP-78	1822588C1
ACEITE	GP-152	1819452C1
AIRE	GA-209	476741C1
CONVENTIONAL con motor/INTERNATIONAL VT365		
SEPARADOR DE COMBUSTIBLE	G-862	1825864C92
ACEITE	G-3752	1844588C91
AIRE	GA-799R	3532799C1
CUT-AWAY CHASSIS con motor/FORD 6.0L TURBO DIESEL		
ACEITE	G-3752	3C3Z-6731-AA
CUT-AWAY CHASSIS con motor/FORD V10 6.8L GASOLINA		
ACEITE	GP-68	F1AZ-6731-BD
AIRE	GA-1615	F6ZZ-9601-A
COMBUSTIBLE	GG-986	F89Z-9155-A
CUT-AWAY CHASSIS con motor/FORD V8 5.4L		
ACEITE	GP-68	F1AZ-6731-BD
AIRE	GA-1615	F6ZZ-9601-AA
COMBUSTIBLE	GG-986	F89Z-9155AA
CUT-AWAY CHASSIS con motor/GM 5.7L GASOLINA		
ACEITE	GP-205	25160561
AIRE	GA-392	25042562
AIRE	GA-192	6419892
AIRE	GA-413R	15153904
COMBUSTIBLE	GG-46	25121792
COMBUSTIBLE	GG-581	25121801
CUT-AWAY CHASSIS con motor/GM 6.5L DIESEL		
ACEITE	GP-205	25160561
COMBUSTIBLE	GPP-419	12552214
AIRE	GA-392	25042562
CUT-AWAY CHASSIS con motor/GM 7.4L GASOLINA		
ACEITE	GP-408	25324052
ACEITE	GP-205	25160561

MARCA-MODELO-MOTOR	GONHER	OEM
MAKE-MODEL-ENGINE	GONHER	OEM

COACH&EQUIPMENT(continuación)		
CAMIONES, TRACTOCAMIONES Y AUTOBUSES		
AIRE	GA-59	6484235
AIRE	GA-392	25042562
COMBUSTIBLE	GG-46	25121792
COMBUSTIBLE	GG-581	25121801
CUT-AWAY CHASSIS con motor/GM V8 6.6L DURAMAX		
AIRE	GA-135	2467368
CUT-AWAY CHASSIS con motor/GM V8 8.1L		
ACEITE	GP-408	25324052
AIRE	GA-135	2467368
AIRE	GA-348	25313349
COMBUSTIBLE	GG-46	25171792

COLEMAN

GENERADORES

CCLTA10-250SQ con motor/CUMMINS M11		
ACEITE	GP-3000	3318853
CNTA855-350SQ con motor/CUMMINS N14		
ACEITE	GP-3000	3318853

COLLINS

CAMIONES, TRACTOCAMIONES Y AUTOBUSES

BANTAM con motor/GM 4.8L		
ACEITE, 2006-EN ADELANTE	GP-406	89017524
ACEITE, 2003-2005	GP-44	6439857
AIRE	GA-413R	15153904
GASOLINA, 2003-2005 (ROSCA EN AMBOS EXTREMOS)		
	GG-46	25055046
GASOLINA, 2003-2005 (ROSCA EN UN EXTREMO)		
	GG-66	25121293
BANTAM con motor/GM 6.0L		
ACEITE, 2007 EN ADELANTE	GP-406	89017524
ACEITE, 2003-2006	GP-44	6439857
AIRE	GA-413R	15153904
GASOLINA, 2003-2005 (ROSCA EN AMBOS EXTREMOS)		
	GG-46	25055046
GASOLINA, 2003-2005 (ROSCA EN UN EXTREMO)		
	GG-66	25121293
CUT-AWAY CHASSIS con motor/FORD 6.0L TURBO DIESEL		
ACEITE	G-3752	3C3Z-6731-AA
CUT-AWAY CHASSIS con motor/FORD 7.3L TURBO DIESEL		
COMBUSTIBLE, SEPARADOR DE AGUA	G-862	F81A-9N184-AB
COMBUSTIBLE, SEPARADOR DE AGUA	G-178	F4TZ-9N184-B
ACEITE	GP-562	F4TZ-6731-A
AIRE	GAVW-620	F5UZ-9601-A
CUT-AWAY CHASSIS con motor/FORD V8 5.4L		
ACEITE	GP-68	F1AZ-6731-BD
AIRE	GA-1615	F6ZZ-9601-A
COMBUSTIBLE	GG-986	F89Z-9155-A
CUT-AWAY CHASSIS con motor/GM 5.7L GASOLINA		
ACEITE	GP-205	25160561
AIRE	GA-392	25042562
AIRE	GA-192	6419892
AIRE	GA-413R	15153904
COMBUSTIBLE	GG-46	25121792
COMBUSTIBLE	GG-581	25121801

MARCA-MODELO-MOTOR	GONHER	OEM
MAKE-MODEL-ENGINE	GONHER	OEM

COLLINS (continuación)		
CAMIONES, TRACTOCAMIONES Y AUTOBUSES		
CUT-AWAY CHASSIS con motor/GM 6.5L DIESEL		
ACEITE	GP-205	25160561
COMBUSTIBLE	GPP-419	12552214
AIRE	GA-392	25042562
CUT-AWAY CHASSIS con motor/GM V8 6.6L DURAMAX		
AIRE	GA-135	2467368
CUT-AWAY CHASSIS con motor/GM V8 8.1L		
ACEITE	GP-408	25324052
AIRE	GA-135	2467368
AIRE	GA-348	25313349
COMBUSTIBLE	GG-46	25171792
CUT-AWAY CHASSIS con motores/GM V8 4.8L VORTEC, GM V8 6.0L VORTEC		
ACEITE	GP-44	89894215
COMBUSTIBLE, ROSCAS EN AMBOS EXTREMOS	GG-46	25171792
COMBUSTIBLE, ROSCA EN UN SOLO EXTREMO	GG-66	25121293
MID BUS con motor/GM 4.8L		
ACEITE, 2006 EN ADELANTE	GP-406	89017524
ACEITE, 2003-2005	GP-44	6439857
AIRE,)	GA-413R	15153904
GASOLINA, 2003-2005 (ROSCA EN AMBOS EXTREMOS)		
	GG-46	25055046
GASOLINA, 2003-2005 (ROSCA EN UN EXTREMO)		
	GG-66	25121293
MID BUS con motor/GM 6.0L		
ACEITE, 2007 EN ADELANTE	GP-406	89017524
ACEITE, 2003-2006	GP-44	6439857
AIRE,)	GA-413R	15153904
GASOLINA, 2003-2005 (ROSCA EN AMBOS EXTREMOS)		
	GG-46	25055046
GASOLINA, 2003-2005 (ROSCA EN UN EXTREMO)		
	GG-66	25121293
CONTINENTAL TELEDYNE		
MOTORES		
22R A GASOLINA, B371 A GASOLINA, B427 A GASOLINA, B6371 A GASOLINA, B6427 A GASOLINA, F226 A GASOLINA, F227 A GASOLINA, F244 A GASOLINA, F245 A GASOLINA, F6227 A GASOLINA, F6244 A GASOLINA, F6245 A GASOLINA, F66245 A GASOLINA, H227 A GASOLINA, H243 A GASOLINA, H260 A GASOLINA, K6227 A GASOLINA, K6290 A GASOLINA, K6330 A GASOLINA, L478 A GASOLINA, L6478 A GASOLINA, LD478 A DIESEL, LDS478 A DIESEL, M271 A GASOLINA, M290 A GASOLINA, M330 A GASOLINA, M6271 A GASOLINA, M6290 A GASOLINA, M6330 A GASOLINA, R513 A GASOLINA, R572 A GASOLINA, R602 A GASOLINA, R6513 A GASOLINA, R6572 A GASOLINA, R6602 A GASOLINA, S6749 A GASOLINA, S749 A GASOLINA, T371 A GASOLINA, T427 A GASOLINA, T6371 A GASOLINA, T6427 A GASOLINA, U501 A GASOLINA, U6501 A GASOLINA, V603 A GASOLINA, V8603 A GASOLINA		
ACEITE	G-31	R600L422
ED201 A DIESEL, ED208 A DIESEL, ED223 A DIESEL, ED233 A DIESEL, GD A DIESEL		
COMBUSTIBLE, PRIMARIO	G-1173	F3340
F124 A GASOLINA, F140 A GASOLINA, F162 A GASOLINA, F163 A GASOLINA, F186 A GASOLINA, F4124 A GASOLINA, F4140 A GASOLINA, F4162 A GASOLINA, F4163 A GASOLINA, F4262 A GASOLINA, F6186 A GASOLINA, G4193 A GASOLINA, Z145 A GASOLINA		
ACEITE, DERIVACION (BY PASS)	GP-50	F600L4340
F600 A GASOLINA		
AIRE	GA-105	F600F428

MARCA-MODELO-MOTOR	GONHER	OEM
MAKE-MODEL-ENGINE	GONHER	OEM

CONTINENTALTELEDYNE(continuación)		
MOTORES		
GD157 A DIESEL, RD572 A DIESEL, RD6572 A DIESEL, VD603 A DIESEL, VD8603 A DIESEL		
ACEITE	G-31	TD600L4000
HD A DIESEL, HD243 A DIESEL		
COMBUSTIBLE, SECUNDARIO	G-1173	F3340
HD260 A DIESEL		
ACEITE	G-31	R600L422
ACEITE	G-33	PC33
COMBUSTIBLE, SECUNDARIO	G-1173	F3340
COMBUSTIBLE	GP-110	PC1104
HD277 A DIESEL		
ACEITE	G-33	PC33
COMBUSTIBLE, SECUNDARIO	G-1173	F3340
COMBUSTIBLE	GP-110	PC1104
J382 A GASOLINA, J403 A GASOLINA, JD382 A DIESEL		
ACEITE	G-33	PC33
JD342 A DIESEL, JD403 A DIESEL		
ACEITE	G-33	PC33
COMBUSTIBLE, PRIMARIO	G-1173	F3340
COMBUSTIBLE, SECUNDARIO	G-1173	F3340
N4062 A GASOLINA, Y4069 A GASOLINA, Y4091 A GASOLINA, Y4112 A GASOLINA		
ACEITE	GP-50	F600L4340
RD600 A DIESEL, TD600 A DIESEL		
COMBUSTIBLE	G-1176	200790
S6820 A GASOLINA, S820 A GASOLINA		
ACEITE, DERIVACION (BY PASS)	G-31	R600L422
SD6802 A DIESEL, SD802 A DIESEL		
COMBUSTIBLE, SECUNDARIO	G-1176	200790
TD427 A DIESEL, TD6427 A DIESEL		
ACEITE	G-31	R600L422
COMBUSTIBLE, SECUNDARIO	G-1173	F3340
COMBUSTIBLE	GP-110	PC1104
TM13 A GASOLINA, TM20 A GASOLINA, TM27 A GASOLINA		
ACEITE	GP-1	F600L3750
TMD27 A DIESEL		
ACEITE	GP-1	F600L3750
COMBUSTIBLE	G-296	PC1191
COMBUSTIBLE, SECUNDARIO	G-296-B	PC1191
CORBEIL BUS		
CAMIONES, TRACTOCAMIONES Y AUTOBUSES		
CUT-AWAY CHASSIS con motor/FORD 7.3L TURBO DIESEL		
SEPARADOR DE COMBUSTIBLE	G-862	F81Z-9N184-AA
ACEITE	GP-562	F4TZ-6731-A
AIRE	GAVW-620	F5UZ-9601-A
CUT-AWAY CHASSIS con motor/GM 5.7L GASOLINA		
ACEITE	GP-205	25160561
AIRE	GA-392	25042562
AIRE	GA-192	6419892
AIRE	GA-413R	15153904

SERVICIO PESADO

MARCA-MODELO-MOTOR MAKE-MODEL-ENGINE	GONHER GONHER	OEM OEM	MARCA-MODELO-MOTOR MAKE-MODEL-ENGINE	GONHER GONHER	OEM OEM	MARCA-MODELO-MOTOR MAKE-MODEL-ENGINE	GONHER GONHER	OEM OEM
CORBEIL BUS (continuación)			CUMMINS (continuación)			CUMMINS (continuación)		
CAMIONES, TRACTOCAMIONES Y AUTOBUSES			MOTORES			MOTORES		
COMBUSTIBLE	GG-46	25121792	COMBUSTIBLE, SEPARADOR DE AGUA	GPP-11	156172	A1700, A2000, A2300T		
COMBUSTIBLE	GG-581	25121801	ACEITE, DOBLE FLUJO	GP-3000	3318853	COMBUSTIBLE, SEPARADOR DE AGUA	GPP-1122	FS1235
CUT-AWAY CHASSIS con motor/GM 6.5L DIESEL			4A2.3 MARINO, 4AT2.3 MARINO			B3.3 (3.3L) A DIESEL		
ACEITE	GP-205	25160561	ACEITE	GP-68	1220550	ACEITE	GP-58	C600-211-2110
COMBUSTIBLE	GPP-419	12552214	COMBUSTIBLE	G-270	149-1802	C160 A DIESEL, C175 A DIESEL, CS180 A DIESEL, CT190 A DIESEL		
AIRE	GA-392	25042562	AIRE, SIN ASPAS	GA-16	AF25456K	ACEITE, CARTUCHO	G-566	158139
QUANTUM con motor/GM 4.8L			AIRE, CON ASPAS	GAK-16	140-1204	COMBUSTIBLE	GP-11	154709
ACEITE, 2006 EN ADELANTE	GP-406	89017524	AIRE, PRIMARIO	GAK-1532	P183224	COMBUSTIBLE, SEPARADOR DE AGUA	GPP-11	FS1212
ACEITE, 2003-2005	GP-44	6439857	4B3.9 A DIESEL, 4BT3.9 A DIESEL, 4BTA3.9 A DIESEL			AGUA	GP-2071W	299080
AIRE	GA-413R	15153904	COMBUSTIBLE, SECUNDARIO	GP-1122	3903640	ACEITE, DERIVACION (BY PASS)	G-500	256839
GASOLINA, 2003-2005 (ROSCA EN AMBOS EXTREMOS)	GG-46	25055046	COMBUSTIBLE, SEPARADOR DE AGUA	GPP-1122	3903202	ACEITE, DERIVACION (BY PASS)	G-750	256838
GASOLINA, 2003-2005 (ROSCA EN UN EXTREMO)	GG-66	25121293	COMBUSTIBLE, PRIMARIO	GPP-18	3903410	C8.3 A DIESEL		
QUANTUM con motor/GM 6.0L			ACEITE	GP-178	4429615	ACEITE, DOBLE FLUJO	GP-3001	3401544
ACEITE, 2007 EN ADELANTE	GP-406	89017524	ACEITE	GP-390	3903224	COMBUSTIBLE, SEPARADOR DE AGUA	GPP-1122	FS1251
ACEITE, 2003-2006	GP-44	6439857	4B3.9M MARINO, 4BT3.9M MARINO, 4BTA3.9M MARINO			COMBUSTIBLE, SEPARADOR DE AGUA	GPP-1022S	FS1022
AIRE	GA-413R	15153904	COMBUSTIBLE, SECUNDARIO	GP-1122	3903640	FLEET 270 A DIESEL, FORMULA 270 A DIESEL		
GASOLINA, 2003-2005 (ROSCA EN AMBOS EXTREMOS)	GG-46	25055046	COMBUSTIBLE, SIMPLE	GPP-1122	3903202	ACEITE, CARTUCHO PARA FLUJO TOTAL (FULL FLOW)	G-566	158139
GASOLINA, 2003-2005 (ROSCA EN UN EXTREMO)	GG-66	25121293	COMBUSTIBLE, PRIMARIO	GPP-18	3903410	COMBUSTIBLE	GP-1101	154711
			ACEITE	GP-390	3903224	ACEITE, SELLADO FLUJO TOTAL (FULL FLOW)	GP-53	299670
			6A3.4 A DIESEL, 6AT3.4 A DIESEL			ACEITE, SELLADO PARA DERIVACION (BY PASS)	GP-57	3313283
			ACEITE	GP-68	1220550	AGUA	GP-2071W	299080
			COMBUSTIBLE	G-270	1491802	AIRE	GA-37	3001690
			AIRE	GA-403	P184167	ACEITE, CARTUCHO PARA DERIVACION (BY PASS)	G-750	256838
			AIRE	GAK-403	705346	FORMULA 230 A DIESEL		
			6B5.9 A DIESEL, 6BT5.9 A DIESEL, 6BTA5.9 A DIESEL			ACEITE, FLUJO TOTAL (FULL FLOW)	G-566	158139
			COMBUSTIBLE, SEPARADOR DE AGUA	GP-1232	3834656	COMBUSTIBLE	GP-1101	154711
			COMBUSTIBLE, SECUNDARIO	GP-1122	3903640	AGUA	GP-2071W	299080
			COMBUSTIBLE, SEPARADOR DE AGUA	GPP-1122	3903202	AIRE	GA-37	3001690
			COMBUSTIBLE, PRIMARIO	GPP-18	3903410	ACEITE, DERIVACION (BY PASS)	G-750	256838
			ACEITE	GP-178	3903264	FORMULA 240 A DIESEL		
			6B5.9M MARINO, 6BT5.9M MARINO, 6BTA5.9M MARINO			COMBUSTIBLE	GP-1101	154711
			COMBUSTIBLE, SECUNDARIO	GP-1122	3903640	ACEITE, SELLADO	GP-53	299670
			COMBUSTIBLE, SIMPLE	GPP-1122	3903202	ACEITE, SELLADO PARA DERIVACION (BY PASS)	GP-57	3304232
			COMBUSTIBLE, PRIMARIO	GPP-18	3903410	AGUA	GP-2071W	3315116
			ACEITE	GP-178	3903264	ACEITE, CARTUCHO PARA DERIVACION (BY PASS)	G-750	256838
			6C8.3 A DIESEL, 6CT8.3 A DIESEL, 6CTA8.3 MARINO			FORMULA 250 A DIESEL		
			COMBUSTIBLE, SECUNDARIO	GP-1122	3903640	ACEITE, CARTUCHO	G-566	158139
			COMBUSTIBLE, SEPARADOR DE AGUA	GPP-1122	3903202	COMBUSTIBLE	GP-1101	154711
			ACEITE	GP-43	3313281	ACEITE, SELLADO	GP-53	299670
			ACEITE, DOBLE FLUJO	GP-3000	3825970	AGUA	GP-2071W	299080
			AGUA	GP-2071W	3315116	ACEITE, DERIVACION (BY PASS)	G-750	256838
			COMBUSTIBLE, PRIMARIO	GPP-18	3903410	FORMULA 290 A DIESEL		
			6C8.3M MARINO, 6CT8.3M MARINO			ACEITE, CARTUCHO PARA FLUJO TOTAL (FULL FLOW)	G-566	158139
			COMBUSTIBLE, SECUNDARIO	GP-1122	3903640	COMBUSTIBLE	GP-1101	154711
			COMBUSTIBLE, SIMPLE	GPP-1122	3903202	ACEITE, SELLADO FLUJO TOTAL (FULL FLOW)	GP-53	299670
			ACEITE, DOBLE FLUJO	GP-3000	3825970	AGUA	GP-2071W	299080
			COMBUSTIBLE, PRIMARIO	GPP-18	3903410	AIRE	GA-37	3001690
			88-SERIES BIG CAM IV A DIESEL			ACEITE, DERIVACION (BY PASS)	G-750	256838
			COMBUSTIBLE	GP-11	3315844	FORMULA 290 A DIESEL		
			AGUA	GP-2071W	3315116	ACEITE, CARTUCHO PARA FLUJO TOTAL (FULL FLOW)	G-566	158139
			COMBUSTIBLE	GPP-103	3831871S	COMBUSTIBLE	GP-1101	154711
						ACEITE, SELLADO FLUJO TOTAL (FULL FLOW)	GP-53	299670
						AGUA	GP-2071W	299080
						AIRE	GA-37	3001690
						ACEITE, DERIVACION (BY PASS)	G-750	256838

APLICACIONES SERVICIO PESADO
HEAVY DUTY APPLICATIONS



MARCA-MODELO-MOTOR MAKE-MODEL-ENGINE	GONHER GONHER	OEM OEM	MARCA-MODELO-MOTOR MAKE-MODEL-ENGINE	GONHER GONHER	OEM OEM	MARCA-MODELO-MOTOR MAKE-MODEL-ENGINE	GONHER GONHER	OEM OEM
CUMMINS (continuación)			CUMMINS (continuación)			CUMMINS (continuación)		
MOTORES			MOTORES			MOTORES		
FORMULA 300 A DIESEL			ISC SERIES A DIESEL, ISL A DIESEL, ISL SERIES (8.8L) A DIESEL			ACEITE, CARTUCHO PARA DERIVACION (BY PASS)	G-750	256838
COMBUSTIBLE	GPP-14	156172	ACEITE, DOBLE FLUJO	GP-3001	LF9009	KT1150-G A DIESEL, KT1150-GC A DIESEL, KT1150-GS A DIESEL, KT1150L A DIESEL, KT1150P450 A DIESEL, KTA1150G600 A DIESEL, KTA1150-G A DIESEL, KTA1150-GC A DIESEL, KTA1150-GS A DIESEL, KTA1150L A DIESEL, KTA1150P525 A DIESEL, KTA1550-G A DIESEL, KTA1550-GC A DIESEL, KTA1550-GS A DIESEL		
ACEITE, FLUJO TOTAL (FULL FLOW)	GP-53	3313287	ISL (8.9L) A DIESEL			COMBUSTIBLE	GP-1101	154711
ACEITE, SELLADO PARA DERIVACION (BY PASS)	GP-57	3313289	COMBUSTIBLE	GPP-1000	3329289	ACEITE	GP-53	299670
ACEITE, DOBLE FLUJO	GP-3000	3825970	ISL-G A GAS NATURAL			ACEITE, SELLADO PARA DERIVACION (BY PASS)	GP-57	3313283
AGUA	GP-2071W	3315116	ACEITE	GP-3000	3318853	AGUA, PRE-CHARGE	GP-1011Q	299080
ACEITE, CARTUCHO PARA DERIVACION (BY PASS)	G-750	256838	ISM (10.8 L) A DIESEL			AGUA, MANTENIMIENTO	GP-2071W	299080
FORMULA 315 A DIESEL			ACEITE	GP-9000	3406810	ACEITE, CARTUCHO PARA DERIVACION (BY PASS)	G-750	256838
COMBUSTIBLE	GP-1101	154711	COMBUSTIBLE	GPP-1003S	3406889	KT1150M MARINO, KT19M MARINO, KTA1150M MARINO		
ACEITE, FLUJO TOTAL (FULL FLOW)	GP-53	3313287	COMBUSTIBLE, SEPARADOR DE AGUA	GPP-1022S	3406889	COMBUSTIBLE	GPP-14	BM78254
ACEITE, SELLADO PARA DERIVACION (BY PASS)	GP-57	3313289	ISM SERIES A DIESEL, ISX SERIES A DIESEL			ACEITE, FLUJO TOTAL (FULL FLOW)	GP-53	299670
ACEITE, DOBLE FLUJO	GP-3000	3318853	COMBUSTIBLE, CARTUCHO	G-128	FS1029W	ACEITE, SELLADO PARA DERIVACION (BY PASS)	GP-57	3313283
AGUA	GP-2071W	3315116	ACEITE	GP-9000	3406810	COMBUSTIBLE, SEPARADOR DE AGUA	GPP-11	156172
ACEITE, CARTUCHO PARA DERIVACION (BY PASS)	G-750	256838	COMBUSTIBLE, SELLADO	GPP-1022S	3406889	AGUA	GP-2071W	299080
FORMULA 350 A DIESEL			ISX A DIESEL			ACEITE, CARTUCHO PARA DERIVACION (BY PASS)	G-750	256838
ACEITE, CARTUCHO PARA FLUJO TOTAL (FULL FLOW)	G-566	158139	AGUA	GP-2127W	3680434	KT2300 A DIESEL, KT2300G A DIESEL, KT2300L A DIESEL, KT2300M MARINO, KT2300P A DIESEL, KT38M MARINO		
COMBUSTIBLE	GP-1101	154711	ACEITE	GP-9000	3406810	ACEITE	GP-53	299670
ACEITE, SELLADO FLUJO TOTAL (FULL FLOW)	GP-53	3313287	AGUA	GP-2126Q	3680433	COMBUSTIBLE, SEPARADOR DE AGUA	GPP-11	156172
ACEITE, SELLADO PARA DERIVACION (BY PASS)	GP-57	3313289	ACEITE	GP-9001	3406809	AGUA	GP-2071W	299080
ACEITE, DOBLE FLUJO	GP-3000	3318853	COMBUSTIBLE	GPP-1007S	3331096	ACEITE, CARTUCHO PARA DERIVACION (BY PASS)	G-750	256838
AGUA	GP-2071W	299080	ISX565 A DIESEL, ISX600 A DIESEL			KT2300 A DIESEL, KT2300G A DIESEL, KT2300L A DIESEL, KT2300M MARINO, KT2300P A DIESEL, KT38M MARINO		
AIRE	GA-37	3001690	ACEITE	GP-9000	3406810	ACEITE	GP-53	299670
ACEITE, CARTUCHO PARA DERIVACION (BY PASS)	G-750	256838	J401 A DIESEL, JN100 A DIESEL			COMBUSTIBLE	GP-55	299202
FORMULA 400 BIG CAM IV A DIESEL			ACEITE, CARTUCHO	G-566	158139	ACEITE, SELLADO PARA DERIVACION (BY PASS)	GP-57	3313283
COMBUSTIBLE	GP-1101	154711	COMBUSTIBLE	G-1143	256834	AGUA	GP-1011Q	299080
ACEITE, FLUJO TOTAL (FULL FLOW)	GP-53	299670	COMBUSTIBLE	GP-11	154709	ACEITE, CARTUCHO PARA DERIVACION (BY PASS)	G-750	256838
ACEITE, DERIVACION (BY PASS)	GP-57	3313283	COMBUSTIBLE	GP-1101	154709	KT50M MARINO		
COMBUSTIBLE, SEPARADOR DE AGUA	GPP-11	156172	COMBUSTIBLE, SEPARADOR DE AGUA	GPP-11	FS1212	ACEITE, FLUJO TOTAL (FULL FLOW) SELLADO (REQUIERE 5)	GP-53	3307885
ACEITE, DOBLE FLUJO	GP-3000	3318853	AGUA	GP-2071W	299080	COMBUSTIBLE (REQUIERE 2)	GP-55	3313306
FORMULA 450 A DIESEL, FORMULA 525 A DIESEL			ACEITE, DERIVACION (BY PASS)	G-500	256839	ACEITE, DERIVACION (BY PASS) SELLADO (REQUIERE 2)	GP-57	3313283
COMBUSTIBLE	GP-1101	154711	ACEITE, DERIVACION (BY PASS)	G-750	256838	AGUA, SISTEMA DE ENFRIAMIENTO	GP-1011Q	299086
ACEITE, FLUJO TOTAL (FULL FLOW)	GP-53	299670	JN130 A DIESEL			ACEITE, DERIVACION (BY PASS) CARTUCHO (REQUIERE 2)	G-750	256345
ACEITE, SELLADO PARA DERIVACION (BY PASS)	GP-57	3313283	ACEITE, CARTUCHO	G-566	158139	KT1150C525 A DIESEL, KTA1150C600 A DIESEL		
AGUA	GP-1011Q	299080	COMBUSTIBLE	G-1143	256834	COMBUSTIBLE	GPP-14	BM78254
ACEITE, CARTUCHO PARA DERIVACION (BY PASS)	G-750	256838	COMBUSTIBLE	GP-11	154709	ACEITE	GP-53	299670
GTA19 A GAS NATURAL			COMBUSTIBLE	GP-1101	154709	ACEITE, SELLADO PARA DERIVACION (BY PASS)	GP-57	3313283
ACEITE, DERIVACION (BY PASS)	GP-53	299670	COMBUSTIBLE, SEPARADOR DE AGUA	GPP-11	FS1212	AGUA	GP-1011Q	299080
ISB SERIES (3.9L), ISB4 A DIESEL, ISBE A DIESEL			AGUA	GP-2071W	299080	ACEITE, CARTUCHO PARA DERIVACION (BY PASS)	G-750	256838
COMBUSTIBLE	GP-548	4897833	ACEITE, DERIVACION (BY PASS)	G-500	256839	KT1150C525 A DIESEL, KTA1150C600 A DIESEL		
ISB SERIES (5.9L)			ACEITE, DERIVACION (BY PASS)	G-750	256838	COMBUSTIBLE	GPP-14	BM78254
ACEITE	GP-737	4897898	KT1150 A DIESEL			ACEITE	GP-53	299670
ACEITE	GP-3937	LF3970	COMBUSTIBLE	GPP-14	BM78254	ACEITE, DERIVACION (BY PASS)	GP-57	3313283
COMBUSTIBLE, SEPARADOR DE AGUA (CARTUCHO)	GS-1261	FS1261	ACEITE	GP-53	3313283	AGUA	GP-2071W	299080
ISC (8.3L) A DIESEL			AGUA	GP-1011Q	299080	ACEITE, CARTUCHO PARA DERIVACION (BY PASS)	G-750	256838
COMBUSTIBLE	GPP-1022S	3800394	ACEITE	G-750	256838	KT1150C450 A DIESEL, KT450 A DIESEL		
			COMBUSTIBLE	GP-1101	154711	COMBUSTIBLE	GPP-14	156172
			ACEITE	GP-53	299670	ACEITE	GP-53	299670
			ACEITE, SELLADO PARA DERIVACION (BY PASS)	GP-57	3313283	ACEITE, DERIVACION (BY PASS)	GP-57	3313283
			AGUA	GP-1011Q	299080	AGUA	GP-2071W	299080
			ACEITE	G-750	256838	KT19C/L A DIESEL		
			COMBUSTIBLE	GP-1101	154711	COMBUSTIBLE	GPP-14	156172
			ACEITE	GP-53	299670	ACEITE	GP-53	299670
			ACEITE, SELLADO PARA DERIVACION (BY PASS)	GP-57	3313283	ACEITE, DERIVACION (BY PASS)	GP-57	3313283
			AGUA	GP-1011Q	299080	AGUA	GP-2071W	299080
			COMBUSTIBLE	GPP-103	3308638	KT19C/L A DIESEL		
						ACEITE	GP-53	3313279
						ACEITE	GP-57	3313283
						COMBUSTIBLE	GPP-11	156172
						AGUA	GP-2071W	3315116
						COMBUSTIBLE	GPP-103	3308638

SERVICIO PESADO

MARCA-MODELO-MOTOR MAKE-MODEL-ENGINE	GONHER GONHER	OEM OEM	MARCA-MODELO-MOTOR MAKE-MODEL-ENGINE	GONHER GONHER	OEM OEM	MARCA-MODELO-MOTOR MAKE-MODEL-ENGINE	GONHER GONHER	OEM OEM
CUMMINS (continuación)			CUMMINS (continuación)			CUMMINS (continuación)		
MOTORES			MOTORES			MOTORES		
ACEITE	G-750	256838	ACEITE, CARTUCHO PARA DERIVACION (BY PASS)	G-750	256838	ACEITE, DOBLE FLUJO	GP-3000	3318853
KTA19M A DIESEL						AGUA	GP-2071W	299080
COMBUSTIBLE	GPP-14	BM78254	KTTA2300 A DIESEL, KTTA3067 A DIESEL, KTTA38C A DIESEL			COMBUSTIBLE, SEPARADOR DE AGUA	GPP-1000	3889716
ACEITE	GP-53	299670	ACEITE	GP-53	299670	N14 COMMAND SERIES A DIESEL		
ACEITE, SELLADO PARA DERIVACION (BY PASS)	GP-57	3313283	COMBUSTIBLE	GP-55	299202	ACEITE	GP-3001	3401544
COMBUSTIBLE, SEPARADOR DE AGUA	GPP-11	156172	ACEITE	GP-57	3304232	COMBUSTIBLE	GPP-11	3308638
AGUA	GP-2071W	299080	AGUA	GP-1011Q	299080	AGUA	GP-2071W	3315116
ACEITE, CARTUCHO PARA DERIVACION (BY PASS)	G-750	256838	ACEITE	G-750	256838	COMBUSTIBLE	GPP-1000	3329289
KTA2300 A DIESEL, KTA2300G A DIESEL, KTA2300GS/GC A DIESEL, KTA2300L A DIESEL, KTA2300M MARINO, KTA2300P A DIESEL, KTA3067 A DIESEL, KTA3067 MARINO, KTA38M A DIESEL, KTA38M MARINO			KTTA38 (38.0L) A DIESEL			N14 MARINO, N855M MARINO		
ACEITE	GP-53	299670	ACEITE	GP-53	299670	COMBUSTIBLE	GPP-14	BM78254
COMBUSTIBLE	GP-55	299202	COMBUSTIBLE	GP-55	299202	ACEITE	GP-53	299670
ACEITE, SELLADO PARA DERIVACION (BY PASS)	GP-57	3313283	ACEITE, DERIVACION (BY PASS)	GP-57	3313283	ACEITE, SELLADO PARA DERIVACION (BY PASS)	GP-57	3304232
AGUA	GP-1011Q	299080	AGUA	GP-1011Q	299080	COMBUSTIBLE, SEPARADOR DE AGUA	GPP-11	156172
ACEITE, CARTUCHO PARA DERIVACION (BY PASS)	G-750	256838	L10 A DIESEL			ACEITE, DOBLE FLUJO	GP-3000	3318853
KTA3067 SERIES A DIESEL			COMBUSTIBLE	GP-11	3315844	AGUA	GP-2071W	299080
ACEITE, FLUJO TOTAL (FULL FLOW) SELLADO (REQUIERE 5)	GP-53	3307885	ACEITE, SELLADO FLUJO TOTAL (FULL FLOW)	GP-53	299670	ACEITE, CARTUCHO PARA DERIVACION (BY PASS)	G-750	256838
COMBUSTIBLE (SELLADO) (REQUIERE 2)	GP-55	3313306	ACEITE, SELLADO PARA DERIVACION (BY PASS)	GP-57	3304232	N855 A DIESEL		
ACEITE, DERIVACION (BY PASS) SELLADO	GP-57	3313283	COMBUSTIBLE	GPP-11	156172	ACEITE, CARTUCHO PARA FLUJO TOTAL (FULL FLOW)	G-566	158139
AGUA, SISTEMA DE ENFRIAMIENTO (REQUIERE 4)	GP-1011Q	299086	ACEITE, DOBLE FLUJO	GP-3000	3825970	COMBUSTIBLE, CARTUCHO	G-1143	256834
ACEITE, DERIVACION (BY PASS) CARTUCHO	G-750	256345	AGUA	GP-2071W	3315116	COMBUSTIBLE, SELLADO	GPP-14	BM78254
KTA450 A DIESEL			COMBUSTIBLE, SEPARADOR DE AGUA	GPP-103	38318715	ACEITE, SELLADO PARA FLUJO TOTAL (FULL FLOW)	GP-53	299670
COMBUSTIBLE	GP-1101	154711	COMBUSTIBLE, SEPARADOR DE AGUA	GPP-1000	3329289	ACEITE, SELLADO PARA DERIVACION (BY PASS)	GP-57	3304232
ACEITE, FLUJO TOTAL (FULL FLOW)	GP-53	299670	LT10 A DIESEL, LTA10 A DIESEL			COMBUSTIBLE, SEPARADOR DE AGUA	GPP-11	156172
ACEITE, DERIVACION (BY PASS)	GP-57	3313283	COMBUSTIBLE	GP-11	3315844	AGUA, PRE-CHARGE	GP-1011Q	299086
AGUA	GP-1011Q	299080	ACEITE, SELLADO FLUJO TOTAL (FULL FLOW)	GP-53	299670	ACEITE, DOBLE FLUJO	GP-3000	3318853
ACEITE, DERIVACION (BY PASS)	G-750	256838	ACEITE, SELLADO PARA DERIVACION (BY PASS)	GP-57	3304232	AGUA, MANTENIMIENTO	GP-2071W	3315116
KTA50 (50.0L) A DIESEL			COMBUSTIBLE	GPP-11	156172	AIRE, RESPIRADOR	GA-39	255963
ACEITE, REQUIERE 5	GP-53	3307885	AGUA	GP-2071W	3315116	AIRE, SIMPLE	GA-349	AF469
KTA50M MARINO			COMBUSTIBLE, SEPARADOR DE AGUA	GPP-103	38318715	AIRE, SIMPLE	GA-37	3001690
ACEITE, FLUJO TOTAL (FULL FLOW) SELLADO (REQUIERE 5)	GP-53	3307885	COMBUSTIBLE, SEPARADOR DE AGUA	GPP-1000	3329289	AIRE, PRIMARIO	GA-106	204638
COMBUSTIBLE (REQUIERE 2)	GP-55	3313306	LT10A A DIESEL			AIRE, SECUNDARIO	GA-6127	204646
ACEITE, DERIVACION (BY PASS) SELLADO (REQUIERE 2)	GP-57	3313283	ACEITE	GP-3000	3318853	AIRE, PRIMARIO	GA-6129	204645
AGUA, SISTEMA DE ENFRIAMIENTO	GP-1011Q	299086	M11 A DIESEL			AIRE, SECUNDARIO	GA-206	204639
ACEITE, DERIVACION (BY PASS) CARTUCHO (REQUIERE 2)	G-750	256345	COMBUSTIBLE, CARTUCHO	G-128	FS1029W	ACEITE, CARTUCHO PARA DERIVACION (BY PASS)	G-750	256838
KTA525 A DIESEL, KTA600 A DIESEL, KTC450 A DIESEL, KTTA1150 A DIESEL			COMBUSTIBLE, SEPARADOR DE AGUA	GPP-11	156172	NH195 A DIESEL, NH200 A DIESEL, NH220 A DIESEL		
COMBUSTIBLE	GP-11	154709	ACEITE	GP-3000	3825970	ACEITE, CARTUCHO	G-566	158139
COMBUSTIBLE	GPP-14	156172	AGUA	GP-2071W	3315116	COMBUSTIBLE	GP-11	154709
COMBUSTIBLE	GP-1101	154709	COMBUSTIBLE, SEPARADOR DE AGUA	GPP-1000	3329289	ACEITE, SELLADO	GP-53	299670
ACEITE, FLUJO TOTAL (FULL FLOW)	GP-53	299670	COMBUSTIBLE, SEPARADOR DE AGUA	GPP-1003S	FS1003	COMBUSTIBLE	GPP-11	156172
ACEITE, SELLADO PARA DERIVACION (BY PASS)	GP-57	3304232	COMBUSTIBLE, SEPARADOR DE AGUA	GPP-1003S	FS1003	AGUA	GP-2071W	299080
COMBUSTIBLE	GPP-11	3308638	M11 PLUS A DIESEL, N14 PLUS A DIESEL			COMBUSTIBLE	GPP-103	38318715
AGUA	GP-1011Q	299080	ACEITE	GP-3001	LF3000	ACEITE, DERIVACION (BY PASS)	G-750	256838
AGUA	GP-2071W	299080	ACEITE	GP-3000	3318853	NH230 A DIESEL, NH250 A DIESEL, NHC250 A DIESEL		
			COMBUSTIBLE, SEPARADOR DE AGUA	GPP-1000	3329289	ACEITE, CARTUCHO	G-566	158139
			N14 (14.0L) A DIESEL			COMBUSTIBLE	GP-11	154709
			COMBUSTIBLE	GPP-14	BM78254	ACEITE, SELLADO	GP-53	299670
			ACEITE, FLUJO TOTAL (FULL FLOW)	GP-53	299670	ACEITE, SELLADO PARA DERIVACION (BY PASS)	GP-57	3304232
			ACEITE, DERIVACION (BY PASS)	GP-57	3304232	COMBUSTIBLE, SEPARADOR DE AGUA	GPP-11	156172
			COMBUSTIBLE, SEPARADOR DE AGUA	GPP-11	156172	AGUA	GP-2071W	299080
						COMBUSTIBLE	GPP-103	38318715
						AIRE, RESPIRADOR	GA-39	AF250

MARCA-MODELO-MOTOR MAKE-MODEL-ENGINE	GONHER GONHER	OEM OEM	MARCA-MODELO-MOTOR MAKE-MODEL-ENGINE	GONHER GONHER	OEM OEM	MARCA-MODELO-MOTOR MAKE-MODEL-ENGINE	GONHER GONHER	OEM OEM
CUMMINS (continuación)			CUMMINS (continuación)			CUMMINS (continuación)		
MOTORES			MOTORES			MOTORES		
ACEITE, CARTUCHO PARA DERIVACION (BY PASS)	G-750	256838	NT855 BIG CAM I A DIESEL			COMBUSTIBLE, SEPARADOR DE AGUA	GPP-11	156172
			COMBUSTIBLE	GP-11	154709	ACEITE, DOBLE FLUJO	GP-3000	3318853
NHH250 A DIESEL, NHHTC335 A DIESEL			COMBUSTIBLE	GPP-14	156172	AGUA	GP-2071W	299080
ACEITE, FLUJO TOTAL (FULL FLOW)	G-566	158139	COMBUSTIBLE	GP-1101	154709	ACEITE, CARTUCHO PARA DERIVACION (BY PASS)	G-750	256838
COMBUSTIBLE	GP-1101	154711	ACEITE	GP-53	299670	NTA370 A DIESEL, NTA420 A DIESEL		
AGUA	GP-2071W	299080	ACEITE, SELLADO PARA DERIVACION (BY PASS)	GP-57	3304232	ACEITE, FLUJO TOTAL (FULL FLOW)	G-566	158139
ACEITE, DERIVACION (BY PASS)	G-750	256838	COMBUSTIBLE, SEPARADOR DE AGUA	GPP-11	3308638	COMBUSTIBLE	GP-1101	154711
NHHTC290 A DIESEL, NHHTC290 FORMULA A DIESEL, NHHTC355 A DIESEL, NT310 A DIESEL, NT335 A DIESEL			AGUA	GP-2071W	299080	AGUA	GP-1011Q	299086
ACEITE, CARTUCHO PARA FLUJO TOTAL (FULL FLOW)	G-566	158139	ACEITE, CARTUCHO PARA DERIVACION (BY PASS)	G-750	256838	ACEITE, DERIVACION (BY PASS)	G-750	256838
COMBUSTIBLE	GP-1101	154711	NT855 BIG CAM II A DIESEL			NTA400 A DIESEL		
ACEITE, SELLADO PARA FLUJO TOTAL (FULL FLOW)	GP-53	299670	COMBUSTIBLE	GP-11	154709	ACEITE, CARTUCHO PARA FLUJO TOTAL (FULL FLOW)	G-566	158139
AGUA	GP-2071W	299080	COMBUSTIBLE	GPP-14	156172	COMBUSTIBLE	GP-1101	154711
AIRE	GA-37	3001690	COMBUSTIBLE	GP-1101	154709	ACEITE, SELLADO PARA FLUJO TOTAL (FULL FLOW)	GP-53	3313287
ACEITE, DERIVACION (BY PASS)	G-750	256838	ACEITE	GP-53	299670	AGUA	GP-2071W	3315116
NHHTC290 A DIESEL			ACEITE, SELLADO PARA DERIVACION (BY PASS)	GP-57	3304232	AIRE	GA-37	3001690
ACEITE, CARTUCHO PARA FLUJO TOTAL (FULL FLOW)	G-566	158139	COMBUSTIBLE, SEPARADOR DE AGUA	GPP-11	3308638	ACEITE, DERIVACION (BY PASS)	G-750	256838
COMBUSTIBLE	GPP-14	156172	AGUA	GP-2071W	299080	NTA420C A DIESEL		
COMBUSTIBLE	GP-1101	154711	ACEITE, CARTUCHO PARA DERIVACION (BY PASS)	G-750	256838	ACEITE	G-566	158139
ACEITE, SELLADO PARA FLUJO TOTAL (FULL FLOW)	GP-53	299670	NT855 BIG CAM III A DIESEL			COMBUSTIBLE	G-1143	256834
AGUA	GP-2071W	299080	COMBUSTIBLE	GP-11	154709	AGUA	GP-1011Q	299086
ACEITE, DERIVACION (BY PASS)	G-750	256838	COMBUSTIBLE	GPP-14	156172	ACEITE	G-750	256838
NT280 A DIESEL, NT380 A DIESEL, NTA380 A DIESEL			COMBUSTIBLE	GP-1101	154709	NTC A DIESEL		
ACEITE, FLUJO TOTAL (FULL FLOW)	G-566	158139	ACEITE	GP-53	299670	ACEITE, FLUJO TOTAL (FULL FLOW), CARTUCHO	G-566	158139
COMBUSTIBLE	GP-1101	154711	ACEITE, SELLADO PARA DERIVACION (BY PASS)	GP-57	3304232	COMBUSTIBLE	GP-1101	154709
AGUA	GP-2071W	299080	COMBUSTIBLE, SEPARADOR DE AGUA	GPP-11	3308638	COMBUSTIBLE, SEPARADOR DE AGUA	GPP-11	3308638
AIRE	GA-37	3001690	AGUA	GP-2071W	299080	ACEITE, DOBLE FLUJO	GP-3000	3318853
ACEITE, DERIVACION (BY PASS)	G-750	256838	ACEITE, CARTUCHO PARA DERIVACION (BY PASS)	G-750	256838	ACEITE, DERIVACION (BY PASS) CARTUCHO	G-750	256838
NT495 A DIESEL			NT855 BIG CAM IV A DIESEL			NTC230 A DIESEL, NTC230S A DIESEL		
ACEITE	G-566	158139	COMBUSTIBLE	GP-11	3315844	ACEITE, FLUJO TOTAL (FULL FLOW)	G-566	158139
COMBUSTIBLE	G-1143	256834	AGUA	GP-2071W	3315116	COMBUSTIBLE	GP-1101	154711
COMBUSTIBLE	GP-11	154709	COMBUSTIBLE	GPP-103	38318715	AGUA	GP-2071W	299080
AGUA	GP-2071W	299080	NT855 SERIES A DIESEL			AIRE	GA-37	3001690
NT855 A DIESEL, NTA855 A DIESEL			COMBUSTIBLE	GP-11	154709	ACEITE, DERIVACION (BY PASS)	G-750	256838
ACEITE, CARTUCHO PARA FLUJO TOTAL (FULL FLOW)	G-566	158139	ACEITE	GP-53	299670	NTC240 A DIESEL		
COMBUSTIBLE, CARTUCHO	G-1143	256834	ACEITE	GP-57	3304232	COMBUSTIBLE	GP-1101	154711
COMBUSTIBLE, SELLADO	GPP-14	BM78254	COMBUSTIBLE	GPP-11	156172	ACEITE, FLUJO TOTAL (FULL FLOW)	GP-53	299670
ACEITE, SELLADO PARA FLUJO TOTAL (FULL FLOW)	GP-53	299670	AGUA	GP-2071W	299080	ACEITE, SELLADO PARA DERIVACION (BY PASS)	GP-57	3304232
ACEITE, SELLADO PARA DERIVACION (BY PASS)	GP-57	3304232	COMBUSTIBLE	GPP-103	38318715	AGUA	GP-2071W	3315116
COMBUSTIBLE, SEPARADOR DE AGUA	GPP-11	156172	ACEITE	G-750	256838	ACEITE, CARTUCHO PARA DERIVACION (BY PASS)	G-750	256838
AGUA, PRE-CHARGE	GP-1011Q	299086	NT855 SMALL CAM A DIESEL			NTC250 A DIESEL, NTC250S A DIESEL		
ACEITE, DOBLE FLUJO	GP-3000	3318853	ACEITE	G-566	158139	ACEITE	G-566	158139
AGUA, MANTENIMIENTO	GP-2071W	3315116	COMBUSTIBLE	GP-11	154709	COMBUSTIBLE	GP-11	154709
AIRE, RESPIRADOR	GA-39	255963	COMBUSTIBLE	GPP-14	156172	COMBUSTIBLE	GP-1101	154711
AIRE, SIMPLE	GA-349	AF469	ACEITE	GP-53	299670	ACEITE	GP-53	299670
AIRE, SIMPLE	GA-37	3001690	COMBUSTIBLE, SEPARADOR DE AGUA	GPP-11	156172	ACEITE	GP-57	3304232
AIRE, PRIMARIO	GA-106	204638	AGUA	GP-2071W	299080	AGUA	GP-2071W	299080
AIRE, SECUNDARIO	GA-6127	204646	ACEITE	G-750	256838	COMBUSTIBLE	GPP-103	38318715
AIRE, PRIMARIO	GA-6129	204645	NT855M MARINO, NTA855M MARINO			AIRE, RESPIRADOR	GA-39	AF250
AIRE, SECUNDARIO	GA-206	204639	COMBUSTIBLE	GPP-14	BM78254	ACEITE	G-750	256838
ACEITE, CARTUCHO PARA DERIVACION (BY PASS)	G-750	256838	ACEITE	GP-53	299670			
			ACEITE, SELLADO PARA DERIVACION (BY PASS)	GP-57	3304232			

SERVICIO PESADO

MARCA-MODELO-MOTOR MAKE-MODEL-ENGINE	GONHER GONHER	OEM OEM	MARCA-MODELO-MOTOR MAKE-MODEL-ENGINE	GONHER GONHER	OEM OEM	MARCA-MODELO-MOTOR MAKE-MODEL-ENGINE	GONHER GONHER	OEM OEM
CUMMINS (continuación)			CUMMINS (continuación)			CUMMINS (continuación)		
MOTORES			MOTORES			MOTORES		
NTC270 A DIESEL			NTC335 A DIESEL			ACEITE, SELLADO PARA DERIVACION (BY PASS)	GP-57	3304232
COMBUSTIBLE	GP-11	154709	ACEITE, CARTUCHO PARA FLUJO TOTAL (FULL FLOW)	G-566	158139	COMBUSTIBLE, SEPARADOR DE AGUA	GPP-11	156172
ACEITE	GP-53	299670	COMBUSTIBLE	GP-1101	154711	AGUA, PRE-CHARGE	GP-1011Q	299086
ACEITE	GP-57	3304232	ACEITE, SELLADO PARA FLUJO TOTAL (FULL FLOW)	GP-53	299670	ACEITE, DOBLE FLUJO	GP-3000	3318853
COMBUSTIBLE	GPP-11	156172	ACEITE, SELLADO PARA DERIVACION (BY PASS)	GP-57	3313283	AGUA, MANTENIMIENTO	GP-2071W	3315116
AGUA	GP-2071W	299080	ACEITE, DOBLE FLUJO	GP-3000	3318853	AIRE, RESPIRADOR	GA-39	255963
COMBUSTIBLE	GPP-103	38318715	AGUA	GP-2071W	299080	AIRE, SIMPLE	GA-349	AF469
ACEITE	G-750	256838	AIRE	GA-37	3001690	AIRE, SIMPLE	GA-37	3001690
NTC270CT A DIESEL			ACEITE, CARTUCHO PARA DERIVACION (BY PASS)	G-750	256838	AIRE, PRIMARIO	GA-106	204638
ACEITE	G-566	158139	NTC350 A DIESEL			AIRE, SECUNDARIO	GA-6127	204646
COMBUSTIBLE	GP-1101	154711	ACEITE, CARTUCHO PARA FLUJO TOTAL (FULL FLOW)	G-566	158139	AIRE, PRIMARIO	GA-6129	204645
ACEITE	GP-53	299670	COMBUSTIBLE	GPP-14	156172	AIRE, SECUNDARIO	GA-206	204639
ACEITE, SELLADO PARA DERIVACION (BY PASS)	GP-57	3313283	COMBUSTIBLE	GP-1101	154711	ACEITE, CARTUCHO PARA DERIVACION (BY PASS)	G-750	256838
AGUA	GP-2071W	299080	COMBUSTIBLE	GP-1101	154711	NTCC290 A DIESEL , NTCC290 FORMULA A DIESEL, NTF365 A DIESEL		
AIRE	GA-37	3001690	ACEITE, SELLADO PARA FLUJO TOTAL (FULL FLOW)	GP-53	299670	ACEITE, CARTUCHO PARA FLUJO TOTAL (FULL FLOW)	G-566	158139
ACEITE	G-750	256838	ACEITE, SELLADO PARA DERIVACION (BY PASS)	GP-57	3304232	COMBUSTIBLE	GP-1101	154711
NTC280 A DIESEL NTF250 A DIESEL			COMBUSTIBLE, SEPARADOR DE AGUA	GPP-11	3308638	ACEITE, SELLADO PARA FLUJO TOTAL (FULL FLOW)	GP-53	299670
ACEITE, FLUJO TOTAL (FULL FLOW)	G-566	158139	ACEITE, DOBLE FLUJO	GP-3000	3318853	AGUA	GP-2071W	299080
COMBUSTIBLE	GP-1101	154711	AGUA	GP-2071W	299080	AIRE	GA-37	3001690
AGUA	GP-2071W	299080	AIRE	GA-37	3001690	ACEITE, DERIVACION (BY PASS)	G-750	256838
AIRE	GA-37	3001690	ACEITE, CARTUCHO PARA DERIVACION (BY PASS)	G-750	256838	NTCC350 FORMULA A DIESEL, NTE350 A DIESEL, NTE370 A DIESEL		
ACEITE, DERIVACION (BY PASS)	G-750	256838	NTC365 A DIESEL			COMBUSTIBLE	GP-1101	154711
NTC290 A DIESEL			COMBUSTIBLE	GP-11	3315844	ACEITE, FLUJO TOTAL (FULL FLOW)	GP-53	3313287
ACEITE, CARTUCHO PARA FLUJO TOTAL (FULL FLOW)	G-566	158139	COMBUSTIBLE	GPP-14	156172	AGUA	GP-2071W	3315116
COMBUSTIBLE	GPP-14	156172	COMBUSTIBLE	GP-53	3313287	ACEITE, DERIVACION (BY PASS)	G-750	256838
COMBUSTIBLE	GP-1101	154711	ACEITE	GP-53	3313287	NTCC400 A DIESEL		
ACEITE, SELLADO PARA FLUJO TOTAL (FULL FLOW)	GP-53	299670	ACEITE, DERIVACION (BY PASS)	GP-57	3313289	ACEITE	G-566	158139
COMBUSTIBLE	GPP-11	3308638	COMBUSTIBLE	GPP-11	156172	COMBUSTIBLE	GP-1101	154711
AGUA	GP-2071W	299080	ACEITE, DOBLE FLUJO	GP-3000	3318853	ACEITE, FLUJO TOTAL (FULL FLOW)	GP-53	3313287
AIRE	GA-37	3001690	AGUA	GP-2071W	3315116	ACEITE	GP-57	3313289
ACEITE, DERIVACION (BY PASS)	G-750	256838	NTC400 A DIESEL			COMBUSTIBLE	GPP-11	156172
NTC290R A DIESEL			ACEITE, CARTUCHO PARA FLUJO TOTAL (FULL FLOW)	G-566	158139	AGUA	GP-2071W	299080
ACEITE	G-566	158139	COMBUSTIBLE	GP-1101	154711	ACEITE, DERIVACION (BY PASS)	G-750	256838
COMBUSTIBLE	GP-1101	154711	ACEITE, SELLADO PARA FLUJO TOTAL (FULL FLOW)	GP-53	3313287	NTE290 A DIESEL		
ACEITE	GP-53	299670	ACEITE, SELLADO PARA DERIVACION (BY PASS)	GP-57	3313289	COMBUSTIBLE	GPP-14	156172
AGUA	GP-2071W	299080	ACEITE, DOBLE FLUJO	GP-3000	3318853	ACEITE, FLUJO TOTAL (FULL FLOW)	GP-53	3313287
AIRE	GA-37	3001690	AGUA	GP-2071W	299080	AGUA	GP-1011Q	299080
ACEITE	G-750	256838	ACEITE, CARTUCHO PARA DERIVACION (BY PASS)	G-750	256838	ACEITE, DERIVACION (BY PASS)	G-750	256838
NTC300 A DIESEL			NTC444 A DIESEL			NTTC475 A DIESEL		
COMBUSTIBLE	GPP-14	156172	COMBUSTIBLE	GPP-14	156172	ACEITE, CARTUCHO PARA FLUJO TOTAL (FULL FLOW)	G-566	158139
ACEITE, SELLADO PARA FLUJO TOTAL (FULL FLOW)	GP-53	3313287	ACEITE, FLUJO TOTAL (FULL FLOW)	GP-53	3313287	COMBUSTIBLE	GP-1101	154711
ACEITE, SELLADO PARA DERIVACION (BY PASS)	GP-57	3313289	ACEITE, DERIVACION (BY PASS)	GP-57	3313289	ACEITE, SELLADO PARA FLUJO TOTAL (FULL FLOW)	GP-53	299670
ACEITE, DOBLE FLUJO	GP-3000	3825970	COMBUSTIBLE, SEPARADOR DE AGUA	GPP-11	156172	ACEITE, DERIVACION (BY PASS)	GP-57	3313283
AGUA	GP-2071W	3315116	ACEITE, DOBLE FLUJO	GP-3000	3318853	AGUA	GP-2071W	299080
ACEITE, CARTUCHO PARA DERIVACION (BY PASS)	G-750	256838	AGUA	GP-2071W	3315116	POWER TORQUE 300D A DIESEL, POWER TORQUE 330D A DIESEL		
NTC315 A DIESEL			NTC855 SERIES (N14) A DIESEL			ACEITE, CARTUCHO PARA FLUJO TOTAL (FULL FLOW)	G-566	158139
COMBUSTIBLE	GP-11	3315844	ACEITE, CARTUCHO PARA FLUJO TOTAL (FULL FLOW)	G-566	158139	COMBUSTIBLE	GP-1101	154711
ACEITE	GP-53	3313287	COMBUSTIBLE, CARTUCHO	G-1143	256834	ACEITE, SELLADO PARA FLUJO TOTAL (FULL FLOW)	GP-53	299670
ACEITE, DERIVACION (BY PASS)	GP-57	3313289	COMBUSTIBLE, SELLADO	GPP-14	BM78254	AGUA	GP-2071W	299080
ACEITE, DOBLE FLUJO	GP-3000	3318853	ACEITE, SELLADO PARA FLUJO TOTAL (FULL FLOW)	GP-53	299670	AIRE	GA-37	3001690
AGUA	GP-2071W	3315116				ACEITE, DERIVACION (BY PASS)	G-750	256838
COMBUSTIBLE	GPP-103	38318715						

MARCA-MODELO-MOTOR MAKE-MODEL-ENGINE	GONHER GONHER	OEM OEM	MARCA-MODELO-MOTOR MAKE-MODEL-ENGINE	GONHER GONHER	OEM OEM	MARCA-MODELO-MOTOR MAKE-MODEL-ENGINE	GONHER GONHER	OEM OEM
CUMMINS (continuación)			CUMMINS (continuación)			CUMMINS (continuación)		
MOTORES			MOTORES			MOTORES		
POWER TORQUE 315D A DIESEL			AGUA	GP-1011Q	299086	ACEITE	GP-57	3313283
COMBUSTIBLE	GPP-14	156172	ACEITE	G-750	256838	COMBUSTIBLE	GPP-11	156172
PT240 A DIESEL			V1710C500 A DIESEL			ACEITE, FLUJO TOTAL (FULL FLOW)	GP-43	3313281
COMBUSTIBLE	GP-1101	154711	ACEITE	G-566	158139	AGUA	GP-2071W	299080
ACEITE, FLUJO TOTAL (FULL FLOW)	GP-53	299670	COMBUSTIBLE	G-1143	139097	COMBUSTIBLE	GPP-103	38318715
ACEITE, SELLADO PARA DERIVACION (BY PASS)	GP-57	3304232	ACEITE, SELLADO PARA DERIVACION (BY PASS)	GP-57	3313283	ACEITE	G-500	256839
AGUA	GP-2071W	3315116	AGUA	GP-1011Q	299086	V504C A DIESEL		
ACEITE, CARTUCHO PARA DERIVACION (BY PASS)	G-750	256838	ACEITE, CARTUCHO PARA DERIVACION (BY PASS)	G-750	256838	COMBUSTIBLE	GP-1101	154711
PT270 A DIESEL			V250 A DIESEL			ACEITE	GP-57	3313283
ACEITE	G-566	158139	ACEITE, CARTUCHO PARA FLUJO TOTAL (FULL FLOW)	G-566	158139	ACEITE	GP-43	3313281
COMBUSTIBLE	GP-1101	154711	COMBUSTIBLE	GPP-14	BM78254	AGUA	GP-2071W	299080
ACEITE	GP-53	299670	COMBUSTIBLE	GP-1101	154711	ACEITE	G-500	256839
ACEITE, SELLADO PARA DERIVACION (BY PASS)	GP-57	3313283	ACEITE, SELLADO PARA FLUJO TOTAL (FULL FLOW)	GP-53	3889310	V504C210 A DIESEL, V504P210 A DIESEL		
AGUA	GP-2071W	299080	ACEITE, SELLADO PARA DERIVACION (BY PASS)	GP-57	3313283	ACEITE	G-613	173174
AIRE	GA-37	3001690	COMBUSTIBLE, SEPARADOR DE AGUA	GPP-11	3308638	COMBUSTIBLE	GP-1101	154711
ACEITE	G-750	256838	AGUA	GP-2071W	299080	ACEITE	GP-57	3313283
OSC (8.3L) A DIESEL			AIRE	GA-37	3001690	AGUA	GP-2071W	299080
COMBUSTIBLE	GPP-10225	3800394	ACEITE, CARTUCHO PARA DERIVACION (BY PASS)	G-750	256838	ACEITE	G-500	256839
QSK19 A DIESEL			V378 A DIESEL			V504M MARINO		
ACEITE	GP-3000	3825970	ACEITE, CARTUCHO PARA FLUJO TOTAL (FULL FLOW)	G-613	173174	ACEITE, CARTUCHO PARA FLUJO TOTAL (FULL FLOW)	G-613	173174
QSM (11.0L) A DIESEL			COMBUSTIBLE	GP-11	154709	COMBUSTIBLE	GPP-14	BM78254
COMBUSTIBLE	GPP-1000	3889716	COMBUSTIBLE	GP-1101	154711	COMBUSTIBLE, SEPARADOR DE AGUA	GPP-11	156172
QST30 (30.5L) A DIESEL			ACEITE	GP-57	3313283	ACEITE, SELLADO PARA FLUJO TOTAL (FULL FLOW)	GP-43	3313281
ACEITE	GP-53	3889310	COMBUSTIBLE	GPP-11	156172	AGUA	GP-2071W	299080
COMBUSTIBLE	GP-55	299202	ACEITE, SELLADO PARA FLUJO TOTAL (FULL FLOW)	GP-43	3313281	ACEITE, DERIVACION (BY PASS)	G-500	256839
ACEITE	GP-9001	3406809	AGUA	GP-2071W	3315116	V555 A DIESEL		
QST30 A DIESEL			COMBUSTIBLE	GPP-103	38318715	ACEITE, CARTUCHO PARA FLUJO TOTAL (FULL FLOW)	G-566	158139
ACEITE	GP-53	3889310	ACEITE, DERIVACION (BY PASS)	G-500	256839	COMBUSTIBLE	GP-1101	154711
COMBUSTIBLE	GP-55	3313306	V378 F1 A DIESEL, V378 F2 MOTOBOMBA A DIESEL, V378F1 FIRE PUMP A DIESEL, V378F2 FIRE PUMP A DIESEL, V504F1 FIRE PUMP A DIESEL, V504F2 FIRE PUMP A DIESEL			ACEITE, DERIVACION (BY PASS)	GP-57	3304232
ACEITE, DERIVACION (BY PASS)	GP-57	3304232	ACEITE	G-613	173174	COMBUSTIBLE	GPP-11	156172
QSX15 (15.0L) A DIESEL			COMBUSTIBLE	GP-1101	154711	ACEITE, SELLADO PARA FLUJO TOTAL (FULL FLOW)	GP-43	3014654
ACEITE	GP-9000	3406810	AGUA	GP-2071W	299080	AGUA	GP-2071W	299080
SIGNATURE 600 A DIESEL			V378C A DIESEL			COMBUSTIBLE	GPP-103	38318715
AGUA	GP-2127W	3680434	ACEITE, CARTUCHO PARA FLUJO TOTAL (FULL FLOW)	G-613	173174	ACEITE, CARTUCHO PARA DERIVACION (BY PASS)	G-500	256839
ACEITE	GP-9000	3406810	COMBUSTIBLE	GP-1101	154711	V555M MARINO		
AGUA	GP-2126Q	3680433	ACEITE, SELLADO PARA DERIVACION (BY PASS)	GP-57	3313283	ACEITE, CARTUCHO PARA FLUJO TOTAL (FULL FLOW)	G-613	173174
ACEITE	GP-9001	3406809	ACEITE, SELLADO PARA FLUJO TOTAL (FULL FLOW)	GP-43	3313281	COMBUSTIBLE	GPP-14	BM78254
COMBUSTIBLE	GPP-10075	38947945	AGUA	GP-2071W	299080	ACEITE, SELLADO PARA DERIVACION (BY PASS)	GP-57	3304232
V12-500GS/GC A DIESEL			ACEITE, CARTUCHO PARA DERIVACION (BY PASS)	G-500	256839	COMBUSTIBLE, SEPARADOR DE AGUA	GPP-11	156172
ACEITE	G-566	158139	V378P A DIESEL			ACEITE, SELLADO PARA FLUJO TOTAL (FULL FLOW)	GP-43	3313281
COMBUSTIBLE, CARTUCHO	G-1143	139097	ACEITE	G-613	173174	AGUA	GP-2071W	299080
COMBUSTIBLE, SELLADO	GP-55	3313306	COMBUSTIBLE	GP-1101	154711	ACEITE, CARTUCHO PARA DERIVACION (BY PASS)	G-500	256839
AGUA	GP-1011Q	299086	AGUA	GP-2071W	299080	V6-140 A DIESEL		
AIRE	GA-37	3001690	ACEITE, DERIVACION (BY PASS)	G-500	256839	ACEITE, CARTUCHO PARA FLUJO TOTAL (FULL FLOW)	G-613	173174
V1710 C525 A DIESEL			V504 A DIESEL			COMBUSTIBLE, PRIMARIO	GP-11	154709
ACEITE	G-566	158139	ACEITE	G-613	173174	COMBUSTIBLE, SEPARADOR DE AGUA	GPP-11	156172
COMBUSTIBLE	G-1143	33032105	COMBUSTIBLE	GP-11	154709	AGUA	GP-2071W	299080
ACEITE	GP-53	3889310	COMBUSTIBLE	GP-1101	154711	COMBUSTIBLE, SECUNDARIO	GPP-103	38318715
COMBUSTIBLE	GP-55	3313306						
ACEITE	GP-57	3313283						

SERVICIO PESADO

MARCA-MODELO-MOTOR MAKE-MODEL-ENGINE	GONHER GONHER	OEM OEM	MARCA-MODELO-MOTOR MAKE-MODEL-ENGINE	GONHER GONHER	OEM OEM	MARCA-MODELO-MOTOR MAKE-MODEL-ENGINE	GONHER GONHER	OEM OEM
CUMMINS (continuación)			CUMMINS (continuación)			CUMMINS (continuación)		
MOTORES			MOTORES			MOTORES		
AIRE	GA-21	169364	VF 390M A DIESEL			AGUA	GP-2071W	299080
ACEITE, DERIVACION (BY PASS)	G-500	256839	ACEITE	GP-3000	3318853	COMBUSTIBLE	GPP-103	3831871S
V6-150 A DIESEL, V8-210 A DIESEL, VT378 A DIESEL			AGUA, SISTEMA DE ENFRIAMIENTO	GP-2071W	209604	ACEITE, CARTUCHO PARA DERIVACION (BY PASS)	G-500	256839
ACEITE, CARTUCHO PARA FLUJO TOTAL (FULL FLOW)	G-613	173174	COMBUSTIBLE	GPP-1000	3329289	VT240 A DIESEL		
COMBUSTIBLE, PRIMARIO	GP-11	154709	VT12-635GS/GC A DIESEL, VT12-700GS/GC A DIESEL			ACEITE, CARTUCHO	G-566	158139
ACEITE, SELLADO DERIVACION (BY PASS)	GP-57	3313283	ACEITE	G-566	158139	COMBUSTIBLE	GP-11	154709
COMBUSTIBLE, SEPARADOR DE AGUA	GPP-11	156172	COMBUSTIBLE, CARTUCHO	G-1143	3303210S	COMBUSTIBLE	GP-1101	154711
ACEITE, SELLADO FLUJO TOTAL (FULL FLOW)	GP-43	3313281	COMBUSTIBLE, SELLADO	GP-55	3313306	ACEITE, SELLADO PARA DERIVACION (BY PASS)	GP-57	3304232
AGUA	GP-2071W	3315116	AGUA	GP-1011Q	299086	COMBUSTIBLE, SEPARADOR DE AGUA	GPP-11	156172
COMBUSTIBLE, SECUNDARIO	GPP-103	3831871S	VT12-800GS/GC A DIESEL			ACEITE, SELLADO	GP-43	3014654
ACEITE, CARTUCHO PARA DERIVACION (BY PASS)	G-500	256839	ACEITE, CARTUCHO	G-566	158139	AGUA	GP-2071W	299080
V6-352 A DIESEL, V8-185 A DIESEL, V8-470 A DIESEL			COMBUSTIBLE, CARTUCHO	G-1143	3303210S	COMBUSTIBLE	GPP-103	3831871S
ACEITE, CARTUCHO PARA FLUJO TOTAL (FULL FLOW)	G-613	173174	ACEITE, SELLADO	GP-53	3889310	ACEITE, CARTUCHO PARA DERIVACION (BY PASS)	G-500	256839
COMBUSTIBLE, PRIMARIO	GP-11	154709	COMBUSTIBLE, SELLADO	GP-55	3313306	VT28M MARINO		
COMBUSTIBLE, SEPARADOR DE AGUA	GPP-11	156172	AGUA	GP-1011Q	299086	ACEITE	GP-53	3889310
AGUA	GP-2071W	299080	VT155 A DIESEL, VT210 A DIESEL			COMBUSTIBLE	GP-55	3313306
COMBUSTIBLE, SECUNDARIO	GPP-103	3831871S	COMBUSTIBLE	GP-1101	154711	ACEITE, SELLADO PARA DERIVACION (BY PASS)	GP-57	3304232
ACEITE, DERIVACION (BY PASS)	G-500	256839	ACEITE	GP-43	3014654	AGUA	GP-1011Q	299086
V6-378 A DIESEL, V8-504 A DIESEL			AGUA, DERIVACION (BY PASS)	G-500	256839	ACEITE, CARTUCHO PARA DERIVACION (BY PASS)	G-750	256838
ACEITE	G-613	173174	VT1710 SERIES A DIESEL, VT1710M MARINO			VT350 A DIESEL		
V903 A DIESEL, V903C A DIESEL			ACEITE	GP-53	299670	ACEITE, CARTUCHO PARA FLUJO TOTAL (FULL FLOW)	G-566	158139
ACEITE, CARTUCHO PARA FLUJO TOTAL (FULL FLOW)	G-566	158139	COMBUSTIBLE	GP-55	299202	COMBUSTIBLE	GP-11	154709
COMBUSTIBLE	GPP-14	BM78254	ACEITE, SELLADO PARA DERIVACION (BY PASS)	GP-57	3304232	COMBUSTIBLE	GPP-14	156172
COMBUSTIBLE	GP-1101	154711	AGUA	GP-1011Q	299086	ACEITE, SELLADO PARA FLUJO TOTAL (FULL FLOW)	GP-53	299670
ACEITE, SELLADO PARA FLUJO TOTAL (FULL FLOW)	GP-53	3889310	ACEITE, CARTUCHO PARA DERIVACION (BY PASS)	G-750	256838	ACEITE, SELLADO PARA DERIVACION (BY PASS)	GP-57	3304232
ACEITE, SELLADO PARA DERIVACION (BY PASS)	GP-57	3313283	VT1710C525 A DIESEL, VT1710C635 A DIESEL			COMBUSTIBLE, SEPARADOR DE AGUA	GPP-11	3308638
COMBUSTIBLE, SEPARADOR DE AGUA	GPP-11	3308638	ACEITE, CARTUCHO PARA FLUJO TOTAL (FULL FLOW)	G-566	158139	AGUA	GP-2071W	299080
AGUA	GP-2071W	299080	COMBUSTIBLE, CARTUCHO	G-1143	256834	AIRE	GA-37	3001690
AIRE	GA-37	3001690	ACEITE, SELLADO PARA FLUJO TOTAL (FULL FLOW)	GP-53	299670	ACEITE, CARTUCHO PARA DERIVACION (BY PASS)	G-750	256838
ACEITE, CARTUCHO PARA DERIVACION (BY PASS)	G-750	256838	COMBUSTIBLE, SELLADO	GP-55	299202	VT350 FIRE TRUCK A DIESEL		
V903 SERIES A DIESEL			ACEITE, SELLADO PARA DERIVACION (BY PASS)	GP-57	3313283	COMBUSTIBLE	GP-1101	154711
ACEITE	G-566	158139	AGUA	GP-1011Q	299080	ACEITE	GP-53	3889310
COMBUSTIBLE	GP-11	154709	ACEITE, CARTUCHO PARA DERIVACION (BY PASS)	G-750	256838	ACEITE	GP-57	3304232
ACEITE	GP-53	299670	VT1710F INDUSTRIAL FIRE PUMP A DIESEL			AGUA	GP-2071W	299080
ACEITE	GP-57	3304232	ACEITE	G-566	158139	AIRE	GA-37	3001690
COMBUSTIBLE	GPP-11	156172	COMBUSTIBLE	G-1143	256834	ACEITE	G-750	256838
AGUA	GP-2071W	299080	AGUA	GP-1011Q	299080	VT378C A DIESEL		
COMBUSTIBLE	GPP-103	3831871S	VT1710G A DIESEL, VT1710GC A DIESEL, VT1710GS A DIESEL			ACEITE	G-613	173174
ACEITE	G-750	256838	ACEITE	GP-53	3889310	COMBUSTIBLE	GP-1101	154711
V903M A DIESEL			COMBUSTIBLE	GP-55	3313306	ACEITE	GP-57	3313283
ACEITE, CARTUCHO PARA FLUJO TOTAL (FULL FLOW)	G-613	173174	ACEITE, DERIVACION (BY PASS)	GP-57	3304232	AGUA	GP-2071W	299080
COMBUSTIBLE	GPP-14	BM78254	AGUA	GP-1011Q	299086	ACEITE	G-500	256839
ACEITE, SELLADO PARA FLUJO TOTAL (FULL FLOW)	GP-53	3889310	VT225 A DIESEL			VT504 A DIESEL		
ACEITE, SELLADO PARA DERIVACION (BY PASS)	GP-57	3313283	ACEITE, CARTUCHO	G-566	158139	ACEITE	G-613	173174
COMBUSTIBLE, SEPARADOR DE AGUA	GPP-11	156172	COMBUSTIBLE	GP-11	154709	COMBUSTIBLE	GP-11	154709
AGUA	GP-2071W	299080	ACEITE, SELLADO PARA DERIVACION (BY PASS)	GP-57	3304232	ACEITE	GP-57	3313283
ACEITE, CARTUCHO PARA DERIVACION (BY PASS)	G-750	256838	COMBUSTIBLE, SEPARADOR DE AGUA	GPP-11	156172	COMBUSTIBLE	GPP-11	156172
			ACEITE, SELLADO	GP-43	3014654	ACEITE	GP-43	3313281
						AGUA	GP-2071W	3315116
						COMBUSTIBLE	GPP-103	3831871S

MARCA-MODELO-MOTOR MAKE-MODEL-ENGINE	GONHER GONHER	OEM OEM	MARCA-MODELO-MOTOR MAKE-MODEL-ENGINE	GONHER GONHER	OEM OEM	MARCA-MODELO-MOTOR MAKE-MODEL-ENGINE	GONHER GONHER	OEM OEM
CUMMINS (continuación)			CUMMINS (continuación)			DAEWOO		
MOTORES			MOTORES			CARGADORAS		
ACEITE	G-500	256839	ACEITE	G-750	256838	1340XL DESLIZABLE SOBRE GUIA, DSL601 DESLIZABLE SOBRE GUIA, DSL602 DESLIZABLE SOBRE GUIA con motor/YANMAR 4TNE84		
VT504C A DIESEL			VT903M A DIESEL, VTA903M A DIESEL			ACEITE	GP-40	M801209
COMBUSTIBLE	GP-1101	154711	ACEITE, CARTUCHO PARA FLUJO TOTAL (FULL FLOW)	G-613	173174	430, 430 PLUS con motor/CUMMINS A2000		
ACEITE	GP-57	3313283	COMBUSTIBLE	GPP-14	BM78254	COMBUSTIBLE, SEPARADOR DE AGUA	GPP-1122	3931062
ACEITE	GP-43	3313281	ACEITE, SELLADO PARA FLUJO TOTAL (FULL FLOW)	GP-53	3889310	DSL500 con motor/YANMAR 3TN84		
AGUA	GP-2071W	299080	ACEITE, SELLADO PARA DERIVACION (BY PASS)	GP-57	3313283	ACEITE	GP-40	M801209
ACEITE	G-500	256839	COMBUSTIBLE, SEPARADOR DE AGUA	GPP-11	156172	MEGA 200 con motor/DAEWOO DB58T		
VT555 A DIESEL			AGUA	GP-2071W	299080	ACEITE	GP-178	65055105009
ACEITE	G-566	158139	ACEITE, CARTUCHO PARA DERIVACION (BY PASS)	G-750	256838	MEGA 200TC-V con motor/A DIESEL		
COMBUSTIBLE	GP-11	154709	VT12-800GS/GC A DIESEL			COMBUSTIBLE, SEPARADOR DE AGUA	GPP-11	FS1212
COMBUSTIBLE	GP-1101	154711	ACEITE, CARTUCHO	G-566	158139	MEGA 300 con motor/A DIESEL		
ACEITE	GP-57	3304232	COMBUSTIBLE, CARTUCHO	G-1143	33032105	COMBUSTIBLE, SECUNDARIO	G-1123	65125035004
COMBUSTIBLE	GPP-11	156172	ACEITE, SELLADO	GP-53	3889310	MEGA 300-V con motor/DAEWOO DE12T		
ACEITE	GP-43	3014654	COMBUSTIBLE, SELLADO	GP-55	3313306	ACEITE	GP-57	P172510
AGUA	GP-2071W	299080	AGUA	GP-1011Q	299086	MEGA 400 con motor/A DIESEL		
COMBUSTIBLE	GPP-103	38318715	VT1710 SERIES A DIESEL, VTA1710M MARINO, VTA1710P700 A DIESEL, VTA1710P800 A DIESEL, VTA28C A DIESEL, VTA28M MARINO			COMBUSTIBLE, SECUNDARIO	G-1123	65125035004
ACEITE	G-500	256839	ACEITE	GP-53	299670	MEGA 400-III con motor/DAEWOO D2366T		
VT555M MARINO			COMBUSTIBLE	GP-55	299202	COMBUSTIBLE	G-1123	24749026
ACEITE, CARTUCHO PARA FLUJO TOTAL (FULL FLOW)	G-613	173174	ACEITE, SELLADO PARA DERIVACION (BY PASS)	GP-57	3304232	COMBUSTIBLE	G-1123F	P550349
COMBUSTIBLE	GPP-14	BM78254	AGUA	GP-1011Q	299086	AIRE, PRIMARIO	GA-360	24746003
ACEITE, SELLADO PARA DERIVACION (BY PASS)	GP-57	3304232	ACEITE, CARTUCHO PARA DERIVACION (BY PASS)	G-750	256838	AIRE, SECUNDARIO	GA-361	24749038
COMBUSTIBLE, SEPARADOR DE AGUA	GPP-11	156172	VT1710C700 A DIESEL, VTA1710C800 A DIESEL			MEGA 400-V con motor/DAEWOO DE12T		
ACEITE, SELLADO PARA FLUJO TOTAL (FULL FLOW)	GP-43	3313281	ACEITE, CARTUCHO PARA FLUJO TOTAL (FULL FLOW)	G-566	158139	ACEITE	GP-57	P172510
AGUA	GP-2071W	299080	COMBUSTIBLE, CARTUCHO	G-1143	33032105	MEGA 500-V con motor/CUMMINS QSM11		
ACEITE, CARTUCHO PARA DERIVACION (BY PASS)	G-500	256839	ACEITE, SELLADO PARA FLUJO TOTAL (FULL FLOW)	GP-53	3889310	AGUA	GP-1013Q	WF2075
VT903 A DIESEL, VTA450 A DIESEL, VTA903 SERIES A DIESEL			COMBUSTIBLE, SELLADO	GP-55	3313306	COMBUSTIBLE, SEPARADOR DE AGUA	GPP-1000	FS1000
ACEITE, CARTUCHO PARA FLUJO TOTAL (FULL FLOW)	G-566	158139	ACEITE, SELLADO PARA DERIVACION (BY PASS)	GP-57	3313283	ACEITE	GP-9001	LF9001
COMBUSTIBLE	GPP-14	BM78254	AGUA	GP-1011Q	299086	DAEWOO		
COMBUSTIBLE	GP-1101	154711	ACEITE, CARTUCHO PARA DERIVACION (BY PASS)	G-750	256838	EXCAVADORAS		
ACEITE, SELLADO PARA FLUJO TOTAL (FULL FLOW)	GP-53	3889310	VT1710G A DIESEL, VTA1710GC A DIESEL, VTA1710GS A DIESEL			DH130-II con motor/ISUZU		
ACEITE, SELLADO PARA DERIVACION (BY PASS)	GP-57	3313283	ACEITE	GP-53	3889310	ACEITE	GP-178	65.05510.5009
COMBUSTIBLE, SEPARADOR DE AGUA	GPP-11	3308638	COMBUSTIBLE	GP-55	3313306	DH130W con motor/A DIESEL		
AGUA	GP-2071W	299080	ACEITE, DERIVACION (BY PASS)	GP-57	3304232	ACEITE	GP-178	65.05510.5009
AIRE	GA-37	3001690	AGUA	GP-1011Q	299086	DH170 con motor/DAEWOO 1006-6HR		
ACEITE, CARTUCHO PARA DERIVACION (BY PASS)	G-750	256838	VT1710L1 A DIESEL, VTA1710L2 A DIESEL			ACEITE	GP-31	2474-6018
VT903 SERIES A DIESEL			ACEITE	GP-53	299670	COMBUSTIBLE	G-296	2474-6017
ACEITE	G-566	158139	COMBUSTIBLE	GP-55	299202	COMBUSTIBLE	G-296-B	2474-6017
COMBUSTIBLE	GP-11	154709	AGUA	GP-1011Q	299086	AIRE, SECUNDARIO	GA-361	P106834
ACEITE	GP-53	299670	ACEITE, DERIVACION (BY PASS)	G-750	256838	DH180LC con motor/A DIESEL		
ACEITE	GP-57	3304232	VT28 (28.0L) A DIESEL			ACEITE	GP-43	24749037
COMBUSTIBLE	GPP-11	156172	ACEITE	GP-53	299670	DH200LC con motor/DAEWOO D0846HM		
AGUA	GP-2071W	299080	COMBUSTIBLE	GP-55	299202	COMBUSTIBLE, SECUNDARIO	G-1121	65-12503-5003
COMBUSTIBLE	GPP-103	38318715	AGUA	GP-1011Q	299086	DH200W con motor/DAEWOO D1146		
ACEITE	G-750	256838	ACEITE, DERIVACION (BY PASS)	GP-57	3304232	COMBUSTIBLE, SECUNDARIO	G-1121	65125035003
VT903C A DIESEL			VTB903 A DIESEL			COMBUSTIBLE, PRIMARIO	G-1121F	65.12503.5001
ACEITE	G-566	158139	COMBUSTIBLE	GP-1101	154711			
COMBUSTIBLE	GPP-14	BM78254	ACEITE	GP-53	299670			
COMBUSTIBLE	GP-1101	154711	AGUA	GP-2071W	299080			
ACEITE	GP-53	3889310	ACEITE, DERIVACION (BY PASS)	G-750	256838			
ACEITE	GP-57	3313283						
AGUA	GP-2071W	299080						
AIRE	GA-37	3001690						

SERVICIO PESADO

MARCA-MODELO-MOTOR MAKE-MODEL-ENGINE	GONHER GONHER	OEM OEM
DAEWOO (continuación)		
EXCAVADORAS		
ACEITE	GP-43	65055105007
AIRE, SECUNDARIO	GA-361	24749038
DH220ED, DH220LC con motor/A DIESEL		
COMBUSTIBLE, SECUNDARIO	G-1121	65125035003
COMBUSTIBLE, PRIMARIO	G-1121F	65.12503.5001
ACEITE	GP-43	65055105007
DH280, DH320 con motor/DAEWOO D2366		
COMBUSTIBLE, SECUNDARIO	G-1123	65125035004
AIRE, PRIMARIO	GA-360	24746003
AIRE, SECUNDARIO	GA-361	24746025
DH280ED, DH450 con motor/A DIESEL		
COMBUSTIBLE, SECUNDARIO	G-1123	65125035004
DH50 con motor/A DIESEL		
ACEITE	GP-3985	65.05510.5002
S220LC-III con motor/A DIESEL		
COMBUSTIBLE, SECUNDARIO	G-1121	65125035003
COMBUSTIBLE, PRIMARIO	G-1121F	65.12503.5001
ACEITE	GP-43	65055105007
AIRE, SECUNDARIO	GA-361	24749038
S330-III, S400LC-III con motor/A DIESEL		
COMBUSTIBLE, SECUNDARIO	G-1123	65125035004
AIRE, PRIMARIO	GA-360	24746003
AIRE, SECUNDARIO	GA-361	24746025
S450-III con motor/A DIESEL		
COMBUSTIBLE, SECUNDARIO	G-1123	65125035004
SOLAR 015, SOLAR 025, SOLAR 035 con motor/ISUZU 3KR1		
AIRE	GAK-16	1142151350
SOLAR 050 con motor/DAEWOO DC24		
COMBUSTIBLE	G-1123	24749026
SOLAR 130 con motor/DAEWOO DB58		
AIRE, SECUNDARIO	GA-361	24749038
SOLAR 130-III, SOLAR 130W-III, SOLAR 130W-V con motor/DAEWOO DB58T		
ACEITE	GP-178	65.05510.5009
SOLAR 170W-III con motor/DAEWOO D1146		
COMBUSTIBLE, SECUNDARIO	G-1121	65-12503-5003
COMBUSTIBLE, PRIMARIO	G-1121F	65.12503.5001
ACEITE	GP-43	65-05510-5007
AIRE, SECUNDARIO	GA-361	24749038
SOLAR 200W-III con motor/DAEWOO D1146		
COMBUSTIBLE, SECUNDARIO	G-1121	65125035003
COMBUSTIBLE, PRIMARIO	G-1121F	65.12503.5001
ACEITE	GP-43	65055105007
AIRE, SECUNDARIO	GA-361	24749038
SOLAR 220 con motor/DAEWOO D1146		
ACEITE	GP-43	24749037
SOLAR 330 con motor/DAEWOO DE12T		
COMBUSTIBLE	G-1123	24749026

MARCA-MODELO-MOTOR MAKE-MODEL-ENGINE	GONHER GONHER	OEM OEM
DAEWOO (continuación)		
EXCAVADORAS		
SOLAR 400 con motor/DAEWOO DE12T		
ACEITE	GP-43	24749037
SOLAR 450 con motor/DAEWOO DV15T		
COMBUSTIBLE	G-1123	24749026
SOLAR 55W-V con motor/YANMAR 4TNE94		
ACEITE	GP-6811	129150-35151
SOLAR280LC-II, SOLAR280LC-III con motor/DAEWOO D2366		
COMBUSTIBLE, SECUNDARIO	G-1123	65125035004
AIRE, PRIMARIO	GA-360	24746003
AIRE, SECUNDARIO	GA-361	24746025
DAEWOO		
MONTACARGAS		
D355, D40 con motor/PERKINS 4.2482		
ACEITE	GP-1	2654404
COMBUSTIBLE	G-296	868014
COMBUSTIBLE	G-296-B	868014
D70, D50, D60 con motor/PERKINS 4.236		
ACEITE	GP-1	2654404
COMBUSTIBLE	G-296	868014
COMBUSTIBLE	G-296-B	868014
G205-2 con motor/HERCULES 1404 2.7L		
ACEITE	GP-66	D141099
G255 con motor/A DIESEL		
ACEITE	GP-36	LF3497
G255-2, G305-2, GC205-2, GC255-2 con motor/HERCULES 1404 2.7L		
ACEITE	GP-66	D141099
DAF		
CAMIONES, TRACTOCAMIONES Y AUTOBUSES		
55LF.170 con motor/BE123C (02/01 EN DELANTE)		
DIRECCION	G-162H	229348
COMBUSTIBLE	GP-548	1399760
ACEITE	GP-737	1399494
AIRE	GA-697R	1433697
55LF.170 con motor/ISBE (0201 EN DELANTE)		
DIRECCION	G-162H	229348
COMBUSTIBLE	GP-548	1399760
ACEITE	GP-737	LF16015
AIRE	GA-697R	1433697
55LF.180 con motor/CE136C (02/01 EN ADELANTE)		
DIRECCION	G-162H	229348
COMBUSTIBLE	GP-548	1399760
ACEITE	GP-737	1399494
AIRE	GA-697R	1433697
55LF.190 con motor/CE136C (02-01 EN DELANTE)		
DIRECCION	G-162H	229348
COMBUSTIBLE	GP-548	1399760
ACEITE	GP-737	1399494
AIRE	GA-697R	1433697

MARCA-MODELO-MOTOR MAKE-MODEL-ENGINE	GONHER GONHER	OEM OEM
DAF (continuación)		
CAMIONES, TRACTOCAMIONES Y AUTOBUSES		
55LF.220 con motor/CE162C (02-01 EN DELANTE)		
DIRECCION	G-162H	229348
COMBUSTIBLE	GP-548	1399760
ACEITE	GP-737	1399494
AIRE	GA-697R	1433697
55LF.250 con motor/CE184C (02-01 EN DELANTE)		
DIRECCION	G-162H	229348
COMBUSTIBLE	GP-548	1399760
ACEITE	GP-737	1399494
AIRE	GA-697R	1433697
F95.530XF con motor/CUMMINS VF 390M (03/97-10/99)		
DIRECCION	G-162H	229348
ACEITE	GP-3000	3318853
AGUA, SISTEMA DE ENFRIAMIENTO	GP-2071W	1289132
COMBUSTIBLE	GPP-1000	3329289
DANA		
TRANSMISIONES		
SK-12763 con motor/A DIESEL		
TRANSMISION	G-6	P551475
DEMAG		
GRÚAS		
AC665 con motor/CUMMINS N14		
ACEITE	GP-3000	3318853
DETROIT DIESEL		
MOTORES		
11.1L SERIES 60 A DIESEL, 12.7L SERIES 60 A DIESEL		
COMBUSTIBLE	GP-26	6438839
COMBUSTIBLE	GP-27	6438840
ACEITE	GP-53	25010495
ACEITE	GP-57	25011188
ACEITE	GP-193	25014505
12V-149 SERIES A DIESEL		
ACEITE, CARTUCHO	G-33	5573014
ACEITE, SELLADO	GP-53	23518671
COMBUSTIBLE, PRIMARIO	GP-55	25014341
ACEITE, SELLADO	GP-43	25010495
COMBUSTIBLE, SECUNDARIO	GP-85	25013535
12V-71 A DIESEL, 12V-71T A DIESEL, 12V-92 SERIES A DIESEL, 16V-149 SERIES A DIESEL, 16V-71 A DIESEL, 16V-71T SERIES A DIESEL, 16V-92 A DIESEL, 16V-92T A DIESEL		
ACEITE, DERIVACION (BY PASS)	G-31	5572425
ACEITE, CARTUCHO	G-33	5573014
ACEITE, SELLADO	GP-53	25010495
COMBUSTIBLE, PRIMARIO	GP-55	25014341
ACEITE, SELLADO	GP-43	25010495
COMBUSTIBLE, SECUNDARIO	GP-85	25013535
12V-71 SERIES A DIESEL, 16V-71 SERIES A DIESEL, 16V-92 SERIES A DIESEL		
ACEITE, DERIVACION (BY PASS)	G-31	5572425
ACEITE, CARTUCHO	G-33	5573014
ACEITE, SELLADO	GP-53	23518671
16V-149 A DIESEL		
ACEITE	G-33	5573014

MARCA-MODELO-MOTOR MAKE-MODEL-ENGINE	GONHER GONHER	OEM OEM	MARCA-MODELO-MOTOR MAKE-MODEL-ENGINE	GONHER GONHER	OEM OEM	MARCA-MODELO-MOTOR MAKE-MODEL-ENGINE	GONHER GONHER	OEM OEM
DETROIT DIESEL (continuación)			DETROIT DIESEL (continuación)			DETROIT DIESEL (continuación)		
MOTORES			MOTORES			MOTORES		
20V-149 SERIES A DIESEL			COMBUSTIBLE	G-1174	5574961	4-53 SERIES A DIESEL		
COMBUSTIBLE, PRIMARIO	GP-55	25014341	COMBUSTIBLE	G-1175	5574508	ACEITE	G-33	5573014
2-53 A DIESEL			COMBUSTIBLE	GP-92	25011011	COMBUSTIBLE, SECUNDARIO	G-1173	5573263
ACEITE, DERIVACION (BY PASS)	G-31	5572425	COMBUSTIBLE	GP-93	25010959	CARTUCHO 3 1/4 IN		
ACEITE	G-119	5574978	COMBUSTIBLE	GP-43	25011106	COMBUSTIBLE, SECUNDARIO	G-1175	5574508
COMBUSTIBLE, SECUNDARIO	G-1173	5573261	ACEITE			CARTUCHO 7 3/8 IN		
CARTUCHO			3-53 SERIES A DIESEL, 3-53T SERIES A DIESEL			ACEITE	GP-53	23518671
COMBUSTIBLE	G-1174	5574961	ACEITE, CARTUCHO	G-33	5573014	COMBUSTIBLE, PRIMARIO	GP-92	23518527
COMBUSTIBLE	GP-26	6438839	ACEITE, CARTUCHO OPCIONAL	G-119	5574978	COMBUSTIBLE, SECUNDARIO	GP-93	23518526
COMBUSTIBLE	GP-27	6438840	COMBUSTIBLE, SECUNDARIO	G-1173	5573263	CARTUCHO		
COMBUSTIBLE	GP-43	25011106	CARTUCHO 3 1/4 IN			4-53T SERIES A DIESEL		
ACEITE			COMBUSTIBLE, SECUNDARIO	G-1175	5574508	ACEITE, DERIVACION (BY PASS)	G-31	5572425
2-53 SERIES A DIESEL			CARTUCHO 7 3/8 IN			ACEITE, CARTUCHO	G-33	5573014
ACEITE, CARTUCHO	G-31	5572425	COMBUSTIBLE, PRIMARIO	GP-92	23518527	COMBUSTIBLE, SECUNDARIO	G-1173	5573261
ACEITE, DERIVACION (BY PASS)	G-31	5572425	SELLADO			CARTUCHO		
ACEITE, CARTUCHO	G-119	5574978	COMBUSTIBLE, SECUNDARIO	GP-93	23518526	COMBUSTIBLE, PRIMARIO	G-1174	5574961
COMBUSTIBLE, SECUNDARIO	G-1173	5573261	SELLADO			CARTUCHO		
CARTUCHO			ACEITE, SELLADO	GP-43	23518525	COMBUSTIBLE, SECUNDARIO	G-1175	5574508
COMBUSTIBLE, PRIMARIO	G-1174	5574961	379 (6.2L) V8 A DIESEL			CARTUCHO		
CARTUCHO			ACEITE	GP-13	6438384	COMBUSTIBLE, PRIMARIO	GP-92	25011011
COMBUSTIBLE, PRIMARIO	GP-26	6438839	COMBUSTIBLE, PRIMARIO	GP-92	23518527	SELLADO		
SELLADO			COMBUSTIBLE, SECUNDARIO	GP-1122	6439304	COMBUSTIBLE, SECUNDARIO	GP-93	25010959
COMBUSTIBLE, SECUNDARIO	GP-27	6438840	COMBUSTIBLE	G-294	10149549	SELLADO		
SELLADO			395 (6.5L) V8 A DIESEL			ACEITE, SELLADO	GP-43	25010495
ACEITE, SELLADO	GP-43	25011106	ACEITE	GP-205	6438384	4-71 SERIES A DIESEL		
COMBUSTIBLE, SEPARADOR	S 3202	25011910	4.0L PHASER SERIES A DIESEL			ACEITE, DERIVACION (BY PASS)	G-31	5572425
DE AGUA			ACEITE	G-31	5572425	ACEITE, CARTUCHO	G-33	5573014
2-71 A DIESEL, 3-71 A DIESEL, 3-71 SERIES A DIESEL			COMBUSTIBLE	G-296	26561117	COMBUSTIBLE, SECUNDARIO	G-1173	5573261
ACEITE, DERIVACION (BY PASS)	G-31	5572425	COMBUSTIBLE	G-296-B	26561117	CARTUCHO		
ACEITE, CARTUCHO	G-33	5573014	40 (7.6L) SERIES A DIESEL			COMBUSTIBLE, SECUNDARIO	G-1175	5574508
COMBUSTIBLE, SECUNDARIO	G-1173	5573261	COMBUSTIBLE			CARTUCHO		
CARTUCHO			40 (7.6L) SERIES A DIESEL			ACEITE, SELLADO	GP-53	23518671
ACEITE, SELLADO	GP-53	23518671	COMBUSTIBLE	GP-1108	625627C1	COMBUSTIBLE, PRIMARIO	GP-92	23518527
COMBUSTIBLE, PRIMARIO	GP-92	23518527	4000 SERIES A DIESEL			COMBUSTIBLE, SECUNDARIO	GP-93	23518526
COMBUSTIBLE, SECUNDARIO	GP-93	23518526	ACEITE, OPCIONAL	GP-152	5241840301	SELLADO		
SELLADO			4-51 SERIES 204 A DIESEL			50 (8.5L) SERIES A DIESEL		
2-71 SERIES 142 A DIESEL, 3-71 SERIES 213 A DIESEL, 4-71 A DIESEL, 4-71T A DIESEL			COMBUSTIBLE, SECUNDARIO	G-1173	5573261	COMBUSTIBLE, PRIMARIO	GP-26	25014274
ACEITE, DERIVACION (BY PASS)	G-31	5572425	COMBUSTIBLE	G-1174	5574961	COMBUSTIBLE, SECUNDARIO	GP-27	25014342
ACEITE, CARTUCHO	G-33	5573014	COMBUSTIBLE	GP-26	6438839	ACEITE	GP-193	25014505
COMBUSTIBLE, SECUNDARIO	G-1173	5573261	COMBUSTIBLE	GP-27	6438840	509 CID (8.2L) A DIESEL, 509-V8 (8.2L) A DIESEL		
CARTUCHO			COMBUSTIBLE, SEPARADOR	S 3202	23512317	ACEITE	GP-13	6438384
COMBUSTIBLE, PRIMARIO	G-1174	5574961	DE AGUA			COMBUSTIBLE, PRIMARIO	GP-92	23518527
ACEITE, SELLADO	GP-53	25010495	4-51 SERIES A DIESEL			COMBUSTIBLE, SECUNDARIO	GP-93	23518526
COMBUSTIBLE, PRIMARIO	GP-92	25011011	COMBUSTIBLE, SECUNDARIO	G-1173	5573261	518 (8.5L) SERIES 50 A DIESEL		
SELLADO			COMBUSTIBLE, SECUNDARIO			COMBUSTIBLE, PRIMARIO	GP-26	23518481
COMBUSTIBLE, SECUNDARIO	GP-93	25010959	4-53 A DIESEL			COMBUSTIBLE, SECUNDARIO	GP-27	23518482
SELLADO			ACEITE, DERIVACION (BY PASS)	G-31	5572425	ACEITE	GP-193	25014505
ACEITE, SELLADO	GP-43	25010495	ACEITE, CARTUCHO	G-33	5573014	COMBUSTIBLE, SEPARADOR	GPP-1000	23516189
2-71 SERIES A DIESEL			COMBUSTIBLE, SECUNDARIO	G-1173	5573261	DE AGUA OPCIONAL		
ACEITE, DERIVACION (BY PASS)	G-31	5572425	COMBUSTIBLE, PRIMARIO	G-1174	5574961	COMBUSTIBLE, SEPARADOR	S 3202	23512317
ACEITE, CARTUCHO	G-33	5573014	CARTUCHO			DE AGUA		
COMBUSTIBLE, SECUNDARIO	G-1173	5573261	COMBUSTIBLE, SECUNDARIO	G-1175	5574508	6.0L PHASER SERIES A DIESEL		
CARTUCHO			ACEITE, SELLADO	GP-53	25010495	ACEITE	GP-1	2654403
COMBUSTIBLE, PRIMARIO	G-1174	5574961	COMBUSTIBLE, PRIMARIO	GP-92	25011011	COMBUSTIBLE	G-296	26561117
ACEITE, SELLADO	GP-53	23518671	SELLADO			COMBUSTIBLE	G-296-B	26561117
COMBUSTIBLE, PRIMARIO	GP-92	23518527	COMBUSTIBLE, SECUNDARIO	GP-93	25010959	60 (11.1L, 12.7L, 14.0L) SERIES A DIESEL		
COMBUSTIBLE, SECUNDARIO	GP-93	23518526	SELLADO			COMBUSTIBLE, SEPARADOR	G-128	23521528
SELLADO			COMBUSTIBLE, SECUNDARIO	GP-93	25010959	DE AGUA		
350 V8 (OLDS) A DIESEL			SELLADO			COMBUSTIBLE, PRIMARIO	GP-26	25014274
ACEITE	GP-20	6437462	ACEITE, SELLADO	GP-43	25010495	COMBUSTIBLE, SECUNDARIO	GP-27	25014342
3-53 A DIESEL, 3-53T A DIESEL			3-53 A DIESEL, 3-53T A DIESEL			ACEITE, DERIVACION (BY PASS)	GP-57	25011188
ACEITE	G-119	5574978	ACEITE	G-119	5574978	ACEITE, SELLADO	GP-43	25010495
COMBUSTIBLE	G-1173	5573261	COMBUSTIBLE	G-1173	5573261	ACEITE, SELLADO	GP-193	23527033

SERVICIO PESADO

MARCA-MODELO-MOTOR MAKE-MODEL-ENGINE	GONHER GONHER	OEM OEM	MARCA-MODELO-MOTOR MAKE-MODEL-ENGINE	GONHER GONHER	OEM OEM	MARCA-MODELO-MOTOR MAKE-MODEL-ENGINE	GONHER GONHER	OEM OEM
DETROIT DIESEL (continuación)			DETROIT DIESEL (continuación)			DETROIT DIESEL (continuación)		
MOTORES			MOTORES			MOTORES		
COMBUSTIBLE, SEPARADOR DE AGUA	S 3202	25011910	COMBUSTIBLE, PRIMARIO CARTUCHO	G-1176	5575032	8.2L FUEL PINCHER A DIESEL		
6-110 SERIES 660 A DIESEL			COMBUSTIBLE, PRIMARIO	GP-26	23518481	ACEITE	GP-13	6438384
ACEITE, CARTUCHO	G-31	5572425	COMBUSTIBLE, SECUNDARIO SELLADO	GP-27	23518482	COMBUSTIBLE, PRIMARIO	GP-92	25011011
ACEITE, CARTUCHO	G-33	5573014	ACEITE, SELLADO	GP-53	23518671	COMBUSTIBLE, SECUNDARIO	GP-93	25010959
COMBUSTIBLE, PRIMARIO CARTUCHO	G-1174	5574961	ACEITE, SELLADO	GP-43	25010495	8.5 SERIES 50 A DIESEL		
COMBUSTIBLE, SECUNDARIO CARTUCHO	G-1175	5574508	COMBUSTIBLE, SEPARADOR DE AGUA	S 3202	23512317	COMBUSTIBLE	GP-26	6438839
COMBUSTIBLE, PRIMARIO SELLADO	GP-26	6438839	6V-53T SERIES A DIESEL			COMBUSTIBLE	GP-27	6438840
COMBUSTIBLE, SECUNDARIO SELLADO	GP-27	6438840	ACEITE, DERIVACION (BY PASS)	G-31	5572425	ACEITE	GP-193	25014505
COMBUSTIBLE, SEPARADOR DE AGUA	S 3202	23512317	ACEITE, CARTUCHO	G-33	5573014	8V-149 SERIES A DIESEL		
6-110 SERIES A DIESEL			COMBUSTIBLE, SECUNDARIO CARTUCHO	G-1175	5574508	ACEITE	GP-53	23518671
ACEITE, DERIVACION (BY PASS)	G-31	5572425	COMBUSTIBLE, PRIMARIO CARTUCHO	G-1176	5575032	COMBUSTIBLE, PRIMARIO	GP-55	25014341
ACEITE	G-33	5573014	COMBUSTIBLE, PRIMARIO	GP-26	23518481	COMBUSTIBLE, SECUNDARIO	GP-85	25013535
COMBUSTIBLE, SECUNDARIO CARTUCHO	G-1175	5574508	COMBUSTIBLE, SECUNDARIO SELLADO	GP-27	23518482	8V-53 SERIES 424 A DIESEL		
6-71 A DIESEL, 6-71E SERIES 426 A DIESEL, 6-71N SERIES 426 A DIESEL, 6-71T SERIES 426 A DIESEL, 6V-71N SERIES 426 A DIESEL, 8V-71 SERIES 568 A DIESEL, 8V-71 SERIES A DIESEL, 8V-71T SERIES 568 A DIESEL			ACEITE, SELLADO	GP-43	25010495	ACEITE, CARTUCHO	G-33	5573014
ACEITE, DERIVACION (BY PASS)	G-31	5572425	COMBUSTIBLE, SEPARADOR DE AGUA	S 3202	23512317	COMBUSTIBLE, SECUNDARIO CARTUCHO	G-1175	5574508
ACEITE, CARTUCHO	G-33	5573014	6V-71T SERIES 426 A DIESEL			COMBUSTIBLE, PRIMARIO CARTUCHO	G-1176	5575032
COMBUSTIBLE, PRIMARIO CARTUCHO	G-1174	5192854	ACEITE, CARTUCHO	G-31	5572425	COMBUSTIBLE, PRIMARIO SELLADO	GP-26	6438839
COMBUSTIBLE, SECUNDARIO CARTUCHO	G-1175	5574508	ACEITE, CARTUCHO	G-33	5573014	COMBUSTIBLE, SECUNDARIO SELLADO	GP-27	6438840
COMBUSTIBLE, PRIMARIO CARTUCHO	G-1176	5575032	COMBUSTIBLE, PRIMARIO CARTUCHO	G-1174	5574961	COMBUSTIBLE, SEPARADOR DE AGUA	S 3202	23512317
COMBUSTIBLE, PRIMARIO	GP-26	23518481	COMBUSTIBLE, SECUNDARIO CARTUCHO	G-1175	5574508	8V-53 SERIES A DIESEL		
COMBUSTIBLE, SECUNDARIO SELLADO	GP-27	23518482	COMBUSTIBLE, PRIMARIO CARTUCHO	G-1176	5575032	ACEITE	G-33	5573014
ACEITE, SELLADO	GP-53	23518671	COMBUSTIBLE, PRIMARIO SELLADO	GP-26	6438839	8V-92 SERIES 736 A DIESEL, 8V-92T SERIES 736 A DIESEL		
ACEITE, SELLADO	GP-43	25010495	COMBUSTIBLE, SECUNDARIO SELLADO	GP-27	6438840	ACEITE, CARTUCHO	G-33	5573014
COMBUSTIBLE, SEPARADOR DE AGUA	S 3202	23512317	ACEITE, SELLADO	GP-43	25010495	COMBUSTIBLE, SECUNDARIO CARTUCHO	G-1175	5574508
6-71 SERIES A DIESEL, 6V-71 SERIES A DIESEL			COMBUSTIBLE, SEPARADOR DE AGUA	S 3202	23512317	COMBUSTIBLE, PRIMARIO CARTUCHO	G-1176	5575032
ACEITE, DERIVACION (BY PASS)	G-31	5572425	6V-92 SERIES 552 A DIESEL, 6V-92T SERIES 552 A DIESEL			COMBUSTIBLE, PRIMARIO SELLADO	GP-26	6438839
ACEITE, CARTUCHO	G-33	5573014	ACEITE, CARTUCHO	G-33	5573014	COMBUSTIBLE, SECUNDARIO SELLADO	GP-27	6438840
COMBUSTIBLE, SECUNDARIO CARTUCHO	G-1175	5574508	COMBUSTIBLE, SECUNDARIO CARTUCHO	G-1175	5574508	ACEITE, SELLADO	GP-53	25010495
COMBUSTIBLE, PRIMARIO	GP-26	23518481	COMBUSTIBLE, PRIMARIO CARTUCHO	G-1176	5575032	ACEITE, SELLADO	GP-43	25010495
COMBUSTIBLE, SECUNDARIO SELLADO	GP-27	23518482	COMBUSTIBLE, PRIMARIO SELLADO	GP-26	6438839	COMBUSTIBLE, SEPARADOR DE AGUA	S 3202	23512317
ACEITE, SELLADO	GP-53	23518671	COMBUSTIBLE, SECUNDARIO SELLADO	GP-27	6438840	D351 A DIESEL, D478 A DIESEL, D637 A DIESEL, DH478 A DIESEL, DH637 A DIESEL		
ACEITE, SELLADO	GP-43	25010495	ACEITE, SELLADO	GP-53	25010495	ACEITE, CARTUCHO	G-33	5573014
COMBUSTIBLE, SEPARADOR DE AGUA	S 3202	23512317	ACEITE, SELLADO	GP-43	25010495	D638 A DIESEL		
6-71 SERIES A DIESEL, 6V-71 SERIES A DIESEL			6V-92 SERIES A DIESEL, 8V-92 SERIES A DIESEL			ACEITE	GP-31	7984717
ACEITE, DERIVACION (BY PASS)	G-31	5572425	ACEITE, CARTUCHO	G-33	5573014	SERIES 40 (7.6L, 8.7L) A DIESEL		
ACEITE, CARTUCHO	G-33	5573014	COMBUSTIBLE, SECUNDARIO CARTUCHO	G-1175	5574508	COMBUSTIBLE, CAMIONES	GP-78	25011445
COMBUSTIBLE, SECUNDARIO CARTUCHO	G-1175	5574508	COMBUSTIBLE, PRIMARIO CARTUCHO	G-1176	5575032	SERIES 50 (8.5L) A DIESEL		
COMBUSTIBLE, PRIMARIO	GP-26	23518481	COMBUSTIBLE, PRIMARIO SELLADO	GP-26	6438839	COMBUSTIBLE, PRIMARIO	GP-26	23518481
COMBUSTIBLE, SECUNDARIO SELLADO	GP-27	23518482	COMBUSTIBLE, SECUNDARIO SELLADO	GP-27	6438840	COMBUSTIBLE, SECUNDARIO	GP-27	23518482
ACEITE, SELLADO	GP-53	23518671	ACEITE, SELLADO	GP-53	25010495	ACEITE	GP-193	23518480
ACEITE, SELLADO	GP-43	25010495	COMBUSTIBLE, SEPARADOR DE AGUA	S 3202	23512317	COMBUSTIBLE, SEPARADOR DE AGUA	GPP-1000	23516189
COMBUSTIBLE, SEPARADOR DE AGUA	S 3202	23512317	8.2L A DIESEL			COMBUSTIBLE, SEPARADOR DE AGUA	S 3202	23512317
677 (11.1L) A DIESEL, 774 (12.7L) SERIES 60 A DIESEL, SERIES 60 (12.7L, 14.0L) A DIESEL, SERIES 60 A DIESEL			ACEITE	GP-13	6438384	COMBUSTIBLE, SEPARADOR DE AGUA		
COMBUSTIBLE, PRIMARIO	GP-26	23518481	COMBUSTIBLE, PRIMARIO	GP-92	25011011	SERIES 55 A DIESEL		
COMBUSTIBLE, SECUNDARIO	GP-27	23518482	COMBUSTIBLE, SECUNDARIO	GP-93	25010959	COMBUSTIBLE, PRIMARIO	GP-26	23518481
ACEITE	GP-53	23518671	COMBUSTIBLE, SEPARADOR DE AGUA	GPP-1122	12542374	COMBUSTIBLE, SECUNDARIO	GP-27	23518482
ACEITE, DERIVACION (BY PASS)	GP-57	25011188	ACEITE	GP-205	6438384	ACEITE	GP-193	23518480
ACEITE	GP-193	25014505	8.2L A DIESEL			COMBUSTIBLE, SEPARADOR DE AGUA	GPP-1000	23516189
COMBUSTIBLE, SEPARADOR DE AGUA OPCIONAL	GPP-1000	23516189	ACEITE	GP-13	6438384	SERIES 40 (7.6L, 8.7L) A DIESEL		
COMBUSTIBLE, SEPARADOR DE AGUA	S 3202	23512317	COMBUSTIBLE, PRIMARIO	GP-92	25011011	COMBUSTIBLE, CAMIONES	GP-78	25011445
6V-53 SERIES A DIESEL			COMBUSTIBLE, SECUNDARIO	GP-93	25010959	SERIES 50 (8.5L) A DIESEL		
ACEITE, DERIVACION (BY PASS)	G-31	5572425	COMBUSTIBLE, SEPARADOR DE AGUA	GPP-1122	12542374	COMBUSTIBLE, PRIMARIO	GP-26	23518481
ACEITE, CARTUCHO	G-33	5573014	ACEITE	GP-205	6438384	COMBUSTIBLE, SECUNDARIO	GP-27	23518482
COMBUSTIBLE, SECUNDARIO CARTUCHO	G-1173	5573261	COMBUSTIBLE, PRIMARIO	GP-26	23518481	ACEITE	GP-193	23518480
COMBUSTIBLE, SECUNDARIO CARTUCHO	G-1175	5574508	COMBUSTIBLE, SECUNDARIO	GP-27	23518482	COMBUSTIBLE, SEPARADOR DE AGUA	GPP-1000	23516189
			ACEITE, SELLADO	GP-53	23518671	COMBUSTIBLE, SEPARADOR DE AGUA	S 3202	23512317
			8.2L A DIESEL			SERIES 55 A DIESEL		
			ACEITE	GP-13	6438384	COMBUSTIBLE, PRIMARIO	GP-26	23518481
			COMBUSTIBLE, PRIMARIO	GP-92	25011011			
			COMBUSTIBLE, SECUNDARIO	GP-93	25010959			
			COMBUSTIBLE, SEPARADOR DE AGUA	GPP-1122	12542374			
			ACEITE	GP-205	6438384			

MARCA-MODELO-MOTOR MAKE-MODEL-ENGINE	GONHER GONHER	OEM OEM	MARCA-MODELO-MOTOR MAKE-MODEL-ENGINE	GONHER GONHER	OEM OEM	MARCA-MODELO-MOTOR MAKE-MODEL-ENGINE	GONHER GONHER	OEM OEM
DEUTZ			DEUTZ (continuación)			DEUTZ (continuación)		
CARGADORAS			MOTORES			MOTORES		
A1720 con motor/A DIESEL			A2L612 A DIESEL			A6L712 A DIESEL, BF6M716 A DIESEL		
ACEITE	GP-54	1174421	ACEITE	G-330	1168443	COMBUSTIBLE, SIN CUBIERTA	G-1123	1168398
B1750 con motor/A DIESEL			A2L911 A DIESEL			A6L714A A DIESEL		
COMBUSTIBLE, SECUNDARIO	G-1123	1168398	COMBUSTIBLE, SIN CUBIERTA	G-1123	1168398	ACEITE	G-31	P3H4120
			COMBUSTIBLE, CON CUBIERTA	G-1123F	1168398	A6L812 A DIESEL		
			COMBUSTIBLE, SELLADO	GP-1122	Q1H4117	ACEITE	G-330	1168443
						COMBUSTIBLE, SIN CUBIERTA	G-1123	1168398
						COMBUSTIBLE, CON CUBIERTA	G-1123F	1168398
						COMBUSTIBLE, SELLADO	G-1123F	1168398
						B12L714 A DIESEL		
						COMBUSTIBLE, SECUNDARIO	G-1121	1160038
						BA12L614 A DIESEL, BF12L614 A DIESEL		
						ACEITE	G-31	1168469
						COMBUSTIBLE, PRIMARIO SIN CUBIERTA	G-1123	1168407
						COMBUSTIBLE, PRIMARIO CON CUBIERTA	G-1123F	1168407
						BF16M716 A DIESEL		
						ACEITE	G-191	1161212
						BF4L1011 A DIESEL, BF4M1011 A DIESEL		
						ACEITE	GP-28	1172346
						BF4M1008 A DIESEL		
						ACEITE	GP-461	12850069
						BF4M2011 A DIESEL		
						COMBUSTIBLE	GPP-1122	1174482
						BF4M2012 A DIESEL		
						ACEITE, CARTUCHO	G-3827	P550768
						ACEITE, SELLADO	GP-54	1174418
						COMBUSTIBLE	GP-1122	1174423
						BF6L912 A DIESEL		
						ACEITE	GP-54	1174421
						COMBUSTIBLE, PRIMARIO	GP-1122	2133558
						COMBUSTIBLE, SECUNDARIO	GP-1122	2133943
						COMBUSTIBLE, SIMPLE	GP-1122	Q1H4117
						COMBUSTIBLE, PRIMARIO	GPP-1122	2133558
						COMBUSTIBLE, SECUNDARIO	GPP-1122	1174483
						BF6L913 A DIESEL		
						COMBUSTIBLE, PRIMARIO	GP-1122	2133558
						COMBUSTIBLE, SECUNDARIO	GP-1122	2133943
						COMBUSTIBLE, SIMPLE	GP-1122	Q1H4117
						COMBUSTIBLE, PRIMARIO	GPP-1122	2133558
						COMBUSTIBLE, SECUNDARIO	GPP-1122	1174483
						ACEITE	GP-77	1174420
						BF6M2013C A DIESEL, BF6M2013CR A DIESEL		
						ACEITE	G-3754	2931095
						BF8L413 A DIESEL		
						COMBUSTIBLE, SIN CUBIERTA	G-1123	1168398
						COMBUSTIBLE, CON CUBIERTA	G-1123F	1168398
						ACEITE	GP-54	A15H4123
						COMBUSTIBLE	GP-1122	1161341
						BF8L513 A DIESEL, BF8L610 A DIESEL		
						ACEITE	GP-54	1174421

SERVICIO PESADO

MARCA-MODELO-MOTOR MAKE-MODEL-ENGINE	GONHER GONHER	OEM OEM	MARCA-MODELO-MOTOR MAKE-MODEL-ENGINE	GONHER GONHER	OEM OEM	MARCA-MODELO-MOTOR MAKE-MODEL-ENGINE	GONHER GONHER	OEM OEM
DEUTZ (continuación)			DEUTZ (continuación)			DEUTZ (continuación)		
MOTORES			MOTORES			MOTORES		
BF8M1015C A DIESEL, BF8M1015M A DIESEL, F1L410 A DIESEL, F1L511W A DIESEL, F2L410 A DIESEL, F2L511W A DIESEL	GP-1122	1161341	ACEITE	GP-3816	1163420	COMBUSTIBLE	GP-1122	Q1H4117
COMBUSTIBLE			F1L210 A DIESEL			F3L912 A DIESEL, F4L912 A DIESEL		
BF8M716 A DIESEL, F12L413V A DIESEL			ACEITE	GP-9	P550580	ACEITE	GP-36	1160024
COMBUSTIBLE, SIN CUBIERTA	G-1123	Q1H4115	COMBUSTIBLE	GP-1122	1161341	ACEITE	GP-54	A1H4123
F10L312 A DIESEL, F12L312 A DIESEL, F6L312 A DIESEL			ACEITE	GP-81	P550580	COMBUSTIBLE, PRIMARIO	GP-1122	2133558
COMBUSTIBLE, SIN CUBIERTA	G-1123	1168398	F1L410D A DIESEL, F1L411D A DIESEL, F1L411W A DIESEL, F2L410D A DIESEL, F2L410W A DIESEL, F2L411 A DIESEL			COMBUSTIBLE, SECUNDARIO	GP-1122	2133943
COMBUSTIBLE, CON CUBIERTA	G-1123F	1168398	ACEITE	GP-36	1160024	COMBUSTIBLE, SIMPLE	GP-1122	Q1H4117
ACEITE	GP-54	1174421	F1L411 A DIESEL, F2L1011 A DIESEL, F2L411 A DIESEL, F2L511 A DIESEL, F2M1011 A DIESEL			F3M1011 A DIESEL, F4L1011 A DIESEL		
F10L413 A DIESEL			ACEITE, 4 45/64 IN	GP-28	1172346	ACEITE	GP-28	1172346
COMBUSTIBLE, SIN CUBIERTA	G-1123	1168407	COMBUSTIBLE	GP-1122	1161341	F3M417 A DIESEL, F3M716 A DIESEL		
COMBUSTIBLE, CON CUBIERTA	G-1123F	1168407	ACEITE, 3 11/32 IN	GP-3816	1174416	COMBUSTIBLE, SIN CUBIERTA	G-1121	1160038
ACEITE	GP-54	A15H4123	F1L511 A DIESEL, F2L511D A DIESEL, F3L1011 A DIESEL, F4M1011 A DIESEL			COMBUSTIBLE, SIN CUBIERTA	G-1123	1168398
COMBUSTIBLE, PRIMARIO	GP-1122	2133558	ACEITE	GP-28	1172346	COMBUSTIBLE, CON CUBIERTA	G-1121F	1160038
COMBUSTIBLE, SECUNDARIO	GP-1122	2133943	F1L514 A DIESEL, F1L612 A DIESEL, F1L712 A DIESEL, F1L812 A DIESEL, F1M417 A DIESEL, F2L12 A DIESEL, F2L310 A DIESEL, F2M417 A DIESEL, F3L410 A DIESEL, F4L612 A DIESEL			COMBUSTIBLE, CON CUBIERTA	G-1123F	1168398
COMBUSTIBLE, SIMPLE	GP-1122	Q1H4117	COMBUSTIBLE, SIN CUBIERTA	G-1121	Q05H4115	ACEITE	GP-9	P550580
F10L413V A DIESEL, F2L911 A DIESEL, F2L912 A DIESEL			F2L2012 A DIESEL, F2M2012 A DIESEL, F3L2011 A DIESEL, F3M2011 A DIESEL, F4L2011 A DIESEL, F4M2011 A DIESEL			ACEITE	GP-81	P550580
COMBUSTIBLE, SIN CUBIERTA	G-1123	Q1H4115	COMBUSTIBLE	GPP-1122	1174483	F4L310 A DIESEL		
COMBUSTIBLE, CON CUBIERTA	G-1123F	Q1H4115	F2L514 A DIESEL, F2L712 A DIESEL, F3L514 A DIESEL, F3L612 A DIESEL, F3L712 A DIESEL, F3L812 A DIESEL, F4L712 A DIESEL, F4L812 A DIESEL			COMBUSTIBLE, SIN CUBIERTA	G-1121	1160038
COMBUSTIBLE	GP-1122	Q1H4117	ACEITE	G-330	1168443	COMBUSTIBLE, SIN CUBIERTA	G-1123	1168398
F10L513 A DIESEL, F12L513 A DIESEL, F3L914 A DIESEL, F4L914 A DIESEL, F5L413 A DIESEL, F6L513 A DIESEL			COMBUSTIBLE, SECUNDARIO SIN CUBIERTA	G-1121	1160038	COMBUSTIBLE, CON CUBIERTA	G-1121F	1160038
ACEITE	GP-54	P3H4120	COMBUSTIBLE, PRIMARIO SIN CUBIERTA	G-1123	1168398	COMBUSTIBLE, CON CUBIERTA	G-1123F	1168398
F10L714 A DIESEL, F10L814 A DIESEL, F12L614 A DIESEL, F12L714 A DIESEL			COMBUSTIBLE, SECUNDARIO CON CUBIERTA	G-1121F	1160038	COMBUSTIBLE, SELLADO	GP-1122	Q1H4117
ACEITE	G-31	1168469	COMBUSTIBLE, PRIMARIO CON CUBIERTA	G-1123F	1168398	F4L911 A DIESEL		
COMBUSTIBLE, SECUNDARIO SIN CUBIERTA	G-1121	8H4120	COMBUSTIBLE, PRIMARIO	G-1123F	1168398	COMBUSTIBLE, SIN CUBIERTA	G-1123	1168398
COMBUSTIBLE, PRIMARIO SIN CUBIERTA	G-1123	1168407	COMBUSTIBLE, CON CUBIERTA	G-1123F	1168398	COMBUSTIBLE, CON CUBIERTA	G-1123F	1168398
COMBUSTIBLE, SECUNDARIO CON CUBIERTA	G-1121F	8H4120	F2L612 A DIESEL, F3L811 A DIESEL, F3L812D A DIESEL, F4L811 A DIESEL, F4L811D A DIESEL, F4L812D A DIESEL, F4L812G A DIESEL, F4L813 A DIESEL			ACEITE	GP-36	1160024
COMBUSTIBLE, PRIMARIO CON CUBIERTA	G-1123F	1168407	ACEITE	G-330	1168443	ACEITE	GP-54	A1H4123
ACEITE	GP-54	A15H4123	F2L812 A DIESEL			COMBUSTIBLE	GP-1122	Q1H4117
COMBUSTIBLE	GP-1122	1174422	ACEITE	G-330	1168443	F4L913 A DIESEL, F6L413 A DIESEL		
F12L814 A DIESEL			COMBUSTIBLE, SECUNDARIO CARTUCHO	G-1121	1160038	ACEITE	GP-36	1160024
ACEITE	G-31	1168469	COMBUSTIBLE, SECUNDARIO SIN CUBIERTA	G-1123	1168398	ACEITE	GP-54	A1H4123
COMBUSTIBLE, SIN CUBIERTA	G-1123	1168407	COMBUSTIBLE, SECUNDARIO CON CUBIERTA	G-1123F	1168398	COMBUSTIBLE, PRIMARIO	GP-1122	2133558
COMBUSTIBLE, CON CUBIERTA	G-1123F	1168407	COMBUSTIBLE, PRIMARIO SELLADO	GP-1122	2133558	COMBUSTIBLE, SECUNDARIO	GP-1122	2133943
F12M716 A DIESEL			COMBUSTIBLE, SECUNDARIO SELLADO	GP-1122	2133943	COMBUSTIBLE, SIMPLE	GP-1122	Q1H4117
COMBUSTIBLE, PRIMARIO SIN CUBIERTA	G-1123	1168407	F3L310 A DIESEL			COMBUSTIBLE, PRIMARIO	GPP-1122	2133558
COMBUSTIBLE, SECUNDARIO SIN CUBIERTA	G-1123	1168398	COMBUSTIBLE, SIN CUBIERTA	G-1121	1160217	COMBUSTIBLE, SECUNDARIO	GPP-1122	2133943
COMBUSTIBLE, PRIMARIO CON CUBIERTA	G-1123F	1168407	COMBUSTIBLE, CON CUBIERTA	G-1121F	1160217	F4M1008 A DIESEL		
COMBUSTIBLE, SECUNDARIO CON CUBIERTA	G-1123F	1168398	ACEITE	GP-9	P550580	ACEITE	GP-461	12850069
F1L208 A DIESEL, F2L208 A DIESEL, F2M1008F A DIESEL, F3M1008F A DIESEL, F4M1008F A DIESEL			ACEITE	GP-81	P550580	F4M716 A DIESEL		
			F3L911 A DIESEL, F3L913 A DIESEL, F5L911 A DIESEL, F5L912 A DIESEL			COMBUSTIBLE, SIN CUBIERTA	G-1123	1168398
			ACEITE	GP-36	1160024	F6L514 A DIESEL		
			ACEITE	GP-54	A1H4123	ACEITE, DERIVACION (BY PASS)	G-31	P3H4120
						COMBUSTIBLE, SECUNDARIO SIN CUBIERTA	G-1121	1160038
						COMBUSTIBLE, PRIMARIO SIN CUBIERTA	G-1123	1168398
						COMBUSTIBLE, SECUNDARIO CON CUBIERTA	G-1121F	1160038

MARCA-MODELO-MOTOR MAKE-MODEL-ENGINE	GONHER GONHER	OEM OEM	MARCA-MODELO-MOTOR MAKE-MODEL-ENGINE	GONHER GONHER	OEM OEM	MARCA-MODELO-MOTOR MAKE-MODEL-ENGINE	GONHER GONHER	OEM OEM
DEUTZ (continuación)			DEUTZ (continuación)			DEUTZ (continuación)		
MOTORES			MOTORES			TRACTORES		
COMBUSTIBLE, PRIMARIO CON CUBIERTA	G-1123F	1168398	T4M233 A DIESEL, T8M233 A DIESEL, TM233 A DIESEL			D16006 con motor/DEUTZ F6L912		
ACEITE	GP-54	1174421	COMBUSTIBLE, PRIMARIO SIN CUBIERTA	G-1123	1168398	ACEITE	GP-54	1174421
COMBUSTIBLE, SELLADO	GP-1122	Q1H4117	COMBUSTIBLE, SECUNDARIO SIN CUBIERTA	G-1123	1168398	D16006 con motor/DEUTZ F8L413		
F6L613 A DIESEL, F8L714A A DIESEL			COMBUSTIBLE, PRIMARIO CON CUBIERTA	G-1123F	1168398	ACEITE	GP-54	1174421
COMBUSTIBLE, SECUNDARIO	G-1121	1160038	COMBUSTIBLE, SECUNDARIO CON CUBIERTA	G-1123F	1168398	D2505, D3005 con motor/DEUTZ F2L812		
F6L614 A DIESEL, F6L712 A DIESEL, F6L714 A DIESEL, F8L614 A DIESEL, F8L714 A DIESEL, F6M517 A DIESEL, F6M617 A DIESEL, F8L814 A DIESEL, F8M517 A DIESEL, F8M617 A DIESEL			TC2012 A DIESEL			COMBUSTIBLE	G-1123	Q1H4115
ACEITE	G-31	P3H4120	AIRE, ALGUNOS, PRIMARIO RADIAL	GA-966R	P532966	D2506 con motores/DEUTZ F3L912, DEUTZ F4L912		
COMBUSTIBLE, SECUNDARIO SIN CUBIERTA	G-1121	1160038	TM325 A DIESEL, TM425 A DIESEL, TM525 A DIESEL, TM825 A DIESEL			COMBUSTIBLE, SIN CUBIERTA	G-1123	1168398
COMBUSTIBLE, PRIMARIO SIN CUBIERTA	G-1123	1168398	ACEITE	G-31	P3H4120	COMBUSTIBLE, CON CUBIERTA	G-1123F	1168398
COMBUSTIBLE, SECUNDARIO CON CUBIERTA	G-1121F	1160038	COMBUSTIBLE, SIN CUBIERTA	G-1123	1168407	ACEITE	GP-54	1174421
COMBUSTIBLE, PRIMARIO CON CUBIERTA	G-1123F	1168398	COMBUSTIBLE, CON CUBIERTA	G-1123F	1168407	COMBUSTIBLE	GP-1122	1161341
F6L714A A DIESEL			DEUTZ			D3006 con motor/DEUTZ F2L912		
ACEITE	G-31	P3H4120	TRACTORES			COMBUSTIBLE, SIN CUBIERTA	G-1123	Q1H4115
F6L811 A DIESEL, F6L812D A DIESEL			6, 110, 6.01, 6.05, 6.15, 100, 105, 106 con motor/DEUTZ BF6M1012			D3607, D3607A con motor/DEUTZ F2L912		
ACEITE	GP-36	1160024	COMBUSTIBLE	GP-1122	WK723	COMBUSTIBLE, SIN CUBIERTA	G-1123	1168398
F6L812 A DIESEL			6.2, 150, 6.3, 6.45, 120, 135 con motor/DEUTZ BF6M1013			D4005 con motor/DEUTZ F3L812		
ACEITE	G-330	1168443	ACEITE	GP-54	1174421	ACEITE	G-330	1168443
COMBUSTIBLE, SECUNDARIO SIN CUBIERTA	G-1121	1160038	AGROSTAR 6.38 con motor/DEUTZ F6L913			D4005 con motores/DEUTZ F3L812D, DEUTZ F4L812D		
COMBUSTIBLE, PRIMARIO SIN CUBIERTA	G-1123	1168398	ACEITE	GP-54	1174421	ACEITE	GP-36	A1H4123
COMBUSTIBLE, SECUNDARIO CON CUBIERTA	G-1121F	1160038	COMBUSTIBLE, PRIMARIO	GPP-1122	1174483	D4006 con motores/DEUTZ F3L912, DEUTZ F4L912		
COMBUSTIBLE, PRIMARIO CON CUBIERTA	G-1123F	1168398	COMBUSTIBLE, SECUNDARIO	GPP-1122	1174482	ACEITE	GP-36	1174418
F6L911 A DIESEL, F6L913 A DIESEL, F8L610 A DIESEL			AGROTRON 135 con motor/DEUTZ			ACEITE	GP-54	A1H4123
ACEITE	GP-54	1174421	ACEITE	GP-54	1174421	D4007 con motor/A DIESEL		
F6L912 A DIESEL			COMBUSTIBLE, PRIMARIO	GPP-1122	1174483	ACEITE	GP-54	A1H4123
ACEITE	GP-54	1174421	COMBUSTIBLE, SECUNDARIO	GPP-1122	1174482	COMBUSTIBLE, PRIMARIO	GP-1122	2133558
COMBUSTIBLE, PRIMARIO	GP-1122	2133558	D10006 con motor/DEUTZ F6L912			COMBUSTIBLE, SECUNDARIO	GP-1122	2133943
COMBUSTIBLE, SECUNDARIO	GP-1122	2133943	ACEITE	GP-54	A15H4123	D4505 con motor/DEUTZ F3L812		
COMBUSTIBLE, SIMPLE	GP-1122	Q1H4117	COMBUSTIBLE, SECUNDARIO	GP-1122	Q1H4117	ACEITE	G-330	1168443
COMBUSTIBLE, PRIMARIO	GPP-1122	2133558	COMBUSTIBLE, PRIMARIO	GPP-1122	1174483	D4505 con motores/DEUTZ F3L812D, DEUTZ F4L812D		
COMBUSTIBLE, SECUNDARIO	GPP-1122	2133943	COMBUSTIBLE, SECUNDARIO	GP-1122	A15H4123	ACEITE	GP-36	A1H4123
F6M716 A DIESEL, F8L312 A DIESEL			COMBUSTIBLE, PRIMARIO	GPP-1122	1174483	D4506, D4506A con motores/DEUTZ F3L912, DEUTZ F4L912		
COMBUSTIBLE, SIN CUBIERTA	G-1123	1168398	COMBUSTIBLE, SECUNDARIO	GP-1122	2133943	ACEITE	GP-36	1174418
F8L413 A DIESEL, F8L413V A DIESEL, F8L513 A DIESEL			COMBUSTIBLE, PRIMARIO	GPP-1122	1174483	ACEITE	GP-54	A1H4123
COMBUSTIBLE, SIN CUBIERTA	G-1123	1168398	D12006 con motor/A DIESEL			COMBUSTIBLE	GP-1122	Q1H4117
COMBUSTIBLE, CON CUBIERTA	G-1123F	1168398	ACEITE	GP-54	A15H4123	D4507 con motor/A DIESEL		
ACEITE	GP-54	1174421	COMBUSTIBLE, SECUNDARIO	GP-1122	2133943	ACEITE	GP-36	1174418
COMBUSTIBLE	GP-1122	1174423	COMBUSTIBLE, PRIMARIO	GPP-1122	1174483	ACEITE	GP-54	1174421
F8L812 A DIESEL			D13006 con motor/DEUTZ F6L912			COMBUSTIBLE	GP-1122	1161341
ACEITE	G-330	1168443	ACEITE	GP-54	1174421	D4507A con motor/A DIESEL		
COMBUSTIBLE, SECUNDARIO SIN CUBIERTA	G-1121	1160038	COMBUSTIBLE, PRIMARIO	GP-1122	2133558	ACEITE	GP-54	1174421
COMBUSTIBLE, PRIMARIO SIN CUBIERTA	G-1123	1168398	COMBUSTIBLE, SECUNDARIO	GPP-1122	1174483	COMBUSTIBLE	GP-1122	1161341
COMBUSTIBLE, SECUNDARIO CON CUBIERTA	G-1121F	1160038	AIRE	GAK-625	33391	D4507C, D4807C, D4807, D4807A con motor/A DIESEL		
COMBUSTIBLE, PRIMARIO CON CUBIERTA	G-1123F	1168398	D13006A con motor/A DIESEL			ACEITE	GP-54	A1H4123
			ACEITE	GP-54	1174421	COMBUSTIBLE, PRIMARIO	GP-1122	2133558
			COMBUSTIBLE, PRIMARIO	GP-1122	2133558	COMBUSTIBLE, SECUNDARIO	GP-1122	2133943
			COMBUSTIBLE, SECUNDARIO	GPP-1122	1174483			
			AIRE	GAK-625	33391			

SERVICIO PESADO

MARCA-MODELO-MOTOR MAKE-MODEL-ENGINE	GONHER GONHER	OEM OEM	MARCA-MODELO-MOTOR MAKE-MODEL-ENGINE	GONHER GONHER	OEM OEM	MARCA-MODELO-MOTOR MAKE-MODEL-ENGINE	GONHER GONHER	OEM OEM
DEUTZ (continuación)			DEUTZ (continuación)			DEUTZ (continuación)		
TRACTORES			TRACTORES			TRACTORES		
D5005 con motor/DEUTZ F4L812			D6206, D6206A con motores/DEUTZ F3L912, DEUTZ F4L912			D8005 con motor/DEUTZ F6L812		
ACEITE	G-330	1168443	ACEITE	GP-36	1174418	ACEITE	G-330	1168443
D5005 con motor/DEUTZ F4L812D			ACEITE	GP-54	A1H4123	COMBUSTIBLE, SIN CUBIERTA	G-1123	Q1H4115
ACEITE	GP-36	A1H4123	COMBUSTIBLE	GP-1122	Q1H4117	COMBUSTIBLE, CON CUBIERTA	G-1123F	Q1H4115
D5005, D5505 con motor/DEUTZ F3L812D			D6207 con motor/A DIESEL			D8005 con motor/DEUTZ F6L812D		
ACEITE	GP-36	A1H4123	ACEITE	GP-36	1174418	ACEITE	GP-54	A15H4123
D5006, D5206 con motores/DEUTZ F3L912, DEUTZ F4L912			ACEITE	GP-54	1174421	COMBUSTIBLE, PRIMARIO	GP-1122	2133558
ACEITE	GP-36	1174418	COMBUSTIBLE	GP-1122	1161341	COMBUSTIBLE, SECUNDARIO	GP-1122	2133943
ACEITE	GP-54	A1H4123	D6207C con motor/A DIESEL			D8006, D8006A con motor/DEUTZ F6L912		
COMBUSTIBLE	GP-1122	Q1H4117	ACEITE	GP-54	A1H4123	ACEITE	GP-54	A15H4123
D5206A con motor/DEUTZ F3L912			COMBUSTIBLE, PRIMARIO	GP-1122	2133558	COMBUSTIBLE, PRIMARIO	GP-1122	2133558
ACEITE	GP-54	A1H4123	COMBUSTIBLE, SECUNDARIO	GP-1122	2133943	COMBUSTIBLE, SECUNDARIO	GP-1122	2133943
D5207 con motor/A DIESEL			D6806, D6806A con motores/DEUTZ F3L912, DEUTZ F4L912			D9006, D9006A con motor/DEUTZ F6L912		
ACEITE	GP-36	1174418	ACEITE	GP-36	1174418	ACEITE	GP-54	A15H4123
ACEITE	GP-54	1174421	ACEITE	GP-54	A1H4123	COMBUSTIBLE, SECUNDARIO	GP-1122	2133943
COMBUSTIBLE	GP-1122	1161341	COMBUSTIBLE	GP-1122	Q1H4117	COMBUSTIBLE, PRIMARIO	GPP-1122	1174483
D5207A con motor/A DIESEL			D6807A, D6207A, D6265, D6507, D6507A, D6507C, D6807 con motor/A DIESEL			DK100 SOBRE ORUGAS con motor/A DIESEL		
ACEITE	GP-54	1174421	ACEITE	GP-54	1174421	ACEITE	G-31	1168469
D5207C con motor/A DIESEL			D6807C con motor/A DIESEL			DK40 SOBRE ORUGAS con motor/A DIESEL		
ACEITE	GP-54	A1H4123	ACEITE	GP-54	A1H4123	COMBUSTIBLE	G-1121	1160038
COMBUSTIBLE, PRIMARIO	GP-1122	2133558	COMBUSTIBLE, PRIMARIO	GP-1122	2133558	DK60BBA SOBRE ORUGAS, DK75 SOBRE ORUGAS, DK75A SOBRE ORUGAS, DK75B SOBRE ORUGAS, DK75BF SOBRE ORUGAS, DK60A SOBRE ORUGAS, DK60B SOBRE ORUGAS con motor/A DIESEL		
COMBUSTIBLE, SECUNDARIO	GP-1122	2133943	COMBUSTIBLE, SECUNDARIO	GP-1122	2133943	ACEITE	G-31	1168469
D5505 con motor/DEUTZ F4L812			D7006 con motores/DEUTZ F3L912, DEUTZ F4L912			DK90 SOBRE ORUGAS con motor/A DIESEL		
ACEITE	G-330	1168443	ACEITE	GP-36	1174418	ACEITE	G-31	1168469
D5505 con motor/DEUTZ F4L812D			ACEITE	GP-54	A1H4123	DKX100 SOBRE ORUGAS, DL120 SOBRE ORUGAS con motor/A DIESEL		
ACEITE	GP-36	A1H4123	COMBUSTIBLE	GP-1122	Q1H4117	COMBUSTIBLE, SECUNDARIO	G-1123	1168398
D5506 con motores/DEUTZ F3L912, DEUTZ F4L912			D7007, D7007A, D7206A, D7207, D7207A con motor/DEUTZ F4L912			DL1250P SOBRE ORUGAS con motor/DEUTZ F6L312		
ACEITE	GP-36	1174418	ACEITE	GP-54	1174421	COMBUSTIBLE, SECUNDARIO	G-1123	1168398
ACEITE	GP-54	A1H4123	D7007C con motor/A DIESEL			DL150 SOBRE ORUGAS, DL150P SOBRE ORUGAS con motor/A DIESEL		
COMBUSTIBLE	GP-1122	Q1H4117	ACEITE	GP-54	A1H4123	ACEITE	GP-54	1174421
D6005 con motor/DEUTZ F3L812			COMBUSTIBLE, PRIMARIO	GP-1122	2133558	DL50 SOBRE ORUGAS, DL500 SOBRE ORUGAS con motor/A DIESEL		
ACEITE	G-330	1168443	COMBUSTIBLE, SECUNDARIO	GP-1122	2133943	ACEITE	G-330	1168443
D6005 con motor/DEUTZ F3L812D			D7206 con motores/DEUTZ F3L912, DEUTZ F4L912			DL75 SOBRE ORUGAS con motor/A DIESEL		
ACEITE	GP-36	A1H4123	ACEITE	GP-36	1174418	COMBUSTIBLE	G-1173	P550509
D6005 con motor/DEUTZ F4L812			ACEITE	GP-54	A1H4123	DL900 SOBRE ORUGAS, DP900 SOBRE ORUGAS con motor/A DIESEL		
ACEITE	G-330	1168443	COMBUSTIBLE, PRIMARIO	GP-1122	2133558	ACEITE	GP-54	1174421
D6005 con motor/DEUTZ F4L812D			COMBUSTIBLE, SECUNDARIO	GP-1122	2133943	DP1500 SOBRE ORUGAS con motor/A DIESEL		
ACEITE	GP-36	A1H4123	D7506 con motor/DEUTZ F6L912			COMBUSTIBLE, SECUNDARIO	G-1123	1168398
D6006 con motor/DEUTZ F4L912			ACEITE	GP-54	1174421	ACEITE	GP-54	A15H4123
ACEITE	GP-54	A1H4123	D7506A con motor/DEUTZ F4L912			COMBUSTIBLE, BOMBA DE INYECCION EN LINEA	GP-1122	1161341
D6006A con motor/A DIESEL			ACEITE	GP-54	1174421	DP2100 SOBRE ORUGAS con motor/A DIESEL		
ACEITE	GP-36	1174418	D7807, D7807A con motor/DEUTZ F4L913			COMBUSTIBLE, SECUNDARIO	G-1123	1168398
D6007, D6007A, D6007C con motor/A DIESEL			ACEITE	GP-54	1174421	DR100 SOBRE ORUGAS, DR120 SOBRE ORUGAS, DR1250 SOBRE ORUGAS con motor/A DIESEL		
ACEITE	GP-54	A1H4123	D7807C con motor/DEUTZ F4L913			COMBUSTIBLE, SECUNDARIO	G-1123	1168398
COMBUSTIBLE, PRIMARIO	GP-1122	2133558	ACEITE	GP-36	1174418			
COMBUSTIBLE, SECUNDARIO	GP-1122	2133943	ACEITE	GP-54	1174421			
			COMBUSTIBLE	GP-1122	1161341			

MARCA-MODELO-MOTOR MAKE-MODEL-ENGINE	GONHER GONHER	OEM OEM	MARCA-MODELO-MOTOR MAKE-MODEL-ENGINE	GONHER GONHER	OEM OEM	MARCA-MODELO-MOTOR MAKE-MODEL-ENGINE	GONHER GONHER	OEM OEM
DEUTZ (continuación)			DEUTZ (continuación)			DEUTZ (continuación)		
TRACTORES			TRACTORES			TRACTORES		
DR150P SOBRE ORUGAS con motor/A DIESEL			COMBUSTIBLE, PRIMARIO	GPP-1122	1174483	DX92, DX92A con motor/DEUTZ BF4L913T		
COMBUSTIBLE	G-1123	Q1H4115	COMBUSTIBLE, SECUNDARIO	GPP-1122	1174483	ACEITE	GP-54	A1H4123
DR1800P SOBRE ORUGAS con motor/A DIESEL			DX4.10, DX4.30, DX4.31, DX4.50, DX4.51 con motor/DEUTZ F4L913			COMBUSTIBLE, PRIMARIO	GPP-1122	1174483
COMBUSTIBLE, SECUNDARIO	G-1123	1168398	ACEITE	GP-54	1174421	COMBUSTIBLE, SECUNDARIO	GPP-1122	1174483
DR50 SOBRE ORUGAS, DR500 SOBRE ORUGAS con motor/A DIESEL			COMBUSTIBLE	GP-1122	1161341	INTRAC 2002, INTRAC 2003 con motor/DEUTZ F3L912		
ACEITE	G-330	1168443	COMBUSTIBLE, PRIMARIO	GPP-1122	1174483	ACEITE	GP-36	A1H4123
DR75 SOBRE ORUGAS con motor/A DIESEL			COMBUSTIBLE, SECUNDARIO	GPP-1122	1174483	ACEITE	GP-54	Q1H4117
COMBUSTIBLE	G-1173	P550509	AIRE, PRIMARIO	GAK-458	4319257	COMBUSTIBLE, SECUNDARIO	GP-1122	Q1H4117
DR750 SOBRE ORUGAS con motor/A DIESEL			AIRE, SECUNDARIO	GA-459	4319256	INTRAC 2003A con motor/DEUTZ F4L912		
COMBUSTIBLE, CARTUCHO	G-1123	Q1H4115	DX4.70 con motor/DEUTZ F4L913			ACEITE	GP-54	Q1H4117
ACEITE	GP-54	1174421	ACEITE	GP-54	1174421	INTRAC 2005, INTRAC 2006 con motor/A DIESEL		
COMBUSTIBLE, SELLADO	GP-1122	Q1H4117	COMBUSTIBLE, PRIMARIO	GPP-1122	1174483	COMBUSTIBLE, SECUNDARIO	GP-1122	Q1H4117
DR900 SOBRE ORUGAS con motor/A DIESEL			COMBUSTIBLE, SECUNDARIO	GPP-1122	1174483	LD750 SOBRE ORUGAS con motor/A DIESEL		
ACEITE	GP-54	1174421	AIRE, PRIMARIO	GAK-458	4319257	COMBUSTIBLE, CARTUCHO	G-1123	Q1H4115
DRM120 SOBRE ORUGAS, DRM1250 SOBRE ORUGAS con motor/A DIESEL			AIRE, SECUNDARIO	GA-459	4319256	ACEITE	GP-54	1174421
COMBUSTIBLE, SECUNDARIO	G-1123	1168398	DX6.05, DX6.07, DX6.10 con motor/DEUTZ F6L912			COMBUSTIBLE, SELLADO	GP-1122	Q1H4117
DX110 con motores/DEUTZ F5L912, DEUTZ F6L912			ACEITE	GP-54	1174421	UNI SUPER SOBRE ORUGAS con motor/DEUTZ F3L812D		
ACEITE	GP-54	1174421	COMBUSTIBLE, PRIMARIO	GPP-1122	1174483	ACEITE	GP-54	1174421
COMBUSTIBLE, SECUNDARIO	GP-1122	2133943	COMBUSTIBLE, SECUNDARIO	GPP-1122	1174483			
COMBUSTIBLE, SIMPLE	GP-1122	Q1H4117	AIRE, PRIMARIO	GAK-458	4319257			
COMBUSTIBLE, PRIMARIO	GPP-1122	2133558	AIRE, SECUNDARIO	GA-459	4319256			
COMBUSTIBLE, SECUNDARIO	GPP-1122	2133558	DX6.50, DX7.10 con motor/A DIESEL					
AIRE	GAK-458	4319257	COMBUSTIBLE, PRIMARIO	GPP-1122	1174483			
AIRE	GA-459	4319256	COMBUSTIBLE, SECUNDARIO	GPP-1122	1174483			
DX110A con motor/DEUTZ F5L912			ACEITE	GP-77	1174420			
ACEITE	GP-54	1174421	DX7110 con motor/A DIESEL					
DX120, DX120A con motor/A DIESEL			ACEITE	GP-54	1174421			
ACEITE	GP-54	1174421	DX8.30 con motor/A DIESEL					
COMBUSTIBLE, PRIMARIO	GP-1122	2133558	COMBUSTIBLE, PRIMARIO	GPP-1122	1174483			
COMBUSTIBLE, SECUNDARIO	GP-1122	1174483	COMBUSTIBLE, SECUNDARIO	GPP-1122	1174483			
AIRE	GAK-458	4319257	ACEITE	GP-77	1174420			
AIRE	GA-459	4319256	AIRE, PRIMARIO	GA-405	4980649			
DX130, DX160 con motor/A DIESEL			DX80, DX85A, DX80A, DX85 con motor/A DIESEL					
COMBUSTIBLE, PRIMARIO	GP-1122	2133558	ACEITE	GP-54	A1H4123			
COMBUSTIBLE, SECUNDARIO	GP-1122	2133943	COMBUSTIBLE, PRIMARIO	GPP-1122	1174483			
ACEITE	GP-77	1174420	COMBUSTIBLE, SECUNDARIO	GPP-1122	1174483			
DX140, DX160A con motor/DEUTZ BF6L913			COMBUSTIBLE, SECUNDARIO	GPP-1122	1174483			
COMBUSTIBLE, PRIMARIO	GP-1122	2133558	ACEITE	GP-54	A1H4123			
COMBUSTIBLE, SECUNDARIO	GP-1122	2133943	COMBUSTIBLE, PRIMARIO	GPP-1122	1174483			
COMBUSTIBLE, SIMPLE	GP-1122	Q1H4117	COMBUSTIBLE, SECUNDARIO	GPP-1122	1174483			
COMBUSTIBLE, PRIMARIO	GPP-1122	2133558	DX90 con motores/DEUTZ F5L912, DEUTZ F6L912					
COMBUSTIBLE, SECUNDARIO	GPP-1122	2133943	ACEITE	GP-54	1174421			
ACEITE	GP-77	1174420	COMBUSTIBLE, SECUNDARIO	GP-1122	2133943			
DX3.50, DX3.10, DX3.30 con motor/DEUTZ F3L912			COMBUSTIBLE, SIMPLE	GP-1122	Q1H4117			
ACEITE	GP-54	1174421	COMBUSTIBLE, PRIMARIO	GPP-1122	2133558			
COMBUSTIBLE	GP-1122	1161341	COMBUSTIBLE, SECUNDARIO	GPP-1122	2133943			
COMBUSTIBLE, PRIMARIO	GPP-1122	1174483	AIRE, PRIMARIO	GAK-458	4319257			
COMBUSTIBLE, SECUNDARIO	GPP-1122	1174483	AIRE, SECUNDARIO	GA-459	4319256			
DX3.60, DX3.90, DX3.65, DX3.70 con motor/DEUTZ F4L912			DX90A con motor/DEUTZ F6L912					
ACEITE	GP-54	1174421	ACEITE	GP-54	1174421			
COMBUSTIBLE	GP-1122	1161341						

DIAMOND REO

CAMIONES, TRACTOCAMIONES Y AUTOBUSES

UV42 con motor/CUMMINS L10		
ACEITE	GP-3000	3318853

DINA

CAMIONES, TRACTOCAMIONES Y AUTOBUSES

3130 con motor/PERKINS 354		
ACEITE	GP-31	2654407
431-K1 con motor/PERKINS 354 DIESEL		
COMBUSTIBLE, OPCIONAL	GC-1133	FS1202
COMBUSTIBLE, OPCIONAL	GS-1133	FS1203
ACEITE	GP-1	2654404
COMBUSTIBLE	G-296	868014
500 MEDIANO con motor/CUMMINS VAL 155		
ACEITE	G-613	173174
500 TURBO MEDIANO con motor/CUMMINS 155 FLUJO COMPLETO		
ACEITE	GP-43	3313281
500 TURBO MEDIANO con motor/CUMMINS 155 FLUJO PARCIAL		
ACEITE	GP-57	3304232
531 MEDIANO con motor/CUMMINS VAL 155		
ACEITE	G-613	173174
COMBUSTIBLE	GC-1133	136198
COMBUSTIBLE	GS-1133	136197
COMBUSTIBLE	GPP-14	3315847
531 MEDIANO con motor/PERKINS 354		
ACEITE	GP-31	2654407
600 MEDIANO con motor/CUMMINS VAL 210		
ACEITE	G-613	173174
600 TURBO MEDIANO con motor/CUMMINS 210 FLUJO COMPLETO		
ACEITE	GP-43	3313281

SERVICIO PESADO

MARCA-MODELO-MOTOR GONHER OEM
MAKE-MODEL-ENGINE GONHER OEM

DINA (continuación)

CAMIONES, TRACTOCAMIONES Y AUTOBUSES

600 TURBO MEDIANO con motor/CUMMINS 210 FLUJO PARCIAL		
ACEITE	GP-57	3304232
631 MEDIANO, 661 MEDIANO con motor/CUMMINS VAL 210		
ACEITE	G-613	173174
COMBUSTIBLE	GC-1133	136198
COMBUSTIBLE	GS-1133	136197
COMBUSTIBLE	GPP-14	3315847
661 MEDIANO con motores/CUMMINS NH-220 FLUJO PARCIAL, CUMMINS NTC 250 FLUJO PARCIAL		
ACEITE	G-750	101679
9400 CAMIONES YES con motor/DETROIT DIESEL 350 SERIE 60 ANTES DE. 1993 FLUJO COMPLETO		
ACEITE	GP-53	3313287
9400 CAMIONES YES con motor/DETROIT DIESEL 350 SERIE 60 ANTES DE. 1993 FLUJO PARCIAL		
ACEITE	GP-57	25011187
9400 CAMIONES YES con motor/DETROIT DIESEL 775 S-60 POSTERIOR A 1993		
AIRE	GA-221R	AF25033
9400 CAMIONES YES con motores/CUMMINS 350 M11 FLUJO COMPLETO, CUMMINS 350 M11 FLUJO PARCIAL, CUMMINS 855 N-14 ELECTRONICO FLUJO COMPLETO, CUMMINS 855 N-14 ELECTRONICO FLUJO PARCIAL		
COMBUSTIBLE	GPP-103	F51242
9400 SERIES CAMIONES YES con motor/400 FLUJO COMPLETO		
ACEITE	GP-53	3313287
COMBUSTIBLE	GPP-103	F51242
AIRE	GA-31	P109726
9400 SERIES CAMIONES YES con motor/400 FLUJO PARCIAL		
ACEITE	GP-57	25011187
D-1000ETA, D-1004ETA, D-3000ETA con motor/VAM 282		
ACEITE	GP-20	6437462
D-3004ETA con motor/VAM 282		
ACEITE, 5 13/32 IN	GP-5	5515104
ACEITE, 4 7/32 IN	GP-20	6437462
AIRE	GA-70	25099096
GASOLINA, PLASTICO	GG-5	5651090
GASOLINA, LAMINA	GG-5 L	5651090
D-3200ETA, D-3255ETA con motor/PERKINS 236 DIESEL		
ACEITE	GP-1	2654404
COMBUSTIBLE	G-296	868014
AIRE	GAK-403	26510105
F11 CAMIONES YES con motor/DETROIT DIESEL		
ACEITE	GP-193	23527033
F11A CAMIONES YES con motor/CUMMINS L ISC 315		
COMBUSTIBLE	GPP-1003S	3944269
F12 CAMIONES YES con motor/DETROIT DDC IV 50 DIESEL		
ACEITE	GP-193	23527033
F14 CAMIONES YES con motor/DETROIT L DDC IV 60 DIESEL		
ACEITE	GP-193	23527033

MARCA-MODELO-MOTOR GONHER OEM
MAKE-MODEL-ENGINE GONHER OEM

DINA (continuación)

CAMIONES, TRACTOCAMIONES Y AUTOBUSES

G4500 CAMIONES YES con motor/DETROIT L DDC IV 60 DIESEL		
ACEITE	GP-193	23527033
S-500 MEDIANO, S-541 TURBO MEDIANO, S-500 TURBO MEDIANO, S-541 MEDIANO con motor/PERKINS 354 FASE 4		
ACEITE	GP-1	2654404
ACEITE	GP-31	2654407
COMBUSTIBLE	G-297	2650125
AIRE	GA-109	P140426
S-542 MEDIANO C/COMP. DE ALTURA con motor/PERKINS 354 FASE 4		
ACEITE	GP-1	2654404
ACEITE	GP-31	2654407
COMBUSTIBLE	G-297	2650125
AIRE	GA-371	P530866

DODGE

CAMIONES, TRACTOCAMIONES Y AUTOBUSES

100 SERIES con motor/DODGE 170 6 CIL.		
ACEITE	G-236	1557376
ACEITE	GP-1	E5778M
AIRE	GA-71	2206376
GASOLINA	GG-5 L	2525254
100 SERIES con motor/DODGE 198 6 CIL.		
ACEITE	GP-1	E5778M
AIRE	GA-71	2206376
GASOLINA	GG-20	2240546
GASOLINA	GG-5 L	2525254
100 SERIES con motor/DODGE 230 6 CIL.		
GASOLINA	GG-20	2240546
100 SERIES con motor/DODGE 238 V8		
ACEITE	GP-58	2647020
100 SERIES con motor/DODGE 243 6 CIL.		
ACEITE	GP-81	3549957
100 SERIES con motor/DODGE 273A V8		
ACEITE	G-236	2129023
ACEITE	GP-1	1851658
AIRE	GA-70	1739547
GASOLINA	GG-20	2240546
GASOLINA	GG-5 L	2525254
100 SERIES con motor/DODGE 318 V8		
ACEITE	G-236	2129023
ACEITE, SELLADO 5 13/32 IN	GP-1	3549232
ACEITE, SELLADO 3 45/64 IN	GP-81	3549957
AIRE, 1969-79	GA-70	1739547
AIRE, 1980-87	GA-70	1739547
AIRE, HASTA 1979	GA-429	3614353
GASOLINA	GG-20	2240546
GASOLINA	GG-5 L	2525254
100 SERIES con motor/DODGE 360 V8		
ACEITE	G-236	2129023
ACEITE, SELLADO 5 13/32 IN	GP-1	3549232
ACEITE, SELLADO 3 45/64 IN	GP-81	3549957
AIRE, 1979-80 2BBL	GA-70	1739547
AIRE, 1981 EN ADELANTE	GA-70	1739547
AIRE, HASTA 1979	GA-429	3614353
AIRE, 1979-80 4BBL	GA-730	2863349

MARCA-MODELO-MOTOR GONHER OEM
MAKE-MODEL-ENGINE GONHER OEM

DODGE (continuación)

CAMIONES, TRACTOCAMIONES Y AUTOBUSES

GASOLINA	GG-5 L	2525254
100 SERIES con motor/DODGE 838 V8		
ACEITE	G-236	2129023
ACEITE	GP-1	E5778M
AIRE	GA-730	2863349
GASOLINA	GG-5 L	2525254
100 SERIES, 150 SERIES, 200 SERIES, 250 SERIES, 300 SERIES, 350 SERIES con motor/DODGE 225 6 CIL.		
ACEITE	G-236	2129023
ACEITE, SELLADO 5 13/32 IN	GP-1	1851658
ACEITE, SELLADO 3 45/64 IN	GP-81	3549957
AIRE, 1977-78 EXCEPTO VANS	GA-70	1739547
AIRE, 1981 EN ADELANTE EXCEPTO VANS	GA-70	1739547
AIRE, 1967-77	GA-71	2206376
AIRE, 1979-80	GA-77	2453346
AIRE, 1981 EN ADELANTE PARA VANS	GA-77	2453346
AIRE, 1977-78 PARA VANS	GA-78	4041252
GASOLINA	GG-20	2240546
GASOLINA	GG-5 L	2525254
100 SERIES, 200 SERIES, 300 SERIES con motor/DODGE 440 V8		
ACEITE, SELLADO 5 13/32 IN	GP-1	E5778M
ACEITE, SELLADO 3 45/64 IN	GP-81	3549957
AIRE, 3 1/2 IN	GA-429	3614353
AIRE, 2 51/64 IN	GA-730	2863349
GASOLINA	GG-20	2240546
GASOLINA	GG-5 L	2525254
1000 SERIES con motor/DODGE 273A V8		
ACEITE	G-236	2129023
ACEITE	GP-1	1851658
GASOLINA	GG-20	2240546
GASOLINA	GG-5 L	2525254
1000 SERIES con motor/DODGE 318A V8		
ACEITE	G-236	2129023
ACEITE, SELLADO 5 13/32 IN	GP-1	E5778M
ACEITE, SELLADO 3 45/64 IN	GP-81	676575
GASOLINA	GG-20	2240546
GASOLINA	GG-5 L	2525254
1000 SERIES con motor/DODGE 361 V8		
GASOLINA	GG-20	2240546
1000 SERIES con motores/DODGE 360 V8, DODGE 440 V8		
ACEITE, SELLADO 5 13/32 IN	GP-1	E5778M
ACEITE, SELLADO 3 45/64 IN	GP-81	3549957
GASOLINA	GG-5 L	2525254
150 SERIES con motor/CUMMINS 6BT5.9		
ACEITE	GP-178	3914395
150 SERIES con motor/DODGE 318 V8		
ACEITE	G-236	2129023
ACEITE, SELLADO 5 13/32 IN	GP-1	3549232
ACEITE, SELLADO 3 45/64 IN	GP-81	3549957
AIRE, 1969-79	GA-70	1739547
AIRE, 1980-87	GA-70	1739547
AIRE, HASTA 1979	GA-429	3614353
GASOLINA	GG-20	2240546
GASOLINA	GG-5 L	2525254

MARCA-MODELO-MOTOR MAKE-MODEL-ENGINE	GONHER GONHER	OEM OEM	MARCA-MODELO-MOTOR MAKE-MODEL-ENGINE	GONHER GONHER	OEM OEM	MARCA-MODELO-MOTOR MAKE-MODEL-ENGINE	GONHER GONHER	OEM OEM
DODGE (continuación)			DODGE (continuación)			DODGE (continuación)		
CAMIONES, TRACTOCAMIONES Y AUTOBUSES			CAMIONES, TRACTOCAMIONES Y AUTOBUSES			CAMIONES, TRACTOCAMIONES Y AUTOBUSES		
150 SERIES con motor/DODGE 360 V8			250 SERIES con motor/DODGE 318 V8			GASOLINA		
ACEITE	G-236	2129023	ACEITE	G-236	2129023		GG-5 L	2525254
ACEITE, SELLADO 5 13/32 IN	GP-1	3549232	ACEITE, SELLADO 5 13/32 IN	GP-1	3549232	350 SERIES con motor/CUMMINS 6BT5.9		
ACEITE, SELLADO 3 45/64 IN	GP-81	3549957	ACEITE, SELLADO 3 45/64 IN	GP-81	3549957	ACEITE	GP-178	3914395
AIRE, 1979-80 2BBL	GA-70	1739547	AIRE, 1969-79	GA-70	1739547	350 SERIES con motor/DODGE 318 V8		
AIRE, 1981 EN ADELANTE	GA-70	1739547	AIRE, 1980-87	GA-70	1739547	ACEITE	G-236	2129023
AIRE, HASTA 1979	GA-429	3614353	AIRE, HASTA 1979	GA-429	3614353	ACEITE, SELLADO 5 13/32 IN	GP-1	3549232
AIRE, 1979-80 4BBL	GA-730	2863349	GASOLINA	GG-20	2240546	ACEITE, SELLADO 3 45/64 IN	GP-81	3549957
GASOLINA	GG-5 L	2525254	GASOLINA	GG-5 L	2525254	AIRE, 1969-79	GA-70	1739547
200 SERIES con motor/DODGE 170 6 CIL.			250 SERIES con motor/DODGE 360 V8			AIRE, 1980-87	GA-70	1739547
ACEITE	G-236	1557376	ACEITE	G-236	2129023	AIRE, HASTA 1979	GA-429	3614353
ACEITE	GP-1	E5778M	ACEITE, SELLADO 5 13/32 IN	GP-1	3549232	GASOLINA	GG-20	2240546
AIRE	GA-71	2206376	ACEITE, SELLADO 3 45/64 IN	GP-81	3549957	GASOLINA	GG-5 L	2525254
GASOLINA	GG-5 L	2525254	AIRE, 1979-80 2BBL	GA-70	1739547	350 SERIES con motor/DODGE 360 V8		
200 SERIES con motor/DODGE 198 6 CIL.			AIRE, 1981 EN ADELANTE	GA-70	1739547	ACEITE	G-236	2129023
ACEITE	GP-1	E5778M	AIRE, HASTA 1979	GA-429	3614353	ACEITE, SELLADO 5 13/32 IN	GP-1	3549232
AIRE	GA-71	2206376	AIRE, 1979-80 4BBL	GA-730	2863349	ACEITE, SELLADO 3 45/64 IN	GP-81	3549957
GASOLINA	GG-20	2240546	GASOLINA	GG-5 L	2525254	AIRE, 1979-80 2BBL	GA-70	1739547
GASOLINA	GG-5 L	2525254	300 SERIES con motor/DODGE 170 6 CIL.			AIRE, 1981 EN ADELANTE	GA-70	1739547
200 SERIES con motor/DODGE 230 6 CIL.			ACEITE	G-236	1557376	AIRE, HASTA 1979	GA-429	3614353
ACEITE	GP-1	E5778M	ACEITE	GP-1	E5778M	AIRE, 1979-80 4BBL	GA-730	2863349
AIRE	GA-71	2206376	AIRE	GA-71	2206376	GASOLINA	GG-5 L	2525254
GASOLINA	GG-20	2240546	GASOLINA	GG-5 L	2525254	400 SERIES con motor/DODGE 198 6 CIL.		
GASOLINA	GG-5 L	2525254	300 SERIES con motor/DODGE 198 6 CIL.			ACEITE	GP-1	E5778M
200 SERIES con motor/DODGE 238 V8			ACEITE	GP-1	E5778M	AIRE	GA-71	2206376
ACEITE	GP-58	2647020	AIRE	GA-71	2206376	GASOLINA	GG-20	2240546
200 SERIES con motor/DODGE 243 6 CIL.			GASOLINA	GG-20	2240546	GASOLINA	GG-5 L	2525254
ACEITE	GP-81	3549957	GASOLINA	GG-5 L	2525254	400 SERIES con motor/DODGE 225 6 CIL.		
200 SERIES con motor/DODGE 318 V8			300 SERIES con motor/DODGE 238 V8			ACEITE	G-236	2129023
ACEITE	G-236	2129023	ACEITE	GP-58	2647020	ACEITE	GP-1	1851658
ACEITE, SELLADO 5 13/32 IN	GP-1	3549232	ACEITE	GP-81	3549957	ACEITE	GP-81	3549957
ACEITE, SELLADO 3 45/64 IN	GP-81	3549957	300 SERIES con motor/DODGE 243 6 CIL.			AIRE, 1977 EN ADELANTE	GA-70	1739547
AIRE, 1969-79	GA-70	1739547	ACEITE	GP-81	3549957	AIRE, 1967-77	GA-71	2206376
AIRE, 1980-87	GA-70	1739547	300 SERIES con motor/DODGE 318 V8			AIRE, 1977 EN ADELANTE PARA VANS	GA-78	4041252
AIRE, HASTA 1979	GA-429	3614353	ACEITE	G-236	2129023	GASOLINA	GG-20	2240546
GASOLINA	GG-20	2240546	ACEITE, SELLADO 5 13/32 IN	GP-1	3549232	GASOLINA	GG-5 L	2525254
GASOLINA	GG-5 L	2525254	ACEITE, SELLADO 3 45/64 IN	GP-81	3549957	400 SERIES con motor/DODGE 251 6 CIL.		
200 SERIES con motor/DODGE 360 V8			AIRE, 1969-79	GA-70	1739547	ACEITE	G-236	2129023
ACEITE	G-236	2129023	AIRE, 1980-87	GA-70	1739547	ACEITE	GP-1	E5778M
ACEITE, SELLADO 5 13/32 IN	GP-1	3549232	AIRE, HASTA 1979	GA-429	3614353	GASOLINA	GG-20	2240546
ACEITE, SELLADO 3 45/64 IN	GP-81	3549957	GASOLINA	GG-20	2240546	GASOLINA	GG-5 L	2525254
AIRE, 1979-80 2BBL	GA-70	1739547	GASOLINA	GG-5 L	2525254	400 SERIES con motor/DODGE 318A V8		
AIRE, 1981 EN ADELANTE	GA-70	1739547	300 SERIES con motor/DODGE 360 V8			ACEITE, CARTUCHO	G-236	2129023
AIRE, HASTA 1979	GA-429	3614353	ACEITE	G-236	2129023	ACEITE, SELLADO 5 13/32 IN	GP-1	E5778M
AIRE, 1979-80 4BBL	GA-730	2863349	ACEITE, SELLADO 5 13/32 IN	GP-1	3549232	ACEITE, SELLADO 3 45/64 IN	GP-81	3549957
GASOLINA	GG-5 L	2525254	ACEITE, SELLADO 3 45/64 IN	GP-81	3549957	AIRE, 1978 EN ADELANTE	GA-70	1739547
200 SERIES con motor/DODGE 838 V8			AIRE, 1979-80 2BBL	GA-70	1739547	AIRE, HASTA 1974	GA-70	1739547
ACEITE	G-236	2129023	AIRE, 1981 EN ADELANTE	GA-70	1739547	AIRE, 1974-78	GA-429	3614353
ACEITE	GP-1	E5778M	AIRE, HASTA 1979	GA-429	3614353	GASOLINA	GG-20	2240546
AIRE	GA-730	2863349	AIRE, 1979-80 4BBL	GA-730	2863349	GASOLINA	GG-5 L	2525254
GASOLINA	GG-5 L	2525254	GASOLINA	GG-5 L	2525254	400 SERIES con motor/DODGE 360 V8		
200 SERIES, 300 SERIES con motor/DODGE 273A V8			300 SERIES con motor/DODGE 838 V8			ACEITE, SELLADO 5 13/32 IN	GP-1	E5778M
ACEITE	G-236	2129023	ACEITE	G-236	2129023	ACEITE, SELLADO 3 45/64 IN	GP-81	3549957
ACEITE	GP-1	1851658	ACEITE, SELLADO 5 13/32 IN	GP-1	3549232	AIRE	GA-429	3614353
GASOLINA	GG-20	2240546	ACEITE, SELLADO 3 45/64 IN	GP-81	3549957	GASOLINA	GG-5 L	2525254
250 SERIES con motor/CUMMINS 6BT5.9			AIRE, 1979-80 2BBL	GA-70	1739547	400 SERIES con motor/DODGE 360 V8		
ACEITE	GP-178	3914395	AIRE, 1981 EN ADELANTE	GA-70	1739547	ACEITE, SELLADO 5 13/32 IN	GP-1	E5778M
			AIRE, HASTA 1979	GA-429	3614353	ACEITE, SELLADO 3 45/64 IN	GP-81	3549957
			AIRE, 1979-80 4BBL	GA-730	2863349	AIRE	GA-429	3614353
			GASOLINA	GG-5 L	2525254	GASOLINA	GG-5 L	2525254
			300 SERIES con motor/DODGE 838 V8					
			ACEITE	G-236	2129023			
			ACEITE	GP-1	E5778M			
			AIRE	GA-730	2863349			

SERVICIO PESADO

MARCA-MODELO-MOTOR MAKE-MODEL-ENGINE	GONHER GONHER	OEM OEM	MARCA-MODELO-MOTOR MAKE-MODEL-ENGINE	GONHER GONHER	OEM OEM	MARCA-MODELO-MOTOR MAKE-MODEL-ENGINE	GONHER GONHER	OEM OEM
DODGE (continuación)			DODGE (continuación)			DODGE (continuación)		
CAMIONES, TRACTOCAMIONES Y AUTOBUSES			CAMIONES, TRACTOCAMIONES Y AUTOBUSES			CAMIONES, TRACTOCAMIONES Y AUTOBUSES		
400 SERIES, 500 SERIES, 600 SERIES con motor/DODGE 170 6 CIL.			600 SERIES con motor/DODGE 225 6 CIL.			C850 SERIES con motor/DODGE 361 V8		
ACEITE	GP-1	E5778M	ACEITE	G-236	2129023	GASOLINA	GG-20	2240546
400 SERIES, 500 SERIES, 600 SERIES con motor/DODGE 273A V8			ACEITE	GP-1	1851658	CN800 con motor/CATERPILLAR 1100 SERIES		
ACEITE	G-236	2129023	ACEITE	GP-81	3549957	ACEITE	GP-36	9N5680
ACEITE	GP-1	1851658	AIRE, 1977 EN ADELANTE	GA-70	1739547	CN900 con motor/CUMMINS NHC250		
AIRE, 1977 EN ADELANTE	GA-70	1739547	AIRE, 1967-77	GA-71	2206376	ACEITE	G-566	257528
GASOLINA	GG-20	2240546	AIRE, 1977 EN ADELANTE PARA VANS	GA-78	4041252	CN900, CNT900 con motor/GMC 6-71N		
GASOLINA	GG-5 L	2525254	GASOLINA	GG-20	2240546	ACEITE, DERIVACION (BY PASS)	G-31	1595410
400 SERIES, 500 SERIES, 600 SERIES con motor/DODGE 400 V8			GASOLINA	GG-5 L	2525254	ACEITE	G-33	5573013
ACEITE, SELLADO 5 13/32 IN	GP-1	E5778M	600 SERIES con motor/DODGE 251 6 CIL.			COMBUSTIBLE, SECUNDARIO	G-1175	5179839
ACEITE, SELLADO 3 45/64 IN	GP-81	3549957	ACEITE	G-236	2129023	CARTUCHO		
GASOLINA	GG-5 L	2525254	ACEITE	GP-1	E5778M	COMBUSTIBLE, PRIMARIO	GP-26	8423132
400 SERIES, 500 SERIES, 600 SERIES, 700 SERIES, 800 SERIES, 900 SERIES con motor/DODGE 361 V8			GASOLINA	GG-20	2240546	SELLADO		
GASOLINA	GG-20	2240546	GASOLINA	GG-5 L	2525254	COMBUSTIBLE, SECUNDARIO	GP-27	23518482
500 SERIES con motor/DODGE 198 6 CIL.			600 SERIES con motor/DODGE 318A V8			CNT800 con motor/CATERPILLAR 1100 SERIES		
ACEITE	GP-1	E5778M	ACEITE, CARTUCHO	G-236	2129023	ACEITE	GP-36	9N5680
AIRE	GA-71	2206376	ACEITE, SELLADO 5 13/32 IN	GP-1	E5778M	CNT900 con motor/CUMMINS NHC250		
GASOLINA	GG-20	2240546	ACEITE, SELLADO 3 45/64 IN	GP-81	3549957	ACEITE	G-566	257528
GASOLINA	GG-5 L	2525254	AIRE, 1978 EN ADELANTE	GA-70	1739547	CT800 con motor/CATERPILLAR 1100 SERIES		
500 SERIES con motor/DODGE 225 6 CIL.			AIRE, HASTA 1974	GA-70	1739547	ACEITE	GP-36	9N5680
ACEITE	G-236	2129023	AIRE, 1974-78	GA-429	3614353	L600, PC500, PC600, PD500, PD600 con motor/PERKINS 6.354		
ACEITE	GP-1	1851658	GASOLINA	GG-20	2240546	ACEITE	G-834	1531639
ACEITE	GP-81	3549957	GASOLINA	GG-5 L	2525254	COMBUSTIBLE	G-296	868014
AIRE, 1977 EN ADELANTE	GA-70	1739547	600 SERIES con motor/DODGE 360 V8			COMBUSTIBLE	G-296-B	868014
AIRE, 1967-77	GA-71	2206376	ACEITE, SELLADO 5 13/32 IN	GP-1	E5778M	LS1000, LT1000 con motores/GMC 6-71N, GMC 8V-71N		
AIRE, 1977 EN ADELANTE PARA VANS	GA-78	4041252	ACEITE, SELLADO 3 45/64 IN	GP-81	3549957	ACEITE, DERIVACION (BY PASS)	G-31	1595410
GASOLINA	GG-20	2240546	GASOLINA	GG-5 L	2525254	ACEITE	G-33	5573013
GASOLINA	GG-5 L	2525254	700 SERIES, 800 SERIES, 900 SERIES, C850 SERIES con motores/DODGE 360 V8, DODGE 440 V8			COMBUSTIBLE, SECUNDARIO	G-1175	5179839
500 SERIES con motor/DODGE 251 6 CIL.			ACEITE, SELLADO 5 13/32 IN	GP-1	E5778M	COMBUSTIBLE, PRIMARIO	GP-26	8423132
ACEITE	G-236	2129023	ACEITE, SELLADO 3 45/64 IN	GP-81	3549957	SELLADO		
ACEITE	GP-1	E5778M	GASOLINA	GG-5 L	2525254	COMBUSTIBLE, SECUNDARIO	GP-27	23518482
ACEITE	GP-81	3549957	700 SERIES, C850 SERIES, 800 SERIES, 900 SERIES con motor/DODGE 273A V8			MODELOS DE con motor/CUMMINS 5.9L TURBO DIESEL		
AIRE, 1977 EN ADELANTE	GA-70	1739547	ACEITE	G-236	2129023	COMBUSTIBLE, SECUNDARIO	GP-1122	3903640
AIRE, 1967-77	GA-71	2206376	ACEITE	GP-1	1851658	COMBUSTIBLE, SEPARADOR DE AGUA	GPP-18	3925274
AIRE, 1977 EN ADELANTE PARA VANS	GA-78	4041252	GASOLINA	GG-20	2240546	ACEITE	GP-178	3914395
GASOLINA	GG-20	2240546	GASOLINA	GG-5 L	2525254	COMBUSTIBLE	GS-1261	3942470
GASOLINA	GG-5 L	2525254	700 SERIES, C850 SERIES, 800 SERIES, 900 SERIES con motor/DODGE 318A V8			S550 SERIES con motor/DODGE 170 6 CIL.		
500 SERIES con motor/DODGE 318A V8			ACEITE	G-236	2129023	ACEITE	GP-1	E5778M
ACEITE, CARTUCHO	G-236	2129023	ACEITE, SELLADO 5 13/32 IN	GP-1	E5778M	AIRE	GA-71	2206376
ACEITE, SELLADO 5 13/32 IN	GP-1	E5778M	ACEITE, SELLADO 3 45/64 IN	GP-81	676575	GASOLINA	GG-20	2240546
ACEITE, SELLADO 3 45/64 IN	GP-81	3549957	GASOLINA	GG-20	2240546	GASOLINA	GG-5 L	2525254
AIRE, 1978 EN ADELANTE	GA-70	1739547	800 con motor/CATERPILLAR 1100 SERIES					
AIRE, HASTA 1974	GA-70	1739547	ACEITE	G-236	2129023	C800, CN900, CNT900 con motor/CUMMINS 210 V8		
AIRE, 1974-78	GA-429	3614353	ACEITE, SELLADO 5 13/32 IN	GP-1	E5778M	ACEITE	G-613	173174
GASOLINA	GG-20	2240546	ACEITE, SELLADO 3 45/64 IN	GP-81	676575	COMBUSTIBLE	GP-1101	154711
GASOLINA	GG-5 L	2525254	GASOLINA	GG-20	2240546	AGUA	GP-2071W	3315116
500 SERIES con motor/DODGE 360 V8			GASOLINA	GG-5 L	2525254	AIRE, RESPIRADOR	GA-39	255963
ACEITE, SELLADO 5 13/32 IN	GP-1	E5778M	C800 con motor/CATERPILLAR 1100 SERIES			AIRE	GA-37	106837
ACEITE, SELLADO 3 45/64 IN	GP-81	3549957	ACEITE	GP-36	9N5680	ACEITE, DERIVACION (BY PASS)	G-500	256839
AIRE	GA-429	3614353	C800, CN900, CNT900 con motor/CUMMINS 210 V8					
GASOLINA	GG-5 L	2525254	ACEITE	G-613	173174	S550 SERIES con motor/DODGE 225 6 CIL.		
600 SERIES con motor/DODGE 198 6 CIL.			COMBUSTIBLE	GP-1101	154711	ACEITE	G-236	2129023
ACEITE	GP-1	E5778M	AGUA	GP-2071W	3315116	ACEITE	GP-1	1851658
AIRE	GA-71	2206376	AIRE, RESPIRADOR	GA-39	255963	ACEITE	GP-81	3549957
GASOLINA	GG-20	2240546	AIRE	GA-37	106837	AIRE, 1977 EN ADELANTE	GA-70	1739547
GASOLINA	GG-5 L	2525254	ACEITE, DERIVACION (BY PASS)	G-500	256839	AIRE, 1967-77	GA-71	2206376
						AIRE, 1977 EN ADELANTE PARA VANS	GA-78	4041252
						GASOLINA	GG-20	2240546

MARCA-MODELO-MOTOR GONHER OEM

MAKE-MODEL-ENGINE GONHER OEM

DODGE (continuación)

CAMIONES, TRACTOCAMIONES Y AUTOBUSES

GASOLINA	GG-5 L	2525254
S550 SERIES con motor/DODGE 251 6 CIL.		
ACEITE	G-236	2129023
ACEITE	GP-1	E5778M
GASOLINA	GG-20	2240546
GASOLINA	GG-5 L	2525254

S550 SERIES con motor/DODGE 273A V8		
ACEITE	G-236	2129023
ACEITE	GP-1	1851658
AIRE, 1977 EN ADELANTE	GA-70	1739547
GASOLINA	GG-20	2240546
GASOLINA	GG-5 L	2525254

S550 SERIES con motor/DODGE 318A V8		
ACEITE, CARTUCHO	G-236	2129023
ACEITE, SELLADO 5 13/32 IN	GP-1	E5778M
ACEITE, SELLADO 3 45/64 IN	GP-81	3549957
AIRE, 1978 EN ADELANTE	GA-70	1739547
AIRE, HASTA 1974	GA-70	1739547
AIRE, 1974-78	GA-429	3614353
GASOLINA	GG-20	2240546
GASOLINA	GG-5 L	2525254

S550 SERIES con motor/DODGE 360 V8		
ACEITE, SELLADO 5 13/32 IN	GP-1	E5778M
ACEITE, SELLADO 3 45/64 IN	GP-81	3549957
AIRE	GA-429	3614353
GASOLINA	GG-5 L	2525254

S550 SERIES con motor/DODGE 361 V8		
GASOLINA	GG-20	2240546

S550 SERIES con motor/DODGE 400 V8		
ACEITE, SELLADO 5 13/32 IN	GP-1	E5778M
ACEITE, SELLADO 3 45/64 IN	GP-81	3549957
GASOLINA	GG-5 L	2525254

DODGE

MOTORES

100 MARINO, 110 MARINO, 120 MARINO, 130 MARINO, 165 MARINO, 170 MARINO, 215 MARINO, 230 MARINO, 240 MARINO, 243 6 CIL. A DIESEL, 275 MARINO, 360 5.9L V8 A GASOLINA, 360 5.9L V8 A GASOLINA, 360 5.9L V8 A GASOLINA, 360 5.9L V8 A GASOLINA, 360 5.9L V8 A GASOLINA, 360 5.9L V8 A GASOLINA, 360-1 V8 A GASOLINA, 360-1 V8 A GASOLINA, 360-1 V8 A GASOLINA, 360-3 V8 A GASOLINA, 360-3 V8 A GASOLINA, 413 V8 A GASOLINA, 440-1 V8 A GASOLINA, 440-3 V8 A GASOLINA, HEMI MAGNUM V8-537L A GASOLINA, M239 MARINO

ACEITE	GP-81	5281090
--------	-------	---------

120 SUPER CROWN MARINO, 145 SPACE SAVER MARINO, 150 SUPER CROWN MARINO, 215 INDUSTRIAL, 225 INDUSTRIAL, 251 6 CIL. A GASOLINA, 251-1 6 CIL. A GASOLINA, 251-2 6 CIL. A GASOLINA, 251-3 6 CIL. A GASOLINA, 318-3 INDUSTRIAL, H170 INDUSTRIAL, H225 INDUSTRIAL, H318 INDUSTRIAL, H361 INDUSTRIAL, H383 INDUSTRIAL, H413 INDUSTRIAL, H426 INDUSTRIAL, H440 INDUSTRIAL, HA225 INDUSTRIAL, HB170 INDUSTRIAL, HB225 INDUSTRIAL, HB318 INDUSTRIAL, HB361 INDUSTRIAL, HB383 INDUSTRIAL, HB413 INDUSTRIAL, HB426 INDUSTRIAL, HC170 INDUSTRIAL, HC225 INDUSTRIAL, HC318 INDUSTRIAL, HC361 INDUSTRIAL, HC413 INDUSTRIAL, HC426 INDUSTRIAL, HT318 INDUSTRIAL, HT413 INDUSTRIAL, LH318 INDUSTRIAL

ACEITE	G-236	2129023
--------	-------	---------

MARCA-MODELO-MOTOR GONHER OEM

MAKE-MODEL-ENGINE GONHER OEM

DODGE (continuación)

MOTORES

122 MARINO, 125 MARINO, 150 MARINO, 155 MARINO, 170A MARINO, 170AJ JET MARINO, 175 MARINO, 195 MARINO, 200 MARINO, 210 MARINO, 225 MARINO, 235 MARINO, 250 MARINO, 251-1 6 CIL. A GASOLINA, 260 MARINO, 280 MARINO, 300 MARINO, 330 MARINO, 335 MARINO, 375 MARINO, 413 V8 A GASOLINA, 413B MARINO, 413D MARINO, 413E MARINO, 413GL MARINO, 525 MARINO, CM6-55 MARINO, CM6-55A MARINO, CM6-55N MARINO, CM6-55NA MARINO, COMMANDO 175 MARINO, COMMANDO 195 MARINO, COMMANDO 280 MARINO, FURY 190 MARINO, FURY 195 MARINO, FURY 235 MARINO, GOLDEN COMMANDO 280 MARINO, GOLDEN COMMANDO 290 MARINO, GOLDEN LION 300 MARINO, GOLDEN LION 325 MARINO, HA273 INDUSTRIAL, HT361 INDUSTRIAL, IMPERIAL 250 MARINO, IMPERIAL 290 MARINO, IMPERIAL 325 MARINO, JET II MARINO, JET III MARINO, JET IV MARINO, JET MARINO, LM318 MARINO, LM318A MARINO, LM318B MARINO, LM318D MARINO, M170 MARINO, M170A MARINO, M225 MARINO, M225A MARINO, M225D MARINO, M273A MARINO, M273B MARINO, M273B-O/D MARINO, M318A MARINO, M318B MARINO, M318C MARINO, M318G MARINO, M383B MARINO, M413B MARINO, M413D MARINO, M413E MARINO, M413GL MARINO, M426 MARINO, M440B MARINO, M440D MARINO, M80 MARINO, M81 MARINO, MARINOS V8 DE 1962 EN ADELANTE, MH225D MARINO, MODELO 340 MARINO, NEWPORT 260 MARINO, SK GOLDEN LION MARINO, SUPER BEE I MARINO, SUPER BEE II MARINO, SUPER BEE III MARINO, SUPER BEE IV MARINO

ACEITE	GP-1	1851658
--------	------	---------

170 6 CIL. A GASOLINA

ACEITE	G-236	2129023
ACEITE	GP-1	E5778M
AIRE	GA-71	2206376
GASOLINA	GG-5 L	2525254

198 6 CIL. A GASOLINA, 251 6 CIL. A GASOLINA, 251-2 6 CIL. A GASOLINA, 251-3 6 CIL. A GASOLINA, 251-3 6 CIL. A GASOLINA, 273A V8 A GASOLINA

ACEITE	GP-1	E5778M
AIRE	GA-71	2206376
GASOLINA	GG-20	2240546
GASOLINA	GG-5 L	2525254

225 6 CIL. A GASOLINA

ACEITE	GP-1	E5778M
AIRE, 1977 EN ADELANTE	GA-70	1739547
AIRE, 1967-77	GA-71	2206376
AIRE, 1979 EN ADELANTE	GA-77	2453346
AIRE, 1977 EN ADELANTE	GA-78	4041252
GASOLINA	GG-20	2240546
GASOLINA, 1957-81	GG-5 L	2525254
GASOLINA, 1975-81	GG-8 L	3870548

225 6 CIL. A GASOLINA, 318 V8 A GASOLINA

AIRE	GA-70	1739547
------	-------	---------

225-1 6 CIL. A GASOLINA, 225-2 6 CIL. A GASOLINA

ACEITE	G-236	2129023
ACEITE	GP-1	E5778M
ACEITE	GP-81	3549957
AIRE, 1977 EN ADELANTE	GA-70	1739547
AIRE, 1967-77	GA-71	2206376
AIRE, 1979 EN ADELANTE	GA-77	2453346
AIRE, 1977 EN ADELANTE	GA-78	4041252
GASOLINA	GG-20	2240546
GASOLINA, 1957-81	GG-5 L	2525254
GASOLINA, 1975-81	GG-8 L	3870548

230 6 CIL. A GASOLINA, 361 V8 A GASOLINA, 361-2 V8 A GASOLINA, 361-3 V8 A GASOLINA, 361-4 INDUSTRIAL, 361-4 V8 A GASOLINA, 413-2 INDUSTRIAL, 413-3 INDUSTRIAL, IND13 INDUSTRIAL, IND13A INDUSTRIAL, IND14 INDUSTRIAL, IND14A INDUSTRIAL, IND15 INDUSTRIAL, IND15A INDUSTRIAL

GASOLINA	GG-20	2240546
----------	-------	---------

MARCA-MODELO-MOTOR GONHER OEM

MAKE-MODEL-ENGINE GONHER OEM

DODGE (continuación)

MOTORES

238 V6 A GASOLINA

ACEITE	GP-58	2647020
--------	-------	---------

251 6 CIL. A GASOLINA, 251-1 6 CIL. A GASOLINA, 251-2 6 CIL. A GASOLINA, 360 5.9L V8 A GASOLINA, 360-1 V8 A GASOLINA, 360-3 V8 A GASOLINA

ACEITE	G-236	2129023
ACEITE	GP-1	1851658
GASOLINA	GG-5 L	2525254

273A V8 A GASOLINA

ACEITE	G-236	2129023
ACEITE	GP-1	1851658
AIRE	GA-70	1739547
GASOLINA	GG-20	2240546
GASOLINA	GG-5 L	2525254

318 V8 A GASOLINA

ACEITE	GP-1	E5778M
AIRE, 1964-73	GA-70	1739547
AIRE, 1974 EN ADELANTE	GA-429	3614353
GASOLINA, 1959-71	GG-20	2240546
GASOLINA, 1968-81	GG-5 L	2525254
GASOLINA, 1975 EN ADELANTE	GG-8 L	3870548

360 5.9L V8 A GASOLINA, 360-1 V8 A GASOLINA, 360-3 V8 A GASOLINA

GASOLINA	GG-67	4443452
----------	-------	---------

383 V8 A GASOLINA

ACEITE	GP-1	1851658
ACEITE	GP-81	3549957
AIRE	GA-730	2863349
GASOLINA	GG-5 L	2525254

400 V8 A GASOLINA

ACEITE	GP-1	1851658
ACEITE	GP-81	3549957
AIRE	GA-429	3614353
AIRE	GA-730	2863349
GASOLINA	GG-5 L	2525254
GASOLINA	GG-8 L	3870548

440 V8 A GASOLINA

ACEITE, HASTA 1973	GP-1	E5778M
AIRE	GA-429	3614353
AIRE	GA-730	2863349
GASOLINA	GG-20	2240546
GASOLINA	GG-5 L	2525254
GASOLINA	GG-8 L	3870548

440-1 V8 A GASOLINA, 440-3 V8 A GASOLINA

ACEITE	GP-1	1851658
GASOLINA	GG-20	2240546
GASOLINA	GG-5 L	2525254

IND908A INDUSTRIAL, M10 MARINO, M11 MARINO, M16ACE MARINO, M26ACE MARINO, M6 MARINO, M7 MARINO

ACEITE	G-31	925809
--------	------	--------

M44S MARINO, M44SJ MARINO, M45S3 MARINO, M45SP3 MARINO, M46-3 MARINO, M46-4 MARINO, M46-5 MARINO, M47-3 MARINO, M47-4 MARINO, M8 MARINO

ACEITE	G-6	1677224
--------	-----	---------

SERVICIO PESADO

MARCA-MODELO-MOTOR GONHER OEM
MAKE-MODEL-ENGINE GONHER OEM

DRESSER

CARGADORAS

532 con motor/359T		
ACEITE	GP-3000	LF3000
538 con motor/KOMATSU KDC 614		
ACEITE	GP-3000	1294153-H1
542 con motor/KOMATSU KDC 614TA		
ACEITE	GP-3000	1294153-H1
545 con motor/CUMMINS LTA10C		
ACEITE	GP-3000	3318853
558 con motor/CUMMINS NTA855		
ACEITE	GP-3000	3318853
560 con motor/CUMMINS QSK19		
ACEITE	GP-3000	3318853

ELDORADO BUS

CAMIONES, TRACTOCAMIONES Y AUTOBUSES

COMMERCIAL con motor/CUMMINS ISB DIESEL		
ACEITE	GP-3937	3937144
COMMERCIAL con motores/CUMMINS ISB CNG, CUMMINS ISB PROPANE		
ACEITE	GP-3937	3937144
COMMERCIAL con motores/CUMMINS ISC CNG, CUMMINS ISC PROPANE		
ACEITE	GP-3001	3401544
COMMERCIAL, TRANSIT RE con motor/CUMMINS ISC DIESEL		
ACEITE	GP-3001	3401544
COMBUSTIBLE, SEPARADOR DE AGUA	GPP-1003S	3800394
COMBUSTIBLE, SEPARADOR DE AGUA	GPP-1022S	3800394
CONVENTIONAL con motor/CATERPILLAR 31226B		
ACEITE	GP-51	1R0739
CONVENTIONAL con motor/CUMMINS ISB		
ACEITE	GP-3937	3937144
CONVENTIONAL con motor/INTERNATIONAL VT-365		
COMBUSTIBLE, SEPARADOR DE AGUA	G-862	1825864C92
CUT-AWAY CHASSIS con motor/FORD 6.0L TURBO DIESEL		
ACEITE, CARTUCHO	G-3752	3C3Z-6731-AA
CUT-AWAY CHASSIS con motor/FORD 7.3L TURBO DIESEL		
COMBUSTIBLE, SEPARADOR DE AGUA, 1999 EN ADELANTE	G-862	F81A-9N184-AB
COMBUSTIBLE, SEPARADOR DE AGUA	G-178	F4TZ-9N184-B
ACEITE	GP-562	F4TZ-6731-A
AIRE, REQUIERE 2 PIEZAS	GAVW-620	F5UZ-9601-A
CUT-AWAY CHASSIS con motor/FORD V8 5.8L		
ACEITE, SIN OIL COOLER	GP-1	D9AZ-6731-A
ACEITE, CON OIL COOLER	GP-68	F1AZ-6731-A
AIRE	GA-174	E7TZ-9601-B
COMBUSTIBLE	GG-1872	F0TZ-9155-B

MARCA-MODELO-MOTOR GONHER OEM
MAKE-MODEL-ENGINE GONHER OEM

ELDORADO BUS (continuación)

CAMIONES, TRACTOCAMIONES Y AUTOBUSES

CUT-AWAY CHASSIS con motor/GENERAL MOTORS V8 6.0L VORTEC		
ACEITE	GP-44	88984215
AIRE	GA-413R	15153904
COMBUSTIBLE, ROSCA EN AMBOS EXTREMOS	GG-46	25171792
COMBUSTIBLE, ROSCA EN UN SOLO EXTREMO	GG-66	25121293
CUT-AWAY CHASSIS con motor/GENERAL MOTORS V8 6.6L DURAMAX		
AIRE, 4500/5500 SERIES CHASSIS	GA-135	2467368
CUT-AWAY CHASSIS con motor/GENERAL MOTORS V8 8.1L		
ACEITE	GP-408	25324052
AIRE, 4500/5500 SERIES CHASSIS	GA-135	25313349
AIRE, 4500/5500 SERIES CHASSIS	GA-348	25313349
AIRE, G SERIES VANS	GA-413R	25313349
COMBUSTIBLE, 4500/5500 SERIES CHASSIS	GG-46	25171792
COMBUSTIBLE, G-SERIES VAN CHASSIS	GG-581	25319686
CUT-AWAY CHASSIS con motores/FORD V10 6.8L GAS, FORD V8 5.4L		
ACEITE	GP-68	F1AZ-6731-BD
AIRE	GA-1615	F6ZZ-9601-A
COMBUSTIBLE	GG-986	F89Z-9155-A
TRANSIT FE, TRANSIT RE con motor/CUMMINS ISB DIESEL		
ACEITE	GP-3937	3937144
TRANSIT FE, TRANSIT RE con motores/CUMMINS ISB CNG, CUMMINS ISB PROPANE		
ACEITE	GP-3937	3937144
TRANSIT RE con motores/CUMMINS ISC CNG, CUMMINS ISC PROPANE		
ACEITE	GP-3001	3401544

ERF

CAMIONES, TRACTOCAMIONES Y AUTOBUSES

10.30 RD4, 10.30 TP4 con motor/CUMMINS LTA10.300 (08/93 EN DELANTE)		
ACEITE	GP-3000	1355360
10.30 ST con motor/CUMMINS L300 (08/93 EN DELANTE)		
ACEITE	GP-3000	1355360
10.32 con motor/CUMMINS LTA10.325 (08/93 EN DELANTE)		
ACEITE	GP-3000	1355360
10.35 con motor/CUMMINS LTA10.350 (08/93 EN DELANTE)		
ACEITE	GP-3000	1355360
14.34 con motor/CUMMINS NTAA340 (08/93 EN DELANTE)		
ACEITE	GP-3000	1355360
14.38 con motor/CUMMINS NTAA380 (08/93 EN DELANTE)		
ACEITE	GP-3000	1355360
14.41 con motor/CUMMINS NTAA400 (08/93 EN DELANTE)		
ACEITE	GP-3000	1355360
14.47 con motor/CUMMINS N475 (05/00 EN DELANTE)		
ACEITE	GP-3000	1355360

MARCA-MODELO-MOTOR GONHER OEM
MAKE-MODEL-ENGINE GONHER OEM

ERF (continuación)

CAMIONES, TRACTOCAMIONES Y AUTOBUSES

14.5 con motor/CUMMINS N500E (08/93 EN DELANTE)		
ACEITE	GP-3000	1355360
14.52 con motor/CUMMINS N525 (05/00 EN DELANTE)		
ACEITE	GP-3000	1355360
8.24, 8.27 con motor/CUMMINS 6TAA TURBO (08/93 EN DELANTE)		
ACEITE	GP-3000	1355360

EUCLID

CAMIONES, TRACTOCAMIONES Y AUTOBUSES

A464 DE VOLTEO con motor/CUMMINS NT855C		
ACEITE	G-566	257528
COMBUSTIBLE	GP-1101	154711
ACEITE	GP-53	3313287
ACEITE	G-750	9157891
B100 VAGONETA, B110 VAGONETA con motor/GMC 16V-71N		
ACEITE, FLUJO TOTAL (FULL FLOW)	G-33	5577124
TRANSMISION	G-33	5576200
AIRE, PRIMARIO	GA-356	9035992
AIRE, SECUNDARIO	GA-357	9035993
B110 DE VOLTEO, CH100 DE VOLTEO con motor/DETROIT DIESEL 16V-71		
ACEITE, CARTUCHO	G-33	5573014
B30 VAGONETA con motor/DETROIT DIESEL 8V-71N		
TRANSMISION	G-33	5573014
B30 VAGONETA con motor/GMC 8V-71N		
ACEITE, CONVERTIDOR DE TORSION	G-33	5577124
ACEITE, FLUJO TOTAL (FULL FLOW)	G-33	5573014
TRANSMISION	G-33	5576200
COMBUSTIBLE, PRIMARIO	GP-26	8423132
COMBUSTIBLE, SECUNDARIO	GP-27	23518482
B63 VAGONETA, B70 VAGONETA con motor/GMC 12V-71		
ACEITE, DERIVACION (BY PASS)	G-31	5572425
ACEITE, FLUJO TOTAL (FULL FLOW)	G-33	5573014
TRANSMISION	G-33	5577124
CH100 DE VOLTEO con motor/CUMMINS VTA1710C		
ACEITE	GP-53	3313287
COMBUSTIBLE	GP-55	4054556
ACEITE, DERIVACION (BY PASS)	G-750	9157891
CH120 VAGONETA con motor/CUMMINS VTA 1710C		
ACEITE, CARTUCHO	G-566	257528
ACEITE, SELLADO	GP-53	3313287
COMBUSTIBLE	GP-55	4054556
ACEITE, DERIVACION (BY PASS)	G-750	9157891
CH120 VAGONETA con motor/DETROIT DIESEL 16V-71		
ACEITE, CARTUCHO	G-33	5577124
CH120 VAGONETA con motor/DETROIT DIESEL 16V-92		
ACEITE, CARTUCHO	G-33	5573014
CH150 VAGONETA con motor/CUMMINS KTA2300C		
ACEITE	GP-53	3313287

MARCA-MODELO-MOTOR MAKE-MODEL-ENGINE	GONHER GONHER	OEM OEM	MARCA-MODELO-MOTOR MAKE-MODEL-ENGINE	GONHER GONHER	OEM OEM	MARCA-MODELO-MOTOR MAKE-MODEL-ENGINE	GONHER GONHER	OEM OEM
EUCLID (continuación)			EUCLID (continuación)			EUCLID (continuación)		
CAMIONES, TRACTOCAMIONES Y AUTOBUSES			CAMIONES, TRACTOCAMIONES Y AUTOBUSES			CAMIONES, TRACTOCAMIONES Y AUTOBUSES		
COMBUSTIBLE	GP-55	4054556	AIRE, RESPIRADOR	GA-39	255963	R22 (FD SERIES) DE VOLTEO con motor/GMC 6-71		
ACEITE, DERIVACION (BY PASS)	G-750	9157891	ACEITE, DERIVACION (BY PASS)	G-750	9157891	ACEITE	G-33	6439400
						TRANSMISION	G-33	5577124
CH150 VAGONETA con motor/DETROIT DIESEL 12V-149			R150C DE VOLTEO con motor/CUMMINS KTA50C			COMBUSTIBLE, SECUNDARIO	G-1175	9042680
ACEITE, CARTUCHO	G-33	5577124	ACEITE, FLUJO TOTAL (FULL FLOW) SELLADO (REQUIERE 5)	GP-53	3307885			
			COMBUSTIBLE (REQUIERE 2)	GP-55	3313306	R22 (TD, TDT SERIES) DE VOLTEO con motor/GMC 6-110		
R10 (UD SERIES) DE VOLTEO con motor/GMC 4-71			ACEITE, DERIVACION (BY PASS) SELLADO (REQUIERE 2)	GP-57	3313283	ACEITE, DERIVACION (BY PASS)	G-31	1595410
ACEITE	G-33	5577124				7 13/16 IN		
			R170 DE VOLTEO con motor/CUMMINS KTA2300C			ACEITE	G-33	5573013
R100 DE VOLTEO con motor/CUMMINS KTA2300C			ACEITE	GP-53	3313287	COMBUSTIBLE, SECUNDARIO	G-1175	9042680
ACEITE	GP-53	3313287	COMBUSTIBLE	GP-55	4054556	ACEITE, DERIVACION (BY PASS)	G-750	5572425
COMBUSTIBLE	GP-55	4054556	ACEITE, DERIVACION (BY PASS)	G-750	9157891	14 13/16		
ACEITE, DERIVACION (BY PASS)	G-750	9157891						
			R170 DE VOLTEO con motor/CUMMINS KTA3067C			R22 (TD, TDT SERIES) DE VOLTEO con motor/GMC 6-71		
R100 DE VOLTEO con motor/DETROIT DIESEL 12V-149			ACEITE, FLUJO TOTAL (FULL FLOW) SELLADO (REQUIERE 5)	GP-53	3307885	ACEITE	G-33	6439400
ACEITE, CARTUCHO	G-33	5577124	COMBUSTIBLE (SELLADO) (REQUIERE 2)	GP-55	3313306	COMBUSTIBLE, SECUNDARIO	G-1175	9042680
			AGUA, SISTEMA DE ENFRIAMIENTO (REQUIERE 4)	GP-1011Q	299086	AIRE, SECUNDARIO	GA-6127	9034223
R100 FUERA DE CARRETERA con motor/DETROIT DIESEL			ACEITE, DERIVACION (BY PASS) CARTUCHO (REQUIERE 2)	G-750	256345	AIRE, PRIMARIO	GA-6129	9034222
TRANSMISION	G-33	5577124						
R105 DE VOLTEO con motor/CUMMINS QST30			R170 DE VOLTEO, R130 DE VOLTEO, R130M DE VOLTEO con motores/DETROIT DIESEL 12V-149, DETROIT DIESEL 16V-149			R22 SER.; MODELO TD FUERA DE CARRETERA con motor/DETROIT DIESEL 6-71		
ACEITE	GP-53	E12000200	ACEITE, CARTUCHO	G-33	5577124	AIRE, SECUNDARIO	GA-6127	9034223
R105 DE VOLTEO con motor/GMC 12V-149T			R170C DE VOLTEO con motor/CUMMINS KTA50C			R25 DE VOLTEO con motor/CUMMINS NT855C		
ACEITE, DERIVACION (BY PASS)	G-31	5572425	ACEITE, FLUJO TOTAL (FULL FLOW) SELLADO (REQUIERE 5)	GP-53	3307885	ACEITE	G-566	257528
ACEITE	G-33	5577124	COMBUSTIBLE (REQUIERE 2)	GP-55	3313306	COMBUSTIBLE	GP-1101	154711
TRANSMISION	G-33	5576200	ACEITE, DERIVACION (BY PASS) SELLADO (REQUIERE 2)	GP-57	3313283	ACEITE	GP-53	3313287
						ACEITE	G-750	9157891
R12 (UD SERIES) DE VOLTEO con motor/GMC 4-71			R18 (FD, FDT SERIES) DE VOLTEO con motor/GMC 6-71			R25 DE VOLTEO con motor/DETROIT DIESEL 6V-71		
ACEITE	G-33	5577124	ACEITE, DERIVACION (BY PASS)	G-31	5572425	ACEITE, CARTUCHO	G-33	5577124
			ACEITE	G-33	5577124	COMBUSTIBLE, PRIMARIO	GP-26	8423132
R120 DE VOLTEO, R120E DE VOLTEO, R120M DE VOLTEO con motor/CUMMINS KTA2300C			COMBUSTIBLE, SECUNDARIO	G-1175	BM23097	COMBUSTIBLE, SECUNDARIO	GP-27	23518482
ACEITE	GP-53	3313287				ACEITE, SELLADO	GP-53	25010449
COMBUSTIBLE	GP-55	4054556	R190 DE VOLTEO, R190C DE VOLTEO con motor/DETROIT DIESEL 16V-149					
ACEITE, DERIVACION (BY PASS)	G-750	9157891	ACEITE	GP-53	25010449	R27 (TD, TDT SERIES) DE VOLTEO con motor/CUMMINS		
						TRANSMISION	G-33	3301060
R120 DE VOLTEO, R120E DE VOLTEO, R120M DE VOLTEO con motor/DETROIT DIESEL 12V-149			R20 (FD, FDT SERIES) DE VOLTEO con motor/CUMMINS			ACEITE, CARTUCHO PARA FLUJO TOTAL (FULL FLOW)	G-566	257528
ACEITE, CARTUCHO	G-33	5577124	ACEITE, CARTUCHO PARA FLUJO TOTAL (FULL FLOW)	G-566	257528	ACEITE, TURBOCARGADOR	GP-14	4041959
			COMBUSTIBLE, HEAVY DUTY	G-1143	139097	COMBUSTIBLE, 5 47/64 IN	GPP-14	4054551
R13 (UD SERIES) DE VOLTEO con motor/GMC 4-71			ACEITE, TURBOCARGADOR	GP-14	4041959	COMBUSTIBLE, 5 17/32 IN	GP-1101	BM59678
ACEITE	G-33	5577124	COMBUSTIBLE, 5 47/64 IN	GPP-14	4054551	ACEITE, SELLADO PARA FLUJO TOTAL (FULL FLOW)	GP-53	3313287
			COMBUSTIBLE, 5 17/32 IN	GP-1101	BM59678	COMBUSTIBLE, 11 1/2 IN	GP-55	4054556
R130M DE VOLTEO con motor/CUMMINS KTTA38C			ACEITE, SELLADO PARA FLUJO TOTAL (FULL FLOW)	GP-53	3313287	COMBUSTIBLE, SEPARADOR DE AGUA	GPP-11	3600980
ACEITE	GP-53	3313287	COMBUSTIBLE, 11 1/2 IN	GP-55	4054556	AIRE, RESPIRADOR	GA-39	255963
COMBUSTIBLE	GP-55	4054556	COMBUSTIBLE, SEPARADOR DE AGUA	GPP-11	3600980	ACEITE, DERIVACION (BY PASS)	G-750	9157891
ACEITE, DERIVACION (BY PASS)	GP-57	3304232	AIRE, RESPIRADOR	GA-39	255963			
AGUA	GP-2071W	3315116	ACEITE, DERIVACION (BY PASS)	G-750	9157891	R27 (TD, TDT SERIES) DE VOLTEO, R30 (TD, TDT SERIES) DE VOLTEO con motor/GMC 6-110		
						ACEITE, DERIVACION (BY PASS)	G-31	5572425
R15 (FD, FDT SERIES) DE VOLTEO con motor/GMC 6-71			R20 (FD, FDT SERIES) DE VOLTEO con motor/GMC 6-71			ACEITE	G-33	5577124
ACEITE, DERIVACION (BY PASS)	G-31	5572425	ACEITE	G-33	5577124	TRANSMISION	G-33	5576200
ACEITE	G-33	5577124	R22 (FD SERIES) DE VOLTEO con motor/GMC 6-110			COMBUSTIBLE, SECUNDARIO	G-1175	9042680
COMBUSTIBLE, SECUNDARIO	G-1175	9042680	ACEITE, DERIVACION (BY PASS)	G-31	5572425	AIRE, SECUNDARIO	GA-6127	9034223
			ACEITE	G-33	5577124	AIRE, PRIMARIO	GA-6129	9034222
R15 (FD, FDT SERIES) DE VOLTEO, R18 (FD, FDT SERIES) DE VOLTEO, R22 (TD, TDT SERIES) DE VOLTEO con motor/CUMMINS			COMBUSTIBLE, SECUNDARIO	G-1175	9042680			
ACEITE, CARTUCHO PARA FLUJO TOTAL (FULL FLOW)	G-566	257528				R27 SER.; MODELO TD FUERA DE CARRETERA con motor/CUMMINS NRTO-6		
ACEITE, TURBOCARGADOR	GP-14	4041959				TRANSMISION	G-33	5577124
COMBUSTIBLE, 5 47/64 IN	GPP-14	4054551						
COMBUSTIBLE, 5 17/32 IN	GP-1101	BM59678				R27 SER.; MODELO TD FUERA DE CARRETERA con motor/DETROIT DIESEL 6-110		
ACEITE, SELLADO PARA FLUJO TOTAL (FULL FLOW)	GP-53	3313287				TRANSMISION	G-33	5577124
COMBUSTIBLE, 11 1/2 IN	GP-55	4054556				AIRE, SECUNDARIO	GA-6127	9034223
COMBUSTIBLE, SEPARADOR DE AGUA	GPP-11	3600980				AIRE	GA-6129	9034222

SERVICIO PESADO

MARCA-MODELO-MOTOR MAKE-MODEL-ENGINE	GONHER GONHER	OEM OEM	MARCA-MODELO-MOTOR MAKE-MODEL-ENGINE	GONHER GONHER	OEM OEM	MARCA-MODELO-MOTOR MAKE-MODEL-ENGINE	GONHER GONHER	OEM OEM
EUCLID (continuación)			EUCLID (continuación)			EUCLID (continuación)		
CAMIONES, TRACTOCAMIONES Y AUTOBUSES			CAMIONES, TRACTOCAMIONES Y AUTOBUSES			CAMIONES, TRACTOCAMIONES Y AUTOBUSES		
R30 (TD, TDT SERIES) DE VOLTEO con motor/CUMMINS KT1150C			AIRE	GA-356	4012356	R50 DE VOLTEO con motor/CUMMINS VTA28C		
ACEITE, TURBOCARGADOR	GP-14	4041959	AIRE, SECUNDARIO	GA-357	4012357	AGUA, SISTEMA DE ENFRIAMIENTO	GP-1010Q	E12967020
AGUA, SISTEMA DE ENFRIAMIENTO	GP-1010Q	E12967020	R40 (FFD, LD, LDT SERIES) DE VOLTEO con motor/GMC 16V-71			AIRE, RESPIRADOR, MODELOS CON TURBO	GA-39	255963
COMBUSTIBLE, ALT. 5 17/32 IN	GP-1101	120517	ACEITE, DERIVACION (BY PASS)	G-31	5572425	AIRE, PRIMARIO	GA-879	E4082222
COMBUSTIBLE, ALT. 11 15/32 IN	GP-55	4054556	ACEITE	G-33	5577124	R50 SER.; MODELO LLD FUERA DE CARRETERA con motor/DETROIT DIESEL 6-110		
ACEITE, DERIVACION (BY PASS) SELLADO	GP-57	3021658	TRANSMISION	G-33	5576200	TRANSMISION	G-33	6439400
COMBUSTIBLE, SEPARADOR DE AGUA	GPP-11	202893	R40 (FFD, LD, LDT SERIES) DE VOLTEO, R45 (FFD, LD, LDT SERIES) DE VOLTEO con motor/CUMMINS			R50 SER.; MODELO LLD FUERA DE CARRETERA con motores/CUMMINS NRTO-6, CUMMINS NT-335		
AIRE, RESPIRADOR, MODELOS CON TURBO	GA-39	255963	TRANSMISION	G-33	5577124	TRANSMISION	G-33	5577124
AIRE, PRIMARIO	GA-879	E4082222	ACEITE, CARTUCHO PARA FLUJO TOTAL (FULL FLOW)	G-566	257528	R50 SER.; MODELO LLD FUERA DE CARRETERA con motores/CUMMINS VT-1710-C, DETROIT DIESEL 16V-71N		
R30 (TD, TDT SERIES) DE VOLTEO, R35 (TD, TDT SERIES) DE VOLTEO con motor/GMC 12V-71			ACEITE, TURBOCARGADOR	GP-14	4041959	TRANSMISION	G-33	5577124
ACEITE	G-33	5577124	COMBUSTIBLE, 5 47/64 IN	GPP-14	4054551	R60 (LDC SERIES) DE VOLTEO con motor/CUMMINS VTA28C		
R30 SER.; MODELO TD FUERA DE CARRETERA con motores/DETROIT DIESEL 12V-71, DETROIT DIESEL 6-110			COMBUSTIBLE, 5 17/32 IN	GP-1101	BM59678	AGUA, SISTEMA DE ENFRIAMIENTO	GP-1010Q	3305369
TRANSMISION	G-33	5577124	ACEITE, SELLADO PARA FLUJO TOTAL (FULL FLOW)	GP-53	3313287	COMBUSTIBLE, SELLADO	GP-55	4054556
AIRE	GA-356	4012356	COMBUSTIBLE, 11 1/2 IN	GP-55	4054556	ACEITE, DERIVACION (BY PASS), SELLADO	GP-57	3021658
AIRE, SECUNDARIO	GA-357	4012357	COMBUSTIBLE, SEPARADOR DE AGUA	GPP-11	3600980	AIRE, PRIMARIO	GA-879	4082222
R30 SER.; MODELO TD FUERA DE CARRETERA, R35 SER.; MODELO TD FUERA DE CARRETERA con motor/CUMMINS NT-335			AIRE, RESPIRADOR	GA-39	255963	R60 DE VOLTEO, R60C DE VOLTEO, R60D DE VOLTEO con motor/CUMMINS QSK 19		
TRANSMISION	G-33	5577124	ACEITE, DERIVACION (BY PASS)	G-750	9157891	AGUA, SISTEMA DE ENFRIAMIENTO	GP-1010Q	E12967020
R35 (TD, TDT SERIES) DE VOLTEO con motor/CUMMINS KT1150C			R40 (FFD, LD, LDT SERIES) DE VOLTEO, R45 (FFD, LD, LDT SERIES) DE VOLTEO con motor/DOS GMC 6-71			ACEITE, DOBLE FLUJO	GP-3000	E12969457
ACEITE, TURBOCARGADOR	GP-14	4041959	ACEITE	G-33	5577124	COMBUSTIBLE	GPP-1000	E12977622
AGUA, SISTEMA DE ENFRIAMIENTO	GP-1010Q	E12967020	TRANSMISION	G-33	5577124	AIRE, PRIMARIO	GA-879	E4082222
COMBUSTIBLE, SELLADO, ALT. 5 17/32 IN	GP-1101	120517	COMBUSTIBLE, 7 3/8 IN	G-1175	9042680	R62 SER.; MODELO LLD FUERA DE CARRETERA con motores/CUMMINS VT-1710-C, DETROIT DIESEL 16V-71N, DETROIT DIESEL 6-110, CUMMINS NRTO-6, CUMMINS NT-335		
COMBUSTIBLE, SELLADO, ALT. 11 15/32 IN	GP-55	4054556	ACEITE	G-750	9157891	TRANSMISION	G-33	5577124
ACEITE, DERIVACION (BY PASS) SELLADO	GP-57	3021658	R40 DE VOLTEO, R40C DE VOLTEO con motor/CUMMINS QSK 19			R65 DE VOLTEO con motor/CUMMINS VTA28-C		
AIRE, RESPIRADOR, MODELOS CON TURBO	GA-39	255963	AGUA	GP-1013Q	E12565210	ACEITE	GP-53	3313287
AIRE, PRIMARIO	GA-879	E4082222	R40 SER.; MODELO FFD FUERA DE CARRETERA, R40 SER.; MODELO JD FUERA DE CARRETERA, R45 SER.; MODELO FFD FUERA DE CARRETERA con motores/CUMMINS NT6, CUMMINS V12-525			R65 DE VOLTEO, R65C DE VOLTEO, R65D DE VOLTEO con motor/DETROIT DIESEL 12V2000		
R35 (TD, TDT SERIES) DE VOLTEO con motor/GMC 6-110			TRANSMISION	G-33	5577124	AGUA, SISTEMA DE ENFRIAMIENTO	GP-1010Q	E12967020
ACEITE, DERIVACION (BY PASS)	G-31	5572425	R45 (FFD, LD, LDT SERIES) DE VOLTEO con motor/GMC 16V-71			ACEITE	GP-53	5013192
ACEITE	G-33	6439400	ACEITE, DERIVACION (BY PASS)	G-31	5572425	AIRE, PRIMARIO	GA-879	E4082222
TRANSMISION	G-33	5576200	ACEITE	G-33	5577124	R75 DE VOLTEO con motor/CUMMINS		
COMBUSTIBLE, SECUNDARIO	G-1175	9042680	TRANSMISION	G-33	5577124	ACEITE, CARTUCHO PARA FLUJO TOTAL (FULL FLOW)	G-566	257528
AIRE, SECUNDARIO	GA-6127	9034223	R40 SER.; MODELO FFD FUERA DE CARRETERA, R45 SER.; MODELO JD FUERA DE CARRETERA, R45 SER.; MODELO FFD FUERA DE CARRETERA con motores/DETROIT DIESEL 16V-71, DETROIT DIESEL 6-71			ACEITE, TURBOCARGADOR	GP-14	4041959
AIRE, PRIMARIO	GA-6129	9034222	TRANSMISION	G-33	5577124	COMBUSTIBLE, 5 47/64 IN	GPP-14	4054551
R35 DE VOLTEO con motor/DETROIT DIESEL 8V-92			R45 (FFD, LD, LDT SERIES) DE VOLTEO con motor/GMC 16V-71			COMBUSTIBLE, 5 13/32 IN	GP-1101	BM59678
ACEITE, CARTUCHO	G-33	5577124	ACEITE, DERIVACION (BY PASS)	G-31	5572425	ACEITE, SELLADO PARA FLUJO TOTAL (FULL FLOW)	GP-53	3313287
COMBUSTIBLE, PRIMARIO	GP-26	8423132	ACEITE	G-33	5577124	COMBUSTIBLE, 11 1/2 IN	GP-55	4054556
COMBUSTIBLE, SECUNDARIO	GP-27	23518482	TRANSMISION	G-33	5576200	COMBUSTIBLE, SEPARADOR DE AGUA	GPP-11	3600980
ACEITE, SELLADO	GP-53	25010449	COMBUSTIBLE, SECUNDARIO	G-1175	9042680	AIRE, RESPIRADOR	GA-39	255963
R35 DE VOLTEO con motor/GMC 16V-71			AIRE, RESPIRADOR	GA-39	255963	R50 (LLD SERIES) DE VOLTEO, R62 (LLD SERIES) DE VOLTEO con motor/GMC 16V-71		
ACEITE	G-33	5573013	R50 (LLD SERIES) DE VOLTEO, R62 (LLD SERIES) DE VOLTEO con motor/GMC 16V-71			ACEITE	G-33	5577124
R35 SER.; MODELO TD FUERA DE CARRETERA con motores/CUMMINS NTA-380, CUMMINS NTA-855-C			ACEITE, DERIVACION (BY PASS)	G-31	5572425	R50 DE VOLTEO con motor/A DIESEL		
TRANSMISION	G-33	5577124	ACEITE	G-33	5577124	ACEITE	GP-53	E12000200
AIRE	GA-356	P117441	TRANSMISION	G-33	5576200	AGUA	GP-1013Q	E12565210
AIRE, SECUNDARIO	GA-357	P114931	COMBUSTIBLE, SECUNDARIO	G-1175	9042680	AIRE, RESPIRADOR	GA-39	255963
R35 SER.; MODELO TD FUERA DE CARRETERA con motores/DETROIT DIESEL 12V-71, DETROIT DIESEL 6-110			AIRE, RESPIRADOR	GA-39	255963	R75 DE VOLTEO con motor/GMC 16V-71T		
TRANSMISION	G-33	5577124	R50 (LLD SERIES) DE VOLTEO, R62 (LLD SERIES) DE VOLTEO con motor/GMC 16V-71			ACEITE, DERIVACION (BY PASS)	G-31	5572425
			ACEITE	G-33	5577124	ACEITE	G-33	5577124
			R50 DE VOLTEO con motor/A DIESEL			ACEITE, CONVERTIDOR DE TORSION	G-33	5577124
			ACEITE	GP-53	E12000200	TRANSMISION	G-33	5577124
			AGUA	GP-1013Q	E12565210			
			AIRE, RESPIRADOR	GA-39	255963			

MARCA-MODELO-MOTOR GONHER OEM
MAKE-MODEL-ENGINE GONHER OEM

MARCA-MODELO-MOTOR GONHER OEM
MAKE-MODEL-ENGINE GONHER OEM

MARCA-MODELO-MOTOR GONHER OEM
MAKE-MODEL-ENGINE GONHER OEM

EUCLID (continuación)

CAMIONES, TRACTOCAMIONES Y AUTOBUSES

R75 DE VOLTEO con motor/GMC 16V-92		
ACEITE, CARTUCHO	G-33	5577124
R75 FUERA DE CARRETERA con motor/CUMMINS		
AIRE, RESPIRADOR	GA-39	255963
R85 DE VOLTEO con motor/CUMMINS		
ACEITE	GP-53	3313287
COMBUSTIBLE	GP-55	4054556
ACEITE	GP-57	3304232
AGUA	GP-1011Q	4054557
ACEITE	G-750	9157891
R85 DE VOLTEO con motor/DETROIT DIESEL 16V-92		
ACEITE, CARTUCHO	G-33	5577124
R90 DE VOLTEO, R90C DE VOLTEO, R90D DE VOLTEO con motor/CUMMINS QST30		
ACEITE	GP-53	E12000200
R90C DE VOLTEO con motor/CUMMINS KTA38		
ACEITE	GP-53	3313287
COMBUSTIBLE	GP-55	4054556
ACEITE, DERIVACION (BY PASS)	GP-57	3304232
RX105 FUERA DE CARRETERA con motor/DETROIT DIESEL 12V-149T		
TRANSMISION	G-33	5577124

EUCLID

CARGADORAS

72-21 FRONTAL con motor/GMC 3-71		
ACEITE, DERIVACION (BY PASS)	G-31	5572425
ACEITE	G-33	5577124
COMBUSTIBLE, SECUNDARIO	G-1173	9045748
COMBUSTIBLE, PRIMARIO	G-1174	9021029
72-31 FRONTAL, 72-41 FRONTAL con motor/GMC 4-71		
ACEITE, DERIVACION (BY PASS)	G-31	5572425
ACEITE	G-33	5577124
COMBUSTIBLE, SECUNDARIO	G-1173	9045748
COMBUSTIBLE, PRIMARIO	G-1174	9021029
AIRE, SIN ASPAS	GA-27	9030895
72-40 FRONTAL con motor/GMC 6V-71		
ACEITE	G-33	5577124
TRANSMISION	G-33	6439400
COMBUSTIBLE, SECUNDARIO	G-1175	9042680
AIRE, SIN ASPAS	GA-27	9030895
72-40 FRONTAL con motor/GMC 8V-71		
ACEITE	G-33	5577124
TRANSMISION	G-33	5577124
COMBUSTIBLE, SECUNDARIO	G-1175	9042680
AIRE, SIN ASPAS	GA-27	9030895
72-40 PALA con motor/DETROIT DIESEL 6V-71		
TRANSMISION	G-33	5577124
72-40 PALA con motor/DETROIT DIESEL 8V-71		
TRANSMISION	G-33	6439400
72-51 FRONTAL con motor/GMC 6-71		
ACEITE, DERIVACION (BY PASS)	G-31	5572425
ACEITE	G-33	5577124

EUCLID (continuación)

CARGADORAS

COMBUSTIBLE, PRIMARIO	G-1174	9021029
COMBUSTIBLE, SECUNDARIO	G-1175	9042680
AIRE, SECUNDARIO	GA-6127	9034223
AIRE, PRIMARIO	GA-6129	9034222
72-51 PALA con motor/DETROIT DIESEL 6-71		
AIRE, SECUNDARIO	GA-6127	9034223
72-71 FRONTAL con motor/GMC 8V-71		
ACEITE	G-33	5577124
72-81 FRONTAL con motor/GMC 12V-71T		
ACEITE, DERIVACION (BY PASS) 7 13/16 IN	G-31	5572425
ACEITE	G-33	5577124
ACEITE, DERIVACION (BY PASS) 14 13/16	G-750	9157891
82-30 SOBRE ORUGAS con motor/DETROIT DIESEL 6V-71		
TRANSMISION	G-33	5577124
AIRE, SECUNDARIO	GA-6127	9034223
AIRE	GA-6129	9034222
82-40 SOBRE ORUGAS con motor/DETROIT DIESEL 8V-71		
TRANSMISION	G-33	5577124
AIRE, SECUNDARIO	GA-6127	9034223
AIRE	GA-6129	9034222
82-80 SOBRE ORUGAS, TC-12 SOBRE ORUGAS con motor/DETROIT DIESEL 6-71		
TRANSMISION	G-33	5577124
84FD SOBRE ORUGAS con motor/A DIESEL		
COMBUSTIBLE, SECUNDARIO	G-1173	9045748
91FD SERIES A SOBRE ORUGAS, 91FD SERIES B SOBRE ORUGAS, 91FD SERIES C SOBRE ORUGAS, 91FD SERIES D SOBRE ORUGAS con motor/A DIESEL		
ACEITE, DERIVACION (BY PASS)	G-31	5572425
ACEITE	G-33	6439400
COMBUSTIBLE, PRIMARIO	G-1174	9021029
COMBUSTIBLE, SECUNDARIO	G-1175	9042680
BV11 SUPER DE BANDA con motor/GMC 16V-71N		
ACEITE	G-33	5573014
C-6 SOBRE ORUGAS con motor/DETROIT DIESEL 6-71		
TRANSMISION	G-33	5577124
L15 (7UPM SERIES) FRONTAL, L20 (7UPM SERIES) FRONTAL con motores/GMC 3-71, GMC 3-53N		
ACEITE, DERIVACION (BY PASS)	G-31	5572425
ACEITE	G-33	5577124
TRANSMISION	G-33	5577124
COMBUSTIBLE, SECUNDARIO	G-1173	9045748
COMBUSTIBLE, PRIMARIO	G-1174	9021029
L15 PALA, L20 PALA con motor/DETROIT DIESEL 3-71		
TRANSMISION	G-33	5577124
L25 (8UPM SERIES) FRONTAL, L30 (9UPM SERIES) FRONTAL con motor/GMC 4-71		
ACEITE, DERIVACION (BY PASS)	G-31	5572425
ACEITE	G-33	5577124
TRANSMISION	G-33	5577124
COMBUSTIBLE, PRIMARIO	G-1174	9021029
COMBUSTIBLE, SECUNDARIO	G-1175	9042680

EUCLID (continuación)

CARGADORAS

L25 PALA, L30 PALA con motor/DETROIT DIESEL 4-71		
TRANSMISION	G-33	5577124

EUCLID

EQUIPO PARA CONSTRUCCION

13TD, 14TD con motor/A DIESEL		
COMBUSTIBLE, SECUNDARIO	G-1173	9045748
COMBUSTIBLE, SECUNDARIO	G-1174	9021029
COMBUSTIBLE, PRIMARIO	G-1175	9042680
15TD, 17TD, 22TD, 23TD, 40TD con motor/A DIESEL		
COMBUSTIBLE, SECUNDARIO	G-1175	9042680
1UD con motor/A DIESEL		
COMBUSTIBLE, SECUNDARIO	G-1173	9045748
38FDT con motor/A DIESEL		
COMBUSTIBLE, SECUNDARIO	G-1173	9045748
COMBUSTIBLE, PRIMARIO	G-1174	9021029
ACEITE, DERIVACION (BY PASS)	G-750	9157891
49FD, 53FD con motor/A DIESEL		
COMBUSTIBLE, SECUNDARIO	G-1173	9045748
COMBUSTIBLE, PRIMARIO	G-1174	9021029
COMBUSTIBLE, SECUNDARIO	G-1175	9042680
71FDT, 77FDT con motor/A DIESEL		
COMBUSTIBLE, SECUNDARIO	G-1173	9045748
COMBUSTIBLE, PRIMARIO	G-1174	9021029
COMBUSTIBLE	G-1175	9042680
7FFD con motor/A DIESEL		
COMBUSTIBLE, SECUNDARIO 3 1/4 IN	G-1173	9045748
COMBUSTIBLE, PRIMARIO 7 3/8 IN	G-1174	9021029
COMBUSTIBLE, SECUNDARIO 7 3/8 IN	G-1175	9042680
EUCLID		
EQUIPO PARA CONSTRUCCION VIAL		
101FD con motor/GMC 6-110		
ACEITE, DERIVACION (BY PASS)	G-31	5572425
ACEITE	G-33	5577124
COMBUSTIBLE, SECUNDARIO	G-1175	9042680
101FD con motor/GMC 6-71		
ACEITE	G-33	5577124
COMBUSTIBLE	G-1175	9042680
AIRE, SECUNDARIO	GA-6127	9049490
AIRE, PRIMARIO	GA-6129	9038901
10FFD con motores/GMC 4-53, GMC 6-71		
ACEITE, DERIVACION (BY PASS)	G-31	5572425
ACEITE	G-33	5573014
COMBUSTIBLE, SECUNDARIO 3 1/4 IN	G-1173	9045748
COMBUSTIBLE, SECUNDARIO 7 3/8 IN	G-1175	BM23097
10FFD, 15FFD con motor/CUMMINS		
ACEITE, CARTUCHO PARA FLUJO TOTAL (FULL FLOW)	G-566	257528
ACEITE, TURBOCARGADOR	GP-14	4041959
COMBUSTIBLE, 5 47/64 IN	GPP-14	4054551

SERVICIO PESADO

MARCA-MODELO-MOTOR MAKE-MODEL-ENGINE	GONHER GONHER	OEM OEM	MARCA-MODELO-MOTOR MAKE-MODEL-ENGINE	GONHER GONHER	OEM OEM	MARCA-MODELO-MOTOR MAKE-MODEL-ENGINE	GONHER GONHER	OEM OEM
EUCLID (continuación)			EUCLID (continuación)			EUCLID (continuación)		
EQUIPO PARA CONSTRUCCION VIAL			EQUIPO PARA CONSTRUCCION VIAL			EQUIPO PARA CONSTRUCCION VIAL		
COMBUSTIBLE, 5 17/32 IN	GP-1101	BM59678	203FD con motor/GMC			29LOT con motor/GMC		
ACEITE, SELLADO PARA FLUJO TOTAL (FULL FLOW)	GP-53	3313287	ACEITE	G-33	5577124	ACEITE, DERIVACION (BY PASS)	G-31	5572425
COMBUSTIBLE, 11 1/2 IN	GP-55	4054556	TRANSMISION	G-33	5577124	ACEITE	G-33	5577124
COMBUSTIBLE, SEPARADOR DE AGUA	GPP-11	3600980	COMBUSTIBLE, SECUNDARIO	G-1175	9042680	COMBUSTIBLE, SECUNDARIO	G-1175	9042680
AIRE, RESPIRADOR	GA-39	255963	207FD con motor/GMC 6-71			2FD, 24LDT, 25FD, 25FDT, 26FDT, 27FDT, 29FDT con motor/CUMMINS		
ACEITE, DERIVACION (BY PASS)	G-750	9157891	ACEITE	G-33	5577124	ACEITE, CARTUCHO PARA FLUJO TOTAL (FULL FLOW)	G-566	257528
10LD con motor/GMC 16V-71			TRANSMISION	G-33	6439400	COMBUSTIBLE, 7 3/8 IN	G-1175	9042680
ACEITE, DERIVACION (BY PASS)	G-31	5572425	COMBUSTIBLE, SECUNDARIO	G-1175	9042680	ACEITE, TURBOCARGADOR	GP-14	4041959
11FDT, 23FDT, 12FDT, 12TD, 13LDT, 14TD, 15FDT, 15TD, 16FDT, 16LDT, 16TD, 17FDT, 17LDT, 18FD, 18FDT, 18LDT, 19FDT, 19TD, 1FDT, 1TD, 1TDT, 20FD, 20FDT, 20TD, 22FD, 22LDT con motor/CUMMINS			22TDT con motor/A DIESEL			COMBUSTIBLE, 5 47/64 IN	GPP-14	4054551
ACEITE, CARTUCHO PARA FLUJO TOTAL (FULL FLOW)	G-566	257528	ACEITE	G-33	5577124	COMBUSTIBLE, 5 17/32 IN	GP-1101	BM59678
COMBUSTIBLE, 7 3/8 IN	G-1175	9042680	COMBUSTIBLE, SECUNDARIO	G-1175	9042680	ACEITE, SELLADO PARA FLUJO TOTAL (FULL FLOW)	GP-53	3313287
ACEITE, TURBOCARGADOR	GP-14	4041959	ACEITE, DERIVACION (BY PASS)	G-750	5572425	COMBUSTIBLE, 11 1/2 IN	GP-55	4054556
COMBUSTIBLE, 5 47/64 IN	GPP-14	4054551	23LDT con motor/CUMMINS			COMBUSTIBLE, SEPARADOR DE AGUA	GPP-11	3600980
COMBUSTIBLE, 5 17/32 IN	GP-1101	BM59678	ACEITE	G-566	257528	AIRE, RESPIRADOR	GA-39	255963
ACEITE, SELLADO PARA FLUJO TOTAL (FULL FLOW)	GP-53	3313287	COMBUSTIBLE, 7 3/8 IN	G-1175	9042680	ACEITE, DERIVACION (BY PASS)	G-750	9157891
COMBUSTIBLE, 11 1/2 IN	GP-55	4054556	ACEITE	GP-14	4041959	2FDT con motor/CUMMINS		
COMBUSTIBLE, SEPARADOR DE AGUA	GPP-11	3600980	COMBUSTIBLE, 5 47/64 IN	GPP-14	4054551	ACEITE	G-566	257528
AIRE, RESPIRADOR	GA-39	255963	COMBUSTIBLE	GP-1101	BM59678	COMBUSTIBLE, 7 3/8 IN	G-1175	9042680
ACEITE, DERIVACION (BY PASS)	G-750	9157891	ACEITE	GP-53	3313287	ACEITE	GP-14	4041959
11LD con motor/CUMMINS V12			COMBUSTIBLE, 11 1/2 IN	GP-55	4054556	COMBUSTIBLE, 5 47/64 IN	GPP-14	4054551
ACEITE, CARTUCHO PARA FLUJO TOTAL (FULL FLOW)	G-566	257528	COMBUSTIBLE, SEPARADOR DE AGUA	GPP-11	3600980	COMBUSTIBLE	GP-1101	BM59678
ACEITE, TURBOCARGADOR	GP-14	4041959	AIRE, RESPIRADOR	GA-39	255963	ACEITE	GP-53	3313287
COMBUSTIBLE, 5 47/64 IN	GPP-14	4054551	ACEITE	G-750	9157891	COMBUSTIBLE, 11 1/2 IN	GP-55	4054556
COMBUSTIBLE, 5 17/32 IN	GP-1101	BM59678	23TDT con motor/A DIESEL			COMBUSTIBLE, SEPARADOR DE AGUA	GPP-11	3600980
ACEITE, SELLADO PARA FLUJO TOTAL (FULL FLOW)	GP-53	3313287	ACEITE, DERIVACION (BY PASS)	G-31	5572425	AIRE, RESPIRADOR	GA-39	255963
COMBUSTIBLE, 11 1/2 IN	GP-55	4054556	ACEITE	G-33	5577124	ACEITE	G-750	9157891
COMBUSTIBLE, SEPARADOR DE AGUA	GPP-11	3600980	COMBUSTIBLE, SECUNDARIO	G-1175	9042680	2FFD con motor/CUMMINS		
AIRE, RESPIRADOR	GA-39	255963	23TDT SERIES D, 23TDT SERIES E con motor/A DIESEL			ACEITE	G-566	257528
ACEITE, DERIVACION (BY PASS)	G-750	9157891	ACEITE, DERIVACION (BY PASS)	G-31	5572425	2TDT, 30FDT, 31FDT, 32FDT, 36FDT, 2LD, 2TD con motor/CUMMINS		
12LD con motor/GMC 16V-71			ACEITE	G-33	5577124	ACEITE, CARTUCHO PARA FLUJO TOTAL (FULL FLOW)	G-566	257528
ACEITE	G-33	5577124	COMBUSTIBLE, SECUNDARIO	G-1175	9042680	COMBUSTIBLE, 7 3/8 IN	G-1175	9042680
14FFD con motor/GMC 16V-71			24TDT, 28TDT, 2LDT, 3LDT, 4LDT, 5LDT, 66TD, 6LLD, 72FDT, 74FDT, 75TD, 76FDT, 7LDT, 94FD, 9LDT con motor/CUMMINS			ACEITE, TURBOCARGADOR	GP-14	4041959
ACEITE, DERIVACION (BY PASS)	G-31	5572425	ACEITE, CARTUCHO PARA FLUJO TOTAL (FULL FLOW)	G-566	257528	COMBUSTIBLE, 5 47/64 IN	GPP-14	4054551
1FFD con motor/A DIESEL			ACEITE, TURBOCARGADOR	GP-14	4041959	COMBUSTIBLE, 5 17/32 IN	GP-1101	BM59678
COMBUSTIBLE, SECUNDARIO	G-1173	9045748	COMBUSTIBLE, 5 47/64 IN	GPP-14	4054551	ACEITE, SELLADO PARA FLUJO TOTAL (FULL FLOW)	GP-53	3313287
COMBUSTIBLE, PRIMARIO	G-1174	9021029	COMBUSTIBLE, 5 17/32 IN	GP-1101	BM59678	COMBUSTIBLE, 11 1/2 IN	GP-55	4054556
COMBUSTIBLE, SECUNDARIO	G-1175	9042680	ACEITE, SELLADO PARA FLUJO TOTAL (FULL FLOW)	GP-53	3313287	COMBUSTIBLE, SEPARADOR DE AGUA	GPP-11	3600980
1LLD con motor/CUMMINS			COMBUSTIBLE, 11 1/2 IN	GP-55	4054556	AIRE, RESPIRADOR	GA-39	255963
ACEITE, CARTUCHO PARA FLUJO TOTAL (FULL FLOW)	G-566	257528	COMBUSTIBLE, SEPARADOR DE AGUA	GPP-11	3600980	ACEITE, DERIVACION (BY PASS)	G-750	9157891
ACEITE, TURBOCARGADOR	GP-14	4041959	AIRE, RESPIRADOR	GA-39	255963	301TD con motor/GMC		
COMBUSTIBLE, 5 47/64 IN	GPP-14	4054551	ACEITE, DERIVACION (BY PASS)	G-750	9157891	TRANSMISION	G-33	P550951
COMBUSTIBLE, 5 17/32 IN	GP-1101	BM59678	27LOT (S18) con motor/GMC			ACEITE	GP-53	25010449
ACEITE, SELLADO PARA FLUJO TOTAL (FULL FLOW)	GP-53	3313287	ACEITE	G-31	5572425	ACEITE, DERIVACION (BY PASS)	GP-57	3304232
COMBUSTIBLE, 11 1/2 IN	GP-55	4054556	ACEITE	G-33	5577124	AGUA	GP-2071W	25012893
COMBUSTIBLE, SEPARADOR DE AGUA	GPP-11	3600980	TRANSMISION	G-33	5577124	AIRE, RESPIRADOR DIFERENCIAL	GA-135	9067798
AIRE, RESPIRADOR	GA-39	256837	COMBUSTIBLE, SECUNDARIO	G-1175	9042680	AIRE, PRIMARIO	GA-356	9035992
ACEITE, DERIVACION (BY PASS)	G-750	9157891	27LOT (TS18) con motor/GMC			AIRE, SECUNDARIO	GA-357	9035993
			ACEITE	G-31	5572425	30LOT con motor/GMC		
			ACEITE	G-33	5577124	ACEITE, DERIVACION (BY PASS)	G-31	5572425
			ACEITE, CONVERTIDOR DE TORSION	G-836	7984373	ACEITE	G-33	5577124
			COMBUSTIBLE, SECUNDARIO	G-1175	9042680	TRANSMISION	G-33	5576200
			7 3/8 IN			COMBUSTIBLE, SECUNDARIO	G-1175	9042680

MARCA-MODELO-MOTOR MAKE-MODEL-ENGINE	GONHER GONHER	OEM OEM	MARCA-MODELO-MOTOR MAKE-MODEL-ENGINE	GONHER GONHER	OEM OEM	MARCA-MODELO-MOTOR MAKE-MODEL-ENGINE	GONHER GONHER	OEM OEM
EUCLID (continuación)			EUCLID (continuación)			EUCLID (continuación)		
EQUIPO PARA CONSTRUCCION VIAL			EQUIPO PARA CONSTRUCCION VIAL			EQUIPO PARA CONSTRUCCION VIAL		
30TD con motor/CUMMINS			AIRE, RESPIRADOR	GA-39	255963	4TDT, 4FD, 4FDT, 4LD, 4TD con motor/CUMMINS		
ACEITE	G-566	257528	ACEITE, DERIVACION (BY PASS)	G-750	9157891	ACEITE, CARTUCHO PARA FLUJO TOTAL (FULL FLOW)	G-566	257528
COMBUSTIBLE	G-1175	9042680	39LOT con motor/GMC 12V-71			COMBUSTIBLE, 7 3/8 IN	G-1175	9042680
ACEITE, TURBOCARGADOR	GP-14	4041959	ACEITE, DERIVACION (BY PASS)	G-31	1595410	ACEITE, TURBOCARGADOR	GP-14	4041959
ACEITE, DERIVACION (BY PASS)	G-750	9157891	ACEITE	G-33	5573013	COMBUSTIBLE, 5 47/64 IN	GPP-14	4054551
			TRANSMISION	G-33	5573013	COMBUSTIBLE, 5 17/32 IN	GP-1101	BM59678
31FD, 36FD, 38FD, 48FD, 79FD, 80FD, 81FD, 86FD, 87FD, 27FD, 28FD con motor/CUMMINS			39LOT con motor/GMC 6-71			ACEITE, SELLADO PARA FLUJO TOTAL (FULL FLOW)	GP-53	3313287
ACEITE, CARTUCHO PARA FLUJO TOTAL (FULL FLOW)	G-566	257528	ACEITE	G-33	5577124	COMBUSTIBLE, 11 1/2 IN	GP-55	4054556
COMBUSTIBLE	G-1175	9042680	3FDT, 3LD, 3TD con motor/CUMMINS			COMBUSTIBLE, SEPARADOR DE AGUA	GPP-11	3600980
ACEITE, TURBOCARGADOR	GP-14	4041959	ACEITE, CARTUCHO PARA FLUJO TOTAL (FULL FLOW)	G-566	257528	AIRE, RESPIRADOR	GA-39	255963
ACEITE, SELLADO PARA FLUJO TOTAL (FULL FLOW)	GP-53	3313287	COMBUSTIBLE, 7 3/8 IN	G-1175	9042680	ACEITE, DERIVACION (BY PASS)	G-750	9157891
AIRE, RESPIRADOR	GA-39	255963	ACEITE, TURBOCARGADOR	GP-14	4041959	4UOT con motor/GMC		
ACEITE, DERIVACION (BY PASS)	G-750	9157891	COMBUSTIBLE, 5 47/64 IN	GPP-14	4054551	ACEITE, DERIVACION (BY PASS)	G-31	1595410
			COMBUSTIBLE, 5 17/32 IN	GP-1101	BM59678	ACEITE	G-33	5573013
31LOT con motor/GMC			ACEITE, SELLADO PARA FLUJO TOTAL (FULL FLOW)	GP-53	3313287	COMBUSTIBLE, SECUNDARIO	G-1175	9042680
ACEITE, DERIVACION (BY PASS)	G-31	5572425	COMBUSTIBLE, 11 1/2 IN	GP-55	4054556	54FDT con motor/CUMMINS		
ACEITE	G-33	5577124	COMBUSTIBLE, SEPARADOR DE AGUA	GPP-11	3600980	ACEITE, CARTUCHO PARA FLUJO TOTAL (FULL FLOW)	G-566	257528
TRANSMISION	G-33	5577124	AIRE, RESPIRADOR	GA-39	255963	COMBUSTIBLE	G-1175	9042680
COMBUSTIBLE, SECUNDARIO	G-1175	9042680	ACEITE, DERIVACION (BY PASS)	G-750	9157891	ACEITE, TURBOCARGADOR	GP-14	4041959
						COMBUSTIBLE, 5 47/64 IN	GPP-14	4054551
31TD, 32TD con motor/CUMMINS			3FFD con motor/CUMMINS			COMBUSTIBLE, 5 17/32 IN	GP-1101	BM59678
ACEITE	G-566	257528	ACEITE	G-566	257528	ACEITE, SELLADO PARA FLUJO TOTAL (FULL FLOW)	GP-53	3313287
COMBUSTIBLE	G-1175	9042680	3UD con motor/GMC			COMBUSTIBLE, 11 1/2 IN	GP-55	4054556
ACEITE, TURBOCARGADOR	GP-14	4041959	ACEITE	G-33	5577124	COMBUSTIBLE, SEPARADOR DE AGUA	GPP-11	3600980
ACEITE, DERIVACION (BY PASS)	G-750	9157891	3UOT con motor/GMC			AIRE, RESPIRADOR	GA-39	255963
			ACEITE	G-31	5572425	ACEITE, DERIVACION (BY PASS)	G-750	9157891
324TD con motor/A DIESEL			ACEITE	G-33	5577124	5FD, 5FDT, 5LD, 5TDT con motor/CUMMINS		
ACEITE, DERIVACION (BY PASS)	GP-57	3304232	COMBUSTIBLE, SECUNDARIO	G-1175	9042680	ACEITE, CARTUCHO PARA FLUJO TOTAL (FULL FLOW)	G-566	257528
AGUA	GP-1011Q	4054557	404LDC con motor/CUMMINS VTA28C			COMBUSTIBLE, 7 3/8 IN	G-1175	9042680
AIRE, RESPIRADOR DIFERENCIAL	GA-135	9067798	AGUA, SISTEMA DE ENFRIAMIENTO	GP-1010Q	3305369	ACEITE, TURBOCARGADOR	GP-14	4041959
AIRE, PRIMARIO	GA-356	9035992	COMBUSTIBLE	GP-55	4054556	COMBUSTIBLE, 5 47/64 IN	GPP-14	4054551
AIRE, SECUNDARIO	GA-357	9035993	ACEITE, DERIVACION (BY PASS)	GP-57	3021658	COMBUSTIBLE, 5 17/32 IN	GP-1101	BM59678
			AIRE, PRIMARIO	GA-879	AA2906	ACEITE, SELLADO PARA FLUJO TOTAL (FULL FLOW)	GP-53	3313287
34LDT con motor/GMC 12V-71						COMBUSTIBLE, 11 1/2 IN	GP-55	4054556
ACEITE, DERIVACION (BY PASS)	G-31	5572425	40FDT, 45FDT, 46TD, 48FDT con motor/CUMMINS			COMBUSTIBLE, SEPARADOR DE AGUA	GPP-11	3600980
			ACEITE, CARTUCHO PARA FLUJO TOTAL (FULL FLOW)	G-566	257528	AIRE, RESPIRADOR	GA-39	255963
36LDT con motor/CUMMINS NHV12			COMBUSTIBLE	G-1175	9042680	ACEITE, DERIVACION (BY PASS)	G-750	9157891
TRANSMISION	G-33	5577124	ACEITE, TURBOCARGADOR	GP-14	4041959	5FFD con motor/CUMMINS		
ACEITE, CARTUCHO PARA FLUJO TOTAL (FULL FLOW)	G-566	257528	COMBUSTIBLE, 5 47/64 IN	GPP-14	4054551	ACEITE	G-566	257528
ACEITE, TURBOCARGADOR	GP-14	4041959	COMBUSTIBLE, 5 17/32 IN	GP-1101	BM59678	5LLD con motor/GMC DIESEL		
COMBUSTIBLE, 5 47/64 IN	GPP-14	4054551	ACEITE, SELLADO PARA FLUJO TOTAL (FULL FLOW)	GP-53	3313287	ACEITE, DERIVACION (BY PASS)	G-31	5572425
COMBUSTIBLE, 5 17/32 IN	GP-1101	BM59678	COMBUSTIBLE, 11 1/2 IN	GP-55	4054556	ACEITE	G-33	5577124
ACEITE, SELLADO PARA FLUJO TOTAL (FULL FLOW)	GP-53	3313287	COMBUSTIBLE, SEPARADOR DE AGUA	GPP-11	3600980	COMBUSTIBLE, SECUNDARIO 3 1/4 IN	G-1173	9045748
COMBUSTIBLE, 11 1/2 IN	GP-55	4054556	AIRE, RESPIRADOR	GA-39	255963	COMBUSTIBLE, SECUNDARIO 7 3/8 IN	G-1175	9042680
COMBUSTIBLE, SEPARADOR DE AGUA	GPP-11	3600980	ACEITE, DERIVACION (BY PASS)	G-750	9157891	60TD, 63TD SERIES A con motor/A DIESEL		
AIRE, RESPIRADOR	GA-39	255963				ACEITE, DERIVACION (BY PASS)	G-31	5572425
ACEITE, DERIVACION (BY PASS)	G-750	9157891	49LDT con motor/GMC 12V-71			ACEITE	G-33	5577124
			ACEITE	G-33	5577124	COMBUSTIBLE, SECUNDARIO	G-1175	9042680
36TD, 37TD, 39FDT con motor/CUMMINS			4FFD con motor/CUMMINS			ACEITE, DERIVACION (BY PASS)	G-750	9157891
ACEITE, CARTUCHO PARA FLUJO TOTAL (FULL FLOW)	G-566	257528	ACEITE	G-566	257528	14 13/16 IN		
COMBUSTIBLE	G-1175	9042680	COMBUSTIBLE	G-1175	9042680			
ACEITE, TURBOCARGADOR	GP-14	4041959	ACEITE, DERIVACION (BY PASS)	G-750	9157891			
COMBUSTIBLE, 5 47/64 IN	GPP-14	4054551						
COMBUSTIBLE, 5 17/32 IN	GP-1101	BM59678						
ACEITE, SELLADO PARA FLUJO TOTAL (FULL FLOW)	GP-53	3313287						
COMBUSTIBLE, 11 1/2 IN	GP-55	4054556						
COMBUSTIBLE, SEPARADOR DE AGUA	GPP-11	3600980						

SERVICIO PESADO

MARCA-MODELO-MOTOR MAKE-MODEL-ENGINE	GONHER GONHER	OEM OEM	MARCA-MODELO-MOTOR MAKE-MODEL-ENGINE	GONHER GONHER	OEM OEM	MARCA-MODELO-MOTOR MAKE-MODEL-ENGINE	GONHER GONHER	OEM OEM
EUCLID (continuación)			EUCLID (continuación)			EUCLID (continuación)		
RASPADORAS			RASPADORAS			RASPADORAS		
33SH con motor/GMC 6-71			ACEITE	G-33	5577124	SS40 con motor/GMC 12V-71		
ACEITE	G-31	5572425	COMBUSTIBLE, SECUNDARIO	G-1175	9042680	ACEITE, DERIVACION (BY PASS) 7 13/16	G-31	5572425
ACEITE	G-33	5577124				ACEITE	G-33	5577124
COMBUSTIBLE, SECUNDARIO	G-1175	9042680	SS12 con motor/GMC 6-71			TRANSMISION	G-33	5577124
			ACEITE	G-31	5572425	ACEITE, DERIVACION (BY PASS) 14 13/16	G-750	9157891
S12 con motor/GMC 6-71			ACEITE	G-33	5577124			
ACEITE, DERIVACION (BY PASS)	G-31	5572425	COMBUSTIBLE, SECUNDARIO	G-1175	9042680	SS40 con motor/GMC 6-110		
ACEITE	G-33	5577124				ACEITE, DERIVACION (BY PASS) 7 13/16	G-31	5572425
COMBUSTIBLE, SECUNDARIO	G-1175	9042680	SS18 (23TDT SERIES D, E) con motor/A DIESEL			ACEITE	G-33	5577124
			ACEITE, DERIVACION (BY PASS)	G-31	5572425	COMBUSTIBLE, SECUNDARIO	G-1175	9042680
S18 con motor/GMC			ACEITE	G-33	5573014	ACEITE, DERIVACION (BY PASS)	G-750	9157891
ACEITE, DERIVACION (BY PASS)	G-31	5572425	COMBUSTIBLE, SECUNDARIO	G-1175	9042680	14 13/16		
ACEITE	G-33	5577124				TANDEM 14 con motor/TRES GMC 4-71		
TRANSMISION	G-33	5576200	SS18 con motor/GMC			ACEITE	G-33	5577124
COMBUSTIBLE, SECUNDARIO	G-1175	9042680	ACEITE, DERIVACION (BY PASS)	G-31	5572425	TRANSMISION	G-33	5577124
			ACEITE	G-33	5577124	COMBUSTIBLE, SECUNDARIO	G-1175	9042680
S18 con motores/CUMMINS NRT-6B1, DETROIT DIESEL 6-110			TRANSMISION	G-33	5576200			
TRANSMISION	G-33	5577124	COMBUSTIBLE, SECUNDARIO	G-1175	9042680	TANDEM 14, TS14 con motor/DETROIT DIESEL 4-71		
						TRANSMISION	G-33	5577124
S24 con motor/GMC 12V-71			SS18 con motores/CUMMINS NRT-6B1, DETROIT DIESEL 6-110			COMBUSTIBLE, SECUNDARIO	G-1175	9042680
ACEITE, DERIVACION (BY PASS)	G-31	5572425	TRANSMISION	G-33	5577124			
ACEITE	G-33	5577124				TANDEM 14, TS14 con motor/DETROIT DIESEL 4-71		
TRANSMISION	G-33	5577124	SS24 con motor/GMC 12V-71			TRANSMISION	G-33	5577124
			ACEITE, DERIVACION (BY PASS)	G-31	5572425	COMBUSTIBLE, SECUNDARIO	G-1175	9042680
S24 con motor/GMC 6-110			ACEITE	G-33	5577124			
ACEITE, DERIVACION (BY PASS)	G-31	5572425	TRANSMISION	G-33	5577124	TS14, TS18 con motor/DOS GMC		
ACEITE	G-33	5577124				ACEITE, DERIVACION (BY PASS)	G-31	5572425
TRANSMISION	G-33	5577124	SS24 con motor/GMC 6-110			ACEITE	G-33	5577124
COMBUSTIBLE, SECUNDARIO	G-1175	9042680	ACEITE, DERIVACION (BY PASS)	G-31	5572425	TRANSMISION	G-33	5577124
			ACEITE	G-33	5577124	COMBUSTIBLE, SECUNDARIO	G-1175	9042680
S24 con motores/DETROIT DIESEL 6-110, CUMMINS NRTO-6B1, DETROIT DIESEL 12V-71			TRANSMISION	G-33	5577124			
TRANSMISION	G-33	5577124	COMBUSTIBLE, SECUNDARIO	G-1175	9042680	TS18, TS24 con motor/DETROIT DIESEL 6-71		
						TRANSMISION	G-33	5577124
S28 con motor/GMC 12-71			SS24, SS40 con motores/DETROIT DIESEL 6-110, CUMMINS NRTO-6B1, DETROIT DIESEL 12V-71					
ACEITE, DERIVACION (BY PASS) 7 13/16 IN	G-31	5572425	TRANSMISION	G-33	5577124	TS24, TS40 con motor/GMC 6-110 ADELANTE Y GMC 6-71 ATRAS		
ACEITE	G-33	5577124				ACEITE, DERIVACION (BY PASS)	G-31	5572425
TRANSMISION	G-33	5576200	SS28 con motor/GMC 12-71			ACEITE	G-33	5577124
ACEITE, DERIVACION (BY PASS) 14 13/16 IN	G-750	9157891	ACEITE	G-31	5572425	TRANSMISION	G-33	5577124
			ACEITE	G-33	5577124	COMBUSTIBLE, SECUNDARIO	G-1175	9042680
S28 con motor/GMC 6-110			TRANSMISION	G-33	5576200			
ACEITE, DERIVACION (BY PASS)	G-31	5572425	ACEITE	G-31	5572425	TS32 con motores/GMC 12V-71, GMC 8V-71		
ACEITE	G-33	5577124	ACEITE	G-33	5577124	ACEITE, DERIVACION (BY PASS) 7 13/16	G-31	5572425
COMBUSTIBLE, SECUNDARIO	G-1175	9042680	TRANSMISION	G-33	5576200	ACEITE	G-33	5577124
			ACEITE	G-750	9157891	TRANSMISION	G-33	5577124
S28 con motores/CUMMINS NRTO-6B1, DETROIT DIESEL 12V-71, DETROIT DIESEL 6-110			SS28 con motor/GMC 6-110			COMBUSTIBLE, SECUNDARIO	G-1175	9042680
TRANSMISION	G-33	5577124	ACEITE, DERIVACION (BY PASS)	G-31	5572425	ACEITE, DERIVACION (BY PASS) 14 13/16	G-750	9157891
			ACEITE	G-33	5577124			
S32 con motor/DETROIT DIESEL 12V-71			COMBUSTIBLE, SECUNDARIO	G-1175	9042680	TS40 con motor/DETROIT DIESEL 6-110		
TRANSMISION	G-33	5573014				TRANSMISION	G-33	5577124
			SS28 con motores/CUMMINS NRTO-6B1, DETROIT DIESEL 12V-71, DETROIT DIESEL 6-110					
S32 con motor/GMC 12V-71			TRANSMISION	G-33	5577124	TS40 con motor/DETROIT DIESEL 6-71		
ACEITE, DERIVACION (BY PASS) 7 13/16 IN	G-31	5572425				COMBUSTIBLE	G-1175	BM23097
ACEITE	G-33	5577124	SS40 con motor/CUMMINS NHV12					
TRANSMISION	G-33	5577124	TRANSMISION	G-33	5577124	TSS40 con motor/DETROIT DIESEL 16V-71		
ACEITE, DERIVACION (BY PASS) 14 13/16 IN	G-750	9157891	ACEITE, CARTUCHO PARA FLUJO TOTAL (FULL FLOW)	G-566	257528	TRANSMISION	G-33	5577124
			ACEITE, TURBOCARGADOR	GP-14	4041959			
S35E ELEVADORA con motor/GMC 12V-71N			COMBUSTIBLE, 5 47/64 IN	GPP-14	4054551	TSS40 con motor/GMC 16V-71 ADELANTE Y GMC 8V-71 ATRAS		
ACEITE	G-33	5577124	COMBUSTIBLE, 5 17/32 IN	GP-1101	BM59678	ACEITE	G-33	5577124
			ACEITE, SELLADO PARA FLUJO TOTAL (FULL FLOW)	GP-53	3313287	TRANSMISION	G-33	5577124
S7 con motor/GMC DIESEL			COMBUSTIBLE, 11 1/2 IN	GP-55	4054556	COMBUSTIBLE, SECUNDARIO	G-1175	BM23097
ACEITE, DERIVACION (BY PASS)	G-31	5572425	COMBUSTIBLE, SEPARADOR DE AGUA	GPP-11	3600980			
			AIRE, RESPIRADOR	GA-39	255963			
			ACEITE, DERIVACION (BY PASS)	G-750	9157891			

SERVICIO PESADO

MARCA-MODELO-MOTOR MAKE-MODEL-ENGINE	GONHER GONHER	OEM OEM
EUCLID		
TRACTORES		
82-30 con motor/GMC 6V-71		
ACEITE	G-33	5577124
TRANSMISION	G-33	5577124
COMBUSTIBLE, SECUNDARIO	G-1175	9042680
AIRE, SECUNDARIO	GA-6127	9034223
AIRE, PRIMARIO	GA-6129	9034222
82-40 con motor/GMC 8V-71		
ACEITE	G-33	5577124
TRANSMISION	G-33	5577124
COMBUSTIBLE, SECUNDARIO	G-1175	9042680
AIRE, SECUNDARIO	GA-6127	9034223
AIRE, PRIMARIO	GA-6129	9034222
82-50 con motor/GMC 12V-71		
ACEITE	G-33	5577124
82-80 con motor/DOS GMC 6-71		
ACEITE	G-33	5577124
ACEITE, CONVERTIDOR DE TORSION	G-33	5577124
TRANSMISION	G-33	5577124
COMBUSTIBLE, SECUNDARIO	G-1175	9042680
C6 con motor/GMC 6-71 DIESEL		
ACEITE, DERIVACION (BY PASS)	G-31	5572425
ACEITE	G-33	5573014
COMBUSTIBLE, SECUNDARIO	G-1175	9042680
TRANSMISION	G-152	5579770
TC12 con motor/DOS GMC 6-71		
ACEITE, DERIVACION (BY PASS)	G-31	5572425
ACEITE	G-33	5577124
ACEITE, CONVERTIDOR DE TORSION	G-33	5577124
TRANSMISION	G-33	5577124
COMBUSTIBLE, SECUNDARIO	G-1175	9042680

FAIRBANKS		
GENERADORES		
300 SERIES con motor/A DIESEL		
COMBUSTIBLE	G-1143	200B
D1700, D3400, D2300, D3000 con motor/HERCULES		
COMBUSTIBLE	G-296	266537
F 300 B con motor/DEUTZ BF12L413		
AIRE	GA-405	4980649

FAIRBANKS		
MOTORES		
300 SERIES A DIESEL		
COMBUSTIBLE, SECUNDARIO	G-1176	12002743
45B-1/8 A GASOLINA, 45C4-1/8-2 A GASOLINA		
GASOLINA	GG-20	FF114
48B3-1/2 2 CYL. A DIESEL, 48B3-1/2 4 CYL. A DIESEL, 49A-1/2-3 A DIESEL, 49B4-1/2 A DIESEL		
ACEITE	G-31	13312
48B4-1/2 A DIESEL		
COMBUSTIBLE	G-1143	2000A

MARCA-MODELO-MOTOR MAKE-MODEL-ENGINE	GONHER GONHER	OEM OEM
FAIRBANKS (continuación)		
MOTORES		
50A5-4 A DIESEL, 50A5-5 A DIESEL, 50A5-6 A DIESEL		
COMBUSTIBLE	G-11816	FF144
D1700 A DIESEL, D2300 A DIESEL, D3000 A DIESEL, D3400 A DIESEL		
COMBUSTIBLE, SECUNDARIO	G-296	7111526
COMBUSTIBLE, PRIMARIO	G-297	FF5002
COMBUSTIBLE, SECUNDARIO	G-296-B	7111526
COMBUSTIBLE, PRIMARIO	G-297-B	FF5002
RAILROAD DIESEL LOCOMOTORA		
COMBUSTIBLE	GP-26	FF216

FAVELLE FAVCO		
GRÚAS		
FFC9T con motor/CUMMINS 3.9L		
HIDRAULICO, REQUIERE 2 PIEZAS	GP-34	HF28810
COMBUSTIBLE, SECUNDARIO	GP-1122	3903640
COMBUSTIBLE, PRIMARIO	GPP-18	3903410
ACEITE	GP-390	3309950
AIRE, PRIMARIO	GA-697R	P778214

FENDT		
TRACTORES		
FAVORIT 714, FAVORIT 714 VARIO con motor/DEUTZ BF6M2013C		
ACEITE	G-3754	HU945/3x

FIAT		
EXCAVADORAS		
FH270.3 con motor/CUMMINS		
ACEITE	GP-3000	71497005

FIAT-ALLIS		
APLANADORAS		
105C con motor/A DIESEL		
ACEITE	G-33	1901608
65B con motor/A DIESEL		
COMBUSTIBLE	G-296	4621740
AGUA	GP-2071W	4681776
COMBUSTIBLE	G-296-B	4621740
FG105 SERIES B, FG105A SERIES B con motor/CUMMINS 6CT8.3		
COMBUSTIBLE, SECUNDARIO	GP-1122	3903640
ACEITE	GP-43	3313281
COMBUSTIBLE, PRIMARIO	GPP-18	3925274
FG170 con motor/CUMMINS 6CT8.3L		
ACEITE	GP-3000	75285999
FG70, FG70A, FG75 SERIES B, FG75A SERIES B con motor/CUMMINS 6C8.3		
COMBUSTIBLE, SECUNDARIO	GP-1122	3903640
FG75, FG85 con motor/FIAT		
AGUA	GP-2071W	4681776
AIRE, PRIMARIO	GA-360	79043778
AIRE, SECUNDARIO	GA-361	79043779
FG75, FG85, FG95 con motor/CUMMINS		
COMBUSTIBLE, SECUNDARIO	GP-1122	75208272
ACEITE	GP-43	75208314

MARCA-MODELO-MOTOR MAKE-MODEL-ENGINE	GONHER GONHER	OEM OEM
FIAT-ALLIS (continuación)		
APLANADORAS		
COMBUSTIBLE, PRIMARIO	GPP-18	75208274
AIRE, PRIMARIO	GA-360	79043778
AIRE, SECUNDARIO	GA-361	79043779
FG85 SERIES B, FG85A SERIES B con motor/CUMMINS 6CT8.3		
COMBUSTIBLE, SECUNDARIO	GP-1122	3903640
ACEITE	GP-43	3313281
COMBUSTIBLE, PRIMARIO	GPP-18	3925274
FG95 con motor/FIAT		
AGUA	GP-2071W	4681776
AIRE, PRIMARIO	GA-360	79043778
AIRE, SECUNDARIO	GA-361	79043779

FIAT-ALLIS		
CARGADORAS		
10-B SOBRE ORUGAS con motor/A DIESEL		
DIRECCION	G-33	1901608
HIDRAULICO	G-33	4596891
COMBUSTIBLE	G-296	9924318
COMBUSTIBLE	G-296-B	9924318
10-C LGP SOBRE ORUGAS con motor/A DIESEL		
HIDRAULICO	G-33	1930779
AIRE, PRIMARIO	GA-360	79043778
AIRE, SECUNDARIO	GA-361	79043779
345-B con motor/IVECO REPOWER		
COMBUSTIBLE	GPP-1122	79075882
345-B SOBRE RUEDAS con motor/A DIESEL		
COMBUSTIBLE	GP-1101	70697633
GASOLINA	G-293	4024223
COMBUSTIBLE	G-295	74024232
ACEITE	GP-390	74035556

545 SOBRE RUEDAS con motor/ALLIS CHALMERS 2900		
ACEITE	G-33	74395889
HIDRAULICO	G-238	70666421
AIRE	GAK-20	70244728
545B con motor/A DIESEL (S/N 2D112196-UP)		
HIDRAULICO	G-222	70666421
AGUA	GP-2071W	74029089
COMBUSTIBLE	GPP-19	74321716
ACEITE	GP-390	74035556
545B con motor/IVECO REPOWER		
HIDRAULICO	G-222	70666421
545-B SOBRE RUEDAS con motor/ALLIS CHALMERS 2900 MKII DIESEL		
HIDRAULICO	G-238	70666421
545H SOBRE RUEDAS con motor/ALLIS CHALMERS 2900		
TRANSMISION	G-33	74395889
HIDRAULICO	G-238	70666421
AIRE	GAK-20	70244728
605-B con motor/IVECO REPOWER		
HIDRAULICO	G-222	70666421
605-B SOBRE RUEDAS con motor/ALLIS CHALMERS 2900 MKII DIESEL		
HIDRAULICO	G-238	70666421

MARCA-MODELO-MOTOR MAKE-MODEL-ENGINE	GONHER GONHER	OEM OEM	MARCA-MODELO-MOTOR MAKE-MODEL-ENGINE	GONHER GONHER	OEM OEM	MARCA-MODELO-MOTOR MAKE-MODEL-ENGINE	GONHER GONHER	OEM OEM
FIAT-ALLIS (continuación)			FIAT-ALLIS (continuación)			FIAT-ALLIS (continuación)		
CARGADORAS			CARGADORAS			CARGADORAS		
645 con motor/ALLIS CHALMERS 3500 HASTA S/N 2032			AIRE, PRIMARIO PARA CUMMINS	GA-106	79043780	AIRE, SECUNDARIO	GA-6127	70197588
HIDRAULICO	G-222	70666421	AIRE, PRIMARIO KOMATSU	GA-326	79043780	AIRE, PRIMARIO	GA-6129	70659387
			AIRE, SECUNDARIO	GA-206	70662477			
645 con motor/ALLIS CHALMERS 3500 S/N 2032-UP			ACEITE, DERIVACION (BY PASS)	G-750	74059343	945-B SOBRE RUEDAS con motor/ALLIS CHALMERS 25000 MKII		
HIDRAULICO	G-222	70666421				ACEITE	G-33	74395889
AIRE, PRIMARIO	GA-360	79043778	745-B SOBRE RUEDAS con motor/ALLIS CHALMERS 11000			HIDRAULICO	G-238	70666421
AIRE, SECUNDARIO	GA-361	79043779	ACEITE, TURBO	G-6	74372517	HIDRAULICO	G-222	70666421
			ACEITE	G-33	74395889	AGUA	GP-1011Q	74393504
645 SOBRE RUEDAS con motor/ALLIS CHALMERS 3500			HIDRAULICO	G-238	70666421	AGUA	GP-2071W	74393504
TRANSMISION	G-33	74395889	COMBUSTIBLE, SECUNDARIO	G-1173	74348148	COMBUSTIBLE, SEPARADOR DE AGUA	GPP-1000	74394407
HIDRAULICO	G-238	70666421	COMBUSTIBLE, PRIMARIO	G-1174	4353268	AIRE, SECUNDARIO	GA-6127	70197588
AIRE, PRIMARIO	GA-360	70684733	AIRE, PRIMARIO	GA-360	70684733	AIRE, PRIMARIO	GA-6129	70659387
AIRE, SECUNDARIO	GA-361	70662609	AIRE, SECUNDARIO	GA-361	70662609	ACEITE, DERIVACION (BY PASS)	G-750	74059343
						FL10 con motor/A DIESEL		
645-B con motor/A DIESEL (HASTA S/N 3D-56914)			745C con motor/A DIESEL			ACEITE	G-33	1901608
HIDRAULICO	G-222	70666421	ACEITE	G-33	74395889			
AGUA	GP-2071W	74029089	HIDRAULICO	G-222	70666421	FL10B SOBRE ORUGAS con motor/A DIESEL		
AIRE, PRIMARIO	GA-360	79043778	AGUA	GP-1011Q	74393504	DIRECCION	G-33	79032093
AIRE, SECUNDARIO	GA-361	70662609	COMBUSTIBLE	GPP-19	74321716	HIDRAULICO	G-33	4596891
			AIRE, PRIMARIO PARA CUMMINS	GA-106	70684734	COMBUSTIBLE	G-296	9924318
645-B con motor/A DIESEL (S/N 3D-56914-EN ADELANTE)			AIRE, PRIMARIO KOMATSU	GA-326	70684734	COMBUSTIBLE	G-296-B	9924318
HIDRAULICO	G-222	70666421	AIRE, SECUNDARIO	GA-206	70662477	AIRE, PRIMARIO	GA-360	70684733
AGUA	GP-2071W	74029089	ACEITE, DERIVACION (BY PASS)	G-750	74059343	AIRE, SECUNDARIO	GA-361	70662609
COMBUSTIBLE	GPP-19	74321716						
AIRE, PRIMARIO	GA-360	79043778	745C con motor/IVECO REPOWER			FL10C SOBRE ORUGAS con motor/A DIESEL		
AIRE, SECUNDARIO	GA-361	70662609	HIDRAULICO	G-222	70666421	DIRECCION	G-33	79032093
ACEITE, DERIVACION (BY PASS)	G-500	74059373	AGUA	GP-2071W	4734562	HIDRAULICO	G-33	1930779
			AIRE, PRIMARIO PARA CUMMINS	GA-106	79043780	AIRE, PRIMARIO	GA-360	79043778
645-B con motor/IVECO REPOWER			AIRE, PRIMARIO KOMATSU	GA-326	79043780	AIRE, SECUNDARIO	GA-361	79043779
HIDRAULICO	G-222	70666421	AIRE, SECUNDARIO	GA-206	70662477			
AGUA	GP-2071W	4734562				FL10E SOBRE ORUGAS con motor/A DIESEL		
AIRE, PRIMARIO	GA-360	79043778	745-H SERIES B con motor/ALLIS CHALMERS 11000			HIDRAULICO	G-33	1930779
AIRE, SECUNDARIO	GA-361	70662609	ACEITE	G-33	74395889			
			HIDRAULICO	G-222	70666421	FL12 con motor/A DIESEL		
645-B SERIES B con motor/ALLIS CHALMERS 3500 MKII			AGUA	GP-1010Q	74393504	ACEITE	G-33	1901608
HIDRAULICO	G-222	70664000	COMBUSTIBLE, SEPARADOR DE AGUA	GPP-1000	74394407			
AGUA	GP-2071W	74029089	AIRE, PRIMARIO PARA CUMMINS	GA-106	79043780	FL14 con motor/A DIESEL		
COMBUSTIBLE	GPP-19	74321716	AIRE, PRIMARIO KOMATSU	GA-326	79043780	ACEITE	G-33	1901608
ACEITE	GP-390	74023548	AIRE, SECUNDARIO	GA-206	70662477			
AIRE, PRIMARIO	GA-360	70684733	ACEITE, DERIVACION (BY PASS)	G-750	74059343	FL145 con motor/FIAT 8065T		
AIRE, SECUNDARIO	GA-361	70662609				COMBUSTIBLE	G-296	4621740
ACEITE, DERIVACION (BY PASS)	G-500	74059373	945 SOBRE RUEDAS con motor/ALLIS CHALMERS 25000 MKII			COMBUSTIBLE	GPP-1122	1930010
			ACEITE	G-33	74395889	COMBUSTIBLE	G-296-B	4621740
745 SOBRE RUEDAS, 745-C SOBRE RUEDAS, 745-H SOBRE RUEDAS, 745H-B SOBRE RUEDAS con motor/ALLIS CHALMERS 11000			HIDRAULICO	G-238	70666421	FL14B con motor/A DIESEL		
AIRE, PRIMARIO PARA CUMMINS	GA-106	70659533	AGUA	GP-2071W	74393504	DIRECCION	G-33	4596891
AIRE, PRIMARIO KOMATSU	GA-326	70659533	AIRE, SECUNDARIO	GA-6127	70197588			
AIRE, SECUNDARIO	GA-206	70662477	AIRE, PRIMARIO	GA-6129	70659387	FL14B SOBRE ORUGAS con motor/A DIESEL		
			ACEITE, DERIVACION (BY PASS)	G-750	74059343	DIRECCION	G-33	1901608
745, 745H con motor/ALLIS CHALMERS 11000								
ACEITE	G-33	74395889	945B con motor/ALLIS CHALMERS 6138I			FL14-C con motor/IVECO		
HIDRAULICO	G-222	70666421	ACEITE	G-33	74395889	AGUA	GP-2071W	4734562
AIRE, PRIMARIO PARA CUMMINS	GA-106	79043780	HIDRAULICO	G-222	70666421	AIRE, PRIMARIO	GA-360	79043778
AIRE, PRIMARIO KOMATSU	GA-326	79043780	AGUA	GP-1011Q	74393504	AIRE, SECUNDARIO	GA-361	79043779
AIRE, SECUNDARIO	GA-206	70662477	COMBUSTIBLE, SEPARADOR DE AGUA	GPP-1000	74394407			
			AIRE, SECUNDARIO	GA-6127	70197588	FL14-C SOBRE ORUGAS con motor/CUMMINS 6CT8.3		
745-B SERIES B con motor/ALLIS CHALMERS 11000			AIRE, PRIMARIO	GA-6129	70659387	ACEITE	GP-53	3313279
ACEITE	G-33	74395889	ACEITE, DERIVACION (BY PASS)	G-750	74059343	COMBUSTIBLE, SECUNDARIO	GP-1122	3903640
HIDRAULICO	G-222	70666421				AGUA	GP-2071W	3315116
AGUA	GP-1010Q	74393504	945B con motor/IVECO REPOWER			COMBUSTIBLE, PRIMARIO	GPP-18	3903410
AGUA	GP-1011Q	74393504	HIDRAULICO	G-222	70666421			
COMBUSTIBLE, SEPARADOR DE AGUA	GPP-1000	74394407	AGUA	GP-2071W	4734562	FL14-C SOBRE ORUGAS con motor/FIAT		
						DIRECCION	G-33	1901608

SERVICIO PESADO

MARCA-MODELO-MOTOR MAKE-MODEL-ENGINE	GONHER GONHER	OEM OEM	MARCA-MODELO-MOTOR MAKE-MODEL-ENGINE	GONHER GONHER	OEM OEM	MARCA-MODELO-MOTOR MAKE-MODEL-ENGINE	GONHER GONHER	OEM OEM
FIAT-ALLIS (continuación)			FIAT-ALLIS (continuación)			FIAT-ALLIS (continuación)		
CARGADORAS			CARGADORAS			CARGADORAS		
AIRE, PRIMARIO	GA-360	79043778	FR100 con motor/IVECO 8060.05.390			FR15B SOBRE RUEDAS con motor/FIAT 8365		
AIRE, SECUNDARIO	GA-361	70662609	COMBUSTIBLE	G-296	4621740	HIDRAULICO	G-222	79092882
						AGUA	GP-1011Q	4734562
FL14E con motor/A DIESEL			FR100 SOBRE RUEDAS con motor/FIAT 8065			AIRE, PRIMARIO	GAK-16	70684733
AGUA	GP-1011Q	1930549	COMBUSTIBLE	G-296	1909102			
AIRE, PRIMARIO	GA-360	79043778				FR160 con motor/IVECO 8365.25.584		
AIRE, SECUNDARIO	GA-361	70662609	FR10B SOBRE RUEDAS con motor/FIAT 8065			AGUA	GP-2071W	1930549
			COMBUSTIBLE	GPP-1122	79075882			
FL14E SOBRE ORUGAS con motor/FIAT 8365			FR11 SOBRE RUEDAS, FR12B SOBRE RUEDAS con motor/FIAT 8065			FR160 SOBRE RUEDAS con motor/FIAT 8365		
AIRE, PRIMARIO	GA-360	79043778	HIDRAULICO	G-222	79092882	AGUA	GP-1011Q	1930549
FL20 con motor/A DIESEL			FR120 con motor/CUMMINS 6BT5.9			FR160-2 con motor/IVECO 8365.25.584		
TRANSMISION	G-33	79032093	COMBUSTIBLE, SECUNDARIO	GP-1122	75208272	COMBUSTIBLE	GP-1122	1930953
AGUA	GP-2071W	4681776	COMBUSTIBLE, SEPARADOR DE AGUA	GPP-1122	1930010	FR180, FR220 con motor/CUMMINS 6CT8.3		
AIRE, PRIMARIO PARA CUMMINS	GA-106	70684734	COMBUSTIBLE, PRIMARIO	GPP-18	75208274	COMBUSTIBLE, SECUNDARIO	GP-1122	3903640
AIRE, PRIMARIO KOMATSU	GA-326	70684734	ACEITE	GP-178	76192087	ACEITE	GP-43	3313281
						COMBUSTIBLE, PRIMARIO	GPP-18	3925274
FL20 SOBRE ORUGAS con motor/FIAT 8215			FR130 con motor/IVECO					
HIDRAULICO	G-33	1930779	COMBUSTIBLE	GP-1122	1930820	FR20 SOBRE RUEDAS, FR20B SOBRE RUEDAS con motor/FIAT 8215		
AGUA	GP-1011Q	4734562				HIDRAULICO	G-222	79092882
AIRE, PRIMARIO PARA CUMMINS	GA-106	79043780	FR130 SOBRE RUEDAS, FR130.2 SOBRE RUEDAS con motor/FIAT 8065T			AGUA	GP-2071W	4681776
AIRE, PRIMARIO KOMATSU	GA-326	79043780	COMBUSTIBLE	GP-1122	1930820	AIRE, PRIMARIO PARA CUMMINS	GA-106	70684734
AIRE, SECUNDARIO	GA-206	79043781				AIRE, PRIMARIO KOMATSU	GA-326	70684734
			FR130-2 con motor/IVECO 8065.25.093			AIRE, SECUNDARIO	GA-206	70662477
FL4-C SOBRE ORUGAS con motor/A DIESEL			COMBUSTIBLE	GP-1122	1930820			
COMBUSTIBLE	G-296	4621740				FR220 SOBRE RUEDAS con motor/FIAT 8365		
			FR140 SOBRE RUEDAS con motor/CUMMINS 6CT8.3			AGUA	GP-1011Q	1930549
FL5 (HASTA S/N 201360) con motor/A DIESEL			COMBUSTIBLE	G-295	8320238	FR220-2 con motor/IVECO		
AIRE, PRIMARIO	GAK-216	79022025	COMBUSTIBLE, SECUNDARIO	GP-1122	75208272	COMBUSTIBLE	GP-1122	1930953
			ACEITE	GP-3000	75285999			
FL5 (S/N 201360-UP) con motor/A DIESEL			AGUA	GP-2071W	75206848			
COMBUSTIBLE	G-296	4621740	COMBUSTIBLE, PRIMARIO	GPP-18	75208274	FR30 con motor/A DIESEL		
			AIRE, PRIMARIO	GA-360	79043778	HIDRAULICO	G-222	70666421
FL5B con motor/IVECO (S/N 201820-UP)			AIRE, SECUNDARIO	GA-361	79043779	ACEITE	GP-53	70697634
COMBUSTIBLE	G-296	4621740				ACEITE, DERIVACION (BY PASS)	GP-57	73124135
			FR140-2 con motor/CUMMINS 6CT8.3			COMBUSTIBLE, SEPARADOR DE AGUA	GPP-11	73144663
FL5B SOBRE ORUGAS con motor/FIAT 8045			COMBUSTIBLE, SECUNDARIO	GP-1122	3903640	AGUA	GP-2071W	70681546
COMBUSTIBLE	G-296	4621740	COMBUSTIBLE, SEPARADOR DE AGUA	GPP-1122	1930010	AIRE, SECUNDARIO	GA-6127	70197588
COMBUSTIBLE	G-296-B	4621740	ACEITE	GP-3000	3825970	AIRE, PRIMARIO	GA-6129	70659387
AIRE, PRIMARIO	GAK-216	79081327	COMBUSTIBLE, PRIMARIO	GPP-18	3925274			
AIRE, SECUNDARIO	GA-416	79081328				FR35 con motor/IVECO		
			FR15 con motor/A DIESEL			HIDRAULICO	G-222	70666421
FL7 (S/N 250905-UP) con motor/A DIESEL			HIDRAULICO	G-222	70666421			
COMBUSTIBLE	GPP-1122	4795601	AGUA	GP-2071W	4681776	FR35 SOBRE RUEDAS con motor/CUMMINS KT1150		
			AIRE, PRIMARIO	GA-360	79043778	HIDRAULICO	G-222	70666421
FL7B con motor/IVECO			AIRE, SECUNDARIO	GA-361	70662609	ACEITE	GP-53	70697634
COMBUSTIBLE	GPP-1122	79075882				ACEITE, DERIVACION (BY PASS)	GP-57	73124135
			FR15 SOBRE RUEDAS con motor/FIAT 8365			COMBUSTIBLE, SEPARADOR DE AGUA	GPP-11	73144663
FL7B SOBRE ORUGAS con motor/FIAT 8065			AIRE, PRIMARIO	GAK-16	70684733	AGUA	GP-2071W	70681546
ACEITE	GP-1	4630787						
			FR15B (S/N 590101-595100) con motor/A DIESEL			FR35 SOBRE RUEDAS con motor/FIAT 8285		
FL7C SOBRE ORUGAS, FL8 SOBRE ORUGAS, FL9 SOBRE ORUGAS con motor/A DIESEL			HIDRAULICO	G-222	70666421	HIDRAULICO	G-222	79092882
COMBUSTIBLE	G-296	9924318	AIRE, PRIMARIO	GA-360	79043778	AGUA	GP-1011Q	4734562
			AIRE, SECUNDARIO	GA-361	70662609	COMBUSTIBLE	GPP-1000	74394407
FR10 (S/N 525840-UP) con motor/A DIESEL								
HIDRAULICO	G-222	70666421	FR15B (S/N 595101-UP) con motor/A DIESEL			FR7 con motor/A DIESEL		
			HIDRAULICO	G-222	70666421	COMBUSTIBLE	G-296	4621740
FR10, FR12 con motor/A DIESEL			AGUA	GP-1011Q	70697635	COMBUSTIBLE	G-296-B	4621740
HIDRAULICO	G-222	70666421	AIRE, PRIMARIO	GA-360	79043778	AIRE, SECUNDARIO	GA-892	79049790
COMBUSTIBLE	G-296	4621740	AIRE, SECUNDARIO	GA-361	70662609			
AGUA	GP-2071W	4681776				FR70 con motor/IVECO 8045.05.396		
COMBUSTIBLE	G-296-B	4621740				COMBUSTIBLE	GPP-1122	1930010

MARCA-MODELO-MOTOR MAKE-MODEL-ENGINE	GONHER GONHER	OEM OEM
FIAT-ALLIS (continuación)		
CARGADORAS		
AIRE, PRIMARIO	GAK-216	1909128
AIRE, SECUNDARIO	GA-416	1909129
FR7B SOBRE RUEDAS con motor/FIAT 8045		
COMBUSTIBLE	GPP-1122	1930010
AIRE, PRIMARIO	GAK-16	79022025
AIRE, SECUNDARIO	GA-416	79022026
FR90, FR90PL con motor/IVECO 8045.05.395		
COMBUSTIBLE	GPP-1122	1930010
FR9B SOBRE RUEDAS, FR9C SOBRE RUEDAS con motor/FIAT 8045		
COMBUSTIBLE	GPP-1122	1930010
FW110, FW90 con motor/FIAT 8045T		
COMBUSTIBLE	G-296	4621740
FW130 con motor/FIAT 8065T		
COMBUSTIBLE	G-296	4621740
COMBUSTIBLE	GPP-1122	1930010
COMBUSTIBLE	G-296-B	4621740
FW140 con motor/CUMMINS 6BT5.9		
ACEITE	GP-178	3914395
FW60 con motor/DEUTZ F3L1011F		
ACEITE	GP-28	1174484
FW80 con motor/DEUTZ BF4L1011		
ACEITE	GP-28	1174484

FIAT-ALLIS

EXCAVADORAS

FE18 con motor/A DIESEL		
AIRE, PRIMARIO	GA-360	79043778
FE20, FE28 con motor/A DIESEL		
AGUA	GP-1011Q	4734562
AGUA	GP-2071W	4681776
AIRE, PRIMARIO	GA-360	70684733
AIRE, SECUNDARIO	GA-361	70662609
FE40 con motor/A DIESEL		
AIRE, PRIMARIO PARA CUMMINS	GA-106	79043780
AIRE, PRIMARIO KOMATSU	GA-326	79043780
AIRE, SECUNDARIO	GA-206	70662477
FH120 con motor/FIAT 8045		
COMBUSTIBLE	GPP-1122	1930010
FH220, FH300, FH300LC con motor/FIAT		
AGUA	GP-2071W	1930549
FX130, FX130LC con motor/CUMMINS 4BT3.9C		
COMBUSTIBLE, SECUNDARIO	GP-1122	75208272
COMBUSTIBLE, PRIMARIO	GPP-18	75208274
ACEITE	GP-390	76192146
FX210, FX210LC con motor/CUMMINS 6BT5.9C		
COMBUSTIBLE, SECUNDARIO	GP-1122	75208272
COMBUSTIBLE, PRIMARIO	GPP-18	75208274
ACEITE	GP-178	76192087

MARCA-MODELO-MOTOR MAKE-MODEL-ENGINE	GONHER GONHER	OEM OEM
FIAT-ALLIS (continuación)		
EXCAVADORAS		
FX215LC con motor/CUMMINS 6BTA5.9		
ACEITE	GP-178	3914395
FX240, FX240LC, FX270 con motor/CUMMINS 6BTA5.9		
COMBUSTIBLE, SECUNDARIO	GP-1122	3903640
COMBUSTIBLE, PRIMARIO	GPP-18	3925274
ACEITE	GP-178	3914395
FX250, FX250LC con motor/CUMMINS 6BTA5.9C		
COMBUSTIBLE, SECUNDARIO	GP-1122	75208272
COMBUSTIBLE, SEPARADOR DE AGUA	GPP-1122	1930010
COMBUSTIBLE, PRIMARIO	GPP-18	75208274
ACEITE	GP-178	76192087
FX310, FX310LC con motor/CUMMINS 6CT8.3C		
COMBUSTIBLE, SECUNDARIO	GP-1122	75208272
ACEITE	GP-3000	75285999
AGUA	GP-2071W	75206848
COMBUSTIBLE, PRIMARIO	GPP-18	75208274
FX480LC con motor/CUMMINS M11		
ACEITE	GP-3000	3825970
FX600LC con motor/CUMMINS N14		
ACEITE	GP-3000	3825970

FIAT-ALLIS

MOTORES

8045-1, 8060-1		
COMBUSTIBLE	G-296	9924318
820, 821, CP3, CP31, CP35M, CP3M		
ACEITE	G-33	74395889

FIAT-ALLIS

MOTOTRAILLA

161 con motor/CUMMINS V-903		
AGUA	GP-2071W	WF2014
AIRE, SECUNDARIO	GA-6127	70697588
AIRE, PRIMARIO	GA-6129	70659378
161 HASTA S/N 13S00314 con motor/A DIESEL		
ACEITE	G-566	70658126
HIDRAULICO	G-222	70666421
COMBUSTIBLE	GP-1101	70697633
AGUA	GP-1011Q	70697635
AIRE, SECUNDARIO	GA-6127	70197588
AIRE, PRIMARIO	GA-6129	70659387
ACEITE, DERIVACION (BY PASS)	G-750	74059343
161 S/N 13S00314-UP con motor/A DIESEL		
HIDRAULICO	G-222	70666421
COMBUSTIBLE	GP-1101	70697633
ACEITE	GP-53	70697634
ACEITE, DERIVACION (BY PASS)	GP-57	73124135
AGUA	GP-1011Q	70697635
AIRE, SECUNDARIO	GA-6127	70197588
AIRE, PRIMARIO	GA-6129	70659387
260 con motor/A DIESEL		
ACEITE	G-33	74395889
COMBUSTIBLE, SECUNDARIO	G-1176	74056632
ACEITE, DERIVACION (BY PASS)	G-500	70091540

MARCA-MODELO-MOTOR MAKE-MODEL-ENGINE	GONHER GONHER	OEM OEM
FIAT-ALLIS (continuación)		
MOTOTRAILLA		
260A con motor/A DIESEL		
ACEITE	G-33	74395889
COMBUSTIBLE, SECUNDARIO	G-1176	74056632
AGUA	GP-1011Q	74393504
AIRE, SECUNDARIO	GA-6127	70197588
AIRE, PRIMARIO	GA-6129	70659387
ACEITE, DERIVACION (BY PASS)	G-750	74059343
260B con motor/ALLIS CHALMERS 6138I HASTA S/N 14-03563		
ACEITE	G-33	74395889
HIDRAULICO	G-222	70666421
AGUA	GP-1011Q	74393504
COMBUSTIBLE	GPP-19	74321716
COMBUSTIBLE, SEPARADOR DE AGUA	GPP-1000	74394407
AIRE, SECUNDARIO	GA-6127	70197588
AIRE, PRIMARIO	GA-6129	70659387
ACEITE, DERIVACION (BY PASS)	G-750	74059343
260B con motor/ALLIS CHALMERS 6138I S/N 14-03563-UP		
HIDRAULICO	G-222	70666421
ACEITE	GP-53	70697634
AGUA	GP-1011Q	74393504
COMBUSTIBLE	GPP-19	74321716
COMBUSTIBLE, SEPARADOR DE AGUA	GPP-1000	74394407
AIRE, SECUNDARIO	GA-6127	70197588
AIRE, PRIMARIO	GA-6129	70659387
ACEITE, DERIVACION (BY PASS)	G-750	74059343
260-B, 261-B con motor/ALLIS CHALMERS 26000 MKII		
ACEITE	G-33	74395889
COMBUSTIBLE, SECUNDARIO	G-1176	74056632
AGUA	GP-2071W	74393504
AIRE, SECUNDARIO	GA-6127	70197588
AIRE, PRIMARIO	GA-6129	70659387
ACEITE, DERIVACION (BY PASS)	G-750	74059343
260-E con motor/A DIESEL		
ACEITE	G-33	74395889
COMBUSTIBLE, SECUNDARIO	G-1176	74056632
ACEITE, DERIVACION (BY PASS)	G-500	70091540
261B con motor/ALLIS CHALMERS 6138I HASTA S/N 14-03563		
ACEITE	G-33	74395889
HIDRAULICO	G-222	70666421
AGUA	GP-1011Q	74393504
COMBUSTIBLE	GPP-19	74321716
COMBUSTIBLE, SEPARADOR DE AGUA	GPP-1000	74394407
AIRE, SECUNDARIO	GA-6127	70197588
AIRE, PRIMARIO	GA-6129	70659387
ACEITE, DERIVACION (BY PASS)	G-750	74059343
261B con motor/ALLIS CHALMERS 6138I S/N 14-03563-UP		
HIDRAULICO	G-222	70666421
ACEITE	GP-53	70697634
AGUA	GP-1011Q	74393504
COMBUSTIBLE	GPP-19	74321716
COMBUSTIBLE, SEPARADOR DE AGUA	GPP-1000	74394407
AIRE, SECUNDARIO	GA-6127	70197588
AIRE, PRIMARIO	GA-6129	70659387
ACEITE, DERIVACION (BY PASS)	G-750	74059343

SERVICIO PESADO

MARCA-MODELO-MOTOR	GONHER	OEM	MARCA-MODELO-MOTOR	GONHER	OEM	MARCA-MODELO-MOTOR	GONHER	OEM
MAKE-MODEL-ENGINE	GONHER	OEM	MAKE-MODEL-ENGINE	GONHER	OEM	MAKE-MODEL-ENGINE	GONHER	OEM
FIAT-ALLIS (continuación)			FIAT-ALLIS (continuación)			FIAT-ALLIS (continuación)		
MOTOTRILLA			NIVELADORAS			NIVELADORAS		
262B, 263B con motor/A DIESEL			AIRE, PRIMARIO PARA CUMMINS	GA-106	70684734	150-C con motor/ALLIS CHALMERS 11000		
ACEITE	G-33	74395889	AIRE, PRIMARIO KOMATSU	GA-326	70684734	ACEITE	G-33	74395889
ACEITE	GP-53	70697634	AIRE, SECUNDARIO	GA-206	70662477	AGUA	GP-2071W	74393504
AGUA	GP-2071W	74393504				AIRE, PRIMARIO	GA-360	70660360
AIRE, SECUNDARIO	GA-6127	70197588	11-B SOBRE ORUGAS con motor/ALLIS CHALMERS 10000			AIRE, SECUNDARIO	GA-361	70662609
AIRE, PRIMARIO	GA-6129	70659387	TRANSMISION	G-6	74372517			
			ACEITE, TURBO	G-6	74372517	16B con motor/A DIESEL		
262B, 263B con motor/ALLIS CHALMERS 6138I HASTA S/N 14-03563			ACEITE	G-33	74395889	ACEITE	G-33	74395889
ACEITE	G-33	74395889	COMBUSTIBLE, SECUNDARIO	G-1173	74348148	AGUA	GP-1011Q	74393504
HIDRAULICO	G-222	70666421	COMBUSTIBLE, PRIMARIO	G-1174	4353268	COMBUSTIBLE	GPP-1000	74394407
AGUA	GP-1011Q	74393504	ACEITE, DERIVACION (BY PASS)	G-500	70091540	ACEITE, DERIVACION (BY PASS)	G-750	74059343
COMBUSTIBLE	GPP-19	74321716						
COMBUSTIBLE, SEPARADOR DE AGUA	GPP-1000	74394407	11-B SOBRE ORUGAS con motor/ALLIS CHALMERS 11000			16-B SOBRE ORUGAS con motores/ALLIS CHALMERS 16000, ALLIS CHALMERS HD844		
AIRE, SECUNDARIO	GA-6127	70197588	ACEITE	G-33	74395889	ACEITE	G-33	74394889
AIRE, PRIMARIO	GA-6129	70659387	AIRE, PRIMARIO PARA CUMMINS	GA-106	70684734	COMBUSTIBLE, SECUNDARIO	G-1176	74056632
ACEITE, DERIVACION (BY PASS)	G-750	74059343	AIRE, PRIMARIO	GA-360	70684733	AIRE, PRIMARIO	GA-360	79043778
			AIRE, PRIMARIO KOMATSU	GA-326	70684734	AIRE, SECUNDARIO	GA-361	70662609
262B, 263B con motor/ALLIS CHALMERS 6138I S/N 14-03563-UP			AIRE, SECUNDARIO	GA-206	70662477	ACEITE, DERIVACION (BY PASS)	G-500	70091540
ACEITE, TRASERO	G-33	74395889	AIRE, SECUNDARIO	GA-361	70662609			
HIDRAULICO	G-222	70666421				200-C con motor/ALLIS CHALMERS 11000		
ACEITE, FRENTE	GP-53	70697634	11-B SOBRE ORUGAS con motor/ALLIS CHALMERS HD516			ACEITE	G-33	74395889
AGUA	GP-1011Q	74393504	TRANSMISION	G-6	74372517	AGUA	GP-2071W	74393504
COMBUSTIBLE	GPP-19	74321716	ACEITE, TURBO	G-6	74372517	AIRE, PRIMARIO	GA-360	70660360
COMBUSTIBLE, SEPARADOR DE AGUA	GPP-1000	74394407	ACEITE	G-33	74395889	AIRE, SECUNDARIO	GA-361	70662609
AIRE, SECUNDARIO	GA-6127	70197588	COMBUSTIBLE, SECUNDARIO	G-1173	74348148			
AIRE, PRIMARIO	GA-6129	70659387	COMBUSTIBLE, PRIMARIO	G-1174	4353268	21-B SOBRE ORUGAS con motores/ALLIS CHALMERS 19000, ALLIS CHALMERS 21000, ALLIS CHALMERS HDT844		
ACEITE, DERIVACION (BY PASS)	G-750	74059343	ACEITE, DERIVACION (BY PASS)	G-500	70091540	AIRE, SECUNDARIO	GA-6127	70197588
460-C con motor/DETROIT DIESEL 12V-71			12G-B SOBRE ORUGAS con motor/ALLIS CHALMERS 11000			21C con motor/A DIESEL		
TRANSMISION	G-33	1901608	ACEITE, TURBO	G-6	74372517	ACEITE	G-33	74395889
			ACEITE	G-33	74395889	HIDRAULICO	G-222	70666421
			COMBUSTIBLE, SECUNDARIO	G-1173	74348148	AGUA	GP-1011Q	74393504
			COMBUSTIBLE, PRIMARIO	G-1174	4353268	COMBUSTIBLE	GPP-1000	74394407
			AIRE, PRIMARIO PARA CUMMINS	GA-106	70684734	ACEITE, DERIVACION (BY PASS)	G-750	74059343
			AIRE, PRIMARIO KOMATSU	GA-326	70684734			
			AIRE, SECUNDARIO	GA-206	70662477	21C con motor/IVECO REPOWER		
						HIDRAULICO	G-222	70666421
			140, AD12, AD12L con motor/A DIESEL			AGUA	GP-2071W	4734562
			ACEITE	G-33	1901608	ACEITE, DERIVACION (BY PASS)	G-750	74059343
			140C1, 140CA con motor/A DIESEL			21-C SOBRE ORUGAS con motores/ALLIS CHALMERS 19000, ALLIS CHALMERS 21000, ALLIS CHALMERS HDT844		
			ACEITE	G-33	1901608	ACEITE, TURBO	G-6	74372517
						ACEITE	G-33	74395889
			14B con motor/A DIESEL			COMBUSTIBLE, SECUNDARIO	G-1176	74056632
			DIRECCION	G-33	4596891	AGUA	GP-2071W	74393504
						AIRE, SECUNDARIO	GA-6127	70197588
			14C con motor/CUMMINS 6CT8.3			AIRE, PRIMARIO	GA-6129	70659387
			COMBUSTIBLE, SECUNDARIO	GP-1122	3903640	ACEITE, DERIVACION (BY PASS)	G-500	70091540
			ACEITE	GP-43	3313281	ACEITE, DERIVACION (BY PASS)	G-750	74059343
			COMBUSTIBLE, PRIMARIO	GPP-18	3925274			
			14C con motor/FIAT HASTA S/N 050101			31 con motor/A DIESEL		
			DIRECCION	G-33	1901608	HIDRAULICO	G-222	70666421
			AIRE, PRIMARIO	GA-360	79043778	COMBUSTIBLE	GPP-14	70697633
			AIRE, SECUNDARIO	GA-361	70662609	ACEITE	GP-53	70697634
						ACEITE, DERIVACION (BY PASS)	GP-57	73124135
			14C con motor/FIAT S/N 050101-052919			AGUA	GP-1011Q	70697635
			DIRECCION	G-33	79032093			
						31 SOBRE ORUGAS con motor/CUMMINS		
			14C con motor/IVECO (S/N 052919-UP)			AGUA	GP-1011Q	70697635
			AGUA	GP-2071W	4734562			
			AIRE, PRIMARIO	GA-360	79043778			
			AIRE, SECUNDARIO	GA-361	79043779			

MARCA-MODELO-MOTOR MAKE-MODEL-ENGINE	GONHER GONHER	OEM OEM	MARCA-MODELO-MOTOR MAKE-MODEL-ENGINE	GONHER GONHER	OEM OEM	MARCA-MODELO-MOTOR MAKE-MODEL-ENGINE	GONHER GONHER	OEM OEM
FIAT-ALLIS (continuación)			FIAT-ALLIS (continuación)			FIAT-ALLIS (continuación)		
NIVELADORAS			NIVELADORAS			NIVELADORAS		
41 SOBRE ORUGAS con motor/ALLIS CHALMERS 21000			FD14E con motor/A DIESEL			HIDRAULICO	G-222	70664000
ACEITE, TURBO	G-6	74372517	AGUA	GP-2071W	4734562	COMBUSTIBLE	GP-55	73111946
ACEITE	G-33	74395889	AIRE, PRIMARIO	GA-360	79043778	ACEITE, DERIVACION (BY PASS)	GP-57	73124135
HIDRAULICO	G-238	70666421	AIRE, SECUNDARIO	GA-361	79043779	AGUA	GP-2071W	70681546
COMBUSTIBLE, SECUNDARIO	G-1176	74056632				FD50 SOBRE ORUGAS con motor/CUMMINS VT-1710		
41 SOBRE ORUGAS, 41B SOBRE ORUGAS con motor/CUMMINS V-12			FD14E SOBRE ORUGAS con motor/FIAT 8365			ACEITE	G-566	70658126
AGUA	GP-1011Q	70681546	AIRE, PRIMARIO	GA-360	79043778	HIDRAULICO	G-222	79092882
						COMBUSTIBLE	GP-55	73111946
41B (HASTA S/N 3658) con motor/A DIESEL			FD20 con motor/A DIESEL			AGUA	GP-1011Q	1930549
ACEITE	G-566	70658126	TRANSMISION	G-33	79032093	FD7 (S/N 250905-UP) con motor/A DIESEL		
COMBUSTIBLE	G-1143	70658128	AGUA	GP-2071W	4681776	COMBUSTIBLE	GPP-1122	4795601
HIDRAULICO	G-222	70666421	AIRE, PRIMARIO PARA CUMMINS	GA-106	70684734			
AGUA	GP-2071W	70681546	AIRE, PRIMARIO KOMATSU	GA-326	70684734	FD7 SOBRE ORUGAS con motor/FIAT 8065		
ACEITE, DERIVACION (BY PASS)	G-750	74059343				ACEITE	GP-1	4630787
65 con motor/ALLIS CHALMERS D-262			FD20 SOBRE ORUGAS con motor/FIAT 8215					
ACEITE	GP-1	74511629	HIDRAULICO	G-33	1930779	FD80, FD80 LGP con motor/CUMMINS 483.9		
			AGUA	GP-1011Q	4734562	COMBUSTIBLE, SECUNDARIO	GP-1122	3903640
65 con motor/ALLIS CHALMERS G-226			AIRE, PRIMARIO PARA CUMMINS	GA-106	79043780	COMBUSTIBLE, PRIMARIO	GPP-18	3925274
ACEITE	GP-1	4630787	AIRE, PRIMARIO KOMATSU	GA-326	79043780	ACEITE	GP-390	74035556
			AIRE, SECUNDARIO	GA-206	79043781			
65B con motor/FIAT 8065			FD30 con motor/A DIESEL			FG75, FG85, FG95 con motor/FIAT 8365		
ACEITE	GP-1	4630787	HIDRAULICO	G-222	70666421	AGUA	GP-2071W	4681776
COMBUSTIBLE	G-296	4621740				AIRE, PRIMARIO	GA-360	70684733
AGUA	GP-2071W	4681776	FD30 SOBRE ORUGAS con motor/FIAT 8285			AIRE, SECUNDARIO	GA-361	70662609
COMBUSTIBLE	G-296-B	4621740	HIDRAULICO	G-222	70664000			
8 SOBRE ORUGAS con motor/A DIESEL						FIAT-ALLIS		
COMBUSTIBLE	G-296	9924318	FD30B con motor/CUMMINS			TRACTORES		
			HIDRAULICO	G-222	70666421	85-90 con motor/A DIESEL		
8B SOBRE ORUGAS con motor/A DIESEL			ACEITE	GP-53	70697634	COMBUSTIBLE	G-296	1909100
COMBUSTIBLE	G-296	4621740	ACEITE, DERIVACION (BY PASS)	GP-57	73124135	COMBUSTIBLE	G-296-B	1909100
			COMBUSTIBLE, SEPARADOR DE AGUA	GPP-11	73144663	AIRE, PRIMARIO	GAK-458	1909116
AD10 con motor/A DIESEL			AGUA	GP-1011Q	70697635	AIRE, SECUNDARIO	GA-459	1909117
ACEITE	G-33	1901608				AIRE, RADIAL PRIMARIO	GA-853R	1930589
			FD30B con motor/FIAT			88-94 con motor/A DIESEL		
AD10B, BD10B con motor/A DIESEL			HIDRAULICO	G-222	70666421	COMBUSTIBLE	G-296	1909100
ACEITE	G-33	1901608				COMBUSTIBLE	G-296-B	1909100
DIRECCION	G-33	1901608	FD40 con motor/A DIESEL			AIRE, RADIAL PRIMARIO	GA-853R	1930589
AIRE, PRIMARIO	GA-360	70684733	HIDRAULICO	G-222	70666421			
AIRE, SECUNDARIO	GA-361	70662609	COMBUSTIBLE	GPP-14	70697633	90-90 con motor/FIAT 8055.05		
			ACEITE	GP-53	70697634	COMBUSTIBLE (REQUIERE 2)	GPP-1122	1930010
AD14 con motor/A DIESEL			ACEITE, DERIVACION (BY PASS)	GP-57	73124135	AIRE, PRIMARIO	GAK-458	1909116
DIRECCION	G-33	1901608	AGUA	GP-1011Q	70697635	AIRE, SECUNDARIO	GA-459	1909117
						AIRE, RADIAL PRIMARIO	GA-853R	1930589
AD14B, BD14B con motor/A DIESEL			FD40B SOBRE ORUGAS con motor/CUMMINS KT1150			F100, F110, F115, F120 con motor/FIAT 8065.06		
ACEITE	G-33	1901608	HIDRAULICO	G-222	79092882	COMBUSTIBLE (REQUIERE 2)	GPP-1122	1930010
DIRECCION	G-33	1901608	COMBUSTIBLE	GPP-14	70697633			
COMBUSTIBLE	GPP-1122	1930010	AGUA	GP-1010Q	74393504	FIAT-HITACHI		
BD10, BD12, BD12L con motor/A DIESEL			ACEITE	GP-53	70697634	CARGADORAS		
ACEITE	G-33	1901608	ACEITE, DERIVACION (BY PASS)	GP-57	73124135	W190LB, W170, W190 con motor/CUMMINS 6CT8.3		
						ACEITE	GP-3000	3318853
BD14, BD14L con motor/A DIESEL			FD5 (HASTA S/N 201360) con motor/A DIESEL			W230 con motor/CUMMINS 6CTAA8.3		
DIRECCION	G-33	1901608	AIRE, PRIMARIO	GAK-216	79022025	ACEITE	GP-3000	3318853
						W270 con motor/CUMMINS M11		
FD130 con motor/CUMMINS 6BT5.9			FD5 (S/N 201360-UP) con motor/A DIESEL			ACEITE	GP-3000	3318853
ACEITE	GP-178	3914395	COMBUSTIBLE	G-296	4621740	W350 con motor/CUMMINS N14		
			FD5 SOBRE ORUGAS, FD5LGP SOBRE ORUGAS, FD5LT SOBRE ORUGAS con motor/FIAT 8045			ACEITE	GP-3000	3318853
FD145 con motor/FIAT 8065T			AIRE, PRIMARIO	GAK-216	79022025			
COMBUSTIBLE	G-296	4621740						
COMBUSTIBLE	GPP-1122	1930010	FD50 con motor/A DIESEL					
COMBUSTIBLE	G-296-B	4621740	ACEITE	G-566	70658126			

SERVICIO PESADO

MARCA-MODELO-MOTOR	GONHER	OEM
MAKE-MODEL-ENGINE	GONHER	OEM

FIAT-HITACHI (continuación)

CARGADORAS

W450 con motor/CUMMINS QSK19		
ACEITE	GP-3000	3318853

FIAT-HITACHI

EXCAVADORAS

EX255, FH270-3, EX255EL, EX255LC, EX285, EX285LC con motor/CUMMINS 6CT8.3		
ACEITE	GP-3000	3318853

FIAT-HITACHI

NIVELADORAS

D180 con motor/CUMMINS 6CT8.3		
ACEITE	GP-3000	3318853
G170, G200 con motor/CUMMINS 6CT8.3 TURBO		
ACEITE	GP-3000	3318853

FORD

CAMIONES, TRACTOCAMIONES Y AUTOBUSES

200 SERIES con motor/FORD 2-240		
ACEITE	G-330	C5RA-6744-C
ACEITE	GP-1	B7A-6714-A
AIRE	GA-80	C4OZ-9601-A
AIRE	GA-303	C8TZ-9601-A
GASOLINA	GG-20	C4AZ-9365-B
GASOLINA	GG-19	C7AE-9155-A
200 SERIES con motor/FORD 6-200		
ACEITE	GP-1	B7A-6714-A
GASOLINA	GG-20	C4AZ-9365-B
GASOLINA	GG-19	C7AE-9155-A
200 SERIES con motor/FORD 6-223		
ACEITE	G-6	CPN-6731-B
GASOLINA	GG-20	C4AZ-9365-B
GASOLINA	GG-19	C7AE-9155-A
200 SERIES con motor/FORD V8-255		
ACEITE	GP-1	B7A-6714-A
AIRE	GA-75	D2AZ-9601-A
GASOLINA	GG-87	E0ZE-9155-BA
200 SERIES con motor/FORD V8-351		
ACEITE	GP-1	B7A-6714-A
AIRE, 1975-83	GA-75	D2AZ-9601-A
AIRE, 1984-87	GA-85	E4TE-9601-EA
AIRE, 1988 EN ADELANTE	GA-174	E7TZ-9601-B
GASOLINA, 1988 EN ADELANTE	GG-47	E9TZ-9B072-CA
GASOLINA, 1975-76	GG-19	C7AE-9155-A
GASOLINA, ROSCADO	GG-87	E0ZE-9155-BA
200 SERIES con motor/FORD V8-352		
ACEITE, CARTUCHO	G-6	CPN-6731-B
ACEITE, SELLADO	GP-1	B7A-6714-A
GASOLINA	GG-20	C4AZ-9365-B
200 SERIES con motor/FORD V8-460		
ACEITE	GP-1	B7A-6714-A
AIRE, HASTA 1987	GA-85	E4TE-9601-EA
AIRE, 1988 EN ADELANTE	GA-174	E7TZ-9601-B
GASOLINA, 1973-74	GG-20	C4AZ-9365-B
GASOLINA, 1988 EN ADELANTE	GG-47	E9TZ-9B072-CA
GASOLINA, 1973-76	GG-19	C7AE-9155-A
GASOLINA, ROSCADO	GG-87	E0ZE-9155-BA

MARCA-MODELO-MOTOR	GONHER	OEM
MAKE-MODEL-ENGINE	GONHER	OEM

FORD (continuación)

CAMIONES, TRACTOCAMIONES Y AUTOBUSES

GASOLINA, 1988 EN ADELANTE	GG-47	E9TZ-9B072-CA
GASOLINA, 1973-76	GG-19	C7AE-9155-A
GASOLINA, 1979-86	GG-123	D9PZ-9155-A
200 SERIES, 250 SERIES con motor/FORD 6-170		
ACEITE	GP-1	B7A-6714-A
AIRE	GA-80	C4OZ-9601-A
GASOLINA	GG-20	C4AZ-9365-B
GASOLINA	GG-5 L	C2RZ-9115-B
GASOLINA	GG-19	C7AE-9155-A
200 SERIES, 350 SERIES, 250 SERIES, 300 SERIES con motor/FORD 6-300		
ACEITE	GP-1	B7A-6714-A
AIRE, E SERIES 1973-83	GA-80	C4OZ-9601-A
AIRE, F SERIES 1970-79	GA-303	C8TZ-9601-A
AIRE, F SERIES 1982-86	GA-3300	E4TE-9601-AA
AIRE, 1987 EN ADELANTE	GA-174	E7TZ-9601-B
GASOLINA, 1966-72	GG-20	C4AZ-9365-B
GASOLINA, 1987 EN ADELANTE	GG-47	E9TZ-9B072-CA
GASOLINA, 1966-77	GG-19	C7AE-9155-A
GASOLINA, ROSCADO 1982-86	GG-87	E0ZE-9155-BA
200 SERIES, 350 SERIES, 250 SERIES, 300 SERIES con motor/FORD V8-302 EXCEPTO F.I.		
ACEITE, 1960-61	G-6	CPN-6731-B
ACEITE, 1968-73	G-330	C5RA-6744-C
ACEITE, SELLADO	GP-1	B7A-6714-A
AIRE, 1973 EN ADELANTE	GA-75	D2AZ-9601-A
AIRE, 1968-72	GA-80	C4OZ-9601-A
GASOLINA, 1960-76	GG-20	C4AZ-9365-B
GASOLINA, 1968-76	GG-19	C7AE-9155-A
GASOLINA, ROSCADO 1981 EN ADELANTE	GG-87	E0ZE-9155-BA
250 SERIES con motor/FORD V6-232		
ACEITE	GP-1	B7A-6714-A
AIRE	GA-74	D3ZZ-9601-A
GASOLINA	GG-87	E0ZE-9155-BA
250 SERIES con motor/FORD V8-255		
ACEITE	GP-1	B7A-6714-A
AIRE	GA-75	D2AZ-9601-A
GASOLINA	GG-87	E0ZE-9155-BA
250 SERIES con motor/FORD V8-351		
ACEITE	GP-1	B7A-6714-A
AIRE, 1975-83	GA-75	D2AZ-9601-A
AIRE, 1984-87	GA-85	E4TE-9601-EA
AIRE, 1988 EN ADELANTE	GA-174	E7TZ-9601-B
GASOLINA, 1988 EN ADELANTE	GG-47	E9TZ-9B072-CA
GASOLINA, 1975-76	GG-19	C7AE-9155-A
GASOLINA, ROSCADO	GG-87	E0ZE-9155-BA
250 SERIES con motor/FORD V8-352		
ACEITE, CARTUCHO	G-6	CPN-6731-B
ACEITE, SELLADO	GP-1	B7A-6714-A
GASOLINA	GG-20	C4AZ-9365-B
250 SERIES con motor/FORD V8-360		
ACEITE, 1969-74	G-330	C5RA-6744-C
ACEITE	GP-1	B7A-6714-A
AIRE	GA-85	E4TE-9601-EA
GASOLINA	GG-20	C4AZ-9365-B

MARCA-MODELO-MOTOR	GONHER	OEM
MAKE-MODEL-ENGINE	GONHER	OEM

FORD (continuación)

CAMIONES, TRACTOCAMIONES Y AUTOBUSES

GASOLINA	GG-19	C7AE-9155-A
250 SERIES con motor/FORD V8-390		
ACEITE, CARTUCHO	G-330	C5RA-6744-C
ACEITE, SELLADO	GP-1	B7A-6714-A
AIRE	GA-85	E4TE-9601-EA
GASOLINA	GG-20	C4AZ-9365-B
GASOLINA	GG-19	C7AE-9155-A
250 SERIES con motor/FORD V8-400		
ACEITE	GP-1	B7A-6714-A
AIRE	GA-75	D2AZ-9601-A
GASOLINA, ROSCADO 1981 EN ADELANTE	GG-87	E0ZE-9155-BA
250 SERIES con motor/FORD V8-420 (6.9L) DIESEL		
ACEITE	GP-3766	E3TZ-6731-A
COMBUSTIBLE	GP-155	E3TZ-9155-A
AIRE	GA-3501	E7TZ-9600-A
250 SERIES con motor/FORD V8-446 (7.3L) DIESEL		
COMBUSTIBLE	G-178	1822631C91
ACEITE	GP-3766	E3TZ-6731-A
AIRE	GA-442	F5TZ-9601-A
250 SERIES con motor/FORD V8-460		
ACEITE	GP-1	B7A-6714-A
AIRE, HASTA 1987	GA-85	E4TE-9601-EA
AIRE, 1988 EN ADELANTE	GA-174	E7TZ-9601-B
GASOLINA, 1973-74	GG-20	C4AZ-9365-B
GASOLINA, 1988 EN ADELANTE	GG-47	E9TZ-9B072-CA
GASOLINA, 1973-76	GG-19	C7AE-9155-A
GASOLINA, 1979-86	GG-123	D9PZ-9155-A
250 SERIES, 350 SERIES con motor/FORD V8-302 F.I.		
ACEITE	GP-1	B7A-6714-A
AIRE	GA-5056	E5TZ-9601-B
AIRE	GA-174	E7TZ-9601-B
GASOLINA, 1987 EN ADELANTE	GG-47	E9TZ-9B072-CA
300 SERIES con motor/FORD 6-200		
ACEITE	GP-1	B7A-6714-A
GASOLINA	GG-20	C4AZ-9365-B
GASOLINA	GG-19	C7AE-9155-A
300 SERIES con motor/FORD 6-223		
ACEITE	G-6	CPN-6731-B
GASOLINA	GG-20	C4AZ-9365-B
GASOLINA	GG-19	C7AE-9155-A
300 SERIES con motor/FORD V8-255		
ACEITE	GP-1	B7A-6714-A
AIRE	GA-75	D2AZ-9601-A
GASOLINA	GG-87	E0ZE-9155-BA
300 SERIES con motor/FORD V8-351		
ACEITE	GP-1	B7A-6714-A
AIRE, 1975-83	GA-75	D2AZ-9601-A
AIRE, 1984-87	GA-85	E4TE-9601-EA
AIRE, 1988 EN ADELANTE	GA-174	E7TZ-9601-B
GASOLINA, 1988 EN ADELANTE	GG-47	E9TZ-9B072-CA
GASOLINA, 1975-76	GG-19	C7AE-9155-A
GASOLINA, ROSCADO	GG-87	E0ZE-9155-BA

MARCA-MODELO-MOTOR MAKE-MODEL-ENGINE	GONHER GONHER	OEM OEM	MARCA-MODELO-MOTOR MAKE-MODEL-ENGINE	GONHER GONHER	OEM OEM	MARCA-MODELO-MOTOR MAKE-MODEL-ENGINE	GONHER GONHER	OEM OEM
FORD (continuación)			FORD (continuación)			FORD (continuación)		
CAMIONES, TRACTOCAMIONES Y AUTOBUSES			CAMIONES, TRACTOCAMIONES Y AUTOBUSES			CAMIONES, TRACTOCAMIONES Y AUTOBUSES		
300 SERIES con motor/FORD V8-352			GASOLINA, ROSCADO 1981 EN ADELANTE	GG-87	E0ZE-9155-BA	600 SERIES con motor/FORD V8-330		
ACEITE, CARTUCHO	G-6	CPN-6731-B				ACEITE, CARTUCHO (1964-74)	G-6	CPN-6731-B
ACEITE, SELLADO	GP-1	B7A-6714-A	350 SERIES con motor/FORD V8-420 (6.9L) DIESEL			ACEITE, SELLADO 1964 EN ADELANTE	GP-1	B7A-6714-A
GASOLINA	GG-20	C4AZ-9365-B	ACEITE	GP-3766	E3TZ-6731-A	GASOLINA	GG-20	C4AZ-9365-B
			COMBUSTIBLE	GP-155	E3TZ-9155-A			
300 SERIES con motor/FORD V8-460			AIRE	GA-3501	E7TZ-9600-A	600 SERIES con motor/FORD V8-361		
ACEITE	GP-1	B7A-6714-A				ACEITE, FLUJO TOTAL (FULL FLOW)	G-6	CPN-6731-B
AIRE, HASTA 1987	GA-85	E4TE-9601-EA	350 SERIES con motor/FORD V8-446 (7.3L) DIESEL			ACEITE, SELLADO	GP-31	D3HZ-6731-B
AIRE, 1988 EN ADELANTE	GA-174	E7TZ-9601-B	COMBUSTIBLE	G-178	1822631C91	ACEITE, DERIVACION (BY PASS)	G-500	DOTZ-6731-B
GASOLINA, 1973-74	GG-20	C4AZ-9365-B	ACEITE	GP-3766	E3TZ-6731-A	GASOLINA	GG-20	C4AZ-9365-B
GASOLINA, 1988 EN ADELANTE	GG-47	E9TZ-98072-CA	AIRE	GA-442	F5TZ-9601-A			
GASOLINA, 1973-76	GG-19	C7AE-9155-A				600 SERIES con motor/FORD V8-370		
GASOLINA, 1979-86	GG-123	D9PZ-9155-A	350 SERIES con motor/FORD V8-460			ACEITE, SELLADO	GP-31	D3HZ-6731-B
			ACEITE	GP-1	B7A-6714-A	AIRE	GA-89	E1HZ-9601-A
			AIRE, HASTA 1987	GA-85	E4TE-9601-EA	AIRE	GA-529	F1HZ-9601-C
			AIRE, 1988 EN ADELANTE	GA-174	E7TZ-9601-B	GASOLINA	GG-20	C4AZ-9365-B
300 SERIES, 350 SERIES con motor/FORD 6-170			GASOLINA, 1973-74	GG-20	C4AZ-9365-B			
ACEITE	GP-1	B7A-6714-A	GASOLINA, 1988 EN ADELANTE	GG-47	E9TZ-98072-CA	600 SERIES con motor/FORD V8-389		
AIRE	GA-80	C4OZ-9601-A	GASOLINA, 1973-76	GG-19	C7AE-9155-A	ACEITE, FLUJO TOTAL (FULL FLOW)	G-6	CPN-6731-B
GASOLINA	GG-20	C4AZ-9365-B	GASOLINA, 1979-86	GG-123	D9PZ-9155-A	ACEITE, SELLADO	GP-31	D3HZ-6731-B
GASOLINA	GG-5 L	C2RZ-9115-B				ACEITE, DERIVACION (BY PASS)	G-500	DOTZ-6731-B
GASOLINA	GG-19	C7AE-9155-A	350 SERIES, 250 SERIES, 300 SERIES con motor/FORD 6-240			GASOLINA	GG-20	C4AZ-9365-B
			ACEITE	G-330	C5RA-6744-C			
			ACEITE	GP-1	B7A-6714-A	600 SERIES con motor/FORD V8-429		
			AIRE	GA-80	C4OZ-9601-A	ACEITE, SELLADO	GP-31	D3HZ-6731-B
			AIRE	GA-303	C8TZ-9601-A	AIRE	GA-89	E1HZ-9601-A
			GASOLINA	GG-20	C4AZ-9365-B	AIRE	GA-529	F1HZ-9601-C
			GASOLINA	GG-19	C7AE-9155-A	GASOLINA	GG-20	C4AZ-9365-B
			500 SERIES con motor/FORD V8-292			600 SERIES, 6000 CARGO con motor/FORD 6-401 (6.6L)		
			ACEITE, CARTUCHO (1958-63)	G-6	CPN-6731-B	COMBUSTIBLE, SEPARADOR DE AGUA HASTA 1991	GPP-14	E7HZ-9N184-A
			ACEITE, CARTUCHO (1963-64)	G-330	C5RA-6744-C	ACEITE, 1987 EN ADELANTE	GP-54	F2NN-6714-AA
			ACEITE, SELLADO	GP-1	B7A-6714-A	COMBUSTIBLE	GP-1122	E6HZ-9365-C
			GASOLINA	GG-20	C4AZ-9365-B	ACEITE, HASTA 1986	GP-77	E7NN-6714-BB
						COMBUSTIBLE, SEPARADOR DE AGUA 1991 EN ADELANTE	GPP-1287	F1HZ-9365-A
			500 SERIES con motor/FORD V8-330					
			ACEITE, CARTUCHO (1964-74)	G-6	CPN-6731-B	6000 SERIES con motor/FORD 6-363 DIESEL		
			ACEITE, SELLADO 1964 EN ADELANTE	GP-1	B7A-6714-A	ACEITE	G-834	2703E-6731-A
			GASOLINA	GG-20	C4AZ-9365-B			
						6000 SERIES con motor/GMC 8.2L DIESEL		
			500 SERIES con motor/FORD V8-292			ACEITE	GP-13	25013454
			ACEITE, CARTUCHO (1958-63)	G-6	CPN-6731-B	COMBUSTIBLE, PRIMARIO	GP-92	23518527
			ACEITE, CARTUCHO (1963-64)	G-330	C5RA-6744-C	COMBUSTIBLE, SECUNDARIO	GP-93	23518526
			ACEITE, SELLADO	GP-1	B7A-6714-A			
			GASOLINA	GG-20	C4AZ-9365-B	6000 SERIES con motores/FORD 6-220 DIESEL, FORD 6-242 DIESEL, FORD 6-300 DIESEL		
						ACEITE	G-836	C7TZ-6731-A
			550 SERIES con motor/FORD V8-330					
			ACEITE, CARTUCHO (1964-74)	G-6	CPN-6731-B	700 SERIES con motor/DETROIT DIESEL 8.2L		
			ACEITE, SELLADO 1964 EN ADELANTE	GP-1	B7A-6714-A	ACEITE	GP-13	25013454
			GASOLINA	GG-20	C4AZ-9365-B	COMBUSTIBLE, PRIMARIO	GP-92	23518527
						COMBUSTIBLE, SECUNDARIO	GP-93	23518526
			550 SERIES, 600 SERIES con motor/FORD V8-292					
			ACEITE, CARTUCHO (1958-63)	G-6	CPN-6731-B	6000 SERIES con motor/FORD 6-220 DIESEL, FORD 6-242 DIESEL, FORD 6-300 DIESEL		
			ACEITE, CARTUCHO (1963-64)	G-330	C5RA-6744-C	ACEITE	G-836	C7TZ-6731-A
			ACEITE, SELLADO	GP-1	B7A-6714-A			
			GASOLINA	GG-20	C4AZ-9365-B	700 SERIES con motor/FORD 6 CYL. 476 (7.8L) DIESEL		
						COMBUSTIBLE, SEPARADOR DE AGUA HASTA 1991	GPP-14	E7HZ-9N184-A
			600 SERIES con motor/DETROIT DIESEL 8.2L			ACEITE	GP-54	F2NN-6714-AA
			ACEITE	GP-13	25013454	COMBUSTIBLE	GP-1122	E6HZ-9365-C
			COMBUSTIBLE, PRIMARIO	GP-92	23518527	AGUA	GP-2071W	E7HZ-8A424-B
			COMBUSTIBLE, SECUNDARIO	GP-93	23518526	COMBUSTIBLE, SEPARADOR DE AGUA 1991 EN ADELANTE	GPP-1287	F1HZ-9365-A
			350 SERIES con motor/FORD V8-352					
ACEITE, CARTUCHO	G-6	CPN-6731-B						
ACEITE, SELLADO	GP-1	B7A-6714-A						
GASOLINA	GG-20	C4AZ-9365-B						
			350 SERIES con motor/FORD V8-360					
ACEITE, 1969-74	G-330	C5RA-6744-C						
ACEITE	GP-1	B7A-6714-A						
AIRE	GA-85	E4TE-9601-EA						
GASOLINA	GG-20	C4AZ-9365-B						
GASOLINA	GG-19	C7AE-9155-A						
			350 SERIES con motor/FORD V8-390					
ACEITE, CARTUCHO	G-330	C5RA-6744-C						
ACEITE, SELLADO	GP-1	B7A-6714-A						
AIRE	GA-85	E4TE-9601-EA						
GASOLINA	GG-20	C4AZ-9365-B						
GASOLINA	GG-19	C7AE-9155-A						
			350 SERIES con motor/FORD V8-400					
ACEITE	GP-1	B7A-6714-A						
AIRE, 1977 EN ADELANTE	GA-75	D2AZ-9601-A						

SERVICIO PESADO

MARCA-MODELO-MOTOR MAKE-MODEL-ENGINE	GONHER GONHER	OEM OEM	MARCA-MODELO-MOTOR MAKE-MODEL-ENGINE	GONHER GONHER	OEM OEM	MARCA-MODELO-MOTOR MAKE-MODEL-ENGINE	GONHER GONHER	OEM OEM
FORD (continuación)			FORD (continuación)			FORD (continuación)		
CAMIONES, TRACTOCAMIONES Y AUTOBUSES			CAMIONES, TRACTOCAMIONES Y AUTOBUSES			CAMIONES, TRACTOCAMIONES Y AUTOBUSES		
700 SERIES con motor/FORD 6-401 (6.6L)			7000 SERIES con motor/FORD 6-363 DIESEL			800 SERIES con motor/FORD V8-389		
COMBUSTIBLE, SEPARADOR DE AGUA HASTA 1991	GPP-14	E7HZ-9N184-A	ACEITE	G-834	2703E-6731-A	ACEITE, FLUJO TOTAL (FULL FLOW)	G-6	CPN-6731-B
ACEITE, 1987 EN ADELANTE	GP-54	F2NN-6714-AA	7000 SERIES con motor/GMC 8.2L DIESEL			ACEITE, SELLADO	GP-31	D3HZ-6731-B
COMBUSTIBLE	GP-1122	E6HZ-9365-C	ACEITE	GP-13	25013454	ACEITE, DERIVACION (BY PASS)	G-500	DOTZ-6731-B
ACEITE, HASTA 1986	GP-77	E7NN-6714-BB	COMBUSTIBLE, PRIMARIO	GP-92	23518527	GASOLINA	GG-20	C4AZ-9365-B
COMBUSTIBLE, SEPARADOR DE AGUA 1991 EN ADELANTE	GPP-1287	F1HZ-9365-A	COMBUSTIBLE, SECUNDARIO	GP-93	23518526	800 SERIES con motor/FORD V8-391		
700 SERIES con motor/FORD V8-292			7000 SERIES con motores/FORD 6-220 DIESEL, FORD 6-242 DIESEL, FORD 6-300 DIESEL			ACEITE, FLUJO TOTAL (FULL FLOW)	G-6	CPN-6731-B
ACEITE, CARTUCHO (1958-63)	G-6	CPN-6731-B	ACEITE	G-836	C7TZ-6731-A	ACEITE, SELLADO 5 13/32 IN	GP-1	B7A-6714-A
ACEITE, CARTUCHO (1963-64)	G-330	C5RA-6744-C	750 SERIES con motor/FORD V8-330			ACEITE, SELLADO 7 17/32 IN	GP-31	D3HZ-6731-B
ACEITE, SELLADO	GP-1	B7A-6714-A	ACEITE, CARTUCHO (1964-74)	G-6	CPN-6731-B	ACEITE, DERIVACION (BY PASS)	G-500	DOTZ-6731-B
GASOLINA	GG-20	C4AZ-9365-B	ACEITE, SELLADO 1964 EN ADELANTE	GP-1	B7A-6714-A	GASOLINA	GG-20	C4AZ-9365-B
700 SERIES con motor/FORD V8-330			GASOLINA	GG-20	C4AZ-9365-B	800 SERIES con motor/FORD V8-429		
ACEITE, CARTUCHO (1964-74)	G-6	CPN-6731-B	750 SERIES con motor/FORD V8-391			ACEITE	GP-1	B7A-6714-A
ACEITE, SELLADO 1964 EN ADELANTE	GP-1	B7A-6714-A	ACEITE, FLUJO TOTAL (FULL FLOW)	G-6	CPN-6731-B	ACEITE, SELLADO	GP-31	D3HZ-6731-B
GASOLINA	GG-20	C4AZ-9365-B	ACEITE, SELLADO 5 13/32 IN	GP-1	B7A-6714-A	AIRE	GA-89	E1HZ-9601-A
700 SERIES con motor/FORD V8-361			ACEITE, SELLADO 7 17/32 IN	GP-31	D3HZ-6731-B	AIRE	GA-529	F1HZ-9601-C
ACEITE, FLUJO TOTAL (FULL FLOW)	G-6	CPN-6731-B	ACEITE, DERIVACION (BY PASS)	G-500	DOTZ-6731-B	GASOLINA	GG-20	C4AZ-9365-B
ACEITE, SELLADO	GP-31	D3HZ-6731-B	GASOLINA	GG-20	C4AZ-9365-B	GASOLINA	GG-19	C7AE-9155-A
ACEITE, DERIVACION (BY PASS)	G-500	DOTZ-6731-B	750 SERIES con motores/FORD V8-361, FORD V8-389			800 SERIES con motores/FORD V8-534, FORD V8-475, FORD V8-477		
GASOLINA	GG-20	C4AZ-9365-B	ACEITE, FLUJO TOTAL (FULL FLOW)	G-6	CPN-6731-B	ACEITE, CARTUCHO	G-5000	DGPN-6731-A
700 SERIES con motor/FORD V8-370			ACEITE, SELLADO	GP-31	D3HZ-6731-B	ACEITE, SELLADO	GP-1	B7A-6714-A
ACEITE, SELLADO	GP-31	D3HZ-6731-B	ACEITE, DERIVACION (BY PASS)	G-500	DOTZ-6731-B	COMBUSTIBLE, SELLADO	GP-1101	BM59678
AIRE	GA-89	E1HZ-9601-A	GASOLINA	GG-20	C4AZ-9365-B	AIRE	GA-89	E1HZ-9601-A
AIRE	GA-529	F1HZ-9601-C	800 SERIES con motor/DETROIT DIESEL 8.2L			8000 SERIES con motor/GMC 8.2L DIESEL		
GASOLINA	GG-20	C4AZ-9365-B	ACEITE	GP-13	25013454	ACEITE	GP-13	25013454
700 SERIES con motor/FORD V8-389			COMBUSTIBLE, PRIMARIO	GP-92	23518527	COMBUSTIBLE, PRIMARIO	GP-92	23518527
ACEITE, FLUJO TOTAL (FULL FLOW)	G-6	CPN-6731-B	COMBUSTIBLE, SECUNDARIO	GP-93	23518526	COMBUSTIBLE, SECUNDARIO	GP-93	23518526
ACEITE, SELLADO	GP-31	D3HZ-6731-B	800 SERIES con motor/FORD 6 CYL. 476 (7.8L) DIESEL			850 SERIES, 900 SERIES con motor/FORD V8-401		
ACEITE, DERIVACION (BY PASS)	G-500	DOTZ-6731-B	COMBUSTIBLE, SEPARADOR DE AGUA HASTA 1991	GPP-14	E7HZ-9N184-A	ACEITE, CARTUCHO	G-5000	DGPN-6731-A
GASOLINA	GG-20	C4AZ-9365-B	ACEITE	GP-54	F2NN-6714-AA	ACEITE, SELLADO	GP-1	B7A-6714-A
700 SERIES con motor/FORD V8-391			COMBUSTIBLE	GP-1122	E6HZ-9365-C	COMBUSTIBLE, SELLADO	GP-1101	BM59678
ACEITE, FLUJO TOTAL (FULL FLOW)	G-6	CPN-6731-B	AGUA	GP-2071W	E7HZ-8A424-B	AIRE	GA-89	E1HZ-9601-A
ACEITE, SELLADO 5 13/32 IN	GP-1	B7A-6714-A	COMBUSTIBLE, SEPARADOR DE AGUA 1991 EN ADELANTE	GPP-1287	F1HZ-9365-A	900 SERIES con motor/FORD 6 CYL. 476 (7.8L) DIESEL		
ACEITE, SELLADO 7 17/32 IN	GP-31	D3HZ-6731-B	800 SERIES con motor/FORD V8-330			COMBUSTIBLE, SEPARADOR DE AGUA HASTA 1991	GPP-14	E7HZ-9N184-A
ACEITE, DERIVACION (BY PASS)	G-500	DOTZ-6731-B	ACEITE, CARTUCHO (1964-74)	G-6	CPN-6731-B	ACEITE	GP-54	F2NN-6714-AA
GASOLINA	GG-20	C4AZ-9365-B	ACEITE, SELLADO 1964 EN ADELANTE	GP-1	B7A-6714-A	COMBUSTIBLE	GP-1122	E6HZ-9365-C
700 SERIES con motor/FORD V8-429			GASOLINA	GG-20	C4AZ-9365-B	AGUA	GP-2071W	E7HZ-8A424-B
ACEITE, SELLADO	GP-31	D3HZ-6731-B	800 SERIES con motor/FORD V8-361			COMBUSTIBLE, SEPARADOR DE AGUA 1991 EN ADELANTE	GPP-1287	F1HZ-9365-A
AIRE	GA-89	E1HZ-9601-A	ACEITE, FLUJO TOTAL (FULL FLOW)	G-6	CPN-6731-B	900 SERIES con motor/FORD V8-429		
AIRE	GA-529	F1HZ-9601-C	ACEITE, SELLADO	GP-31	D3HZ-6731-B	ACEITE	GP-1	B7A-6714-A
GASOLINA	GG-20	C4AZ-9365-B	ACEITE, DERIVACION (BY PASS)	G-500	DOTZ-6731-B	AIRE	GA-529	F1HZ-9601-C
700 SERIES, 750 SERIES, 800 SERIES, 900 SERIES con motor/FORD V8-332			GASOLINA	GG-20	C4AZ-9365-B	GASOLINA	GG-19	C7AE-9155-A
ACEITE	G-6	CPN-6731-B	800 SERIES con motor/FORD V8-370			900 SERIES con motores/FORD V8-475, FORD V8-477, FORD V8-534		
7000 CARGO con motor/FORD 6-401 (6.6L)			ACEITE, SELLADO	GP-31	D3HZ-6731-B	ACEITE, CARTUCHO	G-5000	DGPN-6731-A
COMBUSTIBLE, SEPARADOR DE AGUA HASTA 1991	GPP-14	E7HZ-9N184-A	AIRE	GA-89	E1HZ-9601-A	ACEITE, SELLADO	GP-1	B7A-6714-A
ACEITE, 1987 EN ADELANTE	GP-54	F2NN-6714-AA	AIRE	GA-529	F1HZ-9601-C	COMBUSTIBLE, SELLADO	GP-1101	BM59678
COMBUSTIBLE	GP-1122	E6HZ-9365-C	GASOLINA	GG-20	C4AZ-9365-B	AIRE	GA-89	E1HZ-9601-A
ACEITE, HASTA 1986	GP-77	E7NN-6714-BB	800 SERIES con motor/FORD V8-370			900 SERIES con motores/FORD V8-475, FORD V8-477, FORD V8-534		
COMBUSTIBLE, SEPARADOR DE AGUA 1991 EN ADELANTE	GPP-1287	F1HZ-9365-A	ACEITE, SELLADO	GP-31	D3HZ-6731-B	ACEITE, CARTUCHO	G-5000	DGPN-6731-A

MARCA-MODELO-MOTOR MAKE-MODEL-ENGINE	GONHER GONHER	OEM OEM	MARCA-MODELO-MOTOR MAKE-MODEL-ENGINE	GONHER GONHER	OEM OEM	MARCA-MODELO-MOTOR MAKE-MODEL-ENGINE	GONHER GONHER	OEM OEM
FORD (continuación)			FORD (continuación)			FORD (continuación)		
CAMIONES, TRACTOCAMIONES Y AUTOBUSES			CAMIONES, TRACTOCAMIONES Y AUTOBUSES			CAMIONES, TRACTOCAMIONES Y AUTOBUSES		
C900, C9000 con motores/FORD V8-370 GASOLINA, FORD V8-429 GASOLINA, FORD V8-477 GASOLINA, FORD V8-531 GASOLINA			COMBUSTIBLE	GP-110	1P2299	COMBUSTIBLE	GPP-1122	F3HZ-9365-E
ACEITE	GP-31	D3HZ-6731-B	ACEITE	GP-9586	9N5570	ACEITE	GP-3000	E8HZ-6731-A
						AGUA	GP-2071W	E7HZ-8A424-C
CF600, CF6000 con motor/FORD 6.6L			CF8000 con motor/FORD 6-476			AIRE	GA-197R	F3HZ-9601-A
AGUA	GP-1010Q	E7HZ-8A424-B	COMBUSTIBLE, SEPARADOR DE AGUA HASTA 1991	GPP-14	E7HZ-9N184-A	AIRE, SECUNDARIO	GA-768R	F3HZ-9R500-A
ACEITE, SELLADO	GP-36	F0HZ-6731-B	ACEITE	GP-54	F2NN-6714-AA			
COMBUSTIBLE	GP-1122	E7HZ-9N184-A	COMBUSTIBLE	GP-1122	E6HZ-9365-C	CFT8000, CT8000 con motor/CATERPILLAR 3208		
ACEITE, SELLADO	GP-77	E6HZ-6731-A	AGUA	GP-2071W	E7HZ-8A424-B	ACEITE	GP-36	9L9200
ACEITE, CARTUCHO PARA DERIVACION (BY PASS)	G-750	SFD-28-028	COMBUSTIBLE, SEPARADOR DE AGUA 1991 EN ADELANTE	GPP-1287	F1HZ-9365-A	GASOLINA, SEPARADOR DE AGUA	G-293	6N7617
						COMBUSTIBLE	GP-110	1P2299
CF700, CF7000 con motor/FORD 6.6L			CF8000 con motor/FORD 7.8L DIESEL			ACEITE	GP-9586	9N5570
AGUA	GP-1010Q	E7HZ-8A424-B	AGUA	GP-1010Q	E7HZ-8A424-B	CL900 con motor/CUMMINS		
ACEITE, SELLADO	GP-36	F0HZ-6731-B	ACEITE, SELLADO	GP-36	F0HZ-6731-B	ACEITE, TURBOCARGADOR	GP-14	4041959
COMBUSTIBLE	GP-1122	E7HZ-9365-B	COMBUSTIBLE	GP-1122	E7HZ-9365-B	COMBUSTIBLE, 5 3/4 IN	GPP-14	3315847
ACEITE, SELLADO	GP-77	E6HZ-6731-A	COMBUSTIBLE, SEPARADOR DE AGUA 1991 EN ADELANTE	GPP-1287	F1HZ-9365-A	COMBUSTIBLE, 5 17/32 IN	GP-1101	154711
COMBUSTIBLE, SEPARADOR DE AGUA 1991 EN ADELANTE	GPP-1287	FD-3368	AIRE	GA-197R	F3HZ-9601-A	ACEITE, SELLADO FLUJO TOTAL (FULL FLOW)	GP-53	3313287
ACEITE, CARTUCHO PARA DERIVACION (BY PASS)	G-750	SFD-28-028	ACEITE, CARTUCHO PARA DERIVACION (BY PASS)	G-750	SFD-28-028	COMBUSTIBLE, 11 15/32 IN	GP-55	3313306
						ACEITE, SELLADO DERIVACION (BY PASS)	GP-57	3304232
CF700, CF7000 con motor/FORD 7.8L			CF8000 con motor/FORD FD1460 8.3L			COMBUSTIBLE, SEPARADOR DE AGUA	GPP-11	3600980
AGUA	GP-1010Q	E7HZ-8A424-B	ACEITE	GP-3001	E8HZ-6731-A	AGUA	GP-2071W	3315116
ACEITE, SELLADO	GP-36	F0HZ-6731-B	AGUA	GP-1010Q	F3HZ-8A424-C	AIRE, RESPIRADOR	GA-39	255963
COMBUSTIBLE	GP-1122	E7HZ-9365-B	COMBUSTIBLE	GPP-1122	F3HZ-9365-E	AIRE	GA-106	P117437
ACEITE, SELLADO	GP-77	E6HZ-6731-A	ACEITE	GP-3000	E8HZ-6731-A	AIRE	GA-372	P129472
COMBUSTIBLE, SEPARADOR DE AGUA 1991 EN ADELANTE	GPP-1287	FD-3368	AGUA	GP-2071W	F3HZ-8A424-C	AIRE	GA-6129	P117443
AIRE	GA-197R	F3HZ-9601-D	AIRE, PRIMARIO	GA-197R	F3HZ-9601-D	ACEITE, CARTUCHO PARA DERIVACION (BY PASS)	G-750	SFD-28-028
ACEITE, CARTUCHO PARA DERIVACION (BY PASS)	G-750	SFD-28-028	AIRE, SECUNDARIO	GA-768R	F3HZ-9R500-A			
						CL900, CL9000, CLT9000 con motor/CATERPILLAR 3406		
CF700, CF7000 con motor/FORD FD1460 8.3L			CFT800 con motor/FORD 7.8L			ACEITE, CUMPLE CON MEDIDAS ORIGINALES	GP-691	1R0716
ACEITE	GP-3001	E8HZ-6731-A	AGUA	GP-1010Q	E7HZ-8A424-B	COMBUSTIBLE, PRIMARIO SELLADO	GP-26	311294
AGUA	GP-1010Q	E7HZ-8A424-C	ACEITE, SELLADO	GP-36	F0HZ-6731-B	ACEITE, SEGUNDA OPCION	GP-52	1R0716
COMBUSTIBLE	GPP-1122	F3HZ-9365-E	COMBUSTIBLE	GP-1122	E7HZ-9365-B	COMBUSTIBLE, SELLADO	GP-1108	1R0712
AGUA	GP-2071W	E7HZ-8A424-C	COMBUSTIBLE, SEPARADOR DE AGUA 1991 EN ADELANTE	GPP-1287	FD-3368	AGUA	GP-2071W	311288
AIRE	GA-197R	F3HZ-9601-A	AIRE	GA-197R	F3HZ-9601-D	AIRE	GA-377	D8HZ-9601-B
			ACEITE, CARTUCHO PARA DERIVACION (BY PASS)	G-750	SFD-28-028	AIRE	GA-372	D8HZ-9601-A
CF700, CF8000, CF7000, CF800 con motor/FORD FD1060 5.9L						AIRE, RADIAL	GA-682R	F1HZ-9601-B
COMBUSTIBLE	GPP-1122	F3HZ-9365-E	CFT800 con motor/FORD FD1460 8.3L					
AGUA	GP-2071W	F3HZ-8A424-C	ACEITE	GP-3001	E8HZ-6731-A	CL9000, CLT9000 con motor/GMC 8V-71 SERIES		
ACEITE	GP-178	F3HZ-6731-C	AGUA	GP-1010Q	E7HZ-8A424-C	ACEITE, FLUJO TOTAL (FULL FLOW)	G-33	5573013
AIRE	GA-197R	F3HZ-9601-A	COMBUSTIBLE	GPP-1122	F3HZ-9365-E	COMBUSTIBLE, PRIMARIO	GP-26	8423132
			AGUA	GP-2071W	E7HZ-8A424-C	COMBUSTIBLE, SECUNDARIO	GP-27	23518482
CF800 con motor/FORD 7.8L DIESEL			AIRE	GA-197R	F3HZ-9601-A	AIRE	GA-372	D8HZ-9601-A
AGUA	GP-1010Q	E7HZ-8A424-B	AIRE, SECUNDARIO	GA-768R	F3HZ-9R500-A	AIRE	GA-6129	P117443
ACEITE, SELLADO	GP-36	F0HZ-6731-B				ACEITE, DERIVACION (BY PASS)	G-750	SFD-28-028
COMBUSTIBLE	GP-1122	E7HZ-9365-B	CFT800, CFT8000 con motor/FORD FD1060 5.9L					
COMBUSTIBLE, SEPARADOR DE AGUA 1991 EN ADELANTE	GPP-1287	F1HZ-9365-A	COMBUSTIBLE	GPP-1122	F3HZ-9365-E	CL9000, CLT9000 con motores/GMC 6V-92 SERIES DIESEL, GMC 8V-92 SERIES DIESEL		
AIRE	GA-197R	F3HZ-9601-A	AGUA	GP-2071W	F3HZ-8A424-C	ACEITE, FLUJO TOTAL (FULL FLOW)	G-33	5573013
ACEITE, CARTUCHO PARA DERIVACION (BY PASS)	G-750	SFD-28-028	ACEITE	GP-178	F3HZ-6731-C	COMBUSTIBLE, PRIMARIO	GP-26	8423132
			AIRE	GA-197R	F3HZ-9601-A	COMBUSTIBLE, SECUNDARIO	GP-27	23518482
CF800 con motor/FORD FD1460 8.3L						AIRE	GA-372	D8HZ-9601-A
ACEITE	GP-3001	E8HZ-6731-A	CFT8000 con motor/FORD 7.8L			ACEITE, DERIVACION (BY PASS)	G-750	SFD-28-028
AGUA	GP-1010Q	F3HZ-8A424-C	AGUA	GP-1010Q	E7HZ-8A424-B			
COMBUSTIBLE	GPP-1122	F3HZ-9365-E	ACEITE, SELLADO	GP-36	F0HZ-6731-B	CLT9000, CL900, CL9000 con motores/CUMMINS 855 SERIES, DETROIT DIESEL 92 SERIES		
AGUA	GP-2071W	F3HZ-8A424-C	COMBUSTIBLE	GP-1122	E7HZ-9365-B	AIRE	GA-377	D8HZ-9601-B
AIRE, PRIMARIO	GA-197R	F3HZ-9601-D	COMBUSTIBLE, SEPARADOR DE AGUA 1991 EN ADELANTE	GPP-1287	FD-3368	ACEITE, DERIVACION (BY PASS)	G-750	SFD-28-028
AIRE, SECUNDARIO	GA-768R	F3HZ-9R500-A	AIRE	GA-197R	F3HZ-9601-D			
			ACEITE, CARTUCHO PARA DERIVACION (BY PASS)	G-750	SFD-28-028	CLT9000, CL900, CL9000 con motores/CUMMINS K SERIES, DETROIT DIESEL 71 SERIES		
CF8000 con motor/CATERPILLAR 3208						AIRE	GA-377	D8HZ-9601-B
ACEITE	GP-36	9L9200	CFT8000 con motor/FORD FD1460 8.3L					
GASOLINA, SEPARADOR DE AGUA	G-293	6N7617	ACEITE	GP-3001	E8HZ-6731-A	CLT9000, CL900, CL9000 con motores/CUMMINS K SERIES, DETROIT DIESEL 71 SERIES		
			AGUA	GP-1010Q	E7HZ-8A424-C	AIRE	GA-377	D8HZ-9601-B

MARCA-MODELO-MOTOR MAKE-MODEL-ENGINE	GONHER GONHER	OEM OEM
FORD (continuación)		
CAMIONES, TRACTOCAMIONES Y AUTOBUSES		
CT600, CT6000 con motores/FORD V8-370 GASOLINA, FORD V8-429 GASOLINA, FORD V8-477 GASOLINA, FORD V8-531 GASOLINA		
ACEITE	GP-31	D3HZ-6731-B
CT7000 con motor/CATERPILLAR 3208		
ACEITE	GP-36	9L9200
CT8000 con motor/CATERPILLAR 1100 SERIES		
ACEITE	GP-36	9N5680
ACEITE, CARTUCHO PARA DERIVACION (BY PASS)	G-750	SFD-28-028
GASOLINA	GG-46	311628
CT8000 con motor/CUMMINS V555		
COMBUSTIBLE	GP-1101	154711
ACEITE, SELLADO FLUJO TOTAL (FULL FLOW)	GP-53	3313287
AGUA	GP-2071W	3315116
CT900 con motor/DETROIT DIESEL 8.2L		
ACEITE	GP-13	25013454
COMBUSTIBLE, PRIMARIO	GP-92	23518527
COMBUSTIBLE, SECUNDARIO	GP-93	23518526
CT900, CT9000 con motores/FORD V8-370 GASOLINA, FORD V8-429 GASOLINA, FORD V8-477 GASOLINA, FORD V8-531 GASOLINA		
ACEITE	GP-31	D3HZ-6731-B
E150, E250 VAN con motor/FORD V6 256 (4.2L)		
ACEITE	GP-3600	E4FZ-6731-A
AIRE	GA-1615	F50Z-9601-BA
GASOLINA, HASTA 2002	GG-1872	F0TZ-9155-B
GASOLINA, 2002 EN ADELANTE	GG-986	F89Z-9155-A
E250 VAN con motor/FORD V8 330 (5.4L)		
ACEITE	GP-68	F1AZ-6731-BD
AIRE	GA-1615	F50Z-9601-BA
GASOLINA, HASTA 2003	GG-1872	F0TZ-9155-B
GASOLINA, 2003 EN ADELANTE	GG-986	F89Z-9155-A
E350 VAN con motores/FORD V10- 415 (6.8L), FORD V8 330 (5.4L)		
ACEITE	GP-68	F1AZ-6731-BD
AIRE	GA-1615	F50Z-9601-BA
GASOLINA, HASTA 2003	GG-1872	F0TZ-9155-B
GASOLINA, 2003 EN ADELANTE	GG-986	F89Z-9155-A
E450 VAN con motor/FORD V10- 415 (6.8L)		
ACEITE	GP-68	F1AZ-6731-BD
AIRE	GA-1615	F50Z-9601-BA
GASOLINA, HASTA 2003	GG-1872	F0TZ-9155-B
GASOLINA, 2003 EN ADELANTE	GG-986	F89Z-9155-A
E450 VAN con motor/FORD V8-363 (6.0L) TURBO DIESEL		
ACEITE	G-3752	FL2016
ECS 302, ECT 332 con motor/A DIESEL		
ACEITE	G-6	CPN-6731-B
EEH, EEJ, EEK 292 con motor/A DIESEL		
ACEITE	G-330	CSRA-6744-C

MARCA-MODELO-MOTOR MAKE-MODEL-ENGINE	GONHER GONHER	OEM OEM
FORD (continuación)		
CAMIONES, TRACTOCAMIONES Y AUTOBUSES		
F250 SUPER DUTY, F350 SUPER DUTY con motor/FORD V10 415 (6.8L)		
ACEITE	GP-68	F1AZ-6731-BD
AIRE	GA-1615	F50Z-9601-BA
GASOLINA	GG-1872	F0TZ-9155-B
F250 SUPER DUTY, F350 SUPER DUTY con motor/FORD V8 330 (5.4L)		
ACEITE	GP-68	F1AZ-6731-BD
AIRE	GA-5056	E5TZ-9601-B
AIRE	GA-1615	F50Z-9601-BA
GASOLINA	GG-1872	F0TZ-9155-B
F250 SUPER DUTY, F350 SUPER DUTY con motor/FORD V8 444 (7.3L) DIESEL		
ACEITE	GP-3766	E3TZ-6731-A
F250 SUPER DUTY, F350 SUPER DUTY con motor/FORD V8 444 (7.3L) TURBO DIESEL		
COMBUSTIBLE, CARTUCHO (1999 EN ADELANTE)	G-862	F81Z-9N184-AA
COMBUSTIBLE, CARTUCHO (HASTA 1999)	G-178	1822631C91
ACEITE, 1993-94	GP-3766	E3TZ-6731-A
AIRE, HASTA 1998	GA-422	E5HZ-9601-B
AIRE, 1999-2001	GA-780	XC3Z-9601-AA
AIRE, 1994-98	GA-442	F5TZ-9601-A
F450 con motor/FORD 6.0L DIESEL		
COMBUSTIBLE	G-1047	FD4604
F550 con motor/FORD 6.0L DIESEL		
COMBUSTIBLE (2003 EN ADELANTE)	G-1047	FD-4604
F550 con motor/FORD V10 415 (6.8L)		
ACEITE	GP-68	F1AZ-6731-BD
AIRE, 1999-2004	GA-1615	F50Z-9601-BA
GASOLINA, 1999-2004	GG-1872	F0TZ-9155-B
GASOLINA	GG-101	FG1011
F550 con motor/FORD V8 444 (7.3L) TURBO DIESEL		
COMBUSTIBLE, CARTUCHO (1998-2003)	G-862	F81Z-9N184-AA
COMBUSTIBLE, CARTUCHO (1994-97)	G-178	1822631C91
ACEITE, 1988-95	GP-3766	E3TZ-6731-A
ACEITE, 1994-2003	GP-562	F4TZ-6731-A
AIRE, CIRCULAR (1988-95)	GA-3501	E3TZ-9601-C
AIRE, RECTANGULAR (HASTA 12 JULIO 1998)	GA-472	F81A-9601-AA
AIRE, 1999 EN ADELANTE	GA-780	XC3Z-9601-AA
AIRE, OVALADO (1994-98)	GA-442	F5TZ-9601-A
F550 con motor/FORD V8 6.4L TURBO DIESEL		
ACEITE	G-3752	FL2016
F600 con motor/FORD A GASOLINA		
ACEITE	GP-31	D3HZ-6731-B
COMBUSTIBLE	GP-1122	E6HZ-9365-C
GASOLINA	GG-1872	F0TZ-9155-B
F600 con motor/FORD FD1060 5.9L		
COMBUSTIBLE, SEPARADOR DE AGUA	GPP-1122	F3HZ-9365-E
AGUA	GP-2071W	F3HZ-8A424-C
ACEITE	GP-178	F3HZ-6731-C
AIRE, PRIMARIO	GA-197R	F3HZ-9601-D
AIRE, SECUNDARIO	GA-768R	F3HZ-9R500-A

MARCA-MODELO-MOTOR MAKE-MODEL-ENGINE	GONHER GONHER	OEM OEM
FORD (continuación)		
CAMIONES, TRACTOCAMIONES Y AUTOBUSES		
F600 con motor/FORD V8-370 GASOLINA		
ACEITE	GP-31	D3HZ-6731-B
F600 con motor/FORD V8-429 GASOLINA		
ACEITE	GP-31	D3HZ-6731-B
COMBUSTIBLE	GP-1122	E6HZ-9365-C
AIRE	GA-529	F1HZ-9601-A
F600 con motor/FORD V8-429 LGP		
ACEITE	GP-31	D3HZ-6731-B
F600 con motores/FORD 6.6L, FORD 7.8L		
AGUA	GP-1010Q	E7HZ-8A424-B
ACEITE, SELLADO	GP-36	F0HZ-6731-B
COMBUSTIBLE	GP-1122	E6HZ-9365-C
COMBUSTIBLE	GPP-1287	F1HZ-9365-A
ACEITE, CARTUCHO PARA DERIVACION (BY PASS)	G-750	SFD-28-028
F600, F6000 con motor/FORD FD1460 8.3L		
ACEITE	GP-3001	E8HZ-6731-A
COMBUSTIBLE	GPP-1122	F3HZ-9365-E
AGUA	GP-2071W	F3HZ-8A424-C
AIRE	GA-197R	F3HZ-9601-D
F6000 con motor/FORD A GASOLINA		
ACEITE	GP-31	D3HZ-6731-B
COMBUSTIBLE	GP-1122	E6HZ-9365-C
GASOLINA	GG-1872	F0TZ-9155-B
F6000 con motor/FORD FD1060 5.9L		
COMBUSTIBLE, SEPARADOR DE AGUA	GPP-1122	F3HZ-9365-E
AGUA	GP-2071W	F3HZ-8A424-C
ACEITE	GP-178	F3HZ-6731-C
AIRE, PRIMARIO	GA-197R	F3HZ-9601-D
AIRE, SECUNDARIO	GA-768R	F3HZ-9R500-A
F6000 con motor/FORD V8-370 GASOLINA		
ACEITE	GP-31	D3HZ-6731-B
F6000 con motor/FORD V8-429 GASOLINA		
ACEITE	GP-31	D3HZ-6731-B
COMBUSTIBLE	GP-1122	E6HZ-9365-C
AIRE	GA-529	F1HZ-9601-A
F6000 con motor/FORD V8-429 LGP		
ACEITE	GP-31	D3HZ-6731-B
F6000 con motores/CATERPILLAR 1140, CATERPILLAR 1145, CATERPILLAR 1150, CATERPILLAR 1160		
ACEITE, SELLADO	GP-36	9N5680
ACEITE, CARTUCHO PARA DERIVACION (BY PASS)	G-750	SFD-28-028
GASOLINA	GG-46	311628
F6000 con motores/FORD 6.6L, FORD 7.8L		
AGUA	GP-1010Q	E7HZ-8A424-B
ACEITE, SELLADO	GP-36	F0HZ-6731-B
COMBUSTIBLE	GP-1122	E6HZ-9365-C
COMBUSTIBLE	GPP-1287	F1HZ-9365-A
ACEITE, CARTUCHO PARA DERIVACION (BY PASS)	G-750	SFD-28-028

SERVICIO PESADO

MARCA-MODELO-MOTOR MAKE-MODEL-ENGINE	GONHER GONHER	OEM OEM	MARCA-MODELO-MOTOR MAKE-MODEL-ENGINE	GONHER GONHER	OEM OEM	MARCA-MODELO-MOTOR MAKE-MODEL-ENGINE	GONHER GONHER	OEM OEM
FORD (continuación)			FORD (continuación)			FORD (continuación)		
CAMIONES, TRACTOCAMIONES Y AUTOBUSES			CAMIONES, TRACTOCAMIONES Y AUTOBUSES			CAMIONES, TRACTOCAMIONES Y AUTOBUSES		
F650 con motor/CATERPILLAR 3126B			F7000 con motor/CATERPILLAR 3208			F800 con motor/FORD A GASOLINA		
ACEITE	GP-51	1R1807	ACEITE	GP-36	9L9200	ACEITE	GP-31	D3HZ-6731-B
COMBUSTIBLE, ALT. 5 13/32 IN	GP-62	1R0751				COMBUSTIBLE	GP-1122	E6HZ-9365-C
COMBUSTIBLE, ALT. 7 13/32 IN	GP-1109	1R0751				GASOLINA	GG-1872	F0TZ-9155-B
AIRE	GA-966R	YC3Z-9601-FA	F7000 con motor/FORD FD1060 5.9L			F800 con motor/FORD FD1060 (5.9L)		
			COMBUSTIBLE, SEPARADOR DE AGUA	GPP-1122	F3HZ-9365-E	COMBUSTIBLE, SEPARADOR DE AGUA	GPP-1122	F3HZ-9365-E
F650 con motor/CATERPILLAR C7 DIESEL			AGUA	GP-2071W	F3HZ-8A424-C	ACEITE	GP-178	F3HZ-6731-B
ACEITE	GP-51	1R0739	AIRE, PRIMARIO	GA-197R	F3HZ-9601-D	AIRE, PRIMARIO	GA-197R	F3HZ-9601-A
COMBUSTIBLE, SECUNDARIO	GP-1109	1R-0751	AIRE, SECUNDARIO	GA-768R	F3HZ-9R500-A	AIRE, SECUNDARIO	GA-768R	F3HZ-9F500-A
AIRE	GA-966R	YC3Z-9601-FA	F7000 con motor/FORD FD1460 8.3L			F800 con motor/FORD FD1460 8.3L		
			ACEITE	GP-3001	E8HZ-6731-A	ACEITE	GP-3001	E8HZ-6731-A
F650 con motor/CUMMINS ISB DIESEL			COMBUSTIBLE	GPP-1122	F3HZ-9365-E	COMBUSTIBLE, SEPARADOR DE AGUA	GPP-1122	F3HZ-9365-E
TRANSMISION	GP-66	D8NMF-933-AB	AGUA	GP-2071W	F3HZ-8A424-C	ACEITE	GP-3000	E8HZ-6731-A
ACEITE	GP-3937	3937144	AIRE, PRIMARIO	GA-197R	F3HZ-9601-D	AGUA	GP-2071W	F3HZ-8A424-C
COMBUSTIBLE	GS-1261	3942470	AIRE, SECUNDARIO	GA-768R	F3HZ-9R500-A	AIRE, PRIMARIO	GA-197R	F3HZ-9601-D
AIRE, PRIMARIO	GA-197R	F3HZ-9601-D				AIRE, SECUNDARIO	GA-768R	F3HZ-9602-A
AIRE	GA-966R	P532966	F7000 con motor/FORD V8-429 GASOLINA			F800 con motor/FORD V8-370 GASOLINA		
			ACEITE	GP-31	D3HZ-6731-B	ACEITE	GP-31	D3HZ-6731-B
F650 con motor/FORD 7.3L TURBO DIESEL			COMBUSTIBLE	GP-1122	E6HZ-9365-C	COMBUSTIBLE	GP-1122	E6HZ-9365-C
COMBUSTIBLE, SEPARADOR DE AGUA	G-862	F81Z-9N184-AA	AIRE	GA-529	F1HZ-9601-A	AIRE	GA-422	E5HZ-9601-B
ACEITE	GP-562	F4TZ-6731-A	F7000 con motores/CATERPILLAR 1140, CATERPILLAR 1145, CATERPILLAR 1150, CATERPILLAR 1160			F800 con motor/FORD V8-429 GASOLINA		
AIRE	GA-197R	YC3Z-9600-BA	ACEITE, SELLADO	GP-36	9N5680	ACEITE	GP-31	D3HZ-6731-B
			ACEITE, CARTUCHO PARA DERIVACION (BY PASS)	G-750	SFD-28-028	COMBUSTIBLE	GP-1122	E6HZ-9365-C
F650 con motor/FORD V8 6.0L TURBO DIESEL			GASOLINA	GG-46	311628	AIRE	GA-422	E5HZ-9601-B
COMBUSTIBLE, SEPARADOR DE AGUA	G-862	F81Z-9N184-AA	F7000 con motores/FORD 6.6L, FORD 7.8L			F800 con motor/FORD V8-429 GASOLINA		
COMBUSTIBLE	G-1047	FD4604	AGUA	GP-1010Q	E7HZ-8A424-B	ACEITE	GP-31	D3HZ-6731-B
ACEITE	G-3752	3C3Z-6731-AA	ACEITE, SELLADO	GP-36	F0HZ-6731-B	COMBUSTIBLE	GP-1122	E6HZ-9365-C
AGUA, REFRIGERANTE	GP-2071W	WF2071	COMBUSTIBLE	GP-1122	E6HZ-9365-C	AIRE	GA-422	E5HZ-9601-B
			COMBUSTIBLE, SEPARADOR DE AGUA	GPP-1287	F1HZ-9365-A	AIRE	GA-529	F1HZ-9601-A
F700 con motor/FORD FD1060 5.9L			ACEITE, CARTUCHO PARA DERIVACION (BY PASS)	G-750	SFD-28-028	F800, F8000 con motor/CUMMINS 5.9L DIESEL		
COMBUSTIBLE, SEPARADOR DE AGUA	GPP-1122	F3HZ-9365-E	F7000 con motores/FORD A GASOLINA, FORD V8-370 GASOLINA			ACEITE		
AGUA	GP-2071W	F3HZ-8A424-C	ACEITE	GP-31	D3HZ-6731-B	GP-178		
ACEITE	GP-178	F3HZ-6731-C	COMBUSTIBLE	GP-1122	E6HZ-9365-C	F3HZ-6731-A		
AIRE, PRIMARIO	GA-197R	F3HZ-9601-D	GASOLINA	GG-1872	F0TZ-9155-B	F800, F8000 con motor/FORD V8-429 LPG		
AIRE, SECUNDARIO	GA-768R	F3HZ-9R500-A	F750 con motor/CUMMINS ISB			ACEITE		
			ACEITE	GP-3937	3937144	GP-31		
F700 con motor/FORD FD1460 8.3L			COMBUSTIBLE, SEPARADOR DE AGUA	GS-1261	3942470	D3HZ-6731-B		
ACEITE	GP-3001	E8HZ-6731-A	AIRE	GA-197R	F3HZ-9601-D	E6HZ-9365-C		
COMBUSTIBLE	GPP-1122	F3HZ-9365-E	F750 con motor/FORD 7.3L TURBO DIESEL			F8000 con motor/CATERPILLAR 3208		
AGUA	GP-2071W	F3HZ-8A424-C	COMBUSTIBLE, SEPARADOR DE AGUA	G-862	F81Z-9N184-AA	ACEITE	GP-36	9L9200
AIRE, PRIMARIO	GA-197R	F3HZ-9601-D	ACEITE	GP-562	F4TZ-6731-A	GASOLINA, SEPARADOR DE AGUA	G-293	6N7617
AIRE, SECUNDARIO	GA-768R	F3HZ-9R500-A	AIRE	GA-197R	YC3Z-9600-BA	COMBUSTIBLE	GP-110	1P2299
			F750 con motor/FORD V8 6.0L TURBO DIESEL			ACEITE	GP-9586	9N5570
F700 con motor/FORD V8-429 GASOLINA			COMBUSTIBLE (2003-05)	G-862	FD4596	F8000 con motor/FORD A GASOLINA		
ACEITE	GP-31	D3HZ-6731-B	COMBUSTIBLE	G-1047	3C3Z-9N184-CA	ACEITE	GP-31	D3HZ-6731-B
COMBUSTIBLE	GP-1122	E6HZ-9365-C	COMBUSTIBLE	G-3752	3C3Z-6731-AA	COMBUSTIBLE	GP-1122	E6HZ-9365-C
AGUA	GG-1872	F0TZ-9155-B	COMBUSTIBLE	GP-2071W	WF2071	GASOLINA	GG-1872	F0TZ-9155-B
			F700 con motores/FORD A GASOLINA, FORD V8-370 GASOLINA			F8000 con motor/FORD FD1060 (5.9L)		
F700 con motores/FORD 6.6L, FORD 7.8L			ACEITE	GP-31	D3HZ-6731-B	COMBUSTIBLE, SEPARADOR DE AGUA	GPP-1122	F3HZ-9365-E
AGUA	GP-1010Q	E7HZ-8A424-B	AGUA, REFRIGERANTE	GP-2071W	WF2071	ACEITE	GP-178	F3HZ-6731-B
ACEITE, SELLADO	GP-36	F0HZ-6731-B	F750 con motores/CATERPILLAR 3126B, CATERPILLAR C7 DIESEL			AIRE, PRIMARIO	GA-197R	F3HZ-9601-A
COMBUSTIBLE	GP-1122	E6HZ-9365-C	ACEITE	GP-51	1R0739	AIRE, SECUNDARIO	GA-768R	F3HZ-9F500-A
COMBUSTIBLE, SEPARADOR DE AGUA	GPP-1287	F1HZ-9365-A	COMBUSTIBLE, SECUNDARIO	GP-1109	1R-0751			
ACEITE, CARTUCHO PARA DERIVACION (BY PASS)	G-750	SFD-28-028	AIRE	GA-966R	YC3Z-9601-FA			

MARCA-MODELO-MOTOR MAKE-MODEL-ENGINE	GONHER GONHER	OEM OEM	MARCA-MODELO-MOTOR MAKE-MODEL-ENGINE	GONHER GONHER	OEM OEM	MARCA-MODELO-MOTOR MAKE-MODEL-ENGINE	GONHER GONHER	OEM OEM
FORD (continuación)			FORD (continuación)			FORD (continuación)		
CAMIONES, TRACTOCAMIONES Y AUTOBUSES			CAMIONES, TRACTOCAMIONES Y AUTOBUSES			CAMIONES, TRACTOCAMIONES Y AUTOBUSES		
F8000 con motor/FORD FD1460 8.3L			FT900, FT9000 con motores/FORD 6.6L, FORD 7.8L			L8000 con motor/FORD 6-476 (7.8L)		
ACEITE	GP-3001	E8HZ-6731-A	AGUA	GP-1010Q	E7HZ-8A424-B	COMBUSTIBLE, SEPARADOR DE AGUA HASTA 1991	GPP-14	E7HZ-9N184-A
COMBUSTIBLE, SEPARADOR DE AGUA	GPP-1122	F3HZ-9365-E	ACEITE	GP-36	F0HZ-6731-B	ACEITE	GP-54	F2NN-6714-AA
AGUA	GP-2071W	F3HZ-8A424-C	COMBUSTIBLE	GP-1122	E6HZ-9365-C	COMBUSTIBLE	GP-1122	E6HZ-9365-C
AIRE, PRIMARIO	GA-197R	F3HZ-9601-D	COMBUSTIBLE, SEPARADOR DE AGUA	GPP-1287	F1HZ-9365-A	AGUA	GP-2071W	E7HZ-8A424-B
AIRE, SECUNDARIO	GA-768R	F3HZ-9602-A	ACEITE, CARTUCHO PARA DERIVACION (BY PASS)	G-750	SFD-28-028	COMBUSTIBLE, SEPARADOR DE AGUA 1991 EN ADELANTE	GPP-1287	F1HZ-9365-A
F8000 con motor/FORD V8-370 GASOLINA			FT9000 con motor/FORD 8.3L			L8000 con motor/FORD A GASOLINA		
ACEITE	GP-31	D3HZ-6731-B	COMBUSTIBLE, SEPARADOR DE AGUA	GPP-1122	F3HZ-9365-E	AIRE	GA-422	E5HZ-9601-B
COMBUSTIBLE	GP-1122	E6HZ-9365-C	AIRE, PRIMARIO	GA-197R	F3HZ-9601-A	L8000 con motor/FORD FD1460 8.3L		
AIRE	GA-422	E5HZ-9601-B	AIRE, SECUNDARIO	GA-768R	F3HZ-9F500-A	ACEITE	GP-3001	E8HZ-6731-A
F8000 con motor/FORD V8-429 GASOLINA			FT9000 con motor/FORD V8-370 GASOLINA			AGUA		
ACEITE	GP-31	D3HZ-6731-B	ACEITE	GP-31	D3HZ-6731-B	COMBUSTIBLE, SEPARADOR DE AGUA	GPP-1122	F3HZ-9365-E
COMBUSTIBLE	GP-1122	E6HZ-9365-C	COMBUSTIBLE	GP-1122	E6HZ-9365-C	ACEITE	GP-3000	E8HZ-6731-A
AIRE	GA-422	E5HZ-9601-B	AIRE	GA-422	E5HZ-9601-B	AIRE, PRIMARIO	GA-197R	F3HZ-9601-D
AIRE	GA-529	F1HZ-9601-A	L800 con motor/CATERPILLAR			AIRE, SECUNDARIO	GA-768R	F3HZ-9R500-A
FT7000 con motor/CATERPILLAR 3208			L800 con motor/CATERPILLAR			L8000 con motor/GMC 6V-53 DIESEL		
ACEITE	GP-36	9L9200	AIRE	GA-682R	F1HZ-9601-B	ACEITE, DERIVACION (BY PASS)	G-31	1595410
FT800, FT8000 con motores/FORD 6.6L, FORD 7.8L			L800 con motor/FORD 6-476 (7.8L)			ACEITE, FLUJO TOTAL (FULL FLOW)		
AGUA	GP-1010Q	E7HZ-8A424-B	AGUA	GP-1010Q	E7HZ-8A424-B	COMBUSTIBLE, SECUNDARIO	G-1173	3290851
ACEITE	GP-36	F0HZ-6731-B	ACEITE, SELLADO	GP-36	F0HZ-6731-B	L8000 con motores/CATERPILLAR 1145, CATERPILLAR 1150, CATERPILLAR 1160		
COMBUSTIBLE	GP-1122	E6HZ-9365-C	COMBUSTIBLE	GP-1122	E7HZ-9365-B	ACEITE, SELLADO	GP-36	9N5680
ACEITE	G-750	SFD-28-028	COMBUSTIBLE, SEPARADOR DE AGUA 1991 EN ADELANTE	GPP-1287	F1HZ-9365-A	GASOLINA, SEPARADOR DE AGUA	G-293	6N7617
FT800, FT8000 con motores/FORD V8-370 GASOLINA, FORD V8-429 GASOLINA			ACEITE, CARTUCHO PARA DERIVACION (BY PASS)			COMBUSTIBLE		
ACEITE	GP-31	D3HZ-6731-B	L800 con motor/FORD A GASOLINA			ACEITE, CARTUCHO PARA DERIVACION (BY PASS)	G-750	SFD-28-028
COMBUSTIBLE	GP-1122	E6HZ-9365-C	AIRE	GA-422	E5HZ-9601-B	L8000 con motores/CUMMINS, DETROIT DIESEL		
AIRE	GA-422	E5HZ-9601-B	L800 con motor/FORD FD1460 8.3L			AIRE		
FT8000 con motor/CATERPILLAR 3208			L800 con motor/FORD 6-476 (7.8L)			L900 con motor/CATERPILLAR		
ACEITE	GP-36	9L9200	ACEITE	GP-3001	E8HZ-6731-A	AIRE	GA-682R	F1HZ-9601-B
GASOLINA, SEPARADOR DE AGUA	G-293	6N7617	COMBUSTIBLE, SEPARADOR DE AGUA	GPP-1122	F3HZ-9365-E	L900 con motor/FORD A GASOLINA		
COMBUSTIBLE	GP-110	1P2299	AGUA	GP-2071W	F3HZ-8A424-C	AIRE	GA-422	E5HZ-9601-B
ACEITE	GP-9586	9N5570	AIRE, PRIMARIO	GA-197R	F3HZ-9601-D	L900 con motores/CUMMINS, DETROIT DIESEL		
FT900 con motor/DETROIT DIESEL 8.2L			AIRE, SECUNDARIO	GA-768R	F3HZ-9R500-A	AIRE		
ACEITE	GP-13	25013454	L800 con motores/CUMMINS, DETROIT DIESEL			L900 con motores/CUMMINS, DETROIT DIESEL		
COMBUSTIBLE, PRIMARIO	GP-92	23518527	AIRE	GA-682R	F1HZ-9601-B	AIRE		
COMBUSTIBLE, SECUNDARIO	GP-93	23518526	L8000 con motor/CATERPILLAR			L900, L9000 con motor/FORD 7.8L		
FT900 con motor/FORD 8.3L			L8000 con motor/CATERPILLAR 3208			AGUA		
COMBUSTIBLE, SEPARADOR DE AGUA	GPP-1122	F3HZ-9365-E	ACEITE	GP-36	9L9200	ACEITE, SELLADO	GP-36	F0HZ-6731-B
ACEITE	GP-3000	E8HZ-6731-A	GASOLINA, SEPARADOR DE AGUA	G-293	6N7617	COMBUSTIBLE	GP-1122	E7HZ-9365-B
AIRE, PRIMARIO	GA-197R	F3HZ-9601-A	COMBUSTIBLE	GP-110	1P2299	COMBUSTIBLE, SEPARADOR DE AGUA	GPP-1287	F1HZ-9365-A
AIRE, SECUNDARIO	GA-768R	F3HZ-9F500-A	ACEITE	GP-9586	9N5570	ACEITE, CARTUCHO PARA DERIVACION (BY PASS)	G-750	SFD-28-028
FT900 con motor/FORD V8-370 GASOLINA			L8000 con motor/CUMMINS V555			L900, L9000 con motor/FORD FD1460 8.3L		
ACEITE	GP-31	D3HZ-6731-B	COMBUSTIBLE	GP-1101	154711	ACEITE	GP-3001	E8HZ-6731-A
COMBUSTIBLE	GP-1122	E6HZ-9365-C	ACEITE, SELLADO FLUJO TOTAL (FULL FLOW)	GP-53	3313287	COMBUSTIBLE	GPP-1122	F3HZ-9365-E
AIRE	GA-422	E5HZ-9601-B	AGUA	GP-2071W	3315116	AGUA	GP-2071W	F3HZ-8A424-C
FT900, FT9000 con motor/FORD V8-429 GASOLINA			L8000 con motor/CUMMINS VT225			L9000 con motor/CATERPILLAR		
ACEITE	GP-31	D3HZ-6731-B	COMBUSTIBLE	GP-1101	154711	AIRE	GA-682R	F1HZ-9601-B
COMBUSTIBLE	GP-1122	E6HZ-9365-C	AGUA	GP-2071W	3315116	L9000 con motor/CUMMINS L10		
AIRE	GA-529	F1HZ-9601-A	ACEITE, DERIVACION (BY PASS)	G-500	256839	AGUA		
GASOLINA	GG-1872	F0TZ-9155-B	FT900, FT9000 con motor/FORD V8-429 LPG			ACEITE		
FT900, FT9000 con motor/FORD V8-429 LPG			ACEITE			GP-31		
ACEITE			GP-31			D3HZ-6731-B		

SERVICIO PESADO

MARCA-MODELO-MOTOR MAKE-MODEL-ENGINE	GONHER GONHER	OEM OEM	MARCA-MODELO-MOTOR MAKE-MODEL-ENGINE	GONHER GONHER	OEM OEM	MARCA-MODELO-MOTOR MAKE-MODEL-ENGINE	GONHER GONHER	OEM OEM
FORD (continuación)			FORD (continuación)			FORD (continuación)		
CAMIONES, TRACTOCAMIONES Y AUTOBUSES			CAMIONES, TRACTOCAMIONES Y AUTOBUSES			CAMIONES, TRACTOCAMIONES Y AUTOBUSES		
L9000 con motor/DETROIT DIESEL SERIES 60			L9513 con motor/CUMMINS N14			COMBUSTIBLE, 5 17/32 IN	GP-1101	154711
COMBUSTIBLE, PRIMARIO	GP-26	8423132	COMBUSTIBLE, SEPARADOR DE AGUA	GPP-11	3600980	ACEITE, SELLADO FLUJO TOTAL (FULL FLOW)	GP-53	3313287
COMBUSTIBLE, SECUNDARIO	GP-27	23518482	ACEITE	GP-3000	3318853	COMBUSTIBLE, 11 15/32 IN	GP-55	3313306
ACEITE, FLUJO TOTAL (FULL FLOW)	GP-53	PF911	AIRE, RADIAL	GA-682R	F1HZ-9601-B	ACEITE, SELLADO DERIVACION (BY PASS)	GP-57	3304232
ACEITE, DERIVACION (BY PASS)	GP-57	P940				COMBUSTIBLE, SEPARADOR DE AGUA	GPP-11	3600980
AGUA	GP-2071W	WF100	L9513 con motor/DETROIT DIESEL SERIES 60			ACEITE	GP-3000	3318853
ACEITE, FLUJO TOTAL (FULL FLOW)	GP-193	PF2100	COMBUSTIBLE, PRIMARIO	GP-26	8423132	AGUA	GP-2071W	3315116
			COMBUSTIBLE, SECUNDARIO	GP-27	23518482	AIRE, RESPIRADOR	GA-39	255963
L9000 con motor/FORD A GASOLINA			ACEITE, FLUJO TOTAL (FULL FLOW) HASTA 1993	GP-53	PF911	AIRE	GA-106	P117437
AIRE	GA-422	ESHZ-9601-B	ACEITE, DERIVACION (BY PASS)	GP-57	P940	AIRE	GA-372	P129472
			ACEITE, FLUJO TOTAL (FULL FLOW) 1993 EN ADELANTE	GP-193	PF2100	AIRE	GA-6129	P117443
L9000 con motor/GMC 6-71N DIESEL						ACEITE, CARTUCHO PARA DERIVACION (BY PASS)	G-750	SFD-28-028
ACEITE, FLUJO TOTAL (FULL FLOW)	G-33	5573013	LA800, LLA900 con motores/DETROIT DIESEL, CATERPILLAR, CUMMINS					
COMBUSTIBLE, PRIMARIO	GP-26	8423132	AIRE	GA-682R	F1HZ-9601-B	LN6000, LN7000 con motores/CATERPILLAR 1140, CATERPILLAR 1145, CATERPILLAR 1150, CATERPILLAR 1160		
COMBUSTIBLE, SECUNDARIO	GP-27	23518482				ACEITE, SELLADO	GP-36	9N5680
AIRE, CUMMINS	GA-106	P117437	LA8000 con motor/FORD FD1460 8.3L			ACEITE, CARTUCHO PARA DERIVACION (BY PASS)	G-750	SFD-28-028
AIRE, KOMATSU	GA-326	P117437	AGUA	GP-1010Q	E7HZ-8A424-B	GASOLINA	GG-46	311628
ACEITE, DERIVACION (BY PASS)	G-750	SFD-28-028	COMBUSTIBLE, SEPARADOR DE AGUA	GPP-1122	F3HZ-9365-E			
			ACEITE	GP-3000	E8HZ-6731-A	LN7000 con motor/CATERPILLAR 3208		
L9000 con motor/GMC 8V-71 SERIES			AIRE, PRIMARIO	GA-197R	F3HZ-9601-D	ACEITE	GP-36	9L9200
ACEITE, FLUJO TOTAL (FULL FLOW)	G-33	5573013	AIRE, SECUNDARIO	GA-768R	F3HZ-9R500-A			
COMBUSTIBLE, PRIMARIO	GP-26	8423132				LN7000 con motor/FORD FD1060 5.9L		
COMBUSTIBLE, SECUNDARIO	GP-27	23518482	LA900 con motores/CATERPILLAR, CUMMINS, DETROIT DIESEL			COMBUSTIBLE, SEPARADOR DE AGUA	GPP-1122	F3HZ-9365-E
AIRE	GA-372	D8HZ-9601-A	AIRE	GA-682R	F1HZ-9601-B			
AIRE	GA-6129	P117443				LN800 con motor/CATERPILLAR		
ACEITE, DERIVACION (BY PASS)	G-750	SFD-28-028	LA9000 con motor/DETROIT DIESEL SERIES 60			AIRE	GA-682R	F1HZ-9601-B
			COMBUSTIBLE, PRIMARIO	GP-26	8423132	LN800 con motor/FORD 6-476 (7.8L)		
L9000 con motores/GMC 6V-92 SERIES DIESEL, GMC 8V-92 SERIES DIESEL			COMBUSTIBLE, SECUNDARIO	GP-27	23518482	AGUA	GP-1010Q	E7HZ-8A424-B
ACEITE, FLUJO TOTAL (FULL FLOW)	G-33	5573013	ACEITE, FLUJO TOTAL (FULL FLOW)	GP-53	PF911	ACEITE, SELLADO	GP-36	F0HZ-6731-B
COMBUSTIBLE, PRIMARIO	GP-26	8423132	ACEITE, DERIVACION (BY PASS)	GP-57	P940	COMBUSTIBLE	GP-1122	E7HZ-9365-B
COMBUSTIBLE, SECUNDARIO	GP-27	23518482	AGUA	GP-2071W	WF100	COMBUSTIBLE, SEPARADOR DE AGUA 1991 EN ADELANTE	GPP-1287	F1HZ-9365-A
AIRE	GA-372	D8HZ-9601-A	ACEITE, FLUJO TOTAL (FULL FLOW)	GP-193	PF2100	ACEITE, CARTUCHO PARA DERIVACION (BY PASS)	G-750	SFD-28-028
ACEITE, DERIVACION (BY PASS)	G-750	SFD-28-028				LN800 con motor/FORD A GASOLINA		
			LA9000, LL9000 con motor/CATERPILLAR 3176B			AIRE	GA-422	ESHZ-9601-B
L9000, WT9000, LA9000, LL9000, LNT9000, LS9000, LT9000, LTA9000, LTL9000, LTS9000 con motor/CATERPILLAR 3406			ACEITE, CUMPLE CON MEDI-DAS ORIGINALES	GP-691	1R0716	LN800 con motor/FORD FD1460 8.3L		
ACEITE, CUMPLE CON MEDI-DAS ORIGINALES	GP-691	1R0716	ACEITE, SEGUNDA OPCION	GP-52	1R0716	ACEITE	GP-3001	E8HZ-6731-A
COMBUSTIBLE, PRIMARIO SELLADO	GP-26	311294	COMBUSTIBLE	GP-1108	1R0712	COMBUSTIBLE, SEPARADOR DE AGUA	GPP-1122	F3HZ-9365-E
ACEITE, SEGUNDA OPCION	GP-52	1R0716	LL9000 con motor/GMC 6-71N DIESEL			AGUA	GP-2071W	F3HZ-8A424-C
COMBUSTIBLE, SELLADO	GP-1108	1R0712	ACEITE, FLUJO TOTAL (FULL FLOW)	G-33	5573013	AIRE, PRIMARIO	GA-197R	F3HZ-9601-D
AGUA	GP-2071W	311288	COMBUSTIBLE, PRIMARIO	GP-26	8423132	AIRE, SECUNDARIO	GA-768R	F3HZ-9R500-A
AIRE	GA-377	D8HZ-9601-B	COMBUSTIBLE, SECUNDARIO	GP-27	23518482			
AIRE	GA-372	D8HZ-9601-A	AIRE, CUMMINS	GA-106	P117437	LN800 con motores/CUMMINS, DETROIT DIESEL		
AIRE, RADIAL	GA-682R	F1HZ-9601-B	AIRE, KOMATSU	GA-326	P117437	AIRE	GA-682R	F1HZ-9601-B
			ACEITE, DERIVACION (BY PASS)	G-750	SFD-28-028			
L9513 con motor/CATERPILLAR 3176						LN8000 con motor/CATERPILLAR		
COMBUSTIBLE	GP-749	1R0749	LLA9000 con motor/DETROIT DIESEL SERIES 60			AIRE	GA-682R	F1HZ-9601-B
ACEITE, CUMPLE CON MEDI-DAS ORIGINALES	GP-691	1R0716	COMBUSTIBLE, PRIMARIO	GP-26	8423132			
ACEITE, SEGUNDA OPCION	GP-52	1R0716	COMBUSTIBLE, SECUNDARIO	GP-27	23518482	LN8000 con motor/CATERPILLAR 3208		
			ACEITE, FLUJO TOTAL (FULL FLOW)	GP-53	PF911	ACEITE	GP-36	9L9200
L9513 con motor/CATERPILLAR 3406E			ACEITE, DERIVACION (BY PASS)	GP-57	P940	GASOLINA, SEPARADOR DE AGUA	G-293	6N7617
ACEITE, CUMPLE CON MEDI-DAS ORIGINALES	GP-691	1R0716	AGUA	GP-2071W	WF100	COMBUSTIBLE	GP-110	1P2299
ACEITE, SEGUNDA OPCION	GP-52	1R0716	ACEITE, FLUJO TOTAL (FULL FLOW)	GP-193	PF2100	ACEITE	GP-9586	9N5570
COMBUSTIBLE	GP-1108	1R0712						
L9513 con motor/CUMMINS M11			LLN9000 con motor/CUMMINS					
ACEITE	GP-3000	3318853	ACEITE, TURBOCARGADOR	GP-14	4041959			
			COMBUSTIBLE, 5 3/4 IN	GPP-14	3315847			

MARCA-MODELO-MOTOR MAKE-MODEL-ENGINE	GONHER GONHER	OEM OEM	MARCA-MODELO-MOTOR MAKE-MODEL-ENGINE	GONHER GONHER	OEM OEM	MARCA-MODELO-MOTOR MAKE-MODEL-ENGINE	GONHER GONHER	OEM OEM
FORD (continuación)			FORD (continuación)			FORD (continuación)		
CAMIONES, TRACTOCAMIONES Y AUTOBUSES			CAMIONES, TRACTOCAMIONES Y AUTOBUSES			CAMIONES, TRACTOCAMIONES Y AUTOBUSES		
LN8000 con motor/CUMMINS V555			LN900, LN9000, LNT800 con motor/FORD FD1460 8.3L			COMBUSTIBLE	GP-110	1P2299
COMBUSTIBLE	GP-1101	154711	ACEITE	GP-3001	E8HZ-6731-A	ACEITE	GP-9586	9N5570
ACEITE, SELLADO FLUJO TOTAL (FULL FLOW)	GP-53	3313287	COMBUSTIBLE	GPP-1122	F3HZ-9365-E			
AGUA	GP-2071W	3315116	AGUA	GP-2071W	F3HZ-8A424-C			
						LN8000 con motor/CUMMINS V555		
LN8000 con motor/CUMMINS VT225			LN9000 con motor/CATERPILLAR			COMBUSTIBLE	GP-1101	154711
COMBUSTIBLE	GP-1101	154711	AIRE	GA-682R	F1HZ-9601-B	ACEITE, SELLADO FLUJO TOTAL (FULL FLOW)	GP-53	3313287
AGUA	GP-2071W	3315116				AGUA	GP-2071W	3315116
ACEITE, DERIVACION (BY PASS)	G-500	256839	LN9000 con motor/CUMMINS					
			AIRE	GA-682R	F1HZ-9601-B	LN8000 con motor/CUMMINS VT225		
						COMBUSTIBLE	GP-1101	154711
LN8000 con motor/FORD 6-476 (7.8L)			LN9000 con motor/DETROIT DIESEL SERIES 60			AGUA	GP-2071W	3315116
AGUA	GP-1010Q	E7HZ-8A424-B	COMBUSTIBLE, PRIMARIO	GP-26	8423132	ACEITE, DERIVACION (BY PASS)	G-500	256839
ACEITE, SELLADO	GP-36	F0HZ-6731-B	COMBUSTIBLE, SECUNDARIO	GP-27	23518482			
COMBUSTIBLE	GP-1122	E7HZ-9365-B	ACEITE, FLUJO TOTAL (FULL FLOW)	GP-53	PF911	LN8000 con motor/FORD 6-476 (7.8L)		
COMBUSTIBLE, SEPARADOR DE AGUA 1991 EN ADELANTE	GPP-1287	F1HZ-9365-A	ACEITE, DERIVACION (BY PASS)	GP-57	P940	COMBUSTIBLE, SEPARADOR DE AGUA HASTA 1991	GPP-14	E7HZ-9N184-A
ACEITE, CARTUCHO PARA DERIVACION (BY PASS)	G-750	SFD-28-028	AGUA	GP-2071W	WF100	ACEITE	GP-54	F2NN-6714-AA
			ACEITE, FLUJO TOTAL (FULL FLOW)	GP-193	PF2100	COMBUSTIBLE	GP-1122	E6HZ-9365-C
						AGUA	GP-2071W	E7HZ-8A424-B
LN8000 con motor/FORD A GASOLINA			LN9000 con motor/FORD A GASOLINA			COMBUSTIBLE, SEPARADOR DE AGUA 1991 EN ADELANTE	GPP-1287	F1HZ-9365-A
AIRE	GA-422	E5HZ-9601-B	AIRE	GA-422	E5HZ-9601-B			
						LN8000 con motor/FORD 7.8L		
LN8000 con motor/FORD FD1460 8.3L			LN9000 con motor/GMC 6-71N DIESEL			AGUA	GP-1010Q	E7HZ-8A424-B
ACEITE	GP-3001	E8HZ-6731-A	ACEITE, FLUJO TOTAL (FULL FLOW)	G-33	5573013	ACEITE, SELLADO	GP-36	F0HZ-6731-B
COMBUSTIBLE, SEPARADOR DE AGUA	GPP-1122	F3HZ-9365-E	COMBUSTIBLE, PRIMARIO	GP-26	8423132	COMBUSTIBLE	GP-1122	E7HZ-9365-B
ACEITE	GP-3000	E8HZ-6731-A	COMBUSTIBLE, SECUNDARIO	GP-27	23518482	COMBUSTIBLE, SEPARADOR DE AGUA	GPP-1287	F1HZ-9365-A
AGUA	GP-2071W	F3HZ-8A424-C	AIRE, CUMMINS	GA-106	P117437	ACEITE, CARTUCHO PARA DERIVACION (BY PASS)	G-750	SFD-28-028
AIRE, PRIMARIO	GA-197R	F3HZ-9601-D	AIRE, KOMATSU	GA-326	P117437			
AIRE, SECUNDARIO	GA-768R	F3HZ-9R500-A	ACEITE, DERIVACION (BY PASS)	G-750	SFD-28-028	LN8000 con motor/FORD FD1460 8.3L		
						AGUA	GP-1010Q	E7HZ-8A424-B
LN8000 con motor/GMC 6V-53 DIESEL			LN9000 con motor/GMC 8V-71 SERIES			COMBUSTIBLE, SEPARADOR DE AGUA	GPP-1122	F3HZ-9365-E
ACEITE, DERIVACION (BY PASS)	G-31	1595410	ACEITE, FLUJO TOTAL (FULL FLOW)	G-33	5573013	ACEITE	GP-3000	E8HZ-6731-A
ACEITE, FLUJO TOTAL (FULL FLOW)	G-33	5573013	COMBUSTIBLE, PRIMARIO	GP-26	8423132	AIRE, PRIMARIO	GA-197R	F3HZ-9601-D
COMBUSTIBLE, SECUNDARIO	G-1173	3290851	COMBUSTIBLE, SECUNDARIO	GP-27	23518482	AIRE, SECUNDARIO	GA-768R	F3HZ-9R500-A
			AIRE	GA-372	D8HZ-9601-A			
LN8000 con motores/CATERPILLAR 1145, CATERPILLAR 1150, CATERPILLAR 1160			AIRE	GA-6129	P117443	LN8000 con motor/GMC 6V-53 DIESEL		
ACEITE, SELLADO	GP-36	9N5680	ACEITE, DERIVACION (BY PASS)	G-750	SFD-28-028	ACEITE, DERIVACION (BY PASS)	G-31	1595410
GASOLINA, SEPARADOR DE AGUA	G-293	6N7617				ACEITE, FLUJO TOTAL (FULL FLOW)	G-33	5573013
COMBUSTIBLE	GP-110	1P2299	LN9000 con motores/GMC 6V-92 SERIES DIESEL, GMC 8V-92 SERIES DIESEL			COMBUSTIBLE, SECUNDARIO	G-1173	3290851
ACEITE, CARTUCHO PARA DERIVACION (BY PASS)	G-750	SFD-28-028	ACEITE, FLUJO TOTAL (FULL FLOW)	G-33	5573013			
			COMBUSTIBLE, PRIMARIO	GP-26	8423132	LN8000 con motores/CATERPILLAR 1145, CATERPILLAR 1150, CATERPILLAR 1160		
LN8000 con motores/CUMMINS, DETROIT DIESEL			COMBUSTIBLE, SECUNDARIO	GP-27	23518482	ACEITE, SELLADO	GP-36	9N5680
AIRE	GA-682R	F1HZ-9601-B	AIRE	GA-372	D8HZ-9601-A	GASOLINA, SEPARADOR DE AGUA	G-293	6N7617
			ACEITE, DERIVACION (BY PASS)	G-750	SFD-28-028	COMBUSTIBLE	GP-110	1P2299
LN900 con motor/CATERPILLAR						ACEITE, CARTUCHO PARA DERIVACION (BY PASS)	G-750	SFD-28-028
AIRE	GA-682R	F1HZ-9601-B	LN800 con motor/FORD 7.8L					
			AGUA	GP-1010Q	E7HZ-8A424-B	LN8000, LT8000, LTS800, LTS900 con motores/DETROIT DIESEL, CATERPILLAR, CUMMINS		
LN900 con motor/FORD A GASOLINA			ACEITE, SELLADO	GP-36	F0HZ-6731-B	AIRE	GA-682R	F1HZ-9601-B
AIRE	GA-422	E5HZ-9601-B	COMBUSTIBLE	GP-1122	E7HZ-9365-B			
			COMBUSTIBLE, SEPARADOR DE AGUA	GPP-1287	F1HZ-9365-A	LN9000 con motor/DETROIT DIESEL SERIES 60		
LN900 con motores/CUMMINS, DETROIT DIESEL			ACEITE, CARTUCHO PARA DERIVACION (BY PASS)	G-750	SFD-28-028	COMBUSTIBLE, PRIMARIO	GP-26	8423132
AIRE	GA-682R	F1HZ-9601-B				COMBUSTIBLE, SECUNDARIO	GP-27	23518482
			LN800 con motor/FORD 7.8L			ACEITE, FLUJO TOTAL (FULL FLOW)	GP-53	PF911
			AGUA	GP-1010Q	E7HZ-8A424-B	ACEITE, DERIVACION (BY PASS)	GP-57	P940
LN900 con motor/FORD A GASOLINA			ACEITE, SELLADO	GP-36	F0HZ-6731-B	AGUA	GP-2071W	WF100
AIRE	GA-422	E5HZ-9601-B	COMBUSTIBLE	GP-1122	E7HZ-9365-B	ACEITE, FLUJO TOTAL (FULL FLOW)	GP-193	PF2100
			COMBUSTIBLE, SEPARADOR DE AGUA	GPP-1287	F1HZ-9365-A			
LN900 con motores/CUMMINS, DETROIT DIESEL			ACEITE, CARTUCHO PARA DERIVACION (BY PASS)	G-750	SFD-28-028	LN8000, LT8000, LTS8000 con motores/CATERPILLAR, CUMMINS, DETROIT DIESEL		
AIRE	GA-682R	F1HZ-9601-B				AIRE	GA-682R	F1HZ-9601-B
			LN800 con motor/FORD 7.8L					
			AGUA	GP-1010Q	E7HZ-8A424-B	LN9000 con motor/DETROIT DIESEL SERIES 60		
LN900, LN9000 con motor/FORD 7.8L			ACEITE, SELLADO	GP-36	F0HZ-6731-B	COMBUSTIBLE, PRIMARIO	GP-26	8423132
AGUA	GP-1010Q	E7HZ-8A424-B	COMBUSTIBLE	GP-1122	E7HZ-9365-B	COMBUSTIBLE, SECUNDARIO	GP-27	23518482
ACEITE, SELLADO	GP-36	F0HZ-6731-B	COMBUSTIBLE, SEPARADOR DE AGUA	GPP-1287	F1HZ-9365-A	ACEITE, FLUJO TOTAL (FULL FLOW)	GP-53	PF911
COMBUSTIBLE	GP-1122	E7HZ-9365-B	ACEITE, CARTUCHO PARA DERIVACION (BY PASS)	G-750	SFD-28-028	ACEITE, DERIVACION (BY PASS)	GP-57	P940
COMBUSTIBLE, SEPARADOR DE AGUA	GPP-1287	F1HZ-9365-A				AGUA	GP-2071W	WF100
ACEITE, CARTUCHO PARA DERIVACION (BY PASS)	G-750	SFD-28-028	LN8000 con motor/CATERPILLAR 3208			ACEITE, FLUJO TOTAL (FULL FLOW)	GP-193	PF2100
			ACEITE	GP-36	9L9200			
			GASOLINA, SEPARADOR DE AGUA	G-293	6N7617			

SERVICIO PESADO

MARCA-MODELO-MOTOR MAKE-MODEL-ENGINE	GONHER GONHER	OEM OEM	MARCA-MODELO-MOTOR MAKE-MODEL-ENGINE	GONHER GONHER	OEM OEM	MARCA-MODELO-MOTOR MAKE-MODEL-ENGINE	GONHER GONHER	OEM OEM
FORD (continuación)			FORD (continuación)			FORD (continuación)		
CAMIONES, TRACTOCAMIONES Y AUTOBUSES			CAMIONES, TRACTOCAMIONES Y AUTOBUSES			CAMIONES, TRACTOCAMIONES Y AUTOBUSES		
LNT9000 con motor/GMC 6-71N DIESEL			LS8000 con motor/FORD 6-476 (7.8L)			GASOLINA, SEPARADOR DE AGUA		
ACEITE, FLUJO TOTAL (FULL FLOW)	G-33	5573013	COMBUSTIBLE, SEPARADOR DE AGUA HASTA 1991	GPP-14	E7HZ-9N184-A	COMBUSTIBLE	GP-110	1P2299
COMBUSTIBLE, PRIMARIO	GP-26	8423132	ACEITE	GP-54	F2NN-6714-AA	ACEITE	GP-9586	9N5570
COMBUSTIBLE, SECUNDARIO	GP-27	23518482	COMBUSTIBLE	GP-1122	E6HZ-9365-C	LT8000 con motor/CUMMINS V555		
AIRE, CUMMINS	GA-106	P117437	AGUA	GP-2071W	E7HZ-8A424-B	COMBUSTIBLE	GP-1101	154711
AIRE, KOMATSU	GA-326	P117437	COMBUSTIBLE, SEPARADOR DE AGUA 1991 EN ADELANTE	GPP-1287	F1HZ-9365-A	ACEITE, SELLADO FLUJO TOTAL (FULL FLOW)	GP-53	3313287
ACEITE, DERIVACION (BY PASS)	G-750	SFD-28-028	LT8000 con motor/FORD FD1460 8.3L			AGUA	GP-2071W	3315116
LNT9000 con motor/GMC 8V-71 SERIES			AGUA			LT8000 con motor/FORD 6-476 (7.8L)		
ACEITE, FLUJO TOTAL (FULL FLOW)	G-33	5573013	COMBUSTIBLE, SEPARADOR DE AGUA	GPP-1122	F3HZ-9365-E	COMBUSTIBLE, SEPARADOR DE AGUA HASTA 1991	GPP-14	E7HZ-9N184-A
COMBUSTIBLE, PRIMARIO	GP-26	8423132	ACEITE	GP-3000	E8HZ-6731-A	ACEITE	GP-54	F2NN-6714-AA
COMBUSTIBLE, SECUNDARIO	GP-27	23518482	AIRE, PRIMARIO	GA-197R	F3HZ-9601-D	COMBUSTIBLE	GP-1122	E6HZ-9365-C
AIRE	GA-372	D8HZ-9601-A	AIRE, SECUNDARIO	GA-768R	F3HZ-9R500-A	AGUA	GP-2071W	E7HZ-8A424-B
AIRE	GA-6129	P117443	LS9000 con motor/DETROIT DIESEL SERIES 60			COMBUSTIBLE, SEPARADOR DE AGUA 1991 EN ADELANTE	GPP-1287	F1HZ-9365-A
ACEITE, DERIVACION (BY PASS)	G-750	SFD-28-028	COMBUSTIBLE, PRIMARIO	GP-26	8423132	LT8000 con motor/FORD 7.8L		
LNT9000 con motores/GMC 6V-92 SERIES DIESEL, GMC 8V-92 SERIES DIESEL			COMBUSTIBLE, SECUNDARIO	GP-27	23518482	AGUA	GP-1010Q	E7HZ-8A424-B
ACEITE, FLUJO TOTAL (FULL FLOW)	G-33	5573013	ACEITE, FLUJO TOTAL (FULL FLOW)	GP-53	PF911	ACEITE, SELLADO	GP-36	FOHZ-6731-B
COMBUSTIBLE, PRIMARIO	GP-26	8423132	ACEITE, DERIVACION (BY PASS)	GP-57	P940	COMBUSTIBLE	GP-1122	E7HZ-9365-B
COMBUSTIBLE, SECUNDARIO	GP-27	23518482	AGUA	GP-2071W	WF100	COMBUSTIBLE, SEPARADOR DE AGUA	GPP-1287	F1HZ-9365-A
AIRE	GA-372	D8HZ-9601-A	ACEITE, FLUJO TOTAL (FULL FLOW)	GP-193	PF2100	ACEITE, CARTUCHO PARA DERIVACION (BY PASS)	G-750	SFD-28-028
ACEITE, DERIVACION (BY PASS)	G-750	SFD-28-028	LS9000 con motor/GMC 6-71N DIESEL			LT8000 con motor/GMC 6V-53 DIESEL		
LOUISVILLE 101 con motor/CATERPILLAR 3176			ACEITE, FLUJO TOTAL (FULL FLOW)	G-33	5573013	ACEITE, DERIVACION (BY PASS)	G-31	1595410
ACEITE, CUMPLE CON MEDIDAS ORIGINALES	GP-691	1R0716	COMBUSTIBLE, PRIMARIO	GP-26	8423132	ACEITE, FLUJO TOTAL (FULL FLOW)	G-33	5573013
ACEITE, SEGUNDA OPCION	GP-52	1R0716	COMBUSTIBLE, SECUNDARIO	GP-27	23518482	COMBUSTIBLE, SECUNDARIO	G-1173	3290851
COMBUSTIBLE	GP-1108	1R0712	AIRE, CUMMINS	GA-106	P117437	LT8000 con motores/CATERPILLAR 1145, CATERPILLAR 1150, CATERPILLAR 1160		
LOUISVILLE 101 con motor/CUMMINS M11			AIRE, KOMATSU	GA-326	P117437	ACEITE, SELLADO	GP-36	9N5680
ACEITE	GP-3000	3318853	ACEITE, DERIVACION (BY PASS)	G-750	SFD-28-028	GASOLINA, SEPARADOR DE AGUA	G-293	6N7617
LOUISVILLE 111 con motor/CATERPILLAR 3406E			LS9000 con motores/GMC 6V-92 SERIES DIESEL, GMC 8V-92 SERIES DIESEL			COMBUSTIBLE	GP-110	1P2299
COMBUSTIBLE	GP-749	1R0749	ACEITE, FLUJO TOTAL (FULL FLOW)	G-33	5573013	ACEITE, CARTUCHO PARA DERIVACION (BY PASS)	G-750	SFD-28-028
ACEITE, CUMPLE CON MEDIDAS ORIGINALES	GP-691	1R0716	COMBUSTIBLE, PRIMARIO	GP-26	8423132	LT8000, LTS8000 con motor/FORD FD1460 8.3L		
ACEITE, SEGUNDA OPCION	GP-52	1R0716	COMBUSTIBLE, SECUNDARIO	GP-27	23518482	ACEITE	GP-3001	E8HZ-6731-A
LOUISVILLE 113 con motor/FORD FD1460			AIRE	GA-372	D8HZ-9601-A	AGUA	GP-1010Q	E7HZ-8A424-B
COMBUSTIBLE, SEPARADOR DE AGUA	GPP-1122	F3HZ-9365-E	ACEITE, DERIVACION (BY PASS)	G-750	SFD-28-028	COMBUSTIBLE, SEPARADOR DE AGUA	GPP-1122	F3HZ-9365-E
LOUISVILLE 122, LT9513 con motor/CUMMINS M11			LT1000 con motor/GMC 8V-92N			ACEITE	GP-3000	E8HZ-6731-A
ACEITE	GP-3000	3318853	ACEITE, CARTUCHO PARA FLUJO TOTAL (FULL FLOW)	G-33	5573013	AGUA	GP-2071W	F3HZ-8A424-C
LOUISVILLE 9000 con motor/CATERPILLAR 3406E			COMBUSTIBLE, PRIMARIO	GP-26	8423132	AIRE, PRIMARIO	GA-197R	F3HZ-9601-D
COMBUSTIBLE, PRIMARIO	GP-749	1R0749	COMBUSTIBLE, SECUNDARIO	GP-27	23518482	AIRE, SECUNDARIO	GA-768R	F3HZ-9R500-A
ACEITE, CUMPLE CON MEDIDAS ORIGINALES	GP-691	1R0716	LT800 con motor/FORD 7.8L			LT900 con motor/FORD 7.8L		
ACEITE, SEGUNDA OPCION	GP-52	1R0716	AGUA	GP-1010Q	E7HZ-8A424-B	AGUA	GP-1010Q	E7HZ-8A424-B
COMBUSTIBLE, SECUNDARIO	GP-1108	1R0712	ACEITE, SELLADO	GP-36	FOHZ-6731-B	ACEITE, SELLADO	GP-36	FOHZ-6731-B
LOUISVILLE 9000 con motor/CUMMINS 8.3L			COMBUSTIBLE	GP-1122	E7HZ-9365-B	COMBUSTIBLE	GP-1122	E7HZ-9365-B
ACEITE	GP-3001	3318853	COMBUSTIBLE, SEPARADOR DE AGUA	GPP-1287	F1HZ-9365-A	COMBUSTIBLE	GPP-1287	F1HZ-9365-A
COMBUSTIBLE, SEPARADOR DE AGUA	GPP-1122	F3HZ-9365-E	ACEITE, CARTUCHO PARA DERIVACION (BY PASS)	G-750	SFD-28-028	ACEITE, CARTUCHO PARA DERIVACION (BY PASS)	G-750	SFD-28-028
ACEITE	GP-3000	3318853	LT800 con motor/FORD FD1460 8.3L			LT900, LT9000 con motor/FORD FD1460 8.3L		
LS8000 con motor/CATERPILLAR 3208			ACEITE	GP-3001	E8HZ-6731-A	ACEITE	GP-3001	E8HZ-6731-A
ACEITE	GP-36	9L9200	COMBUSTIBLE	GPP-1122	F3HZ-9365-E	COMBUSTIBLE	GPP-1122	F3HZ-9365-E
GASOLINA, SEPARADOR DE AGUA	G-293	6N7617	AGUA	GP-2071W	F3HZ-8A424-C	AGUA	GP-2071W	F3HZ-8A424-C
COMBUSTIBLE	GP-110	1P2299	LT8000 con motor/CATERPILLAR 3208					
ACEITE	GP-9586	9N5570	ACEITE	GP-36	9L9200			

MARCA-MODELO-MOTOR MAKE-MODEL-ENGINE	GONHER GONHER	OEM OEM	MARCA-MODELO-MOTOR MAKE-MODEL-ENGINE	GONHER GONHER	OEM OEM	MARCA-MODELO-MOTOR MAKE-MODEL-ENGINE	GONHER GONHER	OEM OEM
FORD (continuación)			FORD (continuación)			FORD (continuación)		
CAMIONES, TRACTOCAMIONES Y AUTOBUSES			CAMIONES, TRACTOCAMIONES Y AUTOBUSES			CAMIONES, TRACTOCAMIONES Y AUTOBUSES		
LT9000 con motor/DETROIT DIESEL SERIES 60			LT9000, LTS9000 con motores/CATERPILLAR, DETROIT DIESEL			LT9000, LTS9000 con motor/DETROIT DIESEL SERIES 60		
COMBUSTIBLE, PRIMARIO	GP-26	8423132	AIRE	GA-682R	F1HZ-9601-B	COMBUSTIBLE, PRIMARIO	GP-26	8423132
COMBUSTIBLE, SECUNDARIO	GP-27	23518482				COMBUSTIBLE, SECUNDARIO	GP-27	23518482
ACEITE, FLUJO TOTAL (FULL FLOW)	GP-53	PF911	LT9513 con motor/CATERPILLAR 3176			ACEITE, FLUJO TOTAL (FULL FLOW)	GP-53	PF911
ACEITE, DERIVACION (BY PASS)	GP-57	P940	COMBUSTIBLE	GP-749	1R0749	ACEITE, DERIVACION (BY PASS)	GP-57	P940
AGUA	GP-2071W	WF100	ACEITE, CUMPLE CON MEDI-DAS ORIGINALES	GP-691	1R0716	AGUA	GP-2071W	WF100
ACEITE, FLUJO TOTAL (FULL FLOW)	GP-193	PF2100	ACEITE, SEGUNDA OPCION	GP-52	1R0716	ACEITE, FLUJO TOTAL (FULL FLOW)	GP-193	PF2100
			LT9513 con motor/CATERPILLAR 3406E					
LT9000 con motor/FORD 7.8L			ACEITE, CUMPLE CON MEDI-DAS ORIGINALES	GP-691	1R0716	LTS800 con motor/FORD 7.8L		
AGUA	GP-1010Q	E7HZ-8A424-B	ACEITE, SEGUNDA OPCION	GP-52	1R0716	AGUA	GP-1010Q	E7HZ-8A424-B
ACEITE, SELLADO	GP-36	F0HZ-6731-B	COMBUSTIBLE	GP-1108	1R0712	ACEITE, SELLADO	GP-36	F0HZ-6731-B
COMBUSTIBLE	GP-1122	E7HZ-9365-B				COMBUSTIBLE	GP-1122	E7HZ-9365-B
COMBUSTIBLE, SEPARADOR DE AGUA	GPP-1287	F1HZ-9365-A	LT9513 con motor/CUMMINS N14			COMBUSTIBLE, SEPARADOR DE AGUA	GPP-1287	F1HZ-9365-A
ACEITE, DERIVACION (BY PASS)	G-750	SFD-28-028	COMBUSTIBLE, SEPARADOR DE AGUA	GPP-11	3600980	ACEITE, CARTUCHO PARA DERIVACION (BY PASS)	G-750	SFD-28-028
			ACEITE	GP-3000	3318853			
LT9000 con motor/GMC 8V-71 SERIES			AIRE, RADIAL	GA-682R	F1HZ-9601-B	LTS800 con motor/FORD FD1460 8.3L		
ACEITE, FLUJO TOTAL (FULL FLOW)	G-33	5573013				ACEITE	GP-3001	E8HZ-6731-A
COMBUSTIBLE, PRIMARIO	GP-26	8423132	LT9513 con motor/DETROIT DIESEL SERIES 60			COMBUSTIBLE	GPP-1122	F3HZ-9365-E
COMBUSTIBLE, SECUNDARIO	GP-27	23518482	COMBUSTIBLE, PRIMARIO	GP-26	8423132	AGUA	GP-2071W	F3HZ-8A424-C
AIRE	GA-372	D8HZ-9601-A	COMBUSTIBLE, SECUNDARIO	GP-27	23518482			
AIRE	GA-6129	P117443	ACEITE, FLUJO TOTAL (FULL FLOW) HASTA 1993	GP-53	PF911	LTS8000 con motor/CUMMINS V555		
ACEITE, DERIVACION (BY PASS)	G-750	SFD-28-028	ACEITE, DERIVACION (BY PASS)	GP-57	P940	COMBUSTIBLE	GP-1101	154711
			ACEITE, FLUJO TOTAL (FULL FLOW) 1993 EN ADELANTE	GP-193	PF2100	ACEITE, SELLADO FLUJO TOTAL (FULL FLOW)	GP-53	3313287
LT9000 con motores/GMC 6V-92 SERIES DIESEL, GMC 8V-92 SERIES DIESEL						AGUA	GP-2071W	3315116
ACEITE, FLUJO TOTAL (FULL FLOW)	G-33	5573013	LTA9000 con motor/CATERPILLAR 3176B					
COMBUSTIBLE, PRIMARIO	GP-26	8423132	ACEITE, CUMPLE CON MEDI-DAS ORIGINALES	GP-691	1R0716	LTS8000 con motor/CUMMINS VT225		
COMBUSTIBLE, SECUNDARIO	GP-27	23518482	ACEITE, SEGUNDA OPCION	GP-52	1R0716	COMBUSTIBLE	GP-1101	154711
AIRE	GA-372	D8HZ-9601-A	COMBUSTIBLE	GP-1108	1R0712	AGUA	GP-2071W	3315116
ACEITE, DERIVACION (BY PASS)	G-750	SFD-28-028				ACEITE, DERIVACION (BY PASS)	G-500	256839
			LT9000, LTL9000 con motor/GMC 6-71N DIESEL					
ACEITE, FLUJO TOTAL (FULL FLOW)	G-33	5573013	LTA9000, LTL9000, CLT9000, L9000, CL9000, W9000, LA9000, LL9000, LNT9000, LS9000 con motor/CUMMINS			LTS8000 con motor/FORD 6-476 (7.8L)		
COMBUSTIBLE, PRIMARIO	GP-26	8423132	ACEITE, TURBOCARGADOR	GP-14	4041959	COMBUSTIBLE, SEPARADOR DE AGUA HASTA 1991	GPP-14	E7HZ-9N184-A
COMBUSTIBLE, SECUNDARIO	GP-27	23518482	COMBUSTIBLE, 5 3/4 IN	GPP-14	3315847	ACEITE	GP-54	F2NN-6714-AA
AIRE, CUMMINS	GA-106	P117437	COMBUSTIBLE, 5 17/32 IN	GP-1101	154711	COMBUSTIBLE	GP-1122	E6HZ-9365-C
AIRE, KOMATSU	GA-326	P117437	ACEITE, SELLADO FLUJO TOTAL (FULL FLOW)	GP-53	3313287	AGUA	GP-2071W	E7HZ-8A424-B
ACEITE, DERIVACION (BY PASS)	G-750	SFD-28-028	COMBUSTIBLE, 11 15/32 IN	GP-55	3313306	COMBUSTIBLE, SEPARADOR DE AGUA 1991 EN ADELANTE	GPP-1287	F1HZ-9365-A
			ACEITE, SELLADO DERIVACION (BY PASS)	GP-57	3304232			
LT9000, LTS9000 con motor/CUMMINS			COMBUSTIBLE, SEPARADOR DE AGUA	GPP-11	3600980	LTS8000 con motor/GMC 6V-53 DIESEL		
ACEITE, TURBOCARGADOR	GP-14	4041959	ACEITE	GP-3000	3318853	ACEITE, DERIVACION (BY PASS)	G-31	1595410
COMBUSTIBLE, 5 3/4 IN	GPP-14	3315847	AGUA	GP-2071W	3315116	ACEITE, FLUJO TOTAL (FULL FLOW)	G-33	5573013
COMBUSTIBLE, 5 17/32 IN	GP-1101	154711	AIRE, RESPIRADOR	GA-39	255963	COMBUSTIBLE, SECUNDARIO	G-1173	3290851
ACEITE, SELLADO FLUJO TOTAL (FULL FLOW)	GP-53	3313287	AIRE	GA-106	P117437			
COMBUSTIBLE, 11 15/32 IN	GP-55	3313306	AIRE	GA-372	P129472	LTS8000 con motores/CATERPILLAR 1145, CATERPILLAR 1150, CATERPILLAR 1160		
ACEITE, SELLADO DERIVACION (BY PASS)	GP-57	3304232	AIRE	GA-6129	P117443	ACEITE, SELLADO	GP-36	9N5680
COMBUSTIBLE, SEPARADOR DE AGUA	GPP-11	3600980	AIRE, PRIMARIO	GA-642	E2HZ-9601-B	GASOLINA, SEPARADOR DE AGUA	G-293	6N7617
ACEITE	GP-3000	3318853	ACEITE, CARTUCHO PARA DERIVACION (BY PASS)	G-750	SFD-28-028	COMBUSTIBLE	GP-110	1P2299
AGUA	GP-2071W	3315116				ACEITE, CARTUCHO PARA DERIVACION (BY PASS)	G-750	SFD-28-028
AIRE, RESPIRADOR	GA-39	255963	LTL9000 con motor/CATERPILLAR 3176B					
AIRE	GA-106	P117437	ACEITE, CUMPLE CON MEDI-DAS ORIGINALES	GP-691	1R0716	LTS8000, LTS900, LTS9000 con motor/FORD 7.8L		
AIRE	GA-372	P129472	ACEITE, SEGUNDA OPCION	GP-52	1R0716	AGUA	GP-1010Q	E7HZ-8A424-B
AIRE	GA-6129	P117443	COMBUSTIBLE	GP-1108	1R0712	ACEITE, SELLADO	GP-36	F0HZ-6731-B
AIRE	GA-682R	F1HZ-9601-B				COMBUSTIBLE	GP-1122	E7HZ-9365-B
AIRE, PRIMARIO	GA-642	E2HZ-9601-B	LTL9000 con motor/CUMMINS N14			COMBUSTIBLE, SEPARADOR DE AGUA	GPP-1287	F1HZ-9365-A
ACEITE, CARTUCHO PARA DERIVACION (BY PASS)	G-750	SFD-28-028	COMBUSTIBLE, SEPARADOR DE AGUA	GPP-11	3600980	ACEITE, CARTUCHO PARA DERIVACION (BY PASS)	G-750	SFD-28-028
			ACEITE	GP-3000	3318853			
			AIRE, RADIAL	GA-682R	F1HZ-9601-B			

SERVICIO PESADO

MARCA-MODELO-MOTOR MAKE-MODEL-ENGINE	GONHER GONHER	OEM OEM	MARCA-MODELO-MOTOR MAKE-MODEL-ENGINE	GONHER GONHER	OEM OEM	MARCA-MODELO-MOTOR MAKE-MODEL-ENGINE	GONHER GONHER	OEM OEM
FORD (continuación)			FORD (continuación)			FORD (continuación)		
CARGADORAS			CARGADORAS			CARGADORAS		
COMBUSTIBLE	G-296	EDPN-9N074-AA	655C RETROEXCAVADORA, 655D RETROEXCAVADORA con motor/A DIESEL			ACEITE	GP-77	E7NN-6714-BB
COMBUSTIBLE	G-296-B	EDPN-9N074-AA	ACEITE, SIN TURBO	GP-1	E7NN-6714-AA	COMBUSTIBLE	G-296-B	D5NN-6714-A
AIRE, SECUNDARIO	GA-588	D1NN-9R500-A	COMBUSTIBLE	G-297	D8NN-9176-AA	COMBUSTIBLE	G-297-B	D8NN-9176-AA
AIRE, PRIMARIO	GA-589	D1NN-9601-A	COMBUSTIBLE	G-297-B	D8NN-9176-AA	A66 con motor/FORD 4 CYL. DIESEL		
545 RETROEXCAVADORA, 545A RETROEXCAVADORA con motor/A DIESEL			ACEITE, CON TURBO	GP-81	E8NN-6714-BA	ACEITE	G-5000	DGPN-6731-A
ACEITE	GP-1	B7A-6714-A	AIRE, SECUNDARIO	GA-588	D1NN-9R500-A	ACEITE, SELLADO	GP-36	D8NN-6714-AA
TRANSMISION	GP-9	C5NN-6714-B	AIRE, PRIMARIO	GA-589	D1NN-9601-A	COMBUSTIBLE	G-296	D5NN-6714-A
COMBUSTIBLE	G-296	EDPN-9N074-AA	675D RETROEXCAVADORA con motor/A DIESEL			COMBUSTIBLE	G-297	D8NN-9176-AA
COMBUSTIBLE	G-296-B	EDPN-9N074-AA	ACEITE	GP-1	E7NN-6714-AA	ACEITE	GP-77	E7NN-6714-BB
HIDRAULICO	GP-166	D8NN-B486-CA	COMBUSTIBLE	G-296	EDPN-9N074-AA	COMBUSTIBLE	G-296-B	D5NN-6714-A
5500 RETROEXCAVADORA, 5550 RETROEXCAVADORA con motor/A DIESEL			COMBUSTIBLE	G-297	D8NN-9176-AA	COMBUSTIBLE	G-297-B	D8NN-9176-AA
ACEITE, CARTUCHO	G-5000	DGPN-6731-A	COMBUSTIBLE	G-296-B	EDPN-9N074-AA	CL20 con motor/ONAN		
ACEITE	GP-1	E7NN-6714-AA	COMBUSTIBLE	G-297-B	D8NN-9176-AA	ACEITE	GP-3600	E4FZ-6731-A
TRANSMISION	GP-9	C5NN-6714-B	AIRE, SECUNDARIO	GA-588	D1NN-9R500-A	CL30 con motor/WISCONSIN VH4D		
COMBUSTIBLE	G-296	D0NN-9N074-B	AIRE, PRIMARIO	GA-589	D1NN-9601-A	AIRE, SIN ASPAS	GA-33	200E-6228
COMBUSTIBLE	G-296-B	D0NN-9N074-B	713 RETROEXCAVADORA, 723 RETROEXCAVADORA, 753 RETROEXCAVADORA con motor/A DIESEL			CL35 con motor/A DIESEL		
555 RETROEXCAVADORA, 555A RETROEXCAVADORA, 555B RETROEXCAVADORA con motor/A DIESEL			HIDRAULICO	GP-66	7700040	ACEITE	GP-9	SBA140516170
ACEITE, SELLADO	GP-9	E8NN-6714-AA	750 RETROEXCAVADORA con motor/A DIESEL			CL40 con motor/FORD 104GF A GASOLINA		
TRANSMISION	GP-9	C5NN-6714-B	ACEITE	GP-1	E7NN-6714-AA	ACEITE	GP-9	B8NN-6714-A
COMBUSTIBLE	G-296	D2NN-9176-A	COMBUSTIBLE	G-296	EDPN-9N074-AA	HIDRAULICO	GP-34	D8NN-M903-FA
COMBUSTIBLE	G-296-B	D2NN-9176-A	COMBUSTIBLE	G-296-B	EDPN-9N074-AA	ACEITE	GP-58	C6JZ-6714-B
AIRE, SECUNDARIO	GA-588	D1NN-9R500-A	AIRE	GA-588	D1NN-9R500-A	AIRE, SIN ASPAS	GA-33	200E-6228
AIRE, PRIMARIO	GA-589	D1NN-9601-A	AIRE	GA-589	D1NN-9601-A	GASOLINA	GG-4	FF5480
555C RETROEXCAVADORA, 555D RETROEXCAVADORA, 575D RETROEXCAVADORA con motor/FORD 256 DIESEL			7500 RETROEXCAVADORA con motor/A DIESEL			CL45 con motor/A DIESEL		
ACEITE, SIN TURBO	GP-1	E7NN-6714-AA	ACEITE	GP-1	E7NN-6714-AA	ACEITE	GP-38	E1NN-6714-BA
COMBUSTIBLE	G-297	D8NN-9176-AA	COMBUSTIBLE	G-296	EDPN-9N074-AA	L454 con motor/A DIESEL		
COMBUSTIBLE	G-297-B	D8NN-9176-AA	HIDRAULICO	GP-66	7700040	ACEITE	GP-3682	EFL125
ACEITE, CON TURBO	GP-81	E8NN-6714-BA	COMBUSTIBLE	G-296-B	EDPN-9N074-AA	L550 con motor/KUBOTA V1902		
AIRE, SECUNDARIO	GA-588	D1NN-9R500-A	AIRE, SECUNDARIO	GA-588	D1NN-9R500-A	COMBUSTIBLE	G-296	EDPN-9N074-AA
AIRE, PRIMARIO	GA-589	D1NN-9601-A	AIRE, PRIMARIO	GA-589	F1NN-9601-A			
555E con motor/A DIESEL			755 RETROEXCAVADORA con motor/FORD 256 DIESEL			FORD		
ACEITE	GP-1	87800083	ACEITE, SIN TURBO	GP-1	E7NN-6714-AA	COMBINADAS		
611 RETROEXCAVADORA con motor/A DIESEL			COMBUSTIBLE	G-296	EDPN-9N074-AA	360 DIESEL con motor/A DIESEL		
ACEITE	G-6	CPN-6731-B	COMBUSTIBLE	G-296-B	EDPN-9N074-AA	COMBUSTIBLE	G-296	C7NN-9176-A
620 RETROEXCAVADORA con motor/A DIESEL			COMBUSTIBLE	GP-81	E8NN-6714-BA	611 con motor/A DIESEL		
ACEITE	G-6	CPN-6731-B	COMBUSTIBLE	GP-81	E8NN-6714-BA	ACEITE, CARTUCHO	G-6	CPN-6731-B
ACEITE	GP-1	B7A-6714-A	ACEITE, CON TURBO	GP-81	E8NN-6714-BA	620 GAS con motor/A GASOLINA		
AIRE	GA-18	C5NE-9A641-A	AIRE, SECUNDARIO	GA-588	D1NN-9R500-A	ACEITE, CARTUCHO	G-5000	DGPN-6731-A
622 RETROEXCAVADORA con motor/A DIESEL			AIRE, PRIMARIO	GA-589	D1NN-9601-A	622 con motor/FORD 6 CYL. 254		
ACEITE	GP-1	C9NN-6714-A	755A RETROEXCAVADORA, 755B RETROEXCAVADORA con motor/FORD A DIESEL			ACEITE	GP-1	B7A-6714-A
650 RETROEXCAVADORA, 6500 RETROEXCAVADORA con motor/FORD 256 DIESEL			ACEITE, SELLADO	GP-9	E8NN-6714-AA	COMBUSTIBLE	G-296	EDPN-9N074-AA
ACEITE	GP-1	E7NN-6714-AA	COMBUSTIBLE	G-296	EDPN-9N074-AA	COMBUSTIBLE	G-296-B	EDPN-9N074-AA
COMBUSTIBLE	G-296	D0NN-9N074-B	COMBUSTIBLE	G-296-B	EDPN-9N074-AA	630 con motor/A DIESEL		
COMBUSTIBLE	G-296-B	D0NN-9N074-B	AIRE	GA-588	D1NN-9R500-A	ACEITE	G-6	CPN-6731-B
655 RETROEXCAVADORA, 655A RETROEXCAVADORA con motor/A DIESEL			AIRE	GA-589	D1NN-9601-A	ACEITE	GP-1	B7A-6714-A
ACEITE	GP-9	E8NN-6714-AA	A62 con motor/FORD 4 CYL. DIESEL			COMBUSTIBLE	G-296	EDPN-9N074-AA
TRANSMISION	GP-9	C8NN-6714-B	COMBUSTIBLE	G-296	D5NN-6714-A	COMBUSTIBLE	G-296-B	EDPN-9N074-AA
COMBUSTIBLE	G-296	EDPN-9N074-AA	ACEITE	GP-77	E7NN-6714-BB	630 con motor/A DIESEL		
COMBUSTIBLE	G-296-B	EDPN-9N074-AA	COMBUSTIBLE	G-296-B	D5NN-6714-A	ACEITE	G-6	CPN-6731-B
AIRE, SECUNDARIO	GA-588	D1NN-9R500-A	ACEITE	GP-81	E4NN-6714-BA	ACEITE	GP-1	B7A-6714-A
AIRE, PRIMARIO	GA-589	D1NN-9601-A	AIRE, SECUNDARIO	GA-588	D1NN-9R500-A	AIRE	GA-18	C5NE-9A641-A
			AIRE, PRIMARIO	GA-589	E9NN-9601-AA	630 con motor/FORD 4 CYL. ENGLISH DIESEL 242		
			A64 con motor/FORD 4 CYL. DIESEL			ACEITE	G-836	C7TZ-6731-A
			ACEITE	G-5000	DGPN-6731-A	COMBUSTIBLE	G-296	EDPN-9N074-AA
			COMBUSTIBLE	G-296	D5NN-6714-A	COMBUSTIBLE	G-296-B	EDPN-9N074-AA
			COMBUSTIBLE	G-297	D8NN-9176-AA			

SERVICIO PESADO

MARCA-MODELO-MOTOR	GONHER	OEM
MAKE-MODEL-ENGINE	GONHER	OEM

FORD (continuación)

COMBINADAS

630 con motor/FORD 6 CYL. ENGLISH DIESEL 363		
ACEITE	G-834	2703E-6731-A
COMBUSTIBLE	G-296	EDPN-9N074-AA
COMBUSTIBLE	G-296-B	EDPN-9N074-AA
630 GAS, 640 GAS con motor/A GASOLINA		
ACEITE	GP-1	B7A-6714-A
640 con motor/A DIESEL		
ACEITE	G-6	CPN-6731-B
ACEITE	GP-1	B7A-6714-A
AIRE	GA-18	C5NE-9A641-A
640 con motor/FORD 4 CYL. ENGLISH DIESEL 242		
ACEITE	G-836	C7TZ-6731-A
COMBUSTIBLE	G-296	EDPN-9N074-AA
COMBUSTIBLE	G-296-B	EDPN-9N074-AA
640 con motor/FORD 6 CYL. ENGLISH DIESEL 363		
ACEITE	G-834	2703E-6731-A
COMBUSTIBLE	G-296	EDPN-9N074-AA
COMBUSTIBLE	G-296-B	EDPN-9N074-AA
642 con motor/FORD 6 CYL. 380		
ACEITE, CARTUCHO	G-834	2703E-6731-A
ACEITE, SELLADO	GP-1	B7A-6714-A
COMBUSTIBLE	G-296	EDPN-9N074-AA
COMBUSTIBLE, SELLADO	GP-1122	1457434050
COMBUSTIBLE	G-296-B	EDPN-9N074-AA
642 con motor/FORD V8-361		
ACEITE, CARTUCHO	G-6	CPN-6731-B
ACEITE, SELLADO	GP-1	B7A-6714-A
GASOLINA	GG-20	C4AZ-9365-B
7700 con motor/A DIESEL		
AIRE	GAK-20	KJ22065
7700 con motor/A GASOLINA		
AIRE	GAK-403	CTJZ9600C

FORD

EXCAVADORAS

H41 con motor/A DIESEL		
ACEITE	G-5000	C5TE-6744-A
COMBUSTIBLE	G-296	EDPN-9N074-AA
ACEITE	GP-66	7700040
COMBUSTIBLE	G-296-B	EDPN-9N074-AA
H48 con motor/FORD 6 CYL.		
ACEITE	G-5000	DGPN-6731-A
COMBUSTIBLE	G-296	D0NN-9N074-B
COMBUSTIBLE	G-296-B	EDPN-9N074-AA
AIRE, SECUNDARIO	GA-588	D1NN-9R500-A
AIRE, PRIMARIO	GA-589	E9NN-9601-AA

FORD

MONTACARGAS

3FD50, 3FD60, 3FG50, 3FG60 con motor/TOYOTA 2F		
ACEITE	GP-1	15600-41010

MARCA-MODELO-MOTOR	GONHER	OEM
MAKE-MODEL-ENGINE	GONHER	OEM

FORD (continuación)

MONTACARGAS

3FD50, 3FD60, 3FG50, 3FG60 con motor/TOYOTA 2H		
TRANSMISION	GP-9	40150-30370-71
5FD10, 5FD14, 5FD15, 5FD18, 5FD20, 5FD23, 5FD25, 5FD28, 5FD30 con motor/TOYOTA 1Z		
ACEITE	GP-1	15600-41010
5FD30, 5FD10, 5FD14, 5FD15, 5FD18, 5FD20, 5FD23, 5FD25, 5FD28 con motor/TOYOTA 2J		
TRANSMISION	GP-9	40150-30370-71
5FD33, 5FD45, 5FD35, 5FD40 con motor/TOYOTA 11Z		
ACEITE	GP-1	15600-41010
5FD50, 5FD60, 5FD70 con motor/TOYOTA 12Z DIESEL		
ACEITE	GP-1	15600-41010
5FDC20 con motor/TOYOTA 2J DIESEL		
ACEITE	GP-1	15600-41010
5FDC20 con motor/TOYOTA 4Y GASOLINA		
TRANSMISION	GP-9	40150-30370-71
5FDC23 con motor/TOYOTA 2J DIESEL		
ACEITE	GP-1	15600-41010
5FDC23 con motor/TOYOTA 4Y GASOLINA		
TRANSMISION	GP-9	40150-30370-71
5FDC25 con motor/TOYOTA 2J DIESEL		
ACEITE	GP-1	15600-41010
5FDC25 con motor/TOYOTA 4Y GASOLINA		
TRANSMISION	GP-9	40150-30370-71
5FDC28 con motor/TOYOTA 2J DIESEL		
ACEITE	GP-1	15600-41010
5FDC28 con motor/TOYOTA 4Y GASOLINA		
TRANSMISION	GP-9	40150-30370-71
5FDC30 con motor/TOYOTA 2J DIESEL		
ACEITE	GP-1	15600-41010
5FDC30 con motor/TOYOTA 4Y GASOLINA		
TRANSMISION	GP-9	40150-30370-71
5FG15, 5FG18, 5FG20, 5FG23, 5FG25, 5FG28, 5FG30, 5FG10, 5FG14 con motor/TOYOTA 1Z		
ACEITE	GP-1	15600-41010
5FG20, 5FG23, 5FG25, 5FG28, 5FG30, 5FG10, 5FG14, 5FG15, 5FG18 con motor/TOYOTA 2J		
TRANSMISION	GP-9	40150-30370-71
5FG33, 5FG45, 5FG35, 5FG40 con motor/TOYOTA 11Z DIESEL		
ACEITE	GP-1	15600-41010
5FGC10, 5FGC13, 5FGC15 con motor/TOYOTA 4Y GASOLINA		
ACEITE	GP-38	15601-33021
5FGC18 con motor/TOYOTA 2J DIESEL		
ACEITE	GP-1	15600-41010
5FGC18 con motor/TOYOTA 4Y GASOLINA		
TRANSMISION	GP-9	40150-30370-71

MARCA-MODELO-MOTOR	GONHER	OEM
MAKE-MODEL-ENGINE	GONHER	OEM

FORD (continuación)

MONTACARGAS

FDC35, FDC40, FDC45 con motor/TOYOTA 2H DIESEL		
TRANSMISION	GP-9	40150-30370-71
FDC45 con motor/TOYOTA 2F GASOLINA		
ACEITE	GP-1	15600-41010
FGC33, FGC35, FGC40, FGC45 con motor/TOYOTA 2F GASOLINA		
ACEITE	GP-1	15600-41010
FGC33, FGC35, FGC40, FGC45 con motor/TOYOTA 2H DIESEL		
TRANSMISION	GP-9	40150-30370-71

FORD

MOTORES

104 A GASOLINA, 104GF (V-4) A GASOLINA, 158G A GASOLINA, 192G A GASOLINA, 192LPG A GASOLINA, 233G A GASOLINA		
ACEITE, CARTUCHO	G-5000	C5TE-6744-A
134 (FOUR) A GASOLINA, 144 A DIESEL, 158GF A GASOLINA, 172 A DIESEL, 201GF A GASOLINA, 256GF A GASOLINA		
ACEITE	GP-9	B8NN-6714-A
140 (2.3L FOUR) INDUSTRIAL A GASOLINA, 170 (SIX) A GASOLINA, 200 A GASOLINA, 200GF A GASOLINA, 250GF A GASOLINA, 2602E A GASOLINA, 2613E A GASOLINA, 2614E A GASOLINA, 2615E A GASOLINA, 2625E A GASOLINA, 2653E A GASOLINA, 2655E A GASOLINA, 2656E A GASOLINA, 302GM (5.0L V8) A GASOLINA, 302GP (5.0L V8) A GASOLINA, 351GM (5.8L V8) A GASOLINA, 351GP (5.8L V8) A GASOLINA, 360 A GASOLINA, 360GP A GASOLINA, 390 A GASOLINA, 390GP A GASOLINA, 400 A GASOLINA, 460 A GASOLINA, 460GM A GASOLINA, 460GP (7.5L V8) A GASOLINA		
ACEITE	GP-1	C1AZ-6731-A
144 (YSD-42M/2, 4L-635M/3,5L) A DIESEL		
ACEITE, CARTUCHO	G-836	C7TZ-6731-A
ACEITE, SELLADO	GP-9	B8NN-6714-A
COMBUSTIBLE	G-296	D0NN-9N074-B
COMBUSTIBLE	G-296-B	D0NN-9N074-B
158 A DIESEL		
ACEITE	G-5000	C5TE-6744-A
ACEITE	GP-1	C1AZ-6731-A
COMBUSTIBLE	G-296	D0NN-9N074-B
158D INDUSTRIAL, 175D A DIESEL, 175D INDUSTRIAL A DIESEL, 201D A DIESEL, 233D A DIESEL		
ACEITE, CARTUCHO	G-5000	C5TE-6744-A
ACEITE, SELLADO	GP-1	B7A-6714-A
COMBUSTIBLE	G-296	D0NN-9N074-B
COMBUSTIBLE	G-296-B	D0NN-9N074-B
168 (SSD-327, 2.7L) A DIESEL, 224 (SSD-437, 437M, 3.7L) INDUSTRIAL		
COMBUSTIBLE	G-296	D0NN-9N074-B
172 (FOUR) A GASOLINA, 330HD A GASOLINA, 330MD A GASOLINA, 332 V8 A GASOLINA, 352 A GASOLINA, 361 A GASOLINA		
ACEITE	G-6	CPN-6731-B
175 (BSD-329, 2.9L A DIESEL, 183 A DIESEL, 192 (BSD-332, 3.2L) A DIESEL, 335 (SSD-655, 5.5L) INDUSTRIAL, 335 (SSD-655M, 5.5L) INDUSTRIAL, 335 (SSD-655MT, 5.5L) INDUSTRIAL		
ACEITE	GP-1	C1AZ-6731-A
ACEITE	GP-9	E4NN-6714-AA
COMBUSTIBLE	G-296	D0NN-9N074-B
COMBUSTIBLE	G-296-B	D0NN-9N074-B

MARCA-MODELO-MOTOR MAKE-MODEL-ENGINE	GONHER GONHER	OEM OEM	MARCA-MODELO-MOTOR MAKE-MODEL-ENGINE	GONHER GONHER	OEM OEM	MARCA-MODELO-MOTOR MAKE-MODEL-ENGINE	GONHER GONHER	OEM OEM
FORD (continuación)			FORD (continuación)			FORD (continuación)		
MOTORES			MOTORES			MOTORES		
201 (BSD-333, 3.3L) INDUSTRIAL			ACEITE, SELLADO	GP-1	B7A-6714-A	363 V8 TURBO		
ACEITE, CARTUCHO	G-5000	C5TE-6744-A				COMBUSTIBLE (PICKUPS)	G-1047	FD4604
ACEITE, SELLADO	GP-1	B7A-6714-A	254 (DSD -442, 4.2L) INDUSTRIAL			380 (DSD-662, 6.2L) INDUSTRIAL		
ACEITE, SELLADO	GP-9	E4NN-6714-AA	ACEITE, CARTUCHO	G-834	2703E-6731-A	ACEITE	G-834	2703E-6731-A
COMBUSTIBLE	G-296	D0NN-9N074-B	ACEITE, CARTUCHO	G-836	EPN-6731-B	ACEITE	GP-1	C1AZ-6731-A
COMBUSTIBLE	G-296-B	D0NN-9N074-B	ACEITE, SELLADO	GP-1	C1AZ-6731-A	ACEITE	GP-9	B8NN-6714-A
220 A DIESEL			ACEITE, SELLADO	GP-9	B8NN-6714-A	COMBUSTIBLE	G-296	D0NN-9N074-B
ACEITE, S/N 1495142 EN ADELANTE	G-813	957E-6731	COMBUSTIBLE	G-296	D0NN-9N074-B	COMBUSTIBLE	G-296-B	D0NN-9N074-B
ACEITE	G-836	C2TZ-6708-A	COMBUSTIBLE	G-296-B	D0NN-9N074-B	380 A DIESEL		
ACEITE, HASTA S/N 1495142	G-870	E1ADKN-18662-A	254 A DIESEL, 256 (BSD-442, 4.2L) INDUSTRIAL, 256 A DIESEL			ACEITE, CARTUCHO	G-834	2703E-6731-A
COMBUSTIBLE, SECUNDARIO	G-11816	EPN-99162-A	ACEITE	GP-1	B7A-6714-A	ACEITE, SELLADO	GP-1	B7A-6714-A
GASOLINA	GG-20	C4AZ-9365-B	COMBUSTIBLE	G-296	EDPN-9N074-AA	COMBUSTIBLE	G-296	EDPN-9N074-AA
220 INDUSTRIAL			COMBUSTIBLE	G-296-B	EDPN-9N074-AA	COMBUSTIBLE, SELLADO	GP-1122	E6HZ-9365-C
ACEITE, S/N 1495142 EN ADELANTE	G-813	EPN-6731-B	262 (SIX) A GASOLINA, 262 6 CYL. A GASOLINA			COMBUSTIBLE	G-296-B	EDPN-9N074-AA
ACEITE, S/N 1495142 EN ADELANTE	G-836	C7TZ-6731-A	ACEITE	G-330	C5RA-6744-C	391 A GASOLINA		
ACEITE, HASTA S/N 1495142	G-870	E1ADKN-18662-A	268 (BSD-444, 4.4L) INDUSTRIAL			ACEITE	G-6	CPN-6731-B
COMBUSTIBLE	G-11816	EPN-99162-A	ACEITE	GP-1	C1AZ-6731-A	401 (6.6L) A DIESEL		
COMBUSTIBLE	G-296	D0NN-9N074-B	COMBUSTIBLE	G-296	D0NN-9N074-B	COMBUSTIBLE, SEPARADOR DE AGUA	GPP-14	FD3370
COMBUSTIBLE	G-296-B	D0NN-9N074-B	COMBUSTIBLE	G-296-B	D0NN-9N074-B	ACEITE	GP-36	E7HZ-6731-A
223 (SIX) A GASOLINA, 240 (SIX) A GASOLINA, 289 A GASOLINA			AIRE	GA-588	D1NN-9R500-A	ACEITE	GP-54	E7HZ-6731-A
ACEITE, CARTUCHO	G-6	CPN-6731-B	AIRE	GA-589	D1NN-9601-A	COMBUSTIBLE	GP-1122	E6HZ-9365-C
ACEITE, CARTUCHO	G-330	C5RA-6744-C	2701E A DIESEL			ACEITE	GP-77	E7NN-6714-BB
ACEITE, SELLADO	GP-1	C1AZ-6731-A	COMBUSTIBLE	G-1173	C0NN-9155-B	COMBUSTIBLE, SEPARADOR DE AGUA	GPP-1287	FD3368
2261E A GASOLINA, 2262E A GASOLINA, 2263E A GASOLINA, 2264E A GASOLINA, 2265E A GASOLINA			2703E A DIESEL			ACEITE, DERIVACION (BY PASS)	G-750	SFD-28-028
ACEITE	GP-3600	E4FZ-6731-A	ACEITE	G-836	C7TZ-6731-A	401 (BSD-666T, 6.6L) INDUSTRIAL		
230 A DIESEL, 330DF A DIESEL			2715E A DIESEL			COMBUSTIBLE	G-297	D8NN-9176-AA
ACEITE	G-836	C2TZ-6708-A	ACEITE	G-834	C7TZ-6731-B	ACEITE	GP-77	E0NN-6714-AA
233 INDUSTRIAL, 401 INDUSTRIAL, 420 INDUSTRIAL			COMBUSTIBLE	G-11816	EPN-99162-A	COMBUSTIBLE	G-297-B	D8NN-9176-AA
ACEITE	GP-9	B8NN-6714-A	ACEITE	GP-1	D9AE-6714-AA	AIRE	GA-827	D5NN-9R500-C
COMBUSTIBLE	G-296	D0NN-9N074-B	COMBUSTIBLE	G-296	D0NN-9N074-B	AIRE	GA-588	D1NN-9R500-A
COMBUSTIBLE	G-296-B	D0NN-9N074-B	COMBUSTIBLE	G-296-B	D0NN-9N074-B	AIRE	GA-589	D1NN-9601-A
240 A GASOLINA			2802E INDUSTRIAL, 330 SIX INDUSTRIAL			401 (BSD-666TI, 6.6L) INDUSTRIAL		
GASOLINA	GG-20	C4AZ-9365-B	ACEITE	G-834	C7TZ-6731-A	ACEITE	GP-36	D8NN-6714-AA
2401E A DIESEL, 2701E INDUSTRIAL, 2702E INDUSTRIAL, 2703E INDUSTRIAL, 2704E INDUSTRIAL			292 V8 A GASOLINA			COMBUSTIBLE	G-297	D8NN-9176-AA
ACEITE	G-836	C7TZ-6731-A	ACEITE	G-330	C5RA-6744-C	COMBUSTIBLE	G-297-B	D8NN-9176-AA
COMBUSTIBLE	G-296	D0NN-9N074-B	300 A GASOLINA, 300HD A GASOLINA, 300LD A GASOLINA			401 A GASOLINA, 475 A GASOLINA		
COMBUSTIBLE	G-296-B	D0NN-9N074-B	ACEITE, CARTUCHO	G-6	CPN-6731-B	ACEITE, CARTUCHO	G-5000	CFPN-6731-B
2402E A DIESEL, 2704ET A DIESEL			ACEITE	G-330	C5RA-6744-C	ACEITE, SELLADO	GP-9	B8NN-6714-A
ACEITE	G-834	2703E-6731-A	ACEITE, SELLADO	GP-1	C1AZ-6731-A	COMBUSTIBLE	GP-1101	BM59678
COMBUSTIBLE	G-296	D0NN-9N074-B	330 A DIESEL			AIRE, SIN ASPAS	GA-24	222531
COMBUSTIBLE	G-296-B	D0NN-9N074-B	ACEITE	G-836	C7TZ-6731-A	401D A DIESEL		
242 A DIESEL, 2711E A DIESEL, 2712E A DIESEL, 2713E A DIESEL, 2714E A DIESEL			COMBUSTIBLE, PRIMARIO	G-1174	FG30	ACEITE, CARTUCHO PARA FLUJO TOTAL (FULL FLOW)	G-5000	DGPN-6731-A
ACEITE, CARTUCHO	G-836	C2TZ-6708-A	COMBUSTIBLE, SECUNDARIO	G-11816	EPN-99162-A	ACEITE, SELLADO FLUJO TOTAL (FULL FLOW)	GP-1	D9NN-6714-EA
COMBUSTIBLE, SECUNDARIO	G-11816	EPN-99162-A	362 (DSD-659, 5.9L) INDUSTRIAL			ACEITE, SELLADO FLUJO TOTAL (FULL FLOW)	GP-36	D8NN-6714-AA
ACEITE, SELLADO	GP-1	B7A-6714-A	ACEITE, CARTUCHO	G-834	2703E-6731-A	COMBUSTIBLE	G-296	EDPN-9N074-AA
COMBUSTIBLE	G-296	7111/296	ACEITE, SELLADO	GP-1	C1AZ-6731-A	ACEITE, SELLADO FLUJO TOTAL (FULL FLOW)	GP-77	E0NN-6714-AA
COMBUSTIBLE	G-296-B	7111/296	COMBUSTIBLE	G-296	D0NN-9N074-B	COMBUSTIBLE	G-296-B	EDPN-9N074-AA
242DF A DIESEL			COMBUSTIBLE	G-296-B	D0NN-9N074-B	476 (7.8L) A DIESEL		
ACEITE, CARTUCHO	G-836	C7TZ-6731-A	363 (DSD-660, 6.0L) INDUSTRIAL, 363 A DIESEL, 363DF A DIESEL			ACEITE	GP-36	F0HZ-6731-A
COMBUSTIBLE	G-1173	C0NN-9155-B	ACEITE	G-834	2703E-6731-A	ACEITE	GP-54	E7HZ-6731-A
			COMBUSTIBLE	G-296	D0NN-9N074-B	COMBUSTIBLE	GP-1122	E6HZ-9365-C
			COMBUSTIBLE	G-296-B	D0NN-9N074-B	AGUA	GP-2071W	F3HZ-8A424-C

SERVICIO PESADO

MARCA-MODELO-MOTOR MAKE-MODEL-ENGINE	GONHER GONHER	OEM OEM	MARCA-MODELO-MOTOR MAKE-MODEL-ENGINE	GONHER GONHER	OEM OEM	MARCA-MODELO-MOTOR MAKE-MODEL-ENGINE	GONHER GONHER	OEM OEM
FORD (continuación)			FORD (continuación)			FORD (continuación)		
MOTORES			MOTORES			MOTORES		
COMBUSTIBLE, SEPARADOR DE AGUA	GPP-1287	FD3368	AIRE	GA-3300	E4TE-9601-AA	COMBUSTIBLE, SECUNDARIO DE AGUA	GP-1122	E7HZ-9365-A
ACEITE, DERIVACION (BY PASS)	G-750	SFD-28-028	AIRE	GA-174	E7TZ-9601-B	COMBUSTIBLE, SEPARADOR DE AGUA	GPP-1287	FD-3368
477 A GASOLINA, 534 A GASOLINA			GASOLINA	GG-20	C4AZ-9365-B	ACEITE, DERIVACION (BY PASS)	G-750	SFD-28-028
ACEITE	G-5000	CFPN-6731-B	GASOLINA	GG-47	E9TZ-9B072-CA	7HNN226 INDUSTRIAL A GASOLINA		
ACEITE	GP-9	B8NN-6714-A	GASOLINA	GG-19	C7AE-9155-A	COMBUSTIBLE	G-11816	EPN-99162-A
COMBUSTIBLE, SELLADO	GP-1101	BM59678	GASOLINA	GG-87	E0ZE-9155-BA	91 (V-4) INDUSTRIAL, DD A DIESEL, DE A DIESEL, E A GASOLINA		
AIRE, SIN ASPAS	GA-24	222531	6-170 A GASOLINA, 6-200 A GASOLINA			ACEITE	GP-9	B8NN-6714-A
515 INDUSTRIAL, 535 THREE INDUSTRIAL			ACEITE	GP-1	B7A-6714-A	91 A GASOLINA, CSG850M INDUSTRIAL, EEN A GASOLINA, EET A GASOLINA, EEV A GASOLINA, EEW A GASOLINA, EFZ A GASOLINA, LRG-423 (2.3L I4) INDUSTRIAL, LSG-423 (2.3L I4) INDUSTRIAL, LSG423 A GASOLINA, LSG-875M INDUSTRIAL, MOTOR HOMES CAMION, O91PV A GASOLINA, V A GASOLINA		
ACEITE	GP-9	B8NN-6714-A	GASOLINA, 1963-65	GG-20	C4AZ-9365-B	ACEITE	GP-1	B7A-6714-A
COMBUSTIBLE	G-296	D0NN-9N074-B	GASOLINA, 1966-72	GG-19	C7AE-9155-A	BSD332 A DIESEL, BSD333 A DIESEL, BSD333H A DIESEL, BSD442 A DIESEL, BSD444 A DIESEL		
COMBUSTIBLE	G-296-B	D0NN-9N074-B	6-215 A GASOLINA, C4PA A GASOLINA, C4PB A GASOLINA, C4PC A GASOLINA, C5PF A GASOLINA, C5PG A GASOLINA, D A GASOLINA, EAF A GASOLINA, EAG A GASOLINA, EAM A GASOLINA, EBR A GASOLINA, EBS A GASOLINA, EBT A GASOLINA, EBV A GASOLINA, EBW A GASOLINA, EBZ A GASOLINA, ECR A GASOLINA, ECS A GASOLINA, ECS2V A GASOLINA, ECS4V A GASOLINA, ECT A GASOLINA, ECT4V A GASOLINA, ECW A GASOLINA, ECV A GASOLINA, EEH A GASOLINA, EEJ A GASOLINA, EEK A GASOLINA, EER A GASOLINA, EFU A GASOLINA, EFV A GASOLINA, EFW A GASOLINA, EFG A GASOLINA, EGA A GASOLINA, EGU A GASOLINA, EGV A GASOLINA, EGW A GASOLINA, EGY A GASOLINA, EGZ A GASOLINA, EHC A GASOLINA, EHF A GASOLINA, EHV A GASOLINA, ET60R1 A GASOLINA, F A GASOLINA, G A GASOLINA, J A GASOLINA, JA A GASOLINA, JA215 A GASOLINA, JB A GASOLINA, JB317 A GASOLINA, JBS A GASOLINA, JBN A GASOLINA, JCS A GASOLINA, JCN A GASOLINA, JD A GASOLINA, JD5 A GASOLINA, JE A GASOLINA, JE134 A GASOLINA, JE5 A GASOLINA, JF A GASOLINA, JF5 A GASOLINA, JG A GASOLINA, JG5 A GASOLINA, JH A GASOLINA, JHS A GASOLINA, JJ A GASOLINA, JL A GASOLINA, K A GASOLINA, L A GASOLINA, V8-256 A GASOLINA, V8-272 A GASOLINA, V8-279 A GASOLINA			ACEITE	GP-1	B7A-6714-A
592E MARINO, DOLPHIN MARINO			ACEITE	G-6	CPN-6731-B	COMBUSTIBLE	G-296	EDPN-9N074-AA
ACEITE	G-813	EPN-6731-B	6-223 A GASOLINA			COMBUSTIBLE	G-296-B	EDPN-9N074-AA
6 CYL. 144 A GASOLINA			ACEITE, CARTUCHO (1954-59)	G-6	CPN-6731-B	ACEITE	GP-81	E7NN-6714-AA
ACEITE	GP-1	B7A-6714-A	ACEITE, CARTUCHO (1960-63)	G-330	C5RA-6744-C	BSD444T A DIESEL, BSD444TS A DIESEL		
AIRE	GA-77	3CAZ-9601-A	ACEITE, SELLADO 1963-64	GP-1	B7A-6714-A	COMBUSTIBLE	G-296	EDPN-9N074-AA
GASOLINA	GG-5 L	C2RZ-9115-B	6-240 A GASOLINA			COMBUSTIBLE	G-296-B	EDPN-9N074-AA
GASOLINA	GG-19	C7AE-9155-A	ACEITE	G-6	CPN-6731-B	ACEITE	GP-81	E8NN-6714-BA
6 CYL. 170 A GASOLINA			6-224 A GASOLINA			BSD666 A DIESEL, BSD666T A DIESEL, BSD666TI A DIESEL		
ACEITE	GP-1	B7A-6714-A	ACEITE, CARTUCHO (1954-59)	G-6	CPN-6731-B	ACEITE	GP-36	D8NN-6714-AA
AIRE	GA-77	3CAZ-9601-A	ACEITE, CARTUCHO (1960-63)	G-330	C5RA-6744-C	COMBUSTIBLE	G-297	D8NN-9176-AA
AIRE	GA-80	C4OZ-9601-A	ACEITE, SELLADO 1963-64	GP-1	B7A-6714-A	ACEITE	GP-77	E7NN-6714-BB
AIRE	GA-303	C8TZ-9601-A	6-240 A GASOLINA			COMBUSTIBLE	G-297-B	D8NN-9176-AA
GASOLINA	GG-20	C4AZ-9365-B	ACEITE	G-6	CPN-6731-B	EDL A GASOLINA, EDL2V A GASOLINA, EDL4V A GASOLINA, EDM A GASOLINA, EDM2V A GASOLINA, EDM4V A GASOLINA, EDN A GASOLINA, EDN4V A GASOLINA, M A GASOLINA, N A GASOLINA, Q A GASOLINA		
GASOLINA	GG-5 L	C2RZ-9115-B	ACEITE	G-330	C5RA-6744-C	ACEITE	G-5000	DGPN-6731-A
GASOLINA	GG-19	C7AE-9155-A	6-240 A GASOLINA			FD1060 (5.9L) A DIESEL		
6 CYL. 200 A GASOLINA			ACEITE	G-330	C5RA-6744-C	COMBUSTIBLE, SEPARADOR DE AGUA	GPP-1122	F3HZ-9365-E
ACEITE	GP-1	B7A-6714-A	6-262 A GASOLINA			AGUA	GP-2071W	F3HZ-8A424-C
AIRE	GA-77	3CAZ-9601-A	ACEITE	G-6	CPN-6731-B	ACEITE	GP-178	F3HZ-6731-B
AIRE	GA-303	C8TZ-9601-A	ACEITE, 1961-64	G-330	C5RA-6744-C	FD1460 (8.3L) A DIESEL		
GASOLINA	GG-20	C4AZ-9365-B	GASOLINA	GG-20	C2AZ-9155-A	ACEITE	GP-3001	E8HZ-6731-A
GASOLINA	GG-19	C7AE-9155-A	6-300 A GASOLINA			COMBUSTIBLE	GPP-1122	F3HZ-9365-E
6 CYL. 223 A GASOLINA			ACEITE, 1965-76	G-330	C5RA-6744-C	AGUA	GP-1011Q	F3HZ-8A424-D
ACEITE	G-6	CPN-6731-B	ACEITE, 1965-93	GP-1	B7A-6714-A	ACEITE	GP-3000	E8HZ-6731-A
ACEITE	G-330	C5RA-6744-C	GASOLINA, 1965-1976	GG-20	C4AZ-9365-B	AGUA	GP-2071W	F3HZ-8A424-D
ACEITE	GP-1	B7A-6714-A	GASOLINA, 1987-93	GG-47	E9TZ-9B072-CA	AIRE	GA-197R	F3HZ-9601-A
AIRE	GA-80	C4OZ-9601-A	GASOLINA, 1966, 1967, 1979, 1980	GG-19	C7AE-9155-A	AIRE	GA-768R	F3HZ-9R500-A
AIRE	GA-303	C8TZ-9601-A	GASOLINA, 1982-85	GG-87	E0ZE-9155-BA	LRG-425 (2.5L I4) INDUSTRIAL		
GASOLINA	GG-20	C4AZ-9365-B	6-401 (6.6L) A DIESEL			ACEITE	GP-3600	E4FZ-6731-A
GASOLINA	GG-19	C7AE-9155-A	AGUA	GP-1010Q	E7HZ-8A424-B	V10 415 A GASOLINA, V10-6.8L TRITON A GASOLINA, V8-281 A GASOLINA		
6 CYL. 226 A GASOLINA, V8-389XD A GASOLINA			ACEITE	GP-36	F0HZ-6731-B	ACEITE	GP-68	F1AZ-6731-BD
ACEITE	G-31	51T-6725-A	COMBUSTIBLE, SECUNDARIO	GP-1122	E7HZ-9365-A	AIRE	GA-1615	F50Z-9601-BA
6 CYL. 240 A GASOLINA			ACEITE	GP-77	E7NN-6714-BB	GASOLINA	GG-1872	F0TZ-9155-B
ACEITE, CARTUCHO	G-330	C5RA-6744-C	COMBUSTIBLE, SEPARADOR DE AGUA	GPP-1287	FD-3368	GASOLINA	GG-986	F89Z-9155-A
ACEITE, SELLADO	GP-1	B7A-6714-A	ACEITE, DERIVACION (BY PASS)	G-750	SFD-28-028			
AIRE	GA-80	C4OZ-9601-A	6-474 (7.8L) A DIESEL					
AIRE	GA-303	C8TZ-9601-A	AGUA	GP-1010Q	E7HZ-8A424-B			
GASOLINA	GG-20	C4AZ-9365-B	ACEITE	GP-36	F0HZ-6731-B			
GASOLINA	GG-19	C7AE-9155-A						
6 CYL. 250 A GASOLINA								
ACEITE	GP-1	B7A-6714-A						
AIRE	GA-3300	E4TE-9601-AA						
GASOLINA	GG-19	C7AE-9155-A						
6 CYL. 300 A GASOLINA								
ACEITE, SELLADO	GP-1	B7A-6714-A						
AIRE	GA-80	C4OZ-9601-A						
AIRE	GA-303	C8TZ-9601-A						

MARCA-MODELO-MOTOR	GONHER	OEM	MARCA-MODELO-MOTOR	GONHER	OEM	MARCA-MODELO-MOTOR	GONHER	OEM
MAKE-MODEL-ENGINE	GONHER	OEM	MAKE-MODEL-ENGINE	GONHER	OEM	MAKE-MODEL-ENGINE	GONHER	OEM
FORD (continuación)			FORD (continuación)			FORD (continuación)		
MOTORES			MOTORES			MOTORES		
V6-232 A GASOLINA			V8-330 A GAS NATURAL			AIRE	GA-78	C7AF-9600-N
ACEITE	GP-1	B7A-6714-A	ACEITE	GP-68	F1AZ-6731-BD	AIRE	GA-85	E4TE-9601-EA
AIRE	GA-74	D3Z2-9601-A				GASOLINA	GG-20	C4AZ-9365-B
GASOLINA	GG-87	E0ZE-9155-BA	V8-330 A GASOLINA			GASOLINA	GG-19	C7AE-9155-A
			ACEITE	G-6	CPN-6731-B			
V6-256 A GASOLINA			ACEITE, 1968-75	G-330	C5RA-6744-C	V8-391 A GASOLINA		
ACEITE	GP-3600	E4FZ-6731-A	ACEITE	GP-1	B7A-6714-A	ACEITE	G-6	CPN-6731-B
AIRE	GA-1615	F50Z-9601-BA	ACEITE	GP-68	F1AZ-6731-BD	ACEITE	GP-1	B7A-6714-A
GASOLINA	GG-1872	F0TZ-9155-B	AIRE	GA-89	E1HZ-9601-A	ACEITE	GP-31	D3HZ-6731-B
GASOLINA	GG-986	F89Z-9155-A	AIRE	GA-1615	F50Z-9601-BA	ACEITE	G-500	D0TZ-6731-B
			ACEITE	G-500	D0TZ-6731-B	GASOLINA	GG-20	C4AZ-9365-B
V8-239 A GASOLINA			GASOLINA	GG-20	C4AZ-9365-B			
ACEITE	G-6	CPN-6731-B	GASOLINA	GG-1872	F0TZ-9155-B	V8-4.6L TRITON A GASOLINA		
ACEITE	G-31	51T-6725-A	GASOLINA	GG-986	F89Z-9155-A	ACEITE	GP-68	F1AZ-6731-A
ACEITE	GP-1	B7A-6714-A				AIRE	GA-1615	F50Z-9601-BA
			V8-351 A GASOLINA			GASOLINA, 1997-98	GG-1872	F0TZ-9155-B
V8-255 A GASOLINA			ACEITE	GP-1	B7A-6714-A	GASOLINA, 1999-04	GG-986	F89Z-9155-A
ACEITE	GP-1	B7A-6714-A	AIRE	GA-75	D2AZ-9601-A			
AIRE	GA-75	D2AZ-9601-A	AIRE	GA-85	E4TE-9601-EA	V8-400 A GASOLINA		
GASOLINA	GG-87	E0ZE-9155-BA	AIRE	GA-86	D0GY-9601-A	ACEITE	GP-1	B7A-6714-A
			AIRE	GA-174	E7TZ-9601-B	AIRE	GA-75	D2AZ-9601-A
V8-260 A GASOLINA			GASOLINA	GG-47	E9TZ-98072-CA	AIRE	GA-85	E4TE-9601-EA
ACEITE	GP-1	B7A-6714-A	GASOLINA	GG-19	C7AE-9155-A	AIRE	GA-86	D0GY-9601-A
AIRE	GA-77	3CAZ-9601-A	GASOLINA	GG-87	E0ZE-9155-BA	GASOLINA	GG-19	C7AE-9155-A
AIRE	GA-80	C4OZ-9601-A				GASOLINA	GG-87	E0ZE-9155-BA
GASOLINA	GG-20	C4AZ-9365-B	V8-359 A GASOLINA					
			ACEITE	G-6	CPN-6731-B	V8-401 A GASOLINA		
V8-289 A GASOLINA			ACEITE	GP-1	B7A-6714-A	ACEITE	G-5000	DGPN-6731-A
ACEITE	GP-1	B7A-6714-A	ACEITE	GP-31	D3HZ-6731-B	ACEITE	GP-1	B7A-6714-A
AIRE	GA-80	C4OZ-9601-A	ACEITE	G-500	D0TZ-6731-B	COMBUSTIBLE	GP-1101	BM59678
AIRE	GA-85	E4TE-9601-EA	GASOLINA	GG-5 L	C2RZ-9115-B			
GASOLINA	GG-20	C4AZ-9365-B				V8-420 (6.9L) IHC A DIESEL		
GASOLINA	GG-19	C7AE-9155-A	V8-360 A GASOLINA			COMBUSTIBLE, PRIMARIO	GPP-14	E7HZ-9N184-A
			ACEITE	G-330	C5RA-6744-C	ACEITE	GP-3766	E3TZ-6731-A
V8-292 A GASOLINA			ACEITE	GP-1	B7A-6714-A	COMBUSTIBLE, PRIMARIO	GP-155	E3TZ-9155-A
ACEITE	G-6	CPN-6731-B	AIRE	GA-85	E4TE-9601-EA			
ACEITE	G-330	C5RA-6744-C	GASOLINA	GG-20	C4AZ-9365-B	V8-428 COBRA JET A GASOLINA		
ACEITE	GP-1	B7A-6714-A	GASOLINA	GG-19	C7AE-9155-A	ACEITE	GP-1	B7A-6714-A
GASOLINA	GG-20	C4AZ-9365-B						
			V8-361 H.D. A GASOLINA			V8-429 A GASOLINA		
V8-302 (EXCEPTO F.I.) A GASOLINA			ACEITE	G-6	CPN-6731-B	ACEITE, 1971-73	GP-1	B7A-6714-A
ACEITE	G-6	CPN-6731-B	ACEITE	GP-1	B7A-6714-A	ACEITE, 1979-92	GP-31	D3HZ-6731-B
ACEITE	G-330	C5RA-6744-C	ACEITE	GP-9	B8NN-6714-A	COMBUSTIBLE, 1986-94	GP-1122	E6HZ-9365-C
ACEITE	GP-1	B7A-6714-A	ACEITE	GP-31	D3HZ-6731-B	AIRE	GA-85	E4TE-9601-EA
AIRE	GA-75	D2AZ-9601-A	ACEITE	G-500	D0TZ-6731-B	AIRE	GA-89	E1HZ-9601-A
AIRE	GA-80	C4OZ-9601-A	GASOLINA	GG-20	C4AZ-9365-B	AIRE	GA-86	D0GY-9601-A
AIRE	GA-85	E4TE-9601-EA	GASOLINA	GG-19	C7AE-9155-A	GASOLINA, 1979-85	GG-20	C4AZ-9365-B
AIRE	GA-303	C8TZ-9601-A	V8-370 A GASOLINA			GASOLINA, HASTA 1991	GG-1872	F0TZ-9155-B
GASOLINA	GG-20	C4AZ-9365-B	ACEITE	GP-31	D3HZ-6731-B	GASOLINA, 1971-73	GG-19	C7AE-9155-A
GASOLINA	GG-19	C7AE-9155-A	COMBUSTIBLE, 1986-94	GP-1122	E6HZ-9365-C	GASOLINA, 1980-1987	GG-123	D9PZ-9155-A
GASOLINA	GG-87	E0ZE-9155-BA	AIRE	GA-89	E1HZ-9601-A			
			GASOLINA, 1986-1994	GG-20	C4AZ-9365-B	V8-444 (7.3L) TURBO (POWER STROKE) A DIESEL		
V8-302 F.I. A GASOLINA			GASOLINA, HASTA 1991	GG-1872	F0TZ-9155-B	COMBUSTIBLE, 1999 EN ADELANTE	G-862	F81Z-9N184-AA
ACEITE	GP-1	B7A-6714-A	GASOLINA, 1992-94	GG-123	D9PZ-9155-A	COMBUSTIBLE, HASTA 1999	G-178	1822631C91
AIRE	GA-5056	E5TZ-9601-B				AIRE, VANS	GA-VW-620	F5UZ-9601-A
AIRE	GA-174	E7TZ-9601-B	V8-389 A GASOLINA			AIRE, 12 DE JULIO DE 1998 AL 2001 (CAMIONES)	GA-780	XC3Z-9601-AA
GASOLINA	GG-47	E9TZ-9B072-CA	ACEITE	G-6	CPN-6731-B	AIRE, 1994 A DIC. DE 1997 (EXC. CAMIONES 1994 VIN K)	GA-442	F5TZ-9601-A
			ACEITE	GP-31	D3HZ-6731-B			
V8-317 A GASOLINA, V8-352 A GASOLINA, V8-332 A GASOLINA			ACEITE	G-500	D0TZ-6731-B	V8-445 (7.3L) IHC A DIESEL, V8-446 (7.3L) A DIESEL		
ACEITE	G-6	CPN-6731-B	GASOLINA	GG-20	C4AZ-9365-B	ACEITE	GP-3766	E3TZ-6731-A
ACEITE	GP-1	B7A-6714-A	V8-390 A GASOLINA					
GASOLINA	GG-20	B6T-9365-A	ACEITE	G-330	C5RA-6744-C			
			ACEITE	GP-1	B7A-6714-A			

SERVICIO PESADO

MARCA-MODELO-MOTOR	GONHER	OEM	MARCA-MODELO-MOTOR	GONHER	OEM	MARCA-MODELO-MOTOR	GONHER	OEM
MAKE-MODEL-ENGINE	GONHER	OEM	MAKE-MODEL-ENGINE	GONHER	OEM	MAKE-MODEL-ENGINE	GONHER	OEM
FORD (continuación)			FORD (continuación)			FORD (continuación)		
MOTORES			MOTORES			TRACTORES		
V8-445 (7.3L) IHC TURBO A DIESEL			X A DIESEL			165 con motor/KOHLER K341		
COMBUSTIBLE, SEPARADOR DE AGUA	G-862	1825864C92	ACEITE	G-813	EPN-6731-B	TRANSMISION	GP-9	B8NN-6714-A
COMBUSTIBLE, SEPARADOR DE AGUA	G-178	1822631C91	COMBUSTIBLE, SECUNDARIO	G-11816	EPN-99162-A	1700 con motor/A DIESEL		
AGUA	GP-2071W	1822627C1	GASOLINA, PRIMARIO	GG-20	C4AZ-9365-B	ACEITE	GP-38	E1NN-6714-BB
ACEITE	GP-562	1814562C1	Y A DIESEL			1710, 1720 con motor/A DIESEL		
V8-460 A GASOLINA			ACEITE	G-836	C7TZ-6731-A	ACEITE	GP-9	E9NN-6714-AA
ACEITE, 1973-97	GP-1	B7A-6714-A	FORD			COMBUSTIBLE	G-296	SBA130366070
ACEITE, 1973-93	GP-171	E4NN-6714-AA	TRACTORES			COMBUSTIBLE	G-296-B	SBA130366070
AIRE	GA-85	E4TE-9601-EA	100 con motor/KOHLER			1715, 1920, 3415 con motor/A DIESEL		
AIRE	GA-86	DOGY-9601-A	TRANSMISION	GP-9	B8NN-6714-A	ACEITE	GP-9	E9NN-6714-AA
AIRE, RESPIRADOR	GA-186	F4TZ-9D695-A	1000 con motor/A DIESEL			1801D con motor/A DIESEL		
GASOLINA, 1977-79	GG-20	C4AZ-9365-B	ACEITE	GP-38	E1NN-6714-BB	ACEITE	GP-1	B7A-6714-A
GASOLINA, 1988-91	GG-47	E9TZ-98072-CA	1020 con motor/A DIESEL			1900 con motor/A DIESEL		
GASOLINA, 1994-97	GG-1872	F0TZ-9155-B	ACEITE	GP-81	E9NN-6714-AA	ACEITE	GP-38	E1NN-6714-BB
GASOLINA, 1971-76	GG-19	C7AE-9155-A	104D, 105D, 106D con motor/A DIESEL			1910 con motor/A DIESEL		
GASOLINA	GG-123	D9PZ-9155-A	ACEITE	GP-9	C9NN-6714-A	ACEITE	GP-28	E1NN-6714-BA
V8-475 A GASOLINA			1100 con motor/A DIESEL			ACEITE	GP-38	E1NN-6714-BB
ACEITE	G-5000	DGPN-6731-A	ACEITE	GP-42	E1NN-6714-AB	AIRE, SIN ASPAS	GA-33	200E-6228
ACEITE	GP-1	B7A-6714-A	1110 con motor/A DIESEL			2000 con motor/FORD 158		
COMBUSTIBLE	GP-1101	BM59678	ACEITE	GP-42	E1NN-6714-AA	ACEITE, CARTUCHO	G-5000	DGPN-6731-A
AIRE	GA-89	E1HZ-9601-A	1120 con motor/A DIESEL			ACEITE, SELLADO	GP-1	E7NN-6714-AA
V8-477 A GASOLINA			ACEITE	GP-58	F0NN-6714-BA	COMBUSTIBLE	G-296	EDPN-9N074-AA
ACEITE, 1958-78	G-5000	DGPN-6731-A	120, 125, 140, 145 con motor/KOHLER			COMBUSTIBLE	G-296-B	EDPN-9N074-AA
ACEITE	GP-1	B7A-6714-A	TRANSMISION	GP-9	B8NN-6714-A	2000 DEXTA BRITANICO con motor/FORD 3 CYL.		
ACEITE, 1978-80	GP-31	D3HZ-6731-B	1200 con motor/A DIESEL			ACEITE	G-5000	DGPN-6731-A
COMBUSTIBLE, 1973-81	GP-1101	BM59678	ACEITE	GP-42	E1NN-6714-AB	ACEITE, SELLADO	GP-1	E7NN-6714-AA
AIRE	GA-89	E1HZ-9601-A	1210, 1215, 1220 con motor/A DIESEL			GASOLINA	GG-20	C4AZ-9365-B
V8-5.4L TRITON (12V) A GASOLINA			ACEITE	GP-58	F0NN-6714-BA	2000 SUPER DEXTA BRITANICO con motor/A DIESEL		
ACEITE	GP-68	F1AZ-6731-BD	1300 con motor/A DIESEL			ACEITE	G-813	EPN-6731-B
AIRE	GA-1615	F50Z-9601-BA	ACEITE	GP-42	E1NN-6714-AA	ACEITE	G-870	E1ADKN-18662-A
GASOLINA	GG-1872	F0TZ-9155-B	1310 con motor/A DIESEL			COMBUSTIBLE	G-11816	EPN-99162-A
GASOLINA	GG-986	F89Z-9155-A	ACEITE	GP-58	F0NN-6714-BA	HIDRAULICO	GP-66	7700040
V8-5.4L TRITON (24V) A GASOLINA			1320 con motor/A DIESEL			204D, 205D con motor/A DIESEL		
ACEITE	GP-68	F1AZ-6731-BD	ACEITE	GP-9	E9NN-6714-AA	ACEITE	GP-9	C9NN-6714-A
V8-534 A GASOLINA			1500 con motor/A DIESEL			2100 con motor/A DIESEL		
ACEITE, 1958-78	G-5000	DGPN-6731-A	ACEITE	GP-38	E1NN-6714-BB	ACEITE, CARTUCHO	G-5000	DGPN-6731-A
ACEITE	GP-1	B7A-6714-A	1510 con motor/A DIESEL			ACEITE, CON TURBO	GP-1	E7NN-6714-AA
ACEITE, 1979-81	GP-31	D3HZ-6731-B	ACEITE	GP-42	E1NN-6714-AA	COMBUSTIBLE	G-296	EDPN-9N074-AA
COMBUSTIBLE, 1973-81	GP-1101	BM59678	1520, 1620 con motor/A DIESEL			COMBUSTIBLE	G-296-B	EDPN-9N074-AA
AIRE	GA-89	E1HZ-9601-A	ACEITE	GP-9	E9NN-6714-AA	GAS	GP-81	E8NN-6714-AA
VSG-411 (1.1L I-4) INDUSTRIAL, VSG-413 (1.3L I-4) INDUSTRIAL			1600 con motor/A DIESEL			2100 con motor/A GASOLINA		
ACEITE	GP-28	778M-6714-C1A	ACEITE	GP-28	E1NN-6714-BA	ACEITE	GP-9	E8NN-6714-AA
VSG411 A GASOLINA			1630 con motor/A DIESEL			2110 COMPACT DIESEL con motor/A DIESEL		
ACEITE, 4 7/64 IN	GP-3682	EFL125	ACEITE	GP-81	86546618	COMBUSTIBLE	G-296	SBA130366070
ACEITE, 4 45/64 IN	GP-3600	E4FZ-6731-A						
GASOLINA, ROSCADO	GG-87	E0ZE-9155-BA						
VSG413 A GASOLINA								
ACEITE, 4 7/64 IN	GP-3682	EFL125						
ACEITE, 4 45/64 IN	GP-3600	E4FZ-6731-A						
GASOLINA, ROSCADO	GG-87	E0ZE-9155-BA						
WSG-858M INDUSTRIAL								
ACEITE	GP-1	D9AZ-6731-A						

MARCA-MODELO-MOTOR MAKE-MODEL-ENGINE	GONHER GONHER	OEM OEM	MARCA-MODELO-MOTOR MAKE-MODEL-ENGINE	GONHER GONHER	OEM OEM	MARCA-MODELO-MOTOR MAKE-MODEL-ENGINE	GONHER GONHER	OEM OEM
FORD (continuación)			FORD (continuación)			FORD (continuación)		
TRACTORES			TRACTORES			TRACTORES		
2110 con motor/FORD A DIESEL			HIDRAULICO	GP-166	D8NN-B486-CA	ACEITE, SELLADO	GP-9	E8NN-6714-AA
ACEITE	GP-1	E7NN-6714-AA	AIRE, PRIMARIO	GA-18	E6NN-98618-AA	GASOLINA	GG-20	C4AZ-9365-B
COMBUSTIBLE	G-296	EDPN-9N074-AA	GASOLINA	GG-20	C4AZ-9365-B			
COMBUSTIBLE	G-296-B	EDPN-9N074-AA						
			233 con motor/A DIESEL			3000 SUPER DEXTA BRITANICO con motor/FORD 3 CYL.		
2110 con motor/FORD A GASOLINA			ACEITE	GP-1	D9NN-6714-EA	ACEITE	G-5000	DGPN-6731-A
ACEITE	GP-9	E8NN-6714-AA	COMBUSTIBLE	G-296	D8NN-9N074-AA	COMBUSTIBLE	G-296	EDPN-9N074-AA
			COMBUSTIBLE	G-296-B	D8NN-9N074-AA	COMBUSTIBLE	G-296-B	EDPN-9N074-AA
2120 con motor/A DIESEL			HIDRAULICO	GP-166	D8NN-B486-CA			
ACEITE	GP-1	E7NN-6714-AA	AIRE	GA-589	E9NN-9601-AA	3100 con motor/FORD A DIESEL		
COMBUSTIBLE	G-296	EDPN-9N074-AA				ACEITE	GP-1	DGPN-6731-A
COMBUSTIBLE	G-296-B	EDPN-9N074-AA				COMBUSTIBLE	G-296	EDPN-9N074-AA
			234, 334 con motor/A DIESEL			COMBUSTIBLE	G-296-B	EDPN-9N074-AA
2120 con motor/A GASOLINA			ACEITE	GP-1	D9NN-6714-EA	3100 con motor/FORD A GASOLINA		
ACEITE, CARTUCHO	G-5000	DGPN-6731-A	COMBUSTIBLE	G-296	D8NN-9N074-AA	ACEITE, CARTUCHO	G-5000	DGPN-6731-A
ACEITE	GP-9	E8NN-6714-AA	COMBUSTIBLE	G-296-B	D8NN-9N074-AA	ACEITE, SELLADO	GP-9	E8NN-6714-AA
GASOLINA	GG-20	C4AZ-9365-B				GASOLINA	GG-20	C4AZ-9365-B
			2600 con motor/A DIESEL					
2150 con motor/A DIESEL			ACEITE, CARTUCHO	G-5000	DGPN-6731-A	3120 con motor/A DIESEL		
ACEITE	GP-1	E7NN-6714-AA	ACEITE	GP-1	E7NN-6714-AA	ACEITE, CARTUCHO	G-5000	DGPN-6731-A
COMBUSTIBLE	G-296	EDPN-9N074-AA	COMBUSTIBLE	G-296	D8NN-9N074-AA	ACEITE, SELLADO	GP-1	E7NN-6714-AA
COMBUSTIBLE	G-296-B	EDPN-9N074-AA	COMBUSTIBLE	G-296-B	D8NN-9N074-AA	COMBUSTIBLE	G-296	EDPN-9N074-AA
			TRANSMISION	GP-166	D8NN-B486-CA	HIDRAULICO	GP-66	7700040
2150 con motor/A GASOLINA						COMBUSTIBLE	G-296-B	EDPN-9N074-AA
ACEITE, CARTUCHO	G-5000	DGPN-6731-A	2600 con motor/A GASOLINA					
ACEITE	GP-9	E8NN-6714-AA	ACEITE	GP-1	E7NN-6714-AA	3230 con motor/FORD 192 CID		
GASOLINA	GG-20	C4AZ-9365-B	COMBUSTIBLE	G-296	D8NN-9N074-AA	ACEITE	GP-1	E7NN-6714-AA
			COMBUSTIBLE	G-296-B	D8NN-9N074-AA	AGUA	GP-1010Q	E8NN-8A424-BB
2300 con motor/A DIESEL			TRANSMISION	GP-166	D8NN-B486-CA	COMBUSTIBLE	G-296	EDPN-9N074-AA
ACEITE	GP-1	E7NN-6714-AA	AIRE, PRIMARIO	GA-589	D1NN-9601-A	COMBUSTIBLE	G-296-B	EDPN-9N074-AA
COMBUSTIBLE	G-296	EDPN-9N074-AA				COMBUSTIBLE	G-296-B	EDPN-9N074-AA
COMBUSTIBLE	G-296-B	EDPN-9N074-AA	2610 con motor/A DIESEL			ACEITE	GP-81	E8NN-6714-AA
			ACEITE	GP-1	E7NN-6714-AA	HIDRAULICO	GP-166	D8NN-B486-CA
2300 con motor/A GASOLINA			COMBUSTIBLE	G-296	EDPN-9N074-AA			
ACEITE, CARTUCHO	G-5000	DGPN-6731-A	COMBUSTIBLE	G-296-B	EDPN-9N074-AA	333 con motor/A DIESEL		
ACEITE	GP-9	E8NN-6714-AA	HIDRAULICO	GP-166	D8NN-B486-CA	ACEITE	GP-1	E7NN-6714-AA
GASOLINA	GG-20	C4AZ-9365-B				ACEITE	GP-9	C5NN-6714-B
			276 II con motor/A DIESEL			COMBUSTIBLE	G-296	EDPN-9N074-AA
230A, 230B con motor/A DIESEL			ACEITE	GP-1	E7NN-6714-AA	COMBUSTIBLE	G-296-B	EDPN-9N074-AA
ACEITE	GP-1	E7NN-6714-AA	COMBUSTIBLE	G-297	D8NN-9176-AA	HIDRAULICO	GP-166	D8NN-B486-CA
COMBUSTIBLE	G-296	EDPN-9N074-AA	COMBUSTIBLE	G-297-B	D8NN-9176-AA	AIRE	GA-589	E9NN-9601-AA
COMBUSTIBLE	G-296-B	EDPN-9N074-AA						
HIDRAULICO	GP-166	D8NN-B486-CA	2810 con motor/A DIESEL			335 con motor/FORD 175		
			ACEITE	GP-1	D9NN-6714-EA	ACEITE	GP-1	C9NN-6714-A
231 con motor/A DIESEL			COMBUSTIBLE	G-296	EDPN-9N074-AA	TRANSMISION	GP-9	C5NN-6714-B
ACEITE	GP-1	E7NN-6714-AA	COMBUSTIBLE	G-296-B	EDPN-9N074-AA	COMBUSTIBLE	G-296	D0NN-9N074-B
COMBUSTIBLE	G-296	EDPN-9N074-AA	HIDRAULICO	GP-166	D8NN-B486-CA	HIDRAULICO	GP-66	7700040
COMBUSTIBLE	G-296-B	EDPN-9N074-AA	AIRE	GA-18	C7NN-9A641-A	COMBUSTIBLE	G-296-B	D0NN-9N074-B
ACEITE	GP-166	D8NN-B486-CA				HIDRAULICO	GP-166	D8NN-B486-EA
AIRE	GA-589	E9NN-9601-AA	2910 con motor/A DIESEL			AIRE	GA-589	D1NN-9601-A
			ACEITE	GP-1	D9NN-6714-EA			
2310 COMPACT DIESEL con motor/A DIESEL			AGUA	GP-1010Q	E8NN-8A424-BB	340 con motor/FORD A DIESEL		
ACEITE	GP-1	E7NN-6714-AA	COMBUSTIBLE	G-296	EDPN-9N074-AA	ACEITE	GP-1	E7NN-6714-AA
COMBUSTIBLE	G-296	EDPN-9N074-AA	COMBUSTIBLE	G-296-B	EDPN-9N074-AA	TRANSMISION	GP-9	C5NN-6714-B
COMBUSTIBLE	G-296-B	EDPN-9N074-AA	HIDRAULICO	GP-166	D8NN-B486-CA	COMBUSTIBLE	G-296	EDPN-9N074-AA
ACEITE	GP-166	D8NN-B486-CA				COMBUSTIBLE	G-296-B	EDPN-9N074-AA
			3 CYL. ALEMAN con motor/A DIESEL			HIDRAULICO	GP-166	D8NN-B486-CA
2310 con motor/A DIESEL			ACEITE	GP-1	B7A-6714-A			
ACEITE, CON TURBO	GP-1	E7NN-6714-AA				340 con motor/FORD A GASOLINA		
COMBUSTIBLE	G-296	EDPN-9N074-AA	3000 con motor/FORD A DIESEL			ACEITE	GP-58	F0NN-6714-BA
COMBUSTIBLE	G-296-B	EDPN-9N074-AA	ACEITE, SELLADO	GP-1	E7NN-6714-AA	ACEITE	GP-166	D8NN-B486-CA
HIDRAULICO	GP-166	D8NN-B486-CA	COMBUSTIBLE	G-296	EDPN-9N074-AA	GASOLINA	GG-5 L	C2RZ-9115-B
			COMBUSTIBLE	G-296-B	EDPN-9N074-AA			
2310 con motor/A GASOLINA						340 con motor/WISCONSIN		
ACEITE	GP-9	E8NN-6714-AA	3000 con motor/FORD A GASOLINA			AIRE, SIN ASPAS	GA-33	200E-6228
			ACEITE, CARTUCHO	G-5000	DGPN-6731-A			

SERVICIO PESADO

MARCA-MODELO-MOTOR MAKE-MODEL-ENGINE	GONHER GONHER	OEM OEM	MARCA-MODELO-MOTOR MAKE-MODEL-ENGINE	GONHER GONHER	OEM OEM	MARCA-MODELO-MOTOR MAKE-MODEL-ENGINE	GONHER GONHER	OEM OEM
FORD (continuación)			FORD (continuación)			FORD (continuación)		
TRACTORES			TRACTORES			TRACTORES		
3400 con motor/FORD A DIESEL			COMBUSTIBLE	G-296	EDPN-9N074-AA	4 CYL. ALEMÁN con motor/A DIESEL		
ACEITE	GP-1	E7NN-6714-AA	HIDRAULICO	GP-66	7700040	ACEITE	G-5000	DGPN-6731-A
COMBUSTIBLE	G-296	EDPN-9N074-AA	COMBUSTIBLE	G-296-B	EDPN-9N074-AA	4000 con motor/A DIESEL		
HIDRAULICO	GP-66	7700040	3550 con motor/FORD A GASOLINA			ACEITE, CARTUCHO	G-5000	DGPN-6731-A
COMBUSTIBLE	G-296-B	EDPN-9N074-AA	ACEITE, CARTUCHO	G-5000	DGPN-6731-A	ACEITE, SELLADO	GP-1	E7NN-6714-AA
3400 con motor/FORD A GASOLINA			TRANSMISION	GP-9	C5NN-6714-B	COMBUSTIBLE	G-296	EDPN-9N074-AA
ACEITE, CARTUCHO	G-5000	DGPN-6731-A	HIDRAULICO	GP-66	7700040	HIDRAULICO	GP-66	7700040
ACEITE, SELLADO	GP-9	E8NN-6714-AA	GASOLINA	GG-20	C4AZ-9365-B	COMBUSTIBLE	G-296-B	EDPN-9N074-AA
HIDRAULICO	GP-66	7700040	3600 BRITANICO con motor/FORD 3 CYL. A GASOLINA			4000 MAJOR BRITANICO con motor/A DIESEL		
GASOLINA	GG-20	C4AZ-9365-B	ACEITE	GP-1	B7A-6714-A	ACEITE	G-5000	DGPN-6731-A
340A, 340B con motor/FORD A DIESEL			3600 con motor/A DIESEL			COMBUSTIBLE	G-296	EDPN-9N074-AA
ACEITE	GP-1	E7NN-6714-AA	ACEITE, CARTUCHO	G-5000	DGPN-6731-A	COMBUSTIBLE	G-296-B	EDPN-9N074-AA
TRANSMISION	GP-9	C5NN-6714-B	ACEITE	GP-1	E7NN-6714-AA	4010 con motor/A DIESEL		
COMBUSTIBLE	G-296	EDPN-9N074-AA	COMBUSTIBLE	G-296	EDPN-9N074-AA	ACEITE, CARTUCHO	G-5000	DGPN-6731-A
COMBUSTIBLE	G-296-B	EDPN-9N074-AA	COMBUSTIBLE	G-296-B	EDPN-9N074-AA	ACEITE, SELLADO	GP-9	B8NN-6714-A
HIDRAULICO	GP-166	D8NN-B486-CA	HIDRAULICO	GP-166	D8NN-B486-CA	COMBUSTIBLE	G-296	EDPN-9N074-AA
3430 con motor/A DIESEL			AIRE, SECUNDARIO	GA-588	D1NN-9R500-DA	COMBUSTIBLE	G-296-B	EDPN-9N074-AA
ACEITE	GP-1	E7NN-6714-AA	AIRE, PRIMARIO	GA-589	D1NN-9601-A	HIDRAULICO	GP-166	D8NN-B486-CA
AGUA	GP-1010Q	E8NN-8A424-BB	361 con motor/A DIESEL			AIRE	GA-589	D1NN-9601-A
COMBUSTIBLE	G-296	EDPN-9N074-AA	ACEITE	G-6	CPN-6731-B	4030 con motor/A DIESEL		
COMBUSTIBLE	G-296-B	EDPN-9N074-AA	3610 con motor/A DIESEL			COMBUSTIBLE	GPP-1122	1930010
ACEITE	GP-81	E8NN-6714-AA	ACEITE	GP-1	D9NN-6714-EA	404D con motor/A DIESEL		
HIDRAULICO	GP-166	D8NN-B486-EA	COMBUSTIBLE	G-296	EDPN-9N074-AA	ACEITE	GP-9	B8NN-6714-A
TRANSMISION	GP-166	D8NN-B486-CA	COMBUSTIBLE	G-296-B	EDPN-9N074-AA	405D con motor/A DIESEL		
345, 445 con motor/A DIESEL			HIDRAULICO	GP-166	D8NN-B486-CA	ACEITE	GP-9	C5NN-6714-B
ACEITE	GP-1	E7NN-6714-AA	3830 con motor/A DIESEL			4100 con motor/A DIESEL		
TRANSMISION	GP-9	C5NN-6714-B	COMBUSTIBLE	GPP-1122	1930010	ACEITE, CARTUCHO	G-5000	DGPN-6731-A
COMBUSTIBLE	G-296	EDPN-9N074-AA	3900 con motor/A DIESEL			ACEITE, SELLADO	GP-1	E7NN-6714-AA
COMBUSTIBLE	G-296-B	EDPN-9N074-AA	ACEITE	GP-1	D9NN-6714-EA	COMBUSTIBLE	G-296	EDPN-9N074-AA
HIDRAULICO	GP-166	D8NN-B486-CA	COMBUSTIBLE	G-296-B	EDPN-9N074-AA	COMBUSTIBLE	G-296-B	EDPN-9N074-AA
345C, 445C, 445D, 250C, 260C con motor/A DIESEL			391 V8 con motor/A DIESEL			4110 con motor/A DIESEL		
ACEITE	GP-1	E7NN-6714-AA	ACEITE	G-6	CPN-6731-B	ACEITE	GP-1	E7NN-6714-AA
COMBUSTIBLE	G-296	EDPN-9N074-AA	3910 con motor/A DIESEL			COMBUSTIBLE	G-296	EDPN-9N074-AA
COMBUSTIBLE	G-296-B	EDPN-9N074-AA	ACEITE	GP-1	E7NN-6714-AA	COMBUSTIBLE	G-296-B	EDPN-9N074-AA
HIDRAULICO	GP-166	D8NN-B486-CA	AGUA	GP-1010Q	E8NN-8A424-BB	HIDRAULICO	GP-166	D8NN-B486-CA
345D con motor/FORD 3 CIL. DIESEL (S/N A442030-UP)			COMBUSTIBLE	G-296	EDPN-9N074-AA	4130 con motor/A DIESEL		
ACEITE	GP-81	87800068	COMBUSTIBLE	G-296-B	EDPN-9N074-AA	ACEITE	GP-1	D9NN-6714-EA
HIDRAULICO (EXTRACTOR VERTICAL)	GP-166	D8NN-B486-CA	ACEITE	GP-81	E8NN-6714-AA	COMBUSTIBLE	G-296	EDPN-9N074-AA
HIDRAULICO (EXTRACTOR HORIZONTAL)	GP-761H	9821387	ACEITE	GP-166	D8NN-B486-CA	COMBUSTIBLE	G-296-B	EDPN-9N074-AA
AIRE, RADIAL PRIMARIO	GA-853R	84036676	3930 con motor/A DIESEL			HIDRAULICO	GP-166	D8NN-B486-CA
LINEA DE COMBUSTIBLE	GG-124	9611973	ACEITE	GP-1	E7NN-6714-AA	4130AP con motor/A DIESEL		
3500 con motor/A DIESEL			ACEITE	GP-9	E8NN-6714-AA	ACEITE	GP-1	E7NN-6714-AA
ACEITE	GP-1	E7NN-6714-AA	AGUA	GP-1010Q	E8NN-8A424-BB	COMBUSTIBLE	G-296	EDPN-9N074-AA
TRANSMISION	GP-9	C5NN-6714-B	COMBUSTIBLE	G-296	EDPN-9N074-AA	COMBUSTIBLE	G-296-B	EDPN-9N074-AA
COMBUSTIBLE	G-296	EDPN-9N074-AA	COMBUSTIBLE	G-296-B	EDPN-9N074-AA	4140, 4190 con motor/FORD A DIESEL		
COMBUSTIBLE	G-296-B	EDPN-9N074-AA	HIDRAULICO	GP-166	D8NN-B486-CA	ACEITE, CARTUCHO	G-5000	DGPN-6731-A
3500 con motor/A GASOLINA			3930N con motor/A DIESEL			ACEITE	GP-9	E7NN-6714-DA
ACEITE, CARTUCHO	G-5000	DGPN-6731-A	ACEITE	GP-1	E7NN-6714-AA	TRANSMISION	GP-9	C5NN-6714-B
ACEITE, SELLADO	GP-9	D8NN-6714-AA	AGUA	GP-1010Q	E8NN-8A424-BB	COMBUSTIBLE	G-296	EDPN-9N074-AA
TRANSMISION	GP-9	C5NN-6714-B	COMBUSTIBLE	G-296	EDPN-9N074-AA	COMBUSTIBLE	G-296-B	EDPN-9N074-AA
GASOLINA	GG-20	C4AZ-9365-B	COMBUSTIBLE	G-296-B	EDPN-9N074-AA	4140, 4190 con motor/FORD A DIESEL		
3550 con motor/FORD A DIESEL			ACEITE	GP-81	E8NN-6714-AA	ACEITE, CARTUCHO	G-5000	DGPN-6731-A
ACEITE, SELLADO	GP-9	E7NN-6714-DA	ACEITE	GP-166	D8NN-B486-CA	ACEITE	GP-9	E7NN-6714-DA
TRANSMISION	GP-9	C5NN-6714-B				TRANSMISION	GP-9	C5NN-6714-B

MARCA-MODELO-MOTOR MAKE-MODEL-ENGINE	GONHER GONHER	OEM OEM	MARCA-MODELO-MOTOR MAKE-MODEL-ENGINE	GONHER GONHER	OEM OEM	MARCA-MODELO-MOTOR MAKE-MODEL-ENGINE	GONHER GONHER	OEM OEM
FORD (continuación)			FORD (continuación)			FORD (continuación)		
TRACTORES			TRACTORES			TRACTORES		
420 con motor/FORD 183			COMBUSTIBLE	G-296-B	EDPN-9N074-AA	AIRE, PRIMARIO	GA-589	E9NN-9601-AA
ACEITE	GP-1	C9NN-6714-A	AIRE	GA-18	C7NN-9A641-A	5000 SUPER MAJOR BRITANICO con motor/A DIESEL		
TRANSMISION	GP-9	C5NN-6714-B	4500 con motor/FORD A GASOLINA			ACEITE, 1958-64	G-813	EPN-6731-B
COMBUSTIBLE	G-296	D0NN-9N074-B	ACEITE, CARTUCHO	G-5000	DGPN-6731-A	ACEITE	G-870	E1ADKN-18662-A
HIDRAULICO	GP-66	7700040	ACEITE, SELLADO	GP-9	E8NN-6714-AA	ACEITE, 1965 EN ADELANTE	G-5000	DGPN-6731-A
COMBUSTIBLE	G-296-B	D0NN-9N074-B	TRANSMISION	GP-9	C5NN-6714-B	COMBUSTIBLE	G-11816	EPN-99162-A
HIDRAULICO	GP-166	D8NN-B486-CA	AIRE	GA-18	C7NN-9A641-A	COMBUSTIBLE, 1965 EN ADELANTE	G-296	EDPN-9N074-AA
4200 con motor/FORD A DIESEL			GASOLINA	GG-20	C4AZ-9365-B	HIDRAULICO	GP-66	7700040
ACEITE, SELLADO	GP-1	E7NN-6714-AA	4600 con motor/A DIESEL			COMBUSTIBLE, 1965 EN ADELANTE	G-296-B	EDPN-9N074-AA
COMBUSTIBLE	G-296	EDPN-9N074-AA	ACEITE, CARTUCHO	G-5000	DGPN-6731-A	501 con motor/A DIESEL		
COMBUSTIBLE	G-296-B	EDPN-9N074-AA	ACEITE, SELLADO	GP-1	E7NN-6714-AA	TRANSMISION	GP-9	C9NN-6714-A
4200 con motor/FORD A GASOLINA			COMBUSTIBLE	G-296	EDPN-9N074-AA	501D con motor/A DIESEL		
ACEITE, CARTUCHO	G-5000	DGPN-6731-A	COMBUSTIBLE	G-296-B	EDPN-9N074-AA	ACEITE	GP-1	B7A-6714-A
ACEITE, SELLADO	GP-9	E8NN-6714-AA	HIDRAULICO	GP-166	D8NN-B486-CA	5030 con motor/FORD 256		
GASOLINA	GG-20	C4AZ-9365-B	AIRE, PRIMARIO	GA-589	D1NN-9601-A	ACEITE	GP-1	E7NN-6714-AA
4230, 4430, 5530 con motor/A DIESEL			4610 con motor/FORD 201 DIESEL			COMBUSTIBLE	G-296	EDPN-9N074-AA
COMBUSTIBLE	G-296	4621740	ACEITE	GP-1	E7NN-6714-AA	COMBUSTIBLE	G-296-B	EDPN-9N074-AA
COMBUSTIBLE	G-296-B	4621740	COMBUSTIBLE	G-296	EDPN-9N074-AA	COMBUSTIBLE	G-296-B	EDPN-9N074-AA
AIRE	GAK-16	1909139	HIDRAULICO	GP-166	D8NN-B486-CA	HIDRAULICO	GP-166	D8NN-B486-EA
431 con motor/A DIESEL			AIRE, SECUNDARIO	GA-588	D1NN-9R500-A	AIRE	GA-589	E9NN-9601-AA
ACEITE	GP-9	C9NN-6714-A	AIRE, PRIMARIO	GA-589	D1NN-9601-A	5100 con motor/FORD A DIESEL		
COMBUSTIBLE	G-296	D0NN-9N074-B	4610 con motor/FORD 201 GASOLINA			ACEITE, CARTUCHO	G-5000	DGPN-6731-A
COMBUSTIBLE	G-296-B	D0NN-9N074-B	ACEITE	GP-1	E7NN-6714-AA	ACEITE, SELLADO	GP-1	E7NN-6714-AA
4400 con motor/FORD A DIESEL			4610 con motor/FORD 210 GASOLINA			COMBUSTIBLE	G-296	EDPN-9N074-AA
ACEITE	GP-1	E7NN-6714-AA	AGUA	GP-1010Q	E8NN-8A424-BB	COMBUSTIBLE	G-296-B	EDPN-9N074-AA
COMBUSTIBLE	G-296	EDPN-9N074-AA	COMBUSTIBLE	G-296	EDPN-9N074-AA	AIRE, SECUNDARIO	GA-588	D1NN-9R500-A
COMBUSTIBLE	G-296-B	EDPN-9N074-AA	COMBUSTIBLE	G-296-B	EDPN-9N074-AA	AIRE, PRIMARIO	GA-589	E9NN-9601-AA
AIRE	GA-18	C7NN-9A641-A	ACEITE, BOMBA HIDRAULICA	GP-166	D8NN-B486-EA	5100 con motor/FORD A GASOLINA		
4400 con motor/FORD A GASOLINA			ACEITE, CONTROLES HIDRAULICOS	GP-166	D8NN-B486-CA	ACEITE, CARTUCHO	G-5000	DGPN-6731-A
ACEITE, CARTUCHO	G-5000	DGPN-6731-A	4610SU con motor/FORD 201 DIESEL			ACEITE	GP-9	E8NN-6714-AA
ACEITE	GP-9	E8NN-6714-AA	ACEITE	GP-1	E7NN-6714-AA	AIRE, SECUNDARIO	GA-588	D1NN-9R500-A
TRANSMISION	GP-9	C5NN-6714-B	COMBUSTIBLE	G-296	EDPN-9N074-AA	AIRE, PRIMARIO	GA-589	E9NN-9601-AA
AIRE	GA-18	C7NN-9A641-A	COMBUSTIBLE	G-296-B	EDPN-9N074-AA	GASOLINA	GG-20	C4AZ-9365-B
GASOLINA	GG-20	C4AZ-9365-B	HIDRAULICO	GP-166	D8NN-B486-CA	515, 535, 531, 532 con motor/FORD		
4410 con motor/FORD A DIESEL			AIRE, SECUNDARIO	GA-588	D1NN-9R500-A	ACEITE	GP-1	E7NN-6714-AA
ACEITE, CON TURBO	GP-1	E7NN-6714-AA	AIRE, PRIMARIO	GA-589	D1NN-9601-A	TRANSMISION	GP-9	C5NN-6714-B
COMBUSTIBLE	G-296	EDPN-9N074-AA	4610SU con motor/FORD 201 GASOLINA			COMBUSTIBLE	G-296	D0NN-9N074-B
COMBUSTIBLE	G-296-B	EDPN-9N074-AA	ACEITE	GP-1	E7NN-6714-AA	COMBUSTIBLE	G-296-B	D0NN-9N074-B
AIRE	GA-18	C7NN-9A641-A	4630, 4830 con motor/A DIESEL			HIDRAULICO	GP-166	D8NN-B486-CA
4410 con motor/FORD A GASOLINA			ACEITE	GP-1	D9NN-6714-EA	AIRE	GA-589	D1NN-9601-A
ACEITE, CARTUCHO	G-5000	DGPN-6731-A	ACEITE	GP-9	E8NN-6714-AA	5200 con motor/FORD A DIESEL		
ACEITE	GP-9	E8NN-6714-AA	AGUA	GP-1010Q	E8NN-8A424-BB	ACEITE, SELLADO	GP-1	E7NN-6714-AA
AIRE	GA-18	C7NN-9A641-A	COMBUSTIBLE	G-296	E7NN-9176-AA	COMBUSTIBLE	G-296	EDPN-9N074-AA
GASOLINA	GG-20	C4AZ-9365-B	COMBUSTIBLE	G-296-B	E7NN-9176-AA	COMBUSTIBLE	G-296-B	EDPN-9N074-AA
445A con motor/A DIESEL			HIDRAULICO	GP-166	D8NN-B486-CA	AIRE, SECUNDARIO	GA-588	D1NN-9R500-A
ACEITE	GP-1	E7NN-6714-AA	5000 con motor/FORD 233			AIRE, PRIMARIO	GA-589	E9NN-9601-AA
TRANSMISION	GP-9	C5NN-6714-B	ACEITE, CARTUCHO (1965-69)	G-5000	DGPN-6731-A	5200 con motor/FORD A GASOLINA		
COMBUSTIBLE	G-296	EDPN-9N074-AA	ACEITE, SELLADO	GP-1	E7NN-6714-AA	ACEITE, CARTUCHO	G-5000	DGPN-6731-A
COMBUSTIBLE	G-296-B	EDPN-9N074-AA	TRANSMISION	GP-9	C5NN-6714-B	ACEITE	GP-9	E8NN-6714-AA
HIDRAULICO	GP-166	D8NN-B486-CA	HIDRAULICO	GP-10	D8NN-F933-AB	AIRE, SECUNDARIO	GA-588	D1NN-9R500-A
4500 con motor/FORD A DIESEL			COMBUSTIBLE	G-296	EDPN-9N074-AA	AIRE, PRIMARIO	GA-589	E9NN-9601-AA
ACEITE, CON TURBO	GP-1	E7NN-6714-AA	HIDRAULICO	GP-66	7700040	GASOLINA	GG-20	C4AZ-9365-B
TRANSMISION	GP-9	C5NN-6714-B	COMBUSTIBLE	G-296-B	EDPN-9N074-AA	530A, 530B con motor/A DIESEL		
COMBUSTIBLE	G-296	EDPN-9N074-AA	AIRE, SECUNDARIO	GA-588	D1NN-9R500-A	ACEITE	GP-1	D9NN-6714-EA
						COMBUSTIBLE	G-296	EDPN-9N074-AA

SERVICIO PESADO

MARCA-MODELO-MOTOR MAKE-MODEL-ENGINE	GONHER GONHER	OEM OEM	MARCA-MODELO-MOTOR MAKE-MODEL-ENGINE	GONHER GONHER	OEM OEM	MARCA-MODELO-MOTOR MAKE-MODEL-ENGINE	GONHER GONHER	OEM OEM
FORD (continuación)			FORD (continuación)			FORD (continuación)		
TRACTORES			TRACTORES			TRACTORES		
COMBUSTIBLE	G-296-B	EDPN-9N074-AA	ACEITE, BOMBA HIDRAULICA (OPCIONAL) (EXTRACTOR HORIZONTAL)	GP-166	D8NN-B486-EA	5640, 6640, 7740 con motor/A DIESEL		
540 con motores/FORD 201 DIESEL, FORD A GASOLINA			AIRE, RADIAL PRIMARIO	GA-853R	84036676	ACEITE	GP-36	F0NN-6714-AA
ACEITE	GP-1	E7NN-6714-AA	LINEA DE COMBUSTIBLE	GG-124	9611973	5700 con motor/A DIESEL		
TRANSMISION	GP-9	C5NN-6714-B	550 con motor/FORD 201			ACEITE	GP-1	C9NN-6714-A
COMBUSTIBLE	G-296	EDPN-9N074-AA	ACEITE	GP-1	E7NN-6714-AA	COMBUSTIBLE	G-296	D0NN-9176-B
COMBUSTIBLE	G-296-B	EDPN-9N074-AA	TRANSMISION	GP-9	C5NN-6714-B	COMBUSTIBLE	G-296-B	D0NN-9176-B
HIDRAULICO	GP-166	D8NN-B486-CA	COMBUSTIBLE	G-296	D0NN-9N074-B	5900 con motor/A DIESEL		
540A con motor/FORD 201 DIESEL			AIRE, SECUNDARIO	GA-588	D1NN-9R500-A	ACEITE	GP-1	E7NN-6714-AA
ACEITE	GP-1	E7NN-6714-AA	AIRE, PRIMARIO	GA-589	D1NN-9601-A	TRANSMISION	GP-9	C5NN-6714-B
ACEITE, CONVERTIDOR DE TORSION	GP-9	C5NN-6714-B	5500 con motor/FORD 223			COMBUSTIBLE	G-296	D0NN-9176-B
COMBUSTIBLE	G-296	EDPN-9N074-AA	ACEITE, CARTUCHO	G-5000	DGPN-6731-A	COMBUSTIBLE	G-296-B	D0NN-9176-B
COMBUSTIBLE	G-296-B	EDPN-9N074-AA	ACEITE, SELLADO	GP-1	E7NN-6714-AA	HIDRAULICO	GP-166	D8NN-B486-CA
ACEITE	GP-166	D8NN-B486-CA	ACEITE, BOMBA HIDRAULICA	GP-9	C5NN-6714-B	600 con motor/A GASOLINA		
540A con motor/FORD A GASOLINA			COMBUSTIBLE	G-296	D2NN-9176-A	ACEITE, CARTUCHO	G-6	CPN-6731-B
ACEITE	GP-1	E7NN-6714-AA	COMBUSTIBLE	G-296-B	D2NN-9176-A	6000 SERIES DIESEL con motor/A DIESEL		
TRANSMISION	GP-9	C5NN-6714-B	5550 con motor/A DIESEL			COMBUSTIBLE	G-1173	CONN-9155-B
COMBUSTIBLE	G-296	EDPN-9N074-AA	ACEITE, CARTUCHO	G-5000	DGPN-6731-A	ACEITE	GP-1	E7NN-6714-AA
COMBUSTIBLE	G-296-B	EDPN-9N074-AA	ACEITE	GP-1	E7NN-6714-AA	TRANSMISION	GP-9	B8NN-6714-A
HIDRAULICO	GP-166	D8NN-B486-CA	TRANSMISION	GP-9	C5NN-6714-B	HIDRAULICO	GP-10	D8NN-F933-AB
540B con motor/FORD 201 DIESEL			COMBUSTIBLE	G-296	EDPN-9N074-AA	HIDRAULICO	GP-66	CONN-6708-A
ACEITE	GP-1	E7NN-6714-AA	COMBUSTIBLE	G-296-B	EDPN-9N074-AA	6000 SERIES GASOLINA con motor/A GASOLINA		
ACEITE, CONVERTIDOR DE TORSION	GP-9	C5NN-6714-B	5600 con motor/A DIESEL			ACEITE, HASTA 1965	G-330	C5RA-6744-C
COMBUSTIBLE	G-296	EDPN-9N074-AA	ACEITE	GP-1	E7NN-6714-AA	ACEITE, 1965 EN ADELANTE	G-5000	DGPN-6731-A
COMBUSTIBLE	G-296-B	EDPN-9N074-AA	TRANSMISION	GP-9	C5NN-6714-B	ACEITE	GP-1	E7NN-6714-AA
ACEITE	GP-166	D8NN-B486-CA	HIDRAULICO	GP-66	D8NNF-933-AB	TRANSMISION	GP-9	B8NN-6714-A
540B con motor/FORD A GASOLINA			COMBUSTIBLE	G-296-B	D0NN-9176-B	HIDRAULICO	GP-10	D8NN-F933-AB
ACEITE	GP-1	E7NN-6714-AA	HIDRAULICO	GP-166	D8NN-B486-CA	HIDRAULICO	GP-66	D8NNF-933-A
TRANSMISION	GP-9	C5NN-6714-B	AIRE, PRIMARIO	GA-589	D1NN-9601-A	601 con motores/A DIESEL, A GASOLINA		
COMBUSTIBLE	G-296	EDPN-9N074-AA	5610 con motor/A DIESEL			ACEITE, CARTUCHO	G-6	CPN-6731-B
COMBUSTIBLE	G-296-B	EDPN-9N074-AA	ACEITE	GP-1	87800083	601D con motor/A DIESEL		
HIDRAULICO	GP-166	D8NN-B486-CA	TRANSMISION	GP-9	C5NN-6714-B	ACEITE	GP-1	B7A-6714-A
545 con motores/FORD A DIESEL, FORD A GASOLINA			COMBUSTIBLE	G-296	EDPN-9N074-AA	6410 con motor/A DIESEL		
ACEITE	GP-1	E7NN-6714-AA	COMBUSTIBLE	G-297	D8NN-9176-AA	ACEITE	GP-1	D9NN-6714-EA
TRANSMISION	GP-9	C5NN-6714-B	COMBUSTIBLE	G-296-B	EDPN-9N074-AA	COMBUSTIBLE	G-296	EDPN-9N074-AA
COMBUSTIBLE	G-296	EDPN-9N074-AA	COMBUSTIBLE	G-297-B	D8NN-9176-AA	COMBUSTIBLE	G-296-B	EDPN-9N074-AA
COMBUSTIBLE	G-296-B	EDPN-9N074-AA	HIDRAULICO	GP-166	D8NN-B486-CA	AIRE	GA-588	D1NN-9R500-A
HIDRAULICO	GP-166	D8NN-B486-EA	TRANSMISION	GP-166	D8NN-B486-CA	AIRE	GA-589	E9NN-9601-AA
545A con motores/FORD A DIESEL, FORD A GASOLINA			ACEITE	GP-310	C7NN-6714-BS	6500 con motor/A DIESEL		
ACEITE	GP-1	E7NN-6714-AA	AIRE, SECUNDARIO	GA-588	D1NN-9R500-A	ACEITE	GP-1	E7NN-6714-AA
TRANSMISION	GP-9	C5NN-6714-B	AIRE, PRIMARIO	GA-589	E9NN-9601-AA	COMBUSTIBLE	G-296	EDPN-9N074-AA
COMBUSTIBLE	G-296	EDPN-9N074-AA	5610S con motor/FORD 256 DIESEL			COMBUSTIBLE	G-296-B	EDPN-9N074-AA
COMBUSTIBLE	G-296-B	EDPN-9N074-AA	COMBUSTIBLE	G-296	EDPN-9N074-AA	ACEITE, CON TURBO	GP-81	E8NN-6714-BA
HIDRAULICO	GP-166	D8NN-B486-EA	TRANSMISION (8X4)	GP-66	D8NN-9176-AA	AIRE, SECUNDARIO	GA-588	D1NN-9R500-A
545C con motor/A DIESEL			COMBUSTIBLE	G-297	D8NN-9176-AA	AIRE, PRIMARIO	GA-589	D1NN-9601-A
ACEITE	GP-1	E7NN-6714-AA	COMBUSTIBLE	G-296-B	EDPN-9N074-AA	6530 con motor/A DIESEL		
COMBUSTIBLE	G-296	EDPN-9N074-AA	COMBUSTIBLE	G-297-B	D8NN-9176-AA	COMBUSTIBLE	G-296	4621740
COMBUSTIBLE	G-296-B	EDPN-9N074-AA	HIDRAULICO	GP-166	D8NN-B486-CA	COMBUSTIBLE	G-296-B	4621740
ACEITE	GP-81	87800068	TRANSMISION	GP-166	D8NN-B486-CA	AIRE	GAK-16	1909139
HIDRAULICO	GP-166	D8NN-B486-CA	ACEITE	GP-310	C7NN-6714-BS	6600 con motor/A DIESEL		
545D con motor/FORD 3 CL. DIESEL (S/N A442030-UP)			AIRE, SECUNDARIO	GA-588	D1NN-9R500-A	ACEITE	GP-1	E7NN-6714-AA
ACEITE	GP-81	87800068	AIRE, PRIMARIO	GA-589	E9NN-9601AA	ACEITE, BOMBA HIDRAULICA	GP-9	C5NN-6714-B
ACEITE, BOMBA HIDRAULICA (EXTRACTOR VERTICAL)	GP-166	D8NN-B486-CA	AIRE, RADIAL PRIMARIO	GA-853R	82981152	COMBUSTIBLE	G-296	EDPN-9N074-AA
						TRANSMISION	GP-66	D8NNF-933-AB
						COMBUSTIBLE	G-296-B	EDPN-9N074-AA

MARCA-MODELO-MOTOR MAKE-MODEL-ENGINE	GONHER GONHER	OEM OEM	MARCA-MODELO-MOTOR MAKE-MODEL-ENGINE	GONHER GONHER	OEM OEM	MARCA-MODELO-MOTOR MAKE-MODEL-ENGINE	GONHER GONHER	OEM OEM
FORD (continuación)			FORD (continuación)			FORD (continuación)		
TRACTORES			TRACTORES			TRACTORES		
HIDRAULICO	GP-166	D8NN-B486-CA	COMBUSTIBLE	G-296	EDPN-9N074-AA	COMBUSTIBLE	G-297	D8NN-9176-AA
AIRE, SECUNDARIO	GA-588	D1NN-9R500-A	TRANSMISION	GP-66	D8NNF-933-AB	COMBUSTIBLE	G-296-B	EDPN-9N074-AA
AIRE, PRIMARIO	GA-589	E9NN-9601-AA	COMBUSTIBLE	G-296-B	EDPN-9N074-AA	COMBUSTIBLE	G-297-B	D8NN-9176-AA
6600-0 con motor/A DIESEL			GAS	GP-81	E8NN-6714-AA	HIDRAULICO	GP-166	D8NN-B486-CA
COMBUSTIBLE	G-296	EDPN-9N074-AA	HIDRAULICO	GP-166	D8NN-B486-CA	AIRE, SECUNDARIO	GA-588	D1NN-9R500-A
6610 con motor/A DIESEL			AIRE, SECUNDARIO	GA-588	D1NN-9R500-A	AIRE, PRIMARIO	GA-589	E9NN-9601-AA
ACEITE	GP-1	E7NN-6714-AA	AIRE, PRIMARIO	GA-589	D1NN-9601-A	7700 con motor/A DIESEL		
TRANSMISION	GP-9	C5NN-6714-B	7200 con motor/A DIESEL			ACEITE	GP-1	E8NN-6714-BA
COMBUSTIBLE	G-296	EDPN-9N074-AA	COMBUSTIBLE	G-296	EDPN-9N074-AA	COMBUSTIBLE	G-296	EDPN-9N074-AA
TRANSMISION	GP-66	D8NNF-933-AB	COMBUSTIBLE	G-296-B	EDPN-9N074-AA	TRANSMISION	GP-66	D8NNF-933-AB
COMBUSTIBLE	G-297	D8NN-9176-AA	ACEITE	GP-81	E8NN-6714-BA	COMBUSTIBLE	G-297	EDPN-9N074-AA
COMBUSTIBLE	G-296-B	EDPN-9N074-AA	AIRE, SECUNDARIO	GA-588	D1NN-9R500-A	COMBUSTIBLE	G-296-B	EDPN-9N074-AA
COMBUSTIBLE	G-297-B	D8NN-9176-AA	AIRE, PRIMARIO	GA-589	D1NN-9601-A	COMBUSTIBLE	G-297-B	EDPN-9N074-AA
HIDRAULICO	GP-166	D6NN-B486-A	750 con motor/FORD 256 DIESEL			HIDRAULICO	GP-166	D8NN-B486-CA
AIRE, SECUNDARIO	GA-588	D1NN-9R500-A	ACEITE, SIN TURBO	GP-1	E7NN-6714-AA	AIRE, SECUNDARIO	GA-588	D1NN-9R500-A
AIRE, PRIMARIO	GA-589	D1NN-9601-A	COMBUSTIBLE	G-296	D0NN-9N074-B	AIRE, PRIMARIO	GA-589	E9NN-9601-AA
6700 con motor/A DIESEL			HIDRAULICO	GP-66	7700040	7710 con motor/A DIESEL		
ACEITE	GP-1	E7NN-6714-AA	COMBUSTIBLE	G-296-B	D0NN-9N074-B	COMBUSTIBLE	G-296	EDPN-9N074-AA
COMBUSTIBLE	G-296	EDPN-9N074-AA	ACEITE, CON TURBO	GP-81	E8NN-6714-BA	COMBUSTIBLE	G-297	D8NN-9176-AA
TRANSMISION	GP-66	D8NNF-933-AB	AIRE, SECUNDARIO	GA-588	D1NN-9R500-A	COMBUSTIBLE	G-296-B	EDPN-9N074-AA
COMBUSTIBLE	G-296-B	EDPN-9N074-AA	AIRE, PRIMARIO	GA-589	D1NN-9601-A	COMBUSTIBLE	G-297-B	D8NN-9176-AA
HIDRAULICO	GP-166	D8NN-B486-CA	7500 con motor/A DIESEL			ACEITE	GP-81	E8NN-6714-BA
AIRE, SECUNDARIO	GA-588	D1NN-9R500-A	ACEITE, SIN TURBO	GP-1	E7NN-6714-AA	HIDRAULICO	GP-166	D8NN-B486-CA
AIRE, PRIMARIO	GA-589	E9NN-9601-AA	ACEITE, BOMBA HIDRAULICA	GP-9	C5NN-6714-B	AIRE, SECUNDARIO	GA-588	D1NN-9R500-A
6710 con motor/A DIESEL			COMBUSTIBLE	G-296	EDPN-9N074-AA	AIRE, PRIMARIO	GA-589	E9NN-9601-AA
ACEITE	GP-1	E7NN-6714-AA	COMBUSTIBLE	G-296-B	EDPN-9N074-AA	7744 con motor/A DIESEL		
TRANSMISION	GP-9	C5NN-6714-B	ACEITE, CON TURBO	GP-81	E8NN-6714-BA	ACEITE	GP-36	F0NN-6714-AA
COMBUSTIBLE	G-296	EDPN-9N074-AA	TRANSMISION SELLADO	GP-166	D8NN-B486-CA	7810, 7910 con motor/A DIESEL		
TRANSMISION	GP-66	D8NNF-933-AB	AIRE, SECUNDARIO	GA-588	D1NN-9R500-A	COMBUSTIBLE	G-297	D8NN-9176-AA
COMBUSTIBLE	G-296-B	EDPN-9N074-AA	AIRE, PRIMARIO	GA-589	D1NN-9601-A	ACEITE	GP-77	E7NN-6714-BB
HIDRAULICO	GP-166	D8NN-B486-CA	7530 con motor/A DIESEL			COMBUSTIBLE	G-297-B	D8NN-9176-AA
AIRE, SECUNDARIO	GA-588	D1NN-9R500-A	COMBUSTIBLE	GPP-1122	1930010	HIDRAULICO	GP-166	D8NN-B486-CA
AIRE, PRIMARIO	GA-589	E9NN-9601-AA	AIRE, PRIMARIO	GAK-458	1909116	AIRE, SECUNDARIO	GA-588	D1NN-9R500-A
6810 con motor/A DIESEL			AIRE, SECUNDARIO	GA-459	1909117	AIRE, PRIMARIO	GA-589	E9NN-9601-AA
ACEITE	GP-1	E7NN-6714-AA	7600 con motor/A DIESEL			7810S con motor/A DIESEL		
COMBUSTIBLE	G-296	EDPN-9N074-AA	ACEITE, SIN TURBO	GP-1	E7NN-6714-AA	COMBUSTIBLE	GPP-1122	F3HZ-9365-E
COMBUSTIBLE	G-296-B	EDPN-9N074-AA	TRANSMISION	GP-9	C5NN-6714-B	HIDRAULICO	GP-166	D8NN-B486-CA
AIRE, SECUNDARIO	GA-588	D1NN-9R500-A	COMBUSTIBLE	G-296	EDPN-9N074-AA	AIRE, SECUNDARIO	GA-588	D1NN-9R500-A
AIRE, PRIMARIO	GA-589	E9NN-9601-AA	COMBUSTIBLE	G-296-B	EDPN-9N074-AA	AIRE, PRIMARIO	GA-589	E9NN-9601-AA
700 con motor/A DIESEL			ACEITE, CON TURBO	GP-81	E8NN-6714-BA	7840, 8240, 8340 con motor/A DIESEL		
ACEITE, CARTUCHO	G-6	CPN-6731-B	HIDRAULICO	GP-166	D8NN-B486-CA	ACEITE	GP-36	F0NN-6714-AA
ACEITE	GP-1	E7NN-6714-AA	AIRE, SECUNDARIO	GA-588	D1NN-9R500-A	80 con motor/KOHLER 8HP		
HIDRAULICO	GP-66	CONNB-951-B	AIRE, PRIMARIO	GA-589	D1NN-9601-A	AIRE	GA-12	231847
7000 con motor/A DIESEL			7600 con motor/FORD 4 CYL. DIESEL			800 con motor/FORD 401 DIESEL		
TRANSMISION	GP-9	C5NN-6714-B	ACEITE	GP-31	D2NN-6714-C	ACEITE, CARTUCHO	G-6	CPN-6731-B
HIDRAULICO	GP-10	D8NN-F933-AB	COMBUSTIBLE	G-296	EDPN-9N074-AA	ACEITE, FLUJO TOTAL (FULL FLOW)	G-5000	DGPN-6731-A
COMBUSTIBLE	G-296	EDPN-9N074-AA	COMBUSTIBLE	G-296-B	EDPN-9N074-AA	ACEITE, SELLADO	GP-1	E7NN-6714-AA
COMBUSTIBLE	G-296-B	EDPN-9N074-AA	AIRE, SECUNDARIO	GA-588	D1NN-9R500-A	8000 con motor/FORD 401 DIESEL		
AIRE, SECUNDARIO	GA-588	D1NN-9R500-A	AIRE, PRIMARIO	GA-589	D1NN-9601-A	ACEITE, CARTUCHO PARA FLUJO TOTAL (FULL FLOW)	G-5000	DGPN-6731-A
AIRE, PRIMARIO	GA-589	D1NN-9601-A	7600 con motor/FORD 4 CYL. GASOLINA			ACEITE, SELLADO	GP-9	B8NN-6714-A
701 con motor/A DIESEL			ACEITE	GP-1	B7A-6714-A	COMBUSTIBLE	G-296	EDPN-9N074-AA
ACEITE, CARTUCHO	G-6	CPN-6731-B	AIRE, SECUNDARIO	GA-588	D1NN-9R500-A	HIDRAULICO	GP-66	D8NNF-933-AB
ACEITE, SELLADO	GP-1	E7NN-6714-AA	AIRE, PRIMARIO	GA-589	D1NN-9601-A	ACEITE	GP-77	E7NN-6714-BA
HIDRAULICO	GP-66	CONNB-951-B	7610 con motor/A DIESEL			COMBUSTIBLE	G-296-B	EDPN-9N074-AA
7100 con motor/FORD			ACEITE	GP-1	87800083	7700 con motor/A DIESEL		
TRANSMISION	GP-9	E8NN-6714-AA	TRANSMISION	GP-9	C5NN-6714-B	ACEITE	GP-77	E7NN-6714-BA
			COMBUSTIBLE	G-296	EDPN-9N074-AA	COMBUSTIBLE	G-296-B	EDPN-9N074-AA

SERVICIO PESADO

MARCA-MODELO-MOTOR MAKE-MODEL-ENGINE	GONHER GONHER	OEM OEM	MARCA-MODELO-MOTOR MAKE-MODEL-ENGINE	GONHER GONHER	OEM OEM	MARCA-MODELO-MOTOR MAKE-MODEL-ENGINE	GONHER GONHER	OEM OEM
FORD (continuación)			FORD (continuación)			FORD (continuación)		
TRACTORES			TRACTORES			TRACTORES		
AIRE, SECUNDARIO	GA-588	D1NN-9R500-A	8670 con motor/A DIESEL			9200, 9260 con motor/FORD DIESEL		
AIRE, PRIMARIO	GA-589	D1NN-9601-A	ACEITE	GP-54	F2NN-6714-AA	ACEITE, CARTUCHO	G-5000	DGPN-6731-A
801 con motor/A DIESEL			AGUA	GP-1012Q	861361	ACEITE, SELLADO	GP-9	B8NN-6714-A
ACEITE, CARTUCHO	G-6	CPN-6731-B	COMBUSTIBLE, SEPARADOR DE AGUA	GPP-1287	87840136	COMBUSTIBLE	G-296	EDPN-9N074-AA
801D con motor/A DIESEL			8700 con motor/A DIESEL			HIDRAULICO	GP-66	D8NNF-933-AB
ACEITE	GP-1	E7NN-6714-AA	ACEITE, CARTUCHO	G-5000	DGPN-6731-A	ACEITE	GP-77	E7NN-6714-BB
8200, 8260, 8400 con motor/FORD DIESEL			HIDRAULICO	GP-10	D8NN-F933-AB	COMBUSTIBLE	G-296-B	EDPN-9N074-AA
ACEITE, CARTUCHO PARA FLUJO TOTAL (FULL FLOW)	G-5000	DGPN-6731-A	COMBUSTIBLE	G-296	EDPN-9N074-AA	9280 con motor/CUMMINS LT10A		
ACEITE, SELLADO	GP-9	B8NN-6714-A	TRANSMISION	GP-66	D8NNF-933-A	COMBUSTIBLE	GPP-14	3315847
COMBUSTIBLE	G-296	EDPN-9N074-AA	ACEITE	GP-77	E7NN-6714-BA	ACEITE, FLUJO TOTAL (FULL FLOW)	GP-53	3313287
HIDRAULICO	GP-66	D8NNF-933-AB	COMBUSTIBLE	G-296-B	EDPN-9N074-AA	ACEITE, DERIVACION (BY PASS)	GP-57	3304232
ACEITE	GP-77	E7NN-6714-BA	AIRE, SECUNDARIO	GA-588	D1NN-9R500-A	COMBUSTIBLE, SEPARADOR DE AGUA	GPP-11	3600980
COMBUSTIBLE	G-296-B	EDPN-9N074-AA	AIRE, PRIMARIO	GA-589	E9NN-9601-AA	ACEITE, DOBLE FLUJO	GP-3000	3825970
AIRE, SECUNDARIO	GA-588	D1NN-9R500-A	8730 con motor/A DIESEL			9480 con motor/CUMMINS N14		
AIRE, PRIMARIO	GA-589	E9NN-9601-AA	ACEITE, BOMBA HIDRAULICA	GP-66	D8NNF-933-AC	COMBUSTIBLE	GPP-14	3315847
8210 con motor/A DIESEL			COMBUSTIBLE	G-297	D8NN-9176-AA	ACEITE, FLUJO TOTAL (FULL FLOW)	GP-53	3313287
ACEITE	G-5000	DGPN-6731-A	ACEITE	GP-77	E7NN-6714-BB	ACEITE, DERIVACION (BY PASS)	GP-57	3304232
COMBUSTIBLE	G-296	EDPN-9N074-AA	COMBUSTIBLE	G-297-B	D8NN-9176-AA	COMBUSTIBLE, SEPARADOR DE AGUA	GPP-11	3600980
HIDRAULICO	GP-66	D8NNF-933-AB	ACEITE, AUXILIAR BOMBA HIDRAULICA	GP-166	D8NN-8486-CA	ACEITE, DOBLE FLUJO	GP-3000	3825970
COMBUSTIBLE	G-297	D8NN-9176-AA	AIRE, SECUNDARIO	GA-398	D8NN-9R500-AA	9600 con motor/FORD 401 DIESEL		
ACEITE	GP-77	E7NN-6714-BB	AIRE, PRIMARIO	GA-616	D8NN-98618-AA	ACEITE, CARTUCHO	G-5000	DGPN-6731-A
AGUA	GP-2071W	F3HZ-8A424-C	8770, 8870, 8970 con motor/A DIESEL			COMBUSTIBLE	G-296	EDPN-9N074-AA
COMBUSTIBLE	G-296-B	EDPN-9N074-AA	ACEITE	GP-54	F2NN-6714-AA	HIDRAULICO	GP-66	D8NNF-933-A
COMBUSTIBLE	G-297-B	D8NN-9176-AA	AGUA	GP-1012Q	861361	ACEITE, SELLADO	GP-77	E7NN-6714-BA
AIRE, SECUNDARIO	GA-588	E0NN-9R500-AA	COMBUSTIBLE	GPP-1287	87840136	COMBUSTIBLE	G-296-B	EDPN-9N074-AA
AIRE, PRIMARIO	GA-589	E9NN-9601-AA	8830 con motor/A DIESEL			AIRE, SECUNDARIO	GA-588	D1NN-9R500-A
85 con motor/BRIGGS & STRATTON 8 HP			ACEITE	GP-36	FOHZ-6731-B	AIRE, PRIMARIO	GA-589	D1NN-9601-A
TRANSMISION	GP-9	E8NN-6714-AA	ACEITE, BOMBA HIDRAULICA	GP-66	D8NNF-933-AC	9680 con motor/CUMMINS N14		
8530 con motor/A DIESEL			COMBUSTIBLE	G-297	D8NN-9176-AA	COMBUSTIBLE	GPP-14	3315847
COMBUSTIBLE	G-297	D8NN-9176-AA	ACEITE	GP-77	E7NN-6714-BB	ACEITE, FLUJO TOTAL (FULL FLOW)	GP-53	3313287
ACEITE	GP-77	E7NN-6714-BB	COMBUSTIBLE	GP-77	E7NN-6714-BB	ACEITE, DERIVACION (BY PASS)	GP-57	3304232
COMBUSTIBLE	G-297-B	D8NN-9176-AA	ACEITE, AUXILIAR BOMBA HIDRAULICA	GP-166	D8NN-8486-CA	COMBUSTIBLE, SEPARADOR DE AGUA	GPP-11	3600980
HIDRAULICO	GP-166	D8NN-8486-CA	AIRE, SECUNDARIO	GA-398	D8NN-9R500-AA	ACEITE, DOBLE FLUJO	GP-3000	3825970
AIRE, SECUNDARIO	GA-588	CD0817503-830	AIRE, SECUNDARIO	GA-588	D1NN-9R500-A	AIRE, PRIMARIO	GA-758	95611
AIRE, PRIMARIO	GA-589	CD0817503-826	AIRE, PRIMARIO	GA-589	D1NN-9601-A	AIRE, SECUNDARIO	GA-759	95612
860 con motor/A DIESEL			AIRE, PRIMARIO	GA-616	D8NN-98618-AA	9700 con motor/A DIESEL		
ACEITE, CARTUCHO	G-6	CPN-6731-B	900 con motor/A DIESEL			ACEITE, CARTUCHO	G-5000	DGPN-6731-A
8600 con motor/FORD 401 DIESEL			ACEITE	G-6	CPN-6731-B	ACEITE, SELLADO	GP-31	D2NN-6714-C
ACEITE, CARTUCHO PARA FLUJO TOTAL (FULL FLOW)	G-5000	DGPN-6731-A	ACEITE	GP-1	E7NN-6714-AA	COMBUSTIBLE	G-296	EDPN-9N074-AA
ACEITE, SELLADO	GP-9	B8NN-6714-A	HIDRAULICO	GP-66	CONNB-951-B	HIDRAULICO	GP-66	D5NNF-933-A
HIDRAULICO	GP-10	D8NN-M903-AA	9000 con motor/FORD 401 DIESEL			ACEITE, SELLADO	GP-77	E0NN-6714-AA
COMBUSTIBLE	G-296	EDPN-9N074-AA	ACEITE, CARTUCHO	G-5000	DGPN-6731-A	COMBUSTIBLE	G-296-B	EDPN-9N074-AA
TRANSMISION	GP-66	D1NNF-933-A	ACEITE, SELLADO	GP-9	B8NN-6714-A	AIRE, SECUNDARIO	GA-827	D5NN-9R500-C
ACEITE	GP-77	E7NN-6714-BA	COMBUSTIBLE	G-296	EDPN-9N074-AA	976 con motor/CUMMINS NTA855		
COMBUSTIBLE	G-296-B	EDPN-9N074-AA	TRANSMISION	GP-66	D8NNF-933-AC	ACEITE, FLUJO TOTAL (FULL FLOW)	GP-53	3313287
AIRE, SECUNDARIO	GA-588	D1NN-9R500-A	ACEITE	GP-77	E7NN-6714-BB	ACEITE, DERIVACION (BY PASS)	GP-57	3304232
AIRE, PRIMARIO	GA-589	D1NN-9601-A	COMBUSTIBLE	G-296-B	EDPN-9N074-AA	COMBUSTIBLE, SEPARADOR DE AGUA	GPP-11	3600980
8630 con motor/A DIESEL			901 con motor/A DIESEL			9880 con motor/CUMMINS N14		
HIDRAULICO	GP-66	D8NNF-933-AC	ACEITE, CARTUCHO	G-6	CPN-6731-B	COMBUSTIBLE	GPP-14	3315847
COMBUSTIBLE	G-297	D8NN-9176-AA	ACEITE, SELLADO	GP-1	E7NN-6714-AA	ACEITE, FLUJO TOTAL (FULL FLOW)	GP-53	3313287
ACEITE	GP-77	E7NN-6714-BB	HIDRAULICO	GP-66	CONNB-951-B	ACEITE, DERIVACION (BY PASS)	GP-57	3304232
COMBUSTIBLE	G-297-B	D8NN-9176-AA	9030 con motor/FORD 4.4L			COMBUSTIBLE, SEPARADOR DE AGUA	GPP-11	3600980
ACEITE, BOMBA HIDRAULICA	GP-166	D8NN-8486-CA	COMBUSTIBLE	G-297	D8NN-9176-AA	9880 con motor/CUMMINS N14		
AIRE, SECUNDARIO	GA-827	D5NN-9R500-C	COMBUSTIBLE	G-297-B	D8NN-9176-AA	COMBUSTIBLE	GPP-14	3315847
			ACEITE	GP-81	E8NN-6714-BA	ACEITE, FLUJO TOTAL (FULL FLOW)	GP-53	3313287
						ACEITE, DERIVACION (BY PASS)	GP-57	3304232

MARCA-MODELO-MOTOR MAKE-MODEL-ENGINE	GONHER GONHER	OEM OEM	MARCA-MODELO-MOTOR MAKE-MODEL-ENGINE	GONHER GONHER	OEM OEM	MARCA-MODELO-MOTOR MAKE-MODEL-ENGINE	GONHER GONHER	OEM OEM
FORD (continuación)			FORD (continuación)			FORD (continuación)		
TRACTORES			TRACTORES			TRACTORES		
COMBUSTIBLE, SEPARADOR DE AGUA	GPP-11	3600980	ACEITE, SELLADO FLUJO TOTAL (FULL FLOW)	GP-53	SFD-01-2187	TW20 con motor/A DIESEL		
ACEITE, DOBLE FLUJO	GP-3000	3825970	TRANSMISION	GP-66	SFD-18-502	ACEITE, CARTUCHO	G-5000	DGPN-6731-A
AGUA	GP-2071W	E5NN-8A424-AA	AGUA	GP-2071W	SFD-28-031	HIDRAULICO	GP-34	D8NN-M903-FA
AIRE, PRIMARIO	GA-758	95611	AIRE, PRIMARIO	GA-356	SFD-45-253	HIDRAULICO	GP-66	D8NNF-933-AB
AIRE, SECUNDARIO	GA-759	95612	AIRE, SECUNDARIO	GA-357	SFD-07-1010	COMBUSTIBLE	G-297	D8NN-9176-AA
			ACEITE, CARTUCHO PARA DERIVACION (BY PASS)	G-750	SFD-28-028	ACEITE	GP-77	E7NN-6714-BB
COSTCUTTER BRITANICO con motor/A DIESEL						COMBUSTIBLE	G-297-B	D8NN-9176-AA
ACEITE	G-870	E1ADKN-18662-A	NINETY-FIVE/100 con motor/A DIESEL			AIRE, SECUNDARIO	GA-827	D5NN-9R500-C
			ACEITE	G-834	2703E-6731-A	TW24 con motor/A DIESEL		
DEXTA BRITANICO con motor/A DIESEL			COMBUSTIBLE	G-296	C7NN-9176-A	ACEITE	GP-77	E7NN-6714-BB
ACEITE	G-813	EPN-6731-B	COMBUSTIBLE	G-296-B	C7NN-9176-A			
			AIRE	GAK-16	P101222	TW25 con motor/A DIESEL		
DEXTA FMD BRITANICO, DEXTA FPMD BRITANICO, DEXTA FSMDBRITANICO con motor/A DIESEL			PLOUGHMASTER/75 con motor/A DIESEL			HIDRAULICO	GP-10	D8NN-F933-AB
ACEITE	G-813	EPN-6731-B	ACEITE	G-5000	C1TZ-6731-C	HIDRAULICO	GP-34	D8NN-M903-FA
ACEITE	G-870	E1ADKN-18662-A	COMBUSTIBLE	G-296	C7NN-9176-A	HIDRAULICO	GP-66	D8NN-B486-CA
COMBUSTIBLE	G-11816	EPN-99162-A	COMBUSTIBLE	G-296-B	C7NN-9176-A	COMBUSTIBLE	G-297	D8NN-9176-AA
						ACEITE	GP-77	E7NN-6714-BB
F1700 con motor/A DIESEL			POWER MAJOR BRITANICO, SUPER MAJOR BRITANICO con motor/A DIESEL			COMBUSTIBLE	G-297-B	D8NN-9176-AA
ACEITE	GP-38	E1NN-6714-BA	COMBUSTIBLE	G-11816	EPN-99162-A	HIDRAULICO	GP-166	D8NN-B486-EA
						AIRE, SECUNDARIO	GA-398	D8NN-9176-AA
FW20 con motor/CUMMINS V555						AIRE, PRIMARIO	GA-616	D8NN-9B618-AA
ACEITE, CARTUCHO PARA FLUJO TOTAL (FULL FLOW)	G-566	257528	SUPER COUNTRY 4, SUPER COUNTRY 6 (1164) con motor/A DIESEL					
COMBUSTIBLE	GPP-14	SFD-28-035	ACEITE, CARTUCHO PARA FLUJO TOTAL (FULL FLOW)	G-5000	CFPN-6731-B	TW30 con motor/A DIESEL		
HIDRAULICO	GP-34	SFD-18-498	COMBUSTIBLE	G-11816	EPN-99162-A	HIDRAULICO	GP-10	D8NN-F933-AB
ACEITE, SELLADO FLUJO TOTAL (FULL FLOW)	GP-53	SFD-01-2187	ACEITE, SELLADO FLUJO TOTAL (FULL FLOW)	GP-1	C9NN-6714-A	ACEITE	GP-36	D8NN-6714-AA
TRANSMISION	GP-66	SFD-18-502	COMBUSTIBLE	G-296	D0NN-9N074-B	HIDRAULICO	GP-66	D8NNF-933-AB
AGUA	GP-2071W	SFD-28-031	COMBUSTIBLE	G-296-B	D0NN-9N074-B	COMBUSTIBLE	G-297	D8NN-9176-AA
ACEITE, DERIVACION (BY PASS)	G-500	SFD-28-028	COMBUSTIBLE	G-296-B	D0NN-9N074-B	COMBUSTIBLE	G-297-B	D8NN-9176-AA
						HIDRAULICO	GA-398	D8NN-9176-AA
FW20 con motor/CUMMINS VT555			SUPER COUNTRY 6 (1124) con motor/A DIESEL			AIRE, PRIMARIO	GA-616	D8NN-9B618-AA
ACEITE, CARTUCHO PARA FLUJO TOTAL (FULL FLOW)	G-566	257528	ACEITE	G-834	2703E-6731-A			
COMBUSTIBLE	GPP-14	3315847	ACEITE, CARTUCHO PARA FLUJO TOTAL (FULL FLOW)	G-5000	CFPN-6731-B	TW35 con motor/A DIESEL		
ACEITE, SELLADO FLUJO TOTAL (FULL FLOW)	GP-53	SFD-01-2187	COMBUSTIBLE	G-11816	EPN-99162-A	HIDRAULICO	GP-10	D8NNF-933-AB
ACEITE	GP-66	SFD-18-502	ACEITE, SELLADO FLUJO TOTAL (FULL FLOW)	GP-1	C9NN-6714-A	ACEITE	GP-36	D8NN-6714-AA
AGUA	GP-2071W	3315116	COMBUSTIBLE	G-296	D0NN-9N074-B	HIDRAULICO	GP-66	D8NNF-933-AB
ACEITE, DERIVACION (BY PASS)	G-500	256839	COMBUSTIBLE	G-296-B	D0NN-9N074-B	COMBUSTIBLE	G-297	D8NN-6714-AA
						COMBUSTIBLE	G-297-B	D8NN-6714-AA
FW30 con motor/CUMMINS VT903			TRY-CYCLE con motor/A DIESEL			HIDRAULICO	GP-166	D8NN-B486-CA
COMBUSTIBLE	GPP-14	3315847	ACEITE	GP-9	C7NN-6714-A	AIRE, SECUNDARIO	GA-398	D8NN-9R500-AA
ACEITE, SELLADO FLUJO TOTAL (FULL FLOW)	GP-53	SFD-01-2187				AIRE, PRIMARIO	GA-616	D8NN-9B618-AA
TRANSMISION	GP-66	SFD-18-502	TW10 con motor/A DIESEL					
AGUA	GP-2071W	SFD-28-031	ACEITE, CARTUCHO	G-5000	DGPN-6731-A	TW5 con motor/A DIESEL		
ACEITE, CARTUCHO PARA DERIVACION (BY PASS)	G-750	SFD-28-028	ACEITE	GP-1	E7NN-6714-AA	HIDRAULICO	GP-10	D8NN-F933-AB
			HIDRAULICO	GP-66	D8NNF-933-AB	HIDRAULICO	GP-34	D8NN-M903-FA
FW30, FW40, FW60 con motor/CUMMINS V903			COMBUSTIBLE	G-297	D8NN-9176-AA	HIDRAULICO	GP-66	D8NN-B486-CA
COMBUSTIBLE	GPP-14	SFD-28-035	ACEITE	GP-77	E7NN-6714-BB	COMBUSTIBLE	G-297	D8NN-9176-AA
HIDRAULICO	GP-34	SFD-18-498	COMBUSTIBLE	G-297-B	D8NN-9176-AA	ACEITE	GP-77	E7NN-6714-BB
ACEITE, SELLADO FLUJO TOTAL (FULL FLOW)	GP-53	SFD-01-2187	AIRE, SECUNDARIO	GA-588	D1NN-9R500-A	COMBUSTIBLE	G-297-B	D8NN-9176-AA
TRANSMISION	GP-66	SFD-18-502	AIRE, PRIMARIO	GA-589	E9NN-9601-AA	HIDRAULICO	GP-166	D8NN-B486-EA
AGUA	GP-2071W	SFD-28-031	TW15 con motor/A DIESEL			AIRE, SECUNDARIO	GA-588	D1NN-9R500-A
AIRE, PRIMARIO	GA-356	SFD-45-252	HIDRAULICO	GP-10	D8NN-F933-AB	AIRE, PRIMARIO	GA-589	E9NN-9601-AA
AIRE, SECUNDARIO	GA-357	SFD-45-253	HIDRAULICO	GP-34	D8NN-M903-FA			
ACEITE, CARTUCHO PARA DERIVACION (BY PASS)	G-750	SFD-28-028	HIDRAULICO	GP-66	D8NN-B486-CA	200 con motor/A DIESEL		
			COMBUSTIBLE	G-297	D8NN-9176-AA	AIRE	GA-7	A700X-9601-ACA
FW60 con motor/CUMMINS VT903			ACEITE	GP-77	E7NN-6714-BB			
ACEITE, CARTUCHO PARA FLUJO TOTAL (FULL FLOW)	G-566	257528	COMBUSTIBLE	G-297-B	D8NN-9176-AA	CM222, CM224 con motor/A DIESEL		
COMBUSTIBLE	GPP-14	3315847	HIDRAULICO	GP-166	D8NN-B486-EA	ACEITE	GP-2951	F0NN-6714-BA
			AIRE, SECUNDARIO	GA-827	D5NN-9R500-C			
						CM272, CM274 con motor/A DIESEL		
						ACEITE	GP-2951	F0NN-6714-BA

SERVICIO PESADO

MARCA-MODELO-MOTOR MAKE-MODEL-ENGINE	GONHER GONHER	OEM OEM
FORD (continuación)		
TRACTORES PEQUEÑOS Y PARA JARDIN		
GT65DSL, GT75DSL con motor/A DIESEL		
ACEITE	GP-2951	F0NN-6714-BA
GT85, GT95 con motor/KOHLER		
ACEITE	GP-58	5205002
LGT100, LGT120 con motor/A DIESEL		
ACEITE	GP-3600	E4FZ-6731-A
LGT125, LGT12H con motor/A DIESEL		
HIDRAULICO	GP-9	E7NN-6714-DA
LGT140 con motor/A DIESEL		
AIRE	GA-7	A700X-9601-ACA
LGT145 con motor/A DIESEL		
HIDRAULICO	GP-9	E7NN-6714-DA
LGT14D con motor/A DIESEL		
ACEITE	GP-2951	F0NN-6714-BA
LGT14H, LGT165 con motor/A DIESEL		
HIDRAULICO	GP-9	E7NN-6714-DA
LGT16D con motor/A DIESEL		
ACEITE	GP-2951	F0NN-6714-BA
LGT17, LGT195 con motor/A DIESEL		
HIDRAULICO	GP-9	E7NN-6714-DA
LGT18H con motor/A DIESEL		
HIDRAULICO	GP-9	E7NN-6714-DA
YT12.5, YT14, YT16, YT16H, YT18H con motor/A DIESEL		
ACEITE	GP-58	5205002

FORDSON		
TRACTORES		
DEXTA, SUPER DEXTA con motor/A DIESEL		
ACEITE	G-813	EPN6731B
ACEITE	G-5000	DGPN-6731-A
COMBUSTIBLE	G-11816	EPN99162A
COMBUSTIBLE	G-296	D5NN-6714-A
HIDRAULICO	GP-66	CONN6708A
COMBUSTIBLE	G-296-B	D5NN-6714-A
JUBILEE con motor/A DIESEL		
ACEITE	G-6	CPA-6731-A
MAJOR con motor/A DIESEL		
ACEITE	G-870	86546620
ACEITE	G-871	EPN6731A
ACEITE	G-5000	CFPN-6731-B
COMBUSTIBLE	G-11816	EPN99162A
COMBUSTIBLE	G-296	D5NN-6714-A
COMBUSTIBLE	G-296-B	D5NN-6714-A
POWER MAJOR con motor/A DIESEL		
ACEITE	G-813	EPN6731B
ACEITE	G-871	DGPN-6731-A
ACEITE	G-5000	DGPN-6731-A
COMBUSTIBLE	G-11816	EPN99162A
COMBUSTIBLE	G-296	D5NN-6714-A
HIDRAULICO	GP-66	CONN6708A

MARCA-MODELO-MOTOR MAKE-MODEL-ENGINE	GONHER GONHER	OEM OEM
FORDSON (continuación)		
TRACTORES		
COMBUSTIBLE		
	G-296-B	D5NN-6714-A
SUPER MAJOR con motor/A DIESEL		
ACEITE	G-813	EPN6731B
ACEITE	G-870	86546620
ACEITE	G-871	DGPN-6731-A
ACEITE	G-5000	DGPN-6731-A
COMBUSTIBLE	G-11816	EPN99162A
COMBUSTIBLE	G-296	D5NN-6714-A
HIDRAULICO	GP-66	CONN6708A
COMBUSTIBLE	G-296-B	D5NN-6714-A

FREIGHTLINER		
CAMIONES, TRACTOCAMIONES Y AUTOBUSES		
112 SERIES con motor/CUMMINS N14		
AGUA, SISTEMA DE ENFRIAMIENTO	GP-1011Q	3315115
112 SERIES, 112SD SERIES con motor/CUMMINS M11		
COMBUSTIBLE	GP-1101	138627
ACEITE, LUBRICACION DE DOBLE FLUJO	GP-3000	3825970
AGUA, SISTEMA DE ENFRIAMIENTO	GP-2071W	3315116
COMBUSTIBLE, SEPARADOR DE AGUA	GPP-1000	3843750
AIRE	GA-6880	P128299
112 SERIES, 112SD SERIES con motor/DETROIT DIESEL SERIES 60		
AGUA, SISTEMA DE ENFRIAMIENTO	GP-2071W	P554071
ACEITE	GP-193	23530573
AIRE	GA-6880	P128299
120 SERIES con motor/CATERPILLAR 3176TAA		
ACEITE	GP-52	1R0716
120 SERIES con motor/CATERPILLAR 3406TA		
ACEITE	GP-52	1R0716
AGUA, SISTEMA DE ENFRIAMIENTO	GP-2071W	9N3368
AIRE	GA-6880	310767
120 SERIES con motor/CUMMINS C8.3		
COMBUSTIBLE	GP-1122	3903640
120 SERIES con motor/DETROIT DIESEL SERIES 60		
AGUA, SISTEMA DE ENFRIAMIENTO	GP-2071W	3315116
ACEITE	GP-193	23518480
AIRE	GA-6880	P116680
120 SERIES con motores/CUMMINS L10, CUMMINS N14		
AGUA, SISTEMA DE ENFRIAMIENTO	GP-2071W	3315116
120 SERIES, 120SD SERIES, 132 SERIES con motor/CUMMINS M11		
ACEITE, LUBRICACION DE DOBLE FLUJO	GP-3000	3318853
AGUA, SISTEMA DE ENFRIAMIENTO	GP-2071W	3315116
COMBUSTIBLE, SEPARADOR DE AGUA	GPP-1000	3329289
AIRE	GA-6880	P116680
120SD SERIES con motor/DETROIT DIESEL SERIES 60		
AGUA, SISTEMA DE ENFRIAMIENTO	GP-2071W	3315116

MARCA-MODELO-MOTOR MAKE-MODEL-ENGINE	GONHER GONHER	OEM OEM
FREIGHTLINER (continuación)		
CAMIONES, TRACTOCAMIONES Y AUTOBUSES		
ACEITE	GP-193	23518480
AIRE	GA-6880	P116680
132 SERIES con motor/DETROIT DIESEL SERIES 60		
AGUA, SISTEMA DE ENFRIAMIENTO	GP-2071W	P554071
ACEITE	GP-193	23518480
AIRE	GA-6880	P116680
ARGOSY con motor/CATERPILLAR C10		
COMBUSTIBLE, SECUNDARIO	GP-749	1R0712
ACEITE, FLUJO TOTAL (FULL FLOW)	GP-52	1R0716
ACEITE, DERIVACION (BY PASS)	GP-57	1W8845
AIRE	GA-682R	P535717
ARGOSY con motor/CATERPILLAR C12		
COMBUSTIBLE	GP-749	1R0712
ACEITE, FLUJO TOTAL (FULL FLOW)	GP-52	1R0716
ACEITE, DERIVACION (BY PASS)	GP-57	1W8845
AIRE	GA-682R	P535717
ARGOSY con motor/CUMMINS ISM		
ACEITE, LUBRICACION DE DOBLE FLUJO (ALT. 13 7/8 IN)	GP-9000	3406810
ACEITE, LUBRICACION DE DOBLE FLUJO (ALT. 11 23/32 IN)	GP-9001	3406809
COMBUSTIBLE, SEPARADOR DE AGUA	GPP-1003S	3406889
AIRE	GA-682R	P535717
ARGOSY con motor/CUMMINS ISX		
COMBUSTIBLE, SEPARADOR DE AGUA (CARTUCHO)	G-128	380087
COMBUSTIBLE, SEPARADOR DE AGUA (CARTUCHO)	GS-557	FS19557
ACEITE	GP-9001	3406809
COMBUSTIBLE, SEPARADOR DE AGUA (SELLADO)	GPP-1007S	3331096
AIRE RADIAL	GA-682R	P535717
ARGOSY con motor/CUMMINS M11		
COMBUSTIBLE, SEPARADOR DE AGUA, CARTUCHO	G-128	FF1005
ACEITE	GP-3000	3318853
COMBUSTIBLE, SEPARADOR DE AGUA, SELLADO	GPP-1000	3329289
ARGOSY con motor/CUMMINS N14		
COMBUSTIBLE	GPP-14	154789
ACEITE, FLUJO TOTAL (FULL FLOW)	GP-53	298670
ACEITE, DERIVACION (BY PASS)	GP-57	3021658
ACEITE, DOBLE FLUJO	GP-3000	3318853
COMBUSTIBLE, SEPARADOR DE AGUA	GPP-1000	3329289
ARGOSY con motor/DETROIT DIESEL SERIES 60		
COMBUSTIBLE, PRIMARIO	GP-26	23518481
COMBUSTIBLE, SECUNDARIO	GP-27	23518482
ACEITE	GP-193	23518480
AIRE, ALT. 14 3/4 IN	GA-682R	P535717
AIRE, ALT. 23 7/16 IN	GA-518R	RS3516
ARGOSY con motores/CATERPILLAR C15, CATERPILLAR C16		
ACEITE	GP-52	1R0716
COMBUSTIBLE, SEPARADOR DE AGUA	GPP-11	311365

MARCA-MODELO-MOTOR MAKE-MODEL-ENGINE	GONHER GONHER	OEM OEM	MARCA-MODELO-MOTOR MAKE-MODEL-ENGINE	GONHER GONHER	OEM OEM	MARCA-MODELO-MOTOR MAKE-MODEL-ENGINE	GONHER GONHER	OEM OEM
FREIGHTLINER (continuación)			FREIGHTLINER (continuación)			FREIGHTLINER (continuación)		
CAMIONES, TRACTOCAMIONES Y AUTOBUSES			CAMIONES, TRACTOCAMIONES Y AUTOBUSES			CAMIONES, TRACTOCAMIONES Y AUTOBUSES		
AIRE	GA-682R	P535717	ACEITE, ALGUNOS DIFERENCIALES	GP-81	3280-V-8394	BUSINESS CLASS M2 con motor/MERCEDES BENZ MBE900		
BUSINESS CLASS M2 con motor/CATERPILLAR 3126			COMBUSTIBLE, SEPARADOR DE AGUA CON PURGADOR	GPP-1291	ABP/ S3226FL02	ACEITE, FLUJO TOTAL (FULL FLOW)	G-3754	1801709
ACEITE, LUBRICACION DEL MOTOR	GP-51	1R0739	AIRE, PRIMARIO	GA-701	P607955	COMBUSTIBLE	G-1046	901551
COMBUSTIBLE (ALT. 5 13/32 IN)	GP-62	1R0751	AIRE, SECUNDARIO	GA-702	P544432	ACEITE, OPCIONAL PARA TRANSMISION (SELLADO)	GP-1	17237
COMBUSTIBLE (ALT. 7 17/32 IN)	GP-1109	1R0751	COMBUSTIBLE, SEPARADOR DE AGUA CON ROSCA PARA TAZON	S 3226 P	ABP/ S3226FL02	ACEITE, ALGUNOS DIFERENCIALES	GP-81	3280-V-8394
ACEITE, ALGUNOS DIFERENCIALES	GP-81	3280-V-8394	BUSINESS CLASS M2 con motor/CATERPILLAR C9			COMBUSTIBLE, SEPARADOR DE AGUA CON PURGADOR	GPP-1291	ABP/ S3226FL02
AIRE, PRIMARIO	GA-701	P548070	ACEITE, OPCIONAL PATA TRANSMISION (SELLADO)	GP-1	17237	AIRE, PRIMARIO	GA-701	P548070
AIRE, SECUNDARIO	GA-702	P544432	ACEITE, LUBRICACION DEL MOTOR	GP-52	1R1808	AIRE, SECUNDARIO	GA-702	P544432
BUSINESS CLASS M2 con motor/CATERPILLAR C11			COMBUSTIBLE (ALT. 5 13/32 IN)	GP-62	1R0751	COMBUSTIBLE, SEPARADOR DE AGUA CON ROSCA PARA TAZON	S 3226 P	ABP/ S3226FL02
ACEITE, OPCIONAL PARA TRANSMISION (SELLADO)	GP-1	17237	COMBUSTIBLE (ALT. 7 17/32 IN)	GP-1109	1R0751	BUSINESS CLASS M2 con motor/MERCEDES BENZ MBE904		
COMBUSTIBLE	GP-749	1R0749	ACEITE, ALGUNOS DIFERENCIALES	GP-81	3280-V-8394	ACEITE, FLUJO TOTAL (FULL FLOW)	G-3827	1801609
ACEITE, LUBRICACION DEL MOTOR	GP-52	1R0716	COMBUSTIBLE, SEPARADOR DE AGUA CON PURGADOR	GPP-1291	S3226FL02	COMBUSTIBLE, SECUNDARIO	G-1046	901551
COMBUSTIBLE, SEPARADOR DE AGUA	GPP-11	311367	AIRE, PRIMARIO	GA-701	P548070	ACEITE, ALGUNOS DIFERENCIALES	GP-81	3280-V-8394
ACEITE, ALGUNOS DIFERENCIALES	GP-81	3280-V-8394	AIRE, SECUNDARIO	GA-702	P544432	AIRE, PRIMARIO	GA-701	P548070
AIRE, PRIMARIO	GA-701	P548070	COMBUSTIBLE, SEPARADOR DE AGUA CON ROSCA PARA TAZON	S 3226 P	S3226FL02	AIRE, SECUNDARIO	GA-702	P544432
AIRE, SECUNDARIO	GA-702	P544432	BUSINESS CLASS M2 con motor/CATERPILLAR C12			BUSINESS CLASS M2 con motor/MERCEDES BENZ MBE906		
BUSINESS CLASS M2 con motor/CATERPILLAR C12			COMBUSTIBLE	GP-749	1R0749	ACEITE, FLUJO TOTAL (FULL FLOW)	G-3754	1801709
COMBUSTIBLE	GP-749	1R0749	ACEITE, LUBRICACION DEL MOTOR	GP-52	1R0716	COMBUSTIBLE	G-1046	901551
ACEITE, LUBRICACION DEL MOTOR	GP-52	1R0716	ACEITE, ALGUNOS DIFERENCIALES	GP-81	3280-V-8394	ACEITE, ALGUNOS DIFERENCIALES	GP-81	3280-V-8394
ACEITE, ALGUNOS DIFERENCIALES	GP-81	3280-V-8394	COMBUSTIBLE, SEPARADOR DE AGUA	GPP-11	311367	AIRE, PRIMARIO	GA-701	P607955
COMBUSTIBLE, SEPARADOR DE AGUA CON PURGADOR	GPP-1291	FS19593	ACEITE, DOBLE FLUJO	GP-3000	3318853	AIRE, SECUNDARIO	GA-702	P544432
AIRE, PRIMARIO	GA-701	P548070	COMBUSTIBLE, SEPARADOR DE AGUA	GPP-18	3903410	BUSINESS CLASS M2 con motor/MERCEDES BENZ MBE926		
AIRE, SECUNDARIO	GA-702	P544432	BUSINESS CLASS M2 con motor/CUMMINS 6C SERIES			ACEITE, FLUJO TOTAL (FULL FLOW)	G-3754	1801709
COMBUSTIBLE, SEPARADOR DE AGUA CON ROSCA PARA TAZON	S 3226 P	FS19593	COMBUSTIBLE, SECUNDARIO	GP-1122	3903640	COMBUSTIBLE	G-1046	901551
BUSINESS CLASS M2 con motor/CATERPILLAR C13			ACEITE, FLUJO TOTAL (FULL FLOW)	GP-43	3014654	ACEITE, ALGUNOS DIFERENCIALES	GP-81	3280-V-8394
ACEITE, OPCIONAL PARA TRANSMISION (SELLADO)	GP-1	17237	ACEITE, DOBLE FLUJO	GP-3000	3318853	AIRE, PRIMARIO	GA-701	P607955
COMBUSTIBLE	GP-749	1R0749	COMBUSTIBLE, SEPARADOR DE AGUA	GPP-18	3903410	AIRE, SECUNDARIO	GA-702	P544432
ACEITE, LUBRICACION DEL MOTOR	GP-52	1R0716	BUSINESS CLASS M2 con motor/CUMMINS ISC			BUSINESS CLASS M2 con motor/MERCEDES BENZ MBE926		
COMBUSTIBLE, SEPARADOR DE AGUA	GPP-11	311368	ACEITE, OPCIONAL PARA TRANSMISION (SELLADO)	GP-1	17237	ACEITE, FLUJO TOTAL (FULL FLOW)	G-3754	1801709
AGUA, SISTEMA DE ENFRIAMIENTO	GP-2071W	WF2071	ACEITE, LUBRICACION DE DOBLE FLUJO	GP-3001	LF9009	COMBUSTIBLE, ALT. 4 5/64 IN	G-1046	901551
ACEITE, ALGUNOS DIFERENCIALES	GP-81	3280-V-8394	COMBUSTIBLE (HASTA DIC. 06)	GP-1109	FF5488	ACEITE, ALGUNOS DIFERENCIALES	GP-81	3280-V-8394
COMBUSTIBLE, SEPARADOR DE AGUA CON PURGADOR	GPP-1291	FS19593	AGUA, SISTEMA DE ENFRIAMIENTO	GP-2071W	WF2071	AIRE, PRIMARIO	GA-701	P607955
AIRE, PRIMARIO	GA-701	P548070	ACEITE, ALGUNOS DIFERENCIALES	GP-81	3280-V-8394	AIRE, SECUNDARIO	GA-702	P544432
AIRE, SECUNDARIO	GA-702	P544432	COMBUSTIBLE, SEPARADOR DE AGUA	GPP-1022S	FS1022	C112 con motor/CATERPILLAR C12		
COMBUSTIBLE, SEPARADOR DE AGUA CON ROSCA PARA TAZON	S 3226 P	FS19593	AIRE, PRIMARIO	GA-701	P548070	COMBUSTIBLE	GP-749	1R0749
BUSINESS CLASS M2 con motor/CATERPILLAR C7			AIRE, SECUNDARIO	GA-702	P544432	ACEITE	GP-52	1R0716
ACEITE, OPCIONAL PARA TRANSMISION (SELLADO)	GP-1	17237	BUSINESS CLASS M2 con motor/MERCEDES BENZ MBE4000			COMBUSTIBLE, SEPARADOR DE AGUA	GPP-1000	P551000
ACEITE, LUBRICACION DEL MOTOR	GP-51	1R0739	ACEITE, OPCIONAL PARA TRANSMISION (SELLADO)	GP-1	17237	C112 con motor/CATERPILLAR M11		
COMBUSTIBLE (ALT. 5 13/32 IN)	GP-62	1R0751	ACEITE, ALGUNOS DIFERENCIALES	GP-81	3280-V-8394	ACEITE, LUBRICACION DE DOBLE FLUJO	GP-3000	3318853
COMBUSTIBLE (ALT. 7 17/32 IN)	GP-1109	1R0751	COMBUSTIBLE, SEPARADOR DE AGUA CON PURGADOR	GPP-1291	S3226FL02	C120 con motor/CATERPILLAR 3406E		
AGUA, SISTEMA DE ENFRIAMIENTO	GP-2071W	9N3368	AIRE, PRIMARIO	GA-701	P548070	COMBUSTIBLE	GP-749	1R0749
			AIRE, SECUNDARIO	GA-702	P544432	C120 con motor/CATERPILLAR C12		
			COMBUSTIBLE, SEPARADOR DE AGUA CON ROSCA PARA TAZON	S 3226 P	S3226FL02	COMBUSTIBLE	GP-749	1R0749
			BUSINESS CLASS M2 con motor/MERCEDES BENZ MBE460			ACEITE	GP-52	1R1808
			COMBUSTIBLE, ALT. 4 5/64 IN	G-1046	901551	COMBUSTIBLE, SEPARADOR DE AGUA	GPP-1000	P551000
			ACEITE, ALGUNOS DIFERENCIALES	GP-81	3280-V-8394	C120 con motor/DETROIT DIESEL SERIES 60		
			AIRE	GA-197R	EAF5067	COMBUSTIBLE, PRIMARIO	GP-26	23518481
						COMBUSTIBLE, SECUNDARIO	GP-27	23518482
						ACEITE	GP-193	23518480
						AIRE (ESTANDAR)	GA-3551	P153551
						AIRE (HEAVY DUTY)	GA-3551 XT	P153551
						C2 CHASIS con motor/CATERPILLAR C7		

SERVICIO PESADO

MARCA-MODELO-MOTOR MAKE-MODEL-ENGINE	GONHER GONHER	OEM OEM	MARCA-MODELO-MOTOR MAKE-MODEL-ENGINE	GONHER GONHER	OEM OEM	MARCA-MODELO-MOTOR MAKE-MODEL-ENGINE	GONHER GONHER	OEM OEM
FREIGHTLINER (continuación)			FREIGHTLINER (continuación)			FREIGHTLINER (continuación)		
CAMIONES, TRACTOCAMIONES Y AUTOBUSES			CAMIONES, TRACTOCAMIONES Y AUTOBUSES			CAMIONES, TRACTOCAMIONES Y AUTOBUSES		
ACEITE	GP-51	1R0739	ACEITE, FLUJO TOTAL (FULL FLOW)	GP-53	298670	CENTURY CST112, CENTURY CST120 con motor/CUMMINS M11		
COMBUSTIBLE, ALT. 5 13/32 IN	GP-62	1R0751	ACEITE, DERIVACION (BY PASS)	GP-57	3021658	COMBUSTIBLE, SEPARADOR DE AGUA, CARTUCHO	G-128	FF1005
COMBUSTIBLE, ALT. 7 17/32 IN	GP-1109	1R0751	COMBUSTIBLE, SEPARADOR DE AGUA	GPP-11	202893	ACEITE	GP-3000	3318853
C2 CHASIS con motor/MERCEDES BENZ MBE900			ACEITE, DOBLE FLUJO	GP-3000	3318853	COMBUSTIBLE, SEPARADOR DE AGUA, SELLADO	GPP-1000	3329289
ACEITE, FLUJO TOTAL (FULL FLOW)	G-3754	A0001801709	AIRE, PRIMARIO	GA-682R	AF25139	CENTURY CST120 con motor/CUMMINS N14		
CARGO con motor/CUMMINS ISB			AIRE, SECUNDARIO	GA-683R	AF25345	COMBUSTIBLE	GPP-14	154789
ACEITE	GP-3937	3937736	CENTURY CLASS con motor/CUMMINS N14 ESP PLUS			ACEITE, FLUJO TOTAL (FULL FLOW)	GP-53	298670
COMBUSTIBLE, SEPARADOR DE AGUA (SELLADO)	GPP-1003S	3954904	ACEITE, LUBRICACION DE DOBLE FLUJO	GP-3001	3401544	ACEITE, DERIVACION (BY PASS)	GP-57	3021658
COMBUSTIBLE, SEPARADOR DE AGUA (CARTUCHO)	GS-1261	3942470	ACEITE, LUBRICACION DE DOBLE FLUJO	GP-3000	3318853	ACEITE, DERIVACION	GP-3000	3318853
AIRE	GA-197R	P530300	COMBUSTIBLE, SEPARADOR DE AGUA	GPP-1000	3889716	COMBUSTIBLE, SEPARADOR DE AGUA	GPP-1000	3329289
CC132 CORONADO con motor/CATERPILLAR C15			AIRE	GA-682R	EA5069	CL112 COLUMBIA con motor/CATERPILLAR C13		
COMBUSTIBLE, SEPARADOR DE AGUA, CARTUCHO	G-128	380087	CENTURY CLASS S/T con motor/CATERPILLAR C15			ACEITE, OPCIONAL PARA TRANSMISION	GP-1	17237
ACEITE, OPCIONAL PARA TRANSMISION	GP-1	17237	ACEITE, OPCIONAL PARA TRANSMISION	GP-1	17237	COMBUSTIBLE	GP-749	1R0749
COMBUSTIBLE	GP-749	1R0749	COMBUSTIBLE	GP-749	1R0749	ACEITE, FLUJO TOTAL (FULL FLOW)	GP-52	1R1808
ACEITE, LUBRICACION DEL MOTOR	GP-52	1R0716	ACEITE	GP-52	1R1808	ACEITE, DERIVACION (BY PASS)	GP-57	9Y4468
COMBUSTIBLE, SEPARADOR DE AGUA SELLADO	GPP-11	311365	AIRE	GA-682R	P527682	AGUA, SISTEMA DE ENFRIAMIENTO (CON QUIMICOS)	GP-2071W	9N3368
AGUA, SISTEMA DE ENFRIAMIENTO (4 UNIDADES BTA+)	GP-2071W	WF2071	CENTURY CLASS S/T con motor/CUMMINS M11			ACEITE, ALGUNOS DIFERENCIALES	GP-81	3280-V-8394
ACEITE, ALGUNOS DIFERENCIALES	GP-81	3280-V-8394	COMBUSTIBLE, SEPARADOR DE AGUA	G-128	FF1005	COMBUSTIBLE, SEPARADOR DE AGUA CON PURGADOR	GPP-1291	ABP/S3226FL02
COMBUSTIBLE, SEPARADOR DE AGUA SELLADO	GPP-1000	P551000	ACEITE	GP-3001	3401544	AIRE	GA-682R	P527682
COMBUSTIBLE, SEPARADOR DE AGUA SELLADO CON PURGADOR	GPP-1291	ABP/S3226FL02	ACEITE	GP-3000	3318853	COMBUSTIBLE, SEPARADOR DE AGUA CON ROSCA PARA TAZON	S 3226 P	ABP/S3226FL02
AIRE	GA-682R	P527682	AIRE	GA-682R	AF25139	CENTURY CLASS S/T con motor/CUMMINS N14		
COMBUSTIBLE, SEPARADOR DE AGUA SELLADO CON ROSCA PARA TAZON	S 3226 P	ABP/S3226FL02	CENTURY CLASS S/T con motor/CUMMINS N14			ACEITE, DERIVACION (BY PASS)	GP-57	3021658
CC132 CORONADO con motor/DETROIT DIESEL SERIES 60			ACEITE, DERIVACION (BY PASS)	GP-57	3021658	ACEITE, DOBLE FLUJO	GP-3000	3318853
ACEITE, OPCIONAL PARA TRANSMISION	GP-1	17237	ACEITE, DOBLE FLUJO	GP-3000	3318853	COMBUSTIBLE, SEPARADOR DE AGUA	GPP-1291	324957001
COMBUSTIBLE, PRIMARIO	GP-26	23518481	COMBUSTIBLE, SEPARADOR DE AGUA	GPP-1291	324957001	AIRE	GA-682R	AF25139
COMBUSTIBLE, SECUNDARIO	GP-27	23518482	AIRE	GA-682R	AF25139	CENTURY CLASS S/T con motor/DETROIT DIESEL SERIES 60		
AGUA, SISTEMA DE ENFRIAMIENTO (2 UNIDADES BTA+)	GP-2071W	WF2071	CENTURY CLASS S/T con motor/DETROIT DIESEL SERIES 60			ACEITE, OPCIONAL PARA TRANSMISION	GP-1	17237
ACEITE, LUBRICACION DEL MOTOR	GP-193	23527033	ACEITE, OPCIONAL PARA TRANSMISION	GP-1	17237	COMBUSTIBLE, SECUNDARIO	GP-27	23518482
ACEITE, ALGUNOS DIFERENCIALES	GP-81	3280-V-8394	AIRE	GA-682R	P527682	ACEITE	GP-193	23518480
COMBUSTIBLE, SEPARADOR DE AGUA SELLADO CON PURGADOR	GPP-1291	324957001	COMBUSTIBLE, PRIMARIO	S 3226 P	324957001	AIRE	GA-682R	P527682
COMBUSTIBLE, SEPARADOR DE AGUA SELLADO CON ROSCA PARA TAZON	S 3226 P	324957001	CENTURY CLASS S/T con motor/MERCEDES BENZ MBE4000			COMBUSTIBLE, SEPARADOR DE AGUA CON ROSCA PARA TAZON	S 3226 P	324957001
COMBUSTIBLE, SEPARADOR DE AGUA SELLADO CON ROSCA PARA TAZON	S 3202	23512317	ACEITE, OPCIONAL PARA TRANSMISION	GP-1	17237	CENTURY CLASS S/T con motor/DETROIT DIESEL SERIES 60		
CENTURY C120 con motor/CUMMINS M11			AIRE	GA-682R	P185069	ACEITE, OPCIONAL PARA TRANSMISION	GP-1	17237
COMBUSTIBLE, SEPARADOR DE AGUA, CARTUCHO	G-128	FF1005	COMBUSTIBLE, SEPARADOR DE AGUA (SELLADO)	S 3226 P	324957001	ACEITE, ALGUNOS DIFERENCIALES	GP-81	3280-V-8394
ACEITE	GP-3000	3318853	CENTURY CLASS S/T con motores/CATERPILLAR C13, CATERPILLAR C11			COMBUSTIBLE, SEPARADOR DE AGUA SELLADO CON PURGADOR	GPP-1291	ABP/S3226FL02
COMBUSTIBLE, SEPARADOR DE AGUA, SELLADO	GPP-1000	3329289	ACEITE, OPCIONAL PARA TRANSMISION	GP-1	17237	AIRE	GA-682R	P527682
AIRE, PRIMARIO	GA-682R	AF25139	COMBUSTIBLE	GP-749	1R0749	COMBUSTIBLE, SEPARADOR DE AGUA SELLADO CON ROSCA PARA TAZON	S 3226 P	ABP/S3226FL02
AIRE, SECUNDARIO	GA-683R	AF25345	ACEITE, FLUJO TOTAL (FULL FLOW)	GP-52	1R0716	CL120 COLUMBIA con motor/CATERPILLAR C15		
CENTURY C120 con motores/CUMMINS L10, CUMMINS N14			ACEITE, DERIVACION, ALGUNOS (SOME BY PASS)	GP-57	1W8845	ACEITE, OPCIONAL PARA TRANSMISION	GP-1	17237
COMBUSTIBLE	GPP-14	154789	COMBUSTIBLE, SEPARADOR DE AGUA CON PURGADOR	GPP-11	311370	COMBUSTIBLE	GP-749	1R0749
			COMBUSTIBLE, SEPARADOR DE AGUA CON PURGADOR	GPP-1291	324957001	ACEITE, LUBRICACION DEL MOTOR	GP-52	1R1808
			AIRE	GA-682R	EA5069	ACEITE, ALGUNOS DIFERENCIALES	GP-81	3280-V-8394
			COMBUSTIBLE, SEPARADOR DE AGUA CON ROSCA PARA TAZON	S 3226 P	324957001	AIRE	GA-682R	P527682

MARCA-MODELO-MOTOR MAKE-MODEL-ENGINE	GONHER GONHER	OEM OEM	MARCA-MODELO-MOTOR MAKE-MODEL-ENGINE	GONHER GONHER	OEM OEM	MARCA-MODELO-MOTOR MAKE-MODEL-ENGINE	GONHER GONHER	OEM OEM
FREIGHTLINER (continuación)			FREIGHTLINER (continuación)			FREIGHTLINER (continuación)		
CAMIONES, TRACTOCAMIONES Y AUTOBUSES			CAMIONES, TRACTOCAMIONES Y AUTOBUSES			CAMIONES, TRACTOCAMIONES Y AUTOBUSES		
CL120 COLUMBIA con motor/DETROIT DIESEL SERIES 60			CLASSIC con motor/DETROIT DIESEL SERIES 60			COMBUSTIBLE, SEPARADOR DE AGUA	GPP-1000	3329289
COMBUSTIBLE PRIMARIO (CARTUCHO)	G-128	23521528	ACEITE, OPCIONAL PARA TRANSMISION	GP-1	17237	AIRE	GA-682R	AF25139
ACEITE, OPCIONAL PARA TRANSMISION	GP-1	17237	COMBUSTIBLE, SECUNDARIO	GP-27	23533726	COLUMBIA con motor/CATERPILLAR C12		
COMBUSTIBLE PRIMARIO (SELLADO)	GP-26	23518481	ACEITE	GP-193	23527033	COMBUSTIBLE	GP-749	1R0749
COMBUSTIBLE SECUNDARIO	GP-27	23518482	ACEITE, ALGUNOS DIFERENCIALES	GP-81	3280-V-8394	ACEITE	GP-52	1R0716
ACEITE, LUBRICACION DEL MOTOR	GP-193	23527033	AIRE	GA-539R	P534816	COMBUSTIBLE, SEPARADOR DE AGUA CON PURGADOR	GPP-1291	324957001
ACEITE, ALGUNOS DIFERENCIALES	GP-81	3280-V-8394	CLASSIC con motor/MERCEDES BENZ MBE4000			AIRE	GA-682R	P527682
COMBUSTIBLE, SEPARADOR DE AGUA CON PURGADOR	GPP-1291	324957001	ACEITE, OPCIONAL PARA TRANSMISION	GP-1	17237	COMBUSTIBLE, SEPARADOR DE AGUA CON ROSCA PARA TAZON	S 3226 P	324957001
AIRE	GA-682R	P527682	ACEITE, ALGUNOS DIFERENCIALES	GP-81	3280-V-8394	COLUMBIA con motor/CATERPILLAR C13		
COMBUSTIBLE, SEPARADOR DE AGUA CON ROSCA PARA TAZON	S 3226 P	324957001	AIRE	GA-539R	AF25247	ACEITE, OPCIONAL PARA TRANSMISION	GP-1	17237
CL120 COLUMBIA con motor/MERCEDES BENZ MBE4000			CLASSIC con motores/CATERPILLAR C10, CATERPILLAR C12			COMBUSTIBLE	GP-749	1R0749
ACEITE, OPCIONAL PARA TRANSMISION	GP-1	17237	COMBUSTIBLE	GP-749	1R0712	ACEITE, LUBRICACION DEL MOTOR	GP-52	1R1808
ACEITE, ALGUNOS DIFERENCIALES	GP-81	3280-V-8394	ACEITE, FLUJO TOTAL (FULL FLOW)	GP-52	1R0716	AGUA, SISTEMA DE ENFRIAMIENTO (CON QUIMICOS)	GP-2071W	9N3368
COMBUSTIBLE, SEPARADOR DE AGUA CON PURGADOR	GPP-1291	ABP/S32265FL02	ACEITE, DERIVACION (BY PASS)	GP-57	1W8845	ACEITE, ALGUNOS DIFERENCIALES	GP-81	3280-V-8394
AIRE	GA-682R	P527682	CLASSIC XL con motor/CATERPILLAR C15			COMBUSTIBLE, SEPARADOR DE AGUA CON PURGADOR	GPP-1291	324957001
COMBUSTIBLE, SEPARADOR DE AGUA CON ROSCA PARA TAZON	S 3226 P	ABP/S32265FL02	ACEITE, OPCIONAL PARA TRANSMISION	GP-1	17237	AIRE	GA-682R	P527682
CLASSIC con motor/CATERPILLAR C15			COMBUSTIBLE	GP-749	1R0749	COMBUSTIBLE, SEPARADOR DE AGUA CON ROSCA PARA TAZON	S 3226 P	324957001
ACEITE, OPCIONAL PARA TRANSMISION	GP-1	17237	ACEITE	GP-52	1R0716	COLUMBIA con motor/CATERPILLAR C15		
COMBUSTIBLE	GP-749	1R0749	ACEITE, ALGUNOS DIFERENCIALES	GP-81	3280-V-8394	COMBUSTIBLE	GP-749	1R0749
ACEITE	GP-52	1R1808	COMBUSTIBLE, SEPARADOR DE AGUA CON PURGADOR	GPP-1291	ABP/S3226FL02	ACEITE, LUBRICACION DEL MOTOR	GP-52	1R1808
ACEITE, ALGUNOS DIFERENCIALES	GP-81	3280-V-8394	AIRE	GA-539R	AF25247	ACEITE, ALGUNOS DIFERENCIALES	GP-81	3280-V-8394
AIRE	GA-539R	AF25247	COMBUSTIBLE, SEPARADOR DE AGUA CON ROSCA PARA TAZON	S 3226 P	324957001	AIRE	GA-682R	P527682
CLASSIC con motor/CATERPILLAR C16			CLASSIC XL con motor/CATERPILLAR C3406E			COLUMBIA con motor/CUMMINS ISX		
COMBUSTIBLE	GP-749	1R0749	COMBUSTIBLE	GP-749	1R0749	ACEITE, LUBRICACION DE DOBLE FLUJO (ALT. 13 7/8 IN)	GP-9000	3406810
ACEITE	GP-52	1R0716	CLASSIC XL con motor/DETROIT DIESEL SERIES 60			ACEITE, LUBRICACION DE DOBLE FLUJO (ALT. 11 23/32 IN)	GP-9001	3406809
COMBUSTIBLE, SEPARADOR DE AGUA	GPP-11	311365	DIRECCION	G-169	83213d	COMBUSTIBLE, SEPARADOR DE AGUA	GPP-1007S	3331096
CLASSIC con motor/CUMMINS ISM			ACEITE, OPCIONAL PARA TRANSMISION	GP-1	17237	COLUMBIA con motor/CUMMINS N14		
ACEITE, LUBRICACION DE DOBLE FLUJO (ALT. 13 7/8 IN)	GP-9000	3406810	COMBUSTIBLE, PRIMARIO	GP-26	23518481	COMBUSTIBLE, SEPARADOR DE AGUA	G-128	FF1005
ACEITE, LUBRICACION DE DOBLE FLUJO (ALT. 11 23/32 IN)	GP-9001	3406809	COMBUSTIBLE, SECUNDARIO	GP-27	23518482	ACEITE, DERIVACION (BY PASS)	GP-57	3021658
COMBUSTIBLE, SEPARADOR DE AGUA	GPP-1003S	3406889	ACEITE, LUBRICACION DE MOTOR	GP-193	23530573	ACEITE, DOBLE FLUJO	GP-3000	3318853
CLASSIC con motor/CUMMINS ISX			ACEITE, ALGUNOS DIFERENCIALES	GP-81	3280-V-8394	AIRE	GA-682R	AF25139
ACEITE, LUBRICACION DE DOBLE FLUJO (ALT. 13 7/8 IN)	GP-9000	3406810	COMBUSTIBLE, SEPARADOR DE AGUA CON PURGADOR	GPP-1291	324957001	COLUMBIA con motor/DETROIT DIESEL SERIES 60		
ACEITE, LUBRICACION DE DOBLE FLUJO (ALT. 11 23/32 IN)	GP-9001	3406809	AIRE	GA-682R	P527682	COMBUSTIBLE, PRIMARIO (CARTUCHO)	G-128	23521528
COMBUSTIBLE, SEPARADOR DE AGUA	GPP-1007S	3331096	COMBUSTIBLE, SEPARADOR DE AGUA CON ROSCA PARA TAZON	S 3226 P	324957001	ACEITE, OPCIONAL PARA TRANSMISION	GP-1	17237
CLASSIC con motor/CUMMINS N14 PLUS			COLUMBIA 120 con motor/CUMMINS M11			COMBUSTIBLE, PRIMARIO (SELLADO)	GP-26	23518481
ACEITE, LUBRICACION DE DOBLE FLUJO	GP-3001	3401544	COMBUSTIBLE, SEPARADOR DE AGUA, CARTUCHO	G-128	FF1005	COMBUSTIBLE, SECUNDARIO	GP-27	23518482
ACEITE, LUBRICACION DE DOBLE FLUJO	GP-3000	3318853	ACEITE	GP-3000	3318853	ACEITE, LUBRICACION DEL MOTOR	GP-193	23527033
COMBUSTIBLE, SEPARADOR DE AGUA	GPP-1000	3889716	COMBUSTIBLE, SEPARADOR DE AGUA, SELLADO	GPP-1000	3329289	COMBUSTIBLE, SEPARADOR DE AGUA CON PURGADOR	GPP-1291	324957001
CLASSIC con motor/CUMMINS N14 PLUS			AIRE	GA-682R	AF25139	COMBUSTIBLE, SEPARADOR DE AGUA CON ROSCA PARA TAZON	S 3226 P	324957001
ACEITE, LUBRICACION DE DOBLE FLUJO	GP-3001	3401544	COLUMBIA 120 con motor/CUMMINS N14			COMBUSTIBLE, SEPARADOR DE AGUA CON ROSCA PARA TAZON	S 3226 P	324957001
ACEITE, LUBRICACION DE DOBLE FLUJO	GP-3000	3318853	COMBUSTIBLE	GPP-14	154789			
COMBUSTIBLE, SEPARADOR DE AGUA	GPP-1000	3889716	ACEITE, FLUJO TOTAL (FULL FLOW)	GP-53	298670			
			ACEITE, DERIVACION (BY PASS)	GP-57	3021658			
			ACEITE, DOBLE FLUJO	GP-3000	3318853			

SERVICIO PESADO

MARCA-MODELO-MOTOR MAKE-MODEL-ENGINE	GONHER GONHER	OEM OEM	MARCA-MODELO-MOTOR MAKE-MODEL-ENGINE	GONHER GONHER	OEM OEM	MARCA-MODELO-MOTOR MAKE-MODEL-ENGINE	GONHER GONHER	OEM OEM
FREIGHTLINER (continuación)			FREIGHTLINER (continuación)			FREIGHTLINER (continuación)		
CAMIONES, TRACTOCAMIONES Y AUTOBUSES			CAMIONES, TRACTOCAMIONES Y AUTOBUSES			CAMIONES, TRACTOCAMIONES Y AUTOBUSES		
COLUMBIA con motor/MERCEDES BENZ MBE4000			CONDOR con motor/CUMMINS C8.3 GAS NATURAL			ACEITE, LUBRICACION DE DOBLE FLUJO (ALT. 13 7/8 IN)		
ACEITE, OPCIONAL PARA TRANSMISION	GP-1	17237	ACEITE, FLUJO TOTAL (FULL FLOW)	GP-43	3014654	ACEITE, LUBRICACION DE DOBLE FLUJO (ALT. 11 23/32 IN)	GP-9001	3406809
ACEITE, ALGUNOS DIFERENCIALES	GP-81	3280-V-8394	CONDOR con motor/CUMMINS ISC			COMBUSTIBLE, SEPARADOR DE AGUA	GPP-1003S	3406889
COMBUSTIBLE, SEPARADOR DE AGUA CON PURGADOR	GPP-1291	324957001	ACEITE, LUBRICACION DE DOBLE FLUJO	GP-3001	3401544	AIRE	GA-682R	P535717
AIRE	GA-682R	P527682	COMBUSTIBLE	GP-1109	3959612	CORONADO con motor/CUMMINS ISX		
COMBUSTIBLE, SEPARADOR DE AGUA CON ROSCA PARA TAZON	S 3226 P	324957001	ACEITE, LUBRICACION DE DOBLE FLUJO	GP-3000	3318853	ACEITE, LUBRICACION DE DOBLE FLUJO (ALT. 13 7/8 IN)	GP-9000	3406810
COLUMBIA con motor/MERCEDES BENZ OM460LA			ACEITE, ALGUNOS DIFERENCIALES	GP-81	3280-V-8394	ACEITE, LUBRICACION DE DOBLE FLUJO (ALT. 11 23/32 IN)	GP-9001	3406809
AIRE	GA-682R	P527682	COMBUSTIBLE, SEPARADOR DE AGUA	GPP-1022S	3800394	COMBUSTIBLE, SEPARADOR DE AGUA	GPP-1007S	3331096
COLUMBIA DX con motor/CATERPILLAR C15			AIRE, PRIMARIO	GA-682R	P527682	AIRE	GA-682R	P535717
COMBUSTIBLE	GP-749	1R0749	AIRE, SECUNDARIO	GA-683R	P527683	CORONADO con motor/CUMMINS ISX		
ACEITE	GP-52	1R0716	CONDOR con motor/CUMMINS ISL			ACEITE, LUBRICACION DE DOBLE FLUJO	GP-3000	3318853
COMBUSTIBLE, SEPARADOR DE AGUA	GPP-1000	P551000	ACEITE, LUBRICACION DE DOBLE FLUJO	GP-3001	3401544	COMBUSTIBLE, SEPARADOR DE AGUA	GPP-1000	3889716
AIRE	GA-682R	P527682	ACEITE, LUBRICACION DE DOBLE FLUJO	GP-3000	3318853	AIRE	GA-682R	P535717
CONDOR con motor/CATERPILLAR 3126			ACEITE, ALGUNOS DIFERENCIALES	GP-81	3280-v-8394	CORONADO con motor/CUMMINS N14		
ACEITE	GP-51	1R0739	COMBUSTIBLE, SEPARADOR DE AGUA	GPP-1000	F51000	ACEITE, LUBRICACION DE DOBLE FLUJO	GP-3000	3318853
COMBUSTIBLE, ALT. 5 13/32 IN	GP-62	614783	COMBUSTIBLE, SEPARADOR DE AGUA CON PURGADOR	GPP-1291	324957001	COMBUSTIBLE, SEPARADOR DE AGUA	GPP-1000	3889716
COMBUSTIBLE, ALT. 7 17/32 IN	GP-1109	614783	AIRE, PRIMARIO	GA-682R	P527682	AIRE	GA-682R	P535717
AIRE	GA-378	P116918	AIRE, SECUNDARIO	GA-683R	P527683	CORONADO con motor/DETROIT DIESEL SERIES 60		
CONDOR con motor/CATERPILLAR C10			CONDOR con motor/CUMMINS ISM			ACEITE, OPCIONAL PARA TRANSMISION	GP-1	17237
COMBUSTIBLE	GP-749	1R0712	ACEITE, LUBRICACION DE DOBLE FLUJO	GP-9001	3406809	COMBUSTIBLE, PRIMARIO	GP-26	23518481
ACEITE, FLUJO TOTAL (FULL FLOW)	GP-52	1R0716	CONDOR con motor/CUMMINS M11			COMBUSTIBLE, SECUNDARIO	GP-27	23518482
ACEITE, DERIVACION OPCIONAL (BY PASS)	GP-57	1W8845	COMBUSTIBLE, SEPARADOR DE AGUA, CARTUCHO	G-128	FF1005	AGUA, SISTEMA DE ENFRIAMIENTO (2 UNIDADES BTA+)	GP-2071W	WF2071
AIRE	GA-378	P116918	TRANSMISION, OPCIONAL	GP-1	LF3306	ACEITE, LUBRICACION DEL MOTOR	GP-193	23527033
CONDOR con motor/CATERPILLAR C7			ACEITE	GP-3000	3318853	ACEITE, ALGUNOS DIFERENCIALES	GP-81	3280-V-8394
DIRECCION	G-159	83804E	COMBUSTIBLE, SEPARADOR DE AGUA, SELLADO	GPP-1000	3329289	COMBUSTIBLE, SEPARADOR DE AGUA CON PURGADOR	GPP-1291	324957001
ACEITE, LUBRICACION DEL MOTOR	GP-51	1R0739	AIRE	GA-3551	AF1968	AIRE	GA-682R	P527682
COMBUSTIBLE, PRIMARIO (ALT.5 13/32 IN)	GP-62	614783	CONDOR con motores/CATERPILLAR C12, CATERPILLAR C13, CATERPILLAR C11			COMBUSTIBLE, SEPARADOR DE AGUA CON ROSCA PARA TAZON	S 3226 P	324957001
COMBUSTIBLE, PRIMARIO (ALT.7 17/32 IN)	GP-1109	614783	ACEITE, OPCIONAL PARA TRANSMISION	GP-1	17237	COMBUSTIBLE, SEPARADOR DE AGUA CON ROSCA PARA TAZON	S 3202	23512317
ACEITE, ALGUNOS DIFERENCIALES	GP-81	3280-V-8394	COMBUSTIBLE	GP-749	1R0749	CORONADO con motores/CATERPILLAR C15, CATERPILLAR C16		
AIRE, PRIMARIO	GA-682R	P527682	ACEITE, LUBRICACION DEL MOTOR	GP-52	1R1808	COMBUSTIBLE, SEPARADOR DE AGUA (CARTUCHO)	G-128	380087
AIRE, SECUNDARIO	GA-683R	P527683	ACEITE, ALGUNOS DIFERENCIALES	GP-81	3280-V-8394	ACEITE, OPCIONAL PARA TRANSMISION	GP-1	17237
CONDOR con motor/CATERPILLAR C9			AIRE, PRIMARIO	GA-682R	P527682	COMBUSTIBLE	GP-749	1R0749
ACEITE, LUBRICACION DEL MOTOR	GP-52	1R0739	AIRE, SECUNDARIO	GA-683R	P527683	ACEITE, LUBRICACION DEL MOTOR	GP-52	1R0716
COMBUSTIBLE, PRIMARIO (ALT. 5 13/32 IN)	GP-62	614783	CORONADO con motor/CATERPILLAR C10			COMBUSTIBLE, SEPARADOR DE AGUA	GPP-11	311365
COMBUSTIBLE, PRIMARIO (ALT. 7 17/32 IN)	GP-1109	614783	COMBUSTIBLE	GP-749	1R0749	AGUA, SISTEMA DE ENFRIAMIENTO (4 UNIDADES BTA+)	GP-2071W	WF2071
ACEITE, ALGUNOS DIFERENCIALES	GP-81	3280-V-8394	ACEITE, FLUJO TOTAL (FULL FLOW)	GP-52	1R0716	ACEITE, ALGUNOS DIFERENCIALES	GP-81	3280-V-8394
AIRE, PRIMARIO	GA-682R	P527682	ACEITE, DERIVACION (BY PASS)	GP-57	1W8845	COMBUSTIBLE, SEPARADOR DE AGUA (SELLADO)	GPP-1000	P551000
AIRE, SECUNDARIO	GA-683R	P527683	AIRE	GA-682R	P535717	COMBUSTIBLE, SEPARADOR DE AGUA CON PURGADOR	GPP-1291	ABP/S3226FL02
CONDOR con motor/CUMMINS 6C SERIES			CONDOR con motor/CATERPILLAR C12			AIRE	GA-682R	P527682
COMBUSTIBLE, SECUNDARIO	GP-1122	3903640	COMBUSTIBLE	GP-749	1R0712	COMBUSTIBLE, SEPARADOR DE AGUA CON ROSCA PARA TAZON	S 3226 P	ABP/S3226FL02
ACEITE, FLUJO TOTAL (FULL FLOW)	GP-43	3014654	ACEITE, FLUJO TOTAL (FULL FLOW)	GP-52	1R0716	CST112 CENTURY CLASS con motor/CATERPILLAR C13		
ACEITE, DOBLE FLUJO	GP-3000	3318853	ACEITE, DERIVACION (BY PASS)	GP-57	1W8845	ACEITE, OPCIONAL PARA TRANSMISION	GP-1	17237
COMBUSTIBLE, SEPARADOR DE AGUA	GPP-18	3903410	AIRE	GA-682R	P535717	COMBUSTIBLE	GP-749	1R0749
CONDOR con motor/CUMMINS 6C SERIES			CORONADO con motor/CUMMINS ISM			ACEITE, FLUJO TOTAL (FULL FLOW)	GP-52	1R0716

MARCA-MODELO-MOTOR MAKE-MODEL-ENGINE	GONHER GONHER	OEM OEM	MARCA-MODELO-MOTOR MAKE-MODEL-ENGINE	GONHER GONHER	OEM OEM	MARCA-MODELO-MOTOR MAKE-MODEL-ENGINE	GONHER GONHER	OEM OEM
FREIGHTLINER (continuación)			FREIGHTLINER (continuación)			FREIGHTLINER (continuación)		
CAMIONES, TRACTOCAMIONES Y AUTOBUSES			CAMIONES, TRACTOCAMIONES Y AUTOBUSES			CAMIONES, TRACTOCAMIONES Y AUTOBUSES		
ACEITE, DERIVACION (BY PASS)	GP-57	1W8845	CST120 CENTURY CLASS S/T con motor/DETROIT DIESEL SERIES 60			FL112 con motor/CUMMINS M11		
COMBUSTIBLE, SEPARADOR DE AGUA	GPP-11	311370	ACEITE, OPCIONAL PARA TRANSMISION	GP-1	17237	ACEITE, LUBRICACION DE DOBLE FLUJO	GP-3000	3318853
COMBUSTIBLE, SEPARADOR DE AGUA CON PURGADOR	GPP-1291	324957001	COMBUSTIBLE, SECUNDARIO	GP-27	23518482	COMBUSTIBLE, SEPARADOR DE AGUA	GPP-1000	3329289
AIRE	GA-682R	EAF5069	ACEITE, LUBRICACION DEL MOTOR	GP-193	23518480	AIRE (ESTANDAR)	GA-3551	P153551
COMBUSTIBLE, SEPARADOR DE AGUA CON ROSCA PARA TAZON	S 3226 P	324957001	ACEITE, ALGUNOS DIFERENCIALES	GP-81	3280-V-8394	AIRE (HEAVY DUTY)	GA-3551 XT	P153551
CST112 CENTURY CLASS con motor/CATERPILLAR C15			COMBUSTIBLE, PRIMARIO, SEPARADOR DE AGUA SELLADO CON PURGADOR	GPP-1291	324957001	FL112 con motor/MERCEDES BENZ MBE4000		
ACEITE, OPCIONAL PARA TRANSMISION	GP-1	17237	AIRE	GA-682R	P527682	AIRE	GA-682R	P527682
COMBUSTIBLE	GP-749	1R0749	COMBUSTIBLE, PRIMARIO, SEPARADOR DE AGUA SELLADO CON ROSCA PARA TAZON	S 3226 P	324957001	FL112, FL112SD con motores/CATERPILLAR C10, CATERPILLAR C12		
ACEITE, LUBRICACION DEL MOTOR	GP-52	1R1808				COMBUSTIBLE	GP-749	1R0749
AIRE	GA-682R	P527682	CST120 CENTURY CLASS S/T con motor/MERCEDES BENZ MBE4000			FL50 con motor/CUMMINS 6C SERIES		
CST112 CENTURY CLASS con motor/DETROIT DIESEL SERIES 60			ACEITE, OPCIONAL PARA TRANSMISION	GP-1	17237	COMBUSTIBLE	GP-1122	3903640
ACEITE, OPCIONAL PARA TRANSMISION	GP-1	17237	ACEITE, ALGUNOS DIFERENCIALES	GP-81	3280-V-8394	ACEITE, FLUJO TOTAL (FULL FLOW)	GP-43	3014654
COMBUSTIBLE, SECUNDARIO	GP-27	23518482	COMBUSTIBLE, SEPARADOR DE AGUA SELLADO CON PURGADOR	GPP-1291	324957001	ACEITE, DOBLE FLUJO	GP-3000	3318853
ACEITE, LUBRICACION DEL MOTOR	GP-193	23518480	AIRE	GA-682R	P185069	COMBUSTIBLE, SEPARADOR DE AGUA	GPP-18	3903410
COMBUSTIBLE, PRIMARIO, SEPARADOR DE AGUA SELLADO CON PURGADOR	GPP-1291	324957001	COMBUSTIBLE, SEPARADOR DE AGUA SELLADO CON ROSCA PARA TAZON	S 3226 P	324957001	AIRE	GA-966R	AF25223
AIRE	GA-682R	P527682	FC70 CARGO, FC80 CARGO con motor/CUMMINS ISB			FL50 con motor/CUMMINS B5.9		
COMBUSTIBLE, PRIMARIO, SEPARADOR DE AGUA SELLADO CON ROSCA PARA TAZON	S 3226 P	324957001	ACEITE	GP-3937	3937736	COMBUSTIBLE, SECUNDARIO	GP-1122	3903640
CST112 CENTURY CLASS con motor/MERCEDES BENZ MBE4000			COMBUSTIBLE, SEPARADOR DE AGUA (SELLADO)	GPP-1003S	3954904	COMBUSTIBLE, PRIMARIO	GPP-18	3925274
ACEITE, OPCIONAL PARA TRANSMISION	GP-1	17237	COMBUSTIBLE, SEPARADOR DE AGUA (CARTUCHO)	GS-1261	3942470	ACEITE	GP-178	3903964
COMBUSTIBLE, SEPARADOR DE AGUA SELLADO CON PURGADOR	GPP-1291	324957001	AIRE	GA-197R	P530300	AIRE, ALT. 19 IN	GA-966R	P532966
AIRE	GA-682R	P185069	FL106 con motor/CUMMINS N14			FL50 con motor/CUMMINS C8.3 GAS NATURAL		
COMBUSTIBLE, SEPARADOR DE AGUA SELLADO CON ROSCA PARA TAZON	S 3226 P	324957001	COMBUSTIBLE	GPP-14	154789	ACEITE, FLUJO TOTAL (FULL FLOW)	GP-43	3014654
CST120 CENTURY CLASS S/T con motor/CATERPILLAR C13			ACEITE, FLUJO TOTAL (FULL FLOW)	GP-53	298670	ACEITE, DOBLE FLUJO	GP-3000	3318853
ACEITE, OPCIONAL PARA TRANSMISION	GP-1	17237	ACEITE, DERIVACION (BY PASS)	GP-57	3021658	AIRE	GA-966R	AF25223
COMBUSTIBLE, SEPARADOR DE AGUA SELLADO CON PURGADOR	GPP-1291	324957001	ACEITE, DOBLE FLUJO	GP-3000	3318853	FL50 con motor/CUMMINS ISB 5.9L		
AIRE	GA-682R	P185069	COMBUSTIBLE, SEPARADOR DE AGUA	GPP-1000	3329289	ACEITE	GP-3937	3937144
COMBUSTIBLE, SEPARADOR DE AGUA SELLADO CON ROSCA PARA TAZON	S 3226 P	324957001	FL106 con motor/DETROIT DIESEL SERIES 50			COMBUSTIBLE (CARTUCHO)	GS-1261	3942470
CST120 CENTURY CLASS S/T con motor/CATERPILLAR C13			COMBUSTIBLE, PRIMARIO	GP-26	23530706	AIRE, PRIMARIO	GA-966R	P532966
ACEITE, OPCIONAL PARA TRANSMISION	GP-1	17237	COMBUSTIBLE, SECUNDARIO	GP-27	23530707	AIRE, SECUNDARIO	GA-967R	P533781
COMBUSTIBLE	GP-749	1R0749	ACEITE, FLUJO TOTAL (FULL FLOW) HASTA 1993	GP-53	23530407	FL50 con motor/CUMMINS ISC		
ACEITE, DERIVACION (BY PASS)	GP-57	1W8845	ACEITE, DERIVACION (BY PASS)	GP-57	P940	ACEITE, LUBRICACION DE DOBLE FLUJO	GP-3001	3401544
COMBUSTIBLE, SEPARADOR DE AGUA	GPP-11	311370	ACEITE, FLUJO TOTAL (FULL FLOW) 1993 EN ADELANTE	GP-193	23530573	AGUA, SISTEMA DE ENFRIAMIENTO	GP-2071W	WF2071
ACEITE, ALGUNOS DIFERENCIALES	GP-81	3280-V-8394	FL112 con motor/CUMMINS ISM			COMBUSTIBLE, SEPARADOR DE AGUA	GPP-1022S	3800394
COMBUSTIBLE, SEPARADOR DE AGUA CON PURGADOR	GPP-1291	324957001	ACEITE, LUBRICACION DE DOBLE FLUJO	GP-9000	3406810	AIRE, PRIMARIO	GA-966R	P532966
AIRE	GA-682R	EAF5069	FL112 con motor/CUMMINS L10			AIRE, SECUNDARIO	GA-967R	P533781
COMBUSTIBLE, SEPARADOR DE AGUA CON ROSCA PARA TAZON	S 3226 P	324957001	DIRECCION	G-169	299634	FL50 con motor/CUMMINS M11		
CST120 CENTURY CLASS S/T con motor/CATERPILLAR C15			COMBUSTIBLE	GPP-14	154789	COMBUSTIBLE, SEPARADOR DE AGUA, CARTUCHO	G-128	FF1005
ACEITE, OPCIONAL PARA TRANSMISION	GP-1	17237	ACEITE, FLUJO TOTAL (FULL FLOW)	GP-53	298670	ACEITE	GP-3000	3318853
COMBUSTIBLE	GP-749	1R0749	COMBUSTIBLE, SEPARADOR DE AGUA	GPP-11	202893	COMBUSTIBLE, SEPARADOR DE AGUA, SELLADO	GPP-1000	3329289
ACEITE, LUBRICACION DEL MOTOR	GP-52	1R1808	ACEITE, DOBLE FLUJO	GP-3000	3318853	AIRE	GA-966R	AF25223
ACEITE, ALGUNOS DIFERENCIALES	GP-81	3280-V-8394	AIRE, CONICO	GA-377	AF1838	FL50 con motor/DODGE V10		
AIRE	GA-682R	P527682	AIRE	GA-3551	AF1968	ACEITE	GP-81	75221481
						FL50, FL60 con motor/MERCEDES BENZ MBE900		
						ACEITE, FLUJO TOTAL (FULL FLOW)	G-3754	A0001801709

SERVICIO PESADO

MARCA-MODELO-MOTOR MAKE-MODEL-ENGINE	GONHER GONHER	OEM OEM	MARCA-MODELO-MOTOR MAKE-MODEL-ENGINE	GONHER GONHER	OEM OEM	MARCA-MODELO-MOTOR MAKE-MODEL-ENGINE	GONHER GONHER	OEM OEM
FREIGHTLINER (continuación)			FREIGHTLINER (continuación)			FREIGHTLINER (continuación)		
CAMIONES, TRACTOCAMIONES Y AUTOBUSES			CAMIONES, TRACTOCAMIONES Y AUTOBUSES			CAMIONES, TRACTOCAMIONES Y AUTOBUSES		
FL60 con motor/CATERPILLAR 3126			ACEITE, DOBLE FLUJO	GP-3000	3318853	ACEITE, DOBLE FLUJO	GP-3000	3318853
ACEITE	GP-51	1R1807	COMBUSTIBLE, SEPARADOR DE AGUA	GPP-18	3903410	COMBUSTIBLE, SEPARADOR DE AGUA	GPP-1287	ABPS3225P
COMBUSTIBLE (ALT. 5 13/32 IN)	GP-62	1R0751	AIRE, SEPARADOR DE AGUA	GA-966R	AF25223	AIRE	GA-966R	AF25223
COMBUSTIBLE (ALT. 7 17/32 IN)	GP-1109	1R0751	FL70 con motor/CUMMINS 6C SERIES GAS NATURAL			FL80 con motor/CUMMINS ISB 5.9L		
COMBUSTIBLE, SEPARADOR DE AGUA CON PURGADOR	GPP-1287	FS1287	ACEITE, FLUJO TOTAL (FULL FLOW)	GP-43	3014654	ACEITE	GP-3937	3937144
COMBUSTIBLE, SEPARADOR DE AGUA CON ROSCA PARA TAZON	S 3225 P	S3225P	ACEITE, DOBLE FLUJO	GP-3000	3318853	COMBUSTIBLE (CARTUCHO)	GS-1261	3942470
			AIRE	GA-966R	AF25223	AIRE, PRIMARIO	GA-966R	P532966
						AIRE, SECUNDARIO	GA-967R	P533781
FL60 con motor/CUMMINS 5.9L GAS NATURAL			FL70 con motor/CUMMINS B5.9			FL80 con motor/CUMMINS ISC		
ACEITE	GP-178	3908615	COMBUSTIBLE, SECUNDARIO	GP-1122	3903640	ACEITE, LUBRICACION DE DOBLE FLUJO	GP-3001	3401544
			COMBUSTIBLE, PRIMARIO	GPP-18	3925274	AGUA, SISTEMA DE ENFRIAMIENTO	GP-2071W	WF2071
FL60 con motor/CUMMINS 6C SERIES DIESEL			ACEITE	GP-178	3903964	COMBUSTIBLE, SEPARADOR DE AGUA	GPP-1022S	3800394
COMBUSTIBLE	GP-1122	3903640	AIRE, ALT. 19 IN	GA-966R	P532966	AIRE, PRIMARIO	GA-966R	P532966
ACEITE, FLUJO TOTAL (FULL FLOW)	GP-43	3014654	FL70 con motor/CUMMINS C8.3			AIRE, SECUNDARIO	GA-967R	P533781
ACEITE, DERIVACION (BY PASS)	GP-3000	3318853	ACEITE, LUBRICACION DE DOBLE FLUJO	GP-3000	3318853	FL80 con motor/DETROIT DIESEL SERIES 60		
COMBUSTIBLE, SEPARADOR DE AGUA	GPP-18	3903410				AGUA, SISTEMA DE ENFRIAMIENTO	GP-2071W	P554071
AIRE	GA-966R	AF25223	FL70 con motor/CUMMINS ISB 5.9L			ACEITE	GP-193	23530573
			ACEITE	GP-3937	3937144	AIRE	GA-518R	RS3516
FL60 con motor/CUMMINS B5.9			COMBUSTIBLE (CARTUCHO)	GS-1261	3942470	FL80 con motor/MERCEDES BENZ MBE900		
COMBUSTIBLE, SECUNDARIO	GP-1122	3903640	AIRE, PRIMARIO	GA-966R	P532966	ACEITE, FLUJO TOTAL (FULL FLOW)	G-3754	A0001801709
COMBUSTIBLE, PRIMARIO	GPP-18	3925274	AIRE, SECUNDARIO	GA-967R	P533781	FLA con motor/CUMMINS NTC-855		
ACEITE	GP-178	3903964				AIRE, ALT. 22 17/32 IN (ESTANDAR)	GA-3551	P153551
AIRE, ALT. 19 IN	GA-966R	P532966	FL70 con motor/CUMMINS ISC			FLA con motor/DETROIT DIESEL SERIES 60		
			ACEITE, LUBRICACION DE DOBLE FLUJO	GP-3001	3401544	COMBUSTIBLE, PRIMARIO	GP-26	23530706
FL60 con motor/CUMMINS ISB 5.9L			AGUA, SISTEMA DE ENFRIAMIENTO	GP-2071W	WF2071	COMBUSTIBLE, SECUNDARIO	GP-27	23530707
ACEITE	GP-3937	3937144	COMBUSTIBLE, SEPARADOR DE AGUA	GPP-1022S	3800394	ACEITE, HASTA 1993	GP-53	23530407
COMBUSTIBLE (CARTUCHO)	GS-1261	3942470	AIRE, PRIMARIO	GA-966R	P532966	ACEITE, 1993 EN ADELANTE	GP-193	23530573
AIRE, PRIMARIO	GA-966R	P532966	AIRE, SECUNDARIO	GA-967R	P533781	AIRE (ESTANDAR)	GA-3551	P153551
AIRE, SECUNDARIO	GA-967R	P533781				AIRE (HEAVY DUTY)	GA-3551 XT	P153551
			FL70 con motor/MERCEDES BENZ MBE900			FLA con motores/CATERPILLAR 3306, CATERPILLAR 3406, CUMMINS L-10		
FL60 con motor/CUMMINS ISC			ACEITE, FLUJO TOTAL (FULL FLOW)	G-3754	A0001801709	AIRE, ALT. 18 1/2 IN	GA-376	70140N
ACEITE, LUBRICACION DE DOBLE FLUJO	GP-3001	3401544	COMBUSTIBLE	G-1046	A0000901551	AIRE, CONICO ALT. 29 IN	GA-377	70179N
AGUA, SISTEMA DE ENFRIAMIENTO	GP-2071W	WF2071	COMBUSTIBLE, SEPARADOR DE AGUA CON PURGADOR	GPP-1291	324957001	AIRE, ALT. 22 17/32 IN (ESTANDAR)	GA-3551	P153551
COMBUSTIBLE, SEPARADOR DE AGUA	GPP-1022S	3800394	AIRE	GA-966R	P532966	AIRE, ALT. 22 17/32 IN (HEAVY DUTY)	GA-3551 XT	P153551
AIRE, PRIMARIO	GA-966R	P532966	COMBUSTIBLE, SEPARADOR DE AGUA CON ROSCA PARA TAZON	S 3226 P	324957001	FLB100 con motor/CUMMINS M11		
AIRE, SECUNDARIO	GA-967R	P533781				ACEITE, LUBRICACION DE DOBLE FLUJO	GP-3000	3318853
			FL80 con motor/CATERPILLAR 3126			FLB100 con motor/DETROIT DIESEL SERIES 60		
FL60 con motor/CUMMINS M11			ACEITE	GP-51	1R0739	COMBUSTIBLE, PRIMARIO	GP-26	23530706
COMBUSTIBLE, SEPARADOR DE AGUA, CARTUCHO	G-128	FF1005	COMBUSTIBLE, ALT. 5 13/32 IN	GP-62	1R0751	COMBUSTIBLE, SECUNDARIO	GP-27	23530707
ACEITE	GP-3000	3318853	COMBUSTIBLE, ALT. 7 17/32 IN	GP-1109	1R0751	ACEITE	GP-193	23530573
COMBUSTIBLE, SEPARADOR DE AGUA, SELLADO	GPP-1000	3329289	AIRE, PRIMARIO	GA-966R	P532966	FLB110 con motor/CATERPILLAR 3406E		
AIRE	GA-966R	AF25223	AIRE, SECUNDARIO	GA-967R	P533781	COMBUSTIBLE	GP-749	1R0749
						FLC112 con motor/DETROIT DIESEL SERIES 60		
FL60 con motores/CUMMINS 6C SERIES GAS NATURAL, CUMMINS C8.3 GAS NATURAL			FL80 con motor/CUMMINS 6C SERIES GAS NATURAL			COMBUSTIBLE, PRIMARIO	GP-26	23518481
ACEITE, FLUJO TOTAL (FULL FLOW)	GP-43	3014654	ACEITE, FLUJO TOTAL (FULL FLOW)	GP-43	3014654	COMBUSTIBLE, SECUNDARIO	GP-27	23518482
ACEITE, DOBLE FLUJO	GP-3000	3318853	ACEITE, DOBLE FLUJO	GP-3000	3318853	ACEITE	GP-193	23530573
AIRE	GA-966R	AF25223	AIRE	GA-966R	AF25223			
FL70 con motor/CATERPILLAR			FL80 con motor/CUMMINS B5.9L					
ACEITE	GP-51	1R1807	COMBUSTIBLE, SECUNDARIO	GP-1122	311321			
AIRE, PRIMARIO	GA-966R	P532966	COMBUSTIBLE, PRIMARIO	GPP-18	3925274			
AIRE, SECUNDARIO	GA-967R	P533781	ACEITE	GP-178	3914395			
FL70 con motor/CUMMINS 6C SERIES DIESEL			FL80 con motor/CUMMINS C8.3L (NORTEAMERICA)					
COMBUSTIBLE	GP-1122	3903640	ACEITE, FLUJO TOTAL (FULL FLOW)	GP-43	3014654			
ACEITE, FLUJO TOTAL (FULL FLOW)	GP-43	3014654						

MARCA-MODELO-MOTOR MAKE-MODEL-ENGINE	GONHER GONHER	OEM OEM	MARCA-MODELO-MOTOR MAKE-MODEL-ENGINE	GONHER GONHER	OEM OEM	MARCA-MODELO-MOTOR MAKE-MODEL-ENGINE	GONHER GONHER	OEM OEM
FREIGHTLINER (continuación)			FREIGHTLINER (continuación)			FREIGHTLINER (continuación)		
CAMIONES, TRACTOCAMIONES Y AUTOBUSES			CAMIONES, TRACTOCAMIONES Y AUTOBUSES			CAMIONES, TRACTOCAMIONES Y AUTOBUSES		
AIRE (ESTANDAR)	GA-3551	P153551	ACEITE, ALGUNOS DIFERENCIAS	GP-81	3280-V-8394	FLD132 con motor/CUMMINS N14		
AIRE (HEAVY DUTY)	GA-3551 XT	P153551				COMBUSTIBLE	GPP-14	311144
FLD112 con motor/CATERPILLAR C12			FLD120SD con motor/CATERPILLAR C9			ACEITE, FLUJO TOTAL (FULL FLOW)	GP-53	311202
COMBUSTIBLE	GP-749	1R0749	ACEITE, OPCIONAL PARA TRANSMISION	GP-1	17237	ACEITE, DERIVACION (BY PASS)	GP-57	311206
ACEITE	GP-52	1R0716	ACEITE, LUBRICACION DEL MOTOR	GP-52	1R1808	COMBUSTIBLE, SEPARADOR DE AGUA	GPP-11	311367
COMBUSTIBLE, SEPARADOR DE AGUA	GPP-1000	P551000	COMBUSTIBLE, ALT. 5 13/32 IN	GP-62	1R0751	ACEITE, LUBRICACION DE DOBLE FLUJO	GP-3000	311265
FLD112 con motor/CUMMINS M11			COMBUSTIBLE, ALT. 7 17/32 IN	GP-1109	1R0751	FLD132 con motor/DETROIT DIESEL SERIES 60		
ACEITE, LUBRICACION DE DOBLE FLUJO	GP-3000	3318853	ACEITE, ALGUNOS DIFERENCIAS	GP-81	3280-V-8394	ACEITE, OPCIONAL PARA TRANSMISION	GP-1	17237
COMBUSTIBLE, SEPARADOR DE AGUA	GPP-1000	3329289	FLD120SD con motor/CUMMINS C8.3			COMBUSTIBLE, PRIMARIO	GP-26	23518481
AIRE (ESTANDAR)	GA-3551	P153551	ACEITE, LUBRICACION DE DOBLE FLUJO	GP-3000	3318853	COMBUSTIBLE, SECUNDARIO	GP-27	23533726
AIRE (HEAVY DUTY)	GA-3551 XT	P153551				AGUA, SISTEMA DE ENFRIAMIENTO	GP-2071W	WF2071
FLD112, FLD112SD con motor/CATERPILLAR 3176B			FLD120SD con motor/DETROIT DIESEL SERIES 60			ACEITE	GP-193	23518480
COMBUSTIBLE, SELLADO	GP-749	1R0749	ACEITE, OPCIONAL PARA TRANSMISION	GP-1	17237	AIRE	GA-539R	AF25247
ACEITE	GP-52	1R1808	COMBUSTIBLE, PRIMARIO	GP-26	23518481	FS65 con motor/CUMMINS ISB		
AIRE (ESTANDAR)	GA-3551	P153551	COMBUSTIBLE, SECUNDARIO	GP-27	23533726	ACEITE	GP-3937	3937144
AIRE (HEAVY DUTY)	GA-3551 XT	P153551	ACEITE, LUBRICACION DEL MOTOR	GP-193	23518480	FS65 ESCOLAR con motor/CUMMINS 6C SERIES		
FLD112SD con motor/CUMMINS ISM			ACEITE, ALGUNOS DIFERENCIAS	GP-81	3280-v-8394	ACEITE	GP-3000	3318853
ACEITE, LUBRICACION DE DOBLE FLUJO	GP-9000	3406810	FLD120SD con motor/MERCEDES BENZ MBE4000			MB SERIES CHASIS con motor/CUMMINS 6C SERIES		
FLD120 con motor/CUMMINS N14			DIRECCION	G-169	84365A	COMBUSTIBLE, SECUNDARIO	GP-1122	3903640
ACEITE, LUBRICACION DE DOBLE FLUJO	GP-3000	3318853	ACEITE, OPCIONAL PARA TRANSMISION	GP-1	17237	ACEITE, FLUJO TOTAL (FULL FLOW)	GP-43	3014654
FLD120 con motor/DETROIT DIESEL SERIES 60			AGUA, SISTEMA DE ENFRIAMIENTO (CON QUIMICOS)	GP-2071W	NF3000	ACEITE, DOBLE FLUJO	GP-3000	3318853
COMBUSTIBLE, PRIMARIO	GP-26	23518481	ACEITE, ALGUNOS DIFERENCIAS	GP-81	3280-V-8394	COMBUSTIBLE, SEPARADOR DE AGUA	GPP-18	3903410
COMBUSTIBLE, SECUNDARIO	GP-27	23518482	AIRE	GA-377	AF4588M	MB-55 SERIES CHASIS con motor/CUMMINS ISB		
ACEITE, FLUJO TOTAL (FULL FLOW) HASTA 1993	GP-53	PF911	FLD120SD con motor/MERCEDES BENZ MBE900			ACEITE	GP-737	4897898
ACEITE, DERIVACION (BY PASS)	GP-57	P940	ACEITE, FLUJO TOTAL (FULL FLOW)	G-3754	1801709	MB80 con motor/MERCEDES BENZ OM366LA		
AIRE (ESTANDAR)	GA-3551	P153551	COMBUSTIBLE	G-1046	901551	COMBUSTIBLE	GP-110	3900920001
AIRE (HEAVY DUTY)	GA-3551 XT	P153551	ACEITE, OPCIONAL PARA TRANSMISION	GP-1	17237	MC SERIES CHASIS con motor/CUMMINS N14		
FLD120 con motores/CATERPILLAR 3406B, CATERPILLAR 3406E			ACEITE, ALGUNOS DIFERENCIAS	GP-81	3280-V-8394	COMBUSTIBLE	GPP-14	154789
COMBUSTIBLE	GP-749	1R0749				ACEITE, FLUJO TOTAL (FULL FLOW)	GP-53	298670
FLD120 con motores/CATERPILLAR C10, CATERPILLAR C12, CATERPILLAR C15			FLD120SD con motores/CATERPILLAR 3406B, CATERPILLAR 3406E			ACEITE, DERIVACION (BY PASS)	GP-57	3021658
COMBUSTIBLE	GP-749	1R0749	COMBUSTIBLE	GP-749	1R0749	COMBUSTIBLE, SEPARADOR DE AGUA	GPP-11	202893
ACEITE	GP-52	1R0716	FLD120SD con motores/CUMMINS ISX, CUMMINS SIGNATURE 600			ACEITE, DOBLE FLUJO	GP-3000	3318853
COMBUSTIBLE, SEPARADOR DE AGUA	GPP-11	175-2949	ACEITE, LUBRICACION DE DOBLE FLUJO (ALT. 13 7/8 IN)	GP-9000	3406810	MT35 con motor/CUMMINS B3.9		
FLD120SD con motor/CATERPILLAR C13			ACEITE, LUBRICACION DE DOBLE FLUJO (ALT. 11 23/32 IN)	GP-9001	3406809	COMBUSTIBLE, SECUNARIO	GP-1122	3903640
ACEITE, OPCIONAL PARA TRANSMISION	GP-1	17237	COMBUSTIBLE, SEPARADOR DE AGUA	GPP-1007S	3101871	COMBUSTIBLE, SEPARADOR DE AGUA	GPP-1122	3903202
COMBUSTIBLE	GP-749	1R0749	FLD132 con motor/CATERPILLAR 3406E			COMBUSTIBLE, SEPARADOR DE AGUA	GPP-18	3903410
ACEITE, LUBRICACION DEL MOTOR	GP-52	1R1808	COMBUSTIBLE	GP-749	1R0749	ACEITE, FLUJO TOTAL (FULL FLOW)	GP-390	3908616
ACEITE, ALGUNOS DIFERENCIAS	GP-81	3280-V-8394	FLD132 con motor/CATERPILLAR C15			MT45 con motor/CUMMINS ISB		
COMBUSTIBLE, SEPARADOR DE AGUA CON PURGADOR	GPP-1291	ABP/S3226FL02	ACEITE, OPCIONAL PARA TRANSMISION	GP-1	17237	ACEITE	GP-3937	3937144
COMBUSTIBLE, SEPARADOR DE AGUA CON ROSCA PARA TAZON	S 3226 P	ABP/S3226FL02	COMBUSTIBLE	GP-749	1R0749	MT-45 SERIES CHASIS con motor/CUMMINS ISB		
FLD120SD con motor/CATERPILLAR C15			ACEITE, LUBRICACION DEL MOTOR	GP-52	1R1808	ACEITE	GP-737	4897898
ACEITE, OPCIONAL PARA TRANSMISION	GP-1	17237	AGUA, SISTEMA DE ENFRIAMIENTO	GP-2071W	WF2071	MT-45 SERIES CHASIS con motor/MERCEDES BENZ MBE900		
COMBUSTIBLE	GP-749	1R0749	AIRE	GA-539R	AF25247	ACEITE, FLUJO TOTAL (FULL FLOW)	G-3754	A0001801709
ACEITE, LUBRICACION DEL MOTOR	GP-52	1R1808						

SERVICIO PESADO

MARCA-MODELO-MOTOR MAKE-MODEL-ENGINE	GONHER GONHER	OEM OEM
FREIGHTLINER (continuación)		
CAMIONES, TRACTOCAMIONES Y AUTOBUSES		
MT55 con motor/CUMMINS ISB		
ACEITE	GP-3937	3937144
MT-55 SERIES CHASIS con motor/CUMMINS ISB		
ACEITE	GP-737	4897898
SPRINTER 2500, SPRINTER 3500 con motor/MERCEDES BENZ MBE600 (2.7L)		
ACEITE	G-918	5086301AA
AIRE, CON FIELTRO	GA-5876	A003094830467
AIRE, SIN FIELTRO	GA-475	A0040942604
SPRINTER CARGO VAN con motor/MERCEDES BENZ MBE600		
ACEITE	G-918	5086301AA
AIRE, CON FIELTRO	GA-5876	A003094830467
AIRE, SIN FIELTRO	GA-475	A0040942604
V SERIES CHASIS con motor/CUMMINS 6C SERIES		
COMBUSTIBLE, SECUNDARIO	GP-1122	3903640
ACEITE, FLUJO TOTAL (FULL FLOW)	GP-43	3014654
ACEITE, DOBLE FLUJO	GP-3000	3318853
COMBUSTIBLE, SEPARADOR DE AGUA	GPP-18	3903410
V SERIES CHASIS con motor/CUMMINS M11		
COMBUSTIBLE, SEPARADOR DE AGUA, CARTUCHO	G-128	FF1005
ACEITE	GP-3000	3318853
COMBUSTIBLE, SEPARADOR DE AGUA, SELLADO	GPP-1000	3329289
XB-SERIES CHASIS con motor/CATERPILLAR C7		
ACEITE	GP-51	1R0739
COMBUSTIBLE, ALT. 5 13/32 IN	GP-62	1R0751
COMBUSTIBLE, ALT. 7 17/32 IN	GP-1109	1R0751
XB-SERIES CHASIS con motor/CUMMINS 6C SERIES		
COMBUSTIBLE, SECUNDARIO	GP-1122	3903640
ACEITE, FLUJO TOTAL (FULL FLOW)	GP-43	3014654
ACEITE, DOBLE FLUJO	GP-3000	3318853
SEPARADOR DE COMBUSTIBLE	GPP-18	3903410
XB-SERIES CHASIS con motor/CUMMINS ISB		
ACEITE	GP-737	4897898
XB-SERIES CHASIS con motor/CUMMINS L10		
COMBUSTIBLE	GPP-14	154789
ACEITE, FLUJO TOTAL (FULL FLOW)	GP-53	298670
ACEITE, DERIVACION (BY PASS)	GP-57	3021658
ACEITE, DOBLE FLUJO	GP-3000	3318853
XC-SERIES CHASIS con motor/CATERPILLAR C7		
ACEITE	GP-51	1R0739
COMBUSTIBLE, ALT. 5 13/32 IN.	GP-62	1R0751
COMBUSTIBLE, ALT. 7 17/32 IN.	GP-1109	1R0751
XC-SERIES CHASIS con motor/CUMMINS ISB		
ACEITE	GP-737	4897898
XC-SERIES CHASIS con motor/CUMMINS ISL		
ACEITE, LUBRICACION DE DOBLE FLUJO	GP-3001	LF9009

MARCA-MODELO-MOTOR MAKE-MODEL-ENGINE	GONHER GONHER	OEM OEM
FREIGHTLINER (continuación)		
CAMIONES, TRACTOCAMIONES Y AUTOBUSES		
COMBUSTIBLE	GP-1109	FF5488
ACEITE	GP-3000	3318853
XC-SERIES CHASIS con motor/MERCEDES BENZ MBE926		
ACEITE, FLUJO TOTAL (FULL FLOW)	G-3754	A0001801709
FULLER		
TRANSMISIONES		
R-1160, R-1550, R-1750 con motor/A DIESEL		
ACEITE	G-6	A-2555
R-46, R-63, R-96, L-1520, L-1550 con motor/A DIESEL		
ACEITE	G-6	A-2555
RM-1750 con motor/A DIESEL		
ACEITE	G-33	A2471
RTO-915, 4A-112, 5A-1120, 5F-1220, RT-910 con motor/A DIESEL		
ACEITE	G-6	A-2555
FURUKAWA		
CARGADORAS		
365-II con motor/CUMMINS M11		
ACEITE	GP-3000	1241160-H1
385-II con motor/CUMMINS QSK19C		
ACEITE	GP-3000	1241160-H1
GALION		
APLANADORAS		
10-14 TON con motor/GMC 3-53		
ACEITE	G-33	D79360
COMBUSTIBLE, SECUNDARIO	G-1173	86327
COMBUSTIBLE	G-1174	86328
10-14 TON con motor/KOMATSU S4D102		
ACEITE	GP-390	161625
10-14 TON con motores/IHC UD236, IHC UD282		
ACEITE	G-335	D80963
14-20 TON con motor/CONTINENTAL M330		
ACEITE	G-31	M330L500
2-66A con motor/WAUKESHA		
COMBUSTIBLE	G-295	177429
AIRE, SIN ASPAS	GA-20	D84371
AIRE	GAK-20	D84371
5-8 TON, 8-10 1/2 TON con motores/IHC UB264, IHC UC263		
ACEITE	G-335	D80963
5-8 TON, 8-10 1/2 TON, 8-12 TON con motor/GMC 3-53		
ACEITE	G-33	D79360
COMBUSTIBLE, SECUNDARIO	G-1173	86327
COMBUSTIBLE	G-1174	86328
708, 710 con motor/A DIESEL		
COMBUSTIBLE, SECUNDARIO	GP-1122	161624
COMBUSTIBLE, PRIMARIO	GPP-18	161623
ACEITE	GP-390	161625
AIRE, SIN ASPAS	GA-403	114360

MARCA-MODELO-MOTOR MAKE-MODEL-ENGINE	GONHER GONHER	OEM OEM
GALION (continuación)		
APLANADORAS		
AIRE	GAK-403	114360
712, 714 con motor/A DIESEL		
COMBUSTIBLE, SECUNDARIO	GP-1122	161624
COMBUSTIBLE, PRIMARIO	GPP-18	161623
AIRE, SIN ASPAS	GA-403	114360
AIRE	GAK-403	114360
8-12 TON con motor/IHC UD282		
ACEITE	G-335	D80963
8-12 TON, 13-20 TON, 5-8 TON con motor/IHC UD236		
ACEITE	G-335	D80963
9-12 TON, 9-15 TON con motor/IHC UD236		
ACEITE	G-335	D80963
CHIEF 10-12 TON, CHIEF 12-14 TON con motor/IHC UD282		
ACEITE	G-335	D80963
P3500A con motor/WAUKESHA VRD310		
COMBUSTIBLE	G-295	177429
AIRE, SIN ASPAS	GA-403	114360
AIRE	GAK-403	114360
AIRE	GAK-625	P120022
PTR3500 con motor/IHC C263		
AIRE, SIN ASPAS	GA-403	D66829
PTR3500 con motor/IHC D312		
ACEITE	GP-69	120303
COMBUSTIBLE, PRIMARIO	GP-1105	120302
COMBUSTIBLE, SECUNDARIO	GP-78	672603-C2
AIRE, SIN ASPAS	GA-403	D66829
AIRE	GAK-403	D66829
PTR3500 con motor/IHC UC263		
ACEITE	G-335	D80963
S4-6 con motor/WAUKESHA		
ACEITE	GP-50	176554
COMBUSTIBLE	G-295	177429
AIRE, SIN ASPAS	GA-33	D79360
AIRE	GAK-16	P101222
SB12A con motor/KOMATSU S4D102		
ACEITE	GP-390	161625
SP600 con motor/CATERPILLAR 3406		
ACEITE, CUMPLE CON MEDI-DAS ORIGINALES	GP-691	1R0716
ACEITE, SEGUNDA OPCION	GP-52	1R0716
COMBUSTIBLE	GP-1108	1R0712
VOS2-66A con motor/WAUKESHA		
COMBUSTIBLE	G-295	177429
VOS2-66B con motor/DETROIT DIESEL 4-53N		
COMBUSTIBLE, SECUNDARIO	G-1173	86327
VOS-84 con motor/DETROIT DIESEL 4-53		
AIRE, PRIMARIO	GA-360	D99737
VOS-84 con motor/IHC UD407		
AIRE	GA-20	D84371

MARCA-MODELO-MOTOR MAKE-MODEL-ENGINE	GONHER GONHER	OEM OEM
GALION (continuación)		
APLANADORAS		
VOS-84A, VOS-A84A con motor/DETROIT DIESEL		
ACEITE	G-33	D79360
COMBUSTIBLE, SECUNDARIO	G-1173	86327
COMBUSTIBLE	G-1174	86328
AIRE, SIN ASPAS	GA-24	78041
VOS-PD66A con motor/WAUKESHA		
ACEITE	GP-50	176554
WARRIOR 6-8 TON, WARRIOR 8-10 con motor/IHC UD236		
ACEITE	G-335	D80963
WARRIOR 8-10 1/2 TON con motor/IHC UD236		
ACEITE	G-335	D80963
GALION		
GRÚAS		
110, 125 con motor/GMC 4-53N		
ACEITE	G-33	5573013
COMBUSTIBLE, SECUNDARIO	G-1173	86327
AIRE	GA-24	D78041
125 con motor/IHC UD282		
ACEITE	G-335	D80963
150 HYDRO con motor/CUMMINS 232		
ACEITE, CONVERTIDOR DE TORSION	G-33	3301060
ACEITE	G-613	173174
COMBUSTIBLE	G-1143	139097
AIRE, RESPIRADOR	GA-39	255963
150 SERIES A con motor/KOMATSU 6D102		
ACEITE	GP-178	1240388-H1
150 SERIES A, 150 SERIES P, 150 SERIES T con motor/GMC 4-53N		
ACEITE	G-33	5573013
COMBUSTIBLE, SECUNDARIO	G-1173	86327
AIRE	GA-24	D78041
150 SERIES P, 150 SERIES T con motor/IHC UB264		
ACEITE	G-335	D80963
150 SERIES P, 150 SERIES T con motor/IHC UD282		
ACEITE	G-335	D80963
150A, 150FA con motor/CUMMINS		
COMBUSTIBLE	G-1143	82289
AIRE	GA-24	78041
ACEITE	G-500	75435
150FA con motor/KOMATSU 6D102		
ACEITE	GP-178	1240388-H1
200FA con motor/A DIESEL		
ACEITE	G-33	79360
COMBUSTIBLE, SECUNDARIO	G-1173	86327
AIRE	GA-24	78041
220 con motor/DETROIT DIESEL 6V-71		
AIRE, PRIMARIO PARA CUMMINS	GA-106	P117437
AIRE, PRIMARIO PARA KOMATSU	GA-326	P117437

MARCA-MODELO-MOTOR MAKE-MODEL-ENGINE	GONHER GONHER	OEM OEM
GALION (continuación)		
GRÚAS		
AIRE, SECUNDARIO	GA-206	P119373
80 con motor/GMC 3-53N		
ACEITE	G-33	5573013
80 con motor/IHC UD282		
ACEITE	G-33	159159
80 con motores/IHC UB264, IHC UC263		
ACEITE	G-335	D80963
90 con motor/GMC 4-53N		
ACEITE	G-33	5573013
COMBUSTIBLE, SECUNDARIO	G-1173	86327
AIRE, SIN ASPAS	GA-24	D78041
90, 110, 125 con motor/IHC UB264		
ACEITE	G-335	D80963
GALION		
NIVELADORAS		
104 con motores/GMC 3-71, GMC 4-71		
ACEITE, DERIVACION (BY PASS)	G-31	1595410
ACEITE, FLUJO TOTAL (FULL FLOW)	G-33	5573013
COMBUSTIBLE, SECUNDARIO	G-1173	86327
118 con motores/CUMMINS NT180, IHC UD554		
AIRE	GA-5648	D73893
118 SERIES B con motor/GMC 4-71		
ACEITE, DERIVACION (BY PASS) (7 13/16 IN)	G-31	1595410
ACEITE, CLUTCH	G-33	5573013
ACEITE, FLUJO TOTAL (FULL FLOW)	G-33	5573013
COMBUSTIBLE, SECUNDARIO	G-1173	86327
AIRE	GA-5648	D73893
ACEITE, DERIVACION (BY PASS) (14 13/16 IN)	G-750	D76491
118 SERIES B con motores/CUMMINS H135CL, CUMMINS NHC4		
TRANSMISION	G-33	D79360
118A con motores/CUMMINS H135, CUMMINS NHC4, DETROIT DIESEL 4-71		
AIRE	GA-5648	D73893
150 SERIES A con motor/GMC 4 CYL. DIESEL		
ACEITE	G-119	5574978
160 con motor/DETROIT DIESEL 6-71		
TRANSMISION	G-33	D79360
160 SERIES A, 160 SERIES B, 160 SERIES C, 160 SERIES L con motor/DETROIT DIESEL 6-71		
TRANSMISION	G-33	D79360
160 SERIES con motor/GMC 7-71		
ACEITE, DERIVACION (BY PASS) (7 13/16 IN)	G-31	1595410
ACEITE, FLUJO TOTAL (FULL FLOW)	G-33	5573013
TRANSMISION	G-33	5573013
COMBUSTIBLE, SECUNDARIO	G-1175	D88913

MARCA-MODELO-MOTOR MAKE-MODEL-ENGINE	GONHER GONHER	OEM OEM
GALION (continuación)		
NIVELADORAS		
160 SERIES L, 160 SERIES B, 160 SERIES C, 160, 160 SERIES A con motor/CUMMINS		
AIRE	GA-5648	D73893
303 con motor/IHC UD263		
ACEITE	G-335	D80963
303 con motor/IHC UD282		
ACEITE	G-335	D80963
400 con motor/GMC 4-71		
ACEITE, DERIVACION (BY PASS)	G-31	1595410
ACEITE, FLUJO TOTAL (FULL FLOW)	G-33	5573013
COMBUSTIBLE, SECUNDARIO	G-1173	86327
503 con motor/IHC UD236		
ACEITE	G-335	D80963
503 SERIES A con motor/IHC UB220		
AIRE, SIN ASPAS	GA-16	D84370
503 SERIES A con motor/IHC UB236		
ACEITE	G-335	D80963
AIRE, SIN ASPAS	GA-16	D84370
AIRE	GAK-16	D84370
560 con motores/GMC 6-71, GMC 6V-71		
ACEITE, DERIVACION (BY PASS)	G-31	1595410
ACEITE, CARTUCHO PARA FLUJO TOTAL (FULL FLOW)	G-33	5573013
COMBUSTIBLE, SECUNDARIO CARTUCHO	G-1173	86327
COMBUSTIBLE, PRIMARIO SELLADO	GP-26	8423132
COMBUSTIBLE, SECUNDARIO SELLADO	GP-27	23518482
ACEITE, SELLADO PARA FLUJO TOTAL (FULL FLOW)	GP-43	25010495
560E con motor/IHC DT466		
ACEITE	GP-69	120303
COMBUSTIBLE, SECUNDARIO	GP-1105	120302
COMBUSTIBLE, PRIMARIO	GP-78	672603-C2
560E con motores/GMC 6-71, GMC 6V-71		
ACEITE, DERIVACION (BY PASS)	G-31	1595410
ACEITE, CARTUCHO PARA FLUJO TOTAL (FULL FLOW)	G-33	5573013
COMBUSTIBLE, SECUNDARIO CARTUCHO	G-1173	86327
COMBUSTIBLE, PRIMARIO SELLADO	GP-26	8423132
COMBUSTIBLE, SECUNDARIO SELLADO	GP-27	23518482
ACEITE, SELLADO PARA FLUJO TOTAL (FULL FLOW)	GP-43	25010495
566E con motor/DETROIT DIESEL 8.2L		
ACEITE	GP-13	25013454
COMBUSTIBLE, PRIMARIO	GP-92	23518527
COMBUSTIBLE, SECUNDARIO	GP-93	23518526
606 con motor/IHC DT466		
ACEITE	GP-69	120303
COMBUSTIBLE, SECUNDARIO	GP-1105	120302
COMBUSTIBLE, PRIMARIO	GP-78	672603-C2

SERVICIO PESADO

MARCA-MODELO-MOTOR MAKE-MODEL-ENGINE	GONHER GONHER	OEM OEM	MARCA-MODELO-MOTOR MAKE-MODEL-ENGINE	GONHER GONHER	OEM OEM	MARCA-MODELO-MOTOR MAKE-MODEL-ENGINE	GONHER GONHER	OEM OEM
GALION (continuación)			GALION (continuación)			GALION (continuación)		
NIVELADORAS			NIVELADORAS			NIVELADORAS		
830B, 830C con motor/KOMATSU S6D102			COMBUSTIBLE, PRIMARIO	GP-92	23518527	ACEITE	G-335	D80963
ACEITE	GP-178	1240388-H1	COMBUSTIBLE, SECUNDARIO	GP-93	23518526	COMBUSTIBLE, SECUNDARIO	GP-110	D99876
						COMBUSTIBLE, PRIMARIO	GPP-1000	702256-C1
850 con motor/CUMMINS			A600 con motor/DETROIT DIESEL 6V-71			T500 A, T500 L con motor/IHC DT407		
COMBUSTIBLE, SECUNDARIO	GP-1122	161624	ACEITE, CARTUCHO PARA FLUJO TOTAL (FULL FLOW)	G-33	159159	AIRE, PRIMARIO	GA-360	D99737
ACEITE, DOBLE FLUJO	GP-3000	1295224-H1	COMBUSTIBLE, PRIMARIO	GP-26	8423132			
AGUA	GP-2071W	3315116	COMBUSTIBLE, SECUNDARIO	GP-27	23518482	T500 con motor/IHC DT466		
COMBUSTIBLE, PRIMARIO	GPP-18	3925274	ACEITE, SELLADO PARA FLUJO TOTAL (FULL FLOW)	GP-43	25010495	ACEITE	GP-69	675617-C91
HIDROSTATICO	GP-761H	1266751-H2	AIRE, PRIMARIO PARA CUMMINS	GA-106	P117437	COMBUSTIBLE	GP-1105	625626-C1
			AIRE, PRIMARIO PARA KOMATSU	GA-326	P117437	COMBUSTIBLE	GP-78	672603-C1
850B, 870C, 850C, 870B con motor/KOMATSU S6D114E			AIRE, SECUNDARIO	GA-206	P119373	AIRE, PRIMARIO PARA CUMMINS	GA-106	D103258
ACEITE, DOBLE FLUJO	GP-3000	1294153-H1	A600 con motor/IHC			AIRE, PRIMARIO PARA KOMATSU	GA-326	D103258
			ACEITE	GP-69	120303	AIRE, SECUNDARIO	GA-206	D103259
A400E con motor/IHC D466			COMBUSTIBLE, PRIMARIO	GP-1108	625627-C1	T500 SERIES A con motor/IHC DT407		
HIDRAULICO	G-33	79360	COMBUSTIBLE, SECUNDARIO	GP-78	672603-C2	TRANSMISION	G-33	159159
ACEITE	GP-69	120303	AIRE, PRIMARIO PARA CUMMINS	GA-106	P117437	ACEITE	G-335	D80963
COMBUSTIBLE, PRIMARIO	GP-1108	625627-C1	AIRE, PRIMARIO PARA KOMATSU	GA-326	P117437	COMBUSTIBLE, PRIMARIO	GP-1105	120302
ACEITE	GP-88	1811953-C1	AIRE, SECUNDARIO	GA-206	P119373	AIRE, PRIMARIO	GA-360	D99737
COMBUSTIBLE, SECUNDARIO	GP-78	672603-C2	A606 con motor/DETROIT DIESEL 6V-71			AIRE, SECUNDARIO	GA-361	D99739
			ACEITE, CARTUCHO PARA FLUJO TOTAL (FULL FLOW)	G-33	159159	T500 SERIES C con motor/IHC DT466		
A450E con motor/GMC 8.2L DIESEL			TRANSMISION	G-33	159159	ACEITE	GP-69	120303
ACEITE	GP-13	25013454	COMBUSTIBLE, PRIMARIO	GP-26	8423132	COMBUSTIBLE, PRIMARIO	GP-1108	625627-C1
COMBUSTIBLE, PRIMARIO	GP-92	23518527	COMBUSTIBLE, SECUNDARIO	GP-27	23518482	COMBUSTIBLE, SECUNDARIO	GP-78	672603-C2
COMBUSTIBLE, SECUNDARIO	GP-93	23518526	ACEITE, SELLADO PARA FLUJO TOTAL (FULL FLOW)	GP-43	25010495	T500, T500 SERIES A con motor/GMC 4-71		
			AIRE, PRIMARIO PARA CUMMINS	GA-106	P117437	ACEITE, CONVERTIDOR DE TORSION	G-33	5573013
A450E con motor/IHC D466			AIRE, PRIMARIO PARA KOMATSU	GA-326	P117437	ACEITE, FLUJO TOTAL (FULL FLOW)	G-33	5573013
HIDRAULICO	G-33	79360	AIRE, SECUNDARIO	GA-206	P119373	TRANSMISION	G-33	5573013
ACEITE	GP-69	120303	D1100 con motor/CUMMINS			COMBUSTIBLE, SECUNDARIO	G-1173	86327
COMBUSTIBLE, SECUNDARIO	GP-1105	120302	TRANSMISION	G-33	3301060	AIRE	GA-5648	D73893
COMBUSTIBLE, PRIMARIO	GP-1107	120301	F1500 con motor/GMC 4-71			T500, T500 SERIES A con motores/CUMMINS C160, CUMMINS JN6		
COMBUSTIBLE, PRIMARIO	GP-1108	625627-C1	ACEITE, FLUJO TOTAL (FULL FLOW)	G-33	5573013	AIRE	GA-5648	D73893
ACEITE	GP-88	1811953-C1	COMBUSTIBLE, SECUNDARIO	G-1175	D88913	T600 con motor/CUMMINS		
COMBUSTIBLE, SECUNDARIO	GP-78	672603-C2	F1900 con motor/GMC 6V-71			AGUA	GP-2071W	299080
			ACEITE, DERIVACION (BY PASS)	G-31	1595410	T600 con motor/GMC 6-71		
A500 con motor/GMC 4-53T			ACEITE, FLUJO TOTAL (FULL FLOW)	G-33	5573013	ACEITE, FLUJO TOTAL (FULL FLOW)	G-33	5573013
ACEITE, FLUJO TOTAL (FULL FLOW)	G-33	5573013	COMBUSTIBLE, SECUNDARIO	G-1175	D88913	COMBUSTIBLE, SECUNDARIO	G-1175	D88913
COMBUSTIBLE, SECUNDARIO	G-1173	86327	S450E, S500E con motor/GMC 8.2L DIESEL			AIRE	GA-5648	D73893
COMBUSTIBLE, SECUNDARIO	G-1175	D88913	ACEITE	GP-13	25013454	T600 SERIES B con motor/CUMMINS CT464		
			COMBUSTIBLE, PRIMARIO	GP-92	23518527	COMBUSTIBLE, SECUNDARIO	G-1143	D82289
A500E con motor/GMC 8.2L DIESEL			COMBUSTIBLE, SECUNDARIO	GP-93	23518526	AGUA	GP-2071W	299080
ACEITE	GP-13	25013454	T400 con motor/GMC 4-53			AIRE	GA-5648	D73893
COMBUSTIBLE, PRIMARIO	GP-92	23518527	ACEITE, FLUJO TOTAL (FULL FLOW)	G-33	5573013	ACEITE	G-750	D76491
COMBUSTIBLE, SECUNDARIO	GP-93	23518526	TRANSMISION	G-33	5573013	T600 SERIES B con motor/GMC 6-71		
			COMBUSTIBLE, SECUNDARIO	G-1175	D88913	ACEITE, FLUJO TOTAL (FULL FLOW)	G-33	5573013
A550 con motor/DETROIT DIESEL 4-53T			S450E, S500E con motor/GMC 8.2L DIESEL			COMBUSTIBLE, SECUNDARIO	G-1175	D88913
ACEITE	G-33	159159	ACEITE	GP-13	25013454	AIRE	GA-5648	D73893
			COMBUSTIBLE, PRIMARIO	GP-92	23518527	T600 SERIES B con motor/CUMMINS CT464		
A550 con motor/IHC DT466			COMBUSTIBLE, SECUNDARIO	GP-93	23518526	COMBUSTIBLE, SECUNDARIO	G-1143	D82289
ACEITE, CONVERTIDOR DE TORSION	G-33	D79360	T400 con motor/GMC 4-53			AGUA	GP-2071W	299080
ACEITE	GP-69	120303	ACEITE, FLUJO TOTAL (FULL FLOW)	G-33	5573013	AIRE	GA-5648	D73893
COMBUSTIBLE, PRIMARIO	GP-1105	120302	TRANSMISION	G-33	5573013	ACEITE	G-750	D76491
COMBUSTIBLE, SECUNDARIO	GP-1107	120301	COMBUSTIBLE	G-1175	D88913	T600 SERIES B con motor/GMC 6-71		
AIRE, PRIMARIO	GA-360	D99737	T400 SERIES A con motor/IHC D407A			ACEITE, FLUJO TOTAL (FULL FLOW)	G-33	5573013
AIRE, SECUNDARIO	GA-361	D99739	TRANSMISION	G-33	159159	COMBUSTIBLE	G-1175	D88913
			ACEITE	G-335	D80963	AIRE	GA-5648	D73893
A556 con motor/IHC DT466			COMBUSTIBLE, SECUNDARIO	GP-110	D99876	T600 SERIES B con motor/IHC DT407		
ACEITE	GP-69	120303	COMBUSTIBLE, PRIMARIO	GPP-1000	702256-C1	ACEITE, CONVERTIDOR DE TORSION	G-33	D79360
COMBUSTIBLE, PRIMARIO	GP-1108	625627-C1	AIRE	GAK-20	D84371	ACEITE	G-335	D85830
COMBUSTIBLE, SECUNDARIO	GP-78	672603-C2	T400 SERIES A con motor/IHC UD407			COMBUSTIBLE, PRIMARIO	GP-1108	D99501
			TRANSMISION	G-33	159159			

MARCA-MODELO-MOTOR MAKE-MODEL-ENGINE	GONHER GONHER	OEM OEM	MARCA-MODELO-MOTOR MAKE-MODEL-ENGINE	GONHER GONHER	OEM OEM	MARCA-MODELO-MOTOR MAKE-MODEL-ENGINE	GONHER GONHER	OEM OEM
GALION (continuación)			GARDNER-DENVER(continuación)			GARDNER-DENVER(continuación)		
NIVELADORAS			COMPRESORES			COMPRESORES		
COMBUSTIBLE, SECUNDARIO	GP-110	D99876	COMBUSTIBLE	GP-110	1P2299	SP600 con motor/CATERPILLAR D333		
AIRE, PRIMARIO	GA-360	D99737				AIRE, SECUNDARIO	GA-6127	P106641
AIRE, SECUNDARIO	GA-361	D99739	SP1200 con motor/CATERPILLAR D343					
			AIRE	GA-5648	2M7941	SP600 con motor/CATERPILLAR D333T		
T660B con motor/IHC DT466			SP1200 con motor/CATERPILLAR D343TA			ACEITE	G-191	550484
ACEITE, CONVERTIDOR DE TORSION	G-33	D79360	ACEITE	G-238	550485	COMBUSTIBLE	G-1166	6H5931
ACEITE	GP-69	D120303	COMBUSTIBLE	G-1166	6H5931	AIRE, SECUNDARIO	GA-6127	P106641
ACEITE, CONVERTIDOR DE TORSION	GP-69	D120303	AIRE	GA-5648	2M7941	AIRE, PRIMARIO	GA-6129	P106632
COMBUSTIBLE, SECUNDARIO	GP-1105	D120302						
COMBUSTIBLE, PRIMARIO	GP-78	D120301	SP1200 con motor/DETROIT DIESEL 12V-71			SP600 con motor/DETROIT DIESEL 6-71		
AIRE, PRIMARIO PARA CUMMINS	GA-106	D103258	AIRE, PRIMARIO	GA-356	P109155	AIRE	GA-5648	2008185
AIRE, PRIMARIO PARA KOMATSU	GA-326	D103258	SP1200 con motor/DETROIT DIESEL 8V-71			SP600 con motor/GMC 6-71		
AIRE, SECUNDARIO	GA-206	D103259	AIRE, SECUNDARIO	GA-6127	P106632	ACEITE	G-31	1595410
						ACEITE	G-33	5573013
T700 con motor/CUMMINS			SP1200 con motor/GMC 12V-71			COMBUSTIBLE	G-1174	5198982
TRANSMISION	G-33	D79360	ACEITE, DERIVACION (BY PASS)	G-31	1595410	COMBUSTIBLE	G-1175	D88913
			ACEITE, FLUJO TOTAL (FULL FLOW)	G-33	5573013	AIRE	GA-5648	51928855
TC812G con motor/IHC U264			AIRE, PRIMARIO	GA-356	152736	SP600DC con motor/GMC 6-71		
ACEITE	G-335	D80963	AIRE, SECUNDARIO	GA-357	P109159	ACEITE	G-33	5573013
						COMBUSTIBLE	G-1174	5198982
			SP1200 con motor/GMC 6-110			COMBUSTIBLE, SECUNDARIO	G-1175	D88913
			ACEITE, DERIVACION (BY PASS)	G-31	1595410			
			ACEITE, FLUJO TOTAL (FULL FLOW)	G-33	5573013	SP900 con motor/CATERPILLAR D343TA		
			COMBUSTIBLE	G-1174	5198982	ACEITE	G-238	550485
			COMBUSTIBLE, SECUNDARIO	G-1175	D88913	COMBUSTIBLE	G-1166	6H5931
						AIRE	GA-5648	2M7941
			SP1200 con motor/GMC 8 V-71					
			ACEITE, DERIVACION (BY PASS)	G-31	1595410	SP900 con motor/DETROIT DIESEL 8V-71		
			ACEITE, FLUJO TOTAL (FULL FLOW)	G-33	5573013	AIRE, SECUNDARIO	GA-6127	P106641
			COMBUSTIBLE, SECUNDARIO	G-1175	D88913			
			AIRE, SECUNDARIO	GA-6127	P106641	SP900 con motor/GMC 12V-71		
			AIRE, PRIMARIO	GA-6129	P106632	ACEITE, DERIVACION (BY PASS)	G-31	1595410
			SP185 con motor/FORD 254 DIESEL			SP900 con motor/GMC 6-110		
			ACEITE	GP-9	C9NN-6714-A	ACEITE, DERIVACION (BY PASS)	G-31	1595410
			COMBUSTIBLE	G-296	C7NN-9176-A	ACEITE, FLUJO TOTAL (FULL FLOW)	G-33	5573013
			COMBUSTIBLE	G-296-B	C5NE9176C	COMBUSTIBLE	G-1174	5198982
						COMBUSTIBLE, SECUNDARIO	G-1175	D88913
			SP185 con motor/JOHN DEERE 4219					
			ACEITE	GP-14	T19044	SP900 con motor/GMC 8 V-71		
						ACEITE, DERIVACION (BY PASS)	G-31	1595410
			SP250 con motor/CATERPILLAR D330T			ACEITE, FLUJO TOTAL (FULL FLOW)	G-33	5573013
			ACEITE	G-191	1R0659	COMBUSTIBLE, SECUNDARIO	G-1175	D88913
						AIRE, SECUNDARIO	GA-6127	P106641
			SP250 con motor/GMC 4-53			AIRE, PRIMARIO	GA-6129	P106632
			ACEITE	G-33	5573013			
			COMBUSTIBLE, SECUNDARIO	G-1173	51928855	SPFGA con motor/A DIESEL		
			COMBUSTIBLE	G-1174	5198982	ACEITE	GP-58	26C28
						AIRE	GA-77	AF267
			SP365 con motor/CATERPILLAR D330TA			GASOLINA	GG-5 L	P550012
			ACEITE	G-191	1R0659			
						SPHDA185 con motor/FORD 250 DIESEL		
			SP365 con motor/GMC 4-71			ACEITE	G-836	753F6731AAIA
			ACEITE, DERIVACION (BY PASS)	G-31	P106632	COMBUSTIBLE	G-296	C5NE9176C
			ACEITE, FLUJO TOTAL (FULL FLOW)	G-33	51928855	COMBUSTIBLE	G-296-B	C5NE9176C
			COMBUSTIBLE, SECUNDARIO	G-1173	3290851			
			COMBUSTIBLE	G-1174	P106641	SPKDB325 con motor/GMC 4-53N		
						ACEITE	G-33	5573013
			SP600 con motor/CATERPILLAR 3306			COMBUSTIBLE, SECUNDARIO	G-1173	3290851
			ACEITE	GP-51	1R0658	COMBUSTIBLE	G-1174	5198982

SERVICIO PESADO

MARCA-MODELO-MOTOR MAKE-MODEL-ENGINE	GONHER GONHER	OEM OEM	MARCA-MODELO-MOTOR MAKE-MODEL-ENGINE	GONHER GONHER	OEM OEM	MARCA-MODELO-MOTOR MAKE-MODEL-ENGINE	GONHER GONHER	OEM OEM
GARDNER-DENVER(continuación)			GENERAL MOTORS / CHEVROLET			GENERAL MOTORS / CHEVROLET		
COMPRESORES			CAMIONES, TRACTOCAMIONES Y AUTOBUSES			CAMIONES, TRACTOCAMIONES Y AUTOBUSES		
WB315D con motor/CATERPILLAR D8800			1500 SERIES con motor/GMC 6-194			GASOLINA, 1967	GG-16	5651920
ACEITE	G-191	550484	ACEITE, 3 45/64 IN	GP-3	6435679	1500 SERIES con motor/GMC V6-351		
WBH365, WBK500D, WH42DA, WH500D, WH500TM con motor/CATERPILLAR			ACEITE, 5 13/32 IN	GP-13	6438384	ACEITE	GP-20	6437994
ACEITE, FLUJO TOTAL (FULL FLOW)	G-191	550484	AIRE, USO ESTANDAR	GA-50	5649797	AIRE, 1966	GA-56	5645017
WH315TMA con motor/A DIESEL			AIRE, USO HEAVY DUTY	GA-192	6483864	AIRE, 1968	GA-192	6483864
ACEITE	G-191	550484	GASOLINA, BRONCE COMPRIMIDO	GG-123	7013404	GASOLINA, 1968 PLASTICO	GG-5	5650780
WHD105 con motor/GMC 2-71			1500 SERIES con motor/GMC 6-250			GASOLINA, 1967	GG-6	5651393
ACEITE, DERIVACION (BY PASS)	G-31	1595410	ACEITE, 3 45/64 IN	GP-3	6435679	GASOLINA, 1968 LAMINA	GG-5 L	5650780
COMBUSTIBLE, SECUNDARIO	G-1173	3290851	ACEITE, 5 13/32 IN	GP-13	6438384	GASOLINA, 1967	GG-16	5651920
COMBUSTIBLE	G-1174	5198982	AIRE, 1966-78	GA-50	5649797	1500 SERIES con motor/GMC V8-283		
WHF210D con motor/CATERPILLAR D318			AIRE, USO HEAVY DUTY	GA-192	6483864	ACEITE	G-200	5574540
ACEITE	G-191	550484	AIRE, 1979 EN ADELANTE	GA-3523	8996587	AIRE, 1964-67	GA-56	5645017
			AIRE, 1970-78	GA-90	5648003	AIRE, 1967-68	GA-192	6419892
			GASOLINA, 1969-72 (3 33/64 IN)	GG-20	5650030	GASOLINA, 1963-67	GG-20	5650030
			GASOLINA, 1968 EN ADELANTE (1 3/64 IN)	GG-6	5651393	GASOLINA, 1967 BRONCE COMPRIMIDO	GG-123	7013404
			GASOLINA, 1979 EN ADELANTE (2 1/16)	GG-7	5651921	1500 SERIES con motor/GMC V8-307		
			GASOLINA, 1968 EN ADELANTE (1 3/64 IN)	GG-16	5651920	ACEITE, CARTUCHO	G-200	5574540
			GASOLINA, 1979 EN ADELANTE (2 1/16)	GG-17	5651921	ACEITE, SELLADO	GP-13	6438384
			GASOLINA, 1966-70 BRONCE COMPRIMIDO	GG-123	7013404	AIRE, 2 15/32 IN	GA-57	6485108
			1500 SERIES con motor/GMC 6-292			AIRE, 3 1/2 IN	GA-192	6483864
			ACEITE, 1966-75 CARTUCHO	G-34	6437562	GASOLINA, 3 33/64 IN	GG-20	5650030
			ACEITE, 3 45/64 IN SELLADO	GP-3	6435679	GASOLINA	GG-6	5651393
			ACEITE, 5 13/32 IN SELLADO	GP-13	6438384	GASOLINA	GG-16	5651920
			AIRE, 1962-67	GA-56	5645017	GASOLINA, BRONCE COMPRIMIDO	GG-123	7013404
			AIRE, 1968-72	GA-192	6483864	1500 SERIES con motor/GMC V8-350 DIESEL		
			AIRE, 1971 EN ADELANTE	GA-90	5648003	ACEITE, 1978	GP-13	6438384
			GASOLINA, 1962-71	GG-20	5650030	1500 SERIES con motor/GMC V8-379 (6.2L) DIESEL		
			GASOLINA, 1968-1986	GG-6	5651393	ACEITE, HASTA 1986	GP-13	6438384
			GASOLINA, 1988 EN ADELANTE	GG-7	5651921	COMBUSTIBLE, 1983 PRIMARIO (VANS)	GP-92	25011422
			GASOLINA, 1968-1986	GG-16	5651920	COMBUSTIBLE, 1982-83 SECUNDARIO (EXCEPTO. VANS)	GP-1122	25011422
			GASOLINA, 1988 EN ADELANTE	GG-17	5651921	ACEITE, 1986 EN ADELANTE	GP-205	25160561
			GASOLINA, 1963-71 BRONCE COMPRIMIDO	GG-123	7013404	COMBUSTIBLE, 1984 EN ADELANTE	G-294	14071064
			1500 SERIES con motor/GMC V6-262 (4.3L)			1500 SERIES con motor/GMC V8-396		
			ACEITE	GP-3980	25171377	ACEITE, HASTA 1969 CARTUCHO	G-34	6437562
			AIRE	GA-192	6483864	ACEITE, 1969-72 CARTUCHO	G-200	5574540
			GASOLINA, CARBURADO	GG-7	5651921	ACEITE, SELLADO	GP-13	6438384
			GASOLINA, FUEL INJECTION	GG-46	25055052	AIRE	GA-55	6421746
			GASOLINA, CARBURADO	GG-17	5651921	AIRE	GA-192	6483864
			1500 SERIES con motor/GMC V6-305C			GASOLINA	GG-20	5650030
			ACEITE, CARBURADO	G-33	5573014	GASOLINA	GG-6	5651393
			ACEITE, 3 45/64 IN SELLADO	GP-20	6437994	GASOLINA	GG-16	5651920
			ACEITE, 5 13/32 IN SELLADO	GP-50	5574639	GASOLINA, BRONCE COMPRIMIDO	GG-123	7013404
			AIRE	GA-56	5645017	1500 SERIES con motor/GMC V8-400		
			GASOLINA, 1960-65	GG-20	5650030	ACEITE	GP-13	6438384
			GASOLINA, 1970-74	GG-6	5651393	ACEITE, 2 CUARTOS	GP-23	25010754
			GASOLINA, 1970-74	GG-16	5651920	AIRE, 1975 EN ADELANTE (EXCEPTO. VANS)	GA-59	6484235
			1500 SERIES con motor/GMC V6-305E			AIRE, 1975 EN ADELANTE (VANS)	GA-192	6483864
			ACEITE, 3 45/64 IN	GP-20	6437994	GASOLINA, 1 3/64 IN	GG-6	5651393
			ACEITE, 5 13/32 IN	GP-50	5574639	GASOLINA, 2 1/16 IN	GG-7	5651921
			AIRE	GA-56	5645017	GASOLINA, 1 3/64 IN	GG-16	5651920
			GASOLINA, 1968-69 PLASTICO	GG-5	5650780	GASOLINA, 2 1/16 IN	GG-17	5651921
			GASOLINA, 1967	GG-6	5651393			
			GASOLINA, 1968-69 LAMINA	GG-5 L	5650780			

APLICACIONES SERVICIO PESADO
HEAVY DUTY APPLICATIONS



MARCA-MODELO-MOTOR MAKE-MODEL-ENGINE	GONHER GONHER	OEM OEM	MARCA-MODELO-MOTOR MAKE-MODEL-ENGINE	GONHER GONHER	OEM OEM	MARCA-MODELO-MOTOR MAKE-MODEL-ENGINE	GONHER GONHER	OEM OEM
GENERAL MOTORS / CHEVROLET			GENERAL MOTORS / CHEVROLET			GENERAL MOTORS / CHEVROLET		
CAMIONES, TRACTOCAMIONES Y AUTOBUSES			CAMIONES, TRACTOCAMIONES Y AUTOBUSES			CAMIONES, TRACTOCAMIONES Y AUTOBUSES		
1500 SERIES con motor/GMC V8-402			2500 SERIES con motor/DETROIT DIESEL 3-53			GASOLINA, FUEL INJECTION	GG-46	25055052
ACEITE	GP-13	6438384	ACEITE	G-119	5574978	GASOLINA, CARBURADO	GG-17	5651921
1500 SERIES con motor/GMC V8-454 (7.4L)			2500 SERIES con motor/GMC 4-153			2500 SERIES con motor/GMC V6-305C		
ACEITE, HASTA 1986	GP-13	6438384	ACEITE, 3 45/64 IN	GP-3	6435679	ACEITE, CARBURADO	G-33	5573014
ACEITE, 1986 EN ADELANTE	GP-205	25160561	ACEITE, 5 13/32 IN	GP-13	6438384	ACEITE, 3 45/64 IN SELLADO	GP-20	6437994
AIRE, 3 7/16 IN	GA-59	6484235	AIRE, USO ESTANDAR	GA-50	5649797	ACEITE, 5 13/32 IN SELLADO	GP-50	5574639
AIRE, 5 7/16 IN	GA-89	25043585	AIRE, USO HEAVY DUTY	GA-192	6483864	AIRE	GA-56	5645017
GASOLINA, 1 3/64 IN	GG-6	5651393	GASOLINA, 1962-66	GG-123	7013404	GASOLINA, 1960-65	GG-20	5650030
GASOLINA, 2 1/16 IN	GG-7	5651921	2500 SERIES con motor/GMC 6-194			GASOLINA, 1970-74	GG-6	5651393
GASOLINA, FUEL INJECTION	GG-46	25055052	ACEITE, 3 45/64 IN	GP-3	6435679	GASOLINA, 1970-74	GG-16	5651920
GASOLINA, 1 3/64 IN	GG-16	5651920	ACEITE, 5 13/32 IN	GP-13	6438384	2500 SERIES con motor/GMC V6-305E		
GASOLINA, 2 1/16 IN	GG-17	5651921	AIRE, USO ESTANDAR	GA-50	5649797	ACEITE, 3 45/64 IN	GP-20	6437994
1500 SERIES, 2500 SERIES con motores/GMC 6-305A, GMC 6-305D			AIRE, USO HEAVY DUTY	GA-192	6483864	ACEITE, 5 13/32 IN	GP-50	5574639
GASOLINA	GG-20	5650030	GASOLINA, BRONCE COM-PRIMIDO	GG-123	7013404	AIRE	GA-56	5645017
1500 SERIES, 2500 SERIES, 3500 SERIES con motor/GMC V8-305			2500 SERIES con motor/GMC 6-230			GASOLINA, 1968-69 PLASTICO	GG-5	5650780
ACEITE, 2WD	GP-13	6438384	ACEITE, 3 45/64 IN	GP-3	6435679	GASOLINA, 1967	GG-6	5651393
ACEITE, 4WD	GP-3980	25171377	ACEITE, 5 13/32 IN	GP-13	6438384	GASOLINA, 1968-69 LAMINA	GG-5 L	5650780
AIRE, 1976-80 EXCEPTO. G SERIES	GA-57	6485108	AIRE, USO ESTANDAR	GA-50	5649797	GASOLINA, 1967	GG-16	5651920
AIRE, 1981 EN ADELANTE (3 7/16 IN)	GA-59	6484235	AIRE, USO HEAVY DUTY	GA-192	6483864	2500 SERIES con motor/GMC V6-351		
AIRE, 1981 EN ADELANTE (5 7/16 IN)	GA-89	25043585	GASOLINA, 1968-69	GG-6	5651393	ACEITE	GP-20	6437994
AIRE, 1976 EN ADELANTE	GA-192	6483864	GASOLINA, 1968-69	GG-16	5651920	AIRE, 1966	GA-56	5645017
GASOLINA, 1 3/64 IN	GG-6	5651393	GASOLINA, 1963-70	GG-123	7013404	AIRE, 1968	GA-192	6483864
GASOLINA, 2 1/16 IN	GG-7	5651921	2500 SERIES con motor/GMC 6-250			GASOLINA, 1968 PLASTICO	GG-5	5650780
GASOLINA, FUEL INJECTION	GG-46	25055052	ACEITE, 3 45/64 IN	GP-3	6435679	GASOLINA, 1967	GG-6	5651393
GASOLINA, 1 3/64 IN	GG-16	5651920	ACEITE, 5 13/32 IN	GP-13	6438384	GASOLINA, 1967	GG-5 L	5650780
GASOLINA, 2 1/16 IN	GG-17	5651921	AIRE, 1966-78	GA-50	5649797	GASOLINA, 1967	GG-16	5651920
1500 SERIES, 2500 SERIES, 3500 SERIES con motor/GMC V8-327			AIRE, USO HEAVY DUTY	GA-192	6483864	2500 SERIES con motor/GMC V8-283		
ACEITE	G-200	5574540	AIRE, 1979 EN ADELANTE	GA-3523	8996587	ACEITE	G-200	5574540
AIRE, 1964-67	GA-56	5645017	AIRE, 1970-78	GA-90	5648003	AIRE, 1964-67	GA-56	5645017
AIRE, 1968 EN ADELANTE	GA-57	6483645	GASOLINA, 1969-72 (3 33/64 IN)	GG-20	5650030	AIRE, 1967-68	GA-192	6419892
GASOLINA, 3 33/64 IN	GG-20	5650030	GASOLINA, 1968 EN ADELANTE (1 3/64 IN)	GG-6	5651393	GASOLINA, 1963-67	GG-20	5650030
GASOLINA, 1 3/64 IN	GG-6	5651393	GASOLINA, 1979 EN ADELANTE (2 1/16)	GG-7	5651921	GASOLINA, 1967 BRONCE COMPRIMIDO	GG-123	7013404
GASOLINA, 1 3/64 IN	GG-16	5651920	GASOLINA, 1968 EN ADELANTE (1 3/64 IN)	GG-16	5651920	2500 SERIES con motor/GMC V8-307		
1500 SERIES, 2500 SERIES, 3500 SERIES con motor/GMC V8-350			GASOLINA, 1979 EN ADELANTE (2 1/16)	GG-17	5651921	ACEITE, CARTUCHO	G-200	5574540
ACEITE, CARTUCHO	G-200	5574540	GASOLINA, 1966-70 BRONCE COMPRIMIDO	GG-123	7013404	ACEITE, SELLADO	GP-13	6438384
ACEITE, SELLADO (EXCEPTO. K SERIES)	GP-13	6438384	2500 SERIES con motor/GMC 6-292			AIRE, 2 15/32 IN	GA-57	6485108
ACEITE, SELLADO	GP-3980	25171377	ACEITE, 1966-75 CARTUCHO	G-34	6437562	AIRE, 3 1/2 IN	GA-192	6483864
AIRE, 1969-71	GA-57	6485108	ACEITE, 3 45/64 IN SELLADO	GP-3	6435679	GASOLINA, 3 33/64 IN	GG-20	5650030
AIRE, 1972-78 (2 15/32 IN)	GA-57	6485108	ACEITE, 5 13/32 IN SELLADO	GP-13	6438384	GASOLINA	GG-6	5651393
AIRE, 1972 EN ADELANTE (3 7/16 IN)	GA-59	6484235	AIRE, 1962-67	GA-56	5645017	GASOLINA	GG-16	5651920
AIRE, 1980 EN ADELANTE (5 7/16 IN)	GA-89	25043585	AIRE, 1968-72	GA-192	6483864	GASOLINA, BRONCE COM-PRIMIDO	GG-123	7013404
AIRE, 1972 EN ADELANTE (VANS)	GA-192	6483864	AIRE, 1971 EN ADELANTE	GA-90	5648003	2500 SERIES con motor/GMC V8-350 DIESEL		
GASOLINA, 3 33/64 IN	GG-20	5650030	GASOLINA, 1962-71	GG-20	5650030	ACEITE, 1978	GP-13	6438384
GASOLINA, 1 3/64 IN	GG-6	5651393	GASOLINA, 1968-1986	GG-6	5651393	2500 SERIES con motor/GMC V8-379 (6.2L) DIESEL		
GASOLINA, 2 1/16 IN	GG-7	5651921	GASOLINA, 1988 EN ADELANTE	GG-7	5651921	ACEITE, HASTA 1986	GP-13	6438384
GASOLINA, FUEL INJECTION	GG-46	25055052	GASOLINA, 1968-1986	GG-16	5651920	COMBUSTIBLE, 1983 PRIMARIO (VANS)	GP-92	25011422
GASOLINA, 1 3/64 IN	GG-16	5651920	GASOLINA, 1988 EN ADELANTE	GG-17	5651921	COMBUSTIBLE, 1982-83 SECUNDARIO (EXCEPTO. VANS)	GP-1122	25011422
GASOLINA, 2 1/16 IN	GG-17	5651921	GASOLINA, 1963-71 BRONCE COMPRIMIDO	GG-123	7013404	ACEITE, 1986 EN ADELANTE	GP-205	25160561
GASOLINA, BRONCE COM-PRIMIDO	GG-123	7013404	2500 SERIES con motor/GMC V6-262 (4.3L)			COMBUSTIBLE, 1984 EN ADELANTE	G-294	14071064
20 SERIES con motor/DETROIT DIESEL 3-53			ACEITE	GP-3980	25171377	2500 SERIES con motor/GMC V8-396		
ACEITE, FLUJO TOTAL (FULL FLOW)	G-119	5574978	AIRE	GA-192	6483864	ACEITE, HASTA 1969 CARTUCHO	G-34	6437562
			GASOLINA, CARBURADO	GG-7	5651921	ACEITE, 1969-72 CARTUCHO	G-200	5574540
						ACEITE, SELLADO	GP-13	6438384

SERVICIO PESADO

MARCA-MODELO-MOTOR MAKE-MODEL-ENGINE	GONHER GONHER	OEM OEM	MARCA-MODELO-MOTOR MAKE-MODEL-ENGINE	GONHER GONHER	OEM OEM	MARCA-MODELO-MOTOR MAKE-MODEL-ENGINE	GONHER GONHER	OEM OEM
GENERAL MOTORS / CHEVROLET			GENERAL MOTORS / CHEVROLET			GENERAL MOTORS / CHEVROLET		
CAMIONES, TRACTOCAMIONES Y AUTOBUSES			CAMIONES, TRACTOCAMIONES Y AUTOBUSES			CAMIONES, TRACTOCAMIONES Y AUTOBUSES		
AIRE	GA-55	6421746	GASOLINA, 1968-69	GG-16	5651920	AIRE, 1968	GA-192	6483864
AIRE	GA-192	6483864	GASOLINA, 1963-70	GG-123	7013404	GASOLINA, 1968 PLASTICO	GG-5	5650780
GASOLINA	GG-20	5650030				GASOLINA, 1967	GG-6	5651393
GASOLINA	GG-6	5651393	3500 SERIES con motor/GMC 6-250			GASOLINA, 1968 LAMINA	GG-5 L	5650780
GASOLINA	GG-16	5651920	ACEITE, 3 45/64 IN	GP-3	6435679	GASOLINA, 1967	GG-16	5651920
GASOLINA, BRONCE COM-PRIMIDO	GG-123	7013404	ACEITE, 5 13/32 IN	GP-13	6438384	3500 SERIES con motor/GMC V8-283		
			AIRE, 1966-78	GA-50	5649797	ACEITE	G-200	5574540
2500 SERIES con motor/GMC V8-400			AIRE, USO HEAVY DUTY	GA-192	6483864	AIRE, 1964-67	GA-56	5645017
ACEITE	GP-13	6438384	AIRE, 1979 EN ADELANTE	GA-3523	8996587	AIRE, 1967-68	GA-192	6419892
ACEITE, 2 CUARTOS	GP-23	25010754	AIRE, 1970-78	GA-90	5648003	GASOLINA, 1963-67	GG-20	5650030
AIRE, 1975 EN ADELANTE (EXCEPTO. VANS)	GA-59	6484235	GASOLINA, 1969-72 (3 33/64 IN)	GG-20	5650030	GASOLINA, 1967 BRONCE COMPRIMIDO	GG-123	7013404
AIRE, 1975 EN ADELANTE (VANS)	GA-192	6483864	GASOLINA, 1968 EN ADELANTE (1 3/64 IN)	GG-6	5651393	3500 SERIES con motor/GMC V8-307		
GASOLINA, 1 3/64 IN	GG-6	5651393	GASOLINA, 1979 EN ADELANTE (2 1/16)	GG-7	5651921	ACEITE, CARTUCHO	G-200	5574540
GASOLINA, 2 1/16 IN	GG-7	5651921	GASOLINA, 1968 EN ADELANTE (1 3/64 IN)	GG-16	5651920	ACEITE, SELLADO	GP-13	6438384
GASOLINA, 1 3/64 IN	GG-16	5651920	GASOLINA, 1979 EN ADELANTE (2 1/16)	GG-17	5651921	AIRE, 2 15/32 IN	GA-57	6485108
GASOLINA, 2 1/16 IN	GG-17	5651921	GASOLINA, 1966-70 BRONCE COMPRIMIDO	GG-123	7013404	AIRE, 3 1/2 IN	GA-192	6483864
2500 SERIES con motor/GMC V8-402						GASOLINA, 3 33/64 IN	GG-20	5650030
ACEITE	GP-13	6438384	3500 SERIES con motor/GMC 6-292			GASOLINA	GG-6	5651393
			ACEITE, 1966-75 CARTUCHO	G-34	6437562	GASOLINA	GG-16	5651920
2500 SERIES con motor/GMC V8-454 (7.4L)			ACEITE, 3 45/64 IN SELLADO	GP-3	6435679	GASOLINA, BRONCE COM-PRIMIDO	GG-123	7013404
ACEITE, HASTA 1986	GP-13	6438384	ACEITE, 5 13/32 IN SELLADO	GP-13	6438384	3500 SERIES con motor/GMC V8-350 DIESEL		
ACEITE, 1986 EN ADELANTE	GP-205	25160561	AIRE, 1962-67	GA-56	5645017	ACEITE, 1978	GP-13	6438384
AIRE, 3 7/16 IN	GA-59	6484235	AIRE, 1968-72	GA-192	6483864	3500 SERIES con motor/GMC V8-379 (6.2L) DIESEL		
AIRE, 5 7/16 IN	GA-89	25043585	AIRE, 1971 EN ADELANTE	GA-90	5648003	ACEITE, HASTA 1986	GP-13	6438384
GASOLINA, 1 3/64 IN	GG-6	5651393	GASOLINA, 1962-71	GG-20	5650030	COMBUSTIBLE, 1983 PRIMARIO (VANS)	GP-92	25011422
GASOLINA, 2 1/16 IN	GG-7	5651921	GASOLINA, 1968-1986	GG-6	5651393	COMBUSTIBLE, 1982-83 SECUNDARIO (EXCEPTO. VANS)	GP-1122	25011422
GASOLINA, FUEL INJECTION	GG-46	25055052	GASOLINA, 1988 EN ADELANTE	GG-7	5651921	ACEITE, 1986 EN ADELANTE	GP-205	25160561
GASOLINA, 1 3/64 IN	GG-16	5651920	GASOLINA, 1968-1986	GG-16	5651920	COMBUSTIBLE, 1984 EN ADELANTE	G-294	14071064
GASOLINA, 2 1/16 IN	GG-17	5651921	GASOLINA, 1988 EN ADELANTE	GG-17	5651921	3500 SERIES con motor/GMC V8-396		
2500 SERIES, 3500 SERIES con motor/GMC V8-305 (5.0L)			GASOLINA, 1963-71 BRONCE COMPRIMIDO	GG-123	7013404	ACEITE, HASTA 1969 CARTUCHO	G-34	6437562
ACEITE, 2WD	GP-13	6438384	3500 SERIES con motor/GMC V6-262 (4.3L)			ACEITE, 1969-72 CARTUCHO	G-200	5574540
ACEITE, 4WD	GP-3980	25171377	ACEITE	GP-3980	25171377	ACEITE, SELLADO	GP-13	6438384
AIRE	GA-59	6484235	AIRE	GA-192	6483864	AIRE	GA-55	6421746
GASOLINA	GG-46	25055052	GASOLINA, CARBURADO	GG-7	5651921	AIRE	GA-192	6483864
			GASOLINA, FUEL INJECTION	GG-46	25055052	GASOLINA	GG-20	5650030
30 SERIES con motor/DETROIT DIESEL 3-53			GASOLINA, CARBURADO	GG-17	5651921	GASOLINA	GG-6	5651393
ACEITE, FLUJO TOTAL (FULL FLOW)	G-119	5574978	3500 SERIES con motor/GMC V6-305C			GASOLINA	GG-16	5651920
3000 SERIES con motor/GMC V8-265			ACEITE, CARBURADO	G-33	5573014	GASOLINA, BRONCE COM-PRIMIDO	GG-123	7013404
ACEITE, CARTUCHO	G-31	5572425	ACEITE, 3 45/64 IN SELLADO	GP-20	6437994	3500 SERIES con motor/GMC V8-400		
			ACEITE, 5 13/32 IN SELLADO	GP-50	5574639	ACEITE	GP-13	6438384
3000 SERIES con motores/GMC 6-216, GMC 6-235			AIRE	GA-56	5645017	ACEITE, 2 CUARTOS	GP-23	25010754
ACEITE	G-31	5572425	GASOLINA, 1960-65	GG-20	5650030	AIRE, 1975 EN ADELANTE (EXCEPTO. VANS)	GA-59	6484235
3500 SERIES con motor/DETROIT DIESEL 3-53			GASOLINA, 1970-74	GG-6	5651393	AIRE, 1975 EN ADELANTE (VANS)	GA-192	6483864
ACEITE	G-119	5574978	GASOLINA, 1970-74	GG-16	5651920	GASOLINA, 1 3/64 IN	GG-6	5651393
3500 SERIES con motor/GMC 6-194			3500 SERIES con motor/GMC V6-305E			GASOLINA, 2 1/16 IN	GG-7	5651921
ACEITE, 3 45/64 IN	GP-3	6435679	ACEITE, 3 45/64 IN	GP-20	6437994	GASOLINA, 1 3/64 IN	GG-6	5651393
ACEITE, 5 13/32 IN	GP-13	6438384	ACEITE, 5 13/32 IN	GP-50	5574639	GASOLINA, 2 1/16 IN	GG-7	5651921
AIRE, USO ESTANDAR	GA-50	5649797	AIRE	GA-56	5645017	GASOLINA, 1 3/64 IN	GG-6	5651920
AIRE, USO HEAVY DUTY	GA-192	6483864	GASOLINA, 1968-69 PLASTICO	GG-5	5650780	GASOLINA, 2 1/16 IN	GG-16	5651920
GASOLINA, BRONCE COM-PRIMIDO	GG-123	7013404	GASOLINA, 1967	GG-6	5651393	GASOLINA, 2 1/16 IN	GG-17	5651921
			GASOLINA, 1968-69 LAMINA	GG-5 L	5650780	3500 SERIES con motor/GMC V8-402		
3500 SERIES con motor/GMC 6-230			GASOLINA, 1967	GG-16	5651920	ACEITE	GP-13	6438384
ACEITE, 3 45/64 IN	GP-3	6435679	3500 SERIES con motor/GMC V6-351			ACEITE, HASTA 1986	GP-13	6438384
ACEITE, 5 13/32 IN	GP-13	6438384	ACEITE	GP-20	6437994			
AIRE, USO ESTANDAR	GA-50	5649797	AIRE, 1966	GA-56	5645017			
AIRE, USO HEAVY DUTY	GA-192	6483864						
GASOLINA, 1968-69	GG-6	5651393						

APLICACIONES SERVICIO PESADO
HEAVY DUTY APPLICATIONS



MARCA-MODELO-MOTOR MAKE-MODEL-ENGINE	GONHER GONHER	OEM OEM	MARCA-MODELO-MOTOR MAKE-MODEL-ENGINE	GONHER GONHER	OEM OEM	MARCA-MODELO-MOTOR MAKE-MODEL-ENGINE	GONHER GONHER	OEM OEM
GENERAL MOTORS / CHEVROLET			GENERAL MOTORS / CHEVROLET			GENERAL MOTORS / CHEVROLET		
CAMIONES, TRACTOCAMIONES Y AUTOBUSES			CAMIONES, TRACTOCAMIONES Y AUTOBUSES			CAMIONES, TRACTOCAMIONES Y AUTOBUSES		
ACEITE, 1986 EN ADELANTE	GP-205	25160561	ACEITE, CARTUCHO ESTANDAR	G-34	6437562	GASOLINA, 1 3/64 IN	GG-16	5651920
AIRE, 3 7/16 IN	GA-59	6484235	ACEITE, CARTUCHO OPCIONAL	G-200	5574540	GASOLINA, BRONCE COM-PRIMIDO	GG-123	7013404
AIRE, 5 7/16 IN	GA-89	25043585	GASOLINA, 3 33/64 IN	GG-20	5650030	4000-6500 SERIES con motor/GMC 6-292		
GASOLINA, 1 3/64 IN	GG-6	5651393	GASOLINA, BRONCE COM-PRIMIDO	GG-123	7013404	ACEITE, CARTUCHO (1963-67)	G-33	5573014
GASOLINA, 2 1/16 IN	GG-7	5651921	40 SERIES con motor/GMC V8-427			ACEITE, CARTUCHO (1968 EN ADELANTE)	G-34	6437562
GASOLINA, FUEL INJECTION	GG-46	25055052	ACEITE, CARTUCHO OPCIONAL	G-33	5573014	ACEITE, 3 45/64 IN	GP-3	6435679
GASOLINA, 1 3/64 IN	GG-16	5651920	ACEITE, CARTUCHO ESTANDAR	G-34	6437562	ACEITE, 5 13/32 IN	GP-13	6438384
GASOLINA, 2 1/16 IN	GG-17	5651921	ACEITE, CARTUCHO OPCIONAL	G-200	5574540	ACEITE, 8 1/2 IN	GP-23	25010754
3500 SERIES con motores/GMC 6-305A, GMC 6-305D			GASOLINA, 3 33/64 IN	GG-20	5650030	AIRE, 2 55/64 IN	GA-56	5645017
GASOLINA	GG-20	5650030	GASOLINA, 1 3/64 IN	GG-6	5651393	AIRE, RESPIRADOR DEL COMPRESOR	GA-135	2031381
40 SERIES con motor/GMC 6-230			GASOLINA, 1 3/64 IN	GG-16	5651920	AIRE, 3 35/64 IN	GA-192	6483864
ACEITE	GP-13	6438384	40 SERIES con motores/GMC 3-53 DIESEL, GMC 3-53N DIESEL			AIRE, 3 5/64 IN	GA-90	5648003
AIRE, COMUN	GA-50	5649797	ACEITE, 1966 EN ADELANTE	G-33	5573014	GASOLINA, PLASTICO	GG-5	5650780
AIRE, USO HEAVY DUTY	GA-192	6483864	ACEITE, 1964-65	G-119	5574978	GASOLINA, 3 33/64 IN	GG-20	5650030
GASOLINA, 1 3/64 IN	GG-6	5651393	COMBUSTIBLE, SECUNDARIO	G-1173	3290851	GASOLINA, 1 3/64 IN	GG-6	5651393
GASOLINA, 1 3/64 IN	GG-16	5651920	40 SERIES, 50 SERIES con motor/GMC 6-292			GASOLINA, LAMINA	GG-5 L	5650780
GASOLINA, BRONCE COM-PRIMIDO	GG-123	7013404	ACEITE, CARTUCHO OPCIONAL	G-33	5573014	GASOLINA, 1 3/64 IN	GG-16	5651920
40 SERIES con motor/GMC 6-250			ACEITE, CARTUCHO	G-34	6437562	GASOLINA, BRONCE COM-PRIMIDO	GG-123	7013404
ACEITE, CARTUCHO OPCIONAL	G-33	5573014	ACEITE, SELLADO 3 45/64 IN	GP-3	6435679	4000-6500 SERIES con motor/GMC V6-305C		
ACEITE, CARTUCHO	G-34	6437562	ACEITE, SELLADO 5 13/32 IN	GP-13	6438384	ACEITE, CARTUCHO	G-33	5573014
ACEITE, SELLADO 3 45/64 IN	GP-3	6435679	AIRE, 1965-66	GA-192	6419892	ACEITE, SELLADO (5 13/32 IN)	GP-5	5515104
ACEITE, SELLADO 5 13/32 IN	GP-13	6438384	AIRE, 1973-78	GA-90	3979645	ACEITE, SELLADO (3 45/64 IN)	GP-20	6437994
AIRE, RESPIRADOR DEL COMPRESOR	GA-135	8875051	GASOLINA, 1973-78	GG-20	5650030	AIRE	GA-56	5645017
AIRE	GA-192	6419892	GASOLINA, 1969-77	GG-6	5651393	AIRE, RESPIRADOR DEL COMPRESOR	GA-135	2467368
AIRE	GA-90	3979576	GASOLINA, 1969-77	GG-16	5651920	GASOLINA, PLASTICO	GG-5	5650780
GASOLINA, 3 33/64 IN	GG-20	5650030	GASOLINA, 1969-77	GG-16	5651920	GASOLINA, 3 33/64 IN	GG-20	5650030
GASOLINA, 1 3/64 IN	GG-6	5651393	GASOLINA, BRONCE COM-PRIMIDO	GG-123	7013404	GASOLINA, 1 3/64 IN	GG-6	5651393
GASOLINA, 1 3/64 IN	GG-16	5651920	4000 SERIES con motor/GMC V8-265			GASOLINA, LAMINA	GG-5 L	5650780
GASOLINA, BRONCE COM-PRIMIDO	GG-123	7013404	ACEITE, CARTUCHO	G-31	5572425	4000-6500 SERIES con motor/GMC V6-305E		
40 SERIES con motor/GMC 6-261			4000 SERIES con motor/GMC V8-283			ACEITE, SELLADO (5 13/32 IN)	GP-5	5515104
ACEITE	G-200	5574540	ACEITE, CARTUCHO	G-200	5574540	ACEITE, SELLADO (3 45/64 IN)	GP-20	6437994
40 SERIES con motor/GMC V8-283			ACEITE, SELLADO	GP-13	6438384	AIRE	GA-56	5645017
ACEITE	G-200	5574540	GASOLINA, BRONCE COM-PRIMIDO	GG-123	7013404	GASOLINA, 1969	GG-5	5650780
AIRE	GA-56	6420690	4000 SERIES con motor/ISUZU			GASOLINA, 3 33/64 IN	GG-20	5650030
AIRE	GA-192	6419892	ACEITE, FLUJO TOTAL (FULL FLOW)	GP-1	94169778	GASOLINA, 1 3/64 IN	GG-6	5651393
GASOLINA	GG-20	5650030	4000 SERIES con motores/GMC 6-216, GMC 6-235			GASOLINA, 1969	GG-5 L	5650780
40 SERIES con motor/GMC V8-307			ACEITE	G-31	5572425	GASOLINA, 1 3/64 IN	GG-16	5651920
ACEITE	G-200	5574540	4000-6500 SERIES con motor/GMC 4-53N			4000-6500 SERIES con motor/GMC V6-351		
AIRE	GA-192	6419892	ACEITE, FLUJO TOTAL (FULL FLOW)	G-33	5573014	ACEITE	G-33	5573014
GASOLINA	GG-123	7013404	COMBUSTIBLE, SECUNDARIO	G-1173	3290851	4000-6500 SERIES con motor/GMC V6-351C		
40 SERIES con motor/GMC V8-350			COMBUSTIBLE, SECUNDARIO	G-1175	5574508	ACEITE, CARTUCHO 1969 EN ADELANTE	G-33	5573014
ACEITE, CARTUCHO OPCIONAL	G-33	5573014	COMBUSTIBLE, SECUNDARIO	G-1175	5574508	ACEITE, SELLADO (5 13/32 IN)	GP-5	5515104
ACEITE, CARTUCHO ESTANDAR	G-34	6437562	AIRE	GA-373	2031381	ACEITE, SELLADO (3 45/64 IN)	GP-20	6437994
ACEITE, CARTUCHO OPCIONAL	G-200	5574540	4000-6500 SERIES con motor/GMC 6-250			AIRE	GA-56	5645017
ACEITE, SELLADO	GP-13	6438384	ACEITE, 3 45/64 IN	GP-3	6435679	AIRE, RESPIRADOR DEL COMPRESOR	GA-135	2467368
AIRE ESTANDAR	GA-57	6485108	ACEITE, 5 13/32 IN	GP-13	6438384	GASOLINA, PLASTICO	GG-5	5650780
AIRE, RESPIRADOR DEL COMPRESOR	GA-135	8875051	AIRE, 1 61/64 IN	GA-50	5649797	GASOLINA, LAMINA	GG-5 L	5650780
GASOLINA, 3 33/64 IN	GG-20	5650030	AIRE, 3 35/64 IN	GA-192	6483864	4000-6500 SERIES con motor/GMC V6-351M		
GASOLINA, 1 3/64 IN	GG-6	5651393	AIRE, 3 5/64 IN	GA-90	3979576	ACEITE, CARTUCHO	G-33	5573014
GASOLINA, 2 1/16 IN	GG-7	5651921	GASOLINA, PLASTICO	GG-5	5650780	AIRE, RESPIRADOR DEL COMPRESOR	GA-135	2467368
GASOLINA, 1 3/64 IN	GG-16	5651920	GASOLINA, 3 33/64 IN	GG-20	5650030	GASOLINA, CARTUCHO	GG-20	5650030
GASOLINA, 2 1/16 IN	GG-17	5651921	GASOLINA, 1 3/64 IN	GG-6	5651393			
40 SERIES con motor/GMC V8-366			GASOLINA, LAMINA	GG-5 L	5650780			
ACEITE, CARTUCHO OPCIONAL	G-33	5573014						

SERVICIO PESADO

MARCA-MODELO-MOTOR MAKE-MODEL-ENGINE	GONHER GONHER	OEM OEM	MARCA-MODELO-MOTOR MAKE-MODEL-ENGINE	GONHER GONHER	OEM OEM	MARCA-MODELO-MOTOR MAKE-MODEL-ENGINE	GONHER GONHER	OEM OEM
GENERAL MOTORS / CHEVROLET			GENERAL MOTORS / CHEVROLET			GENERAL MOTORS / CHEVROLET		
CAMIONES, TRACTOCAMIONES Y AUTOBUSES			CAMIONES, TRACTOCAMIONES Y AUTOBUSES			CAMIONES, TRACTOCAMIONES Y AUTOBUSES		
4000-6500 SERIES con motor/GMC V6-379			GASOLINA, 1 3/64 IN	GG-6	5651393	50 SERIES con motores/GMC 3-53 DIESEL 1962 EN ADELANTE, GMC 3-53N DIESEL 1962 EN ADELANTE		
ACEITE, CARTUCHO	G-33	5573014	GASOLINA, 1 3/64 IN	GG-16	5651920	ACEITE, EXCEPTO. 1964-65	G-33	5573014
ACEITE, SELLADO (5 13/32 IN)	GP-5	5515104	GASOLINA, BRONCE COM-PRIMIDO	GG-123	7013404	ACEITE, 1964-65	G-119	5574978
ACEITE, SELLADO (3 45/64 IN)	GP-20	6437994	50 SERIES con motor/GMC 6-250			COMBUSTIBLE, SECUNDARIO	G-1173	3290851
AIRE, RESPIRADOR DEL COMPRESOR	GA-135	2467368	ACEITE, CARTUCHO OPCIONAL	G-33	5573014	50 SERIES con motores/GMC D351 DIESEL, GMC D478 DIESEL		
GASOLINA	GG-20	5650030	ACEITE, CARTUCHO	G-34	6437562	ACEITE, FLUJO TOTAL (FULL FLOW)	G-33	5573014
4000-6500 SERIES con motor/GMC V6-432			ACEITE, SELLADO 3 45/64 IN	GP-3	6435679	50 SERIES KODIAK con motor/CATERPILLAR 3116		
ACEITE, 1966 EN ADELANTE	G-33	5573014	ACEITE, SELLADO 5 13/32 IN	GP-13	6438384	ACEITE	GP-51	1R0739
4000-6500 SERIES con motor/GMC V6-478			AIRE, RESPIRADOR DEL COMPRESOR	GA-135	8875051	5000 SERIES con motor/GMC V8-265		
ACEITE	G-33	5573014	AIRE	GA-192	6419892	ACEITE, CARTUCHO	G-31	5572425
4000-6500 SERIES con motor/GMC V8-350			AIRE	GA-90	3979576	5000 SERIES con motor/GMC V8-283		
ACEITE, CARTUCHO (2 CUARTOS)	G-34	6437562	GASOLINA, 3 33/64 IN	GG-20	5650030	ACEITE, CARTUCHO	G-200	5574540
ACEITE, CARTUCHO (1 CUARTO)	G-200	5574540	GASOLINA, 1 3/64 IN	GG-6	5651393	ACEITE, SELLADO	GP-13	6438384
ACEITE, 3 45/64 IN	GP-3	6435679	GASOLINA, 1 3/64 IN	GG-16	5651920	GASOLINA, BRONCE COM-PRIMIDO	GG-123	7013404
ACEITE, 5 13/32 IN	GP-13	6438384	GASOLINA, BRONCE COM-PRIMIDO	GG-123	7013404	5000 SERIES con motores/GMC 6-216, GMC 6-235		
ACEITE, 8 1/2 IN	GP-23	25010754	50 SERIES con motor/GMC 6-261			ACEITE	G-31	5572425
AIRE, 1968 EN ADELANTE	GA-57	6483645	ACEITE	G-200	5574540	60 SERIES con motor/GMC 4-53 DIESEL		
AIRE, RESPIRADOR DEL COMPRESOR	GA-135	8875051	50 SERIES con motor/GMC 6V-53 DIESEL			ACEITE, CARTUCHO	G-33	5573014
GASOLINA, 3 33/64 IN	GG-20	5650030	ACEITE	G-33	5573014	COMBUSTIBLE, SECUNDARIO	G-1173	3290851
GASOLINA, 1 3/64 IN	GG-6	5651393	50 SERIES con motor/GMC V8-283			AIRE	GA-373	2031381
GASOLINA, 2 1/16 IN	GG-7	5651921	ACEITE	G-200	5574540	60 SERIES con motor/GMC 6-261		
GASOLINA, 1 3/64 IN	GG-16	5651920	AIRE	GA-56	6420690	ACEITE, CARTUCHO OPCIONAL	G-33	5573014
GASOLINA, 2 1/16 IN	GG-17	5651921	AIRE	GA-192	6419892	ACEITE, CARTUCHO OPCIONAL	G-34	6437562
4000-6500 SERIES con motor/GMC V8-366			GASOLINA	GG-20	5650030	ACEITE, CARTUCHO	G-200	5574540
ACEITE, CARTUCHO	G-34	6437562	50 SERIES con motor/GMC V8-327			ACEITE, SELLADO	GP-13	6438384
ACEITE, 5 13/32 IN	GP-13	6438384	ACEITE	G-200	5574540	ACEITE, SELLADO	GP-13	6438384
ACEITE, 8 1/2 IN	GP-23	25010754	AIRE, 1964-66	GA-56	6420690	60 SERIES con motor/GMC 6-292		
AIRE, RESPIRADOR DEL COMPRESOR	GA-135	9028042	GASOLINA	GG-20	5650030	ACEITE, SELLADO	GP-3	6435679
GASOLINA, BRONCE COM-PRIMIDO	GG-20	5650030	50 SERIES con motor/GMC V8-350			AIRE	GA-192	6419892
4000-6500 SERIES con motor/GMC V8-427			ACEITE, CARTUCHO OPCIONAL	G-33	5573014	AIRE	GA-90	3979645
ACEITE, 2 CUARTOS	G-34	6437562	ACEITE, CARTUCHO ESTANDAR	G-34	6437562	GASOLINA, 2 5/64 DIAM. EXT.	GG-20	5650030
ACEITE, 1 CUARTO	G-200	5574540	ACEITE, CARTUCHO OPCIONAL	G-200	5574540	GASOLINA, 1 3/64 IN	GG-6	5651393
ACEITE, 5 13/32 IN	GP-13	6438384	ACEITE, SELLADO	GP-13	6438384	GASOLINA, 1 3/64 IN	GG-16	5651920
ACEITE, 8 1/2 IN	GP-23	25010754	AIRE ESTANDAR	GA-57	6485108	GASOLINA, BRONCE COM-PRIMIDO	GG-123	7013404
AIRE, RESPIRADOR DEL COMPRESOR	GA-135	8875051	AIRE, RESPIRADOR DEL COMPRESOR	GA-135	8875051	60 SERIES con motor/GMC 6V-53 DIESEL		
GASOLINA, BRONCE COM-PRIMIDO	GG-20	5650030	GASOLINA, 3 33/64 IN	GG-20	5650030	ACEITE	G-33	5573014
4000-6500 SERIES con motores/GMC D478, GMC D478 DIESEL			GASOLINA, 1 3/64 IN	GG-6	5651393	60 SERIES con motor/GMC DH478 DIESEL		
ACEITE, CARTUCHO (1964-74)	G-33	5573014	GASOLINA, 2 1/16 IN	GG-7	5651921	ACEITE, FLUJO TOTAL (FULL FLOW)	G-33	5573014
COMBUSTIBLE, PRIMARIO	G-1175	5574508	GASOLINA, 1 3/64 IN	GG-16	5651920	COMBUSTIBLE, SECUNDARIO	G-1175	5574508
AIRE, RESPIRADOR DEL COMPRESOR	GA-135	2467368	GASOLINA, 2 1/16 IN	GG-17	5651921	AIRE, RESPIRADOR DEL COMPRESOR	GA-135	2031381
4500 con motor/GMC D351 DIESEL			50 SERIES con motor/GMC V8-366			60 SERIES con motor/GMC V6-305C		
ACEITE	G-33	5573014	ACEITE, CARTUCHO OPCIONAL	G-33	5573014	ACEITE, CARTUCHO	G-33	5573014
50 SERIES con motor/GMC 4-53 DIESEL			ACEITE, CARTUCHO ESTANDAR	G-34	6437562	ACEITE, SELLADO	GP-20	6437994
ACEITE, CARTUCHO	G-33	5573014	ACEITE, CARTUCHO OPCIONAL	G-200	5574540	AIRE, RESPIRADOR DEL COMPRESOR	GA-135	2467368
COMBUSTIBLE, SECUNDARIO	G-1173	3290851	GASOLINA, 3 33/64 IN	GG-20	5650030	GASOLINA, PLASTICO	GG-5	5650780
AIRE	GA-373	2031381	GASOLINA, BRONCE COM-PRIMIDO	GG-123	7013404	GASOLINA, CARTUCHO	GG-20	5650030
50 SERIES con motor/GMC 6-230			50 SERIES con motor/GMC V8-427			GASOLINA, LAMINA	GG-5 L	5650780
ACEITE	GP-13	6438384	ACEITE, CARTUCHO OPCIONAL	G-33	5573014	60 SERIES con motor/GMC V6-379		
AIRE, USO COMUN	GA-50	5649797	ACEITE, CARTUCHO ESTANDAR	G-34	6437562	ACEITE, CARTUCHO	G-33	5573014
AIRE, USO HEAVY DUTY	GA-192	6483864	ACEITE, CARTUCHO OPCIONAL	G-200	5574540			
			GASOLINA, 3 33/64 IN	GG-20	5650030			
			GASOLINA, 1 3/64 IN	GG-6	5651393			
			GASOLINA, 1 3/64 IN	GG-16	5651920			

APLICACIONES SERVICIO PESADO
HEAVY DUTY APPLICATIONS



MARCA-MODELO-MOTOR MAKE-MODEL-ENGINE	GONHER GONHER	OEM OEM	MARCA-MODELO-MOTOR MAKE-MODEL-ENGINE	GONHER GONHER	OEM OEM	MARCA-MODELO-MOTOR MAKE-MODEL-ENGINE	GONHER GONHER	OEM OEM
GENERAL MOTORS / CHEVROLET			GENERAL MOTORS / CHEVROLET			GENERAL MOTORS / CHEVROLET		
CAMIONES, TRACTOCAMIONES Y AUTOBUSES			CAMIONES, TRACTOCAMIONES Y AUTOBUSES			CAMIONES, TRACTOCAMIONES Y AUTOBUSES		
ACEITE, SELLADO	GP-20	6437994	65 SERIES con motor/GMC 6-379			COMBUSTIBLE, PRIMARIO	G-1175	5574508
AIRE, RESPIRADOR DEL COMPRESOR	GA-135	2031381	ACEITE, CARTUCHO	G-33	5573014	AIRE, RESPIRADOR DEL COMPRESOR	GA-135	2467368
GASOLINA	GG-20	5650030	ACEITE, 5 13/32 IN	GP-5	5515104			
			ACEITE, 3 /45/64 IN	GP-20	6437994	70 SERIES con motores/GMC V6-401M, GMC V6-478M		
60 SERIES con motor/GMC V6-432			GASOLINA	GG-20	5650030	ACEITE	G-33	5573014
ACEITE	G-33	5573014	65 SERIES con motor/GMC 6-432			AIRE, RESPIRADOR DEL COMPRESOR	GA-135	2467368
			ACEITE, CARTUCHO	G-33	5573014	GASOLINA, PLASTICO	GG-5	5650780
60 SERIES con motor/GMC V8-GASOLINA			65 SERIES con motores/GMC V 427, GMC V8-366			GASOLINA, CARTUCHO	GG-20	5650030
ACEITE, CARTUCHO OPCIONAL	G-33	5573014	ACEITE, CARTUCHO	G-34	6437562	GASOLINA, LAMINA	GG-5 L	5650780
ACEITE, CARTUCHO 1967 EN ADELANTE	G-34	6437562	ACEITE, SELLADO	GP-13	6438384	70 SERIES KODIAK con motor/CATERPILLAR 3116		
ACEITE, CARTUCHO 1960-66	G-200	5574540	ACEITE, SELLADO	GP-23	25010754	ACEITE	GP-51	1R0739
ACEITE, SELLADO	GP-13	6438384	AIRE, RESPIRADOR DEL COMPRESOR	GA-135	2031381	7000 SERIES con motor/CATERPILLAR 3208		
ACEITE, SELLADO	GP-23	25010754	GASOLINA, 3 33/64 IN	GG-20	5650030	GASOLINA, SEPARADOR DE AGUA	G-293	9Y4445
AIRE	GA-56	6422880	GASOLINA, 1 3/64 IN	GG-6	5651393	7000 SERIES con motor/GMC V8-265		
AIRE, RESPIRADOR DEL COMPRESOR	GA-135	8875051	GASOLINA, 2 1/16 IN	GG-7	5651921	ACEITE, CARTUCHO	G-31	5572425
AIRE	GA-192	6483864	GASOLINA, 1 3/64 IN	GG-16	5651920	7000 SERIES con motor/GMC V8-283		
GASOLINA, 3 33/64 IN	GG-20	5650030	GASOLINA, 2 1/16 IN	GG-17	5651921	ACEITE, CARTUCHO	G-200	5574540
GASOLINA, 1 3/64 IN	GG-6	5651393	GASOLINA, BRONCE COM-PRIMIDO	GG-123	7013404	ACEITE, SELLADO	GP-13	6438384
GASOLINA, 2 1/16 IN	GG-7	5651921	6500 con motor/CATERPILLAR 3208			GASOLINA, BRONCE COM-PRIMIDO	GG-123	7013404
GASOLINA, 1 3/64 IN	GG-16	5651920	ACEITE	GP-36	9L9200	7000 SERIES con motores/GMC D637 DIESEL, GMC DH637 DIESEL		
GASOLINA, 2 1/16 IN	GG-17	5651921	GASOLINA, SEPARADOR DE AGUA	G-293	9Y4445	ACEITE	G-33	5573014
GASOLINA, BRONCE COM-PRIMIDO	GG-123	7013404	COMBUSTIBLE	GP-110	1R0740	7000 SERIES con motores/GMC V6-401, GMC V6-478		
60 SERIES con motores/GMC 3-53 DIESEL 1962 EN ADELANTE, GMC 3-53N DIESEL 1962 EN ADELANTE			6500 con motor/GMC V6-401M			ACEITE	G-33	5573014
ACEITE, EXCEPTO. 1964-65	G-33	5573014	ACEITE	G-33	5573014	7000 SERIES con motores/GMC V6-401, GMC V6-478		
ACEITE, 1964-65	G-119	5574978	AIRE, RESPIRADOR DEL COMPRESOR	GA-135	2467368	ACEITE	G-33	5573014
COMBUSTIBLE, SECUNDARIO	G-1173	3290851	GASOLINA, PLASTICO	GG-5	5650780	7500 SERIES con motor/CATERPILLAR 3208		
60 SERIES con motores/GMC D351 DIESEL, GMC D478 DIESEL			GASOLINA, LAMINA	GG-5 L	5650780	ACEITE	GP-36	9L9200
ACEITE, FLUJO TOTAL (FULL FLOW)	G-33	5573014	70 SERIES con motor/CATERPILLAR 3208			GASOLINA, SEPARADOR DE AGUA	G-293	9Y4445
60 SERIES KODIAK con motor/CATERPILLAR 3116			ACEITE	GP-36	9L9200	COMBUSTIBLE	GP-110	1R0740
ACEITE	GP-51	1R0739	GASOLINA, SEPARADOR DE AGUA	G-293	9Y4445	AIRE, RESPIRADOR DEL COMPRESOR	GA-135	8875051
6000 SERIES con motor/GMC 6-235			COMBUSTIBLE	GP-110	1R0740	7500 SERIES con motor/GMC 6V-53N DIESEL		
ACEITE	G-31	5572425	AIRE, RESPIRADOR DEL COMPRESOR	GA-135	2031381	ACEITE, FLUJO TOTAL (FULL FLOW)	G-33	5573014
6000 SERIES con motor/GMC 6-261			70 SERIES con motor/GMC 6V-53 DIESEL			COMBUSTIBLE, SECUNDARIO CARTUCHO	G-1173	3290851
ACEITE, 1950-58	G-31	5572425	ACEITE, FLUJO TOTAL (FULL FLOW)	G-33	5573014	COMBUSTIBLE, PRIMARIO SELLADO	GP-26	25014274
6000 SERIES con motor/GMC V8-265			COMBUSTIBLE, SECUNDARIO CARTUCHO	G-1175	5574508	COMBUSTIBLE, SECUNDARIO SELLADO	GP-27	25014342
ACEITE, CARTUCHO	G-31	5572425	COMBUSTIBLE, PRIMARIO SELLADO	GP-26	25014274	AIRE, RESPIRADOR DEL COMPRESOR	GA-135	2467368
6000 SERIES con motor/GMC V8-283			COMBUSTIBLE, SECUNDARIO SELLADO	GP-27	25014342	ACEITE, DERIVACION (BY PASS)	G-750	2325391
ACEITE, CARTUCHO	G-200	5574540	AGUA, PRE-CARGA	GP-1011Q	25012895	7500 SERIES con motor/GMC V6-351		
ACEITE, SELLADO	GP-13	6438384	AGUA, MANTENIMIENTO	GP-2071W	25012893	ACEITE	G-33	5573014
GASOLINA, BRONCE COM-PRIMIDO	GG-123	7013404	AIRE, RESPIRADOR DEL COMPRESOR	GA-135	2467368	7500 SERIES con motor/GMC V6-351C		
65 SERIES con motor/CATERPILLAR 3208			ACEITE, DERIVACION (BY PASS)	G-750	2325391	ACEITE, CARTUCHO	G-33	5573014
ACEITE	GP-36	9L9200	70 SERIES con motor/GMC V8-GASOLINA			ACEITE, SELLADO (5 13/32 IN)	GP-5	5515104
GASOLINA, SEPARADOR DE AGUA	G-293	9Y4445	ACEITE, CARTUCHO OPCIONAL HASTA 1967	G-33	5573014	ACEITE, SELLADO (3 45/64 IN)	GP-20	6437994
COMBUSTIBLE	GP-110	1R0740	ACEITE, CARTUCHO OPCIONAL 1967 EN ADELANTE	G-34	6437562	AIRE	GA-56	5645017
65 SERIES con motor/DETROIT DIESEL 4-53			ACEITE, CARTUCHO ESTANDAR	G-200	5574540	AIRE, RESPIRADOR DEL COMPRESOR	GA-135	2467368
ACEITE, FLUJO TOTAL (FULL FLOW)	G-33	5573014	70 SERIES con motores/GMC D637 DIESEL, GMC DH478 DIESEL, GMC DH637 DIESEL			GASOLINA, BRONCE COM-PRIMIDO	GG-20	5650030
COMBUSTIBLE, SECUNDARIO	G-1175	5574508	ACEITE	G-33	5573014	GASOLINA, LAMINA	GG-5 L	5650780
AIRE	GA-373	2031381						

SERVICIO PESADO

MARCA-MODELO-MOTOR MAKE-MODEL-ENGINE	GONHER GONHER	OEM OEM	MARCA-MODELO-MOTOR MAKE-MODEL-ENGINE	GONHER GONHER	OEM OEM	MARCA-MODELO-MOTOR MAKE-MODEL-ENGINE	GONHER GONHER	OEM OEM
GENERAL MOTORS / CHEVROLET			GENERAL MOTORS / CHEVROLET			GENERAL MOTORS / CHEVROLET		
CAMIONES, TRACTOCAMIONES Y AUTOBUSES			CAMIONES, TRACTOCAMIONES Y AUTOBUSES			CAMIONES, TRACTOCAMIONES Y AUTOBUSES		
7500 SERIES con motor/GMC V6-351M			COMBUSTIBLE, PRIMARIO SELLADO			80 SERIES con motor/GMC V8-427		
ACEITE, CARTUCHO	G-33	5573014		GP-26	25014274	ACEITE	GP-23	25010754
AIRE	GA-56	6420690	COMBUSTIBLE, SECUNDARIO SELLADO	GP-27	25014342	AIRE, RESPIRADOR DEL COMPRESOR	GA-135	8875051
AIRE, RESPIRADOR DEL COMPRESOR	GA-135	2467368	AGUA, PRE-CARGA	GP-1011Q	25012895	GASOLINA	GG-20	5650030
GASOLINA, CARTUCHO	GG-20	5650030	AGUA, MANTENIMIENTO	GP-2071W	25012893	8000 SERIES con motor/GMC V8-265		
GASOLINA, LAMINA	GG-5 L	5650780	AIRE, RESPIRADOR DEL COMPRESOR	GA-135	2467368	ACEITE, CARTUCHO	G-31	5572425
7500 SERIES con motor/GMC V6-401M			ACEITE, DERIVACION (BY PASS)	G-750	2325391	8000 SERIES con motor/GMC V8-348		
ACEITE, CARTUCHO	G-33	5573014	80 SERIES con motor/GMC 6 CYL GASOLINA			ACEITE, OPCIONAL 2 CUARTOS 1962-65	G-33	5573014
AIRE	GA-56	6420690	ACEITE	G-33	5573014	ACEITE, 1958-65	G-200	5574540
AIRE, RESPIRADOR DEL COMPRESOR	GA-135	2467368	AIRE, RESPIRADOR DEL COMPRESOR	GA-135	2031381	COMBUSTIBLE, 1958-59	G-294	14071064
GASOLINA, CARTUCHO	GG-20	5650030	GASOLINA, PLASTICO	GG-5	5650780	AIRE, 1964-65	GA-56	5645017
GASOLINA, LAMINA	GG-5 L	5650780	GASOLINA, 3 33/64 IN	GG-20	5650030	GASOLINA, 1960-65	GG-20	5650030
7500 SERIES con motor/GMC V6-432M			GASOLINA, 1 3/64 IN	GG-6	5651393	8000 SERIES con motores/GMC V6-401, GMC V6-478		
ACEITE	G-33	5573014	GASOLINA, 2 1/16 IN	GG-7	5651921	ACEITE	G-33	5573014
AIRE, RESPIRADOR DEL COMPRESOR	GA-135	2467368	GASOLINA, LAMINA	GG-5 L	5650780	8000 SERIES, 9000 SERIES con motor/GMC V8-283		
GASOLINA	GG-20	5650030	GASOLINA, 1 3/64 IN	GG-16	5651920	ACEITE, CARTUCHO	G-200	5574540
7500 SERIES con motor/GMC V6-478			GASOLINA, 2 1/16 IN	GG-17	5651921	ACEITE, SELLADO	GP-13	6438384
ACEITE, CARTUCHO	G-33	5573014	GASOLINA, BRONCE COM-PRIMIDO	GG-123	7013404	GASOLINA, BRONCE COM-PRIMIDO	GG-123	7013404
AIRE	GA-56	6420690	80 SERIES con motor/GMC V8-283			8500 SERIES con motor/CATERPILLAR 3126		
AIRE, RESPIRADOR DEL COMPRESOR	GA-135	2467368	ACEITE, CARTUCHO 1962-67	G-33	5573014	ACEITE	GP-51	1R0739
GASOLINA, BRONCE COM-PRIMIDO	GG-20	5650030	ACEITE, CARTUCHO 1958-67	G-200	5574540	8500 SERIES con motor/GMC V6-351C		
GASOLINA, LAMINA	GG-5 L	5650780	ACEITE, SELLADO 1956-67	GP-13	6438384	ACEITE, CARTUCHO	G-33	5573014
7500 SERIES con motor/GMC V8-427			AIRE, 1964-67	GA-56	5645017	ACEITE, SELLADO (5 13/32 IN)	GP-5	5515104
ACEITE, CARTUCHO (2 CUARTOS)	G-34	6437562	GASOLINA, 1960-67	GG-20	5650030	ACEITE, SELLADO (3 45/64 IN)	GP-20	6437994
ACEITE, CARTUCHO (1 CUARTO)	G-200	5574540	80 SERIES con motor/GMC V8-307			AIRE	GA-56	5645017
ACEITE, SELLADO 5 13/32 IN	GP-13	6438384	ACEITE, CARTUCHO	G-200	5574540	AIRE, RESPIRADOR DEL COMPRESOR	GA-135	2467368
ACEITE, SELLADO (8 1/2 IN)	GP-23	25010754	ACEITE, SELLADO	GP-13	6438384	GASOLINA, BRONCE COM-PRIMIDO	GG-20	5650030
AIRE, RESPIRADOR DEL COMPRESOR	GA-135	8875051	AIRE, 12 3/64 DIAM. EXT.	GA-57	6485108	GASOLINA, LAMINA	GG-5 L	5650780
GASOLINA, CARTUCHO	GG-20	5650030	AIRE	GA-192	6483864	8500 SERIES con motor/GMC V6-351M		
7500 SERIES con motor/GMC V8-637			GASOLINA	GG-123	7013404	ACEITE, CARTUCHO	G-33	5573014
ACEITE, FLUJO TOTAL (FULL FLOW)	G-33	5573014	80 SERIES con motor/GMC V8-327			AIRE	GA-56	6420690
COMBUSTIBLE, 1970-72	G-1175	5574508	ACEITE, 1962-66	G-33	5573014	AIRE, RESPIRADOR DEL COMPRESOR	GA-135	2467368
AIRE, RESPIRADOR DEL COMPRESOR	GA-135	2467368	ACEITE, 1967	G-34	6437562	GASOLINA, CARTUCHO	GG-20	5650030
ACEITE, DERIVACION (BY PASS)	G-750	2325391	ACEITE, 1962-66	G-200	5574540	GASOLINA, LAMINA	GG-5 L	5650780
GASOLINA, 1966-72	GG-20	5650030	ACEITE	GP-13	6438384	8500 SERIES con motor/GMC V6-401M		
7500 SERIES con motores/GMC D478 DIESEL, GMC DH478 DIESEL			AIRE, 1964-65	GA-56	5645017	ACEITE, CARTUCHO	G-33	5573014
ACEITE, 1964-74	G-33	5573014	GASOLINA, 1962-67	GG-20	5650030	AIRE	GA-56	6420690
COMBUSTIBLE, PRIMARIO	G-1175	5574508	80 SERIES con motor/GMC V8-348			AIRE, RESPIRADOR DEL COMPRESOR	GA-135	2467368
AIRE, RESPIRADOR DEL COMPRESOR	GA-135	2467368	ACEITE, 1962-65	G-33	5573014	GASOLINA, CARTUCHO	GG-20	5650030
7500 SERIES con motores/GMC D637 DIESEL, GMC DH637 DIESEL			ACEITE, 1958-65	G-200	5574540	GASOLINA, LAMINA	GG-5 L	5650780
ACEITE, FLUJO TOTAL (FULL FLOW)	G-33	5573014	AIRE, 1964-65	GA-56	5645017	8500 SERIES con motor/GMC V6-478		
COMBUSTIBLE	G-1175	5574508	GASOLINA, 1960-65	GG-20	5650030	ACEITE, CARTUCHO	G-33	5573014
AIRE, RESPIRADOR DEL COMPRESOR	GA-135	2467368	80 SERIES con motor/GMC V8-396			AIRE	GA-56	6420690
ACEITE, DERIVACION (BY PASS)	G-750	2325391	ACEITE, CARTUCHO 1966	G-33	5573014	AIRE, RESPIRADOR DEL COMPRESOR	GA-135	2467368
80 SERIES con motor/DETROIT DIESEL 6V-53			ACEITE, CARTUCHO 1967-69	G-34	6437562	GASOLINA, CARTUCHO	GG-20	5650030
ACEITE, FLUJO TOTAL (FULL FLOW)	G-33	5573014	ACEITE, CARTUCHO 1966-67	G-200	5574540	GASOLINA, LAMINA	GG-5 L	5650780
COMBUSTIBLE, SECUNDARIO	G-1175	5574508	ACEITE, SELLADO	GP-13	6438384	8500 SERIES con motor/GMC V6-478		
CARTUCHO			GASOLINA, 3 33/64 IN	GG-20	5650030	ACEITE, CARTUCHO	G-33	5573014
			GASOLINA, 1 3/64 IN	GG-6	5651393	AIRE	GA-56	6420690
			GASOLINA, 1 3/64 IN	GG-16	5651920	AIRE, RESPIRADOR DEL COMPRESOR	GA-135	2467368
			80 SERIES con motor/GMC V8-409			GASOLINA, BRONCE COM-PRIMIDO	GG-20	5650030
			ACEITE	G-33	5573014	GASOLINA, LAMINA	GG-5 L	5650780
			AIRE	GA-56	5645017			
			GASOLINA, 3 33/64 IN	GG-20	5650030			

APLICACIONES SERVICIO PESADO
HEAVY DUTY APPLICATIONS



MARCA-MODELO-MOTOR MAKE-MODEL-ENGINE	GONHER GONHER	OEM OEM	MARCA-MODELO-MOTOR MAKE-MODEL-ENGINE	GONHER GONHER	OEM OEM	MARCA-MODELO-MOTOR MAKE-MODEL-ENGINE	GONHER GONHER	OEM OEM
GENERAL MOTORS / CHEVROLET			GENERAL MOTORS / CHEVROLET			GENERAL MOTORS / CHEVROLET		
CAMIONES, TRACTOCAMIONES Y AUTOBUSES			CAMIONES, TRACTOCAMIONES Y AUTOBUSES			CAMIONES, TRACTOCAMIONES Y AUTOBUSES		
90 SERIES con motor/CATERPILLAR 3406			COMBUSTIBLE, SECUNDARIO SELLADO	GP-27	25014342	COMBUSTIBLE, SECUNDARIO SELLADO	GP-27	25014342
ACEITE, FLUJO TOTAL (FULL FLOW) (CUMPLE CON MEDI-DAS ORIGINALES)	GP-691	877452	AGUA, PRE-CARGA	GP-1011Q	25012895	AIRE, RESPIRADOR DEL COMPRESOR	GA-135	2467368
ACEITE, FLUJO TOTAL (FULL FLOW) (SEGUNDA OPCION)	GP-52	877452	AGUA, MANTENIMIENTO	GP-2071W	25012893	ACEITE, DERIVACION (BY PASS)	G-750	2325391
COMBUSTIBLE	GP-1108	9Y4429	AIRE, RESPIRADOR DEL COMPRESOR	GA-135	2467368	9500 SERIES con motor/GMC V8-637		
AIRE	GA-6129	700016	AIRE	GA-377	2014558	ACEITE, FLUJO TOTAL (FULL FLOW)	G-33	5573014
ACEITE, DERIVACION (BY PASS)	G-750	2325391	AIRE	GA-6129	700016	COMBUSTIBLE, 1970-72	G-1175	5574508
90 SERIES con motor/CUMMINS			ACEITE, DERIVACION (BY PASS)	G-750	2325391	AIRE, RESPIRADOR DEL COMPRESOR	GA-135	2467368
ACEITE, FLUJO TOTAL (FULL FLOW) CARTUCHO	G-566	257528	9000 SERIES con motor/GMC V6-351			ACEITE, DERIVACION (BY PASS)	G-750	2325391
ACEITE, TURBOCARGADOR	GP-14	15514175	ACEITE	G-33	5573014	GASOLINA, 1966-72	GG-20	5650030
COMBUSTIBLE, 5 3/4 IN	GPP-14	3315847	9000 SERIES con motor/GMC V8-348			9500 SERIES con motores/GMC 6V-92N, GMC 8V-92N, GMC 8V-92T, GMC 6V-92T, GMC 6V-92T		
COMBUSTIBLE, 5 17/32 IN	GP-1101	158172	ACEITE, OPCIONAL 2 CUARTOS 1962-65	G-33	5573014	ACEITE, FLUJO TOTAL (FULL FLOW)	G-33	5573014
ACEITE, FLUJO TOTAL (FULL FLOW) SELLADO	GP-53	3313287	ACEITE, 1958-65	G-200	5574540	COMBUSTIBLE, SECUNDARIO CARTUCHO	G-1175	5574508
COMBUSTIBLE, 11 15/32 IN	GP-55	25014341	COMBUSTIBLE, 1958-59	G-294	14071064	COMBUSTIBLE, PRIMARIO SELLADO	GP-26	25014274
COMBUSTIBLE, SEPARADOR DE AGUA	GPP-11	3308638	AIRE, 1964-65	GA-56	5645017	COMBUSTIBLE, SECUNDARIO SELLADO	GP-27	25014342
AGUA	GP-2071W	25012893	GASOLINA, 1960-65	GG-20	5650030	AGUA	GP-2071W	25012893
AIRE, RESPIRADOR CON TURBO	GA-39	255963	9005 SERIES con motores/CUMMINS NTC290, CUMMINS NTC350			AIRE	GA-377	2014558
AIRE, SECUNDARIO	GA-6127	204646	ACEITE, FLUJO TOTAL (FULL FLOW) CARTUCHO	G-566	257528	AIRE	GA-372	2010760
AIRE, PRIMARIO	GA-6129	700016	COMBUSTIBLE	GP-1101	158172	AIRE	GA-6129	700016
ACEITE, DERIVACION (BY PASS)	G-750	2325391	ACEITE, FLUJO TOTAL (FULL FLOW) SELLADO	GP-53	3313287	ACEITE, DERIVACION (BY PASS)	G-750	2325391
90 SERIES con motor/GMC 12V-71 DIESEL			ACEITE, DERIVACION (BY PASS)	G-750	2325391	9500 SERIES, 9502 SERIES con motores/GMC 6-71, GMC 6V-71N, GMC 8V-71N, GMC 8V-71T		
ACEITE, FLUJO TOTAL (FULL FLOW)	G-33	5573014	9005 SERIES, 9006 SERIES con motores/DETROIT DIESEL 6-71, DETROIT DIESEL 6V-92, DETROIT DIESEL 8V-71, DETROIT DIESEL 8V-92			ACEITE, FLUJO TOTAL (FULL FLOW)	G-33	5573014
COMBUSTIBLE, PRIMARIO	GP-26	25014274	ACEITE, FLUJO TOTAL (FULL FLOW)	G-33	5573014	COMBUSTIBLE, SECUNDARIO CARTUCHO	G-1175	5574508
COMBUSTIBLE, SECUNDARIO	GP-27	25014342	COMBUSTIBLE, SECUNDARIO CARTUCHO	G-1175	5574508	COMBUSTIBLE, PRIMARIO SELLADO	GP-26	25014274
AGUA, PRE-CARGA	GP-1011Q	25012895	COMBUSTIBLE, PRIMARIO SELLADO	GP-26	25014274	COMBUSTIBLE, SECUNDARIO SELLADO	GP-27	25014342
AGUA, MANTENIMIENTO	GP-2071W	25012893	COMBUSTIBLE, SECUNDARIO SELLADO	GP-27	25014342	AGUA, PRE-CARGA	GP-1011Q	25012895
AIRE	GA-6129	700016	AGUA	GP-2071W	25012893	AGUA, MANTENIMIENTO	GP-2071W	25012893
ACEITE, DERIVACION (BY PASS)	G-750	2325391	ACEITE, DERIVACION (BY PASS)	G-750	2325391	AIRE, RESPIRADOR DEL COMPRESOR	GA-135	2467368
90 SERIES con motor/GMC V8-637 GASOLINA			95 ASTRO SERIES con motor/GMC 8V-71 DIESEL			AIRE	GA-377	2014558
ACEITE, FLUJO TOTAL (FULL FLOW)	G-33	5573014	ACEITE, DERIVACION (BY PASS)	G-31	5572425	AIRE	GA-372	2010760
AIRE, RESPIRADOR DEL COMPRESOR	GA-135	2467368	ACEITE, FLUJO TOTAL (FULL FLOW)	G-33	5573014	AIRE	GA-6129	9034222
ACEITE, DERIVACION (BY PASS)	G-750	2325391	COMBUSTIBLE, SECUNDARIO	G-1175	5574508	ACEITE, DERIVACION (BY PASS)	G-750	2325391
GASOLINA	GG-20	5650030	9500 SERIES con motor/CUMMINS			9502 SERIES con motor/CATERPILLAR 3406		
90 SERIES con motores/DETROIT DIESEL 6V-92 SERIES, DETROIT DIESEL 8V-92 SERIES			ACEITE, FLUJO TOTAL (FULL FLOW) CARTUCHO	G-566	257528	ACEITE, CUMPLE CON MEDI-DAS ORIGINALES	GP-691	877452
ACEITE, FLUJO TOTAL (FULL FLOW)	G-33	5573014	COMBUSTIBLE, 5 3/4 IN	GPP-14	3315847	ACEITE, SEGUNDA OPCION	GP-52	877452
COMBUSTIBLE, SECUNDARIO CARTUCHO	G-1175	5574508	COMBUSTIBLE, 5 17/32 IN	GP-1101	158172	COMBUSTIBLE	GP-1108	9Y4429
COMBUSTIBLE, PRIMARIO SELLADO	GP-26	25014274	ACEITE, FLUJO TOTAL (FULL FLOW) SELLADO	GP-53	3313287	AGUA	GP-2071W	25012893
COMBUSTIBLE, SECUNDARIO SELLADO	GP-27	25014342	COMBUSTIBLE, SEPARADOR DE AGUA	GPP-11	3308638	AIRE	GA-6129	700016
AGUA, PRE-CARGA	GP-1011Q	25012895	AGUA	GP-2071W	25012893	ACEITE, DERIVACION (BY PASS)	G-750	2325391
AGUA, MANTENIMIENTO	GP-2071W	25012893	AIRE, RESPIRADOR (CON TURBO)	GA-39	255963	9502 SERIES con motor/CUMMINS		
AIRE	GA-377	2014558	AIRE	GA-6129	700016	ACEITE, FLUJO TOTAL (FULL FLOW) CARTUCHO	G-566	257528
AIRE	GA-372	2010760	ACEITE, DERIVACION (BY PASS)	G-750	2325391	COMBUSTIBLE, 5 3/4 IN	GPP-14	3315847
AIRE	GA-6129	700016	9500 SERIES con motor/GMC 6V-53N DIESEL			COMBUSTIBLE, 5 17/32 IN	GP-1101	158172
ACEITE, DERIVACION (BY PASS)	G-750	2325391	ACEITE, FLUJO TOTAL (FULL FLOW)	G-33	5573014	ACEITE, FLUJO TOTAL (FULL FLOW) SELLADO	GP-53	3313287
90 SERIES con motores/GMC 8V-71N DIESEL, GMC 6-71N DIESEL			COMBUSTIBLE, SECUNDARIO CARTUCHO	G-1173	3290851	COMBUSTIBLE, SEPARADOR DE AGUA	GPP-11	3308638
ACEITE, FLUJO TOTAL (FULL FLOW)	G-33	5573014	COMBUSTIBLE, PRIMARIO SELLADO	GP-26	25014274	AGUA	GP-2071W	25012893
COMBUSTIBLE, SECUNDARIO CARTUCHO	G-1175	5574508				AIRE, RESPIRADOR (CON TURBO)	GA-39	255963

SERVICIO PESADO

MARCA-MODELO-MOTOR MAKE-MODEL-ENGINE	GONHER GONHER	OEM OEM	MARCA-MODELO-MOTOR MAKE-MODEL-ENGINE	GONHER GONHER	OEM OEM	MARCA-MODELO-MOTOR MAKE-MODEL-ENGINE	GONHER GONHER	OEM OEM
GENERAL MOTORS / CHEVROLET			GENERAL MOTORS / CHEVROLET			GENERAL MOTORS / CHEVROLET		
CAMIONES, TRACTOCAMIONES Y AUTOBUSES			CAMIONES, TRACTOCAMIONES Y AUTOBUSES			CAMIONES, TRACTOCAMIONES Y AUTOBUSES		
AIRE	GA-6129	700016	COMBUSTIBLE, SECUNDARIO (CORTO)	GP-62	1R0751	COMBUSTIBLE, LARGO (2000-01)	GP-1109	1R0751
ACEITE, DERIVACION (BY PASS)	G-750	2325391	COMBUSTIBLE, PRIMARIO	GP-92	25014371	TRANSMISION (2000-01)	GP-9586	25011122
9502 SERIES con motor/GMC 12V-71			COMBUSTIBLE, SECUNDARIO (LARGO)	GP-1109	1R0751	AIRE	GA-197R	15696245
ACEITE, FLUJO TOTAL (FULL FLOW)	G-33	5573014	TRANSMISION	GP-9586	25011122	ACEITE, DERIVACION (BY PASS) (2002)	G-750	15525633
COMBUSTIBLE, PRIMARIO SELLADO	GP-26	25014274	AIRE	GA-197R	15696245	COMBUSTIBLE, SEPARADOR DE AGUA	S 3202	15618921
COMBUSTIBLE, SECUNDARIO SELLADO	GP-27	25014342	ACEITE, DERIVACION (BY PASS)	G-750	15525633	C5500 TOPKICK (CHEVROLET KODIAK) con motor/GMC 7.4L GASOLINA		
AGUA	GP-2071W	25012893	B7T042 con motor/CATERPILLAR 3126			TRANSMISION	GP-9586	25011122
AIRE	GA-6129	700016	ACEITE	GP-51	1R0739	ACEITE	GP-205	25160561
ACEITE, DERIVACION (BY PASS)	G-750	2325391	COMBUSTIBLE, SECUNDARIO (CORTO)	GP-62	1R0751	AIRE	GA-732R	25168082
9502 SERIES con motores/GMC 6V-92N, GMC 8V-92TT, GMC 6V-92T, GMC 6V-92TT, GMC 8V-92N, GMC 8V-92T			COMBUSTIBLE, PRIMARIO	GP-92	25014371	GASOLINA	GG-46	25055052
ACEITE, FLUJO TOTAL (FULL FLOW)	G-33	5573014	COMBUSTIBLE, SECUNDARIO (LARGO)	GP-1109	1R0751	C5500 TOPKICK (CHEVROLET KODIAK) con motor/GMC V8-8.1L F/ INJ.		
COMBUSTIBLE, SECUNDARIO CARTUCHO	G-1175	5574508	TRANSMISION	GP-9586	25011122	ACEITE	GP-408	25324052
COMBUSTIBLE, PRIMARIO SELLADO	GP-26	25014274	AIRE	GA-135	6585496	AIRE, 2003-04	GA-348	25313349
COMBUSTIBLE, SECUNDARIO SELLADO	GP-27	25014342	AIRE	GA-197R	15696245	AIRE, 2001-02	GA-732R	25168082
AGUA	GP-2071W	25012893	ACEITE, DERIVACION (BY PASS)	G-750	15525633	GASOLINA	GG-46	25121792
AIRE	GA-377	2014558	B7T042 con motor/GMC 6.0L GASOLINA			C5D042 con motor/CUMMINS		
AIRE	GA-372	2010760	ACEITE, 1993-97	GP-23	25010754	AIRE	GA-109	2063585
AIRE	GA-6129	700016	TRANSMISION	GP-9586	25011159	C5D042 con motor/DETROIT DIESEL 4-53		
ACEITE, DERIVACION (BY PASS)	G-750	2325391	ACEITE, 1997-98	GP-205	25160561	AIRE	GA-373	2031381
B6P042 con motor/DETROIT DIESEL 8.2L			AIRE	GA-59	6484235	C5D042 con motor/DETROIT DIESEL 8.2L		
ACEITE	GP-13	6438384	GASOLINA	GG-46	25055052	ACEITE	GP-13	6438384
DIRECCION	GP-14	15514175	B7T042 con motor/GMC 6.5L DIESEL			COMBUSTIBLE, PRIMARIO	GP-92	25011011
COMBUSTIBLE, PRIMARIO	GP-92	25011011	TRANSMISION	GP-9586	25011122	COMBUSTIBLE, SECUNDARIO	GP-93	25010959
COMBUSTIBLE, SECUNDARIO	GP-93	25010959	ACEITE	GP-205	25160561	C5D042 con motor/GASOLINA V6-379		
TRANSMISION	GP-9586	25011122	AIRE	GA-197R	15696245	AIRE	GA-90	5648003
AIRE, COMPRESOR	GA-135	2031381	B7T042 con motor/GMC 7.0L GASOLINA			C5D042 con motor/GMC 6-250		
COMBUSTIBLE, SEPARADOR DE AGUA	S 3202	15618921	ACEITE, 1993-96	GP-23	25010754	ACEITE	GP-3	6435679
B6P042 con motor/GMC 6-292			TRANSMISION	GP-9586	25011159	AIRE	GA-90	5648003
ACEITE	GP-13	6438384	ACEITE, 1997-98	GP-205	25160561	GASOLINA	GG-16	5651920
AIRE	GA-90	5648003	AIRE	GA-59	6484235	C5D042 con motor/GMC 6-292		
GASOLINA	GG-20	5650030	GASOLINA	GG-46	25055052	ACEITE	GP-13	6438384
B6P042, B6PO42 con motor/GMC V8-350			B7T042 con motor/GMC 7.4L GASOLINA			AIRE	GA-90	5648003
ACEITE, 1 CUARTO	GP-13	6438384	TRANSMISION	GP-9586	25011122	GASOLINA, 3 33/64 IN	GG-20	5650030
ACEITE, 2 CUARTOS	GP-23	25010754	ACEITE	GP-408	25324052	GASOLINA, 1 3/64 IN PARA CARBURADORES ROCHESTER	GG-6	5651393
AIRE, COMPRESOR	GA-135	2031381	ACEITE, 1999	GP-205	25160561	GASOLINA, 1 3/64 IN PARA CARBURADORES ROCHESTER	GG-16	5651920
GASOLINA, 3 33/64 IN	GG-20	5650030	AIRE	GA-732R	25168082	AIRE, RESPIRADOR	GA-100	2019681
GASOLINA, 1 3/64 IN PARA CARBURADORES ROCHESTER	GG-6	5651393	GASOLINA	GG-46	25055052	C5D042 con motor/GMC V6-305C		
GASOLINA, 1 3/64 IN PARA CARBURADORES ROCHESTER	GG-16	5651920	B7T042 con motor/GMC V8-8.1L F/INJ.			ACEITE	GP-20	6437994
B6P042, B6PO42 con motores/GMC V8-366, GMC V8-427			TRANSMISION	GP-9586	25011122	AIRE	GA-90	5648003
ACEITE	GP-23	25010754	ACEITE	GP-408	25324052	GASOLINA	GG-6	5651393
AIRE, COMPRESOR	GA-135	2031381	AIRE	GA-348	25313349	C5D042 con motor/GMC V6-432		
GASOLINA	GG-20	5650030	GASOLINA	GG-46	25121792	ACEITE	G-33	5573014
B6P042 con motor/DETROIT DIESEL			C4500 TOPKICK (CHEVROLET KODIAK) con motor/GMC V8-8.1L F/ INJ.			C5D042 con motor/GMC V8-350		
ACEITE	GP-13	6438384	ACEITE	GP-408	25324052	ACEITE, 1 CUARTO	GP-13	6438384
COMBUSTIBLE, PRIMARIO	GP-92	25011011	AIRE	GA-348	25313349	ACEITE, 2 CUARTOS	GP-23	25010754
COMBUSTIBLE, SECUNDARIO	GP-93	25010959	GASOLINA	GG-46	25121792	AIRE	GA-89	25043585
AIRE, COMPRESOR	GA-135	2031381	C5500 TOPKICK (CHEVROLET KODIAK) con motor/CATERPILLAR 3126B			AIRE, COMPRESOR	GA-135	2031381
B7T042 con motor/CATERPILLAR 3116			COMBUSTIBLE, PRIMARIO (2002)	GP-26	25014274	GASOLINA, 3 33/64 IN	GG-20	5650030
ACEITE	GP-51	1R0739	ACEITE	GP-51	1R0739	GASOLINA, 1 3/64 IN PARA CARBURADORES ROCHESTER	GG-6	5651393
			COMBUSTIBLE, CORTO (2000-01)	GP-62	1R0751			

APLICACIONES SERVICIO PESADO
HEAVY DUTY APPLICATIONS



MARCA-MODELO-MOTOR MAKE-MODEL-ENGINE	GONHER GONHER	OEM OEM	MARCA-MODELO-MOTOR MAKE-MODEL-ENGINE	GONHER GONHER	OEM OEM	MARCA-MODELO-MOTOR MAKE-MODEL-ENGINE	GONHER GONHER	OEM OEM
GENERAL MOTORS / CHEVROLET			GENERAL MOTORS / CHEVROLET			GENERAL MOTORS / CHEVROLET		
CAMIONES, TRACTOCAMIONES Y AUTOBUSES			CAMIONES, TRACTOCAMIONES Y AUTOBUSES			CAMIONES, TRACTOCAMIONES Y AUTOBUSES		
GASOLINA, 1 3/64 IN PARA CARBURADORES ROCHESTER	GG-16	5651920	C6500 TOPKICK (CHEVROLET KODIAK) con motor/CATERPILLAR C7			AIRE	GA-90	5648003
C5D042 con motor/GMC V8-366			COMBUSTIBLE, PRIMARIO	GP-26	25014274	GASOLINA	GG-6	5651393
ACEITE	GP-23	25010754	ACEITE	GP-51	1R0739	C6D042 con motor/GMC V6-379		
AIRE	GA-59	6484235	AIRE	GA-197R	15696245	AIRE	GA-90	5648003
AIRE	GA-89	8997890	ACEITE, DERIVACION (BY PASS)	G-750	15525633	C6D042 con motor/GMC V6-432		
GASOLINA	GG-20	5650030	COMBUSTIBLE, SEPARADOR DE AGUA	S 3202	15618921	ACEITE	G-33	5573014
C5D042 con motor/GMC V8-427			C6500 TOPKICK (CHEVROLET KODIAK) con motor/GMC V8-454 (7.4L)			C6D042 con motor/GMC V8-350		
ACEITE	GP-23	25010754	ACEITE	GP-23	25010754	ACEITE, 1 CUARTO	GP-13	6438384
AIRE	GA-89	8997890	TRANSMISION	GP-9586	25011122	ACEITE, 2 CUARTOS	GP-23	25010754
GASOLINA	GG-20	5650030	AIRE	GA-732R	25168082	AIRE, 1985-90	GA-89	25043585
C5D042 con motor/DETROIT DIESEL 8.2L			GASOLINA	GG-46	25055052	AIRE, COMPRESOR	GA-135	2031381
ACEITE	GP-13	6438384	C6500 TOPKICK (CHEVROLET KODIAK) con motor/GMC V8-8.1L F/ INJ.			GASOLINA, 3 33/64 IN	GG-20	5650030
COMBUSTIBLE, PRIMARIO	GP-92	25011011	ACEITE	GP-408	25324052	GASOLINA, 1 3/64 IN PARA CARBURADORES ROCHESTER	GG-6	5651393
COMBUSTIBLE, SECUNDARIO	GP-93	25010959	AIRE	GA-732R	25168082	GASOLINA, 1 3/64 IN PARA CARBURADORES ROCHESTER	GG-16	5651920
C5D042 con motor/GMC 6-292			GASOLINA	GG-46	25121792	C6D042 con motor/GMC V8-366		
ACEITE	GP-13	6438384	C6500 TOPKICK con motor/CATERPILLAR 3116			ACEITE	GP-23	25010754
AIRE	GA-90	3979576	ACEITE	GP-51	1R0739	AIRE	GA-59	6484235
GASOLINA, 3 33/64 IN	GG-20	5650030	COMBUSTIBLE	GP-62	1R0751	AIRE	GA-89	8997890
GASOLINA, 1 3/64 IN PARA CARBURADORES ROCHESTER	GG-6	5651393	AIRE, PRIMARIO	GA-197R	15619013	AIRE, COMPRESOR	GA-135	2031381
GASOLINA, 1 3/64 IN PARA CARBURADORES ROCHESTER	GG-16	5651920	C6D042 con motor/CATERPILLAR 3208			GASOLINA	GG-20	5650030
C5D042 con motor/GMC V8-350			ACEITE	GP-36	9L9200	C6D042 con motor/GMC V8-427		
ACEITE, 1 CUARTO	GP-13	6438384	GASOLINA, SEPARADOR DE AGUA	G-293	9Y4445	ACEITE	GP-23	25010754
ACEITE, 2 CUARTOS	GP-23	25010754	COMBUSTIBLE	GP-110	1R0740	AIRE	GA-89	8997890
AIRE, COMPRESOR	GA-135	2031381	ACEITE	GP-9586	9N5570	AIRE, COMPRESOR	GA-135	2031381
GASOLINA, 3 33/64 IN	GG-20	5650030	C6D042 con motor/CUMMINS			GASOLINA	GG-20	5650030
GASOLINA, 1 3/64 IN PARA CARBURADORES ROCHESTER	GG-6	5651393	AIRE	GA-109	2063585	C6D064, C6D042, C6D064 con motores/GMC V8-366, GMC V8-427		
GASOLINA, 1 3/64 IN PARA CARBURADORES ROCHESTER	GG-16	5651920	C6D042 con motor/DETROIT DIESEL 4-53T			ACEITE	GP-23	25010754
C5H042 con motor/CATERPILLAR 3116			ACEITE, FLUJO TOTAL (FULL FLOW)	G-33	5573014	AIRE, COMPRESOR	GA-135	2031381
ACEITE	GP-51	1R0739	COMBUSTIBLE, SECUNDARIO	G-1173	3290851	GASOLINA	GG-20	5650030
COMBUSTIBLE	GP-92	25014371	AIRE, COMPRESOR	GA-135	2031381	C6D042 con motor/CATERPILLAR C3208		
COMBUSTIBLE	GP-110	1R0740	AIRE	GA-373	2031381	ACEITE	GP-36	9L9200
AIRE	GA-197R	15696245	C6D042 con motor/DETROIT DIESEL 8.2L			GASOLINA, SEPARADOR DE AGUA	G-293	9Y4445
ACEITE, DERIVACION (BY PASS)	G-750	15525633	ACEITE	GP-13	6438384	COMBUSTIBLE	GP-110	1R0740
C5H042 con motores/GMC 6.0L, GMC 7.0L			COMBUSTIBLE, PRIMARIO	GP-92	25011011	ACEITE	GP-9586	9N5570
ACEITE	GP-23	25010754	COMBUSTIBLE, SECUNDARIO	GP-93	25010959	C6D042 con motor/DETROIT DIESEL		
AIRE	GA-59	6484235	AIRE, COMPRESOR	GA-135	2031381	ACEITE	GP-13	6438384
GASOLINA	GG-46	25055052	C6D042 con motor/GMC 6-250			COMBUSTIBLE, PRIMARIO	GP-92	25011011
C6500 KODIAK con motor/DURAMAX 7.8L DIESEL			ACEITE	GP-3	6435679	COMBUSTIBLE, SECUNDARIO	GP-93	25010959
AIRE, PRIMARIO	GA-930R	12471801	AIRE	GA-90	5648003	AIRE, COMPRESOR	GA-135	2031381
C6500 TOPKICK (CHEVROLET KODIAK) con motor/CATERPILLAR 3126B			GASOLINA	GG-16	5651920	C6D042 con motor/DETROIT DIESEL 4-53T		
COMBUSTIBLE, PRIMARIO (2002-03)	GP-26	25014274	C6D042 con motor/GMC 6-292			ACEITE, FLUJO TOTAL (FULL FLOW)	G-33	5573014
ACEITE	GP-51	1R0739	ACEITE	GP-13	6438384	COMBUSTIBLE, SECUNDARIO	G-1173	3290851
COMBUSTIBLE, CORTO (2000-01)	GP-62	1R0751	AIRE	GA-90	5648003	AIRE, COMPRESOR	GA-135	2031381
COMBUSTIBLE, LARGO (2000-01)	GP-1109	1R0751	GASOLINA, 3 33/64 IN	GG-20	5650030	AIRE	GA-373	2031381
TRANSMISION	GP-9586	25011122	GASOLINA, 1 3/64 IN PARA CARBURADORES ROCHESTER	GG-6	5651393	C6D042 con motor/GMC 6-292		
AIRE	GA-197R	15696245	GASOLINA, 1 3/64 IN PARA CARBURADORES ROCHESTER	GG-16	5651920	ACEITE	GP-13	6438384
ACEITE, DERIVACION (BY PASS) (2002-03)	G-750	15525633	AIRE, RESPIRADOR	GA-100	2019681	AIRE	GA-90	3979576
COMBUSTIBLE, SEPARADOR DE AGUA	S 3202	15618921	C6D042 con motor/GMC V6-305C			GASOLINA, 3 33/64 IN	GG-20	5650030
			ACEITE	GP-20	6437994	GASOLINA, 1 3/64 IN PARA CARBURADORES ROCHESTER	GG-6	5651393
						GASOLINA, 1 3/64 IN PARA CARBURADORES ROCHESTER	GG-16	5651920

SERVICIO PESADO

MARCA-MODELO-MOTOR MAKE-MODEL-ENGINE	GONHER GONHER	OEM OEM	MARCA-MODELO-MOTOR MAKE-MODEL-ENGINE	GONHER GONHER	OEM OEM	MARCA-MODELO-MOTOR MAKE-MODEL-ENGINE	GONHER GONHER	OEM OEM
GENERAL MOTORS / CHEVROLET			GENERAL MOTORS / CHEVROLET			GENERAL MOTORS / CHEVROLET		
CAMIONES, TRACTOCAMIONES Y AUTOBUSES			CAMIONES, TRACTOCAMIONES Y AUTOBUSES			CAMIONES, TRACTOCAMIONES Y AUTOBUSES		
C6D042 con motor/GMC V8-350			C7500 TOPKICK (CHEVROLET KODIAK) con motor/CATERPILLAR C7			C7D042 con motor/GMC V6-379		
ACEITE, 1 CUARTO	GP-13	6438384	COMBUSTIBLE, PRIMARIO	GP-26	25014274	AIRE	GA-90	5648003
ACEITE, 2 CUARTOS	GP-23	25010754	ACEITE	GP-51	1R0739			
AIRE, COMPRESOR	GA-135	2031381	AIRE	GA-197R	15696245	C7D042 con motor/GMC V6-432		
GASOLINA, 3 33/64 IN	GG-20	5650030	ACEITE, DERIVACION (BY PASS)	G-750	15525633	ACEITE	G-33	5573014
GASOLINA, 1 3/64 IN PARA CARBURADORES ROCHESTER	GG-6	5651393	COMBUSTIBLE, SEPARADOR DE AGUA	S 3202	15618921	C7D042 con motor/GMC V8-350		
GASOLINA, 1 3/64 IN PARA CARBURADORES ROCHESTER	GG-16	5651920	C7500 TOPKICK (CHEVROLET KODIAK) con motor/GMC 7.4L GASOLINA			ACEITE	GP-23	25010754
C6H042 TOPKICK con motor/CATERPILLAR 3116			TRANSMISION	GP-9586	25011122	AIRE	GA-89	25043585
COMBUSTIBLE	GP-26	25014274	ACEITE	GP-205	25160561	GASOLINA	GG-20	5650030
ACEITE	GP-51	1R0739	AIRE	GA-732R	25168082	C7D042 con motor/GMC V8-366		
COMBUSTIBLE	GP-92	25014371	GASOLINA	GG-46	25055052	ACEITE	GP-23	25010754
COMBUSTIBLE	GP-110	1R0740	C7500 TOPKICK (CHEVROLET KODIAK) con motor/GMC V8-8.1L F/INJ			AIRE	GA-59	6484235
TRANSMISION	GP-9586	25011122	ACEITE	GP-408	25324052	AIRE	GA-89	8997890
AGUA	GP-2071W	25012893	AIRE	GA-732R	25168082	AIRE, COMPRESOR	GA-135	2031381
AIRE, PRIMARIO	GA-197R	15619013	GASOLINA	GG-46	25121792	GASOLINA	GG-20	5650030
AIRE, SECUNDARIO	GA-768R	311455	C7D042 con motor/CATERPILLAR 3208			C7D042 con motor/GMC V8-427		
ACEITE, DERIVACION (BY PASS)	G-750	15525633	ACEITE	GP-36	9L9200	ACEITE	GP-23	25010754
COMBUSTIBLE, SEPARADOR DE AGUA	S 3202	15618921	GASOLINA, SEPARADOR DE AGUA	G-293	9Y4445	AIRE	GA-89	8997890
C6H042 TOPKICK con motor/CATERPILLAR 3126			COMBUSTIBLE	GP-110	1R0740	AIRE, COMPRESOR	GA-135	2031381
AIRE	GA-197R	15696245	ACEITE	GP-9586	9N5570	GASOLINA	GG-20	5650030
ACEITE, DERIVACION (BY PASS)	G-750	15525633	C7D042 con motor/CUMMINS VT225			C7D042 con motor/GMC V8-454		
COMBUSTIBLE, SEPARADOR DE AGUA	S 3202	15618921	ACEITE, FLUJO TOTAL (FULL FLOW) CARTUCHO	G-566	257528	ACEITE	GP-23	25010754
C6H042 TOPKICK con motor/CATERPILLAR 3126B			COMBUSTIBLE	GP-1101	158172	AIRE, COMPRESOR	GA-135	2031381
ACEITE	GP-51	1R0739	ACEITE, FLUJO TOTAL (FULL FLOW) SELLADO	GP-53	3313287	GASOLINA	GG-20	5650030
C6H042 TOPKICK con motor/GMC 6.5L DIESEL			AGUA	GP-2071W	25012893	C7D064 con motor/CATERPILLAR 3208		
TRANSMISION	GP-9586	25011122	C7D042 con motor/DETROIT DIESEL 4-53T			ACEITE	GP-36	9L9200
ACEITE	GP-205	25160561	ACEITE, FLUJO TOTAL (FULL FLOW)	G-33	5573014	GASOLINA, SEPARADOR DE AGUA	G-293	9Y4445
AIRE	GA-197R	15696245	COMBUSTIBLE, SECUNDARIO	G-1173	3290851	COMBUSTIBLE	GP-110	1R0740
C6H042 TOPKICK con motor/GMC 7.0L GASOLINA			AIRE, COMPRESOR	GA-135	2031381	ACEITE	GP-9586	9N5570
ACEITE	GP-23	25010754	AIRE	GA-373	2031381	C7D064 con motor/CUMMINS VT225		
TRANSMISION	GP-9586	25011122	C7D042 con motor/DETROIT DIESEL 8.2L			ACEITE, FLUJO TOTAL (FULL FLOW) CARTUCHO	G-566	257528
ACEITE	GP-205	25160561	ACEITE	GP-13	6438384	COMBUSTIBLE	GP-1101	158172
AIRE	GA-59	6484235	COMBUSTIBLE, PRIMARIO	GP-92	25011011	ACEITE, FLUJO TOTAL (FULL FLOW) SELLADO	GP-53	3313287
GASOLINA	GG-46	25055052	COMBUSTIBLE, SECUNDARIO	GP-93	25010959	AGUA	GP-2071W	25012893
C6H042 TOPKICK con motor/GMC 7.4L GASOLINA			AIRE, COMPRESOR	GA-135	2031381	C7D064 con motor/DETROIT DIESEL 8.2L		
ACEITE	GP-205	25160561	C7D042 con motor/DEUTZ BF6L913			ACEITE	GP-13	6438384
AIRE	GA-732R	25168082	COMBUSTIBLE	GP-1122	25011422	COMBUSTIBLE, PRIMARIO	GP-92	25011011
GASOLINA	GG-46	25055052	C7D042 con motor/GMC 6-250 GASOLINA			COMBUSTIBLE, SECUNDARIO	GP-93	25010959
C6H042 TOPKICK con motor/GMC 6.5L DIESEL			ACEITE	GP-3	6435679	AIRE, COMPRESOR	GA-135	2031381
TRANSMISION	GP-9586	25011122	AIRE	GA-90	5648003	GASOLINA	GG-20	5650030
ACEITE	GP-51	1R0739	GASOLINA	GG-16	5651920	C7D042 con motor/CATERPILLAR C3208		
AIRE	GA-197R	15619013	C7D042 con motor/GMC 6-292 GASOLINA			ACEITE	GP-36	9L9200
AIRE, SECUNDARIO	GA-768R	311455	ACEITE	GP-13	6438384	GASOLINA, SEPARADOR DE AGUA	G-293	9Y4445
C7500 TOPKICK (CHEVROLET KODIAK) con motor/CATERPILLAR 3126B DIESEL			AIRE	GA-90	5648003	COMBUSTIBLE	GP-110	1R0740
COMBUSTIBLE, PRIMARIO	GP-26	25014274	GASOLINA	GG-16	5651920	ACEITE	GP-9586	9N5570
ACEITE	GP-51	1R0739	C7D042 con motor/GMC V6-305C			C7D042 con motor/DETROIT DIESEL		
TRANSMISION	GP-9586	25011122	ACEITE	GP-20	6437994	ACEITE	GP-13	6438384
AIRE	GA-197R	15696245	AIRE	GA-90	5648003	COMBUSTIBLE, PRIMARIO	GP-92	25011011
ACEITE, DERIVACION (BY PASS)	G-750	15525633	GASOLINA	GG-6	5651393	COMBUSTIBLE, SECUNDARIO	GP-93	25010959
COMBUSTIBLE, SEPARADOR DE AGUA	S 3202	15618921						

APLICACIONES SERVICIO PESADO
HEAVY DUTY APPLICATIONS



MARCA-MODELO-MOTOR MAKE-MODEL-ENGINE	GONHER GONHER	OEM OEM	MARCA-MODELO-MOTOR MAKE-MODEL-ENGINE	GONHER GONHER	OEM OEM	MARCA-MODELO-MOTOR MAKE-MODEL-ENGINE	GONHER GONHER	OEM OEM
GENERAL MOTORS / CHEVROLET			GENERAL MOTORS / CHEVROLET			GENERAL MOTORS / CHEVROLET		
CAMIONES, TRACTOCAMIONES Y AUTOBUSES			CAMIONES, TRACTOCAMIONES Y AUTOBUSES			CAMIONES, TRACTOCAMIONES Y AUTOBUSES		
AIRE, COMPRESOR	GA-135	2031381	C7H064 TOPKICK con motor/CATERPILLAR 3116			D9K042 con motor/DETROIT DIESEL 8V-92 SERIES		
C7D042 con motor/DETROIT DIESEL 4-53T			ACEITE	GP-51	1R0739	ACEITE, FLUJO TOTAL (FULL FLOW)	G-33	5573014
ACEITE, FLUJO TOTAL (FULL FLOW)	G-33	5573014	COMBUSTIBLE	GP-62	1R0751	COMBUSTIBLE, PRIMARIO	GP-26	25014274
COMBUSTIBLE, SECUNDARIO	G-1173	3290851	COMBUSTIBLE	GP-110	1R0740	COMBUSTIBLE, SECUNDARIO	GP-27	25014342
AIRE, COMPRESOR	GA-135	2031381	AIRE, PRIMARIO	GA-197R	15696245	AGUA	GP-2071W	25012893
AIRE	GA-373	2031381	AIRE, SECUNDARIO	GA-768R	311455	AIRE	GA-376	15515589
						AIRE	GA-377	2014558
C7D042 con motores/GMC V8-454, GMC V8-366, GMC V8-427			C7H042 KODIAK, C7H064 KODIAK con motor/CATERPILLAR 3116			ACEITE, DERIVACION (BY PASS)	G-750	2325391
ACEITE	GP-23	25010754	GASOLINA, SEPARADOR DE AGUA	G-293	9Y4445	D9K042 con motores/CUMMINS FORMULA 300, CUMMINS FORMULA 350, CUMMINS FORMULA 400, CUMMINS NTC300		
AIRE, COMPRESOR	GA-135	2031381	ACEITE	GP-51	1R0739	COMBUSTIBLE	GP-1101	158172
GASOLINA	GG-20	5650030	COMBUSTIBLE	GP-110	1R0740	ACEITE, FLUJO TOTAL (FULL FLOW) SELLADO	GP-53	3313287
			AIRE, PRIMARIO	GA-197R	15619013	ACEITE, DERIVACION (BY PASS) SELLADO	GP-57	3304232
C7D064 con motor/CATERPILLAR C3208			AIRE, SECUNDARIO	GA-768R	311455	AGUA	GP-2071W	25012893
ACEITE	GP-36	9L9200	C8500 SERIES con motor/CATERPILLAR 3126B			AIRE	GA-376	15515589
GASOLINA, SEPARADOR DE AGUA	G-293	9Y4445	COMBUSTIBLE, PRIMARIO (2002-03)	GP-26	25014274	AIRE	GA-6129	700016
COMBUSTIBLE	GP-110	1R0740	ACEITE	GP-51	1R0739	ACEITE, DERIVACION (BY PASS) CARTUCHO	G-750	2325391
ACEITE	GP-9586	9N5570	COMBUSTIBLE, CORTO	GP-62	1R0751	COMBUSTIBLE	GP-1101	158172
			COMBUSTIBLE, LARGO	GP-1109	1R0751	ACEITE, FLUJO TOTAL (FULL FLOW) SELLADO	GP-53	3313287
C7D064 con motor/DETROIT DIESEL			TRANSMISION	GP-9586	25011122	AIRE	GA-376	15515589
ACEITE	GP-13	6438384	AIRE	GA-197R	15696245	AIRE	GA-6129	700016
COMBUSTIBLE, PRIMARIO	GP-92	25011011	ACEITE, DERIVACION (BY PASS) (2002-03)	G-750	15525633	ACEITE, DERIVACION (BY PASS)	G-750	2325391
COMBUSTIBLE, SECUNDARIO	GP-93	25010959	COMBUSTIBLE, SEPARADOR DE AGUA	S 3202	15618921	D9K042 con motores/CUMMINS NTC290, CUMMINS NTC350, CUMMINS NTC400		
AIRE, COMPRESOR	GA-135	2031381	C8500 SERIES con motor/CATERPILLAR C7 DIESEL			ACEITE, FLUJO TOTAL (FULL FLOW) CARTUCHO	G-566	257528
			COMBUSTIBLE, PRIMARIO	GP-26	25014274	COMBUSTIBLE	GP-1101	158172
C7H042 TOPKICK con motor/CATERPILLAR 3116			ACEITE	GP-51	1R0739	ACEITE, FLUJO TOTAL (FULL FLOW) SELLADO	GP-53	3313287
ACEITE	GP-51	1R0739	ACEITE	GP-51	1R0739	AIRE	GA-376	15515589
COMBUSTIBLE	GP-62	1R0751	AIRE	GA-197R	15696245	AIRE	GA-6129	700016
ACEITE, DERIVACION (BY PASS) SELLADO	GP-57	15964034	ACEITE, DERIVACION (BY PASS)	G-750	15525633	ACEITE, DERIVACION (BY PASS)	G-750	2325391
COMBUSTIBLE	GP-110	1R0740	COMBUSTIBLE, SEPARADOR DE AGUA	S 3202	15618921	D9K042 con motores/DETROIT DIESEL 6-71N, DETROIT DIESEL 6-71T		
TRANSMISION	GP-9586	25011122	C8500 SERIES con motor/GMC 7.4L GASOLINA			ACEITE, FLUJO TOTAL (FULL FLOW)	G-33	5573014
AGUA	GP-2071W	25012893	TRANSMISION	GP-9586	25011122	COMBUSTIBLE, PRIMARIO	GP-26	25014274
AIRE, PRIMARIO	GA-197R	15696245	ACEITE	GP-205	25160561	COMBUSTIBLE, SECUNDARIO	GP-27	25014342
AIRE, SECUNDARIO	GA-768R	311455	AIRE	GA-732R	25168082	AGUA	GP-2071W	25012893
ACEITE, DERIVACION (BY PASS) CARTUCHO	G-750	15525633	GASOLINA	GG-46	25055052	AIRE	GA-377	2014558
COMBUSTIBLE, SEPARADOR DE AGUA	S 3202	15618921	C8500 SERIES con motor/GMC V8-8.1L F/INJ			AIRE	GA-6129	700016
			ACEITE	GP-408	25324052	ACEITE, DERIVACION (BY PASS)	G-750	2325391
C7H042 TOPKICK con motor/CATERPILLAR 3126			AIRE	GA-732R	25168082	D9K042, D9K064 con motor/CATERPILLAR 3406		
AIRE	GA-197R	15696245	GASOLINA	GG-46	25121792	ACEITE, CUMPLE CON MEDI-DAS ORIGINALES	GP-691	8T7452
ACEITE, DERIVACION (BY PASS)	G-750	15525633				ACEITE, SEGUNDA OPCION	GP-52	8T7452
COMBUSTIBLE, SEPARADOR DE AGUA	S 3202	15618921	D9K042 con motor/DETROIT DIESEL 6V-92 SERIES			COMBUSTIBLE	GP-1108	9Y4429
			ACEITE, FLUJO TOTAL (FULL FLOW)	G-33	5573014	AIRE	GA-377	2014558
C7H042 TOPKICK con motor/GMC 6.5L DIESEL			COMBUSTIBLE, PRIMARIO	GP-26	25014274	AIRE	GA-6129	700016
TRANSMISION	GP-9586	25011122	COMBUSTIBLE, SECUNDARIO	GP-27	25014342	D9K042, D9K042 con motor/CUMMINS KT450		
ACEITE	GP-205	25160561	AGUA	GP-2071W	25012893	COMBUSTIBLE	GP-1101	158172
AIRE	GA-197R	15696245	AIRE	GA-376	15515589	ACEITE, FLUJO TOTAL (FULL FLOW)	GP-53	3313287
			AIRE	GA-377	2014558	ACEITE, DERIVACION (BY PASS)	G-750	2325391
C7H042 TOPKICK con motor/GMC 7.4L GASOLINA			ACEITE, DERIVACION (BY PASS)	G-750	2325391	D9K064 con motor/DETROIT DIESEL 6V-92 SERIES		
ACEITE	GP-205	25160561	D9K042 con motor/DETROIT DIESEL 8V-71 SERIES			ACEITE, FLUJO TOTAL (FULL FLOW)	G-33	5573014
AIRE	GA-732R	25168082	ACEITE, FLUJO TOTAL (FULL FLOW)	G-33	5573014	COMBUSTIBLE, PRIMARIO	GP-26	25014274
GASOLINA	GG-46	25055052	COMBUSTIBLE, PRIMARIO	GP-26	25014274	COMBUSTIBLE, SECUNDARIO	GP-27	25014342
			COMBUSTIBLE, SECUNDARIO	GP-27	25014342	AGUA	GP-2071W	25012893
C7H042 TOPKICK con motores/GMC 6.0L GASOLINA, GMC 7.0L GASOLINA			AGUA	GP-2071W	25012893	AIRE	GA-376	15515589
ACEITE	GP-23	25010754	AIRE	GA-377	2014558	AIRE	GA-377	2014558
TRANSMISION	GP-9586	25011122	AIRE	GA-6129	700016	ACEITE, DERIVACION (BY PASS)	G-750	2325391
ACEITE	GP-205	25160561	ACEITE, DERIVACION (BY PASS)	G-750	2325391			
AIRE	GA-59	6484235						
GASOLINA	GG-46	25055052						

SERVICIO PESADO

MARCA-MODELO-MOTOR MAKE-MODEL-ENGINE	GONHER GONHER	OEM OEM	MARCA-MODELO-MOTOR MAKE-MODEL-ENGINE	GONHER GONHER	OEM OEM	MARCA-MODELO-MOTOR MAKE-MODEL-ENGINE	GONHER GONHER	OEM OEM
GENERAL MOTORS / CHEVROLET			GENERAL MOTORS / CHEVROLET			GENERAL MOTORS / CHEVROLET		
CAMIONES, TRACTOCAMIONES Y AUTOBUSES			CAMIONES, TRACTOCAMIONES Y AUTOBUSES			CAMIONES, TRACTOCAMIONES Y AUTOBUSES		
D9K064 con motor/DETROIT DIESEL 8V-71 SERIES			D9K042 con motor/DETROIT DIESEL 8V-71 SERIES			D9L042 con motor/DETROIT DIESEL 6V-92 SERIES		
ACEITE, FLUJO TOTAL (FULL FLOW)	G-33	5573014	ACEITE, FLUJO TOTAL (FULL FLOW)	G-33	5573014	ACEITE, FLUJO TOTAL (FULL FLOW) SELLADO	GP-53	3313287
COMBUSTIBLE, PRIMARIO	GP-26	25014274	COMBUSTIBLE, PRIMARIO	GP-26	25014274	AIRE	GA-6129	700016
COMBUSTIBLE, SECUNDARIO	GP-27	25014342	COMBUSTIBLE, SECUNDARIO	GP-27	25014342	ACEITE, DERIVACION (BY PASS)	G-750	2325391
AGUA	GP-2071W	25012893	AGUA	GP-2071W	25012893	D9L042 con motor/DETROIT DIESEL 6V-92 SERIES		
AIRE	GA-377	2014558	AIRE	GA-6129	700016	ACEITE, FLUJO TOTAL (FULL FLOW)	G-33	5573014
AIRE	GA-6129	700016	ACEITE, DERIVACION (BY PASS)	G-750	2325391	COMBUSTIBLE, PRIMARIO	GP-26	25014274
ACEITE, DERIVACION (BY PASS)	G-750	2325391	D9K042 con motor/DETROIT DIESEL 8V-92 SERIES			COMBUSTIBLE, SECUNDARIO	GP-27	25014342
D9K064 con motor/DETROIT DIESEL 8V-92 SERIES			ACEITE, FLUJO TOTAL (FULL FLOW)	G-33	5573014	AGUA	GP-2071W	25012893
ACEITE, FLUJO TOTAL (FULL FLOW)	G-33	5573014	COMBUSTIBLE, PRIMARIO	GP-26	25014274	AIRE	GA-376	15515589
COMBUSTIBLE, PRIMARIO	GP-26	25014274	COMBUSTIBLE, SECUNDARIO	GP-27	25014342	AIRE	GA-377	2014558
COMBUSTIBLE, SECUNDARIO	GP-27	25014342	AGUA	GP-2071W	25012893	ACEITE, DERIVACION (BY PASS)	G-750	2325391
AGUA	GP-2071W	25012893	AIRE	GA-377	2014558	D9L042 con motor/DETROIT DIESEL 8V-71 SERIES		
AIRE	GA-376	15515589	ACEITE, DERIVACION (BY PASS)	G-750	2325391	ACEITE, FLUJO TOTAL (FULL FLOW)	G-33	5573014
AIRE	GA-377	2014558	D9K042 con motores/CUMMINS NTC290, CUMMINS NTC350, CUMMINS NTC400			COMBUSTIBLE, PRIMARIO	GP-26	25014274
ACEITE, DERIVACION (BY PASS)	G-750	2325391	ACEITE, FLUJO TOTAL (FULL FLOW) SELLADO	G-566	257528	COMBUSTIBLE, SECUNDARIO	GP-27	25014342
D9K064 con motores/CUMMINS FORMULA 300, CUMMINS FORMULA 350, CUMMINS FORMULA 400, CUMMINS NTC300			COMBUSTIBLE	GP-1101	158172	AGUA	GP-2071W	25012893
COMBUSTIBLE	GP-1101	158172	COMBUSTIBLE	GP-1101	158172	AIRE	GA-377	2014558
ACEITE, FLUJO TOTAL (FULL FLOW) SELLADO	GP-53	3313287	ACEITE, FLUJO TOTAL (FULL FLOW) SELLADO	GP-53	3313287	AIRE	GA-6129	700016
ACEITE, DERIVACION (BY PASS) SELLADO	GP-57	3304232	AIRE	GA-6129	700016	ACEITE, DERIVACION (BY PASS)	G-750	2325391
AGUA	GP-2071W	25012893	ACEITE, DERIVACION (BY PASS)	G-750	2325391	D9L042 con motores/CUMMINS NTC290, CUMMINS NTC350, CUMMINS NTC400		
AIRE	GA-376	15515589	D9K064 con motor/CATERPILLAR 3406			ACEITE, FLUJO TOTAL (FULL FLOW) SELLADO	G-566	257528
AIRE	GA-6129	700016	ACEITE, CUMPLE CON MEDI-DAS ORIGINALES	GP-691	877452	COMBUSTIBLE	GP-1101	158172
ACEITE, DERIVACION (BY PASS) CARTUCHO	G-750	2325391	ACEITE, SEGUNDA OPCION	GP-52	877452	ACEITE, FLUJO TOTAL (FULL FLOW) SELLADO	GP-53	3313287
D9K064 con motores/CUMMINS NTC400, CUMMINS NTC290, CUMMINS NTC350			COMBUSTIBLE	GP-1108	9Y4429	AIRE	GA-376	15515589
ACEITE, FLUJO TOTAL (FULL FLOW) SELLADO	G-566	257528	AIRE	GA-377	2014558	AIRE	GA-6129	700016
COMBUSTIBLE	GP-1101	158172	AIRE	GA-6129	700016	ACEITE, DERIVACION (BY PASS)	G-750	2325391
ACEITE, FLUJO TOTAL (FULL FLOW) SELLADO	GP-53	3313287	D9K064 con motor/DETROIT DIESEL 6V-92 SERIES			ACEITE, FLUJO TOTAL (FULL FLOW) SELLADO	GP-53	3313287
AIRE	GA-376	15515589	ACEITE, FLUJO TOTAL (FULL FLOW)	G-33	5573014	AIRE	GA-376	15515589
AIRE	GA-6129	700016	COMBUSTIBLE, PRIMARIO	GP-26	25014274	AIRE	GA-6129	700016
ACEITE, DERIVACION (BY PASS)	G-750	2325391	COMBUSTIBLE, SECUNDARIO	GP-27	25014342	ACEITE, DERIVACION (BY PASS)	G-750	2325391
D9K064 con motores/DETROIT DIESEL 6-71N, DETROIT DIESEL 6-71T			AGUA	GP-2071W	25012893	D9L042, D9K042, D9K064 con motores/DETROIT DIESEL 6-71N, DETROIT DIESEL 6-71T		
ACEITE, FLUJO TOTAL (FULL FLOW)	G-33	5573014	ACEITE, DERIVACION (BY PASS)	G-750	2325391	ACEITE, FLUJO TOTAL (FULL FLOW)	G-33	5573014
COMBUSTIBLE, PRIMARIO	GP-26	25014274	D9K064 con motor/DETROIT DIESEL 8V-71 SERIES			COMBUSTIBLE, PRIMARIO	GP-26	25014274
COMBUSTIBLE, SECUNDARIO	GP-27	25014342	ACEITE, FLUJO TOTAL (FULL FLOW)	G-33	5573014	COMBUSTIBLE, SECUNDARIO	GP-27	25014342
AGUA	GP-2071W	25012893	COMBUSTIBLE, PRIMARIO	GP-26	25014274	AGUA	GP-2071W	25012893
AIRE	GA-377	2014558	COMBUSTIBLE, SECUNDARIO	GP-27	25014342	AIRE	GA-377	2014558
AIRE	GA-6129	700016	AGUA	GP-2071W	25012893	AIRE	GA-6129	700016
ACEITE, DERIVACION (BY PASS)	G-750	2325391	AIRE	GA-6129	700016	ACEITE, DERIVACION (BY PASS)	G-750	2325391
D9K064 con motores/DETROIT DIESEL 6-71N, DETROIT DIESEL 6-71T			ACEITE, DERIVACION (BY PASS)	G-750	2325391	D9L042, D9L064 con motor/CATERPILLAR 3406		
ACEITE, FLUJO TOTAL (FULL FLOW)	G-33	5573014	D9K064 con motor/DETROIT DIESEL 8V-71 SERIES			ACEITE, CUMPLE CON MEDI-DAS ORIGINALES	GP-691	877452
COMBUSTIBLE, PRIMARIO	GP-26	25014274	ACEITE, FLUJO TOTAL (FULL FLOW)	G-33	5573014	ACEITE, SEGUNDA OPCION	GP-52	877452
COMBUSTIBLE, SECUNDARIO	GP-27	25014342	COMBUSTIBLE, PRIMARIO	GP-26	25014274	COMBUSTIBLE	GP-1108	9Y4429
AGUA	GP-2071W	25012893	COMBUSTIBLE, SECUNDARIO	GP-27	25014342	AIRE	GA-377	2014558
AIRE	GA-377	2014558	AGUA	GP-2071W	25012893	AIRE	GA-6129	700016
AIRE	GA-6129	700016	AIRE	GA-377	2014558	D9L042 con motor/DETROIT DIESEL 6V-92 SERIES		
ACEITE, DERIVACION (BY PASS)	G-750	2325391	ACEITE, DERIVACION (BY PASS)	G-750	2325391	ACEITE, FLUJO TOTAL (FULL FLOW)	G-33	5573014
D9K042 con motor/CATERPILLAR 3406			D9K064 con motor/DETROIT DIESEL 8V-92 SERIES			COMBUSTIBLE, PRIMARIO	GP-26	25014274
ACEITE, CUMPLE CON MEDI-DAS ORIGINALES	GP-691	877452	ACEITE, FLUJO TOTAL (FULL FLOW)	G-33	5573014	COMBUSTIBLE, SECUNDARIO	GP-27	25014342
ACEITE, SEGUNDA OPCION	GP-52	877452	COMBUSTIBLE, PRIMARIO	GP-26	25014274	AGUA	GP-2071W	25012893
COMBUSTIBLE	GP-1108	9Y4429	COMBUSTIBLE, SECUNDARIO	GP-27	25014342	ACEITE, DERIVACION (BY PASS)	G-750	2325391
AIRE	GA-377	2014558	AGUA	GP-2071W	25012893	D9L042 con motor/DETROIT DIESEL 8V-71 SERIES		
AIRE	GA-6129	700016	AIRE	GA-377	2014558	ACEITE, FLUJO TOTAL (FULL FLOW)	G-33	5573014
D9K042 con motor/DETROIT DIESEL 6V-92 SERIES			ACEITE, DERIVACION (BY PASS)	G-750	2325391	COMBUSTIBLE, PRIMARIO	GP-26	25014274
ACEITE, FLUJO TOTAL (FULL FLOW)	G-33	5573014	D9K064 con motores/CUMMINS NTC290, CUMMINS NTC350, CUMMINS NTC400			COMBUSTIBLE, SECUNDARIO	GP-27	25014342
COMBUSTIBLE, PRIMARIO	GP-26	25014274	ACEITE, FLUJO TOTAL (FULL FLOW) SELLADO	G-566	257528	AGUA	GP-2071W	25012893
COMBUSTIBLE, SECUNDARIO	GP-27	25014342	COMBUSTIBLE	GP-1101	158172	AIRE	GA-6129	700016
AGUA	GP-2071W	25012893	D9K064 con motor/DETROIT DIESEL 6V-92 SERIES			D9L042 con motor/DETROIT DIESEL 8V-71 SERIES		
ACEITE, DERIVACION (BY PASS)	G-750	2325391	ACEITE, FLUJO TOTAL (FULL FLOW)	G-33	5573014	ACEITE, FLUJO TOTAL (FULL FLOW)	G-33	5573014

APLICACIONES SERVICIO PESADO
HEAVY DUTY APPLICATIONS



MARCA-MODELO-MOTOR MAKE-MODEL-ENGINE	GONHER GONHER	OEM OEM	MARCA-MODELO-MOTOR MAKE-MODEL-ENGINE	GONHER GONHER	OEM OEM	MARCA-MODELO-MOTOR MAKE-MODEL-ENGINE	GONHER GONHER	OEM OEM
GENERAL MOTORS / CHEVROLET			GENERAL MOTORS / CHEVROLET			GENERAL MOTORS / CHEVROLET		
CAMIONES, TRACTOCAMIONES Y AUTOBUSES			CAMIONES, TRACTOCAMIONES Y AUTOBUSES			CAMIONES, TRACTOCAMIONES Y AUTOBUSES		
ACEITE, DERIVACION (BY PASS)	G-750	2325391	J9C042 con motor/CUMMINS NTC300			COMBUSTIBLE	GP-1108	9Y4429
D9L042 con motores/CUMMINS NTC290, CUMMINS NTC350, CUMMINS NTC400			COMBUSTIBLE	GP-1101	158172	J9C064 con motor/CUMMINS NTC300		
ACEITE, FLUJO TOTAL (FULL FLOW) CARTUCHO	G-566	257528	ACEITE, FLUJO TOTAL (FULL FLOW)	GP-53	3313287	COMBUSTIBLE	GP-1101	158172
COMBUSTIBLE	GP-1101	158172	AIRE, COMPRESOR	GA-135	2031381	ACEITE, FLUJO TOTAL (FULL FLOW)	GP-53	3313287
ACEITE, FLUJO TOTAL (FULL FLOW) SELLADO	GP-53	3313287	AIRE	GA-377	2014558	AIRE, COMPRESOR	GA-135	2031381
AIRE	GA-6129	700016	ACEITE, DERIVACION (BY PASS)	G-750	2325391	AIRE	GA-377	2014558
ACEITE, DERIVACION (BY PASS)	G-750	2325391	J9C042 con motores/CUMMINS FORMULA 300, CUMMINS FORMULA 350, CUMMINS L10 SERIES			ACEITE, DERIVACION (BY PASS)	G-750	2325391
D9L042 con motores/DETROIT DIESEL 6-71N, DETROIT DIESEL 6-71T			COMBUSTIBLE	GP-1101	158172	J9C064 con motores/CUMMINS FORMULA 300, CUMMINS FORMULA 350, CUMMINS L10 SERIES		
ACEITE, FLUJO TOTAL (FULL FLOW)	G-33	5573014	ACEITE, FLUJO TOTAL (FULL FLOW)	GP-53	3313287	COMBUSTIBLE	GP-1101	158172
COMBUSTIBLE, PRIMARIO	GP-26	25014274	ACEITE, DERIVACION (BY PASS)	GP-57	3304232	ACEITE, FLUJO TOTAL (FULL FLOW)	GP-53	3313287
COMBUSTIBLE, SECUNDARIO	GP-27	25014342	AGUA	GP-2071W	25012893	ACEITE, DERIVACION (BY PASS)	GP-57	3304232
AGUA	GP-2071W	25012893	AIRE	GA-377	2014558	AGUA	GP-2071W	25012893
AIRE	GA-377	2014558	J9C042 con motores/DETROIT DIESEL 6-71N, DETROIT DIESEL 6-71T			AIRE	GA-377	2014558
AIRE	GA-6129	700016	ACEITE, FLUJO TOTAL (FULL FLOW)	G-33	5573014	J9C064 con motores/DETROIT DIESEL 6-71N, DETROIT DIESEL 6-71T		
ACEITE, DERIVACION (BY PASS)	G-750	2325391	COMBUSTIBLE, PRIMARIO	GP-26	25014274	ACEITE, FLUJO TOTAL (FULL FLOW)	G-33	5573014
F6B042 T SERIES, F7B042 T SERIES con motor/CATERPILLAR 3116			COMBUSTIBLE, SECUNDARIO	GP-27	25014342	COMBUSTIBLE, PRIMARIO	GP-26	25014274
COMBUSTIBLE	GP-26	25014274	AGUA	GP-2071W	25012893	COMBUSTIBLE, SECUNDARIO	GP-27	25014342
ACEITE	GP-51	1R0739	AIRE, RESPIRADOR DEL COMPRESOR	GA-135	2031381	AGUA	GP-2071W	25012893
TRANSMISION	GP-9586	25011122	AIRE	GA-377	2014558	AIRE, RESPIRADOR DEL COMPRESOR	GA-135	2031381
ACEITE, DERIVACION (BY PASS)	G-750	15525633	ACEITE, DERIVACION (BY PASS)	G-750	2325391	AIRE	GA-377	2014558
COMBUSTIBLE, SEPARADOR DE AGUA	S 3202	15618921	J9C042 con motores/DETROIT DIESEL 6V-92 SERIES, DETROIT DIESEL 8V-71N			ACEITE, DERIVACION (BY PASS)	G-750	2325391
F6B042 T SERIES, F7B042 T SERIES con motor/GMC 6.0L GASOLINA			ACEITE, FLUJO TOTAL (FULL FLOW)	G-33	5573014	J9C064 con motores/DETROIT DIESEL 6V-92 SERIES, DETROIT DIESEL 8V-71N		
TRANSMISION	GP-9586	25011122	COMBUSTIBLE, PRIMARIO	GP-26	25014274	ACEITE, FLUJO TOTAL (FULL FLOW)	G-33	5573014
ACEITE	GP-205	25160561	COMBUSTIBLE, SECUNDARIO	GP-27	25014342	COMBUSTIBLE, PRIMARIO	GP-26	25014274
AIRE	GA-59	6484235	AGUA	GP-2071W	25012893	COMBUSTIBLE, SECUNDARIO	GP-27	25014342
GASOLINA	GG-46	25055052	AIRE, COMPRESOR	GA-135	2031381	AGUA	GP-2071W	25012893
F6B042 T SERIES, F7B042 T SERIES con motor/SUZUKI 7.1L DIESEL			AIRE	GA-377	2014558	AIRE, COMPRESOR	GA-135	2031381
TRANSMISION	GP-9586	25011122	ACEITE, DERIVACION (BY PASS)	G-750	2325391	AIRE	GA-377	2014558
J8C042, J8C064 con motor/GMC V8-427			J9C042, J9C064 con motor/CUMMINS VT225			ACEITE, DERIVACION (BY PASS)	G-750	2325391
ACEITE	GP-23	25010754	ACEITE, FLUJO TOTAL (FULL FLOW) CARTUCHO	G-566	257528	J9C042, J9C064 con motor/CUMMINS NTC300		
AIRE, COMPRESOR	GA-135	2031381	COMBUSTIBLE	GP-1101	158172	COMBUSTIBLE	GP-1101	158172
GASOLINA	GG-20	5650030	ACEITE, FLUJO TOTAL (FULL FLOW) SELLADO	GP-53	3313287	ACEITE, FLUJO TOTAL (FULL FLOW)	GP-53	3313287
J8C042, J8C064, J8C064, J8C042 con motor/CATERPILLAR 3208			AGUA	GP-2071W	25012893	AIRE, COMPRESOR	GA-135	2031381
ACEITE, FLUJO TOTAL (FULL FLOW)	GP-36	9L9200	J9C042, J9C064 con motores/CUMMINS NTC290, CUMMINS NTC350			ACEITE, DERIVACION (BY PASS)	G-750	2325391
GASOLINA, SEPARADOR DE AGUA	G-293	9Y4445	ACEITE, FLUJO TOTAL (FULL FLOW) CARTUCHO	G-566	257528	J9C042, J9C064 con motores/CUMMINS NTC290, CUMMINS NTC350		
COMBUSTIBLE	GP-110	1R0740	COMBUSTIBLE	GP-1101	158172	ACEITE, FLUJO TOTAL (FULL FLOW) CARTUCHO	G-566	257528
ACEITE, FLUJO TOTAL (FULL FLOW)	GP-9586	9N5570	ACEITE, FLUJO TOTAL (FULL FLOW) SELLADO	GP-53	3313287	COMBUSTIBLE	GP-1101	158172
AIRE, COMPRESOR	GA-135	2031381	AIRE, COMPRESOR	GA-135	2031381	ACEITE, FLUJO TOTAL (FULL FLOW) SELLADO	GP-53	3313287
ACEITE, DERIVACION (BY PASS)	G-750	2325391	AIRE	GA-377	2014558	AIRE, COMPRESOR	GA-135	2031381
J8C042, J8C064, J8C064, J8C042 con motor/DETROIT DIESEL 6V-53 SERIES			ACEITE, DERIVACION (BY PASS)	G-750	2325391	ACEITE, DERIVACION (BY PASS)	G-750	2325391
ACEITE, FLUJO TOTAL (FULL FLOW)	G-33	5573014	J9C064 con motor/CATERPILLAR 3208			J9C042, J9C064 con motores/DETROIT DIESEL 6-71N, DETROIT DIESEL 6-71T		
COMBUSTIBLE, PRIMARIO	GP-26	25014274	ACEITE	GP-36	9L9200	ACEITE, FLUJO TOTAL (FULL FLOW)	G-33	5573014
COMBUSTIBLE, SECUNDARIO	GP-27	25014342	GASOLINA, SEPARADOR DE AGUA	G-293	9Y4445	COMBUSTIBLE, PRIMARIO	GP-26	25014274
AIRE, COMPRESOR	GA-135	2031381	COMBUSTIBLE	GP-110	1R0740	COMBUSTIBLE, SECUNDARIO	GP-27	25014342
J8C042, J8C064 con motor/GMC V8-427			ACEITE	GP-9586	9N5570	AGUA	GP-2071W	25012893
ACEITE	GP-23	25010754	J9C064 con motor/CATERPILLAR 3406			AIRE, COMPRESOR	GA-135	2031381
AIRE, COMPRESOR	GA-135	100696A	ACEITE, CUMPLE CON MEDI-DAS ORIGINALES	GP-691	8T7452	ACEITE, DERIVACION (BY PASS)	G-750	2325391
GASOLINA	GG-20	5650030	ACEITE, SEGUNDA OPCION	GP-52	8T7452			

SERVICIO PESADO

MARCA-MODELO-MOTOR MAKE-MODEL-ENGINE	GONHER GONHER	OEM OEM	MARCA-MODELO-MOTOR MAKE-MODEL-ENGINE	GONHER GONHER	OEM OEM	MARCA-MODELO-MOTOR MAKE-MODEL-ENGINE	GONHER GONHER	OEM OEM
GENERAL MOTORS / CHEVROLET			GENERAL MOTORS / CHEVROLET			GENERAL MOTORS / CHEVROLET		
CAMIONES, TRACTOCAMIONES Y AUTOBUSES			CAMIONES, TRACTOCAMIONES Y AUTOBUSES			CAMIONES, TRACTOCAMIONES Y AUTOBUSES		
J9C042, J9C064 con motores/DETROIT DIESEL 6V-92 SERIES, DETROIT DIESEL 8V-71N			N9E064, N9F064 con motores/CUMMINS NTC400, CUMMINS NTC290, CUMMINS NTC350			P6 FORWARD CHASIS con motor/GMC 4.8L GASOLINA		
ACEITE, FLUJO TOTAL (FULL FLOW)	G-33	5573014	ACEITE, FLUJO TOTAL (FULL FLOW) CARTUCHO	G-566	257528	ACEITE	GP-13	6438384
COMBUSTIBLE, PRIMARIO	GP-26	25014274	ACEITE, RESPIRADERO DEL EJE	GP-3	6435679	AIRE	GA-90	5648003
COMBUSTIBLE, SECUNDARIO	GP-27	25014342	COMBUSTIBLE	GP-1101	158172	GASOLINA	GG-20	5650030
AGUA	GP-2071W	25012893	ACEITE, FLUJO TOTAL (FULL FLOW) SELLADO	GP-53	3313287	P6 FORWARD CHASIS con motor/GMC 5.7L GASOLINA		
AIRE, COMPRESOR	GA-135	2031381	ACEITE, DERIVACION (BY PASS)	G-750	2325391	ACEITE	GP-23	25010754
AIRE, 1980	GA-377	2014558	N9F064 con motor/CATERPILLAR 3406			AIRE	GA-89	25043585
ACEITE, DERIVACION (BY PASS)	G-750	2325391	ACEITE, RESPIRADERO DEL EJE	GP-3	6435679	GASOLINA	GG-20	5650030
N9E042, N9E064, N9F042, N9F064 con motor/CUMMINS			ACEITE, FLUJO TOTAL (FULL FLOW) (CUMPLE CON MEDIDAS ORIGINALES)	GP-691	877452	P6 FORWARD CHASIS con motores/GMC 6.0L GASOLINA, GMC 7.0L GASOLINA		
ACEITE, FLUJO TOTAL (FULL FLOW) CARTUCHO	G-566	257528	ACEITE, FLUJO TOTAL (FULL FLOW) (SEGUNDA OPCION)	GP-52	877452	ACEITE	GP-23	25010754
ACEITE, RESPIRADERO DEL EJE	GP-3	6435679	COMBUSTIBLE	GP-1108	9Y4429	AIRE, 1992-96	GA-59	6484235
COMBUSTIBLE	GP-1101	158172	AIRE	GA-378	2038573	GASOLINA, 1983-90	GG-20	5650030
ACEITE, FLUJO TOTAL (FULL FLOW) SELLADO	GP-53	3313287	ACEITE, DERIVACION (BY PASS)	G-750	2325391	GASOLINA, 1992-96	GG-46	25055052
ACEITE, DERIVACION (BY PASS) SELLADO	GP-57	3304232	N9F042, N9F064 con motor/DETROIT DIESEL 8V-92 SERIES			T5500 T/F SERIES TILT CAB, T6500 KODIAK con motor/CATERPILLAR 3126B DIESEL		
AIRE	GA-378	2038573	ACEITE, FLUJO TOTAL (FULL FLOW)	G-33	5573014	COMBUSTIBLE, PRIMARIO	GP-26	25014274
ACEITE, DERIVACION (BY PASS) CARTUCHO	G-750	2325391	ACEITE, RESPIRADERO DEL EJE	GP-3	6435679	ACEITE	GP-51	1R0739
N9E042, N9E064, N9F042, N9F064 con motor/DETROIT DIESEL			COMBUSTIBLE, PRIMARIO	GP-26	25014274	COMBUSTIBLE, CORTO	GP-62	1R0751
ACEITE, FLUJO TOTAL (FULL FLOW) CARTUCHO	G-33	5573014	COMBUSTIBLE, SECUNDARIO	GP-27	25014342	COMBUSTIBLE, LARGO	GP-1109	1R0751
ACEITE, RESPIRADERO DEL EJE	GP-3	6435679	AGUA	GP-2071W	25012893	TRANSMISION	GP-9586	25011122
COMBUSTIBLE, PRIMARIO	GP-26	25014274	ACEITE, DERIVACION (BY PASS)	G-750	2325391	AIRE	GA-930R	12471801
COMBUSTIBLE, SECUNDARIO	GP-27	25014342	N9F064 con motor/CATERPILLAR 3406			ACEITE, DERIVACION (BY PASS)	G-750	15525633
ACEITE, FLUJO TOTAL (FULL FLOW) SELLADO	GP-43	25313733	ACEITE, RESPIRADERO DEL EJE	GP-3	6435679	COMBUSTIBLE, SEPARADOR DE AGUA	S 3202	15618921
AGUA	GP-2071W	25012893	ACEITE, FLUJO TOTAL (FULL FLOW) (CUMPLE CON MEDIDAS ORIGINALES)	GP-691	877452	T5500 T/F SERIES TILT CAB, T6500 KODIAK, T6500 T/F SERIES TILT CAB con motor/GMC 7.8L DIESEL		
AIRE	GA-378	2038573	ACEITE, FLUJO TOTAL (FULL FLOW) (SEGUNDA OPCION)	GP-52	877452	TRANSMISION	GP-9586	25011122
ACEITE, DERIVACION (BY PASS) CARTUCHO	G-750	2325391	COMBUSTIBLE	GP-1108	9Y4429	AIRE	GA-930R	12471801
N9E042 con motores/DETROIT DIESEL 6-71N, DETROIT DIESEL 6V-92, DETROIT DIESEL 8V-71			ACEITE, DERIVACION (BY PASS)	G-750	2325391	COMBUSTIBLE, SEPARADOR DE AGUA	S 3202	15618921
ACEITE, FLUJO TOTAL (FULL FLOW)	G-33	5573014	P4 FORWARD CHASIS con motor/GMC 6-292			T6500 KODIAK con motor/DURAMAX 7.8L DIESEL		
ACEITE, RESPIRADERO DEL EJE	GP-3	6435679	ACEITE	GP-13	6438384	AIRE, PRIMARIO	GA-930R	12471801
COMBUSTIBLE, PRIMARIO	GP-26	25014274	AIRE	GA-90	5648003	T6500 T/F SERIES TILT CAB con motor/CATERPILLAR 3126		
COMBUSTIBLE, SECUNDARIO	GP-27	25014342	GASOLINA	GG-20	5650030	COMBUSTIBLE, PRIMARIO	GP-26	25014274
AGUA	GP-2071W	25012893	AIRE, RESPIRADOR	GA-100	2019681	ACEITE	GP-51	1R0739
ACEITE, DERIVACION (BY PASS)	G-750	2325391	P4TO42 con motor/GMC 6-292			COMBUSTIBLE	GP-62	1R0751
N9E042, N9F042 con motores/CUMMINS NTC290, CUMMINS NTC350, CUMMINS NTC400			ACEITE	GP-13	6438384	COMBUSTIBLE	GP-1109	1R0751
ACEITE, FLUJO TOTAL (FULL FLOW) CARTUCHO	G-566	257528	GASOLINA, 3 33/64 IN	GG-20	5650030	TRANSMISION	GP-9586	25011122
ACEITE, RESPIRADERO DEL EJE	GP-3	6435679	GASOLINA, 1 3/64 IN PARA CARBURADORES ROCHESTER	GG-6	5651393	AIRE	GA-930R	12471801
COMBUSTIBLE	GP-1101	158172	GASOLINA, 1 3/64 IN PARA CARBURADORES ROCHESTER	GG-16	5651920	ACEITE, DERIVACION (BY PASS)	G-750	15525633
ACEITE, FLUJO TOTAL (FULL FLOW) SELLADO	GP-53	3313287	P6 FORWARD CHASIS con motor/CATERPILLAR 3116			COMBUSTIBLE, SEPARADOR DE AGUA	S 3202	15618921
ACEITE, DERIVACION (BY PASS)	G-750	2325391	ACEITE	GP-51	1R0739	T6500 T/F SERIES TILT CAB, T8500 T/F SERIES TILT CAB con motor/CATERPILLAR 3126B DIESEL		
N9E064 con motores/DETROIT DIESEL 8V-71, DETROIT DIESEL 6-71N, DETROIT DIESEL 6V-92			COMBUSTIBLE	GP-92	25014371	COMBUSTIBLE, PRIMARIO	GP-26	25014274
ACEITE, FLUJO TOTAL (FULL FLOW)	G-33	5573014	COMBUSTIBLE	GP-110	1R0740	ACEITE	GP-51	1R0739
ACEITE, RESPIRADERO DEL EJE	GP-3	6435679	AIRE	GA-197R	15696245	COMBUSTIBLE, CORTO	GP-62	1R0751
COMBUSTIBLE, PRIMARIO	GP-26	25014274	ACEITE, DERIVACION (BY PASS)	G-750	15525633	COMBUSTIBLE, LARGO	GP-1109	1R0751
COMBUSTIBLE, SECUNDARIO	GP-27	25014342	P6 FORWARD CHASIS con motor/DETROIT DIESEL 8.2L			TRANSMISION	GP-9586	25011122
AGUA	GP-2071W	25012893	ACEITE	GP-13	6438384	AIRE	GA-930R	12471801
ACEITE, DERIVACION (BY PASS)	G-750	2325391	DIRECCION (1987-90)	GP-14	15514175	ACEITE, DERIVACION (BY PASS)	G-750	15525633
			COMBUSTIBLE, PRIMARIO	GP-92	25011011	COMBUSTIBLE, SEPARADOR DE AGUA	S 3202	15618921
			COMBUSTIBLE, SECUNDARIO	GP-93	25010959	T7500 con motor/CATERPILLAR 3116		
			TRANSMISION	GP-9586	25011122	ACEITE	GP-51	1R0739
			COMBUSTIBLE, SEPARADOR DE AGUA	S 3202	15618921	COMBUSTIBLE	GP-62	1R0751
						AIRE	GA-930R	P533930

MARCA-MODELO-MOTOR	GONHER	OEM
MAKE-MODEL-ENGINE	GONHER	OEM

MARCA-MODELO-MOTOR	GONHER	OEM
MAKE-MODEL-ENGINE	GONHER	OEM

MARCA-MODELO-MOTOR	GONHER	OEM
MAKE-MODEL-ENGINE	GONHER	OEM

GENERAL MOTORS / CHEVROLET

CAMIONES, TRACTOCAMIONES Y AUTOBUSES

T7500 con motor/GMC 7.8L		
AIRE	GA-930R	P533930
T7500 T/F SERIES TILT CAB con motores/CATERPILLAR 3126, CATERPILLAR 3126B DIESEL		
COMBUSTIBLE, PRIMARIO	GP-26	25014274
ACEITE	GP-51	1R0739
COMBUSTIBLE, CORTO	GP-62	1R0751
COMBUSTIBLE, LARGO	GP-1109	1R0751
TRANSMISION	GP-9586	25011122
AIRE	GA-930R	12471801
ACEITE, DERIVACION (BY PASS)	G-750	15525633
COMBUSTIBLE, SEPARADOR DE AGUA	S 3202	15618921
T7500 T/F SERIES TILT CAB, T8500 T/F SERIES TILT CAB con motor/GMC 7.8L DIESEL		
TRANSMISION	GP-9586	25011122
AIRE	GA-930R	12471801
COMBUSTIBLE, SEPARADOR DE AGUA	S 3202	15618921
W3500 TILT CAB con motor/4 CIL. 4.8L TURBO DIESEL (4HE1TC)		
AIRE, SOLAMENTE MODELOS CON CABINA REGULAR	GA-633R	8970622940
W3500 TILT CAB, W4500 TILT CAB, W5500 TILT CAB con motor/4 CIL. 5.2L TURBO DIESEL (4HK1TC)		
COMBUSTIBLE, SEPARADOR DE AGUA	GPP-111	94369299
COMBUSTIBLE, SEPARADOR DE AGUA, SEGUNDA OPCION	GPP-524	94369299
AIRE, SOLAMENTE MODELOS CON CABINA REGULAR	GA-633R	8970622940
W3500 TOPKICK (CHEVROLET KODIAK) con motor/GMC V8-5.7L F/ INJ		
ACEITE	GP-205	25160561
W3500 TOPKICK (CHEVROLET KODIAK) con motor/GMC V8-6.0L F/ INJ.		
ACEITE	GP-44	25010633
W3500 TOPKICK (CHEVROLET KODIAK) con motor/ISUZU 4.8L DIESEL		
ACEITE	GP-359	LF3622
W4 SERIES con motor/A GASOLINA		
ACEITE, 1993-95	GP-13	6438384
ACEITE, 1996 EN ADELANTE	GP-205	25160561
AIRE, 1993-9/95	GA-59	6484235
GASOLINA	GG-46	25055052
W4 SERIES FORWARD con motor/ISUZU 4BD1-T		
ACEITE, FLUJO TOTAL (FULL FLOW) 1986-91	GP-58	94463715
W4 SERIES TILTMASER con motor/ISUZU 4BD1-T		
ACEITE, FLUJO TOTAL (FULL FLOW)	GP-1	94169778
W4500 TILT CAB con motor/4 CIL. 4.8L TURBO DIESEL (4HE1TC)		
AIRE, SOLAMENTE MODELOS CON CABINA REGULAR	GA-633R	8970622940
W4500 TOPKICK (CHEVROLET KODIAK) con motor/GMC V8-5.7L F/ INJ		
ACEITE	GP-205	25160561

GENERAL MOTORS / CHEVROLET

CAMIONES, TRACTOCAMIONES Y AUTOBUSES

W4500 TOPKICK (CHEVROLET KODIAK) con motor/GMC V8-6.0L F/ INJ.	GP-44	25010633
ACEITE	GP-44	25010633
W5 SERIES con motor/ISUZU 4.8L DIESEL		
ACEITE	GP-359	LF3622
W5 SERIES con motor/ISUZU 6HE1		
TRANSMISION	GP-9586	94054051
W5500 TILT CAB con motor/4 CIL. 4.8L TURBO DIESEL (4HE1TC)		
AIRE, SOLAMENTE MODELOS CON CABINA REGULAR	GA-633R	8970622940
W6N042, W7N042, W6NO42, W7N042 con motor/GMC V8-350		
ACEITE	GP-23	25010754
AIRE, COMPRESOR	GA-135	2031381
GASOLINA, 3 33/64 IN	GG-20	5650030
GASOLINA, 1 3/64 IN PARA CARBURADORES ROCHESTER	GG-6	5651393
GASOLINA, 1 3/64 IN PARA CARBURADORES ROCHESTER	GG-16	5651920
W6N042, W7N042, W6NO42, W7N042 con motores/GMC V8-366, GMC V8-427		
ACEITE	GP-23	25010754
AIRE, COMPRESOR	GA-135	2031381
GASOLINA	GG-20	5650030
W7 FORWARD, W7H FORWARD con motor/ISUZU 6SA1		
ACEITE, DERIVACION (BY PASS)	GP-57	94056207
WT5500 TOPKICK (CHEVROLET KODIAK) con motor/ISUZU 7.8L DIESEL		
TRANSMISION	GP-9586	25011122

GENERAL MOTORS / CHEVROLET

MOTORES

12V-149 SERIES A DIESEL, 12V-92 SERIES A DIESEL		
ACEITE	G-33	5573014
ACEITE	GP-53	ACPF911
COMBUSTIBLE	GP-55	25014341
12V-71 SERIES A DIESEL, 16V-149 SERIES A DIESEL, 16V-71 SERIES A DIESEL, 16V-92 SERIES A DIESEL		
ACEITE	G-31	5572425
ACEITE	G-33	5573014
ACEITE	GP-53	ACPF911
COMBUSTIBLE	GP-55	25014341
COMBUSTIBLE	GP-85	25010969
20V-149 SERIES A DIESEL		
ACEITE	GP-53	ACPF911
2-53 SERIES A DIESEL		
ACEITE	G-31	5572425
ACEITE	G-119	5574978
COMBUSTIBLE	G-1173	5573263
COMBUSTIBLE	G-1174	5197854
ACEITE	GP-43	ACPF947
2-71 SERIES A DIESEL, 3-71 SERIES A DIESEL		
ACEITE	G-31	5572425
ACEITE	G-33	5573014
COMBUSTIBLE	G-1173	5573263
COMBUSTIBLE	G-1174	5197854

GENERAL MOTORS / CHEVROLET

MOTORES

ACEITE	GP-53	ACPF911
COMBUSTIBLE	GP-92	25011422
COMBUSTIBLE	GP-93	25013273
3-53 SERIES A DIESEL		
ACEITE	G-33	5573014
ACEITE	G-119	5574978
COMBUSTIBLE	G-1173	5573263
COMBUSTIBLE	G-1174	5197854
COMBUSTIBLE	G-1175	5574508
COMBUSTIBLE	GP-92	25011422
COMBUSTIBLE	GP-93	25013273
ACEITE	GP-43	ACPF947
4-109.8 A GASOLINA		
ACEITE, 1972-75	GP-38	25011623
ACEITE, 1976-80	GP-40	6439354
GASOLINA, PLASTICO	GG-5	5650780
GASOLINA, LAMINA	GG-5 L	5650780
4-153 A GASOLINA		
ACEITE	GP-3	6435679
GASOLINA, 1969	GG-6	5651393
GASOLINA, 1962-68	GG-123	7013404
4-51 SERIES A DIESEL		
COMBUSTIBLE	G-1173	5573263
4-53 SERIES A DIESEL		
ACEITE	G-33	5573014
COMBUSTIBLE	G-1173	5573263
COMBUSTIBLE	G-1174	5197854
COMBUSTIBLE	G-1175	5574508
ACEITE	GP-53	ACPF911
COMBUSTIBLE	GP-92	25011422
COMBUSTIBLE	GP-93	25013273
4-71 SERIES A DIESEL		
ACEITE	G-31	5572425
ACEITE	G-33	5573014
COMBUSTIBLE	G-1173	5573263
COMBUSTIBLE	G-1174	5197854
COMBUSTIBLE	G-1175	5574508
ACEITE	GP-53	ACPF911
COMBUSTIBLE	GP-92	25011422
COMBUSTIBLE	GP-93	25013273
509-V8 (8.2L) A DIESEL		
ACEITE	GP-13	6438384
COMBUSTIBLE	GP-92	25011422
COMBUSTIBLE	GP-93	25013273
518 (8.5L) SERIES 50 A DIESEL		
COMBUSTIBLE	GP-26	25014274
COMBUSTIBLE	GP-27	25014342
COMBUSTIBLE	GPP-11	23516189
ACEITE	GP-193	ACPF2100
6-110 SERIES A DIESEL		
ACEITE	G-31	5572425
ACEITE	G-33	5573014
COMBUSTIBLE	G-1174	5197854
COMBUSTIBLE	G-1175	5574508

SERVICIO PESADO

MARCA-MODELO-MOTOR MAKE-MODEL-ENGINE	GONHER GONHER	OEM OEM	MARCA-MODELO-MOTOR MAKE-MODEL-ENGINE	GONHER GONHER	OEM OEM	MARCA-MODELO-MOTOR MAKE-MODEL-ENGINE	GONHER GONHER	OEM OEM
GENERAL MOTORS / CHEVROLET			GENERAL MOTORS / CHEVROLET			GENERAL MOTORS / CHEVROLET		
MOTORES			MOTORES			MOTORES		
6-194 A GASOLINA			6-292 A GASOLINA			ACEITE	GP-53	ACPF911
ACEITE	GP-3	6435679	ACEITE	G-34	6437562	ACEITE	GP-57	23516189
ACEITE	GP-13	6438384	ACEITE	GP-3	6435679	COMBUSTIBLE	GPP-11	23516189
ACEITE	GP-205	25160561	ACEITE	GP-13	6438384	ACEITE	GP-193	ACPF2100
AIRE	GA-50	5649797	ACEITE	GP-205	25160561	6V-53 SERIES A DIESEL		
GASOLINA	GG-123	7013404	GASOLINA	GG-6	5651393	ACEITE	G-31	5572425
6-216 A GASOLINA, 6-235 A GASOLINA, 6-248 A GASOLINA, 6-261 A GASOLINA, 6-270 A GASOLINA, 6-302 A GASOLINA, 6-360 A GASOLINA, 6-427 A GASOLINA, 6-503 A GASOLINA			6-292 A GASOLINA			ACEITE	G-33	5573014
ACEITE, DERIVACION (BY PASS)	G-31	5572425	ACEITE	G-34	6437562	ACEITE	G-33	5573014
6-230 A GASOLINA, 6-250 A GASOLINA			ACEITE	GP-3	6435679	COMBUSTIBLE	G-1173	5573261
ACEITE	GP-3	6435679	ACEITE	GP-13	6438384	COMBUSTIBLE	G-1174	5197854
ACEITE	GP-13	6438384	ACEITE	GP-23	25010754	COMBUSTIBLE	GP-26	25014274
ACEITE	GP-205	25160561	ACEITE	GP-23	25010754	COMBUSTIBLE	GP-27	25014342
GASOLINA	GG-123	7013404	ACEITE	GP-205	25160561	ACEITE	GP-53	ACPF911
6-230 A GASOLINA			GASOLINA	GG-20	5650030	6V-92 SERIES A DIESEL		
ACEITE	GP-3	6435679	GASOLINA	GG-6	5651393	ACEITE	G-33	5573014
ACEITE	GP-13	6438384	GASOLINA	GG-16	5651920	COMBUSTIBLE	G-1175	5574508
ACEITE	GP-205	25160561	6-292 A GASOLINA			COMBUSTIBLE	GP-26	25014274
GASOLINA	GG-123	7013404	ACEITE	GP-3	6435679	COMBUSTIBLE	GP-27	25014342
6-230 A GASOLINA, 6-250 A GASOLINA			ACEITE	GP-13	6438384	ACEITE	GP-53	ACPF911
ACEITE	GP-3	6435679	ACEITE	GP-23	25010754	8V-149 SERIES A DIESEL		
6-250 A GASOLINA			ACEITE	GP-205	25160561	ACEITE	GP-53	ACPF911
ACEITE	GP-3	6435679	GASOLINA	GG-20	5650030	COMBUSTIBLE	GP-55	25014341
ACEITE	GP-13	6438384	GASOLINA	GG-6	5651393	COMBUSTIBLE	GP-85	25010969
ACEITE	GP-205	25160561	GASOLINA	GG-16	5651920	8V-53 SERIES A DIESEL		
6-250 A GASOLINA			6-292 A GASOLINA			ACEITE	G-33	5573014
ACEITE	GP-3	6435679	ACEITE	GP-3	6435679	COMBUSTIBLE	G-1175	5574508
ACEITE	GP-13	6438384	ACEITE	GP-13	6438384	COMBUSTIBLE	GP-26	25014274
ACEITE	GP-205	25160561	ACEITE	GP-23	25010754	COMBUSTIBLE	GP-27	25014342
GASOLINA	GG-6	5651393	ACEITE	GP-205	25160561	ACEITE	GP-53	ACPF911
GASOLINA	GG-123	7013404	GASOLINA	GG-20	5650030	D 351 A DIESEL, D 478 A DIESEL, D 637 A DIESEL, DH 478 A DIESEL,		
6-250 A GASOLINA, 6-250 A GASOLINA			GASOLINA	GG-16	5651920	DH 637 A DIESEL		
ACEITE	GP-3	6435679	6-292 A GASOLINA			ACEITE, CARTUCHO	G-33	5573014
GASOLINA	GG-6	5651393	ACEITE	GP-3	6435679	COMBUSTIBLE, PRIMARIO	G-1174	5197854
GASOLINA	GG-123	7013404	ACEITE	GP-13	6438384	COMBUSTIBLE, SECUNDARIO	G-1175	5574508
6-292 A GASOLINA			ACEITE	GP-23	25010754	P30 HOME CAMION		
ACEITE	GP-3	6435679	ACEITE	GP-205	25160561	ACEITE, CARTUCHO	G-34	6437562
ACEITE	GP-13	6438384	GASOLINA	GG-20	5650030	ACEITE, SELLADO	GP-13	6438384
ACEITE	GP-205	25160561	GASOLINA	GG-16	5651920	AIRE	GA-57	6485108
GASOLINA	GG-20	5650030	6-292 A GASOLINA			GASOLINA	GG-6	5651393
6-292 A GASOLINA			ACEITE	GP-13	6438384	GASOLINA	GG-16	5651920
ACEITE	G-33	5573014	ACEITE	GP-205	25160561	SERIES 50 A DIESEL		
ACEITE	GP-3	6435679	GASOLINA	GG-20	5650030	COMBUSTIBLE	GP-26	25014274
ACEITE	GP-13	6438384	6-73 SERIES A DIESEL, 6V-71 SERIES A DIESEL, 8V-71 SERIES A DIESEL			COMBUSTIBLE	GP-27	25014342
ACEITE	GP-205	25160561	ACEITE	G-31	5572425	COMBUSTIBLE	GPP-11	23516189
GASOLINA	GG-16	5651920	ACEITE	G-33	5573014	ACEITE	GP-193	23518480
6-292 A GASOLINA			COMBUSTIBLE	G-1174	5197854	V12 702 A GASOLINA		
ACEITE	G-34	6437562	COMBUSTIBLE	G-1175	5574508	ACEITE	G-33	5573014
ACEITE	GP-3	6435679	COMBUSTIBLE	GP-26	25014274	V6-173 A GASOLINA		
ACEITE	GP-13	6438384	COMBUSTIBLE	GP-27	25014342	ACEITE, 3 25/64 IN	GP-46	25010766
ACEITE	GP-205	25160561	ACEITE	GP-53	ACPF911	ACEITE, 4 45/64 IN	GP-3980	25171377
GASOLINA	GG-123	7013404	677 (11.1L) SERIES 60 A DIESEL, 774 (12.7L) SERIES 60 A DIESEL, SERIES 60 A DIESEL			AIRE, 1982-85	GA-3681	25041542
6-292 A GASOLINA			COMBUSTIBLE	GP-26	25014274	AIRE, 1986 EN ADELANTE	GA-3588	25040929
ACEITE	G-34	6437562	COMBUSTIBLE	GP-27	25014342			
ACEITE	GP-3	6435679						
ACEITE	GP-13	6438384						
ACEITE	GP-205	25160561						
GASOLINA	GG-123	7013404						

APLICACIONES SERVICIO PESADO
HEAVY DUTY APPLICATIONS



MARCA-MODELO-MOTOR MAKE-MODEL-ENGINE	GONHER GONHER	OEM OEM	MARCA-MODELO-MOTOR MAKE-MODEL-ENGINE	GONHER GONHER	OEM OEM	MARCA-MODELO-MOTOR MAKE-MODEL-ENGINE	GONHER GONHER	OEM OEM
GENERAL MOTORS / CHEVROLET			GENERAL MOTORS / CHEVROLET			GENERAL MOTORS / CHEVROLET		
MOTORES			MOTORES			MOTORES		
GASOLINA, 1982-85	GG-7	5651921	V6-305E A GASOLINA			V8-288 A GASOLINA, V8-316 A GASOLINA, V8-324 A GASOLINA, V8-336 A GASOLINA, V8-347 A GASOLINA		
GASOLINA, 1987	GG-46	25055052	ACEITE	GP-5	5515104	GASOLINA, 1956-1955	GG-5 L	5650780
GASOLINA, 1982-85	GG-17	5651921	ACEITE	GP-20	6437994	V8-305 A GASOLINA		
GASOLINA, 1986, 1988 EN ADELANTE	GG-3728	250055481	GASOLINA	GG-5 L	5650780	ACEITE	GP-13	6438384
V6-200 A GASOLINA			V6-305E A GASOLINA, V6-351C A GASOLINA, V6-351C A GASOLINA			ACEITE, SERIES K 1988 EN ADELANTE	GP-3980	25171377
ACEITE	GP-46	25010766	ACEITE	GP-20	6437994	AIRE, 1976-79	GA-57	6485108
AIRE	GA-192	6483864	V6-351C A GASOLINA			AIRE, 1984 EN ADELANTE	GA-59	6484235
GASOLINA	GG-7	5651921	ACEITE	GP-20	6437994	AIRE, 1980-83	GA-192	6483864
GASOLINA	GG-17	5651921	GASOLINA	GG-20	5650030	GASOLINA, 1 3/64 IN MOTORES CARBURADOS	GG-6	5651393
V6-229 A GASOLINA			GASOLINA	GG-5 L	5650780	GASOLINA, 2 1/16 IN MOTORES CARBURADOS	GG-7	5651921
ACEITE, HASTA 1981	GP-46	25010766	V6-379 A GASOLINA, V6-401 A GASOLINA, V6-401M A GASOLINA, V6-432 A GASOLINA, V6-478 A GASOLINA, V6-478M A GASOLINA			MOTORES CON INYECCION DE COMBUSTIBLE	GG-46	25055052
ACEITE, 1981 EN ADELANTE	GP-3980	25171377	ACEITE	G-33	5573014	GASOLINA, 1 3/64 IN MOTORES CARBURADOS	GG-16	5651920
AIRE, HASTA 1981	GA-192	6483864	V8 6.0L LQ4 A GASOLINA, V8 6.0L LQ4 A GASOLINA			GASOLINA, 2 1/16 IN MOTORES CARBURADOS	GG-17	5651921
AIRE, 1981 EN ADELANTE	GA-3588	25040929	ACEITE	GP-44	25010633	V8-307 A GASOLINA		
GASOLINA, HASTA 1982	GG-6	5651393	AIRE	GA-348	25313349	ACEITE, 1968-69	G-200	5574540
GASOLINA, 1983 EN ADELANTE	GG-7	5651921	GASOLINA	GG-46	25121792	ACEITE, 1970-73	GP-13	6438384
GASOLINA, HASTA 1982	GG-16	5651920	V8 6.0L LQ4 A GASOLINA			GASOLINA, 1973	GG-6	5651393
GASOLINA, 1983 EN ADELANTE	GG-17	5651921	ACEITE	GP-3675	25014748	GASOLINA, BRONCE COMPRIMIDO	GG-123	7013404
V6-231 A GASOLINA			AIRE	GA-348	25313349	V8-322 A GASOLINA		
ACEITE	GP-46	25010766	GASOLINA	GG-46	25121792	GASOLINA	GG-20	5650030
AIRE	GA-192	6483864	V8 6.0L LQ4 A GASOLINA			V8-327 A GASOLINA		
GASOLINA, 1978-79, 1982	GG-6	5651393	ACEITE	GP-3980	25171377	ACEITE, 1967 EXCEPTO. 50-80 SERIES	G-33	5573014
GASOLINA, 1980-81, 1983 EN ADELANTE	GG-7	5651921	AIRE	GA-348	25313349	ACEITE, 1962-68	G-200	5574540
GASOLINA, 1978-79, 1982	GG-16	5651920	GASOLINA	GG-46	25121792	ACEITE, SELLADO	GP-13	6438384
GASOLINA, 1980-81, 1983 EN ADELANTE	GG-17	5651921	V8 6.2L A DIESEL			GASOLINA	GG-20	5650030
V6-262 A GASOLINA			ACEITE	GP-13	6438384	GASOLINA, 1 3/64 IN	GG-6	5651393
ACEITE	GP-3980	25171377	COMBUSTIBLE, PRIMARIO SIN PURGADOR	GP-92	25011422	GASOLINA, 1 3/64 IN	GG-16	5651920
AIRE, EL CAMINO	GA-57	6485108	COMBUSTIBLE, SECUNDARIO	GP-1122	25011422	V8-348 A GASOLINA		
AIRE, PICK UPS, VANS	GA-192	6483864	ACEITE	GP-205	25160561	ACEITE, 1962-65	G-33	5573014
AIRE, ASTRO, S10	GA-3588	25040929	V8 6.2L A DIESEL			ACEITE	G-200	5574540
GASOLINA, 4 BBL	GG-7	5651921	ACEITE	GP-13	6438384	AIRE, 1964-65	GA-56	5645017
GASOLINA, EFI	GG-46	25055052	ACEITE	GP-205	25160561	GASOLINA, 1960-65	GG-20	5650030
GASOLINA, 4 BBL	GG-17	5651921	COMBUSTIBLE	G-294	14071064	GASOLINA, BRONCE COMPRIMIDO	GG-123	7013404
V6-305B A GASOLINA, V6-305C A GASOLINA, V6-305D A GASOLINA, V6-305E A GASOLINA, V6-351 A GASOLINA			V8-265 A GASOLINA			V8-350 A GASOLINA		
ACEITE	G-33	5573014	ACEITE, 1958-59	G-200	5574540	ACEITE	G-34	6437562
V6-305C A GASOLINA, V6-351C A GASOLINA			V8-267 A GASOLINA			ACEITE	G-200	5574540
ACEITE	GP-5	5515104	ACEITE	GP-3	6435679	GASOLINA	GG-123	7013404
V6-305C A GASOLINA, V6-305E A GASOLINA, V6-351M A GASOLINA			AIRE, HASTA 1981	GA-192	6483864	V8-350 A GASOLINA		
ACEITE	G-33	5573014	AIRE, 1981 EN ADELANTE	GA-3588	25040929	ACEITE	G-34	6437562
ACEITE	GP-20	6437994	GASOLINA, 1982	GG-6	5651393	ACEITE	GP-13	6438384
GASOLINA	GG-5 L	5650780	GASOLINA, HASTA 1982	GG-7	5651921	ACEITE	GP-205	25160561
V6-305C A GASOLINA			GASOLINA, 1982	GG-16	5651920	GASOLINA	GG-5	5650780
ACEITE	G-33	5573014	GASOLINA, HASTA 1982	GG-17	5651921	GASOLINA	GG-20	5650030
ACEITE	GP-20	6437994	V8-283 A GASOLINA			V8-350 A GASOLINA		
GASOLINA	GG-6	5651393	ACEITE, 1962-67	G-33	5573014	ACEITE	G-34	6437562
GASOLINA	GG-5 L	5650780	ACEITE, 1958-67	G-200	5574540	ACEITE	GP-13	6438384
V6-305C A GASOLINA			ACEITE, CONVERSION A SELLADO	GP-13	6438384	ACEITE	GP-205	25160561
ACEITE	G-33	5573014	AIRE, 1964-67	GA-56	5645017	ACEITE	GP-205	25160561
ACEITE	GP-20	6437994	GASOLINA, 1960-67	GG-20	5650030	GASOLINA	GG-6	5651393
GASOLINA	GG-6	5651393	GASOLINA, 1959	GG-123	7013404			

SERVICIO PESADO

MARCA-MODELO-MOTOR MAKE-MODEL-ENGINE	GONHER GONHER	OEM OEM	MARCA-MODELO-MOTOR MAKE-MODEL-ENGINE	GONHER GONHER	OEM OEM	MARCA-MODELO-MOTOR MAKE-MODEL-ENGINE	GONHER GONHER	OEM OEM
GENERAL MOTORS / CHEVROLET			GENERAL MOTORS / CHEVROLET			GENERAL MOTORS / CHEVROLET		
MOTORES			MOTORES			MOTORES		
V8-350 A GASOLINA			ACEITE	GP-205	25160561	V8-396 A GASOLINA		
ACEITE	G-34	6437562	GASOLINA	GG-46	25055052	ACEITE	G-34	6437562
ACEITE	GP-13	6438384				ACEITE	GP-13	6438384
ACEITE	GP-23	25010754	V8-350 A GASOLINA			ACEITE	GP-205	25160561
ACEITE	GP-205	25160561	ACEITE	GP-3980	25171377			
GASOLINA	GG-6	5651393	ACEITE	GP-205	25160561	V8-396 A GASOLINA		
			GASOLINA	GG-46	25121792	ACEITE	G-34	6437562
V8-350 A GASOLINA, V8-454 A GASOLINA						ACEITE	GP-13	6438384
ACEITE	GP-13	6438384	V8-350 A GASOLINA			ACEITE	GP-23	25010754
ACEITE	GP-23	25010754	ACEITE	GP-3980	25171377	ACEITE	GP-205	25160561
ACEITE	GP-205	25160561	ACEITE	GP-205	25160561			
GASOLINA	GG-6	5651393	GASOLINA	GG-46	25121792	V8-396 A GASOLINA		
			GASOLINA	GG-580	25121801	ACEITE	G-200	5574540
V8-350 A GASOLINA								
ACEITE	GP-13	6438384	V8-366 A GASOLINA			V8-396 A GASOLINA, V8-454 A GASOLINA		
ACEITE	GP-23	25010754	GASOLINA	GG-20	5650030	ACEITE	G-34	6437562
ACEITE	GP-205	25160561						
GASOLINA	GG-6	5651393	V8-366 A GASOLINA			V8-400 A GASOLINA		
GASOLINA	GG-7	5651921	ACEITE	G-34	6437562	ACEITE	GP-13	6438384
						ACEITE	GP-205	25160561
V8-350 A GASOLINA			V8-366 A GASOLINA			GASOLINA	GG-6	5651393
ACEITE	GP-13	6438384	ACEITE	G-34	6437562			
ACEITE	GP-23	25010754	GASOLINA	GG-20	5650030	V8-400 A GASOLINA		
ACEITE	GP-205	25160561	GASOLINA	GG-6	5651393	ACEITE	GP-13	6438384
GASOLINA	GG-16	5651920						
GASOLINA	GG-17	5651921	V8-366 A GASOLINA			V8-400 A GASOLINA		
			ACEITE	G-34	6437562	ACEITE	GP-13	6438384
V8-350 A GASOLINA			ACEITE	GP-13	6438384	ACEITE	GP-205	25160561
ACEITE	GP-13	6438384	ACEITE	GP-23	25010754	GASOLINA	GG-17	5651921
ACEITE	GP-23	25010754	ACEITE	GP-205	25160561			
ACEITE	GP-205	25160561	GASOLINA	GG-20	5650030	V8-427 A GASOLINA		
GASOLINA	GG-20	5650030	GASOLINA	GG-6	5651393	ACEITE	G-34	6437562
GASOLINA	GG-6	5651393				ACEITE	G-200	5574540
GASOLINA	GG-16	5651920	V8-366 A GASOLINA			ACEITE	GP-13	6438384
GASOLINA	GG-17	5651921	ACEITE	GP-13	6438384	ACEITE	GP-23	25010754
			ACEITE	GP-23	25010754	ACEITE	GP-205	25160561
V8-350 A GASOLINA			ACEITE	GP-205	25160561	GASOLINA	GG-20	5650030
ACEITE	GP-13	6438384	GASOLINA	GG-20	5650030	GASOLINA	GG-46	25055052
ACEITE	GP-23	25010754	GASOLINA	GG-6	5651393			
ACEITE	GP-205	25160561				V8-454 A GASOLINA		
GASOLINA	GG-20	5650030	V8-366 A GASOLINA			GASOLINA	GG-6	5651393
GASOLINA	GG-6	5651393	ACEITE	GP-13	6438384			
GASOLINA	GG-16	5651920	ACEITE	GP-23	25010754	V8-454 A GASOLINA		
GASOLINA	GG-17	5651921	ACEITE	GP-205	25160561	ACEITE	GP-13	6438384
			ACEITE	GP-205	25160561	ACEITE	GP-23	25010754
V8-350 A GASOLINA						ACEITE	GP-205	25160561
ACEITE	GP-13	6438384	V8-366 A GASOLINA			GASOLINA	GG-46	25055052
ACEITE	GP-23	25010754	ACEITE	GP-13	6438384			
ACEITE	GP-205	25160561	ACEITE	GP-23	25010754	V8-454 A GASOLINA		
GASOLINA	GG-20	5650030	ACEITE	GP-205	25160561	ACEITE	GP-13	6438384
GASOLINA	GG-17	5651921	GASOLINA	GG-20	5650030	ACEITE	GP-23	25010754
						ACEITE	GP-205	25160561
V8-350 A GASOLINA, V8-454 A GASOLINA			V8-366 A GASOLINA			GASOLINA	GG-6	5651393
ACEITE	GP-13	6438384	ACEITE	GP-13	6438384			
ACEITE	GP-23	25010754	ACEITE	GP-23	25010754	V8-494 A GASOLINA		
ACEITE	GP-205	25160561	ACEITE	GP-205	25160561	ACEITE	GP-408	25324052
GASOLINA	GG-17	5651921	GASOLINA	GG-46	25055052	AIRE	GA-348	25313349
						GASOLINA	GG-46	25121792
V8-350 A GASOLINA			V8-370 A GASOLINA					
ACEITE	GP-13	6438384	GASOLINA	GG-5 L	5650780	V8-6.2L TURBO A DIESEL		
ACEITE	GP-23	25010754				ACEITE, 1993-1992	GP-13	6438384
ACEITE	GP-205	25160561	V8-396 A GASOLINA					
GASOLINA	GG-46	25055052	ACEITE	G-34	6437562	V8-6.5L TURBO A DIESEL		
			ACEITE	GP-13	6438384	ACEITE	GP-13	6438384
V8-350 A GASOLINA			ACEITE	GP-205	25160561	V8-637 A GASOLINA		
ACEITE	GP-13	6438384	GASOLINA	GG-6	5651393	ACEITE	G-33	5573014

MARCA-MODELO-MOTOR MAKE-MODEL-ENGINE	GONHER GONHER	OEM OEM	MARCA-MODELO-MOTOR MAKE-MODEL-ENGINE	GONHER GONHER	OEM OEM	MARCA-MODELO-MOTOR MAKE-MODEL-ENGINE	GONHER GONHER	OEM OEM
GIRARDIN			HINO			HINO (continuación)		
CAMIONES, TRACTOCAMIONES Y AUTOBUSES			CAMIONES, TRACTOCAMIONES Y AUTOBUSES			CAMIONES, TRACTOCAMIONES Y AUTOBUSES		
CUT-AWAY CHASSIS con motor/FORD 6.0L TURBO DIESEL			2320DH, 2320LP con motor/HINO J08C-TP			FD20 con motor/HINO H06C-TN		
ACEITE	G-3752	3C3Z-6731-AA	COMBUSTIBLE	GPP-1287	23401-1441	COMBUSTIBLE, MOTOR	GP-1101	23501-1010
CUT-AWAY CHASSIS con motor/FORD 7.3L TURBO DIESEL			238, 268 con motor/HINO J08E-TA			TANQUE DE COMBUSTIBLE		
SEPARADOR DE COMBUSTIBLE, 1999 EN ADELANTE	G-862	F81A-9N184-AB	AIRE	GA-197R	17801-3440	AGUA	GP-1011Q	16304-1011
SEPARADOR DE COMBUSTIBLE	G-178	F4TZ-9N184-B	338 con motor/HINO J08E-TB			ACEITE	GP-43	15607-1740
ACEITE	GP-562	F4TZ-6731-A	AIRE	GA-197R	17801-3440	TRANSMISION	GP-9586	34926-1041
AIRE, REQUIERE 2 PIEZAS	GAVW-620	F5UZ-9601-A				FD2220 con motor/HINO J08C-TP		
CUT-AWAY CHASSIS con motor/FORD V8 5.4L			FA14 con motor/HINO W04C-T			COMBUSTIBLE, SECUNDARIO		
ACEITE	GP-68	F1AZ-6731-BD	TANQUE DE COMBUSTIBLE	GP-1101	23501-1010	TRANSMISION	GP-9586	34926-1041
AIRE	GA-1615	F6ZZ-9601-A	AGUA	GP-1011Q	16304-1011	COMBUSTIBLE, SEPARADOR DE AGUA	GPP-1287	23401-1440A
COMBUSTIBLE	GG-986	F89Z-9155-A	ACEITE	GP-43	15607-1750	FD2320-DH, FD2320-LP con motor/HINO J08C-TP		
			TRANSMISION	GP-9586	34926-1041	COMBUSTIBLE, SECUNDARIO		
CUT-AWAY CHASSIS con motor/GM 5.7L GASOLINA			FA15 con motor/HINO W04C-TI			AGUA		
ACEITE	GP-205	25160561	TANQUE DE COMBUSTIBLE	GP-1101	23501-1010	COMBUSTIBLE, SEPARADOR DE AGUA	GPP-1287	23401-1440
AIRE	GA-392	25042562	AGUA	GP-1011Q	16304-1011	FE16 con motor/HINO W06E		
AIRE	GA-192	6419892	ACEITE	GP-43	15607-1750	TANQUE DE COMBUSTIBLE	GP-1101	23501-1010
AIRE	GA-413R	15153904	TRANSMISION	GP-9586	34926-1041	AGUA	GP-1011Q	16304-1011
COMBUSTIBLE	GG-46	25121792	FA1517 con motor/HINO J05C-TD			ACEITE	GP-43	15607-1740
COMBUSTIBLE	GG-581	25121801	TRANSMISION	GP-9586	34926-1041	TRANSMISION	GP-9586	34926-1041
CUT-AWAY CHASSIS con motor/GM 6.5L DIESEL			FB14 con motor/HINO W04C-T			AIRE, SECUNDARIO		
ACEITE	GP-205	25160561	TANQUE DE COMBUSTIBLE	GP-1101	23501-1010	FE19 con motor/HINO H06C-T		
COMBUSTIBLE	GPP-419	12552214	AGUA	GP-1011Q	16304-1011	COMBUSTIBLE, MOTOR	GP-1101	23401-1400
AIRE	GA-392	25042562	TRANSMISION	GP-9586	34926-1041	TANQUE DE COMBUSTIBLE	GP-1101	23501-1010
CUT-AWAY CHASSIS con motores/GM V8 4.8L VORTEC, GM V8 6.0L VORTEC			FB14 con motor/HINO W04C-TD			AGUA		
ACEITE	GP-44	88984215	COMBUSTIBLE	GP-1101	23501-1010	TRANSMISION	GP-9586	34926-1041
AIRE	GA-413R	15153904	AGUA	GP-1011Q	16304-1011	AIRE, SECUNDARIO	GA-398	17801-2460
COMBUSTIBLE, ROSCAS EN AMBOS EXTREMOS	GG-46	25171792	ACEITE	GP-43	15607-1750	FE19 con motor/HINO H06C-TJ		
COMBUSTIBLE, ROSCA EN UN SOLO EXTREMO	GG-66	25121293	TRANSMISION	GP-9586	34926-1041	ACEITE	GP-43	15607-1740
MB-II con motor/GM 4.8L			FB15 con motor/HINO W04C-TI			FE20 con motor/HINO H06C-TN		
ACEITE, 2006 EN ADELANTE	GP-406	89017524	TANQUE DE COMBUSTIBLE	GP-1101	23501-1010	COMBUSTIBLE, MOTOR	GP-1101	23501-1010
ACEITE, 2003-2005	GP-44	6439857	AGUA	GP-1011Q	16304-1011	TANQUE DE COMBUSTIBLE	GP-1101	23401-1400
AIRE	GA-413R	15153904	ACEITE	GP-43	156071381	AGUA	GP-1011Q	16304-1011
GASOLINA, 2003-05 (ROSCA EN AMBOS EXTREMOS)	GG-46	25055046	TRANSMISION	GP-9586	34926-1041	ACEITE	GP-43	15607-1740
GASOLINA, 2003-05 (ROSCA EN UN EXTREMO)	GG-66	25121293	FB1817 con motor/HINO J05C-TD			TRANSMISION	GP-9586	34926-1041
MB-II con motor/GM 6.0L			FD16 con motor/HINO W06E			FE20 con motor/HINO H06C-TI		
ACEITE, 2007 EN ADELANTE	GP-406	89017524	TANQUE DE COMBUSTIBLE	GP-1101	23501-1010	COMBUSTIBLE, MOTOR	GP-1101	23401-1400
ACEITE, 2003-2006	GP-44	6439857	AGUA	GP-1011Q	16304-1011	TANQUE DE COMBUSTIBLE	GP-1101	23501-1010
AIRE	GA-413R	15153904	ACEITE	GP-43	15607-1740	AGUA	GP-1011Q	16304-1011
GASOLINA, 2003-05 (ROSCA EN AMBOS EXTREMOS)	GG-46	25055046	TRANSMISION	GP-9586	34926-1041	TRANSMISION	GP-9586	34926-1041
GASOLINA, 2003-05 (ROSCA EN UN EXTREMO)	GG-66	25121293	AIRE, SECUNDARIO	GA-398	17801-2460	FE2218, FD2218, FD2218LP con motor/A DIESEL		
MB-IV / G5 con motor/GM 6.0L			FD17, FE17 con motor/HINO H07C			COMBUSTIBLE, MOTOR		
ACEITE, 2007 EN ADELANTE	GP-406	89017524	COMBUSTIBLE, MOTOR	GP-1101	23401-1400	COMBUSTIBLE, MOTOR	GP-1101	23401-1400
ACEITE, 2003-2006	GP-44	6439857	TANQUE DE COMBUSTIBLE	GP-1101	23501-1010	TANQUE DE COMBUSTIBLE	GP-1101	23401-1242
AIRE	GA-413R	15153904	AGUA	GP-1011Q	16304-1011	COMBUSTIBLE	GP-1101	23401-1242
GASOLINA, 2003-2005 (ROSCA EN AMBOS EXTREMOS)	GG-46	25055046	ACEITE	GP-43	15607-1740	FE2620 con motor/HINO J08C-TD		
GASOLINA, 2003-2005 (ROSCA EN UN EXTREMO)	GG-66	25121293	TRANSMISION	GP-9586	34926-1041	COMBUSTIBLE		
MB-IV / G5 con motor/GM 6.0L			FD20 con motor/HINO H06C-TI			COMBUSTIBLE		
ACEITE, 2007 EN ADELANTE	GP-406	89017524	COMBUSTIBLE, MOTOR	GP-1101	23401-1400	FE2620 con motor/HINO J08C-TP		
ACEITE, 2003-2006	GP-44	6439857	TANQUE DE COMBUSTIBLE	GP-1101	23501-1010	COMBUSTIBLE, SECUNDARIO	GP-110	23401-1402
AIRE	GA-413R	15153904	AGUA	GP-1011Q	16304-1011	TRANSMISION	GP-9586	34926-1041
GASOLINA, 2003-2005 (ROSCA EN AMBOS EXTREMOS)	GG-46	25055046	ACEITE	GP-43	15607-1740	COMBUSTIBLE, SEPARADOR DE AGUA	GPP-1287	23401-1440A
GASOLINA, 2003-2005 (ROSCA EN UN EXTREMO)	GG-66	25121293	TRANSMISION	GP-9586	34926-1041	FF17 con motor/HINO H07C		
MB-IV / G5 con motor/GM 6.0L			FD20 con motor/HINO H06C-TI			COMBUSTIBLE, MOTOR		
ACEITE, 2007 EN ADELANTE	GP-406	89017524	COMBUSTIBLE, MOTOR	GP-1101	23401-1400	TANQUE DE COMBUSTIBLE	GP-1101	23501-1010
ACEITE, 2003-2006	GP-44	6439857	TANQUE DE COMBUSTIBLE	GP-1101	23501-1010	AGUA	GP-1011Q	16304-1011
AIRE	GA-413R	15153904	AGUA	GP-1011Q	16304-1011	ACEITE	GP-43	15607-1740
GASOLINA, 2003-2005 (ROSCA EN AMBOS EXTREMOS)	GG-46	25055046	ACEITE	GP-43	15607-1740	TRANSMISION	GP-9586	34926-1041
GASOLINA, 2003-2005 (ROSCA EN UN EXTREMO)	GG-66	25121293	TRANSMISION	GP-9586	34926-1041	AGUA		

SERVICIO PESADO

MARCA-MODELO-MOTOR MAKE-MODEL-ENGINE	GONHER GONHER	OEM OEM	MARCA-MODELO-MOTOR MAKE-MODEL-ENGINE	GONHER GONHER	OEM OEM	MARCA-MODELO-MOTOR MAKE-MODEL-ENGINE	GONHER GONHER	OEM OEM
HINO (continuación)			HINO (continuación)			HINO (continuación)		
CAMIONES, TRACTOCAMIONES Y AUTOBUSES			CAMIONES, TRACTOCAMIONES Y AUTOBUSES			CAMIONES, TRACTOCAMIONES Y AUTOBUSES		
TRANSMISION	GP-9586	34926-1041	AGUA	GP-1011Q	16304-1011	K-K797, K-ZM785, K-KF724, K-KF767, K-KF787, K-KF797, K-RS121, K-RS121P, K-RS141, K-RS141P, K-RS161, K-RS161P, K-RV731, K-RV732, K-RV741, K-RV742, K-RV761, K-TC703, K-ZM705, K-ZM706, K-ZM745, K-ZM765 con motor/HINO EF350		
AIRE, SECUNDARIO	GA-398	17801-2460	ACEITE	GP-43	15607-1740	AIRE, SIN ASPAS	GA-27	17801-1020
FF17 con motor/HINO H07C-F			TRANSMISION	GP-9586	34926-1041	K-KB314, K-KB324, K-KB344, K-KB384, K-KB394, K-KB721.980 con motor/HINO EB300		
ACEITE	GP-43	15607-1740	AIRE, SECUNDARIO	GA-398	17801-2460	AIRE, SIN ASPAS	GA-27	17801-1020
FF19 con motor/HINO H06C-T			FS270KD, FS271 con motor/HINO EK100			K-KB501, K-WD300D (4x4), K-ZC101, K-ZC121, K-ZM302, K-ZM303, K-KS341, KS341, KS390, KS391, K-TC922, K-TC942 con motor/HINO EK100		
COMBUSTIBLE, MOTOR	GP-1101	23401-1400	AIRE	GA-758	17801-2170	AIRE, SIN ASPAS	GA-27	17801-1020
TANQUE DE COMBUSTIBLE	GP-1101	23501-1010	FS2K con motor/HINO K13D			K-KF505, K-RS320, K-RS320P, K-RS340, K-RS360, K-RS360P, K-RV531, K-RV561, K-TC582, K-TC585, K-ZM500, K-ZM540, K-ZM560 con motor/HINO EF500		
AGUA	GP-1011Q	16304-1011	COMBUSTIBLE	GP-1101	23401-1221	AIRE, SIN ASPAS	GA-27	17801-1020
TRANSMISION	GP-9586	34926-1041	GC17 con motor/HINO H07C			K-TC562, K-HH341, K-KC562 con motor/HINO EF700		
AIRE, SECUNDARIO	GA-398	17801-2460	COMBUSTIBLE, MOTOR	GP-1101	23401-1400	AIRE, SIN ASPAS	GA-27	17801-1020
FF19, FG19 con motor/HINO H06C-TJ			TANQUE DE COMBUSTIBLE	GP-1101	23501-1010	K-ZM764, K-ZM704, K-ZM744 con motor/HINO EF300		
ACEITE	GP-43	15607-1740	AGUA	GP-1011Q	16304-1011	AIRE, SIN ASPAS	GA-27	17801-1020
FF20 con motor/HINO H06C-TN			TRANSMISION	GP-9586	34926-1041	P-FH272 con motor/HINO EK100		
COMBUSTIBLE, MOTOR	GP-1101	23501-1010	AIRE, SECUNDARIO	GA-398	17801-2460	AIRE	GA-758	17801-2170
TANQUE DE COMBUSTIBLE	GP-1101	23401-1400	GC17 con motor/HINO H07C-F			RS360, RS360P, RV531, RV541, RV561 con motor/HINO EF500		
AGUA	GP-1011Q	16304-1011	ACEITE	GP-43	15607-1740	AIRE, SIN ASPAS	GA-27	17801-1020
ACEITE	GP-43	15607-1740	GC20 con motor/HINO H06C-TN			RV761, RS120, RS120P, RV731, RV741 con motor/HINO EF300		
TRANSMISION	GP-9586	34926-1041	COMBUSTIBLE, MOTOR	GP-1101	23501-1010	AIRE, SIN ASPAS	GA-27	17801-1020
FF23 con motor/HINO H06C-TI			TANQUE DE COMBUSTIBLE	GP-1101	23401-1400	SG19 con motor/HINO H06C-T		
COMBUSTIBLE, MOTOR	GP-1101	23401-1400	AGUA	GP-1011Q	16304-1011	COMBUSTIBLE, MOTOR	GP-1101	23401-1400
TANQUE DE COMBUSTIBLE	GP-1101	23501-1010	ACEITE	GP-43	15607-1740	TANQUE DE COMBUSTIBLE	GP-1101	23501-1010
AGUA	GP-1011Q	163041011	TRANSMISION	GP-9586	34926-1041	AGUA	GP-1011Q	16304-1011
TRANSMISION	GP-9586	34926-1041	GC20, SG20 con motor/HINO H06C-TI			TRANSMISION	GP-9586	34926-1041
AIRE, SECUNDARIO	GA-398	17801-2460	COMBUSTIBLE, MOTOR	GP-1101	23401-1400	AIRE, SECUNDARIO	GA-398	17801-2460
FF23 con motor/HINO H06C-TN			TANQUE DE COMBUSTIBLE	GP-1101	23501-1010	SG19 con motor/HINO H06C-TJ		
COMBUSTIBLE, MOTOR	GP-1101	23501-1010	AGUA	GP-1011Q	16304-1011	ACEITE	GP-43	15607-1740
TANQUE DE COMBUSTIBLE	GP-1101	23401-1400	TRANSMISION	GP-9586	34926-1041	SG20 con motor/HINO H06C-TN		
AGUA	GP-1011Q	16304-1011	GS221, GS221KD, GS221KM, GS224, GS224KA con motor/HINO EM100			COMBUSTIBLE, MOTOR	GP-1101	23501-1010
ACEITE	GP-43	15607-1740	AIRE, SECUNDARIO	GA-398	17801-2460	TANQUE DE COMBUSTIBLE	GP-1101	23401-1400
TRANSMISION	GP-9586	34926-1041	HV10 con motor/A DIESEL			AGUA	GP-1011Q	16304-1011
FF3018 con motor/HINO J08C-TP			ACEITE	GP-1	1560A41010	ACEITE	GP-43	15607-1740
COMBUSTIBLE, MOTOR	GP-1101	23401-1400	KB501 con motor/HINO EK100			TRANSMISION	GP-9586	34926-1041
FF3020 con motor/HINO J08C-TP			AIRE, SIN ASPAS	GA-27	17801-1020	AIRE, SECUNDARIO	GA-398	17801-2460
COMBUSTIBLE, MOTOR	GP-1101	23401-1400	KF703, KF797, KF706, KF707, KF746, KF766, KF783, KF786 con motor/HINO EF300			SG23 con motor/A DIESEL		
TANQUE DE COMBUSTIBLE	GP-1101	23501-1010	AIRE, SIN ASPAS	GA-27	17801-1020	COMBUSTIBLE, MOTOR	GP-1101	23501-1010
COMBUSTIBLE, SECUNDARIO	GP-110	23401-1402	K-FF505 con motor/HINO EF550			TANQUE DE COMBUSTIBLE	GP-1101	23401-1400
TRANSMISION	GP-9586	34926-1041	AIRE, SIN ASPAS	GA-27	17801-1020	AGUA	GP-1011Q	16304-1011
COMBUSTIBLE, SEPARADOR DE AGUA	GPP-1287	23401-1440A	K-FF700, K-FF704, K-FF747 con motor/HINO EF350			ACEITE	GP-43	15607-1740
FFC1 con motor/CUMMINS 6BT5.9			AIRE, SIN ASPAS	GA-27	17801-1020	TRANSMISION	GP-9586	34926-1041
COMBUSTIBLE	GPP-1122	3286503	K-HE366 con motor/HINO EF700			SG23 con motor/HINO H06C-TI		
AGUA	GP-1011Q	163041011	AIRE, SIN ASPAS	GA-27	17801-1020	COMBUSTIBLE, MOTOR	GP-1101	23501-1010
ACEITE	GP-178	3914395	K-HE526 con motor/A DIESEL			TANQUE DE COMBUSTIBLE	GP-1101	23401-1400
AIRE, SECUNDARIO	GA-398	17801-2460	ACEITE	GP-1	1560A41010	AGUA	GP-1011Q	16304-1011
FG19 con motor/HINO H06C-T			K-HT275, K-RC721, K-HT276, K-HU275, K-HU276, K-RC701 con motor/HINO EK200			ACEITE	GP-43	15607-1740
COMBUSTIBLE, MOTOR	GP-1101	23401-1400	AIRE, SIN ASPAS	GA-27	17801-1020	TRANSMISION	GP-9586	34926-1041
TANQUE DE COMBUSTIBLE	GP-1101	23501-1010	K-HT275, K-RC721, K-HT276, K-HU275, K-HU276, K-RC701 con motor/HINO EK200			AIRE, SECUNDARIO	GA-398	17801-2460
AGUA	GP-1011Q	16304-1011	AIRE, SIN ASPAS	GA-27	17801-1020	SG23 con motor/HINO H06C-TI		
TRANSMISION	GP-9586	34926-1041	AIRE, SIN ASPAS	GA-27	17801-1020	COMBUSTIBLE, MOTOR	GP-1101	23401-1400
AIRE, SECUNDARIO	GA-398	17801-2460	AIRE, SIN ASPAS	GA-27	17801-1020	TANQUE DE COMBUSTIBLE	GP-1101	23501-1010
FG22, SG22 con motor/HINO EM100E			AIRE, SIN ASPAS	GA-27	17801-1020	AGUA	GP-1011Q	163041011
COMBUSTIBLE, MOTOR	GP-1101	23401-1400	AIRE, SIN ASPAS	GA-27	17801-1020	TRANSMISION	GP-9586	34926-1041
TANQUE DE COMBUSTIBLE	GP-1101	23501-1010	AIRE, SIN ASPAS	GA-27	17801-1020	AIRE, SECUNDARIO	GA-398	17801-2460
ACEITE, DERIVACION (BY PASS)	GP-57	15607-1760	AIRE, SIN ASPAS	GA-27	17801-1020			

MARCA-MODELO-MOTOR MAKE-MODEL-ENGINE	GONHER GONHER	OEM OEM
HINO (continuación)		
CAMIONES, TRACTOCAMIONES Y AUTOBUSES		
SG3320 con motor/HINO J08C-TP		
COMBUSTIBLE, MOTOR	GP-1101	23401-1400
TANQUE DE COMBUSTIBLE	GP-1101	23501-1010
COMBUSTIBLE, SECUNDARIO	GP-110	23401-1402
TRANSMISION	GP-9586	34926-1041
COMBUSTIBLE, SEPARADOR DE AGUA	GPP-1287	23401-1440A
SG3323 con motor/A DIESEL		
COMBUSTIBLE, MOTOR	GP-1101	23401-1400
TANQUE DE COMBUSTIBLE	GP-1101	23501-1010
AIRE, SECUNDARIO	GA-398	17801-2460
SG3325 con motor/HINO J08C-TR		
COMBUSTIBLE, SECUNDARIO	GP-110	23401-1402
TRANSMISION	GP-9586	34926-1041
COMBUSTIBLE, SEPARADOR DE AGUA	GPP-1287	23401-1440A
SG5523 con motor/A DIESEL		
COMBUSTIBLE, MOTOR	GP-1101	23401-1400
TANQUE DE COMBUSTIBLE	GP-1101	23501-1010
AIRE, SECUNDARIO	GA-398	17801-2460
ZM303, WD300D (4x4), ZM302 con motor/HINO EK100		
AIRE, SIN ASPAS	GA-27	17801-1020
ZM500, ZM540, ZM560 con motor/HINO EF500		
AIRE, SIN ASPAS	GA-27	17801-1020
ZM704, ZM705 con motor/HINO EF300		
AIRE, SIN ASPAS	GA-27	17801-1020

HINO		
GRÚAS		
K-ZR255, ZR255 con motor/HINO EK100		
AIRE, SIN ASPAS	GA-27	17801-1020
ZT300 con motor/HINO ED100		
AIRE	GAK-20	178011491

HINO		
MOTORES		
EM100		
COMBUSTIBLE, PRIMARIO	GP-1101	23401-1281
ACEITE, DERIVACION (BY PASS)	GP-57	15607-1420
ACEITE	GP-43	15607-1381
AGUA	GP-2071W	P554071
AIRE, SECUNDARIO	GA-398	17801-2460
H06C-T, H07C		
COMBUSTIBLE, PRIMARIO	GP-1101	23401-1281
ACEITE	GP-43	15607-1381
AIRE, SECUNDARIO	GA-398	17801-2460
H06C-TN, H06C-TM		
COMBUSTIBLE, MOTOR	GP-1101	23501-1010
TANQUE DE COMBUSTIBLE	GP-1101	23401-1400
ACEITE	GP-43	15607-1740
H07C-B, W06E		
ACEITE	GP-43	15607-1381

MARCA-MODELO-MOTOR MAKE-MODEL-ENGINE	GONHER GONHER	OEM OEM
HINO (continuación)		
MOTORES		
W04C-TH		
COMBUSTIBLE, PRIMARIO	GP-1101	23401-1281
HINO		
TRACTORES		
HE336 con motor/HINO EF500		
AIRE, SIN ASPAS	GA-27	17801-1020
HE366, HH341, K-HE366, K-HH341, K-KC562, K-TC562, TC562 con motor/HINO EF700		
AIRE, SIN ASPAS	GA-27	17801-1020
HG301, HG311 con motor/HINO EA100		
AIRE, SIN ASPAS	GA-27	17801-1470
KG301 con motor/HINO EA100		
AIRE, SIN ASPAS	GA-27	17801-1470
HITACHI		
CAMIONES, TRACTOCAMIONES Y AUTOBUSES		
EH1000 DE VOLTEO con motor/CUMMINS QSK19		
AGUA, SISTEMA DE ENFRIAMIENTO	GP-1010Q	E12967020
ACEITE, DOBLE FLUJO	GP-3000	E12969457
COMBUSTIBLE	GPP-1000	E12977622
AIRE, PRIMARIO	GA-879	E4082222
EH1100 DE VOLTEO con motor/DETROIT DIESEL 12V2000		
AGUA, SISTEMA DE ENFRIAMIENTO	GP-1010Q	E12967020

HITACHI		
CARGADORAS		
LX100-3 con motor/JOHN DEERE		
ACEITE	GP-14	T19044
COMBUSTIBLE, PRIMARIO	GPP-424	RE62424
COMBUSTIBLE, SECUNDARIO	GPP-419	RE62419
AIRE, PRIMARIO	GA-697R	AT203469

HITACHI		
EXCAVADORAS		
EX1100 con motor/CUMMINS KTA19C		
ACEITE, DERIVACION (BY PASS), REQUIERE 2 PIEZAS	GP-57	4204048
EX1100 con motor/CUMMINS QSK19		
ACEITE, REQUIERE 2 PIEZAS	GP-3000	4228688
SEPARADOR DE COMBUSTIBLE, REQUIERE 2 PIEZAS	GPP-1000	4377880
AIRE, PRIMARIO	GA-563	4206272
EX1800 con motor/DOS CUMMINS KTA19		
ACEITE, DERIVACION (BY PASS), REQUIERE 2 PIEZAS	GP-57	4175913
AGUA, SISTEMA DE ENFRIAMIENTO, REQUIERE 2 PIEZAS	GP-2071W	4127340
AIRE, PRIMARIO, REQUIERE 2 PIEZAS	GA-563	4206272
EX1800-1 con motor/CUMMINS		
COMBUSTIBLE, REQUIERE 4 PIEZAS	GP-1101	4206090-1
ACEITE, DERIVACION (BY PASS), REQUIERE 2 PIEZAS	GP-57	4204048

MARCA-MODELO-MOTOR MAKE-MODEL-ENGINE	GONHER GONHER	OEM OEM
HITACHI (continuación)		
EXCAVADORAS		
AIRE, PRIMARIO, REQUIERE 2 PIEZAS	GA-563	4206272
EX1800-2 con motor/DOS CUMMINS KTA19		
ACEITE, DERIVACION (BY PASS), REQUIERE 2 PIEZAS	GP-57	4175913
AGUA, SISTEMA DE ENFRIAMIENTO, REQUIERE 2 PIEZAS	GP-2071W	4127340
AIRE, PRIMARIO, REQUIERE 2 PIEZAS	GA-563	4206272
EX1800-3 con motor/DOS CUMMINS QSK19C		
ACEITE, REQUIERE 4 PIEZAS	GP-3000	4228688
SEPARADOR DE COMBUSTIBLE, REQUIERE 4 PIEZAS	GPP-1000	4377880
AIRE, PRIMARIO, REQUIERE 2 PIEZAS	GA-563	4206272
EX2500 con motor/CUMMINS KTA50		
ACEITE, DERIVACION (BY PASS)	GP-57	4204048
AGUA, SISTEMA DE ENFRIAMIENTO	GP-1012Q	4299640
AIRE, PRIMARIO	GA-879	4331923
EX2500-5 con motor/CUMMINS QSK45		
AIRE, PRIMARIO	GA-879	4331923
EX3500, EX3500-2, EX3500-3 con motor/DOS CUMMINS KT38		
ACEITE, DERIVACION (BY PASS), REQUIERE 4 PIEZAS	GP-57	4175913
AGUA, SISTEMA DE ENFRIAMIENTO, REQUIERE 8 PIEZAS	GP-1011Q	4294577
AIRE, PRIMARIO, REQUIERE 2 PIEZAS	GA-563	4206272
EX5500 con motor/DOS CUMMINS KTA50C		
ACEITE, FLUJO TOTAL (FULL FLOW)	GP-53	4085913
ACEITE, DERIVACION (BY PASS)	GP-57	4204048
AGUA, SISTEMA DE ENFRIAMIENTO	GP-1012Q	4299640
AIRE, PRIMARIO	GA-879	4331923
EX5500-5 con motor/DOS CUMMINS QSK45		
AIRE, PRIMARIO	GA-879	4331923
GIANT EX1900, GIANT EX1900-5 con motor/HITACHI S12A-Y1T		
AIRE, PRIMARIO, REQUIERE 2 PIEZAS	GA-563	4206272
GIANT EX2500 con motor/CUMMINS QSK45		
ACEITE, FLUJO TOTAL (FULL FLOW)	GP-53	4085913
ACEITE, DERIVACION (BY PASS)	GP-57	4204048
AGUA, SISTEMA DE ENFRIAMIENTO	GP-1012Q	4299640
AIRE, PRIMARIO	GA-879	4331923
GIANT EX3600, GIANT EX3600-5 con motor/HITACHI S16R-Y1T		
AIRE, PRIMARIO, REQUIERE 4 PIEZAS	GA-563	4206272
HOUGH		
EQUIPO PARA CONSTRUCCION		
350 PAYHAULER con motor/A DIESEL		
ACEITE	G-33	131470H1
ACEITE, CONVERTIDOR DE TORSION	G-33	131470H1

SERVICIO PESADO

MARCA-MODELO-MOTOR MAKE-MODEL-ENGINE	GONHER GONHER	OEM OEM	MARCA-MODELO-MOTOR MAKE-MODEL-ENGINE	GONHER GONHER	OEM OEM	MARCA-MODELO-MOTOR MAKE-MODEL-ENGINE	GONHER GONHER	OEM OEM
HOUGH (continuación)			HOUGH (continuación)			HOUGH (continuación)		
EQUIPO PARA CONSTRUCCION			EQUIPO PARA CONSTRUCCION			EQUIPO PARA CONSTRUCCION		
TRANSMISION	G-33	131470H1	ACEITE, DERIVACION (BY PASS)	GP-57	3304232	D100 SERIES B con motores/CUMMINS NH220, CUMMINS NH250C1		
503 con motor/A DIESEL			550 con motor/IHC DVT800			ACEITE, CONVERTIDOR DE TORSION	G-33	877826-C1
ACEITE, FORD	GP-9	LF3400	ACEITE, CUMPLE CON MEDI-DAS ORIGINALES	GP-691	684206C1	D100 SERIES B con motores/IHC UD817, IHC UDT817		
COMBUSTIBLE	GP-1122	3132428-R2	ACEITE, SEGUNDA OPCION	GP-52	684206C1	ACEITE, CONVERTIDOR DE TORSION	G-33	302574-R91
ACEITE, CHRYSLER	GP-81	395789-R2	COMBUSTIBLE, SECUNDARIO	GP-1107	359251C1	D100, D100 SERIES B con motor/CUMMINS		
AIRE, PRIMARIO	GA-49	3146927R1	COMBUSTIBLE, PRIMARIO	GP-1108	625627C1	TRANSMISION	G-33	302574-R91
506 con motor/IHC D179			AGUA	GP-2071W	1207605H2	ACEITE, CARTUCHO PARA FLUJO TOTAL (FULL FLOW)	G-566	257528
COMBUSTIBLE	GP-1122	3132428-R2	560 con motor/CUMMINS			COMBUSTIBLE	GP-1101	154711
510 con motor/IHC D268			COMBUSTIBLE	GP-1101	154711	ACEITE, SELLADO PARA FLUJO TOTAL (FULL FLOW)	GP-53	3313287
ACEITE	GP-10	397868R1	ACEITE, FLUJO TOTAL (FULL FLOW)	GP-53	3313287	COMBUSTIBLE, SEPARADOR DE AGUA	GPP-11	3600980
COMBUSTIBLE	GP-1122	3132428-R2	ACEITE, SELLADO PARA DERIVACION (BY PASS)	GP-57	3304232	AIRE, SIMPLE	GA-26	304766-C92
AIRE, SECUNDARIO	GA-892	529852-R4	AGUA	GP-2071W	3315116	ACEITE, DERIVACION (BY PASS)	G-750	139096
510B con motor/A DIESEL			AIRE, RESPIRADOR	GA-39	255963	D100, D100 SERIES B con motor/GMC 6V-71		
AIRE, SECUNDARIO	GA-892	529852-R5	AIRE, PRIMARIO	GA-356	X75497	ACEITE, DERIVACION (BY PASS)	G-31	1595410
515 con motor/IHC D358			AIRE, SECUNDARIO	GA-357	P109159	ACEITE, CONVERTIDOR DE TORSION	G-33	5573013
ACEITE	GP-10	528250-R1	ACEITE, CARTUCHO PARA DERIVACION (BY PASS)	G-750	139096	ACEITE, FLUJO TOTAL (FULL FLOW)	G-33	5573013
COMBUSTIBLE	GP-1122	3132428-R2	560 con motores/IHC DT817B, IHC DT817C			COMBUSTIBLE, SECUNDARIO	G-1173	3290851
AIRE, SECUNDARIO	GA-892	529852R5	COMBUSTIBLE, SECUNDARIO	GP-1107	674293-C1	COMBUSTIBLE	G-1174	5198982
515 con motor/IHC D360			COMBUSTIBLE, PRIMARIO	GP-1108	625627-C1	D120 SERIES C, D120, D120 SERIES B con motores/GMC 6V-71, GMC 8V-71		
ACEITE	GP-69	675616C91	COMBUSTIBLE, SECUNDARIO	GP-110	702253-C1	ACEITE, FLUJO TOTAL (FULL FLOW)	G-33	5573013
COMBUSTIBLE, PRIMARIO	GP-1108	625627C1	560B con motor/CUMMINS			TRANSMISION	G-33	302574-R91
COMBUSTIBLE, SECUNDARIO	GP-78	672603-C2	ACEITE, FLUJO TOTAL (FULL FLOW)	GP-53	3313287	COMBUSTIBLE, SECUNDARIO	G-1175	D88913
AIRE, SECUNDARIO	GA-892	529852R1	COMBUSTIBLE	GP-55	3313306	D120, D120 SERIES B, D120 SERIES C con motor/IHC DT817		
515B con motor/DRESSER D359N			ACEITE, DERIVACION (BY PASS)	GP-57	3304232	ACEITE, CONVERTIDOR DE TORSION	G-33	302574-R91
COMBUSTIBLE, SECUNDARIO	GP-1122	161624	AIRE, PRIMARIO	GA-356	X75497	COMBUSTIBLE, PRIMARIO	GP-1107	674293-C1
COMBUSTIBLE, PRIMARIO	GPP-18	161623	AIRE, SECUNDARIO	GA-357	P109159	COMBUSTIBLE, SECUNDARIO	GP-1108	625627-C1
ACEITE	GP-178	1240388-H1	570 con motor/CUMMINS			COMBUSTIBLE, SECUNDARIO	GP-110	702253-C1
520B con motor/IHC DT358			ACEITE, CARTUCHO PARA FLUJO TOTAL (FULL FLOW)	G-566	257528	D400 con motores/CUMMINS, DETROIT DIESEL		
ACEITE	GP-10	528250-R1	ACEITE, SELLADO PARA FLUJO TOTAL (FULL FLOW)	GP-53	3313287	ACEITE, CONVERTIDOR DE TORSION	G-33	877826-C1
530 con motor/IHC DT414			COMBUSTIBLE	GP-55	3313306	D400, D500 con motor/GMC 12V-71		
ACEITE	GP-69	675616C91	ACEITE, DERIVACION (BY PASS)	GP-57	3304232	ACEITE, CONVERTIDOR DE TORSION	G-33	5573013
COMBUSTIBLE, PRIMARIO	GP-1108	625627C1	AGUA	GP-2071W	3315116	D400, D500 con motores/CUMMINS V1710C, CUMMINS VT1710C SERIES		
AGUA	GP-2071W	1207605H2	580 con motor/DETROIT DIESEL 12V-149T			ACEITE, CONVERTIDOR DE TORSION	G-33	302574-R91
COMBUSTIBLE, SECUNDARIO	GP-78	1809789C1	ACEITE, FLUJO TOTAL (FULL FLOW)	G-33	5573014	ACEITE, CARTUCHO PARA FLUJO TOTAL (FULL FLOW)	G-566	257528
AIRE	GA-329	627934C1	AIRE, PRIMARIO	GA-356	X75497	COMBUSTIBLE	G-1143	139097
AIRE	GA-239	627935C1	AIRE, SECUNDARIO	GA-357	P109159	ACEITE, SELLADO PARA FLUJO TOTAL (FULL FLOW)	GP-53	3313287
530 con motor/IHC DT466			D100 con motor/CUMMINS NT855C			ACEITE, DERIVACION (BY PASS)	G-750	139096
ACEITE	GP-69	675616C91	ACEITE, CONVERTIDOR DE TORSION	G-33	877826-C1	D500 con motor/CUMMINS VT12-635		
COMBUSTIBLE, PRIMARIO	GP-1108	625627C1	D100 con motores/CUMMINS NH220, CUMMINS NH250C1			ACEITE, CONVERTIDOR DE TORSION	G-33	3301060
AGUA	GP-2071W	1207605H2	ACEITE, CONVERTIDOR DE TORSION	G-33	877826-C1	D500 con motor/DETROIT DIESEL 12V-71		
COMBUSTIBLE, SECUNDARIO	GP-78	1809789C1	D100 con motor/CUMMINS NT855C			ACEITE, CONVERTIDOR DE TORSION	G-33	5573014
AIRE	GA-7716	LAF7716	ACEITE, CONVERTIDOR DE TORSION	G-33	877826-C1	D500 con motor/CUMMINS V1710C, CUMMINS VT1710C SERIES		
AIRE	GA-7360	AF4514	D100 con motores/CUMMINS NH220, CUMMINS NH250C1			ACEITE, CONVERTIDOR DE TORSION	G-33	302574-R91
540 con motores/IHC DT466B, IHC DT466C			ACEITE, CONVERTIDOR DE TORSION	G-33	877826-C1	ACEITE, CARTUCHO PARA FLUJO TOTAL (FULL FLOW)	G-566	257528
ACEITE	GP-69	675616C91	D100 con motores/IHC UD817, IHC UDT817			COMBUSTIBLE	G-1143	139097
COMBUSTIBLE, PRIMARIO	GP-1108	625627C1	ACEITE, CONVERTIDOR DE TORSION	G-33	302574-R91	ACEITE, SELLADO PARA FLUJO TOTAL (FULL FLOW)	GP-53	3313287
COMBUSTIBLE, SECUNDARIO	GP-78	1809789C1	D100 SERIES B con motor/CUMMINS NT855C			ACEITE, DERIVACION (BY PASS)	G-750	139096
AIRE, PRIMARIO	GA-7716	935694-C1	ACEITE, CONVERTIDOR DE TORSION	G-33	302574-R91	D500 con motor/CUMMINS VT12-635		
AIRE, SECUNDARIO	GA-7360	935693-C1	ACEITE, CONVERTIDOR DE TORSION	G-33	302574-R91	ACEITE, CONVERTIDOR DE TORSION	G-33	3301060
550 con motor/CUMMINS NT855			D100 con motores/CUMMINS NH220, CUMMINS NH250C1			D500 con motor/DETROIT DIESEL 12V-71		
COMBUSTIBLE	GP-1101	154711	ACEITE, CONVERTIDOR DE TORSION	G-33	877826-C1	ACEITE, CONVERTIDOR DE TORSION	G-33	5573014
ACEITE, FLUJO TOTAL (FULL FLOW)	GP-53	3313287						

APLICACIONES SERVICIO PESADO
HEAVY DUTY APPLICATIONS



MARCA-MODELO-MOTOR MAKE-MODEL-ENGINE	GONHER GONHER	OEM OEM	MARCA-MODELO-MOTOR MAKE-MODEL-ENGINE	GONHER GONHER	OEM OEM	MARCA-MODELO-MOTOR MAKE-MODEL-ENGINE	GONHER GONHER	OEM OEM
HOUGH (continuación)			HOUGH (continuación)			HOUGH (continuación)		
EQUIPO PARA CONSTRUCCION			EQUIPO PARA CONSTRUCCION			EQUIPO PARA CONSTRUCCION		
D90 SERIES C con motor/CUMMINS V6R-180			H100, H100 SERIES B, H100 SERIES C con motor/GMC 6V-71			H25 SERIES B con motor/WAUKESHA 180GKB		
ACEITE, CONVERTIDOR DE TORSION	G-33	3301060	ACEITE, DERIVACION (BY PASS)	G-31	1595410	AIRE	GA-16	159012A
ACEITE, FLUJO TOTAL (FULL FLOW)	G-566	1214939H1	ACEITE, CONVERTIDOR DE TORSION	G-33	5573013	H25, H25 SERIES B con motor/IHC C153		
COMBUSTIBLE	GP-1101	126517	ACEITE, FLUJO TOTAL (FULL FLOW)	G-33	5573013	ACEITE, SELLADO	GP-50	538836R1
AIRE	GA-27	250552-C92	COMBUSTIBLE, SECUNDARIO	G-1173	3290851	AIRE, SIMPLE S/ASPAS	GA-16	204439-H1
ACEITE, DERIVACION (BY PASS)	G-750	689032-R91	COMBUSTIBLE	G-1174	5198982	AIRE, SIMPLE	GAK-16	204439-H1
D90 SERIES C con motor/GMC 6V-53			H100C con motores/IHC DT817B, IHC DT817C			AIRE, SECUNDARIO	GA-892	1102604-C1
ACEITE, FLUJO TOTAL (FULL FLOW)	G-33	5573013	COMBUSTIBLE, SECUNDARIO	GP-1107	674293-C1	AIRE, PRIMARIO	GA-891	942534-C1
COMBUSTIBLE, SECUNDARIO	G-1173	3290851	COMBUSTIBLE, PRIMARIO	GP-1108	625627-C1	AIRE, PRIMARIO	GAK-216	924779-C2
COMBUSTIBLE	G-1174	5198982	COMBUSTIBLE, SECUNDARIO	GP-110	702253-C1	AIRE, SECUNDARIO	GA-416	537335-R2
D90 SERIES C con motor/IHC DT573			AIRE, SIMPLE	GA-26	304766-C92	H25, H25 SERIES B con motor/IHC D188		
TRANSMISION	G-33	131470H1	H120 SERIES B con motor/A DIESEL			ACEITE	G-335	279994R91
H100 con motor/CUMMINS NT855C			COMBUSTIBLE	G-1175	182855H1	COMBUSTIBLE	G-1163	304101R91
ACEITE, CONVERTIDOR DE TORSION	G-33	302574-R91	H120 SERIES C con motor/IHC UD817			AIRE, SIMPLE S/ASPAS	GA-16	204439-H1
H100 con motores/CUMMINS NH220, CUMMINS NH250C1			ACEITE, CONVERTIDOR DE TORSION	G-33	302574-R91	AIRE, SIMPLE	GAK-16	204439-H1
ACEITE, CONVERTIDOR DE TORSION	G-33	3301060	TRANSMISION	G-33	302574-R91	AIRE, SECUNDARIO	GA-892	1102604-C1
H100 con motores/IHC UD817, IHC UDT817			COMBUSTIBLE, SECUNDARIO	G-1175	182855H1	AIRE, PRIMARIO	GA-891	942534-C1
ACEITE, CONVERTIDOR DE TORSION	G-33	302574-R91	H120, H120 SERIES B, H120 SERIES C con motor/CUMMINS			AIRE, PRIMARIO	GAK-216	924779-C1
H100 SERIES B con motor/CUMMINS NT855C			TRANSMISION	G-33	302574-R91	AIRE, SECUNDARIO	GA-416	537335-R2
ACEITE	G-33	302574-R91	ACEITE, CARTUCHO PARA FLUJO TOTAL (FULL FLOW)	G-566	257528	H30 SERIES B con motor/GMC 3-53		
H100 SERIES B con motores/CUMMINS NH220, CUMMINS NH250C1			COMBUSTIBLE, CARTUCHO	G-1143	139097	ACEITE, CONVERTIDOR DE TORSION	G-33	5573013
ACEITE, CONVERTIDOR DE TORSION	G-33	302574-R91	ACEITE, TURBOCARGADOR	GP-14	4041959	ACEITE, FLUJO TOTAL (FULL FLOW)	G-33	5573013
H100 SERIES B con motores/IHC UD817, IHC UDT817			COMBUSTIBLE, SELLADO	GPP-14	3315847	ACEITE, FLUJO TOTAL (FULL FLOW)	G-119	5573978
ACEITE, CONVERTIDOR DE TORSION	G-33	302574-R91	COMBUSTIBLE, SELLADO	GP-1101	154711	COMBUSTIBLE, SECUNDARIO	G-1173	3290851
H100 SERIES C con motor/CUMMINS NT855C			ACEITE, SELLADO PARA FLUJO TOTAL (FULL FLOW)	GP-53	3313287	COMBUSTIBLE	G-1174	5198982
ACEITE, CONVERTIDOR DE TORSION	G-33	302574-R91	COMBUSTIBLE, SELLADO	GP-55	3313306	AIRE	GA-20	P181045
H100 SERIES B con motores/CUMMINS NH220, CUMMINS NH250C1			COMBUSTIBLE, SEPARADOR DE AGUA	GPP-11	3600980	AIRE	GAK-20	886017-C91
ACEITE, CONVERTIDOR DE TORSION	G-33	3301060	ACEITE, DERIVACION (BY PASS)	G-750	139096	H30 SERIES B con motor/IHC D301		
H100 SERIES B con motores/IHC UD817, IHC UDT817			H120, H120 SERIES B, H120 SERIES C con motor/IHC DT817			ACEITE, CONVERTIDOR DE TORSION	G-33	131470H1
ACEITE, CONVERTIDOR DE TORSION	G-33	302574-R91	ACEITE, CONVERTIDOR DE TORSION	G-33	302574-R91	ACEITE	G-335	279994R91
H100 SERIES C con motor/CUMMINS NT855C			COMBUSTIBLE, PRIMARIO	GP-1107	674293-C1	COMBUSTIBLE, SECUNDARIO	G-1163	304101R91
ACEITE, CONVERTIDOR DE TORSION	G-33	302574-R91	COMBUSTIBLE, PRIMARIO	GP-1108	625627-C1	AIRE	GA-20	P181045
H100 SERIES C con motor/IHC UD817			COMBUSTIBLE, SECUNDARIO	GP-110	702253-C1	AIRE	GAK-20	868446C9
ACEITE, CONVERTIDOR DE TORSION	G-33	131470H1	H120, H120 SERIES B, H120 SERIES C con motores/GMC 6V-71, GMC 8V-71			H30 SERIES B, H30F SERIES B con motor/IHC D236		
H100 SERIES C con motor/IHC UDT817			ACEITE, FLUJO TOTAL (FULL FLOW)	G-33	5573013	ACEITE, CONVERTIDOR DE TORSION	G-33	302574-R91
ACEITE, CONVERTIDOR DE TORSION	G-33	302574-R91	TRANSMISION	G-33	302574-R91	AIRE, PRIMARIO	GAK-216	924779-C1
H100 SERIES C con motores/CUMMINS NH220, CUMMINS NH250C1			COMBUSTIBLE, SECUNDARIO	G-1175	D88913	AIRE, SECUNDARIO	GA-416	537335-R1
ACEITE, CONVERTIDOR DE TORSION	G-33	3301060	H25 con motor/WAUKESHA 180DLC			H30 SERIES B, H30F SERIES B con motores/IHC C263, IHC D235		
H100, H100 SERIES B, H100 SERIES C con motor/CUMMINS			ACEITE, CONVERTIDOR DE TORSION	G-6	LP129	ACEITE, CONVERTIDOR DE TORSION	G-33	131470H1
TRANSMISION	G-33	302574-R91	HIDRAULICO	G-6	122731H1	ACEITE, CARTUCHO	G-335	279994R91
ACEITE, CARTUCHO PARA FLUJO TOTAL (FULL FLOW)	G-566	257528	ACEITE	G-31	950964	COMBUSTIBLE, SECUNDARIO	G-1163	304101R91
COMBUSTIBLE	GP-1101	154711	AIRE	GAK-16	204439-H1	ACEITE, SELLADO	GP-10	397868R1
ACEITE, SELLADO PARA FLUJO TOTAL (FULL FLOW)	GP-53	3313287	H25 con motor/WAUKESHA 180GLB			AIRE, SIMPLE S/ASPAS	GA-403	886019-C91
COMBUSTIBLE, SEPARADOR DE AGUA	GPP-11	3600980	ACEITE, CONVERTIDOR DE TORSION	G-6	LP129	AIRE, SIMPLE	GAK-403	886019-C91
AIRE, SIMPLE	GA-26	304766-C92	H25 SERIES B con motor/WAUKESHA 180DLC			AIRE, PRIMARIO	GAK-216	924779-C2
ACEITE, DERIVACION (BY PASS)	G-750	139096	ACEITE	G-31	950964	AIRE, SECUNDARIO	GA-416	537335-R2

SERVICIO PESADO

MARCA-MODELO-MOTOR MAKE-MODEL-ENGINE	GONHER GONHER	OEM OEM	MARCA-MODELO-MOTOR MAKE-MODEL-ENGINE	GONHER GONHER	OEM OEM	MARCA-MODELO-MOTOR MAKE-MODEL-ENGINE	GONHER GONHER	OEM OEM
HOUGH (continuación)			HOUGH (continuación)			HOUGH (continuación)		
EQUIPO PARA CONSTRUCCION			EQUIPO PARA CONSTRUCCION			EQUIPO PARA CONSTRUCCION		
AIRE	GAK-20	886017-C91	H50 SERIES B con motor/DETROIT DIESEL 3-53			H60 SERIES B con motor/CUMMINS V352C		
H30F SERIES B con motor/IHC D301			ACEITE, CONVERTIDOR DE TORSION	G-33	302574-R91	ACEITE	G-613	173174
ACEITE, CONVERTIDOR DE TORSION	G-33	131470H1				AIRE, SIMPLE S/ASPAS	GA-20	886017-C92
ACEITE	G-335	279994R91	H50 SERIES B con motor/GMC 3-53			AIRE, SIMPLE	GAK-20	886017-C92
COMBUSTIBLE, SECUNDARIO	G-1163	304101R91	ACEITE, CONVERTIDOR DE TORSION	G-33	5573013	H60 SERIES B con motor/GMC 3-71		
AIRE	GA-20	P101234	ACEITE, FLUJO TOTAL (FULL FLOW)	G-33	5573013	ACEITE, FLUJO TOTAL (FULL FLOW)	G-33	5573013
AIRE	GAK-20	P101234	ACEITE, FLUJO TOTAL (FULL FLOW)	G-119	5573978	COMBUSTIBLE, SECUNDARIO	G-1173	3290851
H30R SERIES B con motor/GMC 3-53			COMBUSTIBLE, SECUNDARIO	G-1173	3290851	COMBUSTIBLE	G-1174	5198982
ACEITE, CONVERTIDOR DE TORSION	G-33	302574-R91	COMBUSTIBLE	G-1174	5198982	H60 SERIES B con motor/IHC D301		
ACEITE, FLUJO TOTAL (FULL FLOW)	G-119	5573978	H50 SERIES B con motores/IHC D301, IHC G263, IHC UD282			ACEITE	G-335	279994R91
COMBUSTIBLE, SECUNDARIO	G-1173	3290851	ACEITE, CONVERTIDOR DE TORSION	G-33	131470H1	COMBUSTIBLE, SECUNDARIO	G-1163	306353-R91
COMBUSTIBLE	G-1174	5198982	ACEITE	G-335	279994R91	AIRE	GA-403	389363R91
H30R SERIES B con motor/IHC G263			COMBUSTIBLE, SECUNDARIO	G-1163	304101R91	AIRE	GAK-403	389263-R92
ACEITE	G-335	279994R91				H60 SERIES B con motor/IHC G301		
H30R SERIES B con motor/IHC U240			H50 SERIES C con motor/GMC 3-53			ACEITE	G-335	279994R91
ACEITE, CONVERTIDOR DE TORSION	G-33	302574-R91	ACEITE, FLUJO TOTAL (FULL FLOW)	G-33	5573013	AIRE	GA-403	389363R91
ACEITE	G-335	279994R91	ACEITE, FLUJO TOTAL (FULL FLOW)	G-119	5573978	AIRE	GAK-403	389263-R92
COMBUSTIBLE, SECUNDARIO	G-1163	304101R91	COMBUSTIBLE, SECUNDARIO	G-1173	3290851	H60 SERIES E con motor/CUMMINS V352C		
COMBUSTIBLE	G-1174	5198982	COMBUSTIBLE	G-1174	5198982	AIRE	GAK-20	P101234
H30R SERIES B con motores/IHC D301, IHC UD236			AIRE	GA-20	P181045	H60, H60C con motores/CUMMINS JF6, CUMMINS JF6-1		
ACEITE, CONVERTIDOR DE TORSION	G-33	302574-R91	AIRE	GAK-20	P101234	ACEITE, CONVERTIDOR DE TORSION	G-33	302574-R91
ACEITE	G-335	279994R91	H50 SERIES C con motor/IHC C301			ACEITE, FLUJO TOTAL (FULL FLOW)	G-566	257528
COMBUSTIBLE, SECUNDARIO	G-1163	304101R91	ACEITE, CARTUCHO	G-335	279994R91	COMBUSTIBLE, CARTUCHO	G-1143	139097
H40 con motor/IHC D282			ACEITE, SELLADO	GP-10	397868R1	ACEITE, TURBOCARGADOR	GP-14	4041959
ACEITE, CONVERTIDOR DE TORSION	G-33	302574-R91	AIRE	GA-403	886019-C91	COMBUSTIBLE, SELLADO	GP-1101	154711
ACEITE	G-335	279994R91	AIRE	GAK-403	886019-C91	ACEITE, DERIVACION (BY PASS)	G-500	256839
COMBUSTIBLE, SECUNDARIO	G-1163	304101R91				ACEITE, DERIVACION (BY PASS)	G-750	139096
H40 con motor/IHC G264			H50 SERIES C con motor/IHC D282			H60E con motor/IHC		
ACEITE, CONVERTIDOR DE TORSION	G-33	302574-R91	ACEITE, CARTUCHO	G-335	279994R91	ACEITE, SELLADO	GP-69	675616C91
ACEITE	G-335	279994R91	COMBUSTIBLE, SECUNDARIO	G-1163	304101R91	COMBUSTIBLE, PRIMARIO	GP-1108	625627-C1
COMBUSTIBLE, SECUNDARIO	G-1163	304101R91	ACEITE, SELLADO	GP-69	675616C91	COMBUSTIBLE, SECUNDARIO	GP-78	672603-C1
H40 con motor/IHC UD282			AIRE	GA-403	389363R91			
ACEITE, CONVERTIDOR DE TORSION	G-33	131470H1	AIRE	GAK-403	894639H1	H65 con motor/IHC DIESEL		
ACEITE	G-335	279994R91				ACEITE	G-335	323827-R91
COMBUSTIBLE, SECUNDARIO	G-1163	304101R91	H50 SERIES C con motor/IHC G301			H65 SERIES B con motor/CUMMINS		
H400 con motores/CUMMINS, DETROIT DIESEL			AIRE	GAK-403	894639H1	ACEITE, CONVERTIDOR DE TORSION	G-33	3301060
ACEITE, CONVERTIDOR DE TORSION	G-33	302574-R91				H65 SERIES B con motor/CUMMINS JN6		
H400 SERIES B con motor/A DIESEL			H500 con motores/CUMMINS V1710C, CUMMINS VT1710C SERIES			ACEITE, CONVERTIDOR DE TORSION	G-33	3301060
ACEITE, CONVERTIDOR DE TORSION	G-33	302574-R91	ACEITE, CONVERTIDOR DE TORSION	G-33	302574-R91	ACEITE, FLUJO TOTAL (FULL FLOW)	G-566	257528
ACEITE	G-335	279994R91	ACEITE, CARTUCHO PARA FLUJO TOTAL (FULL FLOW)	G-566	257528	COMBUSTIBLE, CARTUCHO	G-1143	139097
COMBUSTIBLE, SECUNDARIO	G-1163	304101R91	COMBUSTIBLE	G-1143	139097	ACEITE, TURBOCARGADOR	GP-14	4041959
H400, H400B, H400C con motores/CUMMINS V1710C, CUMMINS VT1710C SERIES			ACEITE, SELLADO PARA FLUJO TOTAL (FULL FLOW)	GP-53	3313287	COMBUSTIBLE, SELLADO	GP-1101	154711
ACEITE, CONVERTIDOR DE TORSION	G-33	302574-R91	ACEITE, DERIVACION (BY PASS)	G-750	139096	ACEITE, DERIVACION (BY PASS)	G-750	139096
ACEITE, CARTUCHO PARA FLUJO TOTAL (FULL FLOW)	G-566	257528	H60 con motor/DETROIT DIESEL					
COMBUSTIBLE	G-1143	139097	ACEITE, CONVERTIDOR DE TORSION	G-33	5573014	H65 SERIES B con motor/DETROIT DIESEL		
ACEITE, SELLADO PARA FLUJO TOTAL (FULL FLOW)	GP-53	3313287				ACEITE, CONVERTIDOR DE TORSION	G-33	5573014
ACEITE, DERIVACION (BY PASS)	G-750	139096	H60 con motor/IHC C372 GASOLINA			H65 SERIES B con motor/GMC 3-71		
H400, H500 con motor/GMC 12V-71			ACEITE, CONVERTIDOR DE TORSION	G-33	302574-R91	ACEITE, DERIVACION (BY PASS)	G-31	1595410
ACEITE, CONVERTIDOR DE TORSION	G-33	5573013	H60 con motor/IHC DIESEL			ACEITE, CONVERTIDOR DE TORSION	G-33	5573013
ACEITE	G-335	323837-R91	ACEITE	G-335	323837-R91	ACEITE, FLUJO TOTAL (FULL FLOW)	G-33	5573013
H50 con motor/IHC								
HIDRAULICO	G-6	122731H1						

MARCA-MODELO-MOTOR MAKE-MODEL-ENGINE	GONHER GONHER	OEM OEM	MARCA-MODELO-MOTOR MAKE-MODEL-ENGINE	GONHER GONHER	OEM OEM	MARCA-MODELO-MOTOR MAKE-MODEL-ENGINE	GONHER GONHER	OEM OEM
HOUGH (continuación)			HOUGH (continuación)			HOUGH (continuación)		
EQUIPO PARA CONSTRUCCION			EQUIPO PARA CONSTRUCCION			EQUIPO PARA CONSTRUCCION		
COMBUSTIBLE, SECUNDARIO	G-1173	3290851	ACEITE, DERIVACION (BY PASS)	G-750	139096	H90 con motor/HERCULES WXLC3		
COMBUSTIBLE	G-1174	5198982				ACEITE, CONVERTIDOR DE TORSION	G-33	302574-R91
H65 SERIES B con motor/IHC C372			H70 SERIES B con motores/GMC 3-71, GMC 4-71			H90 con motor/IHC DT429		
ACEITE, CONVERTIDOR DE TORSION	G-33	131470H1	ACEITE, DERIVACION (BY PASS)	G-31	1595410	COMBUSTIBLE	GP-11	FF5161
H65 SERIES C con motor/IHC 407			ACEITE, FLUJO TOTAL (FULL FLOW)	G-33	5573013	H90 SERIES B con motores/CUMMINS C175, DETROIT DIESEL 4-71		
ACEITE	G-335	279994R91	COMBUSTIBLE, SECUNDARIO	G-1173	3290851	ACEITE, CONVERTIDOR DE TORSION	G-33	302574-R91
COMBUSTIBLE, SEPARADOR DE AGUA	GPP-14	402255C1	COMBUSTIBLE	G-1174	5198982	H90 SERIES C con motor/CUMMINS V6R-180C1		
COMBUSTIBLE, PRIMARIO	GP-1105	702143-C1	H70 SERIES C, H70 SERIES F con motor/IHC DT429			ACEITE, CONVERTIDOR DE TORSION	G-33	3301060
COMBUSTIBLE, PRIMARIO OPCIONAL	GP-1108	702251-C1	COMBUSTIBLE, SECUNDARIO	G-1163	304101R91	H90 SERIES C con motores/IHC DT573, IHC DVT573		
COMBUSTIBLE, SECUNDARIO	GP-110	702253-C1	H70 SERIES C, H70 SERIES F con motores/GMC 3-71, GMC 4-71			COMBUSTIBLE, SECUNDARIO	G-1163	304101R91
AIRE, SIMPLE	GA-24	891129-R92	ACEITE, DERIVACION (BY PASS)	G-31	1595410	H90 SERIES C, H90 SERIES E con motor/CUMMINS		
AIRE, PRIMARIO	GA-360	529821-R1	ACEITE, CONVERTIDOR DE TORSION	G-33	5573013	ACEITE, CARTUCHO PARA FLUJO TOTAL (FULL FLOW)	G-566	257528
AIRE, SECUNDARIO	GA-361	530270-R2	ACEITE, FLUJO TOTAL (FULL FLOW)	G-33	5573013	COMBUSTIBLE, SELLADO	GP-1101	154711
H65 SERIES C con motor/IHC DT361			COMBUSTIBLE, SECUNDARIO	G-1173	3290851	ACEITE, SELLADO PARA FLUJO TOTAL (FULL FLOW)	GP-53	3313287
ACEITE	G-335	279994R91	COMBUSTIBLE	G-1174	5198982	AIRE	GA-27	250552-C92
COMBUSTIBLE	GPP-14	702255-C1	H70 SERIES C, H90 SERIES B, H70 SERIES F, H90 con motor/CUMMINS			ACEITE, DERIVACION (BY PASS)	G-750	139096
COMBUSTIBLE	GP-1108	702251-C1	ACEITE, CONVERTIDOR DE TORSION	G-33	3301060	H90 SERIES C, H90 SERIES E con motor/GMC 6V-53		
COMBUSTIBLE	GP-110	702253-C1	ACEITE, CARTUCHO PARA FLUJO TOTAL (FULL FLOW)	G-566	257528	ACEITE, FLUJO TOTAL (FULL FLOW)	G-33	5573013
H65 SERIES C con motor/IHC DT414			COMBUSTIBLE, CARTUCHO	G-1143	139097	COMBUSTIBLE, SECUNDARIO	G-1173	3290851
ACEITE	GP-69	675616C91	ACEITE, TURBOCARGADOR	GP-14	4041959	COMBUSTIBLE	G-1174	5198982
COMBUSTIBLE, PRIMARIO	GP-1105	625626C1	COMBUSTIBLE, SELLADO	GP-1101	154711	H90 SERIES E con motor/IHC DVT573		
AGUA	GP-2071W	1207605H2	ACEITE, SELLADO PARA FLUJO TOTAL (FULL FLOW)	GP-53	3313287	COMBUSTIBLE, SEPARADOR DE AGUA	GPP-14	402255C1
COMBUSTIBLE, SECUNDARIO	GP-78	1809789C1	ACEITE, DERIVACION (BY PASS)	G-750	139096	COMBUSTIBLE, PRIMARIO 6 5/8 IN	GP-1105	625626C1
H65 SERIES C con motores/CUMMINS 464C, CUMMINS C160, CUMMINS JN130			H70, H70 SERIES B con motor/IHC C372			COMBUSTIBLE, PRIMARIO 7 33/64 IN	GP-1108	625627C1
ACEITE, CARTUCHO PARA FLUJO TOTAL (FULL FLOW)	G-566	257528	ACEITE, CONVERTIDOR DE TORSION	G-33	302574-R91	AIRE	GA-27	250552-C92
COMBUSTIBLE, CARTUCHO	G-1143	139097	H80 SERIES A con motor/CUMMINS			AIRE	GA-31	672019C1
ACEITE, TURBOCARGADOR	GP-14	4041959	ACEITE, CARTUCHO PARA FLUJO TOTAL (FULL FLOW)	G-566	257528	H90 SERIES E con motor/IHC DVT573B		
COMBUSTIBLE, SELLADO	GP-1101	154711	COMBUSTIBLE, SELLADO	GP-1101	154711	COMBUSTIBLE, SECUNDARIO	GP-1107	359251C1
ACEITE, SELLADO PARA FLUJO TOTAL (FULL FLOW)	GP-53	3313287	ACEITE, SELLADO PARA FLUJO TOTAL (FULL FLOW)	GP-53	3313287	H90, H90 SERIES B con motor/GMC 4-71		
AIRE, SIMPLE	GA-24	891129-R92	COMBUSTIBLE, SEPARADOR DE AGUA	GPP-11	3600980	ACEITE, DERIVACION (BY PASS)	G-31	1595410
AIRE, PRIMARIO	GA-360	529821-R1	ACEITE, DERIVACION (BY PASS)	G-750	139096	ACEITE, CONVERTIDOR DE TORSION	G-33	5573013
AIRE, SECUNDARIO	GA-361	530270-R2	H70 con motores/CUMMINS C160, CUMMINS JF6, CUMMINS JN6			ACEITE, FLUJO TOTAL (FULL FLOW)	G-33	5573013
ACEITE, DERIVACION (BY PASS)	G-500	256839	ACEITE, CONVERTIDOR DE TORSION	G-33	302574-R91	COMBUSTIBLE, SECUNDARIO	G-1173	3290851
ACEITE, DERIVACION (BY PASS)	G-750	139096	ACEITE, CARTUCHO PARA FLUJO TOTAL (FULL FLOW)	G-566	257528	COMBUSTIBLE	G-1174	5198982
H70 SERIES B con motores/CUMMINS JN6, CUMMINS C160, CUMMINS JF6			COMBUSTIBLE, CARTUCHO	G-1143	139097	HA con motor/HERCULES D2300		
ACEITE, CONVERTIDOR DE TORSION	G-33	302574-R91	ACEITE, TURBOCARGADOR	GP-14	4041959	ACEITE	GP-1	256269
ACEITE, CARTUCHO PARA FLUJO TOTAL (FULL FLOW)	G-566	257528	COMBUSTIBLE, SELLADO	GP-1101	154711	COMBUSTIBLE	G-296	124219
COMBUSTIBLE, CARTUCHO	G-1143	139097	ACEITE, SELLADO PARA FLUJO TOTAL (FULL FLOW)	GP-53	3313287	COMBUSTIBLE	G-296-B	124219
ACEITE, TURBOCARGADOR	GP-14	4041959	ACEITE, DERIVACION (BY PASS)	G-750	139096	AIRE	GA-16	384812-R93
COMBUSTIBLE, SELLADO	GP-1101	154711	H70 SERIES B con motores/CUMMINS JN6, CUMMINS C160, CUMMINS JF6			AIRE	GAK-16	384812-R93
ACEITE, SELLADO PARA FLUJO TOTAL (FULL FLOW)	GP-53	3313287	ACEITE, CONVERTIDOR DE TORSION	G-33	302574-R91	HA SERIES B, HAC con motor/HERCULES D2300		
ACEITE, DERIVACION (BY PASS)	G-750	139096	ACEITE, CARTUCHO PARA FLUJO TOTAL (FULL FLOW)	G-566	257528	ACEITE	GP-1	920203-C1
H70 con motores/CUMMINS C160, CUMMINS JF6, CUMMINS JN6			COMBUSTIBLE, CARTUCHO	G-1143	139097	COMBUSTIBLE	G-296	124219
ACEITE, CONVERTIDOR DE TORSION	G-33	302574-R91	ACEITE, TURBOCARGADOR	GP-14	4041959	COMBUSTIBLE	G-296-B	124219
ACEITE, CARTUCHO PARA FLUJO TOTAL (FULL FLOW)	G-566	257528	COMBUSTIBLE, SELLADO	GP-1101	154711	AIRE	GA-16	P181052
COMBUSTIBLE, CARTUCHO	G-1143	139097	ACEITE, SELLADO PARA FLUJO TOTAL (FULL FLOW)	GP-53	3313287	AIRE	GAK-16	384812-R93
ACEITE, TURBOCARGADOR	GP-14	4041959	ACEITE, DERIVACION (BY PASS)	G-750	139096	H90 con motor/DETROIT DIESEL 4-71		
COMBUSTIBLE, SELLADO	GP-1101	154711	H80B con motores/IHC DT466, IHC DT466B			ACEITE, CONVERTIDOR DE TORSION	G-33	5573014
ACEITE, SELLADO PARA FLUJO TOTAL (FULL FLOW)	GP-53	3313287	ACEITE	GP-69	675616C91			
ACEITE, DERIVACION (BY PASS)	G-750	139096	COMBUSTIBLE, PRIMARIO 6 5/8 IN	GP-1105	625626C1			
H70 SERIES B con motores/CUMMINS JN6, CUMMINS C160, CUMMINS JF6			COMBUSTIBLE, PRIMARIO 7 33/64 IN	GP-1108	625627C1			
ACEITE, CONVERTIDOR DE TORSION	G-33	302574-R91	COMBUSTIBLE, SECUNDARIO	GP-78	1809789C1			
ACEITE, CARTUCHO PARA FLUJO TOTAL (FULL FLOW)	G-566	257528	H90 con motor/CUMMINS JN6					
COMBUSTIBLE, CARTUCHO	G-1143	139097	ACEITE, CONVERTIDOR DE TORSION	G-33	3301060			
ACEITE, TURBOCARGADOR	GP-14	4041959	H90 con motor/DETROIT DIESEL 4-71					
COMBUSTIBLE, SELLADO	GP-1101	154711	ACEITE, CONVERTIDOR DE TORSION	G-33	5573014			
ACEITE, SELLADO PARA FLUJO TOTAL (FULL FLOW)	GP-53	3313287						

SERVICIO PESADO

MARCA-MODELO-MOTOR MAKE-MODEL-ENGINE	GONHER GONHER	OEM OEM	MARCA-MODELO-MOTOR MAKE-MODEL-ENGINE	GONHER GONHER	OEM OEM	MARCA-MODELO-MOTOR MAKE-MODEL-ENGINE	GONHER GONHER	OEM OEM
HOUGH (continuación)			HOUGH (continuación)			HOUGH (continuación)		
EQUIPO PARA CONSTRUCCION			EQUIPO PARA CONSTRUCCION			EQUIPO PARA CONSTRUCCION		
HA, HA SERIES B, HAC con motores/WAUKESHA 180DLC, WAUKESHA FC			ACEITE, DERIVACION (BY PASS)	G-750	689032-R91	S7 SERIES B con motor/FORD 220		
ACEITE, CONVERTIDOR DE TORSION	G-6	LP129	HO con motor/HERCULES WXLC3			ACEITE	G-813	EPN-6731-B
HAH, HAHC con motor/HERCULES			ACEITE, CONVERTIDOR DE TORSION	G-33	131570-H1	ACEITE	G-836	C2TZ-6731-A
AIRE, SIN ASPAS	GA-16	384812-R93	HR con motor/HERCULES JXD			COMBUSTIBLE	G-11816	EPN99162A
HAHF con motor/HERCULES			ACEITE	G-33	302574-R91	T120F con motor/HERCULES QXLD-3		
AIRE, SIN ASPAS	GA-16	384812-R93	HR con motor/HERCULES QXLD3			ACEITE, CONVERTIDOR DE TORSION	G-6	122731H1
AIRE	GAK-16	384812-R93	ACEITE	G-6	122731H1	T180F con motor/A DIESEL		
AIRE	GAK-216	924779-C1	HR con motores/CUMMINS, HERCULES DIX6D			ACEITE	G-33	302574-R91
AIRE	GA-416	537335-R1	ACEITE	G-6	122731H1	T225SL con motor/GMC 6V-53		
HE con motor/WAUKESHA FC			HR, HRC con motor/HERCULES QXLD			ACEITE, FLUJO TOTAL (FULL FLOW)	G-33	5573013
ACEITE, CONVERTIDOR DE TORSION	G-6	LP129	ACEITE, CONVERTIDOR DE TORSION	G-6	122731H1	COMBUSTIBLE, SECUNDARIO	G-1173	3290851
HF con motor/HERCULES D2300			HR con motor/HERCULES JXD			COMBUSTIBLE	G-1174	5198982
ACEITE	GP-1	920203-C1	ACEITE	G-33	302574-R91	T255SL con motor/IHC V549		
COMBUSTIBLE	G-296	124219	ACEITE	G-33	302574-R91	DIRECCION	G-33	131470H1
COMBUSTIBLE	G-296-B	124219	HRC con motor/HERCULES QXLD3			T500, T500S con motor/A GASOLINA		
AIRE, SIN ASPAS	GA-16	384812-R93	ACEITE	G-6	122731H1	ACEITE	G-33	613797C91
AIRE	GAK-16	384812-R93	HRC con motores/CUMMINS, HERCULES DIX6D			TRANSMISION	G-33	302574R91
HF con motor/HERCULES QXD3			ACEITE, CONVERTIDOR DE TORSION	G-6	122731H1	ACEITE	GP-1	920203C1
ACEITE, CONVERTIDOR DE TORSION	G-6	39251A	L100 con motor/CUMMINS NT855C			T800 con motor/A DIESEL		
HF, HFC, HFH con motor/HERCULES QXLD			ACEITE, CONVERTIDOR DE TORSION	G-33	3301060	TRANSMISION	G-33	613797C91
ACEITE	G-31	47352B	L100 con motor/IHC UD817			COMBUSTIBLE, SECUNDARIO	GP-1107	6742993C1
HFC con motor/HERCULES D2300			ACEITE, CONVERTIDOR DE TORSION	G-33	131470H1	COMBUSTIBLE, PRIMARIO	GP-1108	625627C1
ACEITE	GP-1	256269	L100 con motores/CUMMINS NH220, CUMMINS NH250C1			COMBUSTIBLE	GP-78	674293-C1
COMBUSTIBLE	G-296	124219	ACEITE, CONVERTIDOR DE TORSION	G-33	3301060	T800 con motor/A GASOLINA		
COMBUSTIBLE	G-296-B	124219	L100, L120 con motor/IHC DT817			ACEITE	G-33	227082-R92
AIRE, SIN ASPAS	GA-16	384812-R93	ACEITE, CONVERTIDOR DE TORSION	G-33	302574-R91	TC60 con motor/IHC U240		
AIRE	GAK-16	384812-R93	COMBUSTIBLE, PRIMARIO	GP-1107	674293-C1	ACEITE, CONVERTIDOR DE TORSION	G-6	122731H1
HFC, HFH con motor/HERCULES QXD3			COMBUSTIBLE, PRIMARIO	GP-1108	625627-C1	TD180FB con motor/GMC 6V-53		
ACEITE, CONVERTIDOR DE TORSION	G-6	122731H1	COMBUSTIBLE, SECUNDARIO	GP-110	702253-C1	ACEITE, FLUJO TOTAL (FULL FLOW)	G-33	131570-H1
HFH con motor/HERCULES D2300			L100, L120 con motores/GMC 6V-71, GMC 8V-71			COMBUSTIBLE, SECUNDARIO	G-1173	3290851
ACEITE	GP-1	920203-C1	ACEITE, FLUJO TOTAL (FULL FLOW)	G-33	5573013	COMBUSTIBLE	G-1174	5198982
COMBUSTIBLE	G-296	124219	TRANSMISION	G-33	302574-R91	TD225SL con motor/IHC V549		
COMBUSTIBLE	G-296-B	124219	COMBUSTIBLE, SECUNDARIO	G-1175	D88913	DIRECCION	G-33	131470H1
AIRE, SIN ASPAS	GA-16	384812-R93	L120, D120, D120 SERIES B, D120 SERIES C, L100 con motor/CUMMINS			TD255SL, TD300SL con motor/GMC 6V-53		
AIRE	GAK-16	384812-R93	TRANSMISION	G-33	302574-R91	ACEITE, FLUJO TOTAL (FULL FLOW)	G-33	5573013
HH con motores/HERCULES DJXH, HERCULES JXD			ACEITE, CARTUCHO PARA FLUJO TOTAL (FULL FLOW)	G-566	257528	COMBUSTIBLE, SECUNDARIO	G-1173	3290851
TRANSMISION	G-33	302574-R91	COMBUSTIBLE, CARTUCHO	G-1143	139097	COMBUSTIBLE	G-1174	5198982
HM con motores/HERCULES DJXH, HERCULES JXD			ACEITE, TURBOCARGADOR	GP-14	4041959	TD255SL, TD300SL con motor/DETROIT DIESEL 6V-53		
ACEITE, CONVERTIDOR DE TORSION	G-6	122731H1	COMBUSTIBLE, SELLADO	GPP-14	3315847	DIRECCION	G-33	302574-R91
HMC con motores/HERCULES DJXH, HERCULES JXD			COMBUSTIBLE, SELLADO	GP-1101	154711	TD300SL con motor/IHC V549		
ACEITE	G-6	122731H1	ACEITE, SELLADO PARA FLUJO TOTAL (FULL FLOW)	GP-53	3313287	DIRECCION	G-33	131470H1
HO con motor/CUMMINS			COMBUSTIBLE, SELLADO	GP-55	3313306	TD80, TU80 con motores/IHC UD236, IHC UD282		
ACEITE, CONVERTIDOR DE TORSION	G-33	131570-H1	COMBUSTIBLE, SEPARADOR DE AGUA	GPP-11	3600980	ACEITE	G-335	279994R91
ACEITE, FLUJO TOTAL (FULL FLOW)	G-566	1214939H1	ACEITE, DERIVACION (BY PASS)	G-750	139096	TM con motor/HERCULES JXD4		
COMBUSTIBLE	G-1143	139097				ACEITE, CONVERTIDOR DE TORSION	G-6	122731H1
COMBUSTIBLE, CARTUCHO	GP-1101	126517						

MARCA-MODELO-MOTOR MAKE-MODEL-ENGINE	GONHER GONHER	OEM OEM	MARCA-MODELO-MOTOR MAKE-MODEL-ENGINE	GONHER GONHER	OEM OEM	MARCA-MODELO-MOTOR MAKE-MODEL-ENGINE	GONHER GONHER	OEM OEM
HOUGH (continuación)			HYSTER (continuación)			HYSTER (continuación)		
EQUIPO PARA CONSTRUCCION			CAMIONES, TRACTOCAMIONES Y AUTOBUSES			CAMIONES, TRACTOCAMIONES Y AUTOBUSES		
TU120 con motor/HERCULES QXLD-3			AIRE	GAK-403	97310	M300H ARTICULADO con motor/PERKINS 6.354.4		
ACEITE, CONVERTIDOR DE TORSION	G-6	122731H1	M200F ARTICULADO, M300F ARTICULADO con motores/A DIESEL, A GASOLINA			HIDRAULICO	G-238	75669
			HIDRAULICO	G-238	271415-06	COMBUSTIBLE	G-1174	155100
			M200H ARTICULADO con motor/A DIESEL			COMBUSTIBLE	G-296	124217
			HIDRAULICO	G-238	271415-06	ACEITE, SELLADO	GP-3600	251755
			M200H ARTICULADO con motor/A GASOLINA			COMBUSTIBLE	G-296-B	124217
			HIDRAULICO	G-238	271415-06	AIRE, SIN ASPAS	GA-403	97310
			M200H ARTICULADO con motor/GMC V6-305			AIRE	GAK-403	97310
			HIDRAULICO	G-238	271415-06			
			M200H ARTICULADO con motor/A GASOLINA			M400A-600A ARTICULADO con motor/CUMMINS V8-185		
			HIDRAULICO	G-238	271415-06	TRANSMISION	G-33	3301060
			M200H ARTICULADO con motor/GMC V6-305			HIDRAULICO	G-238	75669
			HIDRAULICO	G-238	75669	TRANSMISION	G-238	75669
			ACEITE, SELLADO	GP-5	147037	ACEITE, DERIVACION (BY PASS)	G-750	183894
			GASOLINA	GG-20	97373			
			M200H ARTICULADO con motor/GMC V8-350			M400A-600A ARTICULADO con motores/CATERPILLAR D330, DETROIT DIESEL 6V-53 N		
			HIDRAULICO	G-238	75669	TRANSMISION	G-33	235849
			ACEITE	GP-13	258237	HIDRAULICO	G-238	75669
			ACEITE	GP-205	258237	TRANSMISION	G-238	75669
			AIRE	GAK-403	97310			
			GASOLINA	GG-20	97372	M400H ARTICULADO con motor/GMC V6-305		
			M200H ARTICULADO con motor/PERKINS 6.354			HIDRAULICO	G-238	75669
			HIDRAULICO	G-238	75669	ACEITE, SELLADO	GP-5	147037
			ACEITE, CARTUCHO	G-834	985651	GASOLINA	GG-20	97373
			COMBUSTIBLE	G-1174	155100			
			ACEITE, SELLADO	GP-31	3000870	M400H ARTICULADO con motor/GMC V8-350		
			COMBUSTIBLE	G-296	124217	HIDRAULICO	G-238	75669
			ACEITE, SELLADO	GP-3600	251755	ACEITE, SELLADO	GP-13	258237
			COMBUSTIBLE	G-296-B	124217	ACEITE, SELLADO	GP-205	258237
			M200H ARTICULADO con motor/PERKINS 6.354.4			AIRE, SIN ASPAS	GA-403	97310
			HIDRAULICO	G-238	75669	AIRE	GAK-403	97310
			COMBUSTIBLE	G-1174	155100	GASOLINA	GG-20	97372
			COMBUSTIBLE	G-296	124217			
			ACEITE, SELLADO	GP-3600	251755	M400H ARTICULADO con motor/PERKINS 6.354		
			COMBUSTIBLE	G-296-B	124217	HIDRAULICO	G-238	75669
			AIRE	GAK-403	97310	ACEITE, CARTUCHO	G-834	985651
			M300H ARTICULADO con motor/A DIESEL			COMBUSTIBLE	G-1174	155100
			ACEITE	G-238	271415-06	ACEITE, SELLADO	GP-31	3000870
			M300H ARTICULADO con motor/A GASOLINA			COMBUSTIBLE	G-296	3000087
			ACEITE	G-238	271415-06	COMBUSTIBLE	G-296-B	3000087
			M300H ARTICULADO con motor/GMC V6-305					
			HIDRAULICO	G-238	75669	M400H ARTICULADO con motor/PERKINS 6.354.4		
			M300H ARTICULADO con motor/GMC V8-350			ACEITE	G-238	75669
			HIDRAULICO	G-238	75669	COMBUSTIBLE	G-1174	155100
			ACEITE	GP-13	258237	COMBUSTIBLE	G-296	3000087
			ACEITE	GP-205	258237	ACEITE, SELLADO	GP-3600	251755
			AIRE	GA-403	97310	COMBUSTIBLE	G-296-B	3000087
			AIRE	GAK-403	97310	AIRE, SIN ASPAS	GA-403	97310
			GASOLINA	GG-20	97372	AIRE	GAK-403	97310
			M200 ARTICULADO con motor/PERKINS 6.354					
			ACEITE	G-238	75669	M500A ARTICULADO con motor/CONTINENTAL T427		
			COMBUSTIBLE	G-1174	155100	ACEITE, DERIVACION (BY PASS)	G-31	M330L500
			ACEITE	GP-31	3000870	TRANSMISION	G-33	235849
			COMBUSTIBLE	G-296	124217	HIDRAULICO	G-238	PC238
			COMBUSTIBLE	G-296-B	124217	AIRE	GA-37	202951
			M200 ARTICULADO con motor/PERKINS 6.354.4			M500A ARTICULADO con motor/CONTINENTAL TD427		
			ACEITE	G-238	75669	TRANSMISION	G-33	235849
			COMBUSTIBLE	G-1174	155100	HIDRAULICO	G-238	PC238
			COMBUSTIBLE	G-296	868014	AIRE	GA-37	202951
			COMBUSTIBLE	G-296-B	124217	ACEITE, DERIVACION (BY PASS)	G-500	234930
			AIRE	GA-403	170681			

SERVICIO PESADO

MARCA-MODELO-MOTOR MAKE-MODEL-ENGINE	GONHER GONHER	OEM OEM	MARCA-MODELO-MOTOR MAKE-MODEL-ENGINE	GONHER GONHER	OEM OEM	MARCA-MODELO-MOTOR MAKE-MODEL-ENGINE	GONHER GONHER	OEM OEM
HYSTER (continuación)			HYSTER (continuación)			HYSTER (continuación)		
CAMIONES, TRACTOCAMIONES Y AUTOBUSES			COMPACTADORAS			COMPACTADORAS		
M500A ARTICULADO, M600A ARTICULADO con motor/CONTINENTAL RD572			COMBUSTIBLE, SECUNDARIO SELLADO	GP-27	6438838	C550A con motor/PERKINS 6.354		
TRANSMISION	G-33	235849	ACEITE, DERIVACION (BY PASS)	GP-31	2654407	ACEITE	G-834	985651
HIDRAULICO	G-238	PC238	HIDRAULICO	GP-34	6439131	COMBUSTIBLE	G-296	124217
AIRE	GA-37	202951				COMBUSTIBLE	G-296-B	124217
M600A ARTICULADO con motor/CONTINENTAL T427			C441A con motor/DETROIT DIESEL 6V-53			C550A PNEUMATIC con motor/GMC 3-53		
ACEITE, DERIVACION (BY PASS)	G-31	M330L500	ACEITE, CARTUCHO	G-33	235849	ACEITE	G-119	5573978
TRANSMISION	G-33	235849	COMBUSTIBLE, PRIMARIO	GP-26	6438837	COMBUSTIBLE, SECUNDARIO	G-1173	157854
HIDRAULICO	G-238	PC238	COMBUSTIBLE, SECUNDARIO	GP-27	6438838	COMBUSTIBLE, PRIMARIO	G-1174	155100
AIRE	GA-37	202951	ACEITE, SELLADO	GP-43	23518524	AIRE	GAK-20	156954
M600A ARTICULADO con motor/CONTINENTAL TD427			C450A con motor/DOS MOTORES CATERPILLAR D330B			C550A PNEUMATIC con motor/PERKINS 6.354		
TRANSMISION	G-33	235849	ACEITE	G-191	1R0659	ACEITE	G-834	985651
HIDRAULICO	G-238	PC238	COMBUSTIBLE	G-1166	6H5931	COMBUSTIBLE	G-11816	985220
AIRE	GA-37	202951	AIRE	GA-29	4L9851	COMBUSTIBLE	G-296	124217
ACEITE, DERIVACION (BY PASS)	G-500	234930				COMBUSTIBLE	G-296-B	124217
HYSTER			C450B, C451B con motor/DOS MOTORES CATERPILLAR 3304			C550BD con motor/PERKINS 4.236		
COMPACTADORAS			GASOLINA, SEPARADOR DE AGUA	G-293	6N7617	ACEITE	GP-1	2654403
14300XL con motor/PERKINS			ACEITE	GP-51	1R0658	ACEITE	GP-66	1551
ACEITE	GP-31	1327905	COMBUSTIBLE	GP-110	1P2299	AIRE	GA-403	170681
AIRE, SIN ASPAS	GA-403	97310				AIRE	GAK-403	P101246
AIRE	GAK-403	97310	C455A con motor/DOS MOTORES CATERPILLAR D330B			C610A, C627B, C610B, C615A, C615B, C620B, C625A, C625B con motor/PERKINS 4.236 DIESEL		
C200B, C210A con motor/DEUTZ F3L812			ACEITE	G-191	1R0659	ACEITE, CARTUCHO	G-801	26560090
ACEITE	G-33	235849	COMBUSTIBLE	G-1166	6H5931	ACEITE, CARTUCHO	G-813	26540132
C250A, C255A con motor/GMC 4-53N			AIRE	GA-29	4L9851	ACEITE, CARTUCHO	G-834	26450153
ACEITE	G-33	235849	C455B con motor/DOS MOTORES CATERPILLAR 3304			ACEITE, CARTUCHO	G-870	26560090
COMBUSTIBLE, SECUNDARIO	G-1173	157854	GASOLINA, SEPARADOR DE AGUA	G-293	6N7617	COMBUSTIBLE	G-11816	32543
COMBUSTIBLE	G-1174	155100	ACEITE	GP-51	1R0658	ACEITE, SELLADO	GP-1	2654403
AIRE, SIN ASPAS	GA-24	T966133	COMBUSTIBLE	GP-110	1P2299	ACEITE, SELLADO	GP-31	2654407
C330A con motor/GMC 4-153 A GASOLINA						COMBUSTIBLE	G-296	26560017
ACEITE, SELLADO	GP-3	127644	C458 con motor/DOS MOTORES CATERPILLAR D330B			COMBUSTIBLE	G-296-B	26560017
C340AD con motor/PERKINS 4.236			ACEITE	G-191	1R0659	C612B con motor/DETROIT DIESEL 3-53		
ACEITE	GP-1	2654403	COMBUSTIBLE	G-1166	6H5931	HIDRAULICO	GP-34	6439131
C340B con motor/A DIESEL			AIRE	GA-29	4L9851	COMBUSTIBLE, PRIMARIO	GP-92	23518527
HIDRAULICO	GP-34	K23018				COMBUSTIBLE, SECUNDARIO	GP-93	23518526
C350A con motor/PERKINS 4.236			C500A con motor/CATERPILLAR D311H			ACEITE	GP-43	23518524
ACEITE	G-801	990325	ACEITE	G-191	1R0659	AIRE	GAK-20	156954
ACEITE	G-870	4193265	COMBUSTIBLE	G-1166	6H5931	C625A con motor/GMC 3-53		
COMBUSTIBLE	G-11816	32543	COMBUSTIBLE	GP-110	1P2299	ACEITE	G-33	235849
C350A, C550A con motor/GMC 6-230						COMBUSTIBLE, SECUNDARIO	G-1173	157854
ACEITE	GP-3	127644	C500A con motor/PERKINS 6.354			COMBUSTIBLE	G-1174	155100
C350BD con motor/PERKINS 4.236			ACEITE	G-834	985651	COMBUSTIBLE, SECUNDARIO	G-1175	D88913
ACEITE	GP-1	2654403	COMBUSTIBLE	G-11816	985220	C625B con motor/DETROIT DIESEL 3-53		
HIDRAULICO	GP-66	1551	COMBUSTIBLE	G-296	124217	COMBUSTIBLE, PRIMARIO	GP-92	23518527
AIRE	GAK-403	P101246	COMBUSTIBLE	G-296-B	124217	COMBUSTIBLE, SECUNDARIO	GP-93	23518526
C440A con motor/GMC 6V-53N						ACEITE	GP-43	23518524
ACEITE, FLUJO TOTAL (FULL FLOW)	G-33	235849	C530A con motor/GMC 3-53			C727A con motor/JOHN DEERE 6466		
COMBUSTIBLE, SECUNDARIO	G-1173	157854	ACEITE	G-119	5573978	ACEITE	GP-34	AR43261
COMBUSTIBLE, PRIMARIO	G-1174	K23018	COMBUSTIBLE, SECUNDARIO	G-1173	157854	C766, C830A con motor/CUMMINS 4B3.9		
COMBUSTIBLE, PRIMARIO	G-1174	K23018	COMBUSTIBLE, PRIMARIO	G-1174	155100	COMBUSTIBLE, SECUNDARIO	GP-1122	385951
COMBUSTIBLE, PRIMARIO SELLADO	GP-26	6438837				COMBUSTIBLE, PRIMARIO	GPP-18	3925274
			C530A con motor/GMC V6-230			ACEITE	GP-390	1320000
			ACEITE	GP-13	25823712	C850A, C852A con motor/DETROIT DIESEL 8.2 L		
			ACEITE, CARTUCHO	G-813	285233	ACEITE	GP-13	258237
			ACEITE	G-870	990325	COMBUSTIBLE, PRIMARIO	GP-92	23518527
			COMBUSTIBLE	G-11816	985220			

MARCA-MODELO-MOTOR GONHER OEM
MAKE-MODEL-ENGINE GONHER OEM

HYSTER (continuación)

COMPACTADORAS

COMBUSTIBLE, SECUNDARIO GP-93 23518526

HYSTER

EXCAVADORAS

M200E DE CABLE con motor/PERKINS P6

HIDRAULICO G-238 75669

M200E DE CABLE, M200F DE CABLE, M300E DE CABLE, M300F DE CABLE con motor/HERCULES JXD

ACEITE G-33 235849

AIRE, SIN ASPAS GA-20 156954

AIRE GA-37 202951

AIRE GAK-20 156954

M200E DE CABLE, M300F DE CABLE, M200F DE CABLE, M300E DE CABLE con motor/CATERPILLAR D320

TRANSMISION G-6 233134

M300E DE CABLE con motor/PERKINS P6

HIDRAULICO G-238 75669

M300F DE CABLE con motor/PERKINS P6

ACEITE G-238 75669

M500A DE CABLE con motor/CONTINENTAL

ACEITE G-31 200336

M500A DE CABLE con motor/CONTINENTAL TD427 DIESEL

ACEITE G-31 200336

M500A DE CABLE, M600A DE CABLE con motor/CONTINENTAL TD572 DIESEL

TRANSMISION G-33 235849

HIDRAULICO G-238 75669

TRANSMISION G-238 75669

COMBUSTIBLE G-1176 200790

M600A DE CABLE con motor/CONTINENTAL

ACEITE G-31 200336

M600A DE CABLE con motor/CONTINENTAL TD427 DIESEL

ACEITE G-31 200336

HYSTER

GRÚAS

K360B con motor/DETROIT DIESEL 4-53

HIDRAULICO G-33 235849

KE KARRY KRANE con motor/CONTINENTAL

ACEITE, DERIVACION (BY PASS) GP-50 180282

KE KARRY KRANE con motor/PERKINS 4.203

COMBUSTIBLE G-296 124217

ACEITE, SELLADO GP-3600 259025

COMBUSTIBLE G-296-B 124217

HYSTER

MONTACARGAS

A225E con motor/A DIESEL

HIDRAULICO G-238 75669

A225E con motor/A GASOLINA

HIDRAULICO G-238 75669

MARCA-MODELO-MOTOR GONHER OEM
MAKE-MODEL-ENGINE GONHER OEM

HYSTER (continuación)

MONTACARGAS

E20-25AR ELECTRIC, E30-40AR ELECTRIC, E30-40CR ELECTRIC, E30-40ER ELECTRIC, E40-50ER ELECTRIC con motor/ELECTRICO

HIDRAULICO GP-66 840666

F80A-4 CHALLENGER con motor/A DIESEL

ACEITE GP-1 195852

COMBUSTIBLE G-296 3000087

COMBUSTIBLE G-296-B 3000087

H100 con motor/CONTINENTAL F244

TRANSMISION G-6 233134

H100B con motor/PERKINS

TRANSMISION G-6 233134

TRANSMISION G-33 235849

HIDRAULICO G-238 75669

ACEITE, CARTUCHO G-813 133575

COMBUSTIBLE, PRIMARIO G-1174 155100

COMBUSTIBLE, SECUNDARIO G-296 124217

COMBUSTIBLE, SECUNDARIO G-296-B 124217

H100C con motor/A DIESEL

ACEITE G-6 233134

HIDRAULICO G-238 75669

ACEITE G-834 985651

H100C con motor/A GASOLINA

ACEITE G-6 233134

H100C con motor/PERKINS 4.236

TRANSMISION G-33 235849

HIDRAULICO G-238 75669

COMBUSTIBLE, PRIMARIO G-1174 155100

COMBUSTIBLE, SECUNDARIO G-296 124217

COMBUSTIBLE, SECUNDARIO G-296-B 124217

H100C, H100SC, H100TC, H10RC con motor/PERKINS 6.305

TRANSMISION G-33 235849

HIDRAULICO G-238 75669

ACEITE, CARTUCHO G-834 985651

COMBUSTIBLE, PRIMARIO G-1174 155100

COMBUSTIBLE, SECUNDARIO G-296 124217

COMBUSTIBLE, SECUNDARIO G-296-B 124217

H100C, H120 con motor/CONTINENTAL F244

TRANSMISION G-6 233134

H100E CHALLENGER con motor/A DIESEL

ACEITE GP-1 195852

COMBUSTIBLE G-296 3000087

COMBUSTIBLE G-296-B 3000087

AIRE GAK-1532 336567

H100E CHALLENGER con motor/A GASOLINA

ACEITE GP-3 127644

AIRE, SIN ASPAS GA-16 1320263

AIRE GAK-16 1320263

AIRE GAK-1532 336567

H100XL CHALLENGER con motor/GMC A GASOLINA

HIDRAULICO GP-9 1328692

ACEITE GP-3980 1320000

TRANSMISION GP-171 1328691

AIRE GAK-16 305080

MARCA-MODELO-MOTOR GONHER OEM
MAKE-MODEL-ENGINE GONHER OEM

HYSTER (continuación)

MONTACARGAS

AIRE GAK-1532 336567

GASOLINA GG-5 L 1346283

GASOLINA GG-46 1330342

H100XL CHALLENGER con motor/PERKINS DIESEL

ACEITE GP-1 195852

HIDRAULICO GP-9 1328692

COMBUSTIBLE G-296 124217

COMBUSTIBLE G-296-B 124217

TRANSMISION GP-171 1328691

AIRE GAK-16 305080

AIRE GAK-1532 336567

H100XL CHALLENGER, H110XL CHALLENGER con motor/A GAS LPG

HIDRAULICO GP-9 1328692

ACEITE GP-3980 1320000

TRANSMISION GP-171 1328691

AIRE GAK-16 305080

AIRE GAK-1532 336567

H100XL2 con motor/GMC 4.3 L

ACEITE GP-3980 375588

H100XL2 con motor/PERKINS 1004.4

ACEITE GP-31 1327905

H1050CH CHALLENGER con motor/PERKINS 2006

AIRE GA-694 1312208

H110-150F CHALLENGER con motor/A DIESEL

TRANSMISION G-33 235849

HIDRAULICO G-238 75669

ACEITE, CARTUCHO G-801 990325

ACEITE, CARTUCHO G-870 990325

ACEITE, SELLADO GP-1 195852

COMBUSTIBLE G-296 124217

COMBUSTIBLE G-296-B 124217

H110-150F CHALLENGER con motor/A GAS LPG

HIDRAULICO G-238 75669

H110-150F CHALLENGER con motor/A GASOLINA

TRANSMISION G-33 235849

HIDRAULICO G-238 75669

ACEITE GP-3 127644

GASOLINA GG-16 1313924

H110E CHALLENGER con motor/A DIESEL

ACEITE GP-1 195852

COMBUSTIBLE G-296 124217

COMBUSTIBLE G-296-B 124217

AIRE GAK-1532 336567

H110E CHALLENGER con motor/A GASOLINA

ACEITE GP-3 127644

AIRE, SIN ASPAS GA-16 1320263

AIRE GAK-16 1320263

AIRE GAK-1532 336567

H110E CHALLENGER con motor/A PETROLEO

ACEITE GP-3 127644

H110E CHALLENGER con motor/GMC 6-250

ACEITE G-238 75669

ACEITE, SELLADO GP-1 195852

SERVICIO PESADO

MARCA-MODELO-MOTOR MAKE-MODEL-ENGINE	GONHER GONHER	OEM OEM	MARCA-MODELO-MOTOR MAKE-MODEL-ENGINE	GONHER GONHER	OEM OEM	MARCA-MODELO-MOTOR MAKE-MODEL-ENGINE	GONHER GONHER	OEM OEM
HYSTER (continuación)			HYSTER (continuación)			HYSTER (continuación)		
MONTACARGAS			MONTACARGAS			MONTACARGAS		
TRANSMISION	GP-1	297865	COMBUSTIBLE, SECUNDARIO	G-296	124217	AIRE, SIN ASPAS	GA-20	156954
			COMBUSTIBLE, SECUNDARIO	G-296-B	124217	AIRE	GAK-20	156954
H110E CHALLENGER con motor/PERKINS			H130F con motor/GMC			H150-275H CHALLENGER con motor/DETROIT DIESEL 4-53N		
COMBUSTIBLE	G-296	124217	ACEITE	GP-3	127644	COMBUSTIBLE	G-1173	157854
ACEITE	GP-3600	259964	H135-155XL CHALLENGER con motor/GMC A GASOLINA			H150-275H CHALLENGER con motor/GMC V8-350		
COMBUSTIBLE	G-296-B	124217	ACEITE	GP-3980	1320000	ACEITE, SELLADO	GP-13	258237
H110XL CHALLENGER con motor/GMC A GASOLINA			TRANSMISION	GP-171	1328691	H150-275H CHALLENGER con motor/PERKINS 6.354		
HIDRAULICO	GP-9	1328692	AIRE	GAK-16	305080	COMBUSTIBLE	G-1174	155100
ACEITE	GP-3980	1320000	AIRE	GAK-1532	336567	COMBUSTIBLE, SEPARADOR DE AGUA	G-296	124217
TRANSMISION	GP-171	1328691	GASOLINA	GG-5 L	1346283	ACEITE, SELLADO	GP-3600	251755
AIRE	GAK-16	305080	GASOLINA	GG-46	1330342	COMBUSTIBLE, SEPARADOR DE AGUA	G-296-B	124217
AIRE	GAK-1532	336567	H135-155XL CHALLENGER con motor/GMC LPG			H150-275H CHALLENGER con motor/PERKINS 6.354.4		
GASOLINA	GG-5 L	1346283	ACEITE	GP-3980	1320000	COMBUSTIBLE	G-296	124217
GASOLINA	GG-46	1330342	TRANSMISION	GP-171	1328691	ACEITE, SELLADO	GP-3600	251755
H110XL CHALLENGER con motor/PERKINS DIESEL			AIRE	GAK-16	305080	COMBUSTIBLE	G-296-B	124217
ACEITE	GP-1	195852	AIRE	GAK-1532	336567	H150E con motor/A GASOLINA		
HIDRAULICO	GP-9	1328692	H135-155XL CHALLENGER con motor/PERKINS			HIDRAULICO		
COMBUSTIBLE	G-296	124217	ACEITE	GP-1	195852		G-238	271415-06
COMBUSTIBLE, SEPARADOR DE AGUA	GPP-1122	1306331	COMBUSTIBLE	G-296	124217	H150E, H165E con motor/A DIESEL		
COMBUSTIBLE	G-296-B	124217	COMBUSTIBLE, SEPARADOR DE AGUA	GPP-1122	1306331	HIDRAULICO		
TRANSMISION	GP-171	1328691	COMBUSTIBLE	G-296-B	124217	H155XL2 con motor/GMC 4.3 L		
AIRE	GAK-16	305080	TRANSMISION	GP-171	1328691	ACEITE	GP-3980	375588
AIRE	GAK-1532	336567	AIRE	GAK-16	305080	H155XL2 con motor/PERKINS 1004.4		
H110XL2 con motor/GMC 4.3 L			AIRE	GAK-1532	336567	ACEITE	GP-31	1327905
ACEITE	GP-3980	375588	H135XL2 con motor/GMC 4.3 L			H165-190XL CHALLENGER con motor/PERKINS DIESEL		
H110XL2 con motor/PERKINS 1004.4			ACEITE	GP-3980	375588	ACEITE	GP-31	1327905
ACEITE	GP-31	1327905	H135XL2 con motor/PERKINS 1004.4			COMBUSTIBLE, SEPARADOR DE AGUA		
H120B con motor/PERKINS			ACEITE	GP-31	1327905	TRANSMISION	GP-171	1315621
TRANSMISION	G-6	233134	H150-250E CHALLENGER con motor/DETROIT DIESEL 4-53N			AIRE, SIN ASPAS	GA-403	97310
TRANSMISION	G-33	235849	HIDRAULICO	G-238	75669	AIRE	GAK-403	97310
HIDRAULICO	G-238	75669	COMBUSTIBLE, SECUNDARIO	G-1173	157854	H165-190XL CHALLENGER con motor/PERKINS TURBO DIESEL		
ACEITE, CARTUCHO	G-813	133575	COMBUSTIBLE, PRIMARIO	G-1174	155100	ACEITE	GP-1	195852
COMBUSTIBLE, PRIMARIO	G-1174	155100	AIRE	GA-24	155748	COMBUSTIBLE, SEPARADOR DE AGUA	GPP-1122	1306331
COMBUSTIBLE, SECUNDARIO	G-296	124217	H150-250E CHALLENGER con motor/GMC V6-305			TRANSMISION	GP-171	1315621
ACEITE, SELLADO	GP-3600	259025	HIDRAULICO	G-238	75669	AIRE, SIN ASPAS	GA-403	97310
COMBUSTIBLE, SECUNDARIO	G-296-B	124217	ACEITE, SELLADO	GP-5	147037	AIRE	GAK-403	97310
H120C con motor/A DIESEL			AIRE, SIN ASPAS	GA-20	156954	H165E con motor/A GASOLINA		
HIDRAULICO	G-238	271415-06	AIRE, SIN ASPAS	GA-403	97310	HIDRAULICO	G-238	271415-06
H120C con motor/A GASOLINA			AIRE	GAK-403	97310	H165XL2 con motor/PERKINS 1006.6		
HIDRAULICO	G-238	271415-06	AIRE	GAK-20	156954	ACEITE	GP-1	195852
H120C con motor/CONTINENTAL F244			GASOLINA	GG-20	97372	H180E con motor/A DIESEL		
TRANSMISION	G-6	233134	H150-250E CHALLENGER con motor/GMC V8-350			HIDRAULICO		
H120C con motor/PERKINS 4.236			HIDRAULICO	G-238	75669	H180E con motor/A GASOLINA		
TRANSMISION	G-33	235849	ACEITE, SELLADO	GP-13	258237	HIDRAULICO		
HIDRAULICO	G-238	75669	ACEITE, SELLADO	GP-205	258237	H190-210XL CHALLENGER con motor/PERKINS DIESEL		
COMBUSTIBLE, PRIMARIO	G-1174	155100	AIRE, SIN ASPAS	GA-20	156954	ACEITE	GP-31	1327905
COMBUSTIBLE, SECUNDARIO	G-296	124217	AIRE	GAK-20	156954	COMBUSTIBLE, SEPARADOR DE AGUA	GPP-1122	1306331
ACEITE	GP-3600	259964	H150-250E CHALLENGER con motor/PERKINS 6.354			TRANSMISION	GP-171	1315621
COMBUSTIBLE, SECUNDARIO	G-296-B	124217	HIDRAULICO	G-238	75669	H150E con motor/PERKINS 1006.6		
H120C, H120SC, H120TC con motor/PERKINS 6.305			ACEITE, CARTUCHO	G-834	985651	H180E con motor/A GASOLINA		
TRANSMISION	G-33	235849	COMBUSTIBLE, PRIMARIO	G-1174	155100	HIDRAULICO		
HIDRAULICO	G-238	75669	COMBUSTIBLE	G-296	124217	H190-210XL CHALLENGER con motor/PERKINS DIESEL		
ACEITE, CARTUCHO	G-834	985651	ACEITE, SELLADO	GP-3600	251755	ACEITE	GP-31	1327905
COMBUSTIBLE, PRIMARIO	G-1174	155100	COMBUSTIBLE	G-296-B	124217	COMBUSTIBLE, SEPARADOR DE AGUA	GPP-1122	1306331

MARCA-MODELO-MOTOR MAKE-MODEL-ENGINE	GONHER GONHER	OEM OEM	MARCA-MODELO-MOTOR MAKE-MODEL-ENGINE	GONHER GONHER	OEM OEM	MARCA-MODELO-MOTOR MAKE-MODEL-ENGINE	GONHER GONHER	OEM OEM
HYSTER (continuación)			HYSTER (continuación)			HYSTER (continuación)		
MONTACARGAS			MONTACARGAS			MONTACARGAS		
AIRE, SIN ASPAS	GA-403	97310	H250-280XL CHALLENGER con motor/PERKINS DIESEL			H25-30-30XL CHALLENGER con motor/ISUZU C240		
AIRE	GAK-403	97310	ACEITE	GP-31	1327905	ACEITE, SELLADO	GP-3985	360974
H190-210XL CHALLENGER con motor/PERKINS TURBO DIESEL			COMBUSTIBLE, SEPARADOR DE AGUA	GPP-1122	1306331	H25-30-30XL CHALLENGER con motor/MAZDA M4-121G		
ACEITE	GP-1	195852	AIRE, SIN ASPAS	GA-403	97310	ACEITE, SELLADO	GP-91	324692
COMBUSTIBLE, SEPARADOR DE AGUA	GPP-1122	1306331	AIRE	GAK-403	97310	AIRE, SIN ASPAS	GA-33	326483
TRANSMISION	GP-171	1315621	H250-280XL CHALLENGER con motor/PERKINS TURBO DIESEL			GASOLINA	GG-5 L	1304950
AIRE, SIN ASPAS	GA-403	97310	ACEITE	GP-1	195852	H25-30XM con motor/MAZDA M4-2.0G		
AIRE	GAK-403	97310	COMBUSTIBLE, SEPARADOR DE AGUA	GPP-1122	1306331	AIRE, SIN ASPAS	GA-33	1369809
H190XL2 con motor/PERKINS 1006.6			AIRE	GA-403	97310	H25-30XM con motor/MAZDA M4-2.0LPG		
ACEITE	GP-1	1315621	AIRE	GAK-403	97310	AIRE, SIN ASPAS	GA-33	1369809
H200E con motor/A DIESEL			H250A con motor/A DIESEL			H25-30XM con motor/MAZDA M4-2.5D		
HIDRAULICO	G-238	75669	HIDRAULICO	G-238	75669	AIRE, SIN ASPAS	GA-33	2033611
H200E con motor/A GASOLINA			H250A con motor/A GASOLINA			H25E CHALLENGER con motor/PERKINS 4.107		
HIDRAULICO	G-238	75669	HIDRAULICO	G-238	75669	ACEITE, CARTUCHO	G-813	133575
H20E CHALLENGER con motor/A GASOLINA			H250A-300A CHALLENGER con motor/DETROIT DIESEL 4-53			TRANSMISION	GP-9	180283
ACEITE	GP-9	180283	COMBUSTIBLE, SECUNDARIO	G-1173	157854	COMBUSTIBLE	G-296	3000087
H20E CHALLENGER con motores/A PETROLEO, CONTINENTAL			COMBUSTIBLE, PRIMARIO	G-1174	155100	COMBUSTIBLE	G-296-B	3000087
ACEITE, DERIVACION (BY PASS)	GP-50	180282	AIRE, SIN ASPAS	GA-24	155748	H25E CHALLENGER con motor/PERKINS 4.108		
H20E CHALLENGER con motores/PERKINS 4.107, PERKINS 4.108			H250A-300A CHALLENGER con motor/GMC V6-305			TRANSMISION	GP-9	180283
ACEITE, CARTUCHO	G-813	133575	ACEITE, SELLADO	GP-5	147037	COMBUSTIBLE	G-296	124217
ACEITE	GP-9	180283	AIRE, SIN ASPAS	GA-403	97310	ACEITE, SELLADO	GP-3600	259964
COMBUSTIBLE	G-296	124217	AIRE	GAK-403	97310	COMBUSTIBLE	G-296-B	124217
COMBUSTIBLE	G-296-B	124217	GASOLINA	GG-20	97372	H25E CHALLENGER con motores/A GASOLINA, CONTINENTAL		
H210-230XL CHALLENGER con motor/PERKINS DIESEL			H250A-300A CHALLENGER con motor/GMC V8-350			ACEITE, DERIVACION (BY PASS)	GP-50	180282
ACEITE	GP-31	1327905	ACEITE, SELLADO	GP-13	258237	H25XM CHALLENGER con motor/MAZDA M4-2.0G		
COMBUSTIBLE, SEPARADOR DE AGUA	GPP-1122	1306331	H250A-300A CHALLENGER con motor/PERKINS 6.354			ACEITE	GP-9	2021461
AIRE, SIN ASPAS	GA-403	97310	ACEITE, CARTUCHO	G-834	985651	AIRE, SIN ASPAS	GA-33	1369809
AIRE	GAK-403	97310	COMBUSTIBLE, PRIMARIO	G-1174	155100	GASOLINA	GG-5 L	1304950
H210-230XL CHALLENGER con motor/PERKINS TURBO DIESEL			COMBUSTIBLE	G-296	124217	H25XM CHALLENGER con motor/MAZDA M4-2.0LPG		
ACEITE	GP-1	195852	ACEITE, SELLADO	GP-3600	25902512	ACEITE	GP-9	2021461
COMBUSTIBLE, SEPARADOR DE AGUA	GPP-1122	1306331	COMBUSTIBLE	G-296-B	124217	H25XM CHALLENGER con motor/MAZDA M4-2.5D		
AIRE, SIN ASPAS	GA-403	97310	AIRE	GA-20	156954	ACEITE	GP-9	2021461
AIRE	GAK-403	97310	AIRE	GA-403	97310	H280XL con motor/PERKINS 6.354		
H210XL2, H230XL2 con motor/PERKINS 1006.6			AIRE	GAK-403	97310	ACEITE, 5 13/32 IN	GP-1	195852
ACEITE	GP-1	1315621	AIRE	GAK-20	156954	H300-350B CHALLENGER con motor/PERKINS 6.354.4		
H230-250XL CHALLENGER con motor/PERKINS DIESEL			H250F con motor/CATERPILLAR D320			ACEITE	GP-31	3000870
ACEITE	GP-31	1327905	TRANSMISION	G-6	233134	COMBUSTIBLE	G-296	3000087
COMBUSTIBLE, SEPARADOR DE AGUA	GPP-1122	1306331	H250F con motor/HERCULES JXD			COMBUSTIBLE	G-296-B	3000087
AIRE, SIN ASPAS	GA-403	97310	ACEITE, CARTUCHO	G-33	235849	H300-350B CHALLENGER con motor/PERKINS T6.354.4		
AIRE	GAK-403	97310	H250F con motor/PERKINS P6			ACEITE	GP-1	3000046
H230-250XL CHALLENGER con motor/PERKINS TURBO DIESEL			HIDRAULICO	G-238	75669	COMBUSTIBLE	G-296	3000087
ACEITE	GP-1	195852	H250XL2, H280XL2 con motor/PERKINS 1006.6			COMBUSTIBLE	G-296-B	3000087
COMBUSTIBLE, SEPARADOR DE AGUA	GPP-1122	1306331	ACEITE	GP-1	1315621	H300-360XL CHALLENGER con motor/PERKINS DIESEL		
AIRE, SIN ASPAS	GA-403	97310	COMBUSTIBLE, SEPARADOR DE AGUA	GPP-425	26560144	ACEITE	GP-31	1327905
AIRE	GAK-403	97310	COMBUSTIBLE	GPP-419	26530142	COMBUSTIBLE, SEPARADOR DE AGUA	GPP-1122	1306331
H25 con motor/CONTINENTAL			AIRE, SIN ASPAS	GA-403	170681	AIRE, SIN ASPAS	GA-403	97310
ACEITE, DERIVACION (BY PASS)	GP-50	180282	AIRE	GAK-403	97310	AIRE	GAK-403	97310
			H25-30-30XL CHALLENGER con motor/A GAS LPG					
			ACEITE, SELLADO	GP-91	324692			

SERVICIO PESADO

MARCA-MODELO-MOTOR MAKE-MODEL-ENGINE	GONHER GONHER	OEM OEM	MARCA-MODELO-MOTOR MAKE-MODEL-ENGINE	GONHER GONHER	OEM OEM	MARCA-MODELO-MOTOR MAKE-MODEL-ENGINE	GONHER GONHER	OEM OEM
HYSTER (continuación)			HYSTER (continuación)			HYSTER (continuación)		
MONTACARGAS			MONTACARGAS			MONTACARGAS		
H300-360XL CHALLENGER con motor/PERKINS TURBO DIESEL			H30H CHALLENGER con motor/A GASOLINA			H35XM CHALLENGER con motor/MAZDA M4-2.0LPG		
ACEITE	GP-1	195852	HIDRAULICO	G-238	75669	TRANSMISION	GP-9	2021461
COMBUSTIBLE, SEPARADOR DE AGUA	GPP-1122	1306331	ACEITE	GP-3	127644	H35XM CHALLENGER con motor/MAZDA M4-2.5D		
AIRE, SIN ASPAS	GA-403	97310	AIRE	GAK-16	305080	TRANSMISION	GP-9	2021461
AIRE	GAK-403	97310	H30H CHALLENGER con motor/A PETROLEO			H360-370C CHALLENGER con motor/PERKINS T8.540		
H300A con motor/A DIESEL			ACEITE	GP-3	127644	HIDRAULICO	GP-3	127644
HIDRAULICO	G-238	75669	H30H CHALLENGER con motor/FORD			ACEITE, SELLADO	GP-31	1327905
H300A con motor/A GASOLINA			ACEITE	GP-1	195852	AIRE, SIN ASPAS	GA-27	151548
HIDRAULICO	G-238	75669	H30H CHALLENGER con motor/GMC 4-181			H360-370C CHALLENGER, H370-400C CHALLENGER, H400-420C CHALLENGER con motores/DETROIT DIESEL, PERKINS TV8.640		
H300BS CHALLENGER con motor/PERKINS 6.354.4			ACEITE	GP-1	195852	HIDRAULICO	GP-3	127644
ACEITE	GP-31	3000870	TRANSMISION	GP-9	309112	H360-400B CHALLENGER con motor/DETROIT DIESEL 6V-53 N		
COMBUSTIBLE	G-296	3000087	GASOLINA	GG-20	97372	TRANSMISION	G-33	235849
COMBUSTIBLE	G-296-B	3000087	H30XL CHALLENGER con motores/MAZDA M4-2.0G, MAZDA M4-2.0LPG, MAZDA M4-2.5D			HIDRAULICO	G-238	75669
H300BS CHALLENGER con motor/PERKINS T6.354.4			ACEITE	GP-81	2021461	AIRE, SIN ASPAS	GA-27	151548
ACEITE	GP-1	3000046	H30XM CHALLENGER con motor/MAZDA M4-2.0G			H360-400B CHALLENGER con motor/GMC V6-478		
COMBUSTIBLE	G-296	3000087	TRANSMISION	GP-9	2021461	ACEITE, CARTUCHO	G-33	165365
COMBUSTIBLE	G-296-B	3000087	AIRE, SIN ASPAS	GA-33	1369809	TRANSMISION	G-33	235849
H300E con motor/CATERPILLAR D320			GASOLINA	GG-5 L	1304950	HIDRAULICO	G-238	75669
TRANSMISION	G-6	233134	H30XM CHALLENGER con motor/MAZDA M4-2.0LPG			AIRE, SIN ASPAS	GA-24	155748
H300E con motor/HERCULES JXD			TRANSMISION	GP-9	2021461	GASOLINA	GG-20	97372
ACEITE, CARTUCHO	G-33	235849	H30XM CHALLENGER con motor/MAZDA M4-2.5D			H360-400B CHALLENGER con motor/PERKINS V8.540 DIESEL		
AIRE, SIN ASPAS	GA-20	156954	TRANSMISION	GP-9	2021461	TRANSMISION	G-33	235849
AIRE	GA-37	202951	H330-360EC CHALLENGER con motor/PERKINS DIESEL			HIDRAULICO	G-238	75669
AIRE	GAK-20	156954	ACEITE	GP-31	1327905	ACEITE, CARTUCHO	G-834	985651
H300E con motor/PERKINS P6			COMBUSTIBLE, SEPARADOR DE AGUA	GPP-1122	1306331	ACEITE, SELLADO	GP-3600	251755
HIDRAULICO	G-238	75669	AIRE, SIN ASPAS	GA-403	97310	AIRE, SIN ASPAS	GA-24	155748
H300XL2 con motor/PERKINS 1006.6			AIRE	GAK-403	97310	H360A con motor/CONTINENTAL A DIESEL		
ACEITE	GP-1	1315621	H330-360EC CHALLENGER con motor/PERKINS TURBO DIESEL			TRANSMISION	G-33	235849
COMBUSTIBLE, SEPARADOR DE AGUA	GPP-425	26560144	ACEITE	GP-1	195852	HIDRAULICO	G-238	75669
COMBUSTIBLE	GPP-419	26530142	COMBUSTIBLE, SEPARADOR DE AGUA	GPP-1122	1306331	COMBUSTIBLE	G-1176	200790
H30E CHALLENGER con motor/A GASOLINA			AIRE, SIN ASPAS	GA-403	97310	AIRE	GA-37	202951
TRANSMISION	GP-9	180283	AIRE	GAK-403	97310	H360A con motor/CONTINENTAL A GASOLINA		
H30E CHALLENGER con motor/A PETROLEO			H330XL2 con motor/PERKINS 1006.6			ACEITE, DERIVACION (BY PASS)	G-31	200336
ACEITE, DERIVACION (BY PASS)	GP-50	180282	ACEITE	GP-1	1315621	HIDRAULICO	G-238	75669
H30E CHALLENGER con motor/PERKINS 4.107			COMBUSTIBLE, SEPARADOR DE AGUA	GPP-425	26560144	AIRE	GA-37	AF-50
ACEITE, CARTUCHO	G-813	133575	COMBUSTIBLE	GPP-419	26530142	H360A con motor/PERKINS 6.354		
TRANSMISION	GP-9	180283	H35-40XM CHALLENGER con motor/MAZDA M4-2.0G			HIDRAULICO	G-238	75669
COMBUSTIBLE	G-296	124217	AIRE, SIN ASPAS	GA-33	1369809	ACEITE	G-834	985651
COMBUSTIBLE	G-296-B	3000087	H35-40XM CHALLENGER con motor/MAZDA M4-2.5D			COMBUSTIBLE	G-296	124217
H30E CHALLENGER con motor/PERKINS 4.108			AIRE, SIN ASPAS	GA-33	1369809	COMBUSTIBLE	G-296-B	124217
TRANSMISION	GP-9	180283	H35-40XM CHALLENGER con motor/MAZDA M4-2.0LPG			AIRE	GA-37	202951
COMBUSTIBLE	G-296	124217	AIRE, SIN ASPAS	GA-33	1369809	H360XL2 con motor/PERKINS 1006.6		
ACEITE	GP-3600	25902512	H35-40XM CHALLENGER con motor/MAZDA M4-2.5D			ACEITE	GP-1	195852
COMBUSTIBLE	G-296-B	124217	AIRE, SIN ASPAS	GA-33	2033611	COMBUSTIBLE, SEPARADOR DE AGUA	GPP-425	26560144
H30H CHALLENGER con motor/A DIESEL			H35XM CHALLENGER con motor/MAZDA M4-2.0G			COMBUSTIBLE	GPP-419	26530142
ACEITE	G-238	75669	TRANSMISION	GP-9	2021461	H370-400C CHALLENGER, H400-420C CHALLENGER con motor/PERKINS T8.540		
COMBUSTIBLE	G-296	124217	AIRE, SIN ASPAS	GA-33	1369809	HIDRAULICO	GP-3	127644
ACEITE	GP-3600	259025	GASOLINA	GG-5 L	1304950	ACEITE, SELLADO	GP-31	1327905
COMBUSTIBLE	G-296-B	124217	H400-460B CHALLENGER con motor/DETROIT DIESEL 6V-53 N			AIRE, SIN ASPAS	GA-27	151548
AIRE	GAK-16	305080	TRANSMISION	G-33	235849			

MARCA-MODELO-MOTOR MAKE-MODEL-ENGINE	GONHER GONHER	OEM OEM	MARCA-MODELO-MOTOR MAKE-MODEL-ENGINE	GONHER GONHER	OEM OEM	MARCA-MODELO-MOTOR MAKE-MODEL-ENGINE	GONHER GONHER	OEM OEM
HYSTER (continuación)			HYSTER (continuación)			HYSTER (continuación)		
MONTACARGAS			MONTACARGAS			MONTACARGAS		
HIDRAULICO	G-238	75669	ACEITE	GP-3	127644	GASOLINA	GG-46	1330342
AIRE, SIN ASPAS	GA-27	151548	AIRE	GAK-16	305080	H45-65XM CHALLENGER con motor/GMC 3.0L A GASOLINA		
H400-460B CHALLENGER con motor/GMC V6-478			H40H CHALLENGER con motor/FORD 192			ACEITE		
ACEITE, CARTUCHO	G-33	165365	ACEITE	GP-9	B8NN-6714-A	TRANSMISION	GP-9	1328692
TRANSMISION	G-33	235849	H40X2 con motor/A DIESEL			AIRE	GAK-16	305080
HIDRAULICO	G-238	75669	ACEITE	GP-9	309112	GASOLINA	GG-46	1330342
AIRE, SIN ASPAS	GA-24	155748	H40XL CHALLENGER con motor/ISUZU 2.4L DIESEL			H45-65XM CHALLENGER con motor/GMC 3.0L LPG		
GASOLINA	GG-20	97372	TRANSMISION	GP-9	1328692	ACEITE	GP-3	127644
H400-460B CHALLENGER con motor/PERKINS V8.540 DIESEL			ACEITE, SELLADO	GP-3985	360974	TRANSMISION	GP-9	1328692
TRANSMISION	G-33	235849	AIRE, SIN ASPAS	GA-33	326483	AIRE	GAK-16	305080
HIDRAULICO	G-238	75669	H40XL CHALLENGER con motor/ISUZU 2.8L DIESEL			H45-65XM CHALLENGER con motor/ISUZU C240 2.4L DIESEL		
ACEITE, CARTUCHO	G-834	985651	TRANSMISION	GP-9	1328692	TRANSMISION	GP-9	1328692
ACEITE, SELLADO	GP-3600	251755	H40XL CHALLENGER con motor/MAZDA M4-121G			ACEITE, SELLADO	GP-3985	360974
AIRE, SIN ASPAS	GA-24	155748	TRANSMISION	GP-9	1328692	AIRE	GAK-16	305080
H400A con motor/CONTINENTAL A DIESEL			ACEITE, SELLADO	GP-91	324692	H45-65XM CHALLENGER con motor/MAZDA M4-2.0G		
ACEITE	G-33	235849	AIRE, SIN ASPAS	GA-33	326483	TRANSMISION	GP-9	1328692
ACEITE	G-238	75669	GASOLINA	GG-5 L	1304950	ACEITE, SELLADO	GP-91	324692
COMBUSTIBLE	G-1176	200790	H40XL CHALLENGER con motor/MAZDA M4-121LPG			AIRE	GAK-16	305080
AIRE	GA-37	202951	TRANSMISION	GP-9	1328692	GASOLINA	GG-5 L	1304950
H400A con motor/CONTINENTAL A GASOLINA			ACEITE, SELLADO	GP-91	324692	H45-65XM CHALLENGER con motor/MAZDA M4-2.0LPG		
ACEITE, DERIVACION (BY PASS)	G-31	200336	AIRE, SIN ASPAS	GA-33	326483	TRANSMISION	GP-9	1328692
HIDRAULICO	G-238	75669	H40XL CHALLENGER con motores/GMC 4-181 A GASOLINA, GMC 4-181 LPG			ACEITE, SELLADO	GP-91	324692
AIRE	GA-37	AF-50	ACEITE, SELLADO	GP-3	127644	AIRE	GAK-16	305080
H400A con motor/PERKINS 6.354			TRANSMISION	GP-9	1328692	H45-65XM CHALLENGER con motores/GMC 2.2L LPG, ISUZU 4JB1 2.8L DIESEL, ISUZU 4JG2 3.1L DIESEL		
HIDRAULICO	G-238	75669	AIRE	GAK-16	305080	TRANSMISION	GP-9	1328692
ACEITE	G-834	985651	H40XM CHALLENGER con motor/MAZDA M4-2.0G			H460-470C CHALLENGER con motor/PERKINS T8.540		
COMBUSTIBLE	G-296	124217	TRANSMISION	GP-9	2021461	HIDRAULICO	GP-3	127644
COMBUSTIBLE	G-296-B	124217	AIRE, SIN ASPAS	GA-33	1369809	ACEITE, SELLADO	GP-31	1327905
AIRE	GA-37	202951	GASOLINA	GG-5 L	1304950	AIRE, SIN ASPAS	GA-27	151548
H40-50J CHALLENGER con motor/A GAS LPG			H40XM CHALLENGER con motor/MAZDA M4-2.0LPG			H460-470C CHALLENGER, H470-510C CHALLENGER con motores/DETROIT DIESEL, PERKINS TV8.640		
HIDRAULICO	G-238	75669	TRANSMISION	GP-9	2021461	HIDRAULICO	GP-3	127644
AIRE, SIN ASPAS	GA-16	1320263	H40XM CHALLENGER con motor/MAZDA M4-2.5D			H460-520B CHALLENGER con motor/DETROIT DIESEL 6V-53 N		
AIRE	GAK-16	1320263	TRANSMISION	GP-9	2021461	TRANSMISION	G-33	235849
H40-50J CHALLENGER con motor/PERKINS 4.203			H420-460C CHALLENGER con motor/DETROIT DIESEL			HIDRAULICO	G-238	75669
ACEITE	G-238	75669	ACEITE, SELLADO	GP-3	127644	AIRE, SIN ASPAS	GA-27	151548
COMBUSTIBLE	G-296	124217	H420-460C CHALLENGER con motor/PERKINS T8.540			H460-520B CHALLENGER con motor/GMC V6-478		
ACEITE, SELLADO	GP-3600	259025	HIDRAULICO	GP-3	127644	ACEITE, CARTUCHO	G-33	165365
COMBUSTIBLE	G-296-B	124217	ACEITE, SELLADO	GP-31	1327905	TRANSMISION	G-33	235849
AIRE, SIN ASPAS	GA-16	1320263	AIRE, SIN ASPAS	GA-27	151548	HIDRAULICO	G-238	75669
AIRE	GAK-16	1320263	H420-460C CHALLENGER con motor/PERKINS TV8.640			AIRE, SIN ASPAS	GA-24	155748
H40-50J CHALLENGER con motores/GMC 4-153, GMC 4-181, GMC 6-250			HIDRAULICO	GP-3	127644	GASOLINA	GG-20	97372
HIDRAULICO	G-238	75669	ACEITE, SELLADO	GP-31	1327905	H460-520B CHALLENGER con motor/PERKINS V8.540		
ACEITE, SELLADO	GP-3	127644	AIRE, SIN ASPAS	GA-27	151548	TRANSMISION	G-33	235849
AIRE, SIN ASPAS	GA-16	1320263	H440FS con motor/CUMMINS 6CT 8.3			HIDRAULICO	G-238	75669
AIRE	GAK-16	1320263	COMBUSTIBLE, SECUNDARIO	GP-1122	385951	ACEITE, CARTUCHO	G-834	985651
GASOLINA	GG-16	1313924	ACEITE, FLUJO TOTAL (FULL FLOW)	GP-43	3313281	ACEITE, SELLADO	GP-3600	251755
H40H CHALLENGER con motor/A DIESEL			ACEITE, DOBLE FLUJO	GP-3000	3825970	AIRE, SIN ASPAS	GA-24	155748
HIDRAULICO	G-238	75669	COMBUSTIBLE, PRIMARIO	GPP-18	3925274	H460A con motor/CONTINENTAL A DIESEL		
COMBUSTIBLE	G-296	124217	H45-65XM CHALLENGER con motor/GMC 2.2L A GASOLINA			ACEITE	G-33	235849
ACEITE, SELLADO	GP-3600	259025	TRANSMISION	GP-9	1328692	ACEITE	G-238	75669
COMBUSTIBLE	G-296-B	124217	AIRE	GAK-16	305080	COMBUSTIBLE	G-1176	200790
AIRE	GAK-16	305080	H460A con motor/CONTINENTAL A DIESEL			AIRE	GA-37	202951

SERVICIO PESADO

MARCA-MODELO-MOTOR MAKE-MODEL-ENGINE	GONHER GONHER	OEM OEM	MARCA-MODELO-MOTOR MAKE-MODEL-ENGINE	GONHER GONHER	OEM OEM	MARCA-MODELO-MOTOR MAKE-MODEL-ENGINE	GONHER GONHER	OEM OEM
HYSTER (continuación)			HYSTER (continuación)			HYSTER (continuación)		
MONTACARGAS			MONTACARGAS			MONTACARGAS		
H460A con motor/CONTINENTAL A GASOLINA			ACEITE, SELLADO	GP-31	1327905	TRANSMISION	G-33	235849
ACEITE, DERIVACION (BY PASS)	G-31	200336	AIRE, SIN ASPAS	GA-27	151548	HIDRAULICO	G-238	75669
HIDRAULICO	G-238	75669	H510-520C CHALLENGER, H580-620C CHALLENGER, H520-550C CHALLENGER, H550-580C CHALLENGER con motores/DETROIT DIESEL, PERKINS TV8.640			ACEITE, CARTUCHO	G-813	133575
AIRE	GA-37	AF-50	HIDRAULICO	GP-3	127644	COMBUSTIBLE	G-296	124217
H460A con motor/PERKINS 6.354			H520-620B CHALLENGER con motor/DETROIT DIESEL 6V-53 N			ACEITE, SELLADO	GP-3600	259025
HIDRAULICO	G-238	75669	TRANSMISION	G-33	235849	COMBUSTIBLE	G-296-B	124217
ACEITE	G-834	985651	HIDRAULICO	G-238	75669	AIRE	GAK-16	305080
COMBUSTIBLE	G-296	124217	AIRE, SIN ASPAS	GA-27	151548	H60C con motores/CONTINENTAL F226 A GASOLINA, CONTINENTAL F226 LPG, CONTINENTAL F227 A GASOLINA, CONTINENTAL F227 LPG		
COMBUSTIBLE	G-296-B	124217	H520-620B CHALLENGER con motor/GMC V6-478			TRANSMISION	G-6	233134
AIRE	GA-37	202951	ACEITE, CARTUCHO	G-33	165365	TRANSMISION	G-33	235849
H470-510C CHALLENGER con motor/PERKINS T8.540			TRANSMISION	G-33	165365	HIDRAULICO	G-238	75669
HIDRAULICO	GP-3	127644	ACEITE	G-238	75669	ACEITE, DERIVACION (BY PASS)	GP-50	180282
ACEITE, SELLADO	GP-31	1327905	AIRE, SIN ASPAS	GA-24	155748	H60E CHALLENGER con motor/A DIESEL		
AIRE, SIN ASPAS	GA-27	151548	GASOLINA	GG-20	97372	ACEITE	GP-1	195852
H50 con motor/CONTINENTAL F162			H520-620B CHALLENGER con motor/PERKINS V8.540 DIESEL			COMBUSTIBLE	G-296	3000087
TRANSMISION	G-6	233134	TRANSMISION	G-33	235849	COMBUSTIBLE	G-296-B	3000087
HIDRAULICO	G-238	75669	HIDRAULICO	G-238	75669	AIRE	GAK-1532	336567
ACEITE, DERIVACION (BY PASS)	GP-50	180282	ACEITE, CARTUCHO	G-834	985651	H60E CHALLENGER con motor/A GASOLINA		
H50H CHALLENGER con motor/A DIESEL			ACEITE, SELLADO	GP-3600	251755	ACEITE	GP-3	127644
ACEITE	G-238	75669	AIRE, SIN ASPAS	GA-24	155748	AIRE, SIN ASPAS	GA-16	1320263
COMBUSTIBLE	G-296	124217	H550-580C CHALLENGER, H580-620C CHALLENGER con motor/PERKINS T8.540			AIRE	GAK-16	1320263
ACEITE, SELLADO	GP-3600	259025	HIDRAULICO	GP-3	127644	AIRE	GAK-1532	336567
COMBUSTIBLE	G-296-B	124217	ACEITE, SELLADO	GP-31	1327905	H60E CHALLENGER con motor/GMC 6-250		
AIRE	GAK-16	305080	AIRE, SIN ASPAS	GA-27	151548	HIDRAULICO	G-238	75669
H50H CHALLENGER con motor/A GASOLINA			H550F, H550FS con motor/CUMMINS 6CT 8.3			ACEITE, SELLADO	GP-1	195852
HIDRAULICO	G-238	75669	COMBUSTIBLE, SECUNDARIO	GP-1122	385951	TRANSMISION	GP-1	297865
ACEITE	GP-3	127644	ACEITE, FLUJO TOTAL (FULL FLOW)	GP-43	3313281	H60E CHALLENGER con motor/PERKINS		
AIRE	GAK-16	305080	ACEITE, DOBLE FLUJO	GP-3000	3825970	COMBUSTIBLE	G-296	124217
H50X2 con motor/A DIESEL			COMBUSTIBLE, PRIMARIO	GPP-18	3925274	ACEITE, SELLADO	GP-3600	259964
HIDRAULICO	GP-9	1328692	H60 con motor/A DIESEL			COMBUSTIBLE	G-296-B	124217
H50XL CHALLENGER con motor/ISUZU 2.4L DIESEL			HIDRAULICO	G-238	271415-06	H60E CHALLENGER, H60H CHALLENGER con motor/A PETROLEO		
TRANSMISION	GP-9	1328692	H60 con motor/A GASOLINA			ACEITE	GP-3	127644
ACEITE, SELLADO	GP-3985	360974	HIDRAULICO	G-238	271415-06	H60F, H60H CHALLENGER con motor/PERKINS		
AIRE, SIN ASPAS	GA-33	326483	H60 con motor/CONTINENTAL F226			TRANSMISION	G-6	233134
H50XL CHALLENGER con motor/ISUZU 2.8L DIESEL			TRANSMISION	G-6	233134	TRANSMISION	G-33	235849
TRANSMISION	GP-9	1328692	HIDRAULICO	G-238	75669	HIDRAULICO	G-238	75669
ACEITE, SELLADO	GP-91	324692	ACEITE, DERIVACION (BY PASS)	GP-3	60518	ACEITE, CARTUCHO	G-813	133575
AIRE, SIN ASPAS	GA-33	326483	H60B con motor/PERKINS P4			COMBUSTIBLE, PRIMARIO	G-1174	155100
GASOLINA	GG-5 L	1304950	ACEITE	G-801	990325	COMBUSTIBLE, SECUNDARIO	G-296	124217
H50XL CHALLENGER con motor/MAZDA M4-121G			H60B, H30H CHALLENGER, H30HE, H30OUE, H30YE con motor/PERKINS			ACEITE, SELLADO	GP-3600	259025
TRANSMISION	GP-9	1328692	TRANSMISION	G-6	233134	COMBUSTIBLE	G-296-B	124217
ACEITE, SELLADO	GP-91	324692	TRANSMISION	G-33	235849	AIRE	GAK-16	305080
AIRE, SIN ASPAS	GA-33	326483	HIDRAULICO	G-238	75669	H60H CHALLENGER con motor/A DIESEL		
GASOLINA	GG-5 L	1304950	ACEITE, CARTUCHO	G-813	133575	HIDRAULICO	G-238	75669
H50XL CHALLENGER con motor/MAZDA M4-121LPG			COMBUSTIBLE, PRIMARIO	G-1174	155100	COMBUSTIBLE	G-296	124217
TRANSMISION	GP-9	1328692	COMBUSTIBLE, SECUNDARIO	G-296	124217	ACEITE, SELLADO	GP-3600	259025
ACEITE, SELLADO	GP-91	324692	ACEITE, SELLADO	GP-3600	259025	COMBUSTIBLE	G-296-B	124217
AIRE, SIN ASPAS	GA-33	326483	COMBUSTIBLE, SECUNDARIO	G-296-B	124217	AIRE	GAK-16	305080
H50XL CHALLENGER con motores/GMC 4-181 A GASOLINA, GMC 4-181 LPG			H60C con motor/PERKINS 4.2032			H60H CHALLENGER con motor/A GASOLINA		
ACEITE, SELLADO	GP-3	127644	TRANSMISION	G-6	233134	HIDRAULICO	G-238	75669
TRANSMISION	GP-9	1328692				COMBUSTIBLE	G-296	124217
AIRE	GAK-16	305080				ACEITE, SELLADO	GP-3	127644
H510-520C CHALLENGER, H520-550C CHALLENGER con motor/PERKINS T8.540						AIRE	GAK-16	305080
HIDRAULICO	GP-3	127644				H60H CHALLENGER con motor/GMC 4-181		
						ACEITE	G-238	75669
						ACEITE, SELLADO	GP-1	195852

MARCA-MODELO-MOTOR MAKE-MODEL-ENGINE	GONHER GONHER	OEM OEM	MARCA-MODELO-MOTOR MAKE-MODEL-ENGINE	GONHER GONHER	OEM OEM	MARCA-MODELO-MOTOR MAKE-MODEL-ENGINE	GONHER GONHER	OEM OEM
HYSTER (continuación)			HYSTER (continuación)			HYSTER (continuación)		
MONTACARGAS			MONTACARGAS			MONTACARGAS		
TRANSMISION	GP-9	309112	ACEITE, FLUJO TOTAL (FULL FLOW)	GP-43	3313281	GASOLINA	GG-5 L	1346283
GASOLINA	GG-20	97372	ACEITE, DOBLE FLUJO	GP-3000	3825970	GASOLINA	GG-46	1330342
H60HE, H60XA, H60UE, H60VA con motor/PERKINS P4			COMBUSTIBLE, PRIMARIO	GPP-18	3925274	H70XL CHALLENGER con motor/PERKINS DIESEL		
ACEITE, CARTUCHO	G-801	990325	H700-H800A CHALLENGER con motor/A DIESEL			ACEITE	GP-1	195852
H60X2 con motor/A DIESEL			HIDRAULICO	G-238	75669	HIDRAULICO	GP-9	1328692
ACEITE	GP-9	309112	AIRE, SIN ASPAS	GA-27	151548	COMBUSTIBLE	G-296	124217
H60XL CHALLENGER con motor/GMC 4-181 A GASOLINA			ACEITE	G-750	183894	COMBUSTIBLE, SECUNDARIO	GPP-1122	1306331
ACEITE	GP-3	127644	H700-H920B CHALLENGER con motor/PERKINS TV8.640			COMBUSTIBLE	G-296-B	124217
TRANSMISION	GP-9	1328692	COMBUSTIBLE	G-296	124217	TRANSMISION	GP-171	1328691
AIRE	GAK-16	305080	COMBUSTIBLE	GP-1122	385951	AIRE	GAK-16	305080
H60XL CHALLENGER con motor/GMC LPG 4-181			ACEITE, SELLADO	GP-3600	251755	AIRE	GAK-1532	336567
ACEITE	GP-3	127644	COMBUSTIBLE	G-296-B	124217	H70XL2 con motor/GMC 4.3 L		
TRANSMISION	GP-9	1327917	AIRE, SIN ASPAS	GA-27	151548	ACEITE	GP-3980	375588
AIRE	GAK-16	305080	H700-H920B CHALLENGER con motores/CUMMINS, DETROIT DIESEL			H70XL2 con motor/PERKINS 1004.4		
H60XL CHALLENGER con motor/ISUZU 2.4L DIESEL			ACEITE, DERIVACION (BY PASS)	G-750	183894	ACEITE	GP-31	1327905
TRANSMISION	GP-9	1328692	H70C con motor/PERKINS 4.203			H80 con motor/A DIESEL		
ACEITE	GP-3985	360974	TRANSMISION	G-6	233134	HIDRAULICO	G-238	271415-06
AIRE, SIN ASPAS	GA-33	326483	TRANSMISION	G-33	235849	H80 con motor/A GASOLINA		
H60XL CHALLENGER con motor/ISUZU 2.8L DIESEL			HIDRAULICO	G-238	75669	HIDRAULICO	G-238	271415-06
HIDRAULICO	GP-9	1328692	ACEITE, CARTUCHO	G-813	133575	H80 con motor/CONTINENTAL F226		
H60XL CHALLENGER con motor/MAZDA M4-121G			ACEITE, DERIVACION (BY PASS)	GP-50	305080	TRANSMISION	G-6	233134
TRANSMISION	GP-9	1328692	ACEITE, SELLADO	GP-3600	259025	H800-880C CHALLENGER con motor/PERKINS 2006		
ACEITE, SELLADO	GP-91	324692	H70C con motor/PERKINS 4.2032			AIRE	GA-694	1312208
AIRE, SIN ASPAS	GA-33	326483	COMBUSTIBLE	G-296	124217	H80B con motor/PERKINS P4		
GASOLINA	GG-5 L	1304950	COMBUSTIBLE	G-296-B	124217	ACEITE	G-801	990325
H60XL CHALLENGER con motor/MAZDA MA-121LPG			AIRE	GAK-16	305080	H80C con motor/PERKINS 4.2032		
ACEITE	GP-9	1328692	H70C con motores/CONTINENTAL F226 A GASOLINA, CONTINENTAL F227 LPG			COMBUSTIBLE	G-296	124217
ACEITE, SELLADO	GP-91	324692	TRANSMISION	G-6	233134	H80C con motores/CONTINENTAL F226 A GASOLINA, CONTINENTAL F227 LPG		
AIRE, SIN ASPAS	GA-33	326483	TRANSMISION	G-33	235849	TRANSMISION	G-6	233134
H60XL con motor/ISUZU			HIDRAULICO	G-238	75669	TRANSMISION	G-33	235849
ACEITE	GP-9	309112	ACEITE, DERIVACION (BY PASS)	GP-50	180282	HIDRAULICO	G-238	75669
H60ZA con motor/PERKINS P4			H70E CHALLENGER con motor/A DIESEL			ACEITE, DERIVACION (BY PASS)	GP-50	180282
ACEITE, CARTUCHO	G-801	990325	ACEITE	GP-1	195852	H80C, H90C con motor/PERKINS 4.203		
H620-650C CHALLENGER, H650-700C CHALLENGER con motor/PERKINS T8.540			COMBUSTIBLE	G-296	3000087	TRANSMISION	G-6	233134
HIDRAULICO	GP-3	127644	COMBUSTIBLE	G-296-B	3000087	TRANSMISION	G-33	235849
ACEITE, SELLADO	GP-31	1327905	AIRE	GAK-1532	336567	HIDRAULICO	G-238	75669
AIRE, SIN ASPAS	GA-27	151548	H70E CHALLENGER con motor/A GASOLINA			ACEITE, CARTUCHO	G-813	133575
H620-650C CHALLENGER, H650-700C CHALLENGER con motores/DETROIT DIESEL, PERKINS TV8.640			ACEITE	GP-3	127644	ACEITE, SELLADO	GP-3600	259025
HIDRAULICO	GP-3	127644	AIRE, SIN ASPAS	GA-16	1320263	AIRE	GAK-16	305080
H70 con motor/A DIESEL			AIRE	GAK-16	1320263	H80E CHALLENGER con motor/A DIESEL		
HIDRAULICO	G-238	271415-06	AIRE	GAK-1532	336567	ACEITE	GP-1	195852
H70 con motor/A GASOLINA			H70XL CHALLENGER con motor/A GAS LPG			COMBUSTIBLE	G-296	124217
HIDRAULICO	G-238	271415-06	HIDRAULICO	GP-9	1328692	COMBUSTIBLE	G-296-B	3000087
H70 con motor/CONTINENTAL F226			ACEITE	GP-3980	1320000	AIRE	GAK-1532	336567
TRANSMISION	G-6	233134	TRANSMISION	GP-171	1328691	H80E CHALLENGER con motor/A GASOLINA		
H700FS, H620F, H620FS, H650F, H700F con motor/CUMMINS 6CT 8.3			AIRE	GAK-16	305080	ACEITE	GP-3	127644
COMBUSTIBLE, SECUNDARIO	GP-1122	385951	AIRE	GAK-1532	336567	AIRE, SIN ASPAS	GA-16	1320263

SERVICIO PESADO

MARCA-MODELO-MOTOR MAKE-MODEL-ENGINE	GONHER GONHER	OEM OEM	MARCA-MODELO-MOTOR MAKE-MODEL-ENGINE	GONHER GONHER	OEM OEM	MARCA-MODELO-MOTOR MAKE-MODEL-ENGINE	GONHER GONHER	OEM OEM
HYSTER (continuación)			HYSTER (continuación)			HYSTER (continuación)		
MONTACARGAS			MONTACARGAS			MONTACARGAS		
H80HE, H80UE, H80VA, H80XA, H80ZA con motor/PERKINS P4			H90XL CHALLENGER, H90XLS CHALLENGER con motor/GMC A GASOLINA			AIRE		
ACEITE	G-801	990325	HIDRAULICO	GP-9	1328692	ACEITE	GA-37	202951
H80XL CHALLENGER con motor/A GAS LPG			ACEITE	GP-3980	1320000	ACEITE	G-500	234930
ACEITE	GP-9	1328692	TRANSMISION	GP-171	1328691	M500A, M600A con motor/CONTINENTAL RD572		
ACEITE	GP-3980	1320000	AIRE	GAK-16	305080	ACEITE	G-33	235849
ACEITE	GP-171	1328691	AIRE	GAK-1532	336567	ACEITE	G-238	75669
AIRE	GAK-16	305080	GASOLINA	GG-5 L	1346283	AIRE	GA-37	202951
AIRE	GAK-1532	336567	GASOLINA	GG-46	1330342	M600A con motor/CONTINENTAL T427		
H80XL CHALLENGER con motor/GMC A GASOLINA			H90XL CHALLENGER, H90XLS CHALLENGER con motor/PERKINS DIESEL			ACEITE	G-31	200336
ACEITE	GP-9	1328692	ACEITE	GP-1	195852	ACEITE	G-33	235849
ACEITE	GP-3980	1320000	HIDRAULICO	GP-9	1328692	ACEITE	G-238	75669
ACEITE	GP-171	1328691	COMBUSTIBLE	G-296	124217	AIRE	GA-37	202951
AIRE	GAK-16	305080	COMBUSTIBLE, SEPARADOR DE AGUA	GPP-1122	1306331	M600A con motor/CONTINENTAL TD427		
AIRE	GAK-1532	336567	COMBUSTIBLE	G-296-B	124217	ACEITE	G-33	235849
GASOLINA	GG-5 L	1346283	TRANSMISION	GP-171	1328691	ACEITE	G-238	75669
GASOLINA	GG-46	1330342	AIRE	GAK-16	305080	AIRE	GA-37	202951
H80XL CHALLENGER con motor/PERKINS DIESEL			AIRE	GAK-1532	336567	ACEITE	G-500	234930
ACEITE	GP-1	195852	H90XL2 con motor/GMC 4.3 L			N30-40XMDR ELECTRIC, N40-45XMDR ELECTRIC, N50XMA ELECTRIC con motor/A DIESEL		
HIDRAULICO	GP-9	1328692	ACEITE	GP-3980	375588	HIDRAULICO	GP-66	2310104
COMBUSTIBLE	G-296	124217	H90XL2 con motor/PERKINS 1004.4			P125-180A CHALLENGER con motor/DETROIT DIESEL 4-53N		
COMBUSTIBLE, SEPARADOR DE AGUA	GPP-1122	1306331	ACEITE	GP-31	1327905	HIDRAULICO	G-238	75669
COMBUSTIBLE	G-296-B	124217	HC50, HE50 con motor/CONTINENTAL A GASOLINA			COMBUSTIBLE, SECUNDARIO	G-1173	157854
TRANSMISION	GP-171	1328691	ACEITE	G-6	233134	COMBUSTIBLE, PRIMARIO	G-1174	155100
AIRE	GAK-16	305080	HE50 CHALLENGER con motor/CONTINENTAL F162			AIRE, SIN ASPAS	GA-24	155748
AIRE	GAK-1532	336567	TRANSMISION	G-6	233134	P125-180A CHALLENGER con motor/GMC V6-305		
H80XL2 con motor/GMC 4.3 L			HIDRAULICO	G-238	75669	ACEITE	G-238	75669
ACEITE	GP-3980	375588	ACEITE, DERIVACION (BY PASS)	GP-50	180282	ACEITE	GP-50	147037
H80XL2 con motor/PERKINS 1004.4			HE50 con motor/A DIESEL			AIRE, SIN ASPAS	GA-20	156954
ACEITE	GP-31	1327905	ACEITE	G-6	233134	AIRE, SIN ASPAS	GA-403	97310
H880-970C CHALLENGER con motor/PERKINS 2006			HR120RC con motor/PERKINS 6.305			AIRE	GAK-403	97310
AIRE	GA-694	1312208	TRANSMISION	G-33	235849	AIRE	GAK-20	156954
H90B con motor/PERKINS			HIDRAULICO	G-238	75669	GASOLINA	GG-20	97372
TRANSMISION	G-6	233134	ACEITE, CARTUCHO	G-813	133575	P125-180A CHALLENGER con motor/GMC V8-350		
TRANSMISION	G-33	235849	COMBUSTIBLE, PRIMARIO	G-1174	155100	HIDRAULICO	G-238	75669
HIDRAULICO	G-238	75669	COMBUSTIBLE, SECUNDARIO	G-296	124217	ACEITE, SELLADO	GP-13	258237
ACEITE, CARTUCHO	G-813	133575	COMBUSTIBLE, SECUNDARIO	G-296-B	124217	ACEITE, SELLADO	GP-205	258237
COMBUSTIBLE, PRIMARIO	G-1174	155100	KD KARRY KRANE con motor/A DIESEL			AIRE, SIN ASPAS	GA-20	156954
COMBUSTIBLE, SECUNDARIO	G-296	124217	ACEITE	G-813	884014	AIRE	GAK-20	156954
ACEITE, SELLADO	GP-3600	259025	M300F, M300H con motor/A GASOLINA			P125-180A CHALLENGER con motor/PERKINS 6.354		
COMBUSTIBLE, SECUNDARIO	G-296-B	124217	ACEITE	G-238	75669	ACEITE	G-238	75669
H90C con motor/PERKINS 4.2032			M300H con motor/A DIESEL			ACEITE, CARTUCHO	G-834	985651
COMBUSTIBLE	G-296	124217	ACEITE	G-238	75669	COMBUSTIBLE	G-1174	155100
H90C con motores/CONTINENTAL F226 A GASOLINA, CONTINENTAL F226 LPG, CONTINENTAL F227 A GASOLINA, CONTINENTAL F227 LPG			M500A con motor/CONTINENTAL T427			COMBUSTIBLE	G-296	124217
TRANSMISION	G-6	233134	ACEITE	G-31	200336	ACEITE, SELLADO	GP-3600	251755
TRANSMISION	G-33	235849	ACEITE	G-33	235849	COMBUSTIBLE	G-296-B	124217
HIDRAULICO	G-238	75669	ACEITE	G-238	75669	AIRE, SIN ASPAS	GA-20	156954
ACEITE, DERIVACION (BY PASS)	GP-50	180282	AIRE	GA-37	202951	AIRE	GAK-20	156954
H90XL CHALLENGER, H90XLS CHALLENGER con motor/A GAS LPG			M500A con motor/CONTINENTAL T427			P125A con motor/A DIESEL		
HIDRAULICO	GP-9	1328692	ACEITE	G-31	200336	HIDRAULICO	G-238	75669
ACEITE	GP-3980	1320000	ACEITE	G-33	235849	P125A con motor/A GASOLINA		
TRANSMISION	GP-171	1328691	ACEITE	G-238	75669	HIDRAULICO	G-238	75669
AIRE	GAK-16	305080	AIRE	GA-37	202951	P150-200B CHALLENGER con motor/DETROIT DIESEL 4-53N		
AIRE	GAK-1532	336567	M500A con motor/CONTINENTAL TD427			COMBUSTIBLE	G-1173	157854
			ACEITE	G-33	235849			
			ACEITE	G-238	75669			

MARCA-MODELO-MOTOR MAKE-MODEL-ENGINE	GONHER GONHER	OEM OEM	MARCA-MODELO-MOTOR MAKE-MODEL-ENGINE	GONHER GONHER	OEM OEM	MARCA-MODELO-MOTOR MAKE-MODEL-ENGINE	GONHER GONHER	OEM OEM
HYSTER (continuación)			HYSTER (continuación)			HYSTER (continuación)		
MONTACARGAS			MONTACARGAS			MONTACARGAS		
P150-200B CHALLENGER con motor/GMC V8-350			RC150 con motor/GMC V6-305			S100E con motor/GMC 6-250		
ACEITE, SELLADO	GP-13	258237	ACEITE	G-33	235849	ACEITE	GP-3	127644
			HIDRAULICO	G-238	75669			
			AIRE	GA-37	202951	S100E, S60E con motor/PERKINS		
P150-200B CHALLENGER con motor/PERKINS 6.354			RC150 con motor/PERKINS P6			HIDRAULICO	G-238	75669
COMBUSTIBLE	G-1174	155100	HIDRAULICO	G-238	75669	ACEITE, CARTUCHO	G-801	990325
COMBUSTIBLE	G-296	124217				ACEITE, CARTUCHO	G-870	990325
ACEITE, SELLADO	GP-3600	251755	RC150 con motores/CHRYSLER IND-52, CHRYSLER IND-53			COMBUSTIBLE	G-296	124217
COMBUSTIBLE	G-296-B	124217	HIDRAULICO	G-238	75669	ACEITE, SELLADO	GP-3600	259964
						COMBUSTIBLE	G-296-B	124217
P150-200B CHALLENGER con motor/PERKINS 6.354.4			RC150 con motores/HERCULES JXC, HERCULES JXD, HERCULES JXE			S120XLS SPACESAVER con motor/GMC A GASOLINA		
COMBUSTIBLE	G-296	124217	ACEITE	G-6	233134	ACEITE	GP-3980	1320000
ACEITE, SELLADO	GP-3600	251755				ACEITE	GP-171	1328691
COMBUSTIBLE	G-296-B	124217	RC160 con motor/GMC V6-305			AIRE	GAK-16	305080
			ACEITE	G-33	235849	GASOLINA	GG-5 L	1346283
P150A, P165E con motor/A DIESEL			RC160 con motor/PERKINS P6			GASOLINA	GG-46	1330342
HIDRAULICO	G-238	271415-06	HIDRAULICO	G-238	75669	S120XLS SPACESAVER con motor/GMC LPG		
			RC180 con motor/GMC V6-305			ACEITE	GP-3980	1320000
P150A, P165E con motor/A GASOLINA			ACEITE	G-33	235849	ACEITE	GP-171	1328691
HIDRAULICO	G-238	271415-06				AIRE	GAK-16	305080
P180A con motor/A DIESEL			RC180 con motor/PERKINS P6			S120XLS SPACESAVER con motor/PERKINS DIESEL		
HIDRAULICO	G-238	75669	HIDRAULICO	G-238	75669	ACEITE	GP-1	195852
			S100 con motor/A DIESEL			COMBUSTIBLE, SEPARADOR DE AGUA	GPP-1122	1306331
P180A con motor/A GASOLINA			ACEITE	G-813	133575	TRANSMISION	GP-171	1328691
HIDRAULICO	G-238	75669				AIRE	GAK-16	305080
P40-P50A PIONER con motor/GMC 4-153			S100 con motor/CONTINENTAL F244			S125-150A SPACESAVER con motor/A DIESEL		
HIDRAULICO	G-238	75669	ACEITE	G-6	233134	TRANSMISION	G-33	235849
ACEITE	GP-3	127644				HIDRAULICO	G-238	75669
GASOLINA	GG-16	1313924	S100B SPACESAVER con motor/A DIESEL			ACEITE, CARTUCHO	G-801	990325
			ACEITE	G-6	233134	ACEITE, CARTUCHO	G-870	990325
P40-P50A PIONER con motor/PERKINS 4.154						ACEITE, SELLADO	GP-1	3000046
HIDRAULICO	G-238	75669	ACEITE	G-238	75669	COMBUSTIBLE	G-296	124217
ACEITE, SELLADO	GP-31	245908	ACEITE	G-813	133575	COMBUSTIBLE	G-296-B	3000087
COMBUSTIBLE	G-296	124217	ACEITE, CARTUCHO	GP-9	180283	AIRE	GAK-16	305080
ACEITE, SELLADO	GP-3600	251755	ACEITE	GP-9	180283			
COMBUSTIBLE	G-296-B	124217	COMBUSTIBLE	G-296	124217	S125-150A SPACESAVER con motor/A GAS LPG		
			COMBUSTIBLE	G-296	124217	TRANSMISION	G-33	235849
P60A con motor/A GASOLINA			ACEITE, SELLADO	GP-3600	259025	HIDRAULICO	G-238	75669
HIDRAULICO	G-238	271415-06	COMBUSTIBLE	G-296-B	124217	AIRE	GAK-16	305080
			S100B SPACESAVER con motor/A GASOLINA					
P60-P80A PIONER con motor/CONTINENTAL			TRANSMISION	G-6	233134	S125-150A SPACESAVER con motor/CONTINENTAL F245		
HIDRAULICO	G-238	75669	HIDRAULICO	G-238	75669	TRANSMISION	G-33	235849
			TRANSMISION	GP-9	180283	HIDRAULICO	G-238	75669
P60-P80A PIONER con motor/PERKINS 4.236			ACEITE, DERIVACION (BY PASS)	GP-50	180282	ACEITE, DERIVACION (BY PASS)	GP-50	180282
HIDRAULICO	G-238	75669				AIRE	GAK-16	305080
ACEITE, CARTUCHO	G-813	133575	S100B SPACESAVER con motor/A PETROLEO					
ACEITE, SELLADO	GP-1	3000046	ACEITE	GP-3	127644	S125-150A SPACESAVER con motor/PERKINS 4.236		
COMBUSTIBLE	G-296	124217	ACEITE, DERIVACION (BY PASS)	GP-50	180282	TRANSMISION	G-33	235849
ACEITE, SELLADO	GP-3600	259964	COMBUSTIBLE	G-296	124217	HIDRAULICO	G-238	75669
COMBUSTIBLE	G-296-B	3000087	COMBUSTIBLE	G-296-B	124217	ACEITE, DERIVACION (BY PASS)	GP-50	180282
						AIRE	GAK-16	305080
R30B ELECTRIC, R30BA ELECTRIC con motor/ELECTRICO			S100B SPACESAVER con motor/PERKINS					
HIDRAULICO	GP-66	180595	HIDRAULICO	G-238	75669	S125-150A SPACESAVER con motor/PERKINS 4.236		
			ACEITE, CARTUCHO	G-813	133575	TRANSMISION	G-33	235849
RC100 con motor/GMC V6-305			COMBUSTIBLE	G-296	124217	HIDRAULICO	G-238	75669
HIDRAULICO	G-238	75669	ACEITE, SELLADO	GP-3600	259025	ACEITE	GP-1	3000046
			COMBUSTIBLE	G-296-B	124217	AIRE	GAK-16	305080
RC100 con motores/CHRYSLER IND-52, CHRYSLER IND-53, PERKINS P6								
HIDRAULICO	G-238	75669	S100B SPACESAVER con motores/CONTINENTAL F226, CONTINENTAL F244			S135-155XL SPACESAVER con motor/GMC A GASOLINA		
			ACEITE	G-6	233134	ACEITE	GP-3980	1320000
RC100 con motores/HERCULES JXC, HERCULES JXD, HERCULES JXE						TRANSMISION	GP-171	1328691
TRANSMISION	G-6	233134				AIRE	GAK-16	305080
						GASOLINA	GG-5 L	1346283
						GASOLINA	GG-46	1330342

SERVICIO PESADO

MARCA-MODELO-MOTOR MAKE-MODEL-ENGINE	GONHER GONHER	OEM OEM	MARCA-MODELO-MOTOR MAKE-MODEL-ENGINE	GONHER GONHER	OEM OEM	MARCA-MODELO-MOTOR MAKE-MODEL-ENGINE	GONHER GONHER	OEM OEM
HYSTER (continuación)			HYSTER (continuación)			HYSTER (continuación)		
MONTACARGAS			MONTACARGAS			MONTACARGAS		
S135-155XL SPACESAVER con motor/GMC LPG			HIDRAULICO	G-238	75669	AIRE, SIN ASPAS	GA-33	326483
ACEITE	GP-3980	1320000	ACEITE	GP-9	180283	GASOLINA	GG-5 L	1304950
TRANSMISION	GP-171	1328691	ACEITE, DERIVACION (BY PASS)	GP-50	180282			
AIRE	GAK-16	305080				S35XL SPACESAVER con motor/ISUZU C240 DIESEL		
			S30B con motor/A DIESEL			TRANSMISION	GP-9	1328692
S135-155XL SPACESAVER con motor/PERKINS DIESEL			ACEITE	G-6	233134	ACEITE	GP-3985	360974
ACEITE	GP-1	195852				AIRE, SIN ASPAS	GA-33	326483
COMBUSTIBLE, SEPARADOR DE AGUA	GPP-1122	1306331	S30B con motor/CONTINENTAL F162					
TRANSMISION	GP-171	1328691	TRANSMISION	G-6	233134	S35XL SPACESAVER con motor/MAZDA M4-121LPG		
AIRE	GAK-16	305080	HIDRAULICO	G-238	75669	TRANSMISION	GP-9	1328692
			ACEITE, DERIVACION (BY PASS)	GP-50	180282	ACEITE	GP-91	324692
S20-25AR SPACESAVER con motores/A GAS LPG, A GASOLINA						AIRE, SIN ASPAS	GA-33	326483
HIDRAULICO	GP-66	840666	S30B con motor/CONTINENTAL F163					
			HIDRAULICO	G-238	75669	S40-50F SPACESAVER con motor/A GAS LPG		
S20A SPACESAVER con motores/A GAS LPG, A GASOLINA						DIRECCION	GP-1	297865
ACEITE	GP-9	180283	S30C SPACESAVER con motor/A PETROLEO					
			ACEITE, DERIVACION (BY PASS)	GP-50	180282	S40-50F SPACESAVER con motor/A GASOLINA		
S25-30XM SPACESAVER con motor/MAZDA M4-2.0G						DIRECCION	GP-1	297865
ACEITE	GP-9	180283	S30C SPACESAVER con motor/PERKINS 3.152			ACEITE	GP-9	127644
AIRE, SIN ASPAS	GA-33	1369809	TRANSMISION	G-6	233134	GASOLINA	GG-16	1313924
GASOLINA	GG-5 L	1304950	HIDRAULICO	G-238	75669			
			ACEITE, CARTUCHO	G-813	133575	S40-50XM SPACESAVER con motor/GMC 3.0L A GASOLINA		
S25-30XM SPACESAVER con motor/MAZDA M4-2.0LPG PROPANO			COMBUSTIBLE	G-296	124217	ACEITE	GP-9	127644
ACEITE	GP-9	2021461	ACEITE, SELLADO	GP-3600	259025			
			COMBUSTIBLE	G-296-B	124217	S40-50XM SPACESAVER con motor/GMC 3.0L LPG		
S25A SPACESAVER con motor/A GAS LPG			TRANSMISION	GP-81	180283	ACEITE	GP-9	127644
ACEITE	GP-9	180283						
S25A SPACESAVER con motor/A GASOLINA			S30C SPACESAVER con motores/CONTINENTAL F163 A GASOLINA, CONTINENTAL F163 LPG			S40-50XM SPACESAVER con motor/MAZDA FE 2.0L A GASOLINA		
ACEITE, DERIVACION (BY PASS)	GP-3	60518	TRANSMISION	G-6	233134	ACEITE	GP-91	324692
TRANSMISION	GP-9	180283	HIDRAULICO	G-238	75669	AIRE	GAK-16	305080
ACEITE, DERIVACION (BY PASS)	GP-50	180282	TRANSMISION	GP-9	180283	GASOLINA	GG-5 L	1304950
			ACEITE, DERIVACION (BY PASS)	GP-50	180282			
S25XL SPACESAVER con motor/ISUZU C240 DIESEL						S40-50XM SPACESAVER con motor/MAZDA FE 2.0L LPG		
TRANSMISION	GP-9	1328692	S30E CHALLENGER con motor/A DIESEL			ACEITE	GP-91	324692
ACEITE	GP-3985	360974	DIRECCION	GP-1	297865			
AIRE, SIN ASPAS	GA-33	326483	ACEITE	GP-31	3000870	S40B con motor/A DIESEL		
			COMBUSTIBLE	G-296	124217	TRANSMISION	G-6	233134
S25XL SPACESAVER con motor/MAZDA M4-121G			COMBUSTIBLE	G-296-B	3000087	HIDRAULICO	G-238	75669
TRANSMISION	GP-9	1328692				ACEITE, CARTUCHO	G-813	133575
ACEITE	GP-91	324692	S30E CHALLENGER con motor/CHEVROLET 4-153					
AIRE, SIN ASPAS	GA-33	326483	DIRECCION	GP-1	297865	S40B con motor/A GASOLINA		
GASOLINA	GG-5 L	1304950				TRANSMISION	G-6	233134
			S30ES con motor/PERKINS					
S25XL SPACESAVER con motor/MAZDA M4-121LPG			ACEITE	G-238	75669	S40C SPACESAVER con motor/CONTINENTAL F163		
ACEITE	GP-9	1328692	COMBUSTIBLE	G-296	124217	TRANSMISION	G-6	233134
ACEITE	GP-91	324692	ACEITE, SELLADO	GP-3600	251755	HIDRAULICO	G-238	75669
AIRE, SIN ASPAS	GA-33	326483	COMBUSTIBLE	G-296-B	124217	TRANSMISION	GP-9	180283
						ACEITE, DERIVACION (BY PASS)	GP-50	180282
S30 con motor/CONTINENTAL F162			S30XL con motor/MAZDA					
TRANSMISION	G-6	233134	ACEITE	GP-462	324692	S40C SPACESAVER con motor/PERKINS 3.152		
HIDRAULICO	G-238	75669				TRANSMISION	G-6	233134
ACEITE, DERIVACION (BY PASS)	GP-50	180282	S30XL SPACESAVER con motor/ISUZU C240 DIESEL			HIDRAULICO	G-238	75669
			TRANSMISION	GP-9	1328692	ACEITE, CARTUCHO	G-813	133575
S30-35XM SPACESAVER con motor/MAZDA M4-2.0G			ACEITE	GP-3985	360974	TRANSMISION	GP-9	180283
TRANSMISION	GP-9	2021461	AIRE, SIN ASPAS	GA-33	326483	COMBUSTIBLE	G-296	124217
AIRE, SIN ASPAS	GA-33	1369809				ACEITE, SELLADO	GP-3600	259025
GASOLINA	GG-5 L	1304950	S30XL SPACESAVER con motor/MAZDA M4-121LPG			COMBUSTIBLE	G-296-B	124217
			TRANSMISION	GP-9	1328692			
S30-35XM SPACESAVER con motor/MAZDA M4-2.0LPG PROPANO			ACEITE	GP-91	324692	S40CPD con motor/PERKINS DIESEL		
TRANSMISION	GP-9	2021461	AIRE, SIN ASPAS	GA-33	326483	TRANSMISION	G-6	233134
						HIDRAULICO	G-238	75669
S30A SPACESAVER con motores/A GAS LPG, A GASOLINA			S30XL SPACESAVER, S35XL SPACESAVER con motor/MAZDA M4-121G			ACEITE, CARTUCHO	G-813	133575
TRANSMISION	G-6	233134	TRANSMISION	GP-9	1328692	COMBUSTIBLE	G-11816	985220
			ACEITE	GP-91	324692			

MARCA-MODELO-MOTOR MAKE-MODEL-ENGINE	GONHER GONHER	OEM OEM	MARCA-MODELO-MOTOR MAKE-MODEL-ENGINE	GONHER GONHER	OEM OEM	MARCA-MODELO-MOTOR MAKE-MODEL-ENGINE	GONHER GONHER	OEM OEM
HYSTER (continuación)			HYSTER (continuación)			HYSTER (continuación)		
MONTACARGAS			MONTACARGAS			MONTACARGAS		
S40E SPACESAVER con motor/A DIESEL			S50B con motor/CONTINENTAL F162			AIRE	GAK-16	305080
DIRECCION	GP-1	297865	TRANSMISION	G-6	233134	GASOLINA	GG-5 L	1304950
ACEITE	GP-31	3000870	HIDRAULICO	G-238	75669	S55-60XM SPACESAVER con motor/MAZDA FE 2.0L LPG		
COMBUSTIBLE	G-296	124217	ACEITE, DERIVACION (BY PASS)	GP-50	180282	ACEITE	GP-91	324692
COMBUSTIBLE	G-296-B	3000087				S60 con motor/A DIESEL		
S40E SPACESAVER con motor/CHEVROLET 4-153			S50B con motor/CONTINENTAL F163			HIDRAULICO	G-238	271415-06
DIRECCION	GP-1	297865	HIDRAULICO	G-238	75669	S60 con motor/A GASOLINA		
S40ES con motor/A PETROLEO			S50C con motor/A DIESEL			HIDRAULICO	G-238	271415-06
ACEITE	GP-3	127644	TRANSMISION	G-6	233134	S60 con motor/CONTINENTAL F226		
ACEITE, DERIVACION (BY PASS)	GP-50	180282	HIDRAULICO	G-238	75669	TRANSMISION	G-6	233134
COMBUSTIBLE	G-296	124217	TRANSMISION	GP-9	180283	S60-120E SPACESAVER con motor/A DIESEL		
COMBUSTIBLE	G-296-B	124217	ACEITE, DERIVACION (BY PASS)	GP-50	180282	ACEITE	GP-1	3000046
S40XL SPACESAVER con motor/GMC 4-153 LPG			S50C con motor/PERKINS 3.152			COMBUSTIBLE, SECUNDARIO	G-296	3000087
ACEITE	GP-3	127644	ACEITE	G-6	233134	COMBUSTIBLE, SECUNDARIO	G-296-B	3000087
TRANSMISION	GP-9	1328692	ACEITE	G-238	75669	S60-120E SPACESAVER con motor/A GASOLINA		
AIRE, SIN ASPAS	GA-33	326483	ACEITE, CARTUCHO	G-813	133575	ACEITE	GP-3	127644
S40XL SPACESAVER con motor/SUZU C240 DIESEL			TRANSMISION	GP-9	180283	S60-65XM SPACESAVER con motor/GMC 3.0 L A GASOLINA		
TRANSMISION	GP-9	1328692	COMBUSTIBLE	G-296	124217	ACEITE	GP-3	127644
ACEITE	GP-3985	360974	ACEITE, SELLADO	GP-3600	259025	S60-65XM SPACESAVER con motor/GMC 3.0 L LPG		
AIRE, SIN ASPAS	GA-33	326483	COMBUSTIBLE	G-296-B	124217	ACEITE	GP-3	127644
S40XL SPACESAVER con motor/MAZDA M4-121G			S50C con motores/CONTINENTAL F163 A GASOLINA, CONTINENTAL F163 LPG			S60-65XM SPACESAVER con motor/MAZDA FE 2.0L A GASOLINA		
TRANSMISION	GP-9	1328692	HIDRAULICO	G-238	75669	ACEITE	GP-91	324692
ACEITE	GP-91	324692	S50E SPACESAVER con motor/A DIESEL			AIRE	GAK-16	305080
AIRE, SIN ASPAS	GA-33	326483	DIRECCION	GP-1	297865	GASOLINA	GG-5 L	1304950
GASOLINA	GG-5 L	1304950	ACEITE	GP-31	3000870	S60-65XM SPACESAVER con motor/MAZDA LPG FE 2.0 L		
S40XL SPACESAVER con motor/MAZDA M4-121LPG			COMBUSTIBLE	G-296	124217	ACEITE	GP-91	324692
TRANSMISION	GP-9	1328692	COMBUSTIBLE	G-296-B	3000087	AIRE	GAK-16	305080
ACEITE	GP-91	324692	S50E SPACESAVER con motor/CHEVROLET 4-153			GASOLINA	GG-5 L	1304950
AIRE, SIN ASPAS	GA-33	326483	DIRECCION	GP-1	297865	S60B SPACESAVER con motor/A DIESEL		
S40XL SPACESAVER, S50XL SPACESAVER con motor/GMC 4-153 A GASOLINA			S50XL SPACESAVER con motor/GMC LPG 4-153			ACEITE, CARTUCHO	G-6	233134
ACEITE	GP-3	127644	ACEITE	GP-3	127644	HIDRAULICO	G-238	75669
TRANSMISION	GP-9	1328692	TRANSMISION	GP-9	1328692	ACEITE, CARTUCHO	G-813	133575
AIRE, SIN ASPAS	GA-33	326483	AIRE, SIN ASPAS	GA-33	326483	TRANSMISION	GP-9	180283
GASOLINA	GG-5 L	1304950	S50XL SPACESAVER con motor/SUZU C240 DIESEL			COMBUSTIBLE	G-296	124217
GASOLINA	GG-16	1313924	TRANSMISION	GP-9	1328692	ACEITE, SELLADO	GP-3600	259025
S40XMS SPACESAVER con motor/MAZDA M4-2.0G			ACEITE, SELLADO	GP-3985	360974	COMBUSTIBLE	G-296-B	124217
TRANSMISION	GP-9	2021461	AIRE, SIN ASPAS	GA-33	326483	S60B SPACESAVER con motor/A GASOLINA		
AIRE, SIN ASPAS	GA-33	1369809	S50E SPACESAVER con motor/MAZDA M4-121G			TRANSMISION	G-6	233134
GASOLINA	GG-5 L	1304950	TRANSMISION	GP-9	1328692	HIDRAULICO	G-238	75669
S40XMS SPACESAVER con motor/MAZDA M4-2.0LPG PROPANO			ACEITE	GP-91	324692	TRANSMISION	GP-9	180283
TRANSMISION	GP-9	2021461	AIRE, SIN ASPAS	GA-33	326483	ACEITE, DERIVACION (BY PASS)	GP-50	180282
S50 con motor/CONTINENTAL F162			GASOLINA	GG-5 L	1304950	S60B SPACESAVER con motor/A PETROLEO		
TRANSMISION	G-6	233134	S50XL SPACESAVER con motor/MAZDA M4-121LPG			ACEITE	GP-3	180282
HIDRAULICO	G-238	75669	TRANSMISION	GP-9	1328692	ACEITE, DERIVACION (BY PASS)	GP-50	127644
ACEITE, DERIVACION (BY PASS)	GP-50	180282	ACEITE	GP-91	324692	COMBUSTIBLE	G-296	124217
S50B con motor/A DIESEL			AIRE, SIN ASPAS	GA-33	326483	COMBUSTIBLE	G-296-B	124217
TRANSMISION	G-6	233134	S55-60XM SPACESAVER con motor/GMC 3.0L A GASOLINA			S60B SPACESAVER con motores/CONTINENTAL F226, CONTINENTAL F244		
HIDRAULICO	G-238	75669	ACEITE	GP-3	127644	TRANSMISION	G-6	233134
ACEITE, CARTUCHO	G-813	133575	S55-60XM SPACESAVER con motor/GMC 3.0L LPG			S60C con motor/PERKINS		
S50B con motor/A GASOLINA			ACEITE	GP-3	127644	HIDRAULICO	G-238	75669
TRANSMISION	G-6	233134	S55-60XM SPACESAVER con motor/MAZDA FE 2.0L A GASOLINA			ACEITE, CARTUCHO	G-813	133575
			ACEITE	GP-91	324692			

SERVICIO PESADO

MARCA-MODELO-MOTOR MAKE-MODEL-ENGINE	GONHER GONHER	OEM OEM	MARCA-MODELO-MOTOR MAKE-MODEL-ENGINE	GONHER GONHER	OEM OEM	MARCA-MODELO-MOTOR MAKE-MODEL-ENGINE	GONHER GONHER	OEM OEM
HYSTER (continuación)			HYSTER (continuación)			HYSTER (continuación)		
MONTACARGAS			MONTACARGAS			MONTACARGAS		
COMBUSTIBLE	G-296	124217	S70-120XL SPACESAVER con motor/GMC A GASOLINA			S80B SPACESAVER con motor/A PETROLEO		
ACEITE, SELLADO	GP-3600	259025	ACEITE	GP-3980	1320000	ACEITE	GP-3	127644
COMBUSTIBLE	G-296-B	124217	ACEITE	GP-171	1328691	ACEITE, DERIVACION (BY PASS)	GP-50	180282
			AIRE	GAK-16	305080	COMBUSTIBLE	G-296	124217
S60E con motor/GMC 6-250			GASOLINA	GG-5 L	1346283	COMBUSTIBLE	G-296-B	124217
ACEITE	GP-3	127644	GASOLINA	GG-46	1330342			
						S80B SPACESAVER con motores/CONTINENTAL F226, CONTINENTAL F244		
S60ES SPACESAVER con motor/A DIESEL			S70-120XL SPACESAVER con motor/GMC LPG			TRANSMISION	G-6	233134
ACEITE	GP-1	297865	ACEITE	GP-3980	1320000			
ACEITE	GP-31	3000870	TRANSMISION	GP-171	1328691	S80E con motor/GMC 6-250		
COMBUSTIBLE	G-296	3000087	AIRE	GAK-16	305080	ACEITE	GP-3	127644
COMBUSTIBLE	G-296-B	3000087						
			S70-120XL SPACESAVER con motor/PERKINS DIESEL			SC150 con motor/HERCULES JXD		
S60ES SPACESAVER con motor/A PETROLEO			ACEITE	GP-1	195852	ACEITE, CARTUCHO	G-33	235849
ACEITE	GP-3	127644	COMBUSTIBLE, SECUNDARIO	GPP-1122	1306331			
ACEITE, DERIVACION (BY PASS)	GP-50	180282	TRANSMISION	GP-171	1328691	SC150 con motor/PERKINS P6		
COMBUSTIBLE	G-296	124217	AIRE	GAK-16	305080	HIDRAULICO	G-238	75669
COMBUSTIBLE	G-296-B	124217						
			S70B SPACESAVER con motor/A DIESEL			SC150, SC160 con motor/CATERPILLAR D320		
S60ES SPACESAVER con motor/CHEVROLET 4-153			HIDRAULICO	G-238	75669	TRANSMISION	G-6	233134
DIRECCION	GP-1	297865	ACEITE, CARTUCHO	G-813	133575			
			TRANSMISION	GP-9	180283	SC160 con motor/HERCULES JXD		
S60ES SPACESAVER con motor/PERKINS			COMBUSTIBLE	G-296	124217	ACEITE, CARTUCHO	G-33	235849
TRANSMISION	G-238	75669	ACEITE, SELLADO	GP-3600	259025			
COMBUSTIBLE	G-296	124217	COMBUSTIBLE	G-296-B	124217	SC160 con motor/PERKINS P6		
ACEITE, SELLADO	GP-3600	251755				HIDRAULICO	G-238	75669
COMBUSTIBLE	G-296-B	124217	S70B SPACESAVER con motor/A GASOLINA					
			TRANSMISION	G-6	233134	SC180 con motor/CATERPILLAR D320		
S60XL SPACESAVER con motor/GMC 4-153 A GASOLINA			HIDRAULICO	G-238	75669	TRANSMISION	G-6	233134
ACEITE	GP-3	127644	TRANSMISION	GP-9	180283			
TRANSMISION	GP-9	1328692	ACEITE, DERIVACION (BY PASS)	GP-50	180282	SC180 con motor/GMC V6-305		
AIRE, SIN ASPAS	GA-33	326483				HIDRAULICO	G-238	75669
GASOLINA	GG-5 L	1304950	S70B SPACESAVER con motor/A PETROLEO					
GASOLINA	GG-16	1313924	ACEITE	GP-3	127644	SC180 con motor/HERCULES JXD		
			ACEITE, DERIVACION (BY PASS)	GP-50	180282	ACEITE	G-6	233134
S60XL SPACESAVER con motor/GMC LPG 4-153			COMBUSTIBLE	G-296	124217	ACEITE, CARTUCHO	G-33	235849
ACEITE	GP-3	127644	COMBUSTIBLE	G-296-B	124217	HIDRAULICO	G-238	75669
TRANSMISION	GP-9	1328692				AIRE	GA-37	202951
AIRE, SIN ASPAS	GA-33	326483	S70E con motor/GMC 6-250					
			ACEITE	GP-3	127644	SC180 con motores/CHRYSLER IND-52, CHRYSLER IND-53		
S60XL SPACESAVER con motor/ISUZU C240 DIESEL						HIDRAULICO	G-238	75669
TRANSMISION	GP-9	1328692	S80 con motor/A DIESEL					
ACEITE	GP-3985	360974	HIDRAULICO	G-238	271415-06	SC180 con motores/HERCULES JXC, HERCULES JXE		
AIRE, SIN ASPAS	GA-33	326483				ACEITE	G-6	233134
			S80 con motor/A GASOLINA					
S60XL SPACESAVER con motor/MAZDA M4-121G			HIDRAULICO	G-238	271415-06	SC180, SC200 con motor/PERKINS P6		
TRANSMISION	GP-9	1328692				HIDRAULICO	G-238	75669
ACEITE	GP-91	324692	S80 con motor/CONTINENTAL F226					
AIRE, SIN ASPAS	GA-33	326483	TRANSMISION	G-6	233134	SC200 con motor/HERCULES JXD		
GASOLINA	GG-5 L	1304950				ACEITE, CARTUCHO	G-33	235849
			S80B SPACESAVER con motor/A DIESEL			AIRE, SIN ASPAS	GA-20	156954
S60XL SPACESAVER con motor/MAZDA M4-121LPG			TRANSMISION	G-6	233134	AIRE	GA-37	202951
TRANSMISION	GP-9	1328692	HIDRAULICO	G-238	75669	AIRE	GAK-20	156954
ACEITE	GP-91	324692	ACEITE, CARTUCHO	G-813	133575			
AIRE, SIN ASPAS	GA-33	326483	TRANSMISION	GP-9	180283	SC200, TC150, TC160, TC165, TC180 con motor/CATERPILLAR D320		
			COMBUSTIBLE	G-296	124217	TRANSMISION	G-6	233134
S70 con motor/A DIESEL			ACEITE, SELLADO	GP-3600	259025			
HIDRAULICO	G-238	271415-06	COMBUSTIBLE	G-296-B	124217	SX35XL con motor/MAZDA M4-121G		
						TRANSMISION	GP-9	309112
S70 con motor/A GASOLINA			S80B SPACESAVER con motor/A GASOLINA			ACEITE	GP-91	324692
HIDRAULICO	G-238	271415-06	ACEITE, CARTUCHO	G-6	233134	AIRE, SIN ASPAS	GA-33	326483
			HIDRAULICO	G-238	75669			
S70, S70B SPACESAVER con motor/CONTINENTAL F226			TRANSMISION	GP-9	180283	TC150 con motor/HERCULES JXD		
TRANSMISION	G-6	233134	ACEITE, DERIVACION (BY PASS)	GP-50	180282	ACEITE, CARTUCHO	G-33	235849

MARCA-MODELO-MOTOR MAKE-MODEL-ENGINE	GONHER GONHER	OEM OEM	MARCA-MODELO-MOTOR MAKE-MODEL-ENGINE	GONHER GONHER	OEM OEM	MARCA-MODELO-MOTOR MAKE-MODEL-ENGINE	GONHER GONHER	OEM OEM
HYSTER (continuación)			HYUNDAI			HYUNDAI (continuación)		
MONTACARGAS			CARGADORAS			EXCAVADORAS		
TC150 con motor/PERKINS P6 HIDRAULICO	G-238	75669	HL730-3 con motor/DEUTZ BF4M1012 ACEITE	GP-54	1162921	ACEITE	GP-178	3914395
TC160 con motor/HERCULES JXD ACEITE, CARTUCHO	G-33	235849	HL740-3, HL740TM-3, HL750 con motor/CUMMINS 6BT5.9 COMBUSTIBLE, SECUNDARIO	GP-1122	3903640	250NLC-3 con motor/CUMMINS 6B5.9 COMBUSTIBLE, SECUNDARIO	GP-1122	3903640
TC160 con motor/PERKINS P6 HIDRAULICO	G-238	75669	COMBUSTIBLE, SEPARADOR DE AGUA	GPP-1122	3286503	COMBUSTIBLE, SEPARADOR DE AGUA	GPP-1122	3286503
TC165 con motor/HERCULES JXD ACEITE, CARTUCHO	G-33	235849	COMBUSTIBLE, PRIMARIO	GPP-18	3925274	COMBUSTIBLE, PRIMARIO	GPP-18	3925274
TC165 con motor/PERKINS P6 HIDRAULICO	G-238	75669	ACEITE	GP-178	3914395	ACEITE	GP-178	3914395
TC180 con motor/HERCULES JXD ACEITE, CARTUCHO	G-33	235849	HL760, HL760-3 con motor/CUMMINS GCT8.3 COMBUSTIBLE, SECUNDARIO	GP-1122	3903640	320LC-3, 320NLC-3, ROBEX 320-3 con motor/CUMMINS 6CTA8.3 COMBUSTIBLE, SECUNDARIO	GP-1122	3903640
TC180 con motor/PERKINS P6 HIDRAULICO	G-238	75669	COMBUSTIBLE, SEPARADOR DE AGUA	GPP-1122	3286503	COMBUSTIBLE, SEPARADOR DE AGUA	GPP-1122	3286503
TC200 con motor/CATERPILLAR D320 TRANSMISION	G-6	233134	ACEITE	GP-43	3313281	ACEITE	GP-43	3313281
TC200 con motor/GMC V6-305 HIDRAULICO	G-238	75669	ACEITE, DERIVACION (BY PASS)	GP-3000	3825970	ACEITE	GP-3000	3825970
TC200 con motor/HERCULES JXD ACEITE	G-6	233134	COMBUSTIBLE, PRIMARIO	GPP-18	3925274	COMBUSTIBLE, PRIMARIO	GPP-18	3925274
ACEITE, CARTUCHO	G-33	235849	HL770 con motor/CUMMINS LTA10 COMBUSTIBLE	GP-1101	154711	360-3, 360LC-3, 450-3, 450LC-3 con motor/CUMMINS LTA10 COMBUSTIBLE	GP-1101	154711
AIRE, SIN ASPAS	GA-20	156954	ACEITE	GP-53	3313287	ACEITE	GP-53	3313287
AIRE	GA-37	202951	ACEITE, DERIVACION (BY PASS)	GP-57	3304232	ACEITE, DERIVACION (BY PASS)	GP-57	3304232
AIRE	GAK-20	156954	COMBUSTIBLE, SEPARADOR DE AGUA	GPP-11	3600980	COMBUSTIBLE, SEPARADOR DE AGUA	GPP-11	3600980
TC225 con motor/A DIESEL AIRE, SIN ASPAS	GA-20	156954	HL770 con motor/CUMMINS M11 COMBUSTIBLE, SEPARADOR DE AGUA	GPP-11	3600980	360LC-3, ROBEX 450-3, 450LC-3, ROBEX 360-3 con motor/CUMMINS M11 ACEITE	GP-3000	3825970
TC40 con motor/CONTINENTAL F162 ACEITE	G-6	233134	HSL610 SKID STEER con motor/YANMAR 4TNE88 ACEITE	GP-6811	2630035056	R130L-3, R130W-3 con motor/CUMMINS 4BTA3.9 COMBUSTIBLE, SECUNDARIO	GP-1122	3903640
UE40, YE40 con motor/A DIESEL ACEITE	G-6	233134	HSL810 SKID STEER con motor/YANMAR 4TNE98 ACEITE	GP-6811	2630035056	COMBUSTIBLE, SEPARADOR DE AGUA	GPP-1122	3286503
VT75 con motor/A GASOLINA HIDRAULICO	G-238	75669	HYUNDAI			COMBUSTIBLE, PRIMARIO	GPP-18	3925274
YC40 con motor/A GASOLINA ACEITE	G-6	233134	EXCAVADORAS			ACEITE	GP-390	3890709
			130LCD-3, 130LCM-3 con motor/CUMMINS 4BTA3.9 COMBUSTIBLE, SECUNDARIO	GP-1122	3903640	R140LC-7 con motor/CUMMINS 4B3.9 ACEITE	GP-390	3890709
			COMBUSTIBLE, SEPARADOR DE AGUA	GPP-1122	3286503	R180LCD-3 con motor/CUMMINS 6B5.9 COMBUSTIBLE, SECUNDARIO	GP-1122	3903640
			COMBUSTIBLE, PRIMARIO	GPP-18	3925274	COMBUSTIBLE, SEPARADOR DE AGUA	GPP-1122	3286503
			ACEITE	GP-390	3890709	COMBUSTIBLE, PRIMARIO	GPP-18	3925274
			160LCD-3, 160NLC-3, ROBEX 160LC-3 con motor/CUMMINS 4B3.9 COMBUSTIBLE, SECUNDARIO	GP-1122	3903640	ACEITE	GP-390	3890709
			COMBUSTIBLE, PRIMARIO	GPP-18	3925274	R210LC-7, R200, R200LCR, R200LCM, R200W-3 con motor/CUMMINS 6BT5.9 COMBUSTIBLE, SECUNDARIO	GP-1122	3903640
			ACEITE	GP-390	3890709	COMBUSTIBLE, SEPARADOR DE AGUA	GPP-1122	3286503
			180NLC-3 con motor/CUMMINS 6B5.9 COMBUSTIBLE, SECUNDARIO	GP-1122	3903640	COMBUSTIBLE, PRIMARIO	GPP-18	3925274
			COMBUSTIBLE, SEPARADOR DE AGUA	GPP-1122	3286503	ACEITE	GP-178	3914395
			COMBUSTIBLE, PRIMARIO	GPP-18	3925274	R290LC-3LR, R290LC-7, 290NLC-3, R290LC-3, 290LC-3, ROBEX 290-3 con motor/CUMMINS 6CT8.3 COMBUSTIBLE, SECUNDARIO	GP-1122	3903640
			ACEITE	GP-390	3890709	COMBUSTIBLE, SEPARADOR DE AGUA	GPP-1122	3286503
			200NLC-3, 210LC-3 con motor/CUMMINS 6BT5.9 COMBUSTIBLE, SECUNDARIO	GP-1122	3903640	ACEITE	GP-43	3313281
			COMBUSTIBLE, SEPARADOR DE AGUA	GPP-1122	3286503	ACEITE	GP-3000	3825970
			COMBUSTIBLE, PRIMARIO	GPP-18	3925274	COMBUSTIBLE, PRIMARIO	GPP-18	3925274
			ACEITE	GP-390	3890709	AIRE, SIN ASPAS	GA-33	15401-11080
			210-7, 210LC-7 con motor/CUMMINS B5.9 COMBUSTIBLE, SECUNDARIO	GP-1122	3903640	R320LC-3 con motor/CUMMINS LT10 COMBUSTIBLE	GP-1101	154711
			COMBUSTIBLE, PRIMARIO	GPP-18	3925274	ACEITE	GP-53	3313287
			ACEITE	GP-178	3914395	ACEITE, DERIVACION (BY PASS)	GP-57	3304232

SERVICIO PESADO

MARCA-MODELO-MOTOR	GONHER	OEM
MAKE-MODEL-ENGINE	GONHER	OEM

HYUNDAI (continuación)

EXCAVADORAS

COMBUSTIBLE, SEPARADOR DE AGUA	GPP-11	3600980
AIRE, SIN ASPAS	GA-33	15401-11080

R360LC-3, R450LC-3 con motor/CUMMINS LTA10		
COMBUSTIBLE	GP-1101	154711
ACEITE	GP-53	3313287
ACEITE, DERIVACION (BY PASS)	GP-57	3304232
COMBUSTIBLE, SEPARADOR DE AGUA	GPP-11	3600980

R360LC-7 con motor/CUMMINS QSC8.3		
ACEITE	GP-3001	3401544

R450LC-7 con motor/CUMMINS QSM11		
ACEITE	GP-9001	3406809

ROBEX 130LC-3 con motor/CUMMINS 4BTA3.9		
COMBUSTIBLE, SECUNDARIO	GP-1122	3903640
COMBUSTIBLE, SEPARADOR DE AGUA	GPP-1122	3286503
COMBUSTIBLE, PRIMARIO	GPP-18	3925274
ACEITE	GP-390	3890709

ROBEX 170W-3 con motor/CUMMINS 6BT5.9		
COMBUSTIBLE, SECUNDARIO	GP-1122	3903640
COMBUSTIBLE, SEPARADOR DE AGUA	GPP-1122	3286503
COMBUSTIBLE, PRIMARIO	GPP-18	3925274
ACEITE	GP-390	3890709

ROBEX 180LC-3 con motor/CUMMINS 6B5.9		
COMBUSTIBLE, SECUNDARIO	GP-1122	3903640
COMBUSTIBLE, SEPARADOR DE AGUA	GPP-1122	3286503
COMBUSTIBLE, PRIMARIO	GPP-18	3925274
ACEITE	GP-390	3890709

ROBEX 200LC, ROBEX 210-3 con motor/CUMMINS 6BT5.9		
COMBUSTIBLE, SECUNDARIO	GP-1122	3903640
COMBUSTIBLE, SEPARADOR DE AGUA	GPP-1122	3286503
COMBUSTIBLE, PRIMARIO	GPP-18	3925274
ACEITE	GP-178	3914395

ROBEX 250LC-3 con motor/CUMMINS 6B5.9		
COMBUSTIBLE, SECUNDARIO	GP-1122	3903640
COMBUSTIBLE, SEPARADOR DE AGUA	GPP-1122	3286503
COMBUSTIBLE, PRIMARIO	GPP-18	3925274
ACEITE	GP-178	3914395

ROBEX 55-3, ROBEX 55W-3 con motor/YANMAR 4TNE94		
ACEITE	GP-6811	2630035056

ROBEX 95W-3 con motor/PERKINS 1004.42		
ACEITE	GP-31	2654407

HYUNDAI

MONTACARGAS

HDF35, HDF45A con motor/PERKINS 1004.4		
ACEITE	GP-31	2654407

HLF20C, HLF25C, HLF30C con motor/CONTINENTAL TM27		
ACEITE	GP-1	F600L3750

MARCA-MODELO-MOTOR	GONHER	OEM
MAKE-MODEL-ENGINE	GONHER	OEM

HYUNDAI

NIVELADORAS

H70, H80 LPG con motor/CUMMINS B3.9		
ACEITE	GP-390	3890709

I.H.C. HARVESTER

CAMIONES, TRACTOCAMIONES Y AUTOBUSES

1050B CARGOSTAR SERIES con motor/IHC DV550B		
ACEITE	GP-10	39080R2
COMBUSTIBLE, PRIMARIO	GP-1108	625626C1
COMBUSTIBLE, SECUNDARIO	GP-78	672603C1

1050B CARGOSTAR SERIES con motores/CATERPILLAR 1145, CATERPILLAR 1150		
ACEITE	GP-36	3136046R93

1400 SERIES, 1600 SERIES con motor/IHC 6.9L		
COMBUSTIBLE, PRIMARIO	GPP-14	674293C1
ACEITE	GP-3766	1804442C1
COMBUSTIBLE, SECUNDARIO	GP-155	1804459C1

1452FC, 1652FC, 1652SC, 1652UPS con motor/IHC 7.3L		
DIRECCION	G-169	279294C92
GASOLINA	G-293	548348-C1
COMBUSTIBLE, SEPARADOR DE AGUA	GPP-547	1677004C91
ACEITE	GP-3766	1804442C1
COMBUSTIBLE	GP-155	1804459C1
AIRE	GA-422	588213C1

1610 CARGOSTAR SERIES con motores/IHC V345, IHC V392		
ACEITE	GP-10	39080R2
AIRE	GA-3501	446661C2
GASOLINA	GG-20	531546R91
1624S SERIES con motor/IHC D170		
ACEITE	GP-10	39080R2
COMBUSTIBLE, SECUNDARIO	GP-1107	702143C1
COMBUSTIBLE, PRIMARIO	GP-1108	625626C1

1624S SERIES con motor/IHC MV404		
ACEITE	GP-10	39080R2
AIRE	GA-3501	446661C2
GASOLINA	GG-5 L	1701232C91

1624S SERIES con motor/IHC V345		
ACEITE	GP-10	39080R2
AIRE	GA-3501	446661C2
GASOLINA	GG-20	531546R91

1650 LOADSTAR SERIES con motor/IHC D150		
ACEITE	GP-10	39080R2
COMBUSTIBLE, SECUNDARIO	GP-1107	702143C1
COMBUSTIBLE, PRIMARIO	GP-1108	625626C1

1652 con motor/IHC T444E		
COMBUSTIBLE, SEPARADOR DE AGUA	G-862	1825864C92
AGUA	GP-2071W	1822313C1
ACEITE	GP-562	1814562C1
AIRE, HASTA 1999	GA-209	476741C1
AIRE, 2000-01	GA-197R	1691027C1

1652FC, 1652SC, 1652UPS con motor/IHC DT360		
DIRECCION	G-169	279294C92
COMBUSTIBLE	GPP-14	674293C1
GASOLINA	G-293	548348-C1

MARCA-MODELO-MOTOR	GONHER	OEM
MAKE-MODEL-ENGINE	GONHER	OEM

I.H.C. HARVESTER (continuación)

CAMIONES, TRACTOCAMIONES Y AUTOBUSES

COMBUSTIBLE, SEPARADOR DE AGUA	GPP-547	1677004C91
ACEITE	GP-88	1811953C1
COMBUSTIBLE	GP-78	1809789C1
AIRE	GA-209	476741C1
AIRE	GA-197R	1691027C1

1652FC, 1652SC, 1652UPS con motor/IHC T444E		
COMBUSTIBLE, SEPARADOR DE AGUA	G-178	1822631C91
AGUA	GP-2071W	1822627C1
ACEITE	GP-562	1814562C1
AIRE	GA-422	588213C1

1654S SERIES con motor/IHC 420 (6.9L) DIESEL		
COMBUSTIBLE, PRIMARIO	GPP-14	674293C1
ACEITE	GP-3766	1804442C1
COMBUSTIBLE, SECUNDARIO	GP-155	1804459C1
AIRE	GA-422	588213C1

1654S SERIES con motor/IHC 7.3L		
ACEITE	GP-3766	1804442C1

1654S SERIES, 1750 CARGOSTAR SERIES con motor/IHC 9.0L		
ACEITE	GP-10	39080R2
COMBUSTIBLE, PRIMARIO	GP-1101	244458R91
COMBUSTIBLE, SECUNDARIO	GP-78	672603C1
AIRE	GA-109	478974C1

1700 LOADSTAR SERIES con motor/IHC MV404		
ACEITE, CARTUCHO	G-333	214731R91
ACEITE, SELLADO 4 13/32 IN	GP-1	388227R91
ACEITE, SELLADO 7 17/32 IN	GP-10	39080R2
AIRE	GA-3501	446661C1
GASOLINA	GG-5 L	1701232C91

1700 LOADSTAR SERIES con motor/IHC V345		
ACEITE	GP-10	39080R2
AIRE	GA-3501	446661C1
GASOLINA	GG-20	531546R91

1724S SERIES con motor/IHC MV404		
ACEITE	GP-10	39080R2
AIRE	GA-3501	446661C1
GASOLINA	GG-5 L	1701232C91

1724S SERIES con motor/IHC V345		
ACEITE	GP-10	39080R2
AIRE	GA-3501	446661C2
GASOLINA	GG-20	631546R91

1750 CARGOSTAR SERIES con motor/CATERPILLAR 3208		
ACEITE	GP-36	9L9200
GASOLINA, SEPARADOR DE AGUA	G-293	548348-C1
COMBUSTIBLE	GP-110	702142C1
ACEITE	GP-9586	9N5570

1750 LOADSTAR SERIES con motor/CATERPILLAR 1145		
ACEITE	GP-36	3136046R93

1750 LOADSTAR SERIES con motor/CATERPILLAR 3208		
ACEITE	GP-36	9L9200
GASOLINA, SEPARADOR DE AGUA	G-293	548348-C1
COMBUSTIBLE	GP-110	702142C1

MARCA-MODELO-MOTOR MAKE-MODEL-ENGINE	GONHER GONHER	OEM OEM	MARCA-MODELO-MOTOR MAKE-MODEL-ENGINE	GONHER GONHER	OEM OEM	MARCA-MODELO-MOTOR MAKE-MODEL-ENGINE	GONHER GONHER	OEM OEM
I.H.C. HARVESTER (continuación)			I.H.C. HARVESTER (continuación)			I.H.C. HARVESTER (continuación)		
CAMIONES, TRACTOCAMIONES Y AUTOBUSES			CAMIONES, TRACTOCAMIONES Y AUTOBUSES			CAMIONES, TRACTOCAMIONES Y AUTOBUSES		
ACEITE	GP-9586	9N5570	GASOLINA	GG-20	531546R91	1854S SERIES con motor/IHC DT466		
1750 LOADSTAR SERIES con motor/IHC 404 GASOLINA			1824S SERIES con motores/IHC MV404, IHC MV446			COMBUSTIBLE, PRIMARIO 5 17/32 IN	GP-1101	244458R91
ACEITE, SELLADO 4 13/32 IN	GP-1	388227R91	ACEITE	GP-10	39080R2	ACEITE	GP-69	1808896C1
ACEITE, SELLADO 7 17/32 IN	GP-10	39080R2	AIRE	GA-3501	446661C1	COMBUSTIBLE, SECUNDARIO	GP-1107	702143C1
AIRE	GA-3501	446661C2	GASOLINA	GG-5 L	1701232C91	COMBUSTIBLE, PRIMARIO 7 17/32	GP-1108	625626C1
GASOLINA	GG-5 L	1701232C91	1850 CARGOSTAR SERIES con motor/IHC 9.0L			ACEITE	GP-88	1811953C1
1750 LOADSTAR SERIES con motor/IHC DT466			ACEITE	GP-10	39080R2	AGUA	GP-2071W	1809789C1
ACEITE	GP-69	675616C91	COMBUSTIBLE, PRIMARIO	GP-1101	244458R91	AIRE, PRIMARIO	GA-209	476741C1
COMBUSTIBLE, SECUNDARIO	GP-1107	702143C1	COMBUSTIBLE, SECUNDARIO	GP-1107	702143C1	AIRE, SECUNDARIO	GA-210	482644C1
COMBUSTIBLE, PRIMARIO	GP-1108	625626C1	1850 CARGOSTAR SERIES con motores/IHC D170, IHC D190			1890 LOADSTAR SERIES con motor/GMC 6V-53N		
AIRE	GA-109	478974C1	ACEITE	GP-10	39080R2	ACEITE, DERIVACION (BY PASS)	G-31	5181127
1750 LOADSTAR SERIES con motores/IHC D150, IHC D170			COMBUSTIBLE, SECUNDARIO	GP-1107	702143C1	ACEITE, FLUJO TOTAL (FULL FLOW)	G-33	302574R91
ACEITE	GP-10	39080R2	COMBUSTIBLE, PRIMARIO	GP-1108	625626C1	COMBUSTIBLE, SECUNDARIO	G-1173	1190507R91
COMBUSTIBLE, SECUNDARIO	GP-1107	702143C1	1850 CARGOSTAR SERIES, 1850 LOADSTAR SERIES con motor/CA- TERPILLAR 3208			1890 LOADSTAR SERIES con motor/PERKINS D354		
COMBUSTIBLE, PRIMARIO	GP-1108	625626C1	ACEITE, LUBRICACION TEMPRANA	GP-36	9L9200	ACEITE	G-834	795840R91
1750 LOADSTAR SERIES con motores/IHC DV550B, IHC DV550BTC			GASOLINA, SEPARADOR DE AGUA	G-293	548348-C1	COMBUSTIBLE	G-296	796051R91
ACEITE, SELLADO	GP-10	427207C2	COMBUSTIBLE	GP-110	702142C1	COMBUSTIBLE	G-296-B	796051R91
COMBUSTIBLE, SECUNDARIO	GP-1107	702143C1	ACEITE, LUBRICACION TARDIA	GP-9586	9N5570	1910 CARGOSTAR SERIES con motor/IHC DT466		
COMBUSTIBLE, PRIMARIO	GP-1108	625626C1	1850 LOADSTAR SERIES con motor/GMC 6V-53N			ACEITE	GP-69	1808896C1
SELLADO			ACEITE, DERIVACION (BY PASS)	G-31	5181127	COMBUSTIBLE, PRIMARIO	GP-1108	625626C1
1753S SERIES con motor/IHC 420 (6.9L) DIESEL			ACEITE, FLUJO TOTAL (FULL FLOW)	G-33	302574R91	ACEITE	GP-88	1811953C1
COMBUSTIBLE, PRIMARIO	GPP-14	674293C1	COMBUSTIBLE, SECUNDARIO	G-1173	1190507R91	COMBUSTIBLE, SECUNDARIO	GP-78	672603C1
ACEITE	GP-3766	1804442C1	1850 LOADSTAR SERIES con motor/IHC DV550B			1910 CARGOSTAR SERIES con motores/IHC RD406, IHC RD450, IHC RD501		
COMBUSTIBLE, SECUNDARIO	GP-155	1804459C1	COMBUSTIBLE, PRIMARIO	GP-1108	625626C1	GASOLINA	GG-5 L	1701232C91
AIRE	GA-422	588213C1	SELLADO			1910 CARGOSTAR SERIES, 1924 SERIES, 1925 SERIES con motor/ CATERPILLAR 3208		
1754S SERIES con motor/IHC 9.0L			1850 LOADSTAR SERIES con motor/IV DV550B			ACEITE	GP-36	9L9200
ACEITE	GP-10	39080R2	ACEITE, SELLADO	GP-10	39080R2	GASOLINA, SEPARADOR DE AGUA	G-293	548348-C1
COMBUSTIBLE, PRIMARIO	GP-1101	244458R91	1850 LOADSTAR SERIES con motores/CATERPILLAR 1145, CATERPI- LLAR 1150			COMBUSTIBLE	GP-110	702142C1
COMBUSTIBLE, SECUNDARIO	GP-1107	702143C1	ACEITE	GP-36	3136046R93	ACEITE	GP-9586	9N5570
1754S SERIES con motores/IHC DT360, IHC DTA360			1850 LOADSTAR SERIES con motores/IHC D170, IHC D190			1910 CARGOSTAR SERIES, 1950 CARGOSTAR SERIES con motor/ IHC V537		
ACEITE	GP-69	675616C91	ACEITE	GP-10	39080R2	ACEITE	GP-10	39080R2
1800 LOADSTAR SERIES con motor/IHC D301 DIESEL			COMBUSTIBLE, SECUNDARIO	GP-1107	702143C1	1924S SERIES, 1925S SERIES con motores/IHC MV404, IHC MV446		
ACEITE	G-335	279994R91	COMBUSTIBLE, PRIMARIO	GP-1108	625626C1	ACEITE	GP-10	39080R2
1800 LOADSTAR SERIES con motor/PERKINS D354			1850 SERIES con motor/IHC DT466			AIRE	GA-3501	446661C2
ACEITE	G-834	795840R91	ACEITE	GP-69	1808896C1	GASOLINA	GG-5 L	1701232C91
COMBUSTIBLE	G-296	796051R91	COMBUSTIBLE, PRIMARIO	GP-1105	625626C1	1925S SERIES con motor/IHC DT466		
COMBUSTIBLE	G-296-B	796051R91	COMBUSTIBLE, SECUNDARIO	GP-1107	702143C1	ACEITE	GP-69	1808896C1
1800 LOADSTAR SERIES con motores/IHC MV404, IHC MV446			ACEITE	GP-88	1811953C1	COMBUSTIBLE, PRIMARIO	GP-1108	625626C1
ACEITE	GP-10	39080R2	AIRE	GA-109	478974C1	ACEITE	GP-88	1811953C1
AIRE	GA-3501	446661C1	1854S SERIES con motor/CATERPILLAR 3208			COMBUSTIBLE, SECUNDARIO	GP-78	672603C1
GASOLINA	GG-5 L	1701232C91	ACEITE	GP-36	9L9200	AIRE	GA-209	476741C1
1800 LOADSTAR SERIES con motores/IHC V345, IHC V392			GASOLINA, SEPARADOR DE AGUA	G-293	548348-C1	1950 CARGOSTAR SERIES con motor/GMC 6V-53 DIESEL		
ACEITE	GP-10	39080R2	COMBUSTIBLE	GP-110	702142C1	ACEITE, FLUJO TOTAL (FULL FLOW)	G-33	302574R91
AIRE	GA-3501	446661C1	ACEITE	GP-9586	9N5570	1950 CARGOSTAR SERIES con motor/IHC 9.0L		
GASOLINA	GG-20	531546R91	1854S SERIES con motor/IHC D190			ACEITE	GP-10	39080R2
1810 CARGOSTAR SERIES con motores/IHC MV404, IHC MV446			ACEITE	GP-10	39080R2	COMBUSTIBLE, PRIMARIO	GP-1101	244458R91
ACEITE	GP-10	39080R2	COMBUSTIBLE, SECUNDARIO	GP-1107	702143C1	COMBUSTIBLE, SECUNDARIO	GP-78	672603C1
AIRE	GA-3501	446661C1	COMBUSTIBLE, PRIMARIO	GP-1108	625626C1			
GASOLINA	GG-5 L	1701232C91						
1810 CARGOSTAR SERIES con motores/IHC V345, IHC V392								
ACEITE	GP-10	39080R2						
AIRE	GA-3501	446661C1						

SERVICIO PESADO

MARCA-MODELO-MOTOR MAKE-MODEL-ENGINE	GONHER GONHER	OEM OEM	MARCA-MODELO-MOTOR MAKE-MODEL-ENGINE	GONHER GONHER	OEM OEM	MARCA-MODELO-MOTOR MAKE-MODEL-ENGINE	GONHER GONHER	OEM OEM
I.H.C. HARVESTER (continuación)			I.H.C. HARVESTER (continuación)			I.H.C. HARVESTER (continuación)		
CAMIONES, TRACTOCAMIONES Y AUTOBUSES			CAMIONES, TRACTOCAMIONES Y AUTOBUSES			CAMIONES, TRACTOCAMIONES Y AUTOBUSES		
1950 CARGOSTAR SERIES con motor/IHC DV550B			1955S SERIES con motores/IHC D170, IHC D190			COMBUSTIBLE, SECUNDARIO	G-1173	1190507R91
ACEITE	GP-10	39080R2	ACEITE	GP-10	39080R2	2050 FLEETSTAR SERIES con motor/IHC DT466		
COMBUSTIBLE, PRIMARIO	GP-1108	625626C1	COMBUSTIBLE, SECUNDARIO	GP-1107	702143C1	DIRECCION	G-169	279294C91
COMBUSTIBLE, SECUNDARIO	GP-78	672603C1	COMBUSTIBLE, PRIMARIO	GP-1108	625626C1	ACEITE	GP-69	1808896C1
						COMBUSTIBLE, PRIMARIO	GP-1105	625626C1
1950 CARGOSTAR SERIES con motor/IHC DVT573			1955S SERIES con motores/IHC MV404, IHC MV466			ACEITE	GP-88	1811953C1
COMBUSTIBLE, PRIMARIO	GP-1108	625626C1	ACEITE	GP-10	39080R2	COMBUSTIBLE, SECUNDARIO	GP-78	672603C1
			AIRE	GA-3501	446661C2			
1950 CARGOSTAR SERIES con motores/CATERPILLAR 1150, CATERPILLAR 1160			GASOLINA	GG-5 L	1701232C91	2050 FLEETSTAR SERIES con motores/IHC D170, IHC D190, IHC DV550B		
ACEITE	GP-36	3136046R93				ACEITE	GP-10	39080R2
			2000 FLEETSTAR SERIES con motor/CUMMINS			COMBUSTIBLE, SECUNDARIO	GP-1107	702143C1
1950 CARGOSTAR SERIES con motores/IHC D170, IHC D190			ACEITE, CARTUCHO PARA FLUJO TOTAL (FULL FLOW)	G-566	244523-R91	COMBUSTIBLE, PRIMARIO	GP-1108	625626C1
ACEITE	GP-10	39080R2	ACEITE, TURBOCARGADOR	GP-14	998457-R91			
COMBUSTIBLE, SECUNDARIO	GP-1107	702143C1	COMBUSTIBLE, 5 3/4 IN	GPP-14	674293C1	2050 FLEETSTAR SERIES, 2070 FLEETSTAR SERIES con motor/CATERPILLAR 3406		
COMBUSTIBLE, PRIMARIO	GP-1108	625626C1	COMBUSTIBLE, 5 17/32 IN	GP-1101	244458R91	ACEITE, CUMPLE CON MEDI-DAS ORIGINALES	GP-691	1R0716
			ACEITE, SELLADO FLUJO TOTAL (FULL FLOW)	GP-53	1212622H1	ACEITE, SEGUNDA OPCION	GP-52	1R0716
1950 CARGOSTAR SERIES con motores/IHC DT466, IHC DT1466			COMBUSTIBLE, 11 15/32 IN	GP-55	3313306	COMBUSTIBLE	GP-1108	625626C1
ACEITE	GP-69	1808896C1	COMBUSTIBLE, SEPARADOR DE AGUA	GPP-11	1214920H1	AGUA	GP-2071W	1809789C1
COMBUSTIBLE, PRIMARIO	GP-1105	625626C1	AIRE, RESPIRADOR	GA-39	255963			
ACEITE	GP-88	1811953C1	AIRE, SIN ASPAS	GA-27	250552C92	2070 FLEETSTAR SERIES con motor/CUMMINS		
COMBUSTIBLE, SECUNDARIO	GP-78	672603C1	ACEITE, DERIVACION (BY PASS)	G-750	689032R91	ACEITE, CARTUCHO PARA FLUJO TOTAL (FULL FLOW)	G-566	244523-R91
						ACEITE, TURBOCARGADOR	GP-14	998457-R91
1950 CARGOSTAR SERIES, 1954S SERIES, 1955S SERIES, 2050 FLEETSTAR SERIES con motor/CATERPILLAR 3208			2000 FLEETSTAR SERIES con motor/GMC 8V-71N			COMBUSTIBLE, 5 3/4 IN	GPP-14	674293C1
ACEITE	GP-36	9L9200	ACEITE, FLUJO TOTAL (FULL FLOW)	G-33	302574R91	COMBUSTIBLE, 5 17/32 IN	GP-1101	244458R91
GASOLINA, SEPARADOR DE AGUA	G-293	548348-C1	COMBUSTIBLE, SECUNDARIO	G-1175	432419R91	ACEITE, SELLADO FLUJO TOTAL (FULL FLOW)	GP-53	1212622H1
COMBUSTIBLE	GP-110	702142C1	AIRE, SIN ASPAS	GA-26	304766C91	COMBUSTIBLE, 11 15/32 IN	GP-55	3313306
ACEITE	GP-9586	9N5570				COMBUSTIBLE, SEPARADOR DE AGUA	GPP-11	1214920H1
			2000 FLEETSTAR SERIES con motores/GMC 6-71, GMC 6V-71N			AIRE, RESPIRADOR	GA-39	255963
1954 SERIES con motores/IHC DT466, IHC DTA466, IHC DT1466			ACEITE, FLUJO TOTAL (FULL FLOW)	G-33	302574R91	AIRE	GA-376	420051C1
ACEITE	GP-69	1808896C1	COMBUSTIBLE, SECUNDARIO	G-1175	432419R91	ACEITE, DERIVACION (BY PASS)	G-750	689032R91
COMBUSTIBLE, PRIMARIO	GP-1108	625626C1	AIRE, SIN ASPAS	GA-27	8873271			
ACEITE	GP-88	1811953C1				2070A FLEETSTAR SERIES con motor/GMC 6-71N		
COMBUSTIBLE, SECUNDARIO	GP-78	672603C1	2000 FLEETSTAR SERIES con motores/IHC RD372, IHC RD501, IHC RD406, IHC RD450			ACEITE, FLUJO TOTAL (FULL FLOW)	G-33	302574R91
AIRE	GA-209	476741C1	GASOLINA	GG-5 L	1701232C91	COMBUSTIBLE, PRIMARIO	GP-26	23518481
						COMBUSTIBLE, SECUNDARIO	GP-27	23518482
1954S SERIES con motor/IHC 9.0L			2010 FLEETSTAR SERIES con motor/IHC V537					
ACEITE	GP-10	39080R2	ACEITE	GP-10	39080R2	2125S SERIES con motor/IHC V537		
COMBUSTIBLE, PRIMARIO	GP-1101	244458R91				ACEITE	GP-10	39080R2
COMBUSTIBLE, SECUNDARIO	GP-78	672603C1	2010 FLEETSTAR SERIES con motores/IHC RD450, IHC RD501					
			GASOLINA	GG-5 L	1701232C91	2125S SERIES con motores/IHC DT466, IHC DT1466, MOTOR IHC DTA466		
1954S SERIES con motores/IHC D170, IHC D190						ACEITE	GP-69	1808896C1
ACEITE	GP-10	39080R2	2050 FLEETSTAR SERIES con motor/CATERPILLAR 1160			COMBUSTIBLE, PRIMARIO	GP-1108	625626C1
COMBUSTIBLE, SECUNDARIO	GP-1107	702143C1	ACEITE	GP-36	3136046R93	ACEITE	GP-88	1811953C1
COMBUSTIBLE, PRIMARIO	GP-1108	625626C1				COMBUSTIBLE, SECUNDARIO	GP-78	672603C1
			2050 FLEETSTAR SERIES con motor/CUMMINS			AIRE	GA-209	476741C1
1954S SERIES con motores/IHC MV404, IHC MV466			ACEITE, CARTUCHO PARA FLUJO TOTAL (FULL FLOW)	G-566	257528			
ACEITE	GP-10	39080R2	ACEITE, TURBOCARGADOR	GP-14	998457-R91	2125S SERIES, 2155S SERIES con motor/CATERPILLAR 3208		
AIRE	GA-3501	446661C2	COMBUSTIBLE, 5 3/4 IN	GPP-14	674293C1	ACEITE	GP-36	9L9200
GASOLINA	GG-5 L	1701232C91	COMBUSTIBLE, 5 17/32 IN	GP-1101	244458R91	GASOLINA, SEPARADOR DE AGUA	G-293	548348-C1
			ACEITE, SELLADO FLUJO TOTAL (FULL FLOW)	GP-53	1212622H1	COMBUSTIBLE	GP-110	702142C1
1955 SERIES con motores/IHC DT1466, IHC DT466, IHC DTA466			COMBUSTIBLE, 11 15/32 IN	GP-55	3313306	ACEITE	GP-9586	9N5570
ACEITE	GP-69	1808896C1	COMBUSTIBLE, SEPARADOR DE AGUA	GPP-11	1214920H1			
COMBUSTIBLE, PRIMARIO	GP-1108	625626C1	AIRE, RESPIRADOR	GA-39	255963	2155S SERIES con motores/MOTOR IHC DTA466, IHC DT466, IHC DT1466		
ACEITE	GP-88	1811953C1	ACEITE, DERIVACION (BY PASS)	G-750	689032R91	ACEITE	GP-69	1808896C1
COMBUSTIBLE, SECUNDARIO	GP-78	672603C1				COMBUSTIBLE, PRIMARIO	GP-1108	625626C1
AIRE	GA-209	476741C1	2050 FLEETSTAR SERIES con motor/GMC 6V-53			ACEITE	GP-88	1811953C1
			ACEITE, DERIVACION (BY PASS)	G-31	5181127	COMBUSTIBLE, SECUNDARIO	GP-78	672603C1
1955S SERIES con motor/IHC 9.0L			ACEITE, FLUJO TOTAL (FULL FLOW)	G-33	302574R91			
ACEITE	GP-10	39080R2						
COMBUSTIBLE, PRIMARIO	GP-1101	244458R91						
COMBUSTIBLE, SECUNDARIO	GP-78	672603C1						

MARCA-MODELO-MOTOR MAKE-MODEL-ENGINE	GONHER GONHER	OEM OEM	MARCA-MODELO-MOTOR MAKE-MODEL-ENGINE	GONHER GONHER	OEM OEM	MARCA-MODELO-MOTOR MAKE-MODEL-ENGINE	GONHER GONHER	OEM OEM
I.H.C. HARVESTER (continuación)			I.H.C. HARVESTER (continuación)			I.H.C. HARVESTER (continuación)		
CAMIONES, TRACTOCAMIONES Y AUTOBUSES			CAMIONES, TRACTOCAMIONES Y AUTOBUSES			CAMIONES, TRACTOCAMIONES Y AUTOBUSES		
AIRE	GA-209	476741C1	2554 con motor/IHC DT466E			2574S SERIES con motor/CUMMINS		
2275S SERIES con motor/CATERPILLAR 3406			AGUA	GP-2071W	1822313C1	ACEITE, CARTUCHO PARA FLUJO TOTAL (FULL FLOW)	G-566	244523-R91
ACEITE, FLUJO TOTAL (FULL FLOW) (CUMPLE CON MEDI-DAS ORIGINALES)	GP-691	1R0716	ACEITE	GP-152	1819452C1	COMBUSTIBLE	GP-1101	244458R91
ACEITE, FLUJO TOTAL (FULL FLOW) (SEGUNDA OPCION)	GP-52	1R0716	AIRE	GA-221R	2005895C1	ACEITE, SELLADO FLUJO TOTAL (FULL FLOW)	GP-53	1212622H1
COMBUSTIBLE	GP-1108	625626C1	2554 con motores/CUMMINS, DETROIT DIESEL			ACEITE, SELLADO DERIVACION (BY PASS)	GP-57	1666053C1
AGUA	GP-2071W	1809789C1	DIRECCION	G-169	279294C92	AGUA	GP-2071W	1809789C1
ACEITE, DERIVACION (BY PASS)	G-750	689032R91	AIRE, PRIMARIO	GA-106	1665598C1	AIRE	GA-107	476743C1
2275S SERIES con motor/CUMMINS			AIRE, SECUNDARIO	GA-206	1665599C1	AIRE	GA-209	476741C1
ACEITE, CARTUCHO PARA FLUJO TOTAL (FULL FLOW)	G-566	244523-R91	2554, 2574 con motor/CATERPILLAR			ACEITE, CARTUCHO PARA DERIVACION (BY PASS)	G-750	689032R91
COMBUSTIBLE	GP-1101	244458R91	COMBUSTIBLE, SEPARADOR DE AGUA	GS-2033	31252	2574S SERIES con motor/GMC DIESEL		
ACEITE, SELLADO FLUJO TOTAL (FULL FLOW)	GP-53	1212622H1	DIRECCION	G-169	279294C92	ACEITE, CARTUCHO PARA FLUJO TOTAL (FULL FLOW)	G-33	302574R91
ACEITE, SELLADO DERIVACION (BY PASS)	GP-57	1666053C1	COMBUSTIBLE, SEPARADOR DE AGUA	GPP-547	1677004C91	COMBUSTIBLE, PRIMARIO	GP-26	23518481
AGUA	GP-2071W	1809789C1	COMBUSTIBLE, SEPARADOR DE AGUA	GPP-1291	1685156C91	COMBUSTIBLE, SECUNDARIO	GP-27	23518482
AIRE	GA-107	476743C1	AIRE, PRIMARIO	GA-107	1674320C3	ACEITE, SELLADO FLUJO TOTAL (FULL FLOW)	GP-43	A77537
AIRE	GA-209	476741C1	AIRE, SECUNDARIO	GA-108	1674313C3	AGUA	GP-2071W	1809789C1
ACEITE, CARTUCHO PARA DERIVACION (BY PASS)	G-750	689032R91	2554, 2574, 2654, 2674 con motor/IHC DT466			AIRE	GA-107	476743C1
2275S SERIES con motor/GMC DIESEL			COMBUSTIBLE, PRIMARIO 1992-93	GP-1101	625625C1	AIRE	GA-209	476741C1
ACEITE, CARTUCHO PARA FLUJO TOTAL (FULL FLOW)	G-33	302574R91	COMBUSTIBLE, PRIMARIO 1992-93	GP-1108	625627C1	ACEITE, DERIVACION (BY PASS)	G-750	689032R91
COMBUSTIBLE, PRIMARIO	GP-26	23518481	ACEITE, 1992-93	GP-88	1811953C1	2574S SERIES, 2575S SERIES con motor/CATERPILLAR 3406		
COMBUSTIBLE, SECUNDARIO	GP-27	23518482	AGUA, 1994-97	GP-2071W	1809789C1	ACEITE, FLUJO TOTAL (FULL FLOW) (CUMPLE CON MEDI-DAS ORIGINALES)	GP-691	1R0716
ACEITE, SELLADO FLUJO TOTAL (FULL FLOW)	GP-43	A77537	COMBUSTIBLE, SECUNDARIO	GP-78	1809789C1	ACEITE, FLUJO TOTAL (FULL FLOW) (SEGUNDA OPCION)	GP-52	1R0716
AGUA	GP-2071W	1809789C1	ACEITE, 1994-97	GP-152	1819452C1	COMBUSTIBLE	GP-1108	625626C1
AIRE	GA-107	476743C1	AIRE, PRIMARIO	GA-106	1665598C1	AGUA	GP-2071W	1809789C1
AIRE	GA-209	476741C1	AIRE, SECUNDARIO	GA-206	1665599C1	ACEITE, DERIVACION (BY PASS)	G-750	689032R91
ACEITE, CARTUCHO PARA DERIVACION (BY PASS)	G-750	689032R91	2554S SERIES con motor/CATERPILLAR 3208			2575S SERIES con motor/CUMMINS		
2275S SERIES con motor/IHC V537			ACEITE	GP-36	9L9200	ACEITE, CARTUCHO PARA FLUJO TOTAL (FULL FLOW)	G-566	244523-R91
ACEITE, FLUJO TOTAL (FULL FLOW)	GP-10	39080R2	GASOLINA, SEPARADOR DE AGUA	G-293	548348-C1	COMBUSTIBLE	GP-1101	244458R91
2375S SERIES con motor/CUMMINS			COMBUSTIBLE	GP-110	702142C1	ACEITE, SELLADO FLUJO TOTAL (FULL FLOW)	GP-53	1212622H1
ACEITE, CARTUCHO PARA FLUJO TOTAL (FULL FLOW)	G-566	244523-R91	ACEITE	GP-9586	9N5570	ACEITE, SELLADO DERIVACION (BY PASS)	GP-57	1666053C1
COMBUSTIBLE	GP-1101	244458R91	ACEITE, DERIVACION (BY PASS)	G-750	689032R91	AGUA	GP-2071W	1809789C1
ACEITE, SELLADO FLUJO TOTAL (FULL FLOW)	GP-53	1212622H1	2554S SERIES, 2654S SERIES con motores/IHC DT466, IHC DT1466			AIRE	GA-107	476743C1
ACEITE, SELLADO DERIVACION (BY PASS)	GP-57	1666053C1	ACEITE	GP-69	1808896C1	AIRE	GA-209	476741C1
AGUA	GP-2071W	1809789C1	COMBUSTIBLE, PRIMARIO	GP-1108	625626C1	ACEITE, CARTUCHO PARA DERIVACION (BY PASS)	G-750	689032R91
AIRE	GA-107	476743C1	ACEITE	GP-88	1811953C1	2575S SERIES con motor/GMC DIESEL		
AIRE	GA-209	476741C1	AGUA	GP-2071W	1809789C1	ACEITE, CARTUCHO PARA FLUJO TOTAL (FULL FLOW)	G-33	302574R91
ACEITE, CARTUCHO PARA DERIVACION (BY PASS)	G-750	689032R91	COMBUSTIBLE, SECUNDARIO	GP-78	672603C1	COMBUSTIBLE, PRIMARIO	GP-26	23518481
2275S SERIES con motor/IHC V537			AIRE	GA-209	476741C1	COMBUSTIBLE, SECUNDARIO	GP-27	23518482
ACEITE, FLUJO TOTAL (FULL FLOW)	GP-10	39080R2	ACEITE, DERIVACION (BY PASS)	G-750	689032R91	ACEITE, SELLADO FLUJO TOTAL (FULL FLOW)	GP-43	A77537
2375S SERIES con motor/CUMMINS			2574 6X4 con motor/CUMMINS N14 DIESEL			AGUA	GP-2071W	1809789C1
ACEITE, CARTUCHO PARA FLUJO TOTAL (FULL FLOW)	G-566	244523-R91	ACEITE	GP-3000	3318853	AIRE	GA-107	476743C1
COMBUSTIBLE	GP-1101	244458R91	COMBUSTIBLE, SEPARADOR DE AGUA	GPP-1000	702256C1	AIRE	GA-209	476741C1
ACEITE, SELLADO FLUJO TOTAL (FULL FLOW)	GP-53	1212622H1	AIRE	GA-107	1674320C2	ACEITE, DERIVACION (BY PASS)	G-750	689032R91
ACEITE, SELLADO DERIVACION (BY PASS)	GP-57	1666053C1	2574 con motor/IHC DT466E			2575S SERIES con motor/GMC DIESEL		
AGUA	GP-2071W	1809789C1	AGUA	GP-2071W	1822313C1	ACEITE, CARTUCHO PARA FLUJO TOTAL (FULL FLOW)	G-33	302574R91
AIRE	GA-107	476743C1	ACEITE	GP-152	1819452C1	COMBUSTIBLE, PRIMARIO	GP-26	23518481
AIRE	GA-209	476741C1	AIRE	GA-221R	2005895C1	COMBUSTIBLE, SECUNDARIO	GP-27	23518482
ACEITE, CARTUCHO PARA DERIVACION (BY PASS)	G-750	689032R91	2574 con motores/CUMMINS, DETROIT DIESEL			ACEITE, SELLADO FLUJO TOTAL (FULL FLOW)	GP-43	A77537
2375S SERIES con motor/GMC DIESEL			DIRECCION	G-169	279294C92	AGUA	GP-2071W	1809789C1
ACEITE, CARTUCHO PARA FLUJO TOTAL (FULL FLOW)	G-33	302574R91	AIRE, PRIMARIO	GA-106	1665598C1	AIRE	GA-107	476743C1
COMBUSTIBLE, PRIMARIO	GP-26	23518481	AIRE, SECUNDARIO	GA-206	1665599C1	AIRE	GA-209	476741C1
COMBUSTIBLE, SECUNDARIO	GP-27	23518482	2574 con motor/IHC DT466E			ACEITE, DERIVACION (BY PASS)	G-750	689032R91
ACEITE, SELLADO FLUJO TOTAL (FULL FLOW)	GP-43	A77537	AGUA	GP-2071W	1822313C1	2654 con motor/IHC DT466E		
AGUA	GP-2071W	1809789C1	ACEITE	GP-152	1819452C1	AGUA	GP-2071W	1822313C1
AIRE	GA-107	476743C1	AIRE	GA-221R	2005895C1	COMBUSTIBLE	GP-78	1822588C1
AIRE	GA-209	476741C1	2574 con motores/CUMMINS, DETROIT DIESEL			ACEITE	GP-152	1819452C1
ACEITE, CARTUCHO PARA DERIVACION (BY PASS)	G-750	689032R91	DIRECCION	G-169	279294C92	AIRE, 2000-01	GA-209	476741C1
2375S SERIES con motor/GMC DIESEL			AIRE, PRIMARIO	GA-106	1665598C1	AIRE, HASTA 1999	GA-221R	2005895C1
ACEITE, CARTUCHO PARA FLUJO TOTAL (FULL FLOW)	G-33	302574R91	AIRE, SECUNDARIO	GA-206	1665599C1	2654, 2674 con motor/CATERPILLAR		
COMBUSTIBLE, PRIMARIO	GP-26	23518481						
COMBUSTIBLE, SECUNDARIO	GP-27	23518482						
ACEITE, SELLADO FLUJO TOTAL (FULL FLOW)	GP-43	A77537						
AGUA	GP-2071W	1809789C1						
AIRE	GA-107	476743C1						
AIRE	GA-209	476741C1						
ACEITE, CARTUCHO PARA DERIVACION (BY PASS)	G-750	689032R91						

SERVICIO PESADO

MARCA-MODELO-MOTOR MAKE-MODEL-ENGINE	GONHER GONHER	OEM OEM	MARCA-MODELO-MOTOR MAKE-MODEL-ENGINE	GONHER GONHER	OEM OEM	MARCA-MODELO-MOTOR MAKE-MODEL-ENGINE	GONHER GONHER	OEM OEM
I.H.C. HARVESTER (continuación)			I.H.C. HARVESTER (continuación)			I.H.C. HARVESTER (continuación)		
CAMIONES, TRACTOCAMIONES Y AUTOBUSES			CAMIONES, TRACTOCAMIONES Y AUTOBUSES			CAMIONES, TRACTOCAMIONES Y AUTOBUSES		
COMBUSTIBLE, SEPARADOR DE AGUA	GS-2033	311252	2674S SERIES, 2275S SERIES, 2524S SERIES, 2624S SERIES, 2654S SERIES con motor/IHC V800			COMBUSTIBLE	GP-78	1809789C1
DIRECCION	G-169	279294C92	COMBUSTIBLE, SECUNDARIO	GP-1107	702143C1	AIRE	GA-373	1685556C1
COMBUSTIBLE, SEPARADOR DE AGUA	GPP-547	1677004C91	COMBUSTIBLE, PRIMARIO	GP-1108	625626C1	AIRE, SECUNDARIO	GA-209	476741C1
COMBUSTIBLE, SEPARADOR DE AGUA	GPP-1291	1685156C91	AGUA	GP-2071W	1809789C1	AIRE	GA-210	482644C1
AIRE, PRIMARIO	GA-107	1674320C3	ACEITE, DERIVACION (BY PASS)	G-750	689032R91		GA-197R	1691027C1
AIRE, SECUNDARIO	GA-108	1674313C3				3600 con motor/IHC T444E		
2654, 2674 con motores/CUMMINS, DETROIT DIESEL			2675S SERIES con motor/CUMMINS			DIRECCION	G-162H	1691121C1
DIRECCION	G-169	279294C92	ACEITE, CARTUCHO PARA FLUJO TOTAL (FULL FLOW)	G-566	244523-R91	COMBUSTIBLE, 1999-2000	G-862	1825864C92
AIRE, PRIMARIO	GA-106	1665598C1	COMBUSTIBLE	GP-1101	244458R91	COMBUSTIBLE, SEPARADOR DE AGUA	G-178	1822631C91
AIRE, SECUNDARIO	GA-206	1665599C1	ACEITE, SELLADO FLUJO TOTAL (FULL FLOW)	GP-53	1212622H1	ACEITE	GP-562	1814562C1
2654S SERIES con motor/CATERPILLAR 3208			ACEITE, SELLADO DERIVACION (BY PASS)	GP-57	1666053C1	AIRE	GA-373	1685556C1
ACEITE	GP-36	9L9200	AGUA	GP-2071W	1809789C1	AIRE, SECUNDARIO	GA-210	482644C1
GASOLINA, SEPARADOR DE AGUA	G-293	548348-C1	AIRE	GA-107	476743C1	AIRE	GA-197R	1691027C1
COMBUSTIBLE	GP-110	702142C1	AIRE	GA-209	476741C1	3600, 3700, 3800, 3900, 3600SC, 3900FC con motor/IHC DT408		
ACEITE	GP-9586	9N5570	ACEITE, CARTUCHO PARA DERIVACION (BY PASS)	G-750	689032R91	DIRECCION	G-162H	1691121C1
ACEITE, DERIVACION (BY PASS)	G-750	689032R91				COMBUSTIBLE, SEPARADOR DE AGUA	GPP-547	1677004C91
2674 con motor/IHC DT466E			3000FE, 3800 SERIES con motor/IHC DT466E			COMBUSTIBLE	GP-62	1820479C1
AGUA	GP-2071W	1822313C1	DIRECCION	G-162H	1691121C1	COMBUSTIBLE	GP-1122	3132428R1
ACEITE	GP-152	1819452C1	COMBUSTIBLE	GP-78	1822588C1	AGUA	GP-2071W	1822313C1
AIRE	GA-221R	2005895C1	ACEITE	GP-152	1819452C1	COMBUSTIBLE	GP-78	1822588C1
2674S SERIES con motor/CATERPILLAR 3406			AIRE	GA-209	476741C1	ACEITE	GP-152	1819452C1
ACEITE, FLUJO TOTAL (FULL FLOW) (CUMPLE CON MEDI-DAS ORIGINALES)	GP-691	1R0716	3000FE, 3800 SERIES con motor/IHC T444E			AIRE	GA-373	1685556C1
ACEITE, FLUJO TOTAL (FULL FLOW) (SEGUNDA OPCION)	GP-52	1R0716	DIRECCION	G-162H	1691121C1	AIRE	GA-209	476741C1
COMBUSTIBLE	GP-1108	625626C1	COMBUSTIBLE, SEPARADOR DE AGUA	G-862	1825864C92	AIRE, SECUNDARIO	GA-210	482644C1
AGUA	GP-2071W	1809789C1	COMBUSTIBLE, SEPARADOR DE AGUA	G-178	1822631C91	AIRE	GA-197R	1691027C1
ACEITE, DERIVACION (BY PASS)	G-750	689032R91	ACEITE	GP-562	1814562C1	3600, 3900FC, 3700, 3800, 3900, 3600SC con motor/IHC DT466		
2674S SERIES con motor/CUMMINS			AIRE	GA-209	476741C1	DIRECCION (1993)	G-162H	1691121C1
ACEITE, CARTUCHO PARA FLUJO TOTAL (FULL FLOW)	G-566	244523-R91	3200 con motor/IHC VT365			COMBUSTIBLE, PRIMARIO 1993	GP-1101	625625C1
COMBUSTIBLE	GP-1101	244458R91	AIRE	GA-799R	3532799C1	GASOLINA, HASTA 1993	G-293	548348-C1
ACEITE, SELLADO FLUJO TOTAL (FULL FLOW)	GP-53	1212622H1	3400 con motor/IHC T444E			COMBUSTIBLE, SEPARADOR DE AGUA	GPP-547	1677004C91
ACEITE, SELLADO DERIVACION (BY PASS)	GP-57	1666053C1	DIRECCION	G-162H	1691121C1	COMBUSTIBLE, 1996-97	GP-62	1820479C1
AGUA	GP-2071W	1809789C1	COMBUSTIBLE, SEPARADOR DE AGUA	G-862	1825864C92	COMBUSTIBLE, 1996-97	GP-1122	3132428R1
AIRE	GA-107	476743C1	COMBUSTIBLE, SEPARADOR DE AGUA	G-178	1822631C91	COMBUSTIBLE, PRIMARIO 1993	GP-1108	625627C1
AIRE	GA-209	476741C1	ACEITE	GP-562	1814562C1	ACEITE, HASTA 1993	GP-88	1811953C1
ACEITE, CARTUCHO PARA DERIVACION (BY PASS)	G-750	689032R91	AIRE	GA-209	476741C1	AGUA, 1996-97	GP-2071W	1822313C1
2674S SERIES con motor/GMC DIESEL			3600 con motor/IHC 7.3L			COMBUSTIBLE	GP-78	1809789C1
ACEITE, CARTUCHO PARA FLUJO TOTAL (FULL FLOW)	G-33	302574R91	DIRECCION	G-162H	1691121C1	ACEITE, 1996-97	GP-152	1819452C1
COMBUSTIBLE, PRIMARIO	GP-26	23518481	DIRECCION	G-169	279294C92	AIRE, 1996-97	GA-373	1685556C1
COMBUSTIBLE, SECUNDARIO	GP-27	23518482	GASOLINA	G-293	548348-C1	AIRE	GA-209	476741C1
ACEITE, SELLADO FLUJO TOTAL (FULL FLOW)	GP-43	A77537	COMBUSTIBLE, SEPARADOR DE AGUA	GPP-547	1677004C91	AIRE, SECUNDARIO	GA-210	482644C1
AGUA	GP-2071W	1809789C1	ACEITE	GP-3766	1804442C1	AIRE, 1996-97	GA-197R	1691027C1
AIRE	GA-107	476743C1	COMBUSTIBLE	GP-155	1804459C1	3600SC con motor/IHC 7.3L		
AIRE	GA-209	476741C1	AIRE	GA-422	588213C1	DIRECCION	G-162H	1691121C1
ACEITE, DERIVACION (BY PASS)	G-750	689032R91	AIRE	GA-209	476710C1	DIRECCION	G-169	279294C92
2674S SERIES con motor/IHC 530E			AIRE, SECUNDARIO	GA-210	482644C1	GASOLINA	G-293	548348-C1
COMBUSTIBLE	GP-78	672603C1	AIRE	GA-197R	1691027C1	COMBUSTIBLE, SEPARADOR DE AGUA	GPP-547	1677004C91
ACEITE	GP-152	1833121C1	3600 con motor/IHC DT360			ACEITE	GP-3766	1804442C1
AIRE	GA-107	1674320C2	DIRECCION	G-162H	1691121C1	COMBUSTIBLE	GP-155	1804459C1
			DIRECCION	G-169	279294C92	AIRE	GA-422	588213C1
			GASOLINA	G-293	548348-C1	AIRE	GA-209	476710C1
			COMBUSTIBLE, SEPARADOR DE AGUA	GPP-547	1677004C91	AIRE, SECUNDARIO	GA-210	482644C1
			ACEITE	GP-88	1811953C1	AIRE	GA-197R	1691027C1
						3600SC con motor/IHC DT360		
						DIRECCION	G-162H	1691121C1
						DIRECCION	G-169	279294C92

APLICACIONES SERVICIO PESADO
HEAVY DUTY APPLICATIONS



MARCA-MODELO-MOTOR MAKE-MODEL-ENGINE	GONHER GONHER	OEM OEM	MARCA-MODELO-MOTOR MAKE-MODEL-ENGINE	GONHER GONHER	OEM OEM	MARCA-MODELO-MOTOR MAKE-MODEL-ENGINE	GONHER GONHER	OEM OEM
I.H.C. HARVESTER (continuación)			I.H.C. HARVESTER (continuación)			I.H.C. HARVESTER (continuación)		
CAMIONES, TRACTOCAMIONES Y AUTOBUSES			CAMIONES, TRACTOCAMIONES Y AUTOBUSES			CAMIONES, TRACTOCAMIONES Y AUTOBUSES		
GASOLINA	G-293	548348-C1	AIRE	GA-209	476710C1	COMBUSTIBLE, SEPARADOR DE AGUA	GPP-547	1677004C91
COMBUSTIBLE, SEPARADOR DE AGUA	GPP-547	1677004C91	AIRE, SECUNDARIO	GA-210	482644C1	ACEITE	GP-88	1811953C1
ACEITE	GP-88	1811953C1	AIRE	GA-197R	1691027C1	COMBUSTIBLE	GP-78	1809789C1
COMBUSTIBLE	GP-78	1809789C1	3800 con motor/IHC DT360			AIRE	GA-373	1685556C1
AIRE	GA-373	1685556C1	DIRECCION	G-162H	1691121C1	AIRE	GA-209	476741C1
AIRE	GA-209	476741C1	DIRECCION	G-169	279294C92	AIRE, SECUNDARIO	GA-210	482644C1
AIRE, SECUNDARIO	GA-210	482644C1	GASOLINA	G-293	548348-C1	AIRE	GA-197R	1691027C1
AIRE	GA-197R	1691027C1	COMBUSTIBLE, SEPARADOR DE AGUA	GPP-547	1677004C91	400 TRANSTAR SERIES con motor/CUMMINS		
3600SC, 3900FC con motor/IHC T444E			ACEITE	GP-88	1811953C1	ACEITE, CARTUCHO PARA FLUJO TOTAL (FULL FLOW)	G-566	244523-R91
DIRECCION	G-162H	1691121C1	COMBUSTIBLE	GP-78	1809789C1	ACEITE, TURBOCARGADOR	GP-14	998457-R91
COMBUSTIBLE, 1999-2000	G-862	1825864C92	AIRE	GA-373	1685556C1	COMBUSTIBLE, 5 3/4 IN	GPP-14	674293C1
COMBUSTIBLE, SEPARADOR DE AGUA	G-178	1822631C91	AIRE	GA-209	476741C1	COMBUSTIBLE, 5 17/32 IN	GP-1101	244458R91
ACEITE	GP-562	1814562C1	AIRE, SECUNDARIO	GA-210	482644C1	ACEITE, SELLADO FLUJO TOTAL (FULL FLOW)	GP-53	1212622H1
AIRE	GA-373	1685556C1	AIRE	GA-197R	1691027C1	COMBUSTIBLE, 11 15/32 IN	GP-55	3313306
AIRE	GA-209	476741C1	3900 con motor/IHC 7.3L			COMBUSTIBLE, SEPARADOR DE AGUA	GPP-11	1214920H1
AIRE, SECUNDARIO	GA-210	482644C1	DIRECCION	G-162H	1691121C1	AIRE, RESPIRADOR	GA-39	255963
AIRE	GA-197R	1691027C1	DIRECCION	G-169	279294C92	AIRE, SIN ASPAS	GA-27	250552C92
3700 con motor/IHC 7.3L			GASOLINA	G-293	548348-C1	ACEITE, DERIVACION (BY PASS)	G-750	689032R91
DIRECCION	G-162H	1691121C1	COMBUSTIBLE, SEPARADOR DE AGUA	GPP-547	1677004C91	400 TRANSTAR SERIES con motor/MOTOR GMC 8V-71		
DIRECCION	G-169	279294C92	ACEITE	GP-3766	1804442C1	ACEITE, FLUJO TOTAL (FULL FLOW)	G-33	302574R91
GASOLINA	G-293	548348-C1	COMBUSTIBLE	GP-155	1804459C1	COMBUSTIBLE, PRIMARIO	GP-26	23518481
COMBUSTIBLE, SEPARADOR DE AGUA	GPP-547	1677004C91	AIRE	GA-422	588213C1	COMBUSTIBLE, SECUNDARIO	GP-27	23518482
ACEITE	GP-3766	1804442C1	AIRE	GA-209	476710C1	400 TRANSTAR SERIES con motores/GMC 6-71, GMC 6V-71		
COMBUSTIBLE	GP-155	1804459C1	AIRE, SECUNDARIO	GA-210	482644C1	ACEITE, DERIVACION (BY PASS)	G-31	5181127
AIRE	GA-422	588213C1	AIRE	GA-197R	1691027C1	ACEITE, FLUJO TOTAL (FULL FLOW)	G-33	302574R91
AIRE	GA-209	476710C1	3900 con motor/IHC DT360			COMBUSTIBLE, SECUNDARIO	G-1175	432419R91
AIRE, SECUNDARIO	GA-210	482644C1	DIRECCION	G-162H	1691121C1	AIRE, SIN ASPAS	GA-27	8873271
AIRE	GA-197R	1691027C1	DIRECCION	G-169	279294C92	4000 SERIES con motor/GMC 8V-71N		
3700 con motor/IHC DT360			GASOLINA	G-293	548348-C1	ACEITE, FLUJO TOTAL (FULL FLOW)	G-33	302574R91
DIRECCION	G-162H	1691121C1	COMBUSTIBLE, SEPARADOR DE AGUA	GPP-547	1677004C91	COMBUSTIBLE, SECUNDARIO	G-1175	432419R91
DIRECCION	G-169	279294C92	ACEITE	GP-88	1811953C1	AIRE, SIN ASPAS	GA-26	304766C91
GASOLINA	G-293	548348-C1	COMBUSTIBLE	GP-78	1809789C1	4000 SERIES con motor/IHC DVT573		
COMBUSTIBLE, SEPARADOR DE AGUA	GPP-547	1677004C91	AIRE	GA-373	1685556C1	COMBUSTIBLE, PRIMARIO	GP-1108	625626C1
ACEITE	GP-88	1811953C1	AIRE	GA-209	476741C1	4000 SERIES con motores/GMC 6-71, GMC 6V-71N		
COMBUSTIBLE	GP-78	1809789C1	AIRE, SECUNDARIO	GA-210	482644C1	ACEITE, FLUJO TOTAL (FULL FLOW)	G-33	302574R91
AIRE	GA-373	1685556C1	AIRE	GA-197R	1691027C1	COMBUSTIBLE, SECUNDARIO	G-1175	432419R91
AIRE	GA-209	476741C1	3900, 3400, 3600, 3700, 3800 con motor/IHC DT466E			AIRE, SIN ASPAS	GA-27	8873271
AIRE, SECUNDARIO	GA-210	482644C1	DIRECCION	G-162H	1691121C1	4000 SERIES con motor/IHC DV573		
AIRE	GA-197R	1691027C1	DIRECCION	G-169	279294C92	COMBUSTIBLE, PRIMARIO	GP-1108	625626C1
3700, 3800, 3900 con motor/IHC T444E			GASOLINA	G-293	548348-C1	4000 SERIES con motores/GMC 6-71, GMC 6V-71N		
DIRECCION	G-162H	1691121C1	COMBUSTIBLE, SEPARADOR DE AGUA	GPP-547	1677004C91	ACEITE, FLUJO TOTAL (FULL FLOW)	G-33	302574R91
COMBUSTIBLE, 1999-2000	G-862	1825864C92	ACEITE	GP-88	1811953C1	COMBUSTIBLE, SECUNDARIO	G-1175	432419R91
COMBUSTIBLE, SEPARADOR DE AGUA	G-178	1822631C91	COMBUSTIBLE	GP-78	1809789C1	AIRE, SIN ASPAS	GA-27	8873271
ACEITE	GP-562	1814562C1	AIRE	GA-373	1685556C1	4000 SERIES con motores/IHC DV462, IHC DV550		
AIRE	GA-373	1685556C1	AIRE, SECUNDARIO	GA-210	482644C1	ACEITE	GP-10	427207C2
AIRE	GA-209	476741C1	AIRE	GA-197R	1691027C1	COMBUSTIBLE, PRIMARIO	GP-1108	625626C1
AIRE, SECUNDARIO	GA-210	482644C1	3900, 3400, 3600, 3700, 3800 con motor/IHC DT466E			COMBUSTIBLE, SECUNDARIO	GP-78	672603C1
AIRE	GA-197R	1691027C1	DIRECCION	G-162H	1691121C1	4070 TRANSTAR II SERIES con motor/CATERPILLAR 3406		
3800 con motor/IHC 7.3L			DIRECCION	G-169	279294C92	ACEITE, CUMPLE CON MEDI-DAS ORIGINALES	GP-691	1R0716
DIRECCION	G-162H	1691121C1	GASOLINA	G-293	548348-C1	ACEITE, SEGUNDA OPCION	GP-52	1R0716
DIRECCION	G-169	279294C92	COMBUSTIBLE, SEPARADOR DE AGUA	GPP-547	1677004C91	COMBUSTIBLE	GP-1108	625626C1
GASOLINA	G-293	548348-C1	ACEITE	GP-3766	1804442C1	AGUA	GP-2071W	1809789C1
COMBUSTIBLE, SEPARADOR DE AGUA	GPP-547	1677004C91	COMBUSTIBLE	GP-155	1804459C1	AIRE	GA-376	420051C1
ACEITE	GP-3766	1804442C1	AIRE	GA-422	588213C1			
COMBUSTIBLE	GP-155	1804459C1	AIRE	GA-209	476710C1			
AIRE	GA-422	588213C1	AIRE, SECUNDARIO	GA-210	482644C1			
			AIRE	GA-197R	1691027C1			
			3900FC con motor/IHC DT360					
			DIRECCION	G-162H	1691121C1			
			DIRECCION	G-169	279294C92			
			GASOLINA	G-293	548348-C1			

SERVICIO PESADO

MARCA-MODELO-MOTOR MAKE-MODEL-ENGINE	GONHER GONHER	OEM OEM	MARCA-MODELO-MOTOR MAKE-MODEL-ENGINE	GONHER GONHER	OEM OEM	MARCA-MODELO-MOTOR MAKE-MODEL-ENGINE	GONHER GONHER	OEM OEM
I.H.C. HARVESTER (continuación)			I.H.C. HARVESTER (continuación)			I.H.C. HARVESTER (continuación)		
CAMIONES, TRACTOCAMIONES Y AUTOBUSES			CAMIONES, TRACTOCAMIONES Y AUTOBUSES			CAMIONES, TRACTOCAMIONES Y AUTOBUSES		
4070 TRANSTAR II SERIES con motor/CUMMINS			COMBUSTIBLE	GP-1108	625626C1	4370 TRANSTAR SERIES con motores/GMC 8V-92, GMC 6V-92, GMC 8V-71		
ACEITE, CARTUCHO PARA FLUJO TOTAL (FULL FLOW)	G-566	244523-R91	AGUA	GP-2071W	1809789C1	ACEITE, FLUJO TOTAL (FULL FLOW)	G-33	302574R91
ACEITE, TURBOCARGADOR	GP-14	998457-R91	AIRE	GA-376	420051C1	COMBUSTIBLE, PRIMARIO	GP-26	23518481
COMBUSTIBLE, 5 17/32 IN	GP-1101	244458R91	4270 TRANSTAR SERIES con motor/IHC V800			COMBUSTIBLE, SECUNDARIO	GP-27	23518482
ACEITE, SELLADO FLUJO TOTAL (FULL FLOW)	GP-53	1212622H1	COMBUSTIBLE, SEPARADOR DE AGUA	GPP-14	674293C1	AIRE	GA-376	420051C1
COMBUSTIBLE, 11 15/32 IN	GP-55	3313306	COMBUSTIBLE, SECUNDARIO	GP-1107	702143C1	4400 con motor/IHC 530E		
COMBUSTIBLE	GPP-11	1214920H1	COMBUSTIBLE, PRIMARIO	GP-1108	625626C1	AGUA	GP-2071W	1822313C1
AGUA	GP-2071W	1809789C1	AGUA	GP-2071W	1809789C1	COMBUSTIBLE	GP-78	1822588C1
AIRE, RESPIRADOR	GA-39	255963	COMBUSTIBLE, SECUNDARIO	GP-78	672603C1	ACEITE	GP-152	1819452C1
AIRE, SIN ASPAS	GA-27	8873271	4270 TRANSTAR SERIES con motores/GMC 6V-92, GMC 8V-71, GMC 8V-92			AIRE	GA-799R	3532799C1
AIRE	GA-376	420051C1	ACEITE, FLUJO TOTAL (FULL FLOW)	G-33	302574R91	4400 con motor/IHC DT466E		
ACEITE, DERIVACION (BY PASS)	G-750	689032R91	COMBUSTIBLE, PRIMARIO	GP-26	23518481	COMBUSTIBLE	GP-78	1822588C1
4070 TRANSTAR II SERIES con motor/GMC			COMBUSTIBLE, SECUNDARIO	GP-27	23518482	ACEITE	GP-152	1833121C1
ACEITE, CARTUCHO PARA FLUJO TOTAL (FULL FLOW)	G-33	302574R91	AIRE	GA-376	420051C1	AIRE	GA-799R	3532799C1
COMBUSTIBLE, PRIMARIO	GP-26	23518481	4270 TRANSTAR SERIES, 4370 TRANSTAR SERIES con motor/CUMMINS			4400 con motor/IHC DT466HT		
COMBUSTIBLE, SECUNDARIO	GP-27	23518482	ACEITE, CARTUCHO PARA FLUJO TOTAL (FULL FLOW)	G-566	244523-R91	AIRE, PRIMARIO	GA-799R	3532799C1
ACEITE, SELLADO FLUJO TOTAL (FULL FLOW)	GP-43	A77537	DIRECCION	G-169	279294C91	4400 con motor/IHC DT530		
AIRE	GA-376	420051C1	COMBUSTIBLE	GP-1101	244458R91	COMBUSTIBLE	GP-78	672603C1
4070 TRANSTAR II SERIES con motor/IHC V800			ACEITE, SELLADO FLUJO TOTAL (FULL FLOW)	GP-53	1212622H1	4400 con motor/IHC DT570		
COMBUSTIBLE, SEPARADOR DE AGUA	GPP-14	674293C1	AGUA	GP-2071W	1809789C1	AGUA, SISTEMA DE ENFRIAMIENTO	GP-2071W	WF2071
COMBUSTIBLE, SECUNDARIO	GP-1107	702143C1	AIRE	GA-376	420051C1	AIRE, PRIMARIO	GA-799R	3532799-C1
COMBUSTIBLE, PRIMARIO	GP-1108	625626C1	ACEITE, DERIVACION (BY PASS)	G-750	689032R91	AIRE, SECUNDARIO	GA-798R	3532800-C1
AGUA	GP-2071W	1809789C1	4300 con motor/CUMMINS			4400LP con motores/IHC DT466HT, IHC DT570		
COMBUSTIBLE, SECUNDARIO	GP-78	672603C1	ACEITE, CARTUCHO PARA FLUJO TOTAL (FULL FLOW)	G-566	244523-R91	AIRE, PRIMARIO	GA-799R	3532799C1
AIRE	GA-376	420051C1	DIRECCION	G-169	279294C91	4500 con motor/IHC 530		
4100 con motor/IHC VT365			COMBUSTIBLE	GP-1101	244458R91	DIRECCION	G-162H	1691121C1
COMBUSTIBLE	G-862	1825864C92	ACEITE, SELLADO FLUJO TOTAL (FULL FLOW)	GP-53	1212622H1	GASOLINA	G-293	548348-C1
ACEITE	G-3752	1840752C91	AGUA	GP-2071W	1809789C1	COMBUSTIBLE, SEPARADOR DE AGUA	GPP-547	1677004C91
AIRE, RADIAL	GA-799R	3532799C1	AIRE	GA-376	420051C1	COMBUSTIBLE	GP-1122	3132428R1
4100 TRANSTAR CONCHO con motor/CUMMINS			ACEITE, DERIVACION (BY PASS)	G-750	689032R91	AGUA	GP-2071W	1822313C1
COMBUSTIBLE, 5 17/32 IN	GP-1101	244458R91	4300 con motor/IHC DT466E			COMBUSTIBLE	GP-78	1822588C1
ACEITE, SELLADO FLUJO TOTAL (FULL FLOW)	GP-53	1212622H1	COMBUSTIBLE, SELLADO	GP-78	1822588-C1	ACEITE	GP-152	1819452C1
COMBUSTIBLE, 11 15/32 IN	GP-55	3313306	ACEITE, FLUJO TOTAL (FULL FLOW)	GP-152	1819452-C1	AIRE, PRIMARIO	GA-209	476741C1
COMBUSTIBLE	GPP-11	1214920H1	AIRE, PRIMARIO	GA-799R	3532799-C1	AIRE, SECUNDARIO	GA-210	482644C1
AIRE, RESPIRADOR	GA-39	255963	AIRE, SECUNDARIO	GA-798R	3532800-C1	4500 con motor/IHC 7.3L		
ACEITE, DERIVACION (BY PASS)	G-750	689032R91	4300LP con motor/IHC DT466E			DIRECCION	G-162H	1691121C1
4100 TRANSTAR CONCHO con motores/GMC 8V-71, GMC 8V-92T			AGUA, SISTEMA DE ENFRIAMIENTO	GP-2071W	WF2071	DIRECCION	G-169	279294C92
ACEITE, CARTUCHO PARA FLUJO TOTAL (FULL FLOW)	G-33	302574R91	4370 TRANSTAR SERIES con motor/CATERPILLAR 3406			GASOLINA	G-293	548348-C1
COMBUSTIBLE, PRIMARIO	GP-26	23518481	ACEITE, CUMPLE CON MEDI-DAS ORIGINALES	GP-691	1R0716	COMBUSTIBLE, SEPARADOR DE AGUA	GPP-547	1677004C91
COMBUSTIBLE, SECUNDARIO	GP-27	23518482	ACEITE, SEGUNDA OPCION	GP-52	1R0716	ACEITE	GP-3766	1804442C1
ACEITE, DERIVACION (BY PASS)	G-750	689032R91	COMBUSTIBLE	GP-1108	625626C1	COMBUSTIBLE	GP-155	1804459C1
4200 con motor/IHC VT365			AGUA	GP-2071W	1809789C1	AIRE	GA-422	588213C1
COMBUSTIBLE	G-862	1825864-C92	AIRE	GA-376	420051C1	AIRE, PRIMARIO	GA-209	476741C1
ACEITE	G-3752	1840752-C91	4370 TRANSTAR SERIES con motor/IHC V800			AIRE, SECUNDARIO	GA-210	482644C1
AIRE, RADIAL	GA-799R	3532799-C1	COMBUSTIBLE, SEPARADOR DE AGUA	GPP-14	674293C1	4500 con motor/IHC DT408		
4200LP con motor/IHC VT365			COMBUSTIBLE, SECUNDARIO	GP-1107	702143C1	DIRECCION	G-162H	1691121C1
COMBUSTIBLE	G-862	1825864C92	COMBUSTIBLE, PRIMARIO	GP-1108	625626C1	GASOLINA	G-293	548348-C1
ACEITE	G-3752	1840752C91	AGUA	GP-2071W	1809789C1	COMBUSTIBLE, SEPARADOR DE AGUA	GPP-547	1677004C91
AIRE, RADIAL	GA-799R	3532799C1	AIRE	GA-376	420051C1	COMBUSTIBLE	GP-1122	3132428R1
4270 TRANSTAR SERIES con motor/CATERPILLAR 3406			4370 TRANSTAR SERIES con motor/IHC V800			AGUA	GP-2071W	1822313C1
ACEITE, CUMPLE CON MEDI-DAS ORIGINALES	GP-691	1R0716	COMBUSTIBLE, SEPARADOR DE AGUA	GPP-14	674293C1	COMBUSTIBLE	GP-78	1822588C1
ACEITE, SEGUNDA OPCION	GP-52	1R0716	COMBUSTIBLE, SECUNDARIO	GP-1107	702143C1			

MARCA-MODELO-MOTOR	GONHER	OEM	MARCA-MODELO-MOTOR	GONHER	OEM	MARCA-MODELO-MOTOR	GONHER	OEM
MAKE-MODEL-ENGINE	GONHER	OEM	MAKE-MODEL-ENGINE	GONHER	OEM	MAKE-MODEL-ENGINE	GONHER	OEM
I.H.C. HARVESTER (continuación)			I.H.C. HARVESTER (continuación)			I.H.C. HARVESTER (continuación)		
CAMIONES, TRACTOCAMIONES Y AUTOBUSES			CAMIONES, TRACTOCAMIONES Y AUTOBUSES			CAMIONES, TRACTOCAMIONES Y AUTOBUSES		
ACEITE	GP-152	1819452C1	4600 con motor/IHC DT408			GASOLINA	G-293	548348-C1
AIRE, PRIMARIO	GA-209	476741C1	DIRECCION	G-162H	1691121C1	COMBUSTIBLE, SEPARADOR DE AGUA	GPP-547	1677004C91
AIRE, SECUNDARIO	GA-210	482644C1	GASOLINA	G-293	548348-C1	ACEITE	GP-88	1811953C1
4500 con motor/IHC T444E			COMBUSTIBLE, SEPARADOR DE AGUA	GPP-547	1677004C91	COMBUSTIBLE	GP-78	1809789C1
DIRECCION	G-162H	1691121C1	COMBUSTIBLE	GP-1122	3132428R1	AIRE, PRIMARIO	GA-209	476741C1
COMBUSTIBLE, SEPARADOR DE AGUA	G-178	1822631C91	AGUA	GP-2071W	1822313C1	AIRE, SECUNDARIO	GA-210	482644C1
AGUA	GP-2071W	1822627C1	COMBUSTIBLE	GP-78	1822588C1	4600LP, 4900 SERIES con motor/IHC T444E		
ACEITE	GP-562	1814562C1	ACEITE	GP-152	1819452C1	DIRECCION	G-162H	1691121C1
AIRE, PRIMARIO	GA-209	476741C1	AIRE, PRIMARIO	GA-209	476741C1	COMBUSTIBLE, SEPARADOR DE AGUA	G-178	1822631C91
AIRE, SECUNDARIO	GA-210	482644C1	AIRE, SECUNDARIO	GA-210	482644C1	AGUA	GP-2071W	1822627C1
AIRE	GA-197R	1691027C1	4600 SERIES con motor/IHC 7.3L			ACEITE	GP-562	1814562C1
4500, 4600, 4800 con motor/IHC DT360			ACEITE	GP-3766	1804442C1	AIRE, PRIMARIO	GA-209	476741C1
DIRECCION	G-162H	1691121C1	4600, 4800 con motor/IHC T444E			AIRE, SECUNDARIO	GA-210	482644C1
DIRECCION	G-169	279294C92	DIRECCION	G-162H	1691121C1	AIRE	GA-197R	1691027C1
GASOLINA	G-293	548348-C1	COMBUSTIBLE, SEPARADOR DE AGUA	GPP-547	1677004C91	4700 SERIES con motor/IHC 530		
COMBUSTIBLE, SEPARADOR DE AGUA	GPP-547	1677004C91	DIRECCION	G-162H	1691121C1	DIRECCION	G-162H	1691121C1
ACEITE	GP-88	1811953C1	COMBUSTIBLE, SEPARADOR DE AGUA	G-178	1822631C91	GASOLINA	G-293	548348-C1
COMBUSTIBLE	GP-78	1809789C1	AGUA	GP-2071W	1822627C1	COMBUSTIBLE, SEPARADOR DE AGUA	GPP-547	1677004C91
AIRE, PRIMARIO	GA-209	476741C1	ACEITE	GP-562	1814562C1	COMBUSTIBLE	GP-1122	3132428R1
AIRE, SECUNDARIO	GA-210	482644C1	AIRE, PRIMARIO	GA-209	476741C1	AGUA	GP-2071W	1822313C1
4500, 4600, 4800, 4600LP, 4700 SERIES, 4700LP, 4900 SERIES con motor/IHC DT466			AIRE, SECUNDARIO	GA-210	482644C1	COMBUSTIBLE	GP-78	1822588C1
DIRECCION	G-162H	1691121C1	AIRE	GA-197R	1691027C1	ACEITE	GP-152	1819452C1
DIRECCION (1990-93)	G-169	279294C92	4600LP con motor/IHC 530			AIRE, PRIMARIO	GA-209	476741C1
COMBUSTIBLE, PRIMARIO 1990-93	GP-1101	625625C1	DIRECCION	G-162H	1691121C1	AIRE, SECUNDARIO	GA-210	482644C1
GASOLINA	G-293	548348-C1	GASOLINA	G-293	548348-C1	4700 SERIES con motor/IHC 7.3L		
COMBUSTIBLE, SEPARADOR DE AGUA	GPP-547	1677004C91	COMBUSTIBLE, SEPARADOR DE AGUA	GPP-547	1677004C91	DIRECCION	G-162H	1691121C1
COMBUSTIBLE, 1994-98	GP-1122	3132428R1	COMBUSTIBLE	GP-1122	3132428R1	DIRECCION	G-169	279294C92
ACEITE, HASTA 1990	GP-69	675616C91	AGUA	GP-2071W	1822313C1	GASOLINA	G-293	548348-C1
COMBUSTIBLE, PRIMARIO 1990-93	GP-1108	625627C1	COMBUSTIBLE	GP-78	1822588C1	COMBUSTIBLE, SEPARADOR DE AGUA	GPP-547	1677004C91
ACEITE, 1990-93	GP-88	1811953C1	ACEITE	GP-152	1819452C1	ACEITE	GP-3766	1804442C1
AGUA, 1994-98	GP-2071W	1822313C1	AIRE, PRIMARIO	GA-209	476741C1	COMBUSTIBLE	GP-155	1804459C1
COMBUSTIBLE, SECUNDARIO	GP-78	1809789C1	AIRE, SECUNDARIO	GA-210	482644C1	AIRE	GA-422	588213C1
ACEITE, 1994-98	GP-152	1819452C1	4600LP con motor/IHC 7.3L			AIRE, PRIMARIO	GA-209	476741C1
AIRE, PRIMARIO	GA-209	476741C1	DIRECCION	G-162H	1691121C1	AIRE, SECUNDARIO	GA-210	482644C1
AIRE, SECUNDARIO	GA-210	482644C1	DIRECCION	G-169	279294C92	4700 SERIES con motor/IHC DT408		
4600 con motor/IHC 530			GASOLINA	G-293	548348-C1	DIRECCION	G-162H	1691121C1
DIRECCION	G-162H	1691121C1	COMBUSTIBLE, SEPARADOR DE AGUA	GPP-547	1677004C91	GASOLINA	G-293	548348-C1
GASOLINA	G-293	548348-C1	ACEITE	GP-3766	1804442C1	COMBUSTIBLE, SEPARADOR DE AGUA	GPP-547	1677004C91
COMBUSTIBLE, SEPARADOR DE AGUA	GPP-547	1677004C91	COMBUSTIBLE	GP-155	1804459C1	COMBUSTIBLE	GP-1122	3132428R1
COMBUSTIBLE	GP-1122	3132428R1	AIRE	GA-422	588213C1	AGUA	GP-2071W	1822313C1
AGUA	GP-2071W	1822313C1	AIRE, PRIMARIO	GA-209	476741C1	COMBUSTIBLE	GP-78	1822588C1
COMBUSTIBLE	GP-78	1822588C1	AIRE, SECUNDARIO	GA-210	482644C1	ACEITE	GP-152	1819452C1
ACEITE	GP-152	1819452C1	4600LP con motor/IHC DT408			AIRE, PRIMARIO	GA-209	476741C1
AIRE, PRIMARIO	GA-209	476741C1	DIRECCION	G-162H	1691121C1	AIRE, SECUNDARIO	GA-210	482644C1
AIRE, SECUNDARIO	GA-210	482644C1	GASOLINA	G-293	548348-C1	4700 SERIES con motor/IHC DTA360		
4600 con motor/IHC 7.3L			COMBUSTIBLE, SEPARADOR DE AGUA	GPP-547	1677004C91	ACEITE	GP-88	1811953C1
DIRECCION	G-162H	1691121C1	COMBUSTIBLE	GP-1122	3132428R1	COMBUSTIBLE	GP-78	1809789C1
DIRECCION	G-169	279294C92	AGUA	GP-2071W	1822313C1	AIRE	GA-209	476741C1
GASOLINA	G-293	548348-C1	COMBUSTIBLE	GP-78	1822588C1	4700 SERIES con motor/IHC T444E		
COMBUSTIBLE, SEPARADOR DE AGUA	GPP-547	1677004C91	ACEITE	GP-152	1819452C1	DIRECCION	G-162H	1691121C1
ACEITE	GP-3766	1804442C1	AIRE, PRIMARIO	GA-209	476741C1	COMBUSTIBLE, SEPARADOR DE AGUA 1999-01	G-862	1825864C92
COMBUSTIBLE	GP-155	1804459C1	AIRE, SECUNDARIO	GA-210	482644C1	COMBUSTIBLE, SEPARADOR DE AGUA	G-178	1822631C91
AIRE	GA-422	588213C1	4600LP, 4700 SERIES con motor/IHC DT360			AGUA	GP-2071W	1822627C1
AIRE, PRIMARIO	GA-209	476741C1	DIRECCION	G-162H	1691121C1	ACEITE	GP-562	1814562C1
AIRE, SECUNDARIO	GA-210	482644C1	DIRECCION	G-169	279294C92			

SERVICIO PESADO

MARCA-MODELO-MOTOR MAKE-MODEL-ENGINE	GONHER GONHER	OEM OEM	MARCA-MODELO-MOTOR MAKE-MODEL-ENGINE	GONHER GONHER	OEM OEM	MARCA-MODELO-MOTOR MAKE-MODEL-ENGINE	GONHER GONHER	OEM OEM
I.H.C. HARVESTER (continuación)			I.H.C. HARVESTER (continuación)			I.H.C. HARVESTER (continuación)		
CAMIONES, TRACTOCAMIONES Y AUTOBUSES			CAMIONES, TRACTOCAMIONES Y AUTOBUSES			CAMIONES, TRACTOCAMIONES Y AUTOBUSES		
AIRE, PRIMARIO	GA-209	476741C1	AGUA	GP-2071W	1822627C1	4900 SERIES con motor/IHC 7.3L		
AIRE, SECUNDARIO	GA-210	482644C1	ACEITE	GP-562	1814562C1	DIRECCION	G-162H	1691121C1
AIRE	GA-197R	1691027C1	AIRE, PRIMARIO	GA-209	476741C1	DIRECCION	G-169	279294C92
4700 SERIES con motores/IHC DT466E, IHC DTA466			AIRE, SECUNDARIO	GA-210	482644C1	GASOLINA	G-293	548348-C1
COMBUSTIBLE, SEPARADOR DE AGUA	GPP-547	1618385C94	AIRE	GA-197R	1691027C1	COMBUSTIBLE, SEPARADOR DE AGUA	GPP-547	1677004C91
COMBUSTIBLE, PRIMARIO	GP-1108	625626C1	4800 con motor/IHC 530			ACEITE	GP-3766	1804442C1
ACEITE, HASTA 1994	GP-88	1811953C1	DIRECCION	G-162H	1691121C1	COMBUSTIBLE	GP-155	1804459C1
AGUA	GP-2071W	1822313C1	GASOLINA	G-293	548348-C1	AIRE	GA-422	588213C1
COMBUSTIBLE, SECUNDARIO	GP-78	672603C3	COMBUSTIBLE, SEPARADOR DE AGUA	GPP-547	1677004C91	AIRE, PRIMARIO	GA-209	476741C1
ACEITE, 1994 EN ADELANTE	GP-152	1819452C1	COMBUSTIBLE	GP-1122	3132428R1	AIRE, SECUNDARIO	GA-210	482644C1
AIRE, PRIMARIO	GA-209	476741C1	AGUA	GP-2071W	1822313C1	4900 SERIES con motor/IHC DT360		
AIRE, SECUNDARIO	GA-210	482644C1	COMBUSTIBLE	GP-78	1822588C1	DIRECCION	G-162H	1691121C1
4700LP con motor/IHC 530			ACEITE	GP-152	1819452C1	DIRECCION	G-169	279294C92
DIRECCION	G-162H	1691121C1	AIRE, PRIMARIO	GA-209	476741C1	GASOLINA	G-293	548348-C1
GASOLINA	G-293	548348-C1	AIRE, SECUNDARIO	GA-210	482644C1	COMBUSTIBLE, SEPARADOR DE AGUA	GPP-547	1677004C91
COMBUSTIBLE, SEPARADOR DE AGUA	GPP-547	1677004C91	4800 con motor/IHC 7.3L			ACEITE	GP-88	1811953C1
COMBUSTIBLE	GP-1122	3132428R1	DIRECCION	G-162H	1691121C1	COMBUSTIBLE	GP-78	1809789C1
AGUA	GP-2071W	1822313C1	DIRECCION	G-169	279294C92	AIRE, PRIMARIO	GA-209	476741C1
COMBUSTIBLE	GP-78	1822588C1	GASOLINA	G-293	548348-C1	AIRE, SECUNDARIO	GA-210	482644C1
ACEITE	GP-152	1819452C1	COMBUSTIBLE, SEPARADOR DE AGUA	GPP-547	1677004C91	4900 SERIES con motor/IHC DT408		
AIRE, PRIMARIO	GA-209	476741C1	ACEITE	GP-3766	1804442C1	DIRECCION	G-162H	1691121C1
AIRE, SECUNDARIO	GA-210	482644C1	COMBUSTIBLE	GP-155	1804459C1	GASOLINA	G-293	548348-C1
4700LP con motor/IHC 7.3L			AIRE	GA-422	588213C1	COMBUSTIBLE, SEPARADOR DE AGUA	GPP-547	1677004C91
DIRECCION	G-162H	1691121C1	AIRE, PRIMARIO	GA-209	476741C1	COMBUSTIBLE	GP-1122	3132428R1
DIRECCION	G-169	279294C92	AIRE, SECUNDARIO	GA-210	482644C1	AGUA	GP-2071W	1822313C1
GASOLINA	G-293	548348-C1	4800 con motor/IHC DT408			COMBUSTIBLE	GP-78	1822588C1
COMBUSTIBLE, SEPARADOR DE AGUA	GPP-547	1677004C91	DIRECCION	G-162H	1691121C1	ACEITE	GP-152	1819452C1
ACEITE	GP-3766	1804442C1	GASOLINA	G-293	548348-C1	AIRE, PRIMARIO	GA-209	476741C1
COMBUSTIBLE	GP-155	1804459C1	COMBUSTIBLE, SEPARADOR DE AGUA	GPP-547	1677004C91	AIRE, SECUNDARIO	GA-210	482644C1
AIRE	GA-422	588213C1	COMBUSTIBLE	GP-1122	3132428R1	4900 SERIES con motores/IHC DT466E, IHC DTA466		
AIRE, PRIMARIO	GA-209	476741C1	AGUA	GP-2071W	1822313C1	COMBUSTIBLE, SEPARADOR DE AGUA	GPP-547	1618385C94
AIRE, SECUNDARIO	GA-210	482644C1	COMBUSTIBLE	GP-78	1822588C1	COMBUSTIBLE, PRIMARIO	GP-1108	625626C1
4700LP con motor/IHC DT360			ACEITE	GP-152	1819452C1	ACEITE, HASTA 1994	GP-88	1811953C1
DIRECCION	G-162H	1691121C1	AIRE, PRIMARIO	GA-209	476741C1	AGUA	GP-2071W	1822313C1
DIRECCION	G-169	279294C92	AIRE, SECUNDARIO	GA-210	482644C1	COMBUSTIBLE, SECUNDARIO	GP-78	672603C3
GASOLINA	G-293	548348-C1	4800 con motor/IHC DT466E			ACEITE, 1994 EN ADELANTE	GP-152	1819452C1
COMBUSTIBLE, SEPARADOR DE AGUA	GPP-547	1677004C91	AGUA	GP-2071W	1822313C1	AIRE, PRIMARIO	GA-209	476741C1
ACEITE	GP-88	1811953C1	COMBUSTIBLE	GP-78	1822588C1	AIRE, SECUNDARIO	GA-210	482644C1
COMBUSTIBLE	GP-78	1809789C1	ACEITE	GP-152	1819452C1	4970 TRANSTAR II SERIES con motor/CATERPILLAR 3406		
AIRE, PRIMARIO	GA-209	476741C1	AIRE, 2000-01	GA-209	476741C1	ACEITE, CUMPLE CON MEDI- DAS ORIGINALES	GP-691	1R0716
AIRE, SECUNDARIO	GA-210	482644C1	AIRE, HASTA 1999	GA-221R	2005895C1	ACEITE, SEGUNDA OPCION	GP-52	1R0716
4700LP con motor/IHC DT408			4900 SERIES con motor/DETROIT DIESEL SERIES 60			COMBUSTIBLE	GP-1108	625626C1
DIRECCION	G-162H	1691121C1	COMBUSTIBLE, PRIMARIO	GP-26	6438839	AGUA	GP-2071W	1809789C1
DIRECCION	G-169	279294C92	COMBUSTIBLE, SECUNDARIO	GP-27	23518482	4970 TRANSTAR II SERIES con motor/CUMMINS		
GASOLINA	G-293	548348-C1	ACEITE	GP-193	23518480	COMBUSTIBLE, 5 17/32 IN	GP-1101	244458R91
COMBUSTIBLE, SEPARADOR DE AGUA	GPP-547	1677004C91	4900 SERIES con motor/IHC 530			ACEITE, FLUJO TOTAL (FULL FLOW)	GP-53	1212622H1
COMBUSTIBLE	GP-1122	3132428R1	DIRECCION	G-162H	1691121C1	COMBUSTIBLE, 11 15/32 IN	GP-55	3313306
AGUA	GP-2071W	1822313C1	GASOLINA	G-293	548348-C1	COMBUSTIBLE, SEPARADOR DE AGUA	GPP-11	1214920H1
COMBUSTIBLE	GP-78	1822588C1	COMBUSTIBLE, SEPARADOR DE AGUA	GPP-547	1677004C91	AIRE, RESPIRADOR	GA-39	255963
ACEITE	GP-152	1819452C1	COMBUSTIBLE	GP-1122	3132428R1	ACEITE, DERIVACION (BY PASS)	G-750	689032R91
AIRE, PRIMARIO	GA-209	476741C1	AGUA	GP-2071W	1822313C1	4970 TRANSTAR II SERIES con motores/GMC 8V-71, GMC 8V-92T		
AIRE, SECUNDARIO	GA-210	482644C1	COMBUSTIBLE	GP-78	1822588C1	ACEITE	G-33	302574R91
4700LP, 4700LPX con motor/IHC T444E			ACEITE	GP-152	1819452C1	COMBUSTIBLE, PRIMARIO	GP-26	23518481
DIRECCION	G-162H	1691121C1	AIRE, PRIMARIO	GA-209	476741C1	COMBUSTIBLE, SECUNDARIO	GP-27	23518482
COMBUSTIBLE, SEPARADOR DE AGUA 1999-01	G-862	1825864C92	AIRE, SECUNDARIO	GA-210	482644C1			
COMBUSTIBLE, SEPARADOR DE AGUA	G-178	1822631C91						

APLICACIONES SERVICIO PESADO
HEAVY DUTY APPLICATIONS



MARCA-MODELO-MOTOR MAKE-MODEL-ENGINE	GONHER GONHER	OEM OEM	MARCA-MODELO-MOTOR MAKE-MODEL-ENGINE	GONHER GONHER	OEM OEM	MARCA-MODELO-MOTOR MAKE-MODEL-ENGINE	GONHER GONHER	OEM OEM
I.H.C. HARVESTER (continuación)			I.H.C. HARVESTER (continuación)			I.H.C. HARVESTER (continuación)		
CAMIONES, TRACTOCAMIONES Y AUTOBUSES			CAMIONES, TRACTOCAMIONES Y AUTOBUSES			CAMIONES, TRACTOCAMIONES Y AUTOBUSES		
5000 con motor/CUMMINS M11			5050 PAYSTAR SERIES con motor/IHC DV550B			5900I con motor/CUMMINS N14 PLUS		
COMBUSTIBLE, SEPARADOR DE AGUA	GPP-11	1214920H1	ACEITE	GP-10	427207C2	ACEITE, DOBLE FLUJO	GP-3001	3318853
5000 PAYSTAR con motor/CATERPILLAR 3176			COMBUSTIBLE, SECUNDARIO SELLADO	GP-1107	702143C1	5900I, 5500I, 5600I con motores/CATERPILLAR C10, CATERPILLAR C12		
ACEITE, CUMPLE CON MEDI-DAS ORIGINALES	GP-691	1R0716	COMBUSTIBLE, PRIMARIO SELLADO	GP-1108	625626C1	COMBUSTIBLE	GP-749	1R0749
ACEITE, SEGUNDA OPCION	GP-52	1R0716	5050 PAYSTAR SERIES con motores/CUMMINS V555, CUMMINS VT555			ACEITE, CUMPLE CON MEDI-DAS ORIGINALES	GP-691	1R0716
COMBUSTIBLE, SELLADO	GP-1108	625626C1	ACEITE, CARTUCHO PARA FLUJO TOTAL (FULL FLOW)	G-566	244523-R91	ACEITE, SEGUNDA OPCION	GP-52	1R0716
5000 PAYSTAR con motor/CATERPILLAR 3306			COMBUSTIBLE	GP-1101	244458R91	700, 900 con motores/NISSAN NE6, NISSAN NE6T		
ACEITE	GP-51	1R0739	ACEITE, SELLADO FLUJO TOTAL (FULL FLOW)	GP-53	1212622H1	COMBUSTIBLE	GP-110	702142C1
5000 PAYSTAR con motor/GMC			AGUA	GP-2071W	1809789C1	7070 CONCHO SERIES con motor/CUMMINS NTC290		
ACEITE, FLUJO TOTAL (FULL FLOW)	G-33	302574R91	ACEITE, DERIVACION (BY PASS)	G-500	156839	ACEITE, CARTUCHO PARA FLUJO TOTAL (FULL FLOW)	G-566	244523-R91
COMBUSTIBLE, SECUNDARIO CARTUCHO	G-1175	432419R91	5070 PAYSTAR SERIES con motor/CUMMINS			COMBUSTIBLE	GP-1101	244458R91
COMBUSTIBLE, PRIMARIO SELLADO	GP-26	23518481	ACEITE, CARTUCHO PARA FLUJO TOTAL (FULL FLOW)	G-566	244523-R91	ACEITE, SELLADO FLUJO TOTAL (FULL FLOW)	GP-53	1212622H1
COMBUSTIBLE, SECUNDARIO SELLADO	GP-27	23518482	COMBUSTIBLE	GP-1101	244458R91	AGUA	GP-2071W	1809789C1
AIRE	GA-2984	472098C1	ACEITE, SELLADO FLUJO TOTAL (FULL FLOW)	GP-53	1212622H1	ACEITE, DERIVACION (BY PASS)	G-750	689032R91
ACEITE, DERIVACION (BY PASS)	G-750	689032R91	AGUA	GP-2071W	1809789C1	7100 SERIES con motores/IHC DT466, IHC DTA466		
5000 PAYSTAR con motor/IHC DT530			ACEITE, DERIVACION (BY PASS)	G-750	689032R91	COMBUSTIBLE	GP-1108	625626C1
AGUA	GP-2071W	1822313C1	5070 PAYSTAR SERIES con motor/IHC V800			ACEITE	GP-88	1811953C1
COMBUSTIBLE	GP-78	1809789C1	COMBUSTIBLE, SEPARADOR DE AGUA	GPP-14	674293C1	COMBUSTIBLE	GP-78	672603C1
ACEITE	GP-152	1819452C1	COMBUSTIBLE, SECUNDARIO	GP-1107	702143C1	7300 WORKSTAR con motor/IHC DT466		
5000 PAYSTAR con motor/IHC V800			COMBUSTIBLE, PRIMARIO	GP-1108	625626C1	ACEITE, OPCIONAL PARA TRANSMISION (SELLADO)	GP-1	17237
DIRECCION	G-169	279294C91	AGUA	GP-2071W	1809789C1	7400 WORKSTAR con motor/IHC DT466		
COMBUSTIBLE, SECUNDARIO	GP-1107	702143C1	COMBUSTIBLE, SECUNDARIO	GP-78	672603C1	ACEITE, OPCIONAL PARA TRANSMISION	GP-1	17237
COMBUSTIBLE, PRIMARIO	GP-1108	625627C1	5070 PAYSTAR SERIES con motores/GMC 6-71 SERIES, GMC 8V-71 SERIES			COMBUSTIBLE (HASTA EL 2005)	GP-78	1822588-C1
ACEITE, DERIVACION (BY PASS)	G-750	689032R91	ACEITE, FLUJO TOTAL (FULL FLOW)	G-33	302574R91	ACEITE, LUBRICACION DEL MOTOR (HASTA EL 2005)	GP-152	1833121-C1
5000 PAYSTAR con motores/IHC DT466, IHC DTI466			COMBUSTIBLE, PRIMARIO	GP-26	23518481	AIRE, PRIMARIO	GA-799R	3532799-C1
ACEITE	GP-69	1808896C1	COMBUSTIBLE, SECUNDARIO	GP-27	23518482	AIRE, SECUNDARIO	GA-798R	3532800C1
COMBUSTIBLE, PRIMARIO	GP-1108	625626C1	5370 CARGOSTAR SERIES con motor/CUMMINS			7400 WORKSTAR con motor/IHC DT530		
ACEITE	GP-88	1811953C1	ACEITE, CARTUCHO PARA FLUJO TOTAL (FULL FLOW)	G-566	244523-R91	ACEITE, OPCIONAL PARA TRANSMISION	GP-1	17237
COMBUSTIBLE, SECUNDARIO	GP-78	672603C1	COMBUSTIBLE	GP-1101	244458R91	AGUA, SISTEMA DE ENFRIAMIENTO	GP-2071W	WF2071
5050 PAYSTAR SERIES con motor/CATERPILLAR 1160			ACEITE, SELLADO FLUJO TOTAL (FULL FLOW)	GP-53	1212622H1	COMBUSTIBLE, SELLADO	GP-78	1822588-C1
ACEITE	GP-36	3136046R93	AGUA	GP-2071W	1809789C1	ACEITE, FLUJO TOTAL (FULL FLOW)	GP-152	1819452-C1
5050 PAYSTAR SERIES con motor/CATERPILLAR 3208			ACEITE, DERIVACION (BY PASS)	G-750	689032R91	AIRE, PRIMARIO	GA-799R	3532799C1
ACEITE	GP-36	9L9200	5370 CARGOSTAR SERIES con motor/IHC DT466			AIRE, SECUNDARIO	GA-798R	3532800C1
GASOLINA, SEPARADOR DE AGUA	G-293	548348-C1	ACEITE	GP-69	1808896C1	7400 WORKSTAR con motor/IHC DT570		
COMBUSTIBLE	GP-110	702142C1	COMBUSTIBLE, PRIMARIO	GP-1108	625626C1	ACEITE, OPCIONAL PARA TRANSMISION (SELLADO)	GP-1	17237
ACEITE	GP-9586	9N5570	ACEITE	GP-88	1811953C1	AIRE, PRIMARIO	GA-799R	3532799-C1
5050 PAYSTAR SERIES con motor/GMC 6V-53			COMBUSTIBLE, SECUNDARIO	GP-78	672603C1	AIRE, SECUNDARIO	GA-798R	3532800-C1
ACEITE, FLUJO TOTAL (FULL FLOW)	G-33	302574R91	5500I, 5600I con motor/CUMMINS ISM			7500 WORKSTAR con motor/IHC HT570		
5050 PAYSTAR SERIES con motor/IHC D190			ACEITE, DOBLE FLUJO	GP-9000	3406810	AGUA, SISTEMA DE ENFRIAMIENTO	GP-2071W	WF2071
ACEITE	GP-10	39080R2	5600I con motor/CUMMINS ISX			7600 con motor/CUMMINS M11		
COMBUSTIBLE, PRIMARIO	GP-1108	625626C1	ACEITE, DOBLE FLUJO	GP-9001	3406809	ACEITE, DOBLE FLUJO	GP-3000	3318853
COMBUSTIBLE, SECUNDARIO	GP-78	672603C1	5870 con motor/DONALDSON HOUSING					
5050 PAYSTAR SERIES con motor/IHC DT466			AIRE	GA-376	420051C1			
ACEITE	GP-69	1808896C1	5870 con motor/FRAM HOUSING					
COMBUSTIBLE, PRIMARIO	GP-1105	625626C1	DIRECCION	G-338	386120R91			
ACEITE	GP-88	1811953C1	DIRECCION	G-169	279294C92			
COMBUSTIBLE, SECUNDARIO	GP-78	672603C1	AIRE	GA-135	9L2169			

SERVICIO PESADO

MARCA-MODELO-MOTOR MAKE-MODEL-ENGINE	GONHER GONHER	OEM OEM	MARCA-MODELO-MOTOR MAKE-MODEL-ENGINE	GONHER GONHER	OEM OEM	MARCA-MODELO-MOTOR MAKE-MODEL-ENGINE	GONHER GONHER	OEM OEM
I.H.C. HARVESTER (continuación)			I.H.C. HARVESTER (continuación)			I.H.C. HARVESTER (continuación)		
CAMIONES, TRACTOCAMIONES Y AUTOBUSES			CAMIONES, TRACTOCAMIONES Y AUTOBUSES			CAMIONES, TRACTOCAMIONES Y AUTOBUSES		
7600 con motores/CATERPILLAR C10, CATERPILLAR C12			7700 WORKSTAR con motor/CUMMINS ISM			ACEITE, FLUJO TOTAL (FULL FLOW)		
COMBUSTIBLE	GP-749	1R0749	TRANSMISION, OPCIONAL (SELLADO)	GP-1	17237	ACEITE, DERIVACION (BY PASS)	GP-57	1666053C1
ACEITE, FLUJO TOTAL (FULL FLOW) (CUMPLE CON MEDI-DAS ORIGINALES)	GP-691	1R0716	ACEITE, ALGUNOS DIFERENCIALES	GP-9	3280-V-8394	COMBUSTIBLE, SEPARADOR DE AGUA	GPP-11	1214920H1
ACEITE, FLUJO TOTAL (FULL FLOW) (SEGUNDA OPCION)	GP-52	1R0716	AGUA, SISTEMA DE ENFRIAMIENTO	GP-2071W	WF2071	AGUA	GP-1011Q	1661388H1
ACEITE, DERIVACION (BY PASS)	GP-57	1666053C1	COMBUSTIBLE, SEPARADOR DE AGUA, SELLADO	GPP-1000	3329289	ACEITE, DOBLE FLUJO	GP-3000	3318853
AIRE	GA-4862R	3551814-C1	ACEITE, DOBLE FLUJO	GP-9001	LF9001	AIRE, PRIMARIO	GA-209	476741C1
7600 WORKSTAR con motor/CATERPILLAR C11			AIRE, PRIMARIO			AIRE, SECUNDARIO		
TRANSMISION, OPCIONAL (SELLADO)	GP-1	17237	AIRE, SECUNDARIO	GA-4862R	3551814-C1	8200 con motor/CUMMINS N14		
ACEITE, ALGUNOS DIFERENCIALES	GP-9	3280-V-8394	8100 con motor/CATERPILLAR C10			COMBUSTIBLE, SEPARADOR DE AGUA		
COMBUSTIBLE	GP-749	1R0749	COMBUSTIBLE	GP-749	1R0749	8200 con motores/CATERPILLAR, CUMMINS, DETROIT DIESEL		
ACEITE	GP-691	1R1808	ACEITE, FLUJO TOTAL (FULL FLOW) (CUMPLE CON MEDI-DAS ORIGINALES)	GP-691	1R0716	DIRECCION	G-169	279294C92
AIRE, PRIMARIO	GA-4862R	3551814-C1	ACEITE, FLUJO TOTAL (FULL FLOW) (SEGUNDA OPCION)	GP-52	1R0716	COMBUSTIBLE, SEPARADOR DE AGUA	GPP-1291	1685159C91
AIRE, SECUNDARIO	GA-4863	3551815-C1	COMBUSTIBLE, SECUNDARIO	GP-1108	1R0712	AIRE, PRIMARIO	GA-107	1674320C3
7600 WORKSTAR con motor/CATERPILLAR C13			ACEITE, DERIVACION (BY PASS)			AIRE, SECUNDARIO		
ACEITE, TRANSMISION, OPCIONAL (SELLADO)	GP-1	17237	COMBUSTIBLE, SEPARADOR DE AGUA	GPP-1000	702256C1	8200, 8300 con motor/IHC DT466		
ACEITE, ALGUNOS DIFERENCIALES	GP-9	3280-V-8394	AIRE, PRIMARIO	GA-209	476741C1	DIRECCION	G-169	279294C92
COMBUSTIBLE	GP-749	1R0749	AIRE, SECUNDARIO	GA-210	482644C1	AIRE, PRIMARIO	GA-106	1665598C1
ACEITE	GP-691	1R1808	8100 con motor/CUMMINS ISM			AIRE, SECUNDARIO	GA-206	1665599C1
COMBUSTIBLE, SECUNDARIO	GP-55	3563465-C1	ACEITE	GP-9000	3406810	8300 con motores/DETROIT DIESEL, CATERPILLAR, CUMMINS		
AIRE, PRIMARIO	GA-4862R	3551814-C1	ACEITE	GP-9001	3406809	DIRECCION	G-169	279294C92
AIRE, SECUNDARIO	GA-4863	3551815-C1	COMBUSTIBLE, SEPARADOR DE AGUA	GPP-10225	3406889	COMBUSTIBLE, SEPARADOR DE AGUA	GPP-1291	1685159C91
7600 WORKSTAR con motor/CUMMINS ISM			AIRE, PRIMARIO			AIRE, PRIMARIO		
TRANSMISION, OPCIONAL (SELLADO)	GP-1	17237	AIRE, SECUNDARIO	GA-210	482644C1	AIRE, SECUNDARIO	GA-108	1674319C3
ACEITE, ALGUNOS DIFERENCIALES	GP-9	3280-V-8394	8100 con motor/IHC 530E			8300 con motores/DETROIT DIESEL, CATERPILLAR, CUMMINS		
COMBUSTIBLE, SEPARADOR DE AGUA	GPP-1000	3329289	AGUA	GP-2071W	1822313C1	DIRECCION	G-169	279294C92
ACEITE, DOBLE FLUJO	GP-9001	LF9001	COMBUSTIBLE, PRIMARIO	GP-78	1822588C1	COMBUSTIBLE, SEPARADOR DE AGUA	GPP-1291	1685159C91
AIRE, PRIMARIO	GA-4862R	3551814-C1	COMBUSTIBLE, SECUNDARIO	GP-78	1809789C1	AIRE, PRIMARIO	GA-107	1674320C3
AIRE, SECUNDARIO	GA-4863	3551815-C1	ACEITE	GP-152	1819452C1	AIRE, SECUNDARIO	GA-108	1674319C3
7600 WORKSTAR con motores/IHC MAXXFORCE 11, IHC MAXXFORCE 13			AIRE			8500 TRANSTAR con motor/IHC HT530		
TRANSMISION, OPCIONAL	GP-1	17237	8100 con motor/IHC DT466E			AGUA		
TRANSMISION	GP-58	4304827	AGUA	GP-2071W	1822313C1	COMBUSTIBLE		
AIRE, PRIMARIO	GA-4862R	AF26103	COMBUSTIBLE	GP-78	1822588C1	ACEITE		
AIRE, SECUNDARIO	GA-4863	3551815-C1	ACEITE	GP-152	1819452C1	AIRE		
7700 WORKSTAR con motor/CATERPILLAR C11			AIRE			8500 TRANSTAR con motores/IHC HT570, IHC MAXXFORCE 10		
TRANSMISION, OPCIONAL (SELLADO)	GP-1	17237	8100 con motor/IHC DT530			TRANSMISION, OPCIONAL		
ACEITE, ALGUNOS DIFERENCIALES	GP-9	3280-V-8394	AGUA	GP-2071W	1822313C1	AIRE, RADIAL SIMPLE		
COMBUSTIBLE	GP-749	1R0749	COMBUSTIBLE	GP-78	1822588C1	AIRE, PRIMARIO		
ACEITE	GP-691	1R1808	ACEITE	GP-152	1819452C1	AIRE, SECUNDARIO		
COMBUSTIBLE	GP-55	FF202	AIRE	GA-209	476741C1	8600 TRANSTAR con motor/CUMMINS ISM		
AIRE, PRIMARIO	GA-4862R	3551814-C1	8100, 8200, 8300 con motor/CATERPILLAR 3176			COMBUSTIBLE, SEPARADOR DE AGUA, CARTUCHO		
AIRE, SECUNDARIO	GA-4863	3551815-C1	ACEITE, CUMPLE CON MEDI-DAS ORIGINALES	GP-691	1R0716	TRANSMISION, OPCIONAL (SELLADO)		
7700 WORKSTAR con motor/CATERPILLAR C13			ACEITE, SEGUNDA OPCION	GP-52	1R0716	AGUA, SISTEMA DE ENFRIAMIENTO, 4 UNIDADES		
TRANSMISION, OPCIONAL (SELLADO)	GP-1	17237	COMBUSTIBLE	GP-1108	625626C1	COMBUSTIBLE, SEPARADOR DE AGUA, SELLADO		
ACEITE, ALGUNOS DIFERENCIALES	GP-9	3280-V-8394	ACEITE, DERIVACION (BY PASS)	GP-57	1W8845	AGUA, SISTEMA DE ENFRIAMIENTO, 11.5 UNIDADES		
COMBUSTIBLE	GP-749	1R0749	AGUA	GP-1011Q	1661388H1	ACEITE, DOBLE FLUJO		
ACEITE	GP-691	1R1808	AIRE	GA-107	476743C1	AIRE, PRIMARIO		
COMBUSTIBLE	GP-55	FF202	8100, 8200, 8300 con motor/CUMMINS L10			AIRE, SECUNDARIO		
AIRE, PRIMARIO	GA-4862R	3551814-C1	DIRECCION	G-169	279294C92	8600 TRANSTAR con motor/CUMMINS ISX		
AIRE, SECUNDARIO	GA-4863	3551815-C1	COMBUSTIBLE	GPP-14	674293C1	TRANSMISION, OPCIONAL (SELLADO)		
7700 WORKSTAR con motor/CATERPILLAR C13			8100, 8200, 8300 con motor/CUMMINS L10			AGUA, SISTEMA DE ENFRIAMIENTO, SIN QUIMICOS		
TRANSMISION, OPCIONAL (SELLADO)	GP-1	17237	DIRECCION			AGUA, SISTEMA DE ENFRIAMIENTO, 11.5 UNIDADES		
ACEITE, ALGUNOS DIFERENCIALES	GP-9	3280-V-8394	COMBUSTIBLE			ACEITE, DOBLE FLUJO		
COMBUSTIBLE	GP-749	1R0749	DIRECCION			AIRE, PRIMARIO		
ACEITE	GP-691	1R1808	COMBUSTIBLE			AIRE, SECUNDARIO		
COMBUSTIBLE	GP-55	3563465-C1	DIRECCION			8600 TRANSTAR con motor/CUMMINS ISX		
AIRE, PRIMARIO	GA-4862R	3551814-C1	COMBUSTIBLE			TRANSMISION, OPCIONAL (SELLADO)		
AIRE, SECUNDARIO	GA-4863	3551815-C1	COMBUSTIBLE			AGUA, SISTEMA DE ENFRIAMIENTO, SIN QUIMICOS		
7700 WORKSTAR con motor/CATERPILLAR C13			DIRECCION			AGUA, SISTEMA DE ENFRIAMIENTO, 11.5 UNIDADES		
TRANSMISION, OPCIONAL (SELLADO)	GP-1	17237	COMBUSTIBLE			ACEITE, DOBLE FLUJO		
ACEITE, ALGUNOS DIFERENCIALES	GP-9	3280-V-8394	DIRECCION			AIRE, PRIMARIO		
COMBUSTIBLE	GP-749	1R0749	COMBUSTIBLE			AIRE, SECUNDARIO		
ACEITE	GP-691	1R1808	DIRECCION			8600 TRANSTAR con motor/CUMMINS ISX		
COMBUSTIBLE	GP-55	3563465-C1	COMBUSTIBLE			TRANSMISION, OPCIONAL (SELLADO)		
AIRE, PRIMARIO	GA-4862R	3551814-C1	DIRECCION			AGUA, SISTEMA DE ENFRIAMIENTO, SIN QUIMICOS		
AIRE, SECUNDARIO	GA-4863	3551815-C1	COMBUSTIBLE			AGUA, SISTEMA DE ENFRIAMIENTO, 11.5 UNIDADES		
7700 WORKSTAR con motor/CATERPILLAR C13			DIRECCION			ACEITE, DOBLE FLUJO		
TRANSMISION, OPCIONAL (SELLADO)	GP-1	17237	COMBUSTIBLE			AIRE, PRIMARIO		
ACEITE, ALGUNOS DIFERENCIALES	GP-9	3280-V-8394	DIRECCION			AIRE, SECUNDARIO		
COMBUSTIBLE	GP-749	1R0749	COMBUSTIBLE			8600 TRANSTAR con motor/CUMMINS ISX		
ACEITE	GP-691	1R1808	DIRECCION			TRANSMISION, OPCIONAL (SELLADO)		
COMBUSTIBLE	GP-55	3563465-C1	COMBUSTIBLE			AGUA, SISTEMA DE ENFRIAMIENTO, SIN QUIMICOS		
AIRE, PRIMARIO	GA-4862R	3551814-C1	DIRECCION			AGUA, SISTEMA DE ENFRIAMIENTO, 11.5 UNIDADES		
AIRE, SECUNDARIO	GA-4863	3551815-C1	COMBUSTIBLE			ACEITE, DOBLE FLUJO		
7700 WORKSTAR con motor/CATERPILLAR C13			DIRECCION			AIRE, PRIMARIO		
TRANSMISION, OPCIONAL (SELLADO)	GP-1	17237	COMBUSTIBLE			AIRE, SECUNDARIO		
ACEITE, ALGUNOS DIFERENCIALES	GP-9	3280-V-8394	DIRECCION			8600 TRANSTAR con motor/CUMMINS ISX		
COMBUSTIBLE	GP-749	1R0749	COMBUSTIBLE			TRANSMISION, OPCIONAL (SELLADO)		
ACEITE	GP-691	1R1808	DIRECCION			AGUA, SISTEMA DE ENFRIAMIENTO, SIN QUIMICOS		
COMBUSTIBLE	GP-55	3563465-C1	COMBUSTIBLE			AGUA, SISTEMA DE ENFRIAMIENTO, 11.5 UNIDADES		
AIRE, PRIMARIO	GA-4862R	3551814-C1	DIRECCION			ACEITE, DOBLE FLUJO		
AIRE, SECUNDARIO	GA-4863	3551815-C1	COMBUSTIBLE			AIRE, PRIMARIO		

APLICACIONES SERVICIO PESADO
HEAVY DUTY APPLICATIONS



MARCA-MODELO-MOTOR MAKE-MODEL-ENGINE	GONHER GONHER	OEM OEM	MARCA-MODELO-MOTOR MAKE-MODEL-ENGINE	GONHER GONHER	OEM OEM	MARCA-MODELO-MOTOR MAKE-MODEL-ENGINE	GONHER GONHER	OEM OEM
I.H.C. HARVESTER (continuación)			I.H.C. HARVESTER (continuación)			I.H.C. HARVESTER (continuación)		
CAMIONES, TRACTOCAMIONES Y AUTOBUSES			CAMIONES, TRACTOCAMIONES Y AUTOBUSES			CAMIONES, TRACTOCAMIONES Y AUTOBUSES		
AIRE, SECUNDARIO	GA-4863	3551815-C1	ACEITE, FLUJO TOTAL (FULL FLOW) (SEGUNDA OPCION)	GP-52	1R0716	ACEITE, LUBRICACION DE DOBLE FLUJO	GP-9001	LF9001
8600 TRANSTAR con motores/CATERPILLAR C10, CATERPILLAR C12, CATERPILLAR C13, CATERPILLAR C11			COMBUSTIBLE	GP-1108	625626C1	COMBUSTIBLE, SEPARADOR DE AGUA SELLADO	GPP-1007S	3331096
TRANSMISION, OPCIONAL (SELLADO)	GP-1	17237	ACEITE, DERIVACION (BY PASS)	GP-57	1666053C1	AIRE, SECUNDARIO	GA-682R	3560734-C1
COMBUSTIBLE	GP-749	1R0749	COMBUSTIBLE, SEPARADOR DE AGUA	GPP-1000	702256C1	AIRE, PRIMARIO	GA-683R	AF25345
ACEITE	GP-691	1R1808	AIRE, PRIMARIO	GA-221R	2005895C1	9200I con motor/CUMMINS N14		
COMBUSTIBLE	GP-55	FF202	AIRE, SECUNDARIO	GA-723R	2022289C1	ACEITE, DOBLE FLUJO	GP-3001	3401544
COMBUSTIBLE, SEPARADOR DE AGUA, SELLADO	GPP-11	FS19683	9200 con motor/CUMMINS M11			ACEITE	GP-3000	3318853
AGUA, SISTEMA DE ENFRIAMIENTO, 8 UNIDADES	GP-1011Q	226-6567	COMBUSTIBLE, SEPARADOR DE AGUA	GPP-11	1214920H1	COMBUSTIBLE, SEPARADOR DE AGUA	GPP-1000	3889716
AGUA, SISTEMA DE ENFRIAMIENTO, 4 UNIDADES	GP-2071W	111-2369	9200 con motor/CUMMINS N14			AIRE	GA-682R	3520400C1
AIRE, PRIMARIO	GA-4862R	3551814-C1	DIRECCION	G-169	279294C91	9200I con motor/DETROIT DIESEL SERIES 60		
AIRE, SECUNDARIO	GA-4863	3551815-C1	COMBUSTIBLE	GPP-14	674293C1	COMBUSTIBLE, PRIMARIO	GP-26	23518481
8600 TRANSTAR con motores/IHC MAXXFORCE 11, IHC MAXXFORCE 13			ACEITE, FLUJO TOTAL (FULL FLOW)	GP-53	1212622H1	COMBUSTIBLE, SECUNDARIO	GP-27	23518482
TRANSMISION, OPCIONAL	GP-1	17237	ACEITE, DERIVACION (BY PASS)	GP-57	1666053C1	ACEITE	GP-193	23518480
9100I con motor/CUMMINS ISM			COMBUSTIBLE, SEPARADOR DE AGUA	GPP-11	1214920H1	AIRE	GA-682R	3520400C1
ACEITE	GP-9000	3406810	ACEITE, DOBLE FLUJO	GP-3000	3318853	COMBUSTIBLE, SEPARADOR DE AGUA	S 3202	23512317
ACEITE	GP-9001	3406809	AIRE	GA-376	420051C1	9200I con motores/CATERPILLAR C10, CATERPILLAR C12		
COMBUSTIBLE, SEPARADOR DE AGUA	GPP-1022S	3406889	9200 con motor/DETROIT DIESEL SERIES 60			COMBUSTIBLE, SEPARADOR DE AGUA	G-128	1696265-C1
9100I con motor/CUMMINS ISX			DIRECCION	G-169	279294C91	COMBUSTIBLE	GP-749	1R0749
ACEITE	GP-9000	3406810	COMBUSTIBLE, PRIMARIO	GP-26	23518481	ACEITE, FLUJO TOTAL (FULL FLOW) (CUMPLE CON MEDIDAS ORIGINALES)	GP-691	1R0716
ACEITE	GP-9001	3406809	COMBUSTIBLE, SECUNDARIO	GP-27	23518482	ACEITE, FLUJO TOTAL (FULL FLOW) (SEGUNDA OPCION)	GP-52	1R0716
COMBUSTIBLE, SEPARADOR DE AGUA	GPP-1007S	3331096	AGUA	GP-2071W	1809789C1	COMBUSTIBLE, SECUNDARIO	GP-1108	1R0712
9100I con motor/CUMMINS N14 PLUS			ACEITE	GP-193	23518480	ACEITE, DERIVACION (BY PASS)	GP-57	1W8845
ACEITE, DOBLE FLUJO	GP-3001	3318853	AIRE, PRIMARIO	GA-221R	2005895C1	AIRE	GA-682R	3560734C1
ACEITE	GP-3000	3318853	AIRE, SECUNDARIO	GA-723R	2022289C1	9200I con motores/CATERPILLAR C13, CATERPILLAR C15, CATERPILLAR C11		
COMBUSTIBLE, SEPARADOR DE AGUA	GPP-1000	3889716	9200 con motores/CATERPILLAR, CUMMINS, DETROIT DIESEL			COMBUSTIBLE, SEPARADOR DE AGUA	G-128	1696265-C1
9100I con motor/DETROIT DIESEL 60 SERIES			DIRECCION	G-159	598698C1	COMBUSTIBLE	GP-749	1R0749
COMBUSTIBLE, PRIMARIO	GP-26	23518481	DIRECCION	G-169	279294C92	ACEITE, FLUJO TOTAL (FULL FLOW) (CUMPLE CON MEDIDAS ORIGINALES)	GP-691	1R0716
COMBUSTIBLE, SECUNDARIO	GP-27	23518482	AIRE	GA-376	420051C1	ACEITE, FLUJO TOTAL (FULL FLOW) (SEGUNDA OPCION)	GP-52	1R0716
ACEITE	GP-193	23518480	AIRE	GA-221R	1694039C1	ACEITE, DERIVACION (BY PASS)	GP-57	1666053C1
9100I con motores/CATERPILLAR C10, CATERPILLAR C12			9200I con motor/CATERPILLAR, CUMMINS, DETROIT DIESEL			AIRE	GA-682R	3560734C1
ACEITE, CUMPLE CON MEDIDAS ORIGINALES	GP-691	1R0716	DIRECCION	G-159	598698C1	9300 con motores/CATERPILLAR, CUMMINS, DETROIT DIESEL		
ACEITE, SEGUNDA OPCION	GP-52	1R0716	DIRECCION	G-169	279294C92	DIRECCION	G-159	598698C1
COMBUSTIBLE, SECUNDARIO	GP-1108	1R0712	AIRE	GA-376	420051C1	DIRECCION	G-169	279294C92
ACEITE, DERIVACION (BY PASS)	GP-57	1W8845	AIRE	GA-221R	1694039C1	COMBUSTIBLE, SEPARADOR DE AGUA	GPP-1291	168159C91
9200 con motor/CATERPILLAR C10			9200, 9300 con motor/CATERPILLAR 3406E			AIRE	GA-376	420051C1
ACEITE, FLUJO TOTAL (FULL FLOW) (CUMPLE CON MEDIDAS ORIGINALES)	GP-691	1R0716	DIRECCION	G-169	279294C91	AIRE	GA-221R	1694039C1
ACEITE, FLUJO TOTAL (FULL FLOW) (SEGUNDA OPCION)	GP-52	1R0716	COMBUSTIBLE	GP-749	1R0749	9300, 9400 con motor/CUMMINS N14		
COMBUSTIBLE	GP-1108	625626C1	ACEITE, CUMPLE CON MEDIDAS ORIGINALES	GP-691	1R0716	DIRECCION	G-169	279294C91
ACEITE, DERIVACION	GP-57	1666053C1	ACEITE, SEGUNDA OPCION	GP-52	1R0716	COMBUSTIBLE	GPP-14	674293C1
COMBUSTIBLE, SEPARADOR DE AGUA	GPP-1000	702256C1	ACEITE, DERIVACION (BY PASS)	GP-57	1W8845	ACEITE, FLUJO TOTAL (FULL FLOW)	GP-53	1212622H1
AIRE, PRIMARIO	GA-221R	2005895C1	AGUA	GP-2071W	1822627C1	ACEITE, DERIVACION (BY PASS)	GP-57	1666053C1
AIRE, SECUNDARIO	GA-723R	2022289C1	AIRE, PRIMARIO	GA-221R	2005895C1	COMBUSTIBLE, SEPARADOR DE AGUA	GPP-11	1214920H1
9200 con motor/CATERPILLAR C12			AIRE, SECUNDARIO	GA-723R	2022289C1	AIRE	GA-376	420051C1
ACEITE, FLUJO TOTAL (FULL FLOW) (CUMPLE CON MEDIDAS ORIGINALES)	GP-691	1R0716	9200I con motor/CUMMINS ISM			9200I con motor/CUMMINS N14		
ACEITE, DOBLE FLUJO	GP-52	1R0716	AGUA	GP-2071W	1809789C1	DIRECCION	G-169	279294C91
COMBUSTIBLE	GP-1108	625626C1	ACEITE	GP-9000	3406810	COMBUSTIBLE	GPP-14	674293C1
ACEITE, DERIVACION	GP-57	1666053C1	ACEITE, DOBLE FLUJO	GP-9001	3406809	ACEITE, FLUJO TOTAL (FULL FLOW)	GP-53	1212622H1
COMBUSTIBLE, SEPARADOR DE AGUA	GPP-1000	702256C1	COMBUSTIBLE, SEPARADOR DE AGUA	GPP-1022S	3406889	ACEITE, DERIVACION (BY PASS)	GP-57	1666053C1
AIRE, PRIMARIO	GA-221R	2005895C1	AIRE	GA-682R	3560734C1	COMBUSTIBLE, SEPARADOR DE AGUA	GPP-11	1214920H1
AIRE, SECUNDARIO	GA-723R	2022289C1	9200I con motor/CUMMINS ISX			ACEITE, DOBLE FLUJO	GP-3000	3318853
9200 con motor/CATERPILLAR C10			ACEITE, OPCIONAL PARA TRANSMISION	GP-1	17237	AIRE	GA-376	420051C1
ACEITE, FLUJO TOTAL (FULL FLOW) (CUMPLE CON MEDIDAS ORIGINALES)	GP-691	1R0716	AGUA, SISTEMA DE ENFRIAMIENTO (SIN QUIMICOS)	GP-2127W	WF2127	9200I con motores/CATERPILLAR C13, CATERPILLAR C15, CATERPILLAR C11		
ACEITE, DOBLE FLUJO	GP-52	1R0716	COMBUSTIBLE, SEPARADOR DE AGUA SELLADO	GP-1101	FF2203	COMBUSTIBLE, SEPARADOR DE AGUA	G-128	1696265-C1
COMBUSTIBLE	GP-1108	625626C1	AGUA, SISTEMA DE ENFRIAMIENTO (4 UNIDADES)	GP-2071W	WF2071	COMBUSTIBLE	GP-749	1R0749
ACEITE, DERIVACION	GP-57	1666053C1	AGUA, SISTEMA DE ENFRIAMIENTO (11 1/2 UNIDADES)	GP-2126Q	WF2126	ACEITE, FLUJO TOTAL (FULL FLOW)	GP-691	1R0716
COMBUSTIBLE, SEPARADOR DE AGUA	GPP-1000	702256C1				ACEITE, DERIVACION (BY PASS)	GP-57	1666053C1
AIRE, PRIMARIO	GA-221R	2005895C1				COMBUSTIBLE, SEPARADOR DE AGUA	GPP-11	1214920H1
AIRE, SECUNDARIO	GA-723R	2022289C1				AIRE	GA-376	420051C1

SERVICIO PESADO

MARCA-MODELO-MOTOR MAKE-MODEL-ENGINE	GONHER GONHER	OEM OEM	MARCA-MODELO-MOTOR MAKE-MODEL-ENGINE	GONHER GONHER	OEM OEM	MARCA-MODELO-MOTOR MAKE-MODEL-ENGINE	GONHER GONHER	OEM OEM
I.H.C. HARVESTER (continuación)			I.H.C. HARVESTER (continuación)			I.H.C. HARVESTER (continuación)		
CAMIONES, TRACTOCAMIONES Y AUTOBUSES			CAMIONES, TRACTOCAMIONES Y AUTOBUSES			CAMIONES, TRACTOCAMIONES Y AUTOBUSES		
9370 SERIES con motor/CATERPILLAR 3406B			9400 con motores/CUMMINS, DETROIT DIESEL			ACEITE, CUMPLE CON MEDIDAS ORIGINALES		
ACEITE, FLUJO TOTAL (FULL FLOW) (CUMPLE CON MEDIDAS ORIGINALES)	GP-691	1R0716	DIRECCION	G-159	598698C1	ACEITE, SEGUNDA OPCION	GP-52	1R0716
ACEITE, FLUJO TOTAL (FULL FLOW) (SEGUNDA OPCION)	GP-52	1R0716	DIRECCION	G-169	279294C92	COMBUSTIBLE, SELLADO SEPARADOR DE AGUA	GPP-11	1214920H1
COMBUSTIBLE	GP-1108	625626C1	COMBUSTIBLE, SEPARADOR DE AGUA	GPP-1291	1685159C91	AIRE, PRIMARIO	GA-221R	2005895C1
			AIRE	GA-376	420051C1	AIRE, SECUNDARIO	GA-723R	2022289C1
			AIRE	GA-221R	1694039C1	AIRE, SIMPLE	GA-682R	3520400C1
9370 SERIES con motor/CUMMINS			9400I con motor/CATERPILLAR C12			9600 SERIES con motor/CATERPILLAR 3406		
COMBUSTIBLE	GP-1101	244458R91	COMBUSTIBLE, CARTUCHO SEPARADOR DE AGUA	G-128	1696265-C1	ACEITE, CUMPLE CON MEDIDAS ORIGINALES	GP-691	1R0716
ACEITE, FLUJO TOTAL (FULL FLOW)	GP-53	1212622H1	COMBUSTIBLE	GP-749	1R0749	ACEITE, SEGUNDA OPCION	GP-52	1R0716
ACEITE, SELLADO DERIVACION (BY PASS)	GP-57	1666053C1	ACEITE, CUMPLE CON MEDIDAS ORIGINALES	GP-691	1R0716	COMBUSTIBLE	GP-1108	625626C1
AGUA	GP-2071W	1809789C1	ACEITE, SEGUNDA OPCION	GP-52	1R0716	AIRE	GA-377	587426C1
AIRE	GA-376	420051C1	COMBUSTIBLE, SECUNDARIO	GP-1108	1R0712	AIRE, 1991-97	GA-694	573138-C91
ACEITE, CARTUCHO PARA DERIVACION (BY PASS)	G-750	689032R91	ACEITE, DERIVACION (BY PASS)	GP-57	1W8845			
			COMBUSTIBLE, SELLADO SEPARADOR DE AGUA	GPP-11	1214920H1	9600 SERIES con motor/CATERPILLAR 3406B		
			AIRE, PRIMARIO	GA-221R	2005895C1	ACEITE, CUMPLE CON MEDIDAS ORIGINALES	GP-691	1R0716
			AIRE, SECUNDARIO	GA-723R	2022289C1	ACEITE, SEGUNDA OPCION	GP-52	1R0716
			AIRE, SIMPLE	GA-682R	3520400C1	COMBUSTIBLE	GP-1108	625626C1
						AIRE	GA-377	587426C1
9370 SERIES con motor/DETROIT DIESEL			9400I con motor/CATERPILLAR C16			9600 SERIES con motor/CUMMINS		
ACEITE, CARTUCHO PARA FLUJO TOTAL (FULL FLOW)	G-33	302574R91	COMBUSTIBLE	GP-749	1R0749	DIRECCION	G-169	279294C92
COMBUSTIBLE, PRIMARIO	GP-26	23518481	ACEITE, CUMPLE CON MEDIDAS ORIGINALES	GP-691	1R0716	COMBUSTIBLE	GP-1101	244458R91
COMBUSTIBLE, SECUNDARIO	GP-27	23518482	ACEITE, SEGUNDA OPCION	GP-52	1R0716	ACEITE, FLUJO TOTAL (FULL FLOW)	GP-53	1212622H1
ACEITE, SELLADO FLUJO TOTAL (FULL FLOW)	GP-43	A77537	AGUA	GP-2071W	1809789C1	ACEITE, DERIVACION (BY PASS)	GP-57	1666053C1
AIRE	GA-376	420051C1	AIRE	GA-682R	3520400C1	COMBUSTIBLE, SEPARADOR DE AGUA	GPP-11	1214920H1
9370 SERIES con motores/CUMMINS FORMULA 300, CUMMINS NTC350			9400I con motor/CUMMINS ISM			9600 SERIES con motor/DETROIT DIESEL SERIES 60		
COMBUSTIBLE	GP-1101	244458R91	ACEITE	GP-9000	3406810	DIRECCION	G-169	279294C91
ACEITE, DERIVACION (BY PASS)	GP-57	1666053C1	ACEITE, DOBLE FLUJO	GP-9001	3406809	COMBUSTIBLE, PRIMARIO	GP-26	23518481
COMBUSTIBLE, SEPARADOR DE AGUA	GPP-11	1214920H1	COMBUSTIBLE, SEPARADOR DE AGUA	GPP-10225	3406889	COMBUSTIBLE, SECUNDARIO	GP-27	23518482
AIRE, PRIMARIO	GA-209	476741C1	AIRE	GA-682R	3520400C1	ACEITE	GP-193	23518480
AIRE, SECUNDARIO	GA-210	482644C1				AIRE, PRIMARIO	GA-221R	2005895C1
						AIRE, SECUNDARIO	GA-723R	2022289C1
9400 con motor/CATERPILLAR			9400I con motor/CUMMINS ISX			9600 SERIES con motores/CUMMINS L10, CUMMINS M11		
DIRECCION	G-159	598698C1	COMBUSTIBLE, CARTUCHO SEPARADOR DE AGUA	G-128	1696265-C1	AIRE (ESTANDAR)	GA-3551	3I0415
DIRECCION	G-169	279294C92	ACEITE	GP-9000	3406810			
COMBUSTIBLE, SEPARADOR DE AGUA	GPP-1291	1685159C91	ACEITE, DOBLE FLUJO	GP-9001	3406809	9600 SERIES con motores/CUMMINS N14, CUMMINS NTC855		
AIRE	GA-376	420051C1	COMBUSTIBLE, SEPARADOR DE AGUA	GPP-10075	3331096	AIRE, 1991-97	GA-694	573138-C91
AIRE	GA-221R	1694039C1	AIRE, SIMPLE	GA-682R	3560734C1			
						9670 SERIES con motor/CUMMINS		
9400 con motor/CATERPILLAR 3406B			9400I con motor/CUMMINS N14 PLUS			ACEITE		
DIRECCION	G-169	279294C92	ACEITE, DOBLE FLUJO	GP-3001	3401544	ACEITE, DERIVACION (BY PASS)	GP-57	1666053C1
ACEITE, CUMPLE CON MEDIDAS ORIGINALES	GP-691	1R0716	ACEITE	GP-3000	3318853	COMBUSTIBLE, SEPARADOR DE AGUA	GPP-11	1214920H1
ACEITE, SEGUNDA OPCION	GP-52	1R0716	COMBUSTIBLE, SEPARADOR DE AGUA	GPP-1000	3889716			
COMBUSTIBLE	GP-1108	1R0712	AIRE	GA-682R	3520400C1	9670 SERIES con motor/CUMMINS FORMULA 400 BIG CAM IV		
AGUA, PRE-CHARGE	GP-1011Q	1661388H1				COMBUSTIBLE	GP-1101	244458R91
AGUA, MANTENIMIENTO	GP-2071W	1809789C1				ACEITE, FLUJO TOTAL (FULL FLOW)	GP-53	1212622H1
AIRE	GA-376	420051C1				ACEITE, DERIVACION (BY PASS)	GP-57	1666053C1
9400 con motor/CUMMINS SIGNATURE 600			9400I con motor/DETROIT DIESEL SERIES 60			9670 SERIES con motores/CATERPILLAR 3406, CATERPILLAR 3406B		
ACEITE, DOBLE FLUJO	GP-9000	3406810	COMBUSTIBLE, PRIMARIO	GP-26	23518481	ACEITE, CUMPLE CON MEDIDAS ORIGINALES	GP-691	1R0716
COMBUSTIBLE, SEPARADOR DE AGUA	GPP-10075	3331096	COMBUSTIBLE, SECUNDARIO	GP-27	23518482	ACEITE, SEGUNDA OPCION	GP-52	1R0716
AIRE, PRIMARIO	GA-221R	2005895C1	ACEITE	GP-193	23518480	COMBUSTIBLE	GP-1108	625626C1
AIRE, SECUNDARIO	GA-723R	2022289C1	AIRE	GA-682R	3520400C1	AIRE	GA-377	587426C1
9400 con motor/DETROIT DIESEL SERIES 60			9400I con motores/CATERPILLAR C13, CATERPILLAR C15					
COMBUSTIBLE, PRIMARIO	GP-26	23518481	COMBUSTIBLE, CARTUCHO SEPARADOR DE AGUA	G-128	1696265-C1			
COMBUSTIBLE, SECUNDARIO	GP-27	23518482	COMBUSTIBLE	GP-749	1R0749			
ACEITE	GP-193	23518480						
AIRE, PRIMARIO	GA-221R	2005895C1						
AIRE, SECUNDARIO	GA-723R	2022289C1						

MARCA-MODELO-MOTOR MAKE-MODEL-ENGINE	GONHER GONHER	OEM OEM	MARCA-MODELO-MOTOR MAKE-MODEL-ENGINE	GONHER GONHER	OEM OEM	MARCA-MODELO-MOTOR MAKE-MODEL-ENGINE	GONHER GONHER	OEM OEM
I.H.C. HARVESTER (continuación)			I.H.C. HARVESTER (continuación)			I.H.C. HARVESTER (continuación)		
CAMIONES, TRACTOCAMIONES Y AUTOBUSES			CAMIONES, TRACTOCAMIONES Y AUTOBUSES			CAMIONES, TRACTOCAMIONES Y AUTOBUSES		
9670 SERIES con motores/CUMMINS FORMULA 270, CUMMINS FORMULA 350, CUMMINS NTC300, CUMMINS NTC350, CUMMINS FORMULA 290, CUMMINS FORMULA 300			9800 SERIES con motor/CUMMINS M11			AIRE, PRIMARIO	GA-682R	3560734C1
ACEITE, CARTUCHO PARA FLUJO TOTAL (FULL FLOW)	G-566	244523-R91	COMBUSTIBLE, SEPARADOR DE AGUA	GPP-11	1214920H1	9900I, 9900IX con motor/CATERPILLAR C16		
COMBUSTIBLE	GP-1101	244458R91	9800 SERIES con motor/DETROIT DIESEL SERIES 60			COMBUSTIBLE	GP-749	1R0749
ACEITE, SELLADO FLUJO TOTAL (FULL FLOW)	GP-53	1212622H1	COMBUSTIBLE, PRIMARIO	GP-26	23518481	ACEITE, CUMPLE CON MEDIDAS ORIGINALES	GP-691	1R0716
ACEITE, SELLADO DERIVACION (BY PASS)	GP-57	1666053C1	COMBUSTIBLE, SECUNDARIO	GP-27	23518482	ACEITE, SEGUNDA OPCION	GP-52	1R0716
AGUA	GP-2071W	1809789C1	ACEITE	GP-193	23518480	AGUA	GP-2071W	1809789C1
AIRE	GA-377	587426C1	9900I con motor/CATERPILLAR C13			9900IX con motor/CATERPILLAR 3406E		
ACEITE, CARTUCHO PARA DERIVACION (BY PASS)	G-750	689032R91	COMBUSTIBLE	GP-749	1R0749	COMBUSTIBLE	GP-749	1R0749
9670 SERIES con motores/CUMMINS KTA525, CUMMINS KTA600			ACEITE, CUMPLE CON MEDIDAS ORIGINALES	GP-691	1R0716	ACEITE, CUMPLE CON MEDIDAS ORIGINALES	GP-691	1R0716
COMBUSTIBLE	GP-1101	244458R91	ACEITE, SEGUNDA OPCION	GP-52	1R0716	ACEITE, SEGUNDA OPCION	GP-52	1R0716
ACEITE, FLUJO TOTAL (FULL FLOW)	GP-53	1212622H1	AIRE, PRIMARIO	GA-682R	3560734C1	9900IX con motor/CATERPILLAR C15		
AGUA	GP-1011Q	1661388H1	9900I con motor/CATERPILLAR C15			COMBUSTIBLE, SEPARADOR DE AGUA	G-128	1696265-C1
ACEITE, DERIVACION (BY PASS)	G-750	689032R91	COMBUSTIBLE, SEPARADOR DE AGUA	G-128	1696265-C1	COMBUSTIBLE	GP-749	1R0749
9670 SERIES con motores/CUMMINS NTC400, CUMMINS NTCC400			COMBUSTIBLE	GP-749	1R0749	ACEITE, CUMPLE CON MEDIDAS ORIGINALES	GP-691	1R0716
COMBUSTIBLE	GP-1101	244458R91	ACEITE, CUMPLE CON MEDIDAS ORIGINALES	GP-691	1R0716	ACEITE, SEGUNDA OPCION	GP-52	1R0716
ACEITE, FLUJO TOTAL (FULL FLOW)	GP-53	1212622H1	ACEITE, SEGUNDA OPCION	GP-52	1R0716	AGUA	GP-2071W	1809789C1
AGUA	GP-2071W	1809789C1	AGUA	GP-2071W	1809789C1	9900IX con motor/CUMMINS ISM		
AIRE	GA-377	587426C1	9900I con motor/CUMMINS ISM			ACEITE, DOBLE FLUJO (13 7/8 IN)	GP-9000	3406810
AIRE	GA-372	587425C1	ACEITE, DOBLE FLUJO (13 7/8 IN)	GP-9000	3406810	ACEITE, DOBLE FLUJO (11 23/32 IN)	GP-9001	3406809
ACEITE, DERIVACION (BY PASS)	G-750	689032R91	ACEITE, DOBLE FLUJO (11 23/32 IN)	GP-9001	3406809	COMBUSTIBLE, SEPARADOR DE AGUA	GPP-1022S	3406889
9670 SERIES con motores/DETROIT DIESEL 6V-92, DETROIT DIESEL 8V-92			COMBUSTIBLE, SEPARADOR DE AGUA	GPP-1022S	3406889	9900IX con motor/CUMMINS ISX		
COMBUSTIBLE, PRIMARIO	GP-26	23518481	9900I con motor/CUMMINS ISX			ACEITE, DOBLE FLUJO (13 7/8 IN)	GP-9000	3406810
COMBUSTIBLE, SECUNDARIO	GP-27	23518482	ACEITE, DOBLE FLUJO (13 7/8 IN)	GP-9000	3406810	ACEITE, DOBLE FLUJO	GP-9001	3406809
ACEITE	GP-43	A77537	ACEITE, DOBLE FLUJO	GP-9001	3406809	COMBUSTIBLE, SEPARADOR DE AGUA	GPP-1007S	3331096
AIRE	GA-377	587426C1	COMBUSTIBLE, SEPARADOR DE AGUA	GPP-1007S	3331096	9900IX con motor/CUMMINS N14		
9700 SERIES con motor/CATERPILLAR			9900I con motor/CUMMINS N14			ACEITE, DOBLE FLUJO	GP-3001	3401544
ACEITE, CUMPLE CON MEDIDAS ORIGINALES	GP-691	1R0716	ACEITE, DOBLE FLUJO	GP-3001	3401544	ACEITE	GP-3000	3318853
ACEITE, SEGUNDA OPCION	GP-52	1R0716	ACEITE	GP-3000	3318853	COMBUSTIBLE, SEPARADOR DE AGUA	GPP-1007S	3331096
COMBUSTIBLE	GP-1108	1R0712	COMBUSTIBLE, SEPARADOR DE AGUA	GPP-1007S	3331096	9900IX con motor/CUMMINS SIGNATURE 600		
ACEITE, DERIVACION (BY PASS)	GP-57	1W8845	9900I con motor/CUMMINS SIGNATURE 600			AGUA	GP-2127W	3680434
9700 SERIES con motor/CUMMINS			AGUA	GP-2127W	3680434	ACEITE, DOBLE FLUJO (13 7/8 IN)	GP-9000	3406810
DIRECCION	G-169	279294C92	ACEITE, DOBLE FLUJO (13 7/8 IN)	GP-9000	3406810	AGUA	GP-2126Q	3680433
COMBUSTIBLE	GP-1101	244458R91	AGUA	GP-2126Q	3680433	ACEITE, DOBLE FLUJO (11 23/32 IN)	GP-9001	3406809
ACEITE, FLUJO TOTAL (FULL FLOW)	GP-53	1212622H1	ACEITE, DOBLE FLUJO (11 23/32 IN)	GP-9001	3406809	COMBUSTIBLE, SEPARADOR DE AGUA	GPP-1007S	3331096
ACEITE, DERIVACION (BY PASS)	GP-57	1666053C1	COMBUSTIBLE, SEPARADOR DE AGUA	GPP-1007S	3331096	9900IX con motor/DETROIT DIESEL SERIES 60		
COMBUSTIBLE, SEPARADOR DE AGUA	GPP-11	1214920H1	9900I con motor/DETROIT DIESEL SERIES 60			COMBUSTIBLE, PRIMARIO	GP-26	23518481
9700 SERIES con motor/CUMMINS N14			COMBUSTIBLE, PRIMARIO	GP-26	23518481	COMBUSTIBLE, SECUNDARIO	GP-27	23518482
DIRECCION	G-169	279294C92	COMBUSTIBLE, SECUNDARIO	GP-27	23518482	ACEITE	GP-193	23518480
COMBUSTIBLE	GPP-14	674293C1	ACEITE	GP-193	23518480	BINDER LOADSTAR SERIES con motor/IHC V345		
ACEITE, FLUJO TOTAL (FULL FLOW)	GP-53	1212622H1	9900I con motor/CATERPILLAR C12			ACEITE	GP-10	39080R2
ACEITE, DERIVACION (BY PASS)	GP-57	1666053C1	COMBUSTIBLE	GP-749	1R0749	C ES con motor/IHC VT365		
COMBUSTIBLE, SEPARADOR DE AGUA	GPP-11	1214920H1	ACEITE, CUMPLE CON MEDIDAS ORIGINALES	GP-691	1R0716	COMBUSTIBLE	G-862	1843162-C91
ACEITE, DOBLE FLUJO	GP-3000	3318853	ACEITE, SEGUNDA OPCION	GP-52	1R0716	C81650B con motor/IHC 6.9L		
9700 SERIES con motores/CATERPILLAR 3406, CATERPILLAR 3406B			COMBUSTIBLE, SECUNDARIO	GP-1108	1R0712	COMBUSTIBLE, PRIMARIO	GPP-14	674293C1
ACEITE, CUMPLE CON MEDIDAS ORIGINALES	GP-691	1R0716	ACEITE, DERIVACION (BY PASS)	GP-57	1W8845	ACEITE	GP-3766	1804442C1
ACEITE, SEGUNDA OPCION	GP-52	1R0716						
COMBUSTIBLE	GP-1108	625626C1						
AIRE	GA-377	587426C1						

SERVICIO PESADO

MARCA-MODELO-MOTOR MAKE-MODEL-ENGINE	GONHER GONHER	OEM OEM	MARCA-MODELO-MOTOR MAKE-MODEL-ENGINE	GONHER GONHER	OEM OEM	MARCA-MODELO-MOTOR MAKE-MODEL-ENGINE	GONHER GONHER	OEM OEM
I.H.C. HARVESTER (continuación)			I.H.C. HARVESTER (continuación)			I.H.C. HARVESTER (continuación)		
CAMIONES, TRACTOCAMIONES Y AUTOBUSES			CAMIONES, TRACTOCAMIONES Y AUTOBUSES			CAMIONES, TRACTOCAMIONES Y AUTOBUSES		
COMBUSTIBLE, SECUNDARIO	GP-155	1804459C1	COMBUSTIBLE, SEPARADOR DE AGUA	GPP-1000	FS1000	TRANSTAR con motor/CATERPILLAR C11		
CF-500, CF-600 con motor/IHC VT275			ACEITE, DOBLE FLUJO	GP-9001	LF9001	TRANSMISION, SELLADO	GP-1	17237
COMBUSTIBLE	G-1047	FS19797	AIRE	GA-4862R	3551814-C1	COMBUSTIBLE	GP-749	1R0749
CO1710A CARGOSTAR con motor/IHC MV404			PROSTAR con motor/CUMMINS ISX			ACEITE	GP-691	1R1808
ACEITE	GP-10	39080R2	COMBUSTIBLE, SEPARADOR DE AGUA, CARTUCHO	G-128	FS1029W	COMBUSTIBLE, SEPARADOR DE AGUA	GPP-11	FS19683
AIRE	GA-3501	446661C2	TRANSMISION, OPCIONAL (SELLADO)	GP-1	17237	AGUA, SISTEMA DE ENFRIAMIENTO, 8 UNIDADES	GP-1011Q	226-6567
GASOLINA	GG-5 L	1701232C91	AGUA, SISTEMA DE ENFRIAMIENTO, SIN QUIMICOS	GP-2127W	WF2127	AGUA, SISTEMA DE ENFRIAMIENTO, 4 UNIDADES	GP-2071W	WF2071
CO1710A CARGOSTAR con motores/IHC V345, IHC V392			COMBUSTIBLE	GP-1101	FF2203	AIRE, PRIMARIO	GA-4862R	3551814-C1
ACEITE	GP-10	39080R2	TRANSMISION, SELLADO	GP-58	4304827	AIRE, SECUNDARIO	GA-4863	3551815-C1
AIRE	GA-3501	446661C2	AGUA, SISTEMA DE ENFRIAMIENTO, 11.5 UNIDADES	GP-2126Q	WF2126	TRANSTAR con motor/CATERPILLAR C13		
GASOLINA	GG-20	531546R91	ACEITE, SISTEMA DE ENFRIAMIENTO	GP-9001	LF9001	TRANSMISION, SELLADO	GP-1	17237
CO1710B CARGOSTAR con motor/IHC MV404			AIRE, PRIMARIO	GA-4862R	3551814-C1	COMBUSTIBLE	GP-749	1R0749
ACEITE	GP-10	39080R2	AIRE, RADIAL SIMPLE	GA-4862R	3551814-C1	ACEITE	GP-691	1R1808
AIRE	GA-3501	446661C2	AIRE, SECUNDARIO	GA-4863	3551815-C1	AGUA, SISTEMA DE ENFRIAMIENTO, 8 UNIDADES	GP-1011Q	226-6567
GASOLINA	GG-5 L	1701232C91	PROSTAR con motor/IHC MAXXFORCE 11			AGUA, SISTEMA DE ENFRIAMIENTO, 4 UNIDADES	GP-2071W	WF2071
CO1710B CARGOSTAR con motores/IHC V345, IHC V392			TRANSMISION, OPCIONAL	GP-1	17237	AIRE, PRIMARIO	GA-4862R	3551814-C1
ACEITE	GP-10	39080R2	TRANSMISION	GP-58	4304827	AIRE, SECUNDARIO	GA-4863	3551815-C1
AIRE	GA-3501	446661C2	AIRE, PRIMARIO	GA-4862R	3551814C1	TRANSTAR con motor/CUMMINS ISM		
GASOLINA	GG-20	531546R91	AIRE, SECUNDARIO	GA-4863	3551815C1	COMBUSTIBLE, SEPARADOR DE AGUA, CARTUCHO	G-128	FF1005
CXT con motor/IHC DT466			PROSTAR con motor/IHC MAXXFORCE 13			TRANSMISION, SELLADO	GP-1	17237
COMBUSTIBLE (HASTA EL 2005)	GP-78	1822588-C1	COMBUSTIBLE, SEPARADOR DE AGUA, CARTUCHO	G-128	2503566-C1	COMBUSTIBLE, SEPARADOR DE AGUA, SELLADO	GPP-1000	3329289
ACEITE, LUBRICACION DEL MOTOR (HASTA EL 2005)	GP-152	1833121-C1	TRANSMISION, OPCIONAL	GP-1	17237	ACEITE, DOBLE FLUJO	GP-9001	LF9001
AIRE, PRIMARIO	GA-799R	3532799-C1	TRANSMISION	GP-58	4304827	AIRE, PRIMARIO	GA-4862R	3551814-C1
AIRE, SECUNDARIO	GA-798R	3532800-C1	AIRE, PRIMARIO	GA-4862R	3551814C1	AIRE, SECUNDARIO	GA-4863	3551815-C1
CXT con motor/IHC DT570			AIRE, SECUNDARIO	GA-4863	3551815C1	WORKSTAR con motor/CATERPILLAR C11		
AIRE, PRIMARIO	GA-799R	3532799-C1	PROSTAR con motor/IHC MAXXFORCE 15			TRANSMISION, SELLADO	GP-1	17237
LFE700, LFE900 con motor/A DIESEL			TRANSMISION, OPCIONAL	GP-1	17237	COMBUSTIBLE	GP-749	1R0749
COMBUSTIBLE	GP-1101	1644499425	COMBUSTIBLE	GP-749	1R0749	ACEITE	GP-691	1R1808
M1400, M1600 con motor/IHC 7.3L			ACEITE	GP-691	1R1808	COMBUSTIBLE	GP-55	FF202
ACEITE	GP-3766	1804442C1	AIRE	GA-4862R	3551814-C1	AIRE, PRIMARIO	GA-4862R	3551814-C1
COMBUSTIBLE, PRIMARIO	GP-155	1804459C1	RXT con motor/IHC DT570			AIRE, SECUNDARIO	GA-4863	3551815-C1
AIRE	GA-422	588213C1	AIRE, PRIMARIO	GA-799R	3532799C1	WORKSTAR con motor/CATERPILLAR C13		
M1600 con motor/IHC DT360			RXT con motor/IHC VT365			COMBUSTIBLE, SEPARADOR DE AGUA	G-128	FF1005
ACEITE	GP-88	1811953C1	COMBUSTIBLE	G-862	1825864C92	TRANSMISION, SELLADO	GP-1	17237
COMBUSTIBLE	GP-78	1809789C1	ACEITE	G-3752	1840752C91	COMBUSTIBLE	GP-749	1R0749
AIRE, PRIMARIO	GA-209	476741C1	AIRE, RADIAL PRIMARIO	GA-799R	3532799C1	ACEITE	GP-691	1R1808
AIRE, SECUNDARIO	GA-210	482644C1	AIRE, RADIAL SECUNDARIO	GA-798R	3532800C1	COMBUSTIBLE	GP-55	FF202
MXT con motor/IHC VT365			S1823, S1824, S1853, S1854 con motor/IHC 9.0L			AIRE, PRIMARIO	GA-4862R	3551814-C1
COMBUSTIBLE	G-862	1825864C92	ACEITE	GP-10	39080R2	AIRE, SECUNDARIO	GA-4863	3551815-C1
PROSTAR con motor/CATERPILLAR C13			COMBUSTIBLE	GP-1101	244458R91	WORKSTAR con motor/CUMMINS ISM		
TRANSMISION, OPCIONAL (SELLADO)	GP-1	17237	AIRE, PRIMARIO	GA-109	478974C1	TRANSMISION, SELLADO	GP-1	17237
COMBUSTIBLE	GP-749	1R0749	AIRE, SECUNDARIO	GA-119	530778C1	AGUA, SISTEMA DE ENFRIAMIENTO	GP-2071W	WF2071
ACEITE	GP-691	1R1808	S1823, S1824, S1853, S1854 con motor/IHC DT466			COMBUSTIBLE, SEPARADOR DE AGUA	GPP-1000	3329289
TRANSMISION, OPCIONAL (SELLADO)	GP-58	4304827	COMBUSTIBLE	GP-1101	625625C1	ACEITE, DOBLE FLUJO	GP-9001	LF9001
AIRE, PRIMARIO	GA-4862R	3551814-C1	COMBUSTIBLE, PRIMARIO	GP-1108	625627C1	AIRE, PRIMARIO	GA-4862R	3551814-C1
AIRE, SECUNDARIO	GA-4863	3551815-C1	ACEITE	GP-88	1811953C1	AIRE, SECUNDARIO	GA-4863	3551815-C1
PROSTAR con motor/CUMMINS ISM			COMBUSTIBLE, SECUNDARIO	GP-78	1809789C1	I.H.C. HARVESTER		
TRANSMISION	GP-58	4304827	AIRE, PRIMARIO	GA-109	478974C1	CARGADORAS		
AGUA, SISTEMA DE ENFRIAMIENTO	GP-2071W	WF2071	AIRE, SECUNDARIO	GA-119	530778C1	100C con motor/IHC D206		
TOW MASTER con motor/IHC T444E			TOW MASTER con motor/IHC T444E			TRANSMISION	G-333	615447C1
AIRE, PRIMARIO	GA-209	476741C1	AIRE, PRIMARIO	GA-209	476741C1			

APLICACIONES SERVICIO PESADO
HEAVY DUTY APPLICATIONS



MARCA-MODELO-MOTOR	GONHER	OEM	MARCA-MODELO-MOTOR	GONHER	OEM	MARCA-MODELO-MOTOR	GONHER	OEM
MAKE-MODEL-ENGINE	GONHER	OEM	MAKE-MODEL-ENGINE	GONHER	OEM	MAKE-MODEL-ENGINE	GONHER	OEM
I.H.C. HARVESTER (continuación)			I.H.C. HARVESTER (continuación)			I.H.C. HARVESTER (continuación)		
CARGADORAS			CARGADORAS			CARGADORAS		
HIDRAULICO	G-338	386120R91	150 SOBRE ORUGAS con motor/A DIESEL			COMBUSTIBLE, SECUNDARIO	GP-78	672603C1
ACEITE	GP-10	528250R1	TRANSMISION	G-33	319926R91	COMBUSTIBLE, SEPARADOR DE AGUA	GPP-1000	702256C1
COMBUSTIBLE, PRIMARIO	GPP-1122	3136187R91	ACEITE	G-335	279994R91	AIRE, PRIMARIO	GA-329	627934C1
COMBUSTIBLE, SECUNDARIO	GPP-1122	3136187R91	COMBUSTIBLE, SECUNDARIO	G-1163	306353R91	AIRE, SECUNDARIO	GA-239	627935C1
100C SOBRE ORUGAS con motor/IHC D206			165 con motor/IHC D310			200 SOBRE ORUGAS con motor/DRESSER D505T		
ACEITE	G-338	386120R91	ACEITE, OPCIONAL	GP-10	528250R1	COMBUSTIBLE, SECUNDARIO	GP-1122	161624
ACEITE	GP-10	398080R2	COMBUSTIBLE	G-296	3144477R92	ACEITE	GP-43	A77537
COMBUSTIBLE	G-296	3144477R91	COMBUSTIBLE	G-296-B	3144477R92	COMBUSTIBLE, PRIMARIO	GPP-18	161623
COMBUSTIBLE, SELLADO	GP-1122	3132428R1	COMBUSTIBLE			AIRE, PRIMARIO	GA-329	627934C1
COMBUSTIBLE	G-296-B	3144477R91	165 SOBRE ORUGAS con motor/A DIESEL			AIRE, SECUNDARIO	GA-239	627935C1
100C, 100E con motores/IHC C175, IHC C200			ACEITE	GP-10	398080R2	250A, 250B SOBRE ORUGAS con motor/IHC DT429		
HIDRAULICO	G-338	386120R91	COMBUSTIBLE	G-296	3144477R92	COMBUSTIBLE, PRIMARIO	G-1163	306353R91
			COMBUSTIBLE	G-296-B	3144477R92			
100C, 100E, 125C con motor/IHC D239			175 con motor/A DIESEL			250C con motor/IHC DVT573B		
TRANSMISION	G-333	615447C1	COMBUSTIBLE, PRIMARIO	G-1163	306353R91	COMBUSTIBLE, PRIMARIO 5 /34 IN	GPP-14	702255C1
HIDRAULICO	G-338	386120R91	COMBUSTIBLE, SECUNDARIO	G-1163	306353R91	COMBUSTIBLE, SECUNDARIO 7 17/32 IN	GP-1107	359251C1
ACEITE	GP-10	528250R1	175 SOBRE ORUGAS, 250 SOBRE ORUGAS con motor/A DIESEL			COMBUSTIBLE, PRIMARIO 7 17/32 IN	GP-1108	702251C1
COMBUSTIBLE	G-296	3144477R92	COMBUSTIBLE, SECUNDARIO	G-1163	306353R91	COMBUSTIBLE, SEPARADOR DE AGUA	GPP-11	1214920H1
COMBUSTIBLE, PRIMARIO	GPP-1122	3136187R91	175B con motor/IHC D361			COMBUSTIBLE, SECUNDARIO 7 7/64 IN	GP-78	359251C1
COMBUSTIBLE, SECUNDARIO	GPP-1122	3136187R91	ACEITE	G-335	279994R91	250C SOBRE ORUGAS con motor/A DIESEL		
COMBUSTIBLE	G-296-B	3144477R92	COMBUSTIBLE, PRIMARIO	G-1163	306353R91	COMBUSTIBLE, SEPARADOR DE AGUA	GPP-14	702255C1
100E con motor/IHC D206			COMBUSTIBLE, SECUNDARIO	G-1163	306353R91	COMBUSTIBLE, SECUNDARIO 7 7/64 IN	GP-1107	674293C1
TRANSMISION	G-333	615447C1	175B con motor/IHC UD407			COMBUSTIBLE, PRIMARIO	GP-1108	625627C1
HIDRAULICO	G-338	386120R91	ACEITE	G-335	279994R91	250E SOBRE ORUGAS con motor/CUMMINS L10		
ACEITE	GP-10	528250R1	COMBUSTIBLE, PRIMARIO 6 43/64 IN	GP-1105	625626C1	COMBUSTIBLE, SEPARADOR DE AGUA	GPP-14	998443R91
COMBUSTIBLE, PRIMARIO	GPP-1122	3136187R91	COMBUSTIBLE, PRIMARIO 7 17/32 IN	GP-1108	625627C1	COMBUSTIBLE	GP-1101	625625C1
COMBUSTIBLE, SECUNDARIO	GPP-1122	3136187R91	COMBUSTIBLE, SEPARADOR DE AGUA	GPP-11	1214920H1	ACEITE, FLUJO TOTAL (FULL FLOW)	GP-53	1212622H1
100E SOBRE ORUGAS con motor/A DIESEL			COMBUSTIBLE, SECUNDARIO 7 1/8 IN	GP-110	702142C1	ACEITE, DERIVACION (BY PASS)	GP-57	1212621H1
ACEITE	GP-10	398080R2	175B SOBRE ORUGAS con motor/IHC DT361			AGUA	GP-1011Q	1661388H1
COMBUSTIBLE	G-296	3144477R92	ACEITE	G-335	279994R91	280A con motor/IHC DT358		
COMBUSTIBLE, SELLADO	GP-1122	3132428R1	COMBUSTIBLE, SECUNDARIO	GP-110	702142C1	ACEITE	GP-10	528250R1
COMBUSTIBLE	G-296-B	3144477R92	175B SOBRE ORUGAS con motor/IHC DT407			COMBUSTIBLE	G-296	3144477R92
125 con motor/IHC D239			ACEITE	G-335	279994R91	COMBUSTIBLE, PRIMARIO	GPP-1122	3136187R91
TRANSMISION	G-333	615447C1	COMBUSTIBLE, SEPARADOR DE AGUA	GPP-14	998443R91	COMBUSTIBLE, SECUNDARIO	GPP-1122	3136187R91
HIDRAULICO	G-338	386120R91	COMBUSTIBLE, PRIMARIO 6 43/64 IN	GP-1105	702143C1	COMBUSTIBLE	G-296-B	3144477R92
ACEITE	GP-10	528250R1	COMBUSTIBLE, PRIMARIO 7 17/32 IN	GP-1108	702251C1	AIRE, SECUNDARIO	GA-892	529852R5
COMBUSTIBLE	G-296	3144477R92	COMBUSTIBLE, SECUNDARIO 7 1/8 IN	GP-110	702142C1	4120 con motor/TECUMSEH HH160		
COMBUSTIBLE, PRIMARIO	GPP-1122	3136187R91	175C con motor/IHC DT466			AIRE	GA-7	32008
COMBUSTIBLE, SECUNDARIO	GPP-1122	3136187R91	ACEITE	GP-69	675617C91	4130 con motor/ONAN NHCV		
COMBUSTIBLE	G-296-B	3144477R92	COMBUSTIBLE, PRIMARIO 6 43/64 IN	GP-1105	625626C1	ACEITE	GP-3600	122-0680
125C SOBRE ORUGAS, 125E SOBRE ORUGAS con motor/A DIESEL			COMBUSTIBLE, PRIMARIO 7 17/32 IN	GP-1108	625627C1	4150 con motor/FORD DF172 A DIESEL		
TRANSMISION	G-338	386120R91	COMBUSTIBLE, SECUNDARIO 7 1/8 IN	GP-110	702142C1	ACEITE	GP-1	388227R91
ACEITE	GP-10	398080R2	175C con motor/IHC DT466			HIDRAULICO	GP-34	69149C1
COMBUSTIBLE	G-296	3144477R92	ACEITE	GP-69	675617C91	AIRE, SIN ASPAS	GA-16	P101222
COMBUSTIBLE	GP-1122	3132428R1	COMBUSTIBLE, PRIMARIO 6 43/64 IN	GP-1105	625626C1	AIRE	GAK-16	P101222
COMBUSTIBLE	G-296-B	3144477R92	COMBUSTIBLE, PRIMARIO 7 17/32 IN	GP-1108	625627C1	4150 con motor/FORD DF172 A GASOLINA		
125E con motor/IHC DT239			COMBUSTIBLE, SEPARADOR DE AGUA	GPP-11	1214920H1	ACEITE	GP-1	388227R91
ACEITE	GP-10	528250R1	COMBUSTIBLE, SECUNDARIO	GP-78	672603C1	HIDRAULICO	GP-34	69149C1
COMBUSTIBLE	G-296	3144477R92	AIRE, PRIMARIO	GA-329	627934C1	AIRE, SIN ASPAS	GA-16	P101222
COMBUSTIBLE, SECUNDARIO	GPP-1122	3132428R2	AIRE, SECUNDARIO	GA-239	627935C1	AIRE	GAK-16	P101222
COMBUSTIBLE	G-296-B	3144477R92	175C SOBRE ORUGAS con motor/IHC DT466			GASOLINA	GG-4	4209106
150 con motor/A DIESEL			ACEITE	GP-69	675617C91			
TRANSMISION	G-33	319926R91	COMBUSTIBLE, PRIMARIO 6 43/64 IN	GP-1105	625626C1			
ACEITE	G-335	279994R91	COMBUSTIBLE, PRIMARIO 7 17/32 IN	GP-1108	625627C1			
COMBUSTIBLE, PRIMARIO	G-1163	306353R91						
COMBUSTIBLE, SECUNDARIO	G-1163	306353R91						

SERVICIO PESADO

MARCA-MODELO-MOTOR MAKE-MODEL-ENGINE	GONHER GONHER	OEM OEM	MARCA-MODELO-MOTOR MAKE-MODEL-ENGINE	GONHER GONHER	OEM OEM	MARCA-MODELO-MOTOR MAKE-MODEL-ENGINE	GONHER GONHER	OEM OEM
I.H.C. HARVESTER (continuación)			I.H.C. HARVESTER (continuación)			I.H.C. HARVESTER (continuación)		
CARGADORAS			CARGADORAS			CARGADORAS		
GASOLINA	GG-20	531546R91	PH180 DE TRONCOS con motor/GMC 12V-71			S7B DE TRONCOS con motor/IHC D188		
500 con motor/A DIESEL			ACEITE, DERIVACION (BY PASS)	G-31	5181127	ACEITE	G-335	279994R91
ACEITE	G-870	376364R91	PH330 DE TRONCOS, PH340 DE TRONCOS con motor/A DIESEL			S7C DE TRONCOS, S7D DE TRONCOS, S8 DE TRONCOS con motor/ GMC 3-53		
TRANSMISION	GP-1	918266R91	COMBUSTIBLE, SECUNDARIO	GP-1107	674293C1	ACEITE, FLUJO TOTAL (FULL FLOW)	G-119	165583-H1
COMBUSTIBLE	G-296	3144477R92	PH350 DE TRONCOS, PH350B DE TRONCOS con motor/CUMMINS VT1710C			S8A DE TRONCOS con motor/IHC D360		
COMBUSTIBLE	G-296-B	796051R91	ACEITE, CARTUCHO PARA FLUJO TOTAL (FULL FLOW)	G-566	244523-R91	ACEITE	GP-69	675616C91
500 con motor/A GASOLINA			COMBUSTIBLE, CARTUCHO	G-1143	323838C91	COMBUSTIBLE, PRIMARIO	GP-1105	625626C1
TRANSMISION	GP-1	918266R91	ACEITE, SELLADO FLUJO TOTAL (FULL FLOW)	GP-53	1212622H1	COMBUSTIBLE, PRIMARIO	GP-1108	625627C1
510 con motor/IHC D268			ACEITE, DERIVACION (BY PASS)	G-750	689032R91	COMBUSTIBLE, SECUNDARIO	GP-78	672603C1
ACEITE	GP-10	528250R1	PH350 DE TRONCOS, PH350B DE TRONCOS con motor/GMC 16V-71N			AIRE, SECUNDARIO	GA-892	529852R4
515 con motor/IHC D360			ACEITE, DERIVACION (BY PASS)	G-31	5181127	AIRE, PRIMARIO	GA-891	529851R2
ACEITE	GP-69	675616C91	PH65 DE TRONCOS con motor/IHC D817			S8A DE TRONCOS, S8B DE TRONCOS con motor/IHC D358		
COMBUSTIBLE, PRIMARIO	GP-1105	625626C1	AIRE	GA-5648	313709R91	ACEITE	GP-10	398080R2
COMBUSTIBLE, PRIMARIO	GP-1108	625627C1	PH65B DE TRONCOS con motor/IHC DVT573			COMBUSTIBLE	GPP-1122	3132275R91
COMBUSTIBLE, SEPARADOR DE AGUA	GPP-11	1214920H1	COMBUSTIBLE, SECUNDARIO	G-1163	306353R91	AIRE, SECUNDARIO	GA-892	529852R4
COMBUSTIBLE, SECUNDARIO	GP-78	672603C2	PH65C DE TRONCOS con motor/IHC DVT573B			AIRE	GA-891	529851R2
520B con motor/IHC DT358			COMBUSTIBLE, SEPARADOR DE AGUA 5 3/4 IN	GPP-14	998443R91	S9A DE TRONCOS con motor/IHC D310		
ACEITE	GP-10	528250R1	COMBUSTIBLE, SECUNDARIO	GP-1107	674293C1	ACEITE, OPCIONAL	GP-10	39080R2
530 con motor/IHC DT414			COMBUSTIBLE, PRIMARIO	GP-1108	625627C1	COMBUSTIBLE, PRIMARIO	GPP-1122	3136187R91
ACEITE	GP-69	675617C91	COMBUSTIBLE, SEPARADOR DE AGUA 9 17/32 IN	GPP-1000	702256C1	COMBUSTIBLE, SECUNDARIO	GPP-1122	3132428R1
COMBUSTIBLE, PRIMARIO	GP-1105	625626C1	S10 DE TRONCOS con motor/IHC D360			AIRE, SIN ASPAS	GA-403	389263R92
COMBUSTIBLE, SECUNDARIO	GP-78	672603C2	ACEITE	GP-69	675616C91	AIRE	GAK-403	389263R92
540 con motor/IHC DT466B			COMBUSTIBLE, PRIMARIO	GP-1105	625626C1	S9B DE TRONCOS con motor/A DIESEL		
ACEITE	GP-69	675617C91	COMBUSTIBLE, PRIMARIO	GP-1108	625627C1	ACEITE	GP-69	675616C91
COMBUSTIBLE, PRIMARIO	GP-1108	625627C1	COMBUSTIBLE, PRIMARIO	GP-1108	625627C1	COMBUSTIBLE, PRIMARIO	GP-1108	625627C1
COMBUSTIBLE, SEPARADOR DE AGUA	GPP-11	1214920H1	COMBUSTIBLE, SECUNDARIO	GP-78	672603C2	COMBUSTIBLE, SECUNDARIO	GP-78	672603C1
AGUA	GP-2071W	1261387H1	S10 DE TRONCOS con motor/IHC DT358			S9B DE TRONCOS con motor/IHC DT360		
COMBUSTIBLE, SECUNDARIO	GP-78	672603C2	ACEITE	GP-10	398080R2	COMBUSTIBLE, PRIMARIO	GP-1101	625625C1
555 DE TRONCOS con motor/CUMMINS NTA855-C360			S11A DE TRONCOS con motor/A DIESEL			ACEITE	GP-69	675616C91
ACEITE, FLUJO TOTAL (FULL FLOW)	GP-53	1212622H1	ACEITE	G-335	279994R91	COMBUSTIBLE, SECUNDARIO	GP-78	672603C2
ACEITE, DERIVACION (BY PASS)	GP-57	1212621H1	COMBUSTIBLE, SEPARADOR DE AGUA	GPP-14	998443R91	101 con motor/IHC BD220		
COMBUSTIBLE, SEPARADOR DE AGUA	GPP-11	1214920H1	COMBUSTIBLE, PRIMARIO	GP-1105	702143C1	ACEITE	G-335	279994R91
560 con motor/IHC DT817B			COMBUSTIBLE, PRIMARIO	GP-1108	625627C1	101 con motor/IHC D236		
COMBUSTIBLE, SECUNDARIO	GP-1107	674293C1	COMBUSTIBLE, SECUNDARIO	GP-110	702253C1	ACEITE	G-335	279994R91
COMBUSTIBLE, PRIMARIO	GP-1108	625627C1	S11A DE TRONCOS con motor/IHC DT407			COMBUSTIBLE, PRIMARIO	G-1163	306353R91
COMBUSTIBLE, SEPARADOR DE AGUA	GPP-11	1214920H1	ACEITE	G-335	279994R91	COMBUSTIBLE, SECUNDARIO	G-1163	304101R91
COMBUSTIBLE	GP-78	674293C1	COMBUSTIBLE, PRIMARIO	GP-1105	702143C1	105 con motor/IHC C153		
560 con motor/IHC DT817C			COMBUSTIBLE, PRIMARIO	GP-1108	625627C1	ACEITE, SELLADO	GP-50	538836R1
COMBUSTIBLE, SECUNDARIO	GP-1107	674293C1	COMBUSTIBLE, SEPARADOR DE AGUA	GPP-11	1214920H1	105 con motor/IHC D206		
COMBUSTIBLE	GP-1108	625627C1	COMBUSTIBLE, PRIMARIO	GP-110	702252C1	COMBUSTIBLE, SIN CUBIERTA	G-1123	3055650R91
COMBUSTIBLE, SEPARADOR DE AGUA	GPP-11	1214920H1	S7B DE TRONCOS con motor/FORD 220 DIESEL			COMBUSTIBLE, CON CUBIERTA	G-1123F	3055650R91
COMBUSTIBLE	GP-78	674293C1	ACEITE, 4 7/16 IN	G-813	EPN6731B	ACEITE	GP-10	398080R2
H60B, H60E con motor/IHC			ACEITE, 3 15/16 IN	G-836	C2TZ-6714-A	AIRE, SIN ASPAS	GA-16	204439H1
AIRE, SECUNDARIO	GA-680	924280C1	COMBUSTIBLE	G-11816	3132015R91	AIRE	GAK-16	204439H1
PH100 DE TRONCOS, PH100B DE TRONCOS con motor/IHC DT817			S7B DE TRONCOS con motor/GMC 3-53			140 con motores/IHC C164, IHC C169, IHC C175		
TRANSMISION ALLISON	G-33	319926R91	ACEITE, 9 IN	G-33	302574R91	ACEITE, SELLADO	GP-50	538836R1
PH140 ARRASTRADOR con motor/IHC DT817B			ACEITE, 5 9/16 IN	G-119	165583-H1	141 con motor/IHC BD240		
COMBUSTIBLE	GP-11	3300901	COMBUSTIBLE, SECUNDARIO	G-1173	1190507R91	ACEITE	G-335	279994R91

I.H.C. HARVESTER
COMBINADAS

101 con motor/IHC BD220		
ACEITE	G-335	279994R91
101 con motor/IHC D236		
ACEITE	G-335	279994R91
COMBUSTIBLE, PRIMARIO	G-1163	306353R91
COMBUSTIBLE, SECUNDARIO	G-1163	304101R91
105 con motor/IHC C153		
ACEITE, SELLADO	GP-50	538836R1
105 con motor/IHC D206		
COMBUSTIBLE, SIN CUBIERTA	G-1123	3055650R91
COMBUSTIBLE, CON CUBIERTA	G-1123F	3055650R91
ACEITE	GP-10	398080R2
AIRE, SIN ASPAS	GA-16	204439H1
AIRE	GAK-16	204439H1
140 con motores/IHC C164, IHC C169, IHC C175		
ACEITE, SELLADO	GP-50	538836R1
141 con motor/IHC BD240		
ACEITE	G-335	279994R91

MARCA-MODELO-MOTOR MAKE-MODEL-ENGINE	GONHER GONHER	OEM OEM	MARCA-MODELO-MOTOR MAKE-MODEL-ENGINE	GONHER GONHER	OEM OEM	MARCA-MODELO-MOTOR MAKE-MODEL-ENGINE	GONHER GONHER	OEM OEM
I.H.C. HARVESTER (continuación)			I.H.C. HARVESTER (continuación)			I.H.C. HARVESTER (continuación)		
COMBINADAS			COMBINADAS			COMBINADAS		
141HILLSIDE con motor/IHC BD240			ACEITE	GP-171	395789R2	403 HILLSIDE con motor/IHC C236		
ACEITE	G-335	279994R91				ACEITE, CARTUCHO	G-335	328227R91
1420 con motor/IHC D358			303 con motor/IHC BD220			ACEITE, SELLADO	GP-10	398080R2
ACEITE, OPCIONAL	GP-10	528250R1	ACEITE	G-335	279994R91	AIRE	GA-16	384812R93
ACEITE	GP-66	528250R1	AIRE, SIN ASPAS	GA-16	384812R93	AIRE	GAK-16	384812R93
COMBUSTIBLE, PRIMARIO	GPP-1122	3136187R91	AIRE	GAK-16	384812R93			
COMBUSTIBLE, SECUNDARIO	GPP-1122	3132428R2				403 HILLSIDE con motor/IHC C263		
1440 con motor/IHC D436			303 con motor/IHC C221			ACEITE, CARTUCHO	G-335	328227R91
HIDRAULICO	G-338	386120R91	ACEITE, CARTUCHO	G-335	279994R91	ACEITE, SELLADO	GP-10	398080R2
ACEITE	GP-69	675617C91	ACEITE, SELLADO GASOLINA	GP-10	398080R2	AIRE, SIN ASPAS	GA-16	384812R93
COMBUSTIBLE, PRIMARIO	GP-1105	702143C1	ACEITE, SELLADO LPG	GP-36	3136046R93	AIRE	GAK-16	384812R93
COMBUSTIBLE, SECUNDARIO	GP-1107	674293C1	AIRE, SIN ASPAS	GA-16	384812R93			
COMBUSTIBLE, SECUNDARIO	GP-78	674293C1	AIRE	GAK-16	384812R93	403 HILLSIDE con motor/IHC C282		
AIRE, PRIMARIO	GA-360	3375264R1	315 con motor/IHC A GASOLINA			ACEITE	G-335	328227R91
AIRE, SECUNDARIO	GA-361	530270R2	TRANSMISION	G-338	386120R91	ACEITE, SELLADO	GP-10	398080R2
			ACEITE	GP-10	398080R2	AIRE, SIN ASPAS	GA-16	384812R93
			AIRE	GA-16	384812R93	AIRE	GAK-16	384812R93
			AIRE	GAK-16	384812R93			
1460, 1470, 1480 con motor/IHC D436						403 HILLSIDE con motores/IHC D282, IHC D301		
HIDRAULICO	G-338	386120R91	315 con motor/IHC C221			ACEITE, CARTUCHO	G-335	328227R91
ACEITE	GP-69	675617C91	ACEITE	G-338	386120R91	COMBUSTIBLE, PRIMARIO	G-1163	306353R91
COMBUSTIBLE, PRIMARIO	GP-1105	702143C1	ACEITE	GP-10	398080R2	COMBUSTIBLE, SECUNDARIO	G-1163	306353R91
COMBUSTIBLE, SECUNDARIO	GP-1107	674293C1	AIRE, SIN ASPAS	GA-16	384812R93	ACEITE, TANQUE HIDRAULICO	G-338	528493R3
COMBUSTIBLE, SECUNDARIO	GP-78	674293C1	AIRE	GAK-16	384812R93	ACEITE, SELLADO	GP-69	A184775
						AIRE, SIN ASPAS	GA-403	389263R92
151 con motor/IHC BD264						AIRE	GAK-403	389263R92
ACEITE	G-335	279994R91	315 con motor/IHC D236					
			ACEITE	G-335	328227R91	431 con motor/A DIESEL		
151 con motor/IHC D282			COMBUSTIBLE, CARTUCHO SECUNDARIO	G-1163	306353R91	COMBUSTIBLE, SIN CUBIERTA	G-1123	3132015R91
ACEITE	G-335	279994R91	TRANSMISION	G-338	386120R91	COMBUSTIBLE, CON CUBIERTA	G-1123F	3132015R91
COMBUSTIBLE, PRIMARIO	G-1163	306353R91	COMBUSTIBLE, PRIMARIO SELLADO 5 17/32 IN	GP-1101	A184772	COMBUSTIBLE	G-296	3144477R92
COMBUSTIBLE, SECUNDARIO	G-1163	306353R91	COMBUSTIBLE, PRIMARIO SELLADO 7 17/32 IN	GP-1108	A184773	COMBUSTIBLE, PRIMARIO	GP-1122	3218794R91
			COMBUSTIBLE, SECUNDARIO SELLADO	GP-110	702253C1	COMBUSTIBLE, SECUNDARIO	GP-1122	3132428R1
151 HILLSIDE con motor/IHC BD264			AIRE, SIN ASPAS	GA-403	389263R92	COMBUSTIBLE	G-296-B	3144477R92
ACEITE	G-335	279994R91	AIRE	GAK-403	389263R92	ACEITE	GP-171	395789R2
151 HILLSIDE con motor/IHC D282			403 con motor/IHC C236			435 HILLSIDE, 453 HILLSIDE con motor/IHC C301		
ACEITE	G-335	279994R91	ACEITE, CARTUCHO	G-335	328227R91	HIDRAULICO	G-338	386120R91
COMBUSTIBLE, PRIMARIO	G-1163	306353R91	ACEITE, SELLADO	GP-10	398080R2	ACEITE	GP-10	398080R2
COMBUSTIBLE, SECUNDARIO	G-1163	306353R91	AIRE	GA-16	384812R93	AIRE, SIN ASPAS	GA-16	384812R93
			AIRE	GAK-16	384812R93	AIRE	GAK-16	384812R93
181 con motor/IHC BD264								
ACEITE	G-335	328227R91	403 con motor/IHC C263			453 HILLSIDE con motor/A GASOLINA		
			ACEITE, CARTUCHO	G-335	328227R91	HIDRAULICO	G-338	528493R3
181 con motor/IHC D282			ACEITE, SELLADO	GP-10	398080R2	ACEITE	GP-36	3136046R93
ACEITE	G-335	328227R91	AIRE, SIN ASPAS	GA-16	384812R93	AIRE, HASTA S/N 610	GAK-16	384812R93
COMBUSTIBLE, PRIMARIO	G-1163	306353R91	AIRE	GAK-16	384812R93	AIRE, S/N 610 EN ADELANTE	GAK-403	A40866
COMBUSTIBLE, SECUNDARIO	G-1163	306353R91				GASOLINA	GG-20	405501C1
203 con motor/IHC C153						453 HILLSIDE con motor/IHC D301		
ACEITE, SELLADO	GP-50	538836R1	403 con motor/IHC C282			ACEITE, CARTUCHO	G-335	323827R91
			ACEITE	G-335	328227R91	COMBUSTIBLE, PRIMARIO	G-1163	306353R91
205 con motor/IHC C221			ACEITE, SELLADO	GP-10	398080R2	COMBUSTIBLE, SECUNDARIO	G-1163	306353R91
HIDRAULICO	G-338	386120R91	AIRE, SIN ASPAS	GA-16	384812R93	HIDRAULICO	G-338	386120R91
ACEITE	GP-10	398080R2	AIRE	GAK-16	384812R93	ACEITE, SELLADO	GP-69	675616C91
AIRE, SIN ASPAS	GA-16	384812R93				AIRE	GAK-403	389263R92
AIRE	GAK-16	384812R93	403 con motores/IHC D282, IHC D301					
			ACEITE, CARTUCHO	G-335	328227R91	453 HILLSIDE con motor/IHC D360		
221, 321 con motor/A DIESEL			COMBUSTIBLE, PRIMARIO	G-1163	306353R91	HIDRAULICO	G-338	386120R91
COMBUSTIBLE, SIN CUBIERTA	G-1123	3132015R91	COMBUSTIBLE, SECUNDARIO	G-1163	306353R91	ACEITE	GP-69	675616C91
COMBUSTIBLE, CON CUBIERTA	G-1123F	3132015R91	ACEITE, TANQUE HIDRAULICO	G-338	528493R3	COMBUSTIBLE, PRIMARIO 6 43/64 IN	GP-1105	625626C1
COMBUSTIBLE	G-296	3144477R92	ACEITE, SELLADO	GP-69	A184775	COMBUSTIBLE, PRIMARIO 7 17/32 IN	GP-1108	625627C1
COMBUSTIBLE, PRIMARIO	GP-1122	3218794R91	AIRE, SIN ASPAS	GA-403	389263R92			
COMBUSTIBLE, SECUNDARIO	GP-1122	3132428R1	AIRE	GAK-403	389263R92			
COMBUSTIBLE	G-296-B	3144477R92						

SERVICIO PESADO

MARCA-MODELO-MOTOR MAKE-MODEL-ENGINE	GONHER GONHER	OEM OEM	MARCA-MODELO-MOTOR MAKE-MODEL-ENGINE	GONHER GONHER	OEM OEM	MARCA-MODELO-MOTOR MAKE-MODEL-ENGINE	GONHER GONHER	OEM OEM
I.H.C. HARVESTER (continuación)			I.H.C. HARVESTER (continuación)			I.H.C. HARVESTER (continuación)		
COMBINADAS			COMBINADAS			COMBINADAS		
COMBUSTIBLE, SEPARADOR DE AGUA	GPP-11	1214920H1	AIRE	GAK-403	389263R92	915 con motor/IHC DT407		
COMBUSTIBLE, SECUNDARIO	GP-78	672603C1	AIRE, SECUNDARIO	GA-892	529852R1	ACEITE	G-335	323827R91
AIRE, SIN ASPAS	GA-403	389263R92	715 con motor/IHC D310			HIDRAULICO	G-338	386120R91
AIRE	GAK-403	389263R92	HIDRAULICO	G-338	386120R91	COMBUSTIBLE, PRIMARIO 6 43/64 IN	GP-1105	625626C1
AIRE, SECUNDARIO	GA-892	529852R4	COMBUSTIBLE	G-296	3044506R93	COMBUSTIBLE, PRIMARIO 7 17/32 IN	GP-1108	A184773
50 FORAGE COSECHADORA-BALER con motor/IHC C263			COMBUSTIBLE	GPP-1122	1967094C1	COMBUSTIBLE, SEPARADOR DE AGUA	GPP-11	1214920H1
ACEITE	G-335	279994R91	ACEITE	GP-69	A18775	COMBUSTIBLE, SECUNDARIO	GP-110	702253C1
503 con motor/IHC C282			COMBUSTIBLE	G-296-B	3044506R93	COMBUSTIBLE, SEPARADOR DE AGUA	GPP-1000	702256C1
ACEITE, CARTUCHO	G-335	323827R91	AIRE, SECUNDARIO	GA-892	529852R5	915 con motor/IHC DT414		
ACEITE, SELLADO	GP-10	398080R2	GASOLINA	GG-20	405501C1	HIDRAULICO	G-338	386120R91
GASOLINA	GAK-16	384812R93	76 con motores/IHC C113, IHC C123			ACEITE	GP-69	A184775
AIRE, LPG	GAK-403	389263R92	ACEITE, SELLADO	GP-50	538836R1	COMBUSTIBLE, PRIMARIO 6 43/64 IN	GP-1105	625626C1
503 con motor/IHC D282			815 con motor/IHC D407			COMBUSTIBLE, PRIMARIO 7 17/32 IN	GP-1108	A184773
ACEITE	G-335	323827R91	ACEITE	G-335	323827R91	AGUA	GP-2071W	A151931
COMBUSTIBLE, PRIMARIO	G-1163	306353R91	TRANSMISION	G-338	386120R91	COMBUSTIBLE, SECUNDARIO	GP-78	672603C2
COMBUSTIBLE, SECUNDARIO	G-1163	306353R91	COMBUSTIBLE, PRIMARIO 6 43/64 IN	GP-1105	625626C1	AIRE, PRIMARIO	GA-360	3375264R1
ACEITE	GP-10	398080R2	COMBUSTIBLE, PRIMARIO 7 17/32 IN	GP-1108	A184773	AIRE, SECUNDARIO	GA-361	3375263R1
503 con motor/IHC D301			COMBUSTIBLE, SEPARADOR DE AGUA	GPP-11	1214920H1	915 con motor/IHC V345		
ACEITE, CARTUCHO	G-335	323827R91	COMBUSTIBLE, SECUNDARIO	GP-110	702253C1	TRANSMISION	G-338	386120R91
COMBUSTIBLE, PRIMARIO	G-1163	306353R91	COMBUSTIBLE, SEPARADOR DE AGUA	GPP-1000	702256C1	ACEITE, 7 17/32 IN	GP-10	398080R2
COMBUSTIBLE, SECUNDARIO	G-1163	306353R91	815 con motor/IHC D414			ACEITE, 5 13/32 IN	GP-36	3136046R93
ACEITE, SELLADO	GP-10	398080R2	HIDRAULICO	G-338	386120R91	AIRE, SIN ASPAS	GA-403	389263R92
ACEITE, SELLADO	GP-69	A184775	ACEITE	GP-69	A184775	AIRE	GAK-403	389263R92
AIRE	GAK-403	389263R92	COMBUSTIBLE, PRIMARIO 6 43/64 IN	GP-1105	625626C1	GASOLINA	GG-20	531546R1
606 con motor/IHC C221			COMBUSTIBLE, PRIMARIO 7 17/32 IN	GP-1108	625627C1	915 con motor/IHC V392		
ACEITE, CARTUCHO	G-335	323827R91	COMBUSTIBLE, SEPARADOR DE AGUA	GPP-11	1214920H1	HIDRAULICO	G-338	386120R91
COMBUSTIBLE, PRIMARIO	G-1163	304101R91	AGUA	GP-2071W	A151931	ACEITE, 7 17/32 IN	GP-10	398080R2
COMBUSTIBLE, SECUNDARIO	G-1163	304101R91	COMBUSTIBLE, SECUNDARIO	GP-78	672603C2	ACEITE, 5 13/32 IN	GP-36	3136046R93
ACEITE, SELLADO	GP-10	398080R2	AIRE, PRIMARIO	GA-360	3375264R1	AIRE, SIN ASPAS	GA-403	389263R92
615 con motor/IHC C263			AIRE, SECUNDARIO	GA-361	3375263R1	AIRE	GAK-403	389263R92
HIDRAULICO	G-338	386120R91	815 con motor/IHC V392			GASOLINA	GG-20	531546R1
ACEITE	GP-10	398080R2	ACEITE	GP-10	398080R2	93 con motor/IHC BD220 A GASOLINA		
AIRE	GAK-16	384812R93	AIRE, SIN ASPAS	GA-403	389263R92	ACEITE	G-335	279994R91
GASOLINA	GG-20	170349C1	AIRE	GAK-403	389263R92	93 con motores/IHC C135, IHC C153		
615 con motor/IHC D282			815 con motor/ONAN D160			ACEITE, SELLADO	GP-50	538836R1
ACEITE, CARTUCHO	G-335	323827R91	TRANSMISION	GP-9	395789R2	95 con motor/IHC D310		
COMBUSTIBLE, PRIMARIO	G-1163	306353R91	815 con motores/IHC V304, IHC V345			ACEITE	GP-10	398080R2
COMBUSTIBLE, SECUNDARIO	G-1163	306353R91	HIDRAULICO	G-338	386120R91	COMBUSTIBLE	G-296	3044506R91
HIDRAULICO	G-338	386120R91	ACEITE, 7 17/32 IN	GP-10	398080R2	COMBUSTIBLE	GP-1122	3218794R91
ACEITE, SELLADO	GP-69	675616C91	ACEITE, 5 13/32 IN	GP-36	3136046R93	COMBUSTIBLE, CON PUR-GADOR	GPP-1122	3132275R91
AIRE	GAK-403	389263R92	AIRE, SIN ASPAS	GA-403	389263R92	COMBUSTIBLE	G-296-B	3044506R93
64 con motor/IHC C113			AIRE	GAK-403	389263R92	I.H.C. HARVESTER		
ACEITE, SELLADO	GP-50	538836R1	GASOLINA	GG-20	531546R1	EXCAVADORAS		
715 con motor/IHC C301			91 con motores/IHC C135, IHC C153			3960, 3961 con motor/DEUTZ F6L912		
HIDRAULICO	G-338	386120R91	ACEITE, SELLADO	GP-50	538836R1	ACEITE	GP-54	528250R1
ACEITE	GP-10	398080R2	91, 93 con motor/IHC BD154C			COMBUSTIBLE, SECUNDARIO	GP-1122	Q1H4117
AIRE	GAK-16	384812R93	ACEITE	G-870	376364R91	AIRE, SIN ASPAS	GA-403	886019C91
GASOLINA	GG-20	170349C1	COMBUSTIBLE	G-296	3044506R93	AIRE	GAK-403	886019C91
715 con motor/IHC D301			COMBUSTIBLE	G-296-B	3044506R93	3964, 3964B con motor/DEUTZ F6L912		
ACEITE, CARTUCHO	G-335	279994R91				ACEITE	GP-10	528250R1
COMBUSTIBLE, PRIMARIO	G-1163	306353R91				COMBUSTIBLE, PRIMARIO	GP-1122	Q1H4117
COMBUSTIBLE, SECUNDARIO	G-1163	306353R91						
HIDRAULICO	G-338	386120R91						
ACEITE, SELLADO	GP-69	675616C91						

MARCA-MODELO-MOTOR MAKE-MODEL-ENGINE	GONHER GONHER	OEM OEM	MARCA-MODELO-MOTOR MAKE-MODEL-ENGINE	GONHER GONHER	OEM OEM	MARCA-MODELO-MOTOR MAKE-MODEL-ENGINE	GONHER GONHER	OEM OEM
I.H.C. HARVESTER (continuación)			I.H.C. HARVESTER (continuación)			I.H.C. HARVESTER (continuación)		
MONTACARGAS			MOTORES			MOTORES		
8000 con motor/IHC C200			GASOLINA	GG-5 L	417917C91	BD144A A DIESEL, BD144C A DIESEL, BD154 A DIESEL, BD154C A DIESEL, BD154T A DIESEL		
ACEITE	GP-10	398080R2	304A V8 A GASOLINA, 404 V8 A GASOLINA, 446 V8 (7.3L) A DIESEL			ACEITE	G-870	376364R91
9000 con motor/IHC C291			ACEITE, SELLADO 5 13/32 IN	GP-1	918266R93	COMBUSTIBLE	G-296	3144477R92
ACEITE	G-335	279994R91	ACEITE, SELLADO 7 17/32 IN	GP-10	427207C1	COMBUSTIBLE	G-296-B	3144477R92
AIRE, SIN ASPAS	GA-16	384812R93	AIRE	GA-78	369500C1	BD220 INDUSTRIAL, BD240 INDUSTRIAL, BG220 INDUSTRIAL		
AIRE	GAK-16	384812R93	GASOLINA	GG-5	417917C91	ACEITE, CARTUCHO	G-333	214731R91
9000 con motor/IHC D310			GASOLINA	GG-5 L	417917C91	BD269 INDUSTRIAL		
COMBUSTIBLE, CARTUCHO	G-1123	3132015R91	345A V8 A GASOLINA			GASOLINA	GG-5	1701232C91
ACEITE	GP-10	528250R1	ACEITE, CARTUCHO	G-333	214731R91	C146 A DIESEL		
COMBUSTIBLE	G-296	3044506R91	ACEITE, SELLADO 5 13/32 IN	GP-1	388227R91	ACEITE, SELLADO	GP-50	538836R1
COMBUSTIBLE, PRIMARIO	GP-1122	3132428R1	ACEITE, SELLADO 7 17/32 IN	GP-10	39080R2	C157 A DIESEL, C175 A DIESEL, C200 A DIESEL, D268 A DIESEL		
COMBUSTIBLE, SECUNDARIO	GP-1122	3132428R1	AIRE	GA-78	369500C1	ACEITE	GP-10	398080R2
COMBUSTIBLE	G-296-B	3044506R91	GASOLINA	GG-5 L	1701232C91	C221 A DIESEL, C240 A DIESEL, C282 A DIESEL, C291 A DIESEL, D166 A DIESEL, D188 A DIESEL, D350 A DIESEL, D361 (6.0L) A DIESEL, DT282 A DIESEL		
M10A con motor/IHC DT466B			420 V8 (6.9L) A DIESEL			ACEITE, CARTUCHO	G-335	279994R91
COMBUSTIBLE, SEPARADOR DE AGUA	GPP-14	998443R91	COMBUSTIBLE, PRIMARIO	GPP-14	674293C1	C301 A GAS LPG		
ACEITE	GP-69	675616C91	ACEITE	GP-3766	1804442C1	ACEITE, CARTUCHO	G-335	279994R91
COMBUSTIBLE, PRIMARIO	GP-1108	625627C1	COMBUSTIBLE, SECUNDARIO	GP-155	1804459C1	ACEITE, SELLADO	GP-10	398080R2
COMBUSTIBLE, SECUNDARIO	GP-78	672603C1	AIRE	GA-422	588213C1	GASOLINA, OPCIONAL	GG-20	170349C1
			444 V8 (7.3L) A DIESEL			D150 A DIESEL, D170 A DIESEL, D190 A DIESEL		
			ACEITE	GP-3766	1804442C1	ACEITE	GP-10	39080R2
			530 (NGD) A DIESEL			COMBUSTIBLE, SECUNDARIO	GP-1107	674293C1
			AGUA	GP-2071W	1822313C1	COMBUSTIBLE, PRIMARIO	GP-1108	625627C1
			COMBUSTIBLE, SECUNDARIO	GP-78	1809789C1	COMBUSTIBLE, SEPARADOR DE AGUA	GPP-11	1214920H1
			ACEITE	GP-152	1819452C1	AIRE	GA-2984	472098C1
			537 V8 A GASOLINA, 605 A DIESEL, D392 A DIESEL			D155 A DIESEL		
			ACEITE	GP-10	427207C2	ACEITE	GP-10	398080R2
			551CID (9.0L) A DIESEL			COMBUSTIBLE, HASTA S/N 20002189	G-296	3144477R92
			ACEITE	GP-10	39080R2	COMBUSTIBLE, PRIMARIO S/N 20002190 EN ADELANTE	GP-1122	3132428R1
			COMBUSTIBLE, PRIMARIO	GP-1101	244458R91	COMBUSTIBLE, SECUNDARIO S/N 20002190 EN ADELANTE	GP-1122	3132428R1
			COMBUSTIBLE, SECUNDARIO	GP-78	672603C1	COMBUSTIBLE, HASTA S/N 20002189	G-296-B	3144477R92
			6.9L A DIESEL			D179 A DIESEL		
			ACEITE	GP-3766	1804442C1	ACEITE, 7 17/32 IN	GP-10	398080R2
			AGUA	GP-2071W	1822313C1	ACEITE, 5 13/32 IN	GP-36	3136046R93
			COMBUSTIBLE	GP-155	1804459C1	COMBUSTIBLE	G-296	3144477R92
			7.3 L-DIT A DIESEL			COMBUSTIBLE, PRIMARIO	GP-1122	3132428R1
			COMBUSTIBLE, SEPARADOR DE AGUA	G-178	1822631C91	COMBUSTIBLE, SECUNDARIO	GP-1122	3132428R1
			AGUA	GP-2071W	1822313C1	COMBUSTIBLE	G-296-B	3144477R92
			ACEITE	GP-562	1814562C1	D206 A DIESEL, D310 A DIESEL		
			7.3L A DIESEL			COMBUSTIBLE, SIN CUBIERTA	G-1123	3132015R91
			ACEITE	GP-3766	1804442C1	COMBUSTIBLE, CON CUBIERTA	G-1123F	3132015R91
			AGUA	GP-2071W	1822313C1	ACEITE	GP-10	398080R2
			COMBUSTIBLE	GP-155	1804459C1	COMBUSTIBLE	G-296	3144477R92
			COMBUSTIBLE, SEPARADOR DE AGUA	GPP-1287	1816568C91	COMBUSTIBLE, PRIMARIO	GP-1122	3132428R1
			9.0L A DIESEL			COMBUSTIBLE, SECUNDARIO	GP-1122	3132428R1
			ACEITE	GP-10	427207C2	COMBUSTIBLE	G-296-B	3144477R92
			COMBUSTIBLE, PRIMARIO	GP-1101	625625C1	D239 A DIESEL		
			COMBUSTIBLE, SEPARADOR DE AGUA	GPP-11	1214920H1	ACEITE, 7 17/32 IN	GP-10	398080R2
			COMBUSTIBLE, SECUNDARIO	GP-78	672603C2	ACEITE, 5 13/32 IN	GP-36	3136046R93
			ACEITE, DERIVACION (BY PASS)	G-750	970165R1	ACEITE		
			BC144 A DIESEL, BD144 A DIESEL			COMBUSTIBLE		
			ACEITE	G-870	376364R91			

APLICACIONES SERVICIO PESADO
HEAVY DUTY APPLICATIONS



MARCA-MODELO-MOTOR MAKE-MODEL-ENGINE	GONHER GONHER	OEM OEM	MARCA-MODELO-MOTOR MAKE-MODEL-ENGINE	GONHER GONHER	OEM OEM	MARCA-MODELO-MOTOR MAKE-MODEL-ENGINE	GONHER GONHER	OEM OEM
I.H.C. HARVESTER (continuación)			I.H.C. HARVESTER (continuación)			I.H.C. HARVESTER (continuación)		
MOTORES			MOTORES			MOTORES		
COMBUSTIBLE	G-296	3144477R92	COMBUSTIBLE, PRIMARIO 6 43/64 IN	GP-1105	625626C1	COMBUSTIBLE, SECUNDARIO 7 1/8 IN	GP-110	702142C1
COMBUSTIBLE, PRIMARIO	GP-1122	3136187R91	COMBUSTIBLE, PRIMARIO 7 17/32 IN	GP-1108	625627C1	COMBUSTIBLE, SEPARADOR DE AGUA 9 17/32 IN	GPP-1000	702256C1
COMBUSTIBLE, SECUNDARIO	GP-1122	3133428R91	COMBUSTIBLE, SECUNDARIO 7 1/8 IN	GP-110	702142C1	DT408 (NGD) A DIESEL, DT466 (NGD) A DIESEL		
COMBUSTIBLE	G-296-B	3144477R92	COMBUSTIBLE, SEPARADOR DE AGUA 9 17/32 IN	GPP-1000	702256C1	COMBUSTIBLE, AUTOBUSES	GP-62	1820479C1
D282 A DIESEL			D414 A DIESEL, DT414 A DIESEL			AGUA	GP-2071W	1822313C1
ACEITE, CARTUCHO	G-335	279994R91	COMBUSTIBLE, PRIMARIO 6 43/64 IN	GP-1101	625625C1	COMBUSTIBLE, CAMIONES	GP-78	1822588C1
COMBUSTIBLE, CARTUCHO SECUNDARIO	G-1163	306353R91	ACEITE	GP-69	675617C91	ACEITE	GP-152	1819452C1
COMBUSTIBLE, SEPARADOR DE AGUA 5 3/4 IN	GPP-14	998443R91	COMBUSTIBLE, PRIMARIO 6 43/64 IN	GP-1105	625626C1	DT408 A DIESEL		
COMBUSTIBLE, PRIMARIO 6 43/64 IN	GP-1101	625625C1	COMBUSTIBLE, PRIMARIO 7 17/32 IN	GP-1108	625627C1	COMBUSTIBLE	GP-1122	FF5052
ACEITE, SELLADO	GP-69	675616C91	COMBUSTIBLE, SECUNDARIO	GP-78	672603C2	AGUA	GP-2071W	1822313C1
COMBUSTIBLE, PRIMARIO 6 43/64 IN	GP-1105	625626C1	D436 A DIESEL			COMBUSTIBLE, CAMIONES	GP-78	1822588C1
COMBUSTIBLE, PRIMARIO 7 17/32 IN	GP-1108	625627C1	COMBUSTIBLE, PRIMARIO 6 43/64 IN	GP-1101	625625C1	ACEITE	GP-152	1819452C1
COMBUSTIBLE, SECUNDARIO 7 1/8 IN	GP-110	702142C1	ACEITE	GP-69	675617C91	DT408PLN A DIESEL		
COMBUSTIBLE, SEPARADOR DE AGUA 9 17/32 IN	GPP-1000	702256C1	COMBUSTIBLE, PRIMARIO 6 43/64 IN	GP-1105	625626C1	AGUA	GP-2071W	1822313C1
D301 A DIESEL			COMBUSTIBLE, PRIMARIO 7 17/32 IN	GP-1108	625627C1	ACEITE	GP-78	1822588C1
ACEITE, CARTUCHO	G-335	323827R91	COMBUSTIBLE, SECUNDARIO	GP-78	672603C2	ACEITE	GP-152	1819452C1
COMBUSTIBLE, SECUNDARIO	G-1163	304101R91	DT239 A DIESEL			DT429 A DIESEL		
ACEITE, SELLADO	GP-10	39080R2	ACEITE, 7 17/32 IN	GP-10	398080R2	COMBUSTIBLE, CARTUCHO SECUNDARIO	G-1163	306353R91
D304 A DIESEL, D345 A DIESEL			ACEITE, 5 13/32 IN	GP-36	3136046R93	COMBUSTIBLE, PRIMARIO 6 43/64 IN	GP-1105	625626C1
ACEITE	GP-1	918266R93	COMBUSTIBLE	G-296	3144477R92	COMBUSTIBLE, PRIMARIO 7 17/32 IN	GP-1108	625627C1
D312 A DIESEL			COMBUSTIBLE, PRIMARIO 6 43/64 IN	GP-1122	3132428R1	COMBUSTIBLE, SECUNDARIO SELLADO 7 1/8 IN	GP-110	702142C1
ACEITE	GP-69	675616C91	COMBUSTIBLE, SECUNDARIO	GP-1122	3132428R1	DT436 A DIESEL		
COMBUSTIBLE, PRIMARIO 6 43/64 IN	GP-1105	625626C1	COMBUSTIBLE	G-296-B	3144477R92	ACEITE	GP-69	675617C91
COMBUSTIBLE, PRIMARIO 7 17/32 IN	GP-1108	625627C1	DT358 A DIESEL			COMBUSTIBLE, PRIMARIO	GP-1105	625626C1
COMBUSTIBLE, SECUNDARIO	GP-78	672603C2	ACEITE	GP-10	528250R1	COMBUSTIBLE, SECUNDARIO	GP-1107	702143C1
D354 A DIESEL			COMBUSTIBLE, PRIMARIO	GPP-1122	3136187R91	DT466 (7.6L) A DIESEL		
ACEITE	G-834	795840R91	COMBUSTIBLE, SECUNDARIO	GPP-1122	3132428R1	COMBUSTIBLE, PRIMARIO 5 17/32 IN	GP-1101	625625C1
COMBUSTIBLE	G-296	3044506R91	DT360 (6.0L) A DIESEL			ACEITE, HASTA 1994	GP-69	1808896C1
COMBUSTIBLE	G-296-B	3044506R91	ACEITE	GP-69	1908896C1	COMBUSTIBLE, PRIMARIO 7 17/32 IN	GP-1108	625627C1
D358 A DIESEL			AGUA	GP-1011Q	1661388H1	ACEITE, HASTA 1994	GP-88	1811953C1
ACEITE	GP-10	528250R1	ACEITE	GP-88	1811953C1	AGUA	GP-2071W	1822313C1
COMBUSTIBLE	G-296	3144477R92	COMBUSTIBLE	GP-78	1809789C1	COMBUSTIBLE, FILTRO FINAL PARA CAMIONES	GP-78	1809789C1
COMBUSTIBLE, PRIMARIO	GPP-1122	3136187R91	DT361 (6.0L) A DIESEL			ACEITE, 1994 EN ADELANTE	GP-152	1819452C1
COMBUSTIBLE, SECUNDARIO	GPP-1122	3132428R1	ACEITE, CARTUCHO	G-335	279994R91	AIRE	GA-109	478974C1
COMBUSTIBLE	G-296-B	3144477R92	COMBUSTIBLE, CARTUCHO SECUNDARIO	G-1163	306353R91	AIRE, PRIMARIO	GA-209	476741C1
D360 (6.0L) A DIESEL			COMBUSTIBLE, PRIMARIO SELLADO 6 43/64 IN	GP-1105	625626C1	AIRE, SECUNDARIO	GA-210	482644C1
COMBUSTIBLE, PRIMARIO 6 43/64 IN	GP-1101	625625C1	COMBUSTIBLE, PRIMARIO SELLADO 7 17/32 IN	GP-1108	625627C1	AIRE	GA-2984	472098C1
ACEITE	GP-69	675617C91	COMBUSTIBLE, SECUNDARIO SELLADO	GP-110	702142C1	DT466B (7.6L) A DIESEL		
COMBUSTIBLE, PRIMARIO 6 43/64 IN	GP-1105	625626C1	DT407 A DIESEL			COMBUSTIBLE, PRIMARIO 6 43/64 IN	GP-1101	625625C1
COMBUSTIBLE, PRIMARIO 7 17/32 IN	GP-1108	625627C1	ACEITE, CARTUCHO	G-335	279994R91	ACEITE	GP-69	675617C91
ACEITE	GP-88	1811953C1	COMBUSTIBLE, SEPARADOR DE AGUA 5 3/4 IN	GPP-14	998443R91	COMBUSTIBLE, PRIMARIO 6 43/64 IN	GP-1105	625626C1
COMBUSTIBLE, SECUNDARIO	GP-78	672603C2	COMBUSTIBLE, PRIMARIO 6 43/64 IN	GP-1101	625625C1	COMBUSTIBLE, PRIMARIO 7 17/32 IN	GP-1108	625627C1
D407 A DIESEL			ACEITE, SELLADO	GP-69	675617C91	ACEITE	GP-88	1811953C1
ACEITE, CARTUCHO	G-335	279994R91	COMBUSTIBLE, PRIMARIO 6 43/64 IN	GP-1105	625626C1	COMBUSTIBLE, SECUNDARIO	GP-78	672603C2
COMBUSTIBLE, SEPARADOR DE AGUA 5 3/4 IN	GPP-14	998443R91	ACEITE, SELLADO	GP-69	675617C91	ACEITE, 1994 EN ADELANTE	GP-152	1819452C1
COMBUSTIBLE, PRIMARIO 6 43/64 IN	GP-1101	625625C1	COMBUSTIBLE, PRIMARIO 6 43/64 IN	GP-1105	625626C1	DT466C (7.6L) A DIESEL		
ACEITE, SELLADO	GP-69	675617C91	COMBUSTIBLE, PRIMARIO 7 17/32 IN	GP-1108	625627C1	COMBUSTIBLE, PRIMARIO 5 17/32 IN	GP-1101	625625C1
						ACEITE, HASTA 1994	GP-69	1808896C1

SERVICIO PESADO

MARCA-MODELO-MOTOR MAKE-MODEL-ENGINE	GONHER GONHER	OEM OEM	MARCA-MODELO-MOTOR MAKE-MODEL-ENGINE	GONHER GONHER	OEM OEM	MARCA-MODELO-MOTOR MAKE-MODEL-ENGINE	GONHER GONHER	OEM OEM
I.H.C. HARVESTER (continuación)			I.H.C. HARVESTER (continuación)			I.H.C. HARVESTER (continuación)		
MOTORES			MOTORES			MOTORES		
COMBUSTIBLE, PRIMARIO 7 17/32 IN	GP-1108	625627C1	DV462 A DIESEL			T444E (7.3L) A DIESEL		
ACEITE, HASTA 1994	GP-88	1811953C1	ACEITE, SELLADO	GP-10	39080R2	COMBUSTIBLE, SEPARADOR DE AGUA	G-862	1825864C92
AGUA	GP-2071W	1822313C1	COMBUSTIBLE, SECUNDARIO	GP-1107	702143C1	COMBUSTIBLE, SEPARADOR DE AGUA	G-178	1822631C91
COMBUSTIBLE, FILTRO FINAL PARA CAMIONES	GP-78	1809789C1	COMBUSTIBLE, PRIMARIO	GP-1108	625626C1	COMBUSTIBLE, SEPARADOR DE AGUA	GPP-547	1618385C94
ACEITE, 1994 EN ADELANTE	GP-152	1819452C1	DV550 (9.0L) A DIESEL			AGUA	GP-2071W	1822313C1
AIRE	GA-109	478974C1	ACEITE, SELLADO	GP-10	427207C1	ACEITE	GP-562	1814562C1
AIRE, PRIMARIO	GA-209	476741C1	COMBUSTIBLE, PRIMARIO SELLADO	GP-1108	625627C1	U1 A DIESEL, UB240 A DIESEL, UB264 A DIESEL, UC221 SLEEVED A DIESEL, UC263 SLEEVED A DIESEL, UC301 A DIESEL, UD301 A DIESEL		
AIRE, SECUNDARIO	GA-210	482644C1	COMBUSTIBLE, SEPARADOR DE AGUA	GPP-11	1214920H1	ACEITE	G-335	279994R91
AIRE	GA-2984	472098C1	COMBUSTIBLE, SECUNDARIO SELLADO	GP-78	672603C2	U2 A DIESEL, U2A A DIESEL		
DT466E (7.6L) A DIESEL, DT530 (8.7L) A DIESEL, I530E A DIESEL,			AIRE, CON TURBO	GA-109	478974C1	ACEITE, S/N 5942 EN ADELANTE	GP-50	538836R1
AGUA	GP-2071W	1822313C1	DV550B (9.0L) A DIESEL			U301 A DIESEL, UD166 A DIESEL		
COMBUSTIBLE, CAMIONES	GP-78	1822588C1	ACEITE, SELLADO	GP-10	39080R2	ACEITE	G-335	323827R91
ACEITE	GP-152	1819452C1	COMBUSTIBLE, SECUNDARIO 7 17/32 IN	GP-1107	702143C1	COMBUSTIBLE, PRIMARIO	G-1163	306353R91
DT466PLN (7.6L) A DIESEL			COMBUSTIBLE, PRIMARIO SELLADO	GP-1108	625626C1	COMBUSTIBLE, SECUNDARIO	G-1163	304101R91
COMBUSTIBLE, AUTOBUSES	GP-62	1820479C1	COMBUSTIBLE, SECUNDARIO 7 7/64 IN	GP-78	672603C1	U4 A DIESEL		
AGUA	GP-2071W	1822313C1	AIRE, CON TURBO	GA-109	478974C1	ACEITE, S/N 2730 EN ADELANTE	GP-50	538836R1
COMBUSTIBLE, CAMIONES	GP-78	1822588C1	DV550BTC (9.0L) A DIESEL			U446 A DIESEL		
ACEITE	GP-152	1819452C1	ACEITE, SELLADO	GP-10	39080R2	ACEITE	GP-1	918266R93
DT817B A DIESEL, DT817C A DIESEL, DT817C A DIESEL			COMBUSTIBLE, SECUNDARIO 7 17/32 IN	GP-1107	702143C1	UC135B A DIESEL, UC153 A DIESEL		
COMBUSTIBLE, SECUNDARIO	GP-1107	674293C1	COMBUSTIBLE, PRIMARIO SELLADO	GP-1108	625626C1	ACEITE, S/N 57581 EN ADELANTE	GP-50	538836R1
COMBUSTIBLE, PRIMARIO	GP-1108	625627C1	COMBUSTIBLE, SECUNDARIO SELLADO	GP-78	672603C1	UD144A A DIESEL		
COMBUSTIBLE, SECUNDARIO	GP-110	702253C1	AIRE, CON TURBO	GA-109	478974C1	ACEITE	G-870	705730R91
DTA360 (6.0L) A DIESEL			DVT573 A DIESEL			UD170 A DIESEL		
ACEITE	GP-69	1908896C1	COMBUSTIBLE, PRIMARIO	GP-1108	702251C1	COMBUSTIBLE, PRIMARIO	GP-1108	702251C1
AGUA	GP-1011Q	1661388H1	COMBUSTIBLE, SEPARADOR DE AGUA	GPP-11	1214920H1	UD236 A DIESEL		
ACEITE	GP-88	1811953C1	COMBUSTIBLE, SECUNDARIO SELLADO	GP-78	672603C1	ACEITE	G-335	323827R91
COMBUSTIBLE	GP-78	1809789C1	AIRE, CON TURBO	GA-109	478974C1	COMBUSTIBLE, PRIMARIO	G-1163	306353R91
DTA466 (7.6L) A DIESEL, DTA466C (7.6L) A DIESEL, DTI466 (7.6L) A DIESEL, DVT466 (7.6L) A DIESEL			DVT573B A DIESEL			COMBUSTIBLE, SECUNDARIO	G-1163	304101R91
COMBUSTIBLE, PRIMARIO 5 17/32 IN	GP-1101	625625C1	COMBUSTIBLE, PRIMARIO	GPP-14	702255C1	COMBUSTIBLE, PRIMARIO	GP-1105	702143C1
ACEITE, HASTA 1994	GP-69	1808896C1	COMBUSTIBLE, SEPARADOR DE AGUA	GPP-11	1214920H1	COMBUSTIBLE, PRIMARIO	GP-1108	702251C1
COMBUSTIBLE, PRIMARIO 7 17/32 IN	GP-1108	625627C1	COMBUSTIBLE, SECUNDARIO SELLADO	GP-78	672603C1	COMBUSTIBLE, SEPARADOR DE AGUA	GPP-11	1214920H1
ACEITE, HASTA 1994	GP-88	1811953C1	AIRE, CON TURBO	GA-109	478974C1	COMBUSTIBLE, SECUNDARIO	GP-110	702252C1
AGUA	GP-2071W	1822313C1	DVT800 A DIESEL			UD282 A DIESEL		
COMBUSTIBLE, FILTRO FINAL PARA CAMIONES	GP-78	1809789C1	COMBUSTIBLE, SEPARADOR DE AGUA	GPP-14	998443R91	ACEITE	G-335	323827R91
ACEITE, 1994 EN ADELANTE	GP-152	1819452C1	COMBUSTIBLE, SECUNDARIO SELLADO	GP-78	672603C1	COMBUSTIBLE, PRIMARIO	G-1163	306353R91
AIRE	GA-109	478974C1	AIRE, CON TURBO	GA-109	478974C1	COMBUSTIBLE, SECUNDARIO	G-1163	304101R91
AIRE, PRIMARIO	GA-209	476741C1	DVT573B A DIESEL			COMBUSTIBLE, PRIMARIO	GPP-14	702254C1
AIRE, SECUNDARIO	GA-210	482644C1	COMBUSTIBLE, PRIMARIO	GPP-14	702255C1	COMBUSTIBLE, PRIMARIO	GP-1105	702143C1
AIRE	GA-2984	472098C1	COMBUSTIBLE, SEPARADOR DE AGUA	GP-1107	674293C1	COMBUSTIBLE, PRIMARIO	GP-1108	702251C1
DTI466C (7.6L) A DIESEL			COMBUSTIBLE, SECUNDARIO SELLADO	GP-1108	625627C1	COMBUSTIBLE, SEPARADOR DE AGUA	GPP-11	1214920H1
COMBUSTIBLE, PRIMARIO 6 43/64 IN	GP-1101	625625C1	AIRE, CON TURBO	GA-109	478974C1	COMBUSTIBLE, SECUNDARIO	GP-110	702252C1
ACEITE	GP-69	675617C91	DVT800 A DIESEL			UD312 A DIESEL		
COMBUSTIBLE, PRIMARIO 6 43/64 IN	GP-1105	625626C1	COMBUSTIBLE, SEPARADOR DE AGUA	GPP-14	998443R91	ACEITE	GP-69	675616C91
COMBUSTIBLE, PRIMARIO 7 17/32 IN	GP-1108	625627C1	COMBUSTIBLE, SECUNDARIO SELLADO	GP-78	672603C1	COMBUSTIBLE, PRIMARIO 6 43/64 IN	GP-1105	625626C1
ACEITE	GP-88	1811953C1	AIRE, CON TURBO	GA-109	478974C1	COMBUSTIBLE, PRIMARIO 7 17/32 IN	GP-1108	625627C1
COMBUSTIBLE, SECUNDARIO	GP-78	672603C2	DVT800 A DIESEL			COMBUSTIBLE, SEPARADOR DE AGUA	GPP-11	1214920H1
ACEITE, 1994 EN ADELANTE	GP-152	1819452C1	COMBUSTIBLE, SEPARADOR DE AGUA	GPP-14	998443R91	COMBUSTIBLE, SECUNDARIO	GP-110	702252C1
DU111D A DIESEL, DU66D A DIESEL, DU74D A DIESEL, DU99D A DIESEL			COMBUSTIBLE, SECUNDARIO SELLADO	GP-78	672603C1	IRV446 A DIESEL		
COMBUSTIBLE	G-1121	715712R91	AIRE, CON TURBO	GA-109	478974C1	ACEITE	G-335	323827R91
			DVT800 A DIESEL			COMBUSTIBLE, PRIMARIO	G-1163	306353R91
			COMBUSTIBLE, PRIMARIO	GP-1108	702251C1	COMBUSTIBLE, SECUNDARIO	G-1163	304101R91
			COMBUSTIBLE, SEPARADOR DE AGUA	GPP-11	1214920H1	COMBUSTIBLE, PRIMARIO	GPP-14	702254C1
			COMBUSTIBLE, SECUNDARIO SELLADO	GP-78	672603C1	COMBUSTIBLE, PRIMARIO	GP-1105	702143C1
			AIRE, CON TURBO	GA-109	478974C1	COMBUSTIBLE, PRIMARIO	GP-1108	702251C1
			DVT800 A DIESEL			COMBUSTIBLE, SEPARADOR DE AGUA	GPP-11	1214920H1
			COMBUSTIBLE, SEPARADOR DE AGUA	GPP-14	998443R91	COMBUSTIBLE, SECUNDARIO	GP-110	702252C1
			COMBUSTIBLE, SECUNDARIO SELLADO	GP-78	672603C1	UD312 A DIESEL		
			AIRE, CON TURBO	GA-109	478974C1	ACEITE	GP-69	675616C91
			DVT800 A DIESEL			COMBUSTIBLE, PRIMARIO 6 43/64 IN	GP-1105	625626C1
			COMBUSTIBLE, SEPARADOR DE AGUA	GPP-14	998443R91	COMBUSTIBLE, PRIMARIO 7 17/32 IN	GP-1108	625627C1
			COMBUSTIBLE, SECUNDARIO SELLADO	GP-78	672603C1	COMBUSTIBLE, SEPARADOR DE AGUA	GPP-11	1214920H1
			AIRE, CON TURBO	GA-109	478974C1			
			DVT800 A DIESEL					
			COMBUSTIBLE, SEPARADOR DE AGUA	GPP-14	998443R91			
			COMBUSTIBLE, SECUNDARIO SELLADO	GP-78	672603C1			
			AIRE, CON TURBO	GA-109	478974C1			
			DVT800 A DIESEL					
			COMBUSTIBLE, SEPARADOR DE AGUA	GPP-14	998443R91			
			COMBUSTIBLE, SECUNDARIO SELLADO	GP-78	672603C1			
			AIRE, CON TURBO	GA-109	478974C1			
			DVT800 A DIESEL					
			COMBUSTIBLE, SEPARADOR DE AGUA	GPP-14	998443R91			
			COMBUSTIBLE, SECUNDARIO SELLADO	GP-78	672603C1			
			AIRE, CON TURBO	GA-109	478974C1			
			DVT800 A DIESEL					
			COMBUSTIBLE, SEPARADOR DE AGUA	GPP-14	998443R91			
			COMBUSTIBLE, SECUNDARIO SELLADO	GP-78	672603C1			
			AIRE, CON TURBO	GA-109	478974C1			
			DVT800 A DIESEL					
			COMBUSTIBLE, SEPARADOR DE AGUA	GPP-14	998443R91			
			COMBUSTIBLE, SECUNDARIO SELLADO	GP-78	672603C1			
			AIRE, CON TURBO	GA-109	478974C1			
			DVT800 A DIESEL					
			COMBUSTIBLE, SEPARADOR DE AGUA	GPP-14	998443R91			
			COMBUSTIBLE, SECUNDARIO SELLADO	GP-78	672603C1			
			AIRE, CON TURBO	GA-109	478974C1			
			DVT800 A DIESEL					
			COMBUSTIBLE, SEPARADOR DE AGUA	GPP-14	998443R91			
			COMBUSTIBLE, SECUNDARIO SELLADO	GP-78	672603C1			
			AIRE, CON TURBO	GA-109	478974C1			
			DVT800 A DIESEL					
			COMBUSTIBLE, SEPARADOR DE AGUA	GPP-14	998443R91			
			COMBUSTIBLE, SECUNDARIO SELLADO	GP-78	672603C1			
			AIRE, CON TURBO	GA-109	478974C1			
			DVT800 A DIESEL					
			COMBUSTIBLE, SEPARADOR DE AGUA	GPP-14	998443R91			
			COMBUSTIBLE, SECUNDARIO SELLADO	GP-78	672603C1			
			AIRE, CON TURBO	GA-109	478974C1			
			DVT800 A DIESEL					
			COMBUSTIBLE, SEPARADOR DE AGUA	GPP-14	998443R91			
			COMBUSTIBLE, SECUNDARIO SELLADO	GP-78	672603C1			
			AIRE, CON TURBO	GA-109	478974C1			
			DVT800 A DIESEL					
			COMBUSTIBLE, SEPARADOR DE AGUA	GPP-14	998443R91			
			COMBUSTIBLE, SECUNDARIO SELLADO	GP-78	672603C1			
			AIRE, CON TURBO	GA-109	478974C1			
			DVT800 A DIESEL					
			COMBUSTIBLE, SEPARADOR DE AGUA	GPP-14	998443R91			
			COMBUSTIBLE, SECUNDARIO SELLADO	GP-78	672603C1			
			AIRE, CON TURBO	GA-109	478974C1			
			DVT800 A DIESEL					
			COMBUSTIBLE, SEPARADOR DE AGUA	GPP-14	998443R91			
			COMBUSTIBLE, SECUNDARIO SELLADO	GP-78	672603C1			
			AIRE, CON TURBO	GA-109	478974C1			
			DVT800 A DIESEL					
			COMBUSTIBLE, SEPARADOR DE AGUA	GPP-14	998443R91			
			COMBUSTIBLE, SECUNDARIO SELLADO	GP-78	672603C1			
			AIRE, CON TURBO	GA-109	478974C1			
			DVT800 A DIESEL					
			COMBUSTIBLE, SEPARADOR DE AGUA	GPP-14	998443R91			
			COMBUSTIBLE, SECUNDARIO SELLADO	GP-78	672603C1			
			AIRE, CON TURBO	GA-109	478974C1			
			DVT800 A DIESEL					
			COMBUSTIBLE, SEPARADOR DE AGUA	GPP-14	998443R91			
			COMBUSTIBLE, SECUNDARIO SELLADO	GP-78	672603C1			
			AIRE, CON TURBO	GA-109	478974C1			
			DVT800 A DIESEL					
			COMBUSTIBLE, SEPARADOR DE AGUA	GPP-14	998443R91			
			COMBUSTIBLE, SECUNDARIO SELLADO	GP-78	672603C1			
			AIRE					

MARCA-MODELO-MOTOR MAKE-MODEL-ENGINE	GONHER GONHER	OEM OEM	MARCA-MODELO-MOTOR MAKE-MODEL-ENGINE	GONHER GONHER	OEM OEM	MARCA-MODELO-MOTOR MAKE-MODEL-ENGINE	GONHER GONHER	OEM OEM
I.H.C. HARVESTER (continuación)			I.H.C. HARVESTER (continuación)			I.H.C. HARVESTER (continuación)		
MOTORES			MOTORES			MOTORES		
COMBUSTIBLE, SECUNDARIO	GP-78	672603C2	COMBUSTIBLE, SEPARADOR DE AGUA	GPP-11	1214920H1	AGUA	GP-2071W	1809789C1
UD360 (6.0L) A DIESEL			UDT360 (6.0L) A DIESEL			COMBUSTIBLE, SECUNDARIO	GP-78	672603C2
COMBUSTIBLE, PRIMARIO 5 17/32 IN	GP-1101	625625C1	COMBUSTIBLE, PRIMARIO 6 43/64 IN	GP-1101	625625C1	UDVT573 A DIESEL		
ACEITE	GP-69	675617C91	ACEITE	GP-69	675617C91	COMBUSTIBLE	G-1163	306353R91
COMBUSTIBLE, PRIMARIO 6 43/64 IN	GP-1105	625626C1	COMBUSTIBLE, PRIMARIO 6 43/64 IN	GP-1105	625626C1	COMBUSTIBLE, SECUNDARIO	G-1163	304101R91
COMBUSTIBLE, PRIMARIO 7 17/32 IN	GP-1108	625627C1	COMBUSTIBLE, PRIMARIO 7 17/32 IN	GP-1108	625627C1	COMBUSTIBLE, SECUNDARIO	GPP-14	702255C1
COMBUSTIBLE, SEPARADOR DE AGUA	GPP-11	1214920H1	COMBUSTIBLE, SEPARADOR DE AGUA	GPP-11	1214920H1	COMBUSTIBLE, SECUNDARIO	GP-1107	674293C1
ACEITE	GP-88	1811953C1	ACEITE	GP-88	1811953C1	COMBUSTIBLE, PRIMARIO	GP-1108	702251C1
COMBUSTIBLE, SECUNDARIO	GP-78	672603C2	COMBUSTIBLE, SECUNDARIO	GP-78	672603C2	COMBUSTIBLE, SEPARADOR DE AGUA	GPP-11	1214920H1
UD361 (6.0L) A DIESEL			UDT361 (6.0L) A DIESEL			UV345 A DIESEL		
ACEITE	G-335	323827R91	ACEITE	G-335	323827R91	ACEITE	G-333	216139R91
COMBUSTIBLE, PRIMARIO	G-1163	306353R91	COMBUSTIBLE, PRIMARIO	G-1163	306353R91	V304 A GASOLINA		
COMBUSTIBLE, SECUNDARIO	G-1163	304101R91	COMBUSTIBLE, SECUNDARIO	G-1163	304101R91	ACEITE	GP-10	39080R2
COMBUSTIBLE, PRIMARIO	GP-1105	702143C1	COMBUSTIBLE, PRIMARIO	GP-1105	702143C1	V345 A GASOLINA, V392 A GASOLINA		
COMBUSTIBLE, PRIMARIO	GP-1108	702251C1	COMBUSTIBLE, PRIMARIO	GP-1108	702251C1	ACEITE	GP-10	39080R2
COMBUSTIBLE, SEPARADOR DE AGUA	GPP-11	1214920H1	COMBUSTIBLE, SEPARADOR DE AGUA	GPP-11	1214920H1	AIRE	GA-3501	446661C1
COMBUSTIBLE, SECUNDARIO	GP-110	702142C1	COMBUSTIBLE, SECUNDARIO	GP-110	702142C1	GASOLINA	GG-20	531546R91
UD370 A DIESEL			UDT407 A DIESEL			V537 A DIESEL		
ACEITE	G-335	279994R91	ACEITE, CARTUCHO	G-335	279994R91	ACEITE, FLUJO TOTAL (FULL FLOW)	GP-10	427207C2
UD407 A DIESEL			COMBUSTIBLE, SEPARADOR DE AGUA 5 3/4 IN	GPP-14	998443R91	COMBUSTIBLE	GPP-14	244458R92
ACEITE, CARTUCHO	G-335	279994R91	COMBUSTIBLE, PRIMARIO 6 43/64 IN	GP-1101	625625C1	ACEITE, DERIVACION (BY PASS)	G-750	689032R91
COMBUSTIBLE, SEPARADOR DE AGUA 5 3/4 IN	GPP-14	998443R91	ACEITE, SELLADO	GP-69	675617C91	V605 A DIESEL		
COMBUSTIBLE, PRIMARIO 6 43/64 IN	GP-1101	625625C1	COMBUSTIBLE, PRIMARIO 6 43/64 IN	GP-1105	625626C1	ACEITE, FLUJO TOTAL (FULL FLOW)	GP-10	39080R2
ACEITE, SELLADO	GP-69	675617C91	COMBUSTIBLE, PRIMARIO 7 17/32 IN	GP-1108	625627C1	V800 A DIESEL		
COMBUSTIBLE, PRIMARIO 6 43/64 IN	GP-1105	625626C1	COMBUSTIBLE, SECUNDARIO 7 1/8 IN	GP-110	702142C1	COMBUSTIBLE, PRIMARIO	GPP-14	702255C1
COMBUSTIBLE, PRIMARIO 7 17/32 IN	GP-1108	625627C1	COMBUSTIBLE, SEPARADOR DE AGUA 9 17/32 IN	GPP-1000	702256C1	COMBUSTIBLE	GP-1105	625626C1
COMBUSTIBLE, SECUNDARIO 7 1/8 IN	GP-110	702142C1	UDT429 A DIESEL			COMBUSTIBLE	GP-1107	674293C1
COMBUSTIBLE, SEPARADOR DE AGUA 9 17/32 IN	GPP-1000	702256C1	COMBUSTIBLE, PRIMARIO	G-1163	306353R91	COMBUSTIBLE, PRIMARIO	GP-1108	702251C1
UD414 A DIESEL, UDT414 A DIESEL			COMBUSTIBLE, SECUNDARIO	G-1163	304101R91	COMBUSTIBLE, PRIMARIO	GP-1105	702143C1
COMBUSTIBLE, PRIMARIO 6 43/64 IN	GP-1101	625625C1	COMBUSTIBLE, PRIMARIO	GP-1105	702143C1	COMBUSTIBLE, PRIMARIO	GP-1108	702251C1
ACEITE	GP-69	675617C91	COMBUSTIBLE, SEPARADOR DE AGUA	GPP-11	1214920H1	COMBUSTIBLE, SEPARADOR DE AGUA	GPP-11	1214920H1
COMBUSTIBLE, PRIMARIO 6 43/64 IN	GP-1105	625626C1	COMBUSTIBLE, SECUNDARIO	GP-110	702142C1	AGUA	GP-2071W	1809789C1
COMBUSTIBLE, PRIMARIO 7 17/32 IN	GP-1108	625627C1	UDT436 A DIESEL			COMBUSTIBLE, SECUNDARIO	GP-78	672603C2
COMBUSTIBLE, SEPARADOR DE AGUA	GPP-11	1214920H1	COMBUSTIBLE, SECUNDARIO	GPP-14	674293C1	AIRE	GA-376	420051C1
COMBUSTIBLE, SECUNDARIO	GP-78	672603C2	ACEITE	GP-69	675616C91	AIRE	GA-2984	472098C1
UD466 (7.6L) A DIESEL, UDT466 (7.6L) A DIESEL			COMBUSTIBLE, PRIMARIO	GP-1105	625626C1	VT365 A DIESEL		
ACEITE	GP-69	675617C91	UDT537B A DIESEL, UDT573 A DIESEL			COMBUSTIBLE, PRIMARIO	G-862	1825864-C92
COMBUSTIBLE, PRIMARIO HASTA S/N 13715	GP-1105	625625C1	COMBUSTIBLE, PRIMARIO	G-1163	306353R91	I.H.C. HARVESTER		
COMBUSTIBLE, PRIMARIO S/N 17715 EN ADELANTE	GP-1108	625627C1	COMBUSTIBLE, SECUNDARIO	G-1163	304101R91	PISCADORAS DE ALGODÓN		
COMBUSTIBLE, SEPARADOR DE AGUA	GPP-11	1214920H1	COMBUSTIBLE, PRIMARIO	GPP-14	702251C1	1400 con motor/A DIESEL		
ACEITE	GP-88	1811953C1	COMBUSTIBLE, SECUNDARIO	GPP-14	674293C1	ACEITE, CARTUCHO HIDRAULICO		
COMBUSTIBLE, SECUNDARIO	GP-78	672603C2	COMBUSTIBLE, SEPARADOR DE AGUA	GPP-11	1214920H1	LICO		
UD817B A DIESEL, UDT817B A DIESEL, UDT817C A DIESEL			UDV800 A DIESEL			G-338		
COMBUSTIBLE, SECUNDARIO	GP-1107	674293C1	COMBUSTIBLE, PRIMARIO	GPP-14	702255C1	GP-338		
COMBUSTIBLE, PRIMARIO	GP-1108	625627C1	COMBUSTIBLE	GP-1105	625626C1	70432C91		
			COMBUSTIBLE	GP-1107	674293C1	GP-36		
			COMBUSTIBLE, SEPARADOR DE AGUA	GPP-11	1214920H1	3136046R93		
						GP-34		
						69149C1		
						GP-1122		
						1967094C1		
						GP-2071W		
						1809789C1		
						GA-892		
						529852R4		
						GA-891		
						529851R2		
						214 con motor/IHC D282		
						ACEITE		
						G-335		
						323827R91		
						G-1163		
						306353R91		
						G-1163		
						306353R91		
						GP-10		
						398080R2		

SERVICIO PESADO

MARCA-MODELO-MOTOR MAKE-MODEL-ENGINE	GONHER GONHER	OEM OEM	MARCA-MODELO-MOTOR MAKE-MODEL-ENGINE	GONHER GONHER	OEM OEM	MARCA-MODELO-MOTOR MAKE-MODEL-ENGINE	GONHER GONHER	OEM OEM
I.H.C. HARVESTER (continuación)			I.H.C. HARVESTER (continuación)			I.H.C. HARVESTER		
PISCADORAS DE ALGODÓN			PISCADORAS DE ALGODÓN			RASPADORAS		
214, 220A, 220, 214A con motor/IHC BD240			AIRE, SIN ASPAS	GA-16	384812R93	270 con motor/IHC DVT573		
ACEITE, CARTUCHO	G-335	323827R91	AIRE, SIN ASPAS	GA-403	389263R92	ACEITE	G-33	613798C1
			AIRE	GAK-16	384812R93	COMBUSTIBLE, CARTUCHO SECUNDARIO	G-1163	306353R91
214A, 220A con motor/IHC D282			AIRE	GAK-403	389263R92	COMBUSTIBLE, SECUNDARIO	G-1163	304101R91
ACEITE, CARTUCHO	G-335	323827R91	616 con motor/IHC C301			COMBUSTIBLE, PRIMARIO	GPP-14	702255C1
COMBUSTIBLE, PRIMARIO	G-1163	306353R91	ACEITE, CARTUCHO	G-335	323827R91	COMBUSTIBLE, SECUNDARIO SELLADO	GP-1107	674293C1
COMBUSTIBLE, SECUNDARIO	G-1163	306353R91	HIDRAULICO	G-338	386120R91	COMBUSTIBLE, PRIMARIO SELLADO	GP-1108	625627C1
ACEITE, SELLADO	GP-10	398080R2	ACEITE, SELLADO	GP-10	398080R2	COMBUSTIBLE, SEPARADOR DE AGUA	GPP-11	1214920H1
			AIRE, SIN ASPAS	GA-16	384812R93			
220 con motor/IHC D282			AIRE, SIN ASPAS	GA-403	389263R92	295 con motor/IHC DT817		
ACEITE, CARTUCHO	G-335	323827R91	AIRE	GAK-16	384812R93	TRANSMISION	G-33	319926R91
COMBUSTIBLE, PRIMARIO	G-1163	306353R91	AIRE	GAK-403	389263R92	COMBUSTIBLE, PRIMARIO 6 43/64 IN	GP-1105	625626C1
COMBUSTIBLE, SECUNDARIO	G-1163	306353R91	616 con motor/IHC D310			COMBUSTIBLE, SECUNDARIO	GP-1107	674293C1
ACEITE, SELLADO	GP-10	398080R2	ACEITE, CARTUCHO	G-335	279994R91	COMBUSTIBLE, PRIMARIO 7 17/32 IN	GP-1108	625627C1
			HIDRAULICO	G-338	386120R91	COMBUSTIBLE, SEPARADOR DE AGUA	GPP-11	1214920H1
414 con motor/IHC BD264			COMBUSTIBLE, CARTUCHO	G-1123	3132015R91	COMBUSTIBLE, SECUNDARIO	GP-110	702142C1
ACEITE, CARTUCHO	G-335	323827R91	ACEITE, SELLADO	GP-10	398080R2			
ACEITE, SELLADO	GP-10	398080R2	COMBUSTIBLE	G-296	3144477R92	295, 295B con motor/IHC DT817B		
AIRE, SIN ASPAS	GA-16	384812R93	COMBUSTIBLE, SELLADO	GPP-1122	3132275R91	COMBUSTIBLE, PRIMARIO	GP-1108	625627C1
AIRE	GAK-16	384812R93	COMBUSTIBLE	G-296-B	3144477R92			
			AIRE	GAK-403	389263R92	295B con motor/IHC DT817		
414, 416, 420 con motor/IHC D282			622 con motor/IHC C291			TRANSMISION	G-33	319926R91
ACEITE, CARTUCHO	G-335	323827R91	ACEITE, CARTUCHO	G-335	323827R91	COMBUSTIBLE, PRIMARIO 6 43/64 IN	GP-1105	625626C1
COMBUSTIBLE, PRIMARIO	G-1163	306353R91	HIDRAULICO	G-338	386122R92	COMBUSTIBLE, SECUNDARIO	GP-1107	674293C1
COMBUSTIBLE, SECUNDARIO	G-1163	306353R91	ACEITE, SELLADO	GP-10	398080R2	COMBUSTIBLE, PRIMARIO 7 17/32 IN	GP-1108	625627C1
ACEITE, SELLADO	GP-10	398080R2	AIRE, SIN ASPAS	GA-16	384812R93	COMBUSTIBLE, SEPARADOR DE AGUA	GPP-11	1214920H1
AIRE, SIN ASPAS	GA-403	389263R92	AIRE, SIN ASPAS	GA-403	389263R92	COMBUSTIBLE, SECUNDARIO	GP-110	702142C1
AIRE	GAK-403	389263R92	AIRE	GAK-16	384812R93			
			AIRE	GAK-403	389263R92	295B con motor/IHC DT817		
416 con motor/IHC C263			AIRE	GAK-403	389263R92	TRANSMISION	G-33	319926R91
ACEITE, CARTUCHO	G-335	279994R91	622 con motor/IHC C301			COMBUSTIBLE, PRIMARIO 6 43/64 IN	GP-1105	625626C1
ACEITE, SELLADO	GP-69	A184775	ACEITE, CARTUCHO	G-335	323827R91	COMBUSTIBLE, SECUNDARIO	GP-1107	674293C1
AIRE, SIN ASPAS	GA-16	384812R93	HIDRAULICO	G-338	386120R91	COMBUSTIBLE, PRIMARIO 7 17/32 IN	GP-1108	625627C1
AIRE	GAK-16	384812R93	ACEITE, SELLADO	GP-10	398080R2	COMBUSTIBLE, SEPARADOR DE AGUA	GPP-11	1214920H1
			ACEITE	GP-69	A184775	COMBUSTIBLE, SECUNDARIO	GP-110	702142C1
416, 420, 422 con motor/IHC BD264			AIRE	GA-16	384812R93	412 con motor/IHC		
ACEITE, CARTUCHO	G-335	323827R91	AIRE	GA-403	389263R92	COMBUSTIBLE, SEPARADOR DE AGUA	GPP-14	998443R91
			AIRE	GAK-16	384812R93	ACEITE	GP-69	675617C91
420 con motor/IHC C263			AIRE	GAK-403	389263R92	COMBUSTIBLE, PRIMARIO	GP-1105	625626C1
ACEITE, CARTUCHO	G-335	279994R91	622 con motor/IHC D310			AGUA	GP-2071W	1809789C1
ACEITE, SELLADO	GP-10	398080R2	ACEITE, CARTUCHO	G-335	279994R91	COMBUSTIBLE, SECUNDARIO	GP-78	674293C1
AIRE, SIN ASPAS	GA-16	384812R93	HIDRAULICO	G-338	386120R91	AIRE, PRIMARIO	GA-329	627934C1
AIRE	GAK-16	384812R93	COMBUSTIBLE, CARTUCHO	G-1123	3132015R91	AIRE, SECUNDARIO	GA-239	627935C1
			ACEITE, SELLADO	GP-10	398080R2			
422 con motor/IHC C263			COMBUSTIBLE	G-296	3144477R92	412 con motor/IHC DT466		
ACEITE, CARTUCHO	G-335	279994R91	COMBUSTIBLE, SELLADO	GPP-1122	3132275R91	ACEITE	GP-69	675617C91
ACEITE, SELLADO	GP-69	A184775	COMBUSTIBLE	G-296-B	3144477R92	COMBUSTIBLE, PRIMARIO	GP-1105	702255C1
AIRE, SIN ASPAS	GA-16	384812R93	AIRE	GAK-403	389263R92	COMBUSTIBLE, SECUNDARIO	GP-1107	674293C1
AIRE	GAK-16	384812R93	782 con motor/IHC D310			COMBUSTIBLE, PRIMARIO	GP-1108	625627C1
			ACEITE, CARTUCHO	G-335	279994R91	COMBUSTIBLE, SEPARADOR DE AGUA	GPP-11	1214920H1
422 con motor/IHC D282			HIDRAULICO	G-338	386120R91	COMBUSTIBLE, SECUNDARIO	GP-78	674293C1
ACEITE, CARTUCHO	G-335	323827R91	COMBUSTIBLE, CARTUCHO	G-1123	3132015R91	AIRE, PRIMARIO	GA-329	627934C1
COMBUSTIBLE, PRIMARIO	G-1163	306353R91	ACEITE, SELLADO	GP-10	398080R2	AIRE, SECUNDARIO	GA-239	627935C1
COMBUSTIBLE, SECUNDARIO	G-1163	306353R91	COMBUSTIBLE	G-296	3144477R92			
ACEITE, SELLADO	GP-69	A184775	COMBUSTIBLE, SELLADO	GPP-1122	3132275R91	412B con motor/CUMMINS		
AIRE, SIN ASPAS	GA-403	389263R92	COMBUSTIBLE	G-296-B	3144477R92	COMBUSTIBLE	GP-1101	625625C1
AIRE	GAK-403	389263R92	AIRE	GAK-403	389263R92	412B con motor/IHC		
			782 con motor/A DIESEL			COMBUSTIBLE, SEPARADOR DE AGUA	GPP-14	998443R91
616 con motor/IHC C291			ACEITE	GP-36	3136046R93	ACEITE	GP-69	675617C91
ACEITE, CARTUCHO	G-335	323827R91	HIDRAULICO	GP-34	69149C1	COMBUSTIBLE, PRIMARIO	GP-1105	625626C1
HIDRAULICO	G-338	386122R92	COMBUSTIBLE	GPP-1122	1967094C1	AGUA	GP-2071W	1809789C1
ACEITE	GP-10	398080R2	AIRE, SECUNDARIO	GA-892	529852R1			
			782 con motor/IHC D310					
			ACEITE, OPCIONAL	GP-10	3059246R91			

MARCA-MODELO-MOTOR MAKE-MODEL-ENGINE	GONHER GONHER	OEM OEM	MARCA-MODELO-MOTOR MAKE-MODEL-ENGINE	GONHER GONHER	OEM OEM	MARCA-MODELO-MOTOR MAKE-MODEL-ENGINE	GONHER GONHER	OEM OEM
I.H.C. HARVESTER (continuación)			I.H.C. HARVESTER (continuación)			I.H.C. HARVESTER (continuación)		
RASPADORAS			RASPADORAS			RASPADORAS		
COMBUSTIBLE, SECUNDARIO	GP-78	674293C1				442B con motor/IHC DT466		
AIRE, PRIMARIO	GA-329	627934C1	433 con motor/IHC DVT800			COMBUSTIBLE, SEPARADOR DE AGUA	GPP-14	998443R91
AIRE, SECUNDARIO	GA-239	627935C1	ACEITE, CUMPLE CON MEDIDAS ORIGINALES	GP-691	684206C1	ACEITE	GP-69	675616C91
431 con motor/A DIESEL			COMBUSTIBLE, SEPARADOR DE AGUA	GPP-14	998443R91	COMBUSTIBLE, PRIMARIO	GP-1105	625626C1
TRANSMISION	G-333	615447C1	ACEITE, SEGUNDA OPCION	GP-52	684206C1	ACEITE	GP-88	1811953C1
COMBUSTIBLE, PRIMARIO	GPP-14	702255C1	COMBUSTIBLE, SECUNDARIO	GP-1107	674293C1	AGUA	GP-2071W	1261387H1
COMBUSTIBLE, SECUNDARIO	GP-1107	674293C1	COMBUSTIBLE, PRIMARIO	GP-1108	625627C1	COMBUSTIBLE, SECUNDARIO	GP-78	674293C1
COMBUSTIBLE, PRIMARIO	GP-1108	625627C1	AGUA	GP-2071W	1261387H1	442B con motor/IHC DVT800		
COMBUSTIBLE, SEPARADOR DE AGUA	GPP-11	1214920H1	433B con motor/IHC DT466			ACEITE, CUMPLE CON MEDIDAS ORIGINALES	GP-691	684206C1
COMBUSTIBLE, SECUNDARIO	GP-78	674293C1	COMBUSTIBLE, SEPARADOR DE AGUA	GPP-14	998443R91	COMBUSTIBLE, SEPARADOR DE AGUA	GPP-14	998443R91
431 con motor/IHC DT466			ACEITE	GP-69	675616C91	ACEITE, SEGUNDA OPCION	GP-52	684206C1
COMBUSTIBLE, SEPARADOR DE AGUA	GPP-14	998443R91	COMBUSTIBLE, PRIMARIO	GP-1105	625626C1	COMBUSTIBLE, SECUNDARIO	GP-1107	674293C1
ACEITE	GP-69	675616C91	ACEITE	GP-88	1811953C1	COMBUSTIBLE, PRIMARIO	GP-1108	625627C1
COMBUSTIBLE, PRIMARIO	GP-1105	625626C1	AGUA	GP-2071W	1261387H1	AGUA	GP-2071W	1261387H1
ACEITE	GP-88	1811953C1	COMBUSTIBLE, SECUNDARIO	GP-78	674293C1	444 con motor/IHC DT466		
AGUA	GP-2071W	1261387H1	433B con motor/IHC DVT800			COMBUSTIBLE, SEPARADOR DE AGUA	GPP-14	998443R91
COMBUSTIBLE, SECUNDARIO	GP-78	674293C1	ACEITE, CUMPLE CON MEDIDAS ORIGINALES	GP-691	684206C1	ACEITE	GP-69	675616C91
431 con motor/IHC DVT800			COMBUSTIBLE, SEPARADOR DE AGUA	GPP-14	998443R91	COMBUSTIBLE, PRIMARIO	GP-1105	625626C1
ACEITE, CUMPLE CON MEDIDAS ORIGINALES	GP-691	684206C1	ACEITE, SEGUNDA OPCION	GP-52	684206C1	ACEITE	GP-88	1811953C1
COMBUSTIBLE, SEPARADOR DE AGUA	GPP-14	998443R91	COMBUSTIBLE, SECUNDARIO	GP-1107	674293C1	AGUA	GP-2071W	1261387H1
ACEITE, SEGUNDA OPCION	GP-52	684206C1	COMBUSTIBLE, PRIMARIO	GP-1108	625627C1	COMBUSTIBLE, SECUNDARIO	GP-78	674293C1
COMBUSTIBLE, SECUNDARIO	GP-1107	674293C1	AGUA	GP-2071W	1261387H1	444 con motor/IHC DVT800		
COMBUSTIBLE, PRIMARIO	GP-1108	625627C1	442 con motor/A DIESEL			ACEITE, CUMPLE CON MEDIDAS ORIGINALES	GP-691	684206C1
AGUA	GP-2071W	1261387H1	TRANSMISION	G-333	615447C1	COMBUSTIBLE, SEPARADOR DE AGUA	GPP-14	998443R91
431B con motor/A DIESEL			COMBUSTIBLE, PRIMARIO	GPP-14	702255C1	ACEITE, SEGUNDA OPCION	GP-52	684206C1
TRANSMISION	G-333	615447C1	COMBUSTIBLE, SECUNDARIO	GP-1107	674293C1	COMBUSTIBLE, SECUNDARIO	GP-1107	674293C1
COMBUSTIBLE, PRIMARIO	GPP-14	702255C1	COMBUSTIBLE, PRIMARIO	GP-1108	625627C1	COMBUSTIBLE, PRIMARIO	GP-1108	625627C1
COMBUSTIBLE, SECUNDARIO	GP-1107	674293C1	COMBUSTIBLE, SEPARADOR DE AGUA	GPP-11	1214920H1	AGUA	GP-2071W	1261387H1
COMBUSTIBLE, PRIMARIO	GP-1108	625627C1	COMBUSTIBLE, SECUNDARIO	GP-78	674293C1	444B con motor/IHC DT466		
COMBUSTIBLE, SEPARADOR DE AGUA	GPP-11	1214920H1	442 con motor/IHC DT466			COMBUSTIBLE, SEPARADOR DE AGUA	GPP-14	998443R91
COMBUSTIBLE, SECUNDARIO	GP-78	674293C1	COMBUSTIBLE, SEPARADOR DE AGUA	GPP-14	998443R91	ACEITE	GP-69	675616C91
431B con motor/IHC DT466			ACEITE	GP-69	675616C91	COMBUSTIBLE, PRIMARIO	GP-1105	625626C1
COMBUSTIBLE, SEPARADOR DE AGUA	GPP-14	998443R91	COMBUSTIBLE, PRIMARIO	GP-1105	625626C1	ACEITE	GP-88	1811953C1
ACEITE	GP-69	675616C91	ACEITE	GP-88	1811953C1	AGUA	GP-2071W	1261387H1
COMBUSTIBLE, PRIMARIO	GP-1105	625626C1	AGUA	GP-2071W	1261387H1	COMBUSTIBLE, SECUNDARIO	GP-78	674293C1
ACEITE	GP-88	1811953C1	COMBUSTIBLE, SECUNDARIO	GP-78	674293C1	444B con motor/IHC DVT800		
AGUA	GP-2071W	1261387H1	442 con motor/IHC DVT800			ACEITE, CUMPLE CON MEDIDAS ORIGINALES	GP-691	684206C1
COMBUSTIBLE, SECUNDARIO	GP-78	674293C1	ACEITE, CUMPLE CON MEDIDAS ORIGINALES	GP-691	684206C1	COMBUSTIBLE, SEPARADOR DE AGUA	GPP-14	998443R91
431B con motor/IHC DVT800			COMBUSTIBLE, SEPARADOR DE AGUA	GPP-14	998443R91	ACEITE, SEGUNDA OPCION	GP-52	684206C1
ACEITE, CUMPLE CON MEDIDAS ORIGINALES	GP-691	684206C1	ACEITE, SEGUNDA OPCION	GP-52	684206C1	COMBUSTIBLE, SECUNDARIO	GP-1107	674293C1
COMBUSTIBLE, SEPARADOR DE AGUA	GPP-14	998443R91	COMBUSTIBLE, SECUNDARIO	GP-1107	674293C1	COMBUSTIBLE, PRIMARIO	GP-1108	625627C1
ACEITE, SEGUNDA OPCION	GP-52	684206C1	COMBUSTIBLE, PRIMARIO	GP-1108	625627C1	AGUA	GP-2071W	1261387H1
COMBUSTIBLE, SECUNDARIO	GP-1107	674293C1	AGUA	GP-2071W	1261387H1	495 con motor/IHC DT817		
COMBUSTIBLE, PRIMARIO	GP-1108	625627C1	442B con motor/A DIESEL			TRANSMISION	G-33	319926R91
AGUA	GP-2071W	1261387H1	TRANSMISION	G-333	615447C1	COMBUSTIBLE, PRIMARIO	GP-1105	625626C1
433 con motor/IHC DT466			COMBUSTIBLE, PRIMARIO	GPP-14	702255C1	COMBUSTIBLE, PRIMARIO	GP-1108	625627C1
COMBUSTIBLE, SEPARADOR DE AGUA	GPP-14	998443R91	COMBUSTIBLE, SECUNDARIO	GP-1107	674293C1	COMBUSTIBLE, SEPARADOR DE AGUA	GPP-11	1214920H1
ACEITE	GP-69	675616C91	COMBUSTIBLE, PRIMARIO	GP-1108	625627C1	COMBUSTIBLE, SECUNDARIO	GP-110	702142C1
COMBUSTIBLE, PRIMARIO	GP-1105	625626C1	COMBUSTIBLE, SEPARADOR DE AGUA	GPP-11	1214920H1	495 con motor/IHC DT817B		
ACEITE	GP-88	1811953C1	COMBUSTIBLE, SECUNDARIO	GP-78	674293C1	COMBUSTIBLE, SECUNDARIO	GP-1107	674293C1
AGUA	GP-2071W	1261387H1						
COMBUSTIBLE, SECUNDARIO	GP-78	674293C1						

MARCA-MODELO-MOTOR MAKE-MODEL-ENGINE	GONHER GONHER	OEM OEM	MARCA-MODELO-MOTOR MAKE-MODEL-ENGINE	GONHER GONHER	OEM OEM	MARCA-MODELO-MOTOR MAKE-MODEL-ENGINE	GONHER GONHER	OEM OEM
I.H.C. HARVESTER (continuación)			I.H.C. HARVESTER (continuación)			I.H.C. HARVESTER (continuación)		
RASPADORAS			RASPADORAS			TRACTORES		
55 con motor/CUMMINS HR-6			COMBUSTIBLE, PRIMARIO 17/32 IN	GP-1108	625627C1	1046 SOBRE RUEDAS, 1046A SOBRE RUEDAS con motor/A DIESEL		
COMBUSTIBLE, PRIMARIO	GPP-14	1214920H1	COMBUSTIBLE, SEPARADOR DE AGUA	GPP-11	1214920H1	COMBUSTIBLE	G-296	3144477R92
COMBUSTIBLE, PRIMARIO	GP-1101	625625C1	COMBUSTIBLE, SECUNDARIO 7 1/8 IN	GP-110	702142C1	1056 SOBRE RUEDAS, 1056XL SOBRE RUEDAS con motor/IHC D358		
ACEITE, DERIVACION (BY PASS)	G-750	689032R91	E295 con motor/IHC DT817B			ACEITE	GP-10	3132737R93
75 con motor/CUMMINS NT-6			COMBUSTIBLE, SECUNDARIO	GP-1107	674293C1	COMBUSTIBLE	G-296	3144477R92
COMBUSTIBLE, PRIMARIO	GP-1101	625625C1	E295B con motor/IHC DT817			COMBUSTIBLE, PRIMARIO	GPP-1122	3132275R91
COMBUSTIBLE, PRIMARIO	GPP-11	1214920H1	TRANSMISION	G-33	319926R91	COMBUSTIBLE, SECUNDARIO	GPP-1122	3132275R91
ACEITE, DERIVACION (BY PASS)	G-750	689032R91	COMBUSTIBLE, SECUNDARIO	GP-1107	674293C1	COMBUSTIBLE	G-296-B	3144477R92
E200 con motores/IHC DT361, IHC DT407			COMBUSTIBLE, PRIMARIO	GP-1108	625627C1	1066 SOBRE RUEDAS con motor/IHC DT414		
TRANSMISION	G-333	214731R91	ET200 con motor/IHC DT414			HYDROSTATIC GEAR DRIVE	G-338	70432C91
ACEITE	G-335	279994R91	ACEITE	GP-69	675617C91	COMBUSTIBLE, PRIMARIO 5 17/32 IN	GP-1101	625625C1
COMBUSTIBLE, PRIMARIO 6 43/64 IN	GP-1105	625626C1	COMBUSTIBLE, PRIMARIO 6 43/64 IN	GP-1105	625626C1	ACEITE	GP-69	A184775
COMBUSTIBLE, PRIMARIO 7 17/32 IN	GP-1108	625627C1	COMBUSTIBLE, SECUNDARIO	GP-78	672603C2	COMBUSTIBLE, PRIMARIO 6 43/64 IN	GP-1105	625626C1
COMBUSTIBLE, SEPARADOR DE AGUA	GPP-11	1214920H1	AIRE, PRIMARIO	GA-329	627934C1	COMBUSTIBLE, PRIMARIO 7 17/32 IN	GP-1108	A184773
COMBUSTIBLE, SECUNDARIO 7 1/8 IN	GP-110	702253C1	AIRE, SECUNDARIO	GA-239	627935C1	AGUA	GP-2071W	A151931
E200 con motores/IHC DT414, IHC DT466			AIRE, SECUNDARIO	GA-239	627935C1	COMBUSTIBLE, SECUNDARIO	GP-78	672603C2
COMBUSTIBLE, SEPARADOR DE AGUA	GPP-14	998443R91	ET200 con motores/IHC DT361, IHC DT407			AIRE, PRIMARIO	GA-826	67974C4
ACEITE	GP-69	675617C91	TRANSMISION	G-333	615447C1	AIRE, SECUNDARIO	GA-827	67975C1
COMBUSTIBLE, PRIMARIO 6 43/64 IN	GP-1105	625626C1	ACEITE	G-335	279994R91	1086 SOBRE RUEDAS con motor/IHC DT414		
COMBUSTIBLE, PRIMARIO 7 17/32 IN	GP-1108	625627C1	COMBUSTIBLE, PRIMARIO 6 43/64 IN	GP-1105	625626C1	HYDROSTATIC GEAR DRIVE	G-338	70432C91
AGUA	GP-2071W	1261387H1	COMBUSTIBLE, PRIMARIO 7 17/32 IN	GP-1108	625627C1	ACEITE	GP-69	A184775
COMBUSTIBLE, SECUNDARIO 7 7/64 IN	GP-78	672603C2	COMBUSTIBLE, SEPARADOR DE AGUA	GPP-11	1214920H1	COMBUSTIBLE, PRIMARIO	GP-1108	A184773
AIRE, PRIMARIO	GA-329	627934C1	COMBUSTIBLE, SECUNDARIO 7 1/8 IN	GP-110	702253C1	COMBUSTIBLE, SEPARADOR DE AGUA	GPP-11	1214920H1
AIRE, SECUNDARIO	GA-239	627935C1	PD105 con motor/IHC UD817			AGUA	GP-2071W	A151931
E211 con motor/IHC D407			COMBUSTIBLE, PRIMARIO	GP-1105	625626C1	COMBUSTIBLE, SECUNDARIO	GP-78	672603C2
TRANSMISION	G-333	214731R91	COMBUSTIBLE, PRIMARIO	GP-1108	625627C1	AIRE, PRIMARIO	GA-826	67974C2
ACEITE	G-335	279994R91	COMBUSTIBLE, SEPARADOR DE AGUA	GPP-11	1214920H1	AIRE, SECUNDARIO	GA-827	67975C1
COMBUSTIBLE, PRIMARIO 6 43/64 IN	GP-1105	625626C1	COMBUSTIBLE, SECUNDARIO	GP-110	702253C1	12 HP CADET SOBRE RUEDAS, 14 HP CADET SOBRE RUEDAS con motor/A DIESEL		
COMBUSTIBLE, PRIMARIO 7 17/32 IN	GP-1108	625627C1	PD105 con motor/IHC UD817			ACEITE	GP-171	395789R2
COMBUSTIBLE, SEPARADOR DE AGUA	GPP-11	1214920H1	COMBUSTIBLE, PRIMARIO	GP-1105	625626C1	1206 con motor/A DIESEL		
COMBUSTIBLE, SECUNDARIO 7 1/8 IN	GP-110	702253C1	COMBUSTIBLE, PRIMARIO	GP-1108	625627C1	ACEITE	G-335	279994R91
E270 con motor/IHC DVT573			COMBUSTIBLE, SEPARADOR DE AGUA	GPP-11	1214920H1	1206 SERIES SOBRE RUEDAS con motor/IHC DT361		
COMBUSTIBLE, PRIMARIO	G-1163	306353R91	COMBUSTIBLE, SECUNDARIO	GP-110	702253C1	ACEITE	G-335	323827R91
COMBUSTIBLE, SECUNDARIO	G-1163	304101R91	COMBUSTIBLE, PRIMARIO	GP-1108	625627C1	COMBUSTIBLE, SECUNDARIO	G-1163	306353R91
COMBUSTIBLE, PRIMARIO	GPP-14	702255C1	COMBUSTIBLE, SEPARADOR DE AGUA	GPP-11	1214920H1	HYDROSTATIC GEAR DRIVE	G-338	70432C91
COMBUSTIBLE, SECUNDARIO SELLADO	GP-1107	674293C1	E270 con motor/IHC DVT573B			1206D con motor/IHC D407		
COMBUSTIBLE, PRIMARIO SELLADO	GP-1108	625627C1	ACEITE	G-33	613798C1	ACEITE	G-335	279994R91
COMBUSTIBLE, SEPARADOR DE AGUA	GPP-11	1214920H1	E295 con motor/IHC DT817			COMBUSTIBLE, PRIMARIO	G-1163	306353R91
E270 con motor/IHC DVT573B			TRANSMISION	G-33	319926R91	COMBUSTIBLE, SECUNDARIO	G-1163	306353R91
ACEITE	G-33	613798C1	COMBUSTIBLE, PRIMARIO 6 43/64 IN	GP-1105	625626C1	HIDRAULICO	G-338	70432C91
E295 con motor/IHC DT817			COMBUSTIBLE, SECUNDARIO 7 17/32 IN	GP-1107	674293C1	1250 SOBRE RUEDAS con motor/KOHLER 12 HP		
TRANSMISION	G-33	319926R91	COMBUSTIBLE, SECUNDARIO	GP-1108	625627C1	HYDROSTATIC TRANSMISION	GP-9	395789R2
COMBUSTIBLE, PRIMARIO 6 43/64 IN	GP-1105	625626C1	COMBUSTIBLE, SEPARADOR DE AGUA	GPP-1000	702256C1	1256 SERIES SOBRE RUEDAS, 1456 SERIES con motor/IHC DT407		
COMBUSTIBLE, SECUNDARIO 7 17/32 IN	GP-1107	674293C1	10 HP CADET SOBRE RUEDAS con motor/A DIESEL			ACEITE	G-335	323827R91
E295B con motor/IHC DT817			TRANSMISION	GP-171	395789R2	HYDROSTATIC GEAR DRIVE	G-338	70432C91
TRANSMISION	G-33	319926R91	100 SOBRE RUEDAS con motor/A DIESEL			COMBUSTIBLE, PRIMARIO 6 43/64 IN	GP-1105	625626C1
COMBUSTIBLE, PRIMARIO 6 43/64 IN	GP-1105	625626C1	ACEITE, SELLADO	GP-50	538836R1	COMBUSTIBLE, PRIMARIO 7 17/32 IN	GP-1108	A184773
COMBUSTIBLE, SECUNDARIO 7 17/32 IN	GP-1107	674293C1	1026 SERIES SOBRE RUEDAS con motor/IHC DT407			COMBUSTIBLE	GP-110	702142C1
ACEITE, DERIVACION (BY PASS)	G-750	689032R91	ACEITE	G-335	279994R91	COMBUSTIBLE	GP-110	702142C1
COMBUSTIBLE, PRIMARIO	GP-1101	625625C1	HYDROSTATIC GEAR DRIVE	G-338	70432C91	COMBUSTIBLE	GPP-1000	702256C1
COMBUSTIBLE, SECUNDARIO	GP-1105	625626C1	COMBUSTIBLE, PRIMARIO 6 43/64 IN	GP-1105	625626C1	COMBUSTIBLE		
ACEITE, DERIVACION (BY PASS)	G-750	689032R91	COMBUSTIBLE, PRIMARIO 7 17/32 IN	GP-1108	625627C1	COMBUSTIBLE, SECUNDARIO		
E200 con motores/IHC DT361, IHC DT407			COMBUSTIBLE, SECUNDARIO	GP-110	702142C1	COMBUSTIBLE, SEPARADOR DE AGUA		
TRANSMISION	G-333	214731R91	COMBUSTIBLE, SECUNDARIO	GP-110	702253C1	1206 con motor/A DIESEL		
ACEITE	G-335	279994R91	COMBUSTIBLE, PRIMARIO	GP-1105	625626C1	ACEITE	G-335	279994R91
COMBUSTIBLE, PRIMARIO 6 43/64 IN	GP-1105	625626C1	COMBUSTIBLE, SEPARADOR DE AGUA	GPP-11	1214920H1	1206 SERIES SOBRE RUEDAS con motor/IHC DT361		
COMBUSTIBLE, PRIMARIO 7 17/32 IN	GP-1108	625627C1	COMBUSTIBLE, SECUNDARIO 7 1/8 IN	GP-110	702253C1	ACEITE	G-335	323827R91
AGUA	GP-2071W	1261387H1	PD105 con motor/IHC UD817			COMBUSTIBLE, SECUNDARIO	G-1163	306353R91
COMBUSTIBLE, SECUNDARIO 7 7/64 IN	GP-78	672603C2	COMBUSTIBLE, PRIMARIO	GP-1105	625626C1	HYDROSTATIC GEAR DRIVE	G-338	70432C91
AIRE, PRIMARIO	GA-329	627934C1	COMBUSTIBLE, PRIMARIO	GP-1108	625627C1	1206D con motor/IHC D407		
AIRE, SECUNDARIO	GA-239	627935C1	COMBUSTIBLE, SEPARADOR DE AGUA	GPP-11	1214920H1	ACEITE	G-335	279994R91
E211 con motor/IHC D407			COMBUSTIBLE, SECUNDARIO	GP-110	702253C1	COMBUSTIBLE, PRIMARIO	G-1163	306353R91
TRANSMISION	G-333	214731R91	COMBUSTIBLE, PRIMARIO	GP-1105	625626C1	COMBUSTIBLE, SECUNDARIO	G-1163	306353R91
ACEITE	G-335	279994R91	COMBUSTIBLE, SEPARADOR DE AGUA	GPP-11	1214920H1	HIDRAULICO	G-338	70432C91
COMBUSTIBLE, PRIMARIO 6 43/64 IN	GP-1105	625626C1	COMBUSTIBLE, SECUNDARIO	GP-110	702253C1	1250 SOBRE RUEDAS con motor/KOHLER 12 HP		
COMBUSTIBLE, PRIMARIO 7 17/32 IN	GP-1108	625627C1	COMBUSTIBLE, PRIMARIO	GP-1108	625627C1	HYDROSTATIC TRANSMISION	GP-9	395789R2
COMBUSTIBLE, SEPARADOR DE AGUA	GPP-11	1214920H1	COMBUSTIBLE, SEPARADOR DE AGUA	GPP-11	1214920H1	1256 SERIES SOBRE RUEDAS, 1456 SERIES con motor/IHC DT407		
COMBUSTIBLE, SECUNDARIO 7 1/8 IN	GP-110	702253C1	10 HP CADET SOBRE RUEDAS con motor/A DIESEL			ACEITE	G-335	323827R91
E270 con motor/IHC DVT573			TRANSMISION	GP-171	395789R2	HYDROSTATIC GEAR DRIVE	G-338	70432C91
COMBUSTIBLE, PRIMARIO	G-1163	306353R91	100 SOBRE RUEDAS con motor/A DIESEL			COMBUSTIBLE, PRIMARIO 6 43/64 IN	GP-1105	625626C1
COMBUSTIBLE, SECUNDARIO	G-1163	304101R91	ACEITE, SELLADO	GP-50	538836R1	COMBUSTIBLE, PRIMARIO 7 17/32 IN	GP-1108	A184773
COMBUSTIBLE, PRIMARIO	GPP-14	702255C1	1026 SERIES SOBRE RUEDAS con motor/IHC DT407			COMBUSTIBLE, SECUNDARIO	GP-110	702142C1
COMBUSTIBLE, SECUNDARIO SELLADO	GP-1107	674293C1	ACEITE	G-335	279994R91	COMBUSTIBLE, SEPARADOR DE AGUA	GPP-1000	702256C1
COMBUSTIBLE, PRIMARIO SELLADO	GP-1108	625627C1	HYDROSTATIC GEAR DRIVE	G-338	70432C91	1206 con motor/A DIESEL		
COMBUSTIBLE, SEPARADOR DE AGUA	GPP-11	1214920H1	COMBUSTIBLE, PRIMARIO 6 43/64 IN	GP-1105	625626C1	ACEITE	G-335	279994R91
E270 con motor/IHC DVT573B			COMBUSTIBLE, PRIMARIO 7 17/32 IN	GP-1108	625627C1	COMBUSTIBLE, PRIMARIO	G-1163	306353R91
ACEITE	G-33	613798C1	COMBUSTIBLE, SECUNDARIO	GP-110	702142C1	COMBUSTIBLE, SECUNDARIO	G-1163	306353R91
E295 con motor/IHC DT817			COMBUSTIBLE, SEPARADOR DE AGUA	GPP-1000	702256C1	HIDRAULICO	G-338	70432C91
TRANSMISION	G-33	319926R91	1026 SOBRE RUEDAS con motor/IHC DT407			1250 SOBRE RUEDAS con motor/KOHLER 12 HP		
COMBUSTIBLE, PRIMARIO 6 43/64 IN	GP-1105	625626C1	ACEITE	G-335	279994R91	HYDROSTATIC TRANSMISION	GP-9	395789R2
COMBUSTIBLE, SECUNDARIO 7 17/32 IN	GP-1107	674293C1	HYDROSTATIC GEAR DRIVE	G-338	70432C91	1256 SERIES SOBRE RUEDAS, 1456 SERIES con motor/IHC DT407		
ACEITE, DERIVACION (BY PASS)	G-750	689032R91	COMBUSTIBLE, PRIMARIO 6 43/64 IN	GP-1105	625626C1	ACEITE	G-335	323827R91
COMBUSTIBLE, PRIMARIO	GP-1101	625625C1	COMBUSTIBLE, PRIMARIO 7 17/32 IN	GP-1108	625627C1	HYDROSTATIC GEAR DRIVE	G-338	70432C91
COMBUSTIBLE, SECUNDARIO	GP-1105	625626C1	COMBUSTIBLE, SECUNDARIO	GP-110	702142C1	COMBUSTIBLE, PRIMARIO 6 43/64 IN	GP-1105	625626C1
ACEITE, DERIVACION (BY PASS)	G-750	689032R91	COMBUSTIBLE, SEPARADOR DE AGUA	GPP-1000	702256C1	COMBUSTIBLE, PRIMARIO 7 17/32 IN	GP-1108	A184773
E200 con motores/IHC DT361, IHC DT407			COMBUSTIBLE, SECUNDARIO	GP-110	702142C1	COMBUSTIBLE, SECUNDARIO	GP-110	702142C1
TRANSMISION	G-333	214731R91	COMBUSTIBLE, SECUNDARIO	GP-110	702253C1	COMBUSTIBLE, SEPARADOR DE AGUA	GPP-1000	702256C1
ACEITE	G-335	279994R91	COMBUSTIBLE, PRIMARIO	GP-1105	625626C1	1206 con motor/A DIESEL		
COMBUSTIBLE, PRIMARIO 6 43/64 IN	GP-1105	625626C1	COMBUSTIBLE, SEPARADOR DE AGUA	GPP-11	1214920H1	ACEITE	G-335	279994R91
COMBUSTIBLE, PRIMARIO 7 17/32 IN	GP-1108	625627C1	COMBUSTIBLE, SECUNDARIO	GP-110	702253C1	1206 SERIES SOBRE RUEDAS con motor/IHC DT361		
AGUA	GP-2071W	1261387H1	COMBUSTIBLE, PRIMARIO	GP-1108	625627C1	ACEITE	G-335	323827R91
COMBUSTIBLE, SECUNDARIO 7 7/64 IN	GP-78	672603C2	COMBUSTIBLE, SEPARADOR DE AGUA	GPP-11	1214920H1	COMBUSTIBLE, SECUNDARIO	G-1163	306353R91
AIRE, PRIMARIO	GA-329	627934C1	COMBUSTIBLE, SECUNDARIO	GP-110	702253C1	HYDROSTATIC GEAR DRIVE	G-338	70432C91
AIRE, SECUNDARIO	GA-239	627935C1	PD105 con motor/IHC UD817			1206D con motor/IHC D407		
E211 con motor/IHC D407			COMBUSTIBLE, PRIMARIO	GP-1105	625626C1	ACEITE	G-335	279994R91
TRANSMISION	G-333	214731R91	COMBUSTIBLE, PRIMARIO	GP-1108	625627C1	COMBUSTIBLE, PRIMARIO	G-1163	306353R91
ACEITE	G-335	279994R91	COMBUSTIBLE, SEPARADOR DE AGUA	GPP-11	1214920H1	COMBUSTIBLE, SECUNDARIO	G-1163	306353R91
COMBUSTIBLE, PRIMARIO 6 43/64 IN	GP-1105	625626C1	COMBUSTIBLE, SECUNDARIO	GP-110	702253C1	HIDRAULICO	G-338	70432C91
COMBUSTIBLE, PRIMARIO 7 17/32 IN	GP-1108	625627C1	COMBUSTIBLE, PRIMARIO	GP-1108	625627C1	1250 SOBRE RUEDAS con motor/KOHLER 12 HP		
AGUA	GP-2071W	1261387H1	COMBUSTIBLE, SEPARADOR DE AGUA	GPP-11	1214920H1	HYDROSTATIC		

MARCA-MODELO-MOTOR MAKE-MODEL-ENGINE	GONHER GONHER	OEM OEM	MARCA-MODELO-MOTOR MAKE-MODEL-ENGINE	GONHER GONHER	OEM OEM	MARCA-MODELO-MOTOR MAKE-MODEL-ENGINE	GONHER GONHER	OEM OEM
I.H.C. HARVESTER (continuación)			I.H.C. HARVESTER (continuación)			I.H.C. HARVESTER (continuación)		
TRACTORES			TRACTORES			TRACTORES		
1256D con motor/IHC D407			COMBUSTIBLE, SECUNDARIO	GP-78	672603C2	ACEITE	GP-69	A184775
ACEITE	G-335	279994R91				COMBUSTIBLE, PRIMARIO 6 43/64 IN	GP-1105	625626C1
HIDRAULICO	G-338	70432C91	1468 con motor/IHC DV550B			COMBUSTIBLE, PRIMARIO 7 17/32 IN	GP-1108	A184773
COMBUSTIBLE	GP-1105	625626C1	HYDROSTATIC GEAR DRIVE	G-338	70432C91	COMBUSTIBLE, SEPARADOR DE AGUA	GPP-11	1214920H1
COMBUSTIBLE	GP-1108	625627C1	ACEITE	GP-10	427207C1	AGUA	GP-2071W	1261387H1
COMBUSTIBLE, SEPARADOR DE AGUA	GPP-11	1214920H1	COMBUSTIBLE, SECUNDARIO	GP-1107	674293C1	COMBUSTIBLE, SECUNDARIO	GP-78	672603C2
			COMBUSTIBLE, PRIMARIO	GP-1108	A184773	AIRE, PRIMARIO	GA-826	67974C2
			AGUA	GP-2071W	A151931	AIRE, SECUNDARIO	GA-827	67975C1
1266 SOBRE RUEDAS con motor/IHC D414			1486 con motor/IHC DT436			1650 SOBRE RUEDAS con motor/KOHLER 16 HP		
TRANSMISION	G-338	70432C91	HYDROSTATIC GEAR DRIVE	G-338	70432C91	HYDROSTATIC TRANSMISION	GP-9	395789R2
COMBUSTIBLE, PRIMARIO	GP-1101	625625C1	ACEITE	GP-69	A184775	1810 CUB CADET con motor/KOHLER		
ACEITE	GP-69	675616C91	COMBUSTIBLE, PRIMARIO 6 43/64 IN	GP-1105	702143C1	ACEITE	GP-58	5205002
COMBUSTIBLE, SECUNDARIO	GP-1107	674293C1	COMBUSTIBLE, PRIMARIO 7 17/32 IN	GP-1108	A184773	184 con motor/IHC C60		
COMBUSTIBLE, PRIMARIO	GP-1108	A184773	COMBUSTIBLE, SEPARADOR DE AGUA	GPP-11	1214920H1	ACEITE	G-335	279994R91
			AGUA	GP-2071W	A151931	200 con motor/A DIESEL		
1266 SOBRE RUEDAS con motor/IHC D436			COMBUSTIBLE, SECUNDARIO	GP-78	672603C2	ACEITE, SELLADO	GP-50	538836R1
ACEITE	G-338	70432C91	AIRE, PRIMARIO	GA-826	67974C2	2050A con motor/IHC D179		
COMBUSTIBLE	GP-1101	625625C1	AIRE, SECUNDARIO	GA-827	67975C1	ACEITE	GP-10	398080R2
ACEITE	GP-69	675616C91				COMBUSTIBLE, PRIMARIO	GPP-1122	3132275R91
COMBUSTIBLE	GP-1107	674293C1	1488 con motor/IHC DT436			COMBUSTIBLE, SECUNDARIO	GPP-1122	3132275R91
COMBUSTIBLE	GP-1108	A184773	ACEITE	GP-69	675616C91	2050A con motores/IHC C157, IHC C175		
			COMBUSTIBLE	GP-1105	625626C1	ACEITE	GP-10	398080R2
130 SOBRE RUEDAS, 140 SOBRE RUEDAS con motor/A DIESEL			COMBUSTIBLE	GP-1108	625627C1	21026 SERIES con motor/IHC DT407		
ACEITE, SELLADO	GP-50	538836R1	COMBUSTIBLE	GP-78	672603C2	ACEITE	G-335	323827R91
			AIRE	GA-826	67974C4	HYDRAULIC GEAR DRIVE	G-338	70432C91
1420 CUB CADET SOBRE RUEDAS con motor/KOHLER			AIRE	GA-827	67975C1	COMBUSTIBLE, PRIMARIO 6 43/64 IN	GP-1105	625626C1
ACEITE	GP-58	5205002				COMBUSTIBLE, PRIMARIO 7 17/32 IN	GP-1108	625627C1
			1566 SOBRE RUEDAS con motor/IHC DT436			COMBUSTIBLE, SECUNDARIO	GP-110	702142C1
1450 SOBRE RUEDAS con motor/KOHLER 14 HP			HYDROSTATIC GEAR DRIVE	G-338	70432C91	COMBUSTIBLE, SEPARADOR DE AGUA	GPP-1000	702256C1
HYDROSTATIC TRANSMISION	GP-9	395789R2	ACEITE	GP-69	A184775	21206 SERIES con motor/IHC DT361		
			COMBUSTIBLE, PRIMARIO 6 43/64 IN	GP-1105	702143C1	ACEITE	G-335	323827R91
1456 con motor/IHC D407			COMBUSTIBLE, PRIMARIO 7 17/32 IN	GP-1108	A184773	COMBUSTIBLE, PRIMARIO	G-1163	306353R91
ACEITE	G-335	279994R91	AGUA	GP-2071W	A151931	COMBUSTIBLE, SECUNDARIO	G-1163	306353R91
HIDRAULICO	G-338	70432C91	COMBUSTIBLE, SECUNDARIO	GP-78	672603C2	HYDRAULIC GEAR DRIVE	G-338	70432C91
COMBUSTIBLE, PRIMARIO	GPP-14	402255C1	AIRE, PRIMARIO	GA-826	67974C2	21256, 21456 con motor/IHC DT407		
COMBUSTIBLE, PRIMARIO 6 43/64 IN	GP-1105	625626C1	AIRE, SECUNDARIO	GA-827	67975C1	ACEITE	G-335	323827R91
COMBUSTIBLE, PRIMARIO 7 17/32 IN	GP-1108	625627C1				HYDRAULIC GEAR DRIVE	G-338	70432C91
COMBUSTIBLE, SEPARADOR DE AGUA	GPP-11	1214920H1	1568 con motor/IHC DV550			COMBUSTIBLE, PRIMARIO 6 43/64 IN	GP-1105	625626C1
			ACEITE, OPCIONAL	GP-10	427207C1	COMBUSTIBLE, PRIMARIO 7 17/32 IN	GP-1108	625627C1
1456D con motor/IHC D407			COMBUSTIBLE	GP-1108	625627C1	COMBUSTIBLE, SECUNDARIO	GP-110	702142C1
ACEITE	G-335	279994R91	COMBUSTIBLE, SEPARADOR DE AGUA	GPP-11	1214920H1	COMBUSTIBLE, SEPARADOR DE AGUA	GPP-1000	702256C1
ACEITE	G-338	70432C91	COMBUSTIBLE	GP-78	672603C2	230 con motor/A DIESEL		
COMBUSTIBLE	GP-1105	625626C1				ACEITE, SELLADO	GP-50	538836R1
COMBUSTIBLE	GP-1108	625627C1	1586 con motor/IHC DT414			2300A con motor/A DIESEL		
			AGUA	GP-1010Q	A151931	ACEITE	G-870	376364R91
1466 SERIES con motor/IHC DT436			ACEITE	GP-69	675616C91	COMBUSTIBLE	G-296	3144477R92
HYDROSTATIC GEAR DRIVE	G-338	70432C91	COMBUSTIBLE	GP-1105	625626C1	COMBUSTIBLE	G-296-B	3044506R92
COMBUSTIBLE, PRIMARIO 5 17/32 IN	GP-1101	625625C1	COMBUSTIBLE	GP-1108	625627C1	AIRE, SIN ASPAS	GA-33	3066498R1
ACEITE	GP-69	A184775	AIRE	GA-826	67974C4			
COMBUSTIBLE, PRIMARIO 7 17/32 IN	GP-1108	A184773	AIRE	GA-827	67975C1			
COMBUSTIBLE, SEPARADOR DE AGUA	GPP-11	1214920H1						
COMBUSTIBLE, SECUNDARIO	GP-78	672603C2	1586 con motor/IHC DT436					
AIRE, PRIMARIO	GA-826	67974C2	HYDROSTATIC GEAR DRIVE	G-338	386120R91			
AIRE, SECUNDARIO	GA-827	67975C1						
			1468 con motor/IHC DV550					
1468 con motor/IHC DV550			HYDROSTATIC GEAR DRIVE	G-338	386120R91			
HIDRAULICO	G-338	70432C91	ACEITE	GP-10	398080R2			
ACEITE, OPCIONAL	GP-10	427207C1	COMBUSTIBLE, PRIMARIO	GP-1108	A184773			
COMBUSTIBLE, PRIMARIO 7 17/32 IN	GP-1108	625627C1	COMBUSTIBLE, SECUNDARIO	GP-78	674293C1			
COMBUSTIBLE, SEPARADOR DE AGUA	GPP-11	1214920H1						

SERVICIO PESADO

MARCA-MODELO-MOTOR MAKE-MODEL-ENGINE	GONHER GONHER	OEM OEM	MARCA-MODELO-MOTOR MAKE-MODEL-ENGINE	GONHER GONHER	OEM OEM	MARCA-MODELO-MOTOR MAKE-MODEL-ENGINE	GONHER GONHER	OEM OEM
I.H.C. HARVESTER (continuación)			I.H.C. HARVESTER (continuación)			I.H.C. HARVESTER (continuación)		
TRACTORES			TRACTORES			TRACTORES		
2300A SERIES con motor/IHC BC144			2412B SOBRE RUEDAS con motor/IHC C153			COMBUSTIBLE, PRIMARIO	GP-1122	3132428R1
ACEITE	G-870	376364R91	ACEITE	GP-50	538836R1	COMBUSTIBLE, SECUNDARIO	GP-1122	3132428R1
						COMBUSTIBLE	G-296-B	3144477R92
2300A SERIES con motor/IHC BD144A			2412B SOBRE RUEDAS con motor/IHC D179			2500D con motor/IHC C153		
ACEITE	G-870	376364R91	ACEITE, 7 17/32 IN	GP-10	398080R2	ACEITE, SELLADO	GP-50	538836R1
COMBUSTIBLE	G-296	3144477R92	ACEITE, 5 13/32 IN	GP-36	3136046R93			
COMBUSTIBLE	G-296-B	3044506R93	COMBUSTIBLE	G-296	3144477R92	2500D con motor/IHC D188		
AIRE, SIN ASPAS	GA-33	3066498R2	COMBUSTIBLE, PRIMARIO	GPP-1122	3132428R1	ACEITE	G-335	279994R91
			COMBUSTIBLE, SECUNDARIO	GPP-1122	3132275R91	COMBUSTIBLE	G-1163	306353R91
			COMBUSTIBLE	G-296-B	3144477R92	AIRE	GA-18	313964R91
234 SOBRE RUEDAS, 234H SOBRE RUEDAS con motor/MITSUBISHI K3			2412B SOBRE RUEDAS con motores/IHC C157, IHC C175, IHC C200			2504 con motor/IHC C153		
ACEITE	GP-6811	1275229C1	ACEITE	GP-10	398080R2	ACEITE, SELLADO	GP-50	538836R1
235 SOBRE RUEDAS con motor/A DIESEL			2424 con motor/IHC BD154			2504 con motor/IHC D188		
ACEITE	GP-6811	1275229C1	ACEITE	G-870	376364R91	ACEITE	G-335	279994R91
						COMBUSTIBLE, PRIMARIO	G-1163	304101R91
240 SERIES con motor/IHC C123			2424 con motor/IHC C146			COMBUSTIBLE, SECUNDARIO	G-1163	304101R91
ACEITE, SELLADO	GP-50	538836R1	ACEITE, SELLADO	GP-50	538836R1	AIRE	GA-18	313964R91
2400 SOBRE RUEDAS con motor/IHC D179			2424D con motor/A DIESEL			2504D con motor/IHC D188		
ACEITE, 7 17/32 IN	GP-10	398080R2	ACEITE	G-870	376364R91	ACEITE	G-335	279994R91
ACEITE, 5 13/32 IN	GP-36	3136046R93				COMBUSTIBLE, PRIMARIO	G-1163	304101R91
COMBUSTIBLE	G-296	3144477R92	244 SOBRE RUEDAS, 245 SOBRE RUEDAS con motor/A DIESEL			COMBUSTIBLE, SECUNDARIO	G-1163	304101R91
COMBUSTIBLE	GP-1122	3132428R1	ACEITE	GP-6811	1275229C1	AIRE	GA-18	313964R91
COMBUSTIBLE	G-296-B	3144477R92						
2400 SOBRE RUEDAS, 2400B, 2405B, 2410B SOBRE RUEDAS con motores/IHC C157, IHC C175			2444 con motor/IHC BD154			2505B, 2510B con motor/IHC C200		
ACEITE, CARTUCHO	G-335	279994R91	ACEITE	G-870	376364R91	ACEITE	GP-10	398080R2
2400A con motor/IHC D179			2444 con motores/IHC C146, IHC C153			2505B, 2510B con motor/IHC D239		
ACEITE	GP-10	398080R2	ACEITE, SELLADO	GP-50	538836R1	ACEITE	GP-10	398080R2
COMBUSTIBLE	G-296	3144477R92				COMBUSTIBLE	G-296	3144477R91
COMBUSTIBLE, PRIMARIO	GPP-1122	3132428R1	2444D con motor/IHC BD154			COMBUSTIBLE, PRIMARIO	GP-1122	3136187R91
COMBUSTIBLE, SECUNDARIO	GPP-1122	3132428R1	ACEITE	G-870	376364R91	COMBUSTIBLE, SECUNDARIO	GP-1122	3132428R1
COMBUSTIBLE	G-296-B	3144477R92				COMBUSTIBLE	G-296-B	3144477R91
2400A con motores/IHC C157, IHC C175			2500 con motor/IHC D188			250A SOBRE RUEDAS con motor/A DIESEL		
ACEITE	GP-10	398080R2	ACEITE	G-335	279994R91	ACEITE, 7 17/32 IN	GP-10	398080R2
			COMBUSTIBLE	G-1163	306353R91	ACEITE, 5 13/32 IN	GP-36	3136046R93
			AIRE	GA-18	313964R91	AIRE	GAK-16	1265510C1
2400B con motor/IHC D179			2500 CONSTRUCTALL con motor/IHC C153					
ACEITE, 7 17/32 IN	GP-10	398080R2	ACEITE, SELLADO	GP-50	538836R1	2514B con motor/IHC D239		
ACEITE, 5 13/32 IN	GP-36	3136046R93				ACEITE, 7 17/32 IN	GP-10	398080R2
COMBUSTIBLE	G-296	3144477R92	2500 CONSTRUCTALL con motor/IHC D188			ACEITE, 5 13/32 IN	GP-36	3136046R93
COMBUSTIBLE, PRIMARIO	GP-1122	3132428R1	ACEITE	G-335	279994R91	COMBUSTIBLE	G-296	3144477R91
COMBUSTIBLE, SECUNDARIO	GP-1122	3132428R1	COMBUSTIBLE, SECUNDARIO	G-1163	306353R91	COMBUSTIBLE, PRIMARIO	GP-1122	3136187R91
COMBUSTIBLE	G-296-B	3144477R92	AIRE	GA-18	313964R91	COMBUSTIBLE, SECUNDARIO	GP-1122	3132428R1
						COMBUSTIBLE	G-296-B	3144477R91
2404 SERIES con motor/IHC C135			2500A con motor/IHC D179			2514B con motores/IHC C175, IHC C200		
ACEITE, SELLADO	GP-50	538836R1	ACEITE	GP-10	398080R2	ACEITE	GP-10	398080R2
			COMBUSTIBLE, PRIMARIO	GPP-1122	3132428R1			
2405B, 2410B SOBRE RUEDAS con motor/IHC D179			COMBUSTIBLE, SECUNDARIO	GPP-1122	3132428R1	254 SOBRE RUEDAS, 255 SOBRE RUEDAS con motor/A DIESEL		
ACEITE, CARTUCHO	G-335	279994R91				ACEITE	GP-6811	1275229C1
ACEITE, SELLADO	GP-10	398080R2	2500A con motor/IHC D239					
COMBUSTIBLE	G-296	3144477R91	ACEITE, 7 17/32 IN	GP-10	398080R2			
COMBUSTIBLE, PRIMARIO	GP-1122	3136187R91				2544 con motor/A GASOLINA		
COMBUSTIBLE, SECUNDARIO	GP-1122	3132428R1	2500A con motores/IHC C157, IHC C175, IHC C200			ACEITE, CARTUCHO HIDRAULICO	G-338	70432C91
COMBUSTIBLE	G-296-B	3144477R91	ACEITE	GP-10	398080R2	ACEITE	GP-10	398080R2
						COMBUSTIBLE	GP-92	530824R2
240A SOBRE RUEDAS con motor/A DIESEL			2500B con motor/IHC C200			ACEITE, SELLADO HIDRAULICO	GP-66	530824R2
ACEITE, 7 17/32 IN	GP-10	398080R2	ACEITE, 7 17/32 IN	GP-10	398080R2	AIRE	GA-18	313964R91
ACEITE, 5 13/32 IN	GP-36	3136046R93						
AIRE	GAK-16	1265510C1	2500B con motor/IHC D239					
			ACEITE, 7 17/32 IN	GP-10	398080R2			
			COMBUSTIBLE	G-296	3144477R92			

MARCA-MODELO-MOTOR MAKE-MODEL-ENGINE	GONHER GONHER	OEM OEM	MARCA-MODELO-MOTOR MAKE-MODEL-ENGINE	GONHER GONHER	OEM OEM	MARCA-MODELO-MOTOR MAKE-MODEL-ENGINE	GONHER GONHER	OEM OEM
I.H.C. HARVESTER (continuación)			I.H.C. HARVESTER (continuación)			I.H.C. HARVESTER (continuación)		
TRACTORES			TRACTORES			TRACTORES		
2544 con motor/IHC C200			HIDRAULICO	G-338	70432C91	COMBUSTIBLE, PRIMARIO	GP-1122	3136187R91
HYDROSTATIC GEAR DRIVE CARTUCHO	G-338	70432C91	ACEITE, SELLADO	GP-10	398080R2	COMBUSTIBLE, SECUNDARIO	GP-1122	3132428R1
ACEITE	GP-10	398080R2	AIRE, SIN ASPAS	GA-16	384812R92	COMBUSTIBLE	G-296-B	3144477R92
HYDROSTATIC RETLINE SELLADO	GP-66	528250R1	AIRE	GAK-16	384812R92			
AIRE	GA-18	313964R91				280 con motor/IHC D358		
			2706 con motor/IHC C263			ACEITE	GP-10	398080R2
2544 con motor/IHC D239			ACEITE, CARTUCHO	G-335	279994R91	COMBUSTIBLE	GPP-1122	3132275R91
HYDROSTATIC GEAR DRIVE CARTUCHO	G-338	70432C91	HYDROSTATIC GEAR DRIVE	G-338	70432C91	AIRE, SECUNDARIO	GA-892	529852R4
ACEITE	GP-10	398080R2	ACEITE, SELLADO	GP-10	398080R2	AIRE, PRIMARIO	GA-891	529851R2
COMBUSTIBLE	G-296	3144477R92	AIRE, SIN ASPAS	GA-16	384812R93			
COMBUSTIBLE, PRIMARIO	GP-1122	3136187R91	AIRE	GAK-16	384812R93	2806 con motor/A GASOLINA		
COMBUSTIBLE, SECUNDARIO	GP-1122	3132428R1	2706 con motor/IHC D282			ACEITE, CARTUCHO	G-335	279994R91
HYDROSTATIC RETLINE SELLADO	GP-66	528250R1	ACEITE, CARTUCHO	G-335	279994R91	HIDRAULICO	G-338	70432C91
COMBUSTIBLE	G-296-B	3144477R92	COMBUSTIBLE, SECUNDARIO	G-1163	306353R91	ACEITE, SELLADO	GP-10	398080R2
			HYDROSTATIC GEAR DRIVE	G-338	70432C91			
2544D con motor/A DIESEL			ACEITE, SELLADO	GP-69	675616C91	2806 con motor/IHC C301		
ACEITE, CARTUCHO HIDRAU- LICO	G-338	70432C91	2706 con motor/IHC D310			ACEITE	G-335	323827R91
ACEITE, SELLADO HIDRAULICO	GP-66	530824R2	HYDROSTATIC GEAR DRIVE	G-338	70432C91	2806 con motor/IHC D361		
COMBUSTIBLE, PRIMARIO	GPP-1122	3132428R1	COMBUSTIBLE, SIN CUBIERTA	G-1123	3132015R92	ACEITE	G-335	279994R91
COMBUSTIBLE, SECUNDARIO	GPP-1122	3132428R1	COMBUSTIBLE, CON CUBIERTA	G-1123F	3132015R92	COMBUSTIBLE, SECUNDARIO	G-1163	306353R91
2606 con motor/A GASOLINA			ACEITE	GP-10	528250R1	HYDROSTATIC GEAR DRIVE	G-338	70432C91
ACEITE	G-335	279994R91	COMBUSTIBLE	G-296	3144477R92	2806D con motor/A DIESEL		
			COMBUSTIBLE, PRIMARIO	GP-1122	3136187R91	ACEITE, CARTUCHO	G-335	279994R91
2606 con motor/IHC C221			COMBUSTIBLE, SECUNDARIO	GP-1122	3132428R1	COMBUSTIBLE, PRIMARIO	G-1163	306353R91
ACEITE	G-335	279994R91	COMBUSTIBLE	G-296-B	3144477R92	COMBUSTIBLE, SECUNDARIO	G-1163	306353R91
			2706, 2756 con motor/IHC C291			HIDRAULICO	G-338	70432C91
2606 con motor/IHC D236			ACEITE	G-335	279994R91	280A con motor/IHC D358		
ACEITE	G-335	279994R91	2706D con motor/IHC D282			ACEITE	GP-10	528250R1
			ACEITE, CARTUCHO	G-335	279994R91	COMBUSTIBLE, PRIMARIO	G-296	3144477R92
2606D con motor/A DIESEL			COMBUSTIBLE, PRIMARIO	G-1163	306353R91	COMBUSTIBLE, SECUNDARIO	G-296	3144477R92
ACEITE	G-335	279994R91	COMBUSTIBLE, SECUNDARIO	G-1163	306353R91	ACEITE	GP-66	528250R1
COMBUSTIBLE, PRIMARIO	G-1163	306353R91	HIDRAULICO	G-338	70432C91	COMBUSTIBLE, PRIMARIO	GPP-1122	3136187R91
COMBUSTIBLE, SECUNDARIO	G-1163	306353R91	ACEITE, SELLADO	GP-10	398080R2	COMBUSTIBLE, SECUNDARIO	GPP-1122	3136187R91
			2706D con motor/IHC D310			COMBUSTIBLE, PRIMARIO	G-296-B	3144477R92
260A con motor/IHC D239			HIDRAULICO	G-338	70432C91	COMBUSTIBLE, SECUNDARIO	G-296-B	3144477R92
ACEITE	G-870	3136046R92	COMBUSTIBLE, SIN CUBIERTA	G-1123	3132015R91	AIRE	GA-892	3132428R2
COMBUSTIBLE	G-296	3144477R92	COMBUSTIBLE, CON CUBIERTA	G-1123F	3132015R91	2826 con motor/IHC C301		
COMBUSTIBLE	G-296-B	3144477R92	ACEITE, OPCIONAL	GP-10	528250R1	ACEITE, CARTUCHO	G-335	279994R91
			COMBUSTIBLE, PRIMARIO	GPP-1122	3132275R91	HYDROSTATIC GEAR DRIVE	G-338	70432C91
260A SOBRE RUEDAS con motor/A DIESEL			COMBUSTIBLE, SECUNDARIO	GPP-1122	3132275R91	ACEITE, SELLADO	GP-10	398080R2
ACEITE, 7 17/32 IN	GP-10	398080R2	270A con motor/A DIESEL			2826 con motor/IHC D358		
ACEITE, 5 13/32 IN	GP-36	3136046R93	ACEITE, OPCIONAL	GP-10	528250R1	HYDROSTATIC GEAR DRIVE	G-338	70432C91
COMBUSTIBLE	GPP-1122	3132428R1	274 SOBRE RUEDAS con motor/A DIESEL			ACEITE	GP-10	528250R1
AIRE	GAK-16	1265510C1	ACEITE	GP-38	1062099C1	COMBUSTIBLE, PRIMARIO	GP-1122	3136187R91
			275 con motor/A DIESEL			COMBUSTIBLE, SECUNDARIO	GP-1122	3132428R1
265 SOBRE RUEDAS con motor/A DIESEL			ACEITE	GP-40	25026209	AIRE, SECUNDARIO	GA-892	529852R4
ACEITE	GP-40	25026209	275, 276 con motor/IHC BD144			AIRE, PRIMARIO	GA-891	529851R2
			ACEITE	G-870	376364R91			
2656 con motor/IHC C263			2756 con motor/IHC D310			284 SOBRE RUEDAS con motor/MAZDA A GASOLINA		
ACEITE, CARTUCHO	G-335	279994R91	HYDROSTATIC GEAR DRIVE	G-338	70432C91	HIDRAULICO	GP-66	1004366C1
HYDROSTATIC DRIVE	G-338	70432C91	COMBUSTIBLE, CARTUCHO SIN CUBIERTA	G-1123	3132015R92	ACEITE	GP-42	1014308-C1
ACEITE, SELLADO	GP-10	398080R2	COMBUSTIBLE, CARTUCHO CON CUBIERTA	G-1123F	3132015R92	GASOLINA	GG-5	1701232C91
			ACEITE, SELLADO	GP-10	528250R1	GASOLINA	GG-5 L	1701232C91
2656 con motor/IHC D282			COMBUSTIBLE	G-296	3144477R92	284 SOBRE RUEDAS con motor/NISSAN A DIESEL		
ACEITE, CARTUCHO	G-335	279994R91	2706 con motor/A GASOLINA			ACEITE	GP-38	1062099C1
COMBUSTIBLE, SECUNDARIO	G-1163	306353R91	ACEITE, CARTUCHO	G-335	279994R91	COMBUSTIBLE, PRIMARIO	GP-1122	3136187R91
HYDROSTATIC DRIVE	G-338	70432C91				COMBUSTIBLE, SECUNDARIO	GP-1122	3132428R1
ACEITE, SELLADO	GP-69	675616C91				AIRE, SECUNDARIO	GA-892	529852R4
						AIRE, PRIMARIO	GA-891	529851R2
2706 con motor/A GASOLINA								
ACEITE, CARTUCHO	G-335	279994R91						

MARCA-MODELO-MOTOR MAKE-MODEL-ENGINE	GONHER GONHER	OEM OEM	MARCA-MODELO-MOTOR MAKE-MODEL-ENGINE	GONHER GONHER	OEM OEM	MARCA-MODELO-MOTOR MAKE-MODEL-ENGINE	GONHER GONHER	OEM OEM
I.H.C. HARVESTER (continuación)			I.H.C. HARVESTER (continuación)			I.H.C. HARVESTER (continuación)		
TRACTORES			TRACTORES			TRACTORES		
ACEITE, SELLADO	GP-10	398080R2	3400A SERIES SOBRE RUEDAS con motor/IHC D179			3514 con motor/IHC C153		
2856 con motor/IHC D407			ACEITE	GP-10	398080R2	HYDROSTATIC GEAR DRIVE	G-338	70432C91
ACEITE	G-335	323827R91	COMBUSTIBLE	G-296	3144477R92	ACEITE, SELLADO	GP-50	538836R1
HYDROSTATIC GEAR DRIVE	G-338	70432C91	COMBUSTIBLE	GP-1122	3132428R2	AIRE, SIN ASPAS	GA-16	405916R1
COMBUSTIBLE, PRIMARIO 6 43/64 IN	GP-1105	625626C1	COMBUSTIBLE	G-296-B	3144477R92	AIRE, SIN ASPAS	GA-33	389567R1
COMBUSTIBLE, PRIMARIO 7 17/32 IN	GP-1108	625627C1	340D con motor/A DIESEL			AIRE	GAK-16	405916R1
COMBUSTIBLE, SECUNDARIO	GP-110	702142C1	COMBUSTIBLE	G-1163	304101R91	3514 con motor/IHC C175		
COMBUSTIBLE, SEPARADOR DE AGUA	GPP-1000	702256C1	3414 con motor/IHC BC144			HYDROSTATIC GEAR DRIVE	G-338	70432C91
2856D con motor/IHC D407			ACEITE	G-870	376364R91	ACEITE	GP-10	398080R2
ACEITE	G-335	279994R91	ACEITE, CONVERTIDOR DE TORSION	GP-1	388227R91	AIRE, SIN ASPAS	GA-16	405916R1
ACEITE	G-338	70432C91	TRANSMISION	GP-1	388227R1	AIRE, SIN ASPAS	GA-33	389567R1
COMBUSTIBLE, PRIMARIO	GPP-1000	702256C1	3414, 3444 con motor/IHC BD154			AIRE	GAK-16	405916R1
300 SERIES SOBRE RUEDAS con motor/IHC C169			ACEITE	G-870	376364R91	3514 con motor/IHC D188		
ACEITE, SELLADO	GP-50	538836R1	ACEITE, CONVERTIDOR DE TORSION	GP-1	388227R91	ACEITE	G-335	279994R91
3000 con motor/IHC			TRANSMISION	GP-1	388227R1	COMBUSTIBLE, PRIMARIO	G-1163	304101R91
COMBUSTIBLE, PRIMARIO	GPP-1122	3132275R91	COMBUSTIBLE	G-296	3144477R92	COMBUSTIBLE, SECUNDARIO	G-1163	304101R91
3088 con motor/IHC D358			COMBUSTIBLE	G-296-B	3044506R93	HYDROSTATIC GEAR DRIVE	G-338	70432C91
ACEITE, CARTUCHO HIDRAULICO	G-338	70432C91	COMBUSTIBLE	G-296-B	3044506R93	AIRE	GA-18	313964R91
ACEITE, 7 17/32 IN	GP-10	39080R2	3414D con motor/IHC BD154			3514 con motor/IHC D239		
ACEITE, 5 13/32 IN	GP-36	3136046R93	ACEITE	G-870	376364R91	HYDROSTATIC GEAR DRIVE	G-338	70432C91
COMBUSTIBLE	GPP-1122	1967094C1	ACEITE	GP-1	918266R91	ACEITE	GP-36	3136046R93
AGUA	GP-2071W	A151931	COMBUSTIBLE	G-296	3144477R92	COMBUSTIBLE	G-296	3144477R92
AIRE, SECUNDARIO	GA-892	529852R4	COMBUSTIBLE	G-296-B	3144477R92	COMBUSTIBLE, PRIMARIO	GP-1122	3136187R91
AIRE, PRIMARIO	GA-891	71912C1	COMBUSTIBLE	G-296-B	3144477R92	COMBUSTIBLE, SECUNDARIO	GP-1122	3132428R1
3288 con motor/IHC D358			3444 con motor/IHC BC144 GASOLINA			COMBUSTIBLE	G-296-B	3144477R92
ACEITE, CARTUCHO HIDRAULICO	G-338	528493R3	ACEITE	G-870	376364R91	AIRE, SIN ASPAS	GA-16	405916R1
ACEITE, 7 17/32 IN	GP-10	677709C91	ACEITE, CONVERTIDOR DE TORSION	GP-1	388227R91	AIRE, SIN ASPAS	GA-33	389567R1
ACEITE, 5 13/32 IN	GP-36	3136046R93	TRANSMISION	GP-1	388227R1	AIRE	GAK-16	405916R1
COMBUSTIBLE	GPP-1122	1967094C1	3444D con motor/IHC BD154 DIESEL			354 con motor/IHC BC144		
AGUA	GP-2071W	A151931	ACEITE	G-870	376364R91	ACEITE	G-870	376364R91
AIRE, SECUNDARIO	GA-892	529852R4	ACEITE	GP-1	918266R91	354 con motor/IHC BD144		
AIRE, PRIMARIO	GA-891	71912C1	COMBUSTIBLE	G-296	3044506R91	ACEITE	G-870	376364R91
3388 SOBRE RUEDAS con motor/IHC DT436			COMBUSTIBLE	G-296-B	3144477R92	COMBUSTIBLE	G-296	3144477R92
ACEITE	GP-69	675616C91	COMBUSTIBLE	G-296-B	3144477R92	COMBUSTIBLE	G-296-B	3044506R91
COMBUSTIBLE, PRIMARIO	GP-1108	625626C1	3488 con motor/IHC DT466B			AIRE, SIN ASPAS	GA-33	3066498R1
AGUA	GP-2071W	A151931	HIDRAULICO	G-338	528493R3	3588 con motor/IHC DIESEL		
COMBUSTIBLE, SECUNDARIO	GP-78	674293C1	ACEITE	GP-69	A184775	COMBUSTIBLE, SEPARADOR DE AGUA	GPP-14	998443R91
AIRE, PRIMARIO	GA-826	67974C4	COMBUSTIBLE, PRIMARIO	GP-1108	A184773	ACEITE	GP-69	A184775
AIRE, SECUNDARIO	GA-827	67975C1	AGUA	GP-2071W	690171C1	COMBUSTIBLE, PRIMARIO	GP-1108	A184773
340 con motor/IHC D166			COMBUSTIBLE, SECUNDARIO	GP-78	674293C1	AGUA	GP-2071W	1261387H1
ACEITE	G-335	279994R91	AIRE, SECUNDARIO	GA-892	529852R4	COMBUSTIBLE, SECUNDARIO	GP-78	672603C2
3400 SERIES A con motor/IHC D179			AIRE, PRIMARIO	GA-891	71912C1	AIRE, PRIMARIO	GA-826	67974C2
ACEITE	GP-10	398080R2	350 con motor/IHC C175			AIRE, SECUNDARIO	GA-827	67975C1
COMBUSTIBLE	G-296	3144477R92	ACEITE, SELLADO	GP-50	538836R1	3588 con motor/IHC DT466		
COMBUSTIBLE, PRIMARIO	GPP-1122	3132428R2	3500 SERIES A con motores/IHC D179, IHC D239			AGUA	GP-1010Q	A151931
COMBUSTIBLE, SECUNDARIO	GPP-1122	3132428R2	ACEITE	GP-10	398080R2	ACEITE	GP-69	675617C91
COMBUSTIBLE	G-296-B	3144477R92	COMBUSTIBLE	G-296	3144477R92	COMBUSTIBLE, SECUNDARIO	GP-78	672603C2
3400 SERIES A, 3400A SERIES SOBRE RUEDAS con motor/IHC C175			COMBUSTIBLE, PRIMARIO	GPP-1122	3132275R91	COMBUSTIBLE, PRIMARIO	GPP-1000	702256C1
ACEITE	GP-10	398080R2	COMBUSTIBLE, SECUNDARIO	GPP-1122	3132275R91	AIRE, PRIMARIO	GA-826	67974C1
3500 SERIES A, 3500A SERIES SOBRE RUEDAS con motor/IHC C200			COMBUSTIBLE	G-296-B	3144477R92	AIRE, SECUNDARIO	GA-827	67975C1
ACEITE	GP-10	398080R2	3500 SERIES A, 3500A SERIES SOBRE RUEDAS con motor/IHC C200			3600 SERIES A con motor/IHC C263		
3500A SERIES SOBRE RUEDAS con motor/IHC D239			ACEITE	GP-10	398080R2	ACEITE	G-335	279994R91
ACEITE	GP-10	398080R2	3500A SERIES SOBRE RUEDAS con motor/IHC D239			ACEITE	G-338	528507R91
ACEITE	GP-10	398080R2	ACEITE	GP-10	398080R2	ACEITE	GP-10	398080R2

MARCA-MODELO-MOTOR MAKE-MODEL-ENGINE	GONHER GONHER	OEM OEM	MARCA-MODELO-MOTOR MAKE-MODEL-ENGINE	GONHER GONHER	OEM OEM	MARCA-MODELO-MOTOR MAKE-MODEL-ENGINE	GONHER GONHER	OEM OEM
I.H.C. HARVESTER (continuación)			I.H.C. HARVESTER (continuación)			I.H.C. HARVESTER (continuación)		
TRACTORES			TRACTORES			TRACTORES		
3600 SERIES A con motor/IHC D282			3788 con motor/IHC DIESEL			404, 330, 340 con motor/IHC C135		
ACEITE	G-335	279994R91	ACEITE	GP-69	A184775	ACEITE, SELLADO	GP-50	538836R1
ACEITE	G-338	528507R91	COMBUSTIBLE, PRIMARIO	GP-1108	A184773			
ACEITE	GP-69	675616C91	AGUA	GP-2071W	690171C1	4100 con motor/IHC DT429		
			COMBUSTIBLE, SECUNDARIO	GP-78	672603C2	HYDROSTATIC GEAR DRIVE	G-338	70432C91
3600A SERIES SOBRE RUEDAS con motor/IHC D282			AIRE, PRIMARIO	GA-826	67974C3	COMBUSTIBLE, PRIMARIO	GP-1105	625626C1
ACEITE, CARTUCHO	G-335	279994R91	AIRE, SECUNDARIO	GA-827	67975C1	COMBUSTIBLE, PRIMARIO	GP-1108	A184773
COMBUSTIBLE, SECUNDARIO	G-1163	306353R91				COMBUSTIBLE, SEPARADOR DE AGUA	GPP-11	1214920H1
TRANSMISION	GP-338	528507R91	3788 con motor/IHC DT466B			COMBUSTIBLE, SECUNDARIO	GP-110	702142C1
ACEITE, SELLADO HIDRAULICO	GP-66	70203C1	ACEITE	GP-69	675617C91			
ACEITE, SELLADO	GP-69	675616C91	AGUA	GP-2071W	1809789C1	4100 con motores/IHC D817, IHC DT817		
			COMBUSTIBLE, SECUNDARIO	GP-78	672603C2	HIDRAULICO	G-338	70432C91
3600A SOBRE RUEDAS con motor/IHC C263			COMBUSTIBLE, PRIMARIO	GPP-1000	702256C1			
ACEITE, CARTUCHO	G-335	279994R91	AIRE, PRIMARIO	GA-826	67974C1	414 con motor/IHC BD154		
ACEITE, SELLADO	GP-10	398080R2	AIRE, SECUNDARIO	GA-827	67975C1	ACEITE, SELLADO	GP-50	538836R1
ACEITE, SELLADO HIDRAULICO	GP-66	528250R1						
			3800, 3850 con motor/IHC C263			4150 con motor/FORD		
3616 con motor/IHC C221 GASOLINA			ACEITE, CARTUCHO	G-335	279994R91	ACEITE	GP-34	69149C1
ACEITE, CARTUCHO	G-335	279994R91	ACEITE, SELLADO	GP-10	398080R2			
HIDRAULICO	G-338	70432C91	AIRE, SIN ASPAS	GA-16	384812R93	4150 con motor/IHC		
ACEITE, SELLADO	GP-10	398080R2	AIRE	GAK-16	384812R93	COMBUSTIBLE, PRIMARIO	GPP-1122	3132275R91
AIRE, SIN ASPAS	GA-33	381343R91						
			3800, 3850 con motor/IHC D282			4156 con motor/IHC DT429		
3616 con motor/IHC D236			ACEITE	G-335	279994R91	HYDROSTATIC GEAR DRIVE	G-338	70432C91
ACEITE	G-335	279994R91	COMBUSTIBLE, PRIMARIO 6 43/64 IN	GP-1105	625626C1	COMBUSTIBLE, PRIMARIO 6 43/64 IN	GP-1105	625626C1
HYDROSTATIC GEAR DRIVE	G-338	70432C91	COMBUSTIBLE, PRIMARIO 7 17/32 IN	GP-1108	625627C1	COMBUSTIBLE, PRIMARIO 7 17/32 IN	GP-1108	A184773
COMBUSTIBLE, PRIMARIO 6 43/64 IN	GP-1105	625626C1	COMBUSTIBLE, SECUNDARIO	GP-110	702142C1	COMBUSTIBLE, SEPARADOR DE AGUA	GPP-11	1214920H1
COMBUSTIBLE, PRIMARIO 7 17/32 IN	GP-1108	625627C1	COMBUSTIBLE, SEPARADOR DE AGUA	GPP-1000	702256C1	COMBUSTIBLE, SECUNDARIO	GP-110	702253C1
COMBUSTIBLE, SECUNDARIO	GP-110	702142C1						
COMBUSTIBLE, SEPARADOR DE AGUA	GPP-1000	702256C1	3820 con motor/IHC D310			4166, 4186 con motor/IHC DT436		
			COMBUSTIBLE, CARTUCHO SIN CUBIERTA	G-1123	3132015R92	HYDROSTATIC GEAR DRIVE	G-338	390560R91
3616D con motor/IHC D236			COMBUSTIBLE, CARTUCHO CON CUBIERTA	G-1123F	3132015R92	ACEITE	GP-69	A184775
ACEITE, CARTUCHO	G-335	279994R91	ACEITE	GP-10	528250R1	COMBUSTIBLE, PRIMARIO 6 43/64 IN	GP-1105	625626C1
COMBUSTIBLE, PRIMARIO	G-1163	306353R91	COMBUSTIBLE	G-296	3144477R92	COMBUSTIBLE, PRIMARIO 7 17/32 IN	GP-1108	A184773
COMBUSTIBLE, SECUNDARIO	G-1163	306353R91	COMBUSTIBLE, PRIMARIO	GP-1122	3136187R91	AGUA	GP-2071W	A151931
HIDRAULICO	G-338	70432C91	COMBUSTIBLE, SECUNDARIO	GP-1122	3132428R1	COMBUSTIBLE, SECUNDARIO	GP-78	672603C2
COMBUSTIBLE, PRIMARIO 1993	GP-1101	625625C1	COMBUSTIBLE	G-296-B	3144477R91			
COMBUSTIBLE, PRIMARIO 6 43/64 IN	GP-1105	625626C1				424 con motor/IHC BD154		
AIRE, SIN ASPAS	GA-33	381343R91	3820 SERIES A con motor/IHC D310			ACEITE	G-870	376364R91
			ACEITE, OPCIONAL	GP-10	528250R1			
364 con motor/A DIESEL			COMBUSTIBLE	G-296	3144477R92	424 con motor/IHC C146		
ACEITE	G-870	376364R91	COMBUSTIBLE, PRIMARIO	GPP-1122	3132428R1	ACEITE, SELLADO	GP-50	538836R1
COMBUSTIBLE	G-296	3144477R92	COMBUSTIBLE, SECUNDARIO	GPP-1122	3132428R1			
COMBUSTIBLE	G-296-B	3044506R91	COMBUSTIBLE	G-296-B	3144477R92	424D, 444D con motor/IHC BD154		
AIRE, SIN ASPAS	GA-33	3066498R1				ACEITE	G-870	376364R91
			384 con motor/IHC BD154					
364 con motor/IHC BD154			ACEITE	G-870	376364R91	4300 con motores/IHC D817, IHC DT817		
ACEITE	G-870	376364R91	COMBUSTIBLE	G-296	3144477R92	AIRE	GA-18	313964R91
COMBUSTIBLE	G-296	3144477R92	COMBUSTIBLE	G-296-B	3044506R92			
COMBUSTIBLE	G-296-B	3044506R92	AIRE, SIN ASPAS	GA-33	D48198	433 SOBRE RUEDAS con motor/A DIESEL		
AIRE, SIN ASPAS	GA-33	3066498R92				ACEITE	GP-9	395789R2
			385 con motor/IHC BD155			COMBUSTIBLE	G-296	3144477R92
3688 con motor/IHC D436			ACEITE, 7 17/32 IN	GP-10	398080R2	COMBUSTIBLE	G-296-B	3144477R92
HIDRAULICO	G-338	528493R3	ACEITE, 5 13/32 IN	GP-36	3136046R93	AIRE, PRIMARIO	GA-49	3146927-R91
ACEITE	GP-69	A184775	COMBUSTIBLE	GPP-1122	1967094C1			
COMBUSTIBLE, PRIMARIO	GP-1108	A184773	AIRE, PRIMARIO	GAK-16	1265510C1	434 SOBRE RUEDAS con motor/A DIESEL		
AGUA	GP-2071W	690171C1				ACEITE	G-870	376364R91
COMBUSTIBLE, SECUNDARIO	GP-78	A184774	400 SOBRE ORUGAS con motor/A DIESEL			COMBUSTIBLE	G-296	3144477R92
AIRE, SECUNDARIO	GA-892	71912C1	ACEITE, CARTUCHO	G-870	376364R91	COMBUSTIBLE	G-296-B	3044506R93
AIRE, PRIMARIO	GA-891	529852R4	TRANSMISION	GP-1	918266R93			
			ACEITE, SELLADO	GP-50	538836R1			

SERVICIO PESADO

MARCA-MODELO-MOTOR MAKE-MODEL-ENGINE	GONHER GONHER	OEM OEM	MARCA-MODELO-MOTOR MAKE-MODEL-ENGINE	GONHER GONHER	OEM OEM	MARCA-MODELO-MOTOR MAKE-MODEL-ENGINE	GONHER GONHER	OEM OEM
I.H.C. HARVESTER (continuación)			I.H.C. HARVESTER (continuación)			I.H.C. HARVESTER (continuación)		
TRACTORES			TRACTORES			TRACTORES		
4366 con motor/IHC DT466			COMBUSTIBLE	GP-1108	A184773	COMBUSTIBLE, SEPARADOR DE AGUA	GPP-11	1214920H1
HIDRAULICO	GP-34	69149C1	AGUA	GP-2071W	1261387H1	AGUA	GP-2071W	1809789C1
ACEITE	GP-69	A184775	4568 con motor/IHC V800			COMBUSTIBLE, SECUNDARIO	GP-78	674293C1
COMBUSTIBLE, PRIMARIO 6 43/64 IN	GP-1105	625626C1	COMBUSTIBLE, PRIMARIO 5 3/4 IN	GPP-14	702255C1	4786 con motor/IHC VT800		
COMBUSTIBLE, PRIMARIO 7 17/32 IN	GP-1108	A184773	COMBUSTIBLE, SECUNDARIO 7 17/32 IN	GP-1107	674293C1	COMBUSTIBLE, SECUNDARIO	GP-1107	674293C1
AGUA	GP-2071W	A151931	COMBUSTIBLE, PRIMARIO 7 17/32 IN	GP-1108	625627C1	COMBUSTIBLE, PRIMARIO	GP-1108	A184773
COMBUSTIBLE, SECUNDARIO	GP-78	672603C2	COMBUSTIBLE, SEPARADOR DE AGUA	GPP-11	1214920H1	AGUA	GP-2071W	1261387H1
4386 SOBRE RUEDAS con motor/IHC DT466			AGUA	GP-2071W	1809789C1	484 con motor/IHC D179		
ACEITE	GP-69	675616C91	COMBUSTIBLE, SECUNDARIO 7 7/64 IN	GP-78	674293C1	ACEITE	GP-10	398080R2
COMBUSTIBLE, PRIMARIO 6 43/64 IN	GP-1105	625626C1	4586 con motor/IHC DVT800			COMBUSTIBLE	G-296	3144477R92
COMBUSTIBLE, PRIMARIO 7 17/32 IN	GP-1108	625627C1	COMBUSTIBLE, SECUNDARIO	GP-1107	674293C1	COMBUSTIBLE, PRIMARIO	GPP-1122	3132428R1
AGUA	GP-2071W	1809789C1	COMBUSTIBLE, PRIMARIO	GP-1108	A184773	COMBUSTIBLE, SECUNDARIO	GPP-1122	3132428R1
COMBUSTIBLE, SECUNDARIO	GP-78	672603C2	AGUA	GP-2071W	1261387H1	COMBUSTIBLE	G-296-B	3144477R92
4386 SOBRE RUEDAS con motor/IHC DT466			4586 con motor/IHC V800			484 SOBRE RUEDAS con motor/A DIESEL		
ACEITE, SELLADO HIDRAULICO	GP-34	69149C1	COMBUSTIBLE, SECUNDARIO 7 17/32 IN	GP-1107	674293C1	ACEITE	GP-10	398080R2
ACEITE	GP-69	A184775	COMBUSTIBLE	GP-1108	625627C1	COMBUSTIBLE	G-296	3144477R92
COMBUSTIBLE, PRIMARIO	GP-1108	A184773	COMBUSTIBLE, SEPARADOR DE AGUA	GPP-11	1214920H1	COMBUSTIBLE	G-296-B	3144477R91
ACEITE	GP-88	1811953C1	AGUA	GP-2071W	1809789C1	AIRE, PRIMARIO	GAK-16	3125199R2
AGUA	GP-2071W	A151931	COMBUSTIBLE, SECUNDARIO 7 7/64 IN	GP-78	674293C1	485XL SOBRE RUEDAS con motor/IHC D179		
COMBUSTIBLE, SECUNDARIO	GP-78	672603C2	460 con motor/A DIESEL			ACEITE	GP-10	398080R2
444 con motor/IHC BD154			ACEITE	G-335	279994R91	COMBUSTIBLE	G-296	3144477R92
ACEITE	G-870	376364R91	COMBUSTIBLE, PRIMARIO	G-1163	306353R91	COMBUSTIBLE	G-296-B	3144477R91
444 con motores/IHC C135, IHC C146			COMBUSTIBLE, SECUNDARIO	G-1163	306353R91	AIRE, PRIMARIO	GAK-16	1265510C1
ACEITE, SELLADO	GP-50	538836R1	ACEITE	GP-10	398080R2	500 con motor/A DIESEL		
450 con motor/A DIESEL			460 con motor/IHC C221			ACEITE	G-870	376364R91
ACEITE, SELLADO	GP-50	538836R1	ACEITE	G-335	323827R91	TRANSMISION	GP-1	918266R93
4500A SOBRE RUEDAS, 4500B SOBRE RUEDAS con motor/IHC C157			460 con motor/IHC D236			COMBUSTIBLE	G-296	3144477R92
ACEITE	GP-50	538836R1	ACEITE	G-335	323827R91	COMBUSTIBLE	G-296-B	3144477R92
4500A SOBRE RUEDAS, 4500B SOBRE RUEDAS con motor/IHC D179			460D con motor/A DIESEL			COMBUSTIBLE	G-296-B	3144477R92
ACEITE	GP-10	398080R2	ACEITE	G-335	279994R91	500 con motor/A GASOLINA		
COMBUSTIBLE	G-296	3144477R92	COMBUSTIBLE, PRIMARIO	G-1163	306353R91	TRANSMISION	GP-1	918266R93
COMBUSTIBLE	GPP-1122	3136187R91	COMBUSTIBLE, SECUNDARIO	G-1163	306353R91	500 con motor/IHC BD144C		
COMBUSTIBLE	G-296-B	3144477R92	ACEITE	GP-10	398080R2	ACEITE	G-870	376364R91
454 con motor/IHC C200			464 con motor/IHC C175			AIRE, SIN ASPAS	GA-16	384812R93
ACEITE	GP-10	398080R2	ACEITE	GP-10	398080R2	AIRE	GAK-16	384812R93
454 con motor/IHC D179			464 con motor/IHC D179			500 con motor/IHC BD154T		
ACEITE, 7 17/32 IN	GP-10	398080R2	ACEITE	GP-10	398080R2	AIRE, SIN ASPAS	GA-16	384812R93
ACEITE, 5 13/32 IN	GP-36	3136046R93	COMBUSTIBLE	G-296	3144477R92	500 con motor/IHC D155		
COMBUSTIBLE	G-296	3144477R92	COMBUSTIBLE, PRIMARIO	G-1163	306353R91	TRANSMISION	GP-1	918266R91
COMBUSTIBLE, PRIMARIO	GPP-1122	1967094C1	COMBUSTIBLE, SECUNDARIO	G-1163	306353R91	ACEITE	GP-10	398080R2
COMBUSTIBLE, SECUNDARIO	GPP-1122	1967094C1	ACEITE	GP-10	398080R2	COMBUSTIBLE, PRIMARIO	GPP-1122	3132275R91
COMBUSTIBLE	G-296-B	3144477R91	COMBUSTIBLE	GPP-1122	1967094C1	COMBUSTIBLE, SECUNDARIO	GPP-1122	3132275R91
454 con motor/IHC D239			COMBUSTIBLE	G-296-B	3144477R92	AIRE, SIN ASPAS	GA-16	384812R93
ACEITE	GP-10	398080R2	464D con motor/IHC D179			AIRE	GAK-16	384812R93
COMBUSTIBLE, PRIMARIO	GPP-1122	3132275R91	ACEITE	GP-10	398080R2	500 SERIES C SOBRE ORUGAS con motor/IHC C146		
COMBUSTIBLE, SECUNDARIO	GPP-1122	3132275R91	COMBUSTIBLE	G-296	3144477R92	TRANSMISION	GP-1	918266R91
454 con motores/IHC C157, IHC C175			COMBUSTIBLE, PRIMARIO	GPP-1122	3132428R1	ACEITE	GP-50	538836R1
ACEITE, 7 17/32 IN	GP-10	398080R2	COMBUSTIBLE, SECUNDARIO	GPP-1122	3132428R1	AIRE, SIN ASPAS	GA-16	384812R93
4568 con motor/IHC DVT800			COMBUSTIBLE	G-296-B	3144477R92	AIRE	GAK-16	384812R93
ACEITE, SELLADO HIDRAULICO	GP-34	69149C1	4786 con motor/IHC V800			500 SERIES C SOBRE ORUGAS con motor/IHC D155		
			COMBUSTIBLE, SECUNDARIO	GP-1107	674293C1	TRANSMISION	GP-1	918266R91
			COMBUSTIBLE, PRIMARIO	GP-1108	625627C1	ACEITE	GP-10	398080R2
						COMBUSTIBLE	G-296	3144477R92
						COMBUSTIBLE, PRIMARIO	GPP-1122	3136187R91

MARCA-MODELO-MOTOR MAKE-MODEL-ENGINE	GONHER GONHER	OEM OEM	MARCA-MODELO-MOTOR MAKE-MODEL-ENGINE	GONHER GONHER	OEM OEM	MARCA-MODELO-MOTOR MAKE-MODEL-ENGINE	GONHER GONHER	OEM OEM
I.H.C. HARVESTER (continuación)			I.H.C. HARVESTER (continuación)			I.H.C. HARVESTER (continuación)		
TRACTORES			TRACTORES			TRACTORES		
COMBUSTIBLE, SECUNDARIO	GPP-1122	3136187R91	AIRE	GA-18	313964R91	COMBUSTIBLE	GPP-1122	3132428R1
COMBUSTIBLE	G-296-B	3144477R92	504D con motor/A DIESEL			AIRE	GA-18	313964R91
AIRE, SIN ASPAS	GA-16	384812R93	ACEITE	G-335	323827R91	5488 con motor/IHC DT1466B		
AIRE	GAK-16	384812R93	COMBUSTIBLE	G-1163	306353R91	HIDRAULICO	G-338	528493R3
500 SERIES E SOBRE ORUGAS con motor/IHC D155			AIRE	GA-18	313964R91	COMBUSTIBLE, SEPARADOR DE AGUA	GPP-14	998443R91
TRANSMISION	GP-1	918266R91	5088 con motor/IHC DT436B			ACEITE	GP-69	A184775
HIDRAULICO	GP-10	528250R1	ACEITE, CARTUCHO HIDRAULICO	G-338	528493R3	COMBUSTIBLE, PRIMARIO	GP-1108	A184773
ACEITE, SELLADO	GP-10	398080R2	ACEITE	GP-69	A184775	ACEITE	GP-88	1811953C1
COMBUSTIBLE	G-296	3144477R92	COMBUSTIBLE, PRIMARIO	GP-1108	A184773	AGUA	GP-2071W	A151931
COMBUSTIBLE	G-296-B	3144477R92	COMBUSTIBLE, SEPARADOR DE AGUA	GPP-11	1214920H1	COMBUSTIBLE, SECUNDARIO	GP-78	672603C2
AIRE, SIN ASPAS	GA-16	384812R93	AGUA	GP-2071W	A151931	AIRE, PRIMARIO	GA-826	67974C3
AIRE	GAK-16	384812R93	COMBUSTIBLE, SECUNDARIO	GP-78	672603C2	AIRE, SECUNDARIO	GA-827	67975C1
5000 con motor/CHRYSLER 6 CYL.			AIRE, PRIMARIO	GA-826	67974C2	554 SOBRE RUEDAS con motor/A DIESEL		
ACEITE	GP-1	388227R91	AIRE, SECUNDARIO	GA-827	67975C1	COMBUSTIBLE	G-296	3144477R92
5000 con motor/DEUTZ 4 CYL.			5288 con motor/IHC DT466B			COMBUSTIBLE	G-296-B	3044506R93
ACEITE	GP-54	3136046R93	ACEITE, CARTUCHO HIDRAULICO	G-338	528493R3	ACEITE, SELLADO	GP-171	395789R2
500B con motor/A DIESEL			COMBUSTIBLE, SEPARADOR DE AGUA	GPP-14	998443R91	560 con motor/A DIESEL		
ACEITE	GP-10	398080R2	ACEITE	GP-69	A184775	ACEITE	G-335	279994R91
500C con motores/IHC BD144C, IHC BD154T			COMBUSTIBLE, PRIMARIO	GP-1108	A184773	560 con motor/IHC C263		
TRANSMISION	GP-1	388227R91	COMBUSTIBLE, SEPARADOR DE AGUA	GPP-11	1214920H1	ACEITE, CARTUCHO	G-335	323827R91
ACEITE	GP-10	398080R2	ACEITE	GP-88	1811953C1	560 con motor/IHC D282		
AIRE, SIN ASPAS	GA-16	384812R93	AGUA	GP-2071W	A151931	ACEITE	G-335	323827R91
AIRE	GAK-16	384812R93	COMBUSTIBLE, SECUNDARIO	GP-78	672603C2	560D con motor/A DIESEL		
500C SOBRE ORUGAS con motor/A DIESEL			AIRE, PRIMARIO	GA-826	67974C3	ACEITE	G-335	279994R91
ACEITE, SELLADO	GP-50	538836R1	AIRE, SECUNDARIO	GA-827	67975C1	COMBUSTIBLE, PRIMARIO	G-1163	306353R91
COMBUSTIBLE	G-296	3144477R92	533 SOBRE RUEDAS, 533A SOBRE RUEDAS con motor/A DIESEL			COMBUSTIBLE, SECUNDARIO	G-1163	306353R91
COMBUSTIBLE	G-296-B	3144477R92	ACEITE	GP-9	395789R2	ACEITE	GP-10	398080R2
AIRE	GAK-16	384812R93	COMBUSTIBLE	G-296	3044506R91	ACEITE, TURBO LUBRICACION	GP-50	538836R1
500C, 500E con motor/IHC D155			COMBUSTIBLE	G-296-B	3044506R91	574 con motor/IHC D179		
TRANSMISION	GP-1	388227R91	AIRE, PRIMARIO	GA-49	3146927-R91	ACEITE	GP-10	398080R2
ACEITE	GP-10	398080R2	544 con motor/A DIESEL			COMBUSTIBLE	G-296	3144477R92
COMBUSTIBLE, PRIMARIO	GPP-1122	3132275R91	ACEITE	G-338	70432C91	COMBUSTIBLE, PRIMARIO	GPP-1122	3132428R1
COMBUSTIBLE, SECUNDARIO	GPP-1122	3132275R91	ACEITE	GP-10	398080R2	COMBUSTIBLE, SECUNDARIO	GPP-1122	3132428R1
AIRE, SIN ASPAS	GA-16	384812R93	COMBUSTIBLE	GP-92	530824R2	COMBUSTIBLE	G-296-B	3044506R91
AIRE	GAK-16	384812R93	COMBUSTIBLE	GPP-1122	3132428R1	574 con motor/IHC D239		
500E con motor/IHC BD144C			AIRE	GA-18	313964R91	ACEITE	GP-10	398080R2
ACEITE	G-870	376364R91	544 con motor/IHC C200			COMBUSTIBLE	G-296	3144477R92
AIRE, SIN ASPAS	GA-16	384812R93	ACEITE	G-338	386120R91	COMBUSTIBLE, PRIMARIO	GPP-1122	3132428R1
AIRE	GAK-16	384812R93	ACEITE	GP-36	3136046R93	COMBUSTIBLE, SECUNDARIO	GPP-1122	3132428R1
500E con motor/IHC BD154T			HYDROSTATIC RETLINE SELLADO	GP-66	528250R1	COMBUSTIBLE	G-296-B	3144477R92
AIRE, SIN ASPAS	GA-16	384812R93	AIRE	GA-18	313964R91	574 con motores/IHC C157, IHC C175, IHC C200		
500E SOBRE ORUGAS con motor/A DIESEL			544 con motor/IHC D239			ACEITE	GP-10	398080R2
TRANSMISION	GP-1	918266R93	HYDROSTATIC GEAR DRIVE CARTUCHO	G-338	386120R91	582 con motor/A DIESEL		
ACEITE	GP-10	398080R2	ACEITE	GP-36	3136046R93	ACEITE	GP-9	395789R2
HIDRAULICO	GP-10	528250R1	COMBUSTIBLE	G-296	3144477R92	584 SOBRE RUEDAS con motor/A DIESEL		
COMBUSTIBLE	G-296	3144477R92	HYDROSTATIC RETLINE SELLADO	GP-66	528250R1	ACEITE	GP-36	3136046R93
COMBUSTIBLE	G-296-B	3144477R92	COMBUSTIBLE, SELLADO	GPP-1122	1967094C1	COMBUSTIBLE	G-296	3144477R92
AIRE	GAK-16	384812R93	COMBUSTIBLE	G-296-B	3144477R92	COMBUSTIBLE, SELLADO	GP-1122	3218794R91
504 con motor/IHC C153			544D con motor/A DIESEL			COMBUSTIBLE	G-296-B	3044506R91
ACEITE, SELLADO	GP-50	538836R1	ACEITE	G-338	70432C91	AIRE, PRIMARIO	GAK-16	1265510C1
504 con motor/IHC D188			ACEITE	GP-10	398080R2			
ACEITE	G-335	279994R91	COMBUSTIBLE	GP-92	530824R2			
COMBUSTIBLE	G-1163	304101R91						

SERVICIO PESADO

MARCA-MODELO-MOTOR MAKE-MODEL-ENGINE	GONHER GONHER	OEM OEM	MARCA-MODELO-MOTOR MAKE-MODEL-ENGINE	GONHER GONHER	OEM OEM	MARCA-MODELO-MOTOR MAKE-MODEL-ENGINE	GONHER GONHER	OEM OEM
I.H.C. HARVESTER (continuación)			I.H.C. HARVESTER (continuación)			I.H.C. HARVESTER (continuación)		
TRACTORES			TRACTORES			TRACTORES		
585XL SOBRE RUEDAS con motor/IHC D206			650 con motor/IHC D350			660D con motor/IHC C263		
ACEITE	GP-10	398080R2	HIDRAULICO	G-338	70432C91	ACEITE, CARTUCHO	G-335	323827R91
COMBUSTIBLE	G-296	3144477R92				COMBUSTIBLE, PRIMARIO	G-1163	306353R91
COMBUSTIBLE	GP-1122	3218794R91	650D con motor/A DIESEL			COMBUSTIBLE, SECUNDARIO	G-1163	306353R91
COMBUSTIBLE	G-296-B	3044506R91	HIDRAULICO	G-338	70432C91	HYDROSTATIC DRIVE CAR-TUCHO	G-338	70432C91
AIRE, PRIMARIO	GAK-16	1265510C1				ACEITE, TURBO LUBRICACION	GP-50	538836R1
			654 SOBRE RUEDAS, 654A SOBRE RUEDAS con motor/A DIESEL			ACEITE, SELLADO	GP-69	675616C91
606 con motor/A DIESEL			COMBUSTIBLE	G-296	3144477R92			
ACEITE	G-335	279994R91	COMBUSTIBLE, PRIMARIO	GP-1122	3132428R1	660D con motor/IHC D282		
COMBUSTIBLE	G-1163	306353R91	COMBUSTIBLE, SECUNDARIO	GP-1122	3132428R1	ACEITE, CARTUCHO	G-335	279994R91
ACEITE	GP-10	398080R2	COMBUSTIBLE	G-296-B	3044506R93	COMBUSTIBLE	G-1163	306353R91
			ACEITE	GP-171	395789R2	HIDRAULICO	G-338	70432C91
606 con motor/IHC C221			AIRE	GA-49	3146927-R91	ACEITE, SELLADO	GP-10	398080R2
ACEITE	G-335	279994R91				ACEITE, TURBO LUBRICACION	GP-50	538836R1
			656 con motor/IHC C263					
606 con motor/IHC D236			ACEITE, CARTUCHO	G-335	279994R91	664 con motor/IHC D239		
ACEITE	G-335	279994R91	HYDROSTATIC DRIVE CAR-TUCHO	G-338	70432C91	ACEITE	GP-10	398080R2
			COMBUSTIBLE, SELLADO	GP-1122	3136046R93	COMBUSTIBLE	G-296	3144477R92
606D con motor/A DIESEL			HYDROSTATIC RETLINE SELLADO	GP-66	528250R1	COMBUSTIBLE, PRIMARIO	GPP-1122	3132428R1
ACEITE	G-335	328227R91	AIRE	GAK-16	384812R93	COMBUSTIBLE, SECUNDARIO	GPP-1122	3132428R1
COMBUSTIBLE, PRIMARIO	G-1163	306353R91				COMBUSTIBLE	G-296-B	3044506R91
COMBUSTIBLE, SECUNDARIO	G-1163	306353R91	656 con motor/IHC D282					
ACEITE	GP-10	398080R2	ACEITE, CARTUCHO	G-335	279994R91	666 con motor/IHC C291		
			COMBUSTIBLE, SECUNDARIO	G-1163	306353R91	HYDROSTATIC DRIVE CAR-TUCHO	G-338	528493R3
624 SOBRE RUEDAS (ENSAMBLADO EN ALEMANIA), 724 SOBRE RUEDAS (ENSAMBLADO EN ALEMANIA) con motor/A DIESEL			HYDROSTATIC DRIVE CAR-TUCHO	G-338	70432C91	ACEITE, 7 17/32 IN	GP-10	398080R2
COMBUSTIBLE, SIN CUBIERTA	G-1123	3132015R92	HYDROSTATIC RETLINE SELLADO	GP-66	528250R1	ACEITE, 5 13/32 IN	GP-36	3136046R93
			ACEITE, SELLADO	GP-69	A184775	HYDROSTATIC RETLINE SELLADO	GP-66	70203C2
624 SOBRE RUEDAS, 624A SOBRE RUEDAS con motor/A DIESEL								
COMBUSTIBLE	G-296	3144477R92	656D con motor/IHC D282			666 con motor/IHC D312		
COMBUSTIBLE, PRIMARIO	GP-1122	3132428R1	ACEITE, CARTUCHO	G-335	279994R91	HYDROSTATIC DRIVE CAR-TUCHO	G-338	528493R3
COMBUSTIBLE, SECUNDARIO	GP-1122	3132428R1	COMBUSTIBLE, PRIMARIO	G-1163	306353R91	HYDROSTATIC RETLINE SELLADO	GP-66	528250R1
COMBUSTIBLE	G-296-B	3144477R92	COMBUSTIBLE, SECUNDARIO	G-1163	306353R91	ACEITE	GP-69	A184775
ACEITE	GP-171	395789R2	HIDRAULICO	G-338	70432C91	COMBUSTIBLE, PRIMARIO 46 43/64 IN	GP-1105	625626C1
AIRE	GA-49	3146927-R91	ACEITE	GP-10	398080R2	COMBUSTIBLE, PRIMARIO 7 17/32 IN	GP-1108	A184773
			ACEITE, TURBO LUBRICACION	GP-50	538836R1	AGUA	GP-2071W	A151931
633 SOBRE RUEDAS (ENSAMBLADO EN ALEMANIA) con motor/A DIESEL			ACEITE, SELLADO	GP-69	675616C91	COMBUSTIBLE, SECUNDARIO	GP-78	672603C2
COMBUSTIBLE	G-296	3044506R93						
COMBUSTIBLE	G-296-B	3044506R93	6588 con motor/IHC DIESEL			666 con motor/IHC GASOLINA		
ACEITE	GP-171	395789R2	ACEITE	GP-69	A184775	HIDRAULICO	G-338	528493R3
			COMBUSTIBLE, PRIMARIO	GP-1108	A184773			
633 SOBRE RUEDAS, 633A SOBRE RUEDAS con motor/A DIESEL			COMBUSTIBLE, SEPARADOR DE AGUA	GPP-11	1214920H1	671 con motor/A DIESEL		
ACEITE	GP-9	395789R2	AGUA	GP-2071W	A151931	ACEITE	GP-10	398080R2
COMBUSTIBLE	G-296	3144477R92	COMBUSTIBLE, SECUNDARIO	GP-78	672603C2			
COMBUSTIBLE	G-296-B	3044506R93	AIRE, PRIMARIO	GA-826	67974C3	674 con motor/IHC C200		
AIRE, PRIMARIO	GA-49	3146927-R91	AIRE, SECUNDARIO	GA-827	67975C1	ACEITE	GP-10	398080R2
6388 SOBRE RUEDAS con motor/IHC DT436			660 con motor/IHC C263			674 con motor/IHC D239		
ACEITE	GP-69	A184775	ACEITE, CARTUCHO	G-335	323827R91	ACEITE	GP-10	398080R2
COMBUSTIBLE, PRIMARIO	GP-1108	A184773	COMBUSTIBLE, PRIMARIO	G-1163	306353R91	COMBUSTIBLE	G-296	3144477R92
COMBUSTIBLE, SEPARADOR DE AGUA	GPP-11	1214920H1	COMBUSTIBLE, SECUNDARIO	G-1163	306353R91	COMBUSTIBLE, PRIMARIO	GPP-1122	1967094C1
AGUA	GP-2071W	A151931	HYDROSTATIC DRIVE CAR-TUCHO	G-338	70432C91	COMBUSTIBLE, SECUNDARIO	GPP-1122	1967094C1
COMBUSTIBLE, SECUNDARIO	GP-78	672603C2	ACEITE, TURBO LUBRICACION	GP-50	538836R1	COMBUSTIBLE	G-296-B	3144477R92
AIRE, PRIMARIO	GA-826	67974C3	ACEITE, SELLADO	GP-69	675616C91	AIRE, PRIMARIO	GAK-16	1265510C1
AIRE, SECUNDARIO	GA-827	67975C1						
			644 SOBRE RUEDAS con motor/A DIESEL			6788 con motor/IHC DT1466B		
COMBUSTIBLE	G-296	3144477R92	COMBUSTIBLE	G-335	279994R91	AGUA	GP-1010Q	A151931
COMBUSTIBLE, PRIMARIO	GPP-1122	3132275R91	ACEITE	G-1163	306353R91	ACEITE	GP-69	675616C91
COMBUSTIBLE, SECUNDARIO	GPP-1122	3132275R91	ACEITE	G-338	70432C91	COMBUSTIBLE	GP-1108	625627C1
COMBUSTIBLE	G-296-B	3044506R93	ACEITE	GP-10	398080R2	COMBUSTIBLE	GP-78	672603C2
ACEITE	GP-171	395789R2	ACEITE	GP-69	675616C91	AIRE	GA-826	67974C4

MARCA-MODELO-MOTOR MAKE-MODEL-ENGINE	GONHER GONHER	OEM OEM	MARCA-MODELO-MOTOR MAKE-MODEL-ENGINE	GONHER GONHER	OEM OEM	MARCA-MODELO-MOTOR MAKE-MODEL-ENGINE	GONHER GONHER	OEM OEM
I.H.C. HARVESTER (continuación)			I.H.C. HARVESTER (continuación)			I.H.C. HARVESTER (continuación)		
TRACTORES			TRACTORES			TRACTORES		
AIRE	GA-827	67975C1	706 con motor/IHC C282			733 SOBRE RUEDAS, 733A SOBRE RUEDAS con motor/A DIESEL		
6788 SOBRE RUEDAS con motor/IHC DT466			ACEITE	G-335	279994R91	COMBUSTIBLE	G-296	3144477R92
ACEITE	GP-69	A184775	COMBUSTIBLE	G-1163	306353R91	COMBUSTIBLE	GP-1122	3132428R1
COMBUSTIBLE, PRIMARIO	GP-1108	A184773	ACEITE	G-338	528493R3	COMBUSTIBLE	G-296-B	3044506R91
ACEITE	GP-88	1811953C1	ACEITE	GP-69	A184775	ACEITE	GP-171	395789R2
AGUA	GP-2071W	A151931	706 con motor/IHC D282			AIRE	GA-49	3146927-R91
COMBUSTIBLE, SECUNDARIO	GP-78	672603C2	ACEITE, CARTUCHO	G-335	279994R91	7388 SOBRE RUEDAS con motor/A DIESEL		
AIRE, PRIMARIO	GA-826	67974C3	COMBUSTIBLE	G-1163	304101R91	HIDRAULICO	G-338	528493R3
AIRE, SECUNDARIO	GA-827	67975C1	HYDROSTATIC GEAR DRIVE	G-338	386120R91	ACEITE	GP-69	A184775
682, 782 con motor/KOHLER A GASOLINA			ACEITE, TRACTOR	GP-69	A184775	COMBUSTIBLE, PRIMARIO	GP-1108	A184773
HIDRAULICO	GP-9	395789R2	706 con motor/IHC D310			AGUA	GP-2071W	A151931
684 con motor/A DIESEL			HYDROSTATIC GEAR DRIVE	G-338	528493R3	COMBUSTIBLE, SECUNDARIO	GP-78	A184774
ACEITE	GP-36	3136046R93	COMBUSTIBLE	G-1123	3132015R92	AIRE, PRIMARIO	GA-826	67974C4
COMBUSTIBLE	G-296	3144477R92	ACEITE, 7 17/32 IN	GP-10	528250R1	AIRE, SECUNDARIO	GA-827	67975C1
COMBUSTIBLE	GP-1122	3218794R91	ACEITE, 5 13/32 IN	GP-36	3136046R93	743XL SOBRE RUEDAS, 744 SOBRE RUEDAS, 745 SOBRE RUEDAS, 745S SOBRE RUEDAS, 745XL SOBRE RUEDAS, 743 SOBRE RUEDAS, 743S SOBRE RUEDAS con motor/A DIESEL		
COMBUSTIBLE	G-296-B	3044506R91	COMBUSTIBLE	G-296	3144477R92	COMBUSTIBLE	G-296	3144477R92
AIRE, PRIMARIO	GAK-16	1265510C1	COMBUSTIBLE	GPP-1122	1967094C1	COMBUSTIBLE, PRIMARIO	GPP-1122	3132275R91
684 con motor/IHC D239			COMBUSTIBLE	G-296-B	3144477R92	COMBUSTIBLE, SECUNDARIO	GPP-1122	3132275R91
ACEITE, 7 17/32 IN	GP-10	398080R2	706 con motores/IHC C263, IHC C291			COMBUSTIBLE	G-296-B	3044506R91
ACEITE, 5 13/32 IN	GP-36	3136046R93	ACEITE, CARTUCHO	G-335	279994R91	ACEITE	GP-171	395789R2
COMBUSTIBLE	G-296	3144477R92	HIDRAULICO	G-338	528493R3	756 con motor/IHC D310		
COMBUSTIBLE, PRIMARIO	GPP-1122	3132275R91	ACEITE, SELLADO	GP-10	398080R2	HIDRAULICO	G-338	70432C91
COMBUSTIBLE, SECUNDARIO	GPP-1122	3132275R91	AIRE, SIN ASPAS	GA-16	384812R93	COMBUSTIBLE, SIN CUBIERTA	G-1123	3132015R91
COMBUSTIBLE	G-296-B	3044506R91	AIRE	GAK-16	384812R93	COMBUSTIBLE, CON CUBIERTA	G-1123F	3132015R91
685XL SOBRE RUEDAS con motor/IHC D239			706D con motor/IHC D310			ACEITE, OPCIONAL	GP-10	528250R1
ACEITE	GP-10	398080R2	HIDRAULICO	G-338	70432C91	ACEITE, TURBO LUBRICACION	GP-50	538836R1
COMBUSTIBLE	G-296	3144477R92	COMBUSTIBLE, SIN CUBIERTA	G-1123	3132015R91	COMBUSTIBLE	G-296	3144477R92
COMBUSTIBLE, PRIMARIO	GPP-1122	3132275R91	COMBUSTIBLE, CON CUBIERTA	G-1123F	3132015R91	COMBUSTIBLE, PRIMARIO	GPP-1122	3132275R91
COMBUSTIBLE, SECUNDARIO	GPP-1122	3132275R91	ACEITE, OPCIONAL	GP-10	528250R1	COMBUSTIBLE, SECUNDARIO	GPP-1122	3132275R91
AGUA	GP-2071W	A151931	ACEITE, TURBO LUBRICACION	GP-50	538836R1	COMBUSTIBLE	G-296-B	3144477R92
COMBUSTIBLE	G-296-B	3044506R91	COMBUSTIBLE, PRIMARIO	GPP-1122	3132275R91	756 con motores/IHC C291, IHC C301		
AIRE, PRIMARIO	GAK-16	1265510C1	COMBUSTIBLE, SECUNDARIO	GPP-1122	3132275R91	ACEITE, CARTUCHO	G-335	279994R91
686 con motor/IHC C291			706D con motores/IHC U282, IHC UD282			HIDRAULICO	G-338	70432C91
HYDROSTATIC DRIVE	G-338	528493R3	ACEITE	G-335	279994R91	ACEITE, SECUNDARIO	GP-10	398080R2
ACEITE, 7 17/32 IN	GP-10	398080R2	COMBUSTIBLE, PRIMARIO	G-1163	306353R91	766 con motor/IHC C291		
ACEITE, 5 13/32 IN	GP-36	3136046R93	COMBUSTIBLE, SECUNDARIO	G-1163	306353R91	HYDROSTATIC GEAR DRIVE	G-338	70432C91
HIDRAULICO	GP-66	70203C2	HIDRAULICO	G-338	70432C91	ACEITE, 7 17/32 IN	GP-10	398080R2
686 con motor/IHC D310			AIRE, SIN ASPAS	GA-16	384812R93	ACEITE, 5 13/32 IN	GP-36	3136046R93
HYDROSTATIC DRIVE	G-338	386120R91	AIRE	GAK-16	384812R93	AIRE, SECUNDARIO	GA-892	529852R5
COMBUSTIBLE, CARTUCHO	G-1123	3132015R92	724 SOBRE RUEDAS, 724A SOBRE RUEDAS con motor/A DIESEL			AIRE, PRIMARIO	GA-891	529851R2
ACEITE	GP-36	3136046R93	COMBUSTIBLE	G-296	3144477R92	AIRE, SECUNDARIO	GA-416	537335R2
HIDRAULICO	GP-66	70203C2	COMBUSTIBLE, PRIMARIO	GP-1122	3132428R1	766 con motor/IHC D360		
COMBUSTIBLE, PRIMARIO	GP-1108	A184773	COMBUSTIBLE, SECUNDARIO	GP-1122	3132428R1	HYDROSTATIC GEAR DRIVE	G-338	70432C91
AGUA	GP-2071W	A151931	COMBUSTIBLE	G-296-B	3044506R91	COMBUSTIBLE, PRIMARIO	GP-1101	625625C1
COMBUSTIBLE, SECUNDARIO	GP-78	672603C1	ACEITE	GP-171	395789R2	ACEITE	GP-69	A184775
686 con motor/IHC D312			AIRE	GA-49	3146927-R91	COMBUSTIBLE, SECUNDARIO	GP-78	672603C1
HYDROSTATIC DRIVE	G-338	528493R3	7288, 7488 con motor/A DIESEL			AIRE, SECUNDARIO	GA-892	529852R4
HIDRAULICO	GP-66	70203C2	HIDRAULICO	G-338	528493R3	AIRE, PRIMARIO	GA-891	529851R2
ACEITE	GP-69	A184775	ACEITE	GP-69	A184775	784 SOBRE RUEDAS con motor/A DIESEL		
COMBUSTIBLE, PRIMARIO	GP-1108	625627C1	COMBUSTIBLE, PRIMARIO	GP-1108	A184773	ACEITE	GP-10	398080R2
COMBUSTIBLE, SEPARADOR DE AGUA	GPP-11	1214920H1	AGUA	GP-2071W	A151931	COMBUSTIBLE	G-296	3144477R92
AGUA	GP-2071W	A151931	COMBUSTIBLE, SECUNDARIO	GP-78	A184774	COMBUSTIBLE	GP-1122	3218794R91
COMBUSTIBLE, SECUNDARIO	GP-78	672603C2	AIRE, PRIMARIO	GA-826	67974C4	COMBUSTIBLE	GPP-1122	1967094C1
7 HP CADET con motor/A DIESEL			AIRE, SECUNDARIO	GA-827	67975C1	COMBUSTIBLE	G-296-B	3144477R92
AIRE	GA-11	385163R2				AIRE, PRIMARIO	GAK-16	1265510C1

MARCA-MODELO-MOTOR MAKE-MODEL-ENGINE	GONHER GONHER	OEM OEM	MARCA-MODELO-MOTOR MAKE-MODEL-ENGINE	GONHER GONHER	OEM OEM	MARCA-MODELO-MOTOR MAKE-MODEL-ENGINE	GONHER GONHER	OEM OEM
I.H.C. HARVESTER (continuación)			I.H.C. HARVESTER (continuación)			I.H.C. HARVESTER (continuación)		
TRACTORES			TRACTORES			TRACTORES		
A, AV, B con motor/IHC C113			COMBUSTIBLE, SECUNDARIO	GP-78	672603C2	T500 SOBRE ORUGAS con motor/A GASOLINA		
ACEITE, SELLADO	GP-50	538836R1	AIRE, SECUNDARIO	GA-892	529852R4	ACEITE	G-33	302574R91
			AIRE, PRIMARIO	GA-891	529851R2	ACEITE, CARTUCHO PARA TRANSMISION	G-33	302574R91
B100 con motor/A DIESEL			HYDRO 186 con motor/IHC D436			ACEITE, SELLADO TRANSMISION	GP-1	920203C1
COMBUSTIBLE	G-296	3144477R92	HIDROSTATIC DRIVE	G-338	70432C91	T6-62 SOBRE ORUGAS con motor/A DIESEL		
			ACEITE	GP-69	A184775	ACEITE	G-335	279994R91
B250 con motor/A DIESEL			COMBUSTIBLE, PRIMARIO 6 43/64 IN	GP-1105	702143C1	T7 SOBRE ORUGAS con motor/IHC D206		
ACEITE	G-870	376364R91	COMBUSTIBLE, PRIMARIO 7 17/32 IN	GP-1108	A184773	ACEITE	GP-10	398080R2
			COMBUSTIBLE, SEPARADOR DE AGUA	GPP-11	1214920H1	T7 SOBRE ORUGAS con motores/IHC C175, IHC C200		
B275 con motor/IHC BD144			AGUA	GP-2071W	A151931	HIDRAULICO	G-338	386120R91
ACEITE	G-870	376364R91	COMBUSTIBLE, SECUNDARIO	GP-78	672603C2	T800 SOBRE ORUGAS con motor/A DIESEL		
			AIRE, SECUNDARIO	GA-892	529852R4	ACEITE, CARTUCHO PARA TRANSMISION	G-33	302574R91
B414 con motor/IHC BD154			AIRE, PRIMARIO	GA-891	529851R2	ACEITE, SELLADO TRANSMISION	GP-1	920203C1
ACEITE	G-870	376364R91	HYDRO 70, HYDRO 86 con motor/IHC C291 GASOLINA			COMBUSTIBLE, SECUNDARIO	GP-1107	674293C1
COMBUSTIBLE	G-296	3144477R92	ACEITE	GP-10	398080R2	COMBUSTIBLE, PRIMARIO	GP-1108	625627C1
COMBUSTIBLE	G-296-B	304450693	AIRE, SECUNDARIO	GA-892	529852R1	T800 SOBRE ORUGAS con motor/A GASOLINA		
			AIRE, PRIMARIO	GA-891	71912C1	ACEITE, CARTUCHO PARA TRANSMISION	G-33	302574R91
B414 con motor/IHC DC144			HYDRO 70, HYDRO 86 con motor/IHC D312			COMBUSTIBLE, SECUNDARIO	GP-1107	674293C1
ACEITE	G-870	376364R91	HIDROSTATIC DRIVE	G-338	70432C91	COMBUSTIBLE, PRIMARIO	GP-1108	625627C1
			TRANSMISION	GP-1	918266R93	COMBUSTIBLE, SECUNDARIO	GP-78	672603C1
B414D con motor/A DIESEL			HIDRAULICO SELLADO	GP-66	70203C2	TD12 SOBRE ORUGAS con motor/IHC D466 DIESEL		
ACEITE	G-870	376364R91	ACEITE	GP-69	A184775	ACEITE	GP-69	675617C91
COMBUSTIBLE	G-296	3144477R92	COMBUSTIBLE, PRIMARIO 6 43/64 IN	GP-1105	625626C1	COMBUSTIBLE, PRIMARIO	GP-1105	625626C1
COMBUSTIBLE	G-296-B	3144477R92	COMBUSTIBLE, PRIMARIO 7 17/32 IN	GP-1108	A184773	ACEITE	GP-88	1811953C1
			COMBUSTIBLE, SEPARADOR DE AGUA	GPP-11	1214920H1	COMBUSTIBLE, SECUNDARIO	GP-78	672603C1
BN, BW con motor/IHC C113			AGUA	GP-2071W	A151931	TD12 SOBRE ORUGAS con motor/IHC D466B		
ACEITE, SELLADO	GP-50	538836R1	COMBUSTIBLE, SECUNDARIO	GP-78	672603C2	ACEITE, SELLADO	GP-69	675616C91
			AIRE, SECUNDARIO	GA-892	529852R1	COMBUSTIBLE, PRIMARIO	GP-1108	625627C1
C con motor/A DIESEL			AIRE, PRIMARIO	GA-891	71912C1	COMBUSTIBLE, SECUNDARIO	GP-78	672603C1
ACEITE, SELLADO	GP-50	538836R1	HYDRO 84 con motor/A DIESEL			TD12B SOBRE ORUGAS con motor/A DIESEL		
			ACEITE, 7 17/32 IN	GP-10	398080R2	COMBUSTIBLE, SECUNDARIO	GP-1122	161624
CUB 154 LO-BOY SOBRE RUEDAS con motor/IHC C60			ACEITE, 5 13/32 IN	GP-36	3136046R93	ACEITE	GP-43	A77537
ACEITE	G-335	376373R91	COMBUSTIBLE	G-296	3144477R92	COMBUSTIBLE, PRIMARIO	GPP-18	161623
			COMBUSTIBLE	GP-1122	3218794R91	TD15 SERIES B SOBRE ORUGAS con motor/IHC DT361		
CUB 185 LO-BOY SOBRE RUEDAS con motor/IHC C60			COMBUSTIBLE	G-296-B	3144477R92	HIDRAULICO	G-333	615447C1
ACEITE	G-335	279994R91	COMBUSTIBLE	GAK-16	1265510C1	ACEITE, CARTUCHO	G-335	279994R91
			AIRE			COMBUSTIBLE, PRIMARIO	G-1163	306353R91
CUB SOBRE RUEDAS con motor/A DIESEL			HYDRO 84 con motor/A DIESEL			COMBUSTIBLE, SECUNDARIO	G-1163	306353R91
HIDRAULICO	GP-171	395789R2	ACEITE, 7 17/32 IN	GP-10	398080R2	TD15 SERIES B SOBRE ORUGAS con motor/IHC DT407		
			ACEITE, 5 13/32 IN	GP-36	3136046R93	HIDRAULICO	G-333	615447C1
FARMALL C SOBRE RUEDAS, FARMALL SUPER C SOBRE RUEDAS con motor/IHC C113			COMBUSTIBLE	G-296	3144477R92	ACEITE, CARTUCHO	G-335	279994R91
ACEITE, SELLADO	GP-50	538836R1	COMBUSTIBLE	GP-1122	3218794R91	COMBUSTIBLE, PRIMARIO 6 43/64 IN	GP-1105	625626C1
			COMBUSTIBLE	G-296-B	3144477R92	COMBUSTIBLE, PRIMARIO 7 17/32 IN	GP-1108	625627C1
H, HV con motor/A DIESEL			AIRE	GAK-16	1265510C1	COMBUSTIBLE, SEPARADOR DE AGUA	GPP-11	1214920H1
ACEITE, SELLADO	GP-50	538836R1	HYDRO 100 con motor/A DIESEL			COMBUSTIBLE, SECUNDARIO	GP-110	702253C1
			HIDRAULICO	G-338	70432C91	TD15-150 SOBRE ORUGAS, TD15-151 SOBRE ORUGAS con motor/A DIESEL		
			ACEITE	GP-10	398080R2	ACEITE, CARTUCHO	G-335	323827R91
			ACEITE	GP-69	675616C91	COMBUSTIBLE, PRIMARIO 6 43/64 IN		
			COMBUSTIBLE, PRIMARIO 6 43/64 IN	GP-1105	702143C1	COMBUSTIBLE, PRIMARIO 7 17/32 IN		
			COMBUSTIBLE, SECUNDARIO	GP-78	672603C2	COMBUSTIBLE, SEPARADOR DE AGUA		
			AIRE, SECUNDARIO	GA-892	529852R1	COMBUSTIBLE, SECUNDARIO		
			AIRE, PRIMARIO	GA-891	71912C1	7 1/8 IN		
			HYDRO 100 con motor/IHC D436			TD15-150 SOBRE ORUGAS, TD15-151 SOBRE ORUGAS con motor/A DIESEL		
			HIDROSTATIC DRIVE	G-338	70432C91	ACEITE, CARTUCHO		
			ACEITE	GP-10	677709C91	TD15B SOBRE ORUGAS con motor/A DIESEL		
			COMBUSTIBLE, PRIMARIO 6 43/64 IN	GP-1105	702143C1			
			COMBUSTIBLE, PRIMARIO 7 17/32 IN	GP-1108	A184773			
			AGUA	GP-2071W	A151931			

SERVICIO PESADO

MARCA-MODELO-MOTOR MAKE-MODEL-ENGINE	GONHER GONHER	OEM OEM	MARCA-MODELO-MOTOR MAKE-MODEL-ENGINE	GONHER GONHER	OEM OEM	MARCA-MODELO-MOTOR MAKE-MODEL-ENGINE	GONHER GONHER	OEM OEM
I.H.C. HARVESTER (continuación)			I.H.C. HARVESTER (continuación)			I.H.C. HARVESTER (continuación)		
TRACTORES			TRACTORES			TRACTORES		
ACEITE	G-335	328227R91	COMBUSTIBLE, SECUNDARIO 7 17/32 IN	GP-1107	359251C1	COMBUSTIBLE, PRIMARIO	G-1163	306353R91
COMBUSTIBLE, PRIMARIO 6 43/64 IN	GP-1105	625626C1	COMBUSTIBLE, SECUNDARIO 7 7/64 IN	GP-78	359251C1	COMBUSTIBLE, SECUNDARIO	G-1163	306353R91
COMBUSTIBLE, PRIMARIO 7 17/32 IN	GP-1108	625627C1	AIRE	GA-31	672019C1	TD7C SOBRE ORUGAS con motor/IHC D206		
COMBUSTIBLE, SECUNDARIO 7 1/8 IN	GP-110	702253C1				TRANSMISION	G-338	386120R91
TD15C SOBRE ORUGAS con motor/A DIESEL			TD22 SOBRE ORUGAS con motor/A DIESEL			ACEITE	GP-10	398080R2
COMBUSTIBLE, SEPARADOR DE AGUA	GPP-14	998443R91	COMBUSTIBLE, PRIMARIO	G-1163	306353R91	ACEITE, OPCIONAL	GP-10	528250R1
ACEITE	GP-69	675616C91	TD25 SOBRE ORUGAS con motor/A DIESEL			COMBUSTIBLE	G-296	3144477R92
COMBUSTIBLE, PRIMARIO 6 43/64 IN	GP-1105	625626C1	COMBUSTIBLE, SECUNDARIO	GP-1107	674293C1	COMBUSTIBLE	GP-1122	3132428R1
COMBUSTIBLE, PRIMARIO 7 17/32 IN	GP-1108	625627C1	TD25-250 SOBRE ORUGAS, TD30 SOBRE ORUGAS con motor/A DIESEL			ACEITE	GP-66	528250R1
COMBUSTIBLE, SECUNDARIO	GP-78	672603C1	TRANSMISION	G-33	319926R91	COMBUSTIBLE	GPP-1122	3132428R2
AIRE, PRIMARIO	GA-329	627934C1	TD25B SOBRE ORUGAS con motor/A DIESEL			COMBUSTIBLE	G-296-B	3144477R92
AIRE, SECUNDARIO	GA-239	627935C1	ACEITE, CONVERTIDOR DE TORSION	G-33	319926R91	TD7E SOBRE ORUGAS con motor/IHC D239		
TD15C SOBRE ORUGAS con motor/IHC DT466			COMBUSTIBLE, SECUNDARIO	GP-1107	674293C1	ACEITE, OPCIONAL	GP-10	528250R1
HIDRAULICO	G-333	615447C1	COMBUSTIBLE, PRIMARIO	GP-1108	625627C1	COMBUSTIBLE	G-296	3144477R92
ACEITE, SELLADO	GP-69	675616C91	COMBUSTIBLE, SECUNDARIO	GP-110	702253C1	COMBUSTIBLE	GPP-1122	3132428R2
COMBUSTIBLE, PRIMARIO 6 43/64 IN	GP-1105	625626C1	TD25C SOBRE ORUGAS con motor/IHC DT817B			COMBUSTIBLE	G-296-B	3144477R92
COMBUSTIBLE, PRIMARIO 7 17/32 IN	GP-1108	625627C1	ACEITE	G-33	319926R91	TD7E SOBRE ORUGAS, TD7 SOBRE ORUGAS, TD7C SOBRE ORUGAS con motores/IHC C175, IHC C200		
COMBUSTIBLE, SEPARADOR DE AGUA	GPP-11	1214920H1	COMBUSTIBLE, SECUNDARIO	GP-1107	674293C1	HIDRAULICO	G-338	386120R91
AGUA	GP-2071W	1261387H1	COMBUSTIBLE, PRIMARIO 7 17/32 IN	GP-1108	625627C1	TD8C SOBRE ORUGAS con motor/A DIESEL		
COMBUSTIBLE, SECUNDARIO	GP-78	672603C1	COMBUSTIBLE, SECUNDARIO 7 7/64 IN	GP-78	674293C1	TRANSMISION	G-338	386120R91
AIRE, PRIMARIO	GA-329	627934C1	COMBUSTIBLE, PRIMARIO 9 17/32 IN	GPP-1000	702256C1	ACEITE, SELLADO	GP-10	398080R2
AIRE, SECUNDARIO	GA-239	627935C1	TD25E SOBRE ORUGAS con motor/IHC DT817C			COMBUSTIBLE, PRIMARIO	GP-1122	3132428R1
TD15E SOBRE ORUGAS con motor/IHC D466C			COMBUSTIBLE, SECUNDARIO	GP-1107	674293C1	COMBUSTIBLE, SECUNDARIO	GP-1122	3132428R1
ACEITE	GP-69	675616C91	COMBUSTIBLE, PRIMARIO	GP-1108	625627C1	TD8E SOBRE ORUGAS con motores/IHC D239, IHC DT239		
COMBUSTIBLE, PRIMARIO	GP-1108	625627C1	COMBUSTIBLE, SECUNDARIO	GP-78	672603C2	ACEITE, OPCIONAL	GP-10	528250R1
COMBUSTIBLE, SECUNDARIO	GP-78	672603C2	COMBUSTIBLE, PRIMARIO	GP-1108	625627C1	COMBUSTIBLE	G-296	3144477R92
AIRE, PRIMARIO	GA-329	627934C1	COMBUSTIBLE, SECUNDARIO	GP-78	674293C1	COMBUSTIBLE	GPP-1122	3132428R2
AIRE, SECUNDARIO	GA-239	627935C1	COMBUSTIBLE, PRIMARIO 9 17/32 IN	GPP-1000	702256C1	COMBUSTIBLE	G-296-B	3144477R92
TD20 SERIES C SOBRE ORUGAS con motor/IHC DVT573B			TD25G SOBRE ORUGAS con motor/CUMMINS KT1150C			TD9B SOBRE ORUGAS con motor/A DIESEL		
COMBUSTIBLE, PRIMARIO 4 3/4 IN	GPP-14	702255C1	ACEITE, FLUJO TOTAL (FULL FLOW)	GP-53	1212622H1	TRANSMISION	G-33	302574R91
COMBUSTIBLE, PRIMARIO 7 17/32 IN	GP-1108	702251C1	ACEITE, DERIVACION (BY PASS)	GP-57	1212621H1	COMBUSTIBLE, PRIMARIO	G-1163	306353R91
COMBUSTIBLE, SEPARADOR DE AGUA	GPP-11	1214920H1	COMBUSTIBLE, SEPARADOR DE AGUA	GPP-11	1214920H1	COMBUSTIBLE, SECUNDARIO	G-1163	306353R91
COMBUSTIBLE, SECUNDARIO	GP-78	359251C1	AGUA	GP-1011Q	1661388H1	ACEITE	GP-69	675616C91
AIRE	GA-31	672019C1	TD340 SOBRE ORUGAS, TD340A SOBRE ORUGAS con motor/A DIESEL			TD9B SOBRE ORUGAS con motor/IHC DT282		
TD20B SOBRE ORUGAS con motor/IHC DT429			ACEITE	G-335	279994R91	TRANSMISION	G-33	302574R91
COMBUSTIBLE, PRIMARIO	G-1163	306353R91	COMBUSTIBLE, PRIMARIO	G-1163	306353R91	ACEITE	G-335	323827R91
TD20C SOBRE ORUGAS con motor/A DIESEL			COMBUSTIBLE, SECUNDARIO	G-1163	306353R91	COMBUSTIBLE, PRIMARIO	G-1163	306353R91
COMBUSTIBLE, SECUNDARIO	GP-1107	674293C1	AIRE	GA-18	313964R91	COMBUSTIBLE, SECUNDARIO	G-1163	306353R91
TD20E SOBRE ORUGAS con motor/A DIESEL			TD40 SOBRE ORUGAS con motor/CUMMINS KTA1150C			W4 con motor/A DIESEL		
ACEITE, CUMPLE CON MEDI- DAS ORIGINALES	GP-691	684206C1	ACEITE, FLUJO TOTAL (FULL FLOW)	GP-53	1212622H1	ACEITE	GP-50	538836R1
COMBUSTIBLE, PRIMARIO 4 3/4 IN	GPP-14	998443R91	ACEITE, DERIVACION (BY PASS)	GP-57	1212621H1			
ACEITE, SEGUNDA OPCION	GP-52	684206C1	COMBUSTIBLE, SEPARADOR DE AGUA	GPP-11	1214920H1			
COMBUSTIBLE, SECUNDARIO	GP-1107	674293C1	AGUA	GP-1011Q	1661388H1			
COMBUSTIBLE, PRIMARIO 9 17/32 IN	GPP-1000	702256C1	TD5 SOBRE ORUGAS, TD5B SOBRE ORUGAS con motor/A DIESEL					
TD20E SOBRE ORUGAS con motor/IHC V800			ACEITE	G-870	376364R91			
COMBUSTIBLE, PRIMARIO	GPP-14	702255C1	TD640 SOBRE ORUGAS, TD6-62 SERIES SOBRE ORUGAS, TD9-92 SERIES SOBRE ORUGAS con motor/A DIESEL					
			ACEITE	G-335	279994R91			

INGERSOLL-RAND

APLANADORAS

944DD110 COMPACTADORA Y con motor/CUMMINS 4BTA 3.9L		
AIRE	GA-20	59594846
944DD110 con motor/CUMMINS 3.9L		
COMBUSTIBLE, SECUNDARIO	GP-1122	59765511
COMBUSTIBLE, SEPARADOR DE AGUA	GPP-1122	92100981
COMBUSTIBLE, PRIMARIO	GPP-18	35374669

MARCA-MODELO-MOTOR MAKE-MODEL-ENGINE	GONHER GONHER	OEM OEM	MARCA-MODELO-MOTOR MAKE-MODEL-ENGINE	GONHER GONHER	OEM OEM	MARCA-MODELO-MOTOR MAKE-MODEL-ENGINE	GONHER GONHER	OEM OEM
INGERSOLL-RAND (continuación)			INGERSOLL-RAND (continuación)			INGERSOLL-RAND (continuación)		
APLANADORAS			COMPACTADORAS			COMPACTADORAS		
ACEITE	GP-390	35374651	DD110, DD110HF con motor/CUMMINS 4BTA3.9			SD150D con motor/CUMMINS 6CT8.3		
AIRE, SIN ASPAS	GA-20	59594846	HIDRAULICO	GP-34	59587196	COMBUSTIBLE, SECUNDARIO	GP-1122	35292366
AIRE	GAK-20	59594846	COMBUSTIBLE, SECUNDARIO	GP-1122	59765511	ACEITE	GP-43	35330901
			COMBUSTIBLE, PRIMARIO	GPP-18	35374669	COMBUSTIBLE, PRIMARIO	GPP-18	35374669
CR20, CR32 con motor/DEUTZ F3L1011			ACEITE	GP-390	35374651			
ACEITE	GP-28	92793223				SD150F con motor/DEUTZ		
			DD22 con motor/DEUTZ F3L1011			COMBUSTIBLE	GP-1122	35292366
DA30 con motor/DEUTZ F2L912W			ACEITE	GP-28	59489573			
ACEITE	GP-54	A1H4123	COMBUSTIBLE	GP-1122	59765511	SD170D, SD170F con motor/CUMMINS 6CT8.3		
COMBUSTIBLE	GPP-1122	59560855	HIDRAULICO	GP-66	59480673	COMBUSTIBLE, SECUNDARIO	GP-1122	35292366
AIRE, PRIMARIO	GAK-1532	59567255	AIRE, SIN ASPAS	GA-16	59341560	COMBUSTIBLE, SEPARADOR DE AGUA	GPP-1122	92100981
			AIRE	GAK-16	59341560	ACEITE, FLUJO TOTAL (FULL FLOW)	GP-43	35330901
DA40 con motor/DETROIT DIESEL 3-71						ACEITE, DOBLE FLUJO	GP-3000	35378546
HIDRAULICO	GP-34	59587916	DD24 con motor/DEUTZ F3L1011			COMBUSTIBLE, PRIMARIO	GPP-18	35374669
AIRE	GA-20	59594846	ACEITE	GP-28	59489573	HIDRAULICO	GP-761H	58887936
AIRE	GAK-20	59594846	COMBUSTIBLE	GP-1122	59765511			
			AIRE	GA-16	59341560			
DA50 con motor/DETROIT DIESEL 3-71			AIRE	GAK-16	59341560	SD180D, SD180F con motor/CUMMINS 6CT8.3		
AIRE, SIN ASPAS	GA-20	59594846				COMBUSTIBLE, SECUNDARIO	GP-1122	59765511
			DD70 con motor/CUMMINS 4B3.9			COMBUSTIBLE, SEPARADOR DE AGUA	GPP-1122	92100981
DD32 con motor/DEUTZ F3L1011			COMBUSTIBLE, SECUNDARIO	GP-1122	35292366	ACEITE, FLUJO TOTAL (FULL FLOW)	GP-43	35330901
ACEITE	GP-28	59489573	COMBUSTIBLE, PRIMARIO	GPP-18	35374669	ACEITE, DOBLE FLUJO	GP-3000	35378546
			ACEITE	GP-390	35374651	COMBUSTIBLE, PRIMARIO	GPP-18	35374669
DD65 con motor/DEUTZ F4L913								
HIDRAULICO	GP-34	59587196	DD90, DD90HF con motor/CUMMINS 4B3.9			SD40 con motor/JOHN DEERE 4039		
ACEITE	GP-54	1173430	HIDRAULICO	GP-34	59587196	ACEITE	GP-14	35308030
COMBUSTIBLE	GP-1122	51056604	COMBUSTIBLE	GP-1122	35292366	COMBUSTIBLE, 5 3/16 IN	GPP-418	RE62418
			COMBUSTIBLE, PRIMARIO	GPP-18	35374669	COMBUSTIBLE, 5 15/16 IN	GPP-419	RE62419
R8 con motor/JOHN DEERE			ACEITE	GP-390	35374651			
HIDRAULICO	GP-66	59026500	HIDRAULICO	GP-761H	58887936			
COMBUSTIBLE	GPP-418	RE62418	AIRE, SIN ASPAS	GA-20	59594846	SD70, SD70F con motor/CUMMINS 4BT3.9		
ACEITE	GP-754	RE59754	AIRE	GAK-20	59594846	COMBUSTIBLE	GP-1122	35292366
						COMBUSTIBLE, PRIMARIO	GPP-18	35374669
SD40D con motor/JOHN DEERE 3179			SD100 con motor/CUMMINS 3.9L			ACEITE	GP-390	35374651
ACEITE	GP-14	35308030	ACEITE	GP-34	55440			
HIDRAULICO	GP-34	55440	COMBUSTIBLE, SECUNDARIO	GP-1122	35292366	SD70D, SD70DA con motor/CUMMINS 4BT3.9		
COMBUSTIBLE	G-295	35308048	COMBUSTIBLE, PRIMARIO	GPP-18	35374669	COMBUSTIBLE, SECUNDARIO	GP-1122	35292366
			ACEITE	GP-390	35374651	COMBUSTIBLE, PRIMARIO	GPP-18	35374669
SP56DH con motor/CATERPILLAR 3208			HIDRAULICO	GP-761H	5887936	ACEITE	GP-390	35374651
ACEITE	GP-36	9N5680				ACEITE	GP-761H	58887936
GASOLINA, SEPARADOR DE AGUA	G-293	6N7617	SD100 con motor/DEUTZ					
HIDRAULICO	GP-34	59587196	ACEITE	GP-10	427207-C3	SP42 con motor/FORD 2514E		
COMBUSTIBLE	GP-110	1R-0740				ACEITE	GP-1	C1AZ-6731-A
AIRE, SIN ASPAS	GA-24	P117431	SD100D con motor/CUMMINS 3.9L			COMBUSTIBLE	G-296	92120385
			HIDRAULICO	GP-34	55440	HIDRAULICO	GP-66	1551
SPF48B con motor/DETROIT DIESEL			COMBUSTIBLE, SECUNDARIO	GP-1122	35292366	COMBUSTIBLE	G-296-B	92120385
HIDRAULICO	GP-34	59587916	COMBUSTIBLE, PRIMARIO	GPP-18	35374669	AIRE	GAK-403	P101246
TRANSMISION	GP-34	59587916	ACEITE DEL MOTOR	GP-390	35374651			
COMBUSTIBLE, PRIMARIO	GP-92	35330919	HIDRAULICO, REQUIERE 2 PIEZAS	GP-761H	5887936	SP54 con motor/DETROIT DIESEL 4-53		
COMBUSTIBLE, SECUNDARIO	GP-93	59686261				AIRE, SIN ASPAS	GA-24	P101237
ACEITE	GP-43	35330901	SD110D con motor/CUMMINS 5.9L					
AIRE, SIN ASPAS	GA-24	P117431	COMBUSTIBLE, SECUNDARIO	GP-1122	35292366	SP56 con motor/CATERPILLAR 3208		
			COMBUSTIBLE, SEPARADOR DE AGUA	GPP-1122	92100981	DIRECCION	GP-34	59587916
			COMBUSTIBLE, PRIMARIO	GPP-18	35374669	HIDRAULICO	GP-34	59587916
			ACEITE	GP-178	3914395	AIRE	GA-24	P117431
			HIDRAULICO	GP-761H	58887936			
						SP56 con motor/DEUTZ F6L912		
			SD115D, SD115F, SD150D, SD150F con motor/CUMMINS 5.9L			ACEITE	GP-54	1173430
			COMBUSTIBLE, SECUNDARIO	GP-1122	35292366	COMBUSTIBLE	GP-1122	35292366
			COMBUSTIBLE, SEPARADOR DE AGUA	GPP-1122	92100981	AIRE, SIN ASPAS	GA-24	P117431
			COMBUSTIBLE, PRIMARIO	GPP-18	35374669			
			ACEITE	GP-178	3914395	SP60 con motor/DETROIT DIESEL 6V-71		
			HIDRAULICO	GP-761H	58887936	AIRE	GA-27	P101240

SERVICIO PESADO

MARCA-MODELO-MOTOR MAKE-MODEL-ENGINE	GONHER GONHER	OEM OEM	MARCA-MODELO-MOTOR MAKE-MODEL-ENGINE	GONHER GONHER	OEM OEM	MARCA-MODELO-MOTOR MAKE-MODEL-ENGINE	GONHER GONHER	OEM OEM
INGERSOLL-RAND (continuación)			INGERSOLL-RAND (continuación)			INGERSOLL-RAND (continuación)		
COMPACTADORAS			COMPRESORES			COMPRESORES		
SPF60 con motor/DETROIT DIESEL 6V-71			AIRE, PRIMARIO	GA-6129	35109271	DRA125 con motor/GMC 2-53		
AIRE, SIN ASPAS	GA-27	P101240	DL600 con motor/GMC 6-71			ACEITE	G-119	58148693
INGERSOLL-RAND			ACEITE, DERIVACION (BY PASS)	G-31	557245	COMBUSTIBLE, SECUNDARIO	G-1173	5178782
COMPRESORES			ACEITE, FLUJO TOTAL (FULL FLOW)	G-33	595075568	COMBUSTIBLE	G-1174	92092279
100-47 con motor/WHITE A GASOLINA			COMBUSTIBLE	G-1174	92092279	DRB125, DR150, DRA125 con motor/CONTINENTAL G157		
ACEITE	GP-1	35366681	COMBUSTIBLE, SECUNDARIO	G-1175	92092287	COMBUSTIBLE, SECUNDARIO	G-1173	HD260F3340
125 con motor/FORD			DL900 con motores/GMC 6-110, GMC 8V-71			DRR160 con motor/IHC D239		
ACEITE	G-6	Y1042T1	ACEITE, DERIVACION (BY PASS)	G-31	557245	ACEITE	GP-10	427207-C3
130 con motor/JOHN DEERE			ACEITE, FLUJO TOTAL (FULL FLOW)	G-33	595075568	DXL1050 con motor/CUMMINS V903		
ACEITE, LUBRICACION DE MOTOR	GP-14	35308030	COMBUSTIBLE	G-1174	92092279	ACEITE, CARTUCHO PARA FLUJO TOTAL (FULL FLOW)	G-566	257528
1300 con motor/CUMMINS N14			COMBUSTIBLE, SECUNDARIO	G-1175	92092287	COMBUSTIBLE	GPP-14	90749136
ACEITE, DOBLE FLUJO	GP-3000	35378546	DM25 con motor/CUMMINS			ACEITE, SELLADO FLUJO TOTAL (FULL FLOW)	GP-53	35357243
160 con motor/DEUTZ			COMBUSTIBLE	GP-1101	91671743	ACEITE, DERIVACION (BY PASS)	G-750	91780742
ACEITE	GP-54	1173430	ACEITE	GP-57	35357250	AIRE, PRIMARIO	GA-6129	35109263
30KW con motor/CUMMINS 4B3.9			AIRE, PRIMARIO (MOTOR)	GA-563	P181042	DXL1200 con motor/GMC 12V-71		
COMBUSTIBLE, SECUNDARIO	GPP-1122	59560855	DR120, DR150, DR210 con motor/GMC 4-51			ACEITE, FLUJO TOTAL (FULL FLOW)	G-33	595075568
COMBUSTIBLE, PRIMARIO	GPP-18	35374669	COMBUSTIBLE, SECUNDARIO	G-1173	5178782	AIRE, SECUNDARIO	GA-6127	35109271
ACEITE	GP-390	35374651	DR1200 con motor/GMC 12V-71			AIRE, PRIMARIO	GA-6129	35109263
320 con motor/A DIESEL			ACEITE, FLUJO TOTAL (FULL FLOW)	G-33	595075568	DXL1200S con motor/DETROIT DIESEL 12V-71		
ACEITE	GP-1	35366681	AIRE, SECUNDARIO	GA-6127	35109271	AIRE, SECUNDARIO	GA-6127	35109271
600 con motor/DETROIT DIESEL			AIRE, PRIMARIO	GA-6129	35109271	DXL175 con motor/HERCULES D2300		
COMBUSTIBLE, PRIMARIO	GP-26	91786129	DR125 con motor/CONTINENTAL GD157			COMBUSTIBLE	G-296	92120385
COMBUSTIBLE, SECUNDARIO	GP-27	91786167	COMBUSTIBLE, SECUNDARIO	G-1173	HD260F3340	COMBUSTIBLE	G-296-B	92120385
ACEITE, LUBRICACION DE MOTOR	GP-53	35357243	DR125, DR150 con motor/GMC 2-53			AIRE, SIN ASPAS	GA-20	35109099
825 con motor/CUMMINS L10			ACEITE	G-119	58148693	AIRE	GAK-20	35109099
COMBUSTIBLE	GP-1101	91671743	COMBUSTIBLE, SECUNDARIO	G-1173	5178782	DXL750 con motor/GMC 6V-71		
ACEITE, FLUJO TOTAL (FULL FLOW)	GP-53	35357243	COMBUSTIBLE	G-1174	92092279	ACEITE, DERIVACION (BY PASS)	G-31	557245
ACEITE, DERIVACION (BY PASS)	GP-57	35357250	DR250 con motor/GMC 4-53			ACEITE, FLUJO TOTAL (FULL FLOW)	G-33	595075568
COMBUSTIBLE, SEPARADOR DE AGUA	GPP-11	35357268	ACEITE, FLUJO TOTAL (FULL FLOW)	G-33	595075568	COMBUSTIBLE, SECUNDARIO	G-1175	92092287
ACEITE, DOBLE FLUJO	GP-3000	35378546	COMBUSTIBLE, SECUNDARIO	G-1173	5178782	AIRE, SECUNDARIO	GA-6127	35109271
AGUA	GP-2071W	35375914	COMBUSTIBLE	G-1174	92092279	AIRE, PRIMARIO	GA-6129	35109263
825 con motor/CUMMINS M11			DR315, DR365 con motores/GMC 3-71, GMC 4-71			DXL750, DXL750FT con motor/DETROIT DIESEL 6V-71		
COMBUSTIBLE, SEPARADOR DE AGUA	GPP-11	35357268	ACEITE, DERIVACION (BY PASS)	G-31	557245	AIRE, SECUNDARIO	GA-6127	35109271
85 con motor/IHC UC135B			ACEITE, FLUJO TOTAL (FULL FLOW)	G-33	595075568	DXL900 con motor/GMC 12V-71		
ACEITE	GP-50	4512207-3	COMBUSTIBLE, SECUNDARIO	G-1173	5178782	ACEITE, FLUJO TOTAL (FULL FLOW)	G-33	595075568
95 WD con motor/DEUTZ F3L1011F			COMBUSTIBLE	G-1174	92092279	COMBUSTIBLE	G-1174	92092279
ACEITE	GP-28	92793223	COMBUSTIBLE, SECUNDARIO	G-1175	92092287	COMBUSTIBLE, SECUNDARIO	G-1175	92092287
BD130A con motor/CUMMINS 5.9L			COMBUSTIBLE	G-1174	92092279	DXL900 con motor/GMC 8V-71		
COMBUSTIBLE, SECUNDARIO	GP-1122	59765511	COMBUSTIBLE, SECUNDARIO	G-1175	92092287	ACEITE, FLUJO TOTAL (FULL FLOW)	G-33	595075568
COMBUSTIBLE, SEPARADOR DE AGUA	GPP-1122	92100981	DR900 con motor/DETROIT DIESEL			COMBUSTIBLE	G-1174	92092279
COMBUSTIBLE, PRIMARIO	GPP-18	35374669	AIRE	GA-6127	35109271	COMBUSTIBLE, SECUNDARIO	G-1175	92092287
ACEITE	GP-178	3914395	DR900 con motores/GMC 6-110, GMC 8V-71			AIRE, SECUNDARIO	GA-6127	35109271
HIDRAULICO	GP-761H	58887936	ACEITE, DERIVACION (BY PASS)	G-31	557245	AIRE, PRIMARIO	GA-6129	35109263
DL1200 con motor/GMC 12V-71			ACEITE, FLUJO TOTAL (FULL FLOW)	G-33	595075568	DXL900 con motores/A DIESEL, DETROIT DIESEL		
ACEITE	G-33	595075568	COMBUSTIBLE	G-1174	92092279	AIRE	GA-6127	35109271
AIRE, SECUNDARIO	GA-6127	35109271	COMBUSTIBLE, SECUNDARIO	G-1175	92092287	ECM490 con motor/CUMMINS		
						COMBUSTIBLE, SECUNDARIO	GP-1122	35292366
						ACEITE, DOBLE FLUJO	GP-3000	35378546
						COMBUSTIBLE, PRIMARIO	GPP-18	35374669

MARCA-MODELO-MOTOR MAKE-MODEL-ENGINE	GONHER GONHER	OEM OEM	MARCA-MODELO-MOTOR MAKE-MODEL-ENGINE	GONHER GONHER	OEM OEM	MARCA-MODELO-MOTOR MAKE-MODEL-ENGINE	GONHER GONHER	OEM OEM
INGERSOLL-RAND (continuación)			INGERSOLL-RAND (continuación)			INGERSOLL-RAND (continuación)		
COMPRESORES			COMPRESORES			COMPRESORES		
AIRE, PRIMARIO MOTOR	GA-251	35355395	HP300WCU con motor/CUMMINS 3.9L			ACEITE	GP-390	35374651
ECM580 con motor/CUMMINS C5.9L			COMBUSTIBLE, SECUNDARIO	GP-1122	35292366	L1200 con motor/GMC 12V-71		
COMBUSTIBLE, SECUNDARIO	GP-1122	35292366	COMBUSTIBLE, SEPARADOR DE AGUA	GPP-1122	92100981	ACEITE, FLUJO TOTAL (FULL FLOW)	G-33	595075568
COMBUSTIBLE, SEPARADOR DE AGUA	GPP-1122	92100981	COMBUSTIBLE, PRIMARIO	GPP-18	35374669	AIRE, SECUNDARIO	GA-6127	35109271
COMBUSTIBLE, PRIMARIO	GPP-18	35374669	ACEITE	GP-390	35374651	AIRE, PRIMARIO	GA-6129	35109271
ACEITE	GP-178	3914395	HP300WCU con motor/CUMMINS B3.9			L900 con motor/DETROIT DIESEL		
ECM590 con motor/CUMMINS 8.3L			AIRE	GAK-625	35326230	AIRE	GA-6127	35109271
COMBUSTIBLE, SECUNDARIO	GP-1122	35292366	HP355 con motor/PERKINS 1004.4TW			L900 con motores/GMC 6-110, GMC 8V-71		
ACEITE, DOBLE FLUJO	GP-3000	35378546	ACEITE	GP-31	2254347	ACEITE, DERIVACION (BY PASS)	G-31	557245
COMBUSTIBLE, PRIMARIO	GPP-18	35374669	HP600WCU con motor/CUMMINS 8.3L			ACEITE, FLUJO TOTAL (FULL FLOW)	G-33	595075568
COMBUSTIBLE, SEPARADOR DE AGUA	GPP-1287	R60P	COMBUSTIBLE, SECUNDARIO	GP-1122	35292366	COMBUSTIBLE	G-1174	92092279
GR150 con motor/CONTINENTAL G157			COMBUSTIBLE, SEPARADOR DE AGUA	GPP-1122	92100981	COMBUSTIBLE, SECUNDARIO	G-1175	92092287
COMBUSTIBLE, SECUNDARIO	G-1173	HD260F3340	ACEITE, FLUJO TOTAL (FULL FLOW)	GP-43	35330901	M45 con motor/DEUTZ		
GR150 con motor/GMC 2-53			ACEITE, DOBLE FLUJO	GP-3000	35378546	HIDRAULICO	GP-66	92118678
ACEITE	G-119	58148693	COMBUSTIBLE, PRIMARIO	GPP-18	35374669	P100 con motor/DEUTZ F9L912		
COMBUSTIBLE, SECUNDARIO	G-1173	5178782	HP600WCU con motor/CUMMINS LT10			ACEITE	GP-54	A1H4123
COMBUSTIBLE	G-1174	92092279	ACEITE, FLUJO TOTAL (FULL FLOW)	GP-53	35357243	P100 con motor/JOHN DEERE 3179		
GR150 con motor/GMC 4-51			ACEITE, DERIVACION (BY PASS)	GP-57	35357250	ACEITE	GP-14	35308030
COMBUSTIBLE, SECUNDARIO	G-1173	5178782	COMBUSTIBLE, SEPARADOR DE AGUA	GPP-11	35357268	P100AWD con motor/A DIESEL		
GR600 con motor/GMC 6-71			AGUA	GP-1011Q	35357276	ACEITE	GP-28	35336163
ACEITE, DERIVACION (BY PASS)	G-31	557245	AIRE, PRIMARIO	GA-251	35355395	P100AWW, P100AWWU con motor/A DIESEL		
ACEITE, FLUJO TOTAL (FULL FLOW)	G-33	595075568	HP600WJD con motor/JOHN DEERE 6076A			ACEITE, LUBRICACION DE MOTOR	GP-1	35303692
COMBUSTIBLE	G-1174	92092279	ACEITE	GP-35	36870038	P100BWD con motor/A DIESEL		
COMBUSTIBLE, SECUNDARIO	G-1175	92092287	HP750WCU con motor/CUMMINS 8.3L			ACEITE	GP-28	35336163
GRR85 con motor/IHC UC135			COMBUSTIBLE, SECUNDARIO	GP-1122	59765511	P100BWF, P100WFU, P125BWF con motor/A GASOLINA		
ACEITE	GP-50	4512207-3	COMBUSTIBLE, SEPARADOR DE AGUA	GPP-1122	92100981	ACEITE, LUBRICACION DE MOTOR	GP-1	35366681
GRR85 con motor/IHC UC135B			ACEITE, FLUJO TOTAL (FULL FLOW)	GP-43	35330901	AIRE DEL COMPRESOR	GAK-1532	36876423
AIRE	GA-71	2463980	ACEITE, DOBLE FLUJO	GP-3000	35378546	GASOLINA	GG-5	35366699
GYRO-FLO 105 con motor/GMC 2-71			COMBUSTIBLE, PRIMARIO	GPP-18	35374669	GASOLINA	GG-5 L	35366699
ACEITE, DERIVACION (BY PASS)	G-31	557245	HP750WCU, P750WCU, P900WCU con motor/CUMMINS LT10			P100BWW con motor/A DIESEL		
COMBUSTIBLE, SECUNDARIO	G-1173	5178782	ACEITE, FLUJO TOTAL (FULL FLOW)	GP-53	35357243	ACEITE, LUBRICACION DE MOTOR	GP-1	35366681
COMBUSTIBLE	G-1174	92092279	ACEITE, DERIVACION (BY PASS)	GP-57	35357250	AIRE DEL COMPRESOR	GAK-1532	36876423
GYRO-FLO con motor/FORD			COMBUSTIBLE, SEPARADOR DE AGUA	GPP-11	35357268	GASOLINA	GG-5 L	35366699
ACEITE	G-6	Y1042T1	AGUA	GP-1011Q	35357276	P100CWD con motor/A DIESEL		
HHE con motores/GMC 12108T, GMC 6-110			AIRE, PRIMARIO	GA-251	35355395	ACEITE	GP-28	35336163
ACEITE, DERIVACION (BY PASS)	G-31	557245	HP825WCU con motor/CUMMINS L10			P100DWD, P100EWD, P100FWD con motores/DEUTZ F3L1011, DEUTZ F3M1011F		
ACEITE, FLUJO TOTAL (FULL FLOW)	G-33	595075568	COMBUSTIBLE	GP-1101	91671743	ACEITE, LUBRICACION DE MOTOR	GP-28	92793223
COMBUSTIBLE	G-1174	92092279	ACEITE, FLUJO TOTAL (FULL FLOW)	GP-53	35357243	COMBUSTIBLE	GPP-1122	92100981
COMBUSTIBLE, SECUNDARIO	G-1175	92092287	ACEITE, DERIVACION (BY PASS)	GP-57	35357250	AIRE DEL COMPRESOR	GAK-1532	36876423
HP1000WCU con motor/CUMMINS N14			COMBUSTIBLE, SEPARADOR DE AGUA	GPP-11	35357268	P100SD, P100WDU con motor/A DIESEL		
COMBUSTIBLE	GP-1101	91671743	ACEITE, DOBLE FLUJO	GP-3000	35378546	COMBUSTIBLE	GPP-1122	92100981
ACEITE, FLUJO TOTAL (FULL FLOW)	GP-53	35357243	AGUA	GP-2071W	35375914	P100WD con motor/DEUTZ F2L511D		
ACEITE, DERIVACION (BY PASS)	GP-57	35357250	I85 con motor/JOHN DEERE 4045			ACEITE	GP-28	92793223
COMBUSTIBLE, SEPARADOR DE AGUA	GPP-11	35357268	COMBUSTIBLE	GPP-418	RE62418	P100WF, P125AWF con motor/A GASOLINA		
ACEITE, DOBLE FLUJO	GP-3000	35378546	JET CUTTER con motor/CUMMINS 4BTA 3.9			ACEITE, LUBRICACION DE MOTOR	GP-1	35366681
AGUA	GP-2071W	35375914	COMBUSTIBLE	GP-1122	35292366			
			COMBUSTIBLE, PRIMARIO	GPP-18	35374669			

SERVICIO PESADO

MARCA-MODELO-MOTOR MAKE-MODEL-ENGINE	GONHER GONHER	OEM OEM	MARCA-MODELO-MOTOR MAKE-MODEL-ENGINE	GONHER GONHER	OEM OEM	MARCA-MODELO-MOTOR MAKE-MODEL-ENGINE	GONHER GONHER	OEM OEM
INGERSOLL-RAND (continuación)			INGERSOLL-RAND (continuación)			INGERSOLL-RAND (continuación)		
COMPRESORES			COMPRESORES			COMPRESORES		
GASOLINA	GG-5	35366699	P130WD con motor/DEUTZ F3M1011F			COMBUSTIBLE	G-295	35308048
GASOLINA	GG-5 L	35366699	ACEITE, LUBRICACION DE MOTOR	GP-28	92793223	AIRE	GAK-1532	35291970
P100WJD con motor/JOHN DEERE 3029			COMBUSTIBLE	GPP-1122	92100981	P185AWJD con motor/JOHN DEERE		
ACEITE, LUBRICACION DE MOTOR	GP-14	35308030	AIRE DEL MOTOR	GAK-1532	36876423	ACEITE, LUBRICACION DE MOTOR	GP-14	35308030
P100WW, P100WWU con motor/A DIESEL			P130WJD con motor/JOHN DEERE			COMBUSTIBLE	G-295	35308048
ACEITE, LUBRICACION DE MOTOR	GP-1	35303692	ACEITE, LUBRICACION DE MOTOR	GP-14	35308030	AIRE, PRIMARIO	GAK-1532	59567255
P110AWD con motor/A DIESEL			P150WW con motor/A DIESEL			P185W con motor/JOHN DEERE 4239		
ACEITE	GP-28	35336163	ACEITE, LUBRICACION DE MOTOR	GP-1	35303692	ACEITE	GP-14	35308030
P110BWD, P110CWD con motor/A DIESEL			P160 con motor/JOHN DEERE 3179D			COMBUSTIBLE	G-295	35308048
ACEITE	GP-28	35336163	ACEITE	GP-14	35308030	AIRE	GAK-1532	35291970
P125 con motor/JOHN DEERE			P160BWJD con motor/JOHN DEERE			P185WJD con motor/JOHN DEERE 4045D POWER TECH		
ACEITE	GP-14	92092279	ACEITE, LUBRICACION DE MOTOR	GP-14	35308030	ACEITE, LUBRICACION DE MOTOR	GP-754	36881696
P125AWJD, P125WJD con motor/JOHN DEERE			COMBUSTIBLE	G-295	35308048	P185WJD con motor/JOHN DEERE 4219		
ACEITE, LUBRICACION DE MOTOR	GP-14	35308030	AIRE DEL COMPRESOR	GAK-1532	36876423	ACEITE, LUBRICACION DE MOTOR	GP-14	35308030
P125AWW con motor/A DIESEL			P160CWJD con motor/JOHN DEERE			COMBUSTIBLE	G-295	35308048
ACEITE, LUBRICACION DE MOTOR	GP-1	35303692	ACEITE, LUBRICACION DE MOTOR	GP-14	35308030	AIRE	GAK-1532	59567255
P125BWJD con motor/JOHN DEERE 3029D			P160DWD, P175DWD con motor/JOHN DEERE 3029D			P250 con motor/DEUTZ F4L912		
ACEITE, LUBRICACION DE MOTOR	GP-14	35308030	ACEITE, LUBRICACION DE MOTOR	GP-14	35308030	ACEITE	GP-54	35292358
P125BWW, P125WW con motor/A DIESEL			P160WFU, P175WFU con motor/A DIESEL			P250BWJD, P250CWJD con motor/JOHN DEERE 4045D		
ACEITE, LUBRICACION DE MOTOR	GP-1	35303692	ACEITE, LUBRICACION DE MOTOR	GP-1	35366681	ACEITE, LUBRICACION DE MOTOR	GP-754	36881696
P125DWD, P125EWD, P125FWD con motores/DEUTZ F3L1011, DEUTZ F3M1011F			AIRE DEL COMPRESOR	GAK-1532	36876423	P250WCU con motor/CUMMINS 3.9L		
ACEITE, LUBRICACION DE MOTOR	GP-28	92793223	GASOLINA	GG-5	35366699	COMBUSTIBLE, SECUNDARIO	GP-1122	35292366
COMBUSTIBLE	GPP-1122	92100981	GASOLINA	GG-5 L	35366699	COMBUSTIBLE, SEPARADOR DE AGUA	GPP-1122	92100981
AIRE DEL COMPRESOR	GAK-1532	36876423	P175 con motor/DEUTZ			COMBUSTIBLE, PRIMARIO	GPP-18	35374669
P125WF con motor/A GASOLINA			ACEITE	GP-54	35292358	ACEITE	GP-390	35374651
ACEITE, LUBRICACION DE MOTOR	GP-1	35366681	COMBUSTIBLE	GP-1122	1660243	P250WCU con motor/CUMMINS B3.9		
GASOLINA	GG-5	35366699	AIRE	GAK-1532	P119538	AIRE	GAK-625	35326230
GASOLINA	GG-5 L	35366699	P175 con motor/JOHN DEERE 3179D			P375 con motor/DEUTZ F6L912		
P125WFD con motor/A GASOLINA			ACEITE	GP-14	35308030	AIRE	GAK-625	35326230
ACEITE	GP-1	35366681	COMBUSTIBLE	GP-1122	1660243	P375WCU con motor/CUMMINS 3.9		
AIRE	GAK-1532	36876423	AIRE DEL COMPRESOR	GAK-1532	36876423	COMBUSTIBLE, SECUNDARIO	GP-1122	35292366
GASOLINA	GG-5	35366699	P175BWJD con motor/JOHN DEERE			COMBUSTIBLE, SEPARADOR DE AGUA	GPP-1122	35374677
GASOLINA	GG-5 L	35366699	ACEITE, LUBRICACION DE MOTOR	GP-14	35308030	COMBUSTIBLE, PRIMARIO	GPP-18	35374669
P130AWJD con motor/JOHN DEERE			COMBUSTIBLE	G-295	35308048	ACEITE	GP-390	35374651
ACEITE, LUBRICACION DE MOTOR	GP-14	35308030	AIRE DEL COMPRESOR	GAK-1532	36876423	P375WD con motor/DEUTZ F6L912		
COMBUSTIBLE	G-295	35308048	P175CWJD con motor/JOHN DEERE			ACEITE	GP-54	1173430
AIRE DEL COMPRESOR	GAK-1532	36876423	ACEITE, LUBRICACION DE MOTOR	GP-14	35308030	P375WJD con motor/JOHN DEERE 4045T		
P130CWJD con motor/JOHN DEERE			P175W con motor/DEUTZ F3L912			ACEITE	GP-14	35308030
ACEITE, LUBRICACION DE MOTOR	GP-14	35308030	ACEITE, LUBRICACION DE MOTOR	GP-54	1173430	COMBUSTIBLE, 5 3/16 IN	GPP-418	RE62418
COMBUSTIBLE	G-295	35308048	COMBUSTIBLE	GP-1122	1660243	COMBUSTIBLE, 5 15/16 IN	GPP-419	RE62419
AIRE DEL COMPRESOR	GAK-1532	36876423	AIRE	GAK-1532	P119538	PB4 con motor/CATERPILLAR		
P130DWD con motor/JOHN DEERE			P175WW, P175WWU, P185WW con motor/A DIESEL			ACEITE	GP-51	92658095
ACEITE, LUBRICACION DE MOTOR	GP-14	35308030	ACEITE, LUBRICACION DE MOTOR	GP-1	35303692	PD125 EWD con motores/DEUTZ F3L1011, DEUTZ F3M1011F		
P130DWD con motor/JOHN DEERE			P185 con motor/JOHN DEERE 4239			ACEITE	GP-28	92793223
ACEITE, LUBRICACION DE MOTOR	GP-14	35308030	ACEITE	GP-14	35308030	COMBUSTIBLE	GPP-1122	92100981
						AIRE	GAK-1532	36876423

MARCA-MODELO-MOTOR MAKE-MODEL-ENGINE	GONHER GONHER	OEM OEM	MARCA-MODELO-MOTOR MAKE-MODEL-ENGINE	GONHER GONHER	OEM OEM	MARCA-MODELO-MOTOR MAKE-MODEL-ENGINE	GONHER GONHER	OEM OEM
INGERSOLL-RAND (continuación)			INGERSOLL-RAND (continuación)			INGERSOLL-RAND (continuación)		
COMPRESORES			COMPRESORES			COMPRESORES		
PI272 con motor/DETROIT DIESEL 16V4000			XHP900 con motor/CATERPILLAR 3406B			COMBUSTIBLE, SEPARADOR DE AGUA	GPP-11	35357268
ACEITE	GP-754	36881696	ACEITE, CUMPLE CON MEDI-DAS ORIGINALES	GP-691	1R0716	ACEITE, DOBLE FLUJO	GP-3000	35378546
PT125R con motor/JOHN DEERE 4329			ACEITE, SEGUNDA OPCION	GP-52	1R0716	AGUA	GP-2071W	353759914
ACEITE	GP-14	35308030	COMBUSTIBLE	GP-1108	1R-0712	XP250WCU con motor/CUMMINS LT10		
COMBUSTIBLE	GPP-418	RE62418	AGUA	GP-1011Q	9N3718	AIRE	GA-251	35355395
AIRE, PRIMARIO	GAK-1532	59567255	AIRE, PRIMARIO	GA-251	35355395	XP600WCU con motor/CUMMINS LT10		
SP48 con motor/GMC 4-71N			XL1050 con motor/DETROIT DIESEL 12V-71N			ACEITE, FLUJO TOTAL (FULL FLOW)	GP-53	35357243
ACEITE	G-33	595075568	AIRE	GA-356	P181039	ACEITE, DERIVACION (BY PASS)	GP-57	35357250
COMBUSTIBLE, SECUNDARIO	G-1173	5178782	XL1100 con motor/DETROIT DIESEL			COMBUSTIBLE, SEPARADOR DE AGUA	GPP-11	35357268
COMBUSTIBLE	G-1174	92092279	AIRE, SECUNDARIO	GA-6127	35109271	AGUA	GP-1011Q	35357276
SRB125 con motor/GMC 2-53			XL1100 con motor/GMC			AIRE, PRIMARIO	GA-251	35355395
ACEITE	G-119	58148693	AIRE	GA-679	8994607	XP750 con motor/DETROIT DIESEL 6V-71N		
COMBUSTIBLE, SECUNDARIO	G-1173	5178782	XL750 con motor/CATERPILLAR 3406			AIRE, SECUNDARIO	GA-6127	35109271
COMBUSTIBLE	G-1174	92092279	ACEITE, CUMPLE CON MEDI-DAS ORIGINALES	GP-691	1R0716	XP750A con motor/DETROIT DIESEL 6V-71N		
T4-VHP1050 con motor/CATERPILLAR 3412			ACEITE, SEGUNDA OPCION	GP-52	1R0716	COMBUSTIBLE, PRIMARIO	GP-26	91786129
COMBUSTIBLE	GP-749	1R0749	COMBUSTIBLE	GP-110	1R-0749	COMBUSTIBLE, SECUNDARIO	GP-27	91786167
ACEITE, REQUIERE 2 PIEZAS	GP-52	1R0716	AGUA	GP-1011Q	36868156	ACEITE	GP-43	35357243
AIRE, PRIMARIO	GA-563	52146958	AGUA	GP-1011Q	36868156	XP750WCU con motor/CUMMINS 6CTA8.3		
VHP1050 con motor/CATERPILLAR 3412			XL750 con motor/GMC 8V-71N			COMBUSTIBLE, SECUNDARIO	GP-1122	35374677
ACEITE, CUMPLE CON MEDI-DAS ORIGINALES	GP-691	92036219	ACEITE	G-33	595075568	AGUA	GP-1011Q	36868156
ACEITE, SEGUNDA OPCION	GP-52	92036219	COMBUSTIBLE, PRIMARIO	GP-26	91786129	ACEITE	GP-3000	35378546
COMBUSTIBLE	GP-110	59534669	COMBUSTIBLE, SECUNDARIO	GP-27	91786167	COMBUSTIBLE, PRIMARIO	GPP-18	35374669
AGUA	GP-1011Q	36868156	XL850 con motor/DETROIT DIESEL			AIRE, PRIMARIO	GA-251	36867786
AIRE	GA-356	P181039	AIRE, SECUNDARIO	GA-6127	35109271	XP750WCU, XP825WCU con motor/CUMMINS 8.3L		
AIRE	GA-357	P119159	XL900 con motor/A DIESEL			COMBUSTIBLE, SECUNDARIO	GP-1122	35374677
VHP1050T5VHP con motor/CATERPILLAR 3412			ACEITE	G-33	595075568	COMBUSTIBLE, SEPARADOR DE AGUA	GPP-1122	92100981
ACEITE, CUMPLE CON MEDI-DAS ORIGINALES	GP-691	92036219	COMBUSTIBLE, PRIMARIO	GP-26	91786129	ACEITE, FLUJO TOTAL (FULL FLOW)	GP-43	35330901
ACEITE, SEGUNDA OPCION	GP-52	92036219	COMBUSTIBLE, SECUNDARIO	GP-27	91786167	ACEITE, DOBLE FLUJO	GP-3000	35378546
COMBUSTIBLE	GP-110	59534669	AIRE, SECUNDARIO	GA-6127	35109271	COMBUSTIBLE, PRIMARIO	GPP-18	35374669
AGUA	GP-1011Q	35357276	AIRE, PRIMARIO	GA-6129	35109263	XP750WJD con motor/JOHN DEERE 6076A		
AIRE	GA-356	P181039	XL900 con motor/DETROIT DIESEL 6-71			ACEITE	GP-35	36870038
AIRE	GA-357	P119159	ACEITE	G-33	595075568	XP825WCU con motor/CUMMINS LT10		
VHP400 con motor/DEUTZ			COMBUSTIBLE	G-1175	92092287	ACEITE	GP-53	35357243
COMBUSTIBLE	GP-1122	35292366	AIRE	GA-6127	35109271	ACEITE, DERIVACION (BY PASS)	GP-57	35357250
HIDRAULICO	GP-66	92118678	AIRE	GA-6129	35109263	COMBUSTIBLE, SEPARADOR DE AGUA	GPP-11	35357268
AGUA	GP-2071W	35312396	XP1000WCU con motor/CUMMINS N14			AGUA	GP-1011Q	35357276
AIRE	GA-405	92686948	COMBUSTIBLE	GP-1101	91671743	ACEITE	GP-3000	35378546
VHP600WCU con motor/CUMMINS 6CTA8.3			ACEITE, FLUJO TOTAL (FULL FLOW)	GP-53	35357243	AIRE, PRIMARIO	GA-251	35355395
COMBUSTIBLE, SECUNDARIO	GP-1122	35374677	ACEITE, DERIVACION (BY PASS)	GP-57	35357250	XP900WCU con motor/CUMMINS LTA10		
AGUA	GP-1011Q	36868156	COMBUSTIBLE, SEPARADOR DE AGUA	GPP-11	35357268	COMBUSTIBLE	GP-1101	91671743
ACEITE	GP-3000	35378546	ACEITE, DOBLE FLUJO	GP-3000	35378546	ACEITE, FLUJO TOTAL (FULL FLOW)	GP-53	35357243
COMBUSTIBLE, PRIMARIO	GPP-18	35374669	AGUA	GP-2071W	35375914	ACEITE, DERIVACION (BY PASS)	GP-57	35357250
AIRE, PRIMARIO	GA-251	36867786	XP1400 con motor/DETROIT DIESEL 8V-92T			COMBUSTIBLE, SEPARADOR DE AGUA	GPP-11	35357268
VHP600WJD con motor/JOHN DEERE 6076A			ACEITE	GP-53	25014214	ACEITE, DOBLE FLUJO	GP-3000	35378546
ACEITE	GP-35	36870038	AIRE, PRIMARIO	GA-563	P128407	AGUA	GP-2071W	353759914
VHP900 con motor/CATERPILLAR 3406B			XP1400WCU, XP1600WCU con motor/CUMMINS N14					
AIRE	GA-251	36867786	COMBUSTIBLE	GP-1101	91671743			
VR60B, VR70B, VR90B con motor/PERKINS 1004.4			ACEITE, FLUJO TOTAL (FULL FLOW)	GP-53	35357243			
ACEITE	GP-31	2254347	ACEITE, DERIVACION (BY PASS)	GP-57	35357250			
XHP750 con motor/CATERPILLAR								
ACEITE	GP-51	92658095						

SERVICIO PESADO

MARCA-MODELO-MOTOR	GONHER	OEM
MAKE-MODEL-ENGINE	GONHER	OEM

INGERSOLL-RAND		
EQUIPO PARA CONSTRUCCION VIAL		
660W ASFALTADORA con motor/DEUTZ		
AIRE	GAK-16	59341560
780T ASFALTADORA, 780W ASFALTADORA con motor/CUMMINS 4BTA3.9		
COMBUSTIBLE, SECUNDARIO	GP-1122	59765511
COMBUSTIBLE, PRIMARIO	GPP-18	35374669
ACEITE	GP-390	35374651
780W ASFALTADORA con motor/JOHN DEERE 4039		
ACEITE	GP-14	35308030
880T ASFALTADORA, 910W ASFALTADORA, 880W ASFALTADORA, 910T ASFALTADORA con motor/CUMMINS 4BTA		
COMBUSTIBLE, SECUNDARIO	GP-1122	59765511
COMBUSTIBLE, PRIMARIO	GPP-18	35374669
ACEITE	GP-390	35374651

INGERSOLL-RAND

EXCAVADORAS

600 RETROEXCAVADORA con motor/A DIESEL		
ACEITE	G-33	595075568

INGERSOLL-RAND

GENERADORES

E20X con motor/JOHN DEERE 3179		
ACEITE	GP-14	35308030
COMBUSTIBLE	G-295	35308048
AIRE, PRIMARIO	GAK-1532	35291970
E30XWCU con motor/CUMMINS 4BT3.9		
COMBUSTIBLE, SECUNDARIO	GP-1122	35292366
COMBUSTIBLE, PRIMARIO	GPP-18	35374669
ACEITE	GP-390	35374651
E50XWCU con motor/CUMMINS 4BT3.9		
COMBUSTIBLE, SECUNDARIO	GP-1122	35374677
COMBUSTIBLE, PRIMARIO	GPP-18	35374669
ACEITE	GP-390	35374651

INGERSOLL-RAND

MONTACARGAS

RT705G, RT706G, RT708G con motor/CUMMINS 4B3.9L		
COMBUSTIBLE, SECUNDARIO	GP-1122	35292366
COMBUSTIBLE, PRIMARIO	GPP-18	35374669
ACEITE	GP-390	35374651
RT705G, RT706G, RT708G con motor/JOHN DEERE 4039D		
ACEITE	GP-14	35308030
VR843 con motor/CUMMINS		
COMBUSTIBLE, SEPARADOR DE AGUA	GPP-1122	92100981

INGERSOLL-RAND

TRACTORES PEQUEÑOS Y PARA JARDIN

1114 con motor/A GASOLINA		
ACEITE	GP-58	491056
1212G, 1212H con motor/A GASOLINA		
GASOLINA	GG-116	FGI146

MARCA-MODELO-MOTOR	GONHER	OEM
MAKE-MODEL-ENGINE	GONHER	OEM

INGERSOLL-RAND (continuación)		
TRACTORES PEQUEÑOS Y PARA JARDIN		
1214 con motor/A GASOLINA		
ACEITE	GP-58	491056
220, 222, 224 con motor/KOHLER		
AIRE	GA-7	C28883
3012, 3014, 4014 con motor/KOHLER		
GASOLINA	GG-116	FGI146
3016PS, 4016PS con motor/ONAN 16 HP		
ACEITE	GP-58	C26191
3018PS, 4018PS con motor/ONAN 18 HP		
ACEITE	GP-58	C26191
3118, 4118 con motor/ONAN		
ACEITE	GP-58	C26191
4016 con motor/ONAN 16 HP		
ACEITE	GP-58	C26191
4020PS con motor/ONAN 20 HP		
ACEITE	GP-58	C26191
4120 con motor/ONAN		
ACEITE	GP-58	491056
4444 con motor/KOHLER		
AIRE	GA-7	C28883
6018 con motor/ONAN 18 HP		
ACEITE	GP-58	C26191
HIDRAULICO	GP-66	92118678
GASOLINA	GG-116	FGI146
646 con motor/A GASOLINA		
ACEITE	GP-58	C25402
810 con motor/A GASOLINA		
GASOLINA	GG-116	FGI146

ISUZU

CAMIONES, TRACTOCAMIONES Y AUTOBUSES

ELF 300 con motor/ISUZU L4 3.0L DI DOHC (4JJ1-TC)		
COMBUSTIBLE	G-179	8-98037-011-0
ACEITE	G-3753	8-98018-858-0
AIRE	GA-633R	8970622940
ELF 400/450 con motor/ISUZU 4HK1-TC		
COMBUSTIBLE	GPP-111	8-94483-850-0
ACEITE	GP-359	2-90654-800-0
COMBUSTIBLE	GPP-524	8-94483-850-0
AIRE	GA-633R	8970622940
ELF250 con motor/ISUZU 4HK1 DIESEL, (4/99 EN ADELANTE)		
COMBUSTIBLE	GPP-111	8-94369-299-3
EVR con motor/ISUZU 6SA1		
ACEITE	GP-57	1-13240-163-2
FRR con motor/ISUZU 6-7.8L DIESEL		
TRANSMISION	GP-9586	1-32569-021-0

MARCA-MODELO-MOTOR	GONHER	OEM
MAKE-MODEL-ENGINE	GONHER	OEM

ISUZU (continuación)		
CAMIONES, TRACTOCAMIONES Y AUTOBUSES		
FRR con motor/ISUZU 6BD1T		
TRANSMISION	GP-9586	LF3342
FRR con motores/ISUZU 6HE1, ISUZU 6HK1-TCN DIESEL		
TRANSMISION	GP-9586	1-32569-021-0
FSR con motor/ISUZU 6HE1-TC DIESEL		
TRANSMISION	GP-9586	8-25011-159-0
AIRE	GA-930R	8-12471-801-0
COMBUSTIBLE	S 3202	8-15618-921-0
FSR con motores/ISUZU 6HK1-TCN DIESEL, ISUZU 6HK1-TCS DIESEL		
TRANSMISION	GP-9586	8-25011-122-0
AIRE, PRIMARIO	GA-930R	8-12471-801-0
AIRE, SECUNDARIO	GA-890R	8-12473-086-0
COMBUSTIBLE	S 3202	8-15618-921-0
FSR, FTR con motor/ISUZU 6HK1-TC		
TRANSMISION	GP-9586	8-25011-122-0
AIRE	GA-930R	8-12471-801-0
COMBUSTIBLE	S 3202	8-15618-921-0
FTR con motor/ISUZU 6HE1-TC		
TRANSMISION	GP-9586	8-25011-159-0
AIRE	GA-930R	8-12471-801-0
COMBUSTIBLE	S 3202	8-15618-921-0
FTR, FVR con motor/ISUZU 6HE1-TCN		
TRANSMISION	GP-9586	8-25011-159-0
FTR, FVR con motores/ISUZU 6HK1-TCN DIESEL, ISUZU 6HK1-TCS DIESEL		
TRANSMISION	GP-9586	8-25011-159-0
AIRE, PRIMARIO	GA-930R	8-12471-801-0
AIRE, SECUNDARIO	GA-890R	8-12473-086-0
COMBUSTIBLE	S 3202	8-15618-921-0
FVR con motor/ISUZU 6HE1T (7.1L)		
ACEITE	GP-57	1-13240-067-0
FVR con motor/ISUZU 6HE1-TC		
COMBUSTIBLE	S 3202	8-15618-921-0
FVR con motor/ISUZU 6HK1-TC		
AIRE, PRIMARIO	GA-930R	8-12471-801-0
AIRE, SECUNDARIO	GA-890R	8-12473-086-0
COMBUSTIBLE	S 3202	8-15618-921-0
FVR con motor/ISUZU 6SA1		
ACEITE	GP-57	1-13240-163-2
FXR con motor/ISUZU 6HK1-TC		
AIRE	GA-930R	8-12471-801-0
NK58GR con motor/ISUZU 4BE1 (1988-94)		
COMBUSTIBLE, SEPARADOR DE AGUA	GPP-111	8943692993
NPR con motor/4 CIL. 5.2L TURBO DIESEL (4HK1TC)		
DIESEL	GPP-111	8-94483-850-0
ACEITE	GP-359	2-90654-600-0
DIESEL, SEGUNDA OPCION	GPP-524	8-94483-850-0
TRANSMISION (2004 EN ADELANTE)	GP-3569	97182282
AIRE, SOLAMENTE MODELOS CON CABINA REGULAR	GA-633R	8970622940

MARCA-MODELO-MOTOR MAKE-MODEL-ENGINE	GONHER GONHER	OEM OEM
ISUZU (continuación)		
CAMIONES, TRACTOCAMIONES Y AUTOBUSES		
NPR con motor/GMC 5.7L		
ACEITE	GP-13	8-06438-384-0
ACEITE	GP-205	8-25014-831-0
AIRE	GA-59	8-06484-235-0
GASOLINA	GG-46	8-25055-052-0
NPR con motor/GMC 6.0L		
ACEITE	GP-44	8-25010-633-0
NPR con motor/ISUZU 4.8L		
ACEITE	GP-359	2-90654-600-0
NPR con motor/ISUZU 4BD1T		
ACEITE	GP-58	8-94463-715-0
NPR con motor/ISUZU 4BD-T 3.9L		
ACEITE, DERIVACION (BY PASS)	GP-50	8-94360-419-1
NPR con motor/ISUZU 4HE1		
ACEITE	GP-359	2-90654-800-0
NPR HD con motor/4 CIL. 5.2L TURBO DIESEL (4HK1TC)		
TRANSMISION	GP-3569	97182282
NPR HD con motor/V8 6.0L GASOLINA		
ACEITE, 2008 EN DELANTE	GP-406	89017-524
TRANSMISION	GP-3569	8-97182-282-0
ACEITE, 2003-2007	GP-44	8-88984-215-0
NPS con motor/ISUZU 4BD1T		
ACEITE	GP-1	8-94169-778-2
NQR con motor/ISUZU 4.8L		
ACEITE	GP-359	2-90654-600-0
NQR, NRR con motor/ISUZU 4HK1		
DIESEL, (2004-07)	GPP-111	94369299
ACEITE	GP-359	2-90654-600-0
DIESEL, (2004-07) SEGUNDA OPCION	GPP-524	94369299
TRANSMISION (2004 EN ADELANTE)	GP-3569	97182282
NRR con motor/ISUZU 6BG1		
TRANSMISION	GP-9586	1-32569-021-0
TROOPER UBS69 con motor/ISUZU 4JG2T (1992-94)		
COMBUSTIBLE, SEPARADOR DE AGUA	GPP-111	8943692993
W4 con motor/DIESEL		
TRANSMISION, SELLADO (1988-98)	GP-3569	2-90654-010-0
W5 con motor/DIESEL		
TRANSMISION, SELLADO (2008 EN ADELANTE)	GP-3569	8-97182-282-0
ISUZU		
MOTORES		
111 A DIESEL, QD145T A DIESEL		
AIRE	GAK-403	1142150280
2AB1 A DIESEL, 3AB1 A DIESEL, QD27 A DIESEL, QD40 A DIESEL		
ACEITE	GP-171	H132011

MARCA-MODELO-MOTOR MAKE-MODEL-ENGINE	GONHER GONHER	OEM OEM
ISUZU (continuación)		
MOTORES		
3KC1 A DIESEL		
ACEITE	GP-6811	L14459
4BB1 A DIESEL, 4BD1 (3.9L) A DIESEL, 4BD1-PW A DIESEL, 4BD1T (3.9L) AUTOMOTRIZ, C240 (2.4L) A DIESEL, QD100 A DIESEL, QD100T AUTOMOTRIZ, QD60 A DIESEL, QD90 A DIESEL		
ACEITE	GP-1	13201-2
4BD1T (3.9L) INDUSTRIAL, QD100T INDUSTRIAL		
ACEITE, DERIVACION (BY PASS)	GP-50	11322400890
4FB1 A DIESEL		
ACEITE	GP-3985	8941673990
4HK1 A DIESEL		
DIESEL, (2004-07)	GPP-111	94369299
4LC1		
AIRE, RADIAL PRIMARIO	GA-880R	P821575
4LE1 (2.2L)		
ACEITE	GP-149	8-94456-741-1
6BB1 (5.8L), 6BD1 (5.8L), QD130 A DIESEL, QD145 A DIESEL		
ACEITE	GP-10	X-13201-006
6RB1T TOMA DE FUERZA (13.7L)		
AIRE, SIN ASPAS	GA-27	P182000
D381 A DIESEL		
ACEITE	GP-57	132400421
DA120 A DIESEL, DA220 A DIESEL		
COMBUSTIBLE	G-1123	FF5228
QT23 A DIESEL		
ACEITE	GP-91	8941494180
QT35 A DIESEL		
ACEITE	GP-91	8941494180
AIRE, SIN ASPAS	GA-33	5-14215-014-0
AIRE	GAK-16	5-14215011-0
IVECO		
MOTORES		
NEF45 SM2		
AIRE, PRIMARIO	GA-853R	8041642
NEF45 TM1X		
AIRE	GA-697R	8041322
NEF67 TE2X		
ACEITE	GP-737	2992242
JCB (J.C. BAMFORD)		
CAMIONES, TRACTOCAMIONES Y AUTOBUSES		
15 DE VOLTEO, 22-1/2CWT DE VOLTEO con motor/PETTER PH1		
ACEITE	G-816	32/300801
15 DE VOLTEO, JCB10 DE VOLTEO, 22-1/2 DE VOLTEO, 30CWT DE VOLTEO con motor/PETTER AC1		
GASOLINA	GG-48	S1246

MARCA-MODELO-MOTOR MAKE-MODEL-ENGINE	GONHER GONHER	OEM OEM
JCB (J.C. BAMFORD)(continuación)		
CAMIONES, TRACTOCAMIONES Y AUTOBUSES		
30CWT DE VOLTEO con motor/PETTER PH2		
ACEITE	G-870	988/00038
712 DE VOLTEO ARTICULADO (YA SERIES) con motor/A DIESEL		
ACEITE	GP-31	02/100073
COMBUSTIBLE	G-296	32/400701
COMBUSTIBLE	G-296-B	32/400701
HIDRAULICO SELLADO	GP-761H	32/905501
716 DE VOLTEO ARTICULADO (YB SERIES) con motor/A DIESEL		
COMBUSTIBLE	G-296	32/400701
COMBUSTIBLE	G-296-B	32/400701
HIDRAULICO SELLADO	GP-761H	32/905501
718 DE VOLTEO con motor/CUMMINS 5.9 L		
COMBUSTIBLE, SECUNDARIO	GP-1122	02/910155
JCB10 DE VOLTEO con motor/PETTER PH1		
ACEITE	G-816	32/300801
JCB10 DE VOLTEO con motor/PETTER PH2		
ACEITE	G-870	988/00038
Z7 ARTICULADO, Z8 ARTICULADO con motor/A GASOLINA		
GASOLINA	GG-48	S1246
JCB (J.C. BAMFORD)		
CARGADORAS		
110 SOBRE ORUGAS, 110B SOBRE ORUGAS, 110C SOBRE ORUGAS con motor/A DIESEL		
ACEITE	GP-31	02/100073
COMBUSTIBLE	G-296	32/400701
COMBUSTIBLE	G-297	32/400502
COMBUSTIBLE	G-296-B	32/400701
COMBUSTIBLE	G-297-B	32/400502
AIRE, SIN ASPAS	GA-403	32/200406
AIRE	GAK-403	32/200406
AIRE	GA-360	32/201602
AIRE	GA-361	32/202501
1110T SERIES II con motor/A DIESEL		
AIRE, RADIAL PRIMARIO	GA-853R	32/915701
1250 con motor/PERKINS 6.354		
ACEITE, CARTUCHO	G-834	1531639
ACEITE, SELLADO	GP-31	02/100073
COMBUSTIBLE	G-296	32/400701
COMBUSTIBLE	G-296-B	32/400701
1500, 2000 con motor/LEYLAND 6.80		
COMBUSTIBLE	G-296	32/400701
1550 RETROEXCAVADORA con motor/PERKINS		
ACEITE, CARTUCHO	G-870	988/00038
COMBUSTIBLE	G-296	32/400701
ACEITE, SELLADO	GP-28	02/301217
COMBUSTIBLE	G-297	32/400502
COMBUSTIBLE	G-296-B	32/400701
COMBUSTIBLE	G-297-B	32/400502
ACEITE, SELLADO	GP-171	02/100284
TRANSMISION	GP-171	02/100284
AIRE, PRIMARIO	GAK-216	32/203702
AIRE, SECUNDARIO	GA-416	32/203703

SERVICIO PESADO

MARCA-MODELO-MOTOR MAKE-MODEL-ENGINE	GONHER GONHER	OEM OEM	MARCA-MODELO-MOTOR MAKE-MODEL-ENGINE	GONHER GONHER	OEM OEM	MARCA-MODELO-MOTOR MAKE-MODEL-ENGINE	GONHER GONHER	OEM OEM
JCB(J.C.BAMFORD)(continuación)			JCB(J.C.BAMFORD)(continuación)			JCB(J.C.BAMFORD)(continuación)		
CARGADORAS			CARGADORAS			CARGADORAS		
1700 RETROEXCAVADORA con motor/A DIESEL			COMBUSTIBLE	G-297	32/400502	COMBUSTIBLE	G-296-B	32/400701
ACEITE, CARTUCHO	G-870	988/00038	COMBUSTIBLE	G-296-B	32/400701	3CX RETROEXCAVADORA con motor/A DIESEL		
COMBUSTIBLE	G-296	32/400701	COMBUSTIBLE	G-297-B	32/400502	ACEITE, CARTUCHO	G-870	988/00038
ACEITE, SELLADO	GP-28	02/301217	210SL RETROEXCAVADORA con motor/PERKINS TURBO			COMBUSTIBLE	G-296	32/400701
COMBUSTIBLE	G-297	32/400502	ACEITE	GP-31	02/100073	COMBUSTIBLE	GP-28	02/301217
COMBUSTIBLE	G-296-B	32/400701	COMBUSTIBLE	G-296	32/400701	COMBUSTIBLE	G-297	32/400502
COMBUSTIBLE	G-297-B	32/400502	COMBUSTIBLE	GP-1122	32/912101	COMBUSTIBLE	G-296-B	32/400701
ACEITE, SELLADO	GP-171	02/100284	COMBUSTIBLE	G-297	32/400502	COMBUSTIBLE	G-297-B	32/400502
TRANSMISION	GP-171	02/100284	COMBUSTIBLE	G-296-B	32/400701	COMBUSTIBLE	GP-171	02/100284
AIRE, PRIMARIO	GAK-216	32/203702	COMBUSTIBLE	G-297-B	32/400502	ACEITE, SELLADO	GP-171	02/100284
AIRE, SECUNDARIO	GA-416	32/203703	210SU RETROEXCAVADORA con motor/PERKINS			TRANSMISION	GP-171	02/100284
			ACEITE	GP-1	02/100284	AIRE, PRIMARIO	GAK-216	32/203702
1700B RETROEXCAVADORA con motor/PERKINS TURBO			COMBUSTIBLE	G-296	32/400701	AIRE, SECUNDARIO	GA-416	32/203703
ACEITE	G-871	988/00038	COMBUSTIBLE	GP-1122	32/912101	406 SOBRE RUEDAS ARTICULADO con motor/A DIESEL		
ACEITE	GP-1	02/100284	COMBUSTIBLE	G-297	32/400502	COMBUSTIBLE	G-296	32/400701
ACEITE	GP-31	02/100073	COMBUSTIBLE	G-296-B	32/400701	ACEITE	GP-3600	02/130142
COMBUSTIBLE	G-296	32/400701	COMBUSTIBLE	G-297-B	32/400502	COMBUSTIBLE	G-296-B	32/400701
COMBUSTIBLE	G-296-B	32/400701	210SU RETROEXCAVADORA con motor/PERKINS TURBO			COMBUSTIBLE	GP-171	02/100284
			ACEITE	GP-31	02/100073	TRANSMISION	GP-761H	32/905501
1750 con motor/LEYLAND UE 400			COMBUSTIBLE	G-296	32/400701	AIRE, PRIMARIO	GAK-216	32/203702
COMBUSTIBLE	G-296	32/400701	COMBUSTIBLE	GP-1122	32/912101	AIRE, SECUNDARIO	GA-416	32/203703
1CX RETROEXCAVADORA con motor/PEUGEOT 1.9L DIESEL			COMBUSTIBLE	G-297	32/400502	407 SOBRE RUEDAS con motor/A DIESEL		
COMBUSTIBLE	G-296	32/400701	COMBUSTIBLE	G-296-B	32/400701	ACEITE	GP-1	02/100284
			COMBUSTIBLE	G-297-B	32/400502	COMBUSTIBLE	G-296	32/400701
200 SERIES RETROEXCAVADORA con motor/A DIESEL			COMBUSTIBLE	GP-171	02/100284	COMBUSTIBLE	G-296-B	32/400701
COMBUSTIBLE	G-297	32/400502	COMBUSTIBLE	GP-171	02/100284	AIRE	GAK-216	32/203702
COMBUSTIBLE	G-297-B	32/400502	212S SERIES II, 212SU SERIES II con motor/PERKINS			AIRE	GA-416	32/203703
ACEITE	GP-171	02/100284	COMBUSTIBLE	GPP-1122	32/912001	407B, 409B SOBRE RUEDAS con motor/A DIESEL		
TRANSMISION	GP-171	02/100284	214 con motor/A DIESEL			COMBUSTIBLE, SECUNDARIO	GPP-1122	32/912001
			ACEITE	GP-31	02/100073	ACEITE	GP-3600	02/130142
208S con motor/PERKINS			COMBUSTIBLE	G-297	32/400502	TRANSMISION	GP-171	02/100284
COMBUSTIBLE	G-296	32/400701	COMBUSTIBLE	G-297-B	32/400502	408 RETROEXCAVADORA, 409 RETROEXCAVADORA con motor/A DIESEL		
			COMBUSTIBLE	G-297-B	32/400502	COMBUSTIBLE	G-296	32/400701
208S RETROEXCAVADORA con motor/A DIESEL			214S 2WD & 4WD RETROEXCAVADORA, 215 2WD & 4WD RETROEXCAVADORA, 215S 2WD & 4WD RETROEXCAVADORA, 217 2WD & 4WD RETROEXCAVADORA, 217S 2WD & 4WD RETROEXCAVADORA, 214 2WD & 4WD RETROEXCAVADORA, 214E RETROEXCAVADORA con motor/A DIESEL			COMBUSTIBLE	G-296-B	32/400701
COMBUSTIBLE	G-296	32/400701	COMBUSTIBLE	G-297	32/400502	COMBUSTIBLE	GP-171	02/100284
COMBUSTIBLE	G-296-B	32/400701	COMBUSTIBLE	G-297-B	32/400502	TRANSMISION	GP-171	02/100284
HIDRAULICO	GP-761H	32/909200	COMBUSTIBLE	GP-171	02/100073	AIRE, PRIMARIO	GAK-216	32/203702
			COMBUSTIBLE	GP-171	02/100284	AIRE, SECUNDARIO	GA-416	32/203703
208SHF RETROEXCAVADORA con motor/A DIESEL			TRANSMISION	GP-171	02/100284	408 SOBRE RUEDAS ARTICULADO con motor/A DIESEL		
COMBUSTIBLE	G-296	32/400701	214S, 215 SERIES III, 215S SERIES III, 416B con motor/PERKINS			COMBUSTIBLE	G-296	32/400701
			ACEITE	GP-31	02/100073	COMBUSTIBLE	G-296-B	32/400701
210 con motor/PERKINS			COMBUSTIBLE	G-297	32/400502	HIDRAULICO	GP-761H	32/905501
COMBUSTIBLE	GPP-1122	32/912001	215 SERIES II, 215S SERIES II con motor/PERKINS			AIRE, PRIMARIO	GAK-216	32/203702
			ACEITE	GP-31	02/100073	AIRE, SECUNDARIO	GA-416	32/203703
210S RETROEXCAVADORA con motor/A DIESEL			215E con motor/PERKINS 1004.40T			409 SOBRE RUEDAS con motor/A DIESEL		
COMBUSTIBLE	G-296	32/401102	ACEITE	GP-31	02/100073	COMBUSTIBLE	G-296	32/400701
ACEITE	GP-3600	02/130142	217 SERIES III, 217S SERIES III con motor/PERKINS 1004.40T			COMBUSTIBLE	GPP-1122	32/912001
COMBUSTIBLE	G-296-B	32/401102	ACEITE	GP-1	02/100284	COMBUSTIBLE	G-296-B	32/400701
COMBUSTIBLE	GP-171	02/100284	2CX RETROEXCAVADORA con motor/PERKINS 3.152			HIDRAULICO	GP-761H	32/905501
TRANSMISION	GP-171	02/100284	COMBUSTIBLE	GP-1	02/100284	AIRE, PRIMARIO	GAK-216	32/203702
			COMBUSTIBLE	GP-1	02/100284	AIRE, SECUNDARIO	GA-416	32/203703
210S, 210SL, 210SU con motor/PERKINS 1004.4			COMBUSTIBLE	G-296	32/400701	411 TURBO RETROEXCAVADORA con motor/A DIESEL		
COMBUSTIBLE	G-296	32/400701	COMBUSTIBLE	G-297-B	32/400502	COMBUSTIBLE, S/N		
COMBUSTIBLE	GPP-1122	32/912001	COMBUSTIBLE	G-297	32/400502	527000-EU658592Y	G-296	32/400701
COMBUSTIBLE	G-297	32/400502	COMBUSTIBLE	GP-3600	02/130142	COMBUSTIBLE, S/N		
ACEITE	GP-3600	02/130142	COMBUSTIBLE	G-296-B	32/400701	EU658593Y EN ADELANTE	G-297	32/400502
COMBUSTIBLE	G-296-B	32/400701	ACEITE	GP-3600	02/130142	COMBUSTIBLE, S/N		
COMBUSTIBLE	G-297-B	32/400502	COMBUSTIBLE	G-296-B	32/400701	527000-EU658592Y	G-296-B	32/400701
HIDRAULICO	GP-761H	32/905501	3000 con motor/A DIESEL					
			ACEITE	G-870	988/00038			
210SL RETROEXCAVADORA con motor/PERKINS			COMBUSTIBLE	G-296	32/400701			
ACEITE	GP-1	02/100284	COMBUSTIBLE	GP-1122	32/912101			
COMBUSTIBLE	G-296	32/400701						
COMBUSTIBLE	GP-1122	32/912101						

MARCA-MODELO-MOTOR MAKE-MODEL-ENGINE	GONHER GONHER	OEM OEM	MARCA-MODELO-MOTOR MAKE-MODEL-ENGINE	GONHER GONHER	OEM OEM	MARCA-MODELO-MOTOR MAKE-MODEL-ENGINE	GONHER GONHER	OEM OEM
JCB(J.C.BAMFORD)(continuación)			JCB(J.C.BAMFORD)(continuación)			JCB(J.C.BAMFORD)(continuación)		
CARGADORAS			CARGADORAS			CARGADORAS		
COMBUSTIBLE, S/N EU658593Y EN ADELANTE	G-297-B	32/400502	AIRE, SECUNDARIO	GA-361	32/202501	506C, 508C con motor/PERKINS		
ACEITE	GP-171	02/100073	428 con motor/LEYLAND UE690			ACEITE	GP-31	02/100073
412 SOBRE RUEDAS con motor/PERKINS 4.236			COMBUSTIBLE	G-296	32/400701	506CHL con motor/JCB (J.C. BAMFORD) 80 HP		
ACEITE	GP-1	02/100284	COMBUSTIBLE	G-296-B	32/400701	COMBUSTIBLE	GPP-1122	32/912001
COMBUSTIBLE	G-296	32/400701	AIRE, PRIMARIO	GA-360	32/201602	508 con motor/A DIESEL		
COMBUSTIBLE	G-296-B	32/400701	AIRE, SECUNDARIO	GA-361	32/202501	ACEITE	GP-31	02/100073
AIRE	GA-360	32/201602	428C SOBRE RUEDAS con motor/LEYLAND UE690			510 con motor/PERKINS 1004.4THR		
AIRE	GA-361	32/201601	COMBUSTIBLE	G-296	32/400701	ACEITE	GP-31	02/100073
412E con motor/PERKINS			COMBUSTIBLE	G-296-B	32/400701	520 M/2, 520 M/4 con motor/LEYLAND 4.98NT		
ACEITE	GP-31	02/100073	AIRE	GA-360	32/201602	ACEITE	G-870	988/00038
COMBUSTIBLE	G-296	32/400701	AIRE	GA-361	32/201601	COMBUSTIBLE	G-296	32/400701
COMBUSTIBLE	G-296-B	32/400701	430 con motor/PERKINS T6.354.4			COMBUSTIBLE	G-297	32/400502
413, 418 con motores/PERKINS 6.354, PERKINS T6.354			ACEITE	GP-1	02/100284	ACEITE	GP-3600	02/301217
ACEITE, CARTUCHO	G-834	1531639	COMBUSTIBLE	G-296	32/400701	COMBUSTIBLE	G-296-B	32/400701
ACEITE, SELLADO	GP-31	02/100073	AIRE, PRIMARIO	GA-360	32/201602	COMBUSTIBLE	G-297-B	32/400502
COMBUSTIBLE	G-296	32/400701	AIRE, SECUNDARIO	GA-361	32/202501	AIRE	GAK-1532	32/205702
COMBUSTIBLE	G-296-B	32/400701	435 con motor/PERKINS			520-10 con motor/A DIESEL		
AIRE, PRIMARIO	GA-360	32/201602	COMBUSTIBLE	G-296	32/400701	ACEITE	GP-1	02/100284
AIRE, SECUNDARIO	GA-361	32/202501	COMBUSTIBLE	G-296-B	32/400701	COMBUSTIBLE	G-297	32/400502
415 con motor/PERKINS 4.236			AIRE, PRIMARIO	GA-360	32/201602	COMBUSTIBLE	G-297-B	32/400502
ACEITE	GP-1	02/100284	AIRE, SECUNDARIO	GA-361	32/202501	520-50 con motor/A DIESEL		
COMBUSTIBLE	G-296	32/400701	450BM con motor/LISTER PETTER			ACEITE	GP-1	02/100284
COMBUSTIBLE	G-296-B	32/400701	AIRE	GAK-1532	32/205702	520HL, 520M, 525B con motor/A DIESEL		
416 con motor/PERKINS			456B con motor/CUMMINS 8.3L			COMBUSTIBLE	G-296	32/400701
ACEITE	GP-31	02/100073	COMBUSTIBLE, SECUNDARIO	GPP-1122	32/912001	COMBUSTIBLE	G-296-B	32/400701
COMBUSTIBLE	G-296	32/400701	4CX TURBO RETROEXCAVADORA con motor/PERKINS 1000			ACEITE	GP-171	02/100284
COMBUSTIBLE	GPP-1122	32/912001	ACEITE	GP-31	02/100073	TRANSMISION	GP-171	02/100284
COMBUSTIBLE	G-296-B	32/400701	COMBUSTIBLE	G-297	32/400502	AIRE, PRIMARIO	GAK-216	32/203702
416 TURBO RETROEXCAVADORA con motor/A DIESEL			COMBUSTIBLE	G-297-B	32/400502	AIRE, SECUNDARIO	GA-416	32/203703
COMBUSTIBLE, S/N 527000-EU658592Y	G-296	32/400701	4CX TURBO SERVO PLUS RETROEXCAVADORA con motor/PERKINS 1000			525 con motor/PERKINS		
COMBUSTIBLE, S/N EU658593Y EN ADELANTE	G-297	32/400502	ACEITE	GP-31	02/100073	ACEITE	GP-1	02/100284
COMBUSTIBLE, S/N 527000-EU658592Y	G-296-B	32/400701	COMBUSTIBLE	G-296	32/400701	COMBUSTIBLE	G-296	32/400701
COMBUSTIBLE, S/N EU658593Y EN ADELANTE	G-297-B	32/400502	COMBUSTIBLE	G-296-B	32/400701	COMBUSTIBLE	G-296-B	32/400701
ACEITE	GP-171	02/100073	504B con motor/A DIESEL			AIRE	GAK-1532	32/205702
420 con motor/PERKINS 6.354			COMBUSTIBLE	G-297	32/400502	525, 525-4 con motor/A DIESEL		
ACEITE	GP-31	02/100073	COMBUSTIBLE	G-297-B	32/400502	ACEITE	G-870	988/00038
COMBUSTIBLE	G-296	32/400701	ACEITE	GP-171	02/100284	COMBUSTIBLE	G-296	32/400701
COMBUSTIBLE	G-296-B	32/400701	TRANSMISION	GP-171	02/100284	COMBUSTIBLE	G-297	32/400502
423 SOBRE RUEDAS con motor/LEYLAND UE 680			505, 506 con motor/A DIESEL			ACEITE	GP-3600	02/301217
COMBUSTIBLE	G-296	32/400701	ACEITE, CON TURBO	GP-31	02/100073	COMBUSTIBLE	G-296-B	32/400701
425 con motor/PERKINS			505-19, 505-22, 505-36, 506-36, 506B, 508-40, 510-40 con motor/A DIESEL			COMBUSTIBLE	G-297-B	32/400502
ACEITE	GP-31	02/100073	COMBUSTIBLE	G-296	32/400701	AIRE	GAK-216	32/203702
COMBUSTIBLE	G-296	32/400701	COMBUSTIBLE	G-296-B	32/400701	AIRE	GA-416	32/203703
COMBUSTIBLE	G-296-B	32/400701	ACEITE	GP-171	02/100284	525B-4HL con motor/PERKINS		
426, 436 con motor/PERKINS			TRANSMISION	GP-171	02/100284	ACEITE	GP-1	02/100284
COMBUSTIBLE	GPP-1122	32/912001	506B TURBOCARGADORA, 508-10, 510-10 con motor/A DIESEL			COMBUSTIBLE	G-296	32/400701
AIRE, PRIMARIO	GA-360	32/201602	ACEITE	GP-1	02/100284	COMBUSTIBLE	G-296-B	32/400701
AIRE, SECUNDARIO	GA-361	32/202501	ACEITE	GP-31	02/100073	AIRE	GAK-1532	32/205702
426B, 436B con motor/PERKINS			COMBUSTIBLE	G-296	32/400701	525BHL con motor/A DIESEL		
COMBUSTIBLE	GPP-1122	32/912001	COMBUSTIBLE	G-296-B	32/400701	ACEITE	GP-1	02/100284
AIRE, PRIMARIO	GA-360	32/201602	ACEITE	GP-171	02/100284	COMBUSTIBLE	G-296	32/400701
			TRANSMISION	GP-171	02/100284	COMBUSTIBLE	G-296-B	32/400701
			506B TURBOCARGADORA, 508-10, 510-10 con motor/A DIESEL			AIRE	GAK-1532	32/205702
			ACEITE	GP-1	02/100284			
			ACEITE	GP-31	02/100073			
			COMBUSTIBLE	G-296	32/400701			
			COMBUSTIBLE	G-296-B	32/400701			
			ACEITE	GP-171	02/100284			
			TRANSMISION	GP-171	02/100284			
			506B TURBOCARGADORA, 508-10, 510-10 con motor/A DIESEL					
			ACEITE	GP-1	02/100284			
			ACEITE	GP-31	02/100073			
			COMBUSTIBLE	G-296	32/400701			
			COMBUSTIBLE	G-296-B	32/400701			
			ACEITE	GP-171	02/100284			
			TRANSMISION	GP-171	02/100284			
			506B TURBOCARGADORA, 508-10, 510-10 con motor/A DIESEL					
			ACEITE	GP-1	02/100284			
			ACEITE	GP-31	02/100073			
			COMBUSTIBLE	G-296	32/400701			
			COMBUSTIBLE	G-296-B	32/400701			
			ACEITE	GP-171	02/100284			
			TRANSMISION	GP-171	02/100284			

SERVICIO PESADO

MARCA-MODELO-MOTOR MAKE-MODEL-ENGINE	GONHER GONHER	OEM OEM	MARCA-MODELO-MOTOR MAKE-MODEL-ENGINE	GONHER GONHER	OEM OEM	MARCA-MODELO-MOTOR MAKE-MODEL-ENGINE	GONHER GONHER	OEM OEM
JCB(J.C.BAMFORD)(continuación)			JCB(J.C.BAMFORD)(continuación)			JCB(J.C.BAMFORD)(continuación)		
CARGADORAS			CARGADORAS			EQUIPO		
530, 532 con motor/PERKINS			ROBOT 1110, ROBOT 190 con motor/PERKINS 1004.42			1750 con motores/PERKINS 6.354, PERKINS T6.354		
ACEITE	GP-31	02/100073	COMBUSTIBLE	GPP-1122	32/912001	ACEITE	GP-31	02/100073
530-70 con motor/A DIESEL			ROBOT 150 con motor/A DIESEL			COMBUSTIBLE	G-296	32/400701
ACEITE	GP-31	02/100073	COMBUSTIBLE	G-296	32/400701	COMBUSTIBLE	G-296-B	32/400701
530B TURBOCARGADORA con motor/A DIESEL			ROBOT 165HF con motor/PERKINS			2, 2B, 3C con motor/FORD		
ACEITE	GP-1	02/100284	COMBUSTIBLE	G-296	32/400701	ACEITE	G-813	957E-6731-A
COMBUSTIBLE	G-296	32/400701	ROBOT 170 con motor/A DIESEL			2, 3, 2B con motores/LEYLAND 10-42, LEYLAND 10-45		
COMBUSTIBLE	G-296-B	32/400701	COMBUSTIBLE	G-296	32/400701	ACEITE	G-870	988/00038
530B, 530BHL con motor/A DIESEL			COMBUSTIBLE	G-296	32/400701	COMBUSTIBLE	G-296	32/400701
COMBUSTIBLE	G-296	32/400701	HIDRAULICO	GP-761H	32/909200	COMBUSTIBLE	G-296-B	32/400701
COMBUSTIBLE	G-296-B	32/400701	ROBOT 185HF con motor/PERKINS			2000 con motor/LEYLAND AD400		
ACEITE	GP-171	02/100284	ACEITE	GP-31	02/100073	ACEITE	G-870	988/00038
TRANSMISION	GP-171	02/100284				COMBUSTIBLE	G-296	32/400701
535-95 con motor/PERKINS 1004.40						COMBUSTIBLE	G-296-B	32/400701
ACEITE	GP-31	02/100073	JCB (J.C. BAMFORD)			2CX MKII, 2CXL con motor/A DIESEL		
540 con motor/PERKINS 4.236			EQUIPO			ACEITE	GP-1	02/100284
ACEITE	G-870	988/00038	1 con motor/JCB (J.C. BAMFORD) AC2			TRANSMISION	GP-1	02/100284
ACEITE	GP-1	02/100284	GASOLINA	GG-48	S1246	COMBUSTIBLE	G-297	32/400502
COMBUSTIBLE	G-296	32/400701	1 con motor/PETTER PH2			COMBUSTIBLE	G-297-B	32/400502
COMBUSTIBLE	G-296-B	32/400701	ACEITE	G-870	988/00038	HIDRAULICO	GP-761H	32/905501
AIRE	GAK-216	32/203702	100 con motor/PERKINS 6.354			2D, 3CII con motor/LEYLAND 4 CYL. 38TD		
AIRE	GA-416	32/203703	ACEITE	G-834	1531639	ACEITE	G-870	988/00038
540 TURBOCARGADORA, 540-170, 550 TURBOCARGADORA con motor/PERKINS			ACEITE	GP-31	02/100073	COMBUSTIBLE	G-296	32/400701
ACEITE	GP-31	02/100073	COMBUSTIBLE	G-296	32/400701	COMBUSTIBLE	G-296-B	32/400701
540-70 con motor/PERKINS 1004.40T			COMBUSTIBLE	G-296-B	32/400701	3 con motor/FORD		
ACEITE	GP-31	02/100073	1000 con motor/FORD 2703			ACEITE	G-813	957E-6731-A
540B con motor/LISTER PETTER			ACEITE	G-836	C2TZ-6714-A	3C con motor/LEYLAND 10-65		
AIRE	GAK-1532	32/205702	COMBUSTIBLE	G-296	32/400701	ACEITE	G-870	988/00038
540B2, 540B4 con motor/PERKINS			COMBUSTIBLE	G-296-B	32/400701	3C, 3D con motor/LEYLAND 10-60		
ACEITE	GP-31	02/100073	AIRE, SIN ASPAS	GA-33	BO32/0033	COMBUSTIBLE	G-296	32/400701
COMBUSTIBLE	G-296	32/400701	1000 con motor/PERKINS 6.354			3CII con motor/PERKINS 4.248		
COMBUSTIBLE	G-296-B	32/400701	ACEITE, CARTUCHO	G-834	1531639	ACEITE	G-871	988/00038
700 SOBRE RUEDAS con motor/LEYLAND			ACEITE, SELLADO	GP-31	02/100073	COMBUSTIBLE	G-296	32/400701
ACEITE	G-870	988/00038	COMBUSTIBLE	G-296	32/400701	COMBUSTIBLE	G-296-B	32/400701
COMBUSTIBLE, 2 49/64 IN	G-296	32/400701	COMBUSTIBLE	G-296-B	32/400701	3CIII, 3DIII con motor/LEYLAND 4.98NT		
COMBUSTIBLE, 4 25/64 IN	G-297	32/400502	112 con motor/PERKINS 6.354			ACEITE	G-870	988/00038
COMBUSTIBLE, 2 49/64 IN	G-296-B	32/400701	ACEITE, CARTUCHO	G-834	1531639	COMBUSTIBLE, 2 49/64 IN	G-296	32/400701
COMBUSTIBLE, 4 25/64 IN	G-297-B	32/400502	ACEITE, SELLADO	GP-31	02/100073	COMBUSTIBLE, 4 25/64 IN	G-297	32/400502
900, 902 con motor/PERKINS 6.354			COMBUSTIBLE	G-296	32/400701	COMBUSTIBLE, 2 49/64 IN	G-296-B	32/400701
ACEITE	G-834	1531639	COMBUSTIBLE	G-296-B	32/400701	COMBUSTIBLE, 4 25/64 IN	G-297-B	32/400502
ACEITE	GP-31	02/100073	114 con motor/PERKINS T6.354			AIRE, PRIMARIO	GAK-216	32/203702
COMBUSTIBLE	G-296	32/400701	ACEITE, CARTUCHO	G-836	C2TZ-6714-A	AIRE, SECUNDARIO	GA-416	32/203703
COMBUSTIBLE	G-296-B	32/400701	ACEITE, SELLADO	GP-31	02/100073	3D con motor/FORD		
AIRE, SIN ASPAS	GA-403	32/200406	COMBUSTIBLE	G-296	32/400701	ACEITE	G-813	957E-6731-A
AIRE	GAK-403	32/200406	COMBUSTIBLE	G-296-B	32/400701	3D con motor/LEYLAND 10-65		
908 con motor/LEYLAND 6.80			1550B con motor/PERKINS			ACEITE	G-870	988/00038
COMBUSTIBLE	G-296	32/400701	TRANSMISION	G-870	988/00038	3DII con motor/LEYLAND 4 CYL. 38TD		
CB110 con motor/PERKINS 4.248			ACEITE	GP-31	02/100073	ACEITE	G-870	988/00038
ACEITE	G-834	1531639	COMBUSTIBLE	G-296	32/400701	COMBUSTIBLE	G-296	32/400701
COMBUSTIBLE	G-296	32/400701	COMBUSTIBLE	G-296-B	32/400701	COMBUSTIBLE	G-296-B	32/400701
COMBUSTIBLE	G-296-B	32/400701	AIRE, PRIMARIO	GAK-216	32/203702			
			AIRE, SECUNDARIO	GA-416	32/203703			

MARCA-MODELO-MOTOR MAKE-MODEL-ENGINE	GONHER GONHER	OEM OEM	MARCA-MODELO-MOTOR MAKE-MODEL-ENGINE	GONHER GONHER	OEM OEM	MARCA-MODELO-MOTOR MAKE-MODEL-ENGINE	GONHER GONHER	OEM OEM
JCB(J.C.BAMFORD)(continuación)			JCB(J.C.BAMFORD)(continuación)			JCB(J.C.BAMFORD)(continuación)		
EQUIPO			EQUIPO			EXCAVADORAS		
3DS, 3DX, 4C con motor/LEYLAND 4.98NT			6C con motor/FORD 2703			COMBUSTIBLE	G-297	32/400502
ACEITE, CARTUCHO	G-870	988/00038	ACEITE	G-836	C2TZ-6714-A	COMBUSTIBLE	G-296-B	32/400701
COMBUSTIBLE, 2 49/64 IN	G-296	32/400701	COMBUSTIBLE	G-296	32/400701	COMBUSTIBLE	G-297-B	32/400502
COMBUSTIBLE, 4 25/64 IN	G-297	32/400502	COMBUSTIBLE	G-296-B	32/400701	ACEITE, SELLADO	GP-171	02/100284
ACEITE, SELLADO	GP-3600	02/301217	AIRE, SIN ASPAS	GA-33	BO32/0033	TRANSMISION	GP-171	02/100284
COMBUSTIBLE, 2 49/64 IN	G-296-B	32/400701	6C, 7C con motor/PERKINS 6.354			AIRE, PRIMARIO	GAK-216	32/203702
COMBUSTIBLE, 4 25/64 IN	G-297-B	32/400502	ACEITE, CARTUCHO	G-834	1531639	AIRE, SECUNDARIO	GA-416	32/203703
AIRE, PRIMARIO	GAK-216	32/203702	ACEITE, SELLADO	GP-31	02/100073	1400B RETROEXCAVADORA con motor/PERKINS		
AIRE, SECUNDARIO	GA-416	32/203703	COMBUSTIBLE	G-296	32/400701	ACEITE	GP-1	02/100073
4 con motor/FORD 957E			COMBUSTIBLE	G-296-B	32/400701	COMBUSTIBLE	G-296	32/400701
ACEITE	G-813	957E-6731-A	COMBUSTIBLE			COMBUSTIBLE	G-296-B	32/400701
4 con motor/LEYLAND 10-60			7 con motor/FORD 570E			2 con motor/LEYLAND 3 CYL. 28 TD		
COMBUSTIBLE	G-296	32/400701	ACEITE	G-834	1531639	ACEITE	G-870	988/00038
4 con motor/LEYLAND 10-65			702, 704 con motor/PERKINS 4.236			COMBUSTIBLE	G-296	32/400701
ACEITE	G-870	988/00038	ACEITE	GP-1	02/100073	COMBUSTIBLE	G-296-B	32/400701
410 con motor/LEYLAND			COMBUSTIBLE	G-296	32/400701	2B con motor/LEYLAND 3 CYL. 28 TD		
ACEITE, CARTUCHO	G-870	988/00038	COMBUSTIBLE	G-296-B	32/400701	ACEITE	G-870	988/00038
COMBUSTIBLE	G-296	32/400701	807 con motor/PERKINS 6 CYL.			COMBUSTIBLE	G-296	32/400701
ACEITE, SELLADO	GP-3600	02/301217	ACEITE	G-834	1531639	COMBUSTIBLE	G-296-B	32/400701
COMBUSTIBLE	G-296-B	32/400701	COMBUSTIBLE	G-296	32/400701	2D con motor/LEYLAND 4.98NT		
410 con motor/PERKINS 4.236			COMBUSTIBLE	G-296-B	32/400701	ACEITE	G-870	988/00038
ACEITE, S/N U9213008K EN ADELANTE	GP-1	02/100284	807CL, 806C, 807C con motores/PERKINS T6.354.4, PERKINS 6.354.4			COMBUSTIBLE	G-296	32/400701
ACEITE, HASTA S/N U921308K	GP-31	02/100073	ACEITE	GP-31	02/100073	COMBUSTIBLE	G-297	32/400502
COMBUSTIBLE	G-296	32/400701	COMBUSTIBLE	G-296	32/400701	COMBUSTIBLE	G-296-B	32/400701
COMBUSTIBLE	G-296-B	32/400701	COMBUSTIBLE	G-296-B	32/400701	COMBUSTIBLE	G-297-B	32/400502
4C con motor/FORD 957E			808 con motor/PERKINS T6.354			3 con motores/LEYLAND 4.98 TT, LEYLAND 4.98NT		
ACEITE	G-813	957E-6731-A	ACEITE, CARTUCHO	G-834	1531639	ACEITE	G-870	988/00038
4C, 4D con motor/BMC			ACEITE, SELLADO	GP-1	02/100284	COMBUSTIBLE	G-296	32/400701
ACEITE	G-870	988/00038	COMBUSTIBLE	G-296	32/400701	COMBUSTIBLE	G-297	32/400502
520, 526 con motor/A DIESEL			COMBUSTIBLE	G-296-B	32/400701	ACEITE	GP-3600	02/301217
ACEITE	GP-31	02/100073	AIRE, PRIMARIO	GA-360	32/201602	COMBUSTIBLE	G-296-B	32/400701
520-50 con motor/A DIESEL			AIRE, SECUNDARIO	GA-361	32/202501	COMBUSTIBLE	G-297-B	32/400502
ACEITE	GP-31	02/100073	80C con motor/A DIESEL			3, 3D, 2D, 3C con motor/LEYLAND 4 CYL. 38TD		
520HL-2/4, 520M-2/4 con motor/PERKINS			ACEITE	G-834	1531639	ACEITE	G-870	988/00038
COMBUSTIBLE	G-296	32/400701	COMBUSTIBLE	G-296	32/400701	COMBUSTIBLE	G-296	32/400701
COMBUSTIBLE	G-296-B	32/400701	COMBUSTIBLE	G-296-B	32/400701	COMBUSTIBLE	G-296-B	32/400701
AIRE, PRIMARIO	GAK-216	32/203702	AIRE	GA-360	32/201602	3C con motor/LEYLAND 10/60		
AIRE, SECUNDARIO	GA-416	32/203703	8C, 8D con motor/PERKINS			COMBUSTIBLE	G-296	32/400701
525-50, 530HL con motor/A DIESEL			ACEITE	GP-31	02/100073	COMBUSTIBLE	G-296-B	32/400701
COMBUSTIBLE	G-296	32/400701	COMBUSTIBLE	G-296	32/400701	AIRE	GAK-216	32/203702
525B-2/4 con motor/A DIESEL			COMBUSTIBLE	G-296-B	32/400701	AIRE	GA-416	32/203703
COMBUSTIBLE	G-296	32/400701	COMBUSTIBLE			3C con motor/LEYLAND 10/65		
COMBUSTIBLE	G-296-B	32/400701	907 con motor/PERKINS T6.354			ACEITE	G-870	988/00038
AIRE, PRIMARIO	GAK-216	32/203702	ACEITE	GP-31	02/100073	COMBUSTIBLE	G-296	32/400701
AIRE, SECUNDARIO	GA-416	32/203703	COMBUSTIBLE	G-296	32/400701	COMBUSTIBLE	G-296-B	32/400701
AIRE, PRIMARIO	GAK-1532	32/205702	COMBUSTIBLE	G-296-B	32/400701	AIRE	GAK-216	32/203702
5C con motor/PERKINS 4.248			COMBUSTIBLE			AIRE	GA-416	32/203703
ACEITE	G-870	988/00038	110S SERIES III con motor/A DIESEL			3C con motor/LEYLAND 4.98NT		
6 con motor/PERKINS 4.236			COMBUSTIBLE	GPP-1122	32/912001	ACEITE	G-870	988/00038
ACEITE, CARTUCHO	G-871	988/00038	1400 RETROEXCAVADORA con motor/A DIESEL			COMBUSTIBLE	G-296	32/400701
			ACEITE, CARTUCHO	G-870	988/00038	COMBUSTIBLE	G-297	32/400502
			COMBUSTIBLE	G-296	32/400701	COMBUSTIBLE	G-296-B	32/400701
			ACEITE, SELLADO	GP-28	02/301217	COMBUSTIBLE	G-297-B	32/400502

SERVICIO PESADO

MARCA-MODELO-MOTOR MAKE-MODEL-ENGINE	GONHER GONHER	OEM OEM	MARCA-MODELO-MOTOR MAKE-MODEL-ENGINE	GONHER GONHER	OEM OEM	MARCA-MODELO-MOTOR MAKE-MODEL-ENGINE	GONHER GONHER	OEM OEM
JCB(J.C.BAMFORD)(continuación)			JCB(J.C.BAMFORD)(continuación)			JCB(J.C.BAMFORD)(continuación)		
EXCAVADORAS			EXCAVADORAS			EXCAVADORAS		
3C con motor/PERKINS			4C TURBO con motor/PERKINS T4.236			802 SUPER, 803 PLUS, 803 SUPER con motor/PERKINS 103.15		
ACEITE	GP-1	02/100284	ACEITE	GP-1	02/100284	ACEITE	GP-31	02/100073
ACEITE	GP-31	02/100073	COMBUSTIBLE	G-296	32/400701	COMBUSTIBLE	G-296	32/400701
COMBUSTIBLE	G-296	32/400701	COMBUSTIBLE	G-296-B	32/400701	COMBUSTIBLE	G-296-B	32/400701
COMBUSTIBLE	G-296-B	32/400701	COMBUSTIBLE	G-296-B	32/400701	AIRE	GAK-403	32/200406
3CX SITEMASTER con motor/PERKINS 1004.4			4CX TURBO con motor/LEYLAND 4.98 TT			803 con motor/A DIESEL		
ACEITE	GP-1	02/100284	COMBUSTIBLE	G-296	32/400701	COMBUSTIBLE	G-296	32/401102
ACEITE	GP-31	02/100073	COMBUSTIBLE	G-297	32/400502	COMBUSTIBLE	G-296	32/401102
COMBUSTIBLE	G-297	32/400502	ACEITE	GP-3600	02/301217	803 MINI, 804 MINI con motor/PERKINS	G-296	32/400701
COMBUSTIBLE	G-297-B	32/400502	COMBUSTIBLE	G-296-B	32/400701	COMBUSTIBLE	G-296	32/400701
3CX TURBO con motor/LEYLAND 4.98 TT			4D con motor/LEYLAND 4 CYL. 38TD			805 MINI con motor/PERKINS 4.248		
COMBUSTIBLE	G-296	32/400701	ACEITE	G-870	988/00038	ACEITE, CARTUCHO	G-833	26560076
COMBUSTIBLE	G-297	32/400502	COMBUSTIBLE	G-296	32/400701	ACEITE, SELLADO	GP-1	02/100284
ACEITE	GP-3600	02/301217	COMBUSTIBLE	G-296-B	32/400701	COMBUSTIBLE	G-296	32/400701
COMBUSTIBLE	G-296-B	32/400701	COMBUSTIBLE	G-297-B	32/400502	COMBUSTIBLE	G-296-B	32/400701
COMBUSTIBLE	G-297-B	32/400502	530 con motor/PERKINS			805.2 con motor/PERKINS 103.10		
3CX, 3CX TURBO con motor/PERKINS			ACEITE	GP-1	02/100284	COMBUSTIBLE	G-296	32/400701
ACEITE	GP-1	02/100284	5C con motor/PERKINS 6.354			8052, 8032ZTS MINI, 804 SUPER, ROBOT 165 con motor/A DIESEL		
ACEITE	GP-31	02/100073	ACEITE, CARTUCHO	G-834	1531639	COMBUSTIBLE	G-296	32/400701
COMBUSTIBLE	G-296	32/400701	ACEITE, SELLADO	GP-31	02/100073	COMBUSTIBLE	G-296	32/400701
COMBUSTIBLE	G-297	32/400502	COMBUSTIBLE	G-296	32/400701	805B con motor/PERKINS 6.354	GP-31	02/100073
COMBUSTIBLE	G-296-B	32/400701	COMBUSTIBLE	G-296-B	32/400701	COMBUSTIBLE	G-296	32/400701
COMBUSTIBLE	G-297-B	32/400502	6 con motor/PERKINS 4.236			COMBUSTIBLE	G-296-B	32/400701
3D con motor/LEYLAND 10/60			ACEITE	G-834	1531639	COMBUSTIBLE	G-296-B	32/400701
COMBUSTIBLE	G-296	32/400701	AIRE, SIN ASPAS	GA-403	32/200406	COMBUSTIBLE	G-296-B	32/400701
COMBUSTIBLE	G-296-B	32/400701	AIRE	GAK-403	32/200406	COMBUSTIBLE	G-296-B	32/400701
AIRE	GAK-216	32/203702	6C, 6D, 7B con motor/PERKINS 6.354			805B TURBO con motor/PERKINS T4.236		
AIRE	GA-416	32/203703	ACEITE	G-834	1531639	ACEITE	GP-1	02/100284
3D con motor/LEYLAND 10/65			COMBUSTIBLE	G-296	32/400701	COMBUSTIBLE	G-296	32/400701
ACEITE	G-870	988/00038	COMBUSTIBLE	G-296-B	32/400701	COMBUSTIBLE	G-296	32/400701
COMBUSTIBLE	G-296	32/400701	AIRE, SIN ASPAS	GA-403	32/200406	COMBUSTIBLE	G-296-B	32/400701
COMBUSTIBLE	G-296-B	32/400701	AIRE	GAK-403	32/200406	ACEITE	GP-68	32/600117
AIRE	GAK-216	32/203702	7 con motor/FORD 590E			AIRE	GA-360	32/201602
AIRE	GA-416	32/203703	ACEITE	G-836	C27Z-6714-A	AIRE	GA-361	32/202501
3D con motor/PERKINS			COMBUSTIBLE	G-296	32/400701	806 con motor/FORD		
ACEITE	GP-1	02/100284	COMBUSTIBLE	G-296-B	32/400701	COMBUSTIBLE	G-296	32/400701
ACEITE	GP-31	02/100073	AIRE, SIN ASPAS	GA-403	32/200406	COMBUSTIBLE	G-296-B	32/400701
COMBUSTIBLE	G-296	32/400701	AIRE	GAK-403	32/200406	COMBUSTIBLE	GP-68	32/600117
COMBUSTIBLE	G-296-B	32/400701	801.4 RETROEXCAVADORA con motor/PERKINS 103.10			AIRE	GA-360	32/201602
3DX, 3D, 3DS con motores/LEYLAND 4.98 TT, LEYLAND 4.98NT			ACEITE	GP-31	02/100073	COMBUSTIBLE	GA-361	32/202501
ACEITE	G-870	988/00038	COMBUSTIBLE	G-296	32/400701	806 con motor/PERKINS 6.354		
COMBUSTIBLE	G-296	32/400701	COMBUSTIBLE	G-296-B	32/400701	COMBUSTIBLE	G-296	32/400701
COMBUSTIBLE	G-297	32/400502	AIRE, SIMPLE	GAK-403	32/200406	COMBUSTIBLE	G-296-B	32/400701
ACEITE	GP-3600	02/301217	801.5, 801.6 con motor/PERKINS 103.10			AIRE	GA-360	32/201602
COMBUSTIBLE	G-296-B	32/400701	ACEITE	GP-31	02/100073	AIRE	GA-361	32/202501
COMBUSTIBLE	G-297-B	32/400502	COMBUSTIBLE	G-296	32/400701	806B con motor/FORD 2715E		
4C con motor/A DIESEL 38 T 4 CYL.			COMBUSTIBLE	G-296-B	32/400701	COMBUSTIBLE	G-297-B	32/400502
ACEITE	G-870	988/00038	AIRE, SIMPLE	GAK-403	32/200406	COMBUSTIBLE	GP-68	32/600117
COMBUSTIBLE	G-296	32/400701	8015 con motor/PERKINS 103.10			AIRE	GA-360	32/201602
COMBUSTIBLE	G-296-B	32/400701	ACEITE	GP-31	02/100073	AIRE	GA-361	32/201601
4C con motor/LEYLAND 4.98NT			COMBUSTIBLE	G-296	32/400701	806B con motor/PERKINS 6.354		
ACEITE	G-870	988/00038	COMBUSTIBLE	G-296-B	32/400701	ACEITE	GP-31	02/100073
COMBUSTIBLE	G-296	32/400701	AIRE, SIN ASPAS	GA-403	32/200406	COMBUSTIBLE	G-296	32/400701
COMBUSTIBLE	G-296-B	32/400701	AIRE	GAK-403	32/200406	COMBUSTIBLE	G-296-B	32/400701
COMBUSTIBLE	G-297-B	32/400502	8015 con motor/PERKINS 103.10			AIRE	GA-360	32/201602
COMBUSTIBLE	G-297-B	32/400502	ACEITE	GP-31	02/100073	AIRE	GA-361	32/201601
COMBUSTIBLE	G-296	32/400701	COMBUSTIBLE	G-296	32/400701	806B con motor/PERKINS 6.354		
COMBUSTIBLE	G-297	32/400502	COMBUSTIBLE	G-296-B	32/400701	ACEITE	GP-31	02/100073
COMBUSTIBLE	G-296-B	32/400701	AIRE, SIN ASPAS	GA-403	32/200406	COMBUSTIBLE	G-296	32/400701
COMBUSTIBLE	G-297-B	32/400502	AIRE	GAK-403	32/200406	COMBUSTIBLE	G-296-B	32/400701
COMBUSTIBLE	G-297-B	32/400502	8015 con motor/PERKINS 103.10			AIRE	GA-360	32/201602
COMBUSTIBLE	G-297-B	32/400502	ACEITE	GP-31	02/100073	AIRE	GA-361	32/201601
COMBUSTIBLE	G-296	32/400701	COMBUSTIBLE	G-296	32/400701	806B con motor/PERKINS 6.354		
COMBUSTIBLE	G-297	32/400502	COMBUSTIBLE	G-296-B	32/400701	ACEITE	GP-31	02/100073
COMBUSTIBLE	G-296-B	32/400701	AIRE, SIN ASPAS	GA-403	32/200406	COMBUSTIBLE	G-296	32/400701
COMBUSTIBLE	G-297-B	32/400502	AIRE	GAK-403	32/200406	COMBUSTIBLE	G-296-B	32/400701
COMBUSTIBLE	G-297-B	32/400502	8015 con motor/PERKINS 103.10			AIRE	GA-360	32/201602
COMBUSTIBLE	G-297-B	32/400502	ACEITE	GP-31	02/100073	AIRE	GA-361	32/201601
COMBUSTIBLE	G-296	32/400701	COMBUSTIBLE	G-296	32/400701	806B con motor/PERKINS 6.354		
COMBUSTIBLE	G-297	32/400502	COMBUSTIBLE	G-296-B	32/400701	ACEITE	GP-31	02/100073
COMBUSTIBLE	G-296-B	32/400701	AIRE, SIN ASPAS	GA-403	32/200406	COMBUSTIBLE	G-296	32/400701
COMBUSTIBLE	G-297-B	32/400502	AIRE	GAK-403	32/200406	COMBUSTIBLE	G-296-B	32/400701
COMBUSTIBLE	G-297-B	32/400502	8015 con motor/PERKINS 103.10			AIRE	GA-360	32/201602
COMBUSTIBLE	G-297-B	32/400502	ACEITE	GP-31	02/100073	AIRE	GA-361	32/201601
COMBUSTIBLE	G-296	32/400701	COMBUSTIBLE	G-296	32/400701	806B con motor/PERKINS 6.354		
COMBUSTIBLE	G-297	32/400502	COMBUSTIBLE	G-296-B	32/400701	ACEITE	GP-31	02/100073
COMBUSTIBLE	G-296-B	32/400701	AIRE, SIN ASPAS	GA-403	32/200406	COMBUSTIBLE	G-296	32/400701
COMBUSTIBLE	G-297-B	32/400502	AIRE	GAK-403	32/200406	COMBUSTIBLE	G-296-B	32/400701
COMBUSTIBLE	G-297-B	32/400502	8015 con motor/PERKINS 103.10			AIRE	GA-360	32/201602
COMBUSTIBLE	G-297-B	32/400502	ACEITE	GP-31	02/100073	AIRE	GA-361	32/201601
COMBUSTIBLE	G-296	32/400701	COMBUSTIBLE	G-296	32/400701	806B con motor/PERKINS 6.354		
COMBUSTIBLE	G-297	32/400502	COMBUSTIBLE	G-296-B	32/400701	ACEITE	GP-31	02/100073
COMBUSTIBLE	G-296-B	32/400701	AIRE, SIN ASPAS	GA-403	32/200406	COMBUSTIBLE	G-296	32/400701
COMBUSTIBLE	G-297-B	32/400502	AIRE	GAK-403	32/200406	COMBUSTIBLE	G-296-B	32/400701
COMBUSTIBLE	G-297-B	32/400502	8015 con motor/PERKINS 103.10			AIRE	GA-360	32/201602
COMBUSTIBLE	G-297-B	32/400502	ACEITE	GP-31	02/100073	AIRE	GA-361	32/201601
COMBUSTIBLE	G-296	32/400701	COMBUSTIBLE	G-296	32/400701	806B con motor/PERKINS 6.354		
COMBUSTIBLE	G-297	32/400502	COMBUSTIBLE	G-296-B	32/400701	ACEITE	GP-31	02/100073
COMBUSTIBLE	G-296-B	32/400701	AIRE, SIN ASPAS	GA-403	32/200406	COMBUSTIBLE	G-296	32/400701
COMBUSTIBLE	G-297-B	32/400502	AIRE	GAK-403	32/200406	COMBUSTIBLE	G-296-B	32/400701
COMBUSTIBLE	G-297-B	32/400502	8015 con motor/PERKINS 103.10			AIRE	GA-360	32/201602
COMBUSTIBLE	G-297-B	32/400502	ACEITE	GP-31	02/100073	AIRE	GA-361	32/201601

MARCA-MODELO-MOTOR MAKE-MODEL-ENGINE	GONHER GONHER	OEM OEM	MARCA-MODELO-MOTOR MAKE-MODEL-ENGINE	GONHER GONHER	OEM OEM	MARCA-MODELO-MOTOR MAKE-MODEL-ENGINE	GONHER GONHER	OEM OEM
JCB(J.C. BAMFORD)(continuación)			JCB(J.C. BAMFORD)(continuación)			JCB (J.C. BAMFORD)		
EXCAVADORAS			EXCAVADORAS			MOTORES		
806B, 807B con motor/PERKINS 6.354.4			JS070 con motor/ISUZU 4JB1			AC1 JCB (J.C. BAMFORD) A GASOLINA, AC2 JCB (J.C. BAMFORD) A GASOLINA		
ACEITE	GP-31	02/100073	ACEITE	GP-3985	KNP0065	GASOLINA	GG-48	S1246
COMBUSTIBLE	G-296	32/400701	JS130W, JS150W con motor/ISUZU			JCB (J.C. BAMFORD)		
COMBUSTIBLE	G-296-B	32/400701	AIRE	GA-360	32/201602	NIVELADORAS		
807 con motor/PERKINS 6 CYL.			JS150LC con motor/A DIESEL			1700B con motor/PERKINS		
ACEITE	G-834	1531639	AIRE	GA-892	BRH0282	ACEITE	GP-1	02/100073
COMBUSTIBLE	G-296	32/400701	JS220LC con motor/ISUZU			COMBUSTIBLE	G-296	32/400701
COMBUSTIBLE	G-296-B	32/400701	ACEITE	GP-43	02/800226	COMBUSTIBLE	G-296-B	32/400701
807B con motor/FORD 2715E			JS260 con motor/ISUZU 6B61			JCB (J.C. BAMFORD)		
COMBUSTIBLE	G-297	32/400502	ACEITE	GP-43	1878116380	TRACTORES		
COMBUSTIBLE	G-297-B	32/400502	JS260NLC con motor/ISUZU 6BG1 TPC 01			FASTRAC 1115 con motor/PERKINS 1006.6		
ACEITE	GP-68	32/600117	ACEITE	GP-43	1878116380	ACEITE	GP-31	02/100073
AIRE	GA-360	32/201602	JS300 con motor/ISUZU			COMBUSTIBLE	G-296	32/400701
AIRE	GA-361	32/201601	ACEITE	GP-57	1132410310	COMBUSTIBLE	G-296-B	32/400701
807B con motor/PERKINS 6.354			JS300LC con motor/ISUZU 6RB1T PE-01			COMBUSTIBLE	G-296	32/400701
ACEITE	GP-31	02/100073	COMBUSTIBLE	GPP-11	1132400440	COMBUSTIBLE	G-296-B	32/400701
COMBUSTIBLE	G-296	32/400701	JS300LC con motor/ISUZU 6SDIT PB-01			ACEITE	GP-171	02/100284
COMBUSTIBLE	G-296-B	32/400701	ACEITE	GP-57	02/800003	FASTRAC 115 con motor/PERKINS 1006.6		
AIRE	GA-360	32/201602	JS450 con motor/ISUZU 6RB1TQB			ACEITE	GP-31	02/100073
AIRE	GA-361	32/202501	COMBUSTIBLE	GPP-11	1132400440	COMBUSTIBLE	G-296	32/400701
808D con motor/PERKINS T6.354			JS460L con motor/ISUZU 6RB1T			COMBUSTIBLE	G-296-B	32/400701
ACEITE	GP-31	02/100073	COMBUSTIBLE	GPP-11	1132400440	FASTRAC 125, FASTRAC 130 con motor/PERKINS 1006.6		
COMBUSTIBLE	G-296	32/400701	ROBOT 185 con motor/A DIESEL			ACEITE	GP-1	02/100284
COMBUSTIBLE	G-296-B	32/400701	ACEITE	GP-171	02/100073	ACEITE	GP-31	02/100073
AIRE	GA-360	32/201602	JCB (J.C. BAMFORD)			COMBUSTIBLE	G-296	32/400701
AIRE	GA-361	32/202501	GRÚAS			COMBUSTIBLE	G-296-B	32/400701
811, 812 con motor/PERKINS 6.354			520-55 TELESCOPICA con motor/PERKINS			AIRE	GA-360	32/201602
ACEITE	GP-1	02/100284	COMBUSTIBLE	G-297	32/400502	AIRE	GA-361	32/202501
ACEITE	GP-31	02/100073	525-58 TELESCOPICA, 525-67 TELESCOPICA con motor/PERKINS 1004.4HR			FASTRAC 145 con motor/PERKINS 1006.6 TURBO		
COMBUSTIBLE	G-296	32/400701	COMBUSTIBLE	G-296	32/400701	ACEITE	GP-1	02/100284
COMBUSTIBLE	G-296-B	32/400701	530-67 TELESCOPICA, 530-95 TELESCOPICA con motor/PERKINS 1004.4HR			ACEITE	GP-31	02/100073
AIRE	GA-360	32/201602	COMBUSTIBLE	G-297	32/400502	COMBUSTIBLE	G-296	32/400701
AIRE	GA-361	32/202501	JCB (J.C. BAMFORD)			COMBUSTIBLE	G-297	32/400502
817, 818 con motor/PERKINS 6.354			MONTACARGAS			COMBUSTIBLE	G-296-B	32/400701
ACEITE	GP-1	02/100284	926 con motor/A DIESEL			COMBUSTIBLE	G-296-B	32/400701
COMBUSTIBLE	G-296	32/400701	COMBUSTIBLE	G-297	32/400502	AIRE, PRIMARIO	GA-360	32/201602
COMBUSTIBLE	G-296-B	32/400701	COMBUSTIBLE	G-297-B	32/400502	AIRE, SECUNDARIO	GA-361	32/202501
AIRE	GA-360	32/201602	ACEITE	GP-171	02/100284	FASTRAC 155 con motor/A DIESEL		
AIRE	GA-361	32/201601	TRANSMISION	GP-171	02/100284	ACEITE	GP-9	32/910700
820 con motor/PERKINS 6.354			930, 940 con motor/A DIESEL			COMBUSTIBLE	G-296	32/400701
ACEITE	GP-31	02/100073	COMBUSTIBLE, 2 49/64 IN	G-296	32/400701	COMBUSTIBLE	G-296-B	32/400701
COMBUSTIBLE	G-296	32/400701	COMBUSTIBLE, 4 25/64 IN	G-297	32/400502	AIRE, PRIMARIO	GA-360	32/201602
COMBUSTIBLE	G-296-B	32/400701	COMBUSTIBLE, 2 49/64 IN	G-296-B	32/400701	AIRE, SECUNDARIO	GA-361	32/202501
JCB1 con motor/PETTER AC2			COMBUSTIBLE, 4 25/64 IN	G-297-B	32/400502	FASTRAC 185 con motor/CUMMINS 6BTA5.9		
GASOLINA	GG-48	S1246	COMBUSTIBLE, 2 49/64 IN	GP-171	02/100284	COMBUSTIBLE, SECUNDARIO	GP-1122	02/910155
JCB1 con motor/PETTER PH2			COMBUSTIBLE, 4 25/64 IN	GP-171	02/100284	COMBUSTIBLE, PRIMARIO	GPP-18	02/910155
ACEITE	G-870	988/00038	COMBUSTIBLE, 2 49/64 IN	GP-171	02/100284	ACEITE	GP-178	02/910140
			COMBUSTIBLE, 4 25/64 IN	GP-171	02/100284	AIRE, PRIMARIO	GA-106	32/209101
			TRANSMISION	GP-171	02/100284	AIRE, SECUNDARIO	GA-206	32/209102

SERVICIO PESADO

MARCA-MODELO-MOTOR MAKE-MODEL-ENGINE	GONHER GONHER	OEM OEM	MARCA-MODELO-MOTOR MAKE-MODEL-ENGINE	GONHER GONHER	OEM OEM	MARCA-MODELO-MOTOR MAKE-MODEL-ENGINE	GONHER GONHER	OEM OEM
JCB(J.C. BAMFORD)(continuación)			JOHN DEERE (continuación)			JOHN DEERE (continuación)		
TRACTORES			CARGADORAS			CARGADORAS		
FASTRAC 185-65 con motor/CUMMINS 6BTA5.9			24 con motor/A DIESEL			270 con motor/JOHN DEERE 4045D POWERTECH		
COMBUSTIBLE, SECUNDARIO	GP-1122	02/910155	ACEITE	GP-14	T19044	COMBUSTIBLE	GPP-418	RE62418
COMBUSTIBLE, PRIMARIO	GPP-18	02/910155	COMBUSTIBLE	G-296	AT17387	ACEITE	GP-754	RE59754
ACEITE	GP-178	02/910140	COMBUSTIBLE	G-296-B	AT17387	GASOLINA	GG-5 L	AE29052
FASTRAC 2115, FASTRAC 2135, FASTRAC 2150 con motor/A DIESEL			AIRE	GAK-16	42032381	280 con motor/JOHN DEERE 4045T POWERTECH		
ACEITE	GP-9	32/910700	24 con motor/WISCONSIN VG4D			HIDRAULICO	GP-761H	RE34958
FASTRAC 3185 con motor/A DIESEL			AIRE, SIN ASPAS	GA-33	AH19847	COMBUSTIBLE	GPP-419	RE62419
ACEITE	GP-9	32/910700	240 SERIES II con motor/JOHN DEERE 3029D			ACEITE	GP-754	RE59754
COMBUSTIBLE, SECUNDARIO	GPP-1122	32/912001	ACEITE	GP-14	T19044	AIRE, RADIAL PRIMARIO	GA-853R	KV16429
COMBUSTIBLE, PRIMARIO	GPP-18	02/910155	COMBUSTIBLE	GPP-420	RE60021	LINEA DE COMBUSTIBLE	GG-5 L	AE29052
FASTRAC 3220 con motor/CUMMINS			GASOLINA	GG-5 L	AE29052	300 con motor/A DIESEL		
COMBUSTIBLE	GPP-1122	32/912001	240, 250 con motores/JOHN DEERE 3029D, JOHN DEERE 3029T			HIDRAULICO	G-331	AR75603
JOHN DEERE			ACEITE	GP-14	T19044	TRANSMISION	G-331	AR75603
CAMIONES, TRACTOCAMIONES Y AUTOBUSES			COMBUSTIBLE	GPP-420	RE60021	ACEITE	GP-14	T19044
250D DE VOLTEO, 300D DE VOLTEO con motor/JOHN DEERE 6081H			GASOLINA	GG-5 L	AE29052	COMBUSTIBLE	G-296	AT17387
ACEITE	GP-35	RE57394	244E con motor/A DIESEL			COMBUSTIBLE	G-296-B	AT17387
JOHN DEERE			ACEITE	GP-24	T113883	AIRE	GAK-16	AT20728
CARGADORAS			AIRE, SIN TURBO PRIMARIO	GAK-16	AT20728	300 RETROEXCAVADORA con motor/A DIESEL		
110 RETROEXCAVADORA con motor/JOHN DEERE 2.0 L			AIRE, CON TURBO PRIMARIO	GAK-403	AT44377	HIDRAULICO	G-331	AR75603
TRANSMISION	GP-864H	RE45864	244H con motor/YANMAR 4TNE98			TRANSMISION	G-331	AR75603
125 con motor/A DIESEL			ACEITE	GP-40	M801209	ACEITE	GP-14	T19044
HIDRAULICO	GP-34	AT58368	244J con motor/A DIESEL			COMBUSTIBLE	G-296	AT17387
125 con motor/A GASOLINA			AIRE, RADIAL PRIMARIO	GA-853R	KV16429	COMBUSTIBLE	G-296-B	AT17387
ACEITE	GP-50	HMF600L04340	24A con motor/A DIESEL			AIRE	GAK-16	AT20728
HIDRAULICO	GP-34	GG170-32375	AIRE, SIN ASPAS	GA-33	AH19847	300B con motor/A DIESEL		
AIRE, SIN ASPAS	GA-33	AH19847	24AD con motor/A DIESEL			HIDRAULICO	G-331	AR75603
GASOLINA	GG-5 L	GG420-31259	HIDRAULICO	GP-864H	AT135800	TRANSMISION	G-331	AR75603
14 con motor/ONAN			TRANSMISION	GP-864H	AT135800	ACEITE	GP-14	T19044
HIDRAULICO	GP-66	GG170-32346	AIRE, SIN ASPAS	GA-33	AH19847	COMBUSTIBLE, HASTA S/N 382288	G-296	AT17387
ACEITE	GP-3600	HE122-0800	24AG con motor/A GASOLINA			COMBUSTIBLE, S/N 382288 EN ADELANTE	G-295	AR50041
GASOLINA	GG-5 L	GG420-31259	ACEITE	GP-50	HMF600L04340	COMBUSTIBLE, HASTA S/N 382288	G-296-B	AT17387
170 con motor/A GASOLINA			HIDRAULICO	GP-864H	AT135800	AIRE, PRIMARIO HASTA S/N 386507	GAK-16	AT20728
AIRE, SIN ASPAS	GA-33	AH19847	TRANSMISION	GP-864H	AT135800	AIRE, PRIMARIO DESDE S/N 386507 EN ADELANTE	GAK-216	AR84228
2054 DE TRONCOS con motor/JOHN DEERE 6068T			AIRE	GA-33	AH19847	AIRE, SECUNDARIO DESDE S/N 386507 EN ADELANTE	GA-416	AE31724
COMBUSTIBLE, FILTRO FINAL	GPP-423	RE67901	GASOLINA	GG-5 L	AE29052	300B RETROEXCAVADORA con motor/A DIESEL		
210C RETROEXCAVADORA con motor/A DIESEL			24D con motor/A DIESEL			HIDRAULICO	G-331	AR75603
ACEITE	GP-14	T19044	ACEITE	GP-14	T19044	TRANSMISION	G-331	AR75603
COMBUSTIBLE	G-295	AR50041	COMBUSTIBLE	G-296	AT17387	ACEITE	GP-14	T19044
HIDRAULICO	GP-864H	AT103193	COMBUSTIBLE	G-296-B	AT17387	COMBUSTIBLE, HASTA S/N 382288	G-296	AT17387
AIRE, PRIMARIO	GAK-216	AR84228	AIRE	GAK-16	GG420-32381	COMBUSTIBLE, S/N 382288 EN ADELANTE	G-295	AR50041
AIRE, SECUNDARIO	GA-416	AE31724	24G con motor/A GASOLINA			COMBUSTIBLE, HASTA S/N 382288	G-296-B	AT17387
210E LL con motor/A DIESEL			AIRE, SIN ASPAS	GA-33	AH19847	AIRE, PRIMARIO (HASTA S/N 386506)	GAK-16	AT20728
ACEITE	GP-35	RE57394	2554 DE TRONCOS con motor/JOHN DEERE 6068H			AIRE, PRIMARIO (S/N 386507 EN ADELANTE)	GAK-216	AR84228
210E RETROEXCAVADORA con motor/JOHN DEERE 4045 POWER-TECH			COMBUSTIBLE, FILTRO FINAL	GPP-423	RE67901	AIRE, SECUNDARIO	GA-416	AE31724
COMBUSTIBLE	GPP-418	RE62418	260 con motor/JOHN DEERE 3029T POWERTECH			300D RETROEXCAVADORA con motor/A DIESEL		
210LE con motor/JOHN DEERE 4045 POWERTECH			ACEITE	GP-14	T19044	ACEITE	GP-14	T19044
COMBUSTIBLE, ALGUNOS	GPP-418	RE62418	HIDRAULICO	GP-761H	KV12276	COMBUSTIBLE	G-295	AR50041
COMBUSTIBLE	GPP-419	RE509031	COMBUSTIBLE	GPP-420	RE60021	HIDRAULICO	GP-761H	AT184206
AIRE, RADIAL PRIMARIO	GA-853R	KV16429	AIRE, RADIAL PRIMARIO	GA-853R	KV16429	COMBUSTIBLE, SEPARADOR DE AGUA (S/N 461566 EN ADELANTE)	GPP-419	RE53400
			LINEA DE COMBUSTIBLE	GG-5 L	AE29052	AIRE, SIN TURBO PRIMARIO	GA-403	AT65088

MARCA-MODELO-MOTOR MAKE-MODEL-ENGINE	GONHER GONHER	OEM OEM	MARCA-MODELO-MOTOR MAKE-MODEL-ENGINE	GONHER GONHER	OEM OEM	MARCA-MODELO-MOTOR MAKE-MODEL-ENGINE	GONHER GONHER	OEM OEM
JOHN DEERE (continuación)			JOHN DEERE (continuación)			JOHN DEERE (continuación)		
CARGADORAS			CARGADORAS			CARGADORAS		
301 con motor/A DIESEL			COMBUSTIBLE, HASTA S/N 382288	G-296	AT17387	GASOLINA, LINEA DEL RESPIRADOR DEL TANQUE HIDRAULICO	GG-5 L	AT101565
TRANSMISION	G-331	AR75603	COMBUSTIBLE, S/N 382288 EN ADELANTE	G-295	AR50041	310G con motor/JOHN DEERE 4045D POWERTECH		
ACEITE	GP-14	T19044	COMBUSTIBLE, HASTA S/N 382288	G-296-B	AT17387	COMBUSTIBLE (HASTA S/N 910056 CON TURBO)	GPP-418	RE62418
COMBUSTIBLE	G-296	AT17387	AIRE	GAK-216	AT20728	COMBUSTIBLE (HASTA S/N 911769 SIN TURBO)	GPP-418	RE62418
COMBUSTIBLE	G-296-B	AT17387	302A RETROEXCAVADORA con motor/A DIESEL			COMBUSTIBLE (S/N 910056 EN ADELANTE CON TURBO)	GPP-419	RE509031
AIRE	GAK-16	AR20728	HIDRAULICO	G-331	AR75603	COMBUSTIBLE (S/N 911769 EN ADELANTE SIN TURBO)	GPP-419	RE509031
301 RETROEXCAVADORA con motor/A DIESEL			TRANSMISION	G-331	AR75603	ACEITE (HASTA S/N 910056)	GP-754	RE59754
TRANSMISION	G-331	AR75603	ACEITE	GP-14	T19044	AIRE, RADIAL PRIMARIO	GA-853R	KV16429
ACEITE	GP-14	T19044	COMBUSTIBLE, HASTA S/N 382287 EN ADELANTE	G-296	AT17387	GASOLINA, LINEA DEL RESPIRADOR DEL TANQUE HIDRAULICO	GG-5 L	AT101565
COMBUSTIBLE	G-296	AT17387	COMBUSTIBLE, S/N 382288 EN ADELANTE	G-295	AR50041	310G RETROEXCAVADORA con motor/JOHN DEERE 4045T POWERTECH		
COMBUSTIBLE	G-296-B	AT17387	COMBUSTIBLE, HASTA S/N 382287 EN ADELANTE	G-296-B	AT17387	COMBUSTIBLE, HASTA S/N 93000	GPP-418	RE62418
AIRE	GAK-16	AT20728	AIRE	GAK-16	AT20728	310J, 310SJ, 310TMC con motores/JOHN DEERE 4045D, JOHN DEERE 4045T POWERTECH		
301A con motor/A DIESEL			304J con motor/A DIESEL			COMBUSTIBLE	GPP-419	RE509031
TRANSMISION	G-331	AR75603	AIRE, RADIAL PRIMARIO	GA-853R	KV16429	AIRE, RADIAL PRIMARIO	GA-853R	KV16429
ACEITE	GP-14	T19044	310 RETROEXCAVADORA con motor/A DIESEL			GASOLINA, LINEA DEL RESPIRADOR DEL TANQUE HIDRAULICO	GG-5 L	AT101565
COMBUSTIBLE, HASTA S/N 382288	G-296	AT17387	HIDRAULICO	G-331	AR75603	310SG con motor/JOHN DEERE 4045T POWERTECH		
COMBUSTIBLE, S/N 382288 EN ADELANTE	G-295	AR50041	TRANSMISION	G-331	AR75603	COMBUSTIBLE (HASTA S/N 910056)	GPP-418	RE62418
COMBUSTIBLE, HASTA S/N 382288	G-296-B	AT17387	ACEITE	GP-14	T19044	COMBUSTIBLE (S/N 910056 EN ADELANTE)	GPP-419	RE509031
AIRE, HASTA S/N 386506	GAK-16	AT20728	COMBUSTIBLE	G-296	AT17387	ACEITE (HASTA S/N 910056)	GP-754	RE59754
AIRE, PRIMARIO DESDE S/N 386507 EN ADELANTE	GAK-216	AR84228	COMBUSTIBLE	G-295	AR50041	AIRE, RADIAL PRIMARIO	GA-853R	AT171853
AIRE, SECUNDARIO DESDE S/N 386507 EN ADELANTE	GA-416	AE31724	COMBUSTIBLE	G-296-B	AT17387	GASOLINA, LINEA DEL RESPIRADOR DEL TANQUE HIDRAULICO	GG-5 L	AT101565
301A RETROEXCAVADORA con motor/A DIESEL			AIRE	GAK-16	AT20728	310SG RETROEXCAVADORA con motor/JOHN DEERE 4045D		
HIDRAULICO	G-331	AR75603	310A RETROEXCAVADORA con motor/A DIESEL			COMBUSTIBLE, HASTA S/N 93000	GPP-418	RE62418
TRANSMISION	G-331	AR75603	HIDRAULICO	G-331	AR75603	315C RETROEXCAVADORA, 315CH RETROEXCAVADORA con motor/A DIESEL		
ACEITE	GP-14	T19044	TRANSMISION	G-331	AR75603	ACEITE	GP-14	T19044
COMBUSTIBLE	G-296	AT17387	ACEITE	GP-14	T19044	COMBUSTIBLE	G-295	AR50041
COMBUSTIBLE	G-295	AR50041	COMBUSTIBLE	G-296	AT17387	HIDRAULICO (HASTA S/N 752439)	GP-864H	AT103193
COMBUSTIBLE	G-296-B	AT17387	COMBUSTIBLE	G-295	AR50041	AIRE, PRIMARIO	GA-403	AT65088
AIRE, PRIMARIO (HASTA S/N 386506)	GAK-16	AT20728	COMBUSTIBLE	G-296-B	AT17387	315D RETROEXCAVADORA con motor/A DIESEL		
AIRE, PRIMARIO (S/N 386507 EN ADELANTE)	GAK-216	AR84228	AIRE	GAK-16	AT20728	ACEITE	GP-14	T19044
AIRE, SECUNDARIO	GA-416	AE31724	310B RETROEXCAVADORA con motor/A DIESEL			TRANSMISION	GP-14	T19044
302 con motor/A DIESEL			HIDRAULICO	G-331	AR75603	COMBUSTIBLE, HASTA S/N 461565	G-295	AR50041
TRANSMISION	G-331	AR75603	TRANSMISION	G-331	AR75603	COMBUSTIBLE, S/N 461566 EN ADELANTE	GPP-419	RE62419
ACEITE	GP-14	T19044	ACEITE	GP-14	T19044	AIRE, PRIMARIO	GA-403	AT65088
COMBUSTIBLE, HASTA S/N 382288	G-296	AT17387	COMBUSTIBLE	G-295	AR50041	315SE con motor/A DIESEL		
COMBUSTIBLE, S/N 382288 EN ADELANTE	G-295	AR50041	COMBUSTIBLE	G-296-B	AT17387	COMBUSTIBLE	GPP-418	RE62418
COMBUSTIBLE, HASTA S/N 382288	G-296-B	AT17387	AIRE, PRIMARIO	GAK-16	AT20728	ACEITE	GP-754	RE59754
AIRE	GAK-16	AT20728	310C RETROEXCAVADORA con motor/A DIESEL			AIRE, RADIAL PRIMARIO	GA-853R	AT171853
302 RETROEXCAVADORA con motor/A DIESEL			ACEITE	GP-14	T19044	GASOLINA, LINEA DEL RESPIRADOR DEL TANQUE HIDRAULICO	GG-5 L	AT101565
TRANSMISION	G-331	AR75603	COMBUSTIBLE	G-295	AR50041			
ACEITE	GP-14	T19044	AIRE, PRIMARIO	GA-403	AT65296			
COMBUSTIBLE, HASTA S/N 382287	G-296	AT17387	310D RETROEXCAVADORA con motor/A DIESEL					
COMBUSTIBLE, S/N 382288 EN ADELANTE	G-295	AR50041	ACEITE	GP-14	T19044			
COMBUSTIBLE, HASTA S/N 382287	G-296-B	AT17387	TRANSMISION	GP-14	T19044			
AIRE	GAK-16	AT20728	COMBUSTIBLE, HASTA S/N 461565	G-295	AR50041			
302A con motor/A DIESEL			COMBUSTIBLE, S/N 461566 EN ADELANTE	GPP-419	RE62419			
HIDRAULICO	G-331	AR75603	AIRE, PRIMARIO	GA-403	AT65088			
TRANSMISION	G-331	AR75603	310E RETROEXCAVADORA, 310SE con motor/A DIESEL					
ACEITE	GP-14	T19044	COMBUSTIBLE	GPP-418	RE62418			
			ACEITE	GP-754	RE59754			
			AIRE, RADIAL PRIMARIO	GA-853R	AT171853			

SERVICIO PESADO

MARCA-MODELO-MOTOR MAKE-MODEL-ENGINE	GONHER GONHER	OEM OEM	MARCA-MODELO-MOTOR MAKE-MODEL-ENGINE	GONHER GONHER	OEM OEM	MARCA-MODELO-MOTOR MAKE-MODEL-ENGINE	GONHER GONHER	OEM OEM
JOHN DEERE (continuación)			JOHN DEERE (continuación)			JOHN DEERE (continuación)		
CARGADORAS			CARGADORAS			CARGADORAS		
3155G con motor/JOHN DEERE 4045D POWERTECH			COMBUSTIBLE	G-295	AR50041	350D SOBRE ORUGAS, 355D SOBRE ORUGAS con motor/A DIESEL		
COMBUSTIBLE, HASTA S/N 221706	GPP-418	RE62418	AIRE, PRIMARIO	GAK-403	AT44377	TRANSMISION	G-139	AR26350
						ACEITE	GP-14	T19044
3155G con motor/JOHN DEERE 4045T POWERTECH			344E con motor/A DIESEL			ACEITE, TORNO	GP-14	T19044
COMBUSTIBLE (HASTA S/N 910056)	GPP-418	RE62418	ACEITE	GP-14	T19044	COMBUSTIBLE	G-295	AR50041
COMBUSTIBLE (S/N 910056 EN ADELANTE)	GPP-419	RE509031	COMBUSTIBLE, SEPARADOR DE AGUA	GPP-14	AT81478			
ACEITE (HASTA S/N 910056)	GP-754	RE59754	COMBUSTIBLE	G-270	AR86745	3554 DE TRONCOS con motor/JOHN DEERE 6081H		
AIRE, RADIAL PRIMARIO	GA-853R	KV16429				ACEITE	GP-35	RE57394
GASOLINA, LINEA DEL RESPIRADOR DEL TANQUE HIDRAULICO	GG-5 L	AT101565	344G con motor/JOHN DEERE 4045T					
			ACEITE	GP-14	T19044	375 con motor/A DIESEL		
			COMBUSTIBLE, SEPARADOR DE AGUA	GPP-424	RE62424	ACEITE	GP-91	AM101378
			COMBUSTIBLE	GPP-419	RE62419			
3155J con motor/JOHN DEERE 4045T POWERTECH			344H con motor/JOHN DEERE 4045 POWERTECH			3800 TELESCOPICA con motor/JOHN DEERE 4045 POWERTECH		
COMBUSTIBLE	GPP-419	RE509031	COMBUSTIBLE, S/N 800000 EN ADELANTE	GPP-419	RE62419	COMBUSTIBLE	GPP-419	RE62419
AIRE, RADIAL PRIMARIO	GA-853R	KV16429	COMBUSTIBLE, HASTA S/N 800000	GPP-420	RE60021	400 RETROEXCAVADORA, 401 RETROEXCAVADORA con motor/A DIESEL		
GASOLINA, LINEA DEL RESPIRADOR DEL TANQUE HIDRAULICO	GG-5 L	AT101565	ACEITE	GP-754	RE59754	HIDRAULICO	G-331	AR75603
			AIRE, PRIMARIO	GA-697R	AT222722	TRANSMISION	G-331	AR75603
320 DE TRONCOS con motor/A GASOLINA						ACEITE	GP-14	T19044
GASOLINA	GG-5 L	AE29052	344J con motor/JOHN DEERE 4045 POWERTECH			COMBUSTIBLE	G-296	AT17387
			COMBUSTIBLE	GPP-419	RE509031	COMBUSTIBLE	G-296-B	AT17387
3200 TELESCOPICA con motor/JOHN DEERE 4045TF POWERTECH						AIRE	GAK-16	AT20728
COMBUSTIBLE	GPP-418	RE62418	350 SOBRE ORUGAS con motor/A DIESEL			400, 401 con motor/A DIESEL		
			ACEITE, CONDUCCION EN REVERSA	G-139	AR26350	HIDRAULICO	G-331	AR75603
324H con motor/JOHN DEERE 4045 POWERTECH			ACEITE	GP-14	T19044	TRANSMISION	G-331	AR75603
COMBUSTIBLE	GPP-420	RE60021	ACEITE, TORNO	GP-14	T19044	ACEITE	GP-14	T19044
ACEITE	GP-754	RE59754	COMBUSTIBLE	G-296	AT17387	COMBUSTIBLE	G-296	AT17387
AIRE, PRIMARIO	GA-697R	AT222722	COMBUSTIBLE	G-296-B	AT17387	COMBUSTIBLE	G-296-B	AT17387
			AIRE	GAK-16	AT20728	AIRE	GAK-16	AT20728
324H, 344H con motor/YANMAR 4TNE98						401A con motor/A DIESEL		
ACEITE	GP-6811	M806419	350 SOBRE ORUGAS con motor/A GASOLINA			HIDRAULICO	G-331	AR75603
			HIDRAULICO	G-139	AR26350	TRANSMISION	G-331	AR75603
325 con motor/JOHN DEERE 5030T			TRANSMISION	G-139	AR26350	ACEITE	GP-14	T19044
HIDRAULICO	GP-761H	AT314164	ACEITE	GP-14	T19044	COMBUSTIBLE	G-296	AT17387
AIRE, RADIAL PRIMARIO	GA-853R	KV16429	HIDRAULICO	GP-14	T19044	COMBUSTIBLE	G-295	AR50041
LINEA DE COMBUSTIBLE	GG-5 L	AE29052	AIRE	GAK-16	AT20728	COMBUSTIBLE	G-296-B	AT17387
GASOLINA, RESPIRADOR DEL TANQUE HIDRAULICO	GG-5 L	AT101565				AIRE, HASTA S/N 700323	GAK-16	AT20728
			350B SOBRE ORUGAS con motor/A DIESEL			AIRE, PRIMARIO DESDE S/N 700324 EN ADELANTE	GAK-216	AR84228
328 con motor/JOHN DEERE 5030TW			ACEITE, CONDUCCION EN REVERSA	G-139	AR26350	AIRE, SECUNDARIO DESDE S/N 700324 EN ADELANTE	GA-416	AE31724
HIDRAULICO	GP-761H	AT314164	ACEITE	GP-14	T19044			
AIRE, RADIAL PRIMARIO	GA-853R	KV16429	ACEITE, TORNO	GP-14	T19044	401B con motor/A DIESEL		
LINEA DE COMBUSTIBLE	GG-5 L	AE29052	COMBUSTIBLE, HASTA S/N 191714	G-296	AT17387	TRANSMISION	G-331	AR75603
GASOLINA, RESPIRADOR DEL TANQUE HIDRAULICO	GG-5 L	AT101565	COMBUSTIBLE, S/N 191714 EN ADELANTE	G-295	AR50041	ACEITE	GP-14	T19044
			COMBUSTIBLE, HASTA S/N 191714	G-296-B	AT17387	COMBUSTIBLE, HASTA S/N 529283	G-296	AT17387
332 con motor/JOHN DEERE 5030HW			AIRE	GAK-16	AT20728	COMBUSTIBLE, S/N 529283 EN ADELANTE	G-295	AR50041
HIDRAULICO	GP-761H	AT314164				COMBUSTIBLE, HASTA S/N 529283	G-296-B	AT17387
AIRE, RADIAL PRIMARIO	GA-853R	KV16429	350B SOBRE ORUGAS, 350C SOBRE ORUGAS con motor/A GASOLINA			AIRE, HASTA S/N 700323	GAK-16	AT20728
LINEA DE COMBUSTIBLE	GG-5 L	AE29052	TRANSMISION	G-139	AR26350	AIRE, PRIMARIO DESDE S/N 700324 EN ADELANTE	GAK-216	AR84228
GASOLINA, RESPIRADOR DEL TANQUE HIDRAULICO	GG-5 L	AT101565	ACEITE	GP-14	T19044	AIRE, SECUNDARIO DESDE S/N 700324 EN ADELANTE	GA-416	AE31724
			HIDRAULICO	GP-14	T19044			
335 DE TRONCOS con motor/JOHN DEERE 6068T			AIRE	GAK-16	AT20728	401B RETROEXCAVADORA con motor/A DIESEL		
COMBUSTIBLE, FILTRO FINAL	GPP-419	RE62419				TRANSMISION	G-331	AR75603
			350C SOBRE ORUGAS con motor/A DIESEL			ACEITE	GP-14	T19044
3375 con motor/JOHN DEERE 220 SERIES			TRANSMISION	G-139	AR26350	COMBUSTIBLE, HASTA S/N 529282	G-296	AT17387
ACEITE	GP-91	AM101378	ACEITE	GP-14	T19044	COMBUSTIBLE, S/N 529283 EN ADELANTE	G-295	AR50041
			ACEITE, TORNO	GP-14	T19044	COMBUSTIBLE, HASTA S/N 529283	G-296-B	AT17387
3400 TELESCOPICA con motor/JOHN DEERE 4045TF POWERTECH			COMBUSTIBLE	G-295	AR50041	AIRE, HASTA S/N 700323	GAK-16	AT20728
COMBUSTIBLE	GPP-418	RE62418	AIRE, HASTA S/N 380006	GAK-16	AT20728	AIRE, PRIMARIO DESDE S/N 700324 EN ADELANTE	GAK-216	AR84228
						AIRE, SECUNDARIO DESDE S/N 700324 EN ADELANTE	GA-416	AE31724
340D DE TRONCOS con motor/A DIESEL								
ACEITE	GP-14	T19044						

MARCA-MODELO-MOTOR MAKE-MODEL-ENGINE	GONHER GONHER	OEM OEM	MARCA-MODELO-MOTOR MAKE-MODEL-ENGINE	GONHER GONHER	OEM OEM	MARCA-MODELO-MOTOR MAKE-MODEL-ENGINE	GONHER GONHER	OEM OEM
JOHN DEERE (continuación)			JOHN DEERE (continuación)			JOHN DEERE (continuación)		
CARGADORAS			CARGADORAS			CARGADORAS		
COMBUSTIBLE, HASTA S/N 529282	G-296-B	AT17387	410B RETROEXCAVADORA, 410C RETROEXCAVADORA, 415 RETROEXCAVADORA, 415B RETROEXCAVADORA con motor/A DIESEL			AIRE	GAK-16	AT20728
AIRE, PRIMARIO (HASTA S/N 700323)	GAK-16	AT20728	HIDRAULICO	G-339H	AR94510	440C con motor/A DIESEL		
AIRE, PRIMARIO (S/N 700324 EN ADELANTE)	GAK-216	AR84228	ACEITE	GP-14	T19044	ACEITE	G-331	AR75603
AIRE, SECUNDARIO	GA-416	AE31724	COMBUSTIBLE	G-295	AR50041	ACEITE	GP-14	T19044
			AIRE, PRIMARIO	GA-403	AT65296	COMBUSTIBLE	G-295	AR50041
						AIRE	GAK-403	AT44377
401B SOBRE RUEDAS con motor/A GASOLINA			410D RETROEXCAVADORA con motor/A DIESEL			440D con motor/A DIESEL		
ACEITE	G-331	AR75603	ACEITE	GP-14	T19044	ACEITE	GP-14	T19044
ACEITE	GP-14	T19044	TRANSMISION	GP-14	T19044	COMBUSTIBLE	G-295	AR50041
AIRE	GA-16	AH19852	COMBUSTIBLE	G-295	AR50041	AIRE, PRIMARIO	GAK-403	AT44377
AIRE	GAK-16	AT20728	COMBUSTIBLE, SEPARADOR DE AGUA	GPP-419	RE53400	444 con motor/A DIESEL		
AIRE	GAK-216	AR84228	AIRE, PRIMARIO	GA-403	AT65296	DIRECCION	G-331	AR75603
AIRE	GA-416	AE31724				TRANSMISION	G-331	AR75603
401C con motor/A DIESEL			410E RETROEXCAVADORA con motor/JOHN DEERE 4045T POWER-TECH			ACEITE	GP-14	T19044
HIDRAULICO	G-331	AR75603	COMBUSTIBLE	GPP-418	RE62418	COMBUSTIBLE	G-295	AR50041
TRANSMISION	G-331	AR75603				444C, 444CH con motor/A DIESEL		
ACEITE	GP-14	T19044	410G RETROEXCAVADORA con motor/JOHN DEERE 4045T POWER-TECH			DIRECCION	G-331	AR75603
COMBUSTIBLE, HASTA S/N 382288	G-296	AT17387	COMBUSTIBLE (HASTA S/N 493828)	GPP-418	RE62418	TRANSMISION	G-331	AR75603
COMBUSTIBLE, S/N 382288 EN ADELANTE	G-295	AR50041	COMBUSTIBLE (S/N 493828 EN ADELANTE)	GPP-419	RE509031	ACEITE	GP-14	T19044
COMBUSTIBLE, HASTA S/N 382288	G-296-B	AT17387	ACEITE (HASTA S/N 912000)	GP-754	RE59754	COMBUSTIBLE, SEPARADOR DE AGUA	GPP-14	AT81478
AIRE	GAK-16	AT20728	AIRE, RADIAL PRIMARIO (S/N 926659 EN ADELANTE)	GA-853R	KV16429	COMBUSTIBLE	G-295	AR50041
401C RETROEXCAVADORA con motor/A DIESEL			GASOLINA, LINEA DEL RESPIRADOR DEL TANQUE HIDRAULICO	GG-5 L	AT101565	444D con motor/JOHN DEERE 6239		
HIDRAULICO	G-331	AR75603	410J, 410TMC con motor/JOHN DEERE 4045T POWERTECH			ACEITE	GP-14	T19044
TRANSMISION	G-331	AR75603	COMBUSTIBLE	GPP-419	RE509031	COMBUSTIBLE, SEPARADOR DE AGUA	GPP-14	AT81478
ACEITE	GP-14	T19044	AIRE, RADIAL PRIMARIO	GA-853R	KV16429	COMBUSTIBLE	G-295	AR50041
COMBUSTIBLE, HASTA S/N 382287	G-296	AT17387	GASOLINA, LINEA DEL RESPIRADOR DEL TANQUE HIDRAULICO	GG-5 L	AT101565	HIDRAULICO	GP-864H	AT103193
COMBUSTIBLE, S/N 382288 EN ADELANTE	G-295	AR50041				TRANSMISION	GP-864H	AT103193
COMBUSTIBLE, HASTA S/N 382287	G-296-B	AT17387	435 DE TRONCOS con motor/JOHN DEERE 6068T			444E con motor/A DIESEL		
AIRE	GAK-16	AT20728	COMBUSTIBLE, FILTRO FINAL	GPP-419	RE62419	ACEITE	GP-14	T19044
			440 con motor/A DIESEL			COMBUSTIBLE, SEPARADOR DE AGUA	GPP-14	AT81478
401C SOBRE RUEDAS con motor/A GASOLINA			HIDRAULICO	G-331	AR75603	COMBUSTIBLE	G-270	AR86745
ACEITE	G-331	AR75603	TRANSMISION	G-331	AR75603	444G con motor/JOHN DEERE 4045T		
ACEITE	GP-14	T19044	ACEITE	GP-14	T19044	ACEITE	GP-14	T19044
AIRE	GA-16	AH19852	ACEITE, TORNO	GP-14	T19044	COMBUSTIBLE, SEPARADOR DE AGUA OPCIONAL	GPP-14	AT81478
AIRE	GAK-16	AT20728	COMBUSTIBLE, HASTA S/N 192321	G-296	AT17387	COMBUSTIBLE, SEPARADOR DE AGUA	GPP-424	RE62424
			COMBUSTIBLE, S/N 192322 EN ADELANTE	G-295	AR50041	COMBUSTIBLE	GPP-419	RE62419
401D, 401D RETROEXCAVADORA con motor/A DIESEL			COMBUSTIBLE, HASTA S/N 192321	G-296-B	AT17387	444H, 444H LL, 444HTC con motor/JOHN DEERE 4045T POWERTECH		
HIDRAULICO	G-331	AR75603	AIRE	GAK-16	AT20728	COMBUSTIBLE, PRIMARIO	GPP-424	RE62424
TRANSMISION	G-331	AR75603				COMBUSTIBLE, FILTRO FINAL	GPP-419	RE62419
ACEITE	GP-14	T19044	4400 TELESCOPICA con motor/A DIESEL			COMBUSTIBLE	GPP-420	RE60021
COMBUSTIBLE	G-295	AR50041	ACEITE	GP-14	T19044	ACEITE	GP-754	RE59754
AIRE, PRIMARIO	GAK-216	AR84228	440A, 440B con motor/A DIESEL			AIRE, PRIMARIO	GA-697R	AT222722
AIRE, SECUNDARIO	GA-416	AE31724	HIDRAULICO	G-331	AR75603	444J con motor/JOHN DEERE 4045H		
			TRANSMISION	G-331	AR75603	COMBUSTIBLE, OPCIONAL	GPP-423	RE509032
410 RETROEXCAVADORA con motor/A DIESEL			ACEITE	GP-14	T19044	4475 con motor/JOHN DEERE 220 SERIES		
HIDRAULICO	G-331	AR75603	COMBUSTIBLE, HASTA S/N 382508	G-296	AT17387	ACEITE	GP-149	AM101378
TRANSMISION	G-331	AR75603	COMBUSTIBLE, S/N 382508 EN ADELANTE	G-295	AR50041	AIRE, PRIMARIO	GAK-16	MG86504145
ACEITE	GP-14	T19044	COMBUSTIBLE, HASTA S/N 382508	G-296-B	AT17387	GASOLINA	GG-5 L	AE29052
COMBUSTIBLE	G-295	AR50041	AIRE, HASTA S/N 387066	GAK-16	AT20728	448D con motor/A DIESEL		
AIRE, PRIMARIO	GAK-216	AR84228	AIRE, PRIMARIO DESDE S/N 387067 EN ADELANTE	GAK-216	AR84228	ACEITE	GP-14	T19044
AIRE, SECUNDARIO	GA-416	AE31724	COMBUSTIBLE, S/N 192322 EN ADELANTE	G-295	AR50041	COMBUSTIBLE	G-295	AR50041
			COMBUSTIBLE, HASTA S/N 192321	G-296-B	AT17387			

SERVICIO PESADO

MARCA-MODELO-MOTOR MAKE-MODEL-ENGINE	GONHER GONHER	OEM OEM	MARCA-MODELO-MOTOR MAKE-MODEL-ENGINE	GONHER GONHER	OEM OEM	MARCA-MODELO-MOTOR MAKE-MODEL-ENGINE	GONHER GONHER	OEM OEM
JOHN DEERE (continuación)			JOHN DEERE (continuación)			JOHN DEERE (continuación)		
CARGADORAS			CARGADORAS			CARGADORAS		
AIRE, PRIMARIO	GAK-403	AT44378	ACEITE, CAMBIO DE CUALLO DE TRANSMISION	G-331	AR75603	540A con motor/A DIESEL		
450 SOBRE ORUGAS con motor/A DIESEL			HIDRAULICO	G-331	AR75603	HIDRAULICO	G-331	AR75603
ACEITE	GP-14	T19044	TRANSMISION	G-331	AR75603	TRANSMISION	G-331	AR75603
HIDRAULICO	GP-14	T19044	COMBUSTIBLE, S/N 280001 EN ADELANTE	G-295	AR50041	ACEITE	GP-14	T19044
COMBUSTIBLE	G-296	AT17387	AIRE, SIN PRE LIMPIADOR	GA-403	AR46481	ACEITE, TORNO	GP-14	T19044
COMBUSTIBLE	G-296-B	AT17387				COMBUSTIBLE, HASTA S/N 160726	G-296	AT17387
450 SOBRE ORUGAS con motor/A GASOLINA			500C RETROEXCAVADORA con motor/A DIESEL			COMBUSTIBLE, DESDE S/N 160727	G-295	AR50041
ACEITE	GP-14	T19044	ACEITE	G-139	AR26350	COMBUSTIBLE, HASTA S/N 160726	G-296-B	AT17387
HIDRAULICO	GP-14	T19044	ACEITE, CAMBIO DE CUALLO DE TRANSMISION	G-331	AR75603	AIRE	GAK-403	AT44377
AIRE	GAK-16	AT20728	TRANSMISION	G-331	AR75603	540B con motor/A DIESEL		
4500 TELESCOPICA con motor/A DIESEL			COMBUSTIBLE	G-295	AR50041	HIDRAULICO (HASTA S/N 315074)	G-331	AR75603
ACEITE	GP-14	T19044	AIRE, SIN PRE LIMPIADOR	GA-403	AT65296	TRANSMISION	G-331	AR75603
455D SOBRE ORUGAS con motor/A DIESEL			510 RETROEXCAVADORA con motor/A DIESEL			ACEITE	GP-14	T19044
ACEITE	GP-14	T19044	ACEITE	G-139	AR26350	COMBUSTIBLE	G-295	AR50041
COOLER DE ACEITE	GP-14	T19044	HIDRAULICO	G-331	AR75603	AIRE, PRIMARIO	GAK-403	AT44377
ACEITE, TORNO	GP-14	T19044	TRANSMISION	G-331	AR75603	540D, 548D con motor/A DIESEL		
COMBUSTIBLE	G-295	AR50041	COMBUSTIBLE	G-295	AR50041	ACEITE	GP-14	T19044
455E SOBRE ORUGAS con motor/A DIESEL			AIRE	GA-403	AR46481	ACEITE, TORNO	GP-14	T19044
ACEITE	GP-14	T19044	510B RETROEXCAVADORA con motor/A DIESEL			COMBUSTIBLE	G-295	AR50041
COOLER DE ACEITE	GP-14	T19044	HIDRAULICO	G-339H	AR94510	540E con motor/A DIESEL		
ACEITE, TORNO	GP-14	T19044	ACEITE	GP-14	T19044	ACEITE	GP-14	T19044
COMBUSTIBLE	G-295	AR50041	COMBUSTIBLE	G-295	AR50041	COMBUSTIBLE	G-295	AR50041
AIRE, SIN TURBO PRIMARIO	GA-403	AT65296	AIRE, PRIMARIO	GA-403	AT65296	AIRE, PRIMARIO (S/N 539530 EN ADELANTE)	GA-679	AR79679
455G SOBRE ORUGAS con motor/A DIESEL			510C RETROEXCAVADORA con motor/A DIESEL			AIRE, SECUNDARIO (S/N 539530 EN ADELANTE)	GA-680	AR79680
ACEITE	GP-14	T19044	HIDRAULICO	G-339H	AR94510	540G con motor/JOHN DEERE 6068 SERIES		
COMBUSTIBLE, SEPARADOR DE AGUA	GPP-14	AT81478	ACEITE	GP-14	T19044	COMBUSTIBLE, OPCIONAL (S/N 586337 EN ADELANTE)	GPP-423	RE509032
COMBUSTIBLE	G-295	AR50041	COMBUSTIBLE	G-295	AR50041	COMBUSTIBLE, PRIMARIO (HASTA S/N 586337)	GPP-424	RE62424
AIRE, SIN TURBO PRIMARIO	GA-403	AT65296	AIRE, CON TURBO PRIMARIO	GA-403	AT65296	COMBUSTIBLE	GPP-419	RE62419
460DC, 460DG con motor/JOHN DEERE 6068H			510D RETROEXCAVADORA con motor/A DIESEL			ACEITE, LUBRICACION DEL MOTOR (HASTA S/N 586337)	GP-754	RE59754
AIRE, PRIMARIO	GA-679	AR79679	ACEITE	GP-14	T19044	AIRE, ESTANDAR, PRIMARIO (HASTA S/N 583532)	GA-679	AR79679
460DC, 460DG con motor/JOHN DEERE 6068T			COMBUSTIBLE, SEPARADOR DE AGUA	GPP-419	RE53400	AIRE, ESTANDAR, SECUNDARIO (HASTA S/N 583532)	GA-680	AR79680
COMBUSTIBLE, PRIMARIO	GPP-424	RE62424	AIRE, PRIMARIO	GA-403	AT65296	GASOLINA, RESPIRADOR DEL TANQUE HIDRAULICO	GG-5 L	AT101565
COMBUSTIBLE, FILTRO FINAL	GPP-419	RE62419	515B RETROEXCAVADORA con motor/A DIESEL			540G SERIES II con motor/A DIESEL		
ACEITE	GP-754	RE59754	HIDRAULICO	G-339H	AR94510	COMBUSTIBLE, PRIMARIO	GPP-424	RE62424
AIRE, PRIMARIO	GA-679	AR79679	ACEITE	GP-14	T19044	COMBUSTIBLE, SECUNDARIO	GPP-419	RE62419
AIRE, SECUNDARIO	GA-680	AR79680	COMBUSTIBLE	G-295	AR50041	ACEITE	GP-754	RE59754
500 RETROEXCAVADORA con motor/A DIESEL			AIRE, PRIMARIO	GA-403	AT65296	AIRE, PRIMARIO	GA-679	AR79679
ACEITE	G-139	AR26350	535 DE TRONCOS con motor/JOHN DEERE 6081 POWERTECH			AIRE, SECUNDARIO	GA-680	AR79680
ACEITE, CAMBIO DE CUALLO DE TRANSMISION	G-331	AR75603	COMBUSTIBLE, SEPARADOR DE AGUA	GPP-426	RE65431	540G SERIES III con motor/JOHN DEERE 6068 SERIES		
TRANSMISION	G-331	AR75603	ACEITE	GP-35	RE57394	COMBUSTIBLE, PRIMARIO (MOTOR 6068T)	GPP-424	RE62424
COMBUSTIBLE	GPP-14	AR45097	COMBUSTIBLE	G-270	AR86745	COMBUSTIBLE, FILTRO FINAL (MOTOR 6068T)	GPP-419	RE62419
500A RETROEXCAVADORA con motor/A DIESEL			540 con motor/A DIESEL			ACEITE, MOTOR 6068TDW54	GP-754	RE59754
ACEITE	G-139	AR26350	HIDRAULICO	G-331	AR75603	AIRE, PRIMARIO (HASTA S/N 582802)	GA-679	AR79679
ACEITE, CAMBIO DE CUALLO DE TRANSMISION	G-331	AR75603	TRANSMISION	G-331	AR75603	AIRE, SECUNDARIO (HASTA S/N 582802)	GA-680	AR79680
TRANSMISION	G-331	AR75603	ACEITE	GP-14	T19044	AIRE, PRIMARIO S/N 583532-586336	GA-697R	AT222722
COMBUSTIBLE, HASTA S/N 123114	GPP-14	AR45097	ACEITE, TORNO	GP-14	T19044			
COMBUSTIBLE, S/N 065000 EN ADELANTE	G-295	AR50041	COMBUSTIBLE, HASTA S/N 160726	G-296	AT17387			
AIRE, SIN PRE LIMPIADOR	GA-403	AT65296	COMBUSTIBLE, DESDE S/N 160727	G-295	AR50041			
500B RETROEXCAVADORA con motor/A DIESEL			COMBUSTIBLE, HASTA S/N 160726	G-296-B	AT17387			
ACEITE	G-139	AR26350	AIRE	GAK-403	AT44377			

MARCA-MODELO-MOTOR MAKE-MODEL-ENGINE	GONHER GONHER	OEM OEM	MARCA-MODELO-MOTOR MAKE-MODEL-ENGINE	GONHER GONHER	OEM OEM	MARCA-MODELO-MOTOR MAKE-MODEL-ENGINE	GONHER GONHER	OEM OEM
JOHN DEERE (continuación)			JOHN DEERE (continuación)			JOHN DEERE (continuación)		
CARGADORAS			CARGADORAS			CARGADORAS		
544 con motor/A DIESEL			544G-TC SOBRE RUEDAS con motor/A DIESEL			555A SOBRE ORUGAS, 555B SOBRE ORUGAS con motor/A DIESEL		
DIRECCION	G-331	AR75601	ACEITE	GP-14	T19044	TRANSMISION	G-331	AR75603
TRANSMISION	G-331	AR75601	COMBUSTIBLE	GPP-10035	RE62424	ACEITE	GP-14	T19044
ACEITE	GP-14	T19044	AIRE	GA-3916	T141760	ACEITE, TORNOS	GP-14	T19044
COMBUSTIBLE, HASTA S/N 160681	G-296	AT17387	AIRE	GA-679	AR79679	COMBUSTIBLE	G-295	AR50041
COMBUSTIBLE, S/N 160681 EN ADELANTE	G-295	AR50041	AIRE	GA-680	AR79680	555G SOBRE ORUGAS con motor/A DIESEL		
COMBUSTIBLE, HASTA S/N 160681	G-296-B	AT17387	544H, 544H LL, 544HTC con motor/JOHN DEERE 6068 POWERTECH			ACEITE	GP-14	T19044
544A con motor/A DIESEL			COMBUSTIBLE, SEPARADOR DE AGUA	GPP-424	RE62424	COMBUSTIBLE, SEPARADOR DE AGUA	GPP-14	AT81478
DIRECCION	G-331	AR75601	COMBUSTIBLE	GPP-419	RE62419	COMBUSTIBLE	G-295	AR50041
TRANSMISION	G-331	AR75601	ACEITE	GP-754	RE59754	AIRE, SIN TURBO PRIMARIO	GA-403	AT65296
ACEITE	GP-14	T19044	AIRE, PRIMARIO	GA-697R	AT203469	5575, 7775 con motor/JOHN DEERE 220 SERIES		
COMBUSTIBLE, HASTA S/N 160681	G-296	AT17387	544J con motor/JOHN DEERE 6068H			ACEITE	GP-149	M801209
COMBUSTIBLE, S/N 160681 EN ADELANTE	G-295	AR50041	COMBUSTIBLE, OPCIONAL	GPP-423	RE509032	AIRE, PRIMARIO	GAK-16	RE45825
COMBUSTIBLE, HASTA S/N 160681	G-296-B	AT17387	548E con motor/A DIESEL			GASOLINA	GG-5 L	AE29052
544B con motor/A DIESEL			ACEITE	GP-14	T19044	560D con motor/JOHN DEERE 6081T		
DIRECCION	G-331	AR75603	COMBUSTIBLE, SEPARADOR DE AGUA	GPP-14	AT81478	COMBUSTIBLE, SEPARADOR DE AGUA	GPP-426	RE65431
TRANSMISION	G-331	AR75603	COMBUSTIBLE	G-295	AR50041	ACEITE	GP-35	RE57394
ACEITE	GP-14	T19044	AIRE, PRIMARIO (S/N 539530 EN ADELANTE)	GA-679	AR79679	COMBUSTIBLE	G-270	AR86745
COMBUSTIBLE	G-295	AR50041	AIRE, SECUNDARIO (S/N 539530 EN ADELANTE)	GA-680	AR79680	570 con motor/A GASOLINA		
544C con motor/A DIESEL			548G con motor/JOHN DEERE 6068H			ACEITE	GP-9	MG508129
DIRECCION	G-331	AR75603	COMBUSTIBLE, OPCIONAL (S/N 586337 EN ADELANTE)	GPP-423	RE509032	TRANSMISION	GP-34	636843
TRANSMISION	G-331	AR75603	COMBUSTIBLE, PRIMARIO (HASTA S/N 586337)	GPP-424	RE62424	GASOLINA	GG-4	AM116304
ACEITE	GP-14	T19044	COMBUSTIBLE	GPP-419	RE62419	575 con motor/YANMAR		
COMBUSTIBLE, SEPARADOR DE AGUA	GPP-14	AT81478	ACEITE, LUBRICACION DEL MOTOR (HASTA S/N 586337)	GP-754	RE59754	HIDRAULICO	GP-34	636843
COMBUSTIBLE	G-295	AR50041	AIRE, ESTANDAR, PRIMARIO (HASTA S/N 583532)	GA-679	AR79679	ACEITE	GP-40	M801209
544D con motor/JOHN DEERE 6414T			AIRE, ESTANDAR, SECUNDARIO (HASTA S/N 583532)	GA-680	AR79680	COMBUSTIBLE, SEPARADOR DE AGUA	G-294	AM101004
ACEITE	GP-14	T19044	GASOLINA, RESPIRADOR DEL TANQUE HIDRAULICO	GG-5 L	AT101565	GASOLINA	GG-5 L	AE29052
COMBUSTIBLE, SEPARADOR DE AGUA	GPP-14	AT81478	548G SERIES II con motor/A DIESEL			577A RETROEXCAVADORA con motor/A DIESEL		
COMBUSTIBLE	G-295	AR50041	COMBUSTIBLE, PRIMARIO	GPP-424	RE62424	TRANSMISION	G-331	AR75603
HIDRAULICO (SIN TALADORA)	GP-864H	AT103193	COMBUSTIBLE, SECUNDARIO	GPP-419	RE62419	ACEITE	GP-14	T19044
TRANSMISION	GP-864H	AT103193	ACEITE	GP-754	RE59754	COMBUSTIBLE	G-295	AR50041
544E con motor/A DIESEL			AIRE, PRIMARIO	GA-679	AR79679	60 con motor/A GASOLINA		
ACEITE	GP-14	T19044	AIRE, SECUNDARIO	GA-680	AR79680	HIDRAULICO	GP-36	AM107481
COMBUSTIBLE, SEPARADOR DE AGUA	GPP-14	AT81478	548G SERIES III con motor/JOHN DEERE 6068 SERIES			TRANSMISION	GP-36	AM107481
COMBUSTIBLE	G-295	AR50041	COMBUSTIBLE, PRIMARIO (MOTOR 6068T)	GPP-424	RE62424	ACEITE, S/N 120001 EN ADELANTE	GP-58	AM101207
AIRE, PRIMARIO (S/N 300000 EN ADELANTE)	GA-679	AR79679	COMBUSTIBLE, FILTRO FINAL (MOTOR 6068T)	GPP-419	RE62419	GASOLINA	GG-5 L	AE29052
AIRE, SECUNDARIO (S/N 300000 EN ADELANTE)	GA-680	AR79680	ACEITE, MOTOR 6068TDW54	GP-754	RE59754	600 con motor/A DIESEL		
544E-TC SOBRE RUEDAS con motor/A DIESEL			AIRE, PRIMARIO	GA-679	AR79679	ACEITE	G-139	AR26350
ACEITE	GP-14	T19044	AIRE, SECUNDARIO	GA-680	AR79680	TRANSMISION	G-331	AR75603
COMBUSTIBLE	G-295	AR50041	AIRE, PRIMARIO S/N 583532-586336	GA-697R	AT222722	COMBUSTIBLE, HASTA S/N 215000	GPP-14	AT81478
AIRE	GA-679	AR79679	555 SOBRE ORUGAS con motor/A DIESEL			AIRE	GAK-20	AR36044
AIRE	GA-680	AR79680	TRANSMISION	G-331	AR75603	600 RETROEXCAVADORA con motor/A DIESEL		
544G con motor/JOHN DEERE 6059T			ACEITE	GP-14	T19044	ACEITE, CARTUCHO	G-139	AR28110R
ACEITE	GP-14	T19044	ACEITE, TORNOS	GP-14	T19044	DIRECCION	G-331	AR75603
ACEITE, VUELTA DE LA CERRADURA DEL DIFERENCIAL	GP-14	T19044	COMBUSTIBLE	G-295	AR50041	TRANSMISION	G-331	AR75603
COMBUSTIBLE, SEPARADOR DE AGUA	GPP-424	RE62424	AIRE, PRIMARIO	GA-403	AT65296	ACEITE, SELLADO	GP-14	T19044
COMBUSTIBLE	GPP-419	RE62419	555 SOBRE ORUGAS con motor/A DIESEL			COMBUSTIBLE, PRIMARIO	GPP-14	AR45097
AIRE, PRIMARIO	GA-679	AR79679	TRANSMISION	G-331	AR75603	COMBUSTIBLE	G-296	AT17387
AIRE, SECUNDARIO	GA-680	AR79680	ACEITE	GP-14	T19044	COMBUSTIBLE	G-296-B	AT17387
			ACEITE, TORNOS	GP-14	T19044	AIRE	GAK-403	AR39799
			COMBUSTIBLE	G-295	AR50041	AIRE	GAK-20	AR36044
			AIRE, PRIMARIO	GA-403	AT65296			

SERVICIO PESADO

MARCA-MODELO-MOTOR MAKE-MODEL-ENGINE	GONHER GONHER	OEM OEM	MARCA-MODELO-MOTOR MAKE-MODEL-ENGINE	GONHER GONHER	OEM OEM	MARCA-MODELO-MOTOR MAKE-MODEL-ENGINE	GONHER GONHER	OEM OEM
JOHN DEERE (continuación)			JOHN DEERE (continuación)			JOHN DEERE (continuación)		
CARGADORAS			CARGADORAS			CARGADORAS		
600 RETROEXCAVADORA con motor/A GASOLINA			AIRE, ESTANDAR, SECUNDARIO (HASTA S/N 582802)	GA-680	AR79680	644G con motor/JOHN DEERE 6076		
DIRECCION	G-331	AR75603	GASOLINA, RESPIRADOR DEL TANQUE HIDRAULICO	GG-5 L	AT101565	ACEITE, VUELTA DE LA CERRADURA DEL DIFERENCIAL	GP-14	T19044
TRANSMISION	G-331	AR75603				COMBUSTIBLE, SEPARADOR DE AGUA	GPP-426	RE62423
ACEITE	GP-14	T19044	640G SERIES II con motor/A DIESEL			ACEITE	GP-35	AR101278
AIRE	GAK-403	AR39799	COMBUSTIBLE, PRIMARIO	GPP-424	RE62424	COMBUSTIBLE	G-270	RE27091
			COMBUSTIBLE, SECUNDARIO	GPP-419	RE62419			
605C con motor/A DIESEL			ACEITE	GP-754	RE59754	644H con motor/JOHN DEERE 6081 POWERTECH		
HIDRAULICO	GP-761H	T175002	AIRE, PRIMARIO	GA-679	AR79679	COMBUSTIBLE, SEPARADOR DE AGUA (HASTA S/N 2000)	GPP-426	RE65431
COMBUSTIBLE	GPP-419	RE509031	AIRE, SECUNDARIO	GA-680	AR79680	ACEITE	GP-35	RE57394
AIRE, PRIMARIO	GA-697R	AT222722				COMBUSTIBLE, HASTA S/N 2000	G-270	AR86745
			644 con motor/A DIESEL					
610B RETROEXCAVADORA con motor/A DIESEL			DIRECCION	G-331	AR75603	648 con motor/A DIESEL		
ACEITE	GP-14	T19044	TRANSMISION	G-331	AR75603	ACEITE	GP-14	T19044
COMBUSTIBLE	G-295	AR50041	ACEITE	GP-34	AR43634			
AIRE, PRIMARIO	GA-403	AT65296	COMBUSTIBLE, S/N 280000 EN ADELANTE	G-295	AR50041			
						648D DE TRONCOS con motor/A DIESEL		
610C RETROEXCAVADORA con motor/A DIESEL			644A con motor/A DIESEL			ACEITE	GP-14	T19044
ACEITE	GP-14	T19044	DIRECCION	G-331	AR75603			
COMBUSTIBLE	G-295	AR50041	TRANSMISION	G-331	AR75603	648E con motor/A DIESEL		
AIRE, CON TURBO PRIMARIO	GA-403	AT65296	ACEITE	GP-34	AR43634	ACEITE	GP-14	T19044
			COMBUSTIBLE, S/N 280000 EN ADELANTE	G-295	AR50041	COMBUSTIBLE, SEPARADOR DE AGUA	GPP-14	AT81478
624E, 640E con motor/A DIESEL			644B con motor/A DIESEL			COMBUSTIBLE	G-295	AR50041
ACEITE	GP-14	T19044	DIRECCION	G-331	AR75603	AIRE, PRIMARIO	GA-679	AR79679
COMBUSTIBLE, SEPARADOR DE AGUA	GPP-14	AT81478	TRANSMISION	G-331	AR75603	AIRE, SECUNDARIO	GA-680	AR79680
COMBUSTIBLE	G-295	AR50041	ACEITE	GP-34	AR43634			
AIRE, PRIMARIO	GA-679	AR79679	COMBUSTIBLE, S/N 280000 EN ADELANTE	G-295	AR50041	648G con motor/JOHN DEERE 6068 SERIES		
AIRE, SECUNDARIO	GA-680	AR79680				COMBUSTIBLE, OPCIONAL (S/N 586337 EN ADELANTE)	GPP-423	RE509032
			644C con motor/A DIESEL			COMBUSTIBLE, PRIMARIO (HASTA S/N 586337)	GPP-424	RE62424
624G con motor/JOHN DEERE 6068T			DIRECCION	G-331	AR75603	COMBUSTIBLE	GPP-419	RE62419
ACEITE	GP-14	T19044	TRANSMISION	G-331	AR75603	ACEITE, LUBRICACION DEL MOTOR (HASTA S/N 586337)	GP-754	RE59754
ACEITE, VUELTA DE LA CERRADURA DEL DIFERENCIAL	GP-14	T19044	ACEITE	GP-34	AR43634	AIRE, ESTANDAR, PRIMARIO (HASTA S/N 582802)	GA-679	AR79679
COMBUSTIBLE, SEPARADOR DE AGUA	GPP-424	RE62424	COMBUSTIBLE, S/N 248523	GP-34	AR43634	AIRE, ESTANDAR, SECUNDARIO (HASTA S/N 582802)	GA-680	AR79680
COMBUSTIBLE	GPP-419	RE62419	COMBUSTIBLE, HASTA S/N 241582	G-295	AR50041	GASOLINA, RESPIRADOR DEL TANQUE HIDRAULICO	GG-5 L	AT101565
AIRE, PRIMARIO	GA-679	AR79679	ACEITE, S/N 248524 EN ADELANTE	GP-35	AR101278			
AIRE, SECUNDARIO	GA-680	AR79680	COMBUSTIBLE, S/N 241583 EN ADELANTE	G-270	AR86745	648G con motor/JOHN DEERE 6076		
						ACEITE, HASTA S/N 701060	GP-14	T19044
624H, 624H LL con motor/JOHN DEERE 6068 POWERTECH			644D con motor/JOHN DEERE 6466T			COMBUSTIBLE	G-295	AR50041
COMBUSTIBLE, SEPARADOR DE AGUA	GPP-424	RE62424	COMBUSTIBLE, SEPARADOR DE AGUA	GPP-14	AT81478	ACEITE, S/N 701060 EN ADELANTE	GP-754	RE59754
COMBUSTIBLE, FILTRO FINAL	GPP-419	RE62419	ACEITE	GP-35	AR101278	AIRE, PRIMARIO	GA-679	AR79679
ACEITE	GP-754	RE59754	TRANSMISION	GP-864H	AT103193	AIRE, SECUNDARIO	GA-680	AR79680
			COMBUSTIBLE	G-270	AR86745			
624J con motor/JOHN DEERE 6068H			644E con motor/A DIESEL			648G SERIES II con motor/A DIESEL		
COMBUSTIBLE	GPP-423	RE509032	COMBUSTIBLE, SEPARADOR DE AGUA	GPP-14	AT81478	COMBUSTIBLE, PRIMARIO	GPP-424	RE62424
			ACEITE	GP-35	AR101278	COMBUSTIBLE, SECUNDARIO	GPP-419	RE62419
640 con motor/A DIESEL			TRANSMISION	GP-864H	AT103193	ACEITE	GP-754	RE59754
HIDRAULICO	G-331	AR75603	COMBUSTIBLE	G-270	AR86745	AIRE, PRIMARIO	GA-679	AR79679
TRANSMISION	G-331	AR75603				AIRE, SECUNDARIO	GA-680	AR79680
ACEITE	GP-14	T19044	644ER con motor/A DIESEL					
COMBUSTIBLE	G-295	AR50041	ACEITE	GP-35	RE57394	648G SERIES III con motor/JOHN DEERE 6068 SERIES		
						COMBUSTIBLE, PRIMARIO (MOTOR 6068T)	GPP-424	RE62424
640D con motor/A DIESEL			ACEITE, VUELTA DE LA CERRADURA DEL DIFERENCIAL	GP-35	AR101278	COMBUSTIBLE, FILTRO FINAL (MOTOR 6068T)	GPP-419	RE62419
ACEITE	GP-14	T19044	COMBUSTIBLE	G-270	AR86745	ACEITE, MOTOR 6068T	GP-754	RE59754
			AIRE, PRIMARIO (S/N 536538 EN ADELANTE)	GA-679	AR79679	AIRE, PRIMARIO (HASTA S/N 582802)	GA-679	AR79679
640G con motor/JOHN DEERE 6068 SERIES			AIRE, SECUNDARIO (S/N 536538 EN ADELANTE)	GA-680	AR79680	AIRE, SECUNDARIO (HASTA S/N 582802)	GA-680	AR79680
COMBUSTIBLE, OPCIONAL (S/N 586337 EN ADELANTE)	GPP-423	RE509032						
COMBUSTIBLE, PRIMARIO (HASTA S/N 586337)	GPP-424	RE62424						
COMBUSTIBLE	GPP-419	RE62419						
ACEITE, LUBRICACION DEL MOTOR (HASTA S/N 586337)	GP-754	RE59754						
AIRE, ESTANDAR, PRIMARIO (HASTA S/N 582802)	GA-679	AR79679						

MARCA-MODELO-MOTOR MAKE-MODEL-ENGINE	GONHER GONHER	OEM OEM	MARCA-MODELO-MOTOR MAKE-MODEL-ENGINE	GONHER GONHER	OEM OEM	MARCA-MODELO-MOTOR MAKE-MODEL-ENGINE	GONHER GONHER	OEM OEM
JOHN DEERE (continuación)			JOHN DEERE (continuación)			JOHN DEERE (continuación)		
CARGADORAS			CARGADORAS			CARGADORAS		
655 SOBRE ORUGAS con motor/A DIESEL			710G RETROEXCAVADORA con motor/JOHN DEERE 4045 POWER-TECH			COMBUSTIBLE, SELLADO SEPARADOR DE AGUA	GPP-426	RE62423
ACEITE	GP-14	T19044	COMBUSTIBLE, PRE-FILTRO	GPP-424	RE516477	ACEITE, DOBLE FLUJO	GP-3000	RE44647
COMBUSTIBLE	G-295	AR50041	COMBUSTIBLE, FILTRO FINAL	GPP-419	RE509031	COMBUSTIBLE	G-270	RE27091
TRANSMISION	GP-864H	AT135800	AIRE, PRIMARIO	GA-697R	AT222722	COMBUSTIBLE, CARTUCHO SEPARADOR DE AGUA	2010PM-OR	RE11325
655B SOBRE ORUGAS con motor/A DIESEL			710J RETROEXCAVADORA con motor/JOHN DEERE 6068T POWER-TECH			744H con motor/JOHN DEERE 6125A POWERTECH		
ACEITE	GP-14	T19044	COMBUSTIBLE	GPP-419	RE509031	HIDRAULICO	GP-14	T19044
COMBUSTIBLE	G-295	AR50041	724J con motor/JOHN DEERE 6081 POWERTECH			744H MH, 824J con motor/A DIESEL		
TRANSMISION (HASTA S/N 731274)	GP-864H	AT135800	COMBUSTIBLE, SEPARADOR DE AGUA (HASTA S/N 2000)	GPP-426	RE65431	HIDRAULICO	GP-14	T19044
655C SERIES II SOBRE ORUGAS con motor/LIEBHERR D924T			ACEITE	GP-35	RE57394	744J con motor/JOHN DEERE 6125 POWERTECH		
AGUA, SISTEMA DE ENFRIAMIENTO	GP-1010Q	WF2072	COMBUSTIBLE, HASTA S/N 2000	G-270	AR86745	HIDRAULICO	GP-14	T19044
655C SOBRE ORUGAS con motor/LIEBHERR D924T			740 con motor/A DIESEL			748E con motor/A DIESEL		
AGUA	GP-1011Q	AR94650	HIDRAULICO (HASTA S/N 291775)	G-331	AR75603	COMBUSTIBLE, SEPARADOR DE AGUA	GPP-14	AT81478
6675 con motor/JOHN DEERE 220 SERIES			TRANSMISION	G-331	AR75603	ACEITE	GP-35	RE57394
AIRE, PRIMARIO	GAK-16	RE45825	ACEITE	GP-34	AR43634	COMBUSTIBLE	G-270	RE27091
675 con motor/A DIESEL			ACEITE, HASTA S/N 248524	GP-34	AR43634	AIRE, PRIMARIO	GA-679	AR79679
HIDRAULICO	GP-34	MG9800097	COMBUSTIBLE, HASTA S/N 299564	G-295	AR50041	AIRE, SECUNDARIO	GA-680	AR79680
ACEITE	GP-149	M801209	ACEITE, S/N 248524 EN ADELANTE	GP-35	AR101278	748G con motor/JOHN DEERE 6076		
COMBUSTIBLE	G-294	AM101004	COMBUSTIBLE, S/N 299564 EN ADELANTE	G-270	AR86745	COMBUSTIBLE, SEPARADOR DE AGUA (HASTA S/N 552273)	GPP-14	AT81478
GASOLINA, SEPARADOR DE AGUA	GG-5 L	AE29052	AIRE, PRIMARIO	GA-826	AT44631	COMBUSTIBLE, SEPARADOR DE AGUA (S/N 552273 EN ADELANTE)	GPP-424	RE62424
675B con motor/A DIESEL			AIRE, PRIMARIO (S/N 218117 EN ADELANTE)	GA-826	AT44631	ACEITE	GP-754	RE59754
HIDRAULICO	GP-34	MG9800097	AIRE, SECUNDARIO	GA-827	AT44632	COMBUSTIBLE	G-270	RE27091
ACEITE	GP-149	M801209	AIRE, SECUNDARIO (S/N 218117 EN ADELANTE)	GA-827	AT44632	AIRE, PRIMARIO (HASTA S/N 559115)	GA-679	AR79679
COMBUSTIBLE	G-294	AM101004	740A DE TRONCOS con motor/A DIESEL			AIRE, SECUNDARIO (HASTA S/N 559115)	GA-680	AR79680
GASOLINA, SEPARADOR DE AGUA	GG-5 L	AE29052	ACEITE, HASTA S/N 248523	GP-34	AR43634	748G SERIES II con motor/JOHN DEERE 6081		
70 con motor/ONAN			COMBUSTIBLE, HASTA S/N 241582	G-295	AR50041	COMBUSTIBLE, SEPARADOR DE AGUA (HASTA S/N 552273)	GPP-14	AT81478
ACEITE	GP-3600	HE122-0800	ACEITE, S/N 248524 EN ADELANTE	GP-35	AR101278	COMBUSTIBLE	GPP-426	RE65431
700 RETROEXCAVADORA con motor/A DIESEL			COMBUSTIBLE, S/N 241583 EN ADELANTE	G-270	AR86745	ACEITE	GP-35	RE57394
ACEITE	G-331	AR75603	AIRE, PRIMARIO	GA-826	AT44631	COMBUSTIBLE, SEPARADOR DE AGUA (S/N 552273 EN ADELANTE)	GPP-424	RE62424
TRANSMISION	G-331	AR75603	AIRE, SECUNDARIO	GA-827	AT44632	AIRE, PRIMARIO (HASTA S/N 559115)	GA-679	AR79679
COMBUSTIBLE, PRIMARIO	GPP-14	AR33926R	740E con motor/A DIESEL			AIRE, SECUNDARIO (HASTA S/N 559115)	GA-680	AR79680
COMBUSTIBLE	G-296	AT17387	COMBUSTIBLE, SEPARADOR DE AGUA	GPP-14	AT81478	748G SERIES III con motor/JOHN DEERE 6081T		
COMBUSTIBLE	G-295	AR50041	ACEITE	GP-35	RE57394	COMBUSTIBLE, SEPARADOR DE AGUA	GPP-14	AT81478
COMBUSTIBLE	G-296-B	AT17387	COMBUSTIBLE	G-270	RE27091	ACEITE, SELLADO	GP-35	RE57394
AIRE, HASTA S/N 24037	GAK-20	AR36044	AIRE, PRIMARIO	GA-679	AR79679	COMBUSTIBLE, SEPARADOR DE AGUA	GPP-424	RE62424
700A RETROEXCAVADORA con motor/A DIESEL			AIRE, SECUNDARIO	GA-680	AR79680	COMBUSTIBLE	G-270	RE27091
ACEITE	G-331	AR75603	740G con motor/A DIESEL			AIRE, PRIMARIO	GA-679	AR79679
COMBUSTIBLE	GPP-14	AR33926R	COMBUSTIBLE, SEPARADOR DE AGUA	GPP-14	AT81478	AIRE, SECUNDARIO	GA-680	AR79680
COMBUSTIBLE	G-296	AT17387	ACEITE	GP-35	RE57394	755 SOBRE ORUGAS, 755A SOBRE ORUGAS con motor/A DIESEL		
COMBUSTIBLE	G-295	AR50041	COMBUSTIBLE, SEPARADOR DE AGUA	GPP-424	RE62424	ACEITE	GP-14	T19044
COMBUSTIBLE	G-296-B	AT17387	COMBUSTIBLE	G-270	RE27091	COMBUSTIBLE	G-295	AR50041
710B RETROEXCAVADORA, 710C RETROEXCAVADORA con motor/A DIESEL			AIRE, PRIMARIO	GA-679	AR79679	TRANSMISION	GP-864H	AT135800
ACEITE	GP-14	T19044	AIRE, SECUNDARIO	GA-680	AR79680	755B SOBRE ORUGAS con motor/A DIESEL		
710D RETROEXCAVADORA con motor/A DIESEL			744E con motor/A DIESEL			ACEITE	GP-14	T19044
ACEITE	GP-14	T19044	ACEITE, FLUJO TOTAL (FULL FLOW)	GP-53	RE45576	COMBUSTIBLE	G-295	AR50041
COMBUSTIBLE	G-295	AR50041				TRANSMISION (HASTA S/N 731274)	GP-864H	AT135800
COMBUSTIBLE	GPP-419	RE62419						
710E RETROEXCAVADORA con motor/A DIESEL								
ACEITE	GP-14	T19044						

SERVICIO PESADO

MARCA-MODELO-MOTOR MAKE-MODEL-ENGINE	GONHER GONHER	OEM OEM	MARCA-MODELO-MOTOR MAKE-MODEL-ENGINE	GONHER GONHER	OEM OEM	MARCA-MODELO-MOTOR MAKE-MODEL-ENGINE	GONHER GONHER	OEM OEM
JOHN DEERE (continuación)			JOHN DEERE (continuación)			JOHN DEERE (continuación)		
CARGADORAS			COMBINADAS			COMBINADAS		
755C SOBRE ORUGAS con motor/LIEBHERR D926T			1055 (ENSAMBLADO EN ALEMANIA), 1065, 1065(ENSAMBLADO EN ALEMANIA), 1068(ENSAMBLADO EN ALEMANIA), 1068H, 1075 (ENSAMBLADO EN ALEMANIA), 1166 (ENSAMBLADO EN ALEMANIA), 1169H (ENSAMBLADO EN ALEMANIA), 1174 (ENSAMBLADO EN ALEMANIA), 1174H4 (ENSAMBLADO EN ALEMANIA) con motor/A DIESEL			AIRE, SIN ASPAS	GA-33	AH19847
HIDRAULICO	GP-66	HF7968	ACEITE	GP-14	T19044	AIRE	GAK-16	AT20728
830 RETROEXCAVADORA con motor/A DIESEL			1085, 1085 H4 (HYDRO 4) con motor/A DIESEL			3300 con motor/JOHN DEERE 219 DH		
ACEITE	G-331	AR75603	HIDRAULICO	GP-66	AZ22878	ACEITE, SELLADO	GP-14	T19044
84 con motor/A DIESEL			111 PEANUT con motor/A DIESEL			COMBUSTIBLE	G-296	AT17387
ACEITE	GP-24	T1113883	AIRE	GAK-16	AT20728	COMBUSTIBLE	G-295	AR50041
844 con motor/A DIESEL			1165, 1175 con motor/A DIESEL			COMBUSTIBLE	G-296-B	AT17387
GASOLINA, SEPARADOR DE AGUA (HASTA S/N 506810)	G-293	AR86755	ACEITE, HASTA S/N 45001	GP-14	T19044	AIRE	GAK-403	AT44377
ACEITE, FLUJO TOTAL (FULL FLOW)	GP-34	AR43634	COMBUSTIBLE	GPP-419	RE64450	3300 con motor/JOHN DEERE 219 GH		
ACEITE	GP-35	RE57394	ACEITE, S/N 45001 EN ADELANTE	GP-754	RE59754	ACEITE, SELLADO	GP-14	T19044
ACEITE, FLUJO TOTAL (FULL FLOW)	GP-35	RE46380	1175H con motor/A DIESEL			COMBUSTIBLE	G-296	AT17387
COMBUSTIBLE	G-270	AR86745	ACEITE, HASTA S/N 45001	GP-14	T19044	COMBUSTIBLE	G-296-B	AT17387
COMBUSTIBLE, SEPARADOR DE AGUA (S/N 506810 EN ADELANTE)	2010PM-OR	RE11325	COMBUSTIBLE	GPP-419	RE64450	AIRE	GAK-16	AT20728
848G con motor/CUMMINS 6CTA8.3			ACEITE, S/N 45001 EN ADELANTE	GP-754	RE59754	4270D con motor/A DIESEL		
ACEITE, DOBLE FLUJO	GP-3000	RE44647	1177 (ENSAMBLADO EN ALEMANIA) con motor/A DIESEL			COMBUSTIBLE	G-295	AR50041
848G con motor/JOHN DEERE 6081 POWERTECH			ACEITE	GP-14	T19044	4400 con motor/JOHN DEERE 292		
COMBUSTIBLE, SEPARADOR DE AGUA	GPP-426	RE65431	COMBUSTIBLE	G-295	AR50041	ACEITE	GP-3	TY9429
ACEITE	GP-35	RE57394	HIDRAULICO	GP-66	AZ22878	AIRE, HASTA S/N 250500	GAK-403	AT44377
COMBUSTIBLE	G-270	AR86745	1177H (ENSAMBLADO EN ALEMANIA) con motor/A DIESEL			AIRE, S/N 250501 EN ADELANTE	GAK-20	AR36044
855 SOBRE ORUGAS con motor/A DIESEL			HIDRAULICO	GP-66	AZ22878	4400 con motor/JOHN DEERE 6329DH		
ACEITE, FLUJO TOTAL (FULL FLOW)	GP-35	AR101278	ACEITE	GP-35	AR101278	ACEITE	GP-14	T19044
TRANSMISION	GP-864H	AT135800	COMBUSTIBLE	G-270	AR86745	COMBUSTIBLE	G-295	AR50041
COMBUSTIBLE	G-270	AR86745	1188 (ENSAMBLADO EN ALEMANIA) con motor/A DIESEL			COMBUSTIBLE	G-270	AR86745
875 con motor/JOHN DEERE 3029T			HIDRAULICO	GP-66	AZ22878	AIRE, HASTA S/N 250500	GAK-403	AT44377
ACEITE	GP-14	T19044	ACEITE	GP-35	RE57394	AIRE, S/N 250501 EN ADELANTE	GAK-20	AR36044
COMBUSTIBLE	GPP-418	RE64449	COMBUSTIBLE	G-270	AR86745	4400 SERIES con motor/GMC 6 CYL 292		
AIRE, PRIMARIO	GAK-458	MG86512356	12 con motor/A DIESEL			ACEITE, 3 45/64 IN	GP-3	TY9429
AIRE, SECUNDARIO	GA-459	RE45828	ACEITE, SELLADO	GP-14	T19044	ACEITE, 5 13/32 IN	GP-13	TY9430
GASOLINA	GG-5 L	AE29052	AIRE, SIN ASPAS	GA-33	AH19847	AIRE, HASTA S/N 250501	GAK-403	AT44377
90 con motor/A GASOLINA			AIRE	GAK-16	AT20728	AIRE, S/N 250501 EN ADELANTE	GAK-20	AR36044
HIDROESTATICO	GP-864H	AT135800	1460 con motor/A DIESEL			4400 SERIES con motor/JOHN DEERE 303		
CT332 con motor/JOHN DEERE 5030TW			COMBUSTIBLE, PRIMARIO	GP-1101	158172	HIDRAULICO	G-331	AR75603
HIDRAULICO	GP-761H	AT314164	ACEITE	GP-69	LF3421	ACEITE	GP-14	T19044
AIRE, RADIAL PRIMARIO	GA-853R	KV16429	COMBUSTIBLE, SECUNDARIO	GP-78	MG508129	COMBUSTIBLE	G-295	AR50041
LINEA DE COMBUSTIBLE	GG-5 L	AE29052	162 con motor/A DIESEL			COMBUSTIBLE	G-296-B	AT17387
GASOLINA, LINEA DEL RESPIRADOR DEL TANQUE	GG-5 L	AT101565	AIRE, CON ASPAS	GAK-403	AH20488	COMBUSTIBLE, S/N 237163 EN ADELANTE	G-270	AR86745
HIDRAULICO			2054 con motor/A DIESEL			AIRE, HASTA S/N 250500	GAK-403	AT44377
JOHN DEERE			ACEITE	GP-14	T19044	AIRE, S/N 250501 EN ADELANTE	GAK-20	AR36044
COMBINADAS			2056, 2058 con motor/A DIESEL			4400 SERIES con motores/JOHN DEERE 219, JOHN DEERE 329		
105 con motor/A DIESEL			ACEITE	GP-35	RE46380	ACEITE	GP-14	T19044
ACEITE, MOTORES JOHN DEERE	GP-14	T19044	2064, 2066 con motor/JOHN DEERE 6076 POWERTECH			COMBUSTIBLE	G-270	AR86745
COMBUSTIBLE	G-296	AT17387	ACEITE	GP-35	RE57394	AIRE	GAK-20	AR36044
COMBUSTIBLE	G-296-B	AT17387	25, 30, 40 con motor/A DIESEL			4425 con motor/JOHN DEERE 6359		
AIRE, MOTORES A GASOLINA	GAK-403	AH20488	ACEITE, SELLADO	GP-14	T19044	ACEITE	GP-14	T19044
AIRE, 9 15/16 IN DIAM. EXT.	GAK-20	AR36044				COMBUSTIBLE	G-295	AR50041
						HIDRAULICO	GP-66	AZ22878
						COMBUSTIBLE	G-270	AR86745

MARCA-MODELO-MOTOR MAKE-MODEL-ENGINE	GONHER GONHER	OEM OEM	MARCA-MODELO-MOTOR MAKE-MODEL-ENGINE	GONHER GONHER	OEM OEM	MARCA-MODELO-MOTOR MAKE-MODEL-ENGINE	GONHER GONHER	OEM OEM
JOHN DEERE (continuación)			JOHN DEERE (continuación)			JOHN DEERE (continuación)		
COMBINADAS			COMBINADAS			COMBINADAS		
4435 con motor/A DIESEL			AIRE, S/N 16501-305672	GAK-20	AR36044	7745 con motor/A DIESEL		
ACEITE	GP-14	T19044	AIRE, PRIMARIO (S/N 305673 EN ADELANTE)	GA-679	AR79679	ACEITE	GP-14	T19044
COMBUSTIBLE	G-295	AR50041	AIRE, SECUNDARIO (S/N 305673 EN ADELANTE)	GA-680	AR79680	COMBUSTIBLE	G-295	AR50041
HIDRAULICO	GP-66	AZ22878				AIRE, PRIMARIO	GA-679	AR79679
			6602 con motor/JOHN DEERE 362 GASOLINA			AIRE, SECUNDARIO	GA-680	AR79680
4435 HYDRO con motor/A DIESEL			ACEITE	GP-14	T19044	915 con motor/A DIESEL		
ACEITE	GP-14	T19044				COMBUSTIBLE, PRIMARIO	GP-1101	158172
COMBUSTIBLE	G-295	AR50041	6602 con motor/JOHN DEERE 6404TH			ACEITE	GP-69	LF3421
HIDRAULICO	GP-66	AZ22878	ACEITE	GP-34	AR43634	COMBUSTIBLE, SECUNDARIO	GP-78	MG508129
			COMBUSTIBLE	G-295	AR50041	AIRE, PRIMARIO	GA-361	AR46004
45 con motor/A DIESEL			AIRE, PRIMARIO	GA-679	AR79679	9400 con motor/A DIESEL		
ACEITE, SELLADO	GP-14	T19044	AIRE, SECUNDARIO	GA-680	AR79680	ACEITE, HASTA S/N 337246	GP-14	T19044
COMBUSTIBLE	G-296	AT17387				COMBUSTIBLE, SEPARADOR DE AGUA	GPP-14	AT81478
COMBUSTIBLE	G-296-B	AT17387	6602 con motor/JOHN DEERE 6466TH			HIDRAULICO	GP-761H	AH128449
AIRE	GAK-16	AT20728	ACEITE	GP-34	AR43634	COMBUSTIBLE, S/N 337246 EN ADELANTE	GPP-419	RE62419
			COMBUSTIBLE	G-270	AR86745	ACEITE, S/N 337246 EN ADELANTE	GP-754	RE59754
55 con motor/A DIESEL			AIRE, PRIMARIO	GA-679	AR79679	COMBUSTIBLE, HASTA S/N 337246	G-270	AR86745
ACEITE, SELLADO	GP-14	T19044	AIRE, SECUNDARIO	GA-680	AR79680			
COMBUSTIBLE	G-296	AT17387				9410 con motor/A DIESEL		
COMBUSTIBLE	G-296-B	AT17387	6620, 6622 con motor/A DIESEL			DIRECCION	GP-761H	AH128449
AIRE, 5 9/32 IN DIAM. EXT.	GAK-16	AT20728	ACEITE, HASTA S/N 298393	GP-34	AR43634	TRANSMISION	GP-761H	AH128449
AIRE, 6 1/16 IN DIAM. EXT.	GAK-403	AH20847	ACEITE, S/N 298393 EN ADELANTE	GP-35	RE57394	COMBUSTIBLE	GPP-419	RE62419
			COMBUSTIBLE	G-270	AR86745	ACEITE	GP-754	RE59754
6510 MAXIMIZER con motor/A DIESEL			AIRE, PRIMARIO	GA-679	AR79679	AIRE, SECUNDARIO	GA-723R	RE63932
AIRE, PRIMARIO	GA-221R	RE63931	AIRE, SECUNDARIO	GA-680	AR79680			
						9410 MAXIMIZER con motor/JOHN DEERE 6081		
6600 LEVEL LAND con motor/JOHN DEERE 6329DH			7000 con motor/A DIESEL			COMBUSTIBLE, SEPARADOR DE AGUA	GPP-14	AT81478
ACEITE	GP-14	T19044	ACEITE	GP-34	AR43634	ACEITE	GP-35	RE57394
COMBUSTIBLE	G-296	AT17387	COMBUSTIBLE	G-295	AR50041	COMBUSTIBLE	GPP-419	RE62419
COMBUSTIBLE, S/N 422365 EN ADELANTE	G-295	AR50041	AIRE, PRIMARIO	GA-679	AR79679	AIRE, PRIMARIO	GA-221R	AH148880
COMBUSTIBLE	G-296-B	AT17387	AIRE, SECUNDARIO	GA-680	AR79680	AIRE, SECUNDARIO	GA-723R	RE63932
AIRE	GAK-20	AR36044						
			7700 con motor/JOHN DEERE 362GH			942 (ENSAMBLADO EN ALEMANIA) con motor/A DIESEL		
6600 LEVEL LAND con motor/JOHN DEERE 6329GH			ACEITE	GP-14	T19044	ACEITE	GP-14	T19044
ACEITE	GP-14	T19044	COMBUSTIBLE	G-295	AR50041			
COMBUSTIBLE	G-295	AR50041	HIDRAULICO	GP-166	AT60645	9450 con motor/JOHN DEERE 6068 POWERTECH		
AIRE	GAK-403	AT44377	AIRE, PRIMARIO (S/N 163901 EN ADELANTE)	GAK-20	AR36044	COMBUSTIBLE, SEPARADOR DE AGUA	GPP-1291	RE500186
						COMBUSTIBLE	GPP-419	RE62419
6600 LEVEL LAND con motor/JOHN DEERE 6404DH			7700 con motor/JOHN DEERE 6404DH			ACEITE	GP-754	RE59754
ACEITE	GP-34	AR43634	ACEITE	GP-34	AR43634			
COMBUSTIBLE	G-295	AR50041	COMBUSTIBLE	G-295	AR50041	95 con motor/JOHN DEERE		
AIRE	GAK-20	AR36044	AIRE	GAK-20	AR36044	ACEITE, SELLADO	GP-14	T19044
						COMBUSTIBLE	G-296	AT17387
6600 LEVEL LAND con motor/JOHN DEERE HD-303G			7700 con motor/JOHN DEERE 6404TH			COMBUSTIBLE	G-296-B	AT17387
ACEITE	GP-14	T19044	ACEITE	GP-34	AR43634	AIRE, HASTA S/N 35000	GAK-16	AT20728
COMBUSTIBLE	G-295	AR50041	COMBUSTIBLE	G-295	AR50041	AIRE, S/N 35000 EN ADELANTE	GAK-403	AT44377
AIRE	GAK-403	AT44377	AIRE, PRIMARIO	GA-679	AR79679			
			AIRE, SECUNDARIO	GA-680	AR79680	9500 con motor/A DIESEL		
6600 SERIES con motor/A GASOLINA						COMBUSTIBLE, SEPARADOR DE AGUA	GPP-14	AT81478
ACEITE	GP-14	T19044	7720 con motor/JOHN DEERE 6466A			ACEITE	GP-35	RE57394
			ACEITE, HASTA S/N 298393	GP-34	AR43634	HIDRAULICO	GP-761H	RE39527
6600 SERIES con motor/JOHN DEERE 329			ACEITE, S/N 298393 EN ADELANTE	GP-35	RE57394	TRANSMISION	GP-761H	RE39527
ACEITE	GP-14	T19044	COMBUSTIBLE	G-270	AR86745	COMBUSTIBLE	G-270	AR86745
COMBUSTIBLE, HASTA S/N 237163	G-296	AT17387	AIRE, PRIMARIO	GA-679	AR79679			
COMBUSTIBLE, S/N 237163 EN ADELANTE	G-295	AR50041	AIRE, SECUNDARIO	GA-680	AR79680	9500 SIDE HILL con motor/A DIESEL		
COMBUSTIBLE, HASTA S/N 237163	G-296-B	AT17387				COMBUSTIBLE, SEPARADOR DE AGUA	GPP-14	AT81478
AIRE	GAK-20	AR36044	7722, 8820 con motor/A DIESEL			ACEITE	GP-35	RE57394
			ACEITE, HASTA S/N 298393	GP-34	AR43634	HIDRAULICO	GP-761H	RE39527
6600 SIDE HILL con motor/JOHN DEERE 404			ACEITE, S/N 298393 EN ADELANTE	GP-35	RE57394	TRANSMISION	GP-761H	RE39527
ACEITE	GP-34	AR43634	COMBUSTIBLE	G-270	AR86745	COMBUSTIBLE	G-270	AR86745
COMBUSTIBLE	G-295	AR50041						

SERVICIO PESADO

MARCA-MODELO-MOTOR MAKE-MODEL-ENGINE	GONHER GONHER	OEM OEM	MARCA-MODELO-MOTOR MAKE-MODEL-ENGINE	GONHER GONHER	OEM OEM	MARCA-MODELO-MOTOR MAKE-MODEL-ENGINE	GONHER GONHER	OEM OEM
JOHN DEERE (continuación)			JOHN DEERE (continuación)			JOHN DEERE (continuación)		
COMBINADAS			COMBINADAS			COMBINADAS		
COMBUSTIBLE	G-270	AR86745	9560STS con motor/JOHN DEERE 8.1L			CTS II con motor/A DIESEL		
9510 MAXIMIZER, 9510SH con motor/A DIESEL			AIRE, PRIMARIO	GA-221R	AH148880	COMBUSTIBLE	GPP-14	AT81478
COMBUSTIBLE, SEPARADOR DE AGUA	GPP-14	AT81478	960 (ENSAMBLADO EN ALEMANIA) con motor/A DIESEL			ACEITE	GP-35	RE57394
ACEITE	GP-35	RE57394	ACEITE	GP-14	T19044	HIDRAULICO	GP-761H	AH128449
HIDRAULICO	GP-761H	RE39527	COMBUSTIBLE	G-295	AR50041	COMBUSTIBLE	G-270	RE27091
TRANSMISION	GP-761H	RE39527	AIRE	GAK-20	AR36044	AIRE, PRIMARIO	GA-221R	RE63931
COMBUSTIBLE	G-270	AR86745				AIRE, SECUNDARIO	GA-723R	RE63932
AIRE, PRIMARIO	GA-221R	AH148880	9600 con motor/JOHN DEERE 6076 POWERTECH			CTS RICE con motor/A DIESEL		
AIRE, SECUNDARIO	GA-723R	RE63932	COMBUSTIBLE, SEPARADOR DE AGUA	GPP-14	AT81478	COMBUSTIBLE, SEPARADOR DE AGUA	GPP-14	AT81478
955 (ENSAMBLADO EN ALEMANIA) con motor/A DIESEL			ACEITE	GP-35	RE57394	ACEITE	GP-35	RE57394
ACEITE	GP-14	T19044	HIDRAULICO	GP-761H	AH128449	HIDRAULICO	GP-761H	AH128449
COMBUSTIBLE	G-295	AR50041	TRANSMISION	GP-761H	AH128449	COMBUSTIBLE	G-270	RE27091
AIRE SIMPLE HASTA S/N 014054	GAK-20	AR36044	COMBUSTIBLE	G-270	RE27091			
9550 con motor/JOHN DEERE 6068 POWERTECH			9610 con motor/A DIESEL			JOHN DEERE		
COMBUSTIBLE	GPP-423	RE509032	COMBUSTIBLE, SEPARADOR DE AGUA	GPP-14	AT81478	COMPACTADORAS		
COMBUSTIBLE, SEPARADOR DE AGUA CON PURGADOR	GPP-1291	RE500186	ACEITE	GP-35	RE57394	646, 646B con motor/A DIESEL		
HIDRAULICO (CAJA DE ENGRANES)	GP-761H	AH128449	COMBUSTIBLE	G-270	AR86745	DIRECCION	G-331	AR75603
HIDRAULICO (REQUIERE 2)	GP-761H	AH128449	AIRE, PRIMARIO	GA-221R	AH148880	TRANSMISION	G-331	AR75603
AIRE, RADIAL, PRIMARIO	GA-221R	AH148880	AIRE, SECUNDARIO	GA-723R	RE63932	ACEITE, HASTA S/N 223645	GP-34	AR43634
AIRE, RADIAL, SECUNDARIO	GA-723R	RE63932	965 (ENSAMBLADO EN ALEMANIA), 975 (ENSAMBLADO EN ALEMANIA) con motor/A DIESEL			COMBUSTIBLE	G-295	AR50041
COMBUSTIBLE, SEPARADOR DE AGUA CON ROSCA PARA TAZON	R 90 P	RE500186	ACEITE	GP-14	T19044	ACEITE, S/N 223645 EN ADELANTE	GP-35	AR101278
9550 con motor/JOHN DEERE 6081			COMBUSTIBLE	G-295	AR50041	646C con motor/A DIESEL		
ACEITE	GP-35	RE57394	HIDRAULICO	GP-66	AZ22878	DIRECCION	G-331	AR75603
COMBUSTIBLE, SEPARADOR DE AGUA	GPP-1291	RE500186	9650, 9750 con motor/JOHN DEERE 6081 POWERTECH			TRANSMISION	G-331	AR75603
COMBUSTIBLE	G-270	AR86745	ACEITE	GP-35	RE57394	COMBUSTIBLE, SEPARADOR DE AGUA	GPP-14	AT81478
AIRE, PRIMARIO	GA-221R	AH148880	COMBUSTIBLE, SEPARADOR DE AGUA	GPP-1291	RE500186	ACEITE, HASTA S/N 223645	GP-34	AR43634
AIRE, SECUNDARIO	GA-723R	RE63932	COMBUSTIBLE	G-270	AR86745	COMBUSTIBLE, HASTA S/N 299563	G-295	AR50041
9550 SIDE HILL con motor/JOHN DEERE 6068 POWERTECH			AIRE, PRIMARIO	GA-221R	AH148880	ACEITE, S/N 223645 EN ADELANTE	GP-35	AR101278
COMBUSTIBLE, SEPARADOR DE AGUA	GPP-1291	RE500186	AIRE, SECUNDARIO	GA-723R	RE63932	AGUA, HASTA S/N 256120	GP-1011Q	AR94650
AIRE, PRIMARIO	GA-221R	AH148880	9650CTS con motor/JOHN DEERE 6081 POWERTECH			COMBUSTIBLE, S/N 299564 EN ADELANTE	G-270	AR86745
AIRE, SECUNDARIO	GA-732R	RE63932	ACEITE, HASTA S/N 202102	GP-35	RE57394			
9550 SIDE HILL con motor/JOHN DEERE 6081			COMBUSTIBLE, SEPARADOR DE AGUA	GPP-1291	RE500186	JOHN DEERE		
ACEITE	GP-35	RE57394	COMBUSTIBLE, HASTA S/N 20000	G-270	RE509672	EQUIPO FORESTAL		
COMBUSTIBLE, SEPARADOR DE AGUA	GPP-1291	RE500186	AIRE, PRIMARIO	GA-221R	AH148880	1010D con motor/JOHN DEERE 4045H		
COMBUSTIBLE	G-270	AR86745	AIRE, SECUNDARIO	GA-732R	RE63932	COMBUSTIBLE	GPP-419	RE509031
AIRE, PRIMARIO	GA-221R	AH148880	9650STS con motor/JOHN DEERE 6081 POWERTECH			1058 con motor/CUMMINS 4BTA3.9		
AIRE, SECUNDARIO	GA-723R	RE63932	ACEITE, HASTA S/N 695984	GP-35	RE57394	AIRE, PRIMARIO	GA-697R	F434072
9560 con motor/JOHN DEERE 6068HH			TANQUE DE COMBUSTIBLE (HASTA S/N 695501)	GPP-1291	RE500186	1110D con motor/JOHN DEERE 6068H		
COMBUSTIBLE, SEPARADOR DE AGUA	GPP-423	RE509032	COMBUSTIBLE, HASTA S/N 20000	G-270	AR86745	AIRE, PRIMARIO	GA-697R	F434072
HIDRAULICO (REQUIERE 2)	GP-761H	AH128449	AIRE, PRIMARIO	GA-221R	AH148880	317 con motor/A GASOLINA		
TRANSMISION	GP-761H	AH128449	AIRE, SECUNDARIO	GA-723R	RE63932	GASOLINA	GG-5 L	AE29052
AIRE, RADIAL, PRIMARIO	GA-221R	AH148880	9660STS con motor/JOHN DEERE 6081 POWERTECH			360DC, 360DG con motor/JOHN DEERE 6068T		
AIRE, RADIAL, SECUNDARIO	GA-723R	RE63932	AIRE, PRIMARIO	GA-221R	AH148880	COMBUSTIBLE, PRIMARIO	GPP-424	RE62424
9560SH con motor/JOHN DEERE 6068HH			9750STS con motor/JOHN DEERE 6081 POWERTECH			COMBUSTIBLE, FILTRO FINAL	GPP-419	RE62419
COMBUSTIBLE, SEPARADOR DE AGUA	GPP-423	RE509032	ACEITE, HASTA S/N 695866	GP-35	RE57394	ACEITE	GP-754	RE59754
HIDRAULICO (REQUIERE 2)	GP-761H	AH128449	COMBUSTIBLE, SEPARADOR DE AGUA	GPP-1291	RE500186	AIRE, PRIMARIO HASTA S/N 583392	GA-679	AR79679
TRANSMISION	GP-761H	AH128449	COMBUSTIBLE	G-270	AR86745	AIRE, SECUNDARIO HASTA S/N 583392	GA-680	AR79680
AIRE, RADIAL, PRIMARIO	GA-221R	AH148880	985, 985 HYDRO 4 con motor/A DIESEL			AIRE, PRIMARIO, S/N 583392-586336	GA-697R	AT222722
AIRE, RADIAL, SECUNDARIO	GA-723R	RE63932	ACEITE	GP-14	T19044			

MARCA-MODELO-MOTOR MAKE-MODEL-ENGINE	GONHER GONHER	OEM OEM	MARCA-MODELO-MOTOR MAKE-MODEL-ENGINE	GONHER GONHER	OEM OEM	MARCA-MODELO-MOTOR MAKE-MODEL-ENGINE	GONHER GONHER	OEM OEM
JOHN DEERE (continuación)			JOHN DEERE (continuación)			JOHN DEERE (continuación)		
EQUIPO FORESTAL			EQUIPO FORESTAL			EQUIPO FORESTAL		
440 con motor/A DIESEL			693C con motor/A DIESEL			810D con motor/JOHN DEERE 4045H		
HIDRAULICO	G-331	AR75603	ACEITE	GP-35	AR101278	COMBUSTIBLE	GPP-419	RE509031
TRANSMISION	G-331	AR75603	COMBUSTIBLE	G-270	AR86745			
ACEITE	GP-14	T19044	AIRE, PRIMARIO	GA-679	AR79679	843G con motor/JOHN DEERE 6068T		
COMBUSTIBLE	G-296	AT17387	AIRE, SECUNDARIO	GA-680	AR79680	COMBUSTIBLE, PRIMARIO	GPP-14	AT81478
COMBUSTIBLE	G-295	AR50041				COMBUSTIBLE, PRIMARIO	GPP-424	RE62424
COMBUSTIBLE	G-296-B	AT17387	693D con motor/A DIESEL			COMBUSTIBLE, FILTRO FINAL	GPP-419	RE62419
AIRE	GAK-16	AT20728	ACEITE	GP-14	T19044	ACEITE	GP-754	RE59754
			COMBUSTIBLE	GP-1122	AR50041	AIRE, PRIMARIO	GA-679	AR79679
493D con motor/A DIESEL			AIRE, PRIMARIO	GA-679	AR79679	AIRE, SECUNDARIO	GA-680	AR79680
COMBUSTIBLE	G-295	AR50041	AIRE, SECUNDARIO	GA-680	AR79680			
						843H con motor/JOHN DEERE 6068H POWERTECH		
643 con motor/A DIESEL			743 con motor/A DIESEL			COMBUSTIBLE, SEPARADOR DE AGUA (HASTA S/N 882117)	GPP-14	AT81478
ACEITE	GP-14	T19044	HIDRAULICO (HASTA S/N 228395)	G-331	AR75603	COMBUSTIBLE, SEPARADOR DE AGUA (S/N 882117 EN ADELANTE)	GPP-424	RE62424
			TRANSMISION	G-331	AR75603	COMBUSTIBLE	GPP-419	RE62419
643D con motor/A DIESEL			ACEITE, HASTA S/N 248524	GP-34	AR43634	ACEITE	GP-754	RE59754
ACEITE	GP-14	T19044	COMBUSTIBLE, HASTA S/N 241583	G-295	AR50041	AIRE, ESTANDAR, PRIMARIO (HASTA S/N 882092)	GA-679	AR79679
COMBUSTIBLE, SEPARADOR DE AGUA	GPP-14	AT81478	ACEITE, S/N 248524 EN ADELANTE	GP-35	RE57394	AIRE, ESTANDAR, SECUNDARIO (HASTA S/N 882092)	GA-680	AR79680
COMBUSTIBLE	G-295	AR50041	COMBUSTIBLE, S/N 241583 EN ADELANTE	G-270	AR86745	AIRE, RADIAL, PRIMARIO (S/N 882092 EN ADELANTE)	GA-966R	AT178516
AIRE, PRIMARIO	GA-679	AR79679	AIRE, PRIMARIO	GA-826	AT44631	AIRE, RADIAL, SECUNDARIO (S/N 882092 EN ADELANTE)	GA-967R	AT178517
AIRE, SECUNDARIO	GA-680	AR79680	AIRE, SECUNDARIO	GA-827	AT44632			
						843J con motor/JOHN DEERE 6068H POWERTECH		
643G con motor/JOHN DEERE 6068T			743A con motor/A DIESEL			COMBUSTIBLE	GPP-423	RE509032
COMBUSTIBLE, PRIMARIO	GPP-14	AT81478	ACEITE, HASTA S/N 248524	GP-34	AR43634			
COMBUSTIBLE, PRIMARIO	GPP-424	RE62424	COMBUSTIBLE, HASTA S/N 241583	G-295	AR50041	853G con motor/CUMMINS 6CTA8.3 ENG.		
COMBUSTIBLE, FILTRO FINAL	GPP-419	RE62419	ACEITE, S/N 248524 EN ADELANTE	GP-35	RE57394	AIRE, SECUNDARIO (S/N 3055 EN ADELANTE)	GA-930R	RE51629
ACEITE	GP-754	RE59754	COMBUSTIBLE, S/N 241583 EN ADELANTE	G-270	AR86745			
AIRE, PRIMARIO	GA-679	AR79679	AIRE, PRIMARIO	GA-826	AT44631	JOHN DEERE		
AIRE, SECUNDARIO	GA-680	AR79680	AIRE, SECUNDARIO	GA-827	AT44632	EXCAVADORAS		
						110 con motor/JOHN DEERE 4045 POWERTECH		
643H con motor/JOHN DEERE 6068T POWERTECH			753G con motor/CUMMINS 6CT8.3			COMBUSTIBLE	GPP-419	RE62419
COMBUSTIBLE, SEPARADOR DE AGUA	GPP-14	AT81478	ACEITE, DOBLE FLUJO	GP-3001	3401544			
COMBUSTIBLE	GPP-419	RE62419				120 con motor/A DIESEL		
ACEITE	GP-754	RE59754	753G con motor/CUMMINS 6CTA8.3			COMBUSTIBLE, SEPARADOR DE AGUA	GPP-424	RE62424
AIRE, PRIMARIO	GA-679	AR79679	COMBUSTIBLE, SECUNDARIO	GP-1122	AR50041	COMBUSTIBLE	GPP-419	RE62419
AIRE, SECUNDARIO	GA-680	AR79680				ACEITE	GP-754	RE59754
			753GH con motor/CUMMINS 6CT8.3					
643J con motor/JOHN DEERE 6068H POWERTECH			ACEITE, DOBLE FLUJO	GP-3001	3401544	135C RTS con motor/ISUZU CC-48G1T		
COMBUSTIBLE	GPP-423	RE509032				AIRE, RADIAL PRIMARIO (S/N 300004 EN ADELANTE)	GA-853R	KV16429
			753GH con motor/CUMMINS 6CTA8.3					
653E con motor/A DIESEL			COMBUSTIBLE, SECUNDARIO	GP-1122	AR50041	15 con motor/YANMAR		
ACEITE	GP-14	T19044				ACEITE	GP-91	M806418
COMBUSTIBLE, SEPARADOR DE AGUA	GPP-424	RE62424	753GL con motor/CUMMINS 6CT8.3					
COMBUSTIBLE	GPP-419	RE62419	ACEITE, DOBLE FLUJO	GP-3001	3401544	160LC con motor/A DIESEL		
AIRE, PRIMARIO	GA-679	AR79679				COMBUSTIBLE, SEPARADOR DE AGUA	GPP-424	RE62424
AIRE, SECUNDARIO	GA-680	AR79680	753GLH con motor/CUMMINS 6CT8.3			COMBUSTIBLE	GPP-419	RE62419
			ACEITE, DOBLE FLUJO	GP-3001	3401544	ACEITE	GP-754	RE59754
653G con motor/JOHN DEERE 6068 POWERTECH								
COMBUSTIBLE, SEPARADOR DE AGUA	GPP-14	AT81478	753GLH con motor/CUMMINS 6CTA8.3			190E con motor/A DIESEL		
COMBUSTIBLE	GPP-419	RE62419	COMBUSTIBLE, SECUNDARIO	GP-1122	AR50041	ACEITE	GP-14	T19044
ACEITE	GP-754	RE59754				COMBUSTIBLE	G-295	AR50041
AIRE, PRIMARIO	GA-679	AR79679	753GLH con motor/CUMMINS 6CT8.3			COMBUSTIBLE	GPP-424	RE62424
AIRE, SECUNDARIO	GA-680	AR79680	ACEITE, DOBLE FLUJO	GP-3001	3401544			
658E con motor/JOHN DEERE 6068T			753GLH con motor/CUMMINS 6CTA8.3					
ACEITE	GP-14	T19044	COMBUSTIBLE, SECUNDARIO	GP-1122	AR50041	200C LC con motor/JOHN DEERE 6068H		
						COMBUSTIBLE, FILTRO FINAL	GPP-423	RE67901
693B con motor/A DIESEL			793D con motor/A DIESEL					
ACEITE, HASTA S/N 588854	GP-34	AR43634	ACEITE	GP-35	AR101278			
ACEITE, S/N 588854 EN ADELANTE	GP-35	AR101278	COMBUSTIBLE	G-270	AR86745			
COMBUSTIBLE	G-270	AR86745	AIRE, SECUNDARIO	GA-398	AT81019			

SERVICIO PESADO

MARCA-MODELO-MOTOR MAKE-MODEL-ENGINE	GONHER GONHER	OEM OEM	MARCA-MODELO-MOTOR MAKE-MODEL-ENGINE	GONHER GONHER	OEM OEM	MARCA-MODELO-MOTOR MAKE-MODEL-ENGINE	GONHER GONHER	OEM OEM
JOHN DEERE (continuación)			JOHN DEERE (continuación)			JOHN DEERE (continuación)		
EXCAVADORAS			EXCAVADORAS			EXCAVADORAS		
200LC con motor/JOHN DEERE 6068T			450LC con motor/JOHN DEERE 6101A			690E LC con motor/JOHN DEERE 6068T		
COMBUSTIBLE, SEPARADOR DE AGUA	GPP-426	RE65431	COMBUSTIBLE	GPP-426	RE65431	ACEITE	GP-14	T19044
COMBUSTIBLE	GPP-419	RE62419	ACEITE, DOBLE FLUJO	GP-3000	RE44647	COMBUSTIBLE, SEPARADOR DE AGUA	GPP-14	AT81478
ACEITE	GP-754	RE59754	COMBUSTIBLE	G-270	RE27091	COMBUSTIBLE	G-295	AR50041
			490 con motor/JOHN DEERE 4239T			COMBUSTIBLE, SEPARADOR DE AGUA	GPP-426	RE62423
230C LC, 270C LC con motor/JOHN DEERE 6068H			ACEITE	GP-14	T19044	MANAGER DE COMBUSTIBLE	GPP-419	RE62419
COMBUSTIBLE, FILTRO FINAL	GPP-423	RE67901				ACEITE	GP-754	RE59754
			490D, 495D con motor/A DIESEL			AIRE, PRIMARIO	GA-679	AR79679
230LC con motor/JOHN DEERE 6068H			ACEITE	GP-14	T19044	AIRE, SECUNDARIO	GA-680	AR79680
COMBUSTIBLE, SEPARADOR DE AGUA	GPP-426	RE65431	490E con motor/A DIESEL					
ACEITE	GP-35	RE57394	ACEITE	GP-14	T19044	70 con motor/A DIESEL		
COMBUSTIBLE	GPP-419	RE62419	COMBUSTIBLE, SEPARADOR DE AGUA	GPP-424	RE62424	ACEITE	GP-14	T19044
			COMBUSTIBLE	G-270	AR86745	700 con motor/A DIESEL		
25 con motor/A DIESEL						ACEITE	GP-35	RE57394
ACEITE	GP-6811	M806419	50 con motor/A DIESEL					
			ACEITE	GP-40	M801209	750 con motor/CUMMINS N14		
25 con motor/YANMAR						AGUA	GP-1013Q	AR94650
ACEITE	GP-40	N801209	50C ZTS con motor/ISUZU 4LE2					
			AIRE, RADIAL PRIMARIO	GA-880R	RG60690	790, 792 con motor/A DIESEL		
270LC con motor/JOHN DEERE 6068H						ACEITE	GP-35	RE57394
COMBUSTIBLE	GPP-419	RE62419	50D ZTS con motor/YANMAR 4TNV88			COMBUSTIBLE	G-270	AR86745
			AIRE, RADIAL PRIMARIO	GA-880R	RG60690	AIRE, SECUNDARIO	GA-398	AT81019
27C ZTS con motor/ISUZU 3LD1								
AIRE, RADIAL PRIMARIO	GA-880R	RG60690	550LC con motor/CUMMINS N14			790D con motor/A DIESEL		
			COMBUSTIBLE, SEPARADOR DE AGUA	GPP-11	RE42050	ACEITE	GP-35	RE57394
27D ZTS con motor/YANMAR 3TNV88						COMBUSTIBLE	G-270	AR86745
ACEITE	GP-462	M801002	590D, 595D con motor/A DIESEL			AIRE, SECUNDARIO	GA-398	AT81019
			ACEITE	GP-14	T19044			
27ZTS con motor/ISUZU 3LD1			595, 70D con motor/A DIESEL			790E LC con motor/A DIESEL		
AIRE, RADIAL	GA-880R	RG60690	ACEITE	GP-14	T19044	ACEITE	GP-14	T19044
						COMBUSTIBLE, HASTA S/N 490172	G-295	AR50041
290D con motor/A DIESEL			600C LC, 800C con motor/ISUZU BB6WG1X			COMBUSTIBLE, SEPARADOR DE AGUA	GPP-424	RE62424
ACEITE	GP-14	T19044	COMBUSTIBLE, SEPARADOR DE AGUA	GPP-11	1132400441	COMBUSTIBLE, S/N 490172 EN ADELANTE	GPP-419	RE62419
30 con motor/A DIESEL			690 con motor/A DIESEL			792D-LC con motor/A DIESEL		
ACEITE	GP-40	M801209	ACEITE	GP-34	AR43634	ACEITE	GP-35	RE57394
						COMBUSTIBLE	GPP-424	RE62424
330C LC con motor/JOHN DEERE 6081H			690A con motor/A DIESEL			COMBUSTIBLE	G-270	RE27091
ACEITE	GP-35	RE57394	ACEITE	GP-34	AR43634			
						80 con motor/YANMAR 4TNE98		
330LC con motor/JOHN DEERE 6081H			690B con motor/A DIESEL			COMBUSTIBLE, SEPARADOR DE AGUA	GPP-424	RE62424
COMBUSTIBLE, PRIMARIO	GPP-426	RE65431	ACEITE, HASTA S/N 588854	GP-34	AR43634			
ACEITE	GP-35	RE57394	ACEITE, S/N 588854 EN ADELANTE	GP-35	RE57394	890 con motor/A DIESEL		
COMBUSTIBLE	G-270	AR86745	COMBUSTIBLE	G-270	AR86745	ACEITE, FLUJO TOTAL (FULL FLOW) HASTA S/N 040932	GP-34	AR43634
						ACEITE, FLUJO TOTAL (FULL FLOW) S/N 040932 EN ADELANTE	GP-35	RE57394
35C ZTS con motor/ISUZU 3LD2			690C con motor/A DIESEL			COMBUSTIBLE	G-270	AR86745
AIRE, RADIAL PRIMARIO	GA-880R	RG60690	ACEITE, FLUJO TOTAL (FULL FLOW)	GP-35	RE57394			
			ACEITE, DERIVACION (BY PASS)	GP-57	RE42051	890A con motor/A DIESEL		
35D ZTS con motor/YANMAR 3TNV88			COMBUSTIBLE	G-270	AR86745	ACEITE, FLUJO TOTAL (FULL FLOW) HASTA S/N 040932	GP-34	AR43634
AIRE, RADIAL	GA-880R	RG60690	AIRE, PRIMARIO	GA-679	AR79679	ACEITE, FLUJO TOTAL (FULL FLOW) S/N 040932 EN ADELANTE	GP-35	RE57394
			AIRE, SECUNDARIO	GA-680	AR79680	COMBUSTIBLE	G-270	AR86745
35ZTS con motor/ISUZU 3LD1			690D, 690DR con motor/A DIESEL					
AIRE, RADIAL	GA-880R	RG60690	ACEITE	GP-14	T19044	892D, 892D LC con motor/A DIESEL		
			COMBUSTIBLE	G-295	AR50041	ACEITE	GP-35	RE57394
370 con motor/JOHN DEERE 6081H			AIRE, PRIMARIO	GA-679	AR79679	COMBUSTIBLE	G-270	AR86745
COMBUSTIBLE, PRIMARIO	GPP-426	RE65431	AIRE, SECUNDARIO	GA-680	AR79680	AIRE, SECUNDARIO	GA-398	AT81019
ACEITE	GP-35	RE57394						
COMBUSTIBLE	G-270	AR86745						
370C con motor/JOHN DEERE 6081H								
ACEITE	GP-35	RE57394						

MARCA-MODELO-MOTOR MAKE-MODEL-ENGINE	GONHER GONHER	OEM OEM	MARCA-MODELO-MOTOR MAKE-MODEL-ENGINE	GONHER GONHER	OEM OEM	MARCA-MODELO-MOTOR MAKE-MODEL-ENGINE	GONHER GONHER	OEM OEM
JOHN DEERE (continuación)			JOHN DEERE (continuación)			JOHN DEERE (continuación)		
EXCAVADORAS			FORRAJERA			FORRAJERA		
892E LC con motor/A DIESEL			COMBUSTIBLE	G-270	AR86745	6850 con motor/CUMMINS		
ACEITE	GP-35	RE57394	5820 con motor/JOHN DEERE 616			ACEITE, DERIVACION (BY PASS)	GP-57	RE42051
COMBUSTIBLE, SEPARADOR DE AGUA	GPP-424	RE62424	ACEITE	GP-34	AR43634	6850 con motor/JOHN DEERE 6125 POWERTECH		
COMBUSTIBLE	G-270	RE27091	HIDRAULICO	GP-66	AE33293	GASOLINA, SEPARADOR DE AGUA	G-293	AR86755
990 con motor/A DIESEL			ACEITE	GP-35	RE57394	6950 con motor/CUMMINS		
GASOLINA, SEPARADOR DE AGUA (HASTA S/N 505863)	G-293	AR86755	ACEITE	GP-57	RE21748	ACEITE, DERIVACION (BY PASS)	GP-57	RE42051
ACEITE, FLUJO TOTAL (FULL FLOW)	GP-35	RE57394	COMBUSTIBLE	G-270	AR86745	6950 con motor/CUMMINS N14 CELECT		
COMBUSTIBLE	G-270	AR86745	5820 con motor/JOHN DEERE 619			ACEITE, DOBLE FLUJO	GP-3001	3401544
COMBUSTIBLE, SEPARADOR DE AGUA (S/N 505863 EN ADELANTE)	2010PM-OR	RE11325	GASOLINA, SEPARADOR DE AGUA	G-293	AR86755	7800 con motor/CUMMINS QXS15		
992D LC con motor/A DIESEL			ACEITE, FLUJO TOTAL (FULL FLOW) HASTA S/N 040124	GP-34	AR43634	ACEITE, DOBLE FLUJO	GP-9000	3406810
ACEITE, FLUJO TOTAL (FULL FLOW)	GP-35	RE57394	HIDRAULICO (HASTA S/N 651001)	GP-66	AE33293	AGUA	GP-2126Q	3680433
COMBUSTIBLE	G-270	AR86745	ACEITE, FLUJO TOTAL (FULL FLOW) S/N 040124 EN ADELANTE	GP-35	RE46380	COMBUSTIBLE, SEPARADOR DE AGUA	GPP-1007S	PMFS1007
AIRE, PRIMARIO	GA-106	U44957	COMBUSTIBLE	G-270	AR86745	JOHN DEERE		
AIRE, SECUNDARIO	GA-206	AT166136	5830 con motor/A DIESEL			GENERADORES		
992E LC con motor/A DIESEL			GASOLINA, SEPARADOR DE AGUA	G-293	AR86755	325, 375, 500 con motor/A GASOLINA		
COMBUSTIBLE, SEPARADOR DE AGUA	GPP-424	RE62424	ACEITE, FLUJO TOTAL (FULL FLOW) HASTA S/N 40124	GP-34	AR43634	GASOLINA	GG-4	AM38708
ACEITE, DOBLE FLUJO	GP-3000	RE44647	ACEITE, FLUJO TOTAL (FULL FLOW) S/N 40124-58574	GP-35	RE57394	4000W, 5000W con motor/JOHN DEERE		
COMBUSTIBLE	G-270	RE27091	COMBUSTIBLE	G-270	AR86745	AIRE	GA-7	AM31400
JOHN DEERE			6610 con motor/A DIESEL			G5500K, G5500KE con motor/JOHN DEERE		
FORRAJERA			GASOLINA, SEPARADOR DE AGUA	G-293	AR86755	ACEITE	GP-157	AM107423
5200 con motores/JOHN DEERE 400 SERIES, JOHN DEERE 500 SERIES			ACEITE	GP-35	RE57394	JOHN DEERE		
ACEITE, CARTUCHO	G-331	AR75603	TRANSMISION	GP-761H	AL77061	HILERADORAS		
ACEITE, SELLADO	GP-34	AR43634	COMBUSTIBLE	G-270	RE27091	215 con motor/A DIESEL		
COMBUSTIBLE	G-295	AR50041	AIRE, SECUNDARIO	GA-206	U44956	ACEITE, SELLADO	GP-14	T19044
5400 con motores/JOHN DEERE 400 SERIES, JOHN DEERE 500 SERIES			6650 con motor/JOHN DEERE 6081 POWERTECH			2250 con motor/JOHN DEERE 219		
ACEITE	GP-34	AR43634	GASOLINA, SEPARADOR DE AGUA	G-293	AR86755	ACEITE	GP-14	T19044
COMBUSTIBLE	G-295	AR50041	ACEITE	GP-35	RE57394	COMBUSTIBLE	G-296	AT17387
ACEITE	GP-35	RE57394	TRANSMISION	GP-761H	AL118036	COMBUSTIBLE	G-295	AR50041
5440 con motor/A DIESEL			COMBUSTIBLE	G-270	AR86745	COMBUSTIBLE	G-296-B	AT17387
ACEITE	GP-34	AR43634	AIRE, SECUNDARIO	GA-206	U44956	AIRE, PRIMARIO	GAK-216	AR84228
5460 con motor/A DIESEL			6710 con motor/CUMMINS			AIRE, SECUNDARIO	GA-416	AE31724
ACEITE	GP-34	AR43634	GASOLINA, SEPARADOR DE AGUA	G-293	AR86755	2250, 2270 con motor/CHRYSLER HB225		
ACEITE	GP-35	RE57394	ACEITE, DOBLE FLUJO	GP-3000	RE44647	ACEITE	GP-1	AE28914
COMBUSTIBLE	G-270	AR86745	TRANSMISION	GP-761H	AH128449	AIRE, PRIMARIO	GAK-216	AR84228
5720 con motor/JOHN DEERE 6466			COMBUSTIBLE	G-270	RE27091	AIRE, SECUNDARIO	GA-416	AE31724
GASOLINA, SEPARADOR DE AGUA	G-293	AR86755	6750 con motor/CUMMINS			GASOLINA	GG-5 L	AE29052
ACEITE, HASTA S/N 298393	GP-34	AR43634	GASOLINA, SEPARADOR DE AGUA	G-293	AR86755	2270 con motor/JOHN DEERE 219		
COMBUSTIBLE, HASTA S/N 242196	G-295	AR50041	ACEITE	GP-3000	RE44647	ACEITE	GP-14	T19044
ACEITE, S/N 298393 EN ADELANTE	GP-35	RE57394	COMBUSTIBLE	G-270	AR86745	COMBUSTIBLE	G-296	AT17387
COMBUSTIBLE, S/N 242197 EN ADELANTE	G-270	AR86745	6750 con motor/JOHN DEERE 6125 POWERTECH			COMBUSTIBLE	G-296-B	AT17387
5730 con motor/A DIESEL			GASOLINA, SEPARADOR DE AGUA	G-293	AR86755	AIRE, PRIMARIO	GAK-216	AR84228
GASOLINA, SEPARADOR DE AGUA	G-293	AR86755	ACEITE, DERIVACION (BY PASS)	GP-57	RE42051	AIRE, SECUNDARIO	GA-416	AE31724
ACEITE, HASTA S/N 039937	GP-34	AR43634	COMBUSTIBLE, SEPARADOR DE AGUA	GPP-11	RE42050	2280 con motor/A DIESEL		
ACEITE, S/N 039937 EN ADELANTE	GP-35	AR101278	AGUA	GP-2071W	RE42052	ACEITE	GP-14	T19044

MARCA-MODELO-MOTOR MAKE-MODEL-ENGINE	GONHER GONHER	OEM OEM	MARCA-MODELO-MOTOR MAKE-MODEL-ENGINE	GONHER GONHER	OEM OEM	MARCA-MODELO-MOTOR MAKE-MODEL-ENGINE	GONHER GONHER	OEM OEM
JOHN DEERE (continuación)			JOHN DEERE (continuación)			JOHN DEERE (continuación)		
HILERADORAS			HILERADORAS			MONTACARGAS		
2320 con motor/CHRYSLER 6-225			AIRE, ESTANDAR, PRIMARIO (HASTA S/N 882092)	GA-679	AR79679	COMBUSTIBLE	G-295	AR50041
ACEITE	GP-1	AE28914	AIRE, ESTANDAR, SECUNDARIO (HASTA S/N 882092)	GA-680	AR79680	HIDRAULICO (HASTA S/N 753396)	GP-864H	AT103193
AIRE	GAK-16	AT20728	AIRE, RADIAL, PRIMARIO (S/N 882092 EN ADELANTE)	GA-966R	AT178516	AIRE, PRIMARIO	GAK-216	AR84228
GASOLINA	GG-5 L	AE29052	AIRE, RADIAL, SECUNDARIO (S/N 882092 EN ADELANTE)	GA-967R	AT178517	AIRE, SECUNDARIO	GA-416	AE31724
2360 con motor/A DIESEL			800, 830 con motor/CHRYSLER HB-225			485E, 486E, 488E con motor/JOHN DEERE 4045DT POWERTECH		
ACEITE	GP-14	T19044	ACEITE	GP-1	TY9425	COMBUSTIBLE	GPP-420	RE60021
COMBUSTIBLE	G-295	AR50041	AIRE	GAK-16	AT20728	ACEITE	GP-754	RE59754
HIDRAULICO	GP-66	AE33293	GASOLINA	GG-5 L	AE29052	AIRE, RADIAL PRIMARIO	GA-853R	AT171853
2360 con motor/A GASOLINA			880 con motor/JOHN DEERE 135			GASOLINA, LINEA DEL RESPIRADOR DEL TANQUE HIDRAULICO	GG-5 L	AT101565
ACEITE	GP-81	MG508129	ACEITE	GP-14	T19044	JOHN DEERE		
2420 con motor/CHRYSLER 6-225			880 con motores/JOHN DEERE 180, JOHN DEERE 202			MOTORES		
ACEITE	GP-1	TY9425	ACEITE	GP-14	T19044	115 A GASOLINA, 135 A GASOLINA, 145 A GASOLINA, 152 A GASOLI- NA, 164G, 180, 202G, 217, 219G, 239D, 239T, 276D, 276T, 3029D, 3164G, 329L, 359D, 359T, 4024 (2.4L), 4039, 4039DFM, 4039T (3.9L), 414D, 414T, 4219G, 4238TE, 4238TL, 4239A, 4239D, 4239DE, 4239DL, 4239DT, 4239E, 4239T, 4276D, 4276T, 5030 (3.0L), 6059D, 6059T, 6068D (6.8L), 6068DFM, 6068T (6.8L), 6068TFM, 6329G, 6329L, 6359A, 6359D, 6359DE, 6359DL, 6359E, 6359T, 6359TL, 6414A, 6414D, 6414E, 6414T, 92 A GASOLINA		
AIRE, PRIMARIO	GAK-216	AR84228	ACEITE	GP-14	T19044	ACEITE, SELLADO	GP-14	T19044
AIRE, SECUNDARIO	GA-416	AE31724	JOHN DEERE			135G		
GASOLINA	GG-5 L	AE29052	MONTACARGAS			AIRE, SIN ASPAS	GA-33	AH19847
2420 con motor/JOHN DEERE			380 con motor/A DIESEL			152D, 202		
ACEITE	GP-14	T19044	TRANSMISION	G-331	AR75603	ACEITE, SELLADO	GP-14	T19044
COMBUSTIBLE	G-295	AR50041	ACEITE	GP-14	T19044	COMBUSTIBLE	G-296	AT17387
AIRE, PRIMARIO	GAK-216	AR84228	COMBUSTIBLE, HASTA S/ N382288	G-296	AT17387	COMBUSTIBLE	G-296-B	AT17387
AIRE, SECUNDARIO	GA-416	AE31724	COMBUSTIBLE, S/N 382288 EN ADELANTE	G-295	AR50041	AIRE	GAK-16	AT20728
3430 con motor/JOHN DEERE 4239			HIDRAULICO	GP-66	AT38431	155		
ACEITE	GP-14	T19044	COMBUSTIBLE, HASTA S/ N382288	G-296-B	AT17387	ACEITE	GP-14	T19044
COMBUSTIBLE	G-295	AR50041	AIRE, SIMPLE	GAK-16	AT20728	COMBUSTIBLE	G-296	AT17387
AIRE, PRIMARIO	GAK-216	AR84228	AIRE, PRIMARIO	GAK-216	AR84228	COMBUSTIBLE	G-295	AR50041
AIRE, SECUNDARIO	GA-416	AE31724	AIRE, SECUNDARIO	GA-416	AE31724	COMBUSTIBLE	G-296-B	AT17387
3830 con motor/JOHN DEERE 4239			480 con motor/A DIESEL			164D		
ACEITE	GP-14	T19044	TRANSMISION	G-331	AR75603	ACEITE	GP-14	T19044
COMBUSTIBLE	G-295	AR50041	ACEITE	GP-14	T19044	COMBUSTIBLE	G-296	AT17387
AIRE, PRIMARIO	GAK-403	AT65088	COMBUSTIBLE	G-296	AT17387	COMBUSTIBLE	G-296-B	AT17387
4890 con motor/JOHN DEERE 4045T POWERTECH			COMBUSTIBLE	G-295	AR50041	165		
HIDRAULICO	GP-761H	AH128449	COMBUSTIBLE	G-296-B	AT17387	ACEITE, SELLADO	GP-14	T19044
COMBUSTIBLE	GPP-420	RE60021	AIRE	GAK-16	AT20728	COMBUSTIBLE	G-296	AT17387T
ACEITE	GP-754	RE59754	480A, 480B con motor/A DIESEL			COMBUSTIBLE	G-296-B	AT17387T
AIRE, PRIMARIO	GA-197R	RE67124	TRANSMISION	G-331	AR75603	AIRE, SIN ASPAS (HASTA S/N 201359)	GA-33	AH19847
AIRE, SECUNDARIO	GA-768R	RE34963	ACEITE	GP-14	T19044	AIRE, S/N 35000 EN ADELANTE	GAK-16	AT20728
4895 con motor/JOHN DEERE 4045T POWERTECH			COMBUSTIBLE	G-295	AR50041	219D		
HIDROESTATICO	GP-761H	AH128449	AIRE, SIMPLE	GAK-16	AT20728	ACEITE	GP-14	T19044
ACEITE, TANQUE HIDRAULICO	GP-761H	AH128449	AIRE, PRIMARIO	GAK-216	AR84228	COMBUSTIBLE	G-296	AT17387
COMBUSTIBLE	GPP-420	RE60021	AIRE, SECUNDARIO	GA-416	AE31724	COMBUSTIBLE	G-295	AR50041
ACEITE, LUBRICACION DEL MOTOR	GP-754	RE59754	480C con motor/A DIESEL			COMBUSTIBLE	G-296-B	AT17387
AIRE, PRIMARIO	GA-966R	AT178516	TRANSMISION	G-331	AR75603	AIRE	GAK-403	AH20488
AIRE, SECUNDARIO	GA-967R	AT178517	ACEITE	GP-14	T19044	232		
4990 con motor/JOHN DEERE 6068 POWERTECH			COMBUSTIBLE	G-295	AR50041	ACEITE, SELLADO	GP-14	T19044
COMBUSTIBLE	GPP-420	RE60021	HIDRAULICO	GP-66	AT38431	COMBUSTIBLE, 1963 EN ADELANTE	G-296	AT17387T
ACEITE	GP-754	RE59754	AIRE, SIMPLE	GAK-16	AT20728	COMBUSTIBLE, 1963 EN ADELANTE	G-296-B	AT17387T
AIRE, PRIMARIO	GA-966R	AT178516	AIRE, PRIMARIO	GAK-216	AR84228	482C con motor/A DIESEL		
AIRE, SECUNDARIO	GA-967R	AT178517	AIRE, SECUNDARIO	GA-416	AE31724	ACEITE	GP-14	T19044
4995 con motor/JOHN DEERE 6068 POWERTECH			482C con motor/A DIESEL			JOHN DEERE		
COMBUSTIBLE, SEPARADOR DE AGUA (HASTA S/N 882117)	GPP-14	AT81478	TRANSMISION	G-331	AR75603	MOTORES		
COMBUSTIBLE, SEPARADOR DE AGUA (S/N 882117 EN ADELANTE)	GPP-424	RE62424	ACEITE	GP-14	T19044	115 A GASOLINA, 135 A GASOLINA, 145 A GASOLINA, 152 A GASOLI- NA, 164G, 180, 202G, 217, 219G, 239D, 239T, 276D, 276T, 3029D, 3164G, 329L, 359D, 359T, 4024 (2.4L), 4039, 4039DFM, 4039T (3.9L), 414D, 414T, 4219G, 4238TE, 4238TL, 4239A, 4239D, 4239DE, 4239DL, 4239DT, 4239E, 4239T, 4276D, 4276T, 5030 (3.0L), 6059D, 6059T, 6068D (6.8L), 6068DFM, 6068T (6.8L), 6068TFM, 6329G, 6329L, 6359A, 6359D, 6359DE, 6359DL, 6359E, 6359T, 6359TL, 6414A, 6414D, 6414E, 6414T, 92 A GASOLINA		
COMBUSTIBLE	GPP-419	RE62419	COMBUSTIBLE	G-295	AR50041	ACEITE, SELLADO	GP-14	T19044
ACEITE	GP-754	RE59754	HIDRAULICO	GP-66	AT38431	COMBUSTIBLE	G-296	AT17387
2320 con motor/CHRYSLER 6-225			AIRE, SIMPLE	GAK-16	AT20728	COMBUSTIBLE	G-295	AR50041
ACEITE	GP-1	AE28914	AIRE, PRIMARIO	GAK-216	AR84228	COMBUSTIBLE	G-296-B	AT17387
AIRE	GAK-16	AT20728	AIRE, SECUNDARIO	GA-416	AE31724	AIRE	GAK-403	AH20488
GASOLINA	GG-5 L	AE29052	800, 830 con motor/CHRYSLER HB-225			232		
2360 con motor/A DIESEL			ACEITE	GP-1	TY9425	ACEITE, SELLADO	GP-14	T19044
ACEITE	GP-14	T19044	AIRE	GAK-16	AT20728	COMBUSTIBLE, 1963 EN ADELANTE	G-296	AT17387T
COMBUSTIBLE	G-295	AR50041	GASOLINA	GG-5 L	AE29052	COMBUSTIBLE, 1963 EN ADELANTE	G-296-B	AT17387T
HIDRAULICO	GP-66	AE33293	880 con motor/JOHN DEERE 135			JOHN DEERE		
2360 con motor/A GASOLINA			ACEITE	GP-14	T19044	MOTORES		
ACEITE	GP-81	MG508129	880 con motores/JOHN DEERE 180, JOHN DEERE 202			115 A GASOLINA, 135 A GASOLINA, 145 A GASOLINA, 152 A GASOLI- NA, 164G, 180, 202G, 217, 219G, 239D, 239T, 276D, 276T, 3029D, 3164G, 329L, 359D, 359T, 4024 (2.4L), 4039, 4039DFM, 4039T (3.9L), 414D, 414T, 4219G, 4238TE, 4238TL, 4239A, 4239D, 4239DE, 4239DL, 4239DT, 4239E, 4239T, 4276D, 4276T, 5030 (3.0L), 6059D, 6059T, 6068D (6.8L), 6068DFM, 6068T (6.8L), 6068TFM, 6329G, 6329L, 6359A, 6359D, 6359DE, 6359DL, 6359E, 6359T, 6359TL, 6414A, 6414D, 6414E, 6414T, 92 A GASOLINA		
2420 con motor/CHRYSLER 6-225			ACEITE	GP-14	T19044	ACEITE, SELLADO	GP-14	T19044
ACEITE	GP-1	TY9425	880 con motores/JOHN DEERE 180, JOHN DEERE 202			135G		
AIRE, PRIMARIO	GAK-216	AR84228	ACEITE	GP-14	T19044	AIRE, SIN ASPAS	GA-33	AH19847
AIRE, SECUNDARIO	GA-416	AE31724	JOHN DEERE			152D, 202		
GASOLINA	GG-5 L	AE29052	MONTACARGAS			ACEITE, SELLADO	GP-14	T19044
2420 con motor/JOHN DEERE			380 con motor/A DIESEL			COMBUSTIBLE	G-296	AT17387
ACEITE	GP-14	T19044	TRANSMISION	G-331	AR75603	COMBUSTIBLE	G-296-B	AT17387
COMBUSTIBLE	G-295	AR50041	ACEITE	GP-14	T19044	AIRE	GAK-16	AT20728
AIRE, PRIMARIO	GAK-216	AR84228	COMBUSTIBLE, HASTA S/ N382288	G-296	AT17387	155		
AIRE, SECUNDARIO	GA-416	AE31724	COMBUSTIBLE, S/N 382288 EN ADELANTE	G-295	AR50041	ACEITE	GP-14	T19044
3430 con motor/JOHN DEERE 4239			HIDRAULICO	GP-66	AT38431	COMBUSTIBLE	G-296	AT17387
ACEITE	GP-14	T19044	COMBUSTIBLE, HASTA S/ N382288	G-296-B	AT17387	COMBUSTIBLE	G-295	AR50041
COMBUSTIBLE	G-295	AR50041	AIRE, SIMPLE	GAK-16	AT20728	COMBUSTIBLE	G-296-B	AT17387
AIRE, PRIMARIO	GAK-216	AR84228	AIRE, PRIMARIO	GAK-216	AR84228	164D		
AIRE, SECUNDARIO	GA-416	AE31724	AIRE, SECUNDARIO	GA-416	AE31724	ACEITE	GP-14	T19044
3830 con motor/JOHN DEERE 4239			480 con motor/A DIESEL			COMBUSTIBLE	G-296	AT17387
ACEITE	GP-14	T19044	TRANSMISION	G-331	AR75603	COMBUSTIBLE	G-296-B	AT17387
COMBUSTIBLE	G-295	AR50041	ACEITE	GP-14	T19044	165		
AIRE, PRIMARIO	GAK-403	AT65088	COMBUSTIBLE	G-295	AR50041	ACEITE, SELLADO	GP-14	T19044
4890 con motor/JOHN DEERE 4045T POWERTECH			COMBUSTIBLE	G-296-B	AT17387	COMBUSTIBLE	G-296	AT17387T
HIDRAULICO	GP-761H	AH128449	AIRE	GAK-16	AT20728	COMBUSTIBLE	G-296-B	AT17387T
COMBUSTIBLE	GPP-420	RE60021	480A, 480B con motor/A DIESEL			AIRE, SIN ASPAS (HASTA S/N 201359)	GA-33	AH19847
ACEITE	GP-754	RE59754	TRANSMISION	G-331	AR75603	AIRE, S/N 35000 EN ADELANTE	GAK-16	AT20728
AIRE, PRIMARIO	GA-197R	RE67124	ACEITE	GP-14	T19044	219D		
AIRE, SECUNDARIO	GA-768R	RE34963	COMBUSTIBLE	G-295	AR50041	ACEITE	GP-14	T19044
4895 con motor/JOHN DEERE 4045T POWERTECH			AIRE, SIMPLE	GAK-16	AT20728	COMBUSTIBLE	G-296	AT17387
HIDROESTATICO	GP-761H	AH128449	AIRE, PRIMARIO	GAK-216	AR84228	COMBUSTIBLE	G-295	AR50041
ACEITE, TANQUE HIDRAULICO	GP-761H	AH128449	AIRE, SECUNDARIO	GA-416	AE31724	COMBUSTIBLE	G-296-B	AT17387
COMBUSTIBLE	GPP-420	RE60021	480C con motor/A DIESEL			AIRE	GAK-403	AH20488
ACEITE, LUBRICACION DEL MOTOR	GP-754	RE59754	TRANSMISION	G-331	AR75603	232		
AIRE, PRIMARIO	GA-966R	AT178516	ACEITE	GP-14	T19044	ACEITE, SELLADO	GP-14	T19044
AIRE, SECUNDARIO	GA-967R	AT178517	COMBUSTIBLE	G-295	AR50041	COMBUSTIBLE, 1963 EN ADELANTE	G-296	AT17387T
4990 con motor/JOHN DEERE 6068 POWERTECH			HIDRAULICO	GP-66	AT38431	COMBUSTIBLE, 1963 EN ADELANTE	G-296-B	AT17387T
COMBUSTIBLE	GPP-420	RE60021	AIRE, SIMPLE	GAK-16	AT20728	JOHN DEERE		
ACEITE	GP-754	RE59754	AIRE, PRIMARIO	GAK-216	AR84228	MOTORES		
AIRE, PRIMARIO	GA-966R	AT178516	AIRE, SECUNDARIO	GA-416	AE31724	115 A GASOLINA, 135 A GASOLINA, 145 A GASOLINA, 152 A GASOLI- NA, 164G, 180, 202G, 217, 219G, 239D, 239T, 276D, 276T, 3029D, 3164G, 329L, 359D, 359T, 4024 (2.4L), 4039, 4039DFM, 4039T (3.9L), 414D, 414T, 4219G, 4238TE, 4238TL, 4239A, 4239D, 4239DE, 4239DL, 4239DT, 4239E, 4239T, 4276D, 4276T, 5030 (3.0L), 6059D, 6059T, 6068D (6.8L), 6068DFM, 6068T (6.8L), 6068TFM, 6329G, 6329L, 6359A, 6359D, 6359DE, 6359DL, 6359E, 6359T, 6359TL, 6414A, 6414D, 6414E, 6414T, 92 A GASOLINA		
AIRE, SECUNDARIO	GA-967R	AT178517	480 con motor/A DIESEL			ACEITE, SELLADO	GP-14	T19044
4995 con motor/JOHN DEERE 6068 POWERTECH			TRANSMISION	G-331	AR75603	COMBUSTIBLE	G-296	AT17387
COMBUSTIBLE, SEPARADOR DE AGUA (HASTA S/N 882117)	GPP-14	AT81478	ACEITE	GP-1				

MARCA-MODELO-MOTOR MAKE-MODEL-ENGINE	GONHER GONHER	OEM OEM	MARCA-MODELO-MOTOR MAKE-MODEL-ENGINE	GONHER GONHER	OEM OEM	MARCA-MODELO-MOTOR MAKE-MODEL-ENGINE	GONHER GONHER	OEM OEM
JOHN DEERE (continuación)			JOHN DEERE (continuación)			JOHN DEERE (continuación)		
MOTORES			MOTORES			MOTORES		
248			4045D POWERTECH (4.5L)			ACEITE	GP-35	AR98329
ACEITE, SELLADO	GP-14	T19044	COMBUSTIBLE, 5 3/16 IN	GPP-418	RE62418	6101A (10.1L), 6101H (10.1L)		
COMBUSTIBLE, 1963 EN ADELANTE	G-296	AT17387T	COMBUSTIBLE, 5 15/16 IN	GPP-419	RE62419	COMBUSTIBLE, SEPARADOR DE AGUA	GPP-421	RE53729
COMBUSTIBLE, 1963 EN ADELANTE	G-296-B	AT17387T	ACEITE	GP-754	RE59754	ACEITE, DOBLE FLUJO	GP-3000	RE44647
AIRE	GAK-16	AT20728	4045H POWERTECH (4.5L), 6068 POWERTECH (6.8L)			COMBUSTIBLE	G-270	RE27091
AIRE	GAK-403	AH20488	COMBUSTIBLE, 5 3/16 IN	GPP-418	RE62418	6404D		
3009			4045T POWERTECH (4.5L)			ACEITE	GP-14	T19044
ACEITE	GP-91	AM101378	COMBUSTIBLE, 5 3/16 IN	GPP-418	RE62418	ACEITE	GP-34	AR43634
3011, 4020 POWERTECH			COMBUSTIBLE, 5 15/16 IN	GPP-419	RE62419	COMBUSTIBLE	G-295	AR50041
ACEITE	GP-40	M801209	ACEITE	GP-754	RE59754	AGUA	GP-2071W	RE42052
303, 329G			404A, 404T, 6404A, 6404T			6466A, 6466D, 6466T		
ACEITE, SELLADO	GP-14	T19044	ACEITE	GP-34	AR43634	ACEITE, FLUJO TOTAL (FULL FLOW)	GP-34	AR43634
COMBUSTIBLE	G-296	AT17387	COMBUSTIBLE	G-295	AR50041	COMBUSTIBLE	G-295	AR50041
COMBUSTIBLE	G-296-B	AT17387	AGUA	GP-2071W	RE42052	ACEITE, FLUJO TOTAL (FULL FLOW)	GP-35	AR101278
AIRE	GAK-403	AH20488	AIRE	GAK-403	AH20488	AGUA	GP-2071W	RE42052
3164D			404D			6531D		
ACEITE	GP-14	T19044	ACEITE	GP-14	T19044	ACEITE, CARTUCHO	G-331	AR75603
COMBUSTIBLE	G-296	AT17387	COMBUSTIBLE	GPP-14	AR45097	ACEITE, SELLADO	GP-34	AR43634
COMBUSTIBLE	G-295	AR50041	ACEITE	GP-34	AR43634	COMBUSTIBLE	G-295	AR50041
COMBUSTIBLE	G-296-B	AT17387	COMBUSTIBLE	G-295	AR50041	AGUA	GP-2071W	RE42052
3179D, 3179T, 4039D			AGUA	GP-2071W	RE42052	AIRE	GA-679	AR61967
ACEITE	GP-14	T19044	AIRE	GAK-20	AR36044	AIRE	GA-680	AR61968
COMBUSTIBLE	G-295	AR50041	4219D, 6329D			6619D, 6619T		
COMBUSTIBLE	GPP-418	RE50455	ACEITE	GP-14	T19044	ACEITE	GP-34	AR43634
329D			COMBUSTIBLE	G-296	AT17387	8955A		
ACEITE	GP-14	T19044	COMBUSTIBLE	G-295	AR50041	ACEITE	GP-34	AR43634
COMBUSTIBLE	G-296	AT17387	COMBUSTIBLE	G-296-B	AT17387	COMBUSTIBLE	G-295	AR50041
COMBUSTIBLE	G-295	AR50041	466A, 466D, 466T, 619A, 6619A			AGUA	GP-1013Q	AR87112
COMBUSTIBLE	G-296-B	AT17387	ACEITE	GP-34	AR43634	8955T, 955T		
AIRE	GAK-20	AR36044	COMBUSTIBLE	G-295	AR50041	ACEITE	GP-34	AR43634
341G			ACEITE	GP-35	AR101278	COMBUSTIBLE	G-295	AR50041
ACEITE	GP-14	T19044	AGUA	GP-2071W	RE42052	ACEITE	GP-35	AR101278
COMBUSTIBLE	GPP-14	AR45097	531, 6531			M63VA, ME8TB		
COMBUSTIBLE	G-295	AR50041	ACEITE, CARTUCHO	G-139	AR28110R	ACEITE	GP-14	T19044
AIRE	GAK-403	AH20488	ACEITE, SELLADO (5 13/32 IN)	GP-14	T19044	COMBUSTIBLE	G-296	AT17387
362G			ACEITE, SELLADO (6 27/32 IN)	GP-34	AR43634	COMBUSTIBLE	G-296-B	AT17387
ACEITE, CARTUCHO	G-139	AR26350	AIRE, PRIMARIO	GA-679	AR61967	COMBUSTIBLE		
ACEITE, SELLADO	GP-14	T19044	AIRE, SECUNDARIO	GA-680	AR61968			
COMBUSTIBLE	GPP-14	AR45097	531A, 531T, 6531A, 6531T			JOHN DEERE		
COMBUSTIBLE	G-295	AR50041	ACEITE	GP-34	AR43634	NIVELADORAS		
AIRE	GAK-403	AH20488	COMBUSTIBLE	G-295	AR50041	1050C SOBRE ORUGAS con motor/LIEBHERR D9406		
AIRE	GAK-20	AR36044	AGUA	GP-2071W	RE42052	AGUA	GP-1011Q	WF2073
362L, 6362G, 6362L			531D			1800 con motor/KAWASAKI 18 HP		
ACEITE, CARTUCHO	G-139	AR26350	ACEITE, CARTUCHO	G-331	AR75603	ACEITE	GP-157	AM107423
4045D (4.5L), 4045T (4.5L), 4045TFM (4.5L)			ACEITE, SELLADO	GP-34	AR43634	350 SOBRE ORUGAS con motor/A DIESEL		
ACEITE	GP-14	T19044	COMBUSTIBLE	G-295	AR50041	ACEITE	G-139	AR26350
COMBUSTIBLE	G-295	AR50041	AGUA	GP-2071W	RE42052	ACEITE	GP-14	T19044
COMBUSTIBLE	GPP-418	RE62418	6076A (7.6L), 6076H (7.6L), 6076T (7.6L)			COMBUSTIBLE	G-296	AT17387
COMBUSTIBLE	G-270	RE27091	ACEITE	GP-35	RE46380	COMBUSTIBLE	G-296-B	AT17387
4045D INDUSTRIAL, 4045T INDUSTRIAL			COMBUSTIBLE	GPP-419	RE52987	AIRE	GA-16	AH19852
ACEITE	GP-14	T19044	COMBUSTIBLE	G-270	RE27091	AIRE	GAK-16	AT20728
COMBUSTIBLE	GPP-418	RE62418	6076AFM, 6081 POWERTECH (8.1L), 6081A POWERTECH (8.1L), 6081H POWERTECH (8.1L), 6081T POWERTECH (8.1L)					
AIRE, RADIAL PRIMARIO	GA-853R	AT171853						

SERVICIO PESADO

MARCA-MODELO-MOTOR MAKE-MODEL-ENGINE	GONHER GONHER	OEM OEM	MARCA-MODELO-MOTOR MAKE-MODEL-ENGINE	GONHER GONHER	OEM OEM	MARCA-MODELO-MOTOR MAKE-MODEL-ENGINE	GONHER GONHER	OEM OEM
JOHN DEERE (continuación)			JOHN DEERE (continuación)			JOHN DEERE (continuación)		
NIVELADORAS			NIVELADORAS			NIVELADORAS		
350 SOBRE ORUGAS, 350B SOBRE ORUGAS, 350C SOBRE ORUGAS con motor/A GASOLINA			ACEITE, TORNO	GP-14	T19044	TRANSMISION	GP-761H	T175002
ACEITE	G-139	AR26350	COMBUSTIBLE	G-295	AR50041	COMBUSTIBLE	GPP-420	RE60021
ACEITE	GP-14	T19044	450E SOBRE ORUGAS con motor/A DIESEL			570 MOTONIVELADORA, 570A MOTONIVELADORA con motor/A DIESEL		
AIRE	GA-16	AH19852	ACEITE	GP-14	T19044	TRANSMISION	G-331	AR75603
AIRE	GAK-16	AT20728	COOLER DE ACEITE	GP-14	T19044	ACEITE	GP-14	T19044
350B SOBRE ORUGAS con motor/A DIESEL			ACEITE, TORNO	GP-14	T19044	COMBUSTIBLE	G-296	AT17387
ACEITE	G-139	AR26350	COMBUSTIBLE	G-295	AR50041	COMBUSTIBLE	G-295	AR50041
ACEITE	GP-14	T19044	AIRE, SIN TURBO PRIMARIO	GA-403	AT65296	COMBUSTIBLE	G-296-B	AT17387
COMBUSTIBLE	G-296	AT17387	450G SOBRE ORUGAS con motor/A DIESEL			570B MOTONIVELADORA con motor/A DIESEL		
COMBUSTIBLE	G-295	AR50041	ACEITE, HASTA S/N 742460	GP-14	T19044	TRANSMISION (HASTA S/N 11725)	G-331	AR75603
COMBUSTIBLE	G-296-B	AT17387	COMBUSTIBLE, SEPARADOR DE AGUA	GPP-14	AT81478	ACEITE	GP-14	T19044
AIRE	GA-16	AH19852	COMBUSTIBLE	G-295	AR50041	COMBUSTIBLE	G-295	AR50041
AIRE	GAK-16	AT20728	ACEITE, S/N 742460 EN ADELANTE	GP-754	RE59754	COMBUSTIBLE	G-296-B	AT17387
350C SOBRE ORUGAS con motor/A DIESEL			AIRE, SIN TURBO PRIMARIO	GA-403	AT65296	650G LGP SOBRE ORUGAS, 650G SOBRE ORUGAS con motor/A DIESEL		
ACEITE	G-139	AR26350	450H SERIES con motores/JOHN DEERE 4045D, JOHN DEERE 4045T			ACEITE, HASTA S/N 742460	GP-14	T19044
ACEITE	GP-14	T19044	COMBUSTIBLE, PRIMARIO (S/N 910011 EN ADELANTE (CLIMAS FRIOS))	GPP-424	RE516477	ACEITE, TORNO	GP-14	T19044
COMBUSTIBLE	G-295	AR50041	COMBUSTIBLE, SEPARADOR DE AGUA, PRIMARIO (HASTA S/N 910011)	GPP-424	RE62424	COMBUSTIBLE, SEPARADOR DE AGUA	GPP-14	AT81478
AIRE	GA-16	AH19852	HIDRAULICO	GP-761H	T175002	COMBUSTIBLE	G-295	AR50041
AIRE	GAK-16	AT20728	TRANSMISION	GP-761H	T175002	ACEITE, S/N 742460 EN ADELANTE	GP-754	RE59754
350D SOBRE ORUGAS con motor/A DIESEL			COMBUSTIBLE (S/N 910011 EN ADELANTE)	GPP-419	RE509031	AIRE, SIN TURBO PRIMARIO	GA-403	AT65296
TRANSMISION	G-139	AR26350	COMBUSTIBLE (HASTA S/N 910011)	GPP-420	RE60021	650H SOBRE ORUGAS con motor/JOHN DEERE 4045 POWERTECH		
ACEITE	GP-14	T19044	ACEITE (HASTA S/N 910011)	GP-754	RE59754	COMBUSTIBLE, SEPARADOR DE AGUA	GPP-424	RE62424
HIDRAULICO	GP-14	T19044	AIRE, RADIAL PRIMARIO	GA-853R	AT171853	HIDRAULICO	GP-761H	T175002
COMBUSTIBLE	G-295	AR50041	450J con motor/JOHN DEERE 4045T			TRANSMISION	GP-761H	T175002
400G SOBRE ORUGAS con motor/A DIESEL			COMBUSTIBLE, PRIMARIO (CLIMAS FRIOS)	GPP-424	RE516477	COMBUSTIBLE	GPP-420	RE60021
ACEITE	GP-14	T19044	HIDRAULICO	GP-761H	T175002	ACEITE	GP-14	T19044
COOLER DE ACEITE	GP-14	T19044	TRANSMISION	GP-761H	T175002	AIRE, PRIMARIO	GA-966R	AT178516
ACEITE, TORNO	GP-14	T19044	COMBUSTIBLE	GPP-419	RE509031	AIRE, SECUNDARIO	GA-967R	AT178517
COMBUSTIBLE	G-295	AR50041	AIRE, RADIAL PRIMARIO	GA-853R	AT171853	GASOLINA, RESPIRADOR DEL TANQUE HIDRAULICO	GG-5 L	AT101565
AIRE, PRIMARIO	GA-403	AT65296	550 SOBRE ORUGAS con motor/A DIESEL			670 MOTONIVELADORA, 670A MOTONIVELADORA, 670B MOTONIVELADORA con motor/A DIESEL		
4045D SOBRE ORUGAS, 4045T SOBRE ORUGAS con motor/A DIESEL			TRANSMISION	G-331	AR75603	ACEITE	GP-14	T19044
COMBUSTIBLE	GPP-420	RE60021	ACEITE	GP-14	T19044	TRANSMISION (HASTA S/N 595779)	GP-34	AT193883
ACEITE	GP-754	RE59754	ACEITE, TORNO	GP-14	T19044	COMBUSTIBLE	GPP-419	RE62419
COMBUSTIBLE	GPP-1003S	RE62424	COMBUSTIBLE	G-295	AR50041	ACEITE	GP-754	RE59754
450 SOBRE ORUGAS con motor/A DIESEL			AIRE, PRIMARIO	GA-403	AT65296	AIRE, PRIMARIO	GA-966R	AT178516
COOLER DE ACEITE	GP-14	T19044	550A SOBRE ORUGAS, 550B SOBRE ORUGAS con motor/A DIESEL			AIRE, SECUNDARIO	GA-967R	AT178517
ACEITE, TORNO	GP-14	T19044	TRANSMISION	G-331	AR75603	GASOLINA, RESPIRADOR DEL TANQUE HIDRAULICO	GG-5 L	AT101565
COMBUSTIBLE	G-296	AT17387	ACEITE	GP-14	T19044	670C MOTONIVELADORA, 670CH MOTONIVELADORA con motor/JOHN DEERE 6068 POWERTECH		
COMBUSTIBLE	G-296-B	AT17387	ACEITE, TORNO	GP-14	T19044	TRANSMISION (HASTA S/N 595779)	GP-34	AT193883
AIRE	GA-16	AH19852	COMBUSTIBLE	G-295	AR50041	COMBUSTIBLE	GPP-419	RE62419
AIRE	GA-98	AH69798	AIRE, SIN TURBO PRIMARIO	GA-403	AT65296	ACEITE, LUBRICACION DEL MOTOR	GP-754	RE59754
AIRE	GAK-16	AT20728	550G SOBRE ORUGAS con motor/A DIESEL			AIRE, PRIMARIO	GA-966R	AT178516
450 SOBRE ORUGAS con motor/A GASOLINA			ACEITE	GP-14	T19044	AIRE, SECUNDARIO	GA-967R	AT178517
ACEITE	GP-14	T19044	COMBUSTIBLE, SEPARADOR DE AGUA	GPP-14	AT81478	GASOLINA, RESPIRADOR DEL TANQUE HIDRAULICO	GG-5 L	AT101565
AIRE	GA-16	AH19852	COMBUSTIBLE	G-295	AR50041	670C SERIES II MOTONIVELADORA con motor/JOHN DEERE 6068 POWERTECH		
AIRE	GAK-16	AT20728	AIRE, SIN TURBO PRIMARIO	GA-403	AT65296	COMBUSTIBLE	GPP-419	RE62419
450B SOBRE ORUGAS con motor/A DIESEL			550H SOBRE ORUGAS con motor/JOHN DEERE 4045 POWERTECH			ACEITE	GP-754	RE59754
ACEITE	GP-14	T19044	ACEITE	GP-14	T19044	AIRE, PRIMARIO	GA-966R	AT178516
COOLER DE ACEITE	GP-14	T19044	COMBUSTIBLE, SEPARADOR DE AGUA	GPP-424	RE62424	AIRE, SECUNDARIO	GA-967R	AT178517
ACEITE, TORNO	GP-14	T19044	HIDRAULICO	GP-761H	T175002	670C SERIES II MOTONIVELADORA con motor/JOHN DEERE 6068 POWERTECH		
COMBUSTIBLE	G-296	AT17387	550 SOBRE ORUGAS con motor/A DIESEL			COMBUSTIBLE	GPP-419	RE62419
COMBUSTIBLE	G-296-B	AT17387	ACEITE	GP-14	T19044	ACEITE	GP-754	RE59754
450C SOBRE ORUGAS, 450D SOBRE ORUGAS con motor/A DIESEL			COMBUSTIBLE, SEPARADOR DE AGUA	GPP-424	RE62424	AIRE, PRIMARIO	GA-966R	AT178516
ACEITE	GP-14	T19044	HIDRAULICO	GP-761H	T175002	AIRE, SECUNDARIO	GA-967R	AT178517
COOLER DE ACEITE	GP-14	T19044						

MARCA-MODELO-MOTOR MAKE-MODEL-ENGINE	GONHER GONHER	OEM OEM	MARCA-MODELO-MOTOR MAKE-MODEL-ENGINE	GONHER GONHER	OEM OEM	MARCA-MODELO-MOTOR MAKE-MODEL-ENGINE	GONHER GONHER	OEM OEM
JOHN DEERE (continuación)			JOHN DEERE (continuación)			I.H.C. HARVESTER (continuación)		
NIVELADORAS			NIVELADORAS			CARGADORAS		
COMBUSTIBLE	G-270	RE27091	GASOLINA, RESPIRADOR DEL CIERRE HIDRAULICO DEL DIFERENCIAL	GG-5 L	AT101565	100C SOBRE ORUGAS con motor/IHC D206		
772CH MOTONIVELADORA con motor/JOHN DEERE 6081 POWERTECH			GASOLINA, RESPIRADOR DEL TANQUE HIDRAULICO	GG-5 L	AT101565	ACEITE	G-338	386120R91
TRANSMISION (HASTA S/N 595779)	GP-34	AT193883	950C con motor/LIEBHERR D926TI			ACEITE	GP-10	398080R2
ACEITE, LUBRICACION DEL MOTOR	GP-35	RE57394	AGUA	GP-1011Q	AR94650	COMBUSTIBLE	G-296	3144477R91
COMBUSTIBLE	G-270	AR86745	AMT 600 con motor/A DIESEL			COMBUSTIBLE, SELLADO	GP-1122	3132428R1
AIRE, PRIMARIO	GA-930R	RE51629	ACEITE	GP-91	AM101378	COMBUSTIBLE	G-296-B	3144477R91
AIRE, SECUNDARIO	GA-890R	RE51630	AMT 622, AMT 626 con motor/KAWASAKI			100C, 100E con motores/IHC C175, IHC C200		
GASOLINA, RESPIRADOR DEL TANQUE HIDRAULICO	GG-5 L	AT101565	ACEITE	GP-157	AM107423	HIDRAULICO	G-338	386120R91
772CH SERIES II MOTONIVELADORA con motor/JOHN DEERE 6081 POWERTECH			GATOR 4X2, GATOR 4X2 TRAIL, GATOR 6X4, GATOR 6X4 TRAIL con motor/KAWASAKI			100C, 100E, 125C con motor/IHC D239		
TRANSMISION (HASTA S/N 595779)	GP-34	AT193883	ACEITE	GP-157	AM107423	TRANSMISION	G-333	615447C1
ACEITE	GP-35	RE57394	GATOR 6X4, GATOR 6X4 TRAIL con motor/YANMAR 18 HP			HIDRAULICO	G-338	386120R91
COMBUSTIBLE	G-270	AR86745	ACEITE	GP-91	M806418	ACEITE	GP-10	528250R1
AIRE, PRIMARIO	GA-930R	RE51629	GATOR CS, GATOR CX con motores/KAWASAKI 10 HP, KAWASAKI 8HP			COMBUSTIBLE	G-296	3144477R92
AIRE, SECUNDARIO	GA-890R	RE51630	GASOLINA	GG-4	AM116304	COMBUSTIBLE, PRIMARIO	GPP-1122	3136187R91
GASOLINA, RESPIRADOR DEL TANQUE HIDRAULICO	GG-5 L	AT101565	GATOR HPX 4X2 con motor/KAWASAKI 20 HP			COMBUSTIBLE, SECUNDARIO	GPP-1122	3136187R91
772D con motor/JOHN DEERE 6081H POWERTECH			GASOLINA	GG-4	AM116304	COMBUSTIBLE	G-296-B	3144477R92
AIRE, PRIMARIO	GA-930R	RE51629	GATOR HPX 4X2 DIESEL con motor/YANMAR 3TNE			100E con motor/IHC D206		
AIRE, SECUNDARIO	GA-890R	RE51630	ACEITE	GP-91	M806418	TRANSMISION	G-333	615447C1
GASOLINA, RESPIRADOR DEL CIERRE HIDRAULICO DEL DIFERENCIAL	GG-5 L	AT101565	GATOR HPX 4X4 con motor/KAWASAKI 20 HP			HIDRAULICO	G-338	386120R91
GASOLINA, RESPIRADOR DEL TANQUE HIDRAULICO	GG-5 L	AT101565	GASOLINA	GG-4	AM116304	ACEITE	GP-10	528250R1
850 SOBRE ORUGAS con motor/A DIESEL			GATOR HPX 4X4 DIESEL con motor/YANMAR 3TNE			COMBUSTIBLE, PRIMARIO	GPP-1122	3136187R91
ACEITE, FLUJO TOTAL (FULL FLOW)	GP-35	RE57394	ACEITE	GP-91	M806418	COMBUSTIBLE, SECUNDARIO	GPP-1122	3136187R91
TRANSMISION	GP-864H	AT135800	GATOR HPX 4X4 con motor/KAWASAKI 20 HP			COMBUSTIBLE	G-296-B	3144477R92
COMBUSTIBLE	G-270	AR86745	GASOLINA	GG-4	AM116304	125 con motor/IHC D239		
COMBUSTIBLE, SEPARADOR DE AGUA	2010PM-OR	RE11325	GATOR HPX 4X4 TRAIL con motor/KAWASAKI 20 HP			TRANSMISION	G-333	615447C1
850B SOBRE ORUGAS con motor/A DIESEL			GASOLINA	GG-4	AM116304	HIDRAULICO	G-338	386120R91
TRANSMISION (S/N 731274 EN ADELANTE)	G-339H	AR94510	M-GATOR con motor/YANMAR 18 HP DIESEL			ACEITE	GP-10	528250R1
ACEITE, HASTA S/N 256120	GP-34	AR43634	ACEITE	GP-157	AM107423	COMBUSTIBLE	G-296	3144477R92
ACEITE, S/N 248524 EN ADELANTE	GP-35	RE57394	PROGATOR 2020 con motor/YANMAR 3TG72			COMBUSTIBLE, PRIMARIO	GPP-1122	3136187R91
COMBUSTIBLE, SEPARADOR DE AGUA	GPP-424	RE62424	ACEITE	GP-91	M806418	COMBUSTIBLE, SECUNDARIO	GPP-1122	3136187R91
TRANSMISION (HASTA S/N 731274)	GP-864H	AT135800	GASOLINA	GG-5	AM876035	COMBUSTIBLE	G-296-B	3144477R92
COMBUSTIBLE	G-270	AR86745	GASOLINA	GG-5 L	AM876035	COMBUSTIBLE	GP-1122	3132428R1
AIRE, PRIMARIO	GA-679	AR79679	PROGATOR 2030 con motor/YANMAR 3TNE74			COMBUSTIBLE	G-296-B	3144477R92
AIRE, SECUNDARIO	GA-680	AR79680	ACEITE	GP-91	M806418	125E con motor/IHC DT239		
850C SERIES II SOBRE ORUGAS con motor/JOHN DEERE 6081			TURF GATOR con motor/KAWASAKI 10 HP			ACEITE	GP-10	528250R1
COMBUSTIBLE, PRIMARIO	GPP-426	RE65431	ACEITE	GP-157	AM107423	COMBUSTIBLE	G-296	3144477R92
ACEITE	GP-35	RE57394	WORKSITE GATOR con motor/YANMAR 18 HP			COMBUSTIBLE, SECUNDARIO	GPP-1122	3132428R2
COMBUSTIBLE	G-270	AR86745	ACEITE	GP-91	M806418	COMBUSTIBLE	G-296-B	3144477R92
850C SOBRE ORUGAS con motor/JOHN DEERE 6076			I.H.C. HARVESTER			150 con motor/A DIESEL		
ACEITE	GP-35	RE57394	CARGADORAS			TRANSMISION	G-33	319926R91
COMBUSTIBLE	GPP-424	RE62424	100C con motor/IHC D206			ACEITE	G-335	279994R91
COMBUSTIBLE	GPP-421	RE62421	TRANSMISION	G-333	615447C1	COMBUSTIBLE, PRIMARIO	G-1163	306353R91
COMBUSTIBLE	G-270	RE27091	HIDRAULICO	G-338	386120R91	COMBUSTIBLE, SECUNDARIO	G-1163	306353R91
870D, 872D con motor/JOHN DEERE 6081H POWERTECH			ACEITE	GP-10	528250R1	150 SOBRE ORUGAS con motor/A DIESEL		
AIRE, PRIMARIO	GA-930R	RE51629	COMBUSTIBLE, PRIMARIO	GPP-1122	3136187R91	TRANSMISION	G-33	319926R91
AIRE, SECUNDARIO	GA-890R	RE51630	COMBUSTIBLE, SECUNDARIO	GPP-1122	3136187R91	ACEITE	G-335	279994R91

APLICACIONES SERVICIO PESADO
HEAVY DUTY APPLICATIONS



MARCA-MODELO-MOTOR MAKE-MODEL-ENGINE	GONHER GONHER	OEM OEM	MARCA-MODELO-MOTOR MAKE-MODEL-ENGINE	GONHER GONHER	OEM OEM	MARCA-MODELO-MOTOR MAKE-MODEL-ENGINE	GONHER GONHER	OEM OEM
I.H.C. HARVESTER (continuación)			I.H.C. HARVESTER (continuación)			I.H.C. HARVESTER (continuación)		
CARGADORAS			CARGADORAS			CARGADORAS		
165 con motor/IHC D310			AIRE, SECUNDARIO	GA-239	627935C1	TRANSMISION	GP-1	918266R91
ACEITE, OPCIONAL	GP-10	528250R1	200 SOBRE ORUGAS con motor/DRESSER D505T			COMBUSTIBLE	G-296	3144477R92
COMBUSTIBLE	G-296	3144477R92	COMBUSTIBLE, SECUNDARIO	GP-1122	161624	COMBUSTIBLE	G-296-B	796051R91
COMBUSTIBLE	G-296-B	3144477R92	ACEITE	GP-43	A77537	500 con motor/A GASOLINA		
165 SOBRE ORUGAS con motor/A DIESEL			COMBUSTIBLE, PRIMARIO	GPP-18	161623	TRANSMISION	GP-1	918266R91
ACEITE	GP-10	398080R2	AIRE, PRIMARIO	GA-329	627934C1	510 con motor/IHC D268		
COMBUSTIBLE	G-296	3144477R92	AIRE, SECUNDARIO	GA-239	627935C1	ACEITE	GP-10	528250R1
COMBUSTIBLE	G-296-B	3144477R92	250A, 250B SOBRE ORUGAS con motor/IHC DT429			515 con motor/IHC D360		
175 con motor/A DIESEL			COMBUSTIBLE, PRIMARIO	G-1163	306353R91	ACEITE	GP-69	675616C91
COMBUSTIBLE, PRIMARIO	G-1163	306353R91	250C con motor/IHC DVT573B			COMBUSTIBLE, PRIMARIO	GP-1105	625626C1
175 SOBRE ORUGAS, 250 SOBRE ORUGAS con motor/A DIESEL			COMBUSTIBLE, PRIMARIO	GPP-14	702255C1	COMBUSTIBLE, PRIMARIO	GP-1108	625627C1
COMBUSTIBLE, SECUNDARIO	G-1163	306353R91	5 /34 IN			COMBUSTIBLE, SEPARADOR DE AGUA	GPP-11	1214920H1
175B con motor/IHC D361			COMBUSTIBLE, SECUNDARIO	GP-1107	359251C1	COMBUSTIBLE, SECUNDARIO	GP-78	672603C2
ACEITE	G-335	279994R91	COMBUSTIBLE, PRIMARIO 7 17/32 IN	GP-1108	702251C1	520B con motor/IHC DT358		
COMBUSTIBLE, PRIMARIO	G-1163	306353R91	COMBUSTIBLE, SEPARADOR DE AGUA	GPP-11	1214920H1	ACEITE	GP-10	528250R1
COMBUSTIBLE, SECUNDARIO	G-1163	306353R91	COMBUSTIBLE, SECUNDARIO 7 7/64 IN	GP-78	359251C1	530 con motor/IHC DT414		
175B con motor/IHC UD407			250C SOBRE ORUGAS con motor/A DIESEL			ACEITE	GP-69	675617C91
ACEITE	G-335	279994R91	COMBUSTIBLE, SEPARADOR DE AGUA	GPP-14	702255C1	COMBUSTIBLE, PRIMARIO	GP-1105	625626C1
COMBUSTIBLE, PRIMARIO 6 43/64 IN	GP-1105	625626C1	COMBUSTIBLE, SECUNDARIO	GP-1107	674293C1	COMBUSTIBLE, SECUNDARIO	GP-78	672603C2
COMBUSTIBLE, PRIMARIO 7 17/32 IN	GP-1108	625627C1	COMBUSTIBLE, PRIMARIO	GP-1108	625627C1	540 con motor/IHC DT466B		
COMBUSTIBLE, SEPARADOR DE AGUA	GPP-11	1214920H1	250E SOBRE ORUGAS con motor/CUMMINS L10			ACEITE	GP-69	675617C91
COMBUSTIBLE, SECUNDARIO 7 1/8 IN	GP-110	702142C1	COMBUSTIBLE, SEPARADOR DE AGUA	GPP-14	998443R91	COMBUSTIBLE, PRIMARIO	GP-1108	625627C1
175B SOBRE ORUGAS con motor/IHC DT361			COMBUSTIBLE	GP-1101	625625C1	COMBUSTIBLE, SEPARADOR DE AGUA	GPP-11	1214920H1
ACEITE	G-335	279994R91	ACEITE, FLUJO TOTAL (FULL FLOW)	GP-53	1212622H1	AGUA	GP-2071W	1261387H1
175B SOBRE ORUGAS con motor/IHC DT407			ACEITE, DERIVACION (BY PASS)	GP-57	1212621H1	COMBUSTIBLE, SECUNDARIO	GP-78	672603C2
ACEITE	G-335	279994R91	AGUA	GP-1011Q	1661388H1	555 DE TRONCOS con motor/CUMMINS NT855-C360		
COMBUSTIBLE, SEPARADOR DE AGUA	GPP-14	998443R91	280A con motor/IHC DT358			ACEITE, FLUJO TOTAL (FULL FLOW)	GP-53	1212622H1
COMBUSTIBLE, PRIMARIO 6 43/64 IN	GP-1105	702143C1	ACEITE	GP-10	528250R1	ACEITE, DERIVACION (BY PASS)	GP-57	1212621H1
COMBUSTIBLE, PRIMARIO 7 17/32 IN	GP-1108	702251C1	COMBUSTIBLE	G-296	3144477R92	COMBUSTIBLE, SEPARADOR DE AGUA	GPP-11	1214920H1
COMBUSTIBLE, SECUNDARIO 7 1/8 IN	GP-110	702142C1	COMBUSTIBLE, PRIMARIO	GPP-1122	3136187R91	560 con motor/IHC DT817B		
175C con motor/IHC DT466			COMBUSTIBLE	G-296-B	3144477R92	COMBUSTIBLE, SECUNDARIO	GP-1107	674293C1
ACEITE	GP-69	675617C91	AIRE, SECUNDARIO	GA-892	529852R5	COMBUSTIBLE, PRIMARIO	GP-1108	625627C1
COMBUSTIBLE, PRIMARIO 6 43/64 IN	GP-1105	625626C1	4120 con motor/TECUMSEH HH160			COMBUSTIBLE, SEPARADOR DE AGUA	GPP-11	1214920H1
COMBUSTIBLE, PRIMARIO 7 17/32 IN	GP-1108	625627C1	AIRE	GA-7	32008	560 con motor/IHC DT817C		
COMBUSTIBLE, SEPARADOR DE AGUA	GPP-11	1214920H1	4130 con motor/ONAN NHCV			COMBUSTIBLE, SECUNDARIO	GP-1107	674293C1
COMBUSTIBLE, SECUNDARIO	GP-78	672603C1	ACEITE	GP-3600	122-0680	COMBUSTIBLE	GP-1108	625627C1
AIRE, PRIMARIO	GA-329	627934C1	4150 con motor/FORD DF172 A DIESEL			COMBUSTIBLE, SEPARADOR DE AGUA	GPP-11	1214920H1
AIRE, SECUNDARIO	GA-239	627935C1	ACEITE	GP-1	388227R91	COMBUSTIBLE	GP-78	674293C1
175C SOBRE ORUGAS con motor/IHC DT466			HIDRAULICO	GP-34	69149C1	H60B, H60E con motor/IHC		
ACEITE	GP-69	675617C91	AIRE, SIN ASPAS	GA-16	P101222	AIRE, SECUNDARIO	GA-680	924280C1
COMBUSTIBLE, PRIMARIO 6 43/64 IN	GP-1105	625626C1	AIRE	GAK-16	P101222	PH100 DE TRONCOS, PH100B DE TRONCOS con motor/IHC DT817		
COMBUSTIBLE, PRIMARIO 7 17/32 IN	GP-1108	625627C1	GASOLINA	GG-4	4209106	TRANSMISION ALLISON	G-33	319926R91
COMBUSTIBLE, SECUNDARIO	GP-78	672603C1	GASOLINA	GG-20	531546R91	PH140 ARRASTRADOR con motor/IHC DT817B		
AIRE, PRIMARIO	GA-329	627934C1	500 con motor/A DIESEL			COMBUSTIBLE	GP-11	3300901
AIRE, SECUNDARIO	GA-239	627935C1	ACEITE	G-870	376364R91	PH180 DE TRONCOS con motor/GMC 12V-71		
175C SOBRE ORUGAS con motor/IHC DT466						ACEITE, DERIVACION (BY PASS)	G-31	5181127
ACEITE	GP-69	675617C91						
COMBUSTIBLE, PRIMARIO 6 43/64 IN	GP-1105	625626C1						
COMBUSTIBLE, PRIMARIO 7 17/32 IN	GP-1108	625627C1						
COMBUSTIBLE, SECUNDARIO	GP-78	672603C1						
COMBUSTIBLE, SEPARADOR DE AGUA	GPP-1000	702256C1						
AIRE, PRIMARIO	GA-329	627934C1						

SERVICIO PESADO

MARCA-MODELO-MOTOR GONHER OEM
MAKE-MODEL-ENGINE GONHER OEM

I.H.C. HARVESTER (continuación)

CARGADORAS

PH330 DE TRONCOS, PH340 DE TRONCOS con motor/A DIESEL		
COMBUSTIBLE, SECUNDARIO	GP-1107	674293C1
PH350 DE TRONCOS, PH350B DE TRONCOS con motor/CUMMINS VT1710C		
ACEITE, CARTUCHO PARA FLUJO TOTAL (FULL FLOW)	G-566	244523-R91
COMBUSTIBLE, CARTUCHO	G-1143	323838C91
ACEITE, SELLADO FLUJO TOTAL (FULL FLOW)	GP-53	1212622H1
ACEITE, DERIVACION (BY PASS)	G-750	689032R91
PH350 DE TRONCOS, PH350B DE TRONCOS con motor/GMC 16V-71N		
ACEITE, DERIVACION (BY PASS)	G-31	5181127
PH65 DE TRONCOS con motor/IHC D817		
AIRE	GA-5648	313709R91
PH65B DE TRONCOS con motor/IHC DVT573		
COMBUSTIBLE, SECUNDARIO	G-1163	306353R91
PH65C DE TRONCOS con motor/IHC DVT573B		
COMBUSTIBLE, SEPARADOR DE AGUA 5 3/4 IN	GPP-14	998443R91
COMBUSTIBLE, SECUNDARIO	GP-1107	674293C1
COMBUSTIBLE, PRIMARIO	GP-1108	625627C1
COMBUSTIBLE, SEPARADOR DE AGUA 9 17/32 IN	GPP-1000	702256C1
S10 DE TRONCOS con motor/IHC D360		
ACEITE	GP-69	675616C91
COMBUSTIBLE, PRIMARIO	GP-1105	625626C1
COMBUSTIBLE, PRIMARIO	GP-1108	625627C1
COMBUSTIBLE, SECUNDARIO	GP-78	672603C2
S10 DE TRONCOS con motor/IHC DT358		
ACEITE	GP-10	398080R2
S11A DE TRONCOS con motor/A DIESEL		
ACEITE	G-335	279994R91
COMBUSTIBLE, SEPARADOR DE AGUA	GPP-14	998443R91
COMBUSTIBLE, PRIMARIO	GP-1105	702143C1
COMBUSTIBLE, PRIMARIO	GP-1108	625627C1
COMBUSTIBLE, SECUNDARIO	GP-110	702253C1
S11A DE TRONCOS con motor/IHC DT407		
ACEITE	G-335	279994R91
COMBUSTIBLE, PRIMARIO	GP-1105	702143C1
COMBUSTIBLE, PRIMARIO	GP-1108	625627C1
COMBUSTIBLE, SEPARADOR DE AGUA	GPP-11	1214920H1
COMBUSTIBLE, PRIMARIO	GP-110	702252C1
S7B DE TRONCOS con motor/FORD 220 DIESEL		
ACEITE, 4 7/16 IN	G-813	EPN6731B
ACEITE, 3 15/16 IN	G-836	C2TZ-6714-A
COMBUSTIBLE	G-11816	3132015R91
S7B DE TRONCOS con motor/GMC 3-53		
ACEITE, 9 IN	G-33	302574R91
ACEITE, 5 9/16 IN	G-119	165583-H1
COMBUSTIBLE, SECUNDARIO	G-1173	1190507R91
S7B DE TRONCOS con motor/IHC D188		
ACEITE	G-335	279994R91

MARCA-MODELO-MOTOR GONHER OEM
MAKE-MODEL-ENGINE GONHER OEM

I.H.C. HARVESTER (continuación)

CARGADORAS

S7C DE TRONCOS, S7D DE TRONCOS, S8 DE TRONCOS con motor/GMC 3-53		
ACEITE, FLUJO TOTAL (FULL FLOW)	G-119	165583-H1
S8A DE TRONCOS con motor/IHC D360		
ACEITE	GP-69	675616C91
COMBUSTIBLE, PRIMARIO	GP-1105	625626C1
COMBUSTIBLE, PRIMARIO	GP-1108	625627C1
COMBUSTIBLE, SECUNDARIO	GP-78	672603C1
AIRE, SECUNDARIO	GA-892	529852R4
AIRE, PRIMARIO	GA-891	529851R2
S8A DE TRONCOS, S8B DE TRONCOS con motor/IHC D358		
ACEITE	GP-10	398080R2
COMBUSTIBLE	GPP-1122	3132275R91
AIRE, SECUNDARIO	GA-892	529852R4
AIRE	GA-891	529851R2
S9A DE TRONCOS con motor/IHC D310		
ACEITE, OPCIONAL	GP-10	398080R2
COMBUSTIBLE, PRIMARIO	GPP-1122	3136187R91
COMBUSTIBLE, SECUNDARIO	GPP-1122	3132428R1
AIRE, SIN ASPAS	GA-403	389263R92
AIRE	GAK-403	389263R92
S9B DE TRONCOS con motor/A DIESEL		
ACEITE	GP-69	675616C91
COMBUSTIBLE, PRIMARIO	GP-1108	625627C1
COMBUSTIBLE, SECUNDARIO	GP-78	672603C1
S9B DE TRONCOS con motor/IHC DT360		
COMBUSTIBLE, PRIMARIO	GP-1101	625625C1
ACEITE	GP-69	675616C91
COMBUSTIBLE, SECUNDARIO	GP-78	672603C2

I.H.C. HARVESTER

COMBINADAS

101 con motor/IHC BD220		
ACEITE	G-335	279994R91
101 con motor/IHC D236		
ACEITE	G-335	279994R91
COMBUSTIBLE, PRIMARIO	G-1163	306353R91
COMBUSTIBLE, SECUNDARIO	G-1163	304101R91
105 con motor/IHC C153		
ACEITE, SELLADO	GP-50	538836R1
105 con motor/IHC D206		
COMBUSTIBLE, SIN CUBIERTA	G-1123	3055650R91
COMBUSTIBLE, CON CUBIERTA	G-1123F	3055650R91
ACEITE	GP-10	398080R2
AIRE, SIN ASPAS	GA-16	204439H1
AIRE	GAK-16	204439H1
140 con motores/IHC C164, IHC C169, IHC C175		
ACEITE, SELLADO	GP-50	538836R1
141 con motor/IHC BD240		
ACEITE	G-335	279994R91
141HILLSIDE con motor/IHC BD240		
ACEITE	G-335	279994R91

MARCA-MODELO-MOTOR GONHER OEM
MAKE-MODEL-ENGINE GONHER OEM

I.H.C. HARVESTER (continuación)

COMBINADAS

1420 con motor/IHC D358		
ACEITE, OPCIONAL	GP-10	528250R1
ACEITE	GP-66	528250R1
COMBUSTIBLE, PRIMARIO	GPP-1122	3136187R91
COMBUSTIBLE, SECUNDARIO	GPP-1122	3132428R2
1440 con motor/IHC D436		
HIDRAULICO	G-338	386120R91
ACEITE	GP-69	675617C91
COMBUSTIBLE, PRIMARIO	GP-1105	702143C1
COMBUSTIBLE, SECUNDARIO	GP-1107	674293C1
COMBUSTIBLE, SECUNDARIO	GP-78	674293C1
AIRE, PRIMARIO	GA-360	3375264R1
AIRE, SECUNDARIO	GA-361	530270R2
1460, 1470, 1480 con motor/IHC D436		
HIDRAULICO	G-338	386120R91
ACEITE	GP-69	675617C91
COMBUSTIBLE, PRIMARIO	GP-1105	702143C1
COMBUSTIBLE, SECUNDARIO	GP-1107	674293C1
COMBUSTIBLE, SECUNDARIO	GP-78	674293C1
151 con motor/IHC BD264		
ACEITE	G-335	279994R91
151 con motor/IHC D282		
ACEITE	G-335	279994R91
COMBUSTIBLE, PRIMARIO	G-1163	306353R91
COMBUSTIBLE, SECUNDARIO	G-1163	306353R91
151 HILLSIDE con motor/IHC BD264		
ACEITE	G-335	279994R91
151 HILLSIDE con motor/IHC D282		
ACEITE	G-335	279994R91
COMBUSTIBLE, PRIMARIO	G-1163	306353R91
COMBUSTIBLE, SECUNDARIO	G-1163	306353R91
181 con motor/IHC BD264		
ACEITE	G-335	328227R91
181 con motor/IHC D282		
ACEITE	G-335	328227R91
COMBUSTIBLE, PRIMARIO	G-1163	306353R91
COMBUSTIBLE, SECUNDARIO	G-1163	306353R91
203 con motor/IHC C153		
ACEITE, SELLADO	GP-50	538836R1
205 con motor/IHC C221		
HIDRAULICO	G-338	386120R91
ACEITE	GP-10	398080R2
AIRE, SIN ASPAS	GA-16	384812R93
AIRE	GAK-16	384812R93
221, 321 con motor/A DIESEL		
COMBUSTIBLE, SIN CUBIERTA	G-1123	3132015R91
COMBUSTIBLE, CON CUBIERTA	G-1123F	3132015R91
COMBUSTIBLE	G-296	3144477R92
COMBUSTIBLE, PRIMARIO	GP-1122	3218794R91
COMBUSTIBLE, SECUNDARIO	GP-1122	3132428R1
COMBUSTIBLE	G-296-B	3144477R92
ACEITE	GP-171	395789R2

MARCA-MODELO-MOTOR MAKE-MODEL-ENGINE	GONHER GONHER	OEM OEM	MARCA-MODELO-MOTOR MAKE-MODEL-ENGINE	GONHER GONHER	OEM OEM	MARCA-MODELO-MOTOR MAKE-MODEL-ENGINE	GONHER GONHER	OEM OEM
I.H.C. HARVESTER (continuación)			I.H.C. HARVESTER (continuación)			I.H.C. HARVESTER (continuación)		
COMBINADAS			COMBINADAS			COMBINADAS		
303 con motor/IHC BD220			403 HILLSIDE con motor/IHC C236			COMBUSTIBLE, SECUNDARIO	GP-78	672603C1
ACEITE	G-335	279994R91	ACEITE, CARTUCHO	G-335	328227R91	AIRE, SIN ASPAS	GA-403	389263R92
AIRE, SIN ASPAS	GA-16	384812R93	ACEITE, SELLADO	GP-10	398080R2	AIRE	GAK-403	389263R92
AIRE	GAK-16	384812R93	AIRE	GA-16	384812R93	AIRE, SECUNDARIO	GA-892	529852R4
			AIRE	GAK-16	384812R93			
303 con motor/IHC C221			403 HILLSIDE con motor/IHC C263			50 FORAGE COSECHADORA-BALER con motor/IHC C263		
ACEITE, CARTUCHO	G-335	279994R91	ACEITE, CARTUCHO	G-335	328227R91	ACEITE	G-335	279994R91
ACEITE, SELLADO GASOLINA	GP-10	398080R2	ACEITE, SELLADO	GP-10	398080R2			
ACEITE, SELLADO LPG	GP-36	3136046R93	ACEITE, SELLADO	GP-10	398080R2	503 con motor/IHC C282		
AIRE, SIN ASPAS	GA-16	384812R93	AIRE, SIN ASPAS	GA-16	384812R93	ACEITE, CARTUCHO	G-335	323827R91
AIRE	GAK-16	384812R93	AIRE	GAK-16	384812R93	ACEITE, SELLADO	GP-10	398080R2
						GASOLINA	GAK-16	384812R93
315 con motor/IHC A GASOLINA			403 HILLSIDE con motor/IHC C282			AIRE, LPG	GAK-403	389263R92
TRANSMISION	G-338	386120R91	ACEITE	G-335	328227R91			
ACEITE	GP-10	398080R2	ACEITE, SELLADO	GP-10	398080R2	503 con motor/IHC D282		
AIRE	GA-16	384812R93	AIRE, SIN ASPAS	GA-16	384812R93	ACEITE	G-335	323827R91
AIRE	GAK-16	384812R93	AIRE	GAK-16	384812R93	COMBUSTIBLE, PRIMARIO	G-1163	306353R91
						COMBUSTIBLE, SECUNDARIO	G-1163	306353R91
315 con motor/IHC C221			403 HILLSIDE con motores/IHC D282, IHC D301			ACEITE	GP-10	398080R2
ACEITE	G-338	386120R91	ACEITE, CARTUCHO	G-335	328227R91	503 con motor/IHC D301		
ACEITE	GP-10	398080R2	COMBUSTIBLE, PRIMARIO	G-1163	306353R91	ACEITE, CARTUCHO	G-335	323827R91
AIRE, SIN ASPAS	GA-16	384812R93	COMBUSTIBLE, SECUNDARIO	G-1163	306353R91	COMBUSTIBLE, PRIMARIO	G-1163	306353R91
AIRE	GAK-16	384812R93	ACEITE, TANQUE HIDRAULICO	G-338	528493R3	COMBUSTIBLE, SECUNDARIO	G-1163	306353R91
			ACEITE, SELLADO	GP-69	A184775	ACEITE, SELLADO	GP-10	398080R2
315 con motor/IHC D236			AIRE, SIN ASPAS	GA-403	389263R92	ACEITE, SELLADO	GP-69	A184775
ACEITE	G-335	328227R91	AIRE	GAK-403	389263R92	AIRE	GAK-403	389263R92
COMBUSTIBLE, CARTUCHO SECUNDARIO	G-1163	306353R91						
TRANSMISION	G-338	386120R91	431 con motor/A DIESEL					
COMBUSTIBLE, PRIMARIO SELLADO 5 17/32 IN	GP-1101	A184772	COMBUSTIBLE, SIN CUBIERTA	G-1123	3132015R91	606 con motor/IHC C221		
COMBUSTIBLE, PRIMARIO SELLADO 7 17/32 IN	GP-1108	A184773	COMBUSTIBLE, CON CUBIERTA	G-1123F	3132015R91	ACEITE, CARTUCHO	G-335	323827R91
COMBUSTIBLE, SECUNDARIO SELLADO	GP-110	702253C1	COMBUSTIBLE	G-296	3144477R92	COMBUSTIBLE, PRIMARIO	G-1163	304101R91
AIRE, SIN ASPAS	GA-403	389263R92	COMBUSTIBLE, PRIMARIO	GP-1122	3218794R91	COMBUSTIBLE, SECUNDARIO	G-1163	304101R91
AIRE	GAK-403	389263R92	COMBUSTIBLE, SECUNDARIO	GP-1122	3132428R1	ACEITE, SELLADO	GP-10	398080R2
			COMBUSTIBLE	G-296-B	3144477R92			
403 con motor/IHC C236			ACEITE	GP-171	395789R2	615 con motor/IHC C263		
ACEITE, CARTUCHO	G-335	328227R91				HIDRAULICO	G-338	386120R91
ACEITE, SELLADO	GP-10	398080R2	435 HILLSIDE, 453 HILLSIDE con motor/IHC C301			ACEITE	GP-10	398080R2
AIRE	GA-16	384812R93	HIDRAULICO	G-338	386120R91	AIRE	GAK-16	384812R93
AIRE	GAK-16	384812R93	ACEITE	GP-10	398080R2	GASOLINA	GG-20	170349C1
			AIRE, SIN ASPAS	GA-16	384812R93			
			AIRE	GAK-16	384812R93	615 con motor/IHC D282		
403 con motor/IHC C263						ACEITE, CARTUCHO	G-335	323827R91
ACEITE, CARTUCHO	G-335	328227R91	453 HILLSIDE con motor/A GASOLINA			COMBUSTIBLE, PRIMARIO	G-1163	306353R91
ACEITE, SELLADO	GP-10	398080R2	HIDRAULICO	G-338	528493R3	COMBUSTIBLE, SECUNDARIO	G-1163	306353R91
AIRE, SIN ASPAS	GA-16	384812R93	ACEITE	GP-36	3136046R93	HIDRAULICO	G-338	386120R91
AIRE	GAK-16	384812R93	AIRE, HASTA S/N 610	GAK-16	384812R93	ACEITE, SELLADO	GP-69	675616C91
			AIRE, S/N 610 EN ADELANTE	GAK-403	A40866	AIRE	GAK-403	389263R92
			GASOLINA	GG-20	405501C1			
403 con motor/IHC C282						64 con motor/IHC C113		
ACEITE	G-335	328227R91	453 HILLSIDE con motor/IHC D301			ACEITE, SELLADO	GP-50	538836R1
ACEITE, SELLADO	GP-10	398080R2	ACEITE, CARTUCHO	G-335	323827R91			
AIRE, SIN ASPAS	GA-16	384812R93	COMBUSTIBLE, PRIMARIO	G-1163	306353R91	715 con motor/IHC C301		
AIRE	GAK-16	384812R93	COMBUSTIBLE, SECUNDARIO	G-1163	306353R91	HIDRAULICO	G-338	386120R91
			HIDRAULICO	G-338	386120R91	ACEITE	GP-10	398080R2
			ACEITE, SELLADO	GP-69	675616C91	AIRE	GAK-16	384812R93
			AIRE	GAK-403	389263R92	GASOLINA	GG-20	170349C1
403 con motores/IHC D282, IHC D301								
ACEITE, CARTUCHO	G-335	328227R91	453 HILLSIDE con motor/IHC D360			715 con motor/IHC D301		
COMBUSTIBLE, PRIMARIO	G-1163	306353R91	HIDRAULICO	G-338	386120R91	ACEITE, CARTUCHO	G-335	279994R91
COMBUSTIBLE, SECUNDARIO	G-1163	306353R91	ACEITE	GP-69	675616C91	COMBUSTIBLE, PRIMARIO	G-1163	306353R91
ACEITE, TANQUE HIDRAULICO	G-338	528493R3	COMBUSTIBLE, PRIMARIO 6 43/64 IN	GP-1105	625626C1	COMBUSTIBLE, SECUNDARIO	G-1163	306353R91
ACEITE, SELLADO	GP-69	A184775	COMBUSTIBLE, PRIMARIO 7 17/32 IN	GP-1108	625627C1	HIDRAULICO	G-338	386120R91
AIRE, SIN ASPAS	GA-403	389263R92	COMBUSTIBLE, SEPARADOR DE AGUA	GPP-11	1214920H1	ACEITE, SELLADO	GP-69	675616C91
AIRE	GAK-403	389263R92				AIRE	GAK-403	389263R92
						AIRE, SECUNDARIO	GA-892	529852R1

SERVICIO PESADO

MARCA-MODELO-MOTOR	GONHER	OEM	MARCA-MODELO-MOTOR	GONHER	OEM	MARCA-MODELO-MOTOR	GONHER	OEM
MAKE-MODEL-ENGINE	GONHER	OEM	MAKE-MODEL-ENGINE	GONHER	OEM	MAKE-MODEL-ENGINE	GONHER	OEM
I.H.C. HARVESTER			I.H.C. HARVESTER (continuación)			I.H.C. HARVESTER (continuación)		
HILERADORAS			HILERADORAS			MONTACARGAS		
161, 163 con motores/IHC C123, IHC C135			4000 con motor/IHC C232			8000 con motor/IHC C200		
ACEITE, SELLADO	GP-50	538836R1	ACEITE	GP-20	384843C2	ACEITE	GP-10	398080R2
201 con motor/IHC BD144			AIRE	GAK-216	924779C2	GASOLINA		
ACEITE	G-801	705730R91	GASOLINA	GG-5	1701232C91	9000 con motor/IHC C291		
ACEITE	G-870	376364R91	GASOLINA	GG-5 L	1701232C91	ACEITE	G-335	279994R91
COMBUSTIBLE	G-296	3044506R91	5000 con motor/IHC D239			AIRE, SIN ASPAS	GA-16	384812R93
COMBUSTIBLE	G-296-B	3044506R91	ACEITE	GP-36	3136046R93	AIRE	GAK-16	384812R93
201 con motor/IHC C135			COMBUSTIBLE	GPP-1122	1967094C1	9000 con motor/IHC D310		
ACEITE, SELLADO	GP-50	538836R1	AIRE	GAK-216	924779C2	COMBUSTIBLE, CARTUCHO	G-1123	3132015R91
210, 225, 230 con motor/IHC C153			5000 con motor/IHC HB225			ACEITE	GP-10	528250R1
ACEITE, SELLADO	GP-50	538836R1	ACEITE	GP-10	398080R2	COMBUSTIBLE	G-296	3044506R91
AIRE	GA-18	313964R91	AIRE	GAK-216	924779C2	COMBUSTIBLE, PRIMARIO	GP-1122	3132428R1
AIRE, SIN ASPAS	GA-33	389567R91	GASOLINA	GG-5	417917C91	COMBUSTIBLE, SECUNDARIO	GP-1122	3132428R1
			GASOLINA	GG-5 L	417917C91	COMBUSTIBLE	G-296-B	3044506R91
275 con motor/AMC 6-232			5500 con motor/IHC D239			M10A con motor/IHC DT466B		
ACEITE	GP-20	384843C2	ACEITE	GP-10	398080R2	COMBUSTIBLE, SEPARADOR DE AGUA	GPP-14	998443R91
AIRE	GA-18	313964R91	COMBUSTIBLE, PRIMARIO	GPP-1122	3132275R91	ACEITE	GP-69	675616C91
GASOLINA	GG-5	417917C91	COMBUSTIBLE, SECUNDARIO	GPP-1122	3132275R91	COMBUSTIBLE, PRIMARIO	GP-1108	625627C1
GASOLINA	GG-5 L	417917C91	AIRE	GAK-216	924779C2	COMBUSTIBLE, SECUNDARIO	GP-78	672603C1
275 con motor/IHC C153			5500 con motor/IHC HB225			I.H.C. HARVESTER		
ACEITE, SELLADO	GP-50	538836R1	ACEITE	GP-9	395789R2	MOTORES		
275 con motor/IHC D206			AIRE	GAK-216	924779C2	152 4 CYL. A GASOLINA		
COMBUSTIBLE	G-11816	3132015R91	GASOLINA	GG-5	417917C91	ACEITE, CARTUCHO	G-333	214731R91
COMBUSTIBLE, CARTUCHO	G-1123	3132015R91	GASOLINA	GG-5 L	417917C91	ACEITE, SELLADO	GP-1	918266R93
ACEITE	GP-36	3136046R93	I.H.C. HARVESTER			GASOLINA	GG-5	1701232C91
COMBUSTIBLE	G-296	3144477R92	MONTACARGAS			GASOLINA	GG-5 L	1701232C91
COMBUSTIBLE, PRIMARIO	GPP-1122	1967094C1	4500 con motor/IHC C157 GASOLINA			196 4 CYL. A GASOLINA		
COMBUSTIBLE, SECUNDARIO	GPP-1122	1967094C1	ACEITE	GP-10	398080R2	ACEITE, CARTUCHO	G-333	214731R91
COMBUSTIBLE	G-296-B	3144477R92	4500A con motor/IHC C153			ACEITE, SELLADO	GP-1	918266R93
AIRE	GA-18	313964R91	ACEITE, SELLADO	GP-50	538836R1	AIRE, 1967-68	GA-77	332623C1
375 con motor/AMC 6-232			4500A con motor/IHC C157			AIRE, 1969 EN ADELANTE	GA-78	369500C1
HIDRAULICO	G-338	386120R91	ACEITE	GP-10	398080R2	GASOLINA	GG-5	417917C91
ACEITE	GP-20	384843C2	4500A, 4500B con motor/A DIESEL			GASOLINA	GG-5 L	417917C91
AIRE	GA-18	313964R91	ACEITE	GP-10	398080R2	220 6 CYL. A GASOLINA		
GASOLINA	GG-5	1701232C91	COMBUSTIBLE	G-296	3144477R92	ACEITE, FLUJO TOTAL (FULL FLOW)	G-333	214731R91
GASOLINA	GG-5 L	1701232C91	COMBUSTIBLE, PRIMARIO	GPP-1122	3136187R91	GASOLINA	GG-5	417917C91
375 con motor/IHC C153			COMBUSTIBLE, SECUNDARIO	GPP-1122	3132428R1	GASOLINA	GG-5 L	417917C91
HIDRAULICO	G-338	386120R91	COMBUSTIBLE	G-296-B	3144477R92	232 6 CYL. A GASOLINA, 258 6 CYL. A GASOLINA		
ACEITE, SELLADO	GP-50	538836R1	4500B con motor/IHC C153			ACEITE, 5 13/32 IN	GP-5	998435-R91
AIRE, SIN ASPAS	GA-33	389567R91	ACEITE, SELLADO	GP-50	538836R1	ACEITE, 3 45/64 IN	GP-20	384843C2
375 con motor/IHC C175			4500B con motor/IHC C157			AIRE	GA-78	369500C1
HIDRAULICO	G-338	386120R91	ACEITE	GP-10	398080R2	GASOLINA	GG-5	384843C2
ACEITE	GP-10	398080R2	4500B con motor/IHC D179			GASOLINA	GG-5 L	384843C2
AIRE	GA-18	313964R91	ACEITE	GP-10	398080R2	240 6 CYL. A GASOLINA		
GASOLINA	GG-5	1701232C91	COMBUSTIBLE	G-296	3144477R92	ACEITE, FLUJO TOTAL (FULL FLOW)	G-333	214731R91
GASOLINA	GG-5 L	1701232C91	COMBUSTIBLE, PRIMARIO	GPP-1122	3136187R91	266 V8 A GASOLINA		
375 con motor/IHC D206			COMBUSTIBLE	G-296-B	3144477R92	ACEITE, CARTUCHO	G-333	214731R91
HIDRAULICO	G-338	386120R91	7000 con motores/IHC BC144, IHC BD154			ACEITE, SELLADO 5 13/32 IN	GP-1	918266R93
COMBUSTIBLE, CARTUCHO	G-1123	3132015R91	ACEITE, CARTUCHO	GP-870	376364R91	ACEITE, SELLADO 7 17/32 IN	GP-10	427207C1
ACEITE	GP-36	3136046R93	ACEITE, SELLADO	GP-1	388227R91	AIRE	GA-78	369500C1
COMBUSTIBLE	G-296	3144477R92	COMBUSTIBLE	G-296	3144477R92	GASOLINA	GG-5	417917C91
COMBUSTIBLE, SELLADO	GPP-1122	3132275R91	COMBUSTIBLE	G-296-B	3144477R92	GASOLINA	GG-5 L	417917C91
COMBUSTIBLE	G-296-B	3144477R92						
AIRE	GA-18	313964R91						

SERVICIO PESADO

MARCA-MODELO-MOTOR	GONHER	OEM	MARCA-MODELO-MOTOR	GONHER	OEM	MARCA-MODELO-MOTOR	GONHER	OEM
MAKE-MODEL-ENGINE	GONHER	OEM	MAKE-MODEL-ENGINE	GONHER	OEM	MAKE-MODEL-ENGINE	GONHER	OEM
I.H.C. HARVESTER (continuación)			I.H.C. HARVESTER (continuación)			I.H.C. HARVESTER (continuación)		
MOTORES			MOTORES			MOTORES		
304 V8 A GASOLINA, 345 V8 A GASOLINA, 392 V8 A GASOLINA			COMBUSTIBLE, SEPARADOR DE AGUA	G-178	1822631C91	COMBUSTIBLE, SECUNDARIO S/N 20002190 EN ADELANTE	GP-1122	3132428R1
ACEITE, CARTUCHO	G-333	214731R91	AGUA	GP-2071W	1822313C1	COMBUSTIBLE, HASTA S/N 20002189	G-296-B	3144477R92
ACEITE, SELLADO 5 13/32 IN	GP-1	918266R93	ACEITE	GP-562	1814562C1			
ACEITE, SELLADO 7 17/32 IN	GP-10	427207C1						
AIRE	GA-78	369500C1	7.3L A DIESEL			D179 A DIESEL, D239 A DIESEL		
GASOLINA	GG-5	417917C91	ACEITE	GP-3766	1804442C1	ACEITE, 7 17/32 IN	GP-10	398080R2
GASOLINA	GG-5 L	417917C91	AGUA	GP-2071W	1822313C1	ACEITE, 5 13/32 IN	GP-36	3136046R93
			COMBUSTIBLE	GP-155	1804459C1	COMBUSTIBLE	G-296	3144477R92
304A V8 A GASOLINA			COMBUSTIBLE, SEPARADOR DE AGUA	GPP-1287	1816568C91	COMBUSTIBLE, PRIMARIO	GP-1122	3132428R1
ACEITE, SELLADO 5 13/32 IN	GP-1	918266R93				COMBUSTIBLE, SECUNDARIO	GP-1122	3132428R1
ACEITE, SELLADO 7 17/32 IN	GP-10	427207C1	9.0L A DIESEL			COMBUSTIBLE	G-296-B	3144477R92
AIRE	GA-78	369500C1	ACEITE	GP-10	427207C2	D206 A DIESEL, D310 A DIESEL		
GASOLINA	GG-5	417917C91	COMBUSTIBLE, PRIMARIO	GP-1101	625625C1	COMBUSTIBLE, SIN CUBIERTA	G-1123	3132015R91
GASOLINA	GG-5 L	417917C91	COMBUSTIBLE, SEPARADOR DE AGUA	GPP-11	1214920H1	COMBUSTIBLE, CON CUBIERTA	G-1123F	3132015R91
			ACEITE, DERIVACION (BY PASS)	GP-78	672603C2	ACEITE	GP-10	398080R2
345A V8 A GASOLINA			BC144 A DIESEL, BD144 A DIESEL	G-750	970165R1	COMBUSTIBLE	G-296	3144477R92
ACEITE, CARTUCHO	G-333	214731R91	ACEITE	G-870	376364R91	COMBUSTIBLE, PRIMARIO	GP-1122	3132428R1
ACEITE, SELLADO 5 13/32 IN	GP-1	388227R91				COMBUSTIBLE, SECUNDARIO	GP-1122	3132428R1
ACEITE, SELLADO 7 17/32 IN	GP-10	39080R2	BD144 A DIESEL, BD144C A DIESEL, BD154 A DIESEL, BD154C A DIESEL, BD154T A DIESEL			COMBUSTIBLE	G-296-B	3144477R92
AIRE	GA-78	369500C1	ACEITE			D282 A DIESEL		
GASOLINA	GG-5 L	1701232C91				ACEITE, CARTUCHO	G-335	279994R91
			BD220 INDUSTRIAL, BD240 INDUSTRIAL, BG220 INDUSTRIAL			COMBUSTIBLE, CARTUCHO SECUNDARIO	G-1163	306353R91
400 V8 A GASOLINA			ACEITE, CARTUCHO	G-333	214731R91	COMBUSTIBLE, SEPARADOR DE AGUA 5 3/4 IN	GPP-14	998443R91
ACEITE, 5 13/32 IN	GP-5	998435-R91				COMBUSTIBLE, PRIMARIO 6 43/64 IN	GP-1101	625625C1
ACEITE, 3 45/64 IN	GP-20	384843C2	BD264 INDUSTRIAL, BD282 INDUSTRIAL, BD308 INDUSTRIAL, BG241 INDUSTRIAL, BG265 INDUSTRIAL			ACEITE, SELLADO	GP-69	675616C91
AIRE	GA-78	369500C1	ACEITE, CARTUCHO	G-333	214731R91	COMBUSTIBLE, PRIMARIO 6 43/64 IN	GP-1105	625626C1
GASOLINA	GG-5	417917C91	GASOLINA	GG-5	1701232C91	COMBUSTIBLE, PRIMARIO 7 17/32 IN	GP-1108	625627C1
GASOLINA	GG-5 L	417917C91	GASOLINA	GG-5 L	1701232C91	COMBUSTIBLE, SECUNDARIO 7 1/8 IN	GP-110	702142C1
						COMBUSTIBLE, SEPARADOR DE AGUA 9 17/32 IN	GPP-1000	702256C1
404 V8 A GASOLINA, 446 V8 (7.3L) A DIESEL			BD269 INDUSTRIAL			D301 A DIESEL		
ACEITE, SELLADO 5 13/32 IN	GP-1	918266R93	GASOLINA	GG-5	1701232C91	ACEITE, CARTUCHO	G-335	323827R91
ACEITE, SELLADO 7 17/32 IN	GP-10	427207C2	C146 A DIESEL			COMBUSTIBLE, SECUNDARIO	G-1163	304101R91
AIRE	GA-78	369500C1	ACEITE, SELLADO	GP-50	538836R1	ACEITE, SELLADO	GP-10	39080R2
GASOLINA	GG-20	531546R91				D304 A DIESEL, D345 A DIESEL		
GASOLINA	GG-5 L	417917C91	C221 A DIESEL, C240 A DIESEL, C282 A DIESEL, C291 A DIESEL, D166 A DIESEL, D188 A DIESEL			ACEITE	GP-1	918266R93
			ACEITE, CARTUCHO	G-335	279994R91	D312 A DIESEL		
420 V8 (6.9L) A DIESEL			C301 A GAS LPG			ACEITE	GP-69	675616C91
COMBUSTIBLE, PRIMARIO	GPP-14	674293C1	ACEITE, CARTUCHO	G-335	279994R91	COMBUSTIBLE, PRIMARIO 6 43/64 IN	GP-1105	625626C1
ACEITE	GP-3766	1804442C1	ACEITE, SELLADO	GP-10	398080R2	COMBUSTIBLE, PRIMARIO 7 17/32 IN	GP-1108	625627C1
COMBUSTIBLE, SECUNDARIO	GP-155	1804459C1	GASOLINA, OPCIONAL	GG-20	170349C1	COMBUSTIBLE, SECUNDARIO	GP-78	672603C2
AIRE	GA-422	588213C1						
			D150 A DIESEL, D170 A DIESEL, D190 A DIESEL			D350 A DIESEL		
444 V8 (7.3L) A DIESEL			ACEITE	GP-10	39080R2	ACEITE, FLUJO TOTAL (FULL FLOW)	G-335	279994R91
ACEITE	GP-3766	1804442C1	COMBUSTIBLE, SECUNDARIO	GP-1107	674293C1	D354 A DIESEL		
			COMBUSTIBLE, PRIMARIO	GP-1108	625627C1	ACEITE	G-834	795840R91
530 (NGD) A DIESEL			COMBUSTIBLE, SEPARADOR DE AGUA	GPP-11	1214920H1	COMBUSTIBLE	G-296	3044506R91
AGUA	GP-2071W	1822313C1	AIRE	GA-2984	472098C1	COMBUSTIBLE	G-296-B	3044506R91
COMBUSTIBLE, SECUNDARIO	GP-78	1809789C1	D155 A DIESEL					
ACEITE	GP-152	1819452C1	ACEITE	GP-10	398080R2	D358 A DIESEL		
			COMBUSTIBLE, HASTA S/N 20002189	G-296	3144477R92	ACEITE	GP-10	528250R1
537 V8 A GASOLINA, 605 A DIESEL, C157 A DIESEL, C175 A DIESEL, C200 A DIESEL, D268 A DIESEL			COMBUSTIBLE, PRIMARIO S/N 20002190 EN ADELANTE	GP-1122	3132428R1	COMBUSTIBLE	G-296	3144477R92
ACEITE	GP-10	427207C2				COMBUSTIBLE, PRIMARIO	GPP-1122	3136187R91
551CID (9.0L) A DIESEL								
ACEITE	GP-10	39080R2						
COMBUSTIBLE, PRIMARIO	GP-1101	244458R91						
COMBUSTIBLE, SECUNDARIO	GP-78	672603C1						
6.9L A DIESEL								
ACEITE	GP-3766	1804442C1						
AGUA	GP-2071W	1822313C1						
COMBUSTIBLE	GP-155	1804459C1						
7.3 L-DIT A DIESEL								

MARCA-MODELO-MOTOR MAKE-MODEL-ENGINE	GONHER GONHER	OEM OEM	MARCA-MODELO-MOTOR MAKE-MODEL-ENGINE	GONHER GONHER	OEM OEM	MARCA-MODELO-MOTOR MAKE-MODEL-ENGINE	GONHER GONHER	OEM OEM
I.H.C. HARVESTER (continuación)			I.H.C. HARVESTER (continuación)			I.H.C. HARVESTER (continuación)		
MOTORES			MOTORES			MOTORES		
COMBUSTIBLE, SECUNDARIO	GPP-1122	3132428R1	COMBUSTIBLE, PRIMARIO SELLADO 6 43/64 IN	GP-1105	625626C1	DT817B A DIESEL, DT817C A DIESEL, DT1817C A DIESEL		
COMBUSTIBLE	G-296-B	3144477R92	COMBUSTIBLE, PRIMARIO SELLADO 7 17/32 IN	GP-1108	625627C1	COMBUSTIBLE, SECUNDARIO	GP-1107	674293C1
D360 (6.0L) A DIESEL			COMBUSTIBLE, SECUNDARIO SELLADO	GP-110	702142C1	COMBUSTIBLE, PRIMARIO	GP-1108	625627C1
COMBUSTIBLE, PRIMARIO 6 43/64 IN	GP-1101	625625C1	DT408 (NGD) A DIESEL, DT466 (NGD) A DIESEL, DT466PLN (7.6L) A DIESEL			COMBUSTIBLE, SECUNDARIO	GP-110	702253C1
ACEITE	GP-69	675617C91	COMBUSTIBLE, AUTOBUSES	GP-62	1820479C1	DTA360 (6.0L) A DIESEL		
COMBUSTIBLE, PRIMARIO 6 43/64 IN	GP-1105	625626C1	AGUA	GP-2071W	1822313C1	ACEITE	GP-69	1908896C1
COMBUSTIBLE, PRIMARIO 7 17/32 IN	GP-1108	625627C1	COMBUSTIBLE, CAMIONES	GP-78	1822588C1	AGUA	GP-1011Q	1661388H1
ACEITE	GP-88	1811953C1	ACEITE	GP-152	1819452C1	ACEITE	GP-88	1811953C1
COMBUSTIBLE, SECUNDARIO	GP-78	672603C2	DT408 A DIESEL			COMBUSTIBLE	GP-78	1809789C1
D361 (6.0L) A DIESEL, DT282 A DIESEL			COMBUSTIBLE	GP-1122	FF5052	DU111D A DIESEL, DU66D A DIESEL, DU74D A DIESEL, DU99D A DIESEL		
ACEITE	G-335	279994R91	AGUA	GP-2071W	1822313C1	COMBUSTIBLE	G-1121	715712R91
D392 A DIESEL			COMBUSTIBLE, CAMIONES	GP-78	1822588C1	DV462 A DIESEL		
ACEITE	GP-10	427207C2	ACEITE	GP-152	1819452C1	ACEITE, SELLADO	GP-10	39080R2
D407 A DIESEL, DT407 A DIESEL			DT408PLN A DIESEL, DT466E (7.6L) A DIESEL, DT530 (8.7L) A DIESEL			COMBUSTIBLE, SECUNDARIO	GP-1107	702143C1
ACEITE, CARTUCHO	G-335	279994R91	AGUA	GP-2071W	1822313C1	COMBUSTIBLE, PRIMARIO	GP-1108	625626C1
COMBUSTIBLE, SEPARADOR DE AGUA 5 3/4 IN	GPP-14	998443R91	COMBUSTIBLE	GP-78	1822588C1	DV550 (9.0L) A DIESEL		
COMBUSTIBLE, PRIMARIO 6 43/64 IN	GP-1101	625625C1	ACEITE	GP-152	1819452C1	ACEITE, SELLADO	GP-10	427207C1
ACEITE, SELLADO	GP-69	675617C91	DT429 A DIESEL			COMBUSTIBLE, PRIMARIO SELLADO	GP-1108	625627C1
COMBUSTIBLE, PRIMARIO 6 43/64 IN	GP-1105	625626C1	COMBUSTIBLE, CARTUCHO SECUNDARIO	G-1163	306353R91	COMBUSTIBLE, SEPARADOR DE AGUA	GPP-11	1214920H1
COMBUSTIBLE, PRIMARIO 7 17/32 IN	GP-1108	625627C1	COMBUSTIBLE, PRIMARIO 6 43/64 IN	GP-1105	625626C1	COMBUSTIBLE, SECUNDARIO SELLADO	GP-78	672603C2
COMBUSTIBLE, SECUNDARIO 7 1/8 IN	GP-110	702142C1	COMBUSTIBLE, PRIMARIO 7 17/32 IN	GP-1108	625627C1	AIRE, CON TURBO	GA-109	478974C1
COMBUSTIBLE, SEPARADOR DE AGUA 9 17/32 IN	GPP-1000	702256C1	COMBUSTIBLE, SECUNDARIO SELLADO 7 1/8 IN	GP-110	702142C1	DV550B (9.0L) A DIESEL		
D414 A DIESEL, D436 A DIESEL, DT414 A DIESEL			DT436 A DIESEL			ACEITE, SELLADO	GP-10	39080R2
COMBUSTIBLE, PRIMARIO 6 43/64 IN	GP-1101	625625C1	ACEITE	GP-69	675617C91	COMBUSTIBLE, SECUNDARIO 7 7/64 IN	GP-1107	702143C1
ACEITE	GP-69	675617C91	COMBUSTIBLE, PRIMARIO	GP-1105	625626C1	COMBUSTIBLE, PRIMARIO SELLADO	GP-1108	625626C1
COMBUSTIBLE, PRIMARIO 6 43/64 IN	GP-1105	625626C1	COMBUSTIBLE, SECUNDARIO	GP-1107	702143C1	COMBUSTIBLE, SECUNDARIO 7 7/64 IN	GP-78	672603C1
COMBUSTIBLE, PRIMARIO 7 17/32 IN	GP-1108	625627C1	DT466 (7.6L) A DIESEL, DT466C (7.6L) A DIESEL, DTA466 (7.6L) A DIESEL, DTA466C (7.6L) A DIESEL, DT1466 (7.6L) A DIESEL, DVT466 (7.6L) A DIESEL			AIRE, CON TURBO	GA-109	478974C1
COMBUSTIBLE, SECUNDARIO	GP-78	672603C2	COMBUSTIBLE, PRIMARIO 5 17/32 IN	GP-1101	625625C1	DV550BTC (9.0L) A DIESEL		
DT239 A DIESEL			ACEITE, HASTA 1994	GP-69	1808896C1	ACEITE, SELLADO	GP-10	39080R2
ACEITE, 7 17/32 IN	GP-10	39080R2	COMBUSTIBLE, PRIMARIO 7 17/32 IN	GP-1108	625627C1	COMBUSTIBLE, PRIMARIO SELLADO	GP-1108	625626C1
ACEITE, 5 13/32 IN	GP-36	3136046R93	ACEITE, HASTA 1994	GP-88	1811953C1	COMBUSTIBLE, SECUNDARIO SELLADO	GP-78	672603C1
COMBUSTIBLE	G-296	3144477R92	AGUA	GP-2071W	1822313C1	AIRE, CON TURBO	GA-109	478974C1
COMBUSTIBLE, PRIMARIO	GP-1122	3132428R1	COMBUSTIBLE, FILTRO FINAL PARA CAMIONES	GP-78	1809789C1	DVT573 A DIESEL		
COMBUSTIBLE, SECUNDARIO	GP-1122	3132428R1	ACEITE, 1994 EN ADELANTE	GP-152	1819452C1	COMBUSTIBLE, PRIMARIO	GP-1108	702251C1
COMBUSTIBLE	G-296-B	3144477R92	AIRE	GA-109	478974C1	COMBUSTIBLE, SEPARADOR DE AGUA	GPP-11	1214920H1
DT358 A DIESEL			AIRE, PRIMARIO	GA-209	476741C1	COMBUSTIBLE, SECUNDARIO SELLADO	GP-78	672603C1
ACEITE	GP-10	528250R1	AIRE, SECUNDARIO	GA-210	482644C1	DVT573B A DIESEL		
COMBUSTIBLE, PRIMARIO	GPP-1122	3136187R91	AIRE	GA-2984	472098C1	COMBUSTIBLE, PRIMARIO	GPP-14	702255C1
COMBUSTIBLE, SECUNDARIO	GPP-1122	3132428R1	DT466B (7.6L) A DIESEL, DT1466C (7.6L) A DIESEL			COMBUSTIBLE, SECUNDARIO	GP-1107	674293C1
DT360 (6.0L) A DIESEL			COMBUSTIBLE, PRIMARIO 6 43/64 IN	GP-1101	625625C1	COMBUSTIBLE, PRIMARIO	GP-1108	625627C1
ACEITE	GP-69	1908896C1	ACEITE	GP-69	675617C91	COMBUSTIBLE, SEPARADOR DE AGUA	GPP-11	1214920H1
AGUA	GP-1011Q	1661388H1	COMBUSTIBLE, PRIMARIO 6 43/64 IN	GP-1105	625626C1	DVT800 A DIESEL		
ACEITE	GP-88	1811953C1	COMBUSTIBLE, PRIMARIO 7 17/32 IN	GP-1108	625627C1	COMBUSTIBLE, SEPARADOR DE AGUA	GPP-14	998443R91
COMBUSTIBLE	GP-78	1809789C1	ACEITE	GP-88	1811953C1	COMBUSTIBLE, SECUNDARIO	GP-1107	674293C1
DT361 (6.0L) A DIESEL			COMBUSTIBLE, SECUNDARIO	GP-78	672603C2	COMBUSTIBLE, PRIMARIO	GP-1108	625627C1
ACEITE, CARTUCHO	G-335	279994R91	ACEITE, 1994 EN ADELANTE	GP-152	1819452C1			
COMBUSTIBLE, CARTUCHO SECUNDARIO	G-1163	306353R91						

SERVICIO PESADO

MARCA-MODELO-MOTOR MAKE-MODEL-ENGINE	GONHER GONHER	OEM OEM	MARCA-MODELO-MOTOR MAKE-MODEL-ENGINE	GONHER GONHER	OEM OEM	MARCA-MODELO-MOTOR MAKE-MODEL-ENGINE	GONHER GONHER	OEM OEM
I.H.C. HARVESTER (continuación)			I.H.C. HARVESTER (continuación)			I.H.C. HARVESTER (continuación)		
MOTORES			MOTORES			MOTORES		
I530E A DIESEL, I530PLN A DIESEL			COMBUSTIBLE, SEPARADOR DE AGUA	GPP-11	1214920H1	COMBUSTIBLE, PRIMARIO S/N 17715 EN ADELANTE	GP-1108	625627C1
AGUA	GP-2071W	1822313C1	COMBUSTIBLE, SECUNDARIO	GP-110	702252C1	COMBUSTIBLE, SEPARADOR DE AGUA	GPP-11	1214920H1
COMBUSTIBLE	GP-78	1822588C1	UD282 A DIESEL			ACEITE	GP-88	1811953C1
ACEITE	GP-152	1819452C1	ACEITE	G-335	323827R91	COMBUSTIBLE, SECUNDARIO	GP-78	672603C2
IRV446 A DIESEL			COMBUSTIBLE, PRIMARIO	G-1163	306353R91	UD817B A DIESEL, UDT1817B A DIESEL, UDT817C A DIESEL		
ACEITE	GP-69	675616C91	COMBUSTIBLE, SECUNDARIO	G-1163	304101R91	COMBUSTIBLE, SECUNDARIO	GP-1107	674293C1
COMBUSTIBLE, PRIMARIO	GP-1108	625627C1	COMBUSTIBLE, PRIMARIO	GPP-14	702254C1	COMBUSTIBLE, PRIMARIO	GP-1108	625627C1
COMBUSTIBLE, SECUNDARIO	GP-78	672603C1	COMBUSTIBLE, PRIMARIO	GP-1105	702143C1	COMBUSTIBLE, SEPARADOR DE AGUA	GPP-11	1214920H1
MV404 V8 A GASOLINA, MV406 V8 A GASOLINA, MV446 V8 (7.3L) A GASOLINA			COMBUSTIBLE, PRIMARIO	GP-1108	702251C1	UDT429 A DIESEL		
ACEITE, SELLADO 5 13/32 IN	GP-1	388227R91	COMBUSTIBLE, SEPARADOR DE AGUA	GPP-11	1214920H1	COMBUSTIBLE, PRIMARIO	G-1163	306353R91
ACEITE, SELLADO 7 17/32 IN	GP-10	39080R2	COMBUSTIBLE, SECUNDARIO	GP-110	702252C1	COMBUSTIBLE, SECUNDARIO	G-1163	304101R91
AIRE	GA-78	369500C1	UD312 A DIESEL			COMBUSTIBLE, PRIMARIO	GP-1105	702143C1
GASOLINA	GG-5 L	1701232C91	ACEITE	GP-69	675616C91	COMBUSTIBLE, PRIMARIO	GP-1108	702251C1
RD372 INDUSTRIAL, RD406 INDUSTRIAL, RD450 INDUSTRIAL, RD501 INDUSTRIAL			COMBUSTIBLE, PRIMARIO 6 43/64 IN	GP-1105	625626C1	COMBUSTIBLE, SEPARADOR DE AGUA	GPP-11	1214920H1
GASOLINA	GG-5	1701232C91	COMBUSTIBLE, PRIMARIO 7 17/32 IN	GP-1108	625627C1	COMBUSTIBLE, SECUNDARIO	GP-110	702142C1
T444E (7.3L) A DIESEL			COMBUSTIBLE, SEPARADOR DE AGUA	GPP-11	1214920H1	UDT436 A DIESEL		
COMBUSTIBLE, SEPARADOR DE AGUA	G-862	1825864C92	COMBUSTIBLE, SECUNDARIO	GP-78	672603C2	COMBUSTIBLE, SECUNDARIO	GPP-14	674293C1
COMBUSTIBLE, SEPARADOR DE AGUA	G-178	1822631C91	UD360 (6.0L) A DIESEL, UDT360 (6.0L) A DIESEL			ACEITE	GP-69	675616C91
COMBUSTIBLE, SEPARADOR DE AGUA	GPP-547	1618385C94	COMBUSTIBLE, PRIMARIO 5 17/32 IN	GP-1101	625625C1	COMBUSTIBLE, PRIMARIO	GP-1105	625626C1
AGUA	GP-2071W	1822313C1	ACEITE	GP-69	675617C91	UDT537B A DIESEL, UDT573 A DIESEL		
ACEITE	GP-562	1814562C1	COMBUSTIBLE, PRIMARIO 6 43/64 IN	GP-1105	625626C1	COMBUSTIBLE, PRIMARIO	G-1163	306353R91
U1 A DIESEL, UB240 A DIESEL, UB264 A DIESEL, UD301 A DIESEL, UD370 A DIESEL, UC221 SLEEVED A DIESEL, UC263 SLEEVED A DIESEL, UC301 A DIESEL			COMBUSTIBLE, PRIMARIO 7 17/32 IN	GP-1108	625627C1	COMBUSTIBLE, SECUNDARIO	G-1163	304101R91
ACEITE	G-335	279994R91	COMBUSTIBLE, SEPARADOR DE AGUA	GPP-11	1214920H1	COMBUSTIBLE, PRIMARIO	GPP-14	702251C1
U2 A DIESEL, U2A A DIESEL			ACEITE	GP-88	1811953C1	COMBUSTIBLE, SECUNDARIO	GPP-14	674293C1
ACEITE, S/N 5942 EN ADELANTE	GP-50	538836R1	COMBUSTIBLE, SECUNDARIO	GP-78	672603C2	COMBUSTIBLE, SEPARADOR DE AGUA	GPP-11	1214920H1
U301 A DIESEL, UD166 A DIESEL			UD407 A DIESEL, UDT407 A DIESEL			UDV800 A DIESEL		
ACEITE	G-335	323827R91	ACEITE, CARTUCHO	G-335	279994R91	COMBUSTIBLE, PRIMARIO	GPP-14	702255C1
COMBUSTIBLE, PRIMARIO	G-1163	306353R91	COMBUSTIBLE, SEPARADOR DE AGUA 5 3/4 IN	GPP-14	998443R91	COMBUSTIBLE	GP-1105	625626C1
COMBUSTIBLE, SECUNDARIO	G-1163	304101R91	COMBUSTIBLE, PRIMARIO 6 43/64 IN	GP-1101	625625C1	COMBUSTIBLE	GP-1107	674293C1
U4 A DIESEL			ACEITE, SELLADO	GP-69	675617C91	COMBUSTIBLE, SEPARADOR DE AGUA	GPP-11	1214920H1
ACEITE, S/N 2730 EN ADELANTE	GP-50	538836R1	COMBUSTIBLE, PRIMARIO 6 43/64 IN	GP-1105	625626C1	AGUA	GP-2071W	1809789C1
U446 A DIESEL			COMBUSTIBLE, PRIMARIO 7 17/32 IN	GP-1108	625627C1	COMBUSTIBLE, SECUNDARIO	GP-78	672603C2
ACEITE	GP-1	918266R93	COMBUSTIBLE, SECUNDARIO	GP-110	702142C1	UDVT573 A DIESEL		
UC135B A DIESEL, UC153 A DIESEL			COMBUSTIBLE, SEPARADOR DE AGUA 9 17/32 IN	GPP-1000	702256C1	COMBUSTIBLE	G-1163	306353R91
ACEITE, S/N 57581 EN ADELANTE	GP-50	538836R1	UD414 A DIESEL, UDT414 A DIESEL			COMBUSTIBLE, SECUNDARIO	G-1163	304101R91
UD144A A DIESEL			COMBUSTIBLE, PRIMARIO 6 43/64 IN	GP-1101	625625C1	COMBUSTIBLE, SECUNDARIO	GPP-14	702255C1
ACEITE	G-870	705730R91	ACEITE	GP-69	675617C91	COMBUSTIBLE, SECUNDARIO	GP-1107	674293C1
UD170 A DIESEL			COMBUSTIBLE, PRIMARIO 6 43/64 IN	GP-1105	625626C1	COMBUSTIBLE, PRIMARIO	GP-1108	702251C1
COMBUSTIBLE, PRIMARIO	GP-1108	702251C1	COMBUSTIBLE, PRIMARIO 7 17/32 IN	GP-1108	625627C1	COMBUSTIBLE, SEPARADOR DE AGUA	GPP-11	1214920H1
UD236 A DIESEL, UD361 (6.0L) A DIESEL, UDT361 (6.0L) A DIESEL			COMBUSTIBLE, SEPARADOR DE AGUA	GPP-11	1214920H1	UV345 A DIESEL		
ACEITE	G-335	323827R91	COMBUSTIBLE, SECUNDARIO	GP-78	672603C2	ACEITE	G-333	216139R91
COMBUSTIBLE, PRIMARIO	G-1163	306353R91	UD466 (7.6L) A DIESEL, UDT466 (7.6L) A DIESEL			V304 A GASOLINA		
COMBUSTIBLE, SECUNDARIO	G-1163	304101R91	ACEITE	GP-69	675617C91	ACEITE	GP-10	39080R2
COMBUSTIBLE, PRIMARIO	GP-1105	702143C1	COMBUSTIBLE, PRIMARIO 6 43/64 IN	GP-1105	625626C1	V345 A GASOLINA, V392 A GASOLINA		
COMBUSTIBLE, PRIMARIO	GP-1108	702251C1	COMBUSTIBLE, PRIMARIO 7 17/32 IN	GP-1108	625627C1	ACEITE	GP-10	39080R2
			COMBUSTIBLE, SEPARADOR DE AGUA	GPP-11	1214920H1	AIRE	GA-3501	446661C1
			COMBUSTIBLE, SECUNDARIO	GP-78	672603C2	GASOLINA	GG-20	531546R91
			UD466 (7.6L) A DIESEL, UDT466 (7.6L) A DIESEL			V537 A DIESEL		
			ACEITE	GP-69	675617C91	ACEITE, FLUJO TOTAL (FULL FLOW)	GP-10	427207C2
			COMBUSTIBLE, PRIMARIO HASTA S/N 13715	GP-1105	625625C1			

MARCA-MODELO-MOTOR MAKE-MODEL-ENGINE	GONHER GONHER	OEM OEM	MARCA-MODELO-MOTOR MAKE-MODEL-ENGINE	GONHER GONHER	OEM OEM	MARCA-MODELO-MOTOR MAKE-MODEL-ENGINE	GONHER GONHER	OEM OEM
I.H.C. HARVESTER (continuación)			I.H.C. HARVESTER (continuación)			I.H.C. HARVESTER (continuación)		
RASPADORAS			RASPADORAS			RASPADORAS		
295, 295B con motor/IHC DT817			431 con motor/IHC DVT800			433B con motor/IHC DVT800		
COMBUSTIBLE, PRIMARIO	GP-1108	625627C1	ACEITE, CUMPLE CON MEDIDAS ORIGINALES	GP-691	684206C1	ACEITE, CUMPLE CON MEDIDAS ORIGINALES	GP-691	684206C1
295B con motor/IHC DT817			COMBUSTIBLE, SEPARADOR DE AGUA	GPP-14	998443R91	COMBUSTIBLE, SEPARADOR DE AGUA	GPP-14	998443R91
TRANSMISION	G-33	319926R91	ACEITE, SEGUNDA OPCION	GP-52	684206C1	ACEITE, SEGUNDA OPCION	GP-52	684206C1
COMBUSTIBLE, PRIMARIO 6 43/64 IN	GP-1105	625626C1	COMBUSTIBLE, SECUNDARIO	GP-1107	674293C1	COMBUSTIBLE, SECUNDARIO	GP-1107	674293C1
COMBUSTIBLE, SECUNDARIO	GP-1107	674293C1	COMBUSTIBLE, PRIMARIO	GP-1108	625627C1	COMBUSTIBLE, PRIMARIO	GP-1108	625627C1
COMBUSTIBLE, PRIMARIO 7 17/32 IN	GP-1108	625627C1	AGUA	GP-2071W	1261387H1	AGUA	GP-2071W	1261387H1
COMBUSTIBLE, SEPARADOR DE AGUA	GPP-11	1214920H1	431B con motor/A DIESEL			442 con motor/A DIESEL		
COMBUSTIBLE, SECUNDARIO	GP-110	702142C1	TRANSMISION	G-333	615447C1	TRANSMISION	G-333	615447C1
412 con motor/IHC			COMBUSTIBLE, PRIMARIO	GPP-14	702255C1	COMBUSTIBLE, PRIMARIO	GPP-14	702255C1
COMBUSTIBLE, SEPARADOR DE AGUA	GPP-14	998443R91	COMBUSTIBLE, SECUNDARIO	GP-1107	674293C1	COMBUSTIBLE, SECUNDARIO	GP-1107	674293C1
ACEITE	GP-69	675617C91	COMBUSTIBLE, PRIMARIO	GP-1108	625627C1	COMBUSTIBLE, PRIMARIO	GP-1108	625627C1
COMBUSTIBLE, PRIMARIO	GP-1105	625626C1	COMBUSTIBLE, SEPARADOR DE AGUA	GPP-11	1214920H1	COMBUSTIBLE, SEPARADOR DE AGUA	GPP-11	1214920H1
AGUA	GP-2071W	1809789C1	COMBUSTIBLE, SECUNDARIO	GP-78	674293C1	COMBUSTIBLE, SECUNDARIO	GP-78	674293C1
COMBUSTIBLE, SECUNDARIO	GP-78	674293C1	431B con motor/IHC DT466			442 con motor/IHC DT466		
AIRE, PRIMARIO	GA-329	627934C1	COMBUSTIBLE, SEPARADOR DE AGUA	GPP-14	998443R91	COMBUSTIBLE, SEPARADOR DE AGUA	GPP-14	998443R91
AIRE, SECUNDARIO	GA-239	627935C1	ACEITE	GP-69	675616C91	ACEITE	GP-69	675616C91
412 con motor/IHC DT466			COMBUSTIBLE, PRIMARIO	GP-1105	625626C1	COMBUSTIBLE, PRIMARIO	GP-1105	625626C1
ACEITE	GP-69	675617C91	ACEITE	GP-88	1811953C1	ACEITE	GP-88	1811953C1
COMBUSTIBLE, PRIMARIO	GP-1105	702255C1	AGUA	GP-2071W	1261387H1	AGUA	GP-2071W	1261387H1
COMBUSTIBLE, SECUNDARIO	GP-1107	674293C1	COMBUSTIBLE, SECUNDARIO	GP-78	674293C1	COMBUSTIBLE, SECUNDARIO	GP-78	674293C1
COMBUSTIBLE, PRIMARIO	GP-1108	625627C1	431B con motor/IHC DVT800			442 con motor/IHC DVT800		
COMBUSTIBLE, SEPARADOR DE AGUA	GPP-11	1214920H1	ACEITE, CUMPLE CON MEDIDAS ORIGINALES	GP-691	684206C1	ACEITE, CUMPLE CON MEDIDAS ORIGINALES	GP-691	684206C1
COMBUSTIBLE, SECUNDARIO	GP-78	674293C1	COMBUSTIBLE, SEPARADOR DE AGUA	GPP-14	998443R91	COMBUSTIBLE, SEPARADOR DE AGUA	GPP-14	998443R91
AIRE, PRIMARIO	GA-329	627934C1	ACEITE, SEGUNDA OPCION	GP-52	684206C1	ACEITE, SEGUNDA OPCION	GP-52	684206C1
AIRE, SECUNDARIO	GA-239	627935C1	COMBUSTIBLE, SECUNDARIO	GP-1107	674293C1	COMBUSTIBLE, SECUNDARIO	GP-1107	674293C1
412B con motor/CUMMINS			COMBUSTIBLE, PRIMARIO	GP-1108	625627C1	COMBUSTIBLE, PRIMARIO	GP-1108	625627C1
COMBUSTIBLE	GP-1101	625625C1	AGUA	GP-2071W	1261387H1	AGUA	GP-2071W	1261387H1
412B con motor/IHC			433 con motor/IHC DT466			442B con motor/A DIESEL		
COMBUSTIBLE, SEPARADOR DE AGUA	GPP-14	998443R91	COMBUSTIBLE, SEPARADOR DE AGUA	GPP-14	998443R91	TRANSMISION	G-333	615447C1
ACEITE	GP-69	675617C91	ACEITE	GP-69	675616C91	COMBUSTIBLE, PRIMARIO	GPP-14	702255C1
COMBUSTIBLE, PRIMARIO	GP-1105	625626C1	COMBUSTIBLE, PRIMARIO	GP-1105	625626C1	COMBUSTIBLE, SECUNDARIO	GP-1107	674293C1
AGUA	GP-2071W	1809789C1	ACEITE	GP-88	1811953C1	COMBUSTIBLE, PRIMARIO	GP-1108	625627C1
COMBUSTIBLE, SECUNDARIO	GP-78	674293C1	AGUA	GP-2071W	1261387H1	COMBUSTIBLE, SEPARADOR DE AGUA	GPP-11	1214920H1
AIRE, PRIMARIO	GA-329	627934C1	COMBUSTIBLE, SECUNDARIO	GP-78	674293C1	COMBUSTIBLE, SECUNDARIO	GP-78	674293C1
AIRE, SECUNDARIO	GA-239	627935C1	433 con motor/IHC DVT800			442B con motor/IHC DT466		
431 con motor/A DIESEL			ACEITE, CUMPLE CON MEDIDAS ORIGINALES	GP-691	684206C1	COMBUSTIBLE, SEPARADOR DE AGUA	GPP-14	998443R91
TRANSMISION	G-333	615447C1	COMBUSTIBLE, SEPARADOR DE AGUA	GPP-14	998443R91	ACEITE	GP-69	675616C91
COMBUSTIBLE, PRIMARIO	GPP-14	702255C1	ACEITE, SEGUNDA OPCION	GP-52	684206C1	COMBUSTIBLE, PRIMARIO	GP-1105	625626C1
COMBUSTIBLE, SECUNDARIO	GP-1107	674293C1	COMBUSTIBLE, SECUNDARIO	GP-1107	674293C1	ACEITE	GP-88	1811953C1
COMBUSTIBLE, PRIMARIO	GP-1108	625627C1	COMBUSTIBLE, PRIMARIO	GP-1108	625627C1	AGUA	GP-2071W	1261387H1
COMBUSTIBLE, SEPARADOR DE AGUA	GPP-11	1214920H1	AGUA	GP-2071W	1261387H1	COMBUSTIBLE, SECUNDARIO	GP-78	674293C1
COMBUSTIBLE, SECUNDARIO	GP-78	674293C1	433B con motor/IHC DT466			442B con motor/IHC DVT800		
431 con motor/IHC DT466			COMBUSTIBLE, SEPARADOR DE AGUA	GPP-14	998443R91	ACEITE, CUMPLE CON MEDIDAS ORIGINALES	GP-691	684206C1
COMBUSTIBLE, SEPARADOR DE AGUA	GPP-14	998443R91	ACEITE	GP-69	675616C91	COMBUSTIBLE, SEPARADOR DE AGUA	GPP-14	998443R91
ACEITE	GP-69	675616C91	COMBUSTIBLE, PRIMARIO	GP-1105	625626C1	ACEITE, SEGUNDA OPCION	GP-52	684206C1
COMBUSTIBLE, PRIMARIO	GP-1105	625626C1	ACEITE	GP-88	1811953C1	COMBUSTIBLE, SECUNDARIO	GP-1107	674293C1
ACEITE	GP-88	1811953C1	AGUA	GP-2071W	1261387H1	COMBUSTIBLE, PRIMARIO	GP-1108	625627C1
AGUA	GP-2071W	1261387H1	COMBUSTIBLE, SECUNDARIO	GP-78	674293C1	AGUA	GP-2071W	1261387H1
COMBUSTIBLE, SECUNDARIO	GP-78	674293C1						

MARCA-MODELO-MOTOR MAKE-MODEL-ENGINE	GONHER GONHER	OEM OEM	MARCA-MODELO-MOTOR MAKE-MODEL-ENGINE	GONHER GONHER	OEM OEM	MARCA-MODELO-MOTOR MAKE-MODEL-ENGINE	GONHER GONHER	OEM OEM
I.H.C. HARVESTER (continuación)			I.H.C. HARVESTER (continuación)			I.H.C. HARVESTER (continuación)		
RASPADORAS			RASPADORAS			RASPADORAS		
444 con motor/IHC DT466			COMBUSTIBLE, SECUNDARIO 7 1/8 IN	GP-110	702253C1	AIRE, PRIMARIO	GA-329	627934C1
COMBUSTIBLE, SEPARADOR DE AGUA	GPP-14	998443R91				AIRE, SECUNDARIO	GA-239	627935C1
ACEITE	GP-69	675616C91	E200 con motores/IHC DT414, IHC DT466			ET200 con motores/IHC DT361, IHC DT407		
COMBUSTIBLE, PRIMARIO	GP-1105	625626C1	COMBUSTIBLE, SEPARADOR DE AGUA	GPP-14	998443R91	TRANSMISION	G-333	615447C1
ACEITE	GP-88	1811953C1	ACEITE	GP-69	675617C91	ACEITE	G-335	279994R91
AGUA	GP-2071W	1261387H1	COMBUSTIBLE, PRIMARIO 6 43/64 IN	GP-1105	625626C1	COMBUSTIBLE, PRIMARIO 6 43/64 IN	GP-1105	625626C1
COMBUSTIBLE, SECUNDARIO	GP-78	674293C1	COMBUSTIBLE, PRIMARIO 7 17/32 IN	GP-1108	625627C1	COMBUSTIBLE, PRIMARIO 7 17/32 IN	GP-1108	625627C1
444 con motor/IHC DVT800			AGUA	GP-2071W	1261387H1	COMBUSTIBLE, SEPARADOR DE AGUA	GPP-11	1214920H1
ACEITE, CUMPLE CON MEDI- DAS ORIGINALES	GP-691	684206C1	COMBUSTIBLE, SECUNDARIO 7 7/64 IN	GP-78	672603C2	COMBUSTIBLE, SECUNDARIO 7 1/8 IN	GP-110	702253C1
COMBUSTIBLE, SEPARADOR DE AGUA	GPP-14	998443R91	AIRE, PRIMARIO	GA-329	627934C1	PD105 con motor/IHC UD817		
ACEITE, SEGUNDA OPCION	GP-52	684206C1	AIRE, SECUNDARIO	GA-239	627935C1	COMBUSTIBLE, PRIMARIO	GP-1105	625626C1
COMBUSTIBLE, SECUNDARIO	GP-1107	674293C1	E211 con motor/IHC D407			COMBUSTIBLE, PRIMARIO	GP-1108	625627C1
COMBUSTIBLE, PRIMARIO	GP-1108	625627C1	TRANSMISION	G-333	214731R91	COMBUSTIBLE, SEPARADOR DE AGUA	GPP-11	1214920H1
AGUA	GP-2071W	1261387H1	ACEITE	G-335	279994R91	COMBUSTIBLE, SECUNDARIO	GP-110	702253C1
444B con motor/IHC DT466			COMBUSTIBLE, PRIMARIO 6 43/64 IN	GP-1105	625626C1	I.H.C. HARVESTER		
COMBUSTIBLE, SEPARADOR DE AGUA	GPP-14	998443R91	COMBUSTIBLE, PRIMARIO 7 17/32 IN	GP-1108	625627C1	TRACTORES		
ACEITE	GP-69	675616C91	COMBUSTIBLE, SEPARADOR DE AGUA	GPP-11	1214920H1	10 HP CADET SOBRE RUEDAS con motor/A DIESEL		
COMBUSTIBLE, PRIMARIO	GP-1105	625626C1	COMBUSTIBLE, SECUNDARIO 7 1/8 IN	GP-110	702253C1	TRANSMISION	GP-171	395789R2
ACEITE	GP-88	1811953C1	E270 con motor/IHC DVT573			100 SOBRE RUEDAS con motor/A DIESEL		
AGUA	GP-2071W	1261387H1	COMBUSTIBLE, CARTUCHO PRIMARIO	G-1163	306353R91	ACEITE, SELLADO	GP-50	538836R1
COMBUSTIBLE, SECUNDARIO	GP-78	674293C1	COMBUSTIBLE, PRIMARIO 7 17/32 IN	GP-1108	625627C1	1026 SERIES SOBRE RUEDAS con motor/IHC DT407		
444B con motor/IHC DVT800			COMBUSTIBLE, SEPARADOR DE AGUA	GPP-11	1214920H1	ACEITE	G-335	323827R91
ACEITE, CUMPLE CON MEDI- DAS ORIGINALES	GP-691	684206C1	COMBUSTIBLE, SECUNDARIO 7 1/8 IN	GP-110	702253C1	ACEITE	G-338	70432C91
COMBUSTIBLE, SEPARADOR DE AGUA	GPP-14	998443R91	E270 con motor/IHC DVT573B			COMBUSTIBLE	GP-1105	625626C1
ACEITE, SEGUNDA OPCION	GP-52	684206C1	ACEITE	G-33	613798C1	COMBUSTIBLE	GP-1108	A184773
COMBUSTIBLE, SECUNDARIO	GP-1107	674293C1	E295 con motor/IHC DT817			COMBUSTIBLE	GP-110	702142C1
COMBUSTIBLE, PRIMARIO	GP-1108	625627C1	TRANSMISION	G-33	319926R91	COMBUSTIBLE	GPP-1000	702256C1
AGUA	GP-2071W	1261387H1	COMBUSTIBLE, PRIMARIO 6 43/64 IN	GP-1105	625626C1	1026 SOBRE RUEDAS con motor/IHC DT407		
495 con motor/IHC DT817			COMBUSTIBLE, PRIMARIO 7 17/32 IN	GP-1108	625627C1	ACEITE	G-335	279994R91
TRANSMISION	G-33	319926R91	COMBUSTIBLE, SEPARADOR DE AGUA	GPP-11	1214920H1	HYDROSTATIC GEAR DRIVE	G-338	70432C91
COMBUSTIBLE, PRIMARIO	GP-1105	625626C1	COMBUSTIBLE, SECUNDARIO 7 1/8 IN	GP-1107	674293C1	COMBUSTIBLE, PRIMARIO 6 43/64 IN	GP-1105	625626C1
COMBUSTIBLE, PRIMARIO	GP-1108	625627C1	E295 con motor/IHC DT817			COMBUSTIBLE, PRIMARIO 7 17/32 IN	GP-1108	625627C1
COMBUSTIBLE, SEPARADOR DE AGUA	GPP-11	1214920H1	TRANSMISION	G-33	319926R91	COMBUSTIBLE, SECUNDARIO	GP-110	702142C1
COMBUSTIBLE, SECUNDARIO	GP-110	702142C1	COMBUSTIBLE, PRIMARIO 6 43/64 IN	GP-1105	625626C1	COMBUSTIBLE, SEPARADOR DE AGUA	GPP-1000	702256C1
495 con motor/IHC DT817B			COMBUSTIBLE, SECUNDARIO 7 17/32 IN	GP-1107	674293C1	1046 SOBRE RUEDAS, 1046A SOBRE RUEDAS con motor/A DIESEL		
COMBUSTIBLE, SECUNDARIO	GP-1107	674293C1	COMBUSTIBLE, PRIMARIO 7 17/32 IN	GP-1108	625627C1	COMBUSTIBLE	G-296	3144477R92
55 con motor/CUMMINS HR-6			COMBUSTIBLE, SEPARADOR DE AGUA	GPP-11	1214920H1	1056 SOBRE RUEDAS, 1056XL SOBRE RUEDAS con motor/IHC D358		
COMBUSTIBLE, PRIMARIO	GPP-14	1214920H1	COMBUSTIBLE, SECUNDARIO 7 1/8 IN	GP-110	702142C1	ACEITE	GP-10	3132737R93
COMBUSTIBLE, PRIMARIO	GP-1101	625625C1	E295 con motor/IHC DT817B			COMBUSTIBLE	G-296	3144477R92
ACEITE, DERIVACION (BY PASS)	G-750	689032R91	COMBUSTIBLE, SECUNDARIO	GP-1107	674293C1	COMBUSTIBLE, PRIMARIO	GPP-1122	3132275R91
75 con motor/CUMMINS NT-6			COMBUSTIBLE, PRIMARIO 7 17/32 IN	GP-1108	625627C1	COMBUSTIBLE, SECUNDARIO	GPP-1122	3132275R91
COMBUSTIBLE, PRIMARIO	GP-1101	625625C1	COMBUSTIBLE, SEPARADOR DE AGUA	GPP-11	1214920H1	COMBUSTIBLE	G-296-B	3144477R92
COMBUSTIBLE, PRIMARIO	GPP-11	1214920H1	E295B con motor/IHC DT817			1066 SOBRE RUEDAS con motor/IHC DT414		
ACEITE, DERIVACION (BY PASS)	G-750	689032R91	TRANSMISION	G-33	319926R91	HYDROSTATIC GEAR DRIVE	G-338	70432C91
E200 con motores/IHC DT361, IHC DT407			COMBUSTIBLE, SECUNDARIO	GP-1107	674293C1	COMBUSTIBLE, PRIMARIO 5 17/32 IN	GP-1101	625625C1
TRANSMISION	G-333	214731R91	COMBUSTIBLE, PRIMARIO	GP-1108	625627C1	ACEITE	GP-69	A184775
ACEITE	G-335	279994R91	ET200 con motor/IHC DT414			COMBUSTIBLE, PRIMARIO 6 43/64 IN	GP-1105	625626C1
COMBUSTIBLE, PRIMARIO 6 43/64 IN	GP-1105	625626C1	ACEITE	GP-69	675617C91	COMBUSTIBLE, SECUNDARIO	GP-1108	625626C1
COMBUSTIBLE, PRIMARIO 7 17/32 IN	GP-1108	625627C1	COMBUSTIBLE, PRIMARIO 6 43/64 IN	GP-1105	625626C1	COMBUSTIBLE, SECUNDARIO	GP-78	672603C2
COMBUSTIBLE, SEPARADOR DE AGUA	GPP-11	1214920H1	COMBUSTIBLE, SECUNDARIO	GP-78	672603C2			

SERVICIO PESADO

MARCA-MODELO-MOTOR MAKE-MODEL-ENGINE	GONHER GONHER	OEM OEM	MARCA-MODELO-MOTOR MAKE-MODEL-ENGINE	GONHER GONHER	OEM OEM	MARCA-MODELO-MOTOR MAKE-MODEL-ENGINE	GONHER GONHER	OEM OEM
I.H.C. HARVESTER (continuación)			I.H.C. HARVESTER (continuación)			I.H.C. HARVESTER (continuación)		
TRACTORES			TRACTORES			TRACTORES		
COMBUSTIBLE, PRIMARIO 7 17/32 IN	GP-1108	A184773	1266 SOBRE RUEDAS con motor/IHC D436			COMBUSTIBLE, PRIMARIO 7 17/32 IN	GP-1108	A184773
AGUA	GP-2071W	A151931	ACEITE	G-338	70432C91	COMBUSTIBLE, SEPARADOR DE AGUA	GPP-11	1214920H1
COMBUSTIBLE, SECUNDARIO	GP-78	672603C2	COMBUSTIBLE	GP-1101	625625C1	AGUA	GP-2071W	A151931
AIRE, PRIMARIO	GA-826	67974C4	ACEITE	GP-69	675616C91	COMBUSTIBLE, SECUNDARIO	GP-78	672603C2
AIRE, SECUNDARIO	GA-827	67975C1	COMBUSTIBLE	GP-1107	674293C1	AIRE, PRIMARIO	GA-826	67974C2
			COMBUSTIBLE	GP-1108	A184773	AIRE, SECUNDARIO	GA-827	67975C1
1086 SOBRE RUEDAS con motor/IHC DT414			130 SOBRE RUEDAS, 140 SOBRE RUEDAS con motor/A DIESEL			1488 con motor/IHC DT436		
HYDROSTATIC GEAR DRIVE	G-338	70432C91	ACEITE, SELLADO	GP-50	538836R1	ACEITE	GP-69	675616C91
ACEITE	GP-69	A184775				COMBUSTIBLE	GP-1105	625626C1
COMBUSTIBLE, PRIMARIO	GP-1108	A184773	1420 CUB CADET SOBRE RUEDAS con motor/KOHLER			COMBUSTIBLE	GP-1108	625627C1
COMBUSTIBLE, SEPARADOR DE AGUA	GPP-11	1214920H1	ACEITE	GP-58	5205002	COMBUSTIBLE	GP-78	672603C2
AGUA	GP-2071W	A151931				AIRE	GA-826	67974C4
COMBUSTIBLE, SECUNDARIO	GP-78	672603C2	1450 SOBRE RUEDAS con motor/KOHLER 14 HP			AIRE	GA-827	67975C1
AIRE, PRIMARIO	GA-826	67974C2	HYDROSTATIC TRANSMISION	GP-9	395789R2			
AIRE, SECUNDARIO	GA-827	67975C1				1566 SOBRE RUEDAS con motor/IHC DT436		
			1456 con motor/IHC D407			HYDROSTATIC GEAR DRIVE	G-338	70432C91
12 HP CADET SOBRE RUEDAS, 14 HP CADET SOBRE RUEDAS con motor/A DIESEL			ACEITE	G-335	279994R91	ACEITE	GP-69	A184775
ACEITE	GP-171	395789R2	HIDRAULICO	G-338	70432C91	COMBUSTIBLE, PRIMARIO 6 43/64 IN	GP-1105	702143C1
			COMBUSTIBLE, PRIMARIO	GPP-14	402255C1	COMBUSTIBLE, PRIMARIO 7 17/32 IN	GP-1108	A184773
1206 con motor/A DIESEL			COMBUSTIBLE, PRIMARIO 6 43/64 IN	GP-1105	625626C1	AGUA	GP-2071W	A151931
ACEITE	G-335	279994R91	COMBUSTIBLE, PRIMARIO 7 17/32 IN	GP-1108	625627C1	COMBUSTIBLE, SECUNDARIO	GP-78	672603C2
			COMBUSTIBLE, SEPARADOR DE AGUA	GPP-11	1214920H1	AIRE, PRIMARIO	GA-826	67974C2
1206 SERIES SOBRE RUEDAS con motor/IHC DT361			1456D con motor/IHC D407			AIRE, SECUNDARIO	GA-827	67975C1
ACEITE	G-335	323827R91	ACEITE	G-335	279994R91			
COMBUSTIBLE, SECUNDARIO	G-1163	306353R91	ACEITE	G-338	70432C91	1568 con motor/IHC DV550		
HYDROSTATIC GEAR DRIVE	G-338	70432C91	COMBUSTIBLE	GP-1105	625626C1	ACEITE, OPCIONAL	GP-10	427207C1
			COMBUSTIBLE	GP-1108	625627C1	COMBUSTIBLE	GP-1108	625627C1
1206D con motor/IHC D407						COMBUSTIBLE, SEPARADOR DE AGUA	GPP-11	1214920H1
ACEITE	G-335	279994R91	1466 SERIES con motor/IHC DT436			COMBUSTIBLE	GP-78	672603C2
COMBUSTIBLE, PRIMARIO	G-1163	306353R91	HYDROSTATIC GEAR DRIVE	G-338	70432C91	1568 con motor/IHC DV550B		
COMBUSTIBLE, SECUNDARIO	G-1163	306353R91	COMBUSTIBLE, PRIMARIO 5 17/32 IN	GP-1101	625625C1	HYDROSTATIC GEAR DRIVE	G-338	386120R91
HIDRAULICO	G-338	70432C91	ACEITE	GP-69	A184775	ACEITE	GP-10	398080R2
			COMBUSTIBLE, PRIMARIO 7 17/32 IN	GP-1108	A184773	COMBUSTIBLE, PRIMARIO	GP-1108	A184773
1250 SOBRE RUEDAS con motor/KOHLER 12 HP			COMBUSTIBLE, SEPARADOR DE AGUA	GPP-11	1214920H1	COMBUSTIBLE, SECUNDARIO	GP-78	674293C1
HYDROSTATIC TRANSMISION	GP-9	395789R2	COMBUSTIBLE, SECUNDARIO	GP-78	672603C2			
			AIRE, PRIMARIO	GA-826	67974C2	1586 con motor/IHC DT414		
1256 SERIES SOBRE RUEDAS, 1456 SERIES con motor/IHC DT407			AIRE, SECUNDARIO	GA-827	67975C1	AGUA	GP-1010Q	A151931
ACEITE	G-335	323827R91	1468 con motor/IHC DV550			ACEITE	GP-69	675616C91
HYDROSTATIC GEAR DRIVE	G-338	70432C91	HIDRAULICO	G-338	70432C91	COMBUSTIBLE	GP-1105	625626C1
COMBUSTIBLE, PRIMARIO 6 43/64 IN	GP-1105	625626C1	ACEITE, OPCIONAL	GP-10	427207C1	COMBUSTIBLE	GP-1108	625627C1
COMBUSTIBLE, PRIMARIO 7 17/32 IN	GP-1108	A184773	COMBUSTIBLE, PRIMARIO 7 17/32 IN	GP-1108	625627C1	AIRE	GA-826	67974C4
COMBUSTIBLE, SECUNDARIO	GP-110	702142C1	COMBUSTIBLE, SEPARADOR DE AGUA	GPP-11	1214920H1	AIRE	GA-827	67975C1
COMBUSTIBLE, SEPARADOR DE AGUA	GPP-1000	702256C1	COMBUSTIBLE, SECUNDARIO	GP-78	672603C2			
			AIRE, PRIMARIO	GA-826	67974C2	1586 con motor/IHC DT436		
1256D con motor/IHC D407			AGUA	GP-2071W	A151931	HYDROSTATIC GEAR DRIVE	G-338	386120R91
ACEITE	G-335	279994R91	1468 con motor/IHC DV550B			ACEITE	GP-69	A184775
HIDRAULICO	G-338	70432C91	HYDROSTATIC GEAR DRIVE	G-338	70432C91	COMBUSTIBLE, PRIMARIO 6 43/64 IN	GP-1105	625626C1
COMBUSTIBLE	GP-1105	625626C1	ACEITE	GP-10	427207C1	COMBUSTIBLE, PRIMARIO 7 17/32 IN	GP-1108	A184773
COMBUSTIBLE	GP-1108	625627C1	COMBUSTIBLE, SECUNDARIO	GP-1107	674293C1	COMBUSTIBLE, SEPARADOR DE AGUA	GPP-11	1214920H1
COMBUSTIBLE, SEPARADOR DE AGUA	GPP-11	1214920H1	COMBUSTIBLE, PRIMARIO	GP-1108	A184773	AGUA	GP-2071W	1261387H1
			AGUA	GP-2071W	A151931	COMBUSTIBLE, SECUNDARIO	GP-78	672603C2
1256D con motor/IHC D407			1486 con motor/IHC DT436			AIRE, PRIMARIO	GA-826	67974C2
ACEITE	G-335	279994R91	HYDROSTATIC GEAR DRIVE	G-338	70432C91	AIRE, SECUNDARIO	GA-827	67975C1
HIDRAULICO	G-338	70432C91	ACEITE	GP-69	A184775			
COMBUSTIBLE	GP-1105	625626C1	COMBUSTIBLE, PRIMARIO 6 43/64 IN	GP-1105	702143C1	1650 SOBRE RUEDAS con motor/KOHLER 16 HP		
COMBUSTIBLE	GP-1108	625627C1				HYDROSTATIC TRANSMISION	GP-9	395789R2
COMBUSTIBLE, SEPARADOR DE AGUA	GPP-11	1214920H1						
1266 SOBRE RUEDAS con motor/IHC D414								
TRANSMISION	G-338	70432C91						
COMBUSTIBLE, PRIMARIO	GP-1101	625625C1						
ACEITE	GP-69	675616C91						
COMBUSTIBLE, SECUNDARIO	GP-1107	674293C1						
COMBUSTIBLE, PRIMARIO	GP-1108	A184773						

MARCA-MODELO-MOTOR MAKE-MODEL-ENGINE	GONHER GONHER	OEM OEM	MARCA-MODELO-MOTOR MAKE-MODEL-ENGINE	GONHER GONHER	OEM OEM	MARCA-MODELO-MOTOR MAKE-MODEL-ENGINE	GONHER GONHER	OEM OEM
I.H.C. HARVESTER (continuación)			I.H.C. HARVESTER (continuación)			I.H.C. HARVESTER (continuación)		
TRACTORES			TRACTORES			TRACTORES		
1810 CUB CADET con motor/KOHLER			235 SOBRE RUEDAS con motor/A DIESEL			2424 con motor/IHC BD154		
ACEITE	GP-58	5205002	ACEITE	GP-6811	1275229C1	ACEITE	G-870	376364R91
184 con motor/IHC C60			240 SERIES con motor/IHC C123			2424 con motor/IHC C146		
ACEITE	G-335	279994R91	ACEITE, SELLADO	GP-50	538836R1	ACEITE, SELLADO	GP-50	538836R1
200 con motor/A DIESEL			2400 SOBRE RUEDAS con motor/IHC D179			2424D con motor/A DIESEL		
ACEITE, SELLADO	GP-50	538836R1	ACEITE, 7 17/32 IN	GP-10	398080R2	ACEITE	G-870	376364R91
2050A con motor/IHC D179			ACEITE, 5 13/32 IN	GP-36	3136046R93	244 SOBRE RUEDAS, 245 SOBRE RUEDAS con motor/A DIESEL		
ACEITE	GP-10	398080R2	COMBUSTIBLE	G-296	3144477R92	ACEITE	GP-6811	1275229C1
COMBUSTIBLE, PRIMARIO	GPP-1122	3132275R91	COMBUSTIBLE	GP-1122	3132428R1	2444 con motor/IHC BD154		
COMBUSTIBLE, SECUNDARIO	GPP-1122	3132275R91	COMBUSTIBLE	G-296-B	3144477R92	ACEITE	G-870	376364R91
2050A con motores/IHC C157, IHC C175			2400 SOBRE RUEDAS, 2400B, 2405B, 2410B SOBRE RUEDAS con motores/IHC C157, IHC C175			2444 con motores/IHC C146, IHC C153		
ACEITE	GP-10	398080R2	ACEITE, CARTUCHO	G-335	279994R91	ACEITE, SELLADO	GP-50	538836R1
21026 SERIES con motor/IHC DT407			2400A con motor/IHC D179			2444D con motor/IHC BD154		
ACEITE	G-335	323827R91	ACEITE	GP-10	398080R2	ACEITE	G-870	376364R91
HYDRAULIC GEAR DRIVE	G-338	70432C91	COMBUSTIBLE	G-296	3144477R92	2500 con motor/IHC D188		
COMBUSTIBLE, PRIMARIO 6 43/64 IN	GP-1105	625626C1	COMBUSTIBLE, PRIMARIO	GPP-1122	3132428R1	ACEITE	G-335	279994R91
COMBUSTIBLE, PRIMARIO 7 17/32 IN	GP-1108	625627C1	COMBUSTIBLE, SECUNDARIO	GPP-1122	3132428R1	COMBUSTIBLE	G-1163	306353R91
COMBUSTIBLE, SECUNDARIO	GP-110	702142C1	COMBUSTIBLE	G-296-B	3144477R92	AIRE	GA-18	313964R91
COMBUSTIBLE, SEPARADOR DE AGUA	GPP-1000	702256C1	2400A con motores/IHC C157, IHC C175			2500 CONSTRUCTALL con motor/IHC C153		
21206 SERIES con motor/IHC DT361			ACEITE	GP-10	398080R2	ACEITE, SELLADO	GP-50	538836R1
ACEITE	G-335	323827R91	2400B con motor/IHC D179			2500 CONSTRUCTALL con motor/IHC D188		
COMBUSTIBLE, PRIMARIO	G-1163	306353R91	ACEITE, 7 17/32 IN	GP-10	398080R2	ACEITE	G-335	279994R91
COMBUSTIBLE, SECUNDARIO	G-1163	306353R91	ACEITE, 5 13/32 IN	GP-36	3136046R93	COMBUSTIBLE, SECUNDARIO	G-1163	306353R91
HYDRAULIC GEAR DRIVE	G-338	70432C91	COMBUSTIBLE	G-296	3144477R92	AIRE	GA-18	313964R91
21256, 21456 con motor/IHC DT407			COMBUSTIBLE, PRIMARIO	GP-1122	3132428R1	2500A con motor/IHC D179		
ACEITE	G-335	323827R91	COMBUSTIBLE, SECUNDARIO	GP-1122	3132428R1	ACEITE	GP-10	398080R2
HYDRAULIC GEAR DRIVE	G-338	70432C91	COMBUSTIBLE	G-296-B	3144477R92	COMBUSTIBLE, PRIMARIO	GPP-1122	3132428R1
COMBUSTIBLE, PRIMARIO 6 43/64 IN	GP-1105	625626C1	2404 SERIES con motor/IHC C135			COMBUSTIBLE, SECUNDARIO	GPP-1122	3132428R1
COMBUSTIBLE, PRIMARIO 7 17/32 IN	GP-1108	625627C1	ACEITE, SELLADO	GP-50	538836R1	2500A con motor/IHC D239		
COMBUSTIBLE, SECUNDARIO	GP-110	702142C1	2405B, 2410B SOBRE RUEDAS con motor/IHC D179			ACEITE, 7 17/32 IN	GP-10	398080R2
COMBUSTIBLE, SEPARADOR DE AGUA	GPP-1000	702256C1	ACEITE, CARTUCHO	G-335	279994R91	2500A con motores/IHC C157, IHC C175, IHC C200		
230 con motor/A DIESEL			ACEITE, SELLADO	GP-10	398080R2	ACEITE	GP-10	398080R2
ACEITE, SELLADO	GP-50	538836R1	COMBUSTIBLE	G-296	3144477R91	2500B con motor/IHC C200		
2300A con motor/A DIESEL			COMBUSTIBLE, PRIMARIO	GP-1122	3136187R91	ACEITE, 7 17/32 IN	GP-10	398080R2
ACEITE	G-870	376364R91	COMBUSTIBLE, SECUNDARIO	GP-1122	3132428R1	2500B con motor/IHC D239		
COMBUSTIBLE	G-296	3144477R92	COMBUSTIBLE	G-296-B	3144477R91	ACEITE, 7 17/32 IN	GP-10	398080R2
COMBUSTIBLE	G-296-B	3044506R92	240A SOBRE RUEDAS con motor/A DIESEL			COMBUSTIBLE	G-296	3144477R92
AIRE, SIN ASPAS	GA-33	3066498R1	ACEITE, 7 17/32 IN	GP-10	398080R2	COMBUSTIBLE, PRIMARIO	GP-1122	3132428R1
2300A SERIES con motor/IHC BC144			ACEITE, 5 13/32 IN	GP-36	3136046R93	COMBUSTIBLE, SECUNDARIO	GP-1122	3132428R1
ACEITE	G-870	376364R91	AIRE	GAK-16	1265510C1	COMBUSTIBLE	G-296-B	3144477R92
2300A SERIES con motor/IHC BD144A			2412B SOBRE RUEDAS con motor/IHC C153			2500D con motor/IHC C153		
ACEITE	G-870	376364R91	ACEITE	GP-50	538836R1	ACEITE, SELLADO	GP-50	538836R1
COMBUSTIBLE	G-296	3144477R92	2412B SOBRE RUEDAS con motor/IHC D179			2500D con motor/IHC D188		
COMBUSTIBLE	G-296-B	3044506R93	ACEITE, 7 17/32 IN	GP-10	398080R2	ACEITE	G-335	279994R91
AIRE, SIN ASPAS	GA-33	3066498R2	ACEITE, 5 13/32 IN	GP-36	3136046R93	COMBUSTIBLE	G-1163	306353R91
234 SOBRE RUEDAS, 234H SOBRE RUEDAS con motor/MITSUBISHI K3			COMBUSTIBLE	G-296	3144477R92	AIRE	GA-18	313964R91
ACEITE	GP-6811	1275229C1	COMBUSTIBLE, PRIMARIO	GPP-1122	3132428R1	2504 con motor/IHC C153		
			COMBUSTIBLE, SECUNDARIO	GPP-1122	3132275R91	ACEITE, SELLADO	GP-50	538836R1
			COMBUSTIBLE	G-296-B	3144477R92			
			2412B SOBRE RUEDAS con motores/IHC C157, IHC C175, IHC C200					
			ACEITE	GP-10	398080R2			

SERVICIO PESADO

MARCA-MODELO-MOTOR MAKE-MODEL-ENGINE	GONHER GONHER	OEM OEM	MARCA-MODELO-MOTOR MAKE-MODEL-ENGINE	GONHER GONHER	OEM OEM	MARCA-MODELO-MOTOR MAKE-MODEL-ENGINE	GONHER GONHER	OEM OEM
I.H.C. HARVESTER (continuación)			I.H.C. HARVESTER (continuación)			I.H.C. HARVESTER (continuación)		
TRACTORES			TRACTORES			TRACTORES		
2504 con motor/IHC D188			COMBUSTIBLE	G-296-B	3144477R92	HYDROSTATIC GEAR DRIVE	G-338	70432C91
ACEITE	G-335	279994R91	2544D con motor/A DIESEL			ACEITE, SELLADO	GP-69	675616C91
COMBUSTIBLE, PRIMARIO	G-1163	304101R91	ACEITE, CARTUCHO HIDRAULICO	G-338	70432C91	2706 con motor/IHC D310		
COMBUSTIBLE, SECUNDARIO	G-1163	304101R91	ACEITE, SELLADO HIDRAULICO	GP-66	530824R2	HYDROSTATIC GEAR DRIVE	G-338	70432C91
AIRE	GA-18	313964R91	COMBUSTIBLE, PRIMARIO	GPP-1122	3132428R1	COMBUSTIBLE, SIN CUBIERTA	G-1123	3132015R92
2504D con motor/IHC D188			COMBUSTIBLE, SECUNDARIO	GPP-1122	3132428R1	COMBUSTIBLE, CON CUBIERTA	G-1123F	3132015R92
ACEITE	G-335	279994R91	2606 con motor/A GASOLINA			ACEITE	GP-10	528250R1
COMBUSTIBLE, PRIMARIO	G-1163	304101R91	ACEITE	G-335	279994R91	COMBUSTIBLE	G-296	3144477R92
COMBUSTIBLE, SECUNDARIO	G-1163	304101R91	2606 con motor/IHC C221			COMBUSTIBLE, PRIMARIO	GP-1122	3136187R91
AIRE	GA-18	313964R91	ACEITE	G-335	279994R91	COMBUSTIBLE, SECUNDARIO	GP-1122	3132428R1
2505B, 2510B con motor/IHC C200			2606 con motor/IHC D236			COMBUSTIBLE	G-296-B	3144477R92
ACEITE	GP-10	398080R2	ACEITE	G-335	279994R91	2706, 2756 con motor/IHC C291		
2505B, 2510B con motor/IHC D239			2606D con motor/A DIESEL			ACEITE	G-335	279994R91
ACEITE	GP-10	398080R2	ACEITE	G-335	279994R91	2706D con motor/IHC D282		
COMBUSTIBLE	G-296	3144477R91	COMBUSTIBLE, PRIMARIO	G-335	279994R91	ACEITE, CARTUCHO	G-335	279994R91
COMBUSTIBLE, PRIMARIO	GP-1122	3136187R91	COMBUSTIBLE, SECUNDARIO	G-1163	306353R91	COMBUSTIBLE, PRIMARIO	G-1163	306353R91
COMBUSTIBLE, SECUNDARIO	GP-1122	3132428R1	COMBUSTIBLE, SECUNDARIO	G-1163	306353R91	COMBUSTIBLE, SECUNDARIO	G-1163	306353R91
COMBUSTIBLE	G-296-B	3144477R91	260A con motor/IHC D239			HIDRAULICO	G-338	70432C91
250A SOBRE RUEDAS con motor/A DIESEL			ACEITE	G-870	3136046R92	ACEITE, SELLADO	GP-10	398080R2
ACEITE, 7 17/32 IN	GP-10	398080R2	COMBUSTIBLE	G-296	3144477R92	2706D con motor/IHC D310		
ACEITE, 5 13/32 IN	GP-36	3136046R93	COMBUSTIBLE	G-296-B	3144477R92	HIDRAULICO	G-338	70432C91
AIRE	GAK-16	1265510C1	260A SOBRE RUEDAS con motor/A DIESEL			COMBUSTIBLE, SIN CUBIERTA	G-1123	3132015R91
2514B con motor/IHC D239			ACEITE, 7 17/32 IN	GP-10	398080R2	COMBUSTIBLE, CON CUBIERTA	G-1123F	3132015R91
ACEITE, 7 17/32 IN	GP-10	398080R2	ACEITE, 5 13/32 IN	GP-36	3136046R93	ACEITE, OPCIONAL	GP-10	528250R1
ACEITE, 5 13/32 IN	GP-36	3136046R93	COMBUSTIBLE	GPP-1122	3132428R1	COMBUSTIBLE, PRIMARIO	GPP-1122	3132275R91
COMBUSTIBLE	G-296	3144477R91	AIRE	GAK-16	1265510C1	COMBUSTIBLE, SECUNDARIO	GPP-1122	3132275R91
COMBUSTIBLE, PRIMARIO	GP-1122	3136187R91	265 SOBRE RUEDAS con motor/A DIESEL			270A con motor/A DIESEL		
COMBUSTIBLE, SECUNDARIO	GP-1122	3132428R1	ACEITE	GP-40	25026209	ACEITE, OPCIONAL	GP-10	528250R1
COMBUSTIBLE	G-296-B	3144477R91	2656 con motor/IHC C263			274 SOBRE RUEDAS con motor/A DIESEL		
2514B con motores/IHC C175, IHC C200			ACEITE, CARTUCHO	G-335	279994R91	ACEITE	GP-38	1062099C1
ACEITE	GP-10	398080R2	HYDROSTATIC DRIVE	G-338	70432C91	275 con motor/A DIESEL		
254 SOBRE RUEDAS, 255 SOBRE RUEDAS con motor/A DIESEL			ACEITE, SELLADO	GP-10	398080R2	ACEITE	GP-40	25026209
ACEITE	GP-6811	1275229C1	2656 con motor/IHC D282			275, 276 con motor/IHC BD144		
2544 con motor/A GASOLINA			ACEITE, CARTUCHO	G-335	279994R91	ACEITE	G-870	376364R91
ACEITE, CARTUCHO HIDRAULICO	G-338	70432C91	COMBUSTIBLE, SECUNDARIO	G-1163	306353R91	2756 con motor/IHC D310		
ACEITE	GP-10	398080R2	HYDROSTATIC DRIVE	G-338	70432C91	HYDROSTATIC GEAR DRIVE	G-338	70432C91
COMBUSTIBLE	GP-92	530824R2	ACEITE, SELLADO	GP-69	675616C91	COMBUSTIBLE, CARTUCHO SIN CUBIERTA	G-1123	3132015R92
ACEITE, SELLADO HIDRAULICO	GP-66	530824R2	2706 con motor/A GASOLINA			COMBUSTIBLE, CARTUCHO CON CUBIERTA	G-1123F	3132015R92
AIRE	GA-18	313964R91	ACEITE, CARTUCHO	G-335	279994R91	ACEITE, SELLADO	GP-10	528250R1
2544 con motor/IHC C200			HIDRAULICO	G-338	70432C91	COMBUSTIBLE	G-296	3144477R92
HYDROSTATIC GEAR DRIVE			ACEITE, SELLADO	GP-10	398080R2	COMBUSTIBLE, PRIMARIO	GP-1122	3136187R91
CARTUCHO	G-338	70432C91	AIRE, SIN ASPAS	GA-16	384812R92	COMBUSTIBLE, SECUNDARIO	GP-1122	3132428R1
ACEITE	GP-10	398080R2	AIRE	GAK-16	384812R92	COMBUSTIBLE	G-296-B	3144477R92
HYDROSTATIC RETLINE			2706 con motor/IHC C263			280 con motor/IHC D358		
SELLADO	GP-66	528250R1	ACEITE, CARTUCHO	G-335	279994R91	ACEITE	GP-10	398080R2
AIRE	GA-18	313964R91	HYDROSTATIC GEAR DRIVE	G-338	70432C91	COMBUSTIBLE	GPP-1122	3132275R91
2544 con motor/IHC D239			ACEITE, SELLADO	GP-10	398080R2	AIRE, SECUNDARIO	GA-892	529852R4
HYDROSTATIC GEAR DRIVE			AIRE, SIN ASPAS	GA-16	384812R93	AIRE, PRIMARIO	GA-891	529851R2
CARTUCHO	G-338	70432C91	AIRE	GAK-16	384812R93	2806 con motor/A GASOLINA		
ACEITE	GP-10	398080R2	2706 con motor/IHC D282			ACEITE, CARTUCHO	G-335	279994R91
COMBUSTIBLE	G-296	3144477R92	ACEITE, CARTUCHO	G-335	279994R91	HIDRAULICO	G-338	70432C91
COMBUSTIBLE, PRIMARIO	GP-1122	3136187R91	COMBUSTIBLE, SECUNDARIO	G-1163	306353R91	ACEITE, SELLADO	GP-10	398080R2
COMBUSTIBLE, SECUNDARIO	GP-1122	3132428R1						
HYDROSTATIC RETLINE								
SELLADO	GP-66	528250R1						

MARCA-MODELO-MOTOR MAKE-MODEL-ENGINE	GONHER GONHER	OEM OEM	MARCA-MODELO-MOTOR MAKE-MODEL-ENGINE	GONHER GONHER	OEM OEM	MARCA-MODELO-MOTOR MAKE-MODEL-ENGINE	GONHER GONHER	OEM OEM
I.H.C. HARVESTER (continuación)			I.H.C. HARVESTER (continuación)			I.H.C. HARVESTER (continuación)		
TRACTORES			TRACTORES			TRACTORES		
2806 con motor/IHC C301			COMBUSTIBLE, PRIMARIO	GPP-1000	702256C1	3414, 3444 con motor/IHC BD154		
ACEITE	G-335	323827R91				ACEITE	G-870	376364R91
			300 SERIES SOBRE RUEDAS con motor/IHC C169			ACEITE, CONVERTIDOR DE TORSION	GP-1	388227R91
2806 con motor/IHC D361			ACEITE, SELLADO	GP-50	538836R1	TRANSMISION	GP-1	388227R1
ACEITE	G-335	279994R91				COMBUSTIBLE	G-296	3144477R92
COMBUSTIBLE, SECUNDARIO	G-1163	306353R91	3000 con motor/IHC			COMBUSTIBLE	G-296-B	3044506R93
HYDROSTATIC GEAR DRIVE	G-338	70432C91	COMBUSTIBLE, PRIMARIO	GPP-1122	3132275R91			
						3414D con motor/IHC BD154		
2806D con motor/A DIESEL			3088 con motor/IHC D358			ACEITE	G-870	376364R91
ACEITE, CARTUCHO	G-335	279994R91	ACEITE, CARTUCHO HIDRAULICO	G-338	70432C91	ACEITE	GP-1	918266R91
COMBUSTIBLE, PRIMARIO	G-1163	306353R91	ACEITE, 7 17/32 IN	GP-10	39080R2	COMBUSTIBLE	G-296	3144477R92
COMBUSTIBLE, SECUNDARIO	G-1163	306353R91	ACEITE, 5 13/32 IN	GP-36	3136046R93	COMBUSTIBLE	G-296-B	3144477R92
HIDRAULICO	G-338	70432C91	COMBUSTIBLE	GPP-1122	1967094C1			
			AGUA	GP-2071W	A151931	3444 con motor/IHC BC144 GASOLINA		
280A con motor/IHC D358			AIRE, SECUNDARIO	GA-892	529852R4	ACEITE	G-870	376364R91
ACEITE	GP-10	528250R1	AIRE, PRIMARIO	GA-891	71912C1	ACEITE, CONVERTIDOR DE TORSION	GP-1	388227R91
COMBUSTIBLE, PRIMARIO	G-296	3144477R92				TRANSMISION	GP-1	388227R1
COMBUSTIBLE, SECUNDARIO	G-296	3144477R92	3288 con motor/IHC D358					
ACEITE	GP-66	528250R1	ACEITE, CARTUCHO HIDRAULICO	G-338	528493R3	3444D con motor/IHC BD154 DIESEL		
COMBUSTIBLE, PRIMARIO	GPP-1122	3136187R91	ACEITE, 7 17/32 IN	GP-10	677709C91	ACEITE	G-870	376364R91
COMBUSTIBLE, SECUNDARIO	GPP-1122	3136187R91	ACEITE, 5 13/32 IN	GP-36	3136046R93	ACEITE	GP-1	918266R91
COMBUSTIBLE, PRIMARIO	G-296-B	3144477R92	COMBUSTIBLE	GPP-1122	1967094C1	COMBUSTIBLE	G-296	3044506R91
COMBUSTIBLE, SECUNDARIO	G-296-B	3144477R92	AGUA	GP-2071W	A151931	COMBUSTIBLE	G-296-B	3144477R92
AIRE	GA-892	3132428R2	AIRE, SECUNDARIO	GA-892	529852R4			
			AIRE, PRIMARIO	GA-891	71912C1	3488 con motor/IHC DT466B		
2826 con motor/IHC C301			3388 SOBRE RUEDAS con motor/IHC DT436			HIDRAULICO	G-338	528493R3
ACEITE, CARTUCHO	G-335	279994R91	ACEITE	GP-69	675616C91	ACEITE	GP-69	A184775
HYDROSTATIC GEAR DRIVE	G-338	70432C91	COMBUSTIBLE, PRIMARIO	GP-1108	625626C1	COMBUSTIBLE, PRIMARIO	GP-1108	A184773
ACEITE, SELLADO	GP-10	398080R2	AGUA	GP-2071W	A151931	ACEITE	GP-88	1811953C1
			COMBUSTIBLE, SECUNDARIO	GP-78	674293C1	AGUA	GP-2071W	690171C1
2826 con motor/IHC D358			AIRE, PRIMARIO	GA-826	67974C4	COMBUSTIBLE, SECUNDARIO	GP-78	674293C1
HYDROSTATIC GEAR DRIVE	G-338	70432C91	AIRE, SECUNDARIO	GA-827	67975C1	AIRE, SECUNDARIO	GA-892	529852R4
ACEITE	GP-10	528250R1				AIRE, PRIMARIO	GA-891	71912C1
COMBUSTIBLE, PRIMARIO	GP-1122	3136187R91	340 con motor/IHC D166					
COMBUSTIBLE, SECUNDARIO	GP-1122	3132428R1	ACEITE	G-335	279994R91	350 con motor/IHC C175		
AIRE, SECUNDARIO	GA-892	529852R4				ACEITE, SELLADO	GP-50	538836R1
AIRE, PRIMARIO	GA-891	529851R2	3400 SERIES A con motor/IHC D179					
			ACEITE	GP-10	398080R2	3500 SERIES A con motores/IHC D179, IHC D239		
284 SOBRE RUEDAS con motor/MAZDA A GASOLINA			COMBUSTIBLE	G-296	3144477R92	ACEITE	GP-10	398080R2
HIDRAULICO	GP-66	1004366C1	COMBUSTIBLE, PRIMARIO	GPP-1122	3132428R2	COMBUSTIBLE	G-296	3144477R92
ACEITE	GP-42	1014308-C1	COMBUSTIBLE, SECUNDARIO	GPP-1122	3132428R2	COMBUSTIBLE, PRIMARIO	GPP-1122	3132275R91
GASOLINA	GG-5	1701232C91	COMBUSTIBLE	G-296-B	3144477R92	COMBUSTIBLE, SECUNDARIO	GPP-1122	3132275R91
GASOLINA	GG-5 L	1701232C91				COMBUSTIBLE	G-296-B	3144477R92
			3400 SERIES A, 3400A SERIES SOBRE RUEDAS con motor/IHC C175					
284 SOBRE RUEDAS con motor/NISSAN A DIESEL			ACEITE	GP-10	398080R2	3500 SERIES A, 3500A SERIES SOBRE RUEDAS con motor/IHC C200		
ACEITE	GP-38	1062099C1				ACEITE	GP-10	398080R2
			3400A SERIES SOBRE RUEDAS con motor/IHC D179					
2856 con motor/IHC C301			ACEITE	GP-10	398080R2	3500A SERIES SOBRE RUEDAS con motor/IHC D239		
ACEITE, CARTUCHO	G-335	323827R91	COMBUSTIBLE	G-296	3144477R92	ACEITE	GP-10	398080R2
HYDROSTATIC GEAR DRIVE	G-338	70432C91	COMBUSTIBLE	GP-1122	3132428R2			
ACEITE, SELLADO	GP-10	398080R2	COMBUSTIBLE	G-296-B	3144477R92	3514 con motor/IHC C153		
						HYDROSTATIC GEAR DRIVE	G-338	70432C91
2856 con motor/IHC D407			340D con motor/A DIESEL			ACEITE, SELLADO	GP-50	538836R1
ACEITE	G-335	323827R91	COMBUSTIBLE	G-1163	304101R91	AIRE, SIN ASPAS	GA-16	405916R1
HYDROSTATIC GEAR DRIVE	G-338	70432C91				AIRE, SIN ASPAS	GA-33	389567R1
COMBUSTIBLE, PRIMARIO 6 43/64 IN	GP-1105	625626C1	3414 con motor/IHC BC144			AIRE	GAK-16	405916R1
COMBUSTIBLE, PRIMARIO 7 17/32 IN	GP-1108	625627C1	ACEITE	G-870	376364R91			
COMBUSTIBLE, SECUNDARIO	GP-110	702142C1	ACEITE, CONVERTIDOR DE TORSION	GP-1	388227R91	3514 con motor/IHC C175		
COMBUSTIBLE, SEPARADOR DE AGUA	GPP-1000	702256C1	TRANSMISION	GP-1	388227R1	HYDROSTATIC GEAR DRIVE	G-338	70432C91
						ACEITE	GP-10	398080R2
2856D con motor/IHC D407						AIRE, SIN ASPAS	GA-16	405916R1
ACEITE	G-335	279994R91				AIRE, SIN ASPAS	GA-33	389567R1
ACEITE	G-338	70432C91				AIRE	GAK-16	405916R1

MARCA-MODELO-MOTOR MAKE-MODEL-ENGINE	GONHER GONHER	OEM OEM	MARCA-MODELO-MOTOR MAKE-MODEL-ENGINE	GONHER GONHER	OEM OEM	MARCA-MODELO-MOTOR MAKE-MODEL-ENGINE	GONHER GONHER	OEM OEM
I.H.C. HARVESTER (continuación)			I.H.C. HARVESTER (continuación)			I.H.C. HARVESTER (continuación)		
TRACTORES			TRACTORES			TRACTORES		
3514 con motor/IHC D188			ACEITE, SELLADO HIDRAULICO	GP-66	528250R1	3800, 3850 con motor/IHC C263		
ACEITE	G-335	279994R91				ACEITE, CARTUCHO	G-335	279994R91
COMBUSTIBLE, PRIMARIO	G-1163	304101R91	3616 con motor/IHC C221 GASOLINA			ACEITE, SELLADO	GP-10	398080R2
COMBUSTIBLE, SECUNDARIO	G-1163	304101R91	ACEITE, CARTUCHO	G-335	279994R91	AIRE, SIN ASPAS	GA-16	384812R93
HYDROSTATIC GEAR DRIVE	G-338	70432C91	HIDRAULICO	G-338	70432C91	AIRE	GAK-16	384812R93
AIRE	GA-18	313964R91	ACEITE, SELLADO	GP-10	398080R2			
			AIRE, SIN ASPAS	GA-33	381343R91	3800, 3850 con motor/IHC D282		
3514 con motor/IHC D239			3616 con motor/IHC D236			ACEITE	G-335	279994R91
HYDROSTATIC GEAR DRIVE	G-338	70432C91	ACEITE	G-335	279994R91	COMBUSTIBLE, PRIMARIO 6 43/64 IN	GP-1105	625626C1
ACEITE	GP-36	3136046R93	HYDROSTATIC GEAR DRIVE	G-338	70432C91	COMBUSTIBLE, PRIMARIO 7 17/32 IN	GP-1108	625627C1
COMBUSTIBLE	G-296	3144477R92	COMBUSTIBLE, PRIMARIO 6 43/64 IN	GP-1105	625626C1	COMBUSTIBLE, SECUNDARIO	GP-110	702142C1
COMBUSTIBLE, PRIMARIO	GP-1122	3136187R91	COMBUSTIBLE, PRIMARIO 7 17/32 IN	GP-1108	625627C1	COMBUSTIBLE, SEPARADOR DE AGUA	GPP-1000	702256C1
COMBUSTIBLE, SECUNDARIO	GP-1122	3132428R1	COMBUSTIBLE, SECUNDARIO	GP-110	702142C1			
COMBUSTIBLE	G-296-B	3144477R92	COMBUSTIBLE, SEPARADOR DE AGUA	GPP-1000	702256C1	3820 con motor/IHC D310		
AIRE, SIN ASPAS	GA-16	405916R1				COMBUSTIBLE, CARTUCHO SIN CUBIERTA	G-1123	3132015R92
AIRE, SIN ASPAS	GA-33	389567R1	3616D con motor/IHC D236			COMBUSTIBLE, CARTUCHO CON CUBIERTA	G-1123F	3132015R92
AIRE	GAK-16	405916R1	ACEITE, CARTUCHO	G-335	279994R91	ACEITE	GP-10	528250R1
			COMBUSTIBLE, PRIMARIO	G-1163	306353R91	COMBUSTIBLE	G-296	3144477R92
354 con motor/IHC BC144			COMBUSTIBLE, SECUNDARIO	G-1163	306353R91	COMBUSTIBLE, PRIMARIO	GP-1122	3136187R91
ACEITE	G-870	376364R91	HIDRAULICO	G-338	70432C91	COMBUSTIBLE, SECUNDARIO	GP-1122	3132428R1
			COMBUSTIBLE, PRIMARIO 1993	GP-1101	625625C1	COMBUSTIBLE	G-296-B	3144477R91
354 con motor/IHC BD144			COMBUSTIBLE, PRIMARIO 6 43/64 IN	GP-1105	625626C1			
ACEITE	G-870	376364R91	AIRE, SIN ASPAS	GA-33	381343R91	3820 SERIES A con motor/IHC D310		
COMBUSTIBLE	G-296	3144477R92				ACEITE, OPCIONAL	GP-10	528250R1
COMBUSTIBLE	G-296-B	3044506R91	364 con motor/A DIESEL			COMBUSTIBLE	G-296	3144477R92
AIRE, SIN ASPAS	GA-33	3066498R1	ACEITE	G-870	376364R91	COMBUSTIBLE, PRIMARIO	GPP-1122	3132428R1
			COMBUSTIBLE	G-296	3144477R92	COMBUSTIBLE, SECUNDARIO	GPP-1122	3132428R1
3588 con motor/IHC DIESEL			COMBUSTIBLE	G-296-B	3044506R91	COMBUSTIBLE	G-296-B	3144477R92
COMBUSTIBLE, SEPARADOR DE AGUA	GPP-14	998443R91	AIRE, SIN ASPAS	GA-33	3066498R1			
ACEITE	GP-69	A184775				384 con motor/IHC BD154		
COMBUSTIBLE, PRIMARIO	GP-1108	A184773	364 con motor/IHC BD154			ACEITE	G-870	376364R91
AGUA	GP-2071W	1261387H1	ACEITE	G-870	376364R91	COMBUSTIBLE	G-296	3144477R92
COMBUSTIBLE, SECUNDARIO	GP-78	672603C2	COMBUSTIBLE	G-296	3144477R92	COMBUSTIBLE	G-296-B	3044506R92
AIRE, PRIMARIO	GA-826	67974C2	AIRE, SIN ASPAS	G-296-B	3044506R92	AIRE, SIN ASPAS	GA-33	D48198
AIRE, SECUNDARIO	GA-827	67975C1						
			3688 con motor/IHC D436			385 con motor/IHC BD155		
3588 con motor/IHC DT466			HIDRAULICO	G-338	528493R3	ACEITE, 7 17/32 IN	GP-10	398080R2
AGUA	GP-1010Q	A151931	ACEITE	GP-69	A184775	ACEITE, 5 13/32 IN	GP-36	3136046R93
ACEITE	GP-69	675617C91	COMBUSTIBLE, PRIMARIO	GP-1108	A184773	COMBUSTIBLE	GPP-1122	1967094C1
COMBUSTIBLE, SECUNDARIO	GP-78	672603C2	AGUA	GP-2071W	690171C1	AIRE, PRIMARIO	GAK-16	1265510C1
COMBUSTIBLE, PRIMARIO	GPP-1000	702256C1	COMBUSTIBLE, SECUNDARIO	GP-1108	A184773			
AIRE, PRIMARIO	GA-826	67974C1	AIRE, SECUNDARIO	GA-892	71912C1	400 SOBRE ORUGAS con motor/A DIESEL		
AIRE, SECUNDARIO	GA-827	67975C1	AIRE, PRIMARIO	GA-891	529852R4	ACEITE, CARTUCHO	G-870	376364R91
						TRANSMISION	GP-1	918266R93
3600 SERIES A con motor/IHC C263			3788 con motor/IHC DIESEL			ACEITE, SELLADO	GP-50	538836R1
ACEITE	G-335	279994R91	ACEITE	GP-69	A184775			
ACEITE	G-338	528507R91	COMBUSTIBLE, PRIMARIO	GP-1108	A184773	404, 330, 340 con motor/IHC C135		
ACEITE	GP-10	398080R2	AGUA	GP-2071W	690171C1	ACEITE, SELLADO	GP-50	538836R1
			COMBUSTIBLE, SECUNDARIO	GP-78	672603C2			
3600 SERIES A con motor/IHC D282			AIRE, PRIMARIO	GA-826	67974C3	4100 con motor/IHC DT429		
ACEITE	G-335	279994R91	AIRE, SECUNDARIO	GA-827	67975C1	HYDROSTATIC GEAR DRIVE	G-338	70432C91
ACEITE	G-338	528507R91				COMBUSTIBLE, PRIMARIO	GP-1105	625626C1
ACEITE	GP-69	675616C91	3788 con motor/IHC DT466B			COMBUSTIBLE, PRIMARIO	GP-1108	A184773
			ACEITE	GP-69	675617C91	COMBUSTIBLE, SEPARADOR DE AGUA	GPP-11	1214920H1
3600A SERIES SOBRE RUEDAS con motor/IHC D282			AGUA	GP-2071W	1809789C1	COMBUSTIBLE, SECUNDARIO	GP-110	702142C1
ACEITE, CARTUCHO	G-335	279994R91	COMBUSTIBLE, SECUNDARIO	GP-78	672603C2			
COMBUSTIBLE, SECUNDARIO	G-1163	306353R91	COMBUSTIBLE, PRIMARIO	GPP-1000	702256C1	4100 con motores/IHC D817, IHC DT817		
TRANSMISION	G-338	528507R91	AIRE, PRIMARIO	GA-826	67974C1	HIDRAULICO	G-338	70432C91
ACEITE, SELLADO HIDRAULICO	GP-66	70203C1	AIRE, SECUNDARIO	GA-827	67975C1			
ACEITE, SELLADO	GP-69	675616C91				414 con motor/IHC BD154		
			3600A SOBRE RUEDAS con motor/IHC C263			ACEITE, SELLADO	GP-50	538836R1
ACEITE, CARTUCHO	G-335	279994R91	ACEITE	GP-69	675617C91			
ACEITE, SELLADO	GP-10	398080R2	AGUA	GP-2071W	1809789C1			
			COMBUSTIBLE, SECUNDARIO	GP-78	672603C2			
			COMBUSTIBLE, PRIMARIO	GPP-1000	702256C1			
			AIRE, PRIMARIO	GA-826	67974C1			
			AIRE, SECUNDARIO	GA-827	67975C1			

MARCA-MODELO-MOTOR MAKE-MODEL-ENGINE	GONHER GONHER	OEM OEM	MARCA-MODELO-MOTOR MAKE-MODEL-ENGINE	GONHER GONHER	OEM OEM	MARCA-MODELO-MOTOR MAKE-MODEL-ENGINE	GONHER GONHER	OEM OEM
I.H.C. HARVESTER (continuación)			I.H.C. HARVESTER (continuación)			I.H.C. HARVESTER (continuación)		
TRACTORES			TRACTORES			TRACTORES		
4150 con motor/FORD			4386 SOBRE RUEDAS con motor/IHC DT1466			AGUA	GP-2071W	1261387H1
ACEITE	GP-34	69149C1	ACEITE, SELLADO HIDRAULICO	GP-34	69149C1	4586 con motor/IHC V800		
4150 con motor/IHC			ACEITE	GP-69	A184775	COMBUSTIBLE, SECUNDARIO	GP-1107	674293C1
COMBUSTIBLE, PRIMARIO	GPP-1122	3132275R91	COMBUSTIBLE, PRIMARIO	GP-1108	A184773	7 17/32 IN		
4156 con motor/IHC DT429			ACEITE	GP-88	1811953C1	COMBUSTIBLE	GP-1108	625627C1
HYDROSTATIC GEAR DRIVE	G-338	70432C91	AGUA	GP-2071W	A151931	COMBUSTIBLE, SEPARADOR	GPP-11	1214920H1
COMBUSTIBLE, PRIMARIO 6	GP-1105	625626C1	COMBUSTIBLE, SECUNDARIO	GP-78	672603C2	DE AGUA	GP-2071W	1809789C1
COMBUSTIBLE, PRIMARIO 7	GP-1108	A184773	444 con motor/IHC BD154			AGUA	GP-2071W	1809789C1
COMBUSTIBLE, SEPARADOR	GPP-11	1214920H1	ACEITE	G-870	376364R91	COMBUSTIBLE, SECUNDARIO	GP-78	674293C1
COMBUSTIBLE, SECUNDARIO	GP-110	702253C1	444 con motores/IHC C135, IHC C146			460 con motor/A DIESEL		
4166, 4186 con motor/IHC DT436			ACEITE, SELLADO	GP-50	538836R1	ACEITE	G-335	279994R91
HYDROSTATIC GEAR DRIVE	G-338	390560R91	450 con motor/A DIESEL			COMBUSTIBLE, PRIMARIO	G-1163	306353R91
ACEITE	GP-69	A184775	ACEITE, SELLADO	GP-50	538836R1	COMBUSTIBLE, SECUNDARIO	G-1163	306353R91
COMBUSTIBLE, PRIMARIO 6	GP-1105	625626C1	4500A SOBRE RUEDAS, 4500B SOBRE RUEDAS con motor/IHC C157			ACEITE	GP-10	398080R2
COMBUSTIBLE, PRIMARIO 7	GP-1108	A184773	ACEITE	GP-50	538836R1	460 con motor/IHC C221		
AGUA	GP-2071W	A151931	4500A SOBRE RUEDAS, 4500B SOBRE RUEDAS con motor/IHC D179			ACEITE	G-335	323827R91
COMBUSTIBLE, SECUNDARIO	GP-78	672603C2	ACEITE	GP-10	398080R2	460D con motor/A DIESEL		
424 con motor/IHC BD154			COMBUSTIBLE	G-296	3144477R92	ACEITE	G-335	279994R91
ACEITE	G-870	376364R91	COMBUSTIBLE	GPP-1122	3136187R91	COMBUSTIBLE, PRIMARIO	G-1163	306353R91
424 con motor/IHC C146			COMBUSTIBLE	G-296-B	3144477R92	COMBUSTIBLE, SECUNDARIO	G-1163	306353R91
ACEITE, SELLADO	GP-50	538836R1	454 con motor/IHC C200			ACEITE	GP-10	398080R2
424D, 444D con motor/IHC BD154			ACEITE	GP-10	398080R2	464 con motor/IHC C175		
ACEITE	G-870	376364R91	454 con motor/IHC D179			ACEITE	GP-10	398080R2
4300 con motores/IHC D817, IHC DT817			ACEITE, 7 17/32 IN	GP-10	398080R2	464 con motor/IHC D179		
AIRE	GA-18	313964R91	ACEITE, 5 13/32 IN	GP-36	3136046R93	ACEITE	GP-10	398080R2
433 SOBRE RUEDAS con motor/A DIESEL			COMBUSTIBLE	G-296	3144477R92	COMBUSTIBLE	G-296	3144477R92
ACEITE	GP-9	395789R2	COMBUSTIBLE, PRIMARIO	GPP-1122	1967094C1	COMBUSTIBLE	GPP-1122	1967094C1
COMBUSTIBLE	G-296	3144477R92	COMBUSTIBLE, SECUNDARIO	GPP-1122	1967094C1	COMBUSTIBLE	G-296-B	3144477R92
COMBUSTIBLE	G-296-B	3144477R92	COMBUSTIBLE	G-296-B	3144477R91	464D con motor/IHC D179		
AIRE, PRIMARIO	GA-49	3146927-R91	454 con motor/IHC D239			ACEITE	GP-10	398080R2
434 SOBRE RUEDAS con motor/A DIESEL			ACEITE	GP-10	398080R2	COMBUSTIBLE	G-296	3144477R92
ACEITE	G-870	376364R91	COMBUSTIBLE, PRIMARIO	GPP-1122	3132275R91	COMBUSTIBLE, PRIMARIO	GPP-1122	3132428R1
COMBUSTIBLE	G-296	3144477R92	COMBUSTIBLE, SECUNDARIO	GPP-1122	3132275R91	COMBUSTIBLE, SECUNDARIO	GPP-1122	3132428R1
COMBUSTIBLE	G-296-B	3044506R93	454 con motores/IHC C157, IHC C175			COMBUSTIBLE	G-296-B	3144477R92
4366 con motor/IHC DT466			ACEITE, 7 17/32 IN	GP-10	398080R2	4786 con motor/IHC V800		
HIDRAULICO	GP-34	69149C1	4568 con motor/IHC DVT800			COMBUSTIBLE, SECUNDARIO	GP-1107	674293C1
ACEITE	GP-69	A184775	ACEITE, SELLADO HIDRAULICO	GP-34	69149C1	COMBUSTIBLE, PRIMARIO	GP-1108	625627C1
COMBUSTIBLE, PRIMARIO 6	GP-1105	625626C1	COMBUSTIBLE	GP-1108	A184773	COMBUSTIBLE, SEPARADOR	GPP-11	1214920H1
COMBUSTIBLE, PRIMARIO 7	GP-1108	A184773	AGUA	GP-2071W	1261387H1	DE AGUA	GP-2071W	1809789C1
AGUA	GP-2071W	A151931	4568 con motor/IHC V800			COMBUSTIBLE, SECUNDARIO	GP-78	674293C1
COMBUSTIBLE, SECUNDARIO	GP-78	672603C2	COMBUSTIBLE, PRIMARIO	GPP-14	702255C1	4786 con motor/IHC VT800		
4386 SOBRE RUEDAS con motor/IHC DT466			COMBUSTIBLE, SECUNDARIO	GP-1107	674293C1	COMBUSTIBLE, SECUNDARIO	GP-1107	674293C1
ACEITE	GP-69	675616C91	COMBUSTIBLE, PRIMARIO 7	GP-1108	625627C1	COMBUSTIBLE, PRIMARIO	GP-1108	A184773
COMBUSTIBLE, PRIMARIO 6	GP-1105	625626C1	COMBUSTIBLE, SECUNDARIO	GP-1108	625627C1	AGUA	GP-2071W	1261387H1
COMBUSTIBLE, PRIMARIO 7	GP-1108	625627C1	COMBUSTIBLE, SEPARADOR	GPP-11	1214920H1	484 con motor/IHC D179		
AGUA	GP-2071W	1809789C1	DE AGUA	GP-2071W	1809789C1	ACEITE	GP-10	398080R2
COMBUSTIBLE, SECUNDARIO	GP-78	672603C2	AGUA	GP-78	674293C1	COMBUSTIBLE	G-296	3144477R92
4386 SOBRE RUEDAS con motor/IHC DT466			4586 con motor/IHC DVT800			COMBUSTIBLE, PRIMARIO	GPP-1122	3132428R1
ACEITE	GP-69	675616C91	COMBUSTIBLE, SECUNDARIO	GP-1107	674293C1	COMBUSTIBLE, SECUNDARIO	GPP-1122	3132428R1
COMBUSTIBLE, PRIMARIO 6	GP-1105	625626C1	COMBUSTIBLE, PRIMARIO	GP-1108	A184773	COMBUSTIBLE	G-296-B	3144477R92
COMBUSTIBLE, PRIMARIO 7	GP-1108	625627C1	COMBUSTIBLE, SECUNDARIO	GP-1107	674293C1			
AGUA	GP-2071W	1809789C1	COMBUSTIBLE, SECUNDARIO	GP-1108	625627C1			
COMBUSTIBLE, SECUNDARIO	GP-78	672603C2	COMBUSTIBLE, PRIMARIO	GP-1108	A184773			

MARCA-MODELO-MOTOR MAKE-MODEL-ENGINE	GONHER GONHER	OEM OEM	MARCA-MODELO-MOTOR MAKE-MODEL-ENGINE	GONHER GONHER	OEM OEM	MARCA-MODELO-MOTOR MAKE-MODEL-ENGINE	GONHER GONHER	OEM OEM
I.H.C. HARVESTER (continuación)			I.H.C. HARVESTER (continuación)			I.H.C. HARVESTER (continuación)		
TRACTORES			TRACTORES			TRACTORES		
484 SOBRE RUEDAS con motor/A DIESEL			5000 con motor/DEUTZ 4 CYL.			5288 con motor/IHC DT466B		
ACEITE	GP-10	398080R2	ACEITE	GP-54	3136046R93	ACEITE, CARTUCHO HIDRAU- LICO	G-338	528493R3
COMBUSTIBLE	G-296	3144477R92				COMBUSTIBLE, SEPARADOR DE AGUA	GPP-14	998443R91
COMBUSTIBLE	G-296-B	3144477R91	500B con motor/A DIESEL			ACEITE	GP-69	A184775
AIRE, PRIMARIO	GAK-16	3125199R2	ACEITE	GP-10	398080R2	COMBUSTIBLE, PRIMARIO	GP-1108	A184773
						COMBUSTIBLE, SEPARADOR DE AGUA	GPP-11	1214920H1
485XL SOBRE RUEDAS con motor/IHC D179			500C con motores/IHC BD144C, IHC BD154T			ACEITE	GP-88	1811953C1
ACEITE	GP-10	398080R2	TRANSMISION	GP-1	388227R91	AGUA	GP-2071W	A151931
COMBUSTIBLE	G-296	3144477R92	ACEITE	GP-10	398080R2	COMBUSTIBLE, SECUNDARIO	GP-78	672603C2
COMBUSTIBLE	G-296-B	3144477R91	AIRE, SIN ASPAS	GA-16	384812R93	AIRE, PRIMARIO	GA-826	67974C3
AIRE, PRIMARIO	GAK-16	1265510C1	AIRE	GAK-16	384812R93	AIRE, SECUNDARIO	GA-827	67975C1
500 con motor/A DIESEL			500C SOBRE ORUGAS con motor/A DIESEL			533 SOBRE RUEDAS, 533A SOBRE RUEDAS con motor/A DIESEL		
ACEITE	G-870	376364R91	ACEITE, SELLADO	GP-50	538836R1	ACEITE	GP-9	395789R2
TRANSMISION	GP-1	918266R93	COMBUSTIBLE	G-296	3144477R92	COMBUSTIBLE	G-296	3044506R91
COMBUSTIBLE	G-296	3144477R92	COMBUSTIBLE	G-296-B	3144477R92	COMBUSTIBLE	G-296-B	3044506R91
COMBUSTIBLE	G-296-B	3144477R92	AIRE	GAK-16	384812R93	AIRE, PRIMARIO	GA-49	3146927-R91
500 con motor/A GASOLINA			500C, 500E con motor/IHC D155			544 con motor/A DIESEL		
TRANSMISION	GP-1	918266R93	TRANSMISION	GP-1	388227R91	ACEITE	G-338	70432C91
			ACEITE	GP-10	398080R2	ACEITE	GP-10	398080R2
500 con motor/IHC BD144C			COMBUSTIBLE, PRIMARIO	GPP-1122	3132275R91	COMBUSTIBLE	GP-92	530824R2
ACEITE	G-870	376364R91	COMBUSTIBLE, SECUNDARIO	GPP-1122	3132275R91	COMBUSTIBLE	GPP-1122	3132428R1
AIRE, SIN ASPAS	GA-16	384812R93	AIRE, SIN ASPAS	GA-16	384812R93	AIRE	GA-18	313964R91
AIRE	GAK-16	384812R93	AIRE	GAK-16	384812R93			
500 con motor/IHC BD154T			500E con motor/IHC BD144C			544 con motor/IHC C200		
AIRE, SIN ASPAS	GA-16	384812R93	ACEITE	G-870	376364R91	ACEITE	G-338	386120R91
			AIRE, SIN ASPAS	GA-16	384812R93	ACEITE	GP-36	3136046R93
500 con motor/IHC D155			AIRE	GAK-16	384812R93	HYDROSTATIC RETLINE SELLADO	GP-66	528250R1
TRANSMISION	GP-1	918266R91				AIRE	GA-18	313964R91
ACEITE	GP-10	398080R2	500E con motor/IHC BD154T					
COMBUSTIBLE, PRIMARIO	GPP-1122	3132275R91	AIRE, SIN ASPAS	GA-16	384812R93	544 con motor/IHC D239		
COMBUSTIBLE, SECUNDARIO	GPP-1122	3132275R91				HYDROSTATIC GEAR DRIVE CARTUCHO	G-338	386120R91
AIRE, SIN ASPAS	GA-16	384812R93	500E SOBRE ORUGAS con motor/A DIESEL			ACEITE	GP-36	3136046R93
AIRE	GAK-16	384812R93	TRANSMISION	GP-1	918266R93	COMBUSTIBLE	G-296	3144477R92
			ACEITE	GP-10	398080R2	HYDROSTATIC RETLINE SELLADO	GP-66	528250R1
500 SERIES C SOBRE ORUGAS con motor/IHC C146			HIDRAULICO	GP-10	528250R1	COMBUSTIBLE, SELLADO	GPP-1122	1967094C1
TRANSMISION	GP-1	918266R91	COMBUSTIBLE	G-296	3144477R92	COMBUSTIBLE	G-296-B	3144477R92
ACEITE	GP-50	538836R1	COMBUSTIBLE	G-296-B	3144477R92			
AIRE, SIN ASPAS	GA-16	384812R93	AIRE	GAK-16	384812R93	544D con motor/A DIESEL		
AIRE	GAK-16	384812R93				ACEITE	G-338	70432C91
			504 con motor/IHC C153			ACEITE	GP-10	398080R2
500 SERIES C SOBRE ORUGAS con motor/IHC D155			ACEITE, SELLADO	GP-50	538836R1	COMBUSTIBLE	GP-92	530824R2
TRANSMISION	GP-1	918266R91				COMBUSTIBLE	GPP-1122	3132428R1
ACEITE	GP-10	398080R2	504 con motor/IHC D188			AIRE	GA-18	313964R91
COMBUSTIBLE	G-296	3144477R92	ACEITE	G-335	279994R91			
COMBUSTIBLE, PRIMARIO	GPP-1122	3136187R91	COMBUSTIBLE	G-1163	304101R91	5488 con motor/IHC DT466B		
COMBUSTIBLE, SECUNDARIO	GPP-1122	3136187R91	AIRE	GA-18	313964R91	HIDRAULICO	G-338	528493R3
COMBUSTIBLE	G-296-B	3144477R92				COMBUSTIBLE, SEPARADOR DE AGUA	GPP-14	998443R91
AIRE, SIN ASPAS	GA-16	384812R93	504D con motor/A DIESEL			ACEITE	GP-69	A184775
AIRE	GAK-16	384812R93	ACEITE	G-335	323827R91	COMBUSTIBLE, PRIMARIO	GP-1108	A184773
			COMBUSTIBLE	G-1163	306353R91	AGUA	GP-88	1811953C1
500 SERIES E SOBRE ORUGAS con motor/IHC D155			AIRE	GA-18	313964R91	COMBUSTIBLE, SECUNDARIO	GP-78	672603C2
TRANSMISION	GP-1	918266R91				AIRE, PRIMARIO	GA-826	67974C3
HIDRAULICO	GP-10	528250R1	5088 con motor/IHC DT436B			AIRE, SECUNDARIO	GA-827	67975C1
ACEITE, SELLADO	GP-10	398080R2	ACEITE, CARTUCHO HIDRAU- LICO	G-338	528493R3			
COMBUSTIBLE	G-296	3144477R92	ACEITE	GP-69	A184775			
COMBUSTIBLE	G-296-B	3144477R92	COMBUSTIBLE, PRIMARIO	GP-1108	A184773			
AIRE, SIN ASPAS	GA-16	384812R93	COMBUSTIBLE, SEPARADOR DE AGUA	GPP-11	1214920H1			
AIRE	GAK-16	384812R93	AGUA	GP-2071W	A151931			
			COMBUSTIBLE, SECUNDARIO	GP-78	672603C2			
5000 con motor/CHRYSLER 6 CYL.			AIRE, PRIMARIO	GA-826	67974C2			
ACEITE	GP-1	388227R91	AIRE, SECUNDARIO	GA-827	67975C1			

MARCA-MODELO-MOTOR MAKE-MODEL-ENGINE	GONHER GONHER	OEM OEM	MARCA-MODELO-MOTOR MAKE-MODEL-ENGINE	GONHER GONHER	OEM OEM	MARCA-MODELO-MOTOR MAKE-MODEL-ENGINE	GONHER GONHER	OEM OEM
I.H.C. HARVESTER (continuación)			I.H.C. HARVESTER (continuación)			I.H.C. HARVESTER (continuación)		
TRACTORES			TRACTORES			TRACTORES		
554 SOBRE RUEDAS con motor/A DIESEL			606D con motor/A DIESEL			COMBUSTIBLE, SELLADO	GP-1122	3136046R93
COMBUSTIBLE	G-296	3144477R92	ACEITE	G-335	328227R91	HYDROSTATIC RETLINE SELLADO	GP-66	528250R1
COMBUSTIBLE	G-296-B	3044506R93	COMBUSTIBLE, PRIMARIO	G-1163	306353R91	AIRE	GAK-16	384812R93
ACEITE, SELLADO	GP-171	395789R2	COMBUSTIBLE, SECUNDARIO	G-1163	306353R91	656 con motor/IHC D282		
560 con motor/A DIESEL			ACEITE	GP-10	398080R2	ACEITE, CARTUCHO	G-335	279994R91
ACEITE	G-335	279994R91	624 SOBRE RUEDAS (ENSAMBLADO EN ALEMANIA), 724 SOBRE RUEDAS (ENSAMBLADO EN ALEMANIA) con motor/A DIESEL			COMBUSTIBLE, SECUNDARIO	G-1163	306353R91
560 con motor/IHC C263			COMBUSTIBLE, SIN CUBIERTA	G-1123	3132015R92	HYDROSTATIC DRIVE CARTUCHO	G-338	70432C91
ACEITE, CARTUCHO	G-335	323827R91	624 SOBRE RUEDAS, 624A SOBRE RUEDAS con motor/A DIESEL			HYDROSTATIC RETLINE SELLADO	GP-66	528250R1
560 con motor/IHC D282			COMBUSTIBLE	G-296	3144477R92	ACEITE, SELLADO	GP-69	A184775
ACEITE	G-335	323827R91	COMBUSTIBLE, PRIMARIO	GP-1122	3132428R1	656D con motor/IHC D282		
560D con motor/A DIESEL			COMBUSTIBLE, SECUNDARIO	GP-1122	3132428R1	ACEITE, CARTUCHO	G-335	279994R91
ACEITE	G-335	279994R91	COMBUSTIBLE	G-296-B	3144477R92	COMBUSTIBLE, PRIMARIO	G-1163	306353R91
COMBUSTIBLE, PRIMARIO	G-1163	306353R91	ACEITE	GP-171	395789R2	COMBUSTIBLE, SECUNDARIO	G-1163	306353R91
COMBUSTIBLE, SECUNDARIO	G-1163	306353R91	AIRE	GA-49	3146927-R91	HIDRAULICO	G-338	70432C91
ACEITE	GP-10	398080R2	633 SOBRE RUEDAS (ENSAMBLADO EN ALEMANIA) con motor/A DIESEL			ACEITE	GP-10	398080R2
ACEITE, TURBO LUBRICACION	GP-50	538836R1	COMBUSTIBLE	G-296	3044506R93	ACEITE, TURBO LUBRICACION	GP-50	538836R1
574 con motor/IHC D179			COMBUSTIBLE	G-296-B	3044506R93	ACEITE, SELLADO	GP-69	675616C91
ACEITE	GP-10	398080R2	ACEITE	GP-171	395789R2	6588 con motor/IHC DIESEL		
COMBUSTIBLE	G-296	3144477R92	633 SOBRE RUEDAS, 633A SOBRE RUEDAS con motor/A DIESEL			ACEITE	GP-69	A184775
COMBUSTIBLE, PRIMARIO	GPP-1122	3132428R1	ACEITE	GP-9	395789R2	COMBUSTIBLE, PRIMARIO	GP-1108	A184773
COMBUSTIBLE, SECUNDARIO	GPP-1122	3132428R1	COMBUSTIBLE	G-296	3144477R92	COMBUSTIBLE, SEPARADOR DE AGUA	GPP-11	1214920H1
COMBUSTIBLE	G-296-B	3044506R91	COMBUSTIBLE	G-296-B	3044506R93	AGUA	GP-2071W	A151931
574 con motor/IHC D239			AIRE, PRIMARIO	GA-49	3146927-R91	COMBUSTIBLE, SECUNDARIO	GP-78	672603C2
ACEITE	GP-10	398080R2	6388 SOBRE RUEDAS con motor/IHC DT436			AIRE, PRIMARIO	GA-826	67974C3
COMBUSTIBLE	G-296	3144477R92	ACEITE	GP-69	A184775	AIRE, SECUNDARIO	GA-827	67975C1
COMBUSTIBLE, PRIMARIO	GPP-1122	3132428R1	COMBUSTIBLE, PRIMARIO	GP-1108	A184773	660 con motor/IHC C263		
COMBUSTIBLE, SECUNDARIO	GPP-1122	3132428R1	COMBUSTIBLE, SEPARADOR DE AGUA	GPP-11	1214920H1	ACEITE, CARTUCHO	G-335	323827R91
COMBUSTIBLE	G-296-B	3144477R92	AGUA	GP-2071W	A151931	COMBUSTIBLE, PRIMARIO	G-1163	306353R91
574 con motores/IHC C157, IHC C175, IHC C200			COMBUSTIBLE, SECUNDARIO	GP-78	672603C2	COMBUSTIBLE, SECUNDARIO	G-1163	306353R91
ACEITE	GP-10	398080R2	AIRE, PRIMARIO	GA-826	67974C3	HYDROSTATIC DRIVE CARTUCHO	G-338	70432C91
COMBUSTIBLE	G-296	3144477R92	AIRE, SECUNDARIO	GA-827	67975C1	ACEITE, TURBO LUBRICACION	GP-50	538836R1
COMBUSTIBLE, PRIMARIO	GPP-1122	3132428R1	644 SOBRE RUEDAS con motor/A DIESEL			ACEITE, SELLADO	GP-69	675616C91
COMBUSTIBLE, SECUNDARIO	GPP-1122	3132428R1	COMBUSTIBLE	G-296	3144477R92	660 con motor/IHC D282		
COMBUSTIBLE	G-296-B	3144477R92	COMBUSTIBLE, PRIMARIO	GPP-1122	3132275R91	ACEITE	G-335	279994R91
582 con motor/A DIESEL			COMBUSTIBLE, SECUNDARIO	GPP-1122	3132275R91	COMBUSTIBLE	G-1163	306353R91
ACEITE	GP-9	395789R2	COMBUSTIBLE	G-296-B	3044506R93	ACEITE	G-338	70432C91
584 SOBRE RUEDAS con motor/A DIESEL			ACEITE	GP-171	395789R2	ACEITE	GP-10	398080R2
ACEITE	GP-36	3136046R93	650 con motor/IHC D350			ACEITE	GP-69	675616C91
COMBUSTIBLE	G-296	3144477R92	HIDRAULICO	G-338	70432C91	660D con motor/IHC C263		
COMBUSTIBLE, SELLADO	GP-1122	3218794R91	650D con motor/A DIESEL			ACEITE, CARTUCHO	G-335	323827R91
COMBUSTIBLE	G-296-B	3044506R91	HIDRAULICO	G-338	70432C91	COMBUSTIBLE, PRIMARIO	G-1163	306353R91
AIRE, PRIMARIO	GAK-16	1265510C1	654 SOBRE RUEDAS, 654A SOBRE RUEDAS con motor/A DIESEL			COMBUSTIBLE, SECUNDARIO	G-1163	306353R91
585XL SOBRE RUEDAS con motor/IHC D206			COMBUSTIBLE	G-296	3144477R92	HYDROSTATIC DRIVE CARTUCHO	G-338	70432C91
ACEITE	GP-10	398080R2	COMBUSTIBLE, PRIMARIO	GP-1122	3132428R1	ACEITE, TURBO LUBRICACION	GP-50	538836R1
COMBUSTIBLE	G-296	3144477R92	COMBUSTIBLE, SECUNDARIO	GP-1122	3132428R1	ACEITE, SELLADO	GP-69	675616C91
COMBUSTIBLE	GP-1122	3218794R91	COMBUSTIBLE	G-296-B	3044506R93	660D con motor/IHC D282		
COMBUSTIBLE	G-296-B	3044506R91	ACEITE	GP-171	395789R2	ACEITE, CARTUCHO	G-335	279994R91
AIRE, PRIMARIO	GAK-16	1265510C1	AIRE	GA-49	3146927-R91	COMBUSTIBLE	G-1163	306353R91
606 con motor/A DIESEL			656 con motor/IHC C263			HIDRAULICO	G-338	70432C91
ACEITE	G-335	279994R91	ACEITE, CARTUCHO	G-335	279994R91	ACEITE, SELLADO	GP-10	398080R2
COMBUSTIBLE	G-1163	306353R91	HYDROSTATIC DRIVE CARTUCHO	G-338	70432C91	ACEITE, TURBO LUBRICACION	GP-50	538836R1
COMBUSTIBLE	GP-10	398080R2	606 con motor/IHC C221			664 con motor/IHC D239		
606 con motor/IHC C221			ACEITE	G-335	279994R91	ACEITE	GP-10	398080R2
ACEITE	G-335	279994R91	606 con motor/IHC D236					
606 con motor/IHC D236			ACEITE	G-335	279994R91			
ACEITE	G-335	279994R91						

SERVICIO PESADO

MARCA-MODELO-MOTOR	GONHER	OEM	MARCA-MODELO-MOTOR	GONHER	OEM	MARCA-MODELO-MOTOR	GONHER	OEM
MAKE-MODEL-ENGINE	GONHER	OEM	MAKE-MODEL-ENGINE	GONHER	OEM	MAKE-MODEL-ENGINE	GONHER	OEM
I.H.C. HARVESTER (continuación)			I.H.C. HARVESTER (continuación)			I.H.C. HARVESTER (continuación)		
TRACTORES			TRACTORES			TRACTORES		
COMBUSTIBLE	G-296	3144477R92	COMBUSTIBLE	GP-1122	3218794R91	ACEITE, 5 13/32 IN	GP-36	3136046R93
COMBUSTIBLE, PRIMARIO	GPP-1122	3132428R1	COMBUSTIBLE	G-296-B	3044506R91	COMBUSTIBLE	G-296	3144477R92
COMBUSTIBLE, SECUNDARIO	GPP-1122	3132428R1	AIRE, PRIMARIO	GAK-16	1265510C1	COMBUSTIBLE	GPP-1122	1967094C1
COMBUSTIBLE	G-296-B	3044506R91				COMBUSTIBLE	G-296-B	3144477R92
666 con motor/IHC C291			684 con motor/IHC D239			706 con motores/IHC C263, IHC C291		
HYDROSTATIC DRIVE CAR-TUCHO	G-338	528493R3	ACEITE, 7 17/32 IN	GP-10	398080R2	ACEITE, CARTUCHO	G-335	279994R91
ACEITE, 7 17/32 IN	GP-10	398080R2	ACEITE, 5 13/32 IN	GP-36	3136046R93	HIDRAULICO	G-338	528493R3
ACEITE, 5 13/32 IN	GP-36	3136046R93	COMBUSTIBLE	G-296	3144477R92	ACEITE, SELLADO	GP-10	398080R2
HYDROSTATIC RETLINE SELLADO	GP-66	70203C2	COMBUSTIBLE, PRIMARIO	GPP-1122	3132275R91	AIRE, SIN ASPAS	GA-16	384812R93
			COMBUSTIBLE, SECUNDARIO	GPP-1122	3132275R91	AIRE	GAK-16	384812R93
			COMBUSTIBLE	G-296-B	3044506R91			
666 con motor/IHC D312			685XL SOBRE RUEDAS con motor/IHC D239			706D con motor/IHC D310		
HYDROSTATIC DRIVE CAR-TUCHO	G-338	528493R3	ACEITE	GP-10	398080R2	HIDRAULICO	G-338	70432C91
HYDROSTATIC RETLINE SELLADO	GP-66	528250R1	COMBUSTIBLE	G-296	3144477R92	COMBUSTIBLE, SIN CUBIERTA	G-1123	3132015R91
ACEITE	GP-69	A184775	COMBUSTIBLE, PRIMARIO	GPP-1122	3132275R91	COMBUSTIBLE, CON CUBIERTA	G-1123F	3132015R91
COMBUSTIBLE, PRIMARIO 46 43/64 IN	GP-1105	625626C1	COMBUSTIBLE, SECUNDARIO	GPP-1122	3132275R91	ACEITE, OPCIONAL	GP-10	528250R1
COMBUSTIBLE, PRIMARIO 7 17/32 IN	GP-1108	A184773	AGUA	GP-2071W	A151931	ACEITE, TURBO LUBRICACION	GP-50	538836R1
AGUA	GP-2071W	A151931	COMBUSTIBLE	G-296-B	3044506R91	COMBUSTIBLE, PRIMARIO	GPP-1122	3132275R91
COMBUSTIBLE, SECUNDARIO	GP-78	672603C2	AIRE, PRIMARIO	GAK-16	1265510C1	COMBUSTIBLE, SECUNDARIO	GPP-1122	3132275R91
666 con motor/IHC GASOLINA			686 con motor/IHC C291			706D con motores/IHC U282, IHC UD282		
HIDRAULICO	G-338	528493R3	HYDROSTATIC DRIVE	G-338	528493R3	ACEITE	G-335	279994R91
			ACEITE, 7 17/32 IN	GP-10	398080R2	COMBUSTIBLE, PRIMARIO	G-1163	306353R91
			ACEITE, 5 13/32 IN	GP-36	3136046R93	COMBUSTIBLE, SECUNDARIO	G-1163	306353R91
			HIDRAULICO	GP-66	70203C2	HIDRAULICO	G-338	70432C91
671 con motor/A DIESEL			686 con motor/IHC D310			AIRE, SIN ASPAS	GA-16	384812R93
ACEITE	GP-10	398080R2	HYDROSTATIC DRIVE	G-338	386120R91	AIRE	GAK-16	384812R93
			COMBUSTIBLE, CARTUCHO	G-1123	3132015R92			
674 con motor/IHC C200			ACEITE	GP-36	3136046R93	724 SOBRE RUEDAS, 724A SOBRE RUEDAS con motor/A DIESEL		
ACEITE	GP-10	398080R2	HIDRAULICO	GP-66	70203C2	COMBUSTIBLE	G-296	3144477R92
			COMBUSTIBLE, PRIMARIO	GP-1108	A184773	COMBUSTIBLE, PRIMARIO	GP-1122	3132428R1
674 con motor/IHC D239			AGUA	GP-2071W	A151931	COMBUSTIBLE, SECUNDARIO	GP-1122	3132428R1
ACEITE	GP-10	398080R2	COMBUSTIBLE, SECUNDARIO	GP-78	672603C1	COMBUSTIBLE	G-296-B	3044506R91
COMBUSTIBLE	G-296	3144477R92				ACEITE	GP-171	395789R2
COMBUSTIBLE, PRIMARIO	GPP-1122	1967094C1	686 con motor/IHC D312			AIRE	GA-49	3146927-R91
COMBUSTIBLE, SECUNDARIO	GPP-1122	1967094C1	HYDROSTATIC DRIVE	G-338	528493R3			
COMBUSTIBLE	G-296-B	3144477R92	HIDRAULICO	GP-66	70203C2	7288, 7488 con motor/A DIESEL		
AIRE, PRIMARIO	GAK-16	1265510C1	ACEITE	GP-69	A184775	HIDRAULICO	G-338	528493R3
			COMBUSTIBLE, PRIMARIO	GP-1108	625627C1	ACEITE	GP-69	A184775
			COMBUSTIBLE, SECUNDARIO	GPP-11	1214920H1	COMBUSTIBLE, PRIMARIO	GP-1108	A184773
6788 con motor/IHC DT1466B			COMBUSTIBLE, SEPARADOR DE AGUA	GPP-11	1214920H1	AGUA	GP-2071W	A151931
AGUA	GP-1010Q	A151931	AGUA	GP-2071W	A151931	COMBUSTIBLE, SECUNDARIO	GP-78	A184774
ACEITE	GP-69	675616C91	COMBUSTIBLE, SECUNDARIO	GP-78	672603C2	AIRE, PRIMARIO	GA-826	67974C4
COMBUSTIBLE	GP-1108	625627C1				AIRE, SECUNDARIO	GA-827	67975C1
COMBUSTIBLE	GP-78	672603C2	7 HP CADET con motor/A DIESEL					
AIRE	GA-826	67974C4	AIRE	GA-11	385163R2	733 SOBRE RUEDAS, 733A SOBRE RUEDAS con motor/A DIESEL		
AIRE	GA-827	67975C1				COMBUSTIBLE	G-296	3144477R92
			706 con motor/IHC C282			COMBUSTIBLE	GP-1122	3132428R1
6788 SOBRE RUEDAS con motor/IHC DT466			ACEITE	G-335	279994R91	COMBUSTIBLE	G-296-B	3044506R91
ACEITE	GP-69	A184775	COMBUSTIBLE	G-1163	306353R91	ACEITE	GP-171	395789R2
COMBUSTIBLE, PRIMARIO	GP-1108	A184773	ACEITE	G-338	528493R3	AIRE	GA-49	3146927-R91
ACEITE	GP-88	1811953C1	ACEITE	GP-69	A184775			
AGUA	GP-2071W	A151931				7388 SOBRE RUEDAS con motor/A DIESEL		
COMBUSTIBLE, SECUNDARIO	GP-78	672603C2	706 con motor/IHC D282			HIDRAULICO	G-338	528493R3
AIRE, PRIMARIO	GA-826	67974C3	ACEITE, CARTUCHO	G-335	279994R91	ACEITE	GP-69	A184775
AIRE, SECUNDARIO	GA-827	67975C1	COMBUSTIBLE	G-1163	304101R91	COMBUSTIBLE, PRIMARIO	GP-1108	A184773
			HYDROSTATIC GEAR DRIVE	G-338	386120R91	AGUA	GP-2071W	A151931
682, 782 con motor/KOHLER A GASOLINA			ACEITE, TRACTOR	GP-69	A184775	COMBUSTIBLE, SECUNDARIO	GP-78	A184774
HIDRAULICO	GP-9	395789R2				AIRE, PRIMARIO	GA-826	67974C4
			706 con motor/IHC D310			AIRE, SECUNDARIO	GA-827	67975C1
684 con motor/A DIESEL			HYDROSTATIC GEAR DRIVE	G-338	528493R3			
ACEITE	GP-36	3136046R93	COMBUSTIBLE	G-1123	3132015R92			
COMBUSTIBLE	G-296	3144477R92	ACEITE, 7 17/32 IN	GP-10	528250R1			

MARCA-MODELO-MOTOR MAKE-MODEL-ENGINE	GONHER GONHER	OEM OEM	MARCA-MODELO-MOTOR MAKE-MODEL-ENGINE	GONHER GONHER	OEM OEM	MARCA-MODELO-MOTOR MAKE-MODEL-ENGINE	GONHER GONHER	OEM OEM
I.H.C. HARVESTER (continuación)			I.H.C. HARVESTER (continuación)			I.H.C. HARVESTER (continuación)		
TRACTORES			TRACTORES			TRACTORES		
743XL SOBRE RUEDAS, 744 SOBRE RUEDAS, 745 SOBRE RUEDAS, 745S SOBRE RUEDAS, 745XL SOBRE RUEDAS, 743 SOBRE RUEDAS, 743S SOBRE RUEDAS con motor/A DIESEL			800 CUB CADET SOBRE RUEDAS con motor/A DIESEL			ACEITE, SELLADO	GP-171	395789R2
COMBUSTIBLE	G-296	3144477R92	AIRE	GA-7	385168R2	844S, 844XL con motor/A DIESEL		
COMBUSTIBLE, PRIMARIO	GPP-1122	3132275R91	806 con motor/A DIESEL			ACEITE, CARTUCHO	G-870	376364R91
COMBUSTIBLE, SECUNDARIO	GPP-1122	3132275R91	ACEITE, CARTUCHO	G-335	279994R91	COMBUSTIBLE	G-296	3044506R93
COMBUSTIBLE	G-296-B	3044506R91	HIDRAULICO	G-338	70432C91	COMBUSTIBLE, PRIMARIO	GP-1122	3132428R1
ACEITE	GP-171	395789R2	ACEITE, SELLADO	GP-10	398080R2	COMBUSTIBLE, SECUNDARIO	GP-1122	3132428R1
756 con motor/IHC D310			ACEITE, TURBO LUBRICACION	GP-50	538836R1	COMBUSTIBLE	G-296-B	3044506R93
HIDRAULICO	G-338	70432C91	806 con motor/IHC C301			ACEITE, SELLADO	GP-171	395789R2
COMBUSTIBLE, SIN CUBIERTA	G-1123	3132015R91	ACEITE, CARTUCHO	G-335	323827R91	846 con motor/A DIESEL		
COMBUSTIBLE, CON CUBIERTA	G-1123F	3132015R91	HYDROSTATIC GEAR DRIVE	G-338	70432C91	COMBUSTIBLE	G-296	3044506R93
ACEITE, OPCIONAL	GP-10	528250R1	ACEITE, SELLADO	GP-10	398080R2	COMBUSTIBLE, PRIMARIO	GP-1122	3132428R1
ACEITE, TURBO LUBRICACION	GP-50	538836R1	806 con motor/IHC D361			COMBUSTIBLE, SECUNDARIO	GP-1122	3132428R1
COMBUSTIBLE	G-296	3144477R92	ACEITE	G-335	323827R91	COMBUSTIBLE	G-296-B	3044506R93
COMBUSTIBLE, PRIMARIO	GPP-1122	3132275R91	COMBUSTIBLE, SECUNDARIO	G-1163	306353R91	ACEITE, SELLADO	GP-171	395789R2
COMBUSTIBLE, SECUNDARIO	GPP-1122	3132275R91	HYDROSTATIC GEAR DRIVE	G-338	70432C91	AIRE	GA-49	3146927-R91
COMBUSTIBLE	G-296-B	3144477R92	806D con motor/A DIESEL			856 con motor/IHC D407		
756 con motores/IHC C291, IHC C301			ACEITE, CARTUCHO	G-335	279994R91	ACEITE, CARTUCHO	G-335	323827R91
ACEITE, CARTUCHO	G-335	279994R91	COMBUSTIBLE, PRIMARIO	G-1163	306353R91	HYDROSTATIC GEAR DRIVE	G-338	70432C91
HIDRAULICO	G-338	70432C91	COMBUSTIBLE, SECUNDARIO	G-1163	306353R91	ACEITE, SELLADO	GP-36	3136046R93
ACEITE, SECUNDARIO	GP-10	398080R2	HIDRAULICO	G-338	70432C91	COMBUSTIBLE, PRIMARIO 6 43/64 IN	GP-1105	625626C1
766 con motor/IHC C291			ACEITE, TURBO LUBRICACION	GP-50	538836R1	COMBUSTIBLE, PRIMARIO 7 17/32 IN	GP-1108	A184773
HYDROSTATIC GEAR DRIVE	G-338	70432C91	824 SOBRE RUEDAS, 824A SOBRE RUEDAS con motor/A DIESEL			COMBUSTIBLE, SECUNDARIO	GP-110	702142C1
ACEITE, 7 17/32 IN	GP-10	398080R2	COMBUSTIBLE	G-296	3144477R92	COMBUSTIBLE, SEPARADOR DE AGUA	GPP-1000	702256C1
ACEITE, 5 13/32 IN	GP-36	3136046R93	COMBUSTIBLE, PRIMARIO	GPP-1122	3132275R91	856D con motor/IHC D407		
AIRE, SECUNDARIO	GA-892	529852R5	COMBUSTIBLE, SECUNDARIO	GPP-1122	3132275R91	ACEITE	G-335	279994R91
AIRE, PRIMARIO	GA-891	529851R2	COMBUSTIBLE	G-296-B	3144477R92	HIDRAULICO	G-338	70432C91
AIRE, SECUNDARIO	GA-416	537335R2	ACEITE	GP-171	395789R2	ACEITE, TURBO LUBRICACION	GP-50	538836R1
766 con motor/IHC D360			825 SOBRE RUEDAS (ENSAMBLADO EN ALEMANIA) con motor/A DIESEL			COMBUSTIBLE	GP-1105	625626C1
HYDROSTATIC GEAR DRIVE	G-338	70432C91	COMBUSTIBLE, SIN CUBIERTA	G-1123	3132015R92	COMBUSTIBLE	GP-1108	625627C1
COMBUSTIBLE, PRIMARIO	GP-1101	625625C1	826 con motor/IHC D358			COMBUSTIBLE, SEPARADOR DE AGUA	GPP-11	1214920H1
ACEITE	GP-69	A184775	HYDROSTATIC GEAR DRIVE	G-338	70432C91	884, 885 con motores/IHC D246, IHC D268		
COMBUSTIBLE, SECUNDARIO	GP-78	672603C1	ACEITE, 7 17/32 IN	GP-10	58250R91	ACEITE, 7 17/32 IN	GP-10	58250R91
AIRE, SECUNDARIO	GA-892	529852R4	ACEITE, 5 13/32 IN	GP-36	3136046R93	ACEITE, 5 13/32 IN	GP-36	3136046R93
AIRE, PRIMARIO	GA-891	529851R2	COMBUSTIBLE	GPP-1122	1967094C1	COMBUSTIBLE	G-296	3044506R93
784 SOBRE RUEDAS con motor/A DIESEL			AIRE, SECUNDARIO	GA-892	529852R4	COMBUSTIBLE	GPP-1122	1967094C1
ACEITE	GP-10	398080R2	AIRE, PRIMARIO	GA-891	529851R2	COMBUSTIBLE	G-296-B	3044506R93
COMBUSTIBLE	G-296	3144477R92	826, 856 con motor/IHC C301 GASOLINA			886 con motor/DEUTZ A DIESEL		
COMBUSTIBLE	GP-1122	3218794R91	ACEITE, CARTUCHO	G-335	279994R91	HYDROSTATIC GEAR DRIVE	G-338	70432C91
COMBUSTIBLE	GPP-1122	1967094C1	HIDRAULICO	G-338	70432C91	ACEITE	GP-54	528250R1
COMBUSTIBLE	G-296-B	3144477R92	ACEITE, SELLADO	GP-10	398080R2	COMBUSTIBLE, PRIMARIO	GPP-1122	3132275R91
AIRE, PRIMARIO	GAK-16	1265510C1	826D con motor/IHC D358			COMBUSTIBLE, SECUNDARIO	GPP-1122	3132275R91
785 SOBRE RUEDAS con motor/IHC D246			HIDRAULICO	G-338	70432C91	AGUA	GP-2071W	1261387H1
ACEITE	GP-10	398080R2	ACEITE	GP-10	398080R2	886 con motor/IHC D358		
COMBUSTIBLE	G-296	3144477R92	ACEITE, TURBO LUBRICACION	GP-50	538836R1	HYDROSTATIC GEAR DRIVE	G-338	528493R3
COMBUSTIBLE	GP-1122	3218794R91	COMBUSTIBLE, PRIMARIO	GPP-1122	3132275R91	ACEITE	GP-36	3136046R93
COMBUSTIBLE, PRIMARIO	GPP-1122	1967094C1	COMBUSTIBLE, SECUNDARIO	GPP-1122	3132275R91	COMBUSTIBLE	GPP-1122	1967094C1
COMBUSTIBLE, SECUNDARIO	GPP-1122	3132275R91	AIRE, SECUNDARIO	GA-892	529852R4	AGUA	GP-2071W	A151931
COMBUSTIBLE	G-296-B	3144477R92	AIRE, PRIMARIO	GA-891	529851R2	AIRE, SECUNDARIO	GA-892	529852R5
AIRE, PRIMARIO	GAK-16	1265510C1	844 con motor/A DIESEL			AIRE, PRIMARIO	GA-891	529851R2
786 con motor/IHC D358			ACEITE, CARTUCHO	G-870	376364R91	886 con motor/IHC D360		
HYDROSTATIC GEAR DRIVE	G-338	70432C91	COMBUSTIBLE	G-296	3044506R93	HYDROSTATIC GEAR DRIVE	G-338	528493R3
ACEITE	GP-36	3136046R93	COMBUSTIBLE, PRIMARIO	GP-1122	3132428R1	COMBUSTIBLE, PRIMARIO 4 17/32 IN	GP-1101	625625C1
COMBUSTIBLE	GPP-1122	1967094C1	COMBUSTIBLE, SECUNDARIO	GP-1122	3132428R1	ACEITE	GP-69	A184775
AGUA	GP-2071W	A151931	COMBUSTIBLE	G-296-B	3044506R93			
AIRE, SECUNDARIO	GA-892	529852R5						
AIRE, PRIMARIO	GA-891	529851R2						

SERVICIO PESADO

MARCA-MODELO-MOTOR MAKE-MODEL-ENGINE	GONHER GONHER	OEM OEM	MARCA-MODELO-MOTOR MAKE-MODEL-ENGINE	GONHER GONHER	OEM OEM	MARCA-MODELO-MOTOR MAKE-MODEL-ENGINE	GONHER GONHER	OEM OEM
I.H.C. HARVESTER (continuación)			I.H.C. HARVESTER (continuación)			I.H.C. HARVESTER (continuación)		
TRACTORES			TRACTORES			TRACTORES		
COMBUSTIBLE, PRIMARIO 7 17/32 IN	GP-1108	625627C1	B414 con motor/IHC DC144			HYDRO 70, HYDRO 86 con motor/IHC C291 GASOLINA		
COMBUSTIBLE, SEPARADOR DE AGUA	GPP-11	1214920H1	ACEITE	G-870	376364R91	ACEITE	GP-10	398080R2
AGUA	GP-2071W	A151931				AIRE, SECUNDARIO	GA-892	529852R1
COMBUSTIBLE, SECUNDARIO	GP-78	672603C2	B414D con motor/A DIESEL			AIRE, PRIMARIO	GA-891	71912C1
AIRE, SECUNDARIO	GA-892	529852R4	ACEITE	G-870	376364R91	HYDRO 70, HYDRO 86 con motor/IHC D312		
AIRE, PRIMARIO	GA-891	529851R2	COMBUSTIBLE	G-296	3144477R92	HIDROSTATIC DRIVE	G-338	70432C91
			COMBUSTIBLE	G-296-B	3144477R92	TRANSMISION	GP-1	918266R93
946 SOBRE RUEDAS, 946A SOBRE RUEDAS con motor/A DIESEL						HIDRAULICO SELLADO	GP-66	70203C2
COMBUSTIBLE	G-296	3044506R91	BN, BW con motor/IHC C113			ACEITE	GP-69	A184775
COMBUSTIBLE, PRIMARIO	GPP-1122	3132275R91	ACEITE, SELLADO	GP-50	538836R1	COMBUSTIBLE, PRIMARIO 6 43/64 IN	GP-1105	625626C1
COMBUSTIBLE, SECUNDARIO	GPP-1122	3132275R91				COMBUSTIBLE, PRIMARIO 7 17/32 IN	GP-1108	A184773
COMBUSTIBLE	G-296-B	3044506R93	C con motor/A DIESEL			COMBUSTIBLE, SEPARADOR DE AGUA	GPP-11	1214920H1
			ACEITE, SELLADO	GP-50	538836R1	AGUA	GP-2071W	A151931
956 SOBRE RUEDAS, 956XL SOBRE RUEDAS con motor/IHC D358						COMBUSTIBLE, SECUNDARIO	GP-78	672603C2
HIDRAULICO	G-338	528493R2	CUB 154 LO-BOY SOBRE RUEDAS con motor/IHC C60			AIRE, SECUNDARIO	GA-892	529852R1
ACEITE	GP-10	528250R1	ACEITE	G-335	376373R91	AIRE, PRIMARIO	GA-891	71912C1
COMBUSTIBLE	G-296	3144477R92				HYDRO 84 con motor/A DIESEL		
COMBUSTIBLE, PRIMARIO	GPP-1122	3132275R91	CUB 185 LO-BOY SOBRE RUEDAS con motor/IHC C60			ACEITE, 7 17/32 IN	GP-10	398080R2
COMBUSTIBLE, SECUNDARIO	GPP-1122	3132275R91	ACEITE	G-335	279994R91	ACEITE, 5 13/32 IN	GP-36	3136046R93
COMBUSTIBLE	G-296-B	3144477R92				COMBUSTIBLE	G-296	3144477R92
			CUB SOBRE RUEDAS con motor/A DIESEL			COMBUSTIBLE	GP-1122	3218794R91
966 con motor/IHC D414			HIDRAULICO	GP-171	395789R2	COMBUSTIBLE	G-296-B	3144477R92
HYDROSTATIC GEAR DRIVE	G-338	70432C91	FARMALL C SOBRE RUEDAS, FARMALL SUPER C SOBRE RUEDAS con motor/IHC C113			AIRE	GAK-16	1265510C1
COMBUSTIBLE, PRIMARIO 5 17/32 IN	GP-1101	625625C1	ACEITE, SELLADO	GP-50	538836R1			
ACEITE	GP-69	A184775				I4, O4, M, MV con motor/A DIESEL		
COMBUSTIBLE, 7 17/32 IN	GP-1108	A184773	H, HV con motor/A DIESEL			ACEITE	GP-50	538836R1
AGUA	GP-2071W	A151931	ACEITE, SELLADO	GP-50	538836R1			
COMBUSTIBLE, SECUNDARIO	GP-78	672603C2				SUPER M, SUPER MTA, SUPER MV, SUPER A, SUPER A1, SUPER AV, SUPER C, SUPER H, SUPER HV con motor/A DIESEL		
AIRE, SECUNDARIO	GA-892	529852R4	HYDRO 100 con motor/A DIESEL			ACEITE, SELLADO	GP-50	538836R1
AIRE, PRIMARIO	GA-891	529851R2	HIDRAULICO	G-338	70432C91	T225SL SOBRE ORUGAS con motor/A GASOLINA		
			ACEITE	GP-10	398080R2	DIRECCION	G-33	302574R91
982 con motor/A DIESEL			ACEITE	GP-69	675616C91	T300SL SOBRE ORUGAS con motor/A DIESEL		
HIDRAULICO	GP-9	395789R2	COMBUSTIBLE, PRIMARIO 6 43/64 IN	GP-1105	702143C1	DIRECCION	G-33	302574R91
			COMBUSTIBLE, SECUNDARIO	GP-78	672603C2	T340 SOBRE ORUGAS, T340A SOBRE ORUGAS con motor/A DIESEL		
986 con motor/IHC D436			AIRE, SECUNDARIO	GA-892	529852R1	ACEITE, SELLADO	GP-50	538836R1
HYDROSTATIC GEAR DRIVE	G-338	70432C91	AIRE, PRIMARIO	GA-891	71912C1			
ACEITE	GP-69	675616C91				T4 SOBRE ORUGAS, T5 SOBRE ORUGAS con motor/A DIESEL		
COMBUSTIBLE, PRIMARIO 6 43/64 IN	GP-1105	625626C1	HYDRO 100 con motor/IHC D436			ACEITE, SELLADO	GP-50	538836R1
COMBUSTIBLE, PRIMARIO 7 17/32 IN	GP-1108	A184773	HIDROSTATIC DRIVE	G-338	70432C91			
COMBUSTIBLE, SEPARADOR DE AGUA	GPP-11	1214920H1	ACEITE	GP-10	677709C91	T500 SOBRE ORUGAS con motor/A GASOLINA		
AGUA	GP-2071W	A151931	COMBUSTIBLE, PRIMARIO 6 43/64 IN	GP-1105	702143C1	ACEITE	G-33	302574R91
COMBUSTIBLE, SECUNDARIO	GP-78	672603C2	COMBUSTIBLE, PRIMARIO 7 17/32 IN	GP-1108	A184773	ACEITE, CARTUCHO PARA TRANSMISION	G-33	302574R91
AIRE, SECUNDARIO	GA-892	529852R5	AGUA	GP-2071W	A151931	ACEITE, SELLADO TRANS- MISION	GP-1	920203C1
AIRE, PRIMARIO	GA-891	529851R2	COMBUSTIBLE, SECUNDARIO	GP-78	672603C2			
			AIRE, SECUNDARIO	GA-892	529852R4	T6-62 SOBRE ORUGAS con motor/A DIESEL		
A, AV, B con motor/IHC C113			AIRE, PRIMARIO	GA-891	529851R2	ACEITE	G-335	279994R91
ACEITE, SELLADO	GP-50	538836R1				T7 SOBRE ORUGAS con motor/IHC D206		
			HYDRO 186 con motor/IHC D436			ACEITE	GP-10	398080R2
B100 con motor/A DIESEL			HIDROSTATIC DRIVE	G-338	70432C91	T7 SOBRE ORUGAS con motores/IHC C175, IHC C200		
COMBUSTIBLE	G-296	3144477R92	ACEITE	GP-69	A184775	HIDRAULICO	G-338	386120R91
			COMBUSTIBLE, PRIMARIO 6 43/64 IN	GP-1105	702143C1			
B250 con motor/A DIESEL			COMBUSTIBLE, PRIMARIO 7 17/32 IN	GP-1108	A184773	T800 SOBRE ORUGAS con motor/A DIESEL		
ACEITE	G-870	376364R91	AGUA	GP-2071W	A151931	ACEITE, CARTUCHO PARA TRANSMISION	G-33	302574R91
			COMBUSTIBLE, SECUNDARIO	GP-78	672603C2			
B275 con motor/IHC BD144			AIRE, SECUNDARIO	GA-892	529852R4			
ACEITE	G-870	376364R91	AIRE, PRIMARIO	GA-891	529851R2			
B414 con motor/IHC BD154								
ACEITE	G-870	376364R91						
COMBUSTIBLE	G-296	3144477R92						
COMBUSTIBLE	G-296-B	304450693						

APLICACIONES SERVICIO PESADO
HEAVY DUTY APPLICATIONS



MARCA-MODELO-MOTOR MAKE-MODEL-ENGINE	GONHER GONHER	OEM OEM	MARCA-MODELO-MOTOR MAKE-MODEL-ENGINE	GONHER GONHER	OEM OEM	MARCA-MODELO-MOTOR MAKE-MODEL-ENGINE	GONHER GONHER	OEM OEM
I.H.C. HARVESTER (continuación)			I.H.C. HARVESTER (continuación)			I.H.C. HARVESTER (continuación)		
TRACTORES			TRACTORES			TRACTORES		
ACEITE, SELLADO TRANSMISION	GP-1	920203C1	TD15C SOBRE ORUGAS con motor/IHC DT466			COMBUSTIBLE, PRIMARIO	GP-1108	625627C1
COMBUSTIBLE, SECUNDARIO	GP-1107	674293C1	HIDRAULICO	G-333	615447C1	COMBUSTIBLE, SECUNDARIO	GP-110	702253C1
COMBUSTIBLE, PRIMARIO	GP-1108	625627C1	ACEITE, SELLADO	GP-69	675616C91			
			COMBUSTIBLE, PRIMARIO 6 43/64 IN	GP-1105	625626C1	TD25C SOBRE ORUGAS con motor/IHC DT817B		
T800 SOBRE ORUGAS con motor/A GASOLINA			COMBUSTIBLE, PRIMARIO 7 17/32 IN	GP-1108	625627C1	ACEITE	G-33	319926R91
ACEITE, CARTUCHO PARA TRANSMISION	G-33	302574R91	COMBUSTIBLE, SEPARADOR DE AGUA	GPP-11	1214920H1	COMBUSTIBLE, SECUNDARIO 7 17/32 IN	GP-1107	674293C1
			AGUA	GP-2071W	1261387H1	COMBUSTIBLE, PRIMARIO 7 17/32 IN	GP-1108	625627C1
TD12 SOBRE ORUGAS con motor/IHC D466 DIESEL			COMBUSTIBLE, SECUNDARIO	GP-78	672603C1	COMBUSTIBLE, SECUNDARIO 7 7/64 IN	GP-78	674293C1
ACEITE	GP-69	675617C91	AIRE, PRIMARIO	GA-329	627934C1	COMBUSTIBLE, PRIMARIO 9 17/32 IN	GPP-1000	702256C1
COMBUSTIBLE, PRIMARIO	GP-1105	625626C1	AIRE, SECUNDARIO	GA-239	627935C1			
ACEITE	GP-88	1811953C1				TD25E SOBRE ORUGAS con motor/IHC DT817C		
COMBUSTIBLE, SECUNDARIO	GP-78	672603C1	TD15E SOBRE ORUGAS con motor/IHC D466C			COMBUSTIBLE, SECUNDARIO 7 17/32 IN	GP-1107	674293C1
			ACEITE	GP-69	675616C91	COMBUSTIBLE, PRIMARIO	GP-1108	625627C1
TD12 SOBRE ORUGAS con motor/IHC D466B			COMBUSTIBLE, SECUNDARIO	GP-1108	625627C1	COMBUSTIBLE, SECUNDARIO 7 7/64 IN	GP-78	674293C1
ACEITE, SELLADO	GP-69	675616C91	AIRE, PRIMARIO	GA-329	627934C1	COMBUSTIBLE, SECUNDARIO 7 7/64 IN	GP-78	674293C1
COMBUSTIBLE, PRIMARIO	GP-1108	625627C1	AIRE, SECUNDARIO	GA-239	627935C1			
COMBUSTIBLE, SECUNDARIO	GP-78	672603C1				TD25G SOBRE ORUGAS con motor/CUMMINS KT1150C		
			TD12B SOBRE ORUGAS con motor/A DIESEL			ACEITE, FLUJO TOTAL (FULL FLOW)	GP-53	1212622H1
COMBUSTIBLE, SECUNDARIO	GP-1122	161624	COMBUSTIBLE, SECUNDARIO	GP-1122	161624	ACEITE, DERIVACION (BY PASS)	GP-57	1212621H1
ACEITE	GP-43	A77537	COMBUSTIBLE, PRIMARIO 7 17/32 IN	GP-1108	702251C1	COMBUSTIBLE, SEPARADOR DE AGUA	GPP-11	1214920H1
COMBUSTIBLE, PRIMARIO	GPP-18	161623	COMBUSTIBLE, SEPARADOR DE AGUA	GPP-11	1214920H1	AGUA	GP-1011Q	1661388H1
			COMBUSTIBLE, SECUNDARIO	GP-78	359251C1			
TD15 SERIES B SOBRE ORUGAS con motor/IHC DT361			AIRE	GA-31	672019C1	TD340 SOBRE ORUGAS, TD340A SOBRE ORUGAS con motor/A DIESEL		
HIDRAULICO	G-333	615447C1	TD20B SOBRE ORUGAS con motor/IHC DT429			ACEITE	G-335	279994R91
ACEITE, CARTUCHO	G-335	279994R91	COMBUSTIBLE, PRIMARIO	G-1163	306353R91	COMBUSTIBLE, PRIMARIO	G-1163	306353R91
COMBUSTIBLE, PRIMARIO	G-1163	306353R91	COMBUSTIBLE, SECUNDARIO	GP-1107	674293C1	COMBUSTIBLE, SECUNDARIO	G-1163	306353R91
COMBUSTIBLE, SECUNDARIO	G-1163	306353R91	AIRE	GA-18	313964R91	AIRE	GA-18	313964R91
			TD20C SOBRE ORUGAS con motor/A DIESEL					
TD15 SERIES B SOBRE ORUGAS con motor/IHC DT407			COMBUSTIBLE, SECUNDARIO	GP-1107	674293C1	TD40 SOBRE ORUGAS con motor/CUMMINS KTA1150C		
HIDRAULICO	G-333	615447C1	TD20E SOBRE ORUGAS con motor/A DIESEL			ACEITE, FLUJO TOTAL (FULL FLOW)	GP-53	1212622H1
ACEITE, CARTUCHO	G-335	279994R91	ACEITE, CUMPLE CON MEDIDAS ORIGINALES	GP-691	684206C1	ACEITE, DERIVACION (BY PASS)	GP-57	1212621H1
COMBUSTIBLE, PRIMARIO 6 43/64 IN	GP-1105	625626C1	COMBUSTIBLE, PRIMARIO 4 3/4 IN	GPP-14	998443R91	COMBUSTIBLE, SEPARADOR DE AGUA	GPP-11	1214920H1
COMBUSTIBLE, PRIMARIO 7 17/32 IN	GP-1108	625627C1	ACEITE, SEGUNDA OPCION	GP-52	684206C1	AGUA	GP-1011Q	1661388H1
COMBUSTIBLE, SEPARADOR DE AGUA	GPP-11	1214920H1	COMBUSTIBLE, SECUNDARIO	GP-1107	674293C1			
COMBUSTIBLE, SECUNDARIO 7 1/8 IN	GP-110	702253C1	COMBUSTIBLE, PRIMARIO 9 17/32 IN	GPP-1000	702256C1	TD5 SOBRE ORUGAS, TD5B SOBRE ORUGAS con motor/A DIESEL		
						ACEITE	G-870	376364R91
TD15-150 SOBRE ORUGAS, TD15-151 SOBRE ORUGAS con motor/A DIESEL			TD20E SOBRE ORUGAS con motor/IHC V800					
ACEITE, CARTUCHO	G-335	323827R91	COMBUSTIBLE, PRIMARIO	GPP-14	702255C1	TD640 SOBRE ORUGAS, TD6-62 SERIES SOBRE ORUGAS, TD9-92 SERIES SOBRE ORUGAS con motor/A DIESEL		
			COMBUSTIBLE, SECUNDARIO 7 17/32 IN	GP-1107	359251C1	ACEITE	G-335	279994R91
TD15B SOBRE ORUGAS con motor/A DIESEL			COMBUSTIBLE, SECUNDARIO 7 7/64 IN	GP-78	359251C1	COMBUSTIBLE, PRIMARIO	G-1163	306353R91
ACEITE	G-335	328227R91	AIRE	GA-31	672019C1	COMBUSTIBLE, SECUNDARIO	G-1163	306353R91
COMBUSTIBLE, PRIMARIO 6 43/64 IN	GP-1105	625626C1						
COMBUSTIBLE, PRIMARIO 7 17/32 IN	GP-1108	625627C1	TD22 SOBRE ORUGAS con motor/A DIESEL			TD7C SOBRE ORUGAS con motor/IHC D206		
COMBUSTIBLE, SECUNDARIO 7 1/8 IN	GP-110	702253C1	COMBUSTIBLE, PRIMARIO	G-1163	306353R91	TRANSMISION	G-338	386120R91
			TD25 SOBRE ORUGAS con motor/A DIESEL			ACEITE	GP-10	398080R2
TD15C SOBRE ORUGAS con motor/A DIESEL			COMBUSTIBLE, SECUNDARIO	GP-1107	674293C1	ACEITE, OPCIONAL	GP-10	528250R1
COMBUSTIBLE, SEPARADOR DE AGUA	GPP-14	998443R91	TD25-250 SOBRE ORUGAS, TD30 SOBRE ORUGAS con motor/A DIESEL			COMBUSTIBLE	G-296	3144477R92
ACEITE	GP-69	675616C91	TRANSMISION	G-33	319926R91	COMBUSTIBLE	GP-1122	3132428R1
COMBUSTIBLE, PRIMARIO 6 43/64 IN	GP-1105	625626C1				ACEITE	GP-66	528250R1
COMBUSTIBLE, PRIMARIO 7 17/32 IN	GP-1108	625627C1	TD25B SOBRE ORUGAS con motor/A DIESEL			COMBUSTIBLE	GPP-1122	3132428R2
COMBUSTIBLE, SECUNDARIO	GP-78	672603C1	ACEITE, CONVERTIDOR DE TORSION	G-33	319926R91	COMBUSTIBLE	G-296-B	3144477R92
AIRE, PRIMARIO	GA-329	627934C1	COMBUSTIBLE, SECUNDARIO	GP-1107	674293C1			
AIRE, SECUNDARIO	GA-239	627935C1						

SERVICIO PESADO

MARCA-MODELO-MOTOR MAKE-MODEL-ENGINE	GONHER GONHER	OEM OEM	MARCA-MODELO-MOTOR MAKE-MODEL-ENGINE	GONHER GONHER	OEM OEM	MARCA-MODELO-MOTOR MAKE-MODEL-ENGINE	GONHER GONHER	OEM OEM
INGERSOLL-RAND (continuación)			INGERSOLL-RAND (continuación)			INGERSOLL-RAND (continuación)		
COMPACTADORAS			COMPRESORES			COMPRESORES		
SD180D, SD180F con motor/CUMMINS 6CT8.3			160 con motor/DEUTZ			ACEITE	GP-57	35357250
COMBUSTIBLE, SECUNDARIO	GP-1122	59765511	ACEITE	GP-54	1173430	AIRE, PRIMARIO (MOTOR)	GA-563	P181042
COMBUSTIBLE, SEPARADOR DE AGUA	GPP-1122	92100981	30KW con motor/CUMMINS 4B3.9			DR120, DR150, DR210 con motor/GMC 4-51		
ACEITE, FLUJO TOTAL (FULL FLOW)	GP-43	35330901	COMBUSTIBLE, SECUNDARIO	GPP-1122	59560855	COMBUSTIBLE, SECUNDARIO	G-1173	5178782
ACEITE, DOBLE FLUJO	GP-3000	35378546	COMBUSTIBLE, PRIMARIO	GPP-18	35374669	DR1200 con motor/GMC 12V-71		
COMBUSTIBLE, PRIMARIO	GPP-18	35374669	ACEITE	GP-390	35374651	ACEITE, FLUJO TOTAL (FULL FLOW)	G-33	595075568
SD40 con motor/JOHN DEERE 4039			320 con motor/A DIESEL			AIRE, SECUNDARIO	GA-6127	35109271
ACEITE	GP-14	35308030	ACEITE	GP-1	35366681	AIRE, PRIMARIO	GA-6129	35109271
COMBUSTIBLE, 5 3/16 IN	GPP-418	RE62418	600 con motor/DETROIT DIESEL			DR125 con motor/CONTINENTAL GD157		
COMBUSTIBLE, 5 15/16 IN	GPP-419	RE62419	COMBUSTIBLE, PRIMARIO	GP-26	91786129	COMBUSTIBLE, SECUNDARIO	G-1173	HD260F3340
SD70, SD70F con motor/CUMMINS 4BT3.9			COMBUSTIBLE, SECUNDARIO	GP-27	91786167	DR125, DR150 con motor/GMC 2-53		
COMBUSTIBLE	GP-1122	35292366	ACEITE, LUBRICACION DE MOTOR	GP-53	35357243	ACEITE	G-119	58148693
COMBUSTIBLE, PRIMARIO	GPP-18	35374669	825 con motor/CUMMINS L10			COMBUSTIBLE, SECUNDARIO	G-1173	5178782
ACEITE	GP-390	35374651	COMBUSTIBLE	GP-1101	91671743	COMBUSTIBLE	G-1174	92092279
SD70D, SD70DA con motor/CUMMINS 4BT3.9			ACEITE, FLUJO TOTAL (FULL FLOW)	GP-53	35357243	DR250 con motor/GMC 4-53		
COMBUSTIBLE, SECUNDARIO	GP-1122	35292366	ACEITE, DERIVACION (BY PASS)	GP-57	35357250	ACEITE, FLUJO TOTAL (FULL FLOW)	G-33	595075568
COMBUSTIBLE, PRIMARIO	GPP-18	35374669	COMBUSTIBLE, SEPARADOR DE AGUA	GPP-11	35357268	COMBUSTIBLE, SECUNDARIO	G-1173	5178782
ACEITE	GP-390	35374651	ACEITE, DOBLE FLUJO	GP-3000	35378546	COMBUSTIBLE	G-1174	92092279
ACEITE	GP-761H	58887936	AGUA	GP-2071W	35375914	DR315, DR365 con motores/GMC 3-71, GMC 4-71		
SP42 con motor/FORD 2514E			825 con motor/CUMMINS M11			ACEITE, DERIVACION (BY PASS)	G-31	557245
ACEITE	GP-1	C1AZ-6731-A	COMBUSTIBLE, SEPARADOR DE AGUA	GPP-11	35357268	ACEITE, FLUJO TOTAL (FULL FLOW)	G-33	595075568
COMBUSTIBLE	G-296	92120385	ACEITE, DOBLE FLUJO	GP-3000	35378546	COMBUSTIBLE, SECUNDARIO	G-1173	5178782
HIDRAULICO	GP-66	1551	AGUA	GP-2071W	35375914	COMBUSTIBLE	G-1174	92092279
COMBUSTIBLE	G-296-B	92120385	85 con motor/IHC UC135B			DR600 con motor/GMC 6-71		
AIRE	GAK-403	P101246	ACEITE	GP-50	4512207-3	ACEITE, DERIVACION (BY PASS)	G-31	557245
SP54 con motor/DETROIT DIESEL 4-53			95 WD con motor/DEUTZ F3L1011F			ACEITE, FLUJO TOTAL (FULL FLOW)	G-33	595075568
AIRE, SIN ASPAS	GA-24	P101237	ACEITE	GP-28	92793223	COMBUSTIBLE	G-1174	92092279
SP56 con motor/CATERPILLAR 3208			BD130A con motor/CUMMINS 5.9L			COMBUSTIBLE, SECUNDARIO	G-1175	92092287
DIRECCION	GP-34	59587916	COMBUSTIBLE, SECUNDARIO	GP-1122	59765511	DR900 con motor/DETROIT DIESEL		
HIDRAULICO	GP-34	59587916	COMBUSTIBLE, SEPARADOR DE AGUA	GPP-1122	92100981	AIRE	GA-6127	35109271
AIRE	GA-24	P117431	COMBUSTIBLE, PRIMARIO	GPP-18	35374669	DR900 con motores/GMC 6-110, GMC 8V-71		
SP56 con motor/DEUTZ F6L912			ACEITE	GP-178	3914395	ACEITE, DERIVACION (BY PASS)	G-31	557245
ACEITE	GP-54	1173430	HIDRAULICO	GP-761H	58887936	ACEITE, FLUJO TOTAL (FULL FLOW)	G-33	595075568
COMBUSTIBLE	GP-1122	35292366	DL1200 con motor/GMC 12V-71			COMBUSTIBLE	G-1174	92092279
AIRE, SIN ASPAS	GA-24	P117431	ACEITE	G-33	595075568	COMBUSTIBLE, SECUNDARIO	G-1175	92092287
SP60 con motor/DETROIT DIESEL 6V-71			AIRE, SECUNDARIO	GA-6127	35109271	DRA125 con motor/GMC 2-53		
AIRE	GA-27	P101240	AIRE, PRIMARIO	GA-6129	35109271	ACEITE	G-119	58148693
SPF60 con motor/DETROIT DIESEL 6V-71			DL600 con motor/GMC 6-71			COMBUSTIBLE, SECUNDARIO	G-1173	5178782
AIRE, SIN ASPAS	GA-27	P101240	ACEITE, DERIVACION (BY PASS)	G-31	557245	COMBUSTIBLE	G-1174	92092279
INGERSOLL-RAND			ACEITE, FLUJO TOTAL (FULL FLOW)	G-33	595075568	DRB125, DR150, DRA125 con motor/CONTINENTAL G157		
COMPRESORES			COMBUSTIBLE	G-1174	92092279	COMBUSTIBLE, SECUNDARIO	G-1173	HD260F3340
100-47 con motor/WHITE A GASOLINA			COMBUSTIBLE, SECUNDARIO	G-1175	92092287	DRR160 con motor/IHC D239		
ACEITE	GP-1	35366681	DL900 con motores/GMC 6-110, GMC 8V-71			ACEITE	GP-10	427207-C3
125 con motor/FORD			ACEITE, DERIVACION (BY PASS)	G-31	557245	DXL1050 con motor/CUMMINS V903		
ACEITE	G-6	Y1042T1	ACEITE, FLUJO TOTAL (FULL FLOW)	G-33	595075568	ACEITE, CARTUCHO PARA FLUJO TOTAL (FULL FLOW)	G-566	257528
130 con motor/JOHN DEERE			COMBUSTIBLE	G-1174	92092279	COMBUSTIBLE	GPP-14	90749136
ACEITE, LUBRICACION DE MOTOR	GP-14	35308030	COMBUSTIBLE, SECUNDARIO	G-1175	92092287	ACEITE, SELLADO FLUJO TOTAL (FULL FLOW)	GP-53	35357243
1300 con motor/CUMMINS N14			DM25 con motor/CUMMINS					
ACEITE, DOBLE FLUJO	GP-3000	35378546	COMBUSTIBLE	GP-1101	91671743			

SERVICIO PESADO

MARCA-MODELO-MOTOR MAKE-MODEL-ENGINE	GONHER GONHER	OEM OEM	MARCA-MODELO-MOTOR MAKE-MODEL-ENGINE	GONHER GONHER	OEM OEM	MARCA-MODELO-MOTOR MAKE-MODEL-ENGINE	GONHER GONHER	OEM OEM
INGERSOLL-RAND (continuación)			INGERSOLL-RAND (continuación)			INGERSOLL-RAND (continuación)		
COMPRESORES			COMPRESORES			COMPRESORES		
ACEITE, DERIVACION (BY PASS)	G-750	91780742	GR150 con motor/GMC 2-53			COMBUSTIBLE, PRIMARIO	GPP-18	35374669
DXL1200 con motor/GMC 12V-71			ACEITE	G-119	58148693	HP600WCU con motor/CUMMINS LT10		
ACEITE, FLUJO TOTAL (FULL FLOW)	G-33	595075568	COMBUSTIBLE, SECUNDARIO	G-1173	5178782	ACEITE, FLUJO TOTAL (FULL FLOW)	GP-53	35357243
AIRE, SECUNDARIO	GA-6127	35109271	COMBUSTIBLE	G-1174	92092279	ACEITE, DERIVACION (BY PASS)	GP-57	35357250
AIRE, PRIMARIO	GA-6129	35109263	GR150 con motor/GMC 4-51			COMBUSTIBLE, SEPARADOR DE AGUA	GPP-11	35357268
DXL1200S con motor/DETROIT DIESEL 12V-71			COMBUSTIBLE, SECUNDARIO	G-1173	5178782	AGUA	GP-1011Q	35357276
AIRE, SECUNDARIO	GA-6127	35109271	GR600 con motor/GMC 6-71			AIRE, PRIMARIO	GA-251	35355395
DXL175 con motor/HERCULES D2300			ACEITE, DERIVACION (BY PASS)	G-31	557245	HP600WJD con motor/JOHN DEERE 6076A		
COMBUSTIBLE	G-296	92120385	ACEITE, FLUJO TOTAL (FULL FLOW)	G-33	595075568	ACEITE	GP-35	36870038
COMBUSTIBLE	G-296-B	92120385	COMBUSTIBLE	G-1174	92092279	HP750WCU con motor/CUMMINS 8.3L		
AIRE, SIN ASPAS	GA-20	35109099	COMBUSTIBLE, SECUNDARIO	G-1175	92092287	COMBUSTIBLE, SECUNDARIO	GP-1122	59765511
AIRE	GAK-20	35109099	GRR85 con motor/IHC UC135			COMBUSTIBLE, SEPARADOR DE AGUA	GPP-1122	92100981
DXL750 con motor/GMC 6V-71			ACEITE	GP-50	4512207-3	ACEITE, FLUJO TOTAL (FULL FLOW)	GP-43	35330901
ACEITE, DERIVACION (BY PASS)	G-31	557245	GRR85 con motor/IHC UC135B			ACEITE, DOBLE FLUJO	GP-3000	35378546
ACEITE, FLUJO TOTAL (FULL FLOW)	G-33	595075568	AIRE	GA-71	2463980	COMBUSTIBLE, PRIMARIO	GPP-18	35374669
COMBUSTIBLE, SECUNDARIO	G-1175	92092287	GYRO-FLO 105 con motor/GMC 2-71			HP750WCU, P750WCU, P900WCU con motor/CUMMINS LT10		
AIRE, SECUNDARIO	GA-6127	35109271	ACEITE, DERIVACION (BY PASS)	G-31	557245	ACEITE, FLUJO TOTAL (FULL FLOW)	GP-53	35357243
AIRE, PRIMARIO	GA-6129	35109263	COMBUSTIBLE, SECUNDARIO	G-1173	5178782	ACEITE, DERIVACION (BY PASS)	GP-57	35357250
DXL750, DXL750FT con motor/DETROIT DIESEL 6V-71			COMBUSTIBLE	G-1174	92092279	COMBUSTIBLE, SEPARADOR DE AGUA	GPP-11	35357268
AIRE, SECUNDARIO	GA-6127	35109271	GYRO-FLO con motor/FORD			AGUA	GP-1011Q	35357276
DXL900 con motor/GMC 12V-71			ACEITE	G-6	Y1042T1	AIRE, PRIMARIO	GA-251	35355395
ACEITE, FLUJO TOTAL (FULL FLOW)	G-33	595075568	HHE con motores/GMC 12108T, GMC 6-110			HP825WCU con motor/CUMMINS L10		
COMBUSTIBLE	G-1174	92092279	ACEITE, DERIVACION (BY PASS)	G-31	557245	COMBUSTIBLE	GP-1101	91671743
COMBUSTIBLE, SECUNDARIO	G-1175	92092287	ACEITE, FLUJO TOTAL (FULL FLOW)	G-33	595075568	ACEITE, FLUJO TOTAL (FULL FLOW)	GP-53	35357243
DXL900 con motor/GMC 8V-71			COMBUSTIBLE	G-1174	92092279	ACEITE, DERIVACION (BY PASS)	GP-57	35357250
ACEITE, FLUJO TOTAL (FULL FLOW)	G-33	595075568	COMBUSTIBLE, SECUNDARIO	G-1175	92092287	COMBUSTIBLE, SEPARADOR DE AGUA	GPP-11	35357268
COMBUSTIBLE	G-1174	92092279	HP1000WCU con motor/CUMMINS N14			ACEITE, DOBLE FLUJO	GP-3000	35378546
COMBUSTIBLE, SECUNDARIO	G-1175	92092287	COMBUSTIBLE	GP-1101	91671743	AGUA	GP-2071W	35375914
AIRE, SECUNDARIO	GA-6127	35109271	ACEITE, FLUJO TOTAL (FULL FLOW)	GP-53	35357243	I85 con motor/JOHN DEERE 4045		
AIRE, PRIMARIO	GA-6129	35109263	ACEITE, DERIVACION (BY PASS)	GP-57	35357250	COMBUSTIBLE	GPP-418	RE62418
DXL900 con motores/A DIESEL, DETROIT DIESEL			COMBUSTIBLE, SEPARADOR DE AGUA	GPP-11	35357268	JET CUTTER con motor/CUMMINS 48TA 3.9		
AIRE	GA-6127	35109271	ACEITE, DOBLE FLUJO	GP-3000	35378546	COMBUSTIBLE	GP-1122	35292366
ECM490 con motor/CUMMINS			AGUA	GP-2071W	35375914	COMBUSTIBLE, PRIMARIO	GPP-18	35374669
COMBUSTIBLE, SECUNDARIO	GP-1122	35292366	HP300WCU con motor/CUMMINS 3.9L			ACEITE	GP-390	35374651
ACEITE, DOBLE FLUJO	GP-3000	35378546	COMBUSTIBLE, SECUNDARIO	GP-1122	35292366	L1200 con motor/GMC 12V-71		
COMBUSTIBLE, PRIMARIO	GPP-18	35374669	COMBUSTIBLE, SEPARADOR DE AGUA	GPP-1122	92100981	ACEITE, FLUJO TOTAL (FULL FLOW)	G-33	595075568
AIRE, PRIMARIO MOTOR	GA-251	35355395	COMBUSTIBLE, PRIMARIO	GPP-18	35374669	AIRE, SECUNDARIO	GA-6127	35109271
ECM580 con motor/CUMMINS C5.9L			ACEITE	GP-390	35374651	AIRE, PRIMARIO	GA-6129	35109271
COMBUSTIBLE, SECUNDARIO	GP-1122	35292366	HP300WCU con motor/CUMMINS B3.9			L900 con motor/DETROIT DIESEL		
COMBUSTIBLE, SEPARADOR DE AGUA	GPP-1122	92100981	AIRE	GAK-625	35326230	AIRE	GA-6127	35109271
COMBUSTIBLE, PRIMARIO	GPP-18	35374669	HP355 con motor/PERKINS 1004.4TW			L900 con motores/GMC 6-110, GMC 8V-71		
ACEITE	GP-178	3914395	ACEITE	GP-31	2254347	ACEITE, DERIVACION (BY PASS)	G-31	557245
ECM590 con motor/CUMMINS 8.3L			HP600WCU con motor/CUMMINS 8.3L			ACEITE, FLUJO TOTAL (FULL FLOW)	G-33	595075568
COMBUSTIBLE, SECUNDARIO	GP-1122	35292366	COMBUSTIBLE, SECUNDARIO	GP-1122	35292366	COMBUSTIBLE	G-1174	92092279
ACEITE, DOBLE FLUJO	GP-3000	35378546	COMBUSTIBLE, SEPARADOR DE AGUA	GPP-1122	92100981	COMBUSTIBLE, SECUNDARIO	G-1175	92092287
COMBUSTIBLE, PRIMARIO	GPP-18	35374669	ACEITE, FLUJO TOTAL (FULL FLOW)	GP-43	35330901	M45 con motor/DEUTZ		
COMBUSTIBLE, SEPARADOR DE AGUA	GPP-1287	R60P	ACEITE, DOBLE FLUJO	GP-3000	35378546	HIDRAULICO	GP-66	92118678
GR150 con motor/CONTINENTAL G157								
COMBUSTIBLE, SECUNDARIO	G-1173	HD260F3340						

MARCA-MODELO-MOTOR MAKE-MODEL-ENGINE	GONHER GONHER	OEM OEM	MARCA-MODELO-MOTOR MAKE-MODEL-ENGINE	GONHER GONHER	OEM OEM	MARCA-MODELO-MOTOR MAKE-MODEL-ENGINE	GONHER GONHER	OEM OEM
INGERSOLL-RAND (continuación)			INGERSOLL-RAND (continuación)			INGERSOLL-RAND (continuación)		
COMPRESORES			COMPRESORES			COMPRESORES		
P100 con motor/DEUTZ F9L912			P125AWJD, P125WJD con motor/JOHN DEERE			COMBUSTIBLE	G-295	35308048
ACEITE	GP-54	A1H4123	ACEITE, LUBRICACION DE MOTOR	GP-14	35308030	AIRE DEL COMPRESOR	GAK-1532	36876423
P100 con motor/JOHN DEERE 3179			P125AWW con motor/A DIESEL			P160CWJD con motor/JOHN DEERE		
ACEITE	GP-14	35308030	ACEITE, LUBRICACION DE MOTOR	GP-1	35303692	ACEITE, LUBRICACION DE MOTOR	GP-14	35308030
P100AWD con motor/A DIESEL			P125BWJD con motor/JOHN DEERE 3029D			P160DWJD, P175DWJD con motor/JOHN DEERE 3029D		
ACEITE	GP-28	35336163	ACEITE, LUBRICACION DE MOTOR	GP-14	35308030	ACEITE, LUBRICACION DE MOTOR	GP-14	35308030
P100AWW, P100AWWU con motor/A DIESEL			P125BWW, P125WW con motor/A DIESEL			P160WFU, P175WFU con motor/A DIESEL		
ACEITE, LUBRICACION DE MOTOR	GP-1	35303692	ACEITE, LUBRICACION DE MOTOR	GP-1	35303692	ACEITE, LUBRICACION DE MOTOR	GP-1	35366681
P100BWD con motor/A DIESEL			P125DWD, P125EWD, P125FWD con motores/DEUTZ F3L1011, DEUTZ F3M1011F			AIRE DEL COMPRESOR	GAK-1532	36876423
ACEITE	GP-28	35336163	ACEITE, LUBRICACION DE MOTOR	GP-28	92793223	GASOLINA	GG-5	35366699
P100BWF, P100WFU, P125BWF con motor/A GASOLINA			COMBUSTIBLE	GPP-1122	92100981	GASOLINA	GG-5 L	35366699
ACEITE, LUBRICACION DE MOTOR	GP-1	35366681	AIRE DEL COMPRESOR	GAK-1532	36876423	P175 con motor/DEUTZ		
AIRE DEL COMPRESOR	GAK-1532	36876423	P125WF con motor/A GASOLINA			ACEITE	GP-54	35292358
GASOLINA	GG-5	35366699	ACEITE, LUBRICACION DE MOTOR	GP-1	35366681	COMBUSTIBLE	GP-1122	1660243
GASOLINA	GG-5 L	35366699	GASOLINA	GG-5	35366699	AIRE	GAK-1532	P119538
P100BWW con motor/A DIESEL			GASOLINA	GG-5 L	35366699	P175 con motor/JOHN DEERE 3179D		
ACEITE, LUBRICACION DE MOTOR	GP-1	35303692	P125WFU con motor/A GASOLINA			ACEITE	GP-14	35308030
P100CWD con motor/A DIESEL			ACEITE	GP-1	35366681	P175BWJD con motor/JOHN DEERE		
ACEITE	GP-28	35336163	AIRE	GAK-1532	36876423	ACEITE, LUBRICACION DE MOTOR	GP-14	35308030
P100DWD, P100EWD, P100FWD con motores/DEUTZ F3L1011, DEUTZ F3M1011F			GASOLINA	GG-5	35366699	COMBUSTIBLE	G-295	35308048
ACEITE, LUBRICACION DE MOTOR	GP-28	92793223	GASOLINA	GG-5 L	35366699	AIRE DEL COMPRESOR	GAK-1532	36876423
COMBUSTIBLE	GPP-1122	92100981	P130AWJD con motor/JOHN DEERE			P175CWJD con motor/JOHN DEERE		
AIRE DEL COMPRESOR	GAK-1532	36876423	ACEITE, LUBRICACION DE MOTOR	GP-14	35308030	ACEITE, LUBRICACION DE MOTOR	GP-14	35308030
P100SD, P100WDU con motor/A DIESEL			COMBUSTIBLE	G-295	35308048	P175W con motor/DEUTZ F3L912		
COMBUSTIBLE	GPP-1122	92100981	AIRE DEL COMPRESOR	GAK-1532	36876423	ACEITE, LUBRICACION DE MOTOR	GP-54	1173430
P100WD con motor/DEUTZ F2L511D			P130CWJD con motor/JOHN DEERE			COMBUSTIBLE	GP-1122	1660243
ACEITE	GP-28	92793223	ACEITE, LUBRICACION DE MOTOR	GP-14	35308030	AIRE	GAK-1532	P119538
P100WF, P125AWF con motor/A GASOLINA			P130DWD con motor/JOHN DEERE			P175WW, P175WWU, P185WW con motor/A DIESEL		
ACEITE, LUBRICACION DE MOTOR	GP-1	35366681	ACEITE, LUBRICACION DE MOTOR	GP-14	35308030	ACEITE, LUBRICACION DE MOTOR	GP-1	35303692
GASOLINA	GG-5	35366699	P130WJD con motor/JOHN DEERE			P185 con motor/JOHN DEERE 4239		
GASOLINA	GG-5 L	35366699	ACEITE, LUBRICACION DE MOTOR	GP-14	35308030	ACEITE	GP-14	35308030
P100WJD con motor/JOHN DEERE 3029			P130WD con motor/DEUTZ F3M1011F			COMBUSTIBLE	G-295	35308048
ACEITE, LUBRICACION DE MOTOR	GP-14	35308030	ACEITE, LUBRICACION DE MOTOR	GP-28	92793223	AIRE	GAK-1532	35291970
P100WW, P100WWU con motor/A DIESEL			COMBUSTIBLE	GPP-1122	92100981	P185AWJD con motor/JOHN DEERE		
ACEITE, LUBRICACION DE MOTOR	GP-1	35303692	AIRE DEL MOTOR	GAK-1532	36876423	ACEITE, LUBRICACION DE MOTOR	GP-14	35308030
P110AWD con motor/A DIESEL			P130WJD con motor/JOHN DEERE			COMBUSTIBLE	G-295	35308048
ACEITE	GP-28	35336163	ACEITE, LUBRICACION DE MOTOR	GP-14	35308030	AIRE, PRIMARIO	GAK-1532	59567255
P110BWD, P110CWD con motor/A DIESEL			P150WW con motor/A DIESEL			P185W con motor/JOHN DEERE 4239		
ACEITE	GP-28	35336163	ACEITE, LUBRICACION DE MOTOR	GP-1	35303692	ACEITE	GP-14	35308030
P125 con motor/JOHN DEERE			P160 con motor/JOHN DEERE 3179D			COMBUSTIBLE	G-295	35308048
ACEITE	GP-14	92092279	ACEITE	GP-14	35308030	AIRE	GAK-1532	35291970
			P160BWJD con motor/JOHN DEERE			P185WJD con motor/JOHN DEERE 4045D POWER TECH		
			ACEITE, LUBRICACION DE MOTOR	GP-14	35308030	ACEITE, LUBRICACION DE MOTOR	GP-754	36881696

SERVICIO PESADO

MARCA-MODELO-MOTOR MAKE-MODEL-ENGINE	GONHER GONHER	OEM OEM	MARCA-MODELO-MOTOR MAKE-MODEL-ENGINE	GONHER GONHER	OEM OEM	MARCA-MODELO-MOTOR MAKE-MODEL-ENGINE	GONHER GONHER	OEM OEM		
INGERSOLL-RAND (continuación)			INGERSOLL-RAND (continuación)			INGERSOLL-RAND (continuación)				
COMPRESORES			COMPRESORES			COMPRESORES				
P185WJD con motor/JOHN DEERE 4219			T4-VHP1050 con motor/CATERPILLAR 3412			XL750 con motor/CATERPILLAR 3406				
ACEITE, LUBRICACION DE MOTOR	GP-14	35308030	COMBUSTIBLE	GP-749	1R0749	ACEITE, CUMPLE CON MEDI-DAS ORIGINALES	GP-691	1R0716		
COMBUSTIBLE	G-295	35308048	ACEITE, REQUIERE 2 PIEZAS	GP-52	1R0716	ACEITE, SEGUNDA OPCION	GP-52	1R0716		
AIRE	GAK-1532	59567255	AIRE, PRIMARIO	GA-563	52146958	COMBUSTIBLE	GP-110	1R-0749		
P250 con motor/DEUTZ F4L912			VHP1050 con motor/CATERPILLAR 3412			AGUA			GP-1011Q	36868156
ACEITE	GP-54	35292358	ACEITE, CUMPLE CON MEDI-DAS ORIGINALES	GP-691	92036219	XL750 con motor/GMC 8V-71N				
P250BWJD, P250CWJD con motor/JOHN DEERE 4045D			ACEITE, SEGUNDA OPCION	GP-52	92036219	ACEITE	G-33	595075568		
ACEITE, LUBRICACION DE MOTOR	GP-754	36881696	COMBUSTIBLE	GP-110	59534669	COMBUSTIBLE, PRIMARIO	GP-26	91786129		
P250WCU con motor/CUMMINS 3.9L			AGUA	GP-1011Q	36868156	COMBUSTIBLE, SECUNDARIO	GP-27	91786167		
COMBUSTIBLE, SECUNDARIO	GP-1122	35292366	AIRE	GA-356	P181039	XL850 con motor/DETROIT DIESEL				
COMBUSTIBLE, SEPARADOR DE AGUA	GPP-1122	92100981	AIRE	GA-357	P119159	AIRE, SECUNDARIO	GA-6127	35109271		
COMBUSTIBLE, PRIMARIO	GPP-18	35374669	VHP1050T5VHP con motor/CATERPILLAR 3412			XL900 con motor/A DIESEL				
ACEITE	GP-390	35374651	ACEITE, CUMPLE CON MEDI-DAS ORIGINALES	GP-691	92036219	ACEITE	G-33	595075568		
P250WCU con motor/CUMMINS B3.9			ACEITE, SEGUNDA OPCION	GP-52	92036219	COMBUSTIBLE, PRIMARIO	GP-26	91786129		
AIRE	GAK-625	35326230	COMBUSTIBLE	GP-110	59534669	COMBUSTIBLE, SECUNDARIO	GP-27	91786167		
P375 con motor/DEUTZ F6L912			AGUA	GP-1011Q	35357276	AIRE, SECUNDARIO	GA-6127	35109271		
AIRE	GAK-625	35326230	AIRE	GA-356	P181039	AIRE, PRIMARIO	GA-6129	35109263		
P375WCU con motor/CUMMINS 3.9			AIRE	GA-357	P119159	XP1000WCU con motor/CUMMINS N14				
COMBUSTIBLE, SECUNDARIO	GP-1122	35292366	VHP400 con motor/DEUTZ			COMBUSTIBLE	GP-1101	91671743		
COMBUSTIBLE, SEPARADOR DE AGUA	GPP-1122	35374677	COMBUSTIBLE	GP-1122	35292366	ACEITE, FLUJO TOTAL (FULL FLOW)	GP-53	35357243		
COMBUSTIBLE, PRIMARIO	GPP-18	35374669	HIDRAULICO	GP-66	92118678	ACEITE, DERIVACION (BY PASS)	GP-57	35357250		
ACEITE	GP-390	35374651	AGUA	GP-2071W	35312396	COMBUSTIBLE, SEPARADOR DE AGUA	GPP-11	35357268		
P375WD con motor/DEUTZ F6L912			AIRE	GA-405	92686948	ACEITE, DOBLE FLUJO	GP-3000	35378546		
ACEITE	GP-54	1173430	VHP600WCU con motor/CUMMINS 6CTA8.3			AGUA	GP-2071W	35375914		
P375WJD con motor/JOHN DEERE 4045T			COMBUSTIBLE, SECUNDARIO	GP-1122	35374677	XP1400 con motor/DETROIT DIESEL 8V-92T				
ACEITE	GP-14	35308030	AGUA	GP-1011Q	36868156	COMBUSTIBLE, PRIMARIO	GP-26	91786129		
COMBUSTIBLE, 5 3/16 IN	GPP-418	RE62418	ACEITE	GP-3000	35378546	COMBUSTIBLE, SECUNDARIO	GP-27	91786167		
COMBUSTIBLE, 5 15/16 IN	GPP-419	RE62419	COMBUSTIBLE, PRIMARIO	GPP-18	35374669	ACEITE	GP-53	25014214		
PB4 con motor/CATERPILLAR			AIRE, PRIMARIO	GA-251	36867786	AIRE, PRIMARIO	GA-563	P128407		
ACEITE	GP-51	92658095	VHP600WJD con motor/JOHN DEERE 6076A			XP1400WCU, XP1600WCU con motor/CUMMINS N14				
PD125 EWD con motores/DEUTZ F3L1011, DEUTZ F3M1011F			ACEITE	GP-35	36870038	COMBUSTIBLE	GP-1101	91671743		
ACEITE	GP-28	92793223	VHP900 con motor/CATERPILLAR 3406B			ACEITE, FLUJO TOTAL (FULL FLOW)	GP-53	35357243		
COMBUSTIBLE	GPP-1122	92100981	AIRE	GA-251	36867786	ACEITE, DERIVACION (BY PASS)	GP-57	35357250		
AIRE	GAK-1532	36876423	VR60B, VR70B, VR90B con motor/PERKINS 1004.4			COMBUSTIBLE, SEPARADOR DE AGUA	GPP-11	35357268		
PI272 con motor/DETROIT DIESEL 16V4000			ACEITE	GP-31	2254347	ACEITE, DOBLE FLUJO	GP-3000	35378546		
ACEITE	GP-754	36881696	XHP750 con motor/CATERPILLAR			AGUA	GP-2071W	353759914		
PT125R con motor/JOHN DEERE 4329			ACEITE	GP-51	92658095	XP250WCU con motor/CUMMINS LT10				
ACEITE	GP-14	35308030	XHP900 con motor/CATERPILLAR 3406B			AIRE	GA-251	35355395		
COMBUSTIBLE	GPP-418	RE62418	ACEITE, CUMPLE CON MEDI-DAS ORIGINALES	GP-691	1R0716	XP600WCU con motor/CUMMINS LT10				
AIRE, PRIMARIO	GAK-1532	59567255	ACEITE, SEGUNDA OPCION	GP-52	1R0716	ACEITE, FLUJO TOTAL (FULL FLOW)	GP-53	35357243		
SP48 con motor/GMC 4-71N			COMBUSTIBLE	GP-1108	1R-0712	ACEITE, DERIVACION (BY PASS)	GP-57	35357250		
ACEITE	G-33	595075568	AGUA	GP-1011Q	9N3718	COMBUSTIBLE, SEPARADOR DE AGUA	GPP-11	35357268		
COMBUSTIBLE, SECUNDARIO	G-1173	5178782	AIRE, PRIMARIO	GA-251	35355395	AGUA	GP-1011Q	35357276		
COMBUSTIBLE	G-1174	92092279	XL1050 con motor/DETROIT DIESEL 12V-71N			AIRE, PRIMARIO	GA-251	35355395		
SRB125 con motor/GMC 2-53			XL1100 con motor/DETROIT DIESEL			XP1400WCU, XP1600WCU con motor/CUMMINS N14				
ACEITE	G-119	58148693	AIRE, SECUNDARIO	GA-6127	35109271	COMBUSTIBLE	GP-1101	91671743		
COMBUSTIBLE, SECUNDARIO	G-1173	5178782	XL1100 con motor/GMC			ACEITE, FLUJO TOTAL (FULL FLOW)	GP-53	35357243		
COMBUSTIBLE	G-1174	92092279	AIRE	GA-679	8994607	ACEITE, DERIVACION (BY PASS)	GP-57	35357250		

MARCA-MODELO-MOTOR GONHER OEM
MAKE-MODEL-ENGINE GONHER OEM

INGERSOLL-RAND (continuación)

COMPRESORES

XP750 con motor/DETROIT DIESEL 6V-71N
AIRE, SECUNDARIO GA-6127 35109271

XP750A con motor/DETROIT DIESEL 6V-71N
COMBUSTIBLE, PRIMARIO GP-26 91786129
COMBUSTIBLE, SECUNDARIO GP-27 91786167
ACEITE GP-43 35357243

XP750WCU con motor/CUMMINS 6CTA8.3
COMBUSTIBLE, SECUNDARIO GP-1122 35374677
AGUA GP-1011Q 36868156
ACEITE GP-3000 35378546
COMBUSTIBLE, PRIMARIO GPP-18 35374669
AIRE, PRIMARIO GA-251 36867786

XP750WCU, XP825WCU con motor/CUMMINS 8.3L
COMBUSTIBLE, SECUNDARIO GP-1122 35374677
COMBUSTIBLE, SEPARADOR DE AGUA GPP-1122 92100981
ACEITE, FLUJO TOTAL (FULL FLOW) GP-43 35330901
ACEITE, DOBLE FLUJO GP-3000 35378546
COMBUSTIBLE, PRIMARIO GPP-18 35374669

XP750WJD con motor/JOHN DEERE 6076A
ACEITE GP-35 36870038

XP825WCU con motor/CUMMINS LT10
ACEITE GP-53 35357243
ACEITE, DERIVACION (BY PASS) GP-57 35357250
COMBUSTIBLE, SEPARADOR DE AGUA GPP-11 35357268
AGUA GP-1011Q 35357276
ACEITE GP-3000 35378546
AIRE, PRIMARIO GA-251 35355395

XP900WCU con motor/CUMMINS LTA10
COMBUSTIBLE GP-1101 91671743
ACEITE, FLUJO TOTAL (FULL FLOW) GP-53 35357243
ACEITE, DERIVACION (BY PASS) GP-57 35357250
COMBUSTIBLE, SEPARADOR DE AGUA GPP-11 35357268
ACEITE, DOBLE FLUJO GP-3000 35378546
AGUA GP-2071W 353759914

INGERSOLL-RAND

EQUIPO PARA CONSTRUCCION VIAL

660W ASFALTADORA con motor/DEUTZ
AIRE GAK-16 59341560

780T ASFALTADORA, 780W ASFALTADORA con motor/CUMMINS 4BTA3.9
COMBUSTIBLE, SECUNDARIO GP-1122 59765511
COMBUSTIBLE, PRIMARIO GPP-18 35374669
ACEITE GP-390 35374651

780W ASFALTADORA con motor/JOHN DEERE 4039
ACEITE GP-14 35308030

880T ASFALTADORA, 910W ASFALTADORA, 880W ASFALTADORA, 910T ASFALTADORA con motor/CUMMINS 4BTA
COMBUSTIBLE, SECUNDARIO GP-1122 59765511
COMBUSTIBLE, PRIMARIO GPP-18 35374669
ACEITE GP-390 35374651

MARCA-MODELO-MOTOR GONHER OEM
MAKE-MODEL-ENGINE GONHER OEM

INGERSOLL-RAND

EXCAVADORAS

600 RETROEXCAVADORA con motor/A DIESEL
ACEITE G-33 595075568

INGERSOLL-RAND

GENERADORES

E20X con motor/JOHN DEERE 3179
ACEITE GP-14 35308030
COMBUSTIBLE G-295 35308048
AIRE, PRIMARIO GAK-1532 35291970

E30XWCU con motor/CUMMINS 4BT3.9
COMBUSTIBLE, SECUNDARIO GP-1122 35292366
COMBUSTIBLE, PRIMARIO GPP-18 35374669
ACEITE GP-390 35374651

E50XWCU con motor/CUMMINS 4BT3.9
COMBUSTIBLE, SECUNDARIO GP-1122 35374677
COMBUSTIBLE, PRIMARIO GPP-18 35374669
ACEITE GP-390 35374651

INGERSOLL-RAND

MONTACARGAS

RT705G, RT706G, RT708G con motor/CUMMINS 4B3.9L
COMBUSTIBLE, SECUNDARIO GP-1122 35292366
COMBUSTIBLE, PRIMARIO GPP-18 35374669
ACEITE GP-390 35374651

RT705G, RT706G, RT708G con motor/JOHN DEERE 4039D
ACEITE GP-14 35308030

VR843 con motor/CUMMINS
COMBUSTIBLE, SEPARADOR DE AGUA GPP-1122 92100981

INGERSOLL-RAND

TRACTORES PEQUEÑOS Y PARA JARDIN

1114 con motor/A GASOLINA
ACEITE GP-58 491056

1212G, 1212H con motor/A GASOLINA
GASOLINA GG-116 FGI146

1214 con motor/A GASOLINA
ACEITE GP-58 491056

220, 222, 224 con motor/KOHLER
AIRE GA-7 C28883

3012, 3014, 4014 con motor/KOHLER
GASOLINA GG-116 FGI146

3016PS, 4016PS con motor/ONAN 16 HP
ACEITE GP-58 C26191

3018PS, 4018PS con motor/ONAN 18 HP
ACEITE GP-58 C26191

3118, 4118 con motor/ONAN
ACEITE GP-58 C26191

4016 con motor/ONAN 16 HP
ACEITE GP-58 C26191

MARCA-MODELO-MOTOR GONHER OEM
MAKE-MODEL-ENGINE GONHER OEM

INGERSOLL-RAND (continuación)

TRACTORES PEQUEÑOS Y PARA JARDIN

4020PS con motor/ONAN 20 HP
ACEITE GP-58 C26191

4120 con motor/ONAN
ACEITE GP-58 491056

4444 con motor/KOHLER
AIRE GA-7 C28883

6018 con motor/ONAN 18 HP
ACEITE GP-58 C26191
HIDRAULICO GP-66 92118678
GASOLINA GG-116 FGI146

646 con motor/A GASOLINA
ACEITE GP-58 C25402

810 con motor/A GASOLINA
GASOLINA GG-116 FGI146

ISUZU

CAMIONES, TRACTOCAMIONES Y AUTOBUSES

ELF 300 con motor/ISUZU L4 3.0L DI DOHC (4J11-TC)
COMBUSTIBLE G-179 8-98037-011-0
ACEITE G-3753 8-98018-858-0
AIRE GA-633R 8970622940

ELF 400/450 con motor/ISUZU 4HK1-TC
COMBUSTIBLE GPP-111 8-94483-850-0
ACEITE GP-359 2-90654-800-0
COMBUSTIBLE GPP-524 8-94483-850-0
AIRE GA-633R 8970622940

ELF250 con motor/ISUZU 4HK1
DIESEL, (4/99 EN ADELANTE) GPP-111 8-94369-299-3

EVR con motor/ISUZU 6SA1
ACEITE GP-57 1-13240-163-2

FRR con motor/ISUZU 6-7.8L DIESEL
TRANSMISION GP-9586 1-32569-021-0

FRR con motor/ISUZU 6BD1T
TRANSMISION GP-9586 LF3342

FRR con motores/ISUZU 6HE1, ISUZU 6HK1-TCN DIESEL
TRANSMISION GP-9586 1-32569-021-0

FSR con motor/ISUZU 6HE1-TC DIESEL
TRANSMISION GP-9586 8-25011-159-0
AIRE GA-930R 8-12471-801-0
COMBUSTIBLE S 3202 8-15618-921-0

FSR con motores/ISUZU 6HK1-TCN DIESEL, ISUZU 6HK1-TCS DIESEL
TRANSMISION GP-9586 8-25011-122-0
AIRE, PRIMARIO GA-930R 8-12471-801-0
AIRE, SECUNDARIO GA-890R 8-12473-086-0
COMBUSTIBLE S 3202 8-15618-921-0

FSR, FTR con motor/ISUZU 6HK1-TC
TRANSMISION GP-9586 8-25011-122-0
AIRE GA-930R 8-12471-801-0
COMBUSTIBLE S 3202 8-15618-921-0

SERVICIO PESADO

MARCA-MODELO-MOTOR	GONHER	OEM
MAKE-MODEL-ENGINE	GONHER	OEM

ISUZU (continuación)

CAMIONES, TRACTOCAMIONES Y AUTOBUSES

FTR con motor/ISUZU 6HE1-TC		
TRANSMISION	GP-9586	8-25011-159-0
AIRE	GA-930R	8-12471-801-0
COMBUSTIBLE	S 3202	8-15618-921-0
FTR, FVR con motor/ISUZU 6HE1-TCN		
TRANSMISION	GP-9586	8-25011-159-0
FTR, FVR con motores/ISUZU 6HK1-TCN DIESEL, ISUZU 6HK1-TCS DIESEL		
TRANSMISION	GP-9586	8-25011-159-0
AIRE, PRIMARIO	GA-930R	8-12471-801-0
AIRE, SECUNDARIO	GA-890R	8-12473-086-0
COMBUSTIBLE	S 3202	8-15618-921-0
FVR con motor/ISUZU 6HE1T (7.1L)		
ACEITE	GP-57	1-13240-067-0
FVR con motor/ISUZU 6HE1-TC		
COMBUSTIBLE	S 3202	8-15618-921-0
FVR con motor/ISUZU 6HK1-TC		
AIRE, PRIMARIO	GA-930R	8-12471-801-0
AIRE, SECUNDARIO	GA-890R	8-12473-086-0
COMBUSTIBLE	S 3202	8-15618-921-0
FVR con motor/ISUZU 6SA1		
ACEITE	GP-57	1-13240-163-2
FXR con motor/ISUZU 6HK1-TC		
AIRE	GA-930R	8-12471-801-0
NKS58GR con motor/ISUZU 4BE1 (1988-94)		
COMBUSTIBLE, SEPARADOR DE AGUA	GPP-111	8943692993
NPR con motor/4 CIL. 5.2L TURBO DIESEL (4HK1TC)		
DIESEL	GPP-111	8-94483-850-0
ACEITE	GP-359	2-90654-600-0
DIESEL, SEGUNDA OPCION	GPP-524	8-94483-850-0
TRANSMISION (2004 EN ADELANTE)	GP-3569	97182282
AIRE, SOLAMENTE MODELOS CON CABINA REGULAR	GA-633R	8970622940
NPR con motor/GMC 5.7L		
ACEITE	GP-13	8-06438-384-0
ACEITE	GP-205	8-25014-831-0
AIRE	GA-59	8-06484-235-0
GASOLINA	GG-46	8-25055-052-0
NPR con motor/GMC 6.0L		
ACEITE	GP-44	8-25010-633-0
NPR con motor/ISUZU 4.8L		
ACEITE	GP-359	2-90654-600-0
NPR con motor/ISUZU 4BD1T		
ACEITE	GP-58	8-94463-715-0
NPR con motor/ISUZU 4BD-T 3.9L		
ACEITE, DERIVACION (BY PASS)	GP-50	8-94360-419-1
NPR con motor/ISUZU 4HE1		
ACEITE	GP-359	2-90654-800-0

MARCA-MODELO-MOTOR	GONHER	OEM
MAKE-MODEL-ENGINE	GONHER	OEM

ISUZU (continuación)

CAMIONES, TRACTOCAMIONES Y AUTOBUSES

NPR HD con motor/4 CIL. 5.2L TURBO DIESEL (4HK1TC)		
TRANSMISION	GP-3569	97182282
NPR HD con motor/V8 6.0L GASOLINA		
ACEITE, 2008 EN DELANTE	GP-406	89017-524
TRANSMISION	GP-3569	8-97182-282-0
ACEITE, 2003-2007	GP-44	8-88984-215-0
NPS con motor/ISUZU 4BD1T		
ACEITE	GP-1	8-94169-778-2
NQR con motor/ISUZU 4.8L		
ACEITE	GP-359	2-90654-600-0
NQR, NRR con motor/ISUZU 4HK1 DIESEL, (2004-07)		
ACEITE	GP-359	2-90654-600-0
DIESEL, (2004-07) SEGUNDA OPCION	GPP-524	94369299
TRANSMISION (2004 EN ADELANTE)	GP-3569	97182282
NRR con motor/ISUZU 6BG1		
TRANSMISION	GP-9586	1-32569-021-0
TROOPER UBS69 con motor/ISUZU 4JG2T (1992-94)		
COMBUSTIBLE, SEPARADOR DE AGUA	GPP-111	8943692993
W4 con motor/DIESEL		
TRANSMISION, SELLADO (1988-98)	GP-3569	2-90654-010-0
W5 con motor/DIESEL		
TRANSMISION, SELLADO (2008 EN ADELANTE)	GP-3569	8-97182-282-0

ISUZU

MOTORES

111 A DIESEL, QD145T A DIESEL		
AIRE	GAK-403	1142150280
2AB1 A DIESEL, 3AB1 A DIESEL, QD27 A DIESEL, QD40 A DIESEL		
ACEITE	GP-171	H132011
3KC1 A DIESEL		
ACEITE	GP-6811	L14459
4BB1 A DIESEL, 4BD1 (3.9L) A DIESEL, 4BD1-PW A DIESEL, 4BD1T (3.9L) AUTOMOTRIZ, C240 (2.4L) A DIESEL, QD100 A DIESEL, QD100T AUTOMOTRIZ, QD60 A DIESEL, QD90 A DIESEL		
ACEITE	GP-1	13201-2
4BD1T (3.9L) INDUSTRIAL, QD100T INDUSTRIAL		
ACEITE, DERIVACION (BY PASS)	GP-50	11322400890
4FB1 A DIESEL		
ACEITE	GP-3985	8941673990
4HK1 A DIESEL		
DIESEL, (2004-07)	GPP-111	94369299
4LC1		
AIRE, RADIAL PRIMARIO	GA-880R	P821575

MARCA-MODELO-MOTOR	GONHER	OEM
MAKE-MODEL-ENGINE	GONHER	OEM

ISUZU (continuación)

MOTORES

4LE1 (2.2L)		
ACEITE	GP-149	8-94456-741-1
6BB1 (5.8L), 6BD1 (5.8L), QD130 A DIESEL, QD145 A DIESEL		
ACEITE	GP-10	X-13201-006
6RB1T TOMA DE FUERZA (13.7L)		
AIRE, SIN ASPAS	GA-27	P182000
D381 A DIESEL		
ACEITE	GP-57	132400421
DA120 A DIESEL, DA220 A DIESEL		
COMBUSTIBLE	G-1123	FF5228
QT23 A DIESEL		
ACEITE	GP-91	8941494180
QT35 A DIESEL		
ACEITE	GP-91	8941494180
AIRE, SIN ASPAS	GA-33	5-14215-014-0
AIRE	GAK-16	5-14215011-0

IVECO

MOTORES

NEF45 SM2		
AIRE, PRIMARIO	GA-853R	8041642
NEF45 TM1X		
AIRE	GA-697R	8041322
NEF67 TE2X		
ACEITE	GP-737	2992242

JCB (J.C. BAMFORD)

CAMIONES, TRACTOCAMIONES Y AUTOBUSES

15 DE VOLTEO, 22-1/2CWT DE VOLTEO con motor/PETTER PH1		
ACEITE	G-816	32/300801
15 DE VOLTEO, JCB10 DE VOLTEO, 22-1/2 DE VOLTEO, 30CWT DE VOLTEO con motor/PETTER AC1		
GASOLINA	GG-48	51246
30CWT DE VOLTEO con motor/PETTER PH2		
ACEITE	G-870	988/00038
712 DE VOLTEO ARTICULADO (YA SERIES) con motor/A DIESEL		
ACEITE	GP-31	02/100073
COMBUSTIBLE	G-296	32/400701
COMBUSTIBLE	G-296-B	32/400701
HIDRAULICO SELLADO	GP-761H	32/905501
716 DE VOLTEO ARTICULADO (YB SERIES) con motor/A DIESEL		
COMBUSTIBLE	G-296	32/400701
COMBUSTIBLE	G-296-B	32/400701
HIDRAULICO SELLADO	GP-761H	32/905501
718 DE VOLTEO con motor/CUMMINS 5.9 L		
COMBUSTIBLE, SECUNDARIO	GP-1122	02/910155
JCB10 DE VOLTEO con motor/PETTER PH1		
ACEITE	G-816	32/300801

MARCA-MODELO-MOTOR GONHER OEM
MAKE-MODEL-ENGINE GONHER OEM

JCB (J.C. BAMFORD) (continuación)

CAMIONES, TRACTOCAMIONES Y AUTOBUSES

JCB10 DE VOLTEO con motor/PETTER PH2
ACEITE G-870 988/00038

Z7 ARTICULADO, Z8 ARTICULADO con motor/A GASOLINA
GASOLINA GG-48 51246

JCB (J.C. BAMFORD)

CARGADORAS

110 SOBRE ORUGAS, 110B SOBRE ORUGAS, 110C SOBRE ORUGAS con motor/A DIESEL

ACEITE GP-31 02/100073
COMBUSTIBLE G-296 32/400701
COMBUSTIBLE G-297 32/400502
COMBUSTIBLE G-296-B 32/400701
COMBUSTIBLE G-297-B 32/400502
AIRE, SIN ASPAS GA-403 32/200406
AIRE GAK-403 32/200406
AIRE GA-360 32/201602
AIRE GA-361 32/202501

1110T SERIES II con motor/A DIESEL
AIRE, RADIAL PRIMARIO GA-853R 32/915701

1250 con motor/PERKINS 6.354
ACEITE, CARTUCHO G-834 1531639
ACEITE, SELLADO GP-31 02/100073
COMBUSTIBLE G-296 32/400701
COMBUSTIBLE G-296-B 32/400701

1500, 2000 con motor/LEYLAND 6.80
COMBUSTIBLE G-296 32/400701

1550 RETROEXCAVADORA con motor/PERKINS
ACEITE, CARTUCHO G-870 988/00038
COMBUSTIBLE G-296 32/400701
ACEITE, SELLADO GP-28 02/301217
COMBUSTIBLE G-297 32/400502
COMBUSTIBLE G-296-B 32/400701
COMBUSTIBLE G-297-B 32/400502
ACEITE, SELLADO GP-171 02/100284
TRANSMISION GP-171 02/100284
AIRE, PRIMARIO GAK-216 32/203702
AIRE, SECUNDARIO GA-416 32/203703

1700 RETROEXCAVADORA con motor/A DIESEL
ACEITE, CARTUCHO G-870 988/00038
COMBUSTIBLE G-296 32/400701
ACEITE, SELLADO GP-28 02/301217
COMBUSTIBLE G-297 32/400502
COMBUSTIBLE G-296-B 32/400701
COMBUSTIBLE G-297-B 32/400502
ACEITE, SELLADO GP-171 02/100284
TRANSMISION GP-171 02/100284
AIRE, PRIMARIO GAK-216 32/203702
AIRE, SECUNDARIO GA-416 32/203703

1700B RETROEXCAVADORA con motor/PERKINS TURBO
ACEITE G-871 988/00038
ACEITE GP-1 02/100284
ACEITE GP-31 02/100073
COMBUSTIBLE G-296 32/400701
COMBUSTIBLE G-296-B 32/400701

1750 con motor/LEYLAND UE 400
COMBUSTIBLE G-296 32/400701

MARCA-MODELO-MOTOR GONHER OEM
MAKE-MODEL-ENGINE GONHER OEM

JCB (J.C. BAMFORD) (continuación)

CARGADORAS

1CX RETROEXCAVADORA con motor/PEUGEOT 1.9L DIESEL
COMBUSTIBLE G-296 32/400701

200 SERIES RETROEXCAVADORA con motor/A DIESEL
COMBUSTIBLE G-297 32/400502
COMBUSTIBLE G-297-B 32/400502
ACEITE GP-171 02/100284
TRANSMISION GP-171 02/100284

208S con motor/PERKINS
COMBUSTIBLE G-296 32/400701

208S RETROEXCAVADORA con motor/A DIESEL
COMBUSTIBLE G-296 32/400701
COMBUSTIBLE G-296-B 32/400701
HIDRAULICO GP-761H 32/909200

208SHF RETROEXCAVADORA con motor/A DIESEL
COMBUSTIBLE G-296 32/400701

210 con motor/PERKINS
COMBUSTIBLE GPP-1122 32/912001

210S RETROEXCAVADORA con motor/A DIESEL
COMBUSTIBLE G-296 32/401102
ACEITE GP-3600 02/130142
COMBUSTIBLE G-296-B 32/401102
ACEITE GP-171 02/100284
TRANSMISION GP-171 02/100284

210S, 210SL, 210SU con motor/PERKINS 1004.4
COMBUSTIBLE G-296 32/400701
COMBUSTIBLE GPP-1122 32/912001

COMBUSTIBLE G-297 32/400502
ACEITE GP-3600 02/130142
COMBUSTIBLE G-296-B 32/400701
COMBUSTIBLE G-297-B 32/400502
HIDRAULICO GP-761H 32/905501

210SL RETROEXCAVADORA con motor/PERKINS
ACEITE GP-1 02/100284
COMBUSTIBLE G-296 32/400701
COMBUSTIBLE GP-1122 32/912101
COMBUSTIBLE G-297 32/400502
COMBUSTIBLE G-296-B 32/400701
COMBUSTIBLE G-297-B 32/400502

210SL RETROEXCAVADORA con motor/PERKINS TURBO
ACEITE GP-31 02/100073
COMBUSTIBLE G-296 32/400701
COMBUSTIBLE GP-1122 32/912101
COMBUSTIBLE G-297 32/400502
COMBUSTIBLE G-296-B 32/400701
COMBUSTIBLE G-297-B 32/400502

210SU RETROEXCAVADORA con motor/PERKINS
ACEITE GP-1 02/100284
COMBUSTIBLE G-296 32/400701
COMBUSTIBLE GP-1122 32/912101
COMBUSTIBLE G-297 32/400502
COMBUSTIBLE G-296-B 32/400701
COMBUSTIBLE G-297-B 32/400502

MARCA-MODELO-MOTOR GONHER OEM
MAKE-MODEL-ENGINE GONHER OEM

JCB (J.C. BAMFORD) (continuación)

CARGADORAS

210SU RETROEXCAVADORA con motor/PERKINS TURBO
ACEITE GP-31 02/100073
COMBUSTIBLE G-296 32/400701
COMBUSTIBLE GP-1122 32/912101
COMBUSTIBLE G-297 32/400502
COMBUSTIBLE G-296-B 32/400701
COMBUSTIBLE G-297-B 32/400502

212S SERIES II, 212SU SERIES II con motor/PERKINS
COMBUSTIBLE GPP-1122 32/912001

214 con motor/A DIESEL
ACEITE GP-31 02/100073
COMBUSTIBLE G-297 32/400502
COMBUSTIBLE G-297-B 32/400502

214S 2WD & 4WD RETROEXCAVADORA, 215 2WD & 4WD RETROEXCAVADORA, 215S 2WD & 4WD RETROEXCAVADORA, 217 2WD & 4WD RETROEXCAVADORA, 217S 2WD & 4WD RETROEXCAVADORA, 214E RETROEXCAVADORA con motor/A DIESEL
COMBUSTIBLE G-297 32/400502
COMBUSTIBLE G-297-B 32/400502
ACEITE GP-171 02/100073
TRANSMISION GP-171 02/100284

214S, 215 SERIES III, 215S SERIES III, 416B con motor/PERKINS
ACEITE GP-31 02/100073

215 SERIES II, 215S SERIES II con motor/PERKINS
ACEITE GP-31 02/100073

215E con motor/PERKINS 1004.40T
ACEITE GP-31 02/100073

217 SERIES III, 217S SERIES III con motor/PERKINS 1004.40T
ACEITE GP-1 02/100284

2CX RETROEXCAVADORA con motor/PERKINS 3.152
COMBUSTIBLE G-296 32/400701
ACEITE GP-3600 02/130142
COMBUSTIBLE G-296-B 32/400701

3000 con motor/A DIESEL
ACEITE G-870 988/00038
COMBUSTIBLE G-296 32/400701
COMBUSTIBLE G-296-B 32/400701

3CX RETROEXCAVADORA con motor/A DIESEL
ACEITE, CARTUCHO G-870 988/00038
COMBUSTIBLE G-296 32/400701
ACEITE GP-28 02/301217
COMBUSTIBLE G-297 32/400502
COMBUSTIBLE G-296-B 32/400701
COMBUSTIBLE G-297-B 32/400502
ACEITE, SELLADO GP-171 02/100284
TRANSMISION GP-171 02/100284
AIRE, PRIMARIO GAK-216 32/203702
AIRE, SECUNDARIO GA-416 32/203703

406 SOBRE RUEDAS ARTICULADO con motor/A DIESEL
COMBUSTIBLE G-296 32/400701
ACEITE GP-3600 02/130142
COMBUSTIBLE G-296-B 32/400701
TRANSMISION GP-171 02/100284
HIDRAULICO GP-761H 32/905501

SERVICIO PESADO

MARCA-MODELO-MOTOR MAKE-MODEL-ENGINE	GONHER GONHER	OEM OEM	MARCA-MODELO-MOTOR MAKE-MODEL-ENGINE	GONHER GONHER	OEM OEM	MARCA-MODELO-MOTOR MAKE-MODEL-ENGINE	GONHER GONHER	OEM OEM
JCB(J.C.BAMFORD)(continuación)			JCB(J.C.BAMFORD)(continuación)			JCB(J.C.BAMFORD)(continuación)		
CARGADORAS			CARGADORAS			CARGADORAS		
AIRE, PRIMARIO	GAK-216	32/203702	AIRE, PRIMARIO	GA-360	32/201602	435 con motor/PERKINS		
AIRE, SECUNDARIO	GA-416	32/203703	AIRE, SECUNDARIO	GA-361	32/202501	COMBUSTIBLE	G-296	32/400701
407 SOBRE RUEDAS con motor/A DIESEL			415 con motor/PERKINS 4.236			COMBUSTIBLE	G-296-B	32/400701
ACEITE	GP-1	02/100284	ACEITE	GP-1	02/100284	AIRE, PRIMARIO	GA-360	32/201602
COMBUSTIBLE	G-296	32/400701	COMBUSTIBLE	G-296	32/400701	AIRE, SECUNDARIO	GA-361	32/202501
COMBUSTIBLE	G-296-B	32/400701	COMBUSTIBLE	G-296-B	32/400701	450BM con motor/LISTER PETTER		
AIRE	GAK-216	32/203702	416 con motor/PERKINS			AIRE	GAK-1532	32/205702
AIRE	GA-416	32/203703	ACEITE	GP-31	02/100073	456B con motor/CUMMINS 8.3L		
407B, 409B SOBRE RUEDAS con motor/A DIESEL			COMBUSTIBLE	G-296	32/400701	COMBUSTIBLE, SECUNDARIO	GPP-1122	32/912001
COMBUSTIBLE, SECUNDARIO	GPP-1122	32/912001	COMBUSTIBLE	GPP-1122	32/912001	COMBUSTIBLE, SECUNDARIO	GPP-1122	32/912001
ACEITE	GP-3600	02/130142	COMBUSTIBLE	G-296-B	32/400701	4CX TURBO RETROEXCAVADORA con motor/PERKINS 1000		
TRANSMISION	GP-171	02/100284	416 TURBO RETROEXCAVADORA con motor/A DIESEL			ACEITE	GP-31	02/100073
408 RETROEXCAVADORA, 409 RETROEXCAVADORA con motor/A DIESEL			COMBUSTIBLE, S/N 527000-EU658592Y	G-296	32/400701	COMBUSTIBLE	G-297	32/400502
COMBUSTIBLE	G-296	32/400701	COMBUSTIBLE, S/N EU658593Y EN ADELANTE	G-297	32/400502	COMBUSTIBLE	G-297-B	32/400502
COMBUSTIBLE	G-296-B	32/400701	COMBUSTIBLE, S/N 527000-EU658592Y	G-296-B	32/400701	4CX TURBO SERVO PLUS RETROEXCAVADORA con motor/PERKINS 1000		
ACEITE	GP-171	02/100284	COMBUSTIBLE, S/N 527000-EU658592Y	G-296-B	32/400701	ACEITE	GP-31	02/100073
TRANSMISION	GP-171	02/100284	COMBUSTIBLE, S/N EU658593Y EN ADELANTE	G-297-B	32/400502	COMBUSTIBLE	G-296	32/400701
AIRE, PRIMARIO	GAK-216	32/203702	ACEITE	GP-171	02/100073	COMBUSTIBLE	G-296-B	32/400701
AIRE, SECUNDARIO	GA-416	32/203703	420 con motor/PERKINS 6.354			504B con motor/A DIESEL		
408 SOBRE RUEDAS ARTICULADO con motor/A DIESEL			ACEITE	GP-31	02/100073	COMBUSTIBLE	G-297	32/400502
COMBUSTIBLE	G-296	32/400701	COMBUSTIBLE	G-296	32/400701	COMBUSTIBLE	G-297-B	32/400502
COMBUSTIBLE	G-296-B	32/400701	COMBUSTIBLE	G-296-B	32/400701	ACEITE	GP-171	02/100284
HIDRAULICO	GP-761H	32/905501	423 SOBRE RUEDAS con motor/LEYLAND UE 680			TRANSMISION	GP-171	02/100284
AIRE, PRIMARIO	GAK-216	32/203702	COMBUSTIBLE	G-296	32/400701	505, 506 con motor/A DIESEL		
AIRE, SECUNDARIO	GA-416	32/203703	425 con motor/PERKINS			ACEITE, CON TURBO	GP-31	02/100073
409 SOBRE RUEDAS con motor/A DIESEL			ACEITE	GP-31	02/100073	505-19, 505-22, 505-36, 506-36, 506B, 508-40, 510-40 con motor/A DIESEL		
COMBUSTIBLE	G-296	32/400701	COMBUSTIBLE	G-296	32/400701	COMBUSTIBLE	G-296	32/400701
COMBUSTIBLE	GPP-1122	32/912001	COMBUSTIBLE	G-296-B	32/400701	COMBUSTIBLE	G-296-B	32/400701
COMBUSTIBLE	G-296-B	32/400701	426, 436 con motor/PERKINS			ACEITE	GP-171	02/100284
HIDRAULICO	GP-761H	32/905501	COMBUSTIBLE	GPP-1122	32/912001	TRANSMISION	GP-171	02/100284
AIRE, PRIMARIO	GAK-216	32/203702	AIRE, PRIMARIO	GA-360	32/201602	506B TURBOCARGADORA, 508-10, 510-10 con motor/A DIESEL		
AIRE, SECUNDARIO	GA-416	32/203703	AIRE, SECUNDARIO	GA-361	32/202501	ACEITE	GP-1	02/100284
411 TURBO RETROEXCAVADORA con motor/A DIESEL			426B, 436B con motor/PERKINS			ACEITE	GP-31	02/100073
COMBUSTIBLE, S/N 527000-EU658592Y	G-296	32/400701	COMBUSTIBLE	GPP-1122	32/912001	COMBUSTIBLE	G-296	32/400701
COMBUSTIBLE, S/N EU658593Y EN ADELANTE	G-297	32/400502	AIRE, PRIMARIO	GA-360	32/201602	COMBUSTIBLE	GPP-1122	32/912001
COMBUSTIBLE, S/N 527000-EU658592Y	G-296-B	32/400701	AIRE, SECUNDARIO	GA-361	32/202501	COMBUSTIBLE	G-296-B	32/400701
COMBUSTIBLE, S/N EU658593Y EN ADELANTE	G-297-B	32/400502	428 con motor/LEYLAND UE690			506C, 508C con motor/PERKINS		
ACEITE	GP-171	02/100073	COMBUSTIBLE	G-296	32/400701	ACEITE	GP-31	02/100073
412 SOBRE RUEDAS con motor/PERKINS 4.236			COMBUSTIBLE	G-296-B	32/400701	506CHL con motor/JCB (J.C. BAMFORD) 80 HP		
ACEITE	GP-1	02/100284	AIRE, PRIMARIO	GA-360	32/201602	COMBUSTIBLE	GPP-1122	32/912001
COMBUSTIBLE	G-296	32/400701	AIRE, SECUNDARIO	GA-361	32/202501	508 con motor/A DIESEL		
COMBUSTIBLE	G-296-B	32/400701	428C SOBRE RUEDAS con motor/LEYLAND UE690			ACEITE	GP-31	02/100073
AIRE	GA-360	32/201602	COMBUSTIBLE	G-296	32/400701	510 con motor/PERKINS 1004.4THR		
AIRE	GA-361	32/201601	COMBUSTIBLE	G-296-B	32/400701	ACEITE	GP-31	02/100073
412E con motor/PERKINS			AIRE	GA-360	32/201602	520 M/2, 520 M/4 con motor/LEYLAND 4.98NT		
ACEITE	GP-31	02/100073	AIRE	GA-361	32/201601	ACEITE	G-870	988/00038
COMBUSTIBLE	G-296	32/400701	430 con motor/PERKINS T6.354.4			COMBUSTIBLE	G-296	32/400701
COMBUSTIBLE	G-296-B	32/400701	ACEITE	GP-1	02/100284	COMBUSTIBLE	G-297	32/400502
413, 418 con motores/PERKINS 6.354, PERKINS T6.354			COMBUSTIBLE	G-296	32/400701	ACEITE	GP-3600	02/301217
ACEITE, CARTUCHO	G-834	1531639	COMBUSTIBLE	G-296-B	32/400701	COMBUSTIBLE	G-296-B	32/400701
ACEITE, SELLADO	GP-31	02/100073	AIRE, PRIMARIO	GA-360	32/201602	COMBUSTIBLE	G-297-B	32/400502
COMBUSTIBLE	G-296	32/400701	AIRE, SECUNDARIO	GA-361	32/202501			
COMBUSTIBLE	G-296-B	32/400701						

APLICACIONES SERVICIO PESADO
HEAVY DUTY APPLICATIONS



MARCA-MODELO-MOTOR MAKE-MODEL-ENGINE	GONHER GONHER	OEM OEM	MARCA-MODELO-MOTOR MAKE-MODEL-ENGINE	GONHER GONHER	OEM OEM	MARCA-MODELO-MOTOR MAKE-MODEL-ENGINE	GONHER GONHER	OEM OEM
JCB(J.C. BAMFORD)(continuación)			JCB(J.C. BAMFORD)(continuación)			JCB (J.C. BAMFORD)		
CARGADORAS			CARGADORAS			EQUIPO		
AIRE	GAK-1532	32/205702	540 con motor/PERKINS 4.236			1 con motor/JCB (J.C. BAMFORD) AC2		
520-10 con motor/A DIESEL			ACEITE	G-870	988/00038	GASOLINA	GG-48	51246
ACEITE	GP-1	02/100284	ACEITE	GP-1	02/100284	1 con motor/PETTER PH2		
COMBUSTIBLE	G-297	32/400502	COMBUSTIBLE	G-296	32/400701	ACEITE	G-870	988/00038
COMBUSTIBLE	G-297-B	32/400502	COMBUSTIBLE	G-296-B	32/400701	100 con motor/PERKINS 6.354		
520-50 con motor/A DIESEL			AIRE	GAK-216	32/203702	ACEITE	G-834	1531639
ACEITE	GP-1	02/100284	AIRE	GA-416	32/203703	ACEITE	GP-31	02/100073
520HL, 520M, 525B con motor/A DIESEL			540 TURBOCARGADORA, 540-170, 550 TURBOCARGADORA con motor/PERKINS			COMBUSTIBLE	G-296	32/400701
COMBUSTIBLE	G-296	32/400701	ACEITE	GP-31	02/100073	COMBUSTIBLE	G-296-B	32/400701
COMBUSTIBLE	G-296-B	32/400701	540-70 con motor/PERKINS 1004.40T			1000 con motor/FORD 2703		
ACEITE	GP-171	02/100284	ACEITE	GP-31	02/100073	ACEITE	G-836	C2TZ-6714-A
TRANSMISION	GP-171	02/100284	540B con motor/LISTER PETTER			COMBUSTIBLE	G-296	32/400701
AIRE, PRIMARIO	GAK-216	32/203702	AIRE	GAK-1532	32/205702	COMBUSTIBLE	G-296-B	32/400701
AIRE, SECUNDARIO	GA-416	32/203703	AIRE			AIRE, SIN ASPAS	GA-33	BO32/0033
525 con motor/PERKINS			540B2, 540B4 con motor/PERKINS			1000 con motor/PERKINS 6.354		
ACEITE	GP-1	02/100284	ACEITE	GP-31	02/100073	ACEITE, CARTUCHO	G-834	1531639
COMBUSTIBLE	G-296	32/400701	COMBUSTIBLE	G-296	32/400701	ACEITE, SELLADO	GP-31	02/100073
COMBUSTIBLE	G-296-B	32/400701	COMBUSTIBLE	G-296-B	32/400701	COMBUSTIBLE	G-296	32/400701
AIRE	GAK-1532	32/205702	700 SOBRE RUEDAS con motor/LEYLAND			COMBUSTIBLE	G-296-B	32/400701
525, 525-4 con motor/A DIESEL			ACEITE	G-870	988/00038	112 con motor/PERKINS 6.354		
ACEITE	G-870	988/00038	COMBUSTIBLE, 2 49/64 IN	G-296	32/400701	ACEITE, CARTUCHO	G-834	1531639
COMBUSTIBLE	G-296	32/400701	COMBUSTIBLE, 4 25/64 IN	G-297	32/400502	ACEITE, SELLADO	GP-31	02/100073
COMBUSTIBLE	G-297	32/400502	COMBUSTIBLE, 2 49/64 IN	G-296-B	32/400701	COMBUSTIBLE	G-296	32/400701
ACEITE	GP-3600	02/301217	COMBUSTIBLE, 4 25/64 IN	G-297-B	32/400502	COMBUSTIBLE	G-296-B	32/400701
COMBUSTIBLE	G-296-B	32/400701	900, 902 con motor/PERKINS 6.354			114 con motor/PERKINS T6.354		
COMBUSTIBLE	G-297-B	32/400502	ACEITE	G-834	1531639	ACEITE, CARTUCHO	G-836	C2TZ-6714-A
AIRE	GAK-216	32/203702	ACEITE	GP-31	02/100073	ACEITE, SELLADO	GP-31	02/100073
AIRE	GA-416	32/203703	COMBUSTIBLE	G-296	32/400701	COMBUSTIBLE	G-296	32/400701
525B-4HL con motor/PERKINS			COMBUSTIBLE	G-296-B	32/400701	COMBUSTIBLE	G-296-B	32/400701
ACEITE	GP-1	02/100284	AIRE, SIN ASPAS	GA-403	32/200406	1550B con motor/PERKINS		
COMBUSTIBLE	G-296	32/400701	AIRE	GAK-403	32/200406	TRANSMISION	G-870	988/00038
COMBUSTIBLE	G-296-B	32/400701	908 con motor/LEYLAND 6.80			ACEITE	GP-31	02/100073
525BHL con motor/A DIESEL			COMBUSTIBLE	G-296	32/400701	COMBUSTIBLE	G-296	32/400701
ACEITE	GP-1	02/100284	CB110 con motor/PERKINS 4.248			COMBUSTIBLE	G-296-B	32/400701
COMBUSTIBLE	G-296	32/400701	ACEITE	G-834	1531639	AIRE, PRIMARIO	GAK-216	32/203702
COMBUSTIBLE	G-296-B	32/400701	COMBUSTIBLE	G-296	32/400701	AIRE, SECUNDARIO	GA-416	32/203703
AIRE	GAK-1532	32/205702	COMBUSTIBLE	G-296-B	32/400701	1750 con motores/PERKINS 6.354, PERKINS T6.354		
530, 532 con motor/PERKINS			ROBOT 1110, ROBOT 190 con motor/PERKINS 1004.42			ACEITE	GP-31	02/100073
ACEITE	GP-31	02/100073	COMBUSTIBLE	GPP-1122	32/912001	COMBUSTIBLE	G-296	32/400701
530-70 con motor/A DIESEL			ROBOT 150 con motor/A DIESEL			COMBUSTIBLE	G-296-B	32/400701
ACEITE	GP-31	02/100073	COMBUSTIBLE	G-296	32/400701	2, 2B, 3C con motor/FORD		
530B TURBOCARGADORA con motor/A DIESEL			ROBOT 165HF con motor/PERKINS			ACEITE	G-813	957E-6731-A
ACEITE	GP-1	02/100284	COMBUSTIBLE	G-296	32/400701	2, 3, 2B con motores/LEYLAND 10-42, LEYLAND 10-45		
COMBUSTIBLE	G-296	32/400701	ROBOT 170 con motor/A DIESEL			ACEITE	G-870	988/00038
COMBUSTIBLE	G-296-B	32/400701	COMBUSTIBLE	G-296	32/400701	COMBUSTIBLE	G-296	32/400701
530B, 530BHL con motor/A DIESEL			COMBUSTIBLE	G-296	32/400701	COMBUSTIBLE	G-296-B	32/400701
COMBUSTIBLE	G-296	32/400701	HIDRAULICO	GP-761H	32/909200	2000 con motor/LEYLAND AD400		
COMBUSTIBLE	G-296-B	32/400701	ROBOT 185HF con motor/PERKINS			ACEITE	G-870	988/00038
ACEITE	GP-171	02/100284	ACEITE	GP-31	02/100073	COMBUSTIBLE	G-296	32/400701
TRANSMISION	GP-171	02/100284				COMBUSTIBLE	G-296-B	32/400701
535-95 con motor/PERKINS 1004.40						2CX MKII, 2CXL con motor/A DIESEL		
ACEITE	GP-31	02/100073				ACEITE	GP-1	02/100284
						TRANSMISION	GP-1	02/100284

SERVICIO PESADO

MARCA-MODELO-MOTOR MAKE-MODEL-ENGINE	GONHER GONHER	OEM OEM	MARCA-MODELO-MOTOR MAKE-MODEL-ENGINE	GONHER GONHER	OEM OEM	MARCA-MODELO-MOTOR MAKE-MODEL-ENGINE	GONHER GONHER	OEM OEM
JCB(J.C. BAMFORD)(continuación)			JCB(J.C. BAMFORD)(continuación)			JCB(J.C. BAMFORD)(continuación)		
EQUIPO			EQUIPO			EQUIPO		
COMBUSTIBLE	G-297	32/400502	ACEITE, SELLADO	GP-3600	02/301217	807 con motor/PERKINS 6 CYL.		
COMBUSTIBLE	G-297-B	32/400502	COMBUSTIBLE	G-296-B	32/400701	ACEITE	G-834	1531639
HIDRAULICO	GP-761H	32/905501				COMBUSTIBLE	G-296	32/400701
			410 con motor/PERKINS 4.236			COMBUSTIBLE	G-296-B	32/400701
2D, 3CII con motor/LEYLAND 4 CYL. 38TD			ACEITE, S/N U9213008K EN ADELANTE	GP-1	02/100284	807CL, 806C, 807C con motores/PERKINS T6.354.4, PERKINS 6.354.4		
ACEITE	G-870	988/00038	ACEITE, HASTA S/N U921308K	GP-31	02/100073	ACEITE	GP-31	02/100073
COMBUSTIBLE	G-296	32/400701	COMBUSTIBLE	G-296	32/400701	COMBUSTIBLE	G-296	32/400701
COMBUSTIBLE	G-296-B	32/400701	COMBUSTIBLE	G-296-B	32/400701	COMBUSTIBLE	G-296-B	32/400701
3 con motor/FORD			4C con motor/FORD 957E			808 con motor/PERKINS T6.354		
ACEITE	G-813	957E-6731-A	ACEITE	G-813	957E-6731-A	ACEITE, CARTUCHO	G-834	1531639
3C con motor/LEYLAND 10-65			4C, 4D con motor/BMC			ACEITE, SELLADO	GP-1	02/100284
ACEITE	G-870	988/00038	ACEITE	G-870	988/00038	COMBUSTIBLE	G-296	32/400701
3C, 3D con motor/LEYLAND 10-60			520, 526 con motor/A DIESEL			COMBUSTIBLE	G-296-B	32/400701
COMBUSTIBLE	G-296	32/400701	ACEITE	GP-31	02/100073	AIRE, PRIMARIO	GA-360	32/201602
3CII con motor/PERKINS 4.248			520-50 con motor/A DIESEL			AIRE, SECUNDARIO	GA-361	32/202501
ACEITE	G-871	988/00038	ACEITE	GP-31	02/100073	80C con motor/A DIESEL		
COMBUSTIBLE	G-296	32/400701	520HL-2/4, 520M-2/4 con motor/PERKINS			ACEITE	G-834	1531639
COMBUSTIBLE	G-296-B	32/400701	COMBUSTIBLE	G-296	32/400701	COMBUSTIBLE	G-296	32/400701
3CIII, 3DIII con motor/LEYLAND 4.98NT			COMBUSTIBLE	G-296-B	32/400701	COMBUSTIBLE	G-296-B	32/400701
ACEITE	G-870	988/00038	AIRE, PRIMARIO	GAK-216	32/203702	AIRE	GA-360	32/201602
COMBUSTIBLE, 2 49/64 IN	G-296	32/400701	AIRE, SECUNDARIO	GA-416	32/203703	8C, 8D con motor/PERKINS		
COMBUSTIBLE, 4 25/64 IN	G-297	32/400502	525-50, 530HL con motor/A DIESEL			ACEITE	GP-31	02/100073
COMBUSTIBLE, 2 49/64 IN	G-296-B	32/400701	COMBUSTIBLE	G-296	32/400701	COMBUSTIBLE	G-296	32/400701
COMBUSTIBLE, 4 25/64 IN	G-297-B	32/400502	525B-2/4 con motor/A DIESEL			COMBUSTIBLE	G-296-B	32/400701
AIRE, PRIMARIO	GAK-216	32/203702	COMBUSTIBLE	G-296	32/400701	COMBUSTIBLE	G-296-B	32/400701
AIRE, SECUNDARIO	GA-416	32/203703	COMBUSTIBLE	G-296-B	32/400701	COMBUSTIBLE	G-296-B	32/400701
3D con motor/FORD			AIRE, PRIMARIO	GAK-216	32/203702	907 con motor/PERKINS T6.354		
ACEITE	G-813	957E-6731-A	AIRE, SECUNDARIO	GA-416	32/203703	ACEITE	GP-31	02/100073
3D con motor/LEYLAND 10-65			AIRE, PRIMARIO	GAK-1532	32/205702	COMBUSTIBLE	G-296	32/400701
ACEITE	G-870	988/00038	5C con motor/PERKINS 4.248			COMBUSTIBLE	G-296-B	32/400701
3DII con motor/LEYLAND 4 CYL. 38TD			ACEITE	G-870	988/00038	1105 SERIES III con motor/A DIESEL		
ACEITE	G-870	988/00038	6 con motor/PERKINS 4.236			COMBUSTIBLE	GPP-1122	32/912001
COMBUSTIBLE	G-296	32/400701	ACEITE, CARTUCHO	G-871	988/00038	1400 RETROEXCAVADORA con motor/A DIESEL		
COMBUSTIBLE	G-296-B	32/400701	6C con motor/FORD 2703			ACEITE, CARTUCHO	G-870	988/00038
3DS, 3DX, 4C con motor/LEYLAND 4.98NT			ACEITE	G-836	C27Z-6714-A	COMBUSTIBLE	G-296	32/400701
ACEITE, CARTUCHO	G-870	988/00038	COMBUSTIBLE	G-296	32/400701	ACEITE, SELLADO	GP-28	02/301217
COMBUSTIBLE, 2 49/64 IN	G-296	32/400701	COMBUSTIBLE	G-296-B	32/400701	COMBUSTIBLE	G-297	32/400502
COMBUSTIBLE, 4 25/64 IN	G-297	32/400502	AIRE, SIN ASPAS	GA-33	BO32/0033	COMBUSTIBLE	G-296-B	32/400701
ACEITE, SELLADO	GP-3600	02/301217	6C, 7C con motor/PERKINS 6.354			COMBUSTIBLE	G-297-B	32/400502
COMBUSTIBLE, 2 49/64 IN	G-296-B	32/400701	ACEITE, CARTUCHO	G-834	1531639	ACEITE, SELLADO	GP-171	02/100284
COMBUSTIBLE, 4 25/64 IN	G-297-B	32/400502	ACEITE, SELLADO	GP-31	02/100073	TRANSMISION	GP-171	02/100284
AIRE, PRIMARIO	GAK-216	32/203702	COMBUSTIBLE	G-296	32/400701	AIRE, PRIMARIO	GAK-216	32/203702
AIRE, SECUNDARIO	GA-416	32/203703	COMBUSTIBLE	G-296-B	32/400701	AIRE, SECUNDARIO	GA-416	32/203703
4 con motor/FORD 957E			7 con motor/FORD 570E			1400B RETROEXCAVADORA con motor/PERKINS		
ACEITE	G-813	957E-6731-A	ACEITE	G-834	1531639	ACEITE	GP-1	02/100073
4 con motor/LEYLAND 10-60			702, 704 con motor/PERKINS 4.236			COMBUSTIBLE	G-296	32/400701
COMBUSTIBLE	G-296	32/400701	ACEITE	GP-1	02/100073	COMBUSTIBLE	G-296-B	32/400701
4 con motor/LEYLAND 10-65			COMBUSTIBLE	G-296	32/400701	COMBUSTIBLE	G-296-B	32/400701
ACEITE	G-870	988/00038	COMBUSTIBLE	G-296-B	32/400701	2 con motor/LEYLAND 3 CYL. 28 TD		
410 con motor/LEYLAND			ACEITE, CARTUCHO	G-870	988/00038	ACEITE	G-870	988/00038
ACEITE, CARTUCHO	G-870	988/00038	COMBUSTIBLE	G-296	32/400701	COMBUSTIBLE	G-296	32/400701
COMBUSTIBLE	G-296	32/400701	COMBUSTIBLE	G-296-B	32/400701	COMBUSTIBLE	G-296-B	32/400701
						2B con motor/LEYLAND 3 CYL. 28 TD		
						ACEITE	G-870	988/00038
						COMBUSTIBLE	G-296	32/400701
						COMBUSTIBLE	G-296-B	32/400701

JCB (J.C. BAMFORD)

EXCAVADORAS

1105 SERIES III con motor/A DIESEL		
COMBUSTIBLE	GPP-1122	32/912001
1400 RETROEXCAVADORA con motor/A DIESEL		
ACEITE, CARTUCHO	G-870	988/00038
COMBUSTIBLE	G-296	32/400701
ACEITE, SELLADO	GP-28	02/301217
COMBUSTIBLE	G-297	32/400502
COMBUSTIBLE	G-296-B	32/400701
COMBUSTIBLE	G-297-B	32/400502
ACEITE, SELLADO	GP-171	02/100284
TRANSMISION	GP-171	02/100284
AIRE, PRIMARIO	GAK-216	32/203702
AIRE, SECUNDARIO	GA-416	32/203703
1400B RETROEXCAVADORA con motor/PERKINS		
ACEITE	GP-1	02/100073
COMBUSTIBLE	G-296	32/400701
COMBUSTIBLE	G-296-B	32/400701
2 con motor/LEYLAND 3 CYL. 28 TD		
ACEITE	G-870	988/00038
COMBUSTIBLE	G-296	32/400701
COMBUSTIBLE	G-296-B	32/400701
2B con motor/LEYLAND 3 CYL. 28 TD		
ACEITE	G-870	988/00038
COMBUSTIBLE	G-296	32/400701

MARCA-MODELO-MOTOR MAKE-MODEL-ENGINE	GONHER GONHER	OEM OEM	MARCA-MODELO-MOTOR MAKE-MODEL-ENGINE	GONHER GONHER	OEM OEM	MARCA-MODELO-MOTOR MAKE-MODEL-ENGINE	GONHER GONHER	OEM OEM
JCB(J.C.BAMFORD)(continuación)			JCB(J.C.BAMFORD)(continuación)			JCB(J.C.BAMFORD)(continuación)		
EXCAVADORAS			EXCAVADORAS			EXCAVADORAS		
COMBUSTIBLE	G-296-B	32/400701	COMBUSTIBLE	G-297	32/400502	ACEITE, SELLADO	GP-31	02/100073
2D con motor/LEYLAND 4.98NT			COMBUSTIBLE	G-296-B	32/400701	COMBUSTIBLE	G-296	32/400701
ACEITE	G-870	988/00038	COMBUSTIBLE	G-297-B	32/400502	COMBUSTIBLE	G-296-B	32/400701
COMBUSTIBLE	G-296	32/400701	3D con motor/LEYLAND 10/60			6 con motor/PERKINS 4.236		
COMBUSTIBLE	G-297	32/400502	COMBUSTIBLE	G-296	32/400701	ACEITE	G-834	1531639
COMBUSTIBLE	G-296-B	32/400701	COMBUSTIBLE	G-296-B	32/400701	AIRE, SIN ASPAS	GA-403	32/200406
COMBUSTIBLE	G-297-B	32/400502	AIRE	GAK-216	32/203702	AIRE	GAK-403	32/200406
3 con motores/LEYLAND 4.98 TT, LEYLAND 4.98NT			AIRE	GA-416	32/203703	6C, 6D, 7B con motor/PERKINS 6.354		
ACEITE	G-870	988/00038	3D con motor/LEYLAND 10/65			ACEITE	G-834	1531639
COMBUSTIBLE	G-296	32/400701	ACEITE	G-870	988/00038	COMBUSTIBLE	G-296	32/400701
COMBUSTIBLE	G-297	32/400502	COMBUSTIBLE	G-296	32/400701	COMBUSTIBLE	G-296-B	32/400701
ACEITE	GP-3600	02/301217	COMBUSTIBLE	G-296-B	32/400701	AIRE, SIN ASPAS	GA-403	32/200406
COMBUSTIBLE	G-296-B	32/400701	AIRE	GAK-216	32/203702	AIRE	GAK-403	32/200406
COMBUSTIBLE	G-297-B	32/400502	AIRE	GA-416	32/203703	7 con motor/FORD 590E		
3, 3D, 2D, 3C con motor/LEYLAND 4 CYL. 38TD			3D con motor/PERKINS			ACEITE	G-836	C2TZ-6714-A
ACEITE	G-870	988/00038	ACEITE	GP-1	02/100284	COMBUSTIBLE	G-296	32/400701
COMBUSTIBLE	G-296	32/400701	ACEITE	GP-31	02/100073	COMBUSTIBLE	G-296-B	32/400701
COMBUSTIBLE	G-296-B	32/400701	COMBUSTIBLE	G-296	32/400701	AIRE, SIN ASPAS	GA-403	32/200406
3C con motor/LEYLAND 10/60			COMBUSTIBLE	G-296-B	32/400701	AIRE	GAK-403	32/200406
COMBUSTIBLE	G-296	32/400701	3DX, 3D, 3DS con motores/LEYLAND 4.98 TT, LEYLAND 4.98NT			801.4 RETROEXCAVADORA con motor/PERKINS 103.10		
COMBUSTIBLE	G-296-B	32/400701	ACEITE	G-870	988/00038	ACEITE	GP-31	02/100073
AIRE	GAK-216	32/203702	COMBUSTIBLE	G-296	32/400701	COMBUSTIBLE	G-296	32/400701
AIRE	GA-416	32/203703	COMBUSTIBLE	G-297	32/400502	COMBUSTIBLE	G-296-B	32/400701
3C con motor/LEYLAND 10/65			ACEITE	GP-3600	02/301217	AIRE, SIMPLE	GAK-403	32/200406
ACEITE	G-870	988/00038	COMBUSTIBLE	G-296-B	32/400701	801.5, 801.6 con motor/PERKINS 103.10		
COMBUSTIBLE	G-296	32/400701	COMBUSTIBLE	G-297-B	32/400502	ACEITE	GP-31	02/100073
COMBUSTIBLE	G-296-B	32/400701	4C con motor/A DIESEL 38 T 4 CYL.			COMBUSTIBLE	G-296	32/400701
AIRE	GAK-216	32/203702	ACEITE	G-870	988/00038	COMBUSTIBLE	G-296-B	32/400701
AIRE	GA-416	32/203703	COMBUSTIBLE	G-296	32/400701	AIRE, SIMPLE	GAK-403	32/200406
3C con motor/LEYLAND 4.98NT			COMBUSTIBLE	G-296-B	32/400701	8015 con motor/PERKINS 103.10		
ACEITE	G-870	988/00038	4C con motor/LEYLAND 4.98NT			ACEITE	GP-31	02/100073
COMBUSTIBLE	G-296	32/400701	ACEITE	G-870	988/00038	COMBUSTIBLE	G-296	32/400701
COMBUSTIBLE	G-297	32/400502	COMBUSTIBLE	G-296	32/400701	COMBUSTIBLE	G-296-B	32/400701
COMBUSTIBLE	G-296-B	32/400701	COMBUSTIBLE	G-297	32/400502	AIRE, SIN ASPAS	GA-403	32/200406
COMBUSTIBLE	G-297-B	32/400502	COMBUSTIBLE	G-296-B	32/400701	AIRE	GAK-403	32/200406
3C con motor/PERKINS			COMBUSTIBLE	G-297-B	32/400502	802 SUPER, 803 PLUS, 803 SUPER con motor/PERKINS 103.15		
ACEITE	GP-1	02/100284	4C TURBO con motor/PERKINS T4.236			ACEITE	GP-31	02/100073
ACEITE	GP-31	02/100073	ACEITE	GP-1	02/100284	COMBUSTIBLE	G-296	32/400701
COMBUSTIBLE	G-296	32/400701	COMBUSTIBLE	G-296	32/400701	COMBUSTIBLE	G-296-B	32/400701
COMBUSTIBLE	G-296-B	32/400701	COMBUSTIBLE	G-296-B	32/400701	AIRE	GAK-403	32/200406
3CX SITEMASTER con motor/PERKINS 1004.4			4CX TURBO con motor/LEYLAND 4.98 TT			803 con motor/A DIESEL		
ACEITE	GP-1	02/100284	COMBUSTIBLE	G-296	32/400701	COMBUSTIBLE	G-296	32/401102
ACEITE	GP-31	02/100073	COMBUSTIBLE	G-297	32/400502	803 MINI, 804 MINI con motor/PERKINS		
COMBUSTIBLE	G-297	32/400502	ACEITE	GP-3600	02/301217	COMBUSTIBLE	G-296	32/400701
COMBUSTIBLE	G-297-B	32/400502	COMBUSTIBLE	G-296-B	32/400701	805 MINI con motor/PERKINS 4.248		
3CX TURBO con motor/LEYLAND 4.98 TT			COMBUSTIBLE	G-297-B	32/400502	ACEITE, CARTUCHO	G-833	26560076
COMBUSTIBLE	G-296	32/400701	4D con motor/LEYLAND 4 CYL. 38TD			ACEITE, SELLADO	GP-1	02/100284
COMBUSTIBLE	G-297	32/400502	ACEITE	G-870	988/00038	COMBUSTIBLE	G-296	32/400701
ACEITE	GP-3600	02/301217	COMBUSTIBLE	G-296	32/400701	COMBUSTIBLE	G-296-B	32/400701
COMBUSTIBLE	G-296-B	32/400701	COMBUSTIBLE	G-296-B	32/400701	805.2 con motor/PERKINS 103.10		
COMBUSTIBLE	G-297-B	32/400502	530 con motor/PERKINS			COMBUSTIBLE	G-296	32/400701
3CX, 3CX TURBO con motor/PERKINS			ACEITE	GP-1	02/100284	8052, 8032ZTS MINI, 804 SUPER, ROBOT 165 con motor/A DIESEL		
ACEITE	GP-1	02/100284	5C con motor/PERKINS 6.354			COMBUSTIBLE	G-296	32/400701
ACEITE	GP-31	02/100073	ACEITE, CARTUCHO	G-834	1531639			
COMBUSTIBLE	G-296	32/400701						

SERVICIO PESADO

MARCA-MODELO-MOTOR MAKE-MODEL-ENGINE	GONHER GONHER	OEM OEM	MARCA-MODELO-MOTOR MAKE-MODEL-ENGINE	GONHER GONHER	OEM OEM	MARCA-MODELO-MOTOR MAKE-MODEL-ENGINE	GONHER GONHER	OEM OEM
JCB(J.C.BAMFORD)(continuación)			JCB(J.C.BAMFORD)(continuación)			JCB(J.C.BAMFORD)(continuación)		
EXCAVADORAS			EXCAVADORAS			EXCAVADORAS		
805B con motor/PERKINS 6.354			AIRE	GA-361	32/201601	JS300LC con motor/ISUZU 6SDIT PB-01		
ACEITE	GP-31	02/100073	808D con motor/PERKINS T6.354			ACEITE	GP-57	02/800003
COMBUSTIBLE	G-296	32/400701	ACEITE	GP-31	02/100073	JS450 con motor/ISUZU 6RB1TQB		
COMBUSTIBLE	G-296-B	32/400701	COMBUSTIBLE	G-296	32/400701	COMBUSTIBLE	GPP-11	1132400440
805B TURBO con motor/PERKINS T4.236			COMBUSTIBLE	G-296-B	32/400701	JS460L con motor/ISUZU 6RB1T		
ACEITE	GP-1	02/100284	AIRE	GA-360	32/201602	COMBUSTIBLE	GPP-11	1132400440
COMBUSTIBLE	G-296	32/400701	AIRE	GA-361	32/202501	ROBOT 185 con motor/A DIESEL		
COMBUSTIBLE	G-296-B	32/400701	811, 812 con motor/PERKINS 6.354			ACEITE	GP-171	02/100073
806 con motor/FORD			ACEITE	GP-1	02/100284	JCB (J.C. BAMFORD)		
COMBUSTIBLE	G-296	32/400701	ACEITE	GP-31	02/100073	GRÚAS		
COMBUSTIBLE	G-296-B	32/400701	COMBUSTIBLE	G-296	32/400701	520-55 TELESCOPICA con motor/PERKINS		
ACEITE	GP-68	32/600117	COMBUSTIBLE	G-296-B	32/400701	COMBUSTIBLE	G-297	32/400502
AIRE	GA-360	32/201602	AIRE	GA-360	32/201602	525-58 TELESCOPICA, 525-67 TELESCOPICA con motor/PERKINS 1004.4HR		
AIRE	GA-361	32/202501	AIRE	GA-361	32/202501	COMBUSTIBLE	G-296	32/400701
806 con motor/PERKINS 4.248			814, 814S con motor/PERKINS 6.354			530-67 TELESCOPICA, 530-95 TELESCOPICA con motor/PERKINS 1004.4HR		
COMBUSTIBLE	G-296	32/400701	ACEITE	GP-1	02/100284	COMBUSTIBLE	G-297	32/400502
ACEITE	GP-3600	02/301217	ACEITE	GP-31	02/100073	JCB (J.C. BAMFORD)		
COMBUSTIBLE	G-296-B	32/400701	COMBUSTIBLE	G-296	32/400701	MONTACARGAS		
806 con motor/PERKINS 6.354			COMBUSTIBLE	G-296-B	32/400701	926 con motor/A DIESEL		
COMBUSTIBLE	G-296	32/400701	AIRE	GA-360	32/201602	COMBUSTIBLE	G-297	32/400502
COMBUSTIBLE	G-296-B	32/400701	AIRE	GA-361	32/202501	COMBUSTIBLE	G-297-B	32/400502
AIRE	GA-360	32/201602	820 con motor/PERKINS 6.354			ACEITE	GP-171	02/100284
AIRE	GA-361	32/202501	ACEITE	GP-31	02/100073	TRANSMISION	GP-171	02/100284
806B con motor/FORD 2715E			COMBUSTIBLE	G-296	32/400701	930, 940 con motor/A DIESEL		
COMBUSTIBLE	G-297	32/400502	COMBUSTIBLE	G-296-B	32/400701	COMBUSTIBLE, 2 49/64 IN	G-296	32/400701
COMBUSTIBLE	G-297-B	32/400502	AIRE	GA-360	32/201602	COMBUSTIBLE, 4 25/64 IN	G-297	32/400502
ACEITE	GP-68	32/600117	AIRE	GA-361	32/202501	COMBUSTIBLE, 2 49/64 IN	G-296-B	32/400701
AIRE	GA-360	32/201602	JCB1 con motor/PETTER AC2			COMBUSTIBLE, 4 25/64 IN	G-297-B	32/400502
AIRE	GA-361	32/201601	GASOLINA	GG-48	S1246	ACEITE	GP-171	02/100284
806B con motor/PERKINS 6.354			JCB1 con motor/PETTER PH2			TRANSMISION	GP-171	02/100284
ACEITE	GP-31	02/100073	ACEITE	G-870	988/00038	930, 940 con motor/A DIESEL		
COMBUSTIBLE	G-296	32/400701	JS070 con motor/ISUZU 4JB1			COMBUSTIBLE, 2 49/64 IN	G-296	32/400701
COMBUSTIBLE	G-296-B	32/400701	ACEITE	GP-3985	KNP0065	COMBUSTIBLE, 4 25/64 IN	G-297	32/400502
AIRE	GA-360	32/201602	JS130W, JS150W con motor/ISUZU			COMBUSTIBLE, 4 25/64 IN	G-296-B	32/400701
AIRE	GA-361	32/201601	AIRE	GA-360	32/201602	COMBUSTIBLE, 4 25/64 IN	G-297-B	32/400502
806B, 807B con motor/PERKINS 6.354.4			JS150LC con motor/A DIESEL			ACEITE	GP-171	02/100284
ACEITE	GP-31	02/100073	AIRE	GA-892	BRH0282	TRANSMISION	GP-171	02/100284
COMBUSTIBLE	G-296	32/400701	JS220LC con motor/ISUZU			930, 940 con motor/A DIESEL		
COMBUSTIBLE	G-296-B	32/400701	ACEITE	GP-43	02/800226	COMBUSTIBLE, 2 49/64 IN	G-296	32/400701
807 con motor/PERKINS 6 CYL.			JS260 con motor/ISUZU 6B61			COMBUSTIBLE, 4 25/64 IN	G-297	32/400502
ACEITE	G-834	1531639	ACEITE	GP-43	1878116380	COMBUSTIBLE, 4 25/64 IN	G-296-B	32/400701
COMBUSTIBLE	G-296	32/400701	JS260NLC con motor/ISUZU 6BG1 TPC 01			ACEITE	GP-171	02/100284
COMBUSTIBLE	G-296-B	32/400701	ACEITE	GP-43	1878116380	TRANSMISION	GP-171	02/100284
807B con motor/FORD 2715E			JS300 con motor/ISUZU			JCB (J.C. BAMFORD)		
COMBUSTIBLE	G-297	32/400502	ACEITE	GP-57	1132410310	MOTORES		
COMBUSTIBLE	G-297-B	32/400502	JS300LC con motor/ISUZU 6RB1T PE-01			AC1 JCB (J.C. BAMFORD) A GASOLINA, AC2 JCB (J.C. BAMFORD) A GASOLINA		
ACEITE	GP-68	32/600117	COMBUSTIBLE	GPP-11	1132400440	GASOLINA	GG-48	S1246
AIRE	GA-360	32/201602	JCB (J.C. BAMFORD)			NIVELADORAS		
AIRE	GA-361	32/201601	TRACTORES			1700B con motor/PERKINS		
807B con motor/PERKINS 6.354			FASTRAC 1115 con motor/PERKINS 1006.6			ACEITE	GP-1	02/100073
ACEITE	GP-31	02/100073	ACEITE	GP-31	02/100073	COMBUSTIBLE	G-296	32/400701
COMBUSTIBLE	G-296	32/400701	COMBUSTIBLE	G-296	32/400701	COMBUSTIBLE	G-296-B	32/400701
COMBUSTIBLE	G-296-B	32/400701	JCB (J.C. BAMFORD)			TRACTORES		
AIRE	GA-360	32/201602	TRACTORES			FASTRAC 1115 con motor/PERKINS 1006.6		
AIRE	GA-361	32/201601	ACEITE	GP-57	1132410310	ACEITE	GP-31	02/100073
			COMBUSTIBLE	GPP-11	1132400440	COMBUSTIBLE	G-296	32/400701
			COMBUSTIBLE	GPP-11	1132400440	COMBUSTIBLE	G-296-B	32/400701

MARCA-MODELO-MOTOR MAKE-MODEL-ENGINE	GONHER GONHER	OEM OEM	MARCA-MODELO-MOTOR MAKE-MODEL-ENGINE	GONHER GONHER	OEM OEM	MARCA-MODELO-MOTOR MAKE-MODEL-ENGINE	GONHER GONHER	OEM OEM
JCB(J.C. BAMFORD)(continuación)			JOHN DEERE			JOHN DEERE (continuación)		
TRACTORES			CAMIONES, TRACTOCAMIONES Y AUTOBUSES			CARGADORAS		
FASTRAC 1135 con motor/A DIESEL			250D DE VOLTEO, 300D DE VOLTEO con motor/JOHN DEERE 6081H			24E con motor/A DIESEL		
COMBUSTIBLE	G-296	32/400701	ACEITE	GP-35	RE57394	ACEITE	GP-24	T113883
COMBUSTIBLE	G-296-B	32/400701				AIRE, SIN TURBO PRIMARIO	GAK-16	AT20728
ACEITE	GP-171	02/100284				AIRE, CON TURBO PRIMARIO	GAK-403	AT44377
FASTRAC 115 con motor/PERKINS 1006.6			JOHN DEERE			JOHN DEERE (continuación)		
ACEITE	GP-31	02/100073	CARGADORAS			244H con motor/YANMAR 4TNE98		
COMBUSTIBLE	G-296	32/400701	110 RETROEXCAVADORA con motor/JOHN DEERE 2.0 L			ACEITE	GP-40	M801209
COMBUSTIBLE	G-296-B	32/400701	TRANSMISION	GP-864H	RE45864	244J con motor/A DIESEL		
FASTRAC 125, FASTRAC 130 con motor/PERKINS 1006.6			125 con motor/A DIESEL			AIRE, RADIAL PRIMARIO	GA-853R	KV16429
ACEITE	GP-1	02/100284	HIDRAULICO	GP-34	AT58368	24A con motor/A DIESEL		
ACEITE	GP-31	02/100073	125 con motor/A GASOLINA			AIRE, SIN ASPAS	GA-33	AH19847
COMBUSTIBLE	G-296	32/400701	ACEITE	GP-50	HMf600L04340	24AD con motor/A DIESEL		
COMBUSTIBLE	G-296-B	32/400701	HIDRAULICO	GP-34	GG170-32375	HIDRAULICO	GP-864H	AT135800
FASTRAC 135 con motor/PERKINS 1006.6			AIRE, SIN ASPAS	GA-33	AH19847	TRANSMISION	GP-864H	AT135800
ACEITE	GP-1	02/100284	GASOLINA	GG-5 L	GG420-31259	AIRE, SIN ASPAS	GA-33	AH19847
COMBUSTIBLE	G-296	32/400701	14 con motor/ONAN			24AG con motor/A GASOLINA		
COMBUSTIBLE	G-296-B	32/400701	HIDRAULICO	GP-66	GG170-32346	ACEITE	GP-50	HMf600L04340
AIRE	GA-360	32/201602	ACEITE	GP-3600	HE122-0800	HIDRAULICO	GP-864H	AT135800
AIRE	GA-361	32/202501	GASOLINA	GG-5 L	GG420-31259	TRANSMISION	GP-864H	AT135800
FASTRAC 145 con motor/PERKINS 1006.6 TURBO			170 con motor/A GASOLINA			AIRE	GA-33	AH19847
ACEITE	GP-1	02/100284	AIRE, SIN ASPAS	GA-33	AH19847	GASOLINA	GG-5 L	AE29052
ACEITE	GP-31	02/100073	2054 DE TRONCOS con motor/JOHN DEERE 6068T			24D con motor/A DIESEL		
COMBUSTIBLE	G-296	32/400701	COMBUSTIBLE, FILTRO FINAL	GPP-423	RE67901	ACEITE	GP-14	T19044
COMBUSTIBLE	G-297	32/400502	210C RETROEXCAVADORA con motor/A DIESEL			COMBUSTIBLE	G-296	AT17387
COMBUSTIBLE	G-296-B	32/400701	ACEITE	GP-14	T19044	COMBUSTIBLE	G-296-B	AT17387
COMBUSTIBLE	G-297-B	32/400502	COMBUSTIBLE	G-295	AR50041	AIRE	GAK-16	GG420-32381
FASTRAC 155 con motor/A DIESEL			HIDRAULICO	GP-864H	AT103193	24G con motor/A GASOLINA		
ACEITE	GP-9	32/910700	AIRE, PRIMARIO	GAK-216	AR84228	AIRE, SIN ASPAS	GA-33	AH19847
COMBUSTIBLE	G-296	32/400701	AIRE, SECUNDARIO	GA-416	AE31724	2554 DE TRONCOS con motor/JOHN DEERE 6068H		
COMBUSTIBLE	G-296-B	32/400701	210E LL con motor/A DIESEL			COMBUSTIBLE, FILTRO FINAL	GPP-423	RE67901
AIRE, PRIMARIO	GA-360	32/201602	ACEITE	GP-35	RE57394	260 con motor/JOHN DEERE 3029T POWERTECH		
AIRE, SECUNDARIO	GA-361	32/202501	COMBUSTIBLE	G-295	AR50041	ACEITE	GP-14	T19044
FASTRAC 185 con motor/CUMMINS 6BTA5.9			HIDRAULICO	GP-864H	AT103193	HIDRAULICO	GP-761H	KV12276
COMBUSTIBLE, SECUNDARIO	GP-1122	02/910155	AIRE, PRIMARIO	GAK-216	AR84228	COMBUSTIBLE	GPP-420	RE60021
COMBUSTIBLE, PRIMARIO	GPP-18	02/910155	AIRE, SECUNDARIO	GA-416	AE31724	AIRE, RADIAL PRIMARIO	GA-853R	KV16429
ACEITE	GP-178	02/910140	210E RETROEXCAVADORA con motor/JOHN DEERE 4045 POWERTECH			LINEA DE COMBUSTIBLE	GG-5 L	AE29052
AIRE, PRIMARIO	GA-106	32/209101	COMBUSTIBLE	GPP-418	RE62418	270 con motor/JOHN DEERE 4045D POWERTECH		
AIRE, SECUNDARIO	GA-206	32/209102	COMBUSTIBLE, ALGUNOS	GPP-418	RE62418	COMBUSTIBLE	GPP-418	RE62418
FASTRAC 185-65 con motor/CUMMINS 6BTA5.9			COMBUSTIBLE	GPP-419	RE509031	ACEITE	GP-754	RE59754
COMBUSTIBLE, SECUNDARIO	GP-1122	02/910155	AIRE, RADIAL PRIMARIO	GA-853R	KV16429	GASOLINA	GG-5 L	AE29052
COMBUSTIBLE, PRIMARIO	GPP-18	02/910155	24 con motor/A DIESEL			280 con motor/JOHN DEERE 4045T POWERTECH		
ACEITE	GP-178	02/910140	ACEITE	GP-14	T19044	HIDRAULICO	GP-761H	RE34958
FASTRAC 2115, FASTRAC 2135, FASTRAC 2150 con motor/A DIESEL			COMBUSTIBLE	G-296	AT17387	COMBUSTIBLE	GPP-419	RE62419
ACEITE	GP-9	32/910700	COMBUSTIBLE	G-296-B	AT17387	ACEITE	GP-754	RE59754
FASTRAC 3185 con motor/A DIESEL			AIRE	GAK-16	42032381	AIRE, RADIAL PRIMARIO	GA-853R	KV16429
ACEITE	GP-9	32/910700	24 con motor/WISCONSIN VG4D			LINEA DE COMBUSTIBLE	GG-5 L	AE29052
COMBUSTIBLE, SECUNDARIO	GPP-1122	32/912001	AIRE, SIN ASPAS	GA-33	AH19847	300 con motor/A DIESEL		
COMBUSTIBLE, PRIMARIO	GPP-18	02/910155	240 SERIES II con motor/JOHN DEERE 3029D			HIDRAULICO	G-331	AR75603
FASTRAC 3220 con motor/CUMMINS			ACEITE	GP-14	T19044	TRANSMISION	G-331	AR75603
COMBUSTIBLE	GPP-1122	32/912001	COMBUSTIBLE	GPP-420	RE60021	ACEITE	GP-14	T19044
FASTRAC 185 con motor/CUMMINS 6BTA5.9			GASOLINA	GG-5 L	AE29052	COMBUSTIBLE	G-296	AT17387
COMBUSTIBLE, SECUNDARIO	GPP-1122	32/912001	240, 250 con motores/JOHN DEERE 3029D, JOHN DEERE 3029T			COMBUSTIBLE	G-296-B	AT17387
COMBUSTIBLE, PRIMARIO	GPP-18	02/910155	ACEITE	GP-14	T19044	AIRE	GAK-16	AT20728
ACEITE	GP-178	02/910140	COMBUSTIBLE	GPP-420	RE60021			
FASTRAC 2115, FASTRAC 2135, FASTRAC 2150 con motor/A DIESEL			GASOLINA	GG-5 L	AE29052			
ACEITE	GP-9	32/910700						
FASTRAC 3185 con motor/A DIESEL								
ACEITE	GP-9	32/910700						
COMBUSTIBLE, SECUNDARIO	GPP-1122	32/912001						
COMBUSTIBLE, PRIMARIO	GPP-18	02/910155						
FASTRAC 3220 con motor/CUMMINS								
COMBUSTIBLE	GPP-1122	32/912001						

SERVICIO PESADO

MARCA-MODELO-MOTOR MAKE-MODEL-ENGINE	GONHER GONHER	OEM OEM	MARCA-MODELO-MOTOR MAKE-MODEL-ENGINE	GONHER GONHER	OEM OEM	MARCA-MODELO-MOTOR MAKE-MODEL-ENGINE	GONHER GONHER	OEM OEM
JOHN DEERE (continuación)			JOHN DEERE (continuación)			JOHN DEERE (continuación)		
CARGADORAS			CARGADORAS			CARGADORAS		
300 RETROEXCAVADORA con motor/A DIESEL			COMBUSTIBLE, S/N 382288 EN ADELANTE	G-295	AR50041	304J con motor/A DIESEL		
HIDRAULICO	G-331	AR75603	COMBUSTIBLE, HASTA S/N 382288	G-296-B	AT17387	AIRE, RADIAL PRIMARIO	GA-853R	KV16429
TRANSMISION	G-331	AR75603	AIRE, HASTA S/N 386506	GAK-16	AT20728	310 RETROEXCAVADORA con motor/A DIESEL		
ACEITE	GP-14	T19044	AIRE, PRIMARIO DESDE S/N 386507 EN ADELANTE	GAK-216	AR84228	HIDRAULICO	G-331	AR75603
COMBUSTIBLE	G-296	AT17387	AIRE, SECUNDARIO DESDE S/N 386507 EN ADELANTE	GA-416	AE31724	TRANSMISION	G-331	AR75603
COMBUSTIBLE	G-296-B	AT17387				ACEITE	GP-14	T19044
AIRE	GAK-16	AT20728				COMBUSTIBLE	G-296	AT17387
						COMBUSTIBLE	G-296-B	AT17387
						AIRE	GAK-16	AT20728
300B con motor/A DIESEL			301A RETROEXCAVADORA con motor/A DIESEL			310A RETROEXCAVADORA con motor/A DIESEL		
HIDRAULICO	G-331	AR75603	HIDRAULICO	G-331	AR75603	HIDRAULICO	G-331	AR75603
TRANSMISION	G-331	AR75603	TRANSMISION	G-331	AR75603	TRANSMISION	G-331	AR75603
ACEITE	GP-14	T19044	ACEITE	GP-14	T19044	ACEITE	GP-14	T19044
COMBUSTIBLE, HASTA S/N 382288	G-296	AT17387	COMBUSTIBLE	G-296	AR50041	COMBUSTIBLE	GP-14	T19044
COMBUSTIBLE, S/N 382288 EN ADELANTE	G-295	AR50041	COMBUSTIBLE	G-295	AR50041	COMBUSTIBLE	G-296	AT17387
COMBUSTIBLE, HASTA S/N 382288	G-296-B	AT17387	AIRE, PRIMARIO (HASTA S/N 386506)	GAK-16	AT20728	COMBUSTIBLE	G-295	AR50041
AIRE, PRIMARIO HASTA S/N 386507	GAK-16	AT20728	AIRE, PRIMARIO (S/N 386507 EN ADELANTE)	GAK-216	AR84228	COMBUSTIBLE	G-296-B	AT17387
AIRE, PRIMARIO DESDE S/N 386507 EN ADELANTE	GAK-216	AR84228	AIRE, SECUNDARIO	GA-416	AE31724	AIRE	GAK-16	AT20728
AIRE, SECUNDARIO DESDE S/N 386507 EN ADELANTE	GA-416	AE31724				310B RETROEXCAVADORA con motor/A DIESEL		
			302 con motor/A DIESEL			HIDRAULICO	G-331	AR75603
300B RETROEXCAVADORA con motor/A DIESEL			TRANSMISION	G-331	AR75603	TRANSMISION	G-331	AR75603
HIDRAULICO	G-331	AR75603	ACEITE	GP-14	T19044	ACEITE	GP-14	T19044
TRANSMISION	G-331	AR75603	COMBUSTIBLE, HASTA S/N 382288	G-296	AT17387	COMBUSTIBLE	G-295	AR50041
ACEITE	GP-14	T19044	COMBUSTIBLE, S/N 382288 EN ADELANTE	G-295	AR50041	AIRE, PRIMARIO	GAK-216	AR84228
COMBUSTIBLE, HASTA S/N 382288	G-296	AT17387	COMBUSTIBLE, HASTA S/N 382288	G-296-B	AT17387	AIRE, SECUNDARIO	GA-416	AE31724
COMBUSTIBLE, S/N 382288 EN ADELANTE	G-295	AR50041	AIRE	GAK-16	AT20728			
COMBUSTIBLE, HASTA S/N 382288	G-296-B	AT17387	302 RETROEXCAVADORA con motor/A DIESEL			310C RETROEXCAVADORA con motor/A DIESEL		
AIRE, PRIMARIO (HASTA S/N 386506)	GAK-16	AT20728	TRANSMISION	G-331	AR75603	ACEITE	GP-14	T19044
AIRE, PRIMARIO (S/N 386507 EN ADELANTE)	GAK-216	AR84228	ACEITE	GP-14	T19044	COMBUSTIBLE	G-295	AR50041
AIRE, SECUNDARIO	GA-416	AE31724	COMBUSTIBLE, HASTA S/N 382287	G-296-B	AT17387	AIRE, PRIMARIO	GA-403	AT65296
			AIRE	GAK-16	AT20728			
300D RETROEXCAVADORA con motor/A DIESEL			302A con motor/A DIESEL			310D RETROEXCAVADORA con motor/A DIESEL		
ACEITE	GP-14	T19044	HIDRAULICO	G-331	AR75603	ACEITE	GP-14	T19044
COMBUSTIBLE	G-295	AR50041	TRANSMISION	G-331	AR75603	TRANSMISION	GP-14	T19044
HIDRAULICO	GP-761H	AT184206	ACEITE	GP-14	T19044	COMBUSTIBLE, HASTA S/N 461565	G-295	AR50041
COMBUSTIBLE, SEPARADOR DE AGUA (S/N 461566 EN ADELANTE)	GPP-419	RE53400	COMBUSTIBLE, HASTA S/N 382288	G-296	AT17387	COMBUSTIBLE, S/N 461566 EN ADELANTE	GPP-419	RE62419
AIRE, SIN TURBO PRIMARIO	GA-403	AT65088	COMBUSTIBLE, S/N 382288 EN ADELANTE	G-295	AR50041	AIRE, PRIMARIO	GA-403	AT65088
			COMBUSTIBLE, HASTA S/N 382288	G-296-B	AT17387			
301 con motor/A DIESEL			AIRE	GAK-16	AT20728	310E RETROEXCAVADORA, 310SE con motor/A DIESEL		
TRANSMISION	G-331	AR75603	COMBUSTIBLE, S/N 382287	G-296-B	AT17387	COMBUSTIBLE	GPP-418	RE62418
ACEITE	GP-14	T19044	AIRE	GAK-216	AT20728	ACEITE	GP-754	RE59754
COMBUSTIBLE	G-296	AT17387				AIRE, RADIAL PRIMARIO	GA-853R	AT171853
COMBUSTIBLE	G-296-B	AT17387				GASOLINA, LINEA DEL RESPIRADOR DEL TANQUE	GG-5 L	AT101565
AIRE	GAK-16	AR20728				HIDRAULICO		
301 RETROEXCAVADORA con motor/A DIESEL			302A RETROEXCAVADORA con motor/A DIESEL			310G con motor/JOHN DEERE 4045D POWERTECH		
TRANSMISION	G-331	AR75603	HIDRAULICO	G-331	AR75603	COMBUSTIBLE (HASTA S/N 910056 CON TURBO)	GPP-418	RE62418
ACEITE	GP-14	T19044	TRANSMISION	G-331	AR75603	COMBUSTIBLE (HASTA S/N 911769 SIN TURBO)	GPP-418	RE62418
COMBUSTIBLE	G-296	AT17387	ACEITE	GP-14	T19044	COMBUSTIBLE (S/N 910056 EN ADELANTE CON TURBO)	GPP-419	RE509031
COMBUSTIBLE	G-296-B	AT17387	COMBUSTIBLE, HASTA S/N 382287 EN ADELANTE	G-296	AT17387	COMBUSTIBLE (S/N 911769 EN ADELANTE SIN TURBO)	GPP-419	RE509031
AIRE	GAK-16	AT20728	COMBUSTIBLE, S/N 382288 EN ADELANTE	G-295	AR50041	ACEITE (HASTA S/N 910056)	GP-754	RE59754
			COMBUSTIBLE, HASTA S/N 382287 EN ADELANTE	G-296-B	AT17387	AIRE, RADIAL PRIMARIO	GA-853R	KV16429
301A con motor/A DIESEL			AIRE	GAK-16	AT20728	GASOLINA, LINEA DEL RESPIRADOR DEL TANQUE	GG-5 L	AT101565
TRANSMISION	G-331	AR75603				HIDRAULICO		
ACEITE	GP-14	T19044						
COMBUSTIBLE, HASTA S/N 382288	G-296	AT17387				310G RETROEXCAVADORA con motor/JOHN DEERE 4045T POWER-TECH		
						COMBUSTIBLE, HASTA S/N 93000	GPP-418	RE62418

MARCA-MODELO-MOTOR MAKE-MODEL-ENGINE	GONHER GONHER	OEM OEM	MARCA-MODELO-MOTOR MAKE-MODEL-ENGINE	GONHER GONHER	OEM OEM	MARCA-MODELO-MOTOR MAKE-MODEL-ENGINE	GONHER GONHER	OEM OEM
JOHN DEERE (continuación)			JOHN DEERE (continuación)			JOHN DEERE (continuación)		
CARGADORAS			CARGADORAS			CARGADORAS		
310J, 310SJ, 310TMC con motores/JOHN DEERE 4045D, JOHN DEERE 4045T POWERTECH			320 DE TRONCOS con motor/A GASOLINA			AIRE, PRIMARIO	GA-697R	AT222722
COMBUSTIBLE	GPP-419	RE509031	GASOLINA	GG-5 L	AE29052	344J con motor/JOHN DEERE 4045 POWERTECH		
AIRE, RADIAL PRIMARIO	GA-853R	KV16429	3200 TELESCOPICA con motor/JOHN DEERE 4045TF POWERTECH			COMBUSTIBLE	GPP-419	RE509031
GASOLINA, LINEA DEL RESPIRADOR DEL TANQUE HIDRAULICO	GG-5 L	AT101565	COMBUSTIBLE	GPP-418	RE62418	350 SOBRE ORUGAS con motor/A DIESEL		
310SG con motor/JOHN DEERE 4045T POWERTECH			324H con motor/JOHN DEERE 4045 POWERTECH			ACEITE, CONDUCCION EN REVERSA	G-139	AR26350
COMBUSTIBLE (HASTA S/N 910056)	GPP-418	RE62418	COMBUSTIBLE	GPP-420	RE60021	ACEITE	GP-14	T19044
COMBUSTIBLE (S/N 910056 EN ADELANTE)	GPP-419	RE509031	ACEITE	GP-754	RE59754	ACEITE, TORNO	GP-14	T19044
ACEITE (HASTA S/N 910056)	GP-754	RE59754	AIRE, PRIMARIO	GA-697R	AT222722	COMBUSTIBLE	G-296	AT17387
AIRE, RADIAL PRIMARIO	GA-853R	AT171853	324H, 344H con motor/YANMAR 4TNE98			COMBUSTIBLE	G-296-B	AT17387
GASOLINA, LINEA DEL RESPIRADOR DEL TANQUE HIDRAULICO	GG-5 L	AT101565	ACEITE	GP-6811	M806419	AIRE	GAK-16	AT20728
310SG RETROEXCAVADORA con motor/JOHN DEERE 4045D			325 con motor/JOHN DEERE 5030T			350 SOBRE ORUGAS con motor/A GASOLINA		
COMBUSTIBLE, HASTA S/N 93000	GPP-418	RE62418	HIDRAULICO	GP-761H	AT314164	HIDRAULICO	G-139	AR26350
315C RETROEXCAVADORA, 315CH RETROEXCAVADORA con motor/A DIESEL			AIRE, RADIAL PRIMARIO	GA-853R	KV16429	TRANSMISION	G-139	AR26350
ACEITE	GP-14	T19044	LINEA DE COMBUSTIBLE	GG-5 L	AE29052	ACEITE	GP-14	T19044
COMBUSTIBLE	G-295	AR50041	GASOLINA, RESPIRADOR DEL TANQUE HIDRAULICO	GG-5 L	AT101565	HIDRAULICO	GP-14	T19044
HIDRAULICO (HASTA S/N 752439)	GP-864H	AT103193	328 con motor/JOHN DEERE 5030TW			AIRE	GAK-16	AT20728
AIRE, PRIMARIO	GA-403	AT65088	HIDRAULICO	GP-761H	AT314164	350B SOBRE ORUGAS con motor/A DIESEL		
315D RETROEXCAVADORA con motor/A DIESEL			AIRE, RADIAL PRIMARIO	GA-853R	KV16429	ACEITE, CONDUCCION EN REVERSA	G-139	AR26350
ACEITE	GP-14	T19044	LINEA DE COMBUSTIBLE	GG-5 L	AE29052	ACEITE	GP-14	T19044
TRANSMISION	GP-14	T19044	GASOLINA, RESPIRADOR DEL TANQUE HIDRAULICO	GG-5 L	AT101565	ACEITE, TORNO	GP-14	T19044
COMBUSTIBLE, HASTA S/N 461565	G-295	AR50041	332 con motor/JOHN DEERE 5030HW			COMBUSTIBLE, HASTA S/N 191714	G-296	AT17387
COMBUSTIBLE, S/N 461566 EN ADELANTE	GPP-419	RE62419	HIDRAULICO	GP-761H	AT314164	COMBUSTIBLE, S/N 191714 EN ADELANTE	G-295	AR50041
AIRE, PRIMARIO	GA-403	AT65088	AIRE, RADIAL PRIMARIO	GA-853R	KV16429	COMBUSTIBLE, HASTA S/N 191714	G-296-B	AT17387
315SE con motor/A DIESEL			LINEA DE COMBUSTIBLE	GG-5 L	AE29052	AIRE	GAK-16	AT20728
COMBUSTIBLE	GPP-418	RE62418	GASOLINA, RESPIRADOR DEL TANQUE HIDRAULICO	GG-5 L	AT101565	350B SOBRE ORUGAS, 350C SOBRE ORUGAS con motor/A GASOLINA		
ACEITE	GP-754	RE59754	335 DE TRONCOS con motor/JOHN DEERE 6068T			TRANSMISION	G-139	AR26350
AIRE, RADIAL PRIMARIO	GA-853R	AT171853	COMBUSTIBLE, FILTRO FINAL	GPP-419	RE62419	ACEITE	GP-14	T19044
GASOLINA, LINEA DEL RESPIRADOR DEL TANQUE HIDRAULICO	GG-5 L	AT101565	3375 con motor/JOHN DEERE 220 SERIES			HIDRAULICO	GP-14	T19044
315SG con motor/JOHN DEERE 4045D POWERTECH			ACEITE	GP-91	AM101378	AIRE	GAK-16	AT20728
COMBUSTIBLE, HASTA S/N 221706	GPP-418	RE62418	3400 TELESCOPICA con motor/JOHN DEERE 4045TF POWERTECH			350C SOBRE ORUGAS con motor/A DIESEL		
315SE con motor/JOHN DEERE 4045T POWERTECH			COMBUSTIBLE	GPP-418	RE62418	TRANSMISION	G-139	AR26350
COMBUSTIBLE (HASTA S/N 910056)	GPP-418	RE62418	340D DE TRONCOS con motor/A DIESEL			ACEITE	GP-14	T19044
COMBUSTIBLE (S/N 910056 EN ADELANTE)	GPP-419	RE509031	ACEITE	GP-14	T19044	ACEITE, TORNO	GP-14	T19044
ACEITE (HASTA S/N 910056)	GP-754	RE59754	COMBUSTIBLE	G-295	AR50041	COMBUSTIBLE	G-295	AR50041
AIRE, RADIAL PRIMARIO	GA-853R	KV16429	AIRE, PRIMARIO	GAK-403	AT44377	AIRE, HASTA S/N 380006	GAK-16	AT20728
GASOLINA, LINEA DEL RESPIRADOR DEL TANQUE HIDRAULICO	GG-5 L	AT101565	344E con motor/A DIESEL			350D SOBRE ORUGAS, 355D SOBRE ORUGAS con motor/A DIESEL		
315SJ con motor/JOHN DEERE 4045T POWERTECH			ACEITE	GP-14	T19044	TRANSMISION	G-139	AR26350
COMBUSTIBLE	GPP-419	RE509031	COMBUSTIBLE, SEPARADOR DE AGUA	GPP-14	AT81478	ACEITE	GP-14	T19044
AIRE, RADIAL PRIMARIO	GA-853R	KV16429	COMBUSTIBLE	G-270	AR86745	ACEITE, TORNO	GP-14	T19044
GASOLINA, LINEA DEL RESPIRADOR DEL TANQUE HIDRAULICO	GG-5 L	AT101565	344G con motor/JOHN DEERE 4045T			COMBUSTIBLE	G-295	AR50041
315SG con motor/JOHN DEERE 4045T POWERTECH			ACEITE	GP-14	T19044	3554 DE TRONCOS con motor/JOHN DEERE 6081H		
COMBUSTIBLE (HASTA S/N 910056)	GPP-418	RE62418	COMBUSTIBLE, SEPARADOR DE AGUA	GPP-424	RE62424	ACEITE	GP-35	RE57394
COMBUSTIBLE (S/N 910056 EN ADELANTE)	GPP-419	RE509031	COMBUSTIBLE	GPP-419	RE62419	375 con motor/A DIESEL		
ACEITE (HASTA S/N 910056)	GP-754	RE59754	344H con motor/JOHN DEERE 4045 POWERTECH			ACEITE	GP-91	AM101378
AIRE, RADIAL PRIMARIO	GA-853R	KV16429	COMBUSTIBLE, S/N 800000 EN ADELANTE			3800 TELESCOPICA con motor/JOHN DEERE 4045 POWERTECH		
GASOLINA, LINEA DEL RESPIRADOR DEL TANQUE HIDRAULICO	GG-5 L	AT101565	COMBUSTIBLE, HASTA S/N 800000			COMBUSTIBLE	GPP-419	RE62419
315SJ con motor/JOHN DEERE 4045T POWERTECH			ACEITE	GP-754	RE59754	400 RETROEXCAVADORA, 401 RETROEXCAVADORA con motor/A DIESEL		
COMBUSTIBLE	GPP-419	RE509031				HIDRAULICO	G-331	AR75603
AIRE, RADIAL PRIMARIO	GA-853R	KV16429				TRANSMISION	G-331	AR75603
GASOLINA, LINEA DEL RESPIRADOR DEL TANQUE HIDRAULICO	GG-5 L	AT101565						

SERVICIO PESADO

MARCA-MODELO-MOTOR MAKE-MODEL-ENGINE	GONHER GONHER	OEM OEM	MARCA-MODELO-MOTOR MAKE-MODEL-ENGINE	GONHER GONHER	OEM OEM	MARCA-MODELO-MOTOR MAKE-MODEL-ENGINE	GONHER GONHER	OEM OEM
JOHN DEERE (continuación)			JOHN DEERE (continuación)			JOHN DEERE (continuación)		
CARGADORAS			CARGADORAS			CARGADORAS		
ACEITE	GP-14	T19044	COMBUSTIBLE, HASTA S/N 382288	G-296	AT17387	410G RETROEXCAVADORA con motor/JOHN DEERE 4045T POWER-TECH		
COMBUSTIBLE	G-296	AT17387	COMBUSTIBLE, S/N 382288 EN ADELANTE	G-295	AR50041	COMBUSTIBLE (HASTA S/N 493828)	GPP-418	RE62418
COMBUSTIBLE	G-296-B	AT17387	COMBUSTIBLE, HASTA S/N 382288	G-296-B	AT17387	COMBUSTIBLE (S/N 493828 EN ADELANTE)	GPP-419	RE509031
AIRE	GAK-16	AT20728	AIRE	GAK-16	AT20728	ACEITE (HASTA S/N 912000)	GP-754	RE59754
400, 401 con motor/A DIESEL			401C RETROEXCAVADORA con motor/A DIESEL			AIRE, RADIAL PRIMARIO (S/N 926659 EN ADELANTE)	GA-853R	KV16429
HIDRAULICO	G-331	AR75603	HIDRAULICO	G-331	AR75603	GASOLINA, LINEA DEL RESPIRADOR DEL TANQUE HIDRAULICO	GG-5 L	AT101565
TRANSMISION	G-331	AR75603	ACEITE	GP-14	T19044	410J, 410TMC con motor/JOHN DEERE 4045T POWERTECH		
ACEITE	GP-14	T19044	COMBUSTIBLE, HASTA S/N 382287	G-296	AT17387	COMBUSTIBLE	GPP-419	RE509031
COMBUSTIBLE	G-296	AT17387	COMBUSTIBLE, S/N 382288 EN ADELANTE	G-295	AR50041	AIRE, RADIAL PRIMARIO	GA-853R	KV16429
COMBUSTIBLE	G-296-B	AT17387	COMBUSTIBLE, HASTA S/N 382287	G-296-B	AT17387	GASOLINA, LINEA DEL RESPIRADOR DEL TANQUE HIDRAULICO	GG-5 L	AT101565
AIRE	GAK-16	AT20728	AIRE	GAK-16	AT20728	435 DE TRONCOS con motor/JOHN DEERE 6068T		
401A con motor/A DIESEL			401C SOBRE RUEDAS con motor/A GASOLINA			COMBUSTIBLE, FILTRO FINAL	GPP-419	RE62419
HIDRAULICO	G-331	AR75603	ACEITE	G-331	AR75603	440 con motor/A DIESEL		
TRANSMISION	G-331	AR75603	ACEITE	GP-14	T19044	HIDRAULICO	G-331	AR75603
ACEITE	GP-14	T19044	AIRE	GA-16	AH19852	TRANSMISION	G-331	AR75603
COMBUSTIBLE	G-296	AT17387	AIRE	GAK-16	AT20728	ACEITE	GP-14	T19044
COMBUSTIBLE	G-295	AR50041	401D, 401D RETROEXCAVADORA con motor/A DIESEL			ACEITE, TORNO	GP-14	T19044
COMBUSTIBLE	G-296-B	AT17387	HIDRAULICO	G-331	AR75603	COMBUSTIBLE, HASTA S/N 192321	G-296	AT17387
AIRE, HASTA S/N 700323	GAK-16	AT20728	TRANSMISION	G-331	AR75603	COMBUSTIBLE, S/N 192322 EN ADELANTE	G-295	AR50041
AIRE, PRIMARIO DESDE S/N 700324 EN ADELANTE	GAK-216	AR84228	ACEITE	GP-14	T19044	COMBUSTIBLE, HASTA S/N 192321	G-296-B	AT17387
AIRE, SECUNDARIO DESDE S/N 700324 EN ADELANTE	GA-416	AE31724	AIRE	GAK-16	AT20728	AIRE	GAK-16	AT20728
401B con motor/A DIESEL			410 RETROEXCAVADORA con motor/A DIESEL			4400 TELESCOPICA con motor/A DIESEL		
TRANSMISION	G-331	AR75603	HIDRAULICO	G-331	AR75603	ACEITE	GP-14	T19044
ACEITE	GP-14	T19044	TRANSMISION	G-331	AR75603	440A, 440B con motor/A DIESEL		
COMBUSTIBLE, HASTA S/N 529283	G-296	AT17387	ACEITE	GP-14	T19044	HIDRAULICO	G-331	AR75603
COMBUSTIBLE, S/N 529283 EN ADELANTE	G-295	AR50041	COMBUSTIBLE	G-295	AR50041	TRANSMISION	G-331	AR75603
COMBUSTIBLE, HASTA S/N 529283	G-296-B	AT17387	AIRE, PRIMARIO	GAK-216	AR84228	ACEITE	GP-14	T19044
AIRE, HASTA S/N 700323	GAK-16	AT20728	AIRE, SECUNDARIO	GA-416	AE31724	ACEITE, TORNO	GP-14	T19044
AIRE, PRIMARIO DESDE S/N 700324 EN ADELANTE	GAK-216	AR84228	410B RETROEXCAVADORA, 410C RETROEXCAVADORA, 415 RETROEXCAVADORA, 415B RETROEXCAVADORA con motor/A DIESEL			COMBUSTIBLE, HASTA S/N 192321	G-296	AT17387
AIRE, SECUNDARIO DESDE S/N 700324 EN ADELANTE	GA-416	AE31724	HIDRAULICO	G-339H	AR94510	COMBUSTIBLE, S/N 192322 EN ADELANTE	G-295	AR50041
401B RETROEXCAVADORA con motor/A DIESEL			TRANSMISION	GP-14	T19044	COMBUSTIBLE, HASTA S/N 192321	G-296-B	AT17387
TRANSMISION	G-331	AR75603	ACEITE	GP-14	T19044	AIRE	GAK-16	AT20728
ACEITE	GP-14	T19044	COMBUSTIBLE, HASTA S/N 382508	G-296	AT17387	440C con motor/A DIESEL		
COMBUSTIBLE, HASTA S/N 529282	G-296	AT17387	COMBUSTIBLE, S/N 382508 EN ADELANTE	G-295	AR50041	ACEITE	G-331	AR75603
COMBUSTIBLE, S/N 529283 EN ADELANTE	G-295	AR50041	COMBUSTIBLE, HASTA S/N 382508	G-296-B	AT17387	ACEITE	GP-14	T19044
COMBUSTIBLE, HASTA S/N 529282	G-296-B	AT17387	AIRE, HASTA S/N 387066	GAK-16	AT20728	ACEITE	GP-14	T19044
AIRE, PRIMARIO (HASTA S/N 700323)	GAK-16	AT20728	AIRE, PRIMARIO DESDE S/N 387067 EN ADELANTE	GAK-216	AR84228	COMBUSTIBLE, HASTA S/N 192321	G-296	AT17387
AIRE, PRIMARIO (S/N 700324 EN ADELANTE)	GAK-216	AR84228	AIRE, SECUNDARIO DESDE S/N 387067 EN ADELANTE	GA-416	AE31724	COMBUSTIBLE, S/N 192322 EN ADELANTE	G-295	AR50041
AIRE, SECUNDARIO	GA-416	AE31724	410D RETROEXCAVADORA con motor/A DIESEL			COMBUSTIBLE, HASTA S/N 192321	G-296-B	AT17387
401B SOBRE RUEDAS con motor/A GASOLINA			HIDRAULICO	G-339H	AR94510	AIRE	GAK-16	AT20728
ACEITE	G-331	AR75603	ACEITE	GP-14	T19044	440D con motor/A DIESEL		
ACEITE	GP-14	T19044	TRANSMISION	GP-14	T19044	ACEITE	GP-14	T19044
AIRE	GA-16	AH19852	COMBUSTIBLE	G-295	AR50041	COMBUSTIBLE	G-295	AR50041
AIRE	GAK-16	AT20728	COMBUSTIBLE, SEPARADOR DE AGUA	GPP-419	RE53400	AIRE, PRIMARIO	GAK-403	AT44377
AIRE	GAK-216	AR84228	AIRE, PRIMARIO	GA-403	AT65296	444 con motor/A DIESEL		
AIRE	GA-416	AE31724	410E RETROEXCAVADORA con motor/JOHN DEERE 4045T POWER-TECH			DIRECCION	G-331	AR75603
401C con motor/A DIESEL			COMBUSTIBLE	GPP-418	RE62418	TRANSMISION	G-331	AR75603
HIDRAULICO	G-331	AR75603				ACEITE	GP-14	T19044
TRANSMISION	G-331	AR75603				COMBUSTIBLE	G-295	AR50041
ACEITE	GP-14	T19044						

MARCA-MODELO-MOTOR MAKE-MODEL-ENGINE	GONHER GONHER	OEM OEM	MARCA-MODELO-MOTOR MAKE-MODEL-ENGINE	GONHER GONHER	OEM OEM	MARCA-MODELO-MOTOR MAKE-MODEL-ENGINE	GONHER GONHER	OEM OEM
JOHN DEERE (continuación)			JOHN DEERE (continuación)			JOHN DEERE (continuación)		
CARGADORAS			CARGADORAS			CARGADORAS		
444C, 444CH con motor/A DIESEL			ACEITE, TORNO	GP-14	T19044	AIRE	GA-403	AR46481
DIRECCION	G-331	AR75603	COMBUSTIBLE	G-295	AR50041	510B RETROEXCAVADORA con motor/A DIESEL		
TRANSMISION	G-331	AR75603	455E SOBRE ORUGAS con motor/A DIESEL			HIDRAULICO	G-339H	AR94510
ACEITE	GP-14	T19044	ACEITE	GP-14	T19044	ACEITE	GP-14	T19044
COMBUSTIBLE, SEPARADOR DE AGUA	GPP-14	AT81478	COOLER DE ACEITE	GP-14	T19044	COMBUSTIBLE	G-295	AR50041
COMBUSTIBLE	G-295	AR50041	ACEITE, TORNO	GP-14	T19044	AIRE, PRIMARIO	GA-403	AT65296
444D con motor/JOHN DEERE 6239			COMBUSTIBLE	G-295	AR50041	510C RETROEXCAVADORA con motor/A DIESEL		
ACEITE	GP-14	T19044	AIRE, SIN TURBO PRIMARIO	GA-403	AT65296	HIDRAULICO	G-339H	AR94510
COMBUSTIBLE, SEPARADOR DE AGUA	GPP-14	AT81478	455G SOBRE ORUGAS con motor/A DIESEL			ACEITE	GP-14	T19044
COMBUSTIBLE	G-295	AR50041	ACEITE	GP-14	T19044	COMBUSTIBLE	G-295	AR50041
HIDRAULICO	GP-864H	AT103193	COMBUSTIBLE, SEPARADOR DE AGUA	GPP-14	AT81478	AIRE, CON TURBO PRIMARIO	GA-403	AT65296
TRANSMISION	GP-864H	AT103193	COMBUSTIBLE	G-295	AR50041	510D RETROEXCAVADORA con motor/A DIESEL		
444E con motor/A DIESEL			AIRE, SIN TURBO PRIMARIO	GA-403	AT65296	ACEITE	GP-14	T19044
ACEITE	GP-14	T19044	460DC, 460DG con motor/JOHN DEERE 6068H			TRANSMISION	GP-14	T19044
COMBUSTIBLE, SEPARADOR DE AGUA	GPP-14	AT81478	AIRE, PRIMARIO	GA-679	AR79679	COMBUSTIBLE	G-295	AR50041
COMBUSTIBLE	G-270	AR86745	460DC, 460DG con motor/JOHN DEERE 6068T			COMBUSTIBLE, SEPARADOR DE AGUA	GPP-419	RE53400
444G con motor/JOHN DEERE 4045T			COMBUSTIBLE, PRIMARIO	GPP-424	RE62424	AIRE, PRIMARIO	GA-403	AT65296
ACEITE	GP-14	T19044	COMBUSTIBLE, FILTRO FINAL	GPP-419	RE62419	515B RETROEXCAVADORA con motor/A DIESEL		
COMBUSTIBLE, SEPARADOR DE AGUA OPCIONAL	GPP-14	AT81478	ACEITE	GP-754	RE59754	HIDRAULICO	G-339H	AR94510
COMBUSTIBLE, SEPARADOR DE AGUA	GPP-424	RE62424	AIRE, PRIMARIO	GA-679	AR79679	ACEITE	GP-14	T19044
COMBUSTIBLE	GPP-419	RE62419	AIRE, SECUNDARIO	GA-680	AR79680	COMBUSTIBLE	G-295	AR50041
444H, 444H LL, 444HTC con motor/JOHN DEERE 4045T POWERTECH			500 RETROEXCAVADORA con motor/A DIESEL			AIRE, PRIMARIO	GA-403	AT65296
COMBUSTIBLE, PRIMARIO	GPP-424	RE62424	ACEITE	G-139	AR26350	535 DE TRONCOS con motor/JOHN DEERE 6081 POWERTECH		
COMBUSTIBLE, FILTRO FINAL	GPP-419	RE62419	ACEITE, CAMBIO DE CUALLO DE TRANSMISION	G-331	AR75603	COMBUSTIBLE, SEPARADOR DE AGUA	GPP-426	RE65431
COMBUSTIBLE	GPP-420	RE60021	TRANSMISION	G-331	AR75603	ACEITE	GP-35	RE57394
ACEITE	GP-754	RE59754	COMBUSTIBLE	GPP-14	AR45097	COMBUSTIBLE	G-270	AR86745
AIRE, PRIMARIO	GA-697R	AT222722	500A RETROEXCAVADORA con motor/A DIESEL			540 con motor/A DIESEL		
444J con motor/JOHN DEERE 4045H			ACEITE	G-139	AR26350	HIDRAULICO	G-331	AR75603
COMBUSTIBLE, OPCIONAL	GPP-423	RE509032	ACEITE, CAMBIO DE CUALLO DE TRANSMISION	G-331	AR75603	TRANSMISION	G-331	AR75603
4475 con motor/JOHN DEERE 220 SERIES			TRANSMISION	G-331	AR75603	ACEITE	GP-14	T19044
ACEITE	GP-149	AM101378	COMBUSTIBLE, HASTA S/N 123114	GPP-14	AR45097	ACEITE, TORNO	GP-14	T19044
AIRE, PRIMARIO	GAK-16	MG86504145	COMBUSTIBLE, S/N 065000 EN ADELANTE	G-295	AR50041	COMBUSTIBLE, HASTA S/N 160726	G-296	AT17387
GASOLINA	GG-5 L	AE29052	AIRE, SIN PRE LIMPIADOR	GA-403	AT65296	COMBUSTIBLE, DESDE S/N 160727	G-295	AR50041
448D con motor/A DIESEL			500B RETROEXCAVADORA con motor/A DIESEL			COMBUSTIBLE, HASTA S/N 160726	G-296-B	AT17387
ACEITE	GP-14	T19044	ACEITE	G-139	AR26350	AIRE	GAK-403	AT44377
COMBUSTIBLE	G-295	AR50041	ACEITE, CAMBIO DE CUALLO DE TRANSMISION	G-331	AR75603	540A con motor/A DIESEL		
AIRE, PRIMARIO	GAK-403	AT44378	HIDRAULICO	G-331	AR75603	HIDRAULICO	G-331	AR75603
450 SOBRE ORUGAS con motor/A DIESEL			TRANSMISION	G-331	AR75603	TRANSMISION	G-331	AR75603
ACEITE	GP-14	T19044	COMBUSTIBLE, S/N 280001 EN ADELANTE	G-295	AR50041	ACEITE	GP-14	T19044
HIDRAULICO	GP-14	T19044	AIRE, SIN PRE LIMPIADOR	GA-403	AR46481	ACEITE, TORNO	GP-14	T19044
COMBUSTIBLE	G-296	AT17387	500C RETROEXCAVADORA con motor/A DIESEL			COMBUSTIBLE, HASTA S/N 160726	G-296	AT17387
COMBUSTIBLE	G-296-B	AT17387	ACEITE	G-139	AR26350	COMBUSTIBLE, DESDE S/N 160727	G-295	AR50041
450 SOBRE ORUGAS con motor/A GASOLINA			ACEITE, CAMBIO DE CUALLO DE TRANSMISION	G-331	AR75603	COMBUSTIBLE, HASTA S/N 160726	G-296-B	AT17387
ACEITE	GP-14	T19044	TRANSMISION	G-331	AR75603	AIRE	GAK-403	AT44377
HIDRAULICO	GP-14	T19044	COMBUSTIBLE	G-295	AR50041	540B con motor/A DIESEL		
AIRE	GAK-16	AT20728	AIRE, SIN PRE LIMPIADOR	GA-403	AT65296	HIDRAULICO (HASTA S/N 315074)	G-331	AR75603
4500 TELESCOPICA con motor/A DIESEL			510 RETROEXCAVADORA con motor/A DIESEL			TRANSMISION	G-331	AR75603
ACEITE	GP-14	T19044	ACEITE	G-139	AR26350	ACEITE	GP-14	T19044
455D SOBRE ORUGAS con motor/A DIESEL			HIDRAULICO	G-331	AR75603	COMBUSTIBLE	G-295	AR50041
ACEITE	GP-14	T19044	TRANSMISION	G-331	AR75603	AIRE, PRIMARIO	GAK-403	AT44377
COOLER DE ACEITE	GP-14	T19044	COMBUSTIBLE	G-295	AR50041			

SERVICIO PESADO

MARCA-MODELO-MOTOR MAKE-MODEL-ENGINE	GONHER GONHER	OEM OEM	MARCA-MODELO-MOTOR MAKE-MODEL-ENGINE	GONHER GONHER	OEM OEM	MARCA-MODELO-MOTOR MAKE-MODEL-ENGINE	GONHER GONHER	OEM OEM
JOHN DEERE (continuación)			JOHN DEERE (continuación)			JOHN DEERE (continuación)		
CARGADORAS			CARGADORAS			CARGADORAS		
540D, 548D con motor/A DIESEL			544B con motor/A DIESEL			COMBUSTIBLE, SEPARADOR DE AGUA	GPP-14	AT81478
ACEITE	GP-14	T19044	DIRECCION	G-331	AR75603	COMBUSTIBLE	G-295	AR50041
ACEITE, TORNO	GP-14	T19044	TRANSMISION	G-331	AR75603	AIRE, PRIMARIO (S/N 539530 EN ADELANTE)	GA-679	AR79679
COMBUSTIBLE	G-295	AR50041	ACEITE	GP-14	T19044	AIRE, SECUNDARIO (S/N 539530 EN ADELANTE)	GA-680	AR79680
540E con motor/A DIESEL			COMBUSTIBLE	G-295	AR50041	548G con motor/JOHN DEERE 6068H		
ACEITE	GP-14	T19044	544C con motor/A DIESEL			COMBUSTIBLE, OPCIONAL (S/N 586337 EN ADELANTE)	GPP-423	RE509032
COMBUSTIBLE	G-295	AR50041	DIRECCION	G-331	AR75603	COMBUSTIBLE, PRIMARIO (HASTA S/N 586337)	GPP-424	RE62424
AIRE, PRIMARIO (S/N 539530 EN ADELANTE)	GA-679	AR79679	TRANSMISION	G-331	AR75603	COMBUSTIBLE	GPP-419	RE62419
AIRE, SECUNDARIO (S/N 539530 EN ADELANTE)	GA-680	AR79680	ACEITE	GP-14	T19044	ACEITE, LUBRICACION DEL MOTOR (HASTA S/N 586337)	GP-754	RE59754
540G con motor/JOHN DEERE 6068 SERIES			COMBUSTIBLE, SEPARADOR DE AGUA	GPP-14	AT81478	AIRE, ESTANDAR, PRIMARIO (HASTA S/N 583532)	GA-679	AR79679
COMBUSTIBLE, OPCIONAL (S/N 586337 EN ADELANTE)	GPP-423	RE509032	COMBUSTIBLE	G-295	AR50041	AIRE, ESTANDAR, SECUNDARIO (HASTA S/N 583532)	GA-680	AR79680
COMBUSTIBLE, PRIMARIO (HASTA S/N 586337)	GPP-424	RE62424	HIDRAULICO (SIN TALADORA)	GP-864H	AT103193	GASOLINA, RESPIRADOR DEL TANQUE HIDRAULICO	GG-5 L	AT101565
COMBUSTIBLE	GPP-419	RE62419	TRANSMISION	GP-864H	AT103193	548G SERIES II con motor/A DIESEL		
ACEITE, LUBRICACION DEL MOTOR (HASTA S/N 586337)	GP-754	RE59754	544E con motor/A DIESEL			COMBUSTIBLE, PRIMARIO	GPP-424	RE62424
AIRE, ESTANDAR, PRIMARIO (HASTA S/N 583532)	GA-679	AR79679	ACEITE	GP-14	T19044	COMBUSTIBLE, SECUNDARIO	GPP-419	RE62419
AIRE, ESTANDAR, SECUNDARIO (HASTA S/N 583532)	GA-680	AR79680	COMBUSTIBLE, SEPARADOR DE AGUA	GPP-14	AT81478	ACEITE	GP-754	RE59754
GASOLINA, RESPIRADOR DEL TANQUE HIDRAULICO	GG-5 L	AT101565	COMBUSTIBLE	G-295	AR50041	AIRE, PRIMARIO	GA-679	AR79679
540G SERIES II con motor/A DIESEL			AIRE, PRIMARIO (S/N 300000 EN ADELANTE)	GA-679	AR79679	AIRE, SECUNDARIO	GA-680	AR79680
COMBUSTIBLE, PRIMARIO	GPP-424	RE62424	AIRE, SECUNDARIO (S/N 300000 EN ADELANTE)	GA-680	AR79680	548G SERIES III con motor/JOHN DEERE 6068 SERIES		
COMBUSTIBLE, SECUNDARIO	GPP-419	RE62419	544E-TC SOBRE RUEDAS con motor/A DIESEL			COMBUSTIBLE, PRIMARIO (MOTOR 6068T)	GPP-424	RE62424
ACEITE	GP-754	RE59754	ACEITE	GP-14	T19044	COMBUSTIBLE, FILTRO FINAL (MOTOR 6068T)	GPP-419	RE62419
AIRE, PRIMARIO	GA-679	AR79679	COMBUSTIBLE	G-295	AR50041	ACEITE, MOTOR 6068TDW54	GP-754	RE59754
AIRE, SECUNDARIO	GA-680	AR79680	AIRE	GA-679	AR79679	AIRE, PRIMARIO	GA-679	AR79679
540G SERIES III con motor/JOHN DEERE 6068 SERIES			AIRE	GA-680	AR79680	AIRE, SECUNDARIO	GA-680	AR79680
COMBUSTIBLE, PRIMARIO (MOTOR 6068T)	GPP-424	RE62424	544G con motor/JOHN DEERE 6059T			AIRE, PRIMARIO S/N 583532-586336	GA-697R	AT222722
COMBUSTIBLE, FILTRO FINAL (MOTOR 6068T)	GPP-419	RE62419	ACEITE	GP-14	T19044	555 SOBRE ORUGAS con motor/A DIESEL		
ACEITE, MOTOR 6068TDW54	GP-754	RE59754	COMBUSTIBLE	G-295	AR50041	TRANSMISION	G-331	AR75603
AIRE, PRIMARIO (HASTA S/N 582802)	GA-679	AR79679	AIRE	GA-679	AR79679	ACEITE	GP-14	T19044
AIRE, SECUNDARIO (HASTA S/N 582802)	GA-680	AR79680	AIRE	GA-680	AR79680	ACEITE, TORNO	GP-14	T19044
AIRE, PRIMARIO S/N 583532-586336	GA-697R	AT222722	544G-TC SOBRE RUEDAS con motor/A DIESEL			COMBUSTIBLE	G-295	AR50041
544 con motor/A DIESEL			ACEITE	GP-14	T19044	AIRE, PRIMARIO	GA-403	AT65296
DIRECCION	G-331	AR75601	COMBUSTIBLE	G-295	AR50041	555A SOBRE ORUGAS, 555B SOBRE ORUGAS con motor/A DIESEL		
TRANSMISION	G-331	AR75601	AIRE	GA-3916	T141760	TRANSMISION	G-331	AR75603
ACEITE	GP-14	T19044	AIRE	GA-679	AR79679	ACEITE	GP-14	T19044
COMBUSTIBLE, HASTA S/N 160681	G-296	AT17387	AIRE	GA-680	AR79680	ACEITE, TORNO	GP-14	T19044
COMBUSTIBLE, S/N 160681 EN ADELANTE	G-295	AR50041	544G-TC SOBRE RUEDAS con motor/A DIESEL			COMBUSTIBLE	G-295	AR50041
COMBUSTIBLE, HASTA S/N 160681	G-296-B	AT17387	ACEITE	GP-14	T19044	555G SOBRE ORUGAS con motor/A DIESEL		
544A con motor/A DIESEL			COMBUSTIBLE	GPP-1003S	RE62424	ACEITE	GP-14	T19044
DIRECCION	G-331	AR75601	AIRE	GA-3916	T141760	COMBUSTIBLE, SEPARADOR DE AGUA	GPP-14	AT81478
TRANSMISION	G-331	AR75601	AIRE	GA-679	AR79679	COMBUSTIBLE	G-295	AR50041
ACEITE	GP-14	T19044	AIRE	GA-680	AR79680	AIRE, SIN TURBO PRIMARIO	GA-403	AT65296
COMBUSTIBLE, HASTA S/N 160681	G-296	AT17387	544H, 544H LL, 544HTC con motor/JOHN DEERE 6068 POWERTECH			5575, 7775 con motor/JOHN DEERE 220 SERIES		
COMBUSTIBLE, S/N 160681 EN ADELANTE	G-295	AR50041	COMBUSTIBLE, SEPARADOR DE AGUA	GPP-424	RE62424	ACEITE	GP-149	M801209
COMBUSTIBLE, HASTA S/N 160681	G-296-B	AT17387	COMBUSTIBLE	GPP-419	RE62419	AIRE, PRIMARIO	GAK-16	RE45825
544J con motor/JOHN DEERE 6068H			ACEITE	GP-754	RE59754	GASOLINA	GG-5 L	AE29052
COMBUSTIBLE, OPCIONAL	GPP-423	RE509032	AIRE, PRIMARIO	GA-697R	AT203469	560D con motor/JOHN DEERE 6081T		
548E con motor/A DIESEL			544J con motor/JOHN DEERE 6068H			COMBUSTIBLE, SEPARADOR DE AGUA	GPP-426	RE65431
ACEITE	GP-14	T19044	COMBUSTIBLE, OPCIONAL	GPP-423	RE509032			

APLICACIONES SERVICIO PESADO
HEAVY DUTY APPLICATIONS



MARCA-MODELO-MOTOR MAKE-MODEL-ENGINE	GONHER GONHER	OEM OEM	MARCA-MODELO-MOTOR MAKE-MODEL-ENGINE	GONHER GONHER	OEM OEM	MARCA-MODELO-MOTOR MAKE-MODEL-ENGINE	GONHER GONHER	OEM OEM
JOHN DEERE (continuación)			JOHN DEERE (continuación)			JOHN DEERE (continuación)		
CARGADORAS			CARGADORAS			CARGADORAS		
ACEITE	GP-35	RE57394	624E, 640E con motor/A DIESEL			ACEITE	GP-34	AR43634
COMBUSTIBLE	G-270	AR86745	ACEITE	GP-14	T19044	COMBUSTIBLE, S/N 280000 EN ADELANTE	G-295	AR50041
570 con motor/A GASOLINA			COMBUSTIBLE, SEPARADOR DE AGUA	GPP-14	AT81478	644B con motor/A DIESEL		
ACEITE	GP-9	MG508129	COMBUSTIBLE	G-295	AR50041	DIRECCION	G-331	AR75603
TRANSMISION	GP-34	636843	AIRE, PRIMARIO	GA-679	AR79679	TRANSMISION	G-331	AR75603
GASOLINA	GG-4	AM116304	AIRE, SECUNDARIO	GA-680	AR79680	ACEITE	GP-34	AR43634
575 con motor/YANMAR			624G con motor/JOHN DEERE 6068T			COMBUSTIBLE	G-295	AR50041
HIDRAULICO	GP-34	636843	ACEITE	GP-14	T19044	ACEITE	GP-35	RE57394
ACEITE	GP-40	M801209	ACEITE, VUELTA DE LA CERRADURA DEL DIFERENCIAL	GP-14	T19044	644C con motor/A DIESEL		
COMBUSTIBLE, SEPARADOR DE AGUA	G-294	AM101004	COMBUSTIBLE, SEPARADOR DE AGUA	GPP-424	RE62424	DIRECCION	G-331	AR75603
GASOLINA	GG-5 L	AE29052	COMBUSTIBLE	GPP-419	RE62419	TRANSMISION	G-331	AR75603
577A RETROEXCAVADORA con motor/A DIESEL			AIRE, PRIMARIO	GA-679	AR79679	COMBUSTIBLE, SEPARADOR DE AGUA	GPP-14	AT81478
TRANSMISION	G-331	AR75603	AIRE, SECUNDARIO	GA-680	AR79680	ACEITE, HASTA S/N 248523	GP-34	AR43634
ACEITE	GP-14	T19044	624H, 624H LL con motor/JOHN DEERE 6068 POWERTECH			COMBUSTIBLE, HASTA S/N 241582	G-295	AR50041
COMBUSTIBLE	G-295	AR50041	COMBUSTIBLE, SEPARADOR DE AGUA	GPP-424	RE62424	ACEITE, S/N 248524 EN ADELANTE	GP-35	AR101278
60 con motor/A GASOLINA			COMBUSTIBLE, FILTRO FINAL	GPP-419	RE62419	COMBUSTIBLE, S/N 241583 EN ADELANTE	G-270	AR86745
HIDRAULICO	GP-36	AM107481	ACEITE	GP-754	RE59754	644D con motor/JOHN DEERE 6466T		
TRANSMISION	GP-36	AM107481	624J con motor/JOHN DEERE 6068H			COMBUSTIBLE, SEPARADOR DE AGUA	GPP-14	AT81478
ACEITE, S/N 120001 EN ADELANTE	GP-58	AM101207	COMBUSTIBLE	GPP-423	RE509032	ACEITE	GP-35	AR101278
GASOLINA	GG-5 L	AE29052	640 con motor/A DIESEL			TRANSMISION	GP-864H	AT103193
600 con motor/A DIESEL			HIDRAULICO	G-331	AR75603	COMBUSTIBLE	G-270	AR86745
ACEITE	G-139	AR26350	TRANSMISION	G-331	AR75603	644E con motor/A DIESEL		
TRANSMISION	G-331	AR75603	ACEITE	GP-14	T19044	COMBUSTIBLE, SEPARADOR DE AGUA	GPP-14	AT81478
COMBUSTIBLE, HASTA S/N 215000	GPP-14	AT81478	COMBUSTIBLE	G-295	AR50041	ACEITE, VUELTA DE LA CERRADURA DEL DIFERENCIAL	GP-35	AR101278
AIRE	GAK-20	AR36044	640D con motor/A DIESEL			COMBUSTIBLE	G-270	AR86745
600 RETROEXCAVADORA con motor/A DIESEL			ACEITE	GP-14	T19044	AIRE, PRIMARIO (S/N 536538 EN ADELANTE)	GA-679	AR79679
ACEITE, CARTUCHO	G-139	AR28110R	640G con motor/JOHN DEERE 6068 SERIES			AIRE, SECUNDARIO (S/N 536538 EN ADELANTE)	GA-680	AR79680
DIRECCION	G-331	AR75603	COMBUSTIBLE, OPCIONAL (S/N 586337 EN ADELANTE)	GPP-423	RE509032	644ER con motor/A DIESEL		
TRANSMISION	G-331	AR75603	COMBUSTIBLE, PRIMARIO (HASTA S/N 586337)	GPP-424	RE62424	ACEITE	GP-35	RE57394
ACEITE, SELLADO	GP-14	T19044	COMBUSTIBLE	GPP-419	RE62419	644G con motor/JOHN DEERE 6076		
COMBUSTIBLE, PRIMARIO	GPP-14	AR45097	ACEITE, LUBRICACION DEL MOTOR (HASTA S/N 586337)	GP-754	RE59754	ACEITE, VUELTA DE LA CERRADURA DEL DIFERENCIAL	GP-14	T19044
COMBUSTIBLE	G-296	AT17387	AIRE, ESTANDAR, PRIMARIO (HASTA S/N 582802)	GA-679	AR79679	COMBUSTIBLE, SEPARADOR DE AGUA	GPP-426	RE62423
COMBUSTIBLE	G-296-B	AT17387	AIRE, ESTANDAR, SECUNDARIO (HASTA S/N 582802)	GA-680	AR79680	ACEITE	GP-35	AR101278
AIRE	GAK-403	AR39799	GASOLINA, RESPIRADOR DEL TANQUE HIDRAULICO	GG-5 L	AT101565	COMBUSTIBLE	G-270	RE27091
AIRE	GAK-20	AR36044	640G SERIES II con motor/A DIESEL			644H con motor/JOHN DEERE 6081 POWERTECH		
600 RETROEXCAVADORA con motor/A GASOLINA			COMBUSTIBLE, PRIMARIO	GPP-424	RE62424	COMBUSTIBLE, SEPARADOR DE AGUA (HASTA S/N 2000)	GPP-426	RE65431
DIRECCION	G-331	AR75603	COMBUSTIBLE, SECUNDARIO	GPP-419	RE62419	ACEITE	GP-35	RE57394
TRANSMISION	G-331	AR75603	ACEITE	GP-754	RE59754	COMBUSTIBLE, HASTA S/N 2000	G-270	AR86745
ACEITE	GP-14	T19044	AIRE, PRIMARIO	GA-679	AR79679	648 con motor/A DIESEL		
AIRE	GAK-403	AR39799	AIRE, SECUNDARIO	GA-680	AR79680	ACEITE	GP-14	T19044
605C con motor/A DIESEL			644 con motor/A DIESEL			648D DE TRONCOS con motor/A DIESEL		
HIDRAULICO	GP-761H	T175002	DIRECCION	G-331	AR75603	ACEITE	GP-14	T19044
COMBUSTIBLE	GPP-419	RE509031	TRANSMISION	G-331	AR75603	648E con motor/A DIESEL		
AIRE, PRIMARIO	GA-697R	AT222722	ACEITE	GP-34	AR43634	ACEITE	GP-14	T19044
610B RETROEXCAVADORA con motor/A DIESEL			COMBUSTIBLE, S/N 280000 EN ADELANTE	G-295	AR50041	648E con motor/A DIESEL		
ACEITE	GP-14	T19044	644A con motor/A DIESEL			ACEITE	GP-14	T19044
COMBUSTIBLE	G-295	AR50041	DIRECCION	G-331	AR75603	COMBUSTIBLE, SEPARADOR DE AGUA	GPP-14	AT81478
AIRE, PRIMARIO	GA-403	AT65296	TRANSMISION	G-331	AR75603			
610C RETROEXCAVADORA con motor/A DIESEL								
ACEITE	GP-14	T19044						
COMBUSTIBLE	G-295	AR50041						
AIRE, CON TURBO PRIMARIO	GA-403	AT65296						

SERVICIO PESADO

MARCA-MODELO-MOTOR MAKE-MODEL-ENGINE	GONHER GONHER	OEM OEM	MARCA-MODELO-MOTOR MAKE-MODEL-ENGINE	GONHER GONHER	OEM OEM	MARCA-MODELO-MOTOR MAKE-MODEL-ENGINE	GONHER GONHER	OEM OEM
JOHN DEERE (continuación)			JOHN DEERE (continuación)			JOHN DEERE (continuación)		
CARGADORAS			CARGADORAS			CARGADORAS		
COMBUSTIBLE	G-295	AR50041	COMBUSTIBLE	G-294	AM101004	ACEITE, S/N 248524 EN ADELANTE	GP-35	AR101278
AIRE, PRIMARIO	GA-679	AR79679	GASOLINA, SEPARADOR DE AGUA	GG-5 L	AE29052	COMBUSTIBLE	G-270	AR86745
AIRE, SECUNDARIO	GA-680	AR79680				COMBUSTIBLE, S/N 299564 EN ADELANTE	G-270	AR86745
648G con motor/JOHN DEERE 6068 SERIES			675B con motor/A DIESEL			AIRE, PRIMARIO	GA-826	AT44631
COMBUSTIBLE, OPCIONAL (S/N 586337 EN ADELANTE)	GPP-423	RE509032	HIDRAULICO	GP-34	MG9800097	AIRE, PRIMARIO (S/N 218117 EN ADELANTE)	GA-826	AT44631
COMBUSTIBLE, PRIMARIO (HASTA S/N 586337)	GPP-424	RE62424	ACEITE	GP-149	M801209	AIRE, SECUNDARIO	GA-827	AT44632
COMBUSTIBLE	GPP-419	RE62419	GASOLINA, SEPARADOR DE AGUA	GG-5 L	AE29052	AIRE, SECUNDARIO (S/N 218117 EN ADELANTE)	GA-827	AT44632
ACEITE, LUBRICACION DEL MOTOR (HASTA S/N 586337)	GP-754	RE59754						
AIRE, ESTANDAR, PRIMARIO (HASTA S/N 582802)	GA-679	AR79679	70 con motor/ONAN					
AIRE, ESTANDAR, SECUNDARIO (HASTA S/N 582802)	GA-680	AR79680	ACEITE	GP-3600	HE122-0800			
GASOLINA, RESPIRADOR DEL TANQUE HIDRAULICO	GG-5 L	AT101565				740A DE TRONCOS con motor/A DIESEL		
			700 RETROEXCAVADORA con motor/A DIESEL			ACEITE, HASTA S/N 248523	GP-34	AR43634
648G con motor/JOHN DEERE 6076			ACEITE	G-331	AR75603	COMBUSTIBLE, HASTA S/N 241582	G-295	AR50041
ACEITE, HASTA S/N 701060	GP-14	T19044	TRANSMISION	G-331	AR75603	ACEITE, S/N 248524 EN ADELANTE	GP-35	AR101278
COMBUSTIBLE	G-295	AR50041	COMBUSTIBLE, PRIMARIO	GPP-14	AR33926R	COMBUSTIBLE, S/N 241583 EN ADELANTE	G-270	AR86745
ACEITE, S/N 701060 EN ADELANTE	GP-754	RE59754	COMBUSTIBLE	G-296	AT17387	AIRE, PRIMARIO	GA-826	AT44631
AIRE, PRIMARIO	GA-679	AR79679	COMBUSTIBLE	G-295	AR50041	AIRE, SECUNDARIO	GA-827	AT44632
AIRE, SECUNDARIO	GA-680	AR79680	COMBUSTIBLE	G-296-B	AT17387			
			AIRE, HASTA S/N 24037	GAK-20	AR36044			
648G SERIES II con motor/A DIESEL			700A RETROEXCAVADORA con motor/A DIESEL			740E con motor/A DIESEL		
COMBUSTIBLE, PRIMARIO	GPP-424	RE62424	ACEITE	G-331	AR75603	COMBUSTIBLE, SEPARADOR DE AGUA	GPP-14	AT81478
COMBUSTIBLE, SECUNDARIO	GPP-419	RE62419	COMBUSTIBLE	GPP-14	AR33926R	ACEITE	GP-35	RE57394
ACEITE	GP-754	RE59754	COMBUSTIBLE	G-296	AT17387	COMBUSTIBLE	G-270	RE27091
AIRE, PRIMARIO	GA-679	AR79679	COMBUSTIBLE	G-295	AR50041	AIRE, PRIMARIO	GA-679	AR79679
AIRE, SECUNDARIO	GA-680	AR79680	COMBUSTIBLE	G-296-B	AT17387	AIRE, SECUNDARIO	GA-680	AR79680
648G SERIES III con motor/JOHN DEERE 6068 SERIES			710B RETROEXCAVADORA, 710C RETROEXCAVADORA con motor/A DIESEL			740G con motor/A DIESEL		
COMBUSTIBLE, PRIMARIO (MOTOR 6068T)	GPP-424	RE62424	ACEITE	GP-14	T19044	COMBUSTIBLE, SEPARADOR DE AGUA	GPP-14	AT81478
COMBUSTIBLE, FILTRO FINAL (MOTOR 6068T)	GPP-419	RE62419				ACEITE	GP-35	RE57394
ACEITE, MOTOR 6068T	GP-754	RE59754	710D RETROEXCAVADORA con motor/A DIESEL			COMBUSTIBLE, SEPARADOR DE AGUA	GPP-424	RE62424
AIRE, PRIMARIO (HASTA S/N 582802)	GA-679	AR79679	ACEITE	GP-14	T19044	COMBUSTIBLE	G-270	RE27091
AIRE, SECUNDARIO (HASTA S/N 582802)	GA-680	AR79680	COMBUSTIBLE	G-295	AR50041	AIRE, PRIMARIO	GA-679	AR79679
			COMBUSTIBLE	GPP-419	RE62419	AIRE, SECUNDARIO	GA-680	AR79680
655 SOBRE ORUGAS con motor/A DIESEL								
ACEITE	GP-14	T19044	710E RETROEXCAVADORA con motor/A DIESEL			744E con motor/A DIESEL		
COMBUSTIBLE	G-295	AR50041	ACEITE	GP-14	T19044	ACEITE, FLUJO TOTAL (FULL FLOW)	GP-53	RE45576
TRANSMISION	GP-864H	AT135800				COMBUSTIBLE, SELLADO SEPARADOR DE AGUA	GPP-426	RE62423
			710G RETROEXCAVADORA con motor/JOHN DEERE 4045 POWER-TECH			ACEITE, DOBLE FLUJO	GP-3000	RE44647
655B SOBRE ORUGAS con motor/A DIESEL			COMBUSTIBLE, PRE-FILTRO	GPP-424	RE516477	COMBUSTIBLE	G-270	RE27091
ACEITE	GP-14	T19044	COMBUSTIBLE, FILTRO FINAL	GPP-419	RE509031	COMBUSTIBLE, CARTUCHO SEPARADOR DE AGUA	2010PM-OR	RE11325
COMBUSTIBLE	G-295	AR50041	AIRE, PRIMARIO	GA-697R	AT222722			
TRANSMISION	GP-864H	AT135800						
			710J RETROEXCAVADORA con motor/JOHN DEERE 6068T POWER-TECH			744H con motor/JOHN DEERE 6125A POWERTECH		
655C SERIES II SOBRE ORUGAS con motor/LIEBHERR D924T			COMBUSTIBLE	GPP-419	RE509031	HIDRAULICO	GP-14	T19044
AGUA, SISTEMA DE ENFRIAMIENTO	GP-1010Q	WF2072						
			724J con motor/JOHN DEERE 6081 POWERTECH			744H MH, 824J con motor/A DIESEL		
655C SOBRE ORUGAS con motor/LIEBHERR D924T			COMBUSTIBLE, SEPARADOR DE AGUA (HASTA S/N 2000)	GPP-426	RE65431	HIDRAULICO	GP-14	T19044
AGUA	GP-1011Q	AR94650	ACEITE	GP-35	RE57394	744J con motor/JOHN DEERE 6125 POWERTECH		
			COMBUSTIBLE, HASTA S/N 2000	G-270	AR86745	HIDRAULICO	GP-14	T19044
6675 con motor/JOHN DEERE 220 SERIES								
AIRE, PRIMARIO	GAK-16	RE45825	740 con motor/A DIESEL			748E con motor/A DIESEL		
			HIDRAULICO (HASTA S/N 291775)	G-331	AR75603	COMBUSTIBLE, SEPARADOR DE AGUA	GPP-14	AT81478
675 con motor/A DIESEL			TRANSMISION	G-331	AR75603	ACEITE	GP-35	RE57394
HIDRAULICO	GP-34	MG9800097	ACEITE	GP-34	AR43634	COMBUSTIBLE	G-270	RE27091
ACEITE	GP-149	M801209	ACEITE, HASTA S/N 248524	GP-34	AR43634	AIRE, PRIMARIO	GA-679	AR79679
			COMBUSTIBLE, HASTA S/N 299564	G-295	AR50041	AIRE, SECUNDARIO	GA-680	AR79680

MARCA-MODELO-MOTOR MAKE-MODEL-ENGINE	GONHER GONHER	OEM OEM	MARCA-MODELO-MOTOR MAKE-MODEL-ENGINE	GONHER GONHER	OEM OEM	MARCA-MODELO-MOTOR MAKE-MODEL-ENGINE	GONHER GONHER	OEM OEM
JOHN DEERE (continuación)			JOHN DEERE (continuación)			JOHN DEERE (continuación)		
CARGADORAS			CARGADORAS			COMBINADAS		
748G con motor/JOHN DEERE 6076			848G con motor/CUMMINS 6CTA8.3			ACEITE, S/N 45001 EN ADELANTE	GP-754	RE59754
COMBUSTIBLE, SEPARADOR DE AGUA (HASTA S/N 552273)	GPP-14	AT81478	ACEITE, DOBLE FLUJO	GP-3000	RE44647	1175H con motor/A DIESEL		
COMBUSTIBLE, SEPARADOR DE AGUA (S/N 552273 EN ADELANTE)	GPP-424	RE62424	848G con motor/JOHN DEERE 6081 POWERTECH			ACEITE, HASTA S/N 45001	GP-14	T19044
ACEITE	GP-754	RE59754	COMBUSTIBLE, SEPARADOR DE AGUA	GPP-426	RE65431	COMBUSTIBLE	GPP-419	RE64450
COMBUSTIBLE	G-270	RE27091	ACEITE	GP-35	RE57394	ACEITE, S/N 45001 EN ADELANTE	GP-754	RE59754
AIRE, PRIMARIO (HASTA S/N 559115)	GA-679	AR79679	COMBUSTIBLE	G-270	AR86745	1177 (ENSAMBLADO EN ALEMANIA) con motor/A DIESEL		
AIRE, SECUNDARIO (HASTA S/N 559115)	GA-680	AR79680	855 SOBRE ORUGAS con motor/A DIESEL			ACEITE	GP-14	T19044
748G SERIES II con motor/JOHN DEERE 6081			ACEITE, FLUJO TOTAL (FULL FLOW)	GP-35	AR101278	COMBUSTIBLE	G-295	AR50041
COMBUSTIBLE, SEPARADOR DE AGUA (HASTA S/N 552273)	GPP-14	AT81478	TRANSMISION	GP-864H	AT135800	HIDRAULICO	GP-66	AZ22878
COMBUSTIBLE	GPP-426	RE65431	COMBUSTIBLE	G-270	AR86745	1177H (ENSAMBLADO EN ALEMANIA) con motor/A DIESEL		
ACEITE	GP-35	RE57394	8875 con motor/JOHN DEERE 3029T			HIDRAULICO	GP-66	AZ22878
COMBUSTIBLE, SEPARADOR DE AGUA (S/N 552273 EN ADELANTE)	GPP-424	RE62424	ACEITE	GP-14	T19044	ACEITE	GP-35	AR101278
AIRE, PRIMARIO (HASTA S/N 559115)	GA-679	AR79679	COMBUSTIBLE	GPP-418	RE64449	COMBUSTIBLE	G-270	AR86745
AIRE, SECUNDARIO (HASTA S/N 559115)	GA-680	AR79680	AIRE, PRIMARIO	GAK-458	MG86512356	1188 (ENSAMBLADO EN ALEMANIA) con motor/A DIESEL		
748G SERIES III con motor/JOHN DEERE 6081T			AIRE, SECUNDARIO	GA-459	RE45828	HIDRAULICO	GP-66	AZ22878
COMBUSTIBLE, SEPARADOR DE AGUA	GPP-14	AT81478	GASOLINA	GG-5 L	AE29052	ACEITE	GP-35	RE57394
ACEITE, SELLADO	GP-35	RE57394	90 con motor/A GASOLINA			COMBUSTIBLE	G-270	AR86745
COMBUSTIBLE, SEPARADOR DE AGUA	GPP-424	RE62424	HIDROESTATICO	GP-864H	AT135800	12 con motor/A DIESEL		
COMBUSTIBLE	G-270	RE27091	CT332 con motor/JOHN DEERE 5030TW			ACEITE, SELLADO	GP-14	T19044
AIRE, PRIMARIO	GA-679	AR79679	HIDRAULICO	GP-761H	AT314164	AIRE, SIN ASPAS	GA-33	AH19847
AIRE, SECUNDARIO	GA-680	AR79680	AIRE, RADIAL PRIMARIO	GA-853R	KV16429	AIRE	GAK-16	AT20728
755 SOBRE ORUGAS, 755A SOBRE ORUGAS con motor/A DIESEL			LINEA DE COMBUSTIBLE	GG-5 L	AE29052	1460 con motor/A DIESEL		
ACEITE	GP-14	T19044	GASOLINA, LINEA DEL RESPIRADOR DEL TANQUE HIDRAULICO	GG-5 L	AT101565	COMBUSTIBLE, PRIMARIO	GP-1101	158172
COMBUSTIBLE	G-295	AR50041	JOHN DEERE			ACEITE	GP-69	LF3421
TRANSMISION	GP-864H	AT135800	COMBINADAS			COMBUSTIBLE, SECUNDARIO	GP-78	MG508129
755B SOBRE ORUGAS con motor/A DIESEL			105 con motor/A DIESEL			162 con motor/A DIESEL		
ACEITE	GP-14	T19044	ACEITE, MOTORES JOHN DEERE	GP-14	T19044	AIRE, CON ASPAS	GAK-403	AH20488
COMBUSTIBLE	G-295	AR50041	COMBUSTIBLE	G-296	AT17387	2054 con motor/A DIESEL		
TRANSMISION (HASTA S/N 731274)	GP-864H	AT135800	COMBUSTIBLE	G-296-B	AT17387	ACEITE	GP-14	T19044
755C SOBRE ORUGAS con motor/LIEBHERR D926T			AIRE, MOTORES A GASOLINA	GAK-403	AH20488	2056, 2058 con motor/A DIESEL		
HIDRAULICO	GP-66	HF7968	AIRE, 9 15/16 IN DIAM. EXT.	GAK-20	AR36044	ACEITE	GP-35	RE46380
830 RETROEXCAVADORA con motor/A DIESEL			1055 (ENSAMBLADO EN ALEMANIA), 1065(ENSAMBLADO EN ALEMANIA), 1068(ENSAMBLADO EN ALEMANIA), 1068H, 1075 (ENSAMBLADO EN ALEMANIA), 1166 (ENSAMBLADO EN ALEMANIA), 1169H (ENSAMBLADO EN ALEMANIA), 1174 (ENSAMBLADO EN ALEMANIA) con motor/A DIESEL			2064, 2066 con motor/JOHN DEERE 6076 POWERTECH		
ACEITE	G-331	AR75603	ACEITE	GP-14	T19044	ACEITE	GP-35	RE57394
84 con motor/A DIESEL			COMBUSTIBLE	G-295	AR50041	25, 30, 40 con motor/A DIESEL		
ACEITE	GP-24	T1113883	HIDRAULICO	GP-66	AZ22878	ACEITE, SELLADO	GP-14	T19044
844 con motor/A DIESEL			1065 con motor/A DIESEL			AIRE, SIN ASPAS	GA-33	AH19847
GASOLINA, SEPARADOR DE AGUA (HASTA S/N 506810)	G-293	AR86755	ACEITE	GP-14	T19044	AIRE	GAK-16	AT20728
ACEITE, FLUJO TOTAL (FULL FLOW)	GP-34	AR43634	COMBUSTIBLE	G-295	AR50041	3300 con motor/JOHN DEERE 219 DH		
ACEITE	GP-35	RE57394	HIDRAULICO	GP-66	AZ22878	ACEITE, SELLADO	GP-14	T19044
ACEITE, FLUJO TOTAL (FULL FLOW)	GP-35	RE46380	1085, 1085 H4 (HYDRO 4) con motor/A DIESEL			COMBUSTIBLE	G-296	AT17387
COMBUSTIBLE	G-270	AR86745	HIDRAULICO	GP-66	AZ22878	COMBUSTIBLE	G-295	AR50041
COMBUSTIBLE, SEPARADOR DE AGUA (S/N 506810 EN ADELANTE)	2010PM-OR	RE11325	111 PEANUT con motor/A DIESEL			COMBUSTIBLE	G-296-B	AT17387
			AIRE	GAK-16	AT20728	AIRE	GAK-403	AT44377
			1165, 1175 con motor/A DIESEL			3300 con motor/JOHN DEERE 219 GH		
			ACEITE, HASTA S/N 45001	GP-14	T19044	ACEITE, SELLADO	GP-14	T19044
			COMBUSTIBLE	GPP-419	RE64450	COMBUSTIBLE	G-296	AT17387
						COMBUSTIBLE	G-296-B	AT17387
						AIRE	GAK-16	AT20728
						4270D con motor/A DIESEL		
						COMBUSTIBLE	G-295	AR50041

SERVICIO PESADO

MARCA-MODELO-MOTOR MAKE-MODEL-ENGINE	GONHER GONHER	OEM OEM	MARCA-MODELO-MOTOR MAKE-MODEL-ENGINE	GONHER GONHER	OEM OEM	MARCA-MODELO-MOTOR MAKE-MODEL-ENGINE	GONHER GONHER	OEM OEM
JOHN DEERE (continuación)			JOHN DEERE (continuación)			JOHN DEERE (continuación)		
COMBINADAS			COMBINADAS			COMBINADAS		
4400 con motor/JOHN DEERE 292			55 con motor/A DIESEL			AIRE, PRIMARIO	GA-679	AR79679
ACEITE	GP-3	TY9429	ACEITE, SELLADO	GP-14	T19044	AIRE, SECUNDARIO	GA-680	AR79680
AIRE, HASTA S/N 250500	GAK-403	AT44377	COMBUSTIBLE	G-296	AT17387	6620, 6622 con motor/A DIESEL		
AIRE, S/N 250501 EN ADELANTE	GAK-20	AR36044	COMBUSTIBLE	G-296-B	AT17387	ACEITE, HASTA S/N 298393	GP-34	AR43634
			AIRE, 5 9/32 IN DIAM. EXT.	GAK-16	AT20728	ACEITE, S/N 298393 EN ADELANTE	GP-35	RE57394
			AIRE, 6 1/16 IN DIAM. EXT.	GAK-403	AH20847	COMBUSTIBLE	G-270	AR86745
4400 con motor/JOHN DEERE 6329DH			6510 MAXIMIZER con motor/A DIESEL			AIRE, PRIMARIO	GA-679	AR79679
ACEITE	GP-14	T19044	AIRE, PRIMARIO	GA-221R	RE63931	AIRE, SECUNDARIO	GA-680	AR79680
COMBUSTIBLE	G-295	AR50041				7000 con motor/A DIESEL		
COMBUSTIBLE	G-270	AR86745	6600 LEVEL LAND con motor/JOHN DEERE 6329DH			ACEITE	GP-34	AR43634
AIRE, HASTA S/N 250500	GAK-403	AT44377	ACEITE	GP-14	T19044	COMBUSTIBLE	G-295	AR50041
AIRE, S/N 250501 EN ADELANTE	GAK-20	AR36044	COMBUSTIBLE	G-296	AT17387	AIRE, PRIMARIO	GA-679	AR79679
			COMBUSTIBLE, S/N 422365 EN ADELANTE	G-295	AR50041	AIRE, SECUNDARIO	GA-680	AR79680
			COMBUSTIBLE	G-296-B	AT17387			
4400 SERIES con motor/GMC 6 CYL. 292			AIRE	GAK-20	AR36044	7700 con motor/JOHN DEERE 362GH		
ACEITE, 3 45/64 IN	GP-3	TY9429	6600 LEVEL LAND con motor/JOHN DEERE 6329GH			ACEITE	GP-14	T19044
ACEITE, 5 13/32 IN	GP-13	TY9430	ACEITE	GP-14	T19044	COMBUSTIBLE	G-295	AR50041
AIRE, HASTA S/N 250501	GAK-403	AT44377	COMBUSTIBLE	G-295	AR50041	HIDRAULICO	GP-166	AT60645
AIRE, S/N 250501 EN ADELANTE	GAK-20	AR36044	AIRE	GAK-403	AT44377	AIRE, PRIMARIO (S/N 163901 EN ADELANTE)	GAK-20	AR36044
4400 SERIES con motor/JOHN DEERE 303			6600 LEVEL LAND con motor/JOHN DEERE 6404DH			7700 con motor/JOHN DEERE 6404DH		
HIDRAULICO	G-331	AR75603	ACEITE	GP-34	AR43634	ACEITE	GP-34	AR43634
ACEITE	GP-14	T19044	COMBUSTIBLE	G-295	AR50041	COMBUSTIBLE	G-295	AR50041
COMBUSTIBLE	G-295	AR50041	AIRE	GAK-20	AR36044	AIRE	GAK-20	AR36044
4400 SERIES con motores/JOHN DEERE 219, JOHN DEERE 329			6600 LEVEL LAND con motor/JOHN DEERE HD-303G			7700 con motor/JOHN DEERE 6404TH		
ACEITE	GP-14	T19044	ACEITE	GP-14	T19044	ACEITE	GP-34	AR43634
COMBUSTIBLE	G-296	AT17387	COMBUSTIBLE	G-295	AR50041	COMBUSTIBLE	G-295	AR50041
COMBUSTIBLE, HASTA S/N 237162	G-295	AR50041	AIRE	GAK-403	AT44377	AIRE, PRIMARIO	GA-679	AR79679
COMBUSTIBLE	G-296-B	AT17387				AIRE, SECUNDARIO	GA-680	AR79680
COMBUSTIBLE, S/N 237163 EN ADELANTE	G-270	AR86745	6600 SERIES con motor/A GASOLINA					
AIRE, HASTA S/N 250500	GAK-403	AT44377	ACEITE	GP-14	T19044	7720 con motor/JOHN DEERE 6466A		
AIRE, S/N 250501 EN ADELANTE	GAK-20	AR36044	6600 SERIES con motor/JOHN DEERE 329			ACEITE, HASTA S/N 298393	GP-34	AR43634
			ACEITE	GP-14	T19044	ACEITE, S/N 298393 EN ADELANTE	GP-35	RE57394
			COMBUSTIBLE, HASTA S/N 237163	G-296	AT17387	COMBUSTIBLE	G-270	AR86745
			COMBUSTIBLE, S/N 237163 EN ADELANTE	G-295	AR50041	AIRE, PRIMARIO	GA-679	AR79679
			COMBUSTIBLE, HASTA S/N 237163	G-296-B	AT17387	AIRE, SECUNDARIO	GA-680	AR79680
			AIRE	GAK-20	AR36044			
4425 con motor/JOHN DEERE 6359			6600 SIDE HILL con motor/JOHN DEERE 404			7722, 8820 con motor/A DIESEL		
ACEITE	GP-14	T19044	ACEITE	GP-34	AR43634	ACEITE, HASTA S/N 298393	GP-34	AR43634
COMBUSTIBLE	G-295	AR50041	COMBUSTIBLE	G-295	AR50041	ACEITE, S/N 298393 EN ADELANTE	GP-35	RE57394
HIDRAULICO	GP-66	AZ22878	AIRE, S/N 16501-305672	GAK-20	AR36044	COMBUSTIBLE	G-270	AR86745
COMBUSTIBLE	G-270	AR86745	AIRE, PRIMARIO (S/N 305673 EN ADELANTE)	GA-679	AR79679	AIRE, PRIMARIO	GA-679	AR79679
			AIRE, SECUNDARIO (S/N 305673 EN ADELANTE)	GA-680	AR79680	AIRE, SECUNDARIO	GA-680	AR79680
4435 con motor/A DIESEL			6602 con motor/JOHN DEERE 362 GASOLINA			915 con motor/A DIESEL		
ACEITE	GP-14	T19044	ACEITE	GP-14	T19044	COMBUSTIBLE, PRIMARIO	GP-1101	158172
COMBUSTIBLE	G-295	AR50041	6602 con motor/JOHN DEERE 6404TH			ACEITE	GP-69	LF3421
HIDRAULICO	GP-66	AZ22878	ACEITE	GP-34	AR43634	COMBUSTIBLE, SECUNDARIO	GP-78	MG508129
			COMBUSTIBLE	G-295	AR50041	AIRE, PRIMARIO	GA-361	AR46004
			AIRE, PRIMARIO	GA-679	AR79679			
			AIRE, SECUNDARIO	GA-680	AR79680	9400 con motor/A DIESEL		
						ACEITE, HASTA S/N 337246	GP-14	T19044
4435 HYDRO con motor/A DIESEL			6602 con motor/JOHN DEERE 6466TH			COMBUSTIBLE, SEPARADOR DE AGUA	GPP-14	AT81478
ACEITE	GP-14	T19044	ACEITE	GP-34	AR43634	HIDRAULICO	GP-761H	AH128449
COMBUSTIBLE	G-295	AR50041	COMBUSTIBLE	G-270	AR86745			
HIDRAULICO	GP-66	AZ22878						
45 con motor/A DIESEL								
ACEITE, SELLADO	GP-14	T19044						
COMBUSTIBLE	G-296	AT17387						
COMBUSTIBLE	G-296-B	AT17387						
AIRE	GAK-16	AT20728						

MARCA-MODELO-MOTOR MAKE-MODEL-ENGINE	GONHER GONHER	OEM OEM	MARCA-MODELO-MOTOR MAKE-MODEL-ENGINE	GONHER GONHER	OEM OEM	MARCA-MODELO-MOTOR MAKE-MODEL-ENGINE	GONHER GONHER	OEM OEM
JOHN DEERE (continuación)			JOHN DEERE (continuación)			JOHN DEERE (continuación)		
COMBINADAS			COMBINADAS			COMBINADAS		
COMBUSTIBLE, S/N 337246 EN ADELANTE	GPP-419	RE62419	9550 con motor/JOHN DEERE 6068 POWERTECH			9610 con motor/A DIESEL		
ACEITE, S/N 337246 EN ADELANTE	GP-754	RE59754	COMBUSTIBLE	GPP-423	RE509032	COMBUSTIBLE, SEPARADOR DE AGUA	GPP-14	AT81478
COMBUSTIBLE, HASTA S/N 337246	G-270	AR86745	COMBUSTIBLE, SEPARADOR DE AGUA CON PURGADOR	GPP-1291	RE500186	ACEITE	GP-35	RE57394
9410 con motor/A DIESEL			HIDRAULICO (CAJA DE ENGRANES)	GP-761H	AH128449	COMBUSTIBLE	G-270	AR86745
DIRECCION	GP-761H	AH128449	HIDRAULICO (REQUIERE 2)	GP-761H	AH128449	AIRE, PRIMARIO	GA-221R	AH148880
TRANSMISION	GP-761H	AH128449	AIRE, RADIAL, PRIMARIO	GA-221R	AH148880	AIRE, SECUNDARIO	GA-723R	RE63932
COMBUSTIBLE	GPP-419	RE62419	AIRE, RADIAL, SECUNDARIO	GA-723R	RE63932	965 (ENSAMBLADO EN ALEMANIA), 975 (ENSAMBLADO EN ALEMANIA) con motor/A DIESEL		
ACEITE	GP-754	RE59754	COMBUSTIBLE, SEPARADOR DE AGUA CON ROSCA PARA TAZON	R 90 P	RE500186	ACEITE	GP-14	T19044
AIRE, SECUNDARIO	GA-723R	RE63932	9550 con motor/JOHN DEERE 6081			COMBUSTIBLE	G-295	AR50041
9410 MAXIMIZER con motor/JOHN DEERE 6081			ACEITE	GP-35	RE57394	HIDRAULICO	GP-66	AZ22878
COMBUSTIBLE, SEPARADOR DE AGUA	GPP-14	AT81478	COMBUSTIBLE, SEPARADOR DE AGUA	GPP-1291	RE500186	9650, 9750 con motor/JOHN DEERE 6081 POWERTECH		
ACEITE	GP-35	RE57394	COMBUSTIBLE	G-270	AR86745	ACEITE	GP-35	RE57394
COMBUSTIBLE	GPP-419	RE62419	AIRE, PRIMARIO	GA-221R	AH148880	COMBUSTIBLE, SEPARADOR DE AGUA	GPP-1291	RE500186
AIRE, PRIMARIO	GA-221R	AH148880	AIRE, SECUNDARIO	GA-723R	RE63932	COMBUSTIBLE	G-270	AR86745
AIRE, SECUNDARIO	GA-723R	RE63932	9550 SIDE HILL con motor/JOHN DEERE 6068 POWERTECH			AIRE, PRIMARIO	GA-221R	AH148880
942 (ENSAMBLADO EN ALEMANIA) con motor/A DIESEL			COMBUSTIBLE, SEPARADOR DE AGUA	GPP-1291	RE500186	AIRE, SECUNDARIO	GA-723R	RE63932
ACEITE	GP-14	T19044	AIRE, PRIMARIO	GA-221R	AH148880	9650CTS con motor/JOHN DEERE 6081 POWERTECH		
9450 con motor/JOHN DEERE 6068 POWERTECH			AIRE, SECUNDARIO	GA-732R	RE63932	ACEITE, HASTA S/N 202102	GP-35	RE57394
COMBUSTIBLE, SEPARADOR DE AGUA	GPP-1291	RE500186	9550 SIDE HILL con motor/JOHN DEERE 6081			COMBUSTIBLE, SEPARADOR DE AGUA	GPP-1291	RE500186
COMBUSTIBLE	GPP-419	RE62419	ACEITE	GP-35	RE57394	COMBUSTIBLE, HASTA S/N 20000	G-270	RE509672
ACEITE	GP-754	RE59754	COMBUSTIBLE, SEPARADOR DE AGUA	GPP-1291	RE500186	AIRE, PRIMARIO	GA-221R	AH148880
95 con motor/JOHN DEERE			COMBUSTIBLE	G-270	AR86745	AIRE, SECUNDARIO	GA-732R	RE63932
ACEITE, SELLADO	GP-14	T19044	AIRE, PRIMARIO	GA-221R	AH148880	9650STS con motor/JOHN DEERE 6081 POWERTECH		
COMBUSTIBLE	G-296	AT17387	AIRE, SECUNDARIO	GA-723R	RE63932	ACEITE, HASTA S/N 695984	GP-35	RE57394
COMBUSTIBLE	G-296-B	AT17387	9560 con motor/JOHN DEERE 6068HH			TANQUE DE COMBUSTIBLE (HASTA S/N 695501)	GPP-1291	RE500186
AIRE, HASTA S/N 35000	GAK-16	AT20728	COMBUSTIBLE, SEPARADOR DE AGUA	GPP-423	RE509032	COMBUSTIBLE, HASTA S/N 20000	G-270	AR86745
AIRE, S/N 35000 EN ADELANTE	GAK-403	AT44377	HIDRAULICO (REQUIERE 2)	GP-761H	AH128449	AIRE, PRIMARIO	GA-221R	AH148880
9500 con motor/A DIESEL			TRANSMISION	GP-761H	AH128449	AIRE, SECUNDARIO	GA-723R	RE63932
COMBUSTIBLE, SEPARADOR DE AGUA	GPP-14	AT81478	AIRE, RADIAL, PRIMARIO	GA-221R	AH148880	9660STS con motor/JOHN DEERE 6081 POWERTECH		
ACEITE	GP-35	RE57394	AIRE, RADIAL, SECUNDARIO	GA-723R	RE63932	AIRE, PRIMARIO	GA-221R	AH148880
HIDRAULICO	GP-761H	RE39527	9560SH con motor/JOHN DEERE 6068HH			9750STS con motor/JOHN DEERE 6081 POWERTECH		
TRANSMISION	GP-761H	RE39527	COMBUSTIBLE, SEPARADOR DE AGUA	GPP-423	RE509032	ACEITE, HASTA S/N 695866	GP-35	RE57394
COMBUSTIBLE	G-270	AR86745	HIDRAULICO (REQUIERE 2)	GP-761H	AH128449	COMBUSTIBLE, SEPARADOR DE AGUA	GPP-1291	RE500186
9500 SIDE HILL con motor/A DIESEL			TRANSMISION	GP-761H	AH128449	COMBUSTIBLE	G-270	AR86745
COMBUSTIBLE, SEPARADOR DE AGUA	GPP-14	AT81478	AIRE, RADIAL, PRIMARIO	GA-221R	AH148880	985, 985 HYDRO 4 con motor/A DIESEL		
ACEITE	GP-35	RE57394	AIRE, RADIAL, SECUNDARIO	GA-723R	RE63932	ACEITE	GP-14	T19044
HIDRAULICO	GP-761H	RE39527	9560STS con motor/JOHN DEERE 8.1L			CTS II con motor/A DIESEL		
TRANSMISION	GP-761H	RE39527	AIRE, PRIMARIO	GA-221R	AH148880	COMBUSTIBLE	GPP-14	AT81478
COMBUSTIBLE	G-270	AR86745	960 (ENSAMBLADO EN ALEMANIA) con motor/A DIESEL			ACEITE	GP-35	RE57394
AIRE, PRIMARIO	GA-221R	AH148880	ACEITE	GP-14	T19044	HIDRAULICO	GP-761H	AH128449
AIRE, SECUNDARIO	GA-723R	RE63932	COMBUSTIBLE	G-295	AR50041	COMBUSTIBLE	G-270	RE27091
9510 MAXIMIZER, 9510SH con motor/A DIESEL			AIRE	GAK-20	AR36044	AIRE, PRIMARIO	GA-221R	RE63931
COMBUSTIBLE, SEPARADOR DE AGUA	GPP-14	AT81478	9600 con motor/JOHN DEERE 6076 POWERTECH			AIRE, SECUNDARIO	GA-723R	RE63932
ACEITE	GP-35	RE57394	COMBUSTIBLE, SEPARADOR DE AGUA	GPP-14	AT81478	CTS RICE con motor/A DIESEL		
HIDRAULICO	GP-761H	RE39527	ACEITE	GP-35	RE57394	COMBUSTIBLE, SEPARADOR DE AGUA	GPP-14	AT81478
TRANSMISION	GP-761H	RE39527	HIDRAULICO	GP-761H	AH128449	ACEITE	GP-35	RE57394
COMBUSTIBLE	G-270	AR86745	TRANSMISION	GP-761H	AH128449	HIDRAULICO	GP-761H	AH128449
AIRE, PRIMARIO	GA-221R	AH148880	COMBUSTIBLE	G-270	RE27091	COMBUSTIBLE	G-270	RE27091
AIRE, SECUNDARIO	GA-723R	RE63932	9600 con motor/JOHN DEERE 6076 POWERTECH			COMBUSTIBLE, SEPARADOR DE AGUA	GPP-14	AT81478
955 (ENSAMBLADO EN ALEMANIA) con motor/A DIESEL			COMBUSTIBLE, SEPARADOR DE AGUA	GPP-14	AT81478	ACEITE	GP-35	RE57394
ACEITE	GP-14	T19044	ACEITE	GP-35	RE57394	ACEITE	GP-35	RE57394
COMBUSTIBLE	G-295	AR50041	HIDRAULICO	GP-761H	AH128449	HIDRAULICO	GP-761H	AH128449
AIRE SIMPLE HASTA S/N 014054	GAK-20	AR36044	TRANSMISION	GP-761H	AH128449	COMBUSTIBLE	G-270	RE27091
			COMBUSTIBLE	G-270	RE27091			

SERVICIO PESADO

MARCA-MODELO-MOTOR MAKE-MODEL-ENGINE	GONHER GONHER	OEM OEM	MARCA-MODELO-MOTOR MAKE-MODEL-ENGINE	GONHER GONHER	OEM OEM	MARCA-MODELO-MOTOR MAKE-MODEL-ENGINE	GONHER GONHER	OEM OEM
JOHN DEERE			JOHN DEERE (continuación)			JOHN DEERE (continuación)		
COMPACTADORAS			EQUIPO FORESTAL			EQUIPO FORESTAL		
646, 646B con motor/A DIESEL			AIRE, PRIMARIO	GA-679	AR79679	ACEITE, S/N 248524 EN ADELANTE	GP-35	RE57394
DIRECCION	G-331	AR75603	AIRE, SECUNDARIO	GA-680	AR79680	COMBUSTIBLE, S/N 241583 EN ADELANTE	G-270	AR86745
TRANSMISION	G-331	AR75603	643G con motor/JOHN DEERE 6068T			AIRE, PRIMARIO	GA-826	AT44631
ACEITE, HASTA S/N223645	GP-34	AR43634	COMBUSTIBLE, PRIMARIO	GPP-14	AT81478	AIRE, SECUNDARIO	GA-827	AT44632
COMBUSTIBLE	G-295	AR50041	COMBUSTIBLE, PRIMARIO	GPP-424	RE62424	743A con motor/A DIESEL		
ACEITE, S/N 223645 EN ADELANTE	GP-35	AR101278	COMBUSTIBLE, FILTRO FINAL	GPP-419	RE62419	ACEITE, HASTA S/N 248524	GP-34	AR43634
646C con motor/A DIESEL			ACEITE	GP-754	RE59754	COMBUSTIBLE, HASTA S/N 241583	G-295	AR50041
DIRECCION	G-331	AR75603	AIRE, PRIMARIO	GA-679	AR79679	ACEITE, S/N 248524 EN ADELANTE	GP-35	RE57394
TRANSMISION	G-331	AR75603	AIRE, SECUNDARIO	GA-680	AR79680	COMBUSTIBLE, S/N 241583 EN ADELANTE	G-270	AR86745
COMBUSTIBLE, SEPARADOR DE AGUA	GPP-14	AT81478	643H con motor/JOHN DEERE 6068T POWERTECH			AIRE, PRIMARIO	GA-826	AT44631
ACEITE, HASTA S/N 223645	GP-34	AR43634	COMBUSTIBLE, SEPARADOR DE AGUA	GPP-14	AT81478	AIRE, SECUNDARIO	GA-827	AT44632
COMBUSTIBLE, HASTA S/N 299563	G-295	AR50041	COMBUSTIBLE	GPP-419	RE62419	753G con motor/CUMMINS 6CT8.3		
ACEITE, S/N 223645 EN ADELANTE	GP-35	AR101278	ACEITE	GP-754	RE59754	ACEITE, DOBLE FLUJO	GP-3001	3401544
AGUA, HASTA S/N 256120	GP-1011Q	AR94650	AIRE, PRIMARIO	GA-679	AR79679	753G con motor/CUMMINS 6CTA8.3		
COMBUSTIBLE, S/N 299564 EN ADELANTE	G-270	AR86745	AIRE, SECUNDARIO	GA-680	AR79680	COMBUSTIBLE, SECUNDARIO	GP-1122	AR50041
JOHN DEERE			643J con motor/JOHN DEERE 6068H POWERTECH			753GH con motor/CUMMINS 6CT8.3		
EQUIPO FORESTAL			COMBUSTIBLE	GPP-423	RE509032	ACEITE, DOBLE FLUJO		
1010D con motor/JOHN DEERE 4045H			653E con motor/A DIESEL			753GH con motor/CUMMINS 6CTA8.3		
COMBUSTIBLE	GPP-419	RE509031	ACEITE	GP-14	T19044	ACEITE, DOBLE FLUJO		
1058 con motor/CUMMINS 4BTA3.9			COMBUSTIBLE, SEPARADOR DE AGUA	GPP-424	RE62424	753GL con motor/CUMMINS 6CT8.3		
AIRE, PRIMARIO	GA-697R	F434072	COMBUSTIBLE	GPP-419	RE62419	COMBUSTIBLE, SECUNDARIO		
1110D con motor/JOHN DEERE 6068H			AIRE, PRIMARIO	GA-679	AR79679	753GL con motor/CUMMINS 6CT8.3		
AIRE, PRIMARIO	GA-697R	F434072	AIRE, SECUNDARIO	GA-680	AR79680	ACEITE, DOBLE FLUJO		
317 con motor/A GASOLINA			653G con motor/JOHN DEERE 6068 POWERTECH			753GL con motor/CUMMINS 6CTA8.3		
GASOLINA	GG-5 L	AE29052	COMBUSTIBLE, SEPARADOR DE AGUA	GPP-14	AT81478	COMBUSTIBLE, SECUNDARIO		
360DC, 360DG con motor/JOHN DEERE 6068T			COMBUSTIBLE	GPP-419	RE62419	753GLH con motor/CUMMINS 6CT8.3		
COMBUSTIBLE, PRIMARIO	GPP-424	RE62424	ACEITE	GP-754	RE59754	ACEITE, DOBLE FLUJO		
COMBUSTIBLE, FILTRO FINAL	GPP-419	RE62419	AIRE, PRIMARIO	GA-679	AR79679	753GLH con motor/CUMMINS 6CTA8.3		
ACEITE	GP-754	RE59754	AIRE, SECUNDARIO	GA-680	AR79680	COMBUSTIBLE, SECUNDARIO		
AIRE, PRIMARIO HASTA S/N 583392	GA-679	AR79679	658E con motor/JOHN DEERE 6068T			793D con motor/A DIESEL		
AIRE, SECUNDARIO HASTA S/N 583392	GA-680	AR79680	ACEITE	GP-14	T19044	ACEITE		
AIRE, PRIMARIO, S/N 583392-586336	GA-697R	AT222722	693B con motor/A DIESEL			COMBUSTIBLE		
440 con motor/A DIESEL			ACEITE, HASTA S/N 588854	GP-34	AR43634	AIRE, SECUNDARIO		
HIDRAULICO	G-331	AR75603	ACEITE, S/N 588854 EN ADELANTE	GP-35	AR101278	810D con motor/JOHN DEERE 4045H		
TRANSMISION	G-331	AR75603	COMBUSTIBLE	G-270	AR86745	COMBUSTIBLE		
ACEITE	GP-14	T19044	AIRE, PRIMARIO	GA-679	AR79679	843G con motor/JOHN DEERE 6068T		
COMBUSTIBLE	G-296	AT17387	AIRE, SECUNDARIO	GA-680	AR79680	COMBUSTIBLE, PRIMARIO		
COMBUSTIBLE	G-295	AR50041	693D con motor/A DIESEL			COMBUSTIBLE, PRIMARIO		
COMBUSTIBLE	G-296-B	AT17387	ACEITE	GP-14	T19044	COMBUSTIBLE, FILTRO FINAL		
COMBUSTIBLE	G-296-B	AT17387	COMBUSTIBLE	GP-1122	AR50041	ACEITE		
AIRE	GAK-16	AT20728	AIRE, PRIMARIO	GA-679	AR79679	AIRE, PRIMARIO		
493D con motor/A DIESEL			AIRE, SECUNDARIO	GA-680	AR79680	AIRE, SECUNDARIO		
COMBUSTIBLE	G-295	AR50041	743 con motor/A DIESEL			843H con motor/JOHN DEERE 6068H POWERTECH		
643 con motor/A DIESEL			ACEITE	GP-35	AR101278	COMBUSTIBLE, SEPARADOR DE AGUA (HASTA S/N 882117)		
ACEITE	GP-14	T19044	COMBUSTIBLE	G-270	AR86745	COMBUSTIBLE, SEPARADOR DE AGUA (S/N 882117 EN ADELANTE)		
643D con motor/A DIESEL			AIRE, PRIMARIO	GA-679	AR79679	COMBUSTIBLE		
ACEITE	GP-14	T19044	AIRE, SECUNDARIO	GA-680	AR79680	COMBUSTIBLE, FILTRO FINAL		
COMBUSTIBLE, SEPARADOR DE AGUA	GPP-14	AT81478	693C con motor/A DIESEL			ACEITE		
COMBUSTIBLE	G-295	AR50041	ACEITE	GP-14	T19044	AIRE, PRIMARIO		
643 con motor/A DIESEL			COMBUSTIBLE	GP-1122	AR50041	AIRE, SECUNDARIO		
ACEITE	GP-14	T19044	AIRE, PRIMARIO	GA-679	AR79679	843H con motor/JOHN DEERE 6068H POWERTECH		
COMBUSTIBLE, SEPARADOR DE AGUA	GPP-14	AT81478	AIRE, SECUNDARIO	GA-680	AR79680	COMBUSTIBLE, SEPARADOR DE AGUA (HASTA S/N 882117)		
COMBUSTIBLE	G-295	AR50041	743 con motor/A DIESEL			COMBUSTIBLE, SEPARADOR DE AGUA (S/N 882117 EN ADELANTE)		
643D con motor/A DIESEL			HIDRAULICO (HASTA S/N 228395)	G-331	AR75603	COMBUSTIBLE		
ACEITE	GP-14	T19044	TRANSMISION	G-331	AR75603	COMBUSTIBLE		
COMBUSTIBLE, SEPARADOR DE AGUA	GPP-14	AT81478	ACEITE, HASTA S/N 248524	GP-34	AR43634	COMBUSTIBLE		
COMBUSTIBLE	G-295	AR50041	COMBUSTIBLE, HASTA S/N 241583	G-295	AR50041	ACEITE		
643D con motor/A DIESEL			743 con motor/A DIESEL			AIRE, ESTANDAR, PRIMARIO (HASTA S/N 882092)		
ACEITE	GP-14	T19044	HIDRAULICO (HASTA S/N 228395)	G-331	AR75603	AIRE, ESTANDAR, PRIMARIO (HASTA S/N 882092)		
COMBUSTIBLE, SEPARADOR DE AGUA	GPP-14	AT81478	TRANSMISION	G-331	AR75603			
COMBUSTIBLE	G-295	AR50041	ACEITE, HASTA S/N 248524	GP-34	AR43634			
643D con motor/A DIESEL			COMBUSTIBLE, HASTA S/N 241583	G-295	AR50041			
ACEITE	GP-14	T19044	693C con motor/A DIESEL					
COMBUSTIBLE, SEPARADOR DE AGUA	GPP-14	AT81478	ACEITE	GP-14	T19044			
COMBUSTIBLE	G-295	AR50041	COMBUSTIBLE	GP-1122	AR50041			
643D con motor/A DIESEL			AIRE, PRIMARIO	GA-679	AR79679			
ACEITE	GP-14	T19044	AIRE, SECUNDARIO	GA-680	AR79680			
COMBUSTIBLE, SEPARADOR DE AGUA	GPP-14	AT81478	693D con motor/A DIESEL					
COMBUSTIBLE	G-295	AR50041	ACEITE	GP-14	T19044			
643D con motor/A DIESEL			COMBUSTIBLE	GP-1122	AR50041			
ACEITE	GP-14	T19044	AIRE, PRIMARIO	GA-679	AR79679			
COMBUSTIBLE, SEPARADOR DE AGUA	GPP-14	AT81478	AIRE, SECUNDARIO	GA-680	AR79680			
COMBUSTIBLE	G-295	AR50041	743 con motor/A DIESEL					
643D con motor/A DIESEL			HIDRAULICO (HASTA S/N 228395)	G-331	AR75603			
ACEITE	GP-14	T19044	TRANSMISION	G-331	AR75603			
COMBUSTIBLE, SEPARADOR DE AGUA	GPP-14	AT81478	ACEITE, HASTA S/N 248524	GP-34	AR43634			
COMBUSTIBLE	G-295	AR50041	COMBUSTIBLE, HASTA S/N 241583	G-295	AR50041			
643D con motor/A DIESEL			693C con motor/A DIESEL					
ACEITE	GP-14	T19044	ACEITE	GP-14	T19044			
COMBUSTIBLE, SEPARADOR DE AGUA	GPP-14	AT81478	COMBUSTIBLE	GP-1122	AR50041			
COMBUSTIBLE	G-295	AR50041	AIRE, PRIMARIO	GA-679	AR79679			
643D con motor/A DIESEL			AIRE, SECUNDARIO	GA-680	AR79680			
ACEITE	GP-14	T19044	743 con motor/A DIESEL					
COMBUSTIBLE, SEPARADOR DE AGUA	GPP-14	AT81478	HIDRAULICO (HASTA S/N 228395)	G-331	AR75603			
COMBUSTIBLE	G-295	AR50041	TRANSMISION	G-331	AR75603			
643D con motor/A DIESEL			ACEITE, HASTA S/N 248524	GP-34	AR43634			
ACEITE	GP-14	T19044	COMBUSTIBLE, HASTA S/N 241583	G-295	AR50041			
COMBUSTIBLE, SEPARADOR DE AGUA	GPP-14	AT81478	693D con motor/A DIESEL					
COMBUSTIBLE	G-295	AR50041	ACEITE	GP-14	T19044			
643D con motor/A DIESEL			COMBUSTIBLE	GP-1122	AR50041			
ACEITE	GP-14	T19044	AIRE, PRIMARIO	GA-679	AR79679			
COMBUSTIBLE, SEPARADOR DE AGUA	GPP-14	AT81478	AIRE, SECUNDARIO	GA-680	AR79680			
COMBUSTIBLE	G-295	AR50041	743 con motor/A DIESEL					
643D con motor/A DIESEL			HIDRAULICO (HASTA S/N 228395)	G-331	AR75603			
ACEITE	GP-14	T19044	TRANSMISION	G-331	AR75603			
COMBUSTIBLE, SEPARADOR DE AGUA	GPP-14	AT81478	ACEITE, HASTA S/N 248524	GP-34	AR43634			
COMBUSTIBLE	G-295	AR50041	COMBUSTIBLE, HASTA S/N 241583	G-295	AR50041			

MARCA-MODELO-MOTOR MAKE-MODEL-ENGINE	GONHER GONHER	OEM OEM	MARCA-MODELO-MOTOR MAKE-MODEL-ENGINE	GONHER GONHER	OEM OEM	MARCA-MODELO-MOTOR MAKE-MODEL-ENGINE	GONHER GONHER	OEM OEM
JOHN DEERE (continuación)			JOHN DEERE (continuación)			JOHN DEERE (continuación)		
EQUIPO FORESTAL			EXCAVADORAS			EXCAVADORAS		
AIRE, ESTANDAR, SECUNDARIO (HASTA S/N 882092)	GA-680	AR79680	270LC con motor/JOHN DEERE 6068H			50C ZTS con motor/ISUZU 4LE2		
AIRE, RADIAL, PRIMARIO (S/N 882092 EN ADELANTE)	GA-966R	AT178516	COMBUSTIBLE	GPP-419	RE62419	AIRE, RADIAL PRIMARIO	GA-880R	RG60690
AIRE, RADIAL, SECUNDARIO (S/N 882092 EN ADELANTE)	GA-967R	AT178517	27C ZTS con motor/ISUZU 3LD1			50D ZTS con motor/YANMAR 4TNV88		
843J con motor/JOHN DEERE 6068H POWERTECH			AIRE, RADIAL PRIMARIO	GA-880R	RG60690	AIRE, RADIAL PRIMARIO	GA-880R	RG60690
COMBUSTIBLE	GPP-423	RE509032	27D ZTS con motor/YANMAR 3TNV88			550LC con motor/CUMMINS N14		
853G con motor/CUMMINS 6CTA8.3 ENG.			ACEITE	GP-462	M801002	COMBUSTIBLE, SEPARADOR DE AGUA	GPP-11	RE42050
AIRE, SECUNDARIO (S/N 3055 EN ADELANTE)	GA-930R	RE51629	27ZTS con motor/ISUZU 3LD1			590D, 595D con motor/A DIESEL		
			AIRE, RADIAL	GA-880R	RG60690	ACEITE	GP-14	T19044
			290D con motor/A DIESEL			595, 70D con motor/A DIESEL		
			ACEITE	GP-14	T19044	ACEITE	GP-14	T19044
			30 con motor/A DIESEL			600C LC, 800C con motor/ISUZU BB6WG1X		
			ACEITE	GP-40	M801209	COMBUSTIBLE, SEPARADOR DE AGUA	GPP-11	1132400441
			330C LC con motor/JOHN DEERE 6081H			690 con motor/A DIESEL		
			ACEITE	GP-35	RE57394	ACEITE	GP-34	AR43634
			330LC con motor/JOHN DEERE 6081H			690A con motor/A DIESEL		
			COMBUSTIBLE, PRIMARIO	GPP-426	RE65431	ACEITE	GP-34	AR43634
			ACEITE	GP-35	RE57394	690B con motor/A DIESEL		
			COMBUSTIBLE	G-270	AR86745	ACEITE, HASTA S/N 588854	GP-34	AR43634
			35C ZTS con motor/ISUZU 3LD2			ACEITE, S/N 588854 EN ADELANTE	GP-35	RE57394
			AIRE, RADIAL PRIMARIO	GA-880R	RG60690	COMBUSTIBLE	G-270	AR86745
			35D ZTS con motor/YANMAR 3TNV88			690C con motor/A DIESEL		
			AIRE, RADIAL	GA-880R	RG60690	ACEITE, FLUJO TOTAL (FULL FLOW)	GP-35	RE57394
			35ZTS con motor/ISUZU 3LD1			ACEITE, DERIVACION (BY PASS)	GP-57	RE42051
			AIRE, RADIAL	GA-880R	RG60690	COMBUSTIBLE	G-270	AR86745
			370 con motor/JOHN DEERE 6081H			AIRE, PRIMARIO	GA-679	AR79679
			COMBUSTIBLE, PRIMARIO	GPP-426	RE65431	AIRE, SECUNDARIO	GA-680	AR79680
			ACEITE	GP-35	RE57394	690D, 690DR con motor/A DIESEL		
			COMBUSTIBLE	G-270	AR86745	ACEITE	GP-14	T19044
			370C con motor/JOHN DEERE 6081H			COMBUSTIBLE	G-295	AR50041
			ACEITE	GP-35	RE57394	AIRE, PRIMARIO	GA-679	AR79679
			450LC con motor/JOHN DEERE 6101A			AIRE, SECUNDARIO	GA-680	AR79680
			COMBUSTIBLE	GPP-426	RE65431	690E LC con motor/JOHN DEERE 6068T		
			ACEITE, DOBLE FLUJO	GP-3000	RE44647	ACEITE	GP-14	T19044
			COMBUSTIBLE	G-270	RE27091	COMBUSTIBLE, SEPARADOR DE AGUA	GPP-14	AT81478
			490 con motor/JOHN DEERE 4239T			COMBUSTIBLE	G-295	AR50041
			ACEITE	GP-14	T19044	COMBUSTIBLE, SEPARADOR DE AGUA	GPP-426	RE62423
			490D, 495D con motor/A DIESEL			MANAGER DE COMBUSTIBLE	GPP-419	RE62419
			ACEITE	GP-14	T19044	ACEITE	GP-754	RE59754
			490E con motor/A DIESEL			AIRE, PRIMARIO	GA-679	AR79679
			ACEITE	GP-14	T19044	AIRE, SECUNDARIO	GA-680	AR79680
			COMBUSTIBLE, SEPARADOR DE AGUA	GPP-424	RE62424	70 con motor/A DIESEL		
			COMBUSTIBLE	G-270	AR86745	ACEITE	GP-14	T19044
			50 con motor/A DIESEL			700 con motor/A DIESEL		
			ACEITE	GP-40	M801209	ACEITE	GP-35	RE57394
						750 con motor/CUMMINS N14		
						AGUA	GP-1013Q	AR94650

MARCA-MODELO-MOTOR MAKE-MODEL-ENGINE	GONHER GONHER	OEM OEM	MARCA-MODELO-MOTOR MAKE-MODEL-ENGINE	GONHER GONHER	OEM OEM	MARCA-MODELO-MOTOR MAKE-MODEL-ENGINE	GONHER GONHER	OEM OEM
JOHN DEERE (continuación)			JOHN DEERE (continuación)			JOHN DEERE (continuación)		
EXCAVADORAS			EXCAVADORAS			FORRAJERA		
790, 792 con motor/A DIESEL			AIRE, SECUNDARIO	GA-206	AT166136	5830 con motor/A DIESEL		
ACEITE	GP-35	RE57394				GASOLINA, SEPARADOR DE AGUA	G-293	AR86755
COMBUSTIBLE	G-270	AR86745	992E LC con motor/A DIESEL			ACEITE, FLUJO TOTAL (FULL FLOW) HASTA S/N 40124	GP-34	AR43634
AIRE, SECUNDARIO	GA-398	AT81019	COMBUSTIBLE, SEPARADOR DE AGUA	GPP-424	RE62424	ACEITE, FLUJO TOTAL (FULL FLOW) S/N 40124-58574	GP-35	RE57394
			ACEITE, DOBLE FLUJO	GP-3000	RE44647	COMBUSTIBLE	G-270	AR86745
790D con motor/A DIESEL			COMBUSTIBLE	G-270	RE27091			
ACEITE	GP-35	RE57394	JOHN DEERE			6610 con motor/A DIESEL		
COMBUSTIBLE	G-270	AR86745	FORRAJERA			GASOLINA, SEPARADOR DE AGUA	G-293	AR86755
AIRE, SECUNDARIO	GA-398	AT81019	5200 con motores/JOHN DEERE 400 SERIES, JOHN DEERE 500 SERIES			ACEITE	GP-35	RE57394
			ACEITE, CARTUCHO	G-331	AR75603	TRANSMISION	GP-761H	AL77061
790E LC con motor/A DIESEL			ACEITE, SELLADO	GP-34	AR43634	COMBUSTIBLE	G-270	RE27091
ACEITE	GP-14	T19044	COMBUSTIBLE	G-295	AR50041	AIRE, SECUNDARIO	GA-206	U44956
COMBUSTIBLE, HASTA S/N 490172	G-295	AR50041						
COMBUSTIBLE, SEPARADOR DE AGUA	GPP-424	RE62424	5400 con motores/JOHN DEERE 400 SERIES, JOHN DEERE 500 SERIES			6650 con motor/JOHN DEERE 6081 POWERTECH		
COMBUSTIBLE, S/N 490172 EN ADELANTE	GPP-419	RE62419	ACEITE	GP-34	AR43634	GASOLINA, SEPARADOR DE AGUA	G-293	AR86755
			COMBUSTIBLE	G-295	AR50041	ACEITE	GP-35	RE57394
792D-LC con motor/A DIESEL			ACEITE	GP-35	RE57394	TRANSMISION	GP-761H	AL118036
ACEITE	GP-35	RE57394				COMBUSTIBLE	G-270	AR86745
COMBUSTIBLE	GPP-424	RE62424	5440 con motor/A DIESEL			AIRE, SECUNDARIO	GA-206	U44956
COMBUSTIBLE	G-270	RE27091	ACEITE	GP-34	AR43634			
						6710 con motor/CUMMINS		
80 con motor/YANMAR 4TNE98			5460 con motor/A DIESEL			GASOLINA, SEPARADOR DE AGUA	G-293	AR86755
COMBUSTIBLE, SEPARADOR DE AGUA	GPP-424	RE62424	ACEITE	GP-34	AR43634	ACEITE, DOBLE FLUJO	GP-3000	RE44647
			ACEITE	GP-35	RE57394	TRANSMISION	GP-761H	AH128449
890 con motor/A DIESEL			COMBUSTIBLE	G-270	AR86745	COMBUSTIBLE	G-270	RE27091
ACEITE, FLUJO TOTAL (FULL FLOW) HASTA S/N 040932	GP-34	AR43634						
ACEITE, FLUJO TOTAL (FULL FLOW) S/N 040932 EN ADELANTE	GP-35	RE57394	5720 con motor/JOHN DEERE 6466			6750 con motor/CUMMINS		
COMBUSTIBLE	G-270	AR86745	GASOLINA, SEPARADOR DE AGUA	G-293	AR86755	GASOLINA, SEPARADOR DE AGUA	G-293	AR86755
			ACEITE, HASTA S/N 298393	GP-34	AR43634	ACEITE	GP-3000	RE44647
890A con motor/A DIESEL			COMBUSTIBLE, HASTA S/N 242196	G-295	AR50041	COMBUSTIBLE	G-270	AR86745
ACEITE, FLUJO TOTAL (FULL FLOW) HASTA S/N 040932	GP-34	AR43634	ACEITE, S/N 298393 EN ADELANTE	GP-35	RE57394			
ACEITE, FLUJO TOTAL (FULL FLOW) S/N 040932 EN ADELANTE	GP-35	RE57394	COMBUSTIBLE, S/N 242197 EN ADELANTE	G-270	AR86745	6750 con motor/JOHN DEERE 6125 POWERTECH		
COMBUSTIBLE	G-270	AR86745				GASOLINA, SEPARADOR DE AGUA	G-293	AR86755
			5730 con motor/A DIESEL					
892D, 892D LC con motor/A DIESEL			GASOLINA, SEPARADOR DE AGUA	G-293	AR86755	6810, 6910 con motor/CUMMINS N14		
ACEITE	GP-35	RE57394	ACEITE, HASTA S/N 039937	GP-34	AR43634	ACEITE, DERIVACION (BY PASS)	GP-57	RE42051
COMBUSTIBLE	G-270	AR86745	ACEITE, S/N 039937 EN ADELANTE	GP-35	AR101278	COMBUSTIBLE, SEPARADOR DE AGUA	GPP-11	RE42050
AIRE, SECUNDARIO	GA-398	AT81019	COMBUSTIBLE	G-270	AR86745	AGUA	GP-2071W	RE42052
892E LC con motor/A DIESEL			5820 con motor/JOHN DEERE 616			6850 con motor/CUMMINS		
ACEITE	GP-35	RE57394	ACEITE	GP-34	AR43634	ACEITE, DERIVACION (BY PASS)	GP-57	RE42051
COMBUSTIBLE, SEPARADOR DE AGUA	GPP-424	RE62424	HIDRAULICO	GP-66	AE33293			
COMBUSTIBLE	G-270	RE27091	ACEITE	GP-35	RE57394	6850 con motor/JOHN DEERE 6125 POWERTECH		
			ACEITE	GP-57	RE21748	GASOLINA, SEPARADOR DE AGUA	G-293	AR86755
990 con motor/A DIESEL			COMBUSTIBLE	G-270	AR86745			
GASOLINA, SEPARADOR DE AGUA (HASTA S/N 505863)	G-293	AR86755				6950 con motor/CUMMINS		
ACEITE, FLUJO TOTAL (FULL FLOW)	GP-35	RE57394	5820 con motor/JOHN DEERE 619			ACEITE, DERIVACION (BY PASS)	GP-57	RE42051
COMBUSTIBLE	G-270	AR86745	GASOLINA, SEPARADOR DE AGUA	G-293	AR86755			
COMBUSTIBLE, SEPARADOR DE AGUA (S/N 505863 EN ADELANTE)	2010PM-OR	RE11325	ACEITE, FLUJO TOTAL (FULL FLOW) HASTA S/N 040124	GP-34	AR43634	6950 con motor/CUMMINS N14 CELECT		
			HIDRAULICO (HASTA S/N 651001)	GP-66	AE33293	ACEITE, DOBLE FLUJO	GP-3001	3401544
992D LC con motor/A DIESEL			ACEITE, FLUJO TOTAL (FULL FLOW) S/N 040124 EN ADELANTE	GP-35	RE46380			
ACEITE, FLUJO TOTAL (FULL FLOW)	GP-35	RE57394	COMBUSTIBLE	G-270	AR86745	7800 con motor/CUMMINS QSX15		
COMBUSTIBLE	G-270	AR86745				ACEITE, DOBLE FLUJO	GP-9000	3406810
AIRE, PRIMARIO	GA-106	U44957				AGUA	GP-2126Q	3680433
						COMBUSTIBLE, SEPARADOR DE AGUA	GPP-1007S	PMFS1007

MARCA-MODELO-MOTOR MAKE-MODEL-ENGINE	GONHER GONHER	OEM OEM	MARCA-MODELO-MOTOR MAKE-MODEL-ENGINE	GONHER GONHER	OEM OEM	MARCA-MODELO-MOTOR MAKE-MODEL-ENGINE	GONHER GONHER	OEM OEM
JOHN DEERE (continuación)			JOHN DEERE (continuación)			JOHN DEERE (continuación)		
HILERADORAS			MOTORES			MOTORES		
4890 con motor/JOHN DEERE 4045T POWERTECH			155			329G		
HIDRAULICO	GP-761H	AH128449	ACEITE	GP-14	T19044	ACEITE	GP-14	T19044
COMBUSTIBLE	GPP-420	RE60021	COMBUSTIBLE	G-296	AT17387	COMBUSTIBLE	G-296	AT17387
ACEITE	GP-754	RE59754	COMBUSTIBLE	G-296-B	AT17387	COMBUSTIBLE	G-296-B	AT17387
AIRE, PRIMARIO	GA-197R	RE67124				AIRE	GAK-403	AH20488
AIRE, SECUNDARIO	GA-768R	RE34963	164D, 3164D					
			ACEITE	GP-14	T19044	341G		
			COMBUSTIBLE	G-296	AT17387	ACEITE	GP-14	T19044
4895 con motor/JOHN DEERE 4045T POWERTECH			COMBUSTIBLE	G-295	AR50041	COMBUSTIBLE	GPP-14	AR45097
HIDROESTATICO	GP-761H	AH128449	COMBUSTIBLE	G-296-B	AT17387	COMBUSTIBLE	G-295	AR50041
ACEITE, TANQUE HIDRAULICO	GP-761H	AH128449	COMBUSTIBLE	G-296-B	AT17387	AIRE	GAK-403	AH20488
COMBUSTIBLE	GPP-420	RE60021						
ACEITE, LUBRICACION DEL MOTOR	GP-754	RE59754	165			362G		
AIRE, PRIMARIO	GA-966R	AT178516	ACEITE, SELLADO	GP-14	T19044	ACEITE, CARTUCHO	G-139	AR26350
AIRE, SECUNDARIO	GA-967R	AT178517	COMBUSTIBLE	G-296	AT17387T	ACEITE, SELLADO	GP-14	T19044
			COMBUSTIBLE	G-296-B	AT17387T	COMBUSTIBLE	GPP-14	AR45097
4990 con motor/JOHN DEERE 6068 POWERTECH			AIRE, SIN ASPAS (HASTA S/N 201359)	GA-33	AH19847	COMBUSTIBLE	G-295	AR50041
COMBUSTIBLE	GPP-420	RE60021	AIRE, S/N 35000 EN ADELANTE	GAK-16	AT20728	COMBUSTIBLE	GAK-403	AH20488
ACEITE	GP-754	RE59754				AIRE	GAK-20	AR36044
AIRE, PRIMARIO	GA-966R	AT178516	219D					
AIRE, SECUNDARIO	GA-967R	AT178517	ACEITE	GP-14	T19044	362L		
			COMBUSTIBLE	G-296	AT17387	ACEITE, CARTUCHO	G-139	AR26350
			COMBUSTIBLE	G-295	AR50041			
4995 con motor/JOHN DEERE 6068 POWERTECH			COMBUSTIBLE	G-296-B	AT17387	4045D (4.5L), 4045T (4.5L), 4045TFM (4.5L)		
COMBUSTIBLE, SEPARADOR DE AGUA (HASTA S/N 882117)	GPP-14	AT81478	AIRE	GAK-403	AH20488	ACEITE	GP-14	T19044
COMBUSTIBLE, SEPARADOR DE AGUA (S/N 882117 EN ADELANTE)	GPP-424	RE62424				COMBUSTIBLE	G-295	AR50041
COMBUSTIBLE	GPP-419	RE62419	232			COMBUSTIBLE	GPP-418	RE62418
ACEITE	GP-754	RE59754	ACEITE, SELLADO	GP-14	T19044	COMBUSTIBLE	G-270	RE27091
AIRE, ESTANDAR, PRIMARIO (HASTA S/N 882092)	GA-679	AR79679	COMBUSTIBLE, 1963 EN ADELANTE	G-296	AT17387T			
AIRE, ESTANDAR, SECUNDARIO (HASTA S/N 882092)	GA-680	AR79680	COMBUSTIBLE, 1963 EN ADELANTE	G-296-B	AT17387T	4045D INDUSTRIAL, 4045T INDUSTRIAL		
AIRE, RADIAL, PRIMARIO (S/N 882092 EN ADELANTE)	GA-966R	AT178516				ACEITE	GP-14	T19044
AIRE, RADIAL, SECUNDARIO (S/N 882092 EN ADELANTE)	GA-967R	AT178517	248			COMBUSTIBLE	GPP-418	RE62418
			ACEITE, SELLADO	GP-14	T19044	AIRE, RADIAL PRIMARIO	GA-853R	AT171853
800, 830 con motor/CHRYSLER HB-225			COMBUSTIBLE, 1963 EN ADELANTE	G-296	AT17387T			
ACEITE	GP-1	TY9425	COMBUSTIBLE, 1963 EN ADELANTE	G-296-B	AT17387T	4045D POWERTECH (4.5L), 4045T POWERTECH (4.5L)		
AIRE	GAK-16	AT20728	AIRE	GAK-16	AT20728	COMBUSTIBLE, 5 3/16 IN	GPP-418	RE62418
GASOLINA	GG-5 L	AE29052	AIRE	GAK-403	AH20488	COMBUSTIBLE, 5 15/16 IN	GPP-419	RE62419
						ACEITE	GP-754	RE59754
880 con motor/JOHN DEERE 135			3009			4045H POWERTECH (4.5L)		
ACEITE	GP-14	T19044	ACEITE	GP-91	AM101378	COMBUSTIBLE, 5 3/16 IN	GPP-418	RE62418
880 con motores/JOHN DEERE 180, JOHN DEERE 202			3011, 4020 POWERTECH			404A, 404T		
ACEITE	GP-14	T19044	ACEITE	GP-40	M801209	ACEITE	GP-34	AR43634
						COMBUSTIBLE	G-295	AR50041
			303			AGUA	GP-2071W	RE42052
			ACEITE, SELLADO	GP-14	T19044	AIRE	GAK-403	AH20488
			COMBUSTIBLE	G-296	AT17387			
			COMBUSTIBLE	G-296-B	AT17387	404D		
			AIRE	GAK-403	AH20488	ACEITE	GP-14	T19044
						COMBUSTIBLE	GPP-14	AR45097
			3179D, 3179T, 4039D			ACEITE	GP-34	AR43634
			ACEITE	GP-14	T19044	COMBUSTIBLE	G-295	AR50041
			COMBUSTIBLE	G-295	AR50041	AGUA	GP-2071W	RE42052
			COMBUSTIBLE	GPP-418	RE50455	AIRE	GAK-20	AR36044
			329D			414D, 414T, 4219G, 4238TE, 4238TL, 4239A, 4239D, 4239DE, 4239DL, 4239DT, 4239E, 4239T, 4276D, 4276T		
			ACEITE	GP-14	T19044	ACEITE	GP-14	T19044
			COMBUSTIBLE	G-296	AT17387			
			COMBUSTIBLE	G-295	AR50041	4219D		
			COMBUSTIBLE	G-296-B	AT17387	ACEITE	GP-14	T19044
			AIRE	GAK-20	AR36044	COMBUSTIBLE	G-296	AT17387
						COMBUSTIBLE	G-295	AR50041
						COMBUSTIBLE	G-296-B	AT17387

JOHN DEERE

MOTORES

115 A GASOLINA, 135 A GASOLINA, 145 A GASOLINA, 152 A GASOLINA, 164G, 180, 202G, 217, 219G, 239D, 239T, 276D, 276T, 3029D, 3164G, 329L, 359D, 359T, 4024 (2.4L), 4039, 4039DFM, 4039T (3.9L)

ACEITE, SELLADO GP-14 T19044

135G

AIRE, SIN ASPAS GA-33 AH19847

152D, 202

ACEITE, SELLADO GP-14 T19044

COMBUSTIBLE G-296 AT17387

COMBUSTIBLE G-296-B AT17387

AIRE GAK-16 AT20728

MARCA-MODELO-MOTOR MAKE-MODEL-ENGINE	GONHER GONHER	OEM OEM	MARCA-MODELO-MOTOR MAKE-MODEL-ENGINE	GONHER GONHER	OEM OEM	MARCA-MODELO-MOTOR MAKE-MODEL-ENGINE	GONHER GONHER	OEM OEM
JOHN DEERE (continuación)			JOHN DEERE (continuación)			JOHN DEERE (continuación)		
MOTORES			MOTORES			NIVELADORAS		
466A, 466D, 466T, 619A, 6619A			AGUA	GP-2071W	RE42052	AIRE	GA-16	AH19852
ACEITE	GP-34	AR43634				AIRE	GAK-16	AT20728
COMBUSTIBLE	G-295	AR50041	6466A, 6466D, 6466T			350C SOBRE ORUGAS con motor/A DIESEL		
ACEITE	GP-35	AR101278	ACEITE, FLUJO TOTAL (FULL FLOW)	GP-34	AR43634	ACEITE	G-139	AR26350
AGUA	GP-2071W	RE42052	COMBUSTIBLE	G-295	AR50041	ACEITE	GP-14	T19044
5030 (3.0L), 6059D, 6059T, 6068D (6.8L), 6068DFM, 6068T (6.8L), 6068TFM, 6329G, 6329L, 6359A, 6359D, 6359DE, 6359DL, 6359E, 6359T, 6359TL, 6414A, 6414D, 6414E, 6414T, 92 A GASOLINA			ACEITE, FLUJO TOTAL (FULL FLOW)	GP-35	AR101278	COMBUSTIBLE	G-295	AR50041
ACEITE	GP-14	T19044	AGUA	GP-2071W	RE42052	AIRE	GA-16	AH19852
531, 6531			6531D			AIRE	GAK-16	AT20728
ACEITE, CARTUCHO	G-139	AR28110R	ACEITE, CARTUCHO	G-331	AR75603	350D SOBRE ORUGAS con motor/A DIESEL		
ACEITE, SELLADO (5 13/32 IN)	GP-14	T19044	ACEITE, SELLADO	GP-34	AR43634	TRANSMISION	G-139	AR26350
ACEITE, SELLADO (6 27/32 IN)	GP-34	AR43634	COMBUSTIBLE	G-295	AR50041	ACEITE	GP-14	T19044
AIRE, PRIMARIO	GA-679	AR61967	AGUA	GP-2071W	RE42052	HIDRAULICO	GP-14	T19044
AIRE, SECUNDARIO	GA-680	AR61968	AIRE, PRIMARIO	GA-679	AR61967	COMBUSTIBLE	G-295	AR50041
531A, 531T, 6531A, 6531T			AIRE, SECUNDARIO	GA-680	AR61968	400G SOBRE ORUGAS con motor/A DIESEL		
ACEITE	GP-34	AR43634	6619D, 6619T			ACEITE	GP-14	T19044
COMBUSTIBLE	G-295	AR50041	ACEITE	GP-34	AR43634	COOLER DE ACEITE	GP-14	T19044
AGUA	GP-2071W	RE42052	8955A			ACEITE, TORNO	GP-14	T19044
531D			ACEITE	GP-34	AR43634	COMBUSTIBLE	G-295	AR50041
ACEITE, CARTUCHO	G-331	AR75603	COMBUSTIBLE	G-295	AR50041	AIRE, PRIMARIO	GA-403	AT65296
ACEITE, SELLADO	GP-34	AR43634	AGUA	GP-1013Q	AR87112	4045D SOBRE ORUGAS, 4045T SOBRE ORUGAS con motor/A DIESEL		
COMBUSTIBLE	G-295	AR50041	8955T, 955T			COMBUSTIBLE	GPP-420	RE60021
AGUA	GP-2071W	RE42052	ACEITE	GP-34	AR43634	ACEITE	GP-754	RE59754
6068 POWERTECH (6.8L)			COMBUSTIBLE	G-295	AR50041	COMBUSTIBLE	GPP-1003S	RE62424
COMBUSTIBLE	GPP-418	RE50455	ACEITE	GP-35	AR101278	450 SOBRE ORUGAS con motor/A DIESEL		
6076A (7.6L), 6076H (7.6L), 6076T (7.6L)			M63VA, ME8TB			COOLER DE ACEITE	GP-14	T19044
ACEITE	GP-35	RE46380	ACEITE	GP-14	T19044	ACEITE, TORNO	GP-14	T19044
COMBUSTIBLE	GPP-419	RE52987	COMBUSTIBLE	G-296	AT17387	COMBUSTIBLE	G-296	AT17387
COMBUSTIBLE	G-270	RE27091	COMBUSTIBLE	G-296-B	AT17387	COMBUSTIBLE	G-296-B	AT17387
6076AFM, 6081 POWERTECH (8.1L), 6081A POWERTECH (8.1L), 6081H POWERTECH (8.1L), 6081T POWERTECH (8.1L)			JOHN DEERE			AIRE	GA-16	AH19852
ACEITE	GP-35	AR98329	NIVELADORAS			AIRE	GA-98	AH69798
6101A (10.1L), 6101H (10.1L)			1050C SOBRE ORUGAS con motor/LIEBHERR D9406			AIRE	GAK-16	AT20728
COMBUSTIBLE, SEPARADOR DE AGUA	GPP-421	RE53729	AGUA	GP-1011Q	WF2073	450 SOBRE ORUGAS con motor/A GASOLINA		
ACEITE, DOBLE FLUJO	GP-3000	RE44647	1800 con motor/KAWASAKI 18 HP			ACEITE	GP-14	T19044
COMBUSTIBLE	G-270	RE27091	ACEITE	GP-157	AM107423	AIRE	GA-16	AH19852
6329D			350 SOBRE ORUGAS con motor/A DIESEL			AIRE	GAK-16	AT20728
ACEITE	GP-14	T19044	ACEITE	G-139	AR26350	450B SOBRE ORUGAS con motor/A DIESEL		
COMBUSTIBLE	G-296	AT17387	ACEITE	GP-14	T19044	ACEITE	GP-14	T19044
COMBUSTIBLE	G-295	AR50041	COMBUSTIBLE	G-296	AT17387	COOLER DE ACEITE	GP-14	T19044
COMBUSTIBLE	G-296-B	AT17387	COMBUSTIBLE	G-296-B	AT17387	ACEITE, TORNO	GP-14	T19044
6362G, 6362L			AIRE	GA-16	AH19852	COMBUSTIBLE	G-296	AT17387
ACEITE, CARTUCHO	G-139	AR26350	AIRE	GAK-16	AT20728	450C SOBRE ORUGAS, 450D SOBRE ORUGAS con motor/A DIESEL		
6404A, 6404T			350 SOBRE ORUGAS, 350B SOBRE ORUGAS, 350C SOBRE ORUGAS con motor/A GASOLINA			ACEITE	GP-14	T19044
ACEITE	GP-34	AR43634	ACEITE	G-139	AR26350	COOLER DE ACEITE	GP-14	T19044
COMBUSTIBLE	G-295	AR50041	ACEITE	GP-14	T19044	ACEITE, TORNO	GP-14	T19044
AGUA	GP-2071W	RE42052	AIRE	GA-16	AH19852	COMBUSTIBLE	G-295	AR50041
AIRE	GAK-403	AH20488	AIRE	GAK-16	AT20728	450E SOBRE ORUGAS con motor/A DIESEL		
6404D			350B SOBRE ORUGAS con motor/A DIESEL			ACEITE	GP-14	T19044
ACEITE	GP-14	T19044	ACEITE	G-139	AR26350	COOLER DE ACEITE	GP-14	T19044
ACEITE	GP-34	AR43634	ACEITE	GP-14	T19044	ACEITE, TORNO	GP-14	T19044
COMBUSTIBLE	G-295	AR50041	COMBUSTIBLE	G-296	AT17387	COMBUSTIBLE	G-295	AR50041
AGUA	GP-2071W	RE42052	COMBUSTIBLE	G-295	AR50041	AIRE, SIN TURBO PRIMARIO		
AIRE	GAK-403	AH20488	COMBUSTIBLE	G-296-B	AT17387	AIRE, SIN TURBO PRIMARIO	GA-403	AT65296

MARCA-MODELO-MOTOR MAKE-MODEL-ENGINE	GONHER GONHER	OEM OEM	MARCA-MODELO-MOTOR MAKE-MODEL-ENGINE	GONHER GONHER	OEM OEM	MARCA-MODELO-MOTOR MAKE-MODEL-ENGINE	GONHER GONHER	OEM OEM
JOHN DEERE (continuación)			JOHN DEERE (continuación)			JOHN DEERE (continuación)		
NIVELADORAS			NIVELADORAS			NIVELADORAS		
450G SOBRE ORUGAS con motor/A DIESEL			570B MOTONIVELADORA con motor/A DIESEL			670D con motor/JOHN DEERE 6068H POWERTECH		
ACEITE, HASTA S/N 742460	GP-14	T19044	TRANSMISION (HASTA S/N 11725)	G-331	AR75603	COMBUSTIBLE	GPP-423	RE509032
COMBUSTIBLE, SEPARADOR DE AGUA	GPP-14	AT81478	ACEITE	GP-14	T19044	ACEITE, LUBRICACION DEL MOTOR	GP-35	RE57394
COMBUSTIBLE	G-295	AR50041	COMBUSTIBLE	G-295	AR50041	AIRE, RADIAL, PRIMARIO	GA-966R	AT178516
ACEITE, S/N 742460 EN ADELANTE	GP-754	RE59754	650G LGP SOBRE ORUGAS, 650G SOBRE ORUGAS con motor/A DIESEL			AIRE, RADIAL, SECUNDARIO	GA-967R	AT178517
AIRE, SIN TURBO PRIMARIO	GA-403	AT65296	ACEITE, HASTA S/N 742460	GP-14	T19044	GASOLINA, RESPIRADOR DEL CIERRE HIDRAULICO DEL DIFERENCIAL	GG-5 L	AT101565
450H SERIES con motores/JOHN DEERE 4045D, JOHN DEERE 4045T			ACEITE, TORNO	GP-14	T19044	GASOLINA, RESPIRADOR DEL TANQUE HIDRAULICO	GG-5 L	AT101565
COMBUSTIBLE, PRIMARIO (S/N 910011 EN ADELANTE (CLIMAS FRIOS))	GPP-424	RE516477	COMBUSTIBLE, SEPARADOR DE AGUA	GPP-14	AT81478	672A MOTONIVELADORA con motor/A DIESEL		
COMBUSTIBLE, SEPARADOR DE AGUA, PRIMARIO (HASTA S/N 910011)	GPP-424	RE62424	COMBUSTIBLE	G-295	AR50041	ACEITE	GP-14	T19044
HIDRAULICO	GP-761H	T175002	ACEITE, S/N 742460 EN ADELANTE	GP-754	RE59754	ACEITE, BOMBA HIDRAULICA	GP-34	AT58368
TRANSMISION	GP-761H	T175002	AIRE, SIN TURBO PRIMARIO	GA-403	AT65296	COMBUSTIBLE	G-295	AR50041
COMBUSTIBLE (S/N 910011 EN ADELANTE)	GPP-419	RE509031	650H SOBRE ORUGAS con motor/JOHN DEERE 4045 POWERTECH			672B MOTONIVELADORA con motor/A DIESEL		
COMBUSTIBLE (HASTA S/N 910011)	GPP-420	RE60021	COMBUSTIBLE, SEPARADOR DE AGUA	GPP-424	RE62424	ACEITE	GP-14	T19044
ACEITE (HASTA S/N 910011)	GP-754	RE59754	HIDRAULICO	GP-761H	T175002	ACEITE, BOMBA HIDRAULICA PARA LA TRACCION DELANTERA	GP-34	AT58368
AIRE, RADIAL PRIMARIO	GA-853R	AT171853	TRANSMISION	GP-761H	T175002	COMBUSTIBLE	G-295	AR50041
450J con motor/JOHN DEERE 4045T			COMBUSTIBLE	GPP-420	RE60021	672CH MOTONIVELADORA con motor/JOHN DEERE 6068 POWERTECH		
COMBUSTIBLE, PRIMARIO (CLIMAS FRIOS)	GPP-424	RE516477	670 MOTONIVELADORA, 670A MOTONIVELADORA, 670B MOTONIVELADORA con motor/A DIESEL	GP-14	T19044	TRANSMISION (HASTA S/N 595779)	GP-34	AT193883
HIDRAULICO	GP-761H	T175002	ACEITE	GP-14	T19044	COMBUSTIBLE	GPP-423	RE509032
TRANSMISION	GP-761H	T175002	670 SERIES II MOTONIVELADORA con motor/JOHN DEERE 6068 POWERTECH			ACEITE	GP-35	RE57394
COMBUSTIBLE	GPP-419	RE509031	TRANSMISION (HASTA S/N 595779)	GP-34	AT193883	AIRE, PRIMARIO	GA-966R	AT178516
AIRE, RADIAL PRIMARIO	GA-853R	AT171853	COMBUSTIBLE	GPP-419	RE62419	AIRE, SECUNDARIO	GA-967R	AT178517
550 SOBRE ORUGAS con motor/A DIESEL			ACEITE	GP-754	RE59754	GASOLINA, RESPIRADOR DEL CIERRE HIDRAULICO DEL DIFERENCIAL	GG-5 L	AT101565
TRANSMISION	G-331	AR75603	AIRE, PRIMARIO	GA-966R	AT178516	GASOLINA, RESPIRADOR DEL TANQUE HIDRAULICO	GG-5 L	AT101565
ACEITE	GP-14	T19044	AIRE, SECUNDARIO	GA-967R	AT178517	672CH SERIES II MOTONIVELADORA con motor/JOHN DEERE 6068 POWERTECH		
ACEITE, TORNO	GP-14	T19044	GASOLINA, RESPIRADOR DEL TANQUE HIDRAULICO	GG-5 L	AT101565	TRANSMISION (HASTA S/N 595779)	GP-34	AT193883
COMBUSTIBLE	G-295	AR50041	670C MOTONIVELADORA, 670CH MOTONIVELADORA con motor/JOHN DEERE 6068 POWERTECH			COMBUSTIBLE	GPP-419	RE62419
AIRE, PRIMARIO	GA-403	AT65296	TRANSMISION (HASTA S/N 595779)	GP-34	AT193883	ACEITE	GP-754	RE59754
550A SOBRE ORUGAS, 550B SOBRE ORUGAS con motor/A DIESEL			COMBUSTIBLE	GPP-419	RE62419	AIRE, PRIMARIO	GA-966R	AT178516
TRANSMISION	G-331	AR75603	ACEITE, LUBRICACION DEL MOTOR	GP-754	RE59754	AIRE, SECUNDARIO	GA-967R	AT178517
ACEITE	GP-14	T19044	AIRE, PRIMARIO	GA-966R	AT178516	GASOLINA, RESPIRADOR DEL TANQUE HIDRAULICO	GG-5 L	AT101565
ACEITE, TORNO	GP-14	T19044	AIRE, SECUNDARIO	GA-967R	AT178517	672D con motor/JOHN DEERE 6068H POWERTECH		
COMBUSTIBLE	G-295	AR50041	GASOLINA, RESPIRADOR DEL TANQUE HIDRAULICO	GG-5 L	AT101565	COMBUSTIBLE	GPP-423	RE509032
AIRE, SIN TURBO PRIMARIO	GA-403	AT65296	670C SERIES II MOTONIVELADORA con motor/JOHN DEERE 6068 POWERTECH			ACEITE, LUBRICACION DEL MOTOR	GP-35	RE57394
550G SOBRE ORUGAS con motor/A DIESEL			COMBUSTIBLE	GPP-419	RE62419	AIRE, RADIAL, PRIMARIO	GA-966R	AT178516
ACEITE	GP-14	T19044	ACEITE	GP-754	RE59754	AIRE, RADIAL, SECUNDARIO	GA-967R	AT178517
COMBUSTIBLE, SEPARADOR DE AGUA	GPP-14	AT81478	AIRE, PRIMARIO	GA-966R	AT178516	GASOLINA, RESPIRADOR DEL CIERRE HIDRAULICO DEL DIFERENCIAL	GG-5 L	AT101565
COMBUSTIBLE	G-295	AR50041	AIRE, SECUNDARIO	GA-967R	AT178517	GASOLINA, RESPIRADOR DEL TANQUE HIDRAULICO	GG-5 L	AT101565
AIRE, SIN TURBO PRIMARIO	GA-403	AT65296	670CH SERIES II MOTONIVELADORA con motor/JOHN DEERE 6068 POWERTECH			700H LGP SOBRE ORUGAS con motor/A DIESEL		
550H SOBRE ORUGAS con motor/JOHN DEERE 4045 POWERTECH			TRANSMISION (HASTA S/N 595779)	GP-34	AT193883	COMBUSTIBLE, PRIMARIO	GPP-424	RE62424
ACEITE	GP-14	T19044	COMBUSTIBLE	GPP-419	RE62419	COMBUSTIBLE	GPP-419	RE62419
COMBUSTIBLE, SEPARADOR DE AGUA	GPP-424	RE62424	ACEITE	GP-754	RE59754	ACEITE	GP-754	RE59754
HIDRAULICO	GP-761H	T175002	AIRE, PRIMARIO	GA-966R	AT178516	AIRE, PRIMARIO	GA-966R	AT178516
TRANSMISION	GP-761H	T175002	AIRE, SECUNDARIO	GA-967R	AT178517	AIRE, SECUNDARIO	GA-967R	AT178517
COMBUSTIBLE	GPP-420	RE60021	670CH SERIES II MOTONIVELADORA con motor/JOHN DEERE 6068 POWERTECH			GASOLINA, RESPIRADOR DEL TANQUE HIDRAULICO	GG-5 L	AT101565
570 MOTONIVELADORA, 570A MOTONIVELADORA con motor/A DIESEL			TRANSMISION (HASTA S/N 595779)	GP-34	AT193883	700H LGP SOBRE ORUGAS con motor/A DIESEL		
TRANSMISION	G-331	AR75603	COMBUSTIBLE	GPP-419	RE62419	COMBUSTIBLE, PRIMARIO	GPP-424	RE62424
ACEITE	GP-14	T19044	ACEITE	GP-754	RE59754	COMBUSTIBLE	GPP-419	RE62419
COMBUSTIBLE	G-296	AT17387	AIRE, PRIMARIO	GA-966R	AT178516	ACEITE	GP-754	RE59754
COMBUSTIBLE	G-295	AR50041	AIRE, SECUNDARIO	GA-967R	AT178517	AIRE, PRIMARIO	GA-966R	AT178516
COMBUSTIBLE	G-296-B	AT17387	GASOLINA, RESPIRADOR DEL TANQUE HIDRAULICO	GG-5 L	AT101565	AIRE, SECUNDARIO	GA-967R	AT178517
						GASOLINA, RESPIRADOR DEL TANQUE HIDRAULICO	GG-5 L	AT101565

MARCA-MODELO-MOTOR MAKE-MODEL-ENGINE	GONHER GONHER	OEM OEM	MARCA-MODELO-MOTOR MAKE-MODEL-ENGINE	GONHER GONHER	OEM OEM	MARCA-MODELO-MOTOR MAKE-MODEL-ENGINE	GONHER GONHER	OEM OEM
JOHN DEERE (continuación)			JOHN DEERE (continuación)			JOHN DEERE (continuación)		
NIVELADORAS			NIVELADORAS			NIVELADORAS		
700J LGP, 700J LT, 700J XLT con motor/JOHN DEERE 6068T			770C SERIES II MOTONIVELADORA con motor/JOHN DEERE 6081 POWERTECH			GASOLINA, RESPIRADOR DEL TANQUE HIDRAULICO	GG-5 L	AT101565
COMBUSTIBLE, PRIMARIO	GPP-424	RE516477	TRANSMISION (HASTA S/N 595779)	GP-34	AT193883	772CH SERIES II MOTONIVELADORA con motor/JOHN DEERE 6081 POWERTECH		
HIDRAULICO	GP-761H	T175002	ACEITE	GP-35	RE57394	TRANSMISION (HASTA S/N 595779)	GP-34	AT193883
TRANSMISION	GP-761H	T175002	COMBUSTIBLE	G-270	AR86745	ACEITE	GP-35	RE57394
COMBUSTIBLE	GPP-419	RE509031	AIRE, PRIMARIO	GA-930R	RE51629	AIRE, PRIMARIO	GA-930R	RE51629
AIRE, PRIMARIO	GA-697R	AT222722	AIRE, SECUNDARIO	GA-890R	RE51630	AIRE, SECUNDARIO	GA-890R	RE51630
750 SOBRE ORUGAS con motor/A DIESEL			GASOLINA, RESPIRADOR DEL TANQUE HIDRAULICO	GG-5 L	AT101565	GASOLINA, RESPIRADOR DEL TANQUE HIDRAULICO	GG-5 L	AT101565
ACEITE	GP-14	T19044	770CH MOTONIVELADORA con motor/JOHN DEERE 6081 POWER-TECH			772D con motor/JOHN DEERE 6081H POWERTECH		
COMBUSTIBLE	G-295	AR50041	TRANSMISION (HASTA S/N 595779)	GP-34	AT193883	AIRE, PRIMARIO	GA-930R	RE51629
TRANSMISION	GP-864H	AT135800	ACEITE, LUBRICACION DEL MOTOR	GP-35	RE57394	AIRE, SECUNDARIO	GA-890R	RE51630
750B SOBRE ORUGAS con motor/A DIESEL			COMBUSTIBLE	G-270	AR86745	GASOLINA, RESPIRADOR DEL CIERRE HIDRAULICO DEL DIFERENCIAL	GG-5 L	AT101565
ACEITE	GP-14	T19044	AIRE, PRIMARIO	GA-930R	RE51629	GASOLINA, RESPIRADOR DEL TANQUE HIDRAULICO	GG-5 L	AT101565
TRANSMISION (HASTA S/N 731273)	GP-34	AT58368	AIRE, SECUNDARIO	GA-890R	RE51630	850 SOBRE ORUGAS con motor/A DIESEL		
COMBUSTIBLE	G-295	AR50041	GASOLINA, RESPIRADOR DEL TANQUE HIDRAULICO	GG-5 L	AT101565	ACEITE, FLUJO TOTAL (FULL FLOW)	GP-35	RE57394
750C SERIES II con motor/JOHN DEERE 6068			770CH SERIES II MOTONIVELADORA con motor/JOHN DEERE 6081 POWERTECH			TRANSMISION	GP-864H	AT135800
COMBUSTIBLE, PRIMARIO	GPP-424	RE62424	TRANSMISION (HASTA S/N 595779)	GP-34	AT193883	COMBUSTIBLE	G-270	AR86745
COMBUSTIBLE, FILTRO FINAL	GPP-419	RE62419	ACEITE	GP-35	RE57394	COMBUSTIBLE, SEPARADOR DE AGUA	2010PM-OR	RE11325
ACEITE	GP-754	RE59754	COMBUSTIBLE	G-270	AR86745	850B SOBRE ORUGAS con motor/A DIESEL		
AIRE, PRIMARIO ESTANDAR	GA-679	AR79679	AIRE, PRIMARIO	GA-930R	RE51629	TRANSMISION (S/N 731274 EN ADELANTE)	G-339H	AR94510
AIRE, SECUNDARIO EST-NDAR	GA-680	AR79680	AIRE, SECUNDARIO	GA-890R	RE51630	ACEITE, HASTA S/N 256120	GP-34	AR43634
750C SOBRE ORUGAS con motor/JOHN DEERE 6068			GASOLINA, RESPIRADOR DEL TANQUE HIDRAULICO	GG-5 L	AT101565	ACEITE, S/N 248524 EN ADELANTE	GP-35	RE57394
ACEITE	GP-14	T19044	770D con motor/JOHN DEERE 6081H POWERTECH			COMBUSTIBLE, SEPARADOR DE AGUA	GPP-424	RE62424
COMBUSTIBLE, SEPARADOR DE AGUA	GPP-424	RE62424	AIRE, PRIMARIO	GA-930R	RE51629	TRANSMISION (HASTA S/N 731274)	GP-864H	AT135800
COMBUSTIBLE	GPP-419	RE62419	AIRE, SECUNDARIO	GA-890R	RE51630	COMBUSTIBLE	G-270	AR86745
AIRE, PRIMARIO	GA-679	AR79679	GASOLINA, RESPIRADOR DEL TANQUE HIDRAULICO	GG-5 L	AT101565	AIRE, PRIMARIO	GA-679	AR79679
AIRE, SECUNDARIO	GA-680	AR79680	770D con motor/JOHN DEERE 6081H POWERTECH			AIRE, SECUNDARIO	GA-680	AR79680
750J SERIES con motor/JOHN DEERE 6068H			AIRE, PRIMARIO	GA-930R	RE51629	850C SERIES II SOBRE ORUGAS con motor/JOHN DEERE 6081		
COMBUSTIBLE	GPP-423	RE509032	AIRE, SECUNDARIO	GA-890R	RE51630	COMBUSTIBLE, PRIMARIO	GPP-426	RE65431
770 MOTONIVELADORA con motor/A DIESEL			GASOLINA, RESPIRADOR DEL CIERRE HIDRAULICO DEL DIFERENCIAL	GG-5 L	AT101565	ACEITE	GP-35	RE57394
ACEITE	GP-34	AR43634	GASOLINA, RESPIRADOR DEL TANQUE HIDRAULICO	GG-5 L	AT101565	COMBUSTIBLE	G-270	AR86745
COMBUSTIBLE	G-295	AR50041	772A MOTONIVELADORA con motor/JOHN DEERE 6466			AIRE, PRIMARIO	GA-679	AR79679
ACEITE	GP-35	RE57394	ACEITE	GP-34	AR43634	AIRE, SECUNDARIO	GA-680	AR79680
770A MOTONIVELADORA con motor/JOHN DEERE 6466			ACEITE	GP-35	RE57394	850C SERIES II SOBRE ORUGAS con motor/JOHN DEERE 6081		
ACEITE, BOMBA HIDRAULICA	GP-34	AT58368	HIDRAULICO	GP-864H	AT120544	COMBUSTIBLE, PRIMARIO	GPP-426	RE65431
ACEITE	GP-35	RE57394	COMBUSTIBLE	G-270	AR86745	ACEITE	GP-35	RE57394
COMBUSTIBLE	G-270	AR86745	772A MOTONIVELADORA con motor/JOHN DEERE 6531			COMBUSTIBLE	G-270	AR86745
770A MOTONIVELADORA con motor/JOHN DEERE 6531			ACEITE	GP-34	AR43634	850C SOBRE ORUGAS con motor/JOHN DEERE 6076		
ACEITE	GP-34	AR43634	ACEITE, BOMBA HIDRAULICA	GP-34	AT58368	ACEITE	GP-35	RE57394
ACEITE, BOMBA HIDRAULICA	GP-34	AT58368	COMBUSTIBLE	G-295	AR50041	COMBUSTIBLE	GPP-424	RE62424
COMBUSTIBLE	G-270	AR86745	HIDRAULICO	GP-864H	AT120544	COMBUSTIBLE	GPP-421	RE62421
770B MOTONIVELADORA, 770BH MOTONIVELADORA, 772BH MOTONIVELADORA con motor/JOHN DEERE 6076			772B MOTONIVELADORA con motor/JOHN DEERE 6076			COMBUSTIBLE	G-270	RE27091
ACEITE	GP-35	RE57394	ACEITE	GP-35	RE57394	870D, 872D con motor/JOHN DEERE 6081H POWERTECH		
770C MOTONIVELADORA con motor/JOHN DEERE 6081 POWER-TECH			HIDRAULICO	GP-864H	AT120544	AIRE, PRIMARIO	GA-930R	RE51629
TRANSMISION (HASTA S/N 595779)	GP-34	AT193883	COMBUSTIBLE	G-270	RE27091	AIRE, SECUNDARIO	GA-890R	RE51630
ACEITE, LUBRICACION DEL MOTOR	GP-35	RE57394	772CH MOTONIVELADORA con motor/JOHN DEERE 6081 POWER-TECH			GASOLINA, RESPIRADOR DEL CIERRE HIDRAULICO DEL DIFERENCIAL	GG-5 L	AT101565
COMBUSTIBLE	G-270	AR86745	TRANSMISION (HASTA S/N 595779)	GP-34	AT193883	GASOLINA, RESPIRADOR DEL TANQUE HIDRAULICO	GG-5 L	AT101565
AIRE, PRIMARIO	GA-930R	RE51629	ACEITE, LUBRICACION DEL MOTOR	GP-35	RE57394	950C con motor/LIEBHERR D926TI		
AIRE, SECUNDARIO	GA-890R	RE51630	COMBUSTIBLE	G-270	AR86745	AGUA	GP-1011Q	AR94650
GASOLINA, RESPIRADOR DEL TANQUE HIDRAULICO	GG-5 L	AT101565	AIRE, PRIMARIO	GA-930R	RE51629	AMT 600 con motor/A DIESEL		
			AIRE, SECUNDARIO	GA-890R	RE51630	ACEITE	GP-91	AM101378

SERVICIO PESADO

MARCA-MODELO-MOTOR MAKE-MODEL-ENGINE	GONHER GONHER	OEM OEM	MARCA-MODELO-MOTOR MAKE-MODEL-ENGINE	GONHER GONHER	OEM OEM	MARCA-MODELO-MOTOR MAKE-MODEL-ENGINE	GONHER GONHER	OEM OEM
JOHN DEERE (continuación)			JOHN DEERE (continuación)			JOHN DEERE (continuación)		
NIVELADORAS			PISCADORAS DE ALGODÓN			PISCADORAS DE ALGODÓN		
AMT 622, AMT 626 con motor/KAWASAKI			499 con motor/JOHN DEERE 219 GASOLINA			9930 con motor/A DIESEL		
ACEITE	GP-157	AM107423	ACEITE	GP-14	T19044	ACEITE	GP-14	T19044
GATOR 4X2, GATOR 4X2 TRAIL, GATOR 6X4, GATOR 6X4 TRAIL con motor/KAWASAKI			699 con motor/JOHN DEERE 303			COMBUSTIBLE	G-295	AR50041
ACEITE	GP-157	AM107423	ACEITE	GP-14	T19044	AIRE, PRIMARIO	GA-679	AR79679
GATOR 6X4, GATOR 6X4 TRAIL con motor/YANMAR 18 HP			COMBUSTIBLE	G-296	AT17387	AIRE, SECUNDARIO	GA-680	AR79680
ACEITE	GP-91	M806418	COMBUSTIBLE	G-296-B	AT17387	9935 con motor/A DIESEL		
GATOR CS, GATOR CX con motores/KAWASAKI 10 HP, KAWASAKI 8HP			AIRE	GAK-403	AH20488	COMBUSTIBLE, SEPARADOR DE AGUA	GPP-426	RE65431
GASOLINA	GG-4	AM116304	699 con motor/JOHN DEERE 329			COMBUSTIBLE	GPP-418	RE62418
GATOR HPX 4X2 con motor/KAWASAKI 20 HP			ACEITE	GP-14	T19044	ACEITE	GP-754	RE59754
GASOLINA	GG-4	AM116304	COMBUSTIBLE, HASTA S/N 237162	G-296	AT17387	AIRE, PRIMARIO	GA-679	AR79679
GATOR HPX 4X2 DIESEL con motor/YANMAR 3TNE			COMBUSTIBLE, S/N 237162 EN ADELANTE	G-295	AR50041	AIRE, SECUNDARIO	GA-680	AR79680
ACEITE	GP-91	M806418	COMBUSTIBLE, HASTA S/N 237162	G-296-B	AT17387	9940 con motor/A DIESEL		
GATOR HPX 4X4 con motor/KAWASAKI 20 HP			AIRE	GAK-403	AH20488	ACEITE, HASTA S/N 298393	GP-34	AR43634
GASOLINA	GG-4	AM116304	699 con motor/MOTOR A GASOLINA			COMBUSTIBLE, HASTA S/N 241583	G-295	AR50041
GATOR HPX 4X4 DIESEL con motor/YANMAR 3TNE			ACEITE, SELLADO	GP-14	T19044	ACEITE, S/N 298393 EN ADELANTE	GP-35	RE57394
ACEITE	GP-91	M806418	7440 con motor/A DIESEL			AGUA	GP-1011Q	AR94650
GATOR HPX 4X4 TRAIL con motor/KAWASAKI 20 HP			ACEITE	GP-14	T19044	COMBUSTIBLE, S/N 241583 EN ADELANTE	G-270	AR86745
GASOLINA	GG-4	AM116304	7445 con motor/A DIESEL			9950 con motor/INTERNACIONAL DTA466		
M-GATOR con motor/YANMAR 18 HP DIESEL			ACEITE	GP-14	T19044	ACEITE	GP-35	RE57394
ACEITE	GP-157	AM107423	COMBUSTIBLE	G-295	AR50041	9960, 9965 con motor/INTERNACIONAL DTA466		
PROGATOR 2020 con motor/YANMAR 3TG72			COMBUSTIBLE, SEPARADOR DE AGUA	GPP-419	RE62419	ACEITE	GP-35	RE57394
ACEITE	GP-91	M806418	AIRE, PRIMARIO	GA-679	AR79679	9970 con motor/A DIESEL		
GASOLINA	GG-5	AM876035	AIRE, SECUNDARIO	GA-680	AR79680	ACEITE	GP-35	RE57394
GASOLINA	GG-5 L	AM876035	7740 con motor/A DIESEL			HIDRAULICO	GP-761H	AH128449
PROGATOR 2030 con motor/YANMAR 3TNE74			ACEITE	GP-14	T19044	COMBUSTIBLE	G-270	RE27091
ACEITE	GP-91	M806418	COMBUSTIBLE	G-295	AR50041	9976 con motor/A DIESEL		
TURF GATOR con motor/KAWASAKI 10 HP			AIRE, PRIMARIO	GA-679	AR79679	COMBUSTIBLE, SEPARADOR DE AGUA	GPP-426	RE65431
ACEITE	GP-157	AM107423	AIRE, SECUNDARIO	GA-680	AR79680	ACEITE	GP-35	RE57394
WORKSITE GATOR con motor/YANMAR 18 HP			99 con motor/A DIESEL			HIDRAULICO	GP-761H	AH128449
ACEITE	GP-91	M806418	ACEITE, SELLADO	GP-14	T19044	COMBUSTIBLE	G-270	AR86745
JOHN DEERE			JOHN DEERE			JOHN DEERE		
PISCADORAS DE ALGODÓN			PISCADORAS DE ALGODÓN			PORTA-HERRAMIENTAS		
299 con motor/JOHN DEERE 217			9900 con motor/A DIESEL			TC44H con motor/JOHN DEERE 4045T POWERTECH		
ACEITE, SELLADO	GP-14	T19044	ACEITE	GP-14	T19044	COMBUSTIBLE, PRIMARIO	GPP-424	RE62424
299 con motor/JOHN DEERE 217 LPG			COMBUSTIBLE, HASTA S/N 237162	G-296	AT17387	COMBUSTIBLE, FILTRO FINAL	GPP-419	RE62419
ACEITE	GP-14	T19044	COMBUSTIBLE, S/N 237162 EN ADELANTE	G-295	AR50041	ACEITE	GP-754	RE59754
299 con motor/JOHN DEERE 248			COMBUSTIBLE, HASTA S/N 237162	G-296-B	AT17387	AIRE, PRIMARIO	GA-697R	AT222722
ACEITE	GP-14	T19044	AIRE	GAK-403	AT44377	TC54H con motor/JOHN DEERE 6068T POWERTECH		
COMBUSTIBLE	G-296	AT17387	9910 con motor/JOHN DEERE 6359			COMBUSTIBLE, PRIMARIO	GPP-424	RE62424
COMBUSTIBLE	G-296-B	AT17387	ACEITE	GP-14	T19044	COMBUSTIBLE, FILTRO FINAL	GPP-419	RE62419
AIRE	GAK-403	AH20488	COMBUSTIBLE	G-295	AR50041	ACEITE	GP-754	RE59754
499 con motor/JOHN DEERE 219 DIESEL			AIRE, SECUNDARIO	GA-426	AR79942	AIRE, PRIMARIO	GA-697R	AT203469
ACEITE	GP-14	T19044	AIRE, PRIMARIO	GA-425	AR79941	TC62H con motor/JOHN DEERE 6068T POWERTECH		
COMBUSTIBLE	G-296	AT17387	9920 con motor/A DIESEL			COMBUSTIBLE, SEPARADOR DE AGUA	GPP-421	RE62424
COMBUSTIBLE	G-296-B	AT17387	ACEITE	GP-14	T19044	COMBUSTIBLE, FILTRO FINAL	GPP-419	RE62419
AIRE	GAK-403	AH20488	COMBUSTIBLE	G-295	AR50041	ACEITE	GP-754	RE59754
			AIRE, CON TURBO PRIMARIO	GA-679	AR79679	AIRE, PRIMARIO	GA-697R	AT203469
			AIRE, CON TURBO SECUN-DARIO	GA-680	AR79680	TC62H con motor/JOHN DEERE 6068T POWERTECH		
			AIRE, SIN TURBO SECUNDARIO	GA-426	AR79942	COMBUSTIBLE, SEPARADOR DE AGUA	GPP-421	RE62424
			AIRE, SIN TURBO PRIMARIO	GA-425	AR79941	COMBUSTIBLE, FILTRO FINAL	GPP-419	RE62419

MARCA-MODELO-MOTOR MAKE-MODEL-ENGINE	GONHER GONHER	OEM OEM	MARCA-MODELO-MOTOR MAKE-MODEL-ENGINE	GONHER GONHER	OEM OEM	MARCA-MODELO-MOTOR MAKE-MODEL-ENGINE	GONHER GONHER	OEM OEM
JOHN DEERE (continuación)			JOHN DEERE (continuación)			JOHN DEERE (continuación)		
PORTA-HERRAMIENTAS			RASPADORAS			TRACTORES		
ACEITE	GP-754	RE59754	COMBUSTIBLE, SECUNDARIO (HASTA S/N 270886)	G-1175	AU42727	AIRE	GAK-16	AT20728
JOHN DEERE			COMBUSTIBLE, PRIMARIO (S/N 270886 EN ADELANTE)	GP-26	AR41419	1020 con motor/A GASOLINA		
RASPADORAS			COMBUSTIBLE, SECUNDARIO (S/N 270886 EN ADELANTE)	GP-27	AT41420	ACEITE	G-139	AR28110R
760 con motor/A DIESEL			AIRE, PRIMARIO	GA-106	U44957	ACEITE	G-331	AR75603
ACEITE	G-331	AR75603	AIRE, SECUNDARIO	GA-206	U44956	ACEITE	GP-14	T19044
TRANSMISION	G-331	AR75603	860B con motor/A DIESEL			AIRE	GA-16	AH19852
COMBUSTIBLE	GPP-14	AR45097	ACEITE, FRENOS DE POTENCIA (HASTA S/N 003095)	G-331	AR75603	AIRE	GAK-16	AT20728
AIRE	GAK-20	AR36044	ACEITE	GP-34	AR43634	1020, 1520 con motor/A DIESEL		
760A con motor/A DIESEL			ACEITE	GP-35	RE57394	ACEITE, CONDUCCION EN REVERSA	G-139	AR26350
ACEITE	G-331	AR75603	ACEITE	GP-35	RE57394	TRANSMISION	G-331	AR75603
HIDRAULICO	G-331	AR75603	ACEITE, FRENOS DE POTENCIA (S/N 003095 EN ADELANTE)	GP-864H	AT135800	ACEITE	GP-14	T19044
TRANSMISION	G-331	AR75603	COMBUSTIBLE	G-270	AR86745	COMBUSTIBLE	G-296	AT17387
COMBUSTIBLE	G-295	AR50041	AIRE, PRIMARIO	GA-106	U44957	COMBUSTIBLE	G-295	AR50041
AIRE, PRIMARIO	GA-360	AR46003	AIRE, SECUNDARIO	GA-206	U44956	COMBUSTIBLE	G-296-B	AT17387
AIRE, SECUNDARIO	GA-361	AR46004	862 con motor/A DIESEL			AIRE	GAK-16	AT20728
762 con motor/A DIESEL			HIDRAULICO	GP-14	T19044	1030 UTILITARIO con motor/A DIESEL		
ACEITE, TANQUE HIDRAULICO	GP-14	T19044	GASOLINA, SEPARADOR DE AGUA	G-293	AR86755	HIDRAULICO	G-331	AR75603
ACEITE	GP-34	AR43634	HIDRAULICO	GP-34	AT58368	TRANSMISION	G-331	AR75603
ACEITE	GP-35	RE57394	ACEITE, FLUJO TOTAL (FULL FLOW)	GP-35	RE57394	ACEITE	GP-14	T19044
ACEITE, CAJA DE CAMBIOS HIDRAULICO	GP-864H	AT135800	COMBUSTIBLE	G-270	AR86745	COMBUSTIBLE	G-295	AR50041
ACEITE, CERRADURA DIFERENCIAL HIDRAULICA	GP-864H	AT135800	862B con motor/A DIESEL			AIRE, HASTA S/N 190320	GAK-16	AT20728
COMBUSTIBLE	G-270	AR86745	HIDRAULICO SELLADO	GP-14	T19044	AIRE, PRIMARIO (S/N 190320 EN ADELANTE)	GAK-216	AR84228
762A con motor/A DIESEL			ACEITE, CERRADURA DIFERENCIAL HIDRAULICA	GP-34	AT58368	AIRE, SECUNDARIO (S/N 190320 EN ADELANTE)	GA-416	AL27159
HIDRAULICO	GP-14	T19044	ACEITE, FLUJO TOTAL (FULL FLOW)	GP-35	RE57394	1040 UTILITARIO, 1040F UTILITARIO, 1040V UTILITARIO, 1140 UTILITARIO, 1140V UTILITARIO, 1350 UTILITARIO con motor/A DIESEL		
GASOLINA, SEPARADOR DE AGUA	G-293	AR86755	COMBUSTIBLE	G-270	AR86745	TRANSMISION	G-331	AR75603
ACEITE, HASTA S/N 248524	GP-34	AR43634	JOHN DEERE			ACEITE	GP-14	T19044
ACEITE, S/N 248524 EN ADELANTE	GP-35	RE57394	TRACTORES			COMBUSTIBLE	G-295	AR50041
ACEITE, CAJA DE CAMBIOS HIDRAULICO	GP-864H	AT135800	1010 con motor/A DIESEL			AIRE, PRIMARIO	GAK-216	AR84228
ACEITE, CERRADURA DIFERENCIAL HIDRAULICA	GP-864H	AT135800	ACEITE, CONDUCCION EN REVERSA	G-139	AR26350	AIRE, SECUNDARIO	GA-416	AL27159
COMBUSTIBLE, S/N 705645 EN ADELANTE	G-270	AR86745	TRANSMISION	G-139	AR26350	1050 con motor/A DIESEL		
762B con motor/A DIESEL			ACEITE, SELLADO (S/N 42001 EN ADELANTE)	GP-14	T19044	HIDRAULICO (HASTA S/N 011001)	GP-1	TY9425
HIDRAULICO	GP-14	T19044	COMBUSTIBLE, S/N 42001 EN ADELANTE	G-296	AT17387T	ACEITE	GP-462	M801002
ACEITE, HASTA S/N 248224	GP-34	AR43634	COMBUSTIBLE, S/N 42001 EN ADELANTE	G-296-B	AT17387T	AIRE, PRIMARIO SIN ASPAS	GA-33	CH12767
ACEITE, S/N 248524 EN ADELANTE	GP-35	RE57394	AIRE	GAK-16	AT20728	1070 UTILITARIO con motor/A DIESEL		
ACEITE, BOMBA DE TRANSMISION	GP-864H	AT135800	1010C, 1010D con motor/A DIESEL			ACEITE	GP-40	M801209
ACEITE, CERRADURA DIFERENCIAL HIDRAULICA	GP-864H	AT135800	ACEITE, CONDUCCION EN REVERSA	G-139	AR26350	11 con motor/KOHLER 6.25 HP		
COMBUSTIBLE	G-270	AR86745	TRANSMISION	G-139	AR26350	AIRE	GA-11	230840
860 con motor/A DIESEL			ACEITE, SELLADO (S/N 42001 EN ADELANTE)	GP-14	T19044	110/CARGADOR/RETROEXCAVADORA con motor/YANMAR 4TNE84		
ACEITE	G-33	AR29554	COMBUSTIBLE, S/N 42001 EN ADELANTE	G-296	AT17387T	TRANSMISION	GP-864H	RE45864
ACEITE, FRENO/DIFERENCIAL	G-331	AR75601	COMBUSTIBLE, S/N 42001 EN ADELANTE	G-296-B	AT17387T	DIRECCION	GP-761H	LVA10419
COMBUSTIBLE, SECUNDARIO (HASTA S/N 270886)	G-1175	AU42727	AIRE	GAK-16	AT20728	AIRE, RADIAL PRIMARIO	GA-880R	M131802
COMBUSTIBLE, PRIMARIO (S/N 270886 EN ADELANTE)	GP-26	AR41419	1010L, 1010W con motor/A DIESEL			1120 con motor/A DIESEL		
COMBUSTIBLE, SECUNDARIO (S/N 270886 EN ADELANTE)	GP-27	AT41420	ACEITE	G-139	AR26350	TRANSMISION (SIN HLT)	G-331	AR75603
AIRE, PRIMARIO	GA-106	U44957	ACEITE	GP-14	T19044	ACEITE	GP-14	T19044
AIRE, SECUNDARIO	GA-206	U44956	COMBUSTIBLE	G-296	AT17387	COMBUSTIBLE	G-295	AR50041
860A con motor/A DIESEL			COMBUSTIBLE	G-296-B	AT17387	AIRE	GAK-16	AT20728
ACEITE	G-33	AR29554	AIRE	GA-16	AH19852	AIRE	GAK-216	AR84228
ACEITE, FRENO/DIFERENCIAL	G-331	AR75601				1130 UTILITARIO con motor/A DIESEL		
						HIDRAULICO	G-331	AR75603
						ACEITE	GP-14	T19044
						COMBUSTIBLE	G-295	AR50041
						AIRE, HASTA S/N 190320	GAK-16	AT20728

SERVICIO PESADO

MARCA-MODELO-MOTOR MAKE-MODEL-ENGINE	GONHER GONHER	OEM OEM	MARCA-MODELO-MOTOR MAKE-MODEL-ENGINE	GONHER GONHER	OEM OEM	MARCA-MODELO-MOTOR MAKE-MODEL-ENGINE	GONHER GONHER	OEM OEM
JOHN DEERE (continuación)			JOHN DEERE (continuación)			JOHN DEERE (continuación)		
TRACTORES			TRACTORES			TRACTORES		
AIRE, PRIMARIO (S/N 190320 EN ADELANTE)	GAK-216	AR84228	COMBUSTIBLE	G-296	AT17387T	2010D, 2010F con motor/A DIESEL		
AIRE, SECUNDARIO (S/N 190320 EN ADELANTE)	GA-416	AL27159	COMBUSTIBLE	G-296-B	AT17387T	ACEITE	G-331	AR75603
			AIRE, MOTORES A GASOLINA	GAK-16	AT20728	ACEITE	GP-14	T19044
						COMBUSTIBLE	G-296	AT17387
1250, 1450 con motor/A DIESEL			1650, 1800, 2000, 2100, 2200 con motor/A DIESEL			COMBUSTIBLE	G-296-B	AT17387
ACEITE	GP-14	T19044	ACEITE	GP-14	T19044			
AIRE, PRIMARIO	GAK-216	AR84228				2010W con motor/A DIESEL		
AIRE, SECUNDARIO	GA-416	AE31724	1750 UTILITARIO con motor/A DIESEL			ACEITE	G-139	AT15088T
			TRANSMISION	G-331	AR75603	ACEITE	GP-14	T19044
			ACEITE	GP-14	T19044	AIRE	GAK-16	AT20728
145, 155 con motor/A DIESEL			COMBUSTIBLE	G-295	AR50041			
ACEITE, SELLADO	GP-14	T19044	AIRE, PRIMARIO (SIN PRE LIMPIADOR)	GAK-216	AR84228	2020 con motor/A DIESEL		
			AIRE, SECUNDARIO (SIN PRE LIMPIADOR)	GA-416	AE31724	ACEITE, CARTUCHO	G-139	AR26350
1520, 2020 con motor/A GASOLINA						TRANSMISION	G-331	AR75603
ACEITE, CARTUCHO	G-139	AR28110R	1830 UTILITARIO con motor/A DIESEL			ACEITE, SELLADO	GP-14	T19044
TRANSMISION	G-331	AR75603	TRANSMISION (SIN HLT)	G-331	AR75603	COMBUSTIBLE	G-296	AT17387
ACEITE, SELLADO	GP-14	T19044	ACEITE	GP-14	T19044	COMBUSTIBLE	G-296-B	AT17387
AIRE	GAK-16	AT20728	COMBUSTIBLE	G-296	AT17387	AIRE	GAK-16	AT20728
			COMBUSTIBLE	G-295	AR50041			
1530 con motor/A DIESEL			COMBUSTIBLE	G-296-B	AT17387	2030 con motor/A DIESEL		
ACEITE, CONDUCCION EN REVERSA	G-139	AR26350	AIRE, HASTA S/N 190320	GAK-16	AT20728	TRANSMISION	G-331	AR75603
TRANSMISION	G-331	AR75603	AIRE, PRIMARIO (S/N 190320 EN ADELANTE)	GAK-216	AR84228	ACEITE	GP-14	T19044
ACEITE	GP-14	T19044	AIRE, SECUNDARIO (S/N 190320 EN ADELANTE)	GA-416	AL27159	COMBUSTIBLE	G-296	AT17387
COMBUSTIBLE	G-295	AR50041				COMBUSTIBLE	G-295	AR50041
AIRE, HASTA S/N 190320	GAK-16	AT20728	1840 UTILITARIO con motor/A DIESEL			COMBUSTIBLE	G-296-B	AT17387
AIRE, PRIMARIO (S/N 190320 EN ADELANTE)	GAK-216	AR84228	TRANSMISION	G-331	AR75603	AIRE, S/N 190320 EN ADELANTE	GAK-16	AT20728
AIRE, SECUNDARIO (S/N 190320 EN ADELANTE)	GA-416	AE31724	ACEITE	GP-14	T19044	AIRE, PRIMARIO (S/N 190320 EN ADELANTE)	GAK-216	AR84228
			COMBUSTIBLE	G-295	AR50041	AIRE, SECUNDARIO (S/N 190320 EN ADELANTE)	GA-416	AE31724
1550 UTILITARIO con motor/A DIESEL			AIRE, PRIMARIO	GAK-216	AR84228			
TRANSMISION	G-331	AR75603	AIRE, SECUNDARIO	GA-416	AL27159	2040 UTILITARIO, 2040F UTILITARIO, 2040S UTILITARIO con motor/A DIESEL		
ACEITE	GP-14	T19044				ACEITE, BOMBA HIDRAULICA	G-331	AR75601
COMBUSTIBLE	G-295	AR50041	1850 UTILITARIO con motor/A DIESEL			ACEITE	GP-14	T19044
AIRE, PRIMARIO (SIN PRE LIMPIADOR)	GAK-216	AR84228	TRANSMISION	G-331	AR75603	COMBUSTIBLE	G-295	AR50041
AIRE, SECUNDARIO (SIN PRE LIMPIADOR)	GA-416	AE31724	ACEITE	GP-14	T19044	AIRE, SIMPLE (TRACTORES EN-SAMBLADOS EN DUBUQUE)	GAK-16	AT20728
			COMBUSTIBLE	G-295	AR50041	AIRE, PRIMARIO	GAK-216	AR84228
1630 UTILITARIO con motor/A DIESEL			AIRE, PRIMARIO (SIN PRE LIMPIADOR)	GAK-216	AR84228	AIRE, SECUNDARIO	GA-416	AE31724
TRANSMISION (SIN HLT)	G-331	AR75603	AIRE, SECUNDARIO (SIN PRE LIMPIADOR)	GA-416	AE31724			
COMBUSTIBLE	G-295	AR50041				21 con motor/KOHLER 14 HP		
AIRE, HASTA S/N 190320	GAK-16	AT20728	1950 UTILITARIO con motor/A DIESEL			AIRE	GA-7	AM31400
AIRE, PRIMARIO (S/N 190320 EN ADELANTE)	GAK-216	AR84228	TRANSMISION	G-331	AR75603			
AIRE, SECUNDARIO (S/N 190320 EN ADELANTE)	GA-416	AL27159	ACEITE	GP-14	T19044	2120 con motor/A DIESEL		
			COMBUSTIBLE	G-295	AR50041	TRANSMISION	G-331	AR75603
1630VU UTILITARIO con motor/A DIESEL			AIRE, SECUNDARIO	GA-416	AL27159	ACEITE	GP-14	T19044
TRANSMISION (SIN HLT)	G-331	AR75603				COMBUSTIBLE	G-296	AT17387
ACEITE	GP-14	T19044	2010 con motor/A DIESEL			COMBUSTIBLE	G-296-B	AT17387
COMBUSTIBLE	G-295	AR50041	ACEITE, CONDUCCION EN REVERSA	G-139	AR26350	AIRE, SIMPLE	GAK-16	AT20728
AIRE, HASTA S/N 190320	GAK-16	AT20728	ACEITE, SELLADO (S/N 042001 EN ADELANTE)	GP-14	T19044	AIRE, PRIMARIO	GAK-216	AR84228
AIRE, PRIMARIO (S/N 190320 EN ADELANTE)	GAK-216	AR84228	COMBUSTIBLE, S/N 42001 EN ADELANTE	G-296	AT17387	AIRE, SECUNDARIO	GA-416	AE31724
AIRE, SECUNDARIO (S/N 190320 EN ADELANTE)	GA-416	AL27159	COMBUSTIBLE, S/N 42001 EN ADELANTE	G-296-B	AT17387			
			AIRE	GAK-16	AT20728	2120CDN con motor/A DIESEL		
1640 UTILITARIO, 1640F UTILITARIO con motor/A DIESEL						TRANSMISION	G-331	AR75603
TRANSMISION	G-331	AR75603	2010C con motor/A DIESEL			ACEITE	GP-14	T19044
ACEITE	GP-14	T19044	ACEITE	G-139	AT15088T	COMBUSTIBLE	G-296	AT17387
COMBUSTIBLE	G-295	AR50041	ACEITE	GP-14	T19044	COMBUSTIBLE	G-296-B	AT17387
AIRE, PRIMARIO	GAK-216	AR84228	COMBUSTIBLE	G-296	AT17387	AIRE, SIMPLE	GAK-16	AT20728
AIRE, SECUNDARIO	GA-416	AL27159	COMBUSTIBLE	G-296-B	AT17387	AIRE, PRIMARIO	GAK-216	AR84228
			AIRE	GAK-16	AT20728	AIRE, SECUNDARIO	GA-416	AE31724
165 con motor/A DIESEL Y GASOLINA								
ACEITE, SELLADO	GP-14	T19044	2010D con motor/A DIESEL			2130 con motor/A DIESEL		
			ACEITE	G-139	AT15088T	TRANSMISION (SIN HLT)	G-331	AR75603
			ACEITE	GP-14	T19044	ACEITE	GP-14	T19044
			COMBUSTIBLE	G-296	AT17387	COMBUSTIBLE	G-296	AT17387
			COMBUSTIBLE	G-296-B	AT17387			
			AIRE	GAK-16	AT20728			

MARCA-MODELO-MOTOR MAKE-MODEL-ENGINE	GONHER GONHER	OEM OEM	MARCA-MODELO-MOTOR MAKE-MODEL-ENGINE	GONHER GONHER	OEM OEM	MARCA-MODELO-MOTOR MAKE-MODEL-ENGINE	GONHER GONHER	OEM OEM
JOHN DEERE (continuación)			JOHN DEERE (continuación)			JOHN DEERE (continuación)		
TRACTORES			TRACTORES			TRACTORES		
COMBUSTIBLE	G-295	AR50041	2355N con motor/A DIESEL			ACEITE	GP-14	T19044
COMBUSTIBLE	G-296-B	AT17387	TRANSMISION	G-331	AR75603	COMBUSTIBLE	G-295	AR50041
AIRE, SIMPLE	GAK-16	AT20728	ACEITE	GP-14	T19044	2855N, 3055 UTILITARIO con motor/A DIESEL		
AIRE, PRIMARIO	GAK-216	AE31723	COMBUSTIBLE	G-295	AR50041	TRANSMISION	G-331	AR75603
AIRE, SECUNDARIO	GA-416	AE31724	HIDRAULICO	GP-66	AL56469	ACEITE	GP-14	T19044
2140 UTILITARIO, 2250 UTILITARIO, 2450 UTILITARIO, 2650 UTILITARIO con motor/A DIESEL			AIRE, SECUNDARIO	GA-416	AL27159	COMBUSTIBLE	G-295	AR50041
TRANSMISION	G-331	AR75603	2440 con motor/A DIESEL			HIDRAULICO	GP-66	AL56469
ACEITE	GP-14	T19044	TRANSMISION	G-331	AR75603	2940 con motor/A DIESEL		
COMBUSTIBLE	G-295	AR50041	ACEITE	GP-14	T19044	HIDRAULICO	G-331	AR75603
2150, 2255 con motor/A DIESEL			COMBUSTIBLE	G-295	AR50041	TRANSMISION	G-331	AR75603
HIDRAULICO	G-331	AR75603	AIRE, SIMPLE	GAK-16	AT20728	ACEITE	GP-14	T19044
ACEITE	GP-14	T19044	AIRE, PRIMARIO	GAK-216	AR84228	COMBUSTIBLE	G-295	AR50041
COMBUSTIBLE	G-295	AR50041	AIRE, SECUNDARIO	GA-416	AL27159	2950 con motor/A DIESEL		
AIRE, PRIMARIO	GAK-216	AR84228	2510 con motor/A DIESEL			TRANSMISION	G-331	AR75603
AIRE, SECUNDARIO	GA-416	AE31724	TRANSMISION	G-331	AR75603	ACEITE	GP-14	T19044
2155 con motor/A DIESEL			ACEITE	GP-14	T19044	COMBUSTIBLE	G-295	AR50041
TRANSMISION	G-331	AR75603	COMBUSTIBLE	G-296	AT17387	2955 con motor/A DIESEL		
ACEITE	GP-14	T19044	COMBUSTIBLE	G-296-B	AT17387	TRANSMISION	G-331	AR75603
COMBUSTIBLE	G-295	AR50041	2520 COMPACTO con motor/YANMAR 3TNV82A			ACEITE	GP-14	T19044
HIDRAULICO	GP-66	AL56469	AIRE, RADIAL PRIMARIO	GA-880R	R660690	COMBUSTIBLE	G-295	AR50041
AIRE, PRIMARIO (HASTA S/N 622000)	GAK-216	AR84228	2520 con motor/A DIESEL			HIDRAULICO	GP-66	AL56469
AIRE, SECUNDARIO	GA-416	AE31724	TRANSMISION	G-331	AR75603	3010 con motor/A DIESEL		
2210 con motor/YANMAR 3TNE74			ACEITE	GP-14	T19044	ACEITE	G-139	AR26350
ACEITE	GP-91	M806418	COMBUSTIBLE	G-296	AT17387	TRANSMISION	G-331	AR75603
2240 (ENSAMBLADO EN ALEMANIA) con motor/A DIESEL			COMBUSTIBLE	G-296-B	AT17387	COMBUSTIBLE, SELLADO (1962 EN ADELANTE)	GPP-14	AR45097
TRANSMISION	G-331	AR75603	AIRE	GA-403	AR46481	COMBUSTIBLE	G-295	AR50041
COMBUSTIBLE	G-295	AR50041	2550 con motor/A DIESEL			HIDRAULICO	GP-66	AT38431
AIRE, PRIMARIO	GAK-216	AR84228	HIDRAULICO	G-331	AR75603	AIRE, PRIMARIO	GAK-216	AR84228
AIRE, SECUNDARIO	GA-416	AE31724	ACEITE	GP-14	T19044	AIRE, SECUNDARIO	GA-416	AE31724
2240 (ENSAMBLADO EN DUBUQUE) con motor/A DIESEL			COMBUSTIBLE	G-295	AR50041	3020 con motor/A DIESEL		
TRANSMISION	G-331	AR75603	AIRE, PRIMARIO	GAK-216	AR84228	ACEITE	G-139	AR26350
ACEITE	GP-14	T19044	AIRE, SECUNDARIO	GA-416	AL27159	ACEITE, SYNCRO RANGE	G-331	AR75603
COMBUSTIBLE	G-295	AR50041	2555 con motor/A DIESEL			TRANSMISION	G-331	AR75603
AIRE, HASTA S/N 190319	GAK-16	AT20728	TRANSMISION	G-331	AR75603	COMBUSTIBLE, HASTA S/N 125000	GPP-14	AR45097
AIRE, PRIMARIO (S/N 190320 EN ADELANTE)	GAK-216	AR84228	ACEITE	GP-14	T19044	COMBUSTIBLE, S/N 125000 EN ADELANTE	G-295	AR50041
AIRE, SECUNDARIO (S/N 190320 EN ADELANTE)	GA-416	AE31724	COMBUSTIBLE	G-295	AR50041	AIRE, SIN ASPAS (S/N 123000 EN ADELANTE)	GA-403	AR46481
2300, 2400 con motor/A DIESEL			HIDRAULICO	GP-66	AL56469	AIRE, CON ASPAS (S/N 123000 EN ADELANTE)	GAK-403	AR46481
ACEITE	GP-14	T19044	AIRE, SECUNDARIO (S/N 634103 EN ADELANTE)	GA-416	AL27159	3030 con motor/A DIESEL		
2305, 2320 con motor/YANMAR 3TNV76			2630, 2640 con motor/A DIESEL			ACEITE, TREN DE PODER	G-331	AR75603
ACEITE	GP-91	M806418	TRANSMISION	G-331	AR75603	ACEITE	GP-14	T19044
2350 con motor/A DIESEL			ACEITE	GP-14	T19044	COMBUSTIBLE	G-296	AT17387
HIDRAULICO	G-331	AR75603	COMBUSTIBLE	G-295	AR50041	COMBUSTIBLE	G-296-B	AT17387
ACEITE	GP-14	T19044	AIRE, PRIMARIO	GAK-216	AR84228	3040 UTILITARIO con motor/A DIESEL		
COMBUSTIBLE	G-295	AR50041	AIRE, SECUNDARIO	GA-416	AL27159	HIDRAULICO	G-331	AR75603
AIRE, PRIMARIO	GAK-216	AR84228	2750, 2755 con motor/A DIESEL			ACEITE	GP-14	T19044
AIRE, SECUNDARIO	GA-416	AL27159	TRANSMISION	G-331	AR75603	COMBUSTIBLE	G-295	AR50041
2355 con motor/A DIESEL			ACEITE	GP-14	T19044	AIRE, SECUNDARIO	GA-426	AR79942
TRANSMISION	G-331	AR75603	COMBUSTIBLE	G-295	AR50041	AIRE, PRIMARIO	GA-425	AR79941
ACEITE	GP-14	T19044	HIDRAULICO	GP-66	AL56469	3050 ROW CROP, 3130 UTILITARIO con motor/A DIESEL		
COMBUSTIBLE	G-295	AR50041	2840 con motor/A DIESEL			TRANSMISION	G-331	AR75603
HIDRAULICO	GP-66	AL56469	ACEITE	GP-14	T19044	ACEITE	GP-14	T19044
AIRE, SECUNDARIO (S/N 634103 EN ADELANTE)	GA-416	AL27159	COMBUSTIBLE	G-295	AR50041	COMBUSTIBLE	G-295	AR50041
2850 UTILITARIO con motor/A DIESEL			HIDRAULICO	GP-66	AL56469	2850 UTILITARIO con motor/A DIESEL		
HIDRAULICO	G-331	AR75603	2840 con motor/A DIESEL			TRANSMISION	G-331	AR75603
2850 UTILITARIO con motor/A DIESEL			ACEITE	GP-14	T19044	ACEITE	GP-14	T19044
HIDRAULICO	G-331	AR75603	2850 UTILITARIO con motor/A DIESEL			COMBUSTIBLE	G-295	AR50041
HIDRAULICO	G-331	AR75603	HIDRAULICO	G-331	AR75603			

SERVICIO PESADO

MARCA-MODELO-MOTOR MAKE-MODEL-ENGINE	GONHER GONHER	OEM OEM	MARCA-MODELO-MOTOR MAKE-MODEL-ENGINE	GONHER GONHER	OEM OEM	MARCA-MODELO-MOTOR MAKE-MODEL-ENGINE	GONHER GONHER	OEM OEM
JOHN DEERE (continuación)			JOHN DEERE (continuación)			JOHN DEERE (continuación)		
TRACTORES			TRACTORES			TRACTORES		
3100 con motor/A DIESEL			ACEITE	GP-14	T19044	4050 con motor/JOHN DEERE 6466		
ACEITE	GP-14	T19044	TRANSMISION	G-295	AR50041	HIDRAULICO	G-339H	AR94510
COMBUSTIBLE	GPP-418	RE62418	3830 con motor/JOHN DEERE 4039			GASOLINA, SEPARADOR DE AGUA	G-293	AR86755
AIRE, RADIAL PRIMARIO	GA-853R	RT6005011111	ACEITE	GP-14	T19044	COMBUSTIBLE, HASTA S/N 306870	G-295	AR50041
312 HIDROESTATICO, 314 HIDROESTATICO con motor/A GASOLINA			COMBUSTIBLE	G-295	AR50041	ACEITE	GP-35	RE57394
AIRE, HASTA S/N 80001	GA-7	AM31400	AIRE, PRIMARIO	GA-403	AT65296	COMBUSTIBLE, S/N 299564-337107	G-270	AR86745
3140 UTILITARIO, 3140DT UTILITARIO con motor/A DIESEL			400 HIDROESTATICO con motor/KOHLER			AIRE, PRIMARIO	GA-679	AR79679
TRANSMISION	G-331	AR75603	HIDRAULICO	GP-9	AM35176	AIRE, SECUNDARIO	GA-680	AR79680
ACEITE	GP-14	T19044	TRANSMISION	GP-9	AM35176	4055 con motor/JOHN DEERE 7.6L		
COMBUSTIBLE	G-295	AR50041	ACEITE	GP-3600	AM39687	HIDRAULICO	G-339H	AR94510
AIRE, SECUNDARIO	GA-426	AR79942	4000 con motor/A DIESEL, GASOLINA O LPG			GASOLINA, SEPARADOR DE AGUA	G-293	AR86755
AIRE, PRIMARIO	GA-425	AR79941	ACEITE	G-139	AR26350	ACEITE	GP-35	RE57394
3150 con motor/A DIESEL			ACEITE, SYNCRO RANGE	G-331	AR75603	COMBUSTIBLE	G-270	RE27091
HIDRAULICO	G-331	AR75603	TRANSMISION	G-331	AR75603	AIRE, PRIMARIO	GA-679	AR79679
ACEITE	GP-14	T19044	COMBUSTIBLE, HASTA S/N 215000	GPP-14	AR45097	AIRE, SECUNDARIO	GA-680	AR79680
COMBUSTIBLE	G-295	AR50041	COMBUSTIBLE, S/N280001 EN ADELANTE	G-295	AR50041	4100 con motor/A DIESEL		
3155, 3255 con motor/A DIESEL			4010 con motor/A DIESEL			ACEITE	GP-91	M806418
TRANSMISION	G-331	AR75603	ACEITE	G-139	AR26350	4100N con motor/A DIESEL		
ACEITE	GP-14	T19044	TRANSMISION	G-331	AR75603	ACEITE	GP-91	M806418
COMBUSTIBLE	G-295	AR50041	COMBUSTIBLE	G-295	AR50041	4110 con motor/YANMAR 3TNE74		
HIDRAULICO	GP-66	ALS6469	4010 con motor/YANMAR 3TNE68			ACEITE	GP-91	M806418
316 HIDROESTATICO con motor/A GASOLINA			ACEITE	GP-91	M806418	4210 con motor/YANMAR 3TNE82		
ACEITE, S/N 285001-420000	GP-58	AM101207	4020 con motor/A DIESEL, GASOLINA O LPG			HIDROSTATICO	GP-761H	LVA10419
TRANSMISION	GP-3816	AM39653	ACEITE	G-139	AR26350	4230 con motor/JOHN DEERE 362 A GASOLINA		
GASOLINA	GG-4	AM380708	ACEITE, SYNCRO RANGE	G-331	AR75603	ACEITE	G-139	AR26350
3200 X, 3300 X, 3400 X con motor/A DIESEL			TRANSMISION	G-331	AR75603	TRANSMISION	G-331	AR75603
ACEITE	GP-14	T19044	COMBUSTIBLE, HASTA S/N 215000	GPP-14	AR45097	GASOLINA, SEPARADOR DE AGUA	G-293	AR86755
COMBUSTIBLE	GPP-418	RE62418	COMBUSTIBLE, S/N 280001 EN ADELANTE	G-295	AR50041	AIRE, SECUNDARIO	GA-426	AR79942
AIRE, RADIAL PRIMARIO	GA-853R	RT6005011111	4030 con motor/A DIESEL			AIRE, PRIMARIO	GA-425	AR79941
3200, 3300 con motor/A DIESEL			TRANSMISION	G-331	AR75603	4230 con motor/JOHN DEERE 404 A DIESEL		
ACEITE	GP-14	T19044	ACEITE	GP-14	T19044	TRANSMISION	G-331	AR75603
COMBUSTIBLE	GPP-418	RE62418	GASOLINA, SEPARADOR DE AGUA	G-293	AR86755	GASOLINA, SEPARADOR DE AGUA	G-293	AR86755
AIRE, RADIAL PRIMARIO	GA-853R	RT6005011111	COMBUSTIBLE	G-295	AR50041	ACEITE	GP-34	AR43634
3350 con motor/A DIESEL			AIRE, SECUNDARIO	GA-426	AR79942	COMBUSTIBLE	G-295	AR50041
TRANSMISION	G-331	AR75603	AIRE, PRIMARIO	GA-425	AR79941	AIRE, SECUNDARIO	GA-426	AR79942
ACEITE	GP-14	T19044	4040 con motor/JOHN DEERE 404 DIESEL			AIRE, PRIMARIO	GA-425	AR79941
COMBUSTIBLE	G-295	AR50041	TRANSMISION	G-339H	AR94510	4240 con motor/JOHN DEERE 466 A DIESEL		
3400 con motor/A DIESEL			GASOLINA, SEPARADOR DE AGUA	G-293	AR86755	TRANSMISION	G-339H	AR94510
ACEITE	GP-14	T19044	ACEITE	GP-34	AR43634	ACEITE, HASTA S/N 292346	GP-34	AR43634
COMBUSTIBLE	GPP-418	RE62418	COMBUSTIBLE	G-295	AR50041	COMBUSTIBLE	G-295	AR50041
AIRE, RADIAL PRIMARIO	GA-853R	RT6005011111	AIRE, SECUNDARIO	GA-426	AR79942	ACEITE, S/N 292346 EN ADELANTE	GP-35	RE57394
3430 con motor/A DIESEL			AIRE, PRIMARIO	GA-425	AR79941	AIRE, SECUNDARIO	GA-426	AR79942
ACEITE	GP-14	T19044	4050 con motor/JOHN DEERE 6359			AIRE, PRIMARIO	GA-425	AR79941
COMBUSTIBLE	G-295	AR50041	HIDRAULICO	G-339H	AR94510	4250 con motor/A DIESEL		
AIRE, PRIMARIO	GAK-216	AR84228	ACEITE	GP-14	T19044	TRANSMISION	G-339H	AR94510
AIRE, SECUNDARIO	GA-416	AE31724	GASOLINA, SEPARADOR DE AGUA	G-293	AR86755	GASOLINA, SEPARADOR DE AGUA	G-293	AR86755
3640 UTILITARIO con motor/A DIESEL			COMBUSTIBLE, HASTA S/N 306870	G-295	AR50041	ACEITE	GP-35	RE57394
TRANSMISION	G-331	AR75603	AIRE, SECUNDARIO	GA-426	AR79942	COMBUSTIBLE	G-270	AR86745
ACEITE	GP-14	T19044	AIRE, PRIMARIO	GA-425	AR79941	AIRE, PRIMARIO	GA-679	AR79679
COMBUSTIBLE	G-295	AR50041	4050 con motor/JOHN DEERE 6359			AIRE, SECUNDARIO	GA-680	AR79680
3650 UTILITARIO con motor/A DIESEL			HIDRAULICO	G-339H	AR94510			
ACEITE	G-331	AR75603	ACEITE	GP-14	T19044			

APLICACIONES SERVICIO PESADO
HEAVY DUTY APPLICATIONS



MARCA-MODELO-MOTOR MAKE-MODEL-ENGINE	GONHER GONHER	OEM OEM	MARCA-MODELO-MOTOR MAKE-MODEL-ENGINE	GONHER GONHER	OEM OEM	MARCA-MODELO-MOTOR MAKE-MODEL-ENGINE	GONHER GONHER	OEM OEM
JOHN DEERE (continuación)			JOHN DEERE (continuación)			JOHN DEERE (continuación)		
TRACTORES			TRACTORES			TRACTORES		
4255 con motor/A DIESEL			4455 con motor/A DIESEL			4755 con motor/A DIESEL		
HIDRAULICO	G-339H	AR94510	HIDRAULICO	G-339H	AR94510	TRANSMISION	G-339H	AR94510
GASOLINA, SEPARADOR DE AGUA	G-293	AR86755	GASOLINA, SEPARADOR DE AGUA	G-293	AR86755	GASOLINA, SEPARADOR DE AGUA	G-293	AR86755
ACEITE	GP-35	RE57394	ACEITE	GP-35	RE57394	ACEITE	GP-35	RE57394
COMBUSTIBLE	G-270	AR86745	COMBUSTIBLE	G-270	RE27091	COMBUSTIBLE	G-270	RE27091
AIRE, PRIMARIO	GA-679	AR79679	AIRE, PRIMARIO	GA-679	AR79679			
AIRE, SECUNDARIO	GA-680	AR79680	AIRE, SECUNDARIO	GA-680	AR79680	4760 con motor/A DIESEL		
						TRANSMISION	G-339H	AR94510
4310 con motor/YANMAR 3TNE84			4510, 4610 con motor/YANMAR 4TNE84			ACEITE	GP-35	RE57394
HIDROSTATICO	GP-761H	LVA10419	DIRECCION (PRT)	GP-761H	LVA10419	AGUA	GP-2071W	RE42052
						COMBUSTIBLE	G-270	RE27091
4320 con motor/A DIESEL			4520 con motor/A DIESEL			4840 con motor/A DIESEL		
TRANSMISION	G-331	AR75603	ACEITE, SYNCHRO RANGE TRANSMISION	G-331	AR75603	TRANSMISION	G-339H	AR94510
ACEITE	GP-34	AR43634	TRANSMISION	G-331	AR75603	GASOLINA, SEPARADOR DE AGUA	G-293	AR86755
COMBUSTIBLE	G-295	AR50041	ACEITE	GP-34	AR43634	ACEITE, HASTA S/N 361359	GP-34	AR43634
AIRE, PRIMARIO	GA-679	AR49839	COMBUSTIBLE	G-295	AR50041	COMBUSTIBLE	G-295	AR50041
AIRE, SECUNDARIO	GA-680	AR49840				ACEITE, S/N 361359 EN ADELANTE	GP-35	RE57394
4350 con motor/A DIESEL			4555 con motor/A DIESEL			4850 con motor/A DIESEL		
TRANSMISION	G-339H	AR94510	HIDRAULICO	G-339H	AR94510	TRANSMISION	G-339H	AR94510
ACEITE	GP-35	RE57394	GASOLINA, SEPARADOR DE AGUA	G-293	AR86755	GASOLINA, SEPARADOR DE AGUA	G-293	AR86755
COMBUSTIBLE	G-270	AR86745	ACEITE	GP-35	RE57394	ACEITE	GP-35	RE57394
AIRE, PRIMARIO	GA-679	AR79679	COMBUSTIBLE	G-270	RE27091	COMBUSTIBLE	G-270	AR86745
AIRE, SECUNDARIO	GA-680	AR79680						
440 con motor/A GASOLINA			4560 con motor/A DIESEL			4955 con motor/A DIESEL		
TRANSMISION	G-331	AR75603	TRANSMISION	G-339H	AR94510	TRANSMISION	G-339H	AR94510
ACEITE, TORNO DE POTENCIA	GP-14	T19044	ACEITE	GP-35	RE57394	GASOLINA, SEPARADOR DE AGUA	G-293	AR86755
COMBUSTIBLE	G-296	AT17387T	AGUA	GP-2071W	RE42052	ACEITE	GP-35	RE57394
COMBUSTIBLE	G-296-B	AT17387T	COMBUSTIBLE	G-270	RE27091	COMBUSTIBLE	G-270	AR86745
4400 con motor/A DIESEL			4620 con motor/A DIESEL			4960 con motor/A DIESEL		
HIDROSTATICO	GP-761H	LVA10419	ACEITE, SYNCHRO RANGE TRANSMISION	G-331	AR75603	TRANSMISION	G-339H	AR94510
			TRANSMISION	G-331	AR75603	ACEITE	GP-35	RE57394
4410 con motor/YANMAR 3TNE88			ACEITE	GP-34	AR43634	COMBUSTIBLE	G-270	RE27091
HIDROSTATICO	GP-761H	LVA10419	COMBUSTIBLE	G-295	AR50041			
4430 con motor/JOHN DEERE 404 DIESEL			4630 con motor/JOHN DEERE 404 DIESEL			50 con motor/A DIESEL		
TRANSMISION	G-331	AR75603	TRANSMISION	G-331	AR75603	ACEITE	G-139	AR26350
GASOLINA, SEPARADOR DE AGUA	G-293	AR86755	ACEITE	GP-34	AR43634			
ACEITE	GP-34	AR43634	COMBUSTIBLE	G-295	AR50041	5010 con motor/A DIESEL		
COMBUSTIBLE	G-295	AR50041				ACEITE	G-331	AR75603
AIRE, PRIMARIO	GA-679	AR61967	4640 con motor/JOHN DEERE 466TI DIESEL			TRANSMISION	G-331	AR75603
AIRE, SECUNDARIO	GA-680	AR61968	TRANSMISION	G-339H	AR94510	COMBUSTIBLE	GPP-14	AR45097
			GASOLINA, SEPARADOR DE AGUA	G-293	AR86755	COMBUSTIBLE	G-295	AR50041
4440 con motor/JOHN DEERE 466T DIESEL			ACEITE, HASTA S/N 361359	GP-34	AR43634	AIRE	GAK-20	AR36044
TRANSMISION	G-339H	AR94510	COMBUSTIBLE	G-295	AR50041			
ACEITE, HASTA S/N 292346	GP-34	AR43634	ACEITE, S/N 361359 EN D ELANTE	GP-35	RE57394	5020 con motor/A DIESEL		
COMBUSTIBLE	G-295	AR50041				ACEITE	G-331	AR75603
ACEITE, S/N 292346 EN ADELANTE	GP-35	RE57394	4650 con motor/A DIESEL			TRANSMISION	G-331	AR75603
AIRE, PRIMARIO	GA-679	AR79679	TRANSMISION	G-339H	AR94510	COMBUSTIBLE, HASTA S/N M24767	GPP-14	AR45097
AIRE, SECUNDARIO	GA-680	AR79680	GASOLINA, SEPARADOR DE AGUA	G-293	AR86755	COMBUSTIBLE, S/N280001 EN ADELANTE	G-295	AR50041
			ACEITE	GP-35	RE57394	AIRE, SIMPLE	GAK-20	AR36044
4450 con motor/A DIESEL			COMBUSTIBLE	G-270	AR86745			
TRANSMISION	G-339H	AR94510				5103 con motor/JOHN DEERE 3029TF		
GASOLINA, SEPARADOR DE AGUA	G-293	AR86755	4700, 4200, 4300, 4500, 4600 con motor/A DIESEL			HIDRAULICO	GP-864H	RE45864
ACEITE	GP-35	RE57394	AIRE, RADIAL PRIMARIO	GA-880R	M131802	COMBUSTIBLE	GPP-420	RE60021
COMBUSTIBLE	G-270	RE27091				AIRE, RADIAL PRIMARIO (S/N 9123 EN ADELANTE)	GA-853R	AT171853
AIRE, PRIMARIO	GA-679	AR79679	4710 con motor/YANMAR 4TNE88					
AIRE, SECUNDARIO	GA-680	AR79680	DIRECCION (PRT)	GP-761H	LVA10419			

SERVICIO PESADO

MARCA-MODELO-MOTOR MAKE-MODEL-ENGINE	GONHER GONHER	OEM OEM	MARCA-MODELO-MOTOR MAKE-MODEL-ENGINE	GONHER GONHER	OEM OEM	MARCA-MODELO-MOTOR MAKE-MODEL-ENGINE	GONHER GONHER	OEM OEM
JOHN DEERE (continuación)			JOHN DEERE (continuación)			JOHN DEERE (continuación)		
TRACTORES			TRACTORES			TRACTORES		
5105 con motor/JOHN DEERE 2.9L POWERTECH			5320 con motor/JOHN DEERE 2.9L POWERTECH			COMBUSTIBLE	GPP-420	RE60021
ACEITE	GP-14	T19044	ACEITE	GP-14	T19044	ACEITE	GP-754	RE59754
HIDRAULICO	GP-864H	RE45864	HIDRAULICO	GP-864H	RE45864	AIRE, RADIAL PRIMARIO	GA-853R	AT171853
COMBUSTIBLE	GPP-420	RE60021	COMBUSTIBLE	GPP-420	RE60021			
			AIRE, RADIAL PRIMARIO	GA-853R	AT171853	5425 con motor/JOHN DEERE 4045T POWERTECH		
520 con motor/A DIESEL						AIRE, RADIAL PRIMARIO	GA-853R	KV16429
ACEITE	G-139	AR26350	5320N con motor/JOHN DEERE 2.9L POWERTECH					
			ACEITE	GP-14	T19044	5425H, 5425N con motor/JOHN DEERE 4045T POWERTECH		
5200 con motor/JOHN DEERE 3029			HIDRAULICO	GP-864H	RE45864	AIRE, RADIAL PRIMARIO	GA-853R	KV16429
ACEITE	GP-14	T19044	COMBUSTIBLE	GPP-420	RE60021			
HIDRAULICO	GP-864H	RE45864	AIRE, RADIAL PRIMARIO	GA-853R	AT171853	544 con motor/A DIESEL		
COMBUSTIBLE	GPP-418	RE50455				DIRECCION	G-331	AR75603
AIRE, PRIMARIO	GAK-16	RE45825	5325 con motor/JOHN DEERE 5030T POWERTECH			TRANSMISION	G-331	AR75603
			AIRE, RADIAL PRIMARIO	GA-853R	KV16429	ACEITE	GP-14	T19044
5203 con motor/JOHN DEERE 3029TF						COMBUSTIBLE	G-296	AT17387
HIDRAULICO	GP-864H	RE45864	5325N con motor/JOHN DEERE 5030T POWERTECH			COMBUSTIBLE	G-296-B	AT17387
COMBUSTIBLE	GPP-420	RE60021	AIRE, RADIAL PRIMARIO	GA-853R	KV16429			
AIRE, RADIAL PRIMARIO (S/N 1466 EN ADELANTE)	GA-853R	AT171853				5500 con motor/JOHN DEERE 4039T		
			5400 con motor/JOHN DEERE 3029			ACEITE	GP-14	T19044
5205 con motor/JOHN DEERE 2.9L POWERTECH			ACEITE	GP-14	T19044	HIDRAULICO	GP-864H	RE45864
ACEITE	GP-14	T19044	HIDRAULICO	GP-864H	RE45864	COMBUSTIBLE	GPP-418	RE62418
HIDRAULICO	GP-864H	RE45864	COMBUSTIBLE	GPP-418	RE62418	AIRE, PRIMARIO	GAK-458	RE45827
COMBUSTIBLE	GPP-420	RE60021	AIRE, PRIMARIO	GAK-458	RE45827	AIRE, SECUNDARIO	GA-459	RE45828
			AIRE, SECUNDARIO	GA-459	RE45828			
5210 con motor/JOHN DEERE 3029 SERIES			5400 con motor/JOHN DEERE 3179			5500N con motor/JOHN DEERE 4039T		
ACEITE	GP-14	T19044	ACEITE	GP-14	T19044	ACEITE	GP-14	T19044
HIDRAULICO (REQUIERE 2)	GP-864H	RE45864	HIDRAULICO	GP-864H	RE45864	HIDRAULICO	GP-864H	RE45864
COMBUSTIBLE	GPP-420	RE60021	COMBUSTIBLE	GPP-418	RE62418	COMBUSTIBLE	GPP-418	RE62418
AIRE, RADIAL PRIMARIO (S/N 121088 EN ADELANTE)	GA-853R	AT171853	AIRE	GAK-458	RE45827	AIRE, PRIMARIO	GAK-458	RE45827
			AIRE	GA-459	RE45828	AIRE, SECUNDARIO	GA-459	RE45828
5220 con motor/JOHN DEERE 2.9L POWERTECH			5400N con motor/JOHN DEERE 3029			5520, 5420, 5510 con motor/JOHN DEERE 4045 POWERTECH		
ACEITE	GP-14	T19044	ACEITE	GP-14	T19044	HIDRAULICO	GP-864H	RE45864
HIDRAULICO	GP-864H	RE45864	HIDRAULICO	GP-864H	RE45864	COMBUSTIBLE	GPP-420	RE60021
COMBUSTIBLE	GPP-420	RE60021	COMBUSTIBLE	GPP-418	RE62418	ACEITE	GP-754	RE59754
AIRE, RADIAL PRIMARIO	GA-853R	AT171853	AIRE, PRIMARIO	GAK-458	RE45827	AIRE, RADIAL PRIMARIO	GA-853R	AT171853
			AIRE, SECUNDARIO	GA-459	RE45828	5525 con motor/JOHN DEERE 4045T POWERTECH		
5225 con motor/JOHN DEERE 5030T			5400N con motor/JOHN DEERE 3179			COMBUSTIBLE	GPP-419	RE62419
AIRE, RADIAL PRIMARIO	GA-853R	KV16429	ACEITE	GP-14	T19044			
			HIDRAULICO	GP-864H	RE45864	5525N con motor/JOHN DEERE 4045T POWERTECH		
5300 con motor/JOHN DEERE 3029			COMBUSTIBLE	GPP-418	RE62418	AIRE, RADIAL PRIMARIO	GA-853R	KV16429
ACEITE	GP-14	T19044	AIRE	GAK-458	RE45827			
HIDRAULICO	GP-864H	RE45864	AIRE	GA-459	RE45828	5603 con motor/JOHN DEERE 4045TL (TIER 2)		
COMBUSTIBLE	GPP-418	RE50455				HIDRAULICO	GP-864H	RE45864
AIRE, PRIMARIO	GAK-16	RE45825	5403 con motor/JOHN DEERE 3029T			COMBUSTIBLE	GPP-419	RE62419
			HIDRAULICO	GP-864H	RE45864	AIRE, RADIAL PRIMARIO	GA-853R	KV16429
5303 con motor/JOHN DEERE 3029TF			COMBUSTIBLE	GPP-420	RE60021			
HIDRAULICO	GP-864H	RE45864	AIRE, RADIAL PRIMARIO	GA-853R	AT171853	5615 SERIES, 5715 SERIES con motor/JOHN DEERE 4045T POWERTECH		
COMBUSTIBLE	GPP-420	RE60021				HIDRAULICO	GP-864H	RE45864
AIRE, RADIAL PRIMARIO	GA-853R	AT171853	5410 con motor/A DIESEL			COMBUSTIBLE	GPP-420	RE60021
			HIDRAULICO	GP-864H	RE45864	ACEITE	GP-754	RE59754
5310 con motor/JOHN DEERE 3029 SERIES			COMBUSTIBLE	GPP-420	RE60021	AIRE, RADIAL PRIMARIO	GA-853R	AT171853
ACEITE	GP-14	T19044	ACEITE	GP-754	RE59754			
HIDRAULICO (REQUIERE 2)	GP-864H	RE45864	AIRE, RADIAL PRIMARIO	GA-853R	AT171853	5620 con motor/JOHN DEERE 4045DL		
COMBUSTIBLE	GPP-420	RE60021				TRANSMISION	GP-761H	AL118036
AIRE, RADIAL PRIMARIO	GA-853R	AT171853	5415 SERIES con motor/JOHN DEERE 4045D POWERTECH			COMBUSTIBLE, FILTRO FINAL (5 3/16 IN)	GPP-418	RE62418
			HIDRAULICO	GP-864H	RE45864	COMBUSTIBLE, FILTRO FINAL (5 15/16 IN)	GPP-419	RE62419
5310N con motor/JOHN DEERE 3029 SERIES			COMBUSTIBLE	GPP-420	RE60021			
ACEITE	GP-14	T19044	ACEITE	GP-754	RE59754	5625 con motor/JOHN DEERE 4045D POWERTECH		
HIDRAULICO (REQUIERE 2)	GP-864H	RE45864	AIRE, RADIAL PRIMARIO	GA-853R	AT171853	HIDRAULICO	GP-864H	RE45864
COMBUSTIBLE	GPP-420	RE60021				COMBUSTIBLE	GPP-420	RE60021
AIRE, RADIAL PRIMARIO	GA-853R	AT171853	5420N, 5510N, 5520N con motor/JOHN DEERE 4045 POWERTECH			ACEITE	GP-754	RE59754
			HIDRAULICO	GP-864H	RE45864			

MARCA-MODELO-MOTOR MAKE-MODEL-ENGINE	GONHER GONHER	OEM OEM	MARCA-MODELO-MOTOR MAKE-MODEL-ENGINE	GONHER GONHER	OEM OEM	MARCA-MODELO-MOTOR MAKE-MODEL-ENGINE	GONHER GONHER	OEM OEM
JOHN DEERE (continuación)			JOHN DEERE (continuación)			JOHN DEERE (continuación)		
TRACTORES			TRACTORES			TRACTORES		
AIRE, RADIAL PRIMARIO	GA-853R	KV16429	AIRE, SECUNDARIO	GA-782	AL78224	6320L, 6420L con motor/JOHN DEERE 4045 POWERTECH		
5625 con motor/JOHN DEERE 4045TL (TIER 2)			6120, 6220 con motor/JOHN DEERE 4045 POWERTECH			HIDRAULICO	GP-761H	AL118036
COMBUSTIBLE	GPP-419	RE62419	HIDRAULICO	GP-761H	AL77061	COMBUSTIBLE	GPP-419	RE62419
570, 575 con motor/YANMAR			COMBUSTIBLE	GPP-419	RE62419	ACEITE	GP-754	RE59754
HIDRAULICO	GP-34	AR43634	ACEITE	GP-754	RE59754	6400 con motor/JOHN DEERE 4045T		
5720, 5820 con motor/JOHN DEERE 4045TL			6120L, 6220L con motor/JOHN DEERE 4045 POWERTECH			ACEITE	GP-14	T19044
TRANSMISION	GP-761H	AL118036	HIDRAULICO	GP-761H	AL77061	TRANSMISION	GP-761H	AL77061
COMBUSTIBLE, FILTRO FINAL (5 3/16 IN)	GPP-418	RE62418	COMBUSTIBLE	GPP-419	RE62419	COMBUSTIBLE	GPP-419	RE64450
COMBUSTIBLE, FILTRO FINAL (5 15/16 IN)	GPP-419	RE62419	ACEITE	GP-754	RE59754	AIRE, PRIMARIO	GA-781	AL78223
5725 con motor/JOHN DEERE 4045T POWERTECH			6200 con motores/JOHN DEERE 4039D, JOHN DEERE 4039T			AIRE, SECUNDARIO	GA-782	AL78224
HIDRAULICO	GP-864H	RE45864	ACEITE	GP-14	T19044	6400L, 6500L con motor/JOHN DEERE 4045T		
COMBUSTIBLE	GPP-420	RE60021	HIDRAULICO	GP-761H	AL118036	ACEITE	GP-14	T19044
ACEITE	GP-754	RE59754	COMBUSTIBLE	GPP-419	RE62419	HIDRAULICO	GP-761H	AL77061
AIRE, RADIAL PRIMARIO	GA-853R	KV16429	AIRE, PRIMARIO	GA-781	AL78223	TRANSMISION	GP-761H	AL77061
5725H, 5725HC con motor/JOHN DEERE 4045T POWERTECH			AIRE, SECUNDARIO	GA-782	AL78224	COMBUSTIBLE	GPP-419	RE62419
HIDRAULICO	GP-864H	RE45864	6200L, 6300L con motor/JOHN DEERE 4045T			AIRE, PRIMARIO	GA-781	AL78223
COMBUSTIBLE	GPP-420	RE60021	ACEITE	GP-14	T19044	AIRE, SECUNDARIO	GA-782	AL78224
ACEITE	GP-754	RE59754	HIDRAULICO	GP-761H	AL77061	6403 con motor/JOHN DEERE 4045T POWERTECH		
AIRE, RADIAL PRIMARIO	GA-853R	KV16429	TRANSMISION	GP-761H	AL77061	COMBUSTIBLE (TAMIZ)	GPP-424	RE62424
60, 70 con motor/A DIESEL			COMBUSTIBLE	GPP-419	RE62419	COMBUSTIBLE	GPP-419	RE62419
ACEITE	G-139	AR26350	COMBUSTIBLE	GPP-419	RE62419	ACEITE (HASTA S/N 1348 DEL MOTOR)	GP-754	RE59754
600 HI-CYCLE con motor/A DIESEL			AIRE, PRIMARIO	GA-781	AL78223	AIRE, RADIAL PRIMARIO	GA-853R	AT171853
ACEITE	GP-14	T19044	AIRE, SECUNDARIO	GA-782	AL78224	6405 con motor/JOHN DEERE 4045 POWERTECH		
6000 HI-CYCLE con motor/A DIESEL			6210 con motor/JOHN DEERE 4045 POWERTECH			COMBUSTIBLE	GPP-419	RE62419
ACEITE	GP-14	T19044	HIDRAULICO	GP-761H	AL77061	ACEITE	GP-754	RE59754
COMBUSTIBLE	G-295	AR50041	COMBUSTIBLE	GPP-418	RE62418	AIRE, PRIMARIO	GA-781	AL78223
HIDRAULICO	GP-66	AE33293	ACEITE	GP-754	RE59754	AIRE, SECUNDARIO	GA-782	AL78224
AIRE, PRIMARIO	GAK-16	AT20728	AIRE, PRIMARIO	GA-781	AL78223	6410 con motor/JOHN DEERE 4045 POWERTECH		
6020 con motor/JOHN DEERE 4045 POWERTECH			AIRE, SECUNDARIO	GA-782	AL78224	HIDRAULICO	GP-761H	AL77061
HIDRAULICO SELLADO	GP-761H	AL118036	6215 con motor/JOHN DEERE 4045 POWERTECH			COMBUSTIBLE	GPP-419	RE62419
COMBUSTIBLE	GPP-419	RE62419	COMBUSTIBLE	GPP-419	RE62419	ACEITE	GP-754	RE59754
ACEITE	GP-754	RE59754	6300 con motor/JOHN DEERE 4039T			AIRE, PRIMARIO	GA-781	AL78223
6030 con motor/JOHN DEERE 6531A			ACEITE	GP-14	T19044	AIRE, SECUNDARIO	GA-782	AL78224
ACEITE	G-331	AR75603	TRANSMISION	GP-761H	AL77061	6415 con motor/JOHN DEERE 4045T POWERTECH		
ACEITE	GP-34	AR43634	COMBUSTIBLE	GPP-419	RE62419	COMBUSTIBLE	GPP-419	RE62419
TRANSMISION	G-295	AR50041	AIRE, PRIMARIO	GA-781	AL78223	6420, 6420S con motor/JOHN DEERE 4045 POWERTECH		
6030 con motor/JOHN DEERE 6531D			AIRE, SECUNDARIO	GA-782	AL78224	HIDRAULICO PRINCIPAL	GP-761H	AL118036
ACEITE	G-331	AR75603	6300U con motor/A DIESEL			6500 con motor/JOHN DEERE 4045T		
TRANSMISION	G-331	AR75603	TRANSMISION (SIN HLT)	G-331	AR75603	ACEITE	GP-14	T19044
COMBUSTIBLE	G-295	AR50041	ACEITE	GP-14	T19044	TRANSMISION	GP-761H	AL77061
6100 con motores/JOHN DEERE 4039D, JOHN DEERE 4039T			COMBUSTIBLE	G-295	AR50041	COMBUSTIBLE	GPP-419	RE64450
ACEITE	GP-14	T19044	AIRE, HASTA S/N 56700	GAK-16	AT20728	AIRE, PRIMARIO	GA-781	AL78223
HIDRAULICO	GP-761H	AL118036	AIRE, PRIMARIO (S/N 56700 EN ADELANTE)	GAK-216	AR84228	AIRE, SECUNDARIO	GA-782	AL78224
COMBUSTIBLE	GPP-419	RE62419	AIRE, SECUNDARIO (S/N 56700 EN ADELANTE)	GA-416	AE31724	6500 HI-CYCLE con motor/A DIESEL		
AIRE, PRIMARIO	GA-781	AL78223	6310 con motor/JOHN DEERE 4045 POWERTECH			ACEITE	GP-14	T19044
AIRE, SECUNDARIO	GA-782	AL78224	HIDRAULICO	GP-761H	AL77061	HIDRAULICO	GP-66	AE33293
6110 con motor/JOHN DEERE 4045 POWERTECH			COMBUSTIBLE	GPP-419	RE62419	COMBUSTIBLE	GPP-418	RE50455
HIDRAULICO	GP-761H	AL77061	ACEITE	GP-754	RE59754	AIRE, PRIMARIO	GAK-403	AT44377
COMBUSTIBLE	GPP-418	RE62418	AIRE, PRIMARIO	GA-781	AL78223	6506, 6900, 6600, 6800 con motor/A DIESEL		
ACEITE	GP-754	RE59754	AIRE, SECUNDARIO	GA-782	AL78224	ACEITE	GP-14	T19044
AIRE, PRIMARIO	GA-781	AL78223	6320 con motor/JOHN DEERE 4045 POWERTECH			HIDRAULICO	GP-761H	AL77061
			HIDRAULICO	GP-761H	AL118036	TRANSMISION	GP-761H	AL77061
			COMBUSTIBLE	GPP-419	RE62419	COMBUSTIBLE	GPP-419	RE64450
			ACEITE	GP-754	RE59754			

SERVICIO PESADO

MARCA-MODELO-MOTOR MAKE-MODEL-ENGINE	GONHER GONHER	OEM OEM	MARCA-MODELO-MOTOR MAKE-MODEL-ENGINE	GONHER GONHER	OEM OEM	MARCA-MODELO-MOTOR MAKE-MODEL-ENGINE	GONHER GONHER	OEM OEM
JOHN DEERE (continuación)			JOHN DEERE (continuación)			JOHN DEERE (continuación)		
TRACTORES			TRACTORES			TRACTORES		
6510 con motor/JOHN DEERE 4045 POWERTECH			ACEITE	GP-754	RE59754	7405 con motor/JOHN DEERE 6068T		
HIDRAULICO	GP-761H	RE34958				HIDRAULICO	GP-864H	AT135800
COMBUSTIBLE	GPP-418	RE62418	700 con motor/A DIESEL Y GASOLINA			TRANSMISION	GP-761H	RE39527
ACEITE	GP-754	RE59754	ACEITE	G-331	AR75603	COMBUSTIBLE	GPP-419	RE62419
AIRE, PRIMARIO	GA-781	AL78223	TRANSMISION	G-331	AR75603	ACEITE	GP-754	RE59754
AIRE, SECUNDARIO	GA-782	AL78224	COMBUSTIBLE, MOTORES A DIESEL	GPP-14	AT81478			
						7410 con motor/JOHN DEERE 6068		
6510L con motor/JOHN DEERE 4045 POWERTECH			700 HI-CYCLE con motor/A DIESEL			HIDRAULICO	GP-761H	AL77061
HIDRAULICO	GP-761H	RE34958	ACEITE	GP-14	T19044	TRANSMISION	GP-761H	AL77061
COMBUSTIBLE	GPP-418	RE62418				COMBUSTIBLE, PRINCIPAL	GPP-419	RE62419
ACEITE	GP-754	RE59754	700A con motor/A DIESEL			ACEITE	GP-754	RE59754
AIRE, PRIMARIO	GA-781	AL78223	ACEITE	G-331	AR75603	AIRE	GA-403	RE24619
AIRE, SECUNDARIO	GA-782	AL78224	TRANSMISION	G-331	AR75603			
			COMBUSTIBLE, S/N 280001 EN ADELANTE	G-295	AR50041	7420 con motor/JOHN DEERE 6068 SERIES		
6515 con motor/JOHN DEERE 6068 POWERTECH			AIRE, HASTA S/N 24038	GAK-20	AR36044	COMBUSTIBLE (ALT. 7 5/8 IN)	GPP-423	RE509032
COMBUSTIBLE	GPP-419	RE62419				COMBUSTIBLE (TIEMPO DE FRIO)	GPP-424	RE516477
			7020 con motor/A DIESEL			HIDRAULICO (POWER QUAD), SELLADO	GP-761H	AL118036
6520, 6620 con motor/A DIESEL			TRANSMISION	G-331	AR75603	COMBUSTIBLE (ALT. 5 15/16 IN)	GPP-419	RE509031
HIDRAULICO	GP-761H	AL118036	ACEITE	GP-34	AR43634			
			COMBUSTIBLE	G-295	AR50041	7500 con motor/A DIESEL		
6520L con motor/JOHN DEERE 4045 POWERTECH						HIDRAULICO	GP-864H	RE45864
HIDRAULICO	GP-761H	RE34958	720, 730 con motor/A DIESEL			TRANSMISION	GP-761H	AL77061
COMBUSTIBLE	GPP-419	RE62419	ACEITE	G-139	AR26350	COMBUSTIBLE	GPP-419	RE53400
ACEITE	GP-754	RE59754				ACEITE	GP-754	RE59754
			7200 con motor/JOHN DEERE 6059					
655 con motor/A DIESEL			ACEITE	GP-14	T19044	7510 con motor/JOHN DEERE 6068T		
ACEITE	GP-91	AM101378	HIDRAULICO	GP-761H	AL77061	HIDRAULICO	GP-761H	AL77061
			TRANSMISION	GP-761H	AL77061	TRANSMISION	GP-761H	AL77061
6603 con motor/JOHN DEERE 6068T POWERTECH			COMBUSTIBLE, PRINCIPAL	GPP-419	RE62419	COMBUSTIBLE, PRINCIPAL	GPP-419	RE62419
COMBUSTIBLE, STRAINER	GPP-424	RE62424	AIRE, FUERA DE CABINA	GA-403	RE24619	ACEITE	GP-754	RE59754
COMBUSTIBLE	GPP-419	RE62419	AIRE, PRIMARIO	GA-781	AL78223	AIRE	GA-403	RE24619
ACEITE, HASTA S/N 1237	GP-754	RE59754	AIRE, SECUNDARIO	GA-782	AL78224			
						7520 con motor/CUMMINS		
6605 con motor/JOHN DEERE 6068T POWERTECH			7210 con motor/JOHN DEERE 6068T			TRANSMISION	G-331	AR75603
HIDRAULICO	GP-761H	AL77061	HIDRAULICO	GP-761H	AL77061	ACEITE	GP-34	AR43634
COMBUSTIBLE	GPP-418	RE62418	TRANSMISION	GP-761H	AL77061	COMBUSTIBLE	G-295	AR50041
ACEITE	GP-754	RE59754	COMBUSTIBLE, PRINCIPAL	GPP-419	RE62419	AIRE, PRIMARIO	GA-106	P117437
			ACEITE	GP-754	RE59754	AIRE, SECUNDARIO	GA-206	P119373
6615, 6715 con motor/JOHN DEERE 6068T POWERTECH			AIRE, FUERA DE CABINA	GA-403	RE24619			
COMBUSTIBLE	GPP-419	RE62419				7520 con motor/JOHN DEERE 6068 POWERTECH		
			7220, 7320 con motor/JOHN DEERE 6068T			COMBUSTIBLE (ALT. 7 5/8 IN)	GPP-423	RE509032
670 con motor/A DIESEL			COMBUSTIBLE (ALT. 7 5/8 IN)	GPP-423	RE509032	COMBUSTIBLE (TIEMPO DE FRIO)	GPP-424	RE516477
ACEITE	GP-91	M806418	COMBUSTIBLE (TIEMPO DE FRIO)	GPP-424	RE516477	COMBUSTIBLE (TIEMPO DE FRIO)	GPP-424	RE516477
			HIDRAULICO (POWER QUAD), SELLADO	GP-761H	AL118036	HIDRAULICO (POWER QUAD), SELLADO	GP-761H	AL118036
6810 con motor/CUMMINS NTA855			COMBUSTIBLE (ALT. 5 3/16 IN)	GPP-418	RE62418	COMBUSTIBLE (ALT. 5 15/16 IN)	GPP-419	RE509031
ACEITE, FLUJO TOTAL (FULL FLOW)	GP-53	RE42042	COMBUSTIBLE (ALT. 5 15/16 IN)	GPP-419	RE509031			
ACEITE, DERIVACION (BY PASS)	GP-57	RE42051				7520 con motor/JOHN DEERE 6531A		
COMBUSTIBLE, SEPARADOR DE AGUA	GPP-11	RE42050	730 con motor/JOHN DEERE 6068T			TRANSMISION	G-331	AR75603
			ACEITE	G-139	AR28110R	ACEITE	GP-34	AR43634
6810 con motor/JOHN DEERE						COMBUSTIBLE	G-295	AR50041
HIDRAULICO	GP-761H	AL118036	730D con motor/A DIESEL					
COMBUSTIBLE	GPP-419	RE62419	ACEITE	G-139	AR28110R	755, 756 con motor/A DIESEL		
ACEITE	GP-754	RE59754				ACEITE	GP-149	AM101378
			734 HI-CYCLE con motor/A DIESEL					
6910 con motor/JOHN DEERE			ACEITE	GP-14	T19044	760 con motor/A DIESEL		
HIDRAULICO (S/N 263740 EN ADELANTE)	GP-761H	AL118036				ACEITE	G-331	AR75603
COMBUSTIBLE	GPP-419	RE62419	7400 con motor/A DIESEL			TRANSMISION	G-331	AR75603
ACEITE	GP-754	RE59754	ACEITE	GP-14	T19044	COMBUSTIBLE	GPP-14	AR45097
			HIDRAULICO	GP-761H	AL77061	AIRE	GAK-20	AR36044
6910S con motor/JOHN DEERE			TRANSMISION	GP-761H	AL77061			
HIDRAULICO (S/N 263740 EN ADELANTE)	GP-761H	AL118036	COMBUSTIBLE, PRINCIPAL	GPP-419	RE62419	7600 con motor/JOHN DEERE 6068T		
COMBUSTIBLE	GPP-419	RE62419	AIRE	GA-403	RE24619			

MARCA-MODELO-MOTOR MAKE-MODEL-ENGINE	GONHER GONHER	OEM OEM	MARCA-MODELO-MOTOR MAKE-MODEL-ENGINE	GONHER GONHER	OEM OEM	MARCA-MODELO-MOTOR MAKE-MODEL-ENGINE	GONHER GONHER	OEM OEM
JOHN DEERE (continuación)			JOHN DEERE (continuación)			JOHN DEERE (continuación)		
TRACTORES			TRACTORES			TRACTORES		
ACEITE	GP-14	T19044	80 con motor/A DIESEL			820 con motor/A DIESEL		
HIDRAULICO	GP-761H	RE39527	ACEITE	G-331	AR75603	TRANSMISION	G-331	AR75603
TRANSMISION	GP-761H	RE39527				ACEITE	GP-14	T19044
COMBUSTIBLE, PRINCIPAL	GPP-419	RE62419	8010, 8020 con motor/DETROIT DIESEL 6-71			COMBUSTIBLE, HASTA S/N 173885	G-296	AT17387
AIRE	GA-403	RE24619	ACEITE, DERIVACION (BY PASS)	G-31	AR29174R	COMBUSTIBLE, S/N 173885 EN ADELANTE	G-295	AR50041
AIRE, PRIMARIO (RADIAL)	GA-197R	RE34962	ACEITE, TANQUE HIDRAULICO	G-31	AR29174R	COMBUSTIBLE, HASTA S/N 173885	G-296-B	AT17387
AIRE, SECUNDARIO (RADIAL)	GA-768R	RE34963	ACEITE, FLUJO TOTAL (FULL FLOW)	G-33	AR29554R	AIRE	GAK-16	AT20728
			HIDRAULICO	G-33	AR29554R			
7610 con motor/JOHN DEERE 6068 POWERTECH			COMBUSTIBLE, SECUNDARIO	G-1175	AU42727			
HIDRAULICO	GP-761H	RE39527	8020 con motor/JOHN DEERE 6081T POWERTECH			8200, 8210, 8300, 8310, 8410 con motor/JOHN DEERE 6081T		
TRANSMISION	GP-761H	RE39527	ACEITE	GP-35	RE57394	COMBUSTIBLE, SEPARADOR DE AGUA	GPP-426	RE65431
COMBUSTIBLE	GPP-419	RE62419				ACEITE	GP-35	RE57394
ACEITE	GP-754	RE59754	8020T con motor/JOHN DEERE 6081T POWERTECH			COMBUSTIBLE	G-270	AR86745
AIRE	GA-403	RE24619	ACEITE	GP-35	RE57394	AIRE, PRIMARIO	GA-930R	RE51629
AIRE, PRIMARIO (RADIAL)	GA-197R	RE34962				AIRE, SECUNDARIO	GA-890R	RE51630
AIRE, SECUNDARIO (RADIAL)	GA-768R	RE34963						
			8100 con motor/JOHN DEERE 6081T			820D, 830D con motor/A DIESEL		
7620, 7630, 7640 con motor/A DIESEL			COMBUSTIBLE, SEPARADOR DE AGUA	GPP-426	RE65431	ACEITE, CARTUCHO	G-331	AR28271R
ACEITE	GP-14	T19044	ACEITE	GP-35	RE57394	TRANSMISION	G-331	AR28271R
			COMBUSTIBLE	G-270	AR86745	ACEITE, SELLADO	GP-14	T19044
770 UTILITARIO con motor/A DIESEL			AIRE, PRIMARIO	GA-930R	RE51629	COMBUSTIBLE	G-296	AT17387
ACEITE	GP-149	AM101378	AIRE, SECUNDARIO	GA-890R	RE51630	COMBUSTIBLE	G-295	AR50041
						COMBUSTIBLE	G-296-B	AT17387
7700, 7800 con motor/JOHN DEERE 6076T			8100, 8200 con motor/JOHN DEERE 7.6 L			AIRE	GAK-16	AT20728
GASOLINA, SEPARADOR DE AGUA	G-293	AR86755	COMBUSTIBLE, SEPARADOR DE AGUA	GPP-426	RE65431	8210T, 8310T, 8410T con motor/JOHN DEERE 6081T		
ACEITE	GP-35	RE57394	ACEITE, LUBRICACION DEL MOTOR	GP-35	RE57394	COMBUSTIBLE, SEPARADOR DE AGUA	GPP-426	RE65431
HIDRAULICO	GP-761H	RE39527	DIRECCION	GP-761H	RE69054	ACEITE	GP-35	RE57394
TRANSMISION	GP-761H	RE39527	COMBUSTIBLE	G-270	AR86745	DIRECCION	GP-761H	RE69054
COMBUSTIBLE, PRINCIPAL	GPP-419	RE52987	AIRE, PRIMARIO	GA-930R	RE51629	COMBUSTIBLE	G-270	AR86745
COMBUSTIBLE	G-270	RE27091	AIRE, SECUNDARIO	GA-890R	RE51630	AIRE, PRIMARIO	GA-930R	RE51629
AIRE	GA-403	RE24619				AIRE, SECUNDARIO	GA-890R	RE51630
			8100T, 8200T con motor/JOHN DEERE 7.6 L					
7710 ROW-CROP con motor/A DIESEL			COMBUSTIBLE, SEPARADOR DE AGUA	GPP-426	RE65431	830 con motor/A DIESEL		
COMBUSTIBLE	GPP-426	RE65431	ACEITE, LUBRICACION DEL MOTOR	GP-35	RE57394	TRANSMISION	G-331	AR75603
ACEITE	GP-35	RE57394	DIRECCION	GP-761H	RE69054	ACEITE	GP-14	T19044
HIDRAULICO	GP-761H	RE47313	COMBUSTIBLE	G-270	AR86745	COMBUSTIBLE	G-295	AR50041
TRANSMISION	GP-761H	RE47313	AIRE, PRIMARIO	GA-930R	RE51629	AIRE, HASTA S/N 190320	GAK-16	AT20728
COMBUSTIBLE	G-270	AR86745	AIRE, SECUNDARIO	GA-890R	RE51630	AIRE, PRIMARIO (S/N 190320 EN ADELANTE)	GAK-16	AR84228
AIRE, PRIMARIO	GA-403	RE24619				AIRE, SECUNDARIO (S/N 190320 EN ADELANTE)	GA-416	AE31724
			8110 con motor/JOHN DEERE 6081T					
7710, 7810 con motor/JOHN DEERE 6081T			COMBUSTIBLE, SEPARADOR DE AGUA	GPP-426	RE65431	8300T con motor/JOHN DEERE 7.6 L		
COMBUSTIBLE, SEPARADOR DE AGUA	GPP-426	RE65431	ACEITE, LUBRICACION DEL MOTOR	GP-35	RE57394	COMBUSTIBLE, SEPARADOR DE AGUA	GPP-426	RE65431
ACEITE	GP-35	RE57394	DIRECCION	GP-761H	RE69054	ACEITE	GP-35	RE57394
HIDRAULICO	GP-761H	RE39527	COMBUSTIBLE	G-270	AR86745	DIRECCION	GP-761H	RE69054
TRANSMISION	GP-761H	RE39527	AIRE, PRIMARIO	GA-930R	RE51629	COMBUSTIBLE	G-270	AR86745
COMBUSTIBLE	G-270	AR86745	AIRE, SECUNDARIO	GA-890R	RE51630	AIRE, PRIMARIO	GA-930R	RE51629
AIRE	GA-403	RE24619				AIRE, SECUNDARIO	GA-890R	RE51630
			8110T con motor/JOHN DEERE 6081T					
7720, 7815 con motor/JOHN DEERE 6068 POWERTECH			COMBUSTIBLE, SEPARADOR DE AGUA	GPP-426	RE65431	8300T con motor/JOHN DEERE 7.6 L		
COMBUSTIBLE	GPP-423	RE509032	ACEITE, LUBRICACION DEL MOTOR	GP-35	RE57394	COMBUSTIBLE, SEPARADOR DE AGUA	GPP-426	RE65431
			DIRECCION	GP-761H	RE69054	ACEITE	GP-35	RE57394
7720, 7920 con motor/JOHN DEERE 6081 POWERTECH			COMBUSTIBLE	G-270	AR86745	DIRECCION	GP-761H	RE69054
AIRE	GA-403	RE24619	AIRE, PRIMARIO	GA-930R	RE51629	COMBUSTIBLE	G-270	AR86745
			AIRE, SECUNDARIO	GA-890R	RE51630	AIRE, PRIMARIO	GA-930R	RE51629
7820 con motores/JOHN DEERE 6081 POWERTECH, JOHN DEERE 6068						AIRE, SECUNDARIO	GA-890R	RE51630
AIRE	GA-403	RE24619	8110T con motor/JOHN DEERE 6081T					
			COMBUSTIBLE, SEPARADOR DE AGUA	GPP-426	RE65431	8300T con motor/JOHN DEERE 7.6 L		
790 UTILITARIO con motor/YANMAR 3TNE84			ACEITE, LUBRICACION DEL MOTOR	GP-35	RE57394	COMBUSTIBLE, SEPARADOR DE AGUA	GPP-426	RE65431
ACEITE	GP-149	AM101378	DIRECCION	GP-761H	RE69054	ACEITE	GP-35	RE57394
			COMBUSTIBLE	G-270	AR86745	DIRECCION	GP-761H	RE69054
790 UTILITARIO con motor/YANMAR 3TNV82A			AIRE, PRIMARIO	GA-930R	RE51629	COMBUSTIBLE	G-270	AR86745
AIRE, RADIAL PRIMARIO	GA-880R	RG60690	AIRE, SECUNDARIO	GA-890R	RE51630	AIRE, PRIMARIO	GA-930R	RE51629
						AIRE, SECUNDARIO	GA-890R	RE51630
			8120, 8220 con motor/JOHN DEERE 6081T POWERTECH			8301 con motor/A DIESEL		
			AIRE	GA-403	RE24619	ACEITE	G-331	AR28271R

SERVICIO PESADO

MARCA-MODELO-MOTOR MAKE-MODEL-ENGINE	GONHER GONHER	OEM OEM	MARCA-MODELO-MOTOR MAKE-MODEL-ENGINE	GONHER GONHER	OEM OEM	MARCA-MODELO-MOTOR MAKE-MODEL-ENGINE	GONHER GONHER	OEM OEM
JOHN DEERE (continuación)			JOHN DEERE (continuación)			JOHN DEERE (continuación)		
TRACTORES			TRACTORES			TRACTORES		
830D con motor/A DIESEL 2 CYL			ACEITE	GP-34	AR43634	ACEITE, DOBLE FLUJO	GP-3000	RE44647
ACEITE	G-331	AR28271R	COMBUSTIBLE	G-295	AR50041	COMBUSTIBLE	G-270	RE27091
						AIRE	GA-403	RE24619
8320, 8420, 8520 con motor/JOHN DEERE 6081T POWERTECH			8450 con motor/A DIESEL			8850 con motor/A DIESEL		
AIRE	GA-403	RE24619	ACEITE, FLUJO TOTAL (FULL FLOW)	GP-35	RE57394	ACEITE, FLUJO TOTAL (FULL FLOW)	GP-35	RE57394
840 con motor/A DIESEL			COMBUSTIBLE	G-270	AR86745	COMBUSTIBLE	G-270	RE27091
ACEITE	G-331	AR75603	COMBUSTIBLE, SEPARADOR DE AGUA	2010PM-OR	RE11325	COMBUSTIBLE, SEPARADOR DE AGUA	2010PM-OR	RE11325
8400 con motor/JOHN DEERE 8.1 L			856 con motor/YANMAR			8960 con motor/JOHN DEERE 14.0L		
COMBUSTIBLE, SEPARADOR DE AGUA	GPP-426	RE65431	ACEITE	GP-149	AM101378	HIDRAULICO (HASTA S/N 34040)	GP-66	RE34040
ACEITE	GP-35	RE57394	8560 con motor/A DIESEL			ACEITE, DERIVACION (BY PASS) HASTA S/N 2528	GP-57	RE21748
DIRECCION	GP-761H	RE69054	ACEITE	GP-35	RE57394	COMBUSTIBLE, SEPARADOR DE AGUA	GPP-11	RE42050
COMBUSTIBLE	G-270	AR86745	COMBUSTIBLE	G-270	RE27091	ACEITE, DOBLE FLUJO (S/N 2528 EN ADELANTE)	GP-3000	RE44647
AIRE, PRIMARIO	GA-930R	RE51629	AIRE	GA-403	RE24619	COMBUSTIBLE	GPP-419	RE62419
AIRE, SECUNDARIO	GA-890R	RE51630	COMBUSTIBLE, SEPARADOR DE AGUA	2010PM-OR	RE11325	AIRE	GA-403	RE24619
8400T con motor/JOHN DEERE 8.1 L			8570 con motor/JOHN DEERE 6 CYL 7.6L			8970 con motor/JOHN DEERE 14.0L		
COMBUSTIBLE, SEPARADOR DE AGUA	GPP-426	RE65431	COMBUSTIBLE, SEPARADOR DE AGUA	GPP-426	RE65431	COMBUSTIBLE, SEPARADOR DE AGUA	GPP-426	RE65431
ACEITE	GP-35	RE57394	ACEITE	GP-35	RE57394	COMBUSTIBLE, SEPARADOR DE AGUA	GPP-11	RE42050
DIRECCION	GP-761H	RE69054	COMBUSTIBLE	G-270	AR86745	ACEITE, DOBLE FLUJO	GP-3000	RE44647
COMBUSTIBLE	G-270	AR86745	AIRE	GA-403	RE24619	COMBUSTIBLE	GPP-419	RE62419
AIRE, PRIMARIO	GA-930R	RE51629	8630 con motor/A DIESEL			AIRE	GA-403	RE24619
AIRE, SECUNDARIO	GA-890R	RE51630	TRANSMISION (HASTA S/N 7636	G-331	AR75603	90 con motor/ONAN NHC GASOLINA		
840D con motor/A DIESEL			TRANSMISION (S/N 7637 EN ADELANTE)	G-339H	AR94510	HIDRAULICO	GP-34	AR43634
ACEITE, CARTUCHO	G-331	AR28271R	GASOLINA, SEPARADOR DE AGUA	G-293	AR86755	9020 con motor/JOHN DEERE 6061		
TRANSMISION	G-331	AR75603	ACEITE	GP-34	AR43634	ACEITE	GP-35	RE57394
ACEITE, SELLADO	GP-14	T19044	ACEITE	GP-35	RE57394	HIDRAULICO	GP-761H	AL77061
COMBUSTIBLE	G-296	AT17387	COMBUSTIBLE	G-270	AR86745	COMBUSTIBLE	G-270	AR86745
COMBUSTIBLE	G-295	AR50041	AIRE	GA-403	RE24619	AIRE	GA-403	RE24619
COMBUSTIBLE	G-296-B	AT17387	8640 con motor/A DIESEL			AIRE	GAK-403	AT44377
AIRE	GAK-16	AT20728	HIDRAULICO	G-339H	AR94510	AIRE	GA-221R	RE63931
8410 con motor/JOHN DEERE 8.1 L			TRANSMISION	G-339H	AR94510	AIRE	GA-723R	RE63932
ACEITE	GP-35	RE57394	GASOLINA, SEPARADOR DE AGUA	G-293	AR86755	9020 con motor/JOHN DEERE 6081T POWERTECH		
COMBUSTIBLE	G-270	AR86745	ACEITE, HASTA S/N 039936	GP-34	AR43634	ACEITE	GP-35	RE57394
AIRE	GA-930R	RE51629	ACEITE, FLUJO TOTAL (FULL FLOW) S/N 039937 EN ADELANTE	GP-35	RE57394	9020T con motor/JOHN DEERE 6061		
AIRE	GA-890R	RE51630	COMBUSTIBLE	G-270	AR86745	ACEITE	GP-35	RE57394
8410T con motor/JOHN DEERE 8.1 L			8650 con motor/A DIESEL			HIDRAULICO	GP-761H	AL77061
COMBUSTIBLE, SEPARADOR DE AGUA	GPP-426	RE65431	ACEITE, FLUJO TOTAL /FULL FLOW)	GP-35	RE57394	COMBUSTIBLE	G-270	AR86745
ACEITE	GP-35	RE57394	COMBUSTIBLE	G-270	AR86745	AIRE	GA-403	RE24619
COMBUSTIBLE	G-270	AR86745	COMBUSTIBLE, SEPARADOR DE AGUA	2010PM-OR	RE11325	AIRE	GAK-403	AT44377
AIRE, PRIMARIO	GA-930R	RE51629	870 UTILITARIO con motor/A DIESEL			AIRE	GA-221R	RE63931
AIRE, SECUNDARIO	GA-890R	RE51630	ACEITE	GP-40	M801209	AIRE	GA-723R	RE63932
8430 con motor/A DIESEL			8760 con motor/A DIESEL			9020T con motor/JOHN DEERE 6081T POWERTECH		
ACEITE, CLUTCH (HASTA S/N 5626)	G-331	AR75603	HIDRAULICO	GP-66	RE34040	ACEITE	GP-35	RE57394
TRANSMISION (HASTA S/N 5626)	G-331	AR75603	COMBUSTIBLE	G-270	AR86745	90HC con motor/A DIESEL		
ACEITE, CLUTCH (S/N 5626 EN ADELANTE)	G-339H	AR94510	COMBUSTIBLE, SEPARADOR DE AGUA	2010PM-OR	RE11325	ACEITE	GP-24	M801002
GASOLINA, SEPARADOR DE AGUA	G-293	AR86755	8770, 8870 con motor/JOHN DEERE 10.1L			COMBUSTIBLE, SEPARADOR DE AGUA	GPP-426	RE65431
ACEITE	GP-34	AR43634	COMBUSTIBLE, SEPARADOR DE AGUA	GPP-426	RE62423	ACEITE	GP-35	RE57394
COMBUSTIBLE	G-295	AR50041	8770, 8870 con motor/JOHN DEERE 10.1L			ACEITE, EJE HIDRAULICO	GP-761H	AL77061
8440 con motor/A DIESEL			COMBUSTIBLE, SEPARADOR DE AGUA	GPP-426	RE62423	COMBUSTIBLE	G-270	AR86745
ACEITE, CLUTCH	G-339H	AR94510						
HIDRAULICO	G-339H	AR94510						
TRANSMISION	G-339H	AR94510						
GASOLINA, SEPARADOR DE AGUA	G-293	AR86755						

MARCA-MODELO-MOTOR MAKE-MODEL-ENGINE	GONHER GONHER	OEM OEM	MARCA-MODELO-MOTOR MAKE-MODEL-ENGINE	GONHER GONHER	OEM OEM	MARCA-MODELO-MOTOR MAKE-MODEL-ENGINE	GONHER GONHER	OEM OEM
JOHN DEERE (continuación)			JOHN DEERE (continuación)			JOHN DEERE (continuación)		
TRACTORES			TRACTORES			TRACTORES		
AIRE	GA-403	RE24619	ACEITE	GP-14	T19044	ACEITE, SELLADO	GP-462	M801002
AIRE, PRIMARIO	GA-221R	RE63931	COMBUSTIBLE	G-295	AR50041	AIRE, SIN ASPAS	GA-33	CH12767
AIRE, SECUNDARIO	GA-723R	RE63932	AIRE, PRIMARIO	GAK-216	AR84228	R SERIES con motor/A DIESEL		
9100T con motor/JOHN DEERE 6081			AIRE, SECUNDARIO	GA-416	AE31724	ACEITE	G-139	AR26350
COMBUSTIBLE, SEPARADOR DE AGUA	GPP-426	RE65431	9400 con motor/JOHN DEERE 6125H			WA14, WA17 con motor/CUMMINS		
ACEITE	GP-35	RE57394	ACEITE, DOBLE FLUJO	GP-3000	RE58935	ACEITE, FLUJO TOTAL (FULL FLOW) CARTUCHO	G-566	257528
ACEITE, EJE HIDRAULICO	GP-761H	AL77061	AIRE	GA-403	RE24619	ACEITE, TURBOCARGADOR	GP-14	T19044
COMBUSTIBLE	G-270	AR86745	AIRE, PRIMARIO	GA-221R	RE63931	COMBUSTIBLE, 5 3/4 IN	GPP-14	AT81478
AIRE	GA-403	RE24619	AIRE, SECUNDARIO	GA-723R	RE63932	COMBUSTIBLE, 5 17/32 IN	GP-1101	158172
AIRE, PRIMARIO	GA-221R	RE63931	COMBUSTIBLE, SEPARADOR DE AGUA	R 90 P	RE500186	ACEITE, FLUJO TOTAL (FULL FLOW) SELLADO	GP-53	RE21058
AIRE, SECUNDARIO	GA-723R	RE63932	9400T con motor/JOHN DEERE 6125H			COMBUSTIBLE, 11 15/32 IN	GP-55	3313306
9120 con motor/JOHN DEERE 6081T POWERTECH			ACEITE, DOBLE FLUJO	GP-3000	RE58935	COMBUSTIBLE, SEPARADOR DE AGUA	GPP-11	RE42050
AIRE	GA-403	RE24619	COMBUSTIBLE, SEPARADOR DE AGUA	GPP-1291	RE500186	AIRE, RESPIRADOR CON TURBO	GA-39	255963
AIRE, PRIMARIO	GA-221R	RE63931	AIRE	GA-403	RE24619	ACEITE, DERIVACION (BY PASS)	G-750	151531
AIRE, SECUNDARIO	GA-723R	RE63932	AIRE, PRIMARIO	GA-221R	RE63931			
915 con motor/A DIESEL			AIRE, SECUNDARIO	GA-723R	RE63932			
ACEITE	GP-91	AM101378	9420, 9520, 9620 con motor/JOHN DEERE 6125 POWERTECH					
920 con motor/A DIESEL			ACEITE, DOBLE FLUJO	GP-3000	RE58935	JOHN DEERE		
TRANSMISION	G-331	AR75603	HIDRAULICO	GP-761H	RE39527	TRACTORES PEQUEÑOS Y PARA JARDIN		
ACEITE	GP-14	T19044	AIRE	GA-403	RE24619	108 con motor/A GASOLINA		
COMBUSTIBLE	G-296	AT17387	AIRE, PRIMARIO	GA-221R	RE63931	GASOLINA	GG-4	AM38708
COMBUSTIBLE	G-296-B	AT17387	AIRE, SECUNDARIO	GA-723R	RE63932	110 con motor/A GASOLINA 8 HP		
AIRE	GAK-16	AT20728	9420T, 9520T, 9620T con motor/JOHN DEERE 6125 POWERTECH			AIRE	GA-12	AM30800
9200, 9300 con motor/JOHN DEERE 6125H			ACEITE, DOBLE FLUJO	GP-3000	RE58935	110 con motor/KOHLER K161S		
ACEITE, DOBLE FLUJO	GP-3000	RE58935	AIRE	GA-403	RE24619	AIRE	GA-11	230840
AIRE	GA-403	RE24619	AIRE, PRIMARIO	GA-221R	RE63931	110 con motores/KOHLER K181S, KOHLER K241AS		
AIRE, PRIMARIO	GA-221R	RE63931	AIRE, SECUNDARIO	GA-723R	RE63932	AIRE	GA-7	AM31400
AIRE, SECUNDARIO	GA-723R	RE63932	955 UTILITARIO, 970 UTILITARIO con motor/A DIESEL			110H con motor/A GASOLINA 8 HP		
COMBUSTIBLE, SEPARADOR DE AGUA (HASTA S/N 007567)	R 90 P	RE500186	ACEITE	GP-40	M801209	AIRE	GA-12	AM30800
9200T, 9300T con motor/JOHN DEERE 6125H			990 UTILITARIO con motor/YANMAR 4TNE84			110H con motor/KOHLER K161S		
ACEITE, DOBLE FLUJO	GP-3000	RE58935	AIRE, RADIAL PRIMARIO	GA-880R	M131802	AIRE	GA-11	230840
COMBUSTIBLE, SEPARADOR DE AGUA	GPP-1291	RE500186	A, AN, ANH, AO, AR, AW, AWH, B, BN, BNH, BO con motor/A DIESEL			110H con motores/KOHLER K181S, KOHLER K241AS		
AIRE	GA-403	RE24619	ACEITE	G-139	AR26350	AIRE	GA-7	AM31400
AIRE, PRIMARIO	GA-221R	RE63931	D SERIES, BW, BWH, 530, 620, 630, BR con motor/A DIESEL			111 con motores/A GASOLINA, BRIGGS & STRATTON GASOLINA	GG-4	AM38708
AIRE, SECUNDARIO	GA-723R	RE63932	ACEITE	G-139	AR26350	111H, 116H con motor/A GASOLINA		
9220 con motor/JOHN DEERE 6125 POWERTECH			G SERIES, GM SERIES con motor/A DIESEL			GASOLINA	GG-4	AM38708
ACEITE, DOBLE FLUJO	GP-3000	RE58935	ACEITE	G-139	AR26350	112 con motor/A GASOLINA		
AIRE	GA-403	RE24619	JD650, JD750 con motor/YANMAR			AIRE	GA-7	AM31400
AIRE, PRIMARIO	GA-221R	RE63931	ACEITE	GP-462	M801002	112 con motor/KAWASAKI		
AIRE, SECUNDARIO	GA-723R	RE63932	JD850 con motor/A DIESEL			ACEITE	GP-58	AM101207
9320 con motor/JOHN DEERE 6125 POWERTECH			HIDRAULICO HASTA S/N 16001	GP-1	TY9425	112 con motor/KOHLER		
AIRE	GA-403	RE24619	ACEITE, SELLADO	GP-462	M801002	AIRE, S/N 100001-250001	GA-7	AM31400
AIRE, PRIMARIO	GA-221R	RE63931	AIRE, SIN ASPAS	GA-33	CH12767	112 con motor/TECUMSEH		
AIRE, SECUNDARIO	GA-723R	RE63932	JD855 con motor/YANMAR 3TN75			AIRE	GA-7	AM31400
9320T con motor/JOHN DEERE 6125 POWERTECH			ACEITE	GP-462	M801002	112H con motor/KOHLER		
AIRE	GA-403	RE24619	JD900HC con motor/A DIESEL			AIRE, S/N 100001-250001	GA-7	AM31400
AIRE, PRIMARIO	GA-221R	RE63931	ACEITE, SELLADO	GP-462	M801002	112H con motor/TECUMSEH		
AIRE, SECUNDARIO	GA-723R	RE63932	JD950 con motor/A DIESEL			AIRE	GA-7	AM31400
935 con motor/A DIESEL			HIDRAULICO HASTA S/N 020001	GP-1	TY9425			
ACEITE	GP-91	AM101378						
940 UTILITARIO con motor/A DIESEL								
HIDRAULICO/TRANSMISION	G-331	AR75603						

SERVICIO PESADO

MARCA-MODELO-MOTOR MAKE-MODEL-ENGINE	GONHER GONHER	OEM OEM	MARCA-MODELO-MOTOR MAKE-MODEL-ENGINE	GONHER GONHER	OEM OEM	MARCA-MODELO-MOTOR MAKE-MODEL-ENGINE	GONHER GONHER	OEM OEM
JOHN DEERE (continuación)			JOHN DEERE (continuación)			JOHN DEERE (continuación)		
TRACTORES PEQUEÑOS Y PARA JARDIN			TRACTORES PEQUEÑOS Y PARA JARDIN			TRACTORES PEQUEÑOS Y PARA JARDIN		
112L con motor/A GASOLINA			332 con motor/A GASOLINA			GX355 con motor/A GASOLINA		
ACEITE	GP-157	AM107423	ACEITE	GP-91	AM101378	ACEITE	GP-91	M806418
116, 130 con motor/A GASOLINA			335 con motor/KAWASAKI 17 HP			L110 con motor/KOHLER 17.5 HP		
GASOLINA	GG-4	AM38708	ACEITE	GP-157	AM107423	ACEITE	GP-58	AM31400
120, 140 con motor/A GASOLINA			335, 425 con motor/KAWASAKI 20 HP			L120, L130 con motor/BRIGGS & STRATTON 20 HP		
TRANSMISION	GP-3816	AM39653	ACEITE	GP-157	AM107423	ACEITE	GP-58	AM125424
160, 165, 240 con motor/KAWASAKI			345 con motores/KAWASAKI 18 HP, KAWASAKI 20 HP			LT133, LT155 con motores/KOHLER 13 HP, KOHLER 15 HP		
ACEITE	GP-157	AM107423	ACEITE	GP-157	AM107423	ACEITE	GP-58	AM125424
165 con motor/TOYOTA			355D con motor/YANMAR 2V78 18HP			LT150, LT160, LT150G, LT150H con motor/A GASOLINA		
ACEITE	GP-58	AM101207	ACEITE	GP-91	M806418	ACEITE	GP-58	AM125424
170 con motor/KAWASAKI			415 con motor/A GASOLINA			LT166, LTR166 con motor/BRIGGS & STRATTON 16 HP		
ACEITE	GP-157	AM107423	ACEITE	GP-91	M806418	ACEITE	GP-58	AM125424
170 con motor/ONAN NHB			420 con motor/A GASOLINA			AIRE	GA-6	LG394018
ACEITE	GP-81	MG508129	TRANSMISION	GP-3816	AM39653	GASOLINA	GG-4	AM116304
170 con motor/WISCONSIN VG4D			GASOLINA	GG-4	AM380708	LT170 con motor/A GASOLINA		
AIRE	GA-33	P101275	430 con motor/A GASOLINA 20 HP			ACEITE	GP-58	AM125424
175, 180, 185 con motor/KAWASAKI			TRANSMISION	GP-3816	AM39653	LT180 con motor/A GASOLINA		
ACEITE	GP-157	AM107423	ACEITE	GP-91	AM101378	ACEITE	GP-157	AM107423
185 con motor/TOYOTA			COMBUSTIBLE	G-294	AM101004	LTR180 con motor/KAWASAKI		
ACEITE	GP-58	AM101207	445 con motor/A DIESEL			ACEITE	GP-157	AM107423
200, 208, 210, 212, 214, 216 con motor/KOHLER 8 HP			ACEITE	GP-149	AM101378	LX172 con motor/KAWASAKI		
AIRE	GA-7	AM31400	445 con motor/KAWASAKI 22 HP			ACEITE	GP-157	AM107423
245, 260, 265, 285 con motor/KAWASAKI			ACEITE	GP-157	AM107423	LX173 con motor/BRIGGS & STRATTON		
ACEITE	GP-157	AM107423	455 con motor/KAWASAKI			ACEITE	GP-58	AM125424
300 con motor/A GASOLINA			ACEITE	GP-157	AM107423	LX176, LX178, LX186, LX188 con motor/KAWASAKI		
TRANSMISION	GP-3816	AM39653	455 con motor/YANMAR 3TNA72 22 HP			ACEITE	GP-157	AM107423
317 con motor/KOHLER 17 HP			ACEITE	GP-91	M806418	LX227 con motor/KAWASAKI 17 HP		
ACEITE	GP-58	AM101207	737, 757 con motores/KAWASAKI 23 HP, KAWASAKI 25 HP			ACEITE	GP-157	AM107423
317 con motor/KOHLER 18 HP			ACEITE	GP-157	AM107423	LX255 con motor/BRIGGS & STRATTON		
ACEITE	GP-58	AM101207	80D con motor/A GASOLINA			ACEITE	GP-58	AM125424
TRANSMISION	GP-3816	AM39653	ACEITE	G-331	AT34670	LX266 con motor/A GASOLINA		
GASOLINA	GG-4	AM380708	997 con motor/YANMAR TNV82A			ACEITE	GP-58	AM125424
318 con motores/KOHLER 17 HP, KOHLER 18 HP			AIRE, RADIAL PRIMARIO	GA-880R	M131802	LX277, LX279 con motor/KAWASAKI 17 HP		
ACEITE	GP-58	AM101207	G100 con motor/KOHLER 25 HP			ACEITE	GP-157	AM107423
320 con motor/A GASOLINA			ACEITE	GP-58	AM125424	LX279 con motor/BRIGGS & STRATTON 18 HP V-TWIN		
ACEITE	GP-157	AM107423	GT225 con motor/BRIGGS & STRATTON			AIRE	GA-6	LG394018
322 con motor/A GASOLINA			ACEITE	GP-58	AM125424	LX288 con motor/BRIGGS & STRATTON 18 HP V-TWIN		
TRANSMISION	GP-3816	AM39653	GT235, GT235E con motor/BRIGGS & STRATTON			ACEITE	GP-58	AM125424
ACEITE	GP-91	AM101378	ACEITE	GP-58	AM125424	AIRE	GA-6	LG394018
GASOLINA	GG-5	AM876035	AIRE	GA-6	LG394018	GASOLINA	GG-4	AM116304
325 con motores/KAWASAKI 17 HP, KAWASAKI 18 HP			GASOLINA	GG-4	AM116304	SST15 con motor/A GASOLINA		
ACEITE	GP-157	AM107423	GT235, GT235E, GT242, GT262, GT275 con motor/KAWASAKI			ACEITE	GP-58	AM125424
330 con motor/A GASOLINA			ACEITE	GP-157	AM107423	SST16, SST18 con motor/A GASOLINA		
TRANSMISION	GP-3816	AM39653	GT245, GX345, GX325, GX335 con motor/A GASOLINA			ACEITE	GP-58	AM125424
			ACEITE	GP-157	AM107423	AIRE	GA-6	LG394018

MARCA-MODELO-MOTOR MAKE-MODEL-ENGINE	GONHER GONHER	OEM OEM	MARCA-MODELO-MOTOR MAKE-MODEL-ENGINE	GONHER GONHER	OEM OEM	MARCA-MODELO-MOTOR MAKE-MODEL-ENGINE	GONHER GONHER	OEM OEM
JOHN DEERE (continuación)			KENWORTH (continuación)			KENWORTH (continuación)		
TRACTORES PEQUEÑOS Y PARA JARDIN			CAMIONES, TRACTOCAMIONES Y AUTOBUSES			CAMIONES, TRACTOCAMIONES Y AUTOBUSES		
GASOLINA	GG-4	AM116304	AGUA, SISTEMA DE ENFRIAMIENTO (4 UNIDADES)	GP-2071W	WF2071	AGUA	GP-1011Q	9N3367
STX30, STX38, STX46 con motor/KOHLER			COMBUSTIBLE, SEPARADOR DE AGUA (SELLADO)	GPP-1000	256-8753	AGUA	GP-2071W	3I1288
ACEITE	GP-58	AM101207	AIRE, RADIAL (ALT. 23 23/32 IN)	GA-539R	P534816	AIRE	GA-378	P181008
X465 con motor/KAWASAKI 21 HP			AIRE, RADIAL (ALT. 15 21/32 IN)	GA-968R	P549644	AIRE	GA-229	P181007
GASOLINA	GG-4	AM116304	C500 con motor/CATERPILLAR C16			C500 con motores/CATERPILLAR C13, CATERPILLAR C11		
X475, X575 con motor/KAWASAKI 23 HP			COMBUSTIBLE	GP-749	1R0749	TRANSMISION (CARTUCHO)	G-152	2M3943
ACEITE	GP-157	AM107423	ACEITE, CUMPLE CON MEDIDAS ORIGINALES	GP-691	1R0716	DIRECCION	G-159	83804E
X485, X585 con motor/KAWASAKI 25 HP			ACEITE, SEGUNDA OPCION	GP-52	1R0716	ACEITE, OPCIONAL PARA TRANSMISION (SELLADO)	GP-1	17237
ACEITE	GP-157	AM107423	C500 con motor/CUMMINS			COMBUSTIBLE	GP-749	1R0749
GASOLINA, SIN SOPORTE	GG-581	AM118131	COMBUSTIBLE	GP-1101	154711	ACEITE, LUBRICACION DEL MOTOR	GP-52	1R0716
GASOLINA, CON SOPORTE	GG-177	AM118131	ACEITE	GP-53	3313287	AGUA, SISTEMA DE ENFRIAMIENTO (8 UNIDADES)	GP-1011Q	9N-3367
X495, X595 con motor/YANMAR			COMBUSTIBLE	GP-55	3313306	AGUA, SISTEMA DE ENFRIAMIENTO (4 UNIDADES)	GP-2071W	WF2071
ACEITE	GP-91	M806418	ACEITE, SELLADO PARA DERIVACION (BY PASS)	GP-57	3304232	COMBUSTIBLE, SEPARADOR DE AGUA (SELLADO)	GPP-1000	256-8753
			COMBUSTIBLE, SEPARADOR DE AGUA	GPP-11	3600980	AIRE, RADIAL	GA-968R	P549644
			AGUA	GP-2071W	3315116	C523, C825, C524, C525, C823, C824 con motor/CUMMINS		
			AIRE, RESPIRADOR	GA-39	255963	ACEITE, CARTUCHO	G-566	257528
			AIRE	GA-378	P181008	ACEITE, TURBOCARGADOR	GP-14	4041959
			AIRE	GA-229	P181007	COMBUSTIBLE	GPP-14	3315847
			ACEITE, CARTUCHO PARA DERIVACION (BY PASS)	G-750	139096	COMBUSTIBLE	GP-1101	154711
			C500 con motor/CUMMINS ISM			ACEITE, SELLADO	GP-53	3313287
			AGUA	GP-2071W	WF2071	COMBUSTIBLE	GP-55	3313306
			ACEITE	GP-9001	3406809	COMBUSTIBLE, SEPARADOR DE AGUA	GPP-11	3600980
			COMBUSTIBLE	GPP-10225	3800394	AIRE, RESPIRADOR	GA-39	255963
			AIRE, RESPIRADOR	GA-39	255963	ACEITE, DERIVACION (BY PASS)	G-750	139096
			AIRE	GA-378	P181008	C800 con motor/CATERPILLAR C15		
			AIRE	GA-229	P181007	COMBUSTIBLE	GP-749	1R0749
			C500 con motor/CUMMINS ISX			ACEITE, CUMPLE CON MEDIDAS ORIGINALES	GP-691	1R0716
			AGUA	GP-2127W	WF2127	ACEITE, SEGUNDA OPCION	GP-52	1R0716
			AGUA	GP-2126Q	WF2126	HUSTLER con motor/CATERPILLAR 3306		
			ACEITE	GP-9001	3406809	GASOLINA, SEPARADOR DE AGUA	G-293	6N7617
			COMBUSTIBLE, SEPARADOR DE AGUA	GPP-10075	F51040	ACEITE	GP-51	1R0739
			AIRE, RESPIRADOR	GA-39	255963	COMBUSTIBLE	GP-110	1R0740
			AIRE	GA-378	P181008	HUSTLER con motor/CUMMINS		
			AIRE	GA-229	P181007	ACEITE, CARTUCHO	G-566	257528
			C500 con motor/DETROIT DIESEL SERIES 60			COMBUSTIBLE	GP-1101	154711
			COMBUSTIBLE, PRIMARIO	GP-26	23518481	ACEITE, SELLADO	GP-53	3313287
			COMBUSTIBLE, SECUNDARIO	GP-27	23518482	AGUA	GP-2071W	3315116
			AGUA	GP-2071W	P554071	ACEITE, DERIVACION (BY PASS)	G-750	139096
			ACEITE	GP-193	23527033	HUSTLER con motor/GMC DIESEL		
			AIRE	GA-378	KW852M	ACEITE	G-33	5573013
			C500 con motor/GMC 8V-92TA DIESEL			COMBUSTIBLE, PRIMARIO	GP-26	KW207
			ACEITE	G-33	5573013	COMBUSTIBLE, SECUNDARIO	GP-27	KW206
			COMBUSTIBLE, PRIMARIO	GP-26	KW207	ACEITE, DERIVACION (BY PASS)	G-750	2495994
			COMBUSTIBLE, SECUNDARIO	GP-27	KW206	K100 con motor/GMC 12V-71		
			ACEITE	GP-53	25010449	ACEITE, CARTUCHO	G-33	5573013
			AIRE	GA-378	P181008	COMBUSTIBLE, PRIMARIO	GP-26	KW207
			AIRE	GA-229	P181007	COMBUSTIBLE, SECUNDARIO	GP-27	KW206
			C500 con motores/CATERPILLAR 3406, CATERPILLAR 3406C			AIRE, SIN ASPAS	GA-27	P117331
			ACEITE, CUMPLE CON MEDIDAS ORIGINALES	GP-691	1R0716	AIRE	GA-229	P117797
			ACEITE, SEGUNDA OPCION	GP-52	1R0716	ACEITE, DERIVACION (BY PASS)	G-750	2495994
			COMBUSTIBLE, OPCIONAL	GP-110	1P2299			

SERVICIO PESADO

MARCA-MODELO-MOTOR MAKE-MODEL-ENGINE	GONHER GONHER	OEM OEM	MARCA-MODELO-MOTOR MAKE-MODEL-ENGINE	GONHER GONHER	OEM OEM	MARCA-MODELO-MOTOR MAKE-MODEL-ENGINE	GONHER GONHER	OEM OEM
KENWORTH (continuación)			KENWORTH (continuación)			KENWORTH (continuación)		
CAMIONES, TRACTOCAMIONES Y AUTOBUSES			CAMIONES, TRACTOCAMIONES Y AUTOBUSES			CAMIONES, TRACTOCAMIONES Y AUTOBUSES		
K100 con motores/ALLIS CHALMERS 21000, ALLIS CHALMERS 25000			K100, K100E con motores/DETROIT DIESEL 6-71, DETROIT DIESEL 6V-92, DETROIT DIESEL 8V-71, DETROIT DIESEL 8V-92			ACEITE, MOTORES 3.9L		
ACEITE	G-33	4395889	ACEITE, CARTUCHO	G-33	5573014	K333 con motor/CUMMINS C SERIES	GP-390	3890709
COMBUSTIBLE, SECUNDARIO	G-1176	4052172	COMBUSTIBLE, PRIMARIO	GP-26	KW207	COMBUSTIBLE, SECUNDARIO	GP-1122	3903640
AIRE, SIN ASPAS	GA-27	P117331	COMBUSTIBLE, SECUNDARIO	GP-27	KW206	ACEITE	GP-43	3313281
AIRE	GA-378	P116918	ACEITE, SELLADO	GP-53	25010449	ACEITE	GP-3000	3825970
K100 con motores/CATERPILLAR 1673C, CATERPILLAR 1674			AIRE, SIN ASPAS	GA-26	P117332	COMBUSTIBLE, PRIMARIO	GPP-18	3925274
ACEITE	G-191	1R0659	AIRE, SIN ASPAS	GA-27	P117331	KW45 con motores/PACCAR 4 CIL., PACCAR 6 CIL.		
GASOLINA, SEPARADOR DE AGUA	G-293	6N7617	AIRE	GA-378	P116918	ACEITE	GP-737	LF16015
COMBUSTIBLE	GP-110	1P2299	AIRE	GA-229	P117797	KW55 con motor/PACCAR		
AIRE, RESPIRADOR	GA-135	9L2169	AIRE	GA-694	P150694	ACEITE	GP-737	LF16015
AIRE, SIN ASPAS	GA-27	P117331	ACEITE, DERIVACION (BY PASS)	G-750	2495994	L700 con motor/CATERPILLAR 3208		
AIRE	GA-229	P117797	K100E con motor/DETROIT DIESEL SERIES 60			ACEITE	GP-36	9L9200
K100 con motores/CATERPILLAR 1693T, CATERPILLAR 1693TA			COMBUSTIBLE, PRIMARIO	GP-26	KW207	GASOLINA, SEPARADOR DE AGUA	G-293	6N7617
ACEITE	G-238	550485	COMBUSTIBLE, SECUNDARIO	GP-27	KW206	COMBUSTIBLE	GP-110	1P2299
COMBUSTIBLE	G-1166	6H5931	ACEITE	GP-53	25010449	ACEITE	GP-9586	9N5570
ACEITE, CUMPLE CON MEDIDAS ORIGINALES	GP-691	1R0716	K121, K122, K123, K124, K125, LW923, LW924, PD221, PD223, PD225 con motor/CUMMINS			L700 con motor/CATERPILLAR 3306		
ACEITE, SEGUNDA OPCION	GP-52	1R0716	ACEITE, CARTUCHO	G-566	257528	GASOLINA, SEPARADOR DE AGUA	G-293	6N7617
COMBUSTIBLE	GP-110	1P2299	ACEITE, TURBOCARGADOR	GP-14	4041959	ACEITE	GP-51	1R0739
AIRE, RESPIRADOR	GA-135	9L2169	COMBUSTIBLE, 5 47/64 IN	GPP-14	3315847	COMBUSTIBLE	GP-110	1R0740
AIRE, SIN ASPAS	GA-26	P117332	COMBUSTIBLE, 5 13/32 IN	GP-1101	154711	L700 con motor/CUMMINS		
AIRE	GA-378	P116918	ACEITE, SELLADO	GP-53	3313287	COMBUSTIBLE	GP-1101	154711
K100, K100E con motor/CATERPILLAR 3306			COMBUSTIBLE, 11 1/2 IN	GP-55	3313306	ACEITE	GP-53	3313287
ACEITE	GP-51	1R0739	COMBUSTIBLE, SEPARADOR DE AGUA	GPP-11	3600980	ACEITE, DERIVACION (BY PASS)	GP-57	3304232
COMBUSTIBLE	GP-110	1R0740	AIRE, RESPIRADOR	GA-39	255963	ACEITE, DOBLE FLUJO	GP-3000	3825970
AIRE, SIN ASPAS	GA-27	P181000	ACEITE, DERIVACION (BY PASS)	G-750	139096	AIRE, RESPIRADOR	GA-39	255963
AIRE	GA-378	P181008	K130, K150 MIDRANGER con motor/CUMMINS 6CT8.3			AIRE, SIN ASPAS	GA-26	P117332
AIRE	GA-694	P150694	COMBUSTIBLE, SECUNDARIO	GP-1122	3903640	AIRE, SIN ASPAS	GA-27	P117331
K100, K100E con motor/CUMMINS			COMBUSTIBLE, OPCIONAL	GPP-1122	3286503	AIRE	GA-378	P116918
ACEITE, CARTUCHO	G-566	257528	ACEITE	GP-43	3313281	AIRE	GA-229	P117797
ACEITE, TURBOCARGADOR	GP-14	4041959	COMBUSTIBLE, PRIMARIO	GPP-18	3925274	AIRE	GA-694	P150694
COMBUSTIBLE, 5 47/64 IN	GPP-14	3315847	AIRE	GA-209	P112803	ACEITE, MOTOR 5.9L		
COMBUSTIBLE, 5 13/32 IN	GP-1101	154711	K220 MIDRANGER con motor/CUMMINS 6CT8.3			ACEITE, MOTORES 3.9L	GP-390	3890709
ACEITE, SELLADO	GP-53	3313287	COMBUSTIBLE, SECUNDARIO	GP-1122	3903640	K300 con motor/CUMMINS B SERIES		
COMBUSTIBLE, 11 1/2 IN	GP-55	3313306	COMBUSTIBLE, OPCIONAL	GPP-1122	3286503	COMBUSTIBLE, SECUNDARIO	GP-1122	3903640
ACEITE, SELLADO PARA DERIVACION (BY PASS)	GP-57	3304232	ACEITE	GP-43	3313281	COMBUSTIBLE, PRIMARIO	GPP-18	3925274
COMBUSTIBLE, SEPARADOR DE AGUA	GPP-11	3600980	COMBUSTIBLE, PRIMARIO	GPP-18	3925274	ACEITE, MOTOR 5.9L	GP-178	3914395
ACEITE, DOBLE FLUJO	GP-3000	3825970	K300 con motor/CUMMINS C SERIES			ACEITE, MOTORES 3.9L	GP-390	3890709
AIRE, RESPIRADOR	GA-39	255963	COMBUSTIBLE, SECUNDARIO	GP-1122	3903640	K300 con motor/CUMMINS ISB 5.9L		
AIRE, SIN ASPAS	GA-26	P117332	ACEITE	GP-43	3313281	TRANSMISION	GP-9586	25011159
AIRE, SIN ASPAS	GA-27	P117331	ACEITE	GP-3000	3825970	ACEITE	GP-3937	3937144
AIRE	GA-378	P116918	COMBUSTIBLE, PRIMARIO	GPP-18	3925274	COMBUSTIBLE	GS-1261	3942470
AIRE	GA-229	P117797	ACEITE, MOTOR 5.9L	GP-178	3914395	AIRE	GA-197R	P527484
AIRE	GA-694	P150694	ACEITE, MOTORES 3.9L	GP-390	3890709	K333 con motor/CUMMINS B SERIES		
ACEITE, CARTUCHO PARA DERIVACION (BY PASS)	G-750	139096	K300 con motor/CUMMINS C SERIES			COMBUSTIBLE, SECUNDARIO	GP-1122	3903640
K100, K100E con motores/CATERPILLAR 3406, CATERPILLAR 3408			COMBUSTIBLE, SECUNDARIO	GP-1122	3903640	COMBUSTIBLE, PRIMARIO	GPP-18	3925274
ACEITE, CUMPLE CON MEDIDAS ORIGINALES	GP-691	1R0716	ACEITE	GP-43	3313281	K300 con motor/CUMMINS ISB 5.9L		
ACEITE, SEGUNDA OPCION	GP-52	1R0716	ACEITE	GP-3000	3825970	TRANSMISION	GP-9586	25011159
COMBUSTIBLE	GP-110	1P2299	COMBUSTIBLE, PRIMARIO	GPP-18	3925274	ACEITE	GP-3937	3937144
AGUA	GP-2071W	3I1288	K300 con motor/CUMMINS ISB 5.9L			COMBUSTIBLE	GS-1261	3942470
AIRE, SIN ASPAS	GA-26	P181001	TRANSMISION	GP-9586	25011159	AIRE	GA-197R	P527484
AIRE	GA-378	P181008	ACEITE	GP-3937	3937144	K333 con motor/CUMMINS B SERIES		
AIRE	GA-229	P181007	COMBUSTIBLE	GS-1261	3942470	COMBUSTIBLE, SECUNDARIO	GP-1122	3903640
AIRE	GA-694	P150694	AIRE	GA-197R	P527484	COMBUSTIBLE, PRIMARIO	GPP-18	3925274
K100, K100E con motores/CATERPILLAR 3406, CATERPILLAR 3408			ACEITE, MOTOR 5.9L	GP-178	3914395	K333 con motor/CUMMINS B SERIES		
ACEITE, CUMPLE CON MEDIDAS ORIGINALES	GP-691	1R0716	K300 con motor/CUMMINS C SERIES			COMBUSTIBLE, SECUNDARIO	GP-1122	3903640
ACEITE, SEGUNDA OPCION	GP-52	1R0716	COMBUSTIBLE, SECUNDARIO	GP-1122	3903640	COMBUSTIBLE, PRIMARIO	GPP-18	3925274
COMBUSTIBLE	GP-110	1P2299	ACEITE	GP-43	3313281	ACEITE, MOTOR 5.9L	GP-178	3914395
AGUA	GP-2071W	3I1288	ACEITE	GP-3000	3825970	K333 con motor/CUMMINS B SERIES		
AIRE, SIN ASPAS	GA-26	P181001	COMBUSTIBLE, PRIMARIO	GPP-18	3925274	COMBUSTIBLE, SECUNDARIO	GP-1122	3903640
AIRE	GA-378	P181008	K300 con motor/CUMMINS ISB 5.9L			COMBUSTIBLE, PRIMARIO	GPP-18	3925274
AIRE	GA-229	P181007	TRANSMISION	GP-9586	25011159	ACEITE, MOTOR 5.9L	GP-178	3914395
AIRE	GA-694	P150694	ACEITE	GP-3937	3937144	K333 con motor/CUMMINS B SERIES		
K100, K100E con motores/CATERPILLAR 3406, CATERPILLAR 3408			COMBUSTIBLE	GS-1261	3942470	COMBUSTIBLE, SECUNDARIO	GP-1122	3903640
ACEITE, CUMPLE CON MEDIDAS ORIGINALES	GP-691	1R0716	AIRE	GA-197R	P527484	COMBUSTIBLE, PRIMARIO	GPP-18	3925274
ACEITE, SEGUNDA OPCION	GP-52	1R0716	K300 con motor/CUMMINS ISB 5.9L			ACEITE, MOTOR 5.9L	GP-178	3914395
COMBUSTIBLE	GP-110	1P2299	TRANSMISION	GP-9586	25011159	K333 con motor/CUMMINS B SERIES		
AGUA	GP-2071W	3I1288	ACEITE	GP-3937	3937144	COMBUSTIBLE, SECUNDARIO	GP-1122	3903640
AIRE, SIN ASPAS	GA-26	P181001	COMBUSTIBLE	GS-1261	3942470	COMBUSTIBLE, PRIMARIO	GPP-18	3925274
AIRE	GA-378	P181008	AIRE	GA-197R	P527484	ACEITE, MOTOR 5.9L	GP-178	3914395
AIRE	GA-229	P181007	K300 con motor/CUMMINS ISB 5.9L			K333 con motor/CUMMINS B SERIES		
AIRE	GA-694	P150694	TRANSMISION	GP-9586	25011159	COMBUSTIBLE, SECUNDARIO	GP-1122	3903640
K100, K100E con motores/CATERPILLAR 3406, CATERPILLAR 3408			ACEITE	GP-3937	3937144	COMBUSTIBLE, PRIMARIO	GPP-18	3925274
ACEITE, CUMPLE CON MEDIDAS ORIGINALES	GP-691	1R0716	COMBUSTIBLE	GS-1261	3942470	ACEITE, MOTOR 5.9L	GP-178	3914395
ACEITE, SEGUNDA OPCION	GP-52	1R0716	AIRE	GA-197R	P527484	K333 con motor/CUMMINS B SERIES		
COMBUSTIBLE	GP-110	1P2299	K300 con motor/CUMMINS ISB 5.9L			COMBUSTIBLE, SECUNDARIO	GP-1122	3903640
AGUA	GP-2071W	3I1288	TRANSMISION	GP-9586	25011159	COMBUSTIBLE, PRIMARIO	GPP-18	3925274
AIRE, SIN ASPAS	GA-26	P181001	ACEITE	GP-3937	3937144	ACEITE, MOTOR 5.9L	GP-178	3914395
AIRE	GA-378	P181008	COMBUSTIBLE	GS-1261	3942470	K333 con motor/CUMMINS B SERIES		
AIRE	GA-229	P181007	AIRE	GA-197R	P527484	COMBUSTIBLE, SECUNDARIO	GP-1122	3903640
AIRE	GA-694	P150694	K300 con motor/CUMMINS ISB 5.9L			COMBUSTIBLE, PRIMARIO	GPP-18	3925274
K100, K100E con motores/CATERPILLAR 3406, CATERPILLAR 3408			TRANSMISION	GP-9586	25011159	ACEITE, MOTOR 5.9L	GP-178	3914395
ACEITE, CUMPLE CON MEDIDAS ORIGINALES	GP-691	1R0716	ACEITE	GP-3937	3937144	K333 con motor/CUMMINS B SERIES		
ACEITE, SEGUNDA OPCION	GP-52	1R0716	COMBUSTIBLE	GS-1261	3942470	COMBUSTIBLE, SECUNDARIO	GP-1122	3903640
COMBUSTIBLE	GP-110	1P2299	AIRE	GA-197R	P527484	COMBUSTIBLE, PRIMARIO	GPP-18	3925274
AGUA	GP-2071W	3I1288	K300 con motor/CUMMINS ISB 5.9L			ACEITE, MOTOR 5.9L	GP-178	3914395
AIRE, SIN ASPAS	GA-26	P181001	TRANSMISION	GP-9586	25011159	K333 con motor/CUMMINS B SERIES		
AIRE	GA-378	P181008	ACEITE	GP-3937	3937144	COMBUSTIBLE, SECUNDARIO	GP-1122	3903640
AIRE	GA-229	P181007	COMBUSTIBLE	GS-1261	3942470	COMBUSTIBLE, PRIMARIO	GPP-18	3925274
AIRE	GA-694	P150694	AIRE	GA-197R	P527484	ACEITE, MOTOR 5.9L	GP-178	3914395
K100, K100E con motores/CATERPILLAR 3406, CATERPILLAR 3408			TRANSMISION	GP-9586	25011159	K333 con motor/CUMMINS B SERIES		
ACEITE, CUMPLE CON MEDIDAS ORIGINALES	GP-691	1R0716	ACEITE	GP-3937	3937144	COMBUSTIBLE, SECUNDARIO	GP-1122	3903640
ACEITE, SEGUNDA OPCION	GP-52	1R0716	COMBUSTIBLE	GS-1261	3942470	COMBUSTIBLE, PRIMARIO	GPP-18	3925274
COMBUSTIBLE	GP-110	1P2299	AIRE	GA-197R	P527484	ACEITE, MOTOR 5.9L	GP-178	3914395
AGUA	GP-2071W	3I1288	K300 con motor/CUMMINS ISB 5.9L			K333 con motor/CUMMINS B SERIES		
AIRE, SIN ASPAS	GA-26	P181001	TRANSMISION	GP-9586	25011159	COMBUSTIBLE, SECUNDARIO	GP-1122	3903640
AIRE	GA-378	P181008	ACEITE	GP-3937	3937144	COMBUSTIBLE, PRIMARIO	GPP-18	3925274
AIRE	GA-229	P181007	COMBUSTIBLE	GS-1261	3942470	ACEITE, MOTOR 5.9L	GP-178	3914395
AIRE	GA-694	P150694	AIRE	GA-197R	P527484	K333 con motor/CUMMINS B SERIES		
K100, K100E con motores/CATERPILLAR 3406, CATERPILLAR 3408			TRANSMISION	GP-9586	25011159	COMBUSTIBLE, SECUNDARIO	GP-1122	3903640
ACEITE, CUMPLE CON MEDIDAS ORIGINALES	GP-691	1R0716	ACEITE	GP-3937	3937144	COMBUSTIBLE, PRIMARIO	GPP-18	3925274
ACEITE, SEGUNDA OPCION	GP-52	1R0716	COMBUSTIBLE	GS-1261	3942470	ACEITE, MOTOR 5.9L	GP-178	3914395
COMBUSTIBLE	GP-110	1P2299	AIRE	GA-197R	P527484	K333 con motor/CUMMINS B SERIES		
AGUA	GP-2071W	3I1288	K300 con motor/CUMMINS ISB 5.9L			COMBUSTIBLE, SECUNDARIO	GP-1122	3903640
AIRE, SIN ASPAS	GA-26	P181001	TRANSMISION	GP-9586	25011159	COMBUSTIBLE, PRIMARIO	GPP-18	3925274
AIRE	GA-378	P181008	ACEITE	GP-3937	3937144	ACEITE, MOTOR 5.9L	GP-178	3914395
AIRE	GA-229	P181007	COMBUSTIBLE	GS-1261	3942470	K333 con motor/CUMMINS B SERIES		
AIRE	GA-694	P150694	AIRE	GA-197R	P527484	COMBUSTIBLE, SECUNDARIO	GP-1122	3903640
K100, K100E con motores/CATERPILLAR 3406, CATERPILLAR 3408			TRANSMISION	GP-9586	25011159	COMBUSTIBLE, PRIMARIO	GPP-18	3925274
ACEITE, CUMPLE CON MEDIDAS ORIGINALES	GP-691	1R0716	ACEITE	GP-3937	3937144	ACEITE, MOTOR 5.9L	GP-178	3914395
ACEITE, SEGUNDA OPCION	GP-52	1R0716	COMBUSTIBLE	GS-1261	3942470	K333 con motor/CUMMINS B SERIES		
COMBUSTIBLE	GP-110	1P2299	AIRE	GA-197R	P527484	COMBUSTIBLE, SECUND		

MARCA-MODELO-MOTOR MAKE-MODEL-ENGINE	GONHER GONHER	OEM OEM	MARCA-MODELO-MOTOR MAKE-MODEL-ENGINE	GONHER GONHER	OEM OEM	MARCA-MODELO-MOTOR MAKE-MODEL-ENGINE	GONHER GONHER	OEM OEM
KENWORTH (continuación)			KENWORTH (continuación)			KENWORTH (continuación)		
CAMIONES, TRACTOCAMIONES Y AUTOBUSES			CAMIONES, TRACTOCAMIONES Y AUTOBUSES			CAMIONES, TRACTOCAMIONES Y AUTOBUSES		
COMBUSTIBLE, SEPARADOR DE AGUA	GPP-1000	256-8753	AIRE, PRIMARIO	GA-930R	P536142	COMBUSTIBLE, SEPARADOR DE AGUA	GPP-1000	702256C1
AIRE, RADIAL	GA-968R	P542101	AIRE, RADIAL	GA-968R	P542101	AIRE (ESTANDAR)	GA-3551	P153551
T2000 con motor/CATERPILLAR C15			T300 con motor/CUMMINS 5.9L A GAS NATURAL			AIRE (HEAVY DUTY)	GA-3551 XT	P153551
ACEITE, OPCIONAL PARA TRANSMISION	GP-1	17237	ACEITE	GP-178	3914395	T600 con motor/CATERPILLAR C13		
COMBUSTIBLE (SELLADO)	GP-749	1R0749	T300 con motor/CUMMINS 8.3L			COMBUSTIBLE	GP-749	1R0749
ACEITE, FLUJO TOTAL (FULL FLOW)	GP-52	1R1808	COMBUSTIBLE, SECUNDARIO	GP-1122	3903640	ACEITE, CUMPLE CON MEDI-DAS ORIGINALES	GP-691	1R1808
AGUA, SISTEMA DE ENFRIAMIENTO (4 UNIDADES)	GP-2071W	WF2071	ACEITE	GP-3000	3825970	ACEITE, SEGUNDA OPCION	GP-52	1R1808
COMBUSTIBLE, SEPARADOR DE AGUA	GPP-1000	FS1000	COMBUSTIBLE, PRIMARIO	GP-18	3925274	AIRE (ESTANDAR)	GA-3551	P153551
AIRE, RADIAL	GA-968R	EAF5107	AIRE	GA-197R	P527484	AIRE (HEAVY DUTY)	GA-3551 XT	P153551
T2000 con motor/CATERPILLAR C3406E			AIRE, SECUNDARIO	GA-768R	AF25215	T600 con motor/CATERPILLAR C15		
COMBUSTIBLE (SELLADO)	GP-749	1R0749	T300 con motor/CUMMINS ISC			COMBUSTIBLE	GP-749	1R0749
ACEITE, LUBRICACION DEL MOTOR	GP-52	1R0716	ACEITE	GP-3001	3401544	ACEITE, CUMPLE CON MEDI-DAS ORIGINALES	GP-691	1R1808
COMBUSTIBLE, SEPARADOR DE AGUA OPCIONAL	GPP-1000	256-8753	AGUA	GP-2071W	3315116	ACEITE, SEGUNDA OPCION	GP-52	1R1808
AIRE, RADIAL	GA-930R	P536142	COMBUSTIBLE	GPP-10225	FS1003	COMBUSTIBLE, SEPARADOR DE AGUA	GPP-1000	702256C1
AIRE, PRIMARIO	GA-968R	P542101	AIRE	GA-197R	P527484	AIRE (ESTANDAR)	GA-3551	P153551
T2000 con motor/CUMMINS ISL			T300 con motores/CATERPILLAR 3126, CATERPILLAR C7			AIRE (HEAVY DUTY)	GA-3551 XT	P153551
ACEITE, OPCIONAL PARA TRANSMISION	GP-1	17237	ACEITE	GP-51	1R1807	T600 con motor/CUMMINS ISX		
ACEITE, LUBRICACION DE DOBLE FLUJO	GP-3001	LF9009	COMBUSTIBLE, CORTO	GP-62	1R0751	COMBUSTIBLE, SEPARADOR DE AGUA	G-128	FF5369
AGUA, SISTEMA DE ENFRIAMIENTO	GP-2071W	WF2071	COMBUSTIBLE, LARGO	GP-1109	1R0751	AGUA	GP-2071W	WF2127
AIRE, RADIAL	GA-968R	EAF5107	COMBUSTIBLE, SEPARADOR DE AGUA	GPP-1000	702256C1	AGUA	GP-2126Q	WF2126
T2000 con motor/CUMMINS ISM			AIRE	GA-197R	P527484	ACEITE	GP-9001	LF9001
ACEITE, OPCIONAL PARA TRANSMISION	GP-1	17237	T400A con motor/CATERPILLAR 3176			COMBUSTIBLE, SEPARADOR DE AGUA	GPP-10075	FS1040
AGUA, SISTEMA DE ENFRIAMIENTO	GP-2071W	WF2071	AIRE (ESTANDAR)	GA-3551	P153551	AIRE	GA-197R	P527484
COMBUSTIBLE, SEPARADOR DE AGUA	GPP-1000	FS1000	T400A con motor/CATERPILLAR 3306			T600 con motor/CUMMINS N14		
ACEITE, LUBRICACION DE DOBLE FLUJO	GP-9001	LF9001	ACEITE	GP-51	1R0739	AGUA	GP-2071W	3315116
AIRE, RADIAL	GA-968R	EAF5107	T400A con motor/CUMMINS L10			T600 con motor/DETROIT DIESEL SERIES 60		
T2000 con motor/CUMMINS ISX			ACEITE	GP-53	3313287	AGUA	GP-2071W	3315116
ACEITE, OPCIONAL PARA TRANSMISION	GP-1	17237	ACEITE, DERIVACION (BY PASS)	GP-57	3304232	ACEITE	GP-193	23527033
AGUA, SISTEMA DE ENFRIAMIENTO	GP-2127W	WF2127	COMBUSTIBLE, SEPARADOR DE AGUA	GPP-11	3600980	AIRE	GA-378	KW852M
COMBUSTIBLE (PRE FILTRO)	GP-1101	FF2203	ACEITE	GP-3000	3825970	T600A con motor/CATERPILLAR 3306		
ACEITE, LUBRICACION DE DOBLE FLUJO (ALT. 13 7/8 IN)	GP-9000	3406810	AIRE (ESTANDAR)	GA-3551	P153551	ACEITE	GP-51	1R0739
ACEITE, LUBRICACION DE DOBLE FLUJO (ALT. 11 23/32 IN)	GP-9001	LF9001	AIRE (HEAVY DUTY)	GA-3551 XT	P153551	T600A con motor/CATERPILLAR 3406E		
COMBUSTIBLE, SEPARADOR DE AGUA	GPP-10075	FS1007	T450A con motor/CATERPILLAR 3176			COMBUSTIBLE	GP-749	1R0749
AIRE, RADIAL	GA-968R	EAF5107	ACEITE, CUMPLE CON MEDI-DAS ORIGINALES	GP-691	1R0716	ACEITE, CUMPLE CON MEDI-DAS ORIGINALES	GP-691	1R1808
T2000 con motor/CUMMINS N14			ACEITE, SEGUNDA OPCION	GP-52	1R0716	ACEITE, SEGUNDA OPCION	GP-52	1R1808
ACEITE, LUBRICACION DE DOBLE FLUJO	GP-3001	3401544	COMBUSTIBLE, OPCIONAL	GP-110	1R0712	AGUA	GP-2071W	311288
COMBUSTIBLE (SELLADO)	GPP-14	3843447	AIRE (ESTANDAR)	GA-3551	P153551	COMBUSTIBLE, SEPARADOR DE AGUA	GPP-1000	702256C1
ACEITE, FLUJO TOTAL (FULL FLOW)	GP-53	3310445	AIRE (HEAVY DUTY)	GA-3551 XT	P153551	AIRE (ESTANDAR)	GA-3551	P153551
ACEITE, DERIVACION (BY PASS)	GP-57	3313283	T600 AERO CAB con motor/CATERPILLAR C12			AIRE (HEAVY DUTY)	GA-3551 XT	P153551
ACEITE, LUBRICACION DE DOBLE FLUJO	GP-3000	3318853	COMBUSTIBLE	GP-749	1R0749	T600A con motor/CATERPILLAR C10		
AGUA, SISTEMA DE ENFRIAMIENTO	GP-2071W	299080	ACEITE, CUMPLE CON MEDI-DAS ORIGINALES	GP-691	1R1808	ACEITE, CUMPLE CON MEDI-DAS ORIGINALES	GP-691	1R0716
COMBUSTIBLE, SEPARADOR DE AGUA	GPP-1000	3889716	ACEITE, SEGUNDA OPCION	GP-52	1R1808	ACEITE, SEGUNDA OPCION	GP-52	1R0716
			AGUA	GP-2071W	311288	ACEITE, DERIVACION (BY PASS)	GP-57	9Y4468
			T600 con motor/CATERPILLAR 3406E			COMBUSTIBLE	GP-110	1P2299
			COMBUSTIBLE	GP-749	1R0749	COMBUSTIBLE, SEPARADOR DE AGUA	GPP-1000	702256C1
			ACEITE, CUMPLE CON MEDI-DAS ORIGINALES	GP-691	1R1808	AIRE (ESTANDAR)	GA-3551	P153551
			ACEITE, SEGUNDA OPCION	GP-52	1R1808	AIRE (HEAVY DUTY)	GA-3551 XT	P153551
			AGUA	GP-2071W	311288			

SERVICIO PESADO

MARCA-MODELO-MOTOR MAKE-MODEL-ENGINE	GONHER GONHER	OEM OEM	MARCA-MODELO-MOTOR MAKE-MODEL-ENGINE	GONHER GONHER	OEM OEM	MARCA-MODELO-MOTOR MAKE-MODEL-ENGINE	GONHER GONHER	OEM OEM
KENWORTH (continuación)			KENWORTH (continuación)			KENWORTH (continuación)		
CAMIONES, TRACTOCAMIONES Y AUTOBUSES			CAMIONES, TRACTOCAMIONES Y AUTOBUSES			CAMIONES, TRACTOCAMIONES Y AUTOBUSES		
T600A con motor/CUMMINS N14			ACEITE, SEGUNDA OPCION	GP-52	1R1808	AIRE (HEAVY DUTY)	GA-3551 XT	P153551
ACEITE	GP-53	3313287	COMBUSTIBLE, SEPARADOR DE AGUA	GPP-1000	702256C1	T800 TIFFIN con motor/CATERPILLAR C12		
ACEITE, DERIVACION (BY PASS)	GP-57	3304232				ACEITE, CUMPLE CON MEDIDAS ORIGINALES	GP-691	1R0716
COMBUSTIBLE, SEPARADOR DE AGUA	GPP-11	3600980	T800 con motor/CATERPILLAR C15			ACEITE, SEGUNDA OPCION	GP-52	1R0716
ACEITE, DOBLE FLUJO	GP-3000	3825970	COMBUSTIBLE	GP-749	1R0749	ACEITE, DERIVACION (BY PASS)	GP-57	9Y4468
AIRE (ESTANDAR)	GA-3551	P153551	ACEITE, CUMPLE CON MEDIDAS ORIGINALES	GP-691	1R1808	COMBUSTIBLE	GP-110	1P2299
AIRE (HEAVY DUTY)	GA-3551 XT	P153551	ACEITE, SEGUNDA OPCION	GP-52	1R1808	COMBUSTIBLE, SEPARADOR DE AGUA	GPP-1000	702256C1
			AGUA	GP-2071W	9N3368	AIRE (ESTANDAR)	GA-3551	P153551
T600A con motor/DETROIT DIESEL SERIES 60			COMBUSTIBLE, SEPARADOR DE AGUA	GPP-1000	702256C1	AIRE (HEAVY DUTY)	GA-3551 XT	P153551
COMBUSTIBLE, PRIMARIO	GP-26	KW207						
COMBUSTIBLE, SECUNDARIO	GP-27	KW206	T800 con motor/CUMMINS ISM			T800B con motor/CUMMINS ISL		
ACEITE, HASTA 1993	GP-53	25010449	AGUA	GP-2071W	WF2071	ACEITE	GP-3001	3401544
ACEITE, DERIVACION (BY PASS)	GP-57	KW777	COMBUSTIBLE, SEPARADOR DE AGUA	GPP-1000	3329289	AGUA	GP-2071W	WF2071
ACEITE, 1993 EN ADELANTE	GP-193	23527033	ACEITE	GP-9001	LF9001	COMBUSTIBLE	GPP-1022S	3800394
AIRE (ESTANDAR)	GA-3551	P153551				AIRE (ESTANDAR)	GA-3551	P153551
AIRE (HEAVY DUTY)	GA-3551 XT	P153551	T800 con motor/CUMMINS ISX			AIRE (HEAVY DUTY)	GA-3551 XT	P153551
			AGUA	GP-2127W	WF2127			
T600B con motor/CATERPILLAR C15			ACEITE	GP-9000	3406810	T800B con motor/CUMMINS ISX		
COMBUSTIBLE	GP-749	1R0749	AGUA	GP-2126Q	WF2126	AGUA	GP-2127W	WF2127
ACEITE, CUMPLE CON MEDIDAS ORIGINALES	GP-691	1R1808	ACEITE	GP-9001	3406809	AGUA	GP-2126Q	WF2126
ACEITE, SEGUNDA OPCION	GP-52	1R1808	COMBUSTIBLE, SEPARADOR DE AGUA	GPP-1007S	FS1040	ACEITE	GP-9001	3406809
COMBUSTIBLE, SEPARADOR DE AGUA	GPP-1000	702256C1				COMBUSTIBLE, SEPARADOR DE AGUA	GPP-1007S	FS1040
AIRE (ESTANDAR)	GA-3551	P153551	T800 con motor/CUMMINS L10					
AIRE (HEAVY DUTY)	GA-3551 XT	P153551	COMBUSTIBLE	GP-1101	K251C390	T800B con motores/CATERPILLAR C13, CATERPILLAR C15		
			ACEITE	GP-53	KW670	COMBUSTIBLE	GP-749	1R0749
T600B con motor/CUMMINS ISX			ACEITE, DERIVACION (BY PASS)	GP-57	KW777	ACEITE, CUMPLE CON MEDIDAS ORIGINALES	GP-691	1R1808
COMBUSTIBLE, SEPARADOR DE AGUA	G-128	380087	COMBUSTIBLE, SEPARADOR DE AGUA	GPP-11	KW1212	ACEITE, SEGUNDA OPCION	GP-52	1R1808
			AGUA	GP-2071W	3315116	AIRE (ESTANDAR)	GA-3551	P153551
T600B con motor/CUMMINS N14			AIRE	GA-378	KW852M	AIRE (HEAVY DUTY)	GA-3551 XT	P153551
AIRE (ESTANDAR)	GA-3551	P153551	AIRE	GA-229	KW853M			
			T800 con motor/CATERPILLAR 3306			T800W con motor/CATERPILLAR C15		
GASOLINA, SEPARADOR DE AGUA	G-293	6N7617	COMBUSTIBLE, SEPARADOR DE AGUA	GPP-11	3600980	DIRECCION	G-159	83804E
ACEITE	GP-51	1R0739	ACEITE	GP-3000	3825970	COMBUSTIBLE, SEPARADOR DE AGUA (CARTUCHO)	G-128	P550463
COMBUSTIBLE	GP-110	1R0740	AGUA	GP-2071W	3315116	ACEITE, OPCIONAL. TRANSMISION	GP-1	17237
			AIRE (ESTANDAR)	GA-3551	P153551	COMBUSTIBLE	GP-749	1R0749
T800 con motor/CATERPILLAR C10			AIRE (HEAVY DUTY)	GA-3551 XT	P153551	ACEITE	GP-52	1R1808
ACEITE, CUMPLE CON MEDIDAS ORIGINALES	GP-691	1R0716				COMBUSTIBLE, SEPARADOR DE AGUA (SELLADO)	GPP-1000	2568753
ACEITE, SEGUNDA OPCION	GP-52	1R0716	T800 con motor/CUMMINS N14			AIRE, RADIAL (REQUIERE 2)	GA-534R	P534925
ACEITE, DERIVACION (BY PASS)	GP-57	9Y4468	COMBUSTIBLE	GPP-14	3315847			
COMBUSTIBLE	GP-110	1P2299	ACEITE	GP-53	3313287	T800W con motor/CUMMINS ISX		
COMBUSTIBLE, SEPARADOR DE AGUA	GPP-1000	702256C1	ACEITE, DERIVACION (BY PASS)	GP-57	3304232	DIRECCION	G-159	83804E
AIRE (ESTANDAR)	GA-3551	P153551	COMBUSTIBLE, SEPARADOR DE AGUA	GPP-11	3600980	ACEITE, OPCIONAL. TRANSMISION	GP-1	17237
AIRE (HEAVY DUTY)	GA-3551 XT	P153551	ACEITE	GP-3000	3825970	AGUA, SISTEMA DE ENFRIAMIENTO	GP-2127W	3680434
						COMBUSTIBLE, SEPARADOR DE AGUA	GP-1101	FF2203
T800 con motor/CATERPILLAR C12			T800 con motor/DETROIT DIESEL SERIES 60			ACEITE, LUBRICACION DE DOBLE FLUJO	GP-9001	LF9001
ACEITE, CUMPLE CON MEDIDAS ORIGINALES	GP-691	1R0716	AGUA	GP-2071W	P554071	AIRE, RADIAL (REQUIERE 2)	GA-534R	P534925
ACEITE, SEGUNDA OPCION	GP-52	1R0716	ACEITE	GP-193	23527033			
ACEITE, DERIVACION (BY PASS)	GP-57	9Y4468	AIRE	GA-378	KW852M	T953 con motor/CATERPILLAR 3176		
COMBUSTIBLE	GP-110	1P2299				ACEITE, CUMPLE CON MEDIDAS ORIGINALES	GP-691	1R0716
AGUA	GP-2071W	WF2071	T800 con motores/CATERPILLAR 3406B, CATERPILLAR 3406E			ACEITE, SEGUNDA OPCION	GP-52	1R0716
COMBUSTIBLE, SEPARADOR DE AGUA	GPP-1000	702256C1	COMBUSTIBLE	GP-749	1R0749	AIRE	GA-378	KW852M
AIRE (ESTANDAR)	GA-3551	P153551	ACEITE, CUMPLE CON MEDIDAS ORIGINALES	GP-691	1R0716			
AIRE (HEAVY DUTY)	GA-3551 XT	P153551	ACEITE, SEGUNDA OPCION	GP-52	1R0716	W900 con motor/CATERPILLAR C15		
			COMBUSTIBLE	GP-110	1R0712	DIRECCION	G-159	83804E
T800 con motor/CATERPILLAR C13			AGUA	GP-2071W	311288	COMBUSTIBLE, SEPARADOR DE AGUA (CARTUCHO)	G-128	P550463
COMBUSTIBLE	GP-749	1R0749	COMBUSTIBLE, SEPARADOR DE AGUA	GPP-1000	702256C1			
ACEITE, CUMPLE CON MEDIDAS ORIGINALES	GP-691	1R1808	AIRE (ESTANDAR)	GA-3551	P153551			

MARCA-MODELO-MOTOR MAKE-MODEL-ENGINE	GONHER GONHER	OEM OEM	MARCA-MODELO-MOTOR MAKE-MODEL-ENGINE	GONHER GONHER	OEM OEM	MARCA-MODELO-MOTOR MAKE-MODEL-ENGINE	GONHER GONHER	OEM OEM
KENWORTH (continuación)			KENWORTH (continuación)			KENWORTH (continuación)		
CAMIONES, TRACTOCAMIONES Y AUTOBUSES			CAMIONES, TRACTOCAMIONES Y AUTOBUSES			CAMIONES, TRACTOCAMIONES Y AUTOBUSES		
ACEITE, OPCIONAL. TRANSMISION	GP-1	17237	W900 con motores/ALLIS CHALMERS 21000, ALLIS CHALMERS 25000			COMBUSTIBLE, SEPARADOR DE AGUA	GPP-11	3600980
COMBUSTIBLE	GP-749	1R0749	ACEITE	G-33	4395889	ACEITE, DOBLE FLUJO	GP-3000	3825970
ACEITE, FLUJO TOTAL (FULL FLOW)	GP-52	1R1808	COMBUSTIBLE, SECUNDARIO	G-1176	4056632	AGUA	GP-2071W	3315116
AGUA, SISTEMA DE ENFRIAMIENTO	GP-2071W	9N3368	AIRE, SIN ASPAS	GA-27	P117331			
COMBUSTIBLE, SEPARADOR DE AGUA (SELLADO)	GPP-1000	2568753	AIRE	GA-378	P116918	W900B con motor/DETROIT DIESEL SERIES 60		
AIRE, ESTANDAR (USO ESTANDAR)	GA-3551	P153551	W900 con motores/CATERPILLAR 1673C, CATERPILLAR 1674			COMBUSTIBLE, PRIMARIO	GP-26	KW207
AIRE, RADIAL (REQUIERE 2)	GA-539R	P534816	ACEITE	G-191	1R0659	COMBUSTIBLE, SECUNDARIO	GP-27	KW206
AIRE, RADIAL	GA-534R	P534925	GASOLINA, SEPARADOR DE AGUA	G-293	6N7617	ACEITE	GP-53	25010449
AIRE, ESTANDAR (USO HEAVY DUTY)	GA-3551 XT	P153551	COMBUSTIBLE	GP-110	1P2299	W900L con motor/CATERPILLAR 3406E		
			AIRE, RESPIRADOR	GA-135	9L2169	COMBUSTIBLE	GP-749	1R0749
			AIRE, SIN ASPAS	GA-27	P117331	ACEITE, CUMPLE CON MEDIDAS ORIGINALES	GP-691	1R0716
			AIRE	GA-229	P117797	ACEITE, SEGUNDA OPCION	GP-52	1R0716
W900 con motor/CUMMINS			AIRE			COMBUSTIBLE, SEPARADOR DE AGUA	GPP-1000	702256C1
ACEITE, CARTUCHO	G-566	257528	W900 con motores/CATERPILLAR 1693T, CATERPILLAR 1693TA					
ACEITE, TURBOCARGADOR	GP-14	4041959	ACEITE, CARTUCHO	G-238	5S0485			
COMBUSTIBLE, 5 47/64 IN	GPP-14	3315847	COMBUSTIBLE, CARTUCHO	G-1166	6H5931	W900L con motor/CATERPILLAR C12		
COMBUSTIBLE, 5 13/32 IN	GP-1101	154711	ACEITE, SELLADO (CUMPLE CON MEDIDAS ORIGINALES)	GP-691	1R0716	ACEITE, OPCIONAL. TRANSMISION	GP-1	17237
ACEITE, SELLADO	GP-53	3313287	ACEITE, SELLADO (SEGUNDA OPCION)	GP-52	1R0716	COMBUSTIBLE, SELLADO	GP-749	1R0749
COMBUSTIBLE, 11 1/2 IN	GP-55	3313306	COMBUSTIBLE, SELLADO	GP-110	1P2299	ACEITE	GP-52	1R0716
ACEITE, SELLADO PARA DERIVACION (BY PASS)	GP-57	3304232	AIRE, RESPIRADOR	GA-135	9L2169	COMBUSTIBLE, OPCIONAL. SEPARADOR DE AGUA	GPP-1000	FS1000
COMBUSTIBLE, SEPARADOR DE AGUA	GPP-11	3600980	AIRE, SIN ASPAS	GA-26	P117332	AIRE, ESTANDAR (USO ESTANDAR)	GA-3551	P153551
AIRE, RESPIRADOR	GA-39	255963	AIRE, SIN ASPAS	GA-27	P117331	AIRE, RADIAL (REQUIERE 2)	GA-534R	P534925
AIRE, SIN ASPAS	GA-26	P117332	AIRE	GA-378	P116918	AIRE, RADIAL	GA-968R	P542101
AIRE, SIN ASPAS	GA-27	P117331	AIRE	GA-229	P117797	AIRE, ESTANDAR (USO HEAVY DUTY)	GA-3551 XT	P153551
AIRE	GA-378	P181008						
AIRE	GA-229	P117797	W900 con motores/GMC 6-71 SERIES, GMC 6V-92 SERIES, GMC 8V-71 SERIES, GMC 8V-92 SERIES, GMC 6V-53 SERIES, GMC 6V-71 SERIES			W900L con motor/CATERPILLAR C13		
ACEITE, CARTUCHO PARA DERIVACION (BY PASS)	G-750	139096	ACEITE, CARTUCHO	G-33	5573013	COMBUSTIBLE, SEPARADOR DE AGUA (CARTUCHO)	G-128	380087
			COMBUSTIBLE, PRIMARIO	GP-26	KW207	ACEITE, OPCIONAL. TRANSMISION	GP-1	17237
W900 con motor/CUMMINS ISX			COMBUSTIBLE, SECUNDARIO	GP-27	KW206	COMBUSTIBLE, 10 1/2 IN.	GP-749	1R0749
DIRECCION	G-159	83804E	ACEITE, SELLADO	GP-53	25010449	ACEITE	GP-52	1R1808
ACEITE, OPCIONAL. TRANSMISION	GP-1	17237	AIRE, SIN ASPAS	GA-26	P117332	COMBUSTIBLE, 7 17/32 IN.	GP-1109	1R0759
AGUA, SISTEMA DE ENFRIAMIENTO (SIN UNIDADES)	GP-2127W	WF2127	AIRE, SIN ASPAS	GA-27	P117331	AGUA, SISTEMA DE ENFRIAMIENTO	GP-2071W	9N3368
COMBUSTIBLE, PRIMARIO	GP-1101	FF2203	AIRE	GA-378	P116918	COMBUSTIBLE, SEPARADOR DE AGUA (SELLADO)	GPP-1000	2568753
AGUA, SISTEMA DE ENFRIAMIENTO (11 1/2 UNIDADES)	GP-2126Q	WF2126	AIRE	GA-229	P117797	AIRE, RADIAL (REQUIERE 2)	GA-534R	P534925
ACEITE, LUBRICACION DE DOBLE FLUJO	GP-9001	3406810	ACEITE, CARTUCHO PARA DERIVACION (BY PASS)	G-750	2495994			
COMBUSTIBLE, SEPARADOR DE AGUA (SELLADO)	GPP-1007S	FS1040				W900L con motor/CATERPILLAR C15		
AIRE, RADIAL (REQUIERE 2)	GA-539R	P534816	W900, W900B con motor/CATERPILLAR 3306			ACEITE, OPCIONAL. TRANSMISION	GP-1	17237
AIRE, RADIAL	GA-534R	P534925	GASOLINA, SEPARADOR DE AGUA	G-293	6N7617	COMBUSTIBLE, SELLADO	GP-749	1R0749
			ACEITE	GP-51	1R0739	ACEITE, LUBRICACION DEL MOTOR	GP-52	1R1808
W900 con motor/CUMMINS N14			COMBUSTIBLE	GP-110	1R0740	COMBUSTIBLE, OPCIONAL. SEPARADOR DE AGUA	GPP-1000	FS1000
AGUA	GP-2071W	3315116	AIRE, SIN ASPAS	GA-27	P181000	AIRE, ESTANDAR (USO ESTANDAR)	GA-3551	P153551
			AIRE	GA-229	P181007	AIRE, RADIAL (REQUIERE 2)	GA-534R	P534925
W900 con motor/DETROIT DIESEL SERIES 60						AIRE, RADIAL	GA-968R	P542101
AGUA	GP-2071W	P554071	W900, W900B con motores/CATERPILLAR 3406, CATERPILLAR 3408			AIRE, ESTANDAR (USO HEAVY DUTY)	GA-3551 XT	P153551
ACEITE	GP-193	23527033	ACEITE, CUMPLE CON MEDIDAS ORIGINALES	GP-691	1R0716			
AIRE	GA-378	KW852M	ACEITE, SEGUNDA OPCION	GP-52	1R0716	W900L con motor/CATERPILLAR C16		
			COMBUSTIBLE, OPCIONAL	GP-110	1P2299	ACEITE, OPCIONAL. TRANSMISION	GP-1	17237
W900 con motor/GMC 12V-71			AGUA	GP-2071W	3I1288	COMBUSTIBLE, SELLADO	GP-749	1R0749
ACEITE, CARTUCHO	G-33	5573013	AIRE, SIN ASPAS	GA-26	P181001	ACEITE, LUBRICACION DEL MOTOR	GP-52	1R1808
COMBUSTIBLE, PRIMARIO	GP-26	KW207	AIRE, SIN ASPAS	GA-27	P181000	COMBUSTIBLE, SEPARADOR DE AGUA	GPP-1000	FS1000
COMBUSTIBLE, SECUNDARIO	GP-27	KW206	AIRE	GA-378	P181008	AIRE, ESTANDAR (USO ESTANDAR)	GA-3551	P153551
AIRE, SIN ASPAS	GA-26	P117797	AIRE	GA-229	P181007			
AIRE, SIN ASPAS	GA-27	P117331	W900B con motor/CUMMINS L10			W900L con motor/CATERPILLAR C16		
ACEITE, CARTUCHO PARA DERIVACION (BY PASS)	G-750	2495994	COMBUSTIBLE	GP-1101	154711	ACEITE, OPCIONAL. TRANSMISION	GP-1	17237
			ACEITE	GP-53	3313287	COMBUSTIBLE, SELLADO	GP-749	1R0749
			ACEITE, DERIVACION (BY PASS)	GP-57	3304232	ACEITE, LUBRICACION DEL MOTOR	GP-52	1R1808
						COMBUSTIBLE, SEPARADOR DE AGUA	GPP-1000	FS1000
						AIRE, ESTANDAR (USO ESTANDAR)	GA-3551	P153551

SERVICIO PESADO

MARCA-MODELO-MOTOR MAKE-MODEL-ENGINE	GONHER GONHER	OEM OEM	MARCA-MODELO-MOTOR MAKE-MODEL-ENGINE	GONHER GONHER	OEM OEM	MARCA-MODELO-MOTOR MAKE-MODEL-ENGINE	GONHER GONHER	OEM OEM
KENWORTH (continuación)			KOHLER (continuación)			KOHLER (continuación)		
CAMIONES, TRACTOCAMIONES Y AUTOBUSES			GENERADORES			GENERADORES		
AIRE, RADIAL (REQUIERE 2)	GA-534R	P534925	12.5RCOP-23, 10AOP63, 10APO63, 12.5ACOP63, 12.5AO63, 12.5AOP63 con motor/A DIESEL			50RZ DE RAPIDA RESPUESTA con motor/A DIESEL		
AIRE, RADIAL	GA-968R	P542101	ACEITE	G-836	7961399	ACEITE	GP-1	918266-R93
AIRE, ESTANDAR (USO HEAVY DUTY)	GA-3551 XT	P153551	125 SERIES con motor/JOHN DEERE 6531A			5MMS65 con motor/A GASOLINA		
W900L con motor/CUMMINS ISX			ACEITE	GP-34	AR43634	AIRE	GA-7	235116
ACEITE, OPCIONAL. TRANS-MISION	GP-1	17237	125ROZJ con motor/A DIESEL			60ROZ con motor/CONSOLIDATED 4B3.9		
AGUA, SISTEMA DE ENFRIAMIENTO (SIN UNIDADES)	GP-2127W	WF2127	ACEITE	GP-14	T-19044	COMBUSTIBLE	GP-1122	3903640
COMBUSTIBLE	GP-1101	FF2203	14.5CCO con motor/YANMAR			60ROZJ DE RAPIDA RESPUESTA con motor/JOHN DEERE 4039T		
AGUA, SISTEMA DE ENFRIAMIENTO (11 1/2 UNIDADES)	GP-2126Q	WF2126	ACEITE	GP-91	129150-35150	ACEITE	GP-14	T-19044
ACEITE, LUBRICACION DE DOBLE FLUJO	GP-9001	3406810	16CCO, 20CCO con motor/YANMAR			60RZ DE RAPIDA RESPUESTA con motor/A DIESEL		
COMBUSTIBLE, SEPARADOR DE AGUA (SELLADO)	GPP-10075	FS1007	ACEITE	GP-40	129150-35150	ACEITE	GP-1	918266-R93
AIRE, RADIAL (REQUIERE 2)	GA-534R	P534925	20RO63 con motor/A DIESEL			7.5ACOP63 con motor/A DIESEL		
W900L con motor/CUMMINS N14			ACEITE	G-834	26450153	ACEITE	G-836	7961399
COMBUSTIBLE	GP-1101	154711	20ROZJ DE RAPIDA RESPUESTA, 30ROZJ DE RAPIDA RESPUESTA, 40ROZJ DE RAPIDA RESPUESTA con motor/A DIESEL			7.5C21 con motor/A DIESEL		
ACEITE	GP-53	3313287	ACEITE	GP-14	T-19044	AIRE	GA-12	231847
ACEITE, DERIVACION (BY PASS)	GP-57	3304232	20RZ DE RAPIDA RESPUESTA con motor/A DIESEL			700, 825, 830, 840 con motor/CUMMINS		
COMBUSTIBLE, SEPARADOR DE AGUA	GPP-11	3600980	ACEITE	GP-1	918266-R93	ACEITE	G-566	158139
ACEITE, DOBLE FLUJO	GP-3000	3825970	250, 350 con motor/CUMMINS			COMBUSTIBLE	GP-1101	138627
W900S con motor/CATERPILLAR 3406C			ACEITE, FLUJO TOTAL (FULL FLOW)	G-566	158139	AIRE	GA-39	255963
ACEITE, CUMPLE CON MEDIDAS ORIGINALES	GP-691	1R0716	COMBUSTIBLE	GP-1101	138627	70RZ DE RAPIDA RESPUESTA, 80RZ DE RAPIDA RESPUESTA con motor/A DIESEL		
ACEITE, SEGUNDA OPCION	GP-52	1R0716	AIRE	GA-39	255963	ACEITE	GP-1	918266-R93
COMBUSTIBLE, OPCIONAL	GP-110	1P2299	ACEITE, DERIVACION (BY PASS)	G-750	213428	80ROZJ DE RAPIDA RESPUESTA con motor/A DIESEL		
W900S con motor/CUMMINS M11			30AO27 con motor/A GASOLINA			ACEITE	GP-14	T-19044
COMBUSTIBLE, SEPARADOR DE AGUA	GPP-11	3600980	GASOLINA	GG-48	201-13117	8CCO con motor/YANMAR		
W921, W922, W923, W924, W925 con motor/CUMMINS			30ROZ con motor/CONSOLIDATED 4B3.9			ACEITE	GP-24	124450-35110
ACEITE, CARTUCHO	G-566	257528	COMBUSTIBLE	GP-1122	3903640	9CCO con motor/YANMAR		
ACEITE, TURBOCARGADOR	GP-14	4041959	32KWROZ con motor/CUMMINS 4B3.9			ACEITE	GP-91	129150-35150
COMBUSTIBLE, 5 47/64 IN	GPP-14	3315847	COMBUSTIBLE, SECUNDARIO	GP-1122	3903640	ROZJ con motor/JOHN DEERE		
COMBUSTIBLE, 5 13/32 IN	GP-1101	154711	COMBUSTIBLE, SEPARADOR DE AGUA	GPP-1122	3903202	ACEITE	GP-14	T-19044
ACEITE, SELLADO	GP-53	3313287	COMBUSTIBLE, PRIMARIO	GPP-18	3903410	18 HP MAGNUM, AEGIS LH560 17 HP V-TWIN, AEGIS LH625 20 HP V-TWIN, AEGIS LH675 23 HP V-TWIN, CH11COMMAND PRO, CH12.5, CH13 COMMAND PRO, CH14, CH15 COMMAND PRO, CH25 COMMAND PRO, CV11, CV12.5, CV13, CV14, CV15, CV16		
COMBUSTIBLE, 11 1/2 IN	GP-55	3313306	ACEITE	GP-390	3903224	ACEITE	GP-58	5205002
COMBUSTIBLE, SEPARADOR DE AGUA	GPP-11	3600980	33RZ DE RAPIDA RESPUESTA con motor/A DIESEL			8 HP, K241, K241A, K241P, K241S, K301, K301A, K301AS, K301S, K321, K321A, K321S, K331, K341, K341L, K341S, M8S MAGNUM		
AIRE, RESPIRADOR	GA-39	255963	ACEITE	GP-1	918266-R93	AIRE	GA-7	235116
ACEITE, DERIVACION (BY PASS)	G-750	139096	3A023 con motor/A GASOLINA			CH18S COMMAND, CH20S COMMAND, CV12.5T COMMAND, CV14S COMMAND, CV14T COMMAND, CV18S COMMAND, CV20S COMMAND, CV25 COMMAND		
			GASOLINA	GG-48	201-13117	GASOLINA	GG-116	G4164
			40ROZ con motor/CONSOLIDATED 4B3.9			K101, K121, K91, K91RT, K91T		
			COMBUSTIBLE	GP-1122	3903640	AIRE	GA-11	230840
			45RZ DE RAPIDA RESPUESTA con motor/A DIESEL			K141, K141T, K161, K161T, K181, K181S, K181T		
			ACEITE	GP-1	918266-R93	AIRE	GA-7	235116
			4CCO con motor/YANMAR			AIRE	GA-11	230840
			ACEITE	GP-40	124450-35100			
			50ROZ con motor/CONSOLIDATED 4B3.9					
			COMBUSTIBLE	GP-1122	3903640			
			50ROZJ DE RAPIDA RESPUESTA con motor/A DIESEL					
			ACEITE	GP-14	T-19044			

KOHLER

COMPRESORES

5MMS65 7.5C21 con motor/COMPRESORES GUILLERMO MURGIA		
ACEITE	G-834	26450153

KOHLER

GENERADORES

100ROZJ DE RAPIDA RESPUESTA con motor/A DIESEL		
ACEITE	GP-14	T-19044
100RZ DE RAPIDA RESPUESTA con motor/A DIESEL		
ACEITE	GP-1	918266-R93
12.5CCO con motor/YANMAR		
ACEITE	GP-40	129150-35150

MARCA-MODELO-MOTOR MAKE-MODEL-ENGINE	GONHER GONHER	OEM OEM
KOHLER (continuación)		
MOTORES		
AIRE	GA-12	231847
K482, K482S, K582, K660, K662		
ACEITE	GP-3600	277233
K550		
AIRE	GA-105	272042
TH520 TRIAD OHC 16 HP, TH575 TRIAD OHC 18 HP, TH650 TRIAD OHC 20 HP, TH720 TRIAD OHC 23 HP		
ACEITE	GP-58	5205002

KOMATSU		
CAMIONES, TRACTOCAMIONES Y AUTOBUSES		
330 DE VOLTEO, 385 DE VOLTEO, 445E DE VOLTEO con motor/CUMMINS KTA38		
ACEITE, FLUJO TOTAL (FULL FLOW)	GP-53	600-211-1231
COMBUSTIBLE	GP-55	600-311-7132
ACEITE, DERIVACION (BY PASS) SELLADO	GP-57	600-212-1511
ACEITE, DERIVACION (BY PASS) CARTUCHO	G-750	6610-51-5300
330E DE VOLTEO con motor/KOMATSU SA12V140		
ACEITE, FLUJO TOTAL (FULL FLOW)	GP-53	600-211-1231
COMBUSTIBLE	GP-55	600-311-7132
ACEITE, DERIVACION (BY PASS) SELLADO	GP-57	600-212-1511
ACEITE, DERIVACION (BY PASS) CARTUCHO	G-750	6610-51-5300
330M DE VOLTEO con motor/KOMATSU 12V140Z		
ACEITE	GP-53	600-211-1230
445E DE VOLTEO con motor/DETROIT DIESEL 12V149 SERIES		
ACEITE	GP-43	1240892-H1
510 DE VOLTEO con motor/CUMMINS KTA38		
ACEITE, FLUJO TOTAL (FULL FLOW)	GP-53	600-211-1231
COMBUSTIBLE	GP-55	600-311-7132
ACEITE, DERIVACION (BY PASS)	GP-57	600-212-1511
530E DE VOLTEO, 530M DE VOLTEO con motor/CUMMINS KTA50		
ACEITE, FLUJO TOTAL (FULL FLOW) (REQUIERE 5)	GP-53	3307885
COMBUSTIBLE (REQUIERE 2)	GP-55	3313306
ACEITE, DERIVACION (BY PASS) SELLADO (REQUIERE 2)	GP-57	3313283
ACEITE, DERIVACION (BY PASS) CARTUCHO (REQUIERE 2)	G-750	256345
630E DE VOLTEO con motor/DETROIT DIESEL 16V-149		
ACEITE	GP-43	1240892-H1
685E DE VOLTEO, 780E DE VOLTEO con motor/DETROIT DIESEL 16V-149		
ACEITE	GP-43	600-211-1231
830 DE VOLTEO con motor/DETROIT DIESEL 16V4000		
COMBUSTIBLE	GP-85	25010969
830 DE VOLTEO con motor/DETROIT DIESEL 20V-149		
ACEITE	GP-43	600-211-1231

MARCA-MODELO-MOTOR MAKE-MODEL-ENGINE	GONHER GONHER	OEM OEM
KOMATSU (continuación)		
CAMIONES, TRACTOCAMIONES Y AUTOBUSES		
830E DE VOLTEO, 930E DE VOLTEO con motor/DETROIT DIESEL 16V4000		
COMBUSTIBLE	GP-85	25010969
CD60R DE VOLTEO con motor/KOMATSU S6D102E		
ACEITE	GP-178	6735-51-5140
HA250 DE VOLTEO, HA270 DE VOLTEO con motor/KOMATSU S6D125		
COMBUSTIBLE	GPP-14	600-311-8291
ACEITE	GP-53	600-211-1230
AGUA	GP-1011Q	600-411-1150
HA250-1 DE VOLTEO, HA250-2 DE VOLTEO, HA250-2A DE VOLTEO, HA270-1 DE VOLTEO, HA270-2 DE VOLTEO con motor/KOMATSU S6D125-1		
COMBUSTIBLE	GP-11	600-311-8291
ACEITE	GP-53	600-211-1230
AGUA	GP-1011Q	600-411-1150
AIRE, PRIMARIO	GA-326	600-181-4300
AIRE, SECUNDARIO	GA-206	600-181-4211
HA-2702A DE VOLTEO con motor/KOMATSU S6D125-1		
AGUA	GP-1011Q	600-411-1150
HA270-2A DE VOLTEO con motor/KOMATSU S6D125-1		
COMBUSTIBLE	GP-11	600-311-8291
ACEITE	GP-53	600-211-1230
AIRE, PRIMARIO	GA-326	600-181-4300
AIRE, SECUNDARIO	GA-206	600-181-4211
HA325-2 DE VOLTEO con motor/CUMMINS KT1150		
COMBUSTIBLE	GP-11	600-311-8291
AGUA	GP-1010Q	WF2051
ACEITE	GP-53	600-211-1230
AIRE	GA-326	600-181-4311
AIRE	GA-206	600-181-4212
ACEITE	G-750	6610-51-5050
HD1200M-1 DE VOLTEO con motor/CUMMINS KTA2300		
ACEITE, FLUJO TOTAL (FULL FLOW)	GP-53	600-211-1231
COMBUSTIBLE	GP-55	600-311-7132
ACEITE, DERIVACION (BY PASS)	GP-57	3304232
AGUA	GP-2071W	581-02-12130
HD1200M-1 DE VOLTEO con motor/KOMATSU SA12V170-1		
ACEITE	GP-53	600-211-1231
AGUA	GP-1013Q	600-411-1171
COMBUSTIBLE	GP-55	600-311-7111
HD1600M-1 DE VOLTEO con motor/CUMMINS KTA3067		
ACEITE, FLUJO TOTAL (FULL FLOW) SELLADO (REQUIERE 5)	GP-53	3307885
COMBUSTIBLE (REQUIERE 2)	GP-55	3313306
ACEITE, DERIVACION (BY PASS) SELLADO (REQUIERE 2)	GP-57	3304232
AGUA, SISTEMA DE ENFRIAMIENTO (REQUIERE 2)	GP-2071W	3305367
HD180-2 DE VOLTEO con motor/CUMMINS NTO6		
ACEITE, DERIVACION (BY PASS)	G-750	6610-51-5050
HD180-4 DE VOLTEO con motor/CUMMINS NTO6		
COMBUSTIBLE, SELLADO	GPP-14	600-311-8293
ACEITE, FLUJO TOTAL (FULL FLOW) SELLADO	GP-53	600-211-1231
AGUA	GP-1011Q	6710-61-8112
AIRE, PRIMARIO	GA-106	6125-81-7032

MARCA-MODELO-MOTOR MAKE-MODEL-ENGINE	GONHER GONHER	OEM OEM
KOMATSU (continuación)		
CAMIONES, TRACTOCAMIONES Y AUTOBUSES		
AIRE, SECUNDARIO		
ACEITE, DERIVACION (BY PASS)	GA-206	6125-81-7032
	G-750	6610-51-5050
HD200-2 DE VOLTEO con motor/CUMMINS NTC743		
COMBUSTIBLE, SELLADO	GPP-14	600-311-8293
ACEITE, FLUJO TOTAL (FULL FLOW) SELLADO	GP-53	600-211-1231
AGUA	GP-1011Q	600-411-1151
AIRE, PRIMARIO	GA-106	6125-81-7032
AIRE, SECUNDARIO	GA-206	6125-81-7032
ACEITE, DERIVACION (BY PASS)	G-750	6610-51-5050
HD200-2 DE VOLTEO con motor/KOMATSU NTO6B		
AGUA	GP-1011Q	600-411-1151
HD200D-3 DE VOLTEO, HD205-3 DE VOLTEO con motor/KOMATSU S6D125-1		
COMBUSTIBLE	GPP-14	600-311-8293
ACEITE	GP-53	600-211-1231
AGUA	GP-1011Q	600-411-1151
AIRE, PRIMARIO	GA-326	6125-81-7032
AIRE, SECUNDARIO	GA-206	6125-81-7032
HD255-5 DE VOLTEO con motor/KOMATSU SA6D125E		
COMBUSTIBLE	GPP-14	600-311-8292
ACEITE	GP-53	600-211-1231
AGUA	GP-1011Q	600-411-1151
HD320-2 DE VOLTEO con motor/CUMMINS NTA855		
COMBUSTIBLE, SELLADO	GPP-14	600-311-8291
AGUA	GP-1010Q	6710-61-8112
ACEITE, FLUJO TOTAL (FULL FLOW) SELLADO	GP-53	600-211-1231
AIRE, PRIMARIO	GA-106	6125-81-7032
AIRE, SECUNDARIO	GA-206	6125-81-7032
ACEITE, DERIVACION (BY PASS)	G-750	6610-51-5300
HD320-3 DE VOLTEO con motor/CUMMINS NTA855		
COMBUSTIBLE	GPP-14	600-311-8293
ACEITE, FLUJO TOTAL (FULL FLOW)	GP-53	600-211-1231
AGUA, S/N 180720 EN ADELANTE	GP-1013Q	600-411-1171
AGUA, S/N 169352-180719	GP-1011Q	600-411-1151
AIRE, PRIMARIO	GA-106	6125-81-7032
AIRE, SECUNDARIO	GA-206	6125-81-7032
ACEITE, DERIVACION (BY PASS)	G-750	6610-51-5050
HD325-2 DE VOLTEO con motor/CUMMINS KT1150		
COMBUSTIBLE	GPP-14	600-311-8291
ACEITE	GP-53	600-211-1230
AGUA	GP-2071W	600-411-1170
AIRE, PRIMARIO	GA-106	600-181-4311
AIRE, SECUNDARIO	GA-206	600-181-4212
ACEITE, DERIVACION (BY PASS)	G-750	6610-51-5050
HD325-3 DE VOLTEO con motor/CUMMINS KT1150		
COMBUSTIBLE	GPP-14	600-311-8293
ACEITE	GP-53	299670
AGUA	GP-2071W	6710-61-8112
AIRE, PRIMARIO	GA-106	6125-81-7032
AIRE, SECUNDARIO	GA-206	6125-81-7032
ACEITE, DERIVACION (BY PASS)	G-750	6610-51-5050
HD325-5 DE VOLTEO con motor/KOMATSU SA6D140-1		
ACEITE	GP-53	600-211-1231
AGUA	GP-1013Q	600-411-1171

SERVICIO PESADO

MARCA-MODELO-MOTOR MAKE-MODEL-ENGINE	GONHER GONHER	OEM OEM	MARCA-MODELO-MOTOR MAKE-MODEL-ENGINE	GONHER GONHER	OEM OEM	MARCA-MODELO-MOTOR MAKE-MODEL-ENGINE	GONHER GONHER	OEM OEM
KOMATSU (continuación)			KOMATSU (continuación)			KOMATSU		
CAMIONES, TRACTOCAMIONES Y AUTOBUSES			CAMIONES, TRACTOCAMIONES Y AUTOBUSES			CARGADORAS		
COMBUSTIBLE	GP-55	600-311-7132	HD605-5 DE VOLTEO con motores/KOMATSU SA6D170E, KOMATSU SAA6D170E			505, 507 con motor/KOMATSU 4D94-1		
AIRE, PRIMARIO	GA-326	6125-81-7032	COMBUSTIBLE	GPP-14	600-311-8293	ACEITE	GP-54	600-211-5240
AIRE, SECUNDARIO	GA-206	6125-81-7032	ACEITE, FLUJO TOTAL (FULL FLOW)	GP-53	600-211-1231	510 con motor/KOMATSU 4D105		
HD325-6 DE VOLTEO con motor/KOMATSU SA6D140			AGUA	GP-1013Q	600-411-1171	ACEITE	GP-54	600-211-5240
ACEITE	GP-53	600-211-1231	ACEITE, DERIVACION (BY PASS)	GP-57	600-212-1511	520B PALA con motor/KOMATSU 6D105		
AGUA	GP-1013Q	600-411-1171	HD605-7 DE VOLTEO con motor/KOMATSU SAA6D170E			AGUA	GP-1012Q	600-411-1420
COMBUSTIBLE	GP-55	600-311-7132	COMBUSTIBLE	GPP-14	600-311-8293	530 PALA, 530B PALA con motor/KOMATSU 6D105-1		
AIRE, PRIMARIO	GA-326	6125-81-7032	ACEITE, FLUJO TOTAL (FULL FLOW)	GP-53	600-211-1231	AGUA	GP-1011Q	600-411-1020
AIRE, SECUNDARIO	GA-206	6125-81-7032	AGUA	GP-1013Q	600-411-1171	AIRE, PRIMARIO	GA-329	381-627934-1
HD325-6 DE VOLTEO con motor/KOMATSU SAA6D140E			ACEITE, DERIVACION (BY PASS)	GP-57	600-212-1511	AIRE, SECUNDARIO	GA-239	381-627935-1
AGUA	GP-1013Q	600-411-1171	HD680-2 DE VOLTEO con motor/CUMMINS VTA1710			JH65CV con motor/CUMMINS V504		
HD405 DE VOLTEO con motor/A DIESEL			ACEITE, CARTUCHO	G-566	6710-50-5101	ACEITE, FLUJO TOTAL (FULL FLOW) CARTUCHO	G-613	173174
AGUA	GP-1013Q	600-411-1171	ACEITE, SELLADO	GP-53	600-211-1231	COMBUSTIBLE	GPP-14	600-311-8293
HD405-6 DE VOLTEO con motor/KOMATSU SAA6D140E			COMBUSTIBLE, SELLADO	GP-55	600-311-7132	ACEITE, FLUJO TOTAL (FULL FLOW) SELLADO	GP-53	600-211-1231
ACEITE	GP-53	600-211-1231	AIRE, SECUNDARIO	GA-6127	6127-81-7411	AGUA	GP-1011Q	6710-61-8131
AGUA	GP-1013Q	600-411-1171	AIRE, PRIMARIO	GA-6128	6128-81-7320	ACEITE, DERIVACION (BY PASS)	G-750	6610-51-5300
COMBUSTIBLE	GP-55	600-311-7132	AIRE, PRIMARIO	GA-326	600-181-4311	JH80B, JH80C con motor/A DIESEL		
HD455-1 DE VOLTEO con motor/CUMMINS VTA1710			AIRE, SECUNDARIO	GA-206	600-181-4211	ACEITE, DERIVACION (BY PASS)	G-750	6610-51-5300
ACEITE, CARTUCHO	G-566	6710-50-5101	HD780-1 DE VOLTEO con motor/CUMMINS VTA1710			JH90EV con motor/CUMMINS V903		
ACEITE, SELLADO	GP-53	600-211-1231	ACEITE, FLUJO TOTAL (FULL FLOW)	GP-53	600-211-1231	ACEITE, FLUJO TOTAL (FULL FLOW)	G-566	6710-50-5101
COMBUSTIBLE	GP-55	600-311-7132	COMBUSTIBLE	GP-55	600-311-7132	COMBUSTIBLE	G-1143	6610-70-8063
AIRE, SECUNDARIO	GA-6127	6127-81-7411	AGUA	GP-2071W	3305371	AGUA	GP-1013Q	600-411-1170
AIRE, PRIMARIO	GA-6128	6128-81-7320	ACEITE, DERIVACION (BY PASS)	G-750	6610-51-5050	ACEITE, DERIVACION (BY PASS)	G-750	6610-51-5300
AIRE, PRIMARIO	GA-326	600-181-4311	HD785-1 DE VOLTEO con motores/CUMMINS KT2300, CUMMINS KTA2300			W120-2, W120-3 con motor/KOMATSU SA6D110-1		
AIRE, SECUNDARIO	GA-206	600-181-4211	ACEITE, FLUJO TOTAL (FULL FLOW)	GP-53	600-211-1231	COMBUSTIBLE	GPP-14	600-311-9120
HD460-1 DE VOLTEO con motor/CUMMINS VT1710			ACEITE, DERIVACION (BY PASS) SELLADO	GP-54	33044232	W170 con motor/CUMMINS V903		
AGUA	GP-1010Q	6710-61-8112	COMBUSTIBLE	GP-55	600-311-7132	ACEITE, FLUJO TOTAL (FULL FLOW)	G-566	6710-50-5101
ACEITE, FLUJO TOTAL (FULL FLOW)	GP-53	600-211-1231	AGUA	GP-2071W	1261387-H1	COMBUSTIBLE	G-1143	6610-70-8063
COMBUSTIBLE	GP-55	600-311-7132	ACEITE, DERIVACION (BY PASS) CARTUCHO	G-750	6610-51-5300	ACEITE, DERIVACION (BY PASS)	G-750	6610-51-5300
AIRE, PRIMARIO	GA-106	6127-81-7311	HD785-2 DE VOLTEO con motor/KOMATSU SA8V1710			W170-1 PALA con motor/CUMMINS V-903		
AIRE, SECUNDARIO	GA-206	6128-81-7042	ACEITE	GP-53	600-211-1231	ACEITE	G-566	6610-51-5050
ACEITE, DERIVACION (BY PASS)	G-750	6610-51-5300	AGUA	GP-1013Q	600-411-1160	COMBUSTIBLE	G-1143	6610-51-5050
HD465 DE VOLTEO con motor/KOMATSU SAA6D170E			COMBUSTIBLE	GP-55	600-311-7111	AGUA	GP-1013Q	6610-51-5050
ACEITE, FLUJO TOTAL (FULL FLOW)	GP-53	600-211-1231	HD785-3 DE VOLTEO, HD785-5 DE VOLTEO con motor/KOMATSU SA12V140			ACEITE, DERIVACION (BY PASS)	G-750	6610-51-5050
ACEITE, DERIVACION (BY PASS)	GP-57	600-212-1511	ACEITE, FLUJO TOTAL (FULL FLOW)	GP-53	600-211-1231	W170-2 PALA con motor/CUMMINS NT855		
COMBUSTIBLE	GPP-11	600-311-9121	AGUA	GP-1013Q	600-411-1171	COMBUSTIBLE	GPP-14	6610-51-5050
HD465-2 DE VOLTEO con motor/CUMMINS VTA1710			COMBUSTIBLE	GP-55	600-311-7111	ACEITE, FLUJO TOTAL (FULL FLOW)	GP-53	6610-51-5050
ACEITE, FLUJO TOTAL (FULL FLOW)	GP-53	600-211-1231	ACEITE, DERIVACION (BY PASS)	GP-57	600-212-1511	AGUA	GP-1012Q	6610-51-5050
COMBUSTIBLE	GP-55	600-311-7132	HD985-3 DE VOLTEO con motor/KOMATSU SA12V140-1			AIRE, SECUNDARIO	GA-6127	6610-51-5050
AGUA	GP-1011Q	3300858	ACEITE, FLUJO TOTAL (FULL FLOW)	GP-53	600-211-1230	AIRE, PRIMARIO	GA-6128	6610-51-5050
ACEITE, DERIVACION (BY PASS)	G-750	6610-51-5050	AGUA	GP-1013Q	600-411-1170	ACEITE, DERIVACION (BY PASS)	G-750	6610-51-5050
HD465-3 DE VOLTEO con motor/KOMATSU SA6D170A			COMBUSTIBLE	GP-55	600-311-7110	W180-1 con motor/CUMMINS NT855		
COMBUSTIBLE	GPP-14	600-311-8293	ACEITE, DERIVACION (BY PASS)	GP-57	600-212-1510	AGUA	GP-1010Q	6610-51-5050
ACEITE	GP-53	600-211-1231	HM350-1 DE VOLTEO con motor/KOMATSU SAA6D140E			ACEITE, FLUJO TOTAL (FULL FLOW)	GP-53	6610-51-5050
AGUA	GP-1013Q	600-411-1171	AGUA	GP-1013Q	600-411-1160	COMBUSTIBLE	GPP-11	6610-51-5050
HD465-5 DE VOLTEO con motor/KOMATSU SA6D170-1			COMBUSTIBLE	GP-55	600-311-7111	AIRE, SECUNDARIO	GA-6127	6610-51-5050
COMBUSTIBLE	GPP-14	600-311-8293	ACEITE, DERIVACION (BY PASS)	GP-57	600-212-1511	AIRE, PRIMARIO	GA-6128	6610-51-5050
ACEITE	GP-53	600-211-1231	HD465-7 E VOLTEO con motor/A DIESEL			ACEITE, DERIVACION (BY PASS)	G-750	6610-51-5050
AGUA	GP-1013Q	600-411-1171	ACEITE	GP-53	600-211-1231			

MARCA-MODELO-MOTOR MAKE-MODEL-ENGINE	GONHER GONHER	OEM OEM	MARCA-MODELO-MOTOR MAKE-MODEL-ENGINE	GONHER GONHER	OEM OEM	MARCA-MODELO-MOTOR MAKE-MODEL-ENGINE	GONHER GONHER	OEM OEM
KOMATSU (continuación)			KOMATSU (continuación)			KOMATSU (continuación)		
CARGADORAS			CARGADORAS			CARGADORAS		
W20-1, W30-1 con motor/KOMATSU 4D94			WA180-1 con motor/KOMATSU S6D95L			WA30-2 con motor/KOMATSU 3D84-1		
ACEITE	GP-54	6610-51-5050	ACEITE	GP-36	600-211-6242	ACEITE	GP-24	124550-35110
W260-1 con motor/CUMMINS KT1150			WA180-1, WA250-1 con motor/KOMATSU 610T			WA320 con motor/CUMMINS 6BT5.9		
COMBUSTIBLE	GP-1101	6610-51-5050	COMBUSTIBLE, SECUNDARIO	GP-1122	161624	ACEITE	GP-178	6735-51-5140
ACEITE, FLUJO TOTAL (FULL FLOW)	GP-53	6610-51-5050	COMBUSTIBLE, PRIMARIO	GPP-18	161623	WA320-1 con motor/CUMMINS 6CT8.3		
ACEITE, DERIVACION (BY PASS)	G-750	6610-51-5050	ACEITE	GP-178	1240388H1	COMBUSTIBLE, SECUNDARIO	GP-1122	161624
W40-1 PALA, W40-2 PALA con motor/KOMATSU 4D105-5			AIRE, SECUNDARIO	GA-398	1249058H1	ACEITE	GP-3000	1295155-H1
AGUA	GP-1011Q	6610-51-5050	WA180-3 con motor/KOMATSU S6D95L			AGUA	GP-2071W	1240893-H1
W60-1 PALA, W60-2 PALA, W70-1 PALA, W70-2 PALA, W70-3 PALA con motor/KOMATSU 6D105-1			ACEITE	GP-54	600-211-5242	COMBUSTIBLE, PRIMARIO	GPP-18	161623
COMBUSTIBLE	GPP-14	6610-51-5050	WA180-3, WA180-3D con motor/KOMATSU S6D102E			AIRE, SECUNDARIO	GA-398	419-02-11230
W90-1 PALA con motor/CUMMINS V504			COMBUSTIBLE	GP-1122	6732-71-6111	WA320-1 con motor/KOMATSU 614T		
AGUA	GP-1010Q	WF2051	AGUA	GP-1011Q	600-411-1151	COMBUSTIBLE, SECUNDARIO	GP-1122	161624
COMBUSTIBLE	GP-1101	FF105	ACEITE	GP-178	6735-51-5141	COMBUSTIBLE, PRIMARIO	GPP-18	161623
ACEITE, FLUJO TOTAL (FULL FLOW)	GP-53	LF670SC	WA180PT-3 con motor/KOMATSU S6D102E			AIRE, SECUNDARIO	GA-398	1249058H1
ACEITE, DERIVACION (BY PASS)	G-750	6610-51-5050	COMBUSTIBLE	GP-1122	6732-71-6111	WA320-1 con motor/KOMATSU S6D105		
W90-1 PALA con motor/ISUZU DA640			WA200-1 con motor/KOMATSU 6D105-1			AGUA	GP-2071W	600-411-1191
COMBUSTIBLE, SIN CUBIERTA	G-1123	6110-70-6202	AGUA, S/N 62390-70634	GP-1013Q	600-411-1170	WA320-3 con motor/KOMATSU S6D108-1		
W90-2 PALA, W90-3 PALA con motor/KOMATSU S6D105-1			AGUA	GP-1011Q	600-411-1010	COMBUSTIBLE	GPP-14	600-311-8293
COMBUSTIBLE	GPP-14	600-311-9120	AGUA, S/N 70635 EN ADELANTE	GP-2071W	600-411-1191	WA320-3 con motor/KOMATSU S6D114E		
WA100-1 con motor/KOMATSU 6D95L			WA200-5, WA200L-5 con motor/KOMATSU SAA6D102E-2			COMBUSTIBLE, SECUNDARIO	GP-1122	161624
ACEITE	GP-36	600-211-6242	COMBUSTIBLE	GP-1122	6732-71-6112	ACEITE	GP-3000	1295155-H1
WA100-12 con motores/CUMMINS 4BT3.9, KOMATSU S4D102			AGUA, SISTEMA DE ENFRIAMIENTO	GP-2071W	600-411-1191	AGUA	GP-2071W	1240893-H1
ACEITE	GP-390	6732-51-5140	AIRE, PRIMARIO	GA-697R	600-185-3100	COMBUSTIBLE, PRIMARIO	GPP-18	161623
WA120 con motor/KOMATSU 6D95L			WA20-1 con motor/KOMATSU 3D78-1			AIRE, SECUNDARIO	GA-398	419-02-11230
ACEITE	GP-36	600-211-6241	ACEITE	GP-40	129-150-35150	WA320-3 con motor/KOMATSU SA6D102E-1		
WA120-1 con motor/CUMMINS			WA250 con motor/CUMMINS 5.9L			ACEITE	GP-178	6735-51-5141
COMBUSTIBLE, SECUNDARIO	GP-1122	161624	COMBUSTIBLE, SECUNDARIO	GP-1122	6732-71-6110	WA350-1 con motor/KOMATSU S6D110		
WA120-1 con motor/KOMATSU 410T			COMBUSTIBLE, PRIMARIO	GPP-18	6732-71-6120	COMBUSTIBLE	GPP-11	600-311-9120
COMBUSTIBLE	GP-1122	161624	ACEITE	GP-178	6735-51-5140	WA380-1 con motor/CUMMINS 8.3L		
COMBUSTIBLE	GPP-18	161623	WA250-1 con motor/KOMATSU S6D105			COMBUSTIBLE, SECUNDARIO	GP-1122	6732-71-6110
ACEITE	GP-390	161625	AGUA	GP-2071W	600-411-1191	ACEITE, FLUJO TOTAL (FULL FLOW)	GP-43	1240892-H1
WA120-3 con motor/KOMATSU 6D95L			WA250-3 con motor/KOMATSU S6D95L			ACEITE, DOBLE FLUJO	GP-3000	1295224-H1
ACEITE	GP-54	600-211-5242	ACEITE	GP-54	600-211-5242	COMBUSTIBLE, PRIMARIO	GPP-18	6732-71-6120
WA120-3 PALA con motor/KOMATSU SA6D110-1			WA250-3, WA250PT-3, WA270-3 con motor/KOMATSU S6D102E			WA380-1 con motor/KOMATSU 614T		
COMBUSTIBLE	GPP-11	600-311-8291	ACEITE	GP-178	6735-51-5140	ACEITE	GP-3001	1295155H1
WA120-CS3 con motor/KOMATSU 6D95L			WA260-1 con motor/CUMMINS KT1150			COMBUSTIBLE, SECUNDARIO	GP-1122	161624
ACEITE	GP-54	600-211-5242	COMBUSTIBLE	GPP-14	FF105D	ACEITE	GP-3000	1295155H1
WA150-1 con motor/KOMATSU S6D95L			AGUA	GP-1010Q	WF2072	COMBUSTIBLE, PRIMARIO	GPP-18	161623
ACEITE	GP-36	600-211-6242	ACEITE, FLUJO TOTAL (FULL FLOW)	GP-53	LF670	WA380-1 con motor/KOMATSU SA6D110		
WA180-1 con motor/CUMMINS			ACEITE, DERIVACION (BY PASS)	G-750	6610-51-5050	COMBUSTIBLE	GPP-11	600-311-9121
COMBUSTIBLE, SECUNDARIO	GP-1122	161624	WA300-1 con motor/KOMATSU S6D105			AGUA	GP-2071W	600-411-1191
			AGUA	GP-2071W	600-411-1191	AIRE, PRIMARIO	GA-326	6125-81-7032
			WA300-3 con motor/KOMATSU SA6D102E			AIRE, SECUNDARIO	GA-206	6125-81-7032
			ACEITE	GP-178	6735-51-5140	AIRE, SECUNDARIO	GA-398	600-181-8370
			WA30-1 con motor/KOMATSU 2D94-2			WA380-3 con motor/KOMATSU S6D108-1		
			ACEITE	GP-54	600-211-5240	COMBUSTIBLE	GPP-14	600-311-8293
						AGUA	GP-2071W	600-411-1191
						AIRE, SECUNDARIO	GA-398	600-181-8370
						WA380-3 con motor/KOMATSU S6D114E		
						COMBUSTIBLE, SECUNDARIO	GP-1122	6732-71-6110
						ACEITE, DOBLE FLUJO	GP-3000	1295155-H1

SERVICIO PESADO

MARCA-MODELO-MOTOR MAKE-MODEL-ENGINE	GONHER GONHER	OEM OEM	MARCA-MODELO-MOTOR MAKE-MODEL-ENGINE	GONHER GONHER	OEM OEM	MARCA-MODELO-MOTOR MAKE-MODEL-ENGINE	GONHER GONHER	OEM OEM
KOMATSU (continuación)			KOMATSU (continuación)			KOMATSU (continuación)		
CARGADORAS			CARGADORAS			CARGADORAS		
COMBUSTIBLE, PRIMARIO	GPP-18	6732-71-6120	WA450-1 con motor/KOMATSU SA6D110			WA600-1 con motor/CUMMINS		
WA380-3 con motor/PERKINS 1006.6TW			COMBUSTIBLE	GPP-14	600-311-8293	ACEITE, FLUJO TOTAL (FULL FLOW)	GP-53	1239943-H1
ACEITE	GP-1	15208-W1120	AIRE	GA-106	6125-81-7032	ACEITE, DERIVACION (BY PASS)	GP-57	1239944-H1
WA380H con motor/A DIESEL			AIRE	GA-206	6125-81-7032	AGUA	GP-1012Q	1295263-H1
COMBUSTIBLE, SECUNDARIO	GP-1122	6732-71-6110	WA450-2 con motor/CUMMINS			AIRE, SECUNDARIO	GA-6127	6128-81-7042
ACEITE, DOBLE FLUJO	GP-3000	1295155-H1	ACEITE	GP-3001	1295224-H1	AIRE, PRIMARIO	GA-6128	600-181-4400
COMBUSTIBLE, PRIMARIO	GPP-18	6732-71-6120	AGUA	GP-1013Q	1246557-H1	WA600-1 con motor/CUMMINS QSK19		
WA400 con motor/KOMATSU SA6D108			COMBUSTIBLE, SEPARADOR DE AGUA	GPP-11	1214920H1	ACEITE	GP-3000	1295224-H1
COMBUSTIBLE	GPP-11	600-311-9121	ACEITE	GP-3000	1295224-H1	AIRE, SECUNDARIO	GA-356	942626-C1
WA400-1 con motor/KOMATSU SA6D110			WA450-3 con motor/CUMMINS MTA11			AIRE, PRIMARIO	GA-357	942625C-1
COMBUSTIBLE	GPP-14	600-311-8293	AGUA	GP-1013Q	1246557-H1	WA600-1 con motor/KOMATSU S6D170-1		
AGUA	GP-2071W	600-411-1191	WA450-3LL, WA470-3 con motor/KOMATSU S6D125-1			COMBUSTIBLE	GPP-14	600-311-8293
AIRE, PRIMARIO	GA-326	6125-81-7032	COMBUSTIBLE	GPP-14	600-311-8293	ACEITE	GP-53	600-211-1231
AIRE, SECUNDARIO	GA-206	6125-81-7032	ACEITE	GP-53	600-211-1231	AGUA	GP-1013Q	600-411-1171
WA40-1 con motor/KOMATSU 4D95L			AGUA	GP-1011Q	600-411-1151	AIRE, SECUNDARIO	GA-6127	6128-81-7042
ACEITE	GP-36	600-211-6241	WA450L-3 con motor/KOMATSU SA6D125E			AIRE, PRIMARIO	GA-6128	6128-81-7042
WA420-1 con motor/CUMMINS			COMBUSTIBLE	GPP-14	600-311-8293	WA600-3 con motor/CUMMINS QSK19C		
COMBUSTIBLE, SECUNDARIO	GP-1122	6732-71-6110	ACEITE	GP-53	600-211-1231	ACEITE, DOBLE FLUJO	GP-3000	1295224-H1
ACEITE, DOBLE FLUJO	GP-3000	1295155-H1	AGUA	GP-1011Q	600-411-1151	WA600-3 con motor/KOMATSU S6D170E		
AGUA	GP-2071W	1240893-H1	WA470-1 con motor/KOMATSU S6D125-1			COMBUSTIBLE	GPP-14	600-311-8293
COMBUSTIBLE, PRIMARIO	GPP-18	6732-71-6120	COMBUSTIBLE	GPP-14	600-311-8293	ACEITE	GP-53	600-211-1231
WA420-1 con motor/KOMATSU 614T			ACEITE	GP-53	600-211-1231	AGUA	GP-1013Q	600-411-1171
ACEITE	GP-3001	1295155H1	AGUA	GP-1011Q	600-411-1151	AIRE, SECUNDARIO	GA-6127	6128-81-7042
COMBUSTIBLE, SECUNDARIO	GP-1122	161624	AIRE, PRIMARIO	GA-326	6125-81-7032	AIRE, PRIMARIO	GA-6128	6128-81-7042
ACEITE	GP-3000	1295155H1	AIRE, SECUNDARIO	GA-206	600-181-4212	WA65-3, WA65PT con motor/KOMATSU 4D94E		
COMBUSTIBLE, PRIMARIO	GPP-18	161623	WA500-1 con motor/CUMMINS NTA855C			DIESEL	GPP-111	FF5160
WA420-1 con motor/KOMATSU SA6D110			ACEITE, FLUJO TOTAL (FULL FLOW)	GP-53	1239943-H1	WA700-1 con motor/KOMATSU SA6D170		
COMBUSTIBLE	GPP-14	600-311-8293	ACEITE, DERIVACION (BY PASS)	GP-57	1239944-H1	COMBUSTIBLE	GPP-14	600-311-8293
AGUA	GP-2071W	600-411-1191	AIRE, SECUNDARIO	GA-6127	6128-81-7042	ACEITE	GP-53	600-211-1230
AIRE, PRIMARIO	GA-326	600-181-4300	AIRE, PRIMARIO	GA-6128	600-181-4400	AGUA	GP-1013Q	600411-1171
AIRE, SECUNDARIO	GA-206	600-181-4211	WA500-1 con motor/KOMATSU S6D140-1			AIRE, SECUNDARIO	GA-6127	6128-81-7042
WA420-3 con motor/KOMATSU SA6D108			ACEITE, FLUJO TOTAL (FULL FLOW)	GP-53	600-211-1231	AIRE, PRIMARIO	GA-6128	6128-81-7042
COMBUSTIBLE	GPP-14	600-311-8293	COMBUSTIBLE, DERIVACION (BY PASS)	GP-55	600-311-7132	WA700-3 con motor/KOMATSU SAAD170E		
AGUA	GP-2071W	600-411-1191	AGUA	GP-1011Q	600-411-1151	COMBUSTIBLE, SEPARADOR DE AGUA	GPP-14	600-311-8293
AIRE, SECUNDARIO	GA-398	600-181-8370	AIRE, SECUNDARIO	GA-6127	6128-81-7042	ACEITE, FLUJO TOTAL (FULL FLOW)	GP-53	600-211-1231
WA420-3 con motor/KOMATSU SAA6D114E-1			AIRE, PRIMARIO	GA-6128	6128-71-7042	ACEITE, DERIVACION (BY PASS)	GP-57	600-212-1511
COMBUSTIBLE, SECUNDARIO	GP-1122	6732-71-6110	WA500-3 con motor/CUMMINS M11			WA70-1 con motor/KOMATSU 4D95L		
ACEITE	GP-3000	1295155-H1	COMBUSTIBLE	GPP-11	600-311-9121	ACEITE	GP-36	600-211-6242
AGUA	GP-2071W	1261387-H1	AGUA	GP-1011Q	6710-61-8131	AGUA	GP-1011Q	600-411-1140
WA420-3CS con motor/KOMATSU SA6D114			ACEITE	GP-3000	1295224-H1	AIRE, S/N 11437-36215	GAK-16	600-181-7300
COMBUSTIBLE	GP-1122	6742-01-3790	WA500-3 con motor/CUMMINS N14			WA80 con motor/CUMMINS 4B3.9		
AGUA	GP-1011Q	6742-01-3490	ACEITE, FLUJO TOTAL (FULL FLOW)	GP-53	600-211-1231	ACEITE	GP-390	6732-51-5140
ACEITE	GP-3000	6742-01-2430	ACEITE, DERIVACION (BY PASS)	GP-57	600-212-1511	WA800-1 con motor/KOMATSU SA8V170		
COMBUSTIBLE, SEPARADOR DE AGUA	GPP-18	6742-01-0020	ACEITE, DOBLE FLUJO	GP-3000	1295224-H1	ACEITE, FLUJO TOTAL (FULL FLOW)	GP-53	600-211-1231
WA450-1 con motor/KOMATSU S6D125-1			COMBUSTIBLE	GPP-1000	3329289	AGUA	GP-1013Q	600-411-1171
COMBUSTIBLE	GPP-14	600-311-8293	WA500-3 con motor/KOMATSU S6D140E			COMBUSTIBLE	GP-55	600-311-7111
ACEITE	GP-53	600-211-1231	ACEITE	GP-53	600-211-1231	ACEITE, DERIVACION (BY PASS)	GP-57	600-212-1510
AGUA	GP-1011Q	600-411-1151	COMBUSTIBLE	GP-55	600-311-7132	AIRE, SECUNDARIO	GA-6127	6128-81-7042
AIRE, PRIMARIO	GA-326	600-181-4311	AGUA	GP-1011Q	600-411-1151	AIRE, PRIMARIO	GA-6128	6128-81-7042
AIRE, SECUNDARIO	GA-206	600-181-4212	AIRE, SECUNDARIO	GA-6127	6128-81-7042	WA800-2 con motor/KOMATSU SA12V140		
			AIRE, PRIMARIO	GA-6128	600-181-4400	ACEITE, FLUJO TOTAL (FULL FLOW)	GP-53	600-211-1231

MARCA-MODELO-MOTOR	GONHER	OEM
MAKE-MODEL-ENGINE	GONHER	OEM

KOMATSU (continuación)

CARGADORAS

AGUA	GP-1013Q	600-411-1171
COMBUSTIBLE	GP-55	600-311-7132
ACEITE, DERIVACION (BY PASS)	GP-57	600-212-1511
AIRE, SECUNDARIO	GA-6127	6128-81-7042
AIRE, PRIMARIO	GA-6128	6128-81-7042
WA800-2 con motor/KOMATSU SA8V170		
ACEITE, FLUJO TOTAL (FULL FLOW)	GP-53	600-211-1231
AGUA	GP-1013Q	600-411-1171
COMBUSTIBLE	GP-55	600-311-7111
ACEITE, DERIVACION (BY PASS)	GP-57	600-212-1510
AIRE, SECUNDARIO	GA-6127	6128-81-7042
AIRE, PRIMARIO	GA-6128	6128-81-7042

WA800-3 con motor/KOMATSU SA12V140		
ACEITE	GP-53	600-211-1231
AGUA	GP-1013Q	600-411-1171
COMBUSTIBLE	GP-55	600-311-7132
AIRE, SECUNDARIO	GA-6127	6128-81-7042
AIRE, PRIMARIO	GA-6128	6128-81-7042

WA900-1 con motor/KOMATSU SA12V140		
ACEITE	GP-53	600-211-1231
AGUA	GP-1013Q	600-411-1171
COMBUSTIBLE	GP-55	600-311-7132
AIRE, SECUNDARIO	GA-6127	6128-81-7042
AIRE, PRIMARIO	GA-6128	6128-81-7042

WB150-2, WB150-2N, WB150AWS-2N con motor/KOMATSU S4D106		
ACEITE	GP-462	119005-35100

WB150PS-2, WB150PS-2N con motor/KOMATSU S4D106		
ACEITE	GP-462	119005-35100

WB93R-5 con motor/KOMATSU S4D104E-3		
AIRE, PRIMARIO	GA-853R	P828889

WR11 con motor/KOMATSU 6D95L		
ACEITE	GP-36	600-211-6240

WR11-1 PALA con motor/KOMATSU 6D95L-1		
ACEITE	GP-36	600-211-6241

WR8 con motor/KOMATSU 4D95L		
ACEITE	GP-36	600-211-6240

KOMATSU

COMPACTADORAS

WF22A-2, WF22T-2 con motor/KOMATSU NTC743		
---	--	--

AGUA	GP-1011Q	600-411-1150
------	----------	--------------

WF450T-1 con motor/KOMATSU S6D125-1		
-------------------------------------	--	--

COMBUSTIBLE	GPP-14	600-311-8293
-------------	--------	--------------

ACEITE	GP-53	600-211-1231
--------	-------	--------------

AGUA	GP-1011Q	600-411-1150
------	----------	--------------

WF600T-1 con motor/KOMATSU S6D140-1		
-------------------------------------	--	--

ACEITE	GP-53	600-211-1231
--------	-------	--------------

COMBUSTIBLE	GP-55	600-311-7132
-------------	-------	--------------

AGUA	GP-1011Q	600-411-1150
------	----------	--------------

AIRE	GA-6127	6128-81-7042
------	---------	--------------

AIRE	GA-6128	6128-81-7042
------	---------	--------------

MARCA-MODELO-MOTOR	GONHER	OEM
MAKE-MODEL-ENGINE	GONHER	OEM

KOMATSU

COMPRESORES

25Z, EC25Z5 con motor/KOMATSU 2D94		
ACEITE	GP-54	600-211-5240

25Z5, EC25Z con motor/KOMATSU 2D94		
------------------------------------	--	--

ACEITE	GP-54	600-211-5240
--------	-------	--------------

EC50Z, EC35V3, EC45Z-3 con motor/KOMATSU 4D94-2		
---	--	--

ACEITE	GP-54	600-211-5240
--------	-------	--------------

EC75Z con motor/KOMATSU 4D105-3		
---------------------------------	--	--

ACEITE	GP-54	600-211-5240
--------	-------	--------------

KOMATSU

EXCAVADORAS

DHS030 RETROEXCAVADORA con motor/A DIESEL		
HIDRAULICO	G-222	130-60-48140

P37 con motor/A DIESEL		
------------------------	--	--

COMBUSTIBLE	GP-1122	6732-71-6111
-------------	---------	--------------

PC01-1 con motor/KOMATSU 2T80L		
--------------------------------	--	--

ACEITE	GP-91	124450-35100
--------	-------	--------------

PC02-1 con motor/KOMATSU 2D92		
-------------------------------	--	--

ACEITE	GP-36	600-211-6240
--------	-------	--------------

PC02-1 con motor/KOMATSU 2D94		
-------------------------------	--	--

ACEITE	GP-54	600-211-6240
--------	-------	--------------

PC03 con motor/YANMAR 2TN66E		
------------------------------	--	--

ACEITE	GP-6811	119660-35150
--------	---------	--------------

PC04 con motor/KOMATSU 2D94-2		
-------------------------------	--	--

ACEITE	GP-54	600-211-5240
--------	-------	--------------

PC05 con motores/KOMATSU 3D72-1, KOMATSU 3D72-2C		
--	--	--

ACEITE	GP-68	20M-60-31230
--------	-------	--------------

PC05-1 con motor/KOMATSU 3D72-1		
---------------------------------	--	--

ACEITE	GP-24	171056-35110
--------	-------	--------------

PC05-5 con motor/KOMATSU 3D72-2		
---------------------------------	--	--

ACEITE	GP-149	119660-35150
--------	--------	--------------

PC05-5 con motor/KOMATSU 3D84-1		
---------------------------------	--	--

ACEITE	GP-68	20M-60-31230
--------	-------	--------------

PC05-6 con motor/YANMAR 3D72-2 S/N 11701 EN ADELANTE		
--	--	--

ACEITE	GP-149	119660-35150
--------	--------	--------------

PC05-7 con motores/KOMATSU 3D68E-3, KOMATSU 3D72-2		
--	--	--

ACEITE, S/N 8001-10616	GP-6811	119660-35150
------------------------	---------	--------------

PC100 con motor/CUMMINS 4BT3.9		
--------------------------------	--	--

AGUA	GP-1011Q	600-411-1140
------	----------	--------------

PC1000-1, PC1000LC-1, PC1000SE-1 con motor/KOMATSU SA6D170		
--	--	--

COMBUSTIBLE	GPP-14	600-311-8293
-------------	--------	--------------

ACEITE	GP-53	600-211-1230
--------	-------	--------------

AGUA	GP-1013Q	600-411-1171
------	----------	--------------

AIRE, SECUNDARIO	GA-6127	6128-81-7412
------------------	---------	--------------

AIRE, PRIMARIO	GA-6128	6128-81-7042
----------------	---------	--------------

MARCA-MODELO-MOTOR	GONHER	OEM
MAKE-MODEL-ENGINE	GONHER	OEM

KOMATSU (continuación)

EXCAVADORAS

PC100-1 con motor/A DIESEL		
ACEITE	GP-36	600-211-6241

PC100-3 con motores/KOMATSU 6D95L-1A, KOMATSU 6D95L-1B		
--	--	--

AGUA	GP-2071W	600-411-1191
------	----------	--------------

PC100-3, PC100L-3 con motor/KOMATSU 6D95L-1		
---	--	--

ACEITE	GP-36	600-211-6242
--------	-------	--------------

PC100-5, PC100-6 con motor/KOMATSU S4D95L		
---	--	--

ACEITE	GP-54	600-211-5242
--------	-------	--------------

PC100-6 con motor/KOMATSU S4D102E		
-----------------------------------	--	--

AGUA	GP-2071W	600-411-1191
------	----------	--------------

ACEITE	GP-390	6732-51-5140
--------	--------	--------------

AIRE, SECUNDARIO	GA-361	600-181-6050
------------------	--------	--------------

PC100SE-6, PC1100-6, PC1100LC-6 con motor/KOMATSU SAA-6D170E		
--	--	--

COMBUSTIBLE	GPP-14	600-311-8293
-------------	--------	--------------

ACEITE	GP-53	600-211-1230
--------	-------	--------------

AGUA	GP-1013Q	600-411-1171
------	----------	--------------

AIRE, SECUNDARIO	GA-6127	6128-81-7042
------------------	---------	--------------

AIRE, PRIMARIO	GA-6128	6128-81-7042
----------------	---------	--------------

PC10-1 con motor/KOMATSU 2D94-2		
---------------------------------	--	--

ACEITE	GP-54	600-211-5240
--------	-------	--------------

PC10-2, PC10-3 con motor/KOMATSU 3D75-1		
---	--	--

ACEITE	GP-24	171056-35110
--------	-------	--------------

PC10-5, PC10-6 con motor/KOMATSU 3D75-2		
---	--	--

ACEITE	GP-40	129150-35150
--------	-------	--------------

PC10-7 con motor/YANMAR 3D74E-3 S/N 27777 EN ADELANTE		
---	--	--

ACEITE	GP-91	119305-35150
--------	-------	--------------

PC10-7 con motor/YANMAR 3D78N-1 S/N 25001-27776		
---	--	--

ACEITE	GP-40	129150-35150
--------	-------	--------------

PC12 con motor/YANMAR 3TN66E		
------------------------------	--	--

ACEITE	GP-6811	119660-35150
--------	---------	--------------

PC120 con motor/PERKINS 1004.4T		
---------------------------------	--	--

ACEITE	GP-31	2254347
--------	-------	---------

PC120-1 con motor/A DIESEL		
----------------------------	--	--

ACEITE	GP-36	600-211-6241
--------	-------	--------------

PC120-3 con motor/KOMATSU 4D95L-1		
-----------------------------------	--	--

ACEITE	GP-36	600-211-6242
--------	-------	--------------

PC120-3 con motores/KOMATSU 6D95L-1A, KOMATSU 6D95L-1B		
--	--	--

AGUA	GP-2071W	600-411-1191
------	----------	--------------

PC120-5, PC120-6, PC128UU-1 con motor/KOMATSU S4D95L		
--	--	--

ACEITE	GP-54	600-211-5242
--------	-------	--------------

PC120-6 con motor/KOMATSU S4D102E		
-----------------------------------	--	--

AGUA	GP-2071W	600-411-1191
------	----------	--------------

ACEITE	GP-390	6732-51-5140
--------	--------	--------------

AIRE, SECUNDARIO	GA-361	600-181-6560
------------------	--------	--------------

PC128US-1, PC128US-2 con motor/KOMATSU S4D102E		
--	--	--

COMBUSTIBLE, SECUNDARIO	GP-1122	6732-71-6111
-------------------------	---------	--------------

SERVICIO PESADO

MARCA-MODELO-MOTOR MAKE-MODEL-ENGINE	GONHER GONHER	OEM OEM	MARCA-MODELO-MOTOR MAKE-MODEL-ENGINE	GONHER GONHER	OEM OEM	MARCA-MODELO-MOTOR MAKE-MODEL-ENGINE	GONHER GONHER	OEM OEM
KOMATSU (continuación)			KOMATSU (continuación)			KOMATSU (continuación)		
EXCAVADORAS			EXCAVADORAS			EXCAVADORAS		
PC128UU-1 con motor/KOMATSU S4AD102E			PC15-3 con motores/KOMATSU 3D82E, YANMAR 3D84N-2			ACEITE	GP-178	6735-51-5142
COMBUSTIBLE	GP-1122	6732-71-6111	ACEITE, S/N 5001-6221	GP-40	129150-35150	PC200-7, PC200-7B con motor/KOMATSU SAA6D102E		
PC128UU-1 con motor/KOMATSU S4D102E			ACEITE, S/N 6222 EN ADELANTE	GP-6811	129150-35151	COMBUSTIBLE	GP-1122	6732-71-6112
COMBUSTIBLE, SECUNDARIO	GP-1122	6732-71-6111	AIRE, SIN ASPAS	GA-33	121120-12901	COMBUSTIBLE, SEPARADOR DE AGUA	GPP-11	600-311-9121
PC128UU-2 con motor/KOMATSU S4D102E			PC15R-8 con motor/YANMAR 3D68E			AGUA, SISTEMA DE ENFRIAMIENTO	GP-2071W	600-411-1191
COMBUSTIBLE	GP-1122	6732-71-6112	ACEITE	GP-91	119305-35150	AIRE, PRIMARIO	GA-697R	600-185-3100
PC12R-8 con motor/YANMAR 3D68E-3			PC160 con motor/KOMATSU SA4D102			PC200LC-2 con motor/KOMATSU 6D105		
ACEITE	GP-91	119305-35150	ACEITE	GP-390	6732-51-5140	AGUA	GP-1011Q	6710-61-8131
PC12UU-2 con motores/YANMAR 3D68E, YANMAR 3D72N			PC1600-1 con motor/KOMATSU SA6D140			PC200LC-3 con motor/KOMATSU S6D105		
ACEITE	GP-91	119305-35150	ACEITE	GP-53	600-211-1231	COMBUSTIBLE	GPP-14	600-311-9120
PC130-6 con motor/KOMATSU S4D102E			AGUA	GP-1013Q	600-411-1171	PC200LC-6 con motor/KOMATSU S6D95L		
AGUA	GP-2071W	600-411-1170	COMBUSTIBLE	GP-55	600-311-7132	ACEITE	GP-54	600-211-5242
ACEITE	GP-390	6732-51-5140	AIRE, SECUNDARIO	GA-6127	6128-81-7042	PC200LC-6 con motores/KOMATSU S6D102-1, KOMATSU S6D102E		
AIRE, SECUNDARIO	GA-361	600-181-6050	AIRE, PRIMARIO	GA-6128	6128-81-7042	COMBUSTIBLE, SECUNDARIO	GP-1122	6732-71-6110
PC130-6 con motor/KOMATSU S4D95L			PC180 con motor/KOMATSU SA4D102			AGUA	GP-1011Q	600-411-1151
ACEITE	GP-54	600-211-5242	AGUA	GP-1011Q	600-411-1140	COMBUSTIBLE, PRIMARIO	GPP-18	161623
PC130-7 con motor/KOMATSU SAA4D95LE			PC180 con motor/PERKINS 1004.4T			ACEITE	GP-178	6735-51-5142
ACEITE (8-12 PSI)	GP-58	600-211-2110	ACEITE	GP-31	2254347	PC200LC-7, PC200LC-7B, PC200LL-7 con motor/KOMATSU SAA-6D102E		
PC1400 con motor/CUMMINS VTA28C			PC180L-3 con motor/KOMATSU S6D95L-1P			COMBUSTIBLE	GP-1122	6732-71-6112
ACEITE, FLUJO TOTAL (FULL FLOW)	GP-53	600-211-1231	ACEITE	GP-54	600-211-5242	COMBUSTIBLE, SEPARADOR DE AGUA	GPP-11	600-311-9121
COMBUSTIBLE	GP-55	600-311-7132	PC180LC-3 con motor/KOMATSU S6D95L-1			AGUA, SISTEMA DE ENFRIAMIENTO	GP-2071W	600-411-1191
ACEITE, DERIVACION (BY PASS) SELLADO	GP-57	600-212-1511	ACEITE	GP-36	600-211-6241	AIRE, PRIMARIO	GA-697R	600-185-3100
ACEITE, DERIVACION (BY PASS) CARTUCHO	G-750	6610-51-5300	PC20 con motores/YANMAR 3TNE74, YANMAR 3TNE75E			PC20-1 con motor/KOMATSU 2D94-2		
PC15 con motor/YANMAR 3TN66E			ACEITE	GP-6811	119660-35150	ACEITE	GP-54	600-211-6241
ACEITE	GP-6811	119660-35150	PC200 con motor/CUMMINS 6BT5.9			PC20-2, PC20-3 con motor/KOMATSU 3D84-1		
PC150 con motor/PERKINS 1004.4T			COMBUSTIBLE, SECUNDARIO	GP-1122	161624	ACEITE	GP-24	171056-35110
ACEITE	GP-31	2254347	AGUA	GP-1011Q	600-411-1140	PC20-5 con motor/YANMAR 3D84-1		
PC1500-1 con motor/KOMATSU S6D170			COMBUSTIBLE, PRIMARIO	GPP-18	161623	ACEITE	GP-24	171056-35110
COMBUSTIBLE	GPP-14	600-311-8293	ACEITE	GP-178	6735-51-5141	PC20-6 con motor/KOMATSU 3D84-1		
ACEITE	GP-53	600-211-1231	PC200 con motor/KOMATSU S6D95			AIRE, SIN ASPAS	GA-33	121120-12901
AGUA	GP-1011Q	600-411-1040	AGUA	GP-1011Q	600-411-1140	PC20-7 con motores/KOMATSU 3D82E, KOMATSU 3D84N		
AIRE, SECUNDARIO	GA-6127	6128-81-7042	PC200 con motor/PERKINS 1006.6T			ACEITE, S/N 35001-42354	GP-40	129150-35150
AIRE, PRIMARIO	GA-6128	6128-81-7042	ACEITE	GP-1	15208-W1120	ACEITE, S/N 42355 EN ADELANTE	GP-6811	129150-35151
PC150-1 con motor/KOMATSU 6D105-1			PC200-1, PC200-2 con motores/KOMATSU 6D105, KOMATSU S6D105			AIRE, SIN ASPAS	GA-33	121120-12901
AGUA	GP-1013Q	600-411-1420	COMBUSTIBLE	GPP-11	600-311-9120	PC20HT-1 con motor/KOMATSU 4D130-1		
PC150-3 con motor/KOMATSU S6D95L-1			PC200-3 con motor/KOMATSU S6D105			ACEITE	G-191	6114-50-5100
ACEITE	GP-36	600-211-6242	COMBUSTIBLE	GPP-14	600-311-9120	PC20R-8 con motor/KOMATSU 3D84E		
PC150-5 con motor/KOMATSU S6D95L-1			PC200-5, PC200LC-5 con motor/KOMATSU S6D95L			ACEITE	GP-91	119305-35150
ACEITE	GP-54	600-211-5242	ACEITE	GP-54	600-211-5242	PC210, PC220 con motor/CUMMINS BT5.9		
PC150-6, PC150LC-6 con motor/KOMATSU SA4D102E			AGUA	GP-2071W	600-411-1191	AGUA	GP-1011Q	600-411-1140
ACEITE	GP-390	6732-51-5140	AIRE, SECUNDARIO	GA-361	600-181-6050	PC210-6 con motor/KOMATSU S6D95L		
PC150LC-3 con motor/KOMATSU S6D95L-1			PC200-6 con motor/KOMATSU S6D95L			ACEITE	GP-54	600-211-5242
ACEITE	GP-36	600-211-6242	ACEITE	GP-54	600-211-5242	PC210-6, PC210LC-6 con motores/KOMATSU S6D102-1, KOMATSU S6D102E		
PC15-1, PC15-2 con motor/YANMAR 3D78-1			PC200-6 con motores/KOMATSU S6D102-1, KOMATSU S6D102E			COMBUSTIBLE, SECUNDARIO	GP-1122	6732-71-6110
ACEITE	GP-40	129150-35150	COMBUSTIBLE, SECUNDARIO	GP-1122	6732-71-6110	AGUA	GP-1011Q	600-411-1151
			AGUA	GP-1011Q	600-411-1151	COMBUSTIBLE, PRIMARIO	GPP-18	161623
			COMBUSTIBLE, PRIMARIO	GPP-18	161623			

MARCA-MODELO-MOTOR MAKE-MODEL-ENGINE	GONHER GONHER	OEM OEM	MARCA-MODELO-MOTOR MAKE-MODEL-ENGINE	GONHER GONHER	OEM OEM	MARCA-MODELO-MOTOR MAKE-MODEL-ENGINE	GONHER GONHER	OEM OEM
KOMATSU (continuación)			KOMATSU (continuación)			KOMATSU (continuación)		
EXCAVADORAS			EXCAVADORAS			EXCAVADORAS		
AGUA	GP-1011Q	600-411-1151	PC220LC-6, PC230-6, PC230LC-6 con motor/KOMATSU SA6D102-E			PC25R-8, PC27R-8 con motor/KOMATSU 3D82AE		
COMBUSTIBLE, PRIMARIO	GPP-18	161623	COMBUSTIBLE, SECUNDARIO	GP-1122	6732-71-6110	ACEITE	GP-6811	129150-35151
ACEITE	GP-178	6735-51-5142	AGUA	GP-1011Q	600-411-1151	PC270LC-6, PC270LC-6MH con motor/KOMATSU SA6D102EA		
PC210-7, PC210-7K con motor/KOMATSU SAA6D102E			COMBUSTIBLE, PRIMARIO	GPP-18	161623	ACEITE	GP-178	6735-51-5140
COMBUSTIBLE	GP-1122	6732-71-6112	ACEITE	GP-178	6735-51-5140	PC27MR-2 con motor/KOMATSU 3D82AE		
PC210LC-6 con motor/KOMATSU S6D95L			PC220LC-7, PC220LC-7L con motor/KOMATSU SAA6D102E			AIRE, RADIAL PRIMARIO (CON CABINA)	GA-880R	119808-12520
ACEITE	GP-54	600-211-5242	COMBUSTIBLE	GP-1122	6732-71-6112	PC280-3, PC280LC-3, PC280NLC-3 con motor/KOMATSU S6D110		
PC210LC-7, PC210LC-7K, PC210NLC-7K con motor/KOMATSU SAA6D102E			COMBUSTIBLE, SEPARADOR DE AGUA	GPP-11	600-311-9121	AGUA	GP-1011Q	600-411-1140
COMBUSTIBLE	GP-1122	6732-71-6112	AIRE, PRIMARIO	GA-966R	600-185-4110	PC28UU-1 con motor/A DIESEL		
PC220-1 con motor/A DIESEL			AIRE, SECUNDARIO	GA-967R	600-185-4120	ACEITE	GP-40	129150-35150
AIRE, PRIMARIO	GA-326	6125-81-7032	AIRE, PRIMARIO	GA-697R	600-185-3100	PC28UU-2 con motores/YANMAR 3D82E, YANMAR 3D84N		
PC220-1, PC220-2 con motor/KOMATSU 6D105			PC220LC-8 con motor/KOMATSU SAA6D107E			ACEITE, S/N 7001-10800	GP-40	129150-35150
COMBUSTIBLE	GPP-11	600-311-9120	COMBUSTIBLE	GP-1122	6732-71-6112	ACEITE, S/N 10801 EN ADELANTE	GP-6811	129150-35151
PC220-1, PC220-2 con motor/KOMATSU S6D105			AGUA, SISTEMA DE ENFRIAMIENTO	GP-2071W	600-411-1191	HIDRAULICO	GP-3937	21U-60-11330
COMBUSTIBLE	GPP-11	600-311-9120	AIRE, PRIMARIO	GA-966R	600-185-4110	AIRE, SIN ASPAS	GA-33	121120-12901
AGUA	GP-1011Q	600-411-1140	AIRE, SECUNDARIO	GA-967R	600-185-4120	PC290 con motor/KOMATSU S6D102		
AIRE, PRIMARIO	GA-326	600-181-4311	AIRE, PRIMARIO	GA-697R	600-185-3100	ACEITE	GP-178	6735-51-5140
AIRE, SECUNDARIO	GA-206	600-181-4212	PC220LL-7 con motor/KOMATSU SAA6D102E			PC30 con motor/YANMAR 3TN84E		
PC220-3, PC220LC-3, PC220NLC-3 con motor/KOMATSU S6D105-1Z			COMBUSTIBLE	GP-1122	6732-71-6112	ACEITE	GP-6811	119660-35150
AGUA	GP-2071W	600-411-1191	COMBUSTIBLE, SEPARADOR DE AGUA	GPP-11	600-311-9121	PC300-1, PC300LC-2, PC300-2, PC300LC-1 con motor/CUMMINS N-855		
PC220-5, PC220LC-5 con motor/KOMATSU SA6D95L			AIRE, PRIMARIO	GA-966R	600-185-4110	COMBUSTIBLE	GPP-14	600-311-8291
ACEITE	GP-54	600-211-5242	AIRE, SECUNDARIO	GA-967R	600-185-4120	ACEITE	GP-53	600-211-1230
AGUA	GP-2071W	600-411-1191	AIRE, PRIMARIO	GA-697R	600-185-3100	AGUA	GP-1011Q	6710-61-8113
AIRE, SECUNDARIO	GA-361	600-181-6050	PC228USLC-1, PC228USLC-2 con motor/KOMATSU S6D102E			AIRE	GA-39	6620-21-7550
PC220-6 con motor/KOMATSU SA6D102-E			AGUA	GP-1011Q	600-411-1140	AIRE, PRIMARIO	GA-106	600-181-4311
COMBUSTIBLE, SECUNDARIO	GP-1122	6732-71-6110	PC228US-3, PC228USLC-3 con motor/KOMATSU SAA6D102E			AIRE, SECUNDARIO	GA-206	600-181-4212
AGUA	GP-1011Q	600-411-1151	COMBUSTIBLE	GP-1122	6732-71-6112	ACEITE, DERIVACION	G-750	6610-51-5050
COMBUSTIBLE, PRIMARIO	GPP-18	161623	AGUA, SISTEMA DE ENFRIAMIENTO	GP-2071W	600-411-1191	PC300-3, PC300NLC-3, PC300LC-3, PC300N-3 con motor/KOMATSU S6D125-1		
ACEITE	GP-178	6735-51-5140	AIRE, PRIMARIO	GA-697R	600-185-3110	COMBUSTIBLE	GPP-14	600-311-8293
PC220-6, PC220LC-6 con motor/KOMATSU SA6D95L-1			PC230-6 con motor/KOMATSU S6D102E-1			ACEITE	GP-53	600-211-1231
ACEITE	GP-54	600-211-5242	AGUA	GP-1011Q	600-411-1151	AGUA	GP-1011Q	600-411-1151
PC220-7 con motor/KOMATSU SAA6D102E			PC230-6 con motor/KOMATSU SA6D95L-1			AIRE, PRIMARIO	GA-326	6125-81-7032
COMBUSTIBLE	GP-1122	6732-71-6112	ACEITE	GP-54	600-211-5242	AIRE, SECUNDARIO	GA-206	6125-81-7032
COMBUSTIBLE, SEPARADOR DE AGUA	GPP-11	600-311-9121	PC230LC-6 con motor/KOMATSU S6D102E-1			PC300-5 con motor/KOMATSU SA6D108		
AIRE, PRIMARIO	GA-966R	600-185-4110	AGUA	GP-1011Q	600-411-1151	COMBUSTIBLE	GPP-14	600-311-8293
AIRE, SECUNDARIO	GA-967R	600-185-4120	PC230LC-6 con motor/KOMATSU SA6D95L-1			AGUA	GP-2071W	600-411-1191
AIRE, PRIMARIO	GA-697R	600-185-3100	ACEITE	GP-54	600-211-5242	AIRE, SECUNDARIO	GA-398	600-181-8370
PC220-8 con motor/KOMATSU SAA6D107E			PC240-3 con motor/KOMATSU S6D105-1			PC300-6 con motor/KOMATSU SAA6D108		
COMBUSTIBLE	GP-1122	6732-71-6112	AGUA	GP-1011Q	600-411-1010	COMBUSTIBLE	GPP-14	600-311-8293
AGUA, SISTEMA DE ENFRIAMIENTO	GP-2071W	600-411-1191	PC240LC con motor/KOMATSU S6D102			PC300HD-5 con motor/KOMATSU SA6D108		
AIRE, PRIMARIO	GA-966R	600-185-4110	AGUA	GP-1011Q	600-411-1140	COMBUSTIBLE	GPP-14	600-311-8293
AIRE, SECUNDARIO	GA-967R	600-185-4120	PC240LC-3, PC240NLC-3 con motor/KOMATSU S6D105-1			PC300HD-6 con motor/KOMATSU SA6D114		
AIRE, PRIMARIO	GA-697R	600-185-3100	AGUA	GP-1011Q	600-411-1010	COMBUSTIBLE	GP-1122	6732-71-6111
PC220LC-2 con motor/KOMATSU S6D105			PC250LC-6 con motor/KOMATSU SA6D95L			COMBUSTIBLE, SEPARADOR DE AGUA	GPP-1122	6732-71-6310
COMBUSTIBLE	GPP-11	600-311-9120	ACEITE	GP-54	600-211-5241	ACEITE	GP-3000	1295155-H1
AGUA	GP-1011Q	600-411-1140	PC25-1 con motores/YANMAR 3D82E, YANMAR 3D84N			AGUA	GP-2071W	1261387-H1
AIRE, PRIMARIO	GA-326	600-181-4311	ACEITE	GP-6811	129150-35150	PC300HD-7 con motor/KOMATSU SAA6D114E		
AIRE, SECUNDARIO	GA-206	600-181-4212				ACEITE	GP-3001	1295155H1

SERVICIO PESADO

MARCA-MODELO-MOTOR MAKE-MODEL-ENGINE	GONHER GONHER	OEM OEM	MARCA-MODELO-MOTOR MAKE-MODEL-ENGINE	GONHER GONHER	OEM OEM	MARCA-MODELO-MOTOR MAKE-MODEL-ENGINE	GONHER GONHER	OEM OEM
KOMATSU (continuación)			KOMATSU (continuación)			KOMATSU (continuación)		
EXCAVADORAS			EXCAVADORAS			EXCAVADORAS		
PC300LC-5 con motor/KOMATSU 614TA			PC380 con motor/KOMATSU S6D114			PC40-5 con motor/KOMATSU 3D95S-W-1		
COMBUSTIBLE, SECUNDARIO	GP-1122	161624	ACEITE	GP-3000	1295224-H1	ACEITE	GP-54	600-211-6241
ACEITE	GP-3000	1294153-H1	PC40 con motor/KOMATSU 4TNE84			PC40-6 con motor/KOMATSU 3D95S		
COMBUSTIBLE, PRIMARIO	GPP-18	161-623	ACEITE	GP-40	124450-35100	AIRE, SIN ASPAS	GA-33	600-182-1100
AIRE, SECUNDARIO	GA-398	600-181-8600	PC400-1 con motor/CUMMINS NT655			PC40-7 con motor/YANMAR 4D84-2		
PC300LC-5 con motor/KOMATSU SA6D108			ACEITE, FLUJO TOTAL (FULL FLOW)	GP-53	600-211-1231	AIRE, SIN ASPAS	GA-33	600-182-1100
COMBUSTIBLE	GPP-14	600-311-8293	COMBUSTIBLE	GPP-11	600-311-9121	PC40-7 con motor/YANMAR 4D84E		
AGUA	GP-2071W	600-411-1191	ACEITE, DERIVACION	G-750	6610-51-5050	ACEITE	GP-6811	129150-35151
AIRE, SECUNDARIO	GA-398	600-181-8600	PC400-1, PC400LC-1 con motor/CUMMINS NT855			PC40MRx-1 con motor/KOMATSU 4D84E		
COMBUSTIBLE	GP-1122	6732-71-6111	COMBUSTIBLE	GPP-14	600-311-8291	ACEITE	GP-40	129150-35150
COMBUSTIBLE, SEPARADOR DE AGUA	GPP-1122	6732-71-6310	AGUA	GP-1011Q	6710-61-8113	PC40R-8 con motor/KOMATSU 4D84E		
ACEITE	GP-3000	1295155-H1	ACEITE	GP-43	600-211-1230	ACEITE	GP-6811	129150-35151
AGUA	GP-2071W	1261387-H1	AIRE, SECUNDARIO	GA-6127	6127-81-7412	PC45 con motor/KOMATSU 4TNE84		
PC300LC-6 con motor/KOMATSU SAA6D108			AIRE, PRIMARIO	GA-6129	6127-81-7311	ACEITE	GP-40	124450-35100
COMBUSTIBLE	GPP-14	600-311-8293	ACEITE, DERIVACION	G-750	6610-51-5050	PC450-6, PC450LC-6 con motor/KOMATSU SA6D125E		
PC300LC-7 con motor/KOMATSU SAA6D114E			PC400-3, PC400LC-3 con motor/KOMATSU S6D125			COMBUSTIBLE	GPP-14	600-311-8293
ACEITE	GP-3001	1295155H1	COMBUSTIBLE	GPP-14	600-311-8293	ACEITE	GP-53	600-211-1231
PC30-1, PC30-3, PC30-5 con motor/KOMATSU 3D84-1			AGUA	GP-1011Q	600-411-1151	AGUA	GP-1011Q	600-411-1151
ACEITE	GP-24	171056-35110	AIRE, PRIMARIO	GA-326	6125-81-7032	AIRE, PRIMARIO	GA-326	6125-81-7032
PC30-5, PC30-6 con motor/YANMAR 3D84-1			AIRE, SECUNDARIO	GA-206	6125-81-7032	AIRE, SECUNDARIO	GA-206	6125-81-7032
ACEITE	GP-24	171056-35110	PC400-5 con motor/CUMMINS LTA10			PC45-1 con motor/KOMATSU 4D84 SERIES		
PC30-7 con motor/YANMAR 3D84 SERIES			AGUA	GP-1011Q	600-411-1150	ACEITE	GP-6811	129150-35151
ACEITE	GP-6811	129150-35151	PC400-5 con motor/KOMATSU S6D125			PC45R-8 con motor/KOMATSU 4D84E		
PC30-8, PC30R-8 con motor/KOMATSU 3D84E			COMBUSTIBLE	GPP-14	600-311-8292	ACEITE	GP-6811	129150-35151
ACEITE	GP-6811	129150-35151	ACEITE	GP-53	600-211-1231	PC50UU-1 con motor/A DIESEL		
PC340, PC340LC con motor/KOMATSU 614TA			AGUA	GP-1011Q	600-411-1151	AIRE	GAK-16	600-181-7300
ACEITE	GP-3000	1295224-H1	AIRE, PRIMARIO	GA-326	6125-81-7032	PC50UU-2 con motores/KOMATSU 4D84, KOMATSU 4D88E		
PC35 con motor/YANMAR 3TN84E			AIRE, SECUNDARIO	GA-206	6125-81-7032	ACEITE	GP-6811	129150-35151
ACEITE	GP-6811	119660-35150	PC400HD-5 con motor/KOMATSU S6D125-1VV			PC58UUx con motor/YANMAR 4TNE88		
PC350-6, PC350LC-6 con motor/KOMATSU SAA6D108			ACEITE	GP-53	600-211-1231	ACEITE	GP-6811	129150-35151
COMBUSTIBLE	GPP-14	600-311-8293	PC400HD-6, PC400LC-6 con motor/CUMMINS M11			PC60 con motor/CUMMINS 4B3.9L		
AGUA	GP-1011Q	600-411-1140	COMBUSTIBLE	GPP-14	1304800-H1	ACEITE	GP-390	6732-51-5140
AIRE, SECUNDARIO	GA-398	600-181-8370	PC400LC-1 con motor/CUMMINS NT655			PC60 con motor/KOMATSU 4D95S-1		
PC35R-8, PC35R-8E con motor/KOMATSU 3D84E			ACEITE, FLUJO TOTAL (FULL FLOW)	GP-53	600-211-1231	ACEITE	GP-54	600-211-5240
ACEITE	GP-6811	129150-35151	COMBUSTIBLE	GPP-11	600-311-9121	PC600 con motor/CUMMINS N14		
PC360-3, PC360LC-3 con motor/KOMATSU S6D125			ACEITE, DERIVACION	G-750	6610-51-5050	AGUA	GP-1011Q	600-411-1140
COMBUSTIBLE	GPP-14	600-311-8291	PC400LC-5 con motor/KOMATSU S6D125			AIRE	GA-326	600-181-4300
ACEITE	GP-53	600-211-1230	COMBUSTIBLE	GPP-14	600-311-8292	AIRE	GA-206	600-181-4212
AGUA	GP-1011Q	600-411-1020	ACEITE	GP-53	600-211-1231	PC600LC-6 con motor/CUMMINS N14		
AIRE, PRIMARIO	GA-326	600-181-4311	AGUA	GP-1011Q	600-411-1151	ACEITE	GP-3000	1295224-H1
AIRE, SECUNDARIO	GA-206	600-181-4212	PC360LC-5 con motor/A DIESEL			PC600LC-6 con motor/KOMATSU SA6D140E		
COMBUSTIBLE	GP-11	600-311-8291	COMBUSTIBLE	GP-11	600-311-8291	ACEITE	GP-53	600-211-1231
PC38 con motor/YANMAR 3TN84			ACEITE	GP-53	600-211-1231	PC60-1 con motor/KOMATSU 4D94-2		
ACEITE	GP-6811	119660-35150	AGUA	GP-1011Q	600-411-1151	ACEITE	GP-54	600-211-5240
			PC40-1, PC40-2, PC40-3 con motor/KOMATSU 3D94-2			PC60-2 con motor/KOMATSU 4D94-3		
			ACEITE	GP-54	600-211-6241	ACEITE	GP-54	600-211-6241
			PC40-5 con motor/KOMATSU 3D95S					
			AIRE, SIN ASPAS	GA-33	600-182-1100			

MARCA-MODELO-MOTOR MAKE-MODEL-ENGINE	GONHER GONHER	OEM OEM	MARCA-MODELO-MOTOR MAKE-MODEL-ENGINE	GONHER GONHER	OEM OEM	MARCA-MODELO-MOTOR MAKE-MODEL-ENGINE	GONHER GONHER	OEM OEM
KOMATSU (continuación)			KOMATSU (continuación)			KOMATSU (continuación)		
EXCAVADORAS			EXCAVADORAS			EXCAVADORAS		
PC60-3, PC60-6 con motor/KOMATSU 4D95L-1			AIRE, SECUNDARIO	GA-6127	6128-81-7042	PC80-3, PC80LC-3 con motor/KOMATSU 4D95L-1		
ACEITE	GP-36	600-211-6241	AIRE, PRIMARIO	GA-6128	6128-81-7042	ACEITE	GP-36	600-211-6242
PC60-5, PC60L-5, PC60U-5 con motor/KOMATSU 4D95L-1			PC650-5, PC650LC-5, PC650SE-5 con motor/KOMATSU SA6D140			PC90-1 con motor/KOMATSU 4D95L-1		
ACEITE	GP-36	600-211-6241	ACEITE, FLUJO TOTAL (FULL FLOW)	GP-53	600-211-1231	ACEITE	GP-36	600-211-6242
PC60-7 con motor/KOMATSU 4D95L-1			AGUA	GP-1013Q	600-411-1171	PC95-1, PC95-2 con motor/PERKINS 1004.4		
ACEITE	GP-54	600-211-5242	COMBUSTIBLE	GP-55	600-311-7132	ACEITE	GP-31	2254347
PC60D-2 con motor/KOMATSU 4D94-3			ACEITE, DERIVACION (BY PASS)	GP-57	600-212-1510	COMBUSTIBLE	G-296	PK2656F802
ACEITE	GP-54	600-211-6241	AIRE, SECUNDARIO	GA-6127	6128-81-7042	COMBUSTIBLE	G-296-B	PK2656F802
PC60L-1 con motor/KOMATSU 4D94-2			AIRE, PRIMARIO	GA-6128	6128-81-7042	PF55L-1 con motor/KOMATSU S6D105		
ACEITE	GP-54	600-211-5240	AIRE, SECUNDARIO	GA-206	6125-81-7032	COMBUSTIBLE	GPP-11	600-311-9120
PC60L-2 con motor/KOMATSU 4D94-3			PC650E-1 con motor/KOMATSU S6D170			PPC400HD-5 con motor/KOMATSU S6D125-1VV		
ACEITE	GP-54	600-211-6241	COMBUSTIBLE	GPP-14	600-311-8293	COMBUSTIBLE	GP-11	600-311-8292
PC60L-3 con motor/KOMATSU 4D95L-1			ACEITE	GP-53	600-211-1231	PW05-1 con motor/KOMATSU 3D72-2		
ACEITE	GP-36	600-211-6241	AGUA	GP-1013Q	600-411-1040	ACEITE	GP-6811	119660-35150
PC60SE-3 con motor/KOMATSU SA6D140			COMBUSTIBLE	GP-55	600-311-8293	PW100-3, PW100N-3 con motor/KOMATSU S6D95L-1		
ACEITE	GP-53	600-211-1231	AIRE	GA-6127	6125-81-7032	ACEITE	GP-36	600-211-6242
AGUA	GP-1013Q	600-411-1171	AIRE	GA-6128	6125-81-7032	PW120 con motor/PERKINS 1004.4T		
COMBUSTIBLE	GP-55	600-311-7132	PC650LC-3 con motor/CUMMINS KT19-C			ACEITE	GP-31	2254347
AIRE	GA-6127	6128-81-7042	ACEITE	GP-53	600-211-1231	PW128 con motor/CUMMINS 4BT3.9		
AIRE	GA-6128	6128-81-7042	AGUA	GP-1013Q	600-411-1040	ACEITE	GP-390	6732-51-5140
PC60U-1 con motor/KOMATSU 4D94-2			COMBUSTIBLE	GP-55	600-311-8293	PW150 con motor/KOMATSU SAD102		
ACEITE	GP-54	600-211-5240	AIRE, SECUNDARIO	GA-6127	6125-81-7032	ACEITE	GP-390	6732-51-5140
PC60U-2 con motor/KOMATSU 4D94-3			AIRE, PRIMARIO	GA-6128	6125-81-7032	PW150-1 con motor/KOMATSU 6D95L		
ACEITE	GP-54	600-211-5240	PC650LC-3, PC650SE-3 con motor/KOMATSU SA6D140			ACEITE	GP-36	600-211-6242
PC60U-3 con motor/KOMATSU 4D95L-1			ACEITE	GP-53	600-211-1231	PW170 con motor/PERKINS 1004.4T		
ACEITE	GP-36	600-211-6241	AGUA	GP-1013Q	600-411-1171	ACEITE	GP-31	2254347
PC650-1 con motor/CUMMINS KT1150			COMBUSTIBLE	GP-55	600-311-7132	PW170ES-6 con motor/KOMATSU SA4D102E		
COMBUSTIBLE	GPP-14	600-311-8293	AIRE, SECUNDARIO	GA-6127	6128-81-7042	AGUA	GP-1011Q	600-411-1140
ACEITE, FLUJO TOTAL (FULL FLOW)	GP-53	600-211-1231	AIRE, PRIMARIO	GA-6128	6128-81-7042	PW200 con motores/KOMATSU 6D105, KOMATSU S6D105		
AGUA	GP-2071W	1261387-H1	ACEITE, DERIVACION (BY PASS)	GP-57	600-212-1510	COMBUSTIBLE	GPP-11	600-311-9120
AIRE, PRIMARIO	GA-326	6125-81-7032	AIRE, SECUNDARIO	GA-6127	6128-81-7042	PW200-7 con motor/KOMATSU SAA6D102E-2		
AIRE, SECUNDARIO	GA-206	6125-81-7032	AIRE, PRIMARIO	GA-6128	6128-81-7042	COMBUSTIBLE	GP-1122	6732-71-6112
ACEITE, DERIVACION (BY PASS)	G-750	6610-51-5050	PC75 con motor/KOMATSU SAD95L			ACEITE, S/N K40001-K40056	GP-178	6736-51-5141
PC650-1 con motor/KOMATSU S6D170			ACEITE	GP-54	600-211-6241	AIRE, PRIMARIO	GA-697R	600-185-3100
COMBUSTIBLE	GPP-14	600-311-8293	PC750 con motor/CUMMINS QSK19			PW20-1, PW30-1 con motor/YANMAR 3D84-1		
ACEITE	GP-53	600-211-1231	ACEITE	GP-3000	1295224-H1	ACEITE	GP-24	171056-35110
AGUA	GP-1011Q	600-411-1040	PC750-6, PC750LC-6, PC750LC-6MH, PC750SE-6, PC800SE-6 con motor/KOMATSU SAA6D140E			PW210-1 con motor/KOMATSU S6D105		
AIRE, PRIMARIO	GA-326	6125-81-7032	ACEITE	GP-53	600-211-1231	AGUA	GP-2071W	600-411-1191
AIRE, SECUNDARIO	GA-206	6125-81-7032	COMBUSTIBLE	GP-55	600-311-7132	PW60-1 con motor/KOMATSU 4D94-2		
PC650-3 con motor/CUMMINS KT19-C			AIRE, SECUNDARIO	GA-6127	6128-81-7042	ACEITE	GP-54	600-211-5242
ACEITE	GP-53	600-211-1231	AIRE, PRIMARIO	GA-6128	6128-81-7042	PW60-3 con motor/KOMATSU 4D95L		
AGUA	GP-1013Q	600-411-1040	PC75UU-2 con motor/KOMATSU 4D95L			ACEITE	GP-36	600-211-6242
COMBUSTIBLE	GP-55	600-311-8293	ACEITE	GP-54	600-211-5241	PW60N-1 con motor/KOMATSU 4D94-2		
AIRE, SECUNDARIO	GA-6127	6125-81-7032	PC75UU-3 con motor/KOMATSU 4D102E			ACEITE	GP-54	600-211-5242
AIRE, PRIMARIO	GA-6128	6125-81-7032	COMBUSTIBLE	GP-1122	6732-71-6111			

SERVICIO PESADO

MARCA-MODELO-MOTOR MAKE-MODEL-ENGINE	GONHER GONHER	OEM OEM	MARCA-MODELO-MOTOR MAKE-MODEL-ENGINE	GONHER GONHER	OEM OEM	MARCA-MODELO-MOTOR MAKE-MODEL-ENGINE	GONHER GONHER	OEM OEM
KOMATSU (continuación)			KOMATSU (continuación)			KOMATSU (continuación)		
EXCAVADORAS			MONTACARGAS			MONTACARGAS		
PX21 con motor/A DIESEL			FG10 con motor/A DIESEL			FG25ST-12 con motor/NISSAN		
COMBUSTIBLE	GP-1122	6732-71-6111	ACEITE, SELLADO	GP-38	15601-33021	ACEITE	GP-38	15208-H1010
KOMATSU			KOMATSU			KOMATSU		
GENERADORES			KOMATSU			MOTORES		
EG150-3, EG200-2 con motor/A DIESEL			FG10 H-1, FG10 H-4, FG10 S-2, FG10-2 con motor/NISSAN			2D92, 4D95L		
COMBUSTIBLE	GPP-14	600-311-8291	ACEITE	GP-3682	37-02-OF201	ACEITE	GP-36	600-211-6240
KOMATSU			KOMATSU			MOTORES		
MONTACARGAS			KOMATSU			MOTORES		
15 con motor/A DIESEL			FG10-10, FG10-11 con motor/NISSAN			2D94, 2D94-2, 3D94-2, 4D105-3, 4D92, 4D94, 4D94-2, S4D105-3, S4D95L		
AIRE	GAK-16	600-181-7300	ACEITE	GP-3682	37-02-OF201	ACEITE	GP-54	600-211-5240
25 con motor/NISSAN H20			FG10-12, FG10-14 con motor/TOYOTA			4D120		
AIRE, SIN ASPAS	GA-33	37Z-02-AF931	ACEITE	GP-9	37Z-02-OF301	ACEITE, CARTUCHO	G-191	6110-53-5120
2FD25S-5 con motor/A DIESEL			FG10-15 con motor/A DIESEL			COMBUSTIBLE	G-1123	6110-73-6130
ACEITE	GP-54	600-211-6140	ACEITE	GP-38	15601-33021	ACEITE, SELLADO	GP-54	600-211-5240
AX SERIES con motor/NISSAN H20-II			FG10ST con motor/NISSAN H20			4D130, 66D125-1, 6D105, S4D130-1, S6D105, SA6D110, SL4D130-1		
ACEITE	GP-3682	15208-H8916	ACEITE	GP-3682	37-02-OF201	COMBUSTIBLE	GPP-11	600-311-82-91
DX20 SERIES con motor/PERKINS 1004.4			FG14 con motor/A DIESEL			4D94E		
ACEITE, 5 13/32 IN	GP-1	15208-W1120	ACEITE, SELLADO	GP-38	15601-33021	DIESEL	GPP-111	FF5160
DX20 SERIES con motores/CUMMINS 6B5.9, KOMATSU S6D102E			FG14-10, FG15 con motor/A DIESEL			6D95L, S6D125-1, S6D170-1, SA6D170A-1		
ACEITE	GP-178	6735-51-5140	ACEITE	GP-38	15601-33021	ACEITE	GP-53	612-851-5030
EX SERIES con motor/PERKINS 1006.6TW			FG15 H-1, FG18-2, FG15 H-14, FG15 S-2, FG15-2, FG18 H-1, FG18 H-14, FG18 S-2 con motor/NISSAN			NH220, NH220C-1		
ACEITE	GP-1	15208-W1120	ACEITE	GP-3682	37-02-OF201	ACEITE, FLUJO TOTAL (FULL FLOW) SELLADO	GP-53	600-211-1230
FD20-10, FD20-5 con motor/KOMATSU			FG15-10, FG15-11 con motor/NISSAN			COMBUSTIBLE	GPP-11	600-311-8291
ACEITE	GP-54	600-211-5240	ACEITE	GP-3682	37-02-OF201	AGUA	GP-2071W	6710-61-8112
FD20-7, FD20-8 con motor/ISUZU			FG18-14, FG19-12 con motor/TOYOTA			ACEITE, DERIVACION (BY PASS)	G-750	6610-51-5050
ACEITE, SELLADO	GP-3985	37Z-02-OF102	ACEITE	GP-9	37Z-02-OF301	NTA855C, NTC743C, NTOL		
FD25S-5 con motor/A DIESEL			FG18ST-15 con motor/A DIESEL			AGUA	GP-2071W	6710-61-8112
AIRE, SIN ASPAS	GA-33	37Z-02-AF931L	ACEITE	GP-3682	37-02-OF201	S4D102E, SA4D102E		
FD25ST-5 con motor/A DIESEL			FG20 con motor/NISSAN H20-II			ACEITE	GP-390	6732-51-5140
ACEITE	GP-54	600-211-6140L	ACEITE, CARTUCHO	G-870	15208-32200	S4D120		
FD30 con motor/KOMATSU 4D94E			FG20 con motor/NISSAN H25			ACEITE	G-191	6120-50-5103
DIESEL	GPP-111	129901-55850	ACEITE	GP-3682	37-02-OF201	ACEITE	GP-54	600-211-5240
FD30-10 con motor/KOMATSU			FG20-3, FG20-8, FG20-4, FG20-7 con motor/NISSAN			AGUA	GP-2071W	6110-73-6130
ACEITE	GP-54	600-211-6140L	ACEITE	GP-3682	37-02-OF201	S4D155		
FD30-7, FD30-8 con motor/ISUZU			FG20ST-04, FG20ST-4 con motor/NISSAN			ACEITE, CARTUCHO	G-191	6120-50-5103
ACEITE, SELLADO	GP-3985	37Z-02-OF102	ACEITE	GP-3682	15208-H8916	COMBUSTIBLE	G-1123	6110-73-6130
FD30S-5, FD35-4 con motor/KOMATSU			FG20ST-11 con motor/A DIESEL			AGUA	GP-2071W	600-411-1170
ACEITE	GP-54	600-211-6140	ACEITE	GP-3682	15208-H8916	AIRE, PRIMARIO	GA-326	600-181-4311
FD40 con motor/NISSAN			FG20ST-12 con motor/A DIESEL			AIRE, SECUNDARIO	GA-206	600-181-4211
ACEITE	GP-1	15208-W1120	TRANSMISION	GP-58	AS15000-2300L			
FD45-4, FD45Z-4 con motor/KOMATSU			ACEITE	GP-3682	15208-H8916			
ACEITE	GP-54	600-211-6140	AIRE, SIN ASPAS	GA-33	348-02-31930			
FD80-7 con motores/CUMMINS 6BT5.9, KOMATSU S6D102E			FG25 con motores/NISSAN H20-II, NISSAN H25					
ACEITE	GP-178	6735-51-5140	ACEITE	GP-3682	37-02-OF201			
			FG25L-8 con motor/NISSAN					
			ACEITE	GP-3682	37-02-OF201			

MARCA-MODELO-MOTOR MAKE-MODEL-ENGINE	GONHER GONHER	OEM OEM	MARCA-MODELO-MOTOR MAKE-MODEL-ENGINE	GONHER GONHER	OEM OEM	MARCA-MODELO-MOTOR MAKE-MODEL-ENGINE	GONHER GONHER	OEM OEM
KOMATSU (continuación)			KOMATSU (continuación)			KOMATSU (continuación)		
MOTORES			NIVELADORAS			NIVELADORAS		
S6D102E, SA6D102E			D155A-3, D155AX-3 con motor/KOMATSU S6D140			D20Q-5 con motor/KOMATSU 4D94		
ACEITE	GP-178	6735-51-5140	ACEITE	GP-53	600-211-1231	ACEITE	GP-54	600-211-5242
S6D114E, SA6D114E			COMBUSTIBLE	GP-55	600-311-7132			
ACEITE	GP-3000	1295224-H1	AGUA	GP-1011Q	600-411-1151	D20Q-6 con motor/KOMATSU 4D95S-W		
S6D155			AIRE, SECUNDARIO	GA-6127	6128-81-7042	ACEITE	GP-36	600-211-6242
COMBUSTIBLE	G-1123	6110-73-6130	AIRE, PRIMARIO	GA-6128	6128/-81-7042	D20S-5 con motor/KOMATSU 4D94		
AGUA	GP-2071W	600-411-1170	ACEITE	GP-53	600-211-1230	ACEITE	GP-54	600-211-5242
AIRE	GA-6128	6128-81-7320	D155C-1 con motor/KOMATSU S6D155			D20S-6 con motor/KOMATSU 4D95S-W		
S6DA125			COMBUSTIBLE	GPP-14	600-311-8293	ACEITE	GP-36	600-211-6242
COMBUSTIBLE	GPP-14	600-311-8293	ACEITE	GP-53	600-211-1231	D21-7 con motor/KOMATSU 4D95S		
SA6D155-4			AGUA	GP-1011Q	600-411-1151	ACEITE	GP-36	600-211-6242
ACEITE	G-238	600-211-1210	AIRE, SECUNDARIO	GA-6127	6128-81-7042	D21A-3, D21P-3 con motor/KOMATSU 4D92		
ACEITE, FLUJO TOTAL (FULL FLOW) SELLADO	GP-53	600-211-1230	AIRE, PRIMARIO	GA-6128	6128-81-7042	ACEITE	GP-54	600-211-5240
COMBUSTIBLE	GPP-11	600-311-8291	ACEITE, DERIVACION (BY PASS)	G-750	6610-51-5050	D21A-5 con motor/KOMATSU 4D94		
ACEITE, DERIVACION (BY PASS)	G-750	6610-51-5300	ACEITE, FLUJO TOTAL (FULL FLOW) SELLADO	GP-53	600-211-1231	ACEITE	GP-54	600-211-5242
KOMATSU			D155S-1 con motor/KOMATSU S6D155			D21A-6 con motor/KOMATSU 4D95S-W		
NIVELADORAS			ACEITE, FLUJO TOTAL (FULL FLOW) CARTUCHO	G-191	6120-50-5103	ACEITE	GP-36	600-211-6242
1050 con motor/A DIESEL			ACEITE, FLUJO TOTAL (FULL FLOW) CARTUCHO	G-238	6127-51-5040	D21A-7 con motor/KOMATSU 4D94E		
AIRE	GA-6128	6128-81-7320	COMBUSTIBLE, SELLADO	GPP-14	600-311-8293	DIESEL	GPP-111	FF5160
D135A-2 con motor/KOMATSU S6D140			ACEITE, FLUJO TOTAL (FULL FLOW) SELLADO	GP-53	600-211-1231	D21E-6 con motor/KOMATSU 4D95S-W		
COMBUSTIBLE	GPP-14	600-311-8293	AGUA	GP-1013Q	600-411-1420	ACEITE	GP-36	600-211-6242
ACEITE	GP-53	600-211-1231	AIRE, SECUNDARIO	GA-6127	6127-81-7412	D21P-5 con motor/KOMATSU 4D94		
AGUA	GP-1011Q	600-411-1151	AIRE, PRIMARIO	GA-6128	600-181-4400	ACEITE	GP-54	600-211-5242
AIRE, SECUNDARIO	GA-6127	6128-81-7042	ACEITE, DERIVACION (BY PASS)	G-750	6610-51-5050	D21P-6 con motor/KOMATSU 4D95S-W		
AIRE, PRIMARIO	GA-6128	6128-81-7042	D20-7 con motor/KOMATSU 4D95S			ACEITE	GP-36	600-211-6242
D150A-1 con motor/KOMATSU S6D155			ACEITE	GP-36	600-211-6242	D21P-7 con motor/KOMATSU 4D94E		
ACEITE, FLUJO TOTAL CARTUCHO	G-191	6120-50-5103	D20A-3 con motor/KOMATSU 4D92			DIESEL	GPP-111	FF5160
ACEITE, FLUJO TOTAL CARTUCHO	G-238	6127-51-5040	ACEITE	GP-54	600-211-5240	D21PL-3, D21Q-3, D21S-3 con motor/KOMATSU 4D92		
COMBUSTIBLE, SELLADO	GPP-14	600-311-8293	D20A-5 con motor/KOMATSU 4D94			ACEITE	GP-54	600-211-5240
ACEITE, FLUJO TOTAL SELLADO	GP-53	600-211-1230	ACEITE	GP-54	600-211-5242	D21PL-5 con motor/KOMATSU 4D94		
AGUA	GP-1011Q	600-411-1151	D20A-6 con motor/KOMATSU 4D95S-W			ACEITE	GP-54	600-211-5242
AIRE, SECUNDARIO	GA-6127	6127-81-7412	AIRE	GAK-16	600-181-7300	D21PL-6 con motor/KOMATSU 4D95S-W		
AIRE, PRIMARIO	GA-6128	600-181-4400	D20E-6 con motor/KOMATSU 4D95S-W			ACEITE	GP-36	600-211-6240
ACEITE, DERIVACION (BY PASS)	G-750	6610-51-5050	ACEITE	GP-36	600-211-6242	D21PL-7 con motor/KOMATSU 4D94E		
D155A-1 con motor/KOMATSU S6D155			D20P-3, D20S-3, D20PL-3, D20Q-3 con motor/KOMATSU 4D92			DIESEL	GPP-111	FF5160
ACEITE, FLUJO TOTAL (FULL FLOW) CARTUCHO	G-191	6120-50-5103	ACEITE	GP-54	600-211-5240	D21PL-3, D21Q-3, D21S-3 con motor/KOMATSU 4D92		
ACEITE, FLUJO TOTAL (FULL FLOW) CARTUCHO	G-238	6127-51-5040	D20P-5 con motor/KOMATSU 4D94			ACEITE	GP-54	600-211-5240
COMBUSTIBLE, SELLADO	GPP-14	600-311-8293	ACEITE	GP-54	600-211-5242	D21PL-5 con motor/KOMATSU 4D94		
ACEITE, FLUJO TOTAL SELLADO	GP-53	600-211-1230	D20P-6 con motor/KOMATSU 4D95S-W			ACEITE	GP-54	600-211-5242
AGUA	GP-1011Q	600-411-1151	ACEITE	GP-36	600-211-6242	D21PL-6 con motor/KOMATSU 4D95S-W		
AIRE, SECUNDARIO	GA-6127	6127-81-7412	D20PL-5 con motor/KOMATSU 4D94			ACEITE	GP-36	600-211-6242
AIRE, PRIMARIO	GA-6128	600-181-4400	ACEITE	GP-54	600-211-5242	D21PLL-5 con motor/KOMATSU 4D94		
ACEITE, DERIVACION (BY PASS)	G-750	6610-51-5050	D20PL-6 con motor/KOMATSU 4D95S-W			ACEITE	GP-54	600-211-5242
D155A-2 con motor/KOMATSU S6D155			ACEITE	GP-36	600-211-6242	D21PLL-6 con motor/KOMATSU 4D95S-W		
COMBUSTIBLE	GPP-14	600311-8293	D20PL-5 con motor/KOMATSU 4D94			ACEITE	GP-36	600-211-6242
ACEITE, FLUJO TOTAL (FULL FLOW)	GP-53	600-211-1231	ACEITE	GP-54	600-211-5242	D21Q-5 con motor/KOMATSU 4D94		
AGUA	GP-1011Q	600-411-1151	D20PLL-6 con motor/KOMATSU 4D95S-W			ACEITE	GP-54	600-211-5242
AIRE, SECUNDARIO	GA-6127	6128-81-7042	ACEITE	GP-36	600-211-6242	D21Q-6 con motor/KOMATSU 4D95S-W		
AIRE, PRIMARIO	GA-6128	6128-81-7042				ACEITE	GP-36	600-211-6242

MARCA-MODELO-MOTOR MAKE-MODEL-ENGINE	GONHER GONHER	OEM OEM	MARCA-MODELO-MOTOR MAKE-MODEL-ENGINE	GONHER GONHER	OEM OEM	MARCA-MODELO-MOTOR MAKE-MODEL-ENGINE	GONHER GONHER	OEM OEM
KOMATSU (continuación)			KOMATSU (continuación)			KOMATSU (continuación)		
NIVELADORAS			NIVELADORAS			NIVELADORAS		
D21S-5 con motor/KOMATSU 4D94			D31PL-18 con motor/KOMATSU 6D95L-1			D35S-15 con motor/KOMATSU S4D120		
ACEITE	GP-54	600-211-5242	ACEITE	GP-36	600-211-6242	ACEITE	G-191	6120-50-5103
D21S-6 con motor/KOMATSU 4D95S-W			D31PLL con motor/KOMATSU 6D95L			D37-2 con motor/KOMATSU 6D95L		
ACEITE	GP-36	600-211-6242	ACEITE	GP-36	600-211-6241	ACEITE	GP-53	600-211-1230
D275A-2, D275A-2D con motor/KOMATSU S6D170			D31PLL-16 con motor/KOMATSU 4D105-3			D37-5 con motor/KOMATSU 6D95L		
COMBUSTIBLE	GPP-14	600-311-8293	ACEITE	GP-54	600-211-6241	ACEITE	GP-36	600-211-6242
ACEITE	GP-53	600-211-1231	D31PLL-18 con motor/KOMATSU 6D95L-1			D37-5 con motor/KOMATSU S4D102E (S/N 3731-UP)		
AGUA	GP-1013Q	600-411-1171	ACEITE	GP-36	600-211-6242	COMBUSTIBLE	GP-1122	6732-71-6111
AIRE, SECUNDARIO	GA-6127	6128-81-7042	D31Q-15 con motor/KOMATSU 4D105			ACEITE	GP-390	6732-51-5140
AIRE, PRIMARIO	GA-6128	6128-81-7042	ACEITE	GP-54	600-211-6241	AIRE, SECUNDARIO	GA-361	600-181-6050
D20A-6 con motor/KOMATSU 4D95S-W			D31Q-16 con motor/KOMATSU 4D105-3			D375A-1, D375A-2, D375A-3 con motor/KOMATSU SA6D170		
ACEITE	GP-36	600-211-6241	ACEITE	GP-54	600-211-6241	COMBUSTIBLE	GPP-14	600-311-8293
D30A-15, D30P-15 con motor/KOMATSU 4D105			D31Q-18 con motor/KOMATSU 6D95L-1			ACEITE	GP-53	600-211-1231
ACEITE	GP-54	600-211-6241	ACEITE	GP-36	600-211-6242	AGUA, S/N 11329 EN ADELANTE	GP-1013Q	600-411-1040
D30Q-15, D30S-15 con motor/KOMATSU 4D105			D31S con motor/CUMMINS 4BT3.9			AGUA, S/N 10332-11328	GP-1011Q	600-411-1040
ACEITE	GP-54	600-211-6241	ACEITE	GP-390	6732-51-5140	AIRE, SECUNDARIO	GA-6127	6127-81-7412
D31-20 con motor/KOMATSU 6D95L			D31S-15 con motor/KOMATSU 4D105			AIRE, PRIMARIO	GA-6128	600-181-4400
ACEITE	GP-36	600-211-6242	ACEITE	GP-54	600-211-6241	D37E-2 con motor/KOMATSU 6D95L1		
D31-20 con motor/KOMATSU S4D102E			D31S-16 con motor/KOMATSU 4D105-3			ACEITE	GP-36	600-211-6242
ACEITE	GP-390	6732-51-5140	ACEITE	GP-54	600-211-6241	D37E-5 con motor/KOMATSU 6D95L1		
D31A-15 con motor/KOMATSU 4D105			D31S-18 con motor/KOMATSU 6D95L-1			ACEITE	GP-36	600-211-6241
ACEITE	GP-54	600-211-6241	ACEITE	GP-36	600-211-6242	D37E-5, D37P-5 con motor/KOMATSU S4D102E		
D31A-16 con motor/KOMATSU 4D105-3			D32E-1, D32P-1 con motor/KOMATSU 4D102E			COMBUSTIBLE, SEPARADOR DE AGUA	GPP-1122	6732-71-6310
ACEITE	GP-54	600-211-6241	COMBUSTIBLE, SEPARADOR DE AGUA	GPP-1122	1240619-H2	D37P-2 con motor/KOMATSU 6D95L1		
D31E-18 con motor/KOMATSU 6D95L-1			D355A-1 con motores/KOMATSU S6D155, KOMATSU SA6D155			ACEITE	GP-36	600-211-6242
ACEITE	GP-36	600-211-6242	ACEITE	G-191	6120-50-5103	D38E-1, D38P-1 con motor/KOMATSU S4D102E		
D31E-20, D31EX, D31P-20 con motor/KOMATSU 4D102E			COMBUSTIBLE	G-1123	6127-71-6090	COMBUSTIBLE, SEPARADOR DE AGUA	GPP-1122	1240619-H2
COMBUSTIBLE	GPP-1122	6732-71-6310	AGUA	GP-1011Q	6710-61-8112	HIDRAULICO	GP-761H	1266751-H2
D31E-20, D31P con motor/KOMATSU 6D95L			AIRE, SECUNDARIO	GA-6127	6128-81-7042	AIRE, SECUNDARIO	GA-892	529852-R5
ACEITE	GP-36	600-211-6241	AIRE, PRIMARIO S/N 14050 EN ADELANTE	GA-6128	6128-81-7042	D39E-1, D39P-1 con motor/KOMATSU S4D102E		
D31P-15 con motor/KOMATSU 4D105			AIRE, PRIMARIO HASTA S/N 14050	GA-6129	6127-81-7311	COMBUSTIBLE, SEPARADOR DE AGUA	GPP-1122	1240619-H2
ACEITE	GP-54	600-211-6241	ACEITE, DERIVACION (BY PASS)	G-750	6610-51-5050	HIDRAULICO	GP-761H	1266751-H2
D31P-16 con motor/KOMATSU 4D105-3			D355A-3, D355A-5 con motor/KOMATSU SA6D155			AIRE, SECUNDARIO	GA-892	529852R5
ACEITE	GP-54	600-211-6241	ACEITE, FLUJO TOTAL (FULL FLOW) CARTUCHO	G-238	6127-51-5040	D39EX-21 con motor/KOMATSU SAA4D102E		
D31P-16A con motor/KOMATSU 4D105-3			COMBUSTIBLE, SELLADO	GPP-14	600-311-8293	COMBUSTIBLE	GP-1122	6732-71-6111
ACEITE	GP-54	600-211-5240	ACEITE, FLUJO TOTAL (FULL FLOW) SELLADO	GP-53	600-211-1231	D39EX-22 con motor/KOMATSU SAA4D107E-1		
D31P-18 con motor/KOMATSU 6D95L-1			AGUA, S/N 20338-37512	GP-1013Q	600-411-1420	AIRE, PRIMARIO	GA-697R	600-185-3100
ACEITE	GP-36	600-211-6242	AGUA, S/N 37513 EN ADELANTE	GP-1011Q	600-411-1151	D39PX-21 con motor/KOMATSU SAA4D102E		
D31P-20A con motor/KOMATSU S4D102E			AIRE, SECUNDARIO	GA-6127	6127-81-7412	COMBUSTIBLE	GP-1122	6732-71-6111
COMBUSTIBLE	GP-1122	6732-71-6110	AIRE, PRIMARIO	GA-6128	600-181-4400	D39PX-22 con motor/KOMATSU SAA4D107E-1		
D31P-20A, D31PL con motor/KOMATSU 6D95L			ACEITE, DERIVACION (BY PASS)	G-750	6610-51-5050	AIRE, PRIMARIO	GA-697R	600-185-3100
ACEITE	GP-36	600-211-6241	D355C-3 con motor/KOMATSU S6D155			D40-3 con motor/KOMATSU 6D105		
D31PL-16 con motor/KOMATSU 4D105-3			COMBUSTIBLE	GPP-14	600-311-8293	COMBUSTIBLE, CON PUR-GADOR	GPP-11	600-311-9120
ACEITE	GP-54	600-211-6241	ACEITE	GP-53	600-211-1231	D40A-1, D40P-1 con motor/KOMATSU S4D105		
			AGUA	GP-1011Q	600-411-1151	ACEITE	GP-54	600-211-5242
			AIRE, SECUNDARIO	GA-6127	6127-81-7412			
			AIRE, PRIMARIO	GA-6128	600-181-4400			

APLICACIONES SERVICIO PESADO
HEAVY DUTY APPLICATIONS



MARCA-MODELO-MOTOR MAKE-MODEL-ENGINE	GONHER GONHER	OEM OEM	MARCA-MODELO-MOTOR MAKE-MODEL-ENGINE	GONHER GONHER	OEM OEM	MARCA-MODELO-MOTOR MAKE-MODEL-ENGINE	GONHER GONHER	OEM OEM
KOMATSU (continuación)			KOMATSU (continuación)			KOMATSU (continuación)		
NIVELADORAS			NIVELADORAS			NIVELADORAS		
D40A-3, D40P-3, D40PL-3, D40PLL-3 con motor/KOMATSU 6D105			AIRE, SECUNDARIO	GA-6127	6127-81-7412	D53A-15 con motor/KOMATSU S4D120		
COMBUSTIBLE, CON PURGADOR	GPP-11	600-311-9120	AIRE, PRIMARIO	GA-6128	6128-81-7320	ACEITE, FLUJO TOTAL (FULL FLOW)	G-191	6120-50-5103
D40PL-1, D40PLL-1 con motor/KOMATSU S4D105			D475A-2, D475A-3 con motor/KOMATSU SA12V140			D53A-16, D53P-16 con motor/KOMATSU 4D130		
ACEITE	GP-54	600-211-5242	ACEITE, FLUJO TOTAL (FULL FLOW)	GP-53	600-211-1231	ACEITE, FLUJO TOTAL (FULL FLOW)	G-191	6114-50-5100
D41 con motor/KOMATSU S4D95L			AGUA	GP-1013Q	600-411-1170	COMBUSTIBLE	G-1123	6110-70-6202
ACEITE	GP-54	600-211-6241	COMBUSTIBLE	GP-55	600-311-7110	COMBUSTIBLE	GPP-14	600-311-8293
D41A-3 con motor/KOMATSU 6D105-1			ACEITE, DERIVACION (BY PASS)	GP-57	600-212-1511	AGUA	GP-1013Q	600-411-1420
COMBUSTIBLE, CON PURGADOR	GPP-11	600-311-9120	AIRE, SECUNDARIO	GA-6127	6128-81-7042	D53A-17, D53P-17 con motor/KOMATSU 6D125		
D41A-6 con motor/KOMATSU 6D102-1			AIRE, PRIMARIO	GA-6128	6128-81-7042	COMBUSTIBLE	GPP-14	600-311-8293
COMBUSTIBLE, SEPARADOR DE AGUA	GPP-1122	6732-71-6310	D50A con motor/A DIESEL			D535-15 con motor/KOMATSU S4D120		
ACEITE	GP-178	6735-51-5141	ACEITE, CARTUCHO	G-191	6110-53-5120	ACEITE, FLUJO TOTAL (FULL FLOW)	G-191	6120-50-5103
AIRE, SECUNDARIO	GA-361	600-181-6050	ACEITE, SELLADO	GP-10	528250-R1	D535-16 con motor/KOMATSU 4D130		
D41E-3 con motor/KOMATSU 6D105			AIRE	GA-39	6112-13-8640	ACEITE, FLUJO TOTAL (FULL FLOW)	G-191	6114-50-5100
AGUA	GP-1011Q	6134-61-8110	D50A-15 con motor/KOMATSU 4D120			COMBUSTIBLE	G-1123	6110-70-6202
D41E-6, D41P-6 con motor/KOMATSU S4D102E-1			ACEITE	G-191	6120-50-5103	COMBUSTIBLE, SELLADO	GPP-14	600-311-8293
ACEITE	GP-390	6732-51-5140	D50A-16, D50P-16, D50PL-16 con motor/KOMATSU 4D130			AGUA	GP-1013Q	600-411-1420
D41E-6, D41P-6 con motores/KOMATSU 6D102-1, KOMATSU S6D102E-1			ACEITE, FLUJO TOTAL (FULL FLOW)	G-191	6114-50-5100	D535-17 con motor/KOMATSU 4D130-1		
COMBUSTIBLE	GP-1122	6732-71-6111	COMBUSTIBLE	G-1123	6110-70-6202	COMBUSTIBLE	GPP-14	600-311-8293
ACEITE	GP-178	6735-51-5140	COMBUSTIBLE, SELLADO	GPP-14	600-311-8293	D555-2 con motor/A DIESEL		
AIRE, SECUNDARIO	GA-361	600-181-6050	AGUA	GP-1013Q	600-411-1420	HIDRAULICO	G-222	131-60-48210
D41E-6C con motor/KOMATSU SA6D102E-2A			D50A-17 con motor/KOMATSU 6D125			AIRE	GA-39	6620-21-7550
COMBUSTIBLE	GP-1122	6732-71-6111	COMBUSTIBLE	GPP-14	600-311-8293	ACEITE, DERIVACION (BY PASS)	G-750	6610-51-5300
D41P-3 con motor/KOMATSU 6D105-1			D50F-16 con motor/KOMATSU S4D130			D555-3 con motor/KOMATSU S4D120		
COMBUSTIBLE, CON PURGADOR	GPP-11	600-311-9120	ACEITE	G-191	6114-50-5100	DIRECCION	G-191	145-49-32430
D41P-6C con motor/KOMATSU SA6D102E-2A			COMBUSTIBLE	G-1123	6110-70-6202	ACEITE, FLUJO TOTAL (FULL FLOW)	G-191	145-49-32430
COMBUSTIBLE	GP-1122	6732-71-6111	COMBUSTIBLE	GPP-14	600-311-8291	TRANSMISION	G-191	145-49-32430
D41Q-3, D41S-3 con motor/KOMATSU 6D105-1			AGUA	GP-1011Q	6710-61-8113	HIDRAULICO	G-222	131-60-48210
COMBUSTIBLE, CON PURGADOR	GPP-11	600-311-9120	ACEITE	G-750	6610-51-5050	AGUA	GP-1011Q	6710-61-8112
D455A-1 con motor/CUMMINS VTA1710			D50F-17 con motor/KOMATSU 6D125			AIRE	GA-39	6112-13-8640
ACEITE, FLUJO TOTAL (FULL FLOW)	G-566	6710-50-5101	COMBUSTIBLE	GPP-11	600-311-8291	ACEITE, DERIVACION (BY PASS)	G-750	6610-51-5300
COMBUSTIBLE, SELLADO	GP-55	600-311-7132	D50P-15 con motor/KOMATSU 4D120			D575A-2 con motor/KOMATSU SA12V170		
AGUA	GP-1011Q	600-411-1150	ACEITE	G-191	6120-50-5103	ACEITE, FLUJO TOTAL (FULL FLOW)	GP-53	600-211-1231
AGUA	GP-2071W	6710-61-8112	D50P-17 con motor/KOMATSU 6D125			AGUA	GP-1013Q	600-411-1170
AIRE, SECUNDARIO	GA-6127	6127-81-7412	COMBUSTIBLE	GPP-14	600-311-8293	COMBUSTIBLE	GP-55	600-311-7132
AIRE, PRIMARIO	GA-6128	600-181-400	D50PL-15 con motor/KOMATSU 4D120			ACEITE, DERIVACION (BY PASS)	GP-57	600-212-1511
ACEITE, DERIVACION (BY PASS)	G-750	6610-51-5050	ACEITE	G-191	6120-50-5103	AIRE, SECUNDARIO	GA-6127	6128-81-7042
D45A-1, D45E-1, D45P-1 con motor/KOMATSU S4D105			D50PL-17 con motor/KOMATSU 6D125			AIRE, PRIMARIO	GA-6128	600-311-7111
ACEITE	GP-54	600-211-5242	COMBUSTIBLE	GPP-14	600-311-8293	D575-1 con motor/KOMATSU S4D130 (S/N 6501-19999)		
D45S-1 con motor/KOMATSU S4D105			D50S-15 con motor/KOMATSU 4D120			ACEITE, FLUJO TOTAL (FULL FLOW)	G-191	6114-50-5100
ACEITE	GP-36	600-211-5242	ACEITE	G-191	6120-50-5103	COMBUSTIBLE	G-1123	6110-70-6202
D475A-1 con motor/KOMATSU SA8V170-1			HIDRAULICO	G-222	130-60-18790	COMBUSTIBLE, SELLADO	GPP-14	600-311-8293
ACEITE	GP-53	600-211-1231	ACEITE	GP-10	528250-R1	AGUA	GP-1013Q	600-411-1420
AGUA	GP-1013Q	600-411-1030	AIRE	GA-39	6112-13-8640	ACEITE, DERIVACION (BY PASS)	G-750	6610-51-5050
COMBUSTIBLE	GP-55	600-311-7111	D50S-16 con motor/KOMATSU 4D130			D575-1B con motor/KOMATSU S6D108 (S/N 20001 EN ADELANTE)		
			ACEITE, FLUJO TOTAL (FULL FLOW)	G-191	6114-50-5100	AGUA	GP-2071W	600-411-1191
			COMBUSTIBLE	G-1123	6110-70-6202	D58-1, D58E-1, D58P-1 con motor/KOMATSU 6D125E		
			COMBUSTIBLE, SELLADO	GPP-14	600-3118293	COMBUSTIBLE	GPP-14	600-311-8293
			AGUA	GP-1013Q	600-411-1420			

SERVICIO PESADO

MARCA-MODELO-MOTOR MAKE-MODEL-ENGINE	GONHER GONHER	OEM OEM	MARCA-MODELO-MOTOR MAKE-MODEL-ENGINE	GONHER GONHER	OEM OEM	MARCA-MODELO-MOTOR MAKE-MODEL-ENGINE	GONHER GONHER	OEM OEM
KOMATSU (continuación)			KOMATSU (continuación)			KOMATSU (continuación)		
NIVELADORAS			NIVELADORAS			NIVELADORAS		
D60A-3 con motor/CUMMINS NH220-C1			D60S-6 con motor/KOMATSU NH220C1			AIRE, PRIMARIO	GA-326	6125-81-7032
HIDRAULICO	G-222	131-60-48210	DIRECCION	G-191	145-49-32430	AIRE, SECUNDARIO	GA-206	6125-81-7032
ACEITE, TURBO LUBRICACION	GP-14	6685-81-9910	TRANSMISION	G-191	145-49-32430	D65F-8, D65S-8, D65P-8, D65PL-8 con motor/KOMATSU 6D125		
AIRE	GA-39	6620-21-7550	TRANSMISION	G-813	281-16-11290	COMBUSTIBLE	GPP-14	600-311-8293
ACEITE	G-750	6610-51-5050	AGUA	GP-2071W	6710-61-8112	D65P-6, D65PL-6 con motor/KOMATSU NH220C1		
D60A-6, D60E-6, D60P-6, D60PL-6 con motor/KOMATSU NH220C1			ACEITE, DERIVACION (BY PASS)	G-750	6610-51-5300	DIRECCION	G-191	145-49-32430
DIRECCION	G-191	145-49-32430	D60S-7 con motor/KOMATSU NH220C1			TRANSMISION	G-191	145-49-32430
TRANSMISION	G-191	145-49-32430	DIRECCION	G-813	281-16-11290	TRANSMISION	G-813	281-16-11290
TRANSMISION	G-813	281-16-11290	TRANSMISION	G-813	281-16-11290	AGUA, SELLADO	GP-2071W	6710-61-8112
AGUA, SELLADO	GP-2071W	6710-61-8112	COMBUSTIBLE	GPP-14	600-311-8293	ACEITE, DERIVACION (BY PASS)	G-750	6610-51-5300
AIRE	GA-39	6620-21-7550	ACEITE, FLUJO TOTAL (FULL FLOW)	GP-53	600-211-1230	D65PL-7, D65E-7, D65P-7 con motor/CUMMINS NH220C1		
ACEITE, DERIVACION (BY PASS)	G-750	6610-51-5300	AGUA	GP-2071W	600-411-1020	COMBUSTIBLE	GPP-14	600-311-8293
D60A-7, D60E-7, D60P-7, D60PL-7 con motor/KOMATSU NH220C1			ACEITE, DERIVACION (BY PASS)	G-750	6610-51-5050	AGUA	GP-1010Q	600-411-1020
DIRECCION	G-813	281-16-11290	D60S-8 con motor/KOMATSU 6D125			ACEITE, FLUJO TOTAL (FULL FLOW)	GP-53	600-211-1230
COMBUSTIBLE	GPP-14	600-311-8293	COMBUSTIBLE	GPP-14	600-311-8293	ACEITE, DERIVACION (BY PASS)	G-750	6610-51-5050
AGUA	GP-1010Q	600-411-1020	D61EX-12, D61PX-12 con motor/KOMATSU S6D114E			D65PX-12 con motor/KOMATSU S6D125		
ACEITE, FLUJO TOTAL (FULL FLOW)	GP-53	600-211-1230	AGUA, SISTEMA DE ENFRIAMIENTO	GP-1010Q	6742-01-3970	COMBUSTIBLE	GPP-14	600-311-8293
ACEITE, DERIVACION (BY PASS)	G-750	6610-51-5050	COMBUSTIBLE	GP-1122	6732-71-6112	ACEITE	GP-53	600-211-1231
D60F-7 con motor/CUMMINS NTO6C1			ACEITE, LUBRICACION DE DOBLE FLUJO	GP-3000	6742-01-4120	AGUA	GP-1013Q	600-411-1151
DIRECCION	G-813	281-16-11290	AIRE, PRIMARIO	GA-966R	600-185-4110	AIRE, PRIMARIO	GA-326	6125-81-7032
COMBUSTIBLE	GPP-14	600-311-8293	AIRE, SECUNDARIO	GA-967R	600-185-4120	AIRE, SECUNDARIO	GA-206	6125-81-7032
ACEITE, FLUJO TOTAL (FULL FLOW)	GP-53	600-211-1230	D63E-1 con motor/KOMATSU 6D125			D65S-6 con motor/KOMATSU NH220C1		
AGUA	GP-1013Q	600-411-1151	COMBUSTIBLE	GPP-14	600-311-8293	DIRECCION	G-191	145-49-32430
AIRE, PRIMARIO	GA-106	600-181-4300	D650AW-2C con motor/KOMATSU S6D114			TRANSMISION	G-191	145-49-32430
AIRE, SECUNDARIO	GA-206	600-181-4212	ACEITE	GP-3000	1295224-H1	TRANSMISION	G-813	281-16-11290
ACEITE, DERIVACION (BY PASS)	G-750	6610-51-5050	D65A-7 con motor/KOMATSU NH220C1			AGUA	GP-2071W	6710-61-8112
D60F-7 con motor/KOMATSU NTC743			COMBUSTIBLE	GPP-14	600-311-8293	ACEITE, DERIVACION (BY PASS)	G-750	6610-51-5050
DIRECCION	G-813	281-16-11290	AGUA	GP-1010Q	600-411-1020	D68-1 con motor/CUMMINS N855C		
COMBUSTIBLE	GPP-14	600-311-8293	ACEITE, FLUJO TOTAL (FULL FLOW)	GP-53	600-211-1230	COMBUSTIBLE	GPP-11	600-311-8291
ACEITE, FLUJO TOTAL (FULL FLOW)	GP-53	600-211-1230	ACEITE, DERIVACION (BY PASS)	G-750	6610-51-5050	D68E-1, D68P-1 con motor/KOMATSU 6D125		
AGUA	GP-1013Q	600-411-1151	D65A-8, D65E-8 con motor/KOMATSU 6D125			COMBUSTIBLE, PRIMARIO	GPP-14	600-311-8293
AIRE, PRIMARIO	GA-326	600-181-4300	COMBUSTIBLE	GPP-14	600-311-8293	D70LE con motor/KOMATSU 6D125		
AIRE, SECUNDARIO	GA-206	600-181-4212	ACEITE	GP-53	600-211-1231	COMBUSTIBLE	GPP-14	600-311-8293
ACEITE, DERIVACION (BY PASS)	G-750	6610-51-5050	AGUA	GP-1013Q	600-411-1151	AGUA	GP-1013Q	600-411-1151
D60F-7A con motor/CUMMINS NTC743			AIRE, PRIMARIO	GA-326	6125-81-7032	AIRE, PRIMARIO	GA-326	6125-81-7032
DIRECCION	G-813	281-16-11290	AIRE, SECUNDARIO	GA-206	6125-81-7032	AIRE, SECUNDARIO	GA-206	6125-81-7032
COMBUSTIBLE	GPP-14	600-311-8293	D65E-6 con motor/KOMATSU NH220C1			D75A-1 con motor/KOMATSU S6D125		
ACEITE, FLUJO TOTAL (FULL FLOW)	GP-53	600-211-1230	DIRECCION	G-191	145-49-32430	COMBUSTIBLE	GPP-14	600-311-8293
AGUA	GP-1013Q	600-411-1151	TRANSMISION	G-191	145-49-32430	ACEITE	GP-53	600-211-1231
AIRE, PRIMARIO	GA-106	600-181-4300	TRANSMISION	G-813	281-16-11290	AGUA	GP-1013Q	600-411-1150
AIRE, SECUNDARIO	GA-206	600-181-4212	AGUA, SELLADO	GP-2071W	6710-61-8112	D75S-2 con motor/CUMMINS NH220-C1		
ACEITE, DERIVACION (BY PASS)	G-750	6610-51-5050	ACEITE, DERIVACION (BY PASS)	G-750	6610-51-5300	HIDRAULICO	G-222	131-60-48210
D60F-7A con motor/KOMATSU NTO6C1			D65EX con motor/A DIESEL			ACEITE, TURBO LUBRICACION	GP-14	6685-81-9910
DIRECCION	G-813	281-16-11290	COMBUSTIBLE	GPP-14	600-3118293	AGUA	GP-1011Q	6710-61-8112
COMBUSTIBLE	GPP-14	600-311-8293	D65EX-12, D65P-12 con motor/KOMATSU S6D125			ACEITE, DERIVACION (BY PASS)	G-750	6610-51-5300
ACEITE, FLUJO TOTAL (FULL FLOW)	GP-53	600-211-1230	COMBUSTIBLE	GPP-14	600-311-8293	D75S-3 con motor/CUMMINS NTO6C1		
AGUA	GP-1013Q	600-411-1151	ACEITE	GP-53	600-211-1231	COMBUSTIBLE, SELLADO	GPP-14	600-311-8293
AIRE, PRIMARIO	GA-326	600-181-4300	AGUA	GP-1013Q	600-411-1151			
AIRE, SECUNDARIO	GA-206	600-181-4212						
ACEITE, DERIVACION (BY PASS)	G-750	6610-51-5050						

MARCA-MODELO-MOTOR MAKE-MODEL-ENGINE	GONHER GONHER	OEM OEM	MARCA-MODELO-MOTOR MAKE-MODEL-ENGINE	GONHER GONHER	OEM OEM	MARCA-MODELO-MOTOR MAKE-MODEL-ENGINE	GONHER GONHER	OEM OEM
KOMATSU (continuación)			KOMATSU (continuación)			KOMATSU (continuación)		
NIVELADORAS			NIVELADORAS			NIVELADORAS		
ACEITE, FLUJO TOTAL (FULL FLOW)	GP-53	600-211-1231	D85A-12 con motor/CUMMINS			AIRE, PRIMARIO	GA-6128	600-181-4400
AGUA	GP-1013Q	600-411-1420	DIRECCION	G-191	6610-53-5120	ACEITE, DERIVACION (BY PASS)	G-750	6610-51-5050
AIRE, PRIMARIO	GA-326	600-181-4300	DIRECCION	G-152	154-19-12130	DA75A-3 con motor/KOMATSU SA12V140		
AIRE, SECUNDARIO	GA-206	600-181-4212	ACEITE, TURBO LUBRICACION	GP-14	6685-81-9910	ACEITE	GP-53	600-211-1231
ACEITE, DERIVACION (BY PASS)	G-750	6610-51-5050	AGUA	GP-1011Q	6710-61-8112	AGUA	GP-1013Q	600-411-1170
D75S-5 con motor/KOMATSU S6D125			ACEITE, DERIVACION (BY PASS)	G-750	6610-51-5050	ACEITE	GP-57	600-212-1511
COMBUSTIBLE	GPP-14	600-311-8293	D85A-18, D85E-18, D85P-18 con motor/CUMMINS NT855			AIRE	GA-6127	6128-81-7042
ACEITE	GP-53	600-211-1231	COMBUSTIBLE, SELLADO	GPP-14	600-311-8293	AIRE	GA-6128	6128-81-7042
AGUA	GP-1013Q	600-411-1151	ACEITE, FLUJO TOTAL (FULL FLOW)	GP-53	600-211-1231	GD22-1 con motor/KOMATSU 4D105		
AIRE, PRIMARIO	GA-326	6125-81-7032	AGUA	GP-1011Q	600-411-1151	ACEITE	GP-54	600-211-5240
AIRE, SECUNDARIO	GA-206	6125-81-7032	AIRE, SECUNDARIO	GA-6127	6127-81-7412	GD22AC-1 con motor/KOMATSU 4D105-3		
D80-6, D80-7 con motor/A DIESEL			AIRE, PRIMARIO	GA-6128	600-181-4400	ACEITE	GP-54	600-211-6241
ACEITE	G-191	6120-50-5103	ACEITE, DERIVACION (BY PASS)	G-750	6610-51-5050	GD22H-1 con motor/KOMATSU 4D105-1		
D80A-12 con motor/CUMMINS			D85A-21 con motor/KOMATSU S6D125			ACEITE	GP-54	600-211-5240
DIRECCION	G-191	6610-53-5120	COMBUSTIBLE	GPP-14	600-311-8293	GD28AC-1 con motor/KOMATSU 4D105-3		
DIRECCION	G-152	154-19-12130	ACEITE	GP-53	600-211-1231	ACEITE	GP-54	600-211-6241
ACEITE, TURBO LUBRICACION	GP-14	6685-81-9910	AGUA	GP-1011Q	600-411-1151	GD305A-1A con motor/KOMATSU 6D95L		
AGUA	GP-1011Q	6710-61-8112	AIRE, PRIMARIO	GA-326	6125-81-7032	AGUA	GP-2071W	600-411-1020
ACEITE, DERIVACION (BY PASS)	G-750	6610-51-5050	AIRE, SECUNDARIO	GA-206	6125-81-7032	GD30-5M con motor/KOMATSU 4D120		
D80A-12, D85P-12, D80E-12, D85A-12 con motor/KOMATSU NH220C1			D85E-12 con motor/CUMMINS			ACEITE	G-191	6120-50-5103
AGUA	GP-2071W	6710-61-8112	DIRECCION	G-191	6610-53-5120	GD310RC-3A, GD31RC-3A con motor/KOMATSU 4D130-1		
D80A-18, D80E-18, D80P-18 con motor/CUMMINS NT855			DIRECCION	G-152	154-19-12130	ACEITE	G-191	6114-50-5100
COMBUSTIBLE, SELLADO	GPP-14	600-311-8293	ACEITE, TURBO LUBRICACION	GP-14	6685-81-9910	COMBUSTIBLE	G-1123	6110-70-6202
ACEITE, FLUJO TOTAL (FULL FLOW)	GP-53	600-211-1231	AGUA	GP-1011Q	6710-61-8112	AGUA	GP-1011Q	600-411-1020
AGUA	GP-1011Q	600-411-1151	ACEITE, DERIVACION (BY PASS)	G-750	6610-51-5050	GD313A-1 con motor/KOMATSU 6D95L		
AIRE, SECUNDARIO	GA-6127	6127-81-7412	D85E-21, D85E-SS-2A, D85P-21 con motor/KOMATSU S6D125			ACEITE	GP-36	600-211-6242
AIRE, PRIMARIO	GA-6128	600-181-4400	COMBUSTIBLE	GPP-14	600-311-8293	GD31-3H con motor/KOMATSU 4D120		
ACEITE, DERIVACION (BY PASS)	G-750	6610-51-5060	ACEITE	GP-53	600-211-1231	ACEITE	G-191	6110-53-5120
D80A-8 con motor/CUMMINS NH220 JAPONES			AGUA	GP-1011Q	6710-61-8112	GD34RC-3A con motor/KOMATSU 4S130-1		
HIDRAULICO	G-222	131-60-48210	ACEITE, DERIVACION (BY PASS)	G-750	6610-51-5300	ACEITE	G-191	6120-50-5103
ACEITE, TURBO LUBRICACION	GP-14	6685-81-9910	D87E-2 con motor/KOMATSU S6D125			GD37-5H con motor/KOMATSU 4D120		
AGUA	GP-1011Q	6710-61-8112	ACEITE	GP-53	600-211-1231	ACEITE	G-191	6120-50-5103
ACEITE, DERIVACION (BY PASS)	G-750	6610-51-5300	D87E-2 con motor/KOMATSU S6D125E			GD37-6H con motor/KOMATSU NH220		
D80P-12 con motor/CUMMINS NTO6C1			COMBUSTIBLE	GPP-11	1214920H1	AGUA	GP-1011Q	6710-61-8113
DIRECCION	G-152	154-19-12130	D87P-2 con motor/KOMATSU S6D125			GD40-2 con motor/KOMATSU NH220C1		
AGUA	GP-2071W	6710-61-8112	ACEITE	GP-53	600-211-1231	ACEITE, FLUJO TOTAL (FULL FLOW)	G-566	6710-50-5101
AIRE, PRIMARIO	GA-326	6125-81-7032	D87P-2 con motor/KOMATSU S6D125E			COMBUSTIBLE	G-1176	FF26
AIRE, SECUNDARIO	GA-206	6125-81-7032	COMBUSTIBLE	GPP-11	1214920H1	AGUA	GP-2071W	6710-61-8112
ACEITE, DERIVACION (BY PASS)	G-750	6610-51-5300	D95S-1 con motor/KOMATSU S4D155-4			ACEITE, DERIVACION (BY PASS)	G-750	6610-51-5300
D80S con motor/A DIESEL			ACEITE, FLUJO TOTAL (FULL FLOW)	G-191	6120-50-5103	GD405A-1 con motor/KOMATSU 6D105		
ACEITE, DERIVACION (BY PASS)	G-750	6610-51-5300	DIRECCION	G-152	154-19-12130	AGUA	GP-1011Q	600-411-1151
D83-1 con motor/A DIESEL			TRANSMISION	G-152	154-19-12130	GD40HT-2 con motor/CUMMINS NH-220		
ACEITE	GP-53	600-211-1230	AGUA	GP-2071W	6710-61-8112	AGUA	GP-1011Q	6710-61-8113
COMBUSTIBLE	GPP-11	600-311-8291	AIRE, PRIMARIO	GA-326	6125-81-7032	GD416A-1 con motor/KOMATSU S6D95L-1		
AGUA	GP-1011Q	600-411-1150	AIRE, SECUNDARIO	GA-206	6125-81-7032	ACEITE	GP-36	600-211-6241
AIRE, PRIMARIO	GA-326	6125-81-7032	ACEITE, DERIVACION (BY PASS)	G-750	6610-51-5300			
AIRE, SECUNDARIO	GA-206	6125-81-7032	D95S-2 con motor/CUMMINS NT855					
D83E-1, D83P-1 con motor/KOMATSU S6D125			COMBUSTIBLE	GPP-14	600-311-8293			
COMBUSTIBLE	GPP-14	600-311-8293	ACEITE, FLUJO TOTAL (FULL FLOW)	GP-53	600-211-1231			
ACEITE	GP-53	600-211-1231	AGUA	GP-1011Q	600-411-1151			
AGUA	GP-1011Q	600-411-1151	AIRE, SECUNDARIO	GA-6127	6127-81-7412			
AIRE, PRIMARIO	GA-326	6125-81-7032						
AIRE, SECUNDARIO	GA-206	6125-81-7032						

MARCA-MODELO-MOTOR MAKE-MODEL-ENGINE	GONHER GONHER	OEM OEM	MARCA-MODELO-MOTOR MAKE-MODEL-ENGINE	GONHER GONHER	OEM OEM	MARCA-MODELO-MOTOR MAKE-MODEL-ENGINE	GONHER GONHER	OEM OEM
KOMATSU (continuación)			KOMATSU (continuación)			KOMATSU (continuación)		
NIVELADORAS			NIVELADORAS			NIVELADORAS		
GD461A-1 con motor/KOMATSU S6D95L-1			ACEITE, FLUJO TOTAL (FULL FLOW)	GP-53	600-211-1231	AGUA	GP-1011Q	600-411-1151
ACEITE	GP-36	600-211-6241	AGUA	GP-1011Q	600-411-1151	ACEITE, DERIVACION (BY PASS)	G-750	6610-51-5050
GD500R-1 con motor/KOMATSU S4D130-1			ACEITE, DERIVACION (BY PASS)	G-750	6610-51-5050	GD650R-3 con motor/KOMATSU 6D125-1		
ACEITE, FLUJO TOTAL (FULL FLOW)	G-191	6114-50-5100	GD600R-3 con motor/KOMATSU 6D125-1			COMBUSTIBLE	GPP-14	281-16-11290
COMBUSTIBLE	G-1123	6110-70-6202	COMBUSTIBLE	GPP-14	600-311-8293	GD655 con motor/KOMATSU SA6D102E		
AGUA	GP-1011Q	600-411-1151	GD605A-1 con motor/KOMATSU NH220			ACEITE	GP-178	6735-51-5140
ACEITE, DERIVACION (BY PASS)	G-750	6610-51-5050	AGUA	GP-1011Q	600-411-1151	GD655-3 con motor/KOMATSU S6D114E		
GD500R-2 con motor/KOMATSU S6D105-1			GD605A-2, GD605R-2, GD655A-2, GD655R-2 con motor/CUMMINS NH220			ACEITE	GP-3000	1295224-H1
AGUA	GP-1013Q	600-411-1420	COMBUSTIBLE	GPP-14	600-311-8293	GD655A-1 con motor/CUMMINS NH220		
GD500R-5 con motor/A DIESEL			ACEITE, FLUJO TOTAL (FULL FLOW)	GP-53	600-211-1231	AGUA	GP-1011Q	600-411-1151
AGUA	GP-2071W	6710-61-8112	AGUA	GP-1011Q	600-411-1151	GD655A-3 con motor/KOMATSU 6D125-1		
GD505A-2, GD505R-2 con motor/KOMATSU S6D105-1			ACEITE, DERIVACION (BY PASS)	G-750	6610-51-5050	COMBUSTIBLE	GPP-14	600-311-8293
AGUA	GP-1013Q	600-411-1420	GD605A-3 con motor/KOMATSU 6D125-1			GD655R-1 con motor/CUMMINS NH220		
GD510R-1 con motor/KOMATSU S6D95L-1			COMBUSTIBLE	GPP-14	600-311-8293	AGUA	GP-1011Q	600-411-1151
ACEITE	GP-36	600-211-6241	GD605R-1 con motor/KOMATSU NH220			GD655R-3 con motor/KOMATSU 6D125-1		
GD510R-2 con motor/KOMATSU S6D95L			AGUA	GP-1011Q	600-411-1151	COMBUSTIBLE	GPP-14	600-311-8293
AGUA	GP-2071W	600-411-1191	GD605R-3 con motor/KOMATSU 6D125-1			GD661A-1 con motor/KOMATSU S6D95L		
GD511A-1, GD513R-1, GD511R-1, GD513A-1 con motor/KOMATSU S6D95L			COMBUSTIBLE	GPP-14	600-311-8293	AGUA	GP-2071W	600-411-1191
ACEITE	GP-36	600-211-6241	GD611A-1, GD611R-1, GD613R-1 con motor/KOMATSU S6D105-1			GD663A-1 con motor/KOMATSU 6D125-1		
GD515A-1, GD521R-1 con motor/KOMATSU S6D105-1			AGUA	GP-2071W	600-411-1191	COMBUSTIBLE	GPP-14	600-311-8293
AGUA	GP-1011Q	600-411-1140	GD613A-1, GD623A-1 con motor/KOMATSU 6D125-1			GD670-1, GD670A-2 con motor/CUMMINS 614T		
GD523 con motor/CUMMINS 6BT5.9			COMBUSTIBLE	GPP-14	600-311-8293	COMBUSTIBLE, SECUNDARIO	GP-1122	161624
ACEITE	GP-178	6735-51-5140	GD615A-1 con motor/KOMATSU S6D110-1			ACEITE	GP-3000	1294153-H1
GD523A-1, GD523R-1, GD525A-1 con motor/KOMATSU S6D105-1			AGUA	GP-1011Q	600-411-1140	COMBUSTIBLE, PRIMARIO	GPP-18	161623
AGUA	GP-1011Q	600-411-1140	GD621A-1, GD621R-1 con motor/KOMATSU S6D105-1			ACEITE, CONVERTIDOR DE TORSION	GP-761H	1281327-H1
GD530A-1, GD530A-2 con motor/CUMMINS			AGUA	GP-2071W	600-411-1191	GD670A-2C, GD670AW-2C con motor/KOMATSU S6D114E		
COMBUSTIBLE, SECUNDARIO	GP-1122	161624	GD623 con motor/CUMMINS 6BT5.9			COMBUSTIBLE, SECUNDARIO	GP-1122	161624
COMBUSTIBLE, PRIMARIO	GPP-18	161623	ACEITE	GP-178	6735-51-5140	ACEITE	GP-3000	1294153-H1
ACEITE	GP-178	1240388-H1	GD623R-1 con motor/KOMATSU S6D105-1			COMBUSTIBLE, PRIMARIO	GPP-18	161623
HIDRAULICO	GP-761H	1266751-H2	AGUA	GP-2071W	600-411-1191	ACEITE, CONVERTIDOR DE TORSION	GP-761H	1281327-H1
GD530A-2, GD530A-2C con motores/KOMATSU S6D102, KOMATSU S6D102E			GD625A-1 con motor/KOMATSU 6D125			GD675-3 con motor/KOMATSU SA6D114E		
ACEITE	GP-178	6735-51-5140	COMBUSTIBLE	GPP-14	600-311-8293	ACEITE	GP-3000	1295224-H1
GD530AW-2 con motor/KOMATSU S6D114E			GD650-1, GD650A-2 con motor/KOMATSU S6D114			GD705A-3 con motor/CUMMINS NTO6		
ACEITE	GP-3000	1295224-H1	COMBUSTIBLE, SECUNDARIO	GP-1122	161624	COMBUSTIBLE	GPP-14	600-311-8293
GD530AW-2C con motor/KOMATSU S6D102E			ACEITE	GP-3000	1294153-H1	ACEITE, FLUJO TOTAL (FULL FLOW)	GP-53	600-211-1231
ACEITE	GP-178	6735-51-5140	AGUA	GP-2071W	1261387-H1	AGUA	GP-1011Q	600-411-1151
GD555-3, GD555-3C con motores/KOMATSU SA6D102E, KOMATSU SAA6D102E			COMBUSTIBLE, PRIMARIO	GPP-18	161623	AIRE, PRIMARIO	GA-326	6125-81-7032
COMBUSTIBLE	GP-1122	6732-71-6112	ACEITE, CONVERTIDOR DE TORSION	GP-761H	1281327-H1	AIRE, SECUNDARIO	GA-206	6125-81-7032
COMBUSTIBLE, SEPARADOR DE AGUA	GPP-18	6732-71-6120	GD650A-2C, GD650AW-2C con motor/KOMATSU S6D114			ACEITE, DERIVACION (BY PASS)	G-750	6610-51-5050
AIRE, PRIMARIO	GA-697R	600-185-3110	ACEITE	GP-3000	1295224-H1	GD705A-3, GD705A-4 con motor/KOMATSU S6D125-1		
GD600R-1 con motor/KOMATSU NH220			GD650R-1 con motor/CUMMINS NH-220			COMBUSTIBLE	GPP-14	600-311-8293
AGUA	GP-1011Q	600-411-1151	AGUA	GP-1011Q	600-411-1151	ACEITE	GP-53	600-211-1231
GD600R-2 con motor/KOMATSU NH220			GD650R-2 con motor/CUMMINS NH-220			AGUA	GP-1011Q	600-411-1151
COMBUSTIBLE	GPP-14	600-311-8293	COMBUSTIBLE	GPP-14	600-311-8293	AIRE, PRIMARIO	GA-326	6125-81-7032
			ACEITE, FLUJO TOTAL (FULL FLOW)	GP-53	600-211-1231	AIRE, SECUNDARIO	GA-206	6125-81-7032
						GD705R-2 con motor/CUMMINS NH-220		
						TRANSMISION	G-191	145-49-32430
						AGUA	GP-1011Q	600-411-1151

MARCA-MODELO-MOTOR MAKE-MODEL-ENGINE	GONHER GONHER	OEM OEM
KOMATSU (continuación)		
NIVELADORAS		
ACEITE, DERIVACION (BY PASS)	G-750	6610-51-5050
GD705R-4 con motor/KOMATSU 6D125-1		
COMBUSTIBLE	GPP-14	600-311-8293
GD725A-1 con motor/KOMATSU S6D125		
COMBUSTIBLE	GPP-14	600-311-8293
ACEITE	GP-53	600-211-1231
AGUA	GP-1011Q	600-411-1151
AIRE, PRIMARIO	GA-326	6125-81-7032
AIRE, SECUNDARIO	GA-206	6125-81-7032
GD750A-1 con motor/CUMMINS M11		
ACEITE	GP-3000	1295224-H1
GD825A-1 con motor/KOMATSU S6D140		
ACEITE	GP-53	600-211-1231
COMBUSTIBLE	GP-55	600-311-7132
AGUA	GP-1011Q	600-411-1151
AIRE, SECUNDARIO	GA-6127	6128-81-7042
AIRE, PRIMARIO	GA-6128	6128-81-7042
GD825A-2 con motor/KOMATSU S6D140 SERIES		
ACEITE	GP-53	600-211-1231
COMBUSTIBLE	GP-55	600-311-7132
AGUA	GP-1011Q	600-411-1151
AIRE, SECUNDARIO	GA-6127	6128-81-7042
AIRE, PRIMARIO	GA-6128	6128-81-7042
GD825A-4 con motor/A DIESEL		
ACEITE	GP-53	600-211-1231
COMBUSTIBLE	GP-55	600-311-7132
AGUA	GP-2071W	6710-61-8112
AIRE, SECUNDARIO	GA-6127	6128-81-7042
AIRE, PRIMARIO	GA-6128	6128-81-7042
GS360-1 con motor/A DIESEL		
ACEITE, FLUJO TOTAL (FULL FLOW)	GP-53	600-211-1231
COMBUSTIBLE	GPP-11	600-311-9121
AGUA	GP-2071W	6710-61-8112
AIRE, SECUNDARIO	GA-6127	6128-81-7042
AIRE, PRIMARIO	GA-6128	6128-81-7042
ACEITE, DERIVACION (BY PASS)	G-750	6610-51-5300
JV100-1 con motor/A DIESEL		
AGUA	GP-2071W	6710-61-8112
LW160-1, LW200L-1 con motor/A DIESEL		
AGUA	GP-2071W	6710-61-8112
AIRE, PRIMARIO	GA-326	6125-81-7032
AIRE, SECUNDARIO	GA-206	6125-81-7032
LW250L-1 con motor/A DIESEL		
ACEITE	GP-53	600-211-1231
COMBUSTIBLE	GPP-11	600-311-9121
AGUA	GP-2071W	6710-61-8112
TD8H, TD8LGP, TD9H, TD9LGP con motor/KOMATSU S4D102E		
COMBUSTIBLE, SEPARADOR DE AGUA	GPP-1122	6732-71-6310
WD600-1 con motor/KOMATSU S6D170		
COMBUSTIBLE	GPP-14	600-311-9120
ACEITE	GP-53	600-211-1230
AGUA	GP-1013Q	600-411-1170

MARCA-MODELO-MOTOR MAKE-MODEL-ENGINE	GONHER GONHER	OEM OEM
KOMATSU (continuación)		
NIVELADORAS		
AIRE, SECUNDARIO	GA-6127	6128-81-7042
AIRE, PRIMARIO	GA-6128	600-181-4400
KOMATSU		
RASPADORAS		
WS16-2 con motor/CUMMINS NTO6		
AGUA	GP-2071W	6710-61-8112
WS16S-1 con motor/CUMMINS NTA855		
ACEITE, FLUJO TOTAL (FULL FLOW)	GP-53	600-211-1231
AGUA	GP-2071W	6710-61-8112
AIRE, SECUNDARIO	GA-6127	6128-81-7042
AIRE, PRIMARIO	GA-6128	6128-81-7042
ACEITE, DERIVACION (BY PASS)	G-750	6610-51-5300
WS16S-2, WS23-1 con motor/CUMMINS NTA855		
ACEITE, FLUJO TOTAL (FULL FLOW)	GP-53	600-211-1231
COMBUSTIBLE	GPP-11	600-311-9121
AGUA	GP-2071W	6710-61-8112
AIRE, SECUNDARIO	GA-6127	6128-81-7042
AIRE, PRIMARIO	GA-6128	6128-81-7042
ACEITE, DERIVACION (BY PASS)	G-750	6610-51-5300
WS16S-3 con motor/KOMATSU S6D140		
ACEITE	GP-53	600-211-1230
COMBUSTIBLE	GP-55	600-311-7130
AGUA	GP-1011Q	600-411-1150
AIRE, SECUNDARIO	GA-6127	6128-81-7042
AIRE, PRIMARIO	GA-6128	6128-81-7042
WS23-2 con motor/KOMATSU S6D140-1		
ACEITE	GP-53	600-211-1230
COMBUSTIBLE	GP-55	600-311-7130
AGUA	GP-1011Q	600-411-1150
AIRE, SECUNDARIO	GA-6127	6128-81-7042
AIRE, PRIMARIO	GA-6128	6128-81-7042
WS23S-1 con motor/KOMATSU KT1150		
ACEITE, FLUJO TOTAL (FULL FLOW)	GP-53	600-211-1231
COMBUSTIBLE	GP-55	600-311-7132
AGUA	GP-2071W	1261387-H1
AIRE, SECUNDARIO	GA-6127	6128-81-7042
AIRE, PRIMARIO	GA-6128	6128-81-7042
ACEITE, DERIVACION (BY PASS)	G-750	6610-51-5300
WS23S-2 con motor/KOMATSU S6D140		
ACEITE, FLUJO TOTAL (FULL FLOW)	GP-53	600-211-1230
COMBUSTIBLE	GP-55	600-311-7130
AGUA	GP-2071W	600-411-1170
AIRE, SECUNDARIO	GA-6127	6128-81-7042
AIRE, PRIMARIO	GA-6128	6128-81-7042
KOMATSU		
TRACTORES		
D10A-1, D10S-1 con motor/KOMATSU 2D92		
ACEITE	GP-54	600-211-5240
D10S-2 con motor/KOMATSU 2D94		
ACEITE	GP-54	600-211-5240

MARCA-MODELO-MOTOR MAKE-MODEL-ENGINE	GONHER GONHER	OEM OEM
KOMATSU (continuación)		
TRACTORES		
D120 con motor/A DIESEL		
AGUA	GP-1011Q	6710-61-8112
D120A-18, D125A-18 con motor/CUMMINS		
ACEITE, DERIVACION (BY PASS)	G-750	6610-51-5300
D135-1 con motor/KOMATSU S6D125		
COMBUSTIBLE	GPP-14	600-311-8391
ACEITE	GP-53	600-211-1230
AGUA	GP-1012Q	600-411-1020
AIRE, PRIMARIO	GA-326	600-181-4311
AIRE, SECUNDARIO	GA-206	600-181-4212
D135A-1 con motor/KOMATSU SA6D125		
COMBUSTIBLE	GPP-14	600-311-8293
ACEITE	GP-53	600-211-1231
AGUA	GP-1011Q	600-411-1151
AIRE, PRIMARIO	GA-326	600-181-4300
AIRE, SECUNDARIO	GA-206	6128-81-7042
D40PF SOBRE ORUGAS con motor/CUMMINS 6BTS.9		
ACEITE	GP-178	6735-51-5140
D55 con motor/A DIESEL		
ACEITE	G-222	131-60-48210
D55S con motor/A DIESEL		
ACEITE	G-191	6110-53-5120
HIDRAULICO	G-222	131-60-48210
COMBUSTIBLE	G-1123	6110-73-6130
AGUA	GP-1011Q	6710-61-8112
AIRE	GA-39	6112-13-8640
ACEITE, DERIVACION (BY PASS)	G-500	6671-50-5300
ACEITE, DERIVACION (BY PASS)	G-750	6610-51-5050
D60F-8A con motor/KOMATSU S6D125		
ACEITE	GP-53	600-211-1230
COMBUSTIBLE	GPP-11	600-311-8291
AGUA	GP-1012Q	600-411-1020
AIRE, PRIMARIO	GA-326	600-181-4311
AIRE, SECUNDARIO	GA-206	600-181-4212
D60P-3 con motor/CUMMINS NH220-C1		
ACEITE	G-222	131-60-48210
ACEITE, TURBO LUBRICACION	GP-14	6685-81-9910
HIDRAULICO	GA-39	6620-21-7550
ACEITE	G-750	6610-51-5050
D60S-3 con motor/CUMMINS NH220-C1		
HIDRAULICO	G-222	131-60-48210
ACEITE, TURBO LUBRICACION	GP-14	6685-81-9910
AIRE	GA-39	6620-21-7550
ACEITE	G-750	6610-51-5050
D65 con motor/A DIESEL		
ACEITE, DERIVACION (BY PASS)	G-750	6610-51-5050
D65A-6 con motor/CUMMINS NH220-C1		
HIDRAULICO	G-222	131-60-4810
ACEITE, TURBO LUBRICACION	GP-14	6685-81-9910
AGUA	GP-1011Q	6710-61-8112
AIRE	GA-39	6620-21-7550
ACEITE, DERIVACION (BY PASS)	G-750	6610-51-5050

SERVICIO PESADO

MARCA-MODELO-MOTOR	GONHER	OEM
MAKE-MODEL-ENGINE	GONHER	OEM

KOMATSU (continuación)

TRACTORES

D65S-7 con motor/CUMMINS NH220-C1 S/N 40001-UP		
COMBUSTIBLE	GPP-14	600-311-8293
ACEITE	GP-53	600-211-1230
AGUA	GP-1011Q	600-411-1020
AIRE	GA-39	6620-21-7550
AIRE	GA-6127	6128-81-7412
AIRE	GA-6129	P117433
ACEITE	G-750	6610-51-5050
D65S-8 con motor/KOMATSU S6D125 S/N 45001-UP		
COMBUSTIBLE	GPP-11	600-311-8293
D75S con motor/CUMMINS NH220-C1		
HIDRAULICO	G-222	131-60-48210
ACEITE, TURBO LUBRICACION	GP-14	6685-81-9910
AGUA	GP-1011Q	6710-61-8112
AIRE	GA-39	6620-21-7550
ACEITE, DERIVACION (BY PASS)	G-750	6610-51-5050
D85C-12 con motor/A DIESEL		
AGUA	GP-1011Q	6710-61-8112
D85F-18 con motor/CUMMINS NT-855		
COMBUSTIBLE	GPP-14	600-311-8291
ACEITE	GP-53	600-211-1230
AGUA	GP-1011Q	6710-61-8113
AIRE, SECUNDARIO	GA-6127	6127-81-7412
AIRE, PRIMARIO	GA-6128	6128-81-7320
ACEITE, DERIVACION (BY PASS)	G-750	6610-51-5050

KRYSTAL BUS

CAMIONES, TRACTOCAMIONES Y AUTOBUSES

CUT-AWAY CHASSIS con motor/FORD V10 6.8L A GASOLINA		
ACEITE	GP-68	F1AZ-6731-BD

KW-DART

CARGADORAS

D600 con motor/CATERPILAR D348		
COMBUSTIBLE	G-1166	1R0724
D600 con motor/CUMMINS VTA1710-C700		
COMBUSTIBLE, CARTUCHO	G-1143	139097
COMBUSTIBLE, SELLADO	GP-55	299202
AGUA, SISTEMA DE ENFRIAMIENTO	GP-1011Q	20960
AIRE, RESPIRADOR	GA-39	123716
AIRE, PRIMARIO	GA-879	AA2906
D600 con motor/GMC 16V-92T		
AIRE, PRIMARIO	GA-879	6947176

LANDINI

TRACTORES

LEGEND 180 TDI con motor/PERKINS 1006-E60TA		
ACEITE	GP-31	2254347

LIEBHERR

EXCAVADORAS

A904 con motor/LIEBHERR D924		
COMBUSTIBLE, PRIMARIO	GPP-421	7381877
AGUA, SISTEMA DE ENFRIAMIENTO	GP-2071W	7367045

MARCA-MODELO-MOTOR	GONHER	OEM
MAKE-MODEL-ENGINE	GONHER	OEM

LIEBHERR (continuación)

EXCAVADORAS

COMBUSTIBLE, SECUNDARIO	GPP-419	7381645
AIRE, PRIMARIO	GA-697R	7412732
A912 Li con motor/A DIESEL		
ACEITE	GP-54	5502096
COMBUSTIBLE, PRIMARIO HASTA S/N 2376	GPP-1122	7008776
COMBUSTIBLE, SEPARADOR DE AGUA S/N 2376-5000	GPP-11	7364111
COMBUSTIBLE, PRIMARIO S/N 5000 EN DELANTE	GPP-421	7381877
AGUA, SISTEMA DE ENFRIAMIENTO	GP-2071W	7367045
COMBUSTIBLE, SECUNDARIO S/N 5000 EN DELANTE	GPP-419	7381645
AIRE, PRIMARIO	GA-697R	7412732
A914, R914, R914 Li con motor/LIEBHERR D924		
ACEITE	GP-54	5502096
COMBUSTIBLE, PRIMARIO	GPP-421	7381877
AGUA, SISTEMA DE ENFRIAMIENTO	GP-2071W	7367045
COMBUSTIBLE, SECUNDARIO	GPP-419	7381645
AIRE, PRIMARIO	GA-697R	7412732
R904, R904 Li con motor/LIEBHERR D924		
COMBUSTIBLE, PRIMARIO	GPP-421	7381877
AGUA, SISTEMA DE ENFRIAMIENTO	GP-2071W	7367045
COMBUSTIBLE, SECUNDARIO	GPP-419	7381645
AIRE, PRIMARIO	GA-697R	7412732
R912 Li con motor/A DIESEL		
COMBUSTIBLE, PRIMARIO HASTA S/N 2628	GPP-1122	7008776
COMBUSTIBLE, SEPARADOR DE AGUA S/N 2628-4000	GPP-11	7364111
COMBUSTIBLE, PRIMARIO S/N 4000 EN DELANTE	GPP-421	7381877
AGUA, SISTEMA DE ENFRIAMIENTO	GP-2071W	7367045
COMBUSTIBLE, SECUNDARIO S/N 4000 EN DELANTE	GPP-419	7381645
AIRE, PRIMARIO	GA-697R	7412732
R984 Li con motor/CUMMINS KTA19C		
ACEITE, DERIVACION (BY PASS)	GP-57	5604365
AGUA, SISTEMA DE ENFRIAMIENTO	GP-2071W	7367045
COMBUSTIBLE, SEPARADOR DE AGUA, REQUIERE 2 PIEZAS	GPP-1000	fs1000
AIRE, PRIMARIO	GA-563	7364869

LIEBHERR

NIVELADORAS

L512 (TYPE 466), L514 con motor/A DIESEL		
COMBUSTIBLE, SECUNDARIO	GPP-420	7090244
L524 con motor/A DIESEL		
AIRE, PRIMARIO	GA-697R	7412732
L528 2PLUS1 con motor/LIEBHERR D504TI		
AIRE, PRIMARIO	GA-697R	7412732
LR622, LR622M con motor/LIEBHERR D924T		
COMBUSTIBLE, PRIMARIO S/N 2030 EN DELANTE	GPP-421	7381877

MARCA-MODELO-MOTOR	GONHER	OEM
MAKE-MODEL-ENGINE	GONHER	OEM

LIEBHERR (continuación)

NIVELADORAS

AGUA, SISTEMA DE ENFRIAMIENTO S/N 2030 EN DELANTE	GP-1011Q	7381493
COMBUSTIBLE, SECUNDARIO S/N 2030 EN DELANTE	GPP-419	7381645
AIRE, PRIMARIO S/N 2030 EN DELANTE	GA-697R	7412732
PR712 con motor/LIEBHERR D924T		
COMBUSTIBLE, PRIMARIO HASTA S/N 3000 EN DELANTE	GPP-1122	7381493
COMBUSTIBLE, PRIMARIO	GPP-421	7381877
AGUA, SISTEMA DE ENFRIAMIENTO S/N 3000 EN DELANTE	GP-1011Q	7381493
COMBUSTIBLE, SECUNDARIO S/N 3000 EN DELANTE	GPP-419	7381645
AIRE, PRIMARIO S/N 3000 EN DELANTE	GA-697R	7412732
PR712B con motor/LIEBHERR D924T		
COMBUSTIBLE, PRIMARIO HASTA S/N 3000	GPP-1122	7008776
COMBUSTIBLE, PRIMARIO	GPP-421	7381877
AGUA, SISTEMA DE ENFRIAMIENTO S/N 3000 EN DELANTE	GP-1011Q	7381493
COMBUSTIBLE, SECUNDARIO S/N 3000 EN DELANTE	GPP-419	7381645
AIRE, SECUNDARIO S/N 3000 EN DELANTE	GA-697R	7412732
PR722, PR722B con motor/LIEBHERR D924T		
COMBUSTIBLE, PRIMARIO HASTA S/N 3000	GPP-1122	7008776
COMBUSTIBLE, PRIMARIO S/N 3000 EN DELANTE	GPP-421	7381877
AGUA, SISTEMA DE ENFRIAMIENTO S/N 3000 EN DELANTE	GP-1011Q	7381493
COMBUSTIBLE, SECUNDARIO S/N 3000 EN DELANTE	GPP-419	7381645
AIRE, PRIMARIO S/N 3000 EN DELANTE	GA-697R	7412732
LISTER		
BOMBAS		
365/600 con motor/A DIESEL		
AIRE	GA-37	284203
LISTER		
COMPRESORES		
ARM2 220 con motor/FORD 2741E		
ACEITE	G-834	2702E-6731-A
COMBUSTIBLE	G-296	7111/296
COMBUSTIBLE	G-296-B	7111/296
ARM2 260 con motor/FORD 2741E		
ACEITE	G-834	2702E-6731-A
COMBUSTIBLE	G-296	7111/296
COMBUSTIBLE	G-296-B	351-29760
ARM2 260 S con motor/FORD 2741E		
ACEITE	G-834	2702E-6731-A
COMBUSTIBLE	G-296	7111/296
COMBUSTIBLE	G-296-B	7111/296
PJ 50 con motor/LISTER PJ2		
ACEITE	G-870	352-31720

MARCA-MODELO-MOTOR MAKE-MODEL-ENGINE	GONHER GONHER	OEM OEM
LISTER (continuación)		
COMPRESORES		
PJ 85 con motor/LISTER PJA14		
ACEITE	G-870	352-31720
R140, R140S, R175PD con motor/FORD 2711E		
ACEITE	G-834	2702E-6731-A
ACEITE	G-836	C2TZ-6714-A
ACEITE	G-870	352-31720
COMBUSTIBLE	G-296	7111/296
COMBUSTIBLE	G-296-B	7111/296

LISTER		
GENERADORES		
HSL13 con motor/LISTER TS2		
ACEITE	GP-58	201-55370
HSL15 con motor/LISTER TR2		
ACEITE	GP-58	201-55370
HSL19 con motor/LISTER TS3		
ACEITE	GP-58	201-55370
HSL24 con motor/LISTER TR3		
ACEITE	GP-58	201-55370
HSL6 con motor/LISTER TS1		
ACEITE	GP-58	201-55370
HSL8 con motor/LISTER TR1		
ACEITE	GP-58	201-55370
LXD18 con motor/LISTER 3X90		
COMBUSTIBLE	GPP-1122	751-18100
LXD26 con motor/LISTER 4X90		
COMBUSTIBLE	GPP-1122	751-18100
LXD280, LXD280S con motor/LISTER 4X90		
ACEITE	G-191	328-21600
LXD37 con motor/LISTER 4X90T		
COMBUSTIBLE	GPP-1122	751-18100

LISTER		
MOTORES		
353 A DIESEL, HA A DIESEL, HA2 A DIESEL, HA3 A DIESEL, HA4 A DIESEL, HAMGR MARINO A DIESEL, HB2 A DIESEL, HB2MGR MARINO A DIESEL, HB3 A DIESEL, HB3MGR MARINO A DIESEL, HR3 A DIESEL, HR3A A DIESEL, HRW3 A DIESEL, HW2 A DIESEL		
ACEITE	G-870	352-31720
COMBUSTIBLE	G-296	7111/296
COMBUSTIBLE	G-296-B	351-29760
353 A DIESEL, HA2 A DIESEL, HA3 A DIESEL, HA4 A DIESEL, HB2 A DIESEL		
ACEITE	G-870	352-31720
COMBUSTIBLE	G-11816	P779283
COMBUSTIBLE	G-296	351-29760
COMBUSTIBLE	G-296-B	351-29760
367 A GASOLINA, HA MARINO A DIESEL, HA2MGR MARINO A DIESEL, HA3MGR MARINO A DIESEL, HRW2 A DIESEL		
ACEITE	G-870	352-31720

MARCA-MODELO-MOTOR MAKE-MODEL-ENGINE	GONHER GONHER	OEM OEM
LISTER (continuación)		
MOTORES		
3X90 A DIESEL, 4X90 A DIESEL		
COMBUSTIBLE	GPP-1122	751-18100
AC1 A GASOLINA, AD1 A GASOLINA, LP A DIESEL		
AIRE	GA-8	366-06227
BS649 A DIESEL		
COMBUSTIBLE	G-296	351-29760
ACEITE, SELLADO	GP-58	201-55370
COMBUSTIBLE	G-296-B	351-29760
CD A DIESEL, CR A DIESEL, CRKM3P MARINO A DIESEL, CS A DIESEL, CS4MP MARINO A DIESEL, CS6MP MARINO A DIESEL, CST6MP MARINO A DIESEL, FR3MGR MARINO A DIESEL, FR4MGR MARINO A DIESEL, FR6MGR MARINO A DIESEL, FR6MGR MARINO A DIESEL, HA6 A DIESEL, HB A DIESEL, HB6 A DIESEL, HL A DIESEL, HL4 A DIESEL, HL6 A DIESEL, HLT A DIESEL, HLT6 A DIESEL, HR A DIESEL, HR3 (ROOTES-LISTER) A DIESEL, HR6A A DIESEL, HRS A DIESEL, HRS6 A DIESEL, HRS6A A DIESEL, HRW A DIESEL, HRW2 A DIESEL, HRW2M MARINO A DIESEL, HRW2MGR MARINO A DIESEL, HRW2MWA MARINO A DIESEL, HRW3 A DIESEL, HRW3M MARINO A DIESEL, HRW3MGR MARINO A DIESEL, HRW3MWA MARINO A DIESEL, HRW4 A DIESEL, HRW4M MARINO A DIESEL, HRW4MA MARINO A DIESEL, HRW6 A DIESEL, HRW6M MARINO A DIESEL, HRWM A DIESEL, HRWS A DIESEL, HRWSM A DIESEL, HW A DIESEL, HW2 (ROOTES-LISTER) A DIESEL, HW3 (ROOTES-LISTER) A DIESEL, HW6 A DIESEL, HWS A DIESEL, J SERIES A DIESEL, JA6 A DIESEL, JA6MGR MARINO A DIESEL, JW A DIESEL, JW6MGR MARINO A DIESEL, JWS A DIESEL, K SERIES A DIESEL		
COMBUSTIBLE	G-296	351-29760
CST A DIESEL		
ACEITE	GP-54	328-72260
HB4 A DIESEL, HB6 A DIESEL		
COMBUSTIBLE	G-11816	P779283
HL6 A DIESEL		
AIRE, MAS DE 2000 RPM	GAK-20	27-05568
HR2 A DIESEL, HR2A A DIESEL		
ACEITE	G-870	352-31720
COMBUSTIBLE	G-296	7111/296
COMBUSTIBLE	G-296-B	351-29760
AIRE, 12 3/8 IN	GAK-403	27-05421
AIRE, 10 3/8 IN	GAK-20	27-05568
HR4 A DIESEL		
AIRE, 10 3/8 IN	GAK-20	27-05568
HR6 A DIESEL		
AIRE	GA-20	27-05568
AIRE	GAK-20	27-05568
AIRE	GA-360	27-05583
JA A DIESEL, JAS A DIESEL, JWSC A DIESEL		
COMBUSTIBLE	G-296	351-29760
COMBUSTIBLE	G-296-B	351-29760
AIRE, CUMMINS	GA-106	691-00108
AIRE, KOMATSU	GA-326	691-00108
JK SERIES A GASOLINA, LD A GASOLINA		
GASOLINA	GG-48	201-13118
LD1 A GASOLINA, LD2 A GASOLINA, LD3 A GASOLINA		
ACEITE	G-816	201-26020
LOM 1 G/R A DIESEL		
ACEITE	GP-58	201-55370

MARCA-MODELO-MOTOR MAKE-MODEL-ENGINE	GONHER GONHER	OEM OEM
LISTER (continuación)		
MOTORES		
LPA A DIESEL, LPW A GASOLINA		
COMBUSTIBLE	GPP-1122	751-18100
AIRE	GA-33	602-41760
GASOLINA	GG-48	201-13118
LPA2 A DIESEL		
COMBUSTIBLE	G-296	351-29760
ACEITE	GP-22	751-12870
COMBUSTIBLE	G-296-B	351-29760
ACEITE, LUBRICANTE DE MONTAJE REMOTO	GP-171	328-21600
AIRE, SIN ASPAS	GA-33	602-41760
GASOLINA, CARTUCHO	GG-48	201-13118
LPA2 ALPHA SERIES MARINO A DIESEL		
COMBUSTIBLE	G-296	351-29760
ACEITE	GP-22	751-12870
COMBUSTIBLE	G-296-B	351-29760
ACEITE, LUBRICANTE DE MONTAJE REMOTO	GP-171	328-21600
GASOLINA, CARTUCHO	GG-48	201-13118
LPA3 A DIESEL		
COMBUSTIBLE	G-296	351-29760
ACEITE	GP-58	201-55370
COMBUSTIBLE	G-296-B	351-29760
ACEITE, LUBRICANTE DE MONTAJE REMOTO	GP-171	328-21600
AIRE, SIN ASPAS	GA-33	602-41760
GASOLINA, CARTUCHO	GG-48	201-13118
LPA3 ALPHA SERIES MARINO A DIESEL		
COMBUSTIBLE	G-296	351-29760
ACEITE	GP-58	201-55370
COMBUSTIBLE	G-296-B	351-29760
ACEITE, LUBRICANTE DE MONTAJE REMOTO	GP-171	328-21600
GASOLINA, CARTUCHO	GG-48	201-13118
LPW2 A DIESEL		
COMBUSTIBLE	G-296	351-29760
ACEITE	GP-58	201-55370
COMBUSTIBLE, SELLADO	GPP-1122	751-18100
COMBUSTIBLE	G-296-B	351-29760
ACEITE, LUBRICANTE DE MONTAJE REMOTO	GP-171	328-21600
AIRE, SIN ASPAS	GA-33	602-41760
AIRE	GAK-16	757-15230
GASOLINA, CARTUCHO	GG-48	201-13118
LPW3 A DIESEL		
COMBUSTIBLE	G-296	351-29760
ACEITE	GP-58	201-55370
COMBUSTIBLE, SELLADO	GPP-1122	751-18100
COMBUSTIBLE	G-296-B	351-29760
ACEITE, LUBRICANTE DE MONTAJE REMOTO	GP-171	328-21600
AIRE, SIN ASPAS	GA-33	602-41760
AIRE	GAK-16	757-15230
GASOLINA, CARTUCHO	GG-48	201-13118
LPW4 A DIESEL		
COMBUSTIBLE	G-296	351-29760
ACEITE	GP-58	201-55370
COMBUSTIBLE, SELLADO	GPP-1122	751-18100
COMBUSTIBLE	G-296-B	351-29760
ACEITE	GP-68	328-11500

SERVICIO PESADO

MARCA-MODELO-MOTOR MAKE-MODEL-ENGINE	GONHER GONHER	OEM OEM	MARCA-MODELO-MOTOR MAKE-MODEL-ENGINE	GONHER GONHER	OEM OEM	MARCA-MODELO-MOTOR MAKE-MODEL-ENGINE	GONHER GONHER	OEM OEM	
LISTER (continuación)			LISTER (continuación)			LISTER (continuación)			
MOTORES			MOTORES			MOTORES			
ACEITE, LUBRICANTE DE MONTAJE REMOTO	GP-171	328-21600	LR1 A GASOLINA, SL1 A GASOLINA, SL2 A GASOLINA, SL3 A GASOLINA, SR1 A GASOLINA, SR2 A GASOLINA, SR2Z A GASOLINA, SR3 A GASOLINA, SR3Z A GASOLINA, SRM3 A GASOLINA	ACEITE	G-816	201-26020	ACEITE	GP-58	201-55370
AIRE, SIN ASPAS	GA-33	602-41760	LR2 A GASOLINA, LS1 A GASOLINA, LS3 A GASOLINA, LT A GASOLINA, LT1 A GASOLINA, LV A GASOLINA, LV1 A GASOLINA, PAZ1 A GASOLINA, PH A GASOLINA, PHW A GASOLINA, PJ 1 A GASOLINA, PJ 1 W A GASOLINA, PJ 2 A GASOLINA, PJ 2 W A GASOLINA, PIWZ A GASOLINA, PIZ A GASOLINA, SD2 A GASOLINA, SL A GASOLINA, SL1MGR MARINO A GASOLINA, SL2MGR MARINO A GASOLINA, STW2 A GASOLINA	COMBUSTIBLE	G-296	201-13117	COMBUSTIBLE, SELLADO	GPP-1122	751-18100
AIRE	GAK-16	757-15230	GASOLINA	COMBUSTIBLE	G-296-B	201-13117	COMBUSTIBLE	G-296-B	351-29760
GASOLINA, CARTUCHO	GG-48	201-13118	LT1 A DIESEL, LT2 A DIESEL	AIRE	GA-7	P528231	AIRE, SIN ASPAS	GA-33	602-41760
LPWG2 A DIESEL			COMBUSTIBLE	ACEITE	G-870	250657	GASOLINA, CARTUCHO	GG-48	201-13118
ACEITE	GP-22	751-12870	LV2 A DIESEL	ACEITE	G-816	201-26020			
LPWG4 A DIESEL			AIRE	COMBUSTIBLE	G-11816	P779283			
ACEITE	GP-68	328-11500	MR3MA A DIESEL, PH3 (ROOTES-LISTER) A DIESEL, ST6W3 A DIESEL, STW3 A DIESEL, SW2MA A DIESEL	COMBUSTIBLE	G-296	351-29760			
LPWS A DIESEL			COMBUSTIBLE	COMBUSTIBLE	G-296-B	351-29760			
COMBUSTIBLE	GPP-1122	751-18100	PH 2 A DIESEL, PHW 2 A DIESEL, PJ A DIESEL, PIW A DIESEL	COMBUSTIBLE	G-296-B	351-29760			
AIRE	GA-33	602-41760	ACEITE	COMBUSTIBLE	G-296	351-29760			
GASOLINA	GG-48	201-13118	SLHMGR MARINO A DIESEL	COMBUSTIBLE	G-296-B	351-29760			
LPWS2 A DIESEL			ACEITE	COMBUSTIBLE	G-296	351-29760			
COMBUSTIBLE	G-296	351-29760	ACEITE	COMBUSTIBLE	G-296-B	351-29760			
ACEITE	GP-58	201-55370	SLM4 A DIESEL, SR A GASOLINA, SR4 A DIESEL	COMBUSTIBLE	G-296	351-29760			
COMBUSTIBLE, SELLADO	GPP-1122	751-18100	ACEITE	COMBUSTIBLE	G-296-B	351-29760			
ACEITE	GP-22	751-12870	COMBUSTIBLE	COMBUSTIBLE	G-296	351-29760			
COMBUSTIBLE	G-296-B	351-29760	ST1 A GASOLINA	COMBUSTIBLE	G-296-B	351-29760			
ACEITE	GP-171	328-21600	ACEITE	COMBUSTIBLE	G-296	351-29760			
AIRE, SIN ASPAS	GA-33	602-41760	ACEITE	COMBUSTIBLE	G-296-B	351-29760			
AIRE	GAK-16	757-15230	AIRE, SIN ASPAS	COMBUSTIBLE	G-296	351-29760			
GASOLINA, CARTUCHO	GG-48	201-13118	GASOLINA	COMBUSTIBLE	G-296-B	351-29760			
LPWS3 A DIESEL			ST1A A GASOLINA, ST3A29 A DIESEL	COMBUSTIBLE	G-296	351-29760			
COMBUSTIBLE	G-296	351-29760	AIRE	COMBUSTIBLE	G-296-B	351-29760			
ACEITE	GP-58	201-55370	ST2 A GASOLINA	COMBUSTIBLE	G-296	351-29760			
COMBUSTIBLE, SELLADO	GPP-1122	751-18100	ACEITE	COMBUSTIBLE	G-296-B	351-29760			
COMBUSTIBLE	G-296-B	351-29760	AIRE	COMBUSTIBLE	G-296	351-29760			
ACEITE, LUBRICANTE DE MONTAJE REMOTO	GP-171	328-21600	GASOLINA	COMBUSTIBLE	G-296-B	351-29760			
AIRE, SIN ASPAS	GA-33	602-41760	ST3 A DIESEL	COMBUSTIBLE	G-296	351-29760			
AIRE	GAK-16	757-15230	COMBUSTIBLE	ACEITE	GP-58	201-55370			
GASOLINA, CARTUCHO	GG-48	201-13118	ACEITE	AIRE	GAK-16	27-05420			
LPWS4 A DIESEL			AIRE	GASOLINA	GG-48	201-13117			
COMBUSTIBLE	G-296	351-29760	TL A DIESEL, TL2 A DIESEL, TL3 A DIESEL, TR A DIESEL, TX A DIESEL, TX2 A DIESEL, TX3 A DIESEL	COMBUSTIBLE	G-296	351-29760			
ACEITE	GP-58	201-55370	COMBUSTIBLE	COMBUSTIBLE	GP-58	201-55370			
COMBUSTIBLE, SELLADO	GPP-1122	751-18100	ACEITE	COMBUSTIBLE	G-296-B	351-29760			
COMBUSTIBLE	G-296-B	351-29760	AIRE	COMBUSTIBLE	G-296-B	351-29760			
ACEITE	GP-68	328-11500	TR1 A DIESEL, TS1 A DIESEL	COMBUSTIBLE	G-296	351-29760			
ACEITE, LUBRICANTE DE MONTAJE REMOTO	GP-171	328-21600	COMBUSTIBLE	COMBUSTIBLE	G-296-B	351-29760			
AIRE, SIN ASPAS	GA-33	602-41760	TR1 A DIESEL, TS1 A DIESEL	COMBUSTIBLE	G-296	351-29760			
AIRE	GAK-16	757-15230	COMBUSTIBLE	COMBUSTIBLE	G-296	351-29760			
GASOLINA, CARTUCHO	GG-48	201-13118	TR1 A DIESEL, TS1 A DIESEL	COMBUSTIBLE	G-296	351-29760			
LPWT A DIESEL			COMBUSTIBLE	COMBUSTIBLE	G-296	351-29760			
COMBUSTIBLE	GPP-1122	751-18100	TR1 A DIESEL, TS1 A DIESEL	COMBUSTIBLE	G-296	351-29760			
LPWT4 A DIESEL			COMBUSTIBLE	COMBUSTIBLE	G-296	351-29760			
COMBUSTIBLE	G-296	351-29760	TR1 A DIESEL, TS1 A DIESEL	COMBUSTIBLE	G-296	351-29760			
COMBUSTIBLE, SELLADO	GPP-1122	751-18100	COMBUSTIBLE	COMBUSTIBLE	G-296	351-29760			
COMBUSTIBLE	G-296-B	351-29760	TR1 A DIESEL, TS1 A DIESEL	COMBUSTIBLE	G-296	351-29760			
ACEITE	GP-68	328-11500	COMBUSTIBLE	COMBUSTIBLE	G-296	351-29760			
ACEITE, LUBRICANTE DE MONTAJE REMOTO	GP-171	328-21600	TR1 A DIESEL, TS1 A DIESEL	COMBUSTIBLE	G-296	351-29760			
AIRE, SIN ASPAS	GA-33	602-41760	COMBUSTIBLE	COMBUSTIBLE	G-296	351-29760			
AIRE	GAK-16	757-15230	TR1 A DIESEL, TS1 A DIESEL	COMBUSTIBLE	G-296	351-29760			
GASOLINA, CARTUCHO	GG-48	201-13118	COMBUSTIBLE	COMBUSTIBLE	G-296	351-29760			
LR A GASOLINA, P600 A GASOLINA, SRMGR MARINO A DIESEL, ST A DIESEL			TR1 A DIESEL, TS1 A DIESEL	COMBUSTIBLE	G-296	351-29760			
ACEITE	GP-58	201-55370	COMBUSTIBLE	COMBUSTIBLE	G-296	351-29760			

LISTER

UNIDADES DE REFRIGERACIÓN

BS 649 con motor/A DIESEL		
COMBUSTIBLE	G-296	351-29760
ACEITE	GP-58	201-55370
COMBUSTIBLE	G-296-B	351-29760
DKL 4/50 con motor/A DIESEL		
ACEITE	GP-28	P172540
DPV 30 con motor/A DIESEL		
GASOLINA	GG-48	201-13116
LOCX 4/50 con motor/A DIESEL		
ACEITE	GP-28	P172540
LS 1, LS 3 con motor/A DIESEL		
GASOLINA	GG-48	201-13116
PDL 30 con motor/A DIESEL		
ACEITE	G-870	352-31720
COMBUSTIBLE	G-296	351-29760
COMBUSTIBLE	G-296-B	351-29760
AIRE	GA-33	397079
SD 3 con motor/A DIESEL		
GASOLINA	GG-48	201-13118

M.A.N.

CAMIONES, TRACTOCAMIONES Y AUTOBUSES

10.126, 10.136 con motores/R.V.I. 597, R.V.I. 797		
COMBUSTIBLE	G-1123	81125030042
COMBUSTIBLE, CON CUBIERTA	G-1123F	81125030042
ACEITE, SELLADO	GP-3569	A5000041045
10.136 con motor/M.A.N. D0226MF		
COMBUSTIBLE	GP-1122	WDK724
10.15 con motor/M.A.N. D0826F		
COMBUSTIBLE	GP-1122	WDK724

MARCA-MODELO-MOTOR MAKE-MODEL-ENGINE	GONHER GONHER	OEM OEM	MARCA-MODELO-MOTOR MAKE-MODEL-ENGINE	GONHER GONHER	OEM OEM	MARCA-MODELO-MOTOR MAKE-MODEL-ENGINE	GONHER GONHER	OEM OEM
M.A.N. (continuación)			M.A.N. (continuación)			M.A.N. (continuación)		
CAMIONES, TRACTOCAMIONES Y AUTOBUSES			CAMIONES, TRACTOCAMIONES Y AUTOBUSES			CAMIONES, TRACTOCAMIONES Y AUTOBUSES		
10.156 con motor/M.A.N. D0836M2			12.17 con motor/M.A.N. D0226MKF			13.215 con motores/M.A.N. D2146, M.A.N. D2156, M.A.N. D2356		
COMBUSTIBLE	G-1121	81125030041	COMBUSTIBLE	GP-1122	51125030012	COMBUSTIBLE	G-1123	81125030042
10.16, 10.212, 10.23 con motor/A DIESEL			12.186 con motores/M.A.N. D2146, M.A.N. D2156, M.A.N. D2356			13.23 con motores/M.A.N. D2356, M.A.N. D2146, M.A.N. D2156		
ACEITE	G-31	81055040008	COMBUSTIBLE	G-1123	81125030042	COMBUSTIBLE	G-1123	81125030042
COMBUSTIBLE	G-1123	81125030042	12.192 con motores/M.A.N. D0226MKM, M.A.N. D0226, M.A.N. D0226MKF			13.24 con motor/M.A.N. D2556		
COMBUSTIBLE, CON CUBIERTA	G-1123F	81125030042	COMBUSTIBLE	GPP-1122	81125030075	COMBUSTIBLE	G-1121	81125030041
10.21 con motores/M.A.N. D2146, M.A.N. D2156, M.A.N. D2356			12.192U con motor/M.A.N. D2855 (U1D)			COMBUSTIBLE	G-1123	81125030042
COMBUSTIBLE	G-1123	81125030042	COMBUSTIBLE	G-1123	81125030042	COMBUSTIBLE	G-1121F	81125030050
1070, 1080 con motor/A DIESEL			12.215 con motores/M.A.N. D2146, M.A.N. D2156, M.A.N. D2356			COMBUSTIBLE, CON CUBIERTA	G-1123F	81125030042
ACEITE	G-31	81055040008	COMBUSTIBLE	G-1123	81125030042	13.25 con motores/M.A.N. D2146, M.A.N. D2658, M.A.N. D2156, M.A.N. D2356		
COMBUSTIBLE	G-1123	81125030042	12.23 con motores/M.A.N. D2356, M.A.N. D2146, M.A.N. D2156			COMBUSTIBLE	G-1123	81125030042
COMBUSTIBLE, CON CUBIERTA	G-1123F	81125030042	COMBUSTIBLE	G-1123	81125030042	13.256 con motores/M.A.N. D2146, M.A.N. D2156, M.A.N. D2356		
10U210 con motor/U11D			12.232 con motor/M.A.N. D0826L			COMBUSTIBLE	G-1123	81125030042
COMBUSTIBLE	G-1123	81125030042	COMBUSTIBLE	GPP-1122	81125030075	13.275, 13.304 con motores/M.A.N. D2758, M.A.N. D2858		
11.136 con motores/R.V.I. 597, R.V.I. 797			12.284 con motor/M.A.N. D0836			COMBUSTIBLE	G-1123	81125030042
COMBUSTIBLE	G-1123	81125030042	COMBUSTIBLE	GP-1122	WDK724	14.136 con motor/M.A.N. D0226MF		
COMBUSTIBLE, CON CUBIERTA	G-1123F	81125030042	12U192R14, 12V160 con motor/A DIESEL			COMBUSTIBLE	GP-1122	WDK724
ACEITE, SELLADO	GP-3569	A5000041045	COMBUSTIBLE	G-1123	81125030042	14.163 con motor/M.A.N. D0824 SERIES		
11.136U con motor/M.A.N. D0216MXUL			12U210R15 con motor/U11D			COMBUSTIBLE	GP-1122	WDK724
COMBUSTIBLE	G-296	81125030038	COMBUSTIBLE	G-1123	81125030042	14.163L con motor/M.A.N. D0824 SERIES		
COMBUSTIBLE	G-296-B	81125030038	13.136 con motores/R.V.I. 597, R.V.I. 797			COMBUSTIBLE	GP-1122	WDK724
ACEITE, SELLADO	GP-3569	A5000041045	COMBUSTIBLE	G-1123	81125030042	14.168, 14.192, 15.168 con motor/M.A.N. D2555		
11.136U con motor/U7D			13.136U con motor/M.A.N. D0216MXUL			COMBUSTIBLE	G-1121	81125030041
COMBUSTIBLE	G-1123	81125030042	COMBUSTIBLE	G-296	81125030038	COMBUSTIBLE	G-1123	81125030042
11.168 con motor/M.A.N. D2555			13.136U con motor/U7D			COMBUSTIBLE	G-1121F	81125030050
COMBUSTIBLE	G-1121	81125030041	COMBUSTIBLE	G-1123	81125030042	COMBUSTIBLE, CON CUBIERTA	G-1123F	81125030042
COMBUSTIBLE	G-1123	81125030042	13.168 con motor/M.A.N. D0846			14.17 con motor/M.A.N. D0226MKF		
COMBUSTIBLE	G-1121F	81125030050	ACEITE	G-834	81055040023	COMBUSTIBLE	GP-1122	51125030012
COMBUSTIBLE, CON CUBIERTA	G-1123F	81125030042	COMBUSTIBLE	G-1121	81125030041	14.192 con motores/M.A.N. D0226MKM, M.A.N. D0226, M.A.N. D0226MKF		
11M160, 11M60 con motor/A DIESEL			COMBUSTIBLE	G-1121F	81125030050	COMBUSTIBLE	GPP-1122	81125030075
COMBUSTIBLE	G-1123	81125030042	13.168 con motor/M.A.N. D2555			14.22, 14.24 con motor/M.A.N. D2566		
11U192R13, 11V60 con motor/A DIESEL			COMBUSTIBLE	G-1121	81125030041	COMBUSTIBLE	G-1123	81125030042
COMBUSTIBLE	G-1123	81125030042	COMBUSTIBLE	G-1123	81125030042	ACEITE	G-143	81055040041
11U210R13 con motor/U11D			COMBUSTIBLE	G-1121F	81125030050	COMBUSTIBLE, CON CUBIERTA	G-1123F	81125030042
COMBUSTIBLE	G-1123	81125030042	COMBUSTIBLE, CON CUBIERTA	G-1123F	81125030042	14.232, 15.232, 16.232 con motor/M.A.N. D0826L		
12.136 con motor/M.A.N. D0226MF			13.17 con motor/M.A.N. D0226MKF			COMBUSTIBLE	GPP-1122	81125030075
COMBUSTIBLE	GP-1122	WDK724	COMBUSTIBLE	GP-1122	51125030012	14.262, 14.272 con motor/M.A.N. D2865		
12.136 con motores/R.V.I. 597, R.V.I. 797			13.192 con motor/M.A.N. D2555			COMBUSTIBLE	G-1123	81125030042
COMBUSTIBLE	G-1123	81125030042	COMBUSTIBLE	G-1121	81125030041	COMBUSTIBLE	G-143	81055040041
COMBUSTIBLE, CON CUBIERTA	G-1123F	81125030042	COMBUSTIBLE	G-1123	81125030042	COMBUSTIBLE, CON CUBIERTA	G-1123F	81125030042
ACEITE, SELLADO	GP-3569	A5000041045	COMBUSTIBLE	G-1121F	81125030050	COMBUSTIBLE	GPP-1122	81125030075
12.156 con motor/M.A.N. D0836M2			COMBUSTIBLE, CON CUBIERTA	G-1123F	81125030042	AIRE	GA-467	81083040038
COMBUSTIBLE	G-1121	81125030041	13.192 con motores/M.A.N. D0826T, M.A.N. D0826TF			14.264L, 12.224 L, 14.224L con motor/M.A.N. D0826		
12.168 con motor/M.A.N. D2555			COMBUSTIBLE	GPP-1122	81125030075	COMBUSTIBLE	GP-1122	WDK724
COMBUSTIBLE	G-1121	81125030041	13.192U, 14.192U con motor/M.A.N. D2855 (U10D)			15.136 con motores/R.V.I. 597, R.V.I. 797		
COMBUSTIBLE	G-1123	81125030042	COMBUSTIBLE	G-1123	81125030042	COMBUSTIBLE	G-1123	81125030042
COMBUSTIBLE	G-1121F	81125030050						
COMBUSTIBLE, CON CUBIERTA	G-1123F	81125030042						

SERVICIO PESADO

MARCA-MODELO-MOTOR MAKE-MODEL-ENGINE	GONHER GONHER	OEM OEM	MARCA-MODELO-MOTOR MAKE-MODEL-ENGINE	GONHER GONHER	OEM OEM	MARCA-MODELO-MOTOR MAKE-MODEL-ENGINE	GONHER GONHER	OEM OEM
M.A.N. (continuación)			M.A.N. (continuación)			M.A.N. (continuación)		
CAMIONES, TRACTOCAMIONES Y AUTOBUSES			CAMIONES, TRACTOCAMIONES Y AUTOBUSES			CAMIONES, TRACTOCAMIONES Y AUTOBUSES		
15.168 con motor/M.A.N. D0846			16.17 con motor/M.A.N. D0226MKF			16.291 con motor/M.A.N. D2866		
ACEITE	G-834	81055040023	COMBUSTIBLE	GP-1122	51125030012	COMBUSTIBLE	G-1123	81125030042
COMBUSTIBLE	G-1121	81125030041				COMBUSTIBLE, CON CUBIERTA	G-1123F	81125030042
COMBUSTIBLE	G-1121F	81125030050	16.186, 16.23 con motores/M.A.N. D2356, M.A.N. D2146, M.A.N. D2156			AIRE	GA-467	81083040043
			COMBUSTIBLE	G-1123	81125030042	16.304 con motor/M.A.N. D2858		
15.17 con motor/M.A.N. D0226MKF						COMBUSTIBLE	G-1123	81125030042
COMBUSTIBLE	GP-1122	51125030012	16.192 con motores/M.A.N. D0226MKM, M.A.N. D0826T, M.A.N. D0826T6, M.A.N. D0226, M.A.N. D0226MKF			16.32 con motor/M.A.N. D2530		
			COMBUSTIBLE	GPP-1122	81125030075	COMBUSTIBLE	G-1121	81125030041
15.192 con motores/M.A.N. D0226MKM, M.A.N. D0826T, M.A.N. D0826TF, M.A.N. D0226, M.A.N. D0226MKF			16.192 con motores/M.A.N. D2555, M.A.N. D2565			COMBUSTIBLE	G-1123	81125030042
COMBUSTIBLE	GPP-1122	81125030075	COMBUSTIBLE	G-1121	81125030041	COMBUSTIBLE	G-1121F	81125030050
			COMBUSTIBLE	G-1123	81125030042	COMBUSTIBLE, CON CUBIERTA	G-1123F	81125030042
15.192 con motores/M.A.N. D2146, M.A.N. D2156, M.A.N. D2356			ACEITE	G-143	81055040040	AIRE	GA-405	81082050005
COMBUSTIBLE	G-1123	81125030042	COMBUSTIBLE	G-1121F	81125030050	16.32 con motor/M.A.N. D3530		
			COMBUSTIBLE, CON CUBIERTA	G-1123F	81125030042	COMBUSTIBLE	G-1123	81125030042
15.192, 16.168 con motores/M.A.N. D2555, M.A.N. D2565			16.215 con motores/M.A.N. D2146, M.A.N. D2156, M.A.N. D2356			ACEITE	G-143	81055040041
COMBUSTIBLE	G-1121	81125030041	COMBUSTIBLE	G-1123	81125030042	COMBUSTIBLE, CON CUBIERTA	G-1123F	81125030042
COMBUSTIBLE	G-1123	81125030042						
COMBUSTIBLE	G-1121F	81125030050	16.22 con motor/M.A.N. D2566			16.32, 19.256, 20.32, 22.32, 26.256, 30.256, 30.32, 32.32, 38.32, 40.32 con motor/M.A.N. D2538		
COMBUSTIBLE, CON CUBIERTA	G-1123F	81125030042	COMBUSTIBLE	G-1123	81125030042	COMBUSTIBLE	G-1121	81125030041
			ACEITE	G-143	81055040041	COMBUSTIBLE	G-1123	81125030042
15.192U con motor/M.A.N. D2865 (U10D)			COMBUSTIBLE, CON CUBIERTA	G-1123F	81125030042	ACEITE	G-143	81055040041
COMBUSTIBLE	G-1123	81125030042	16.25 con motor/M.A.N. D2658			COMBUSTIBLE	G-1121F	81125030050
			COMBUSTIBLE	G-1123	81125030042	COMBUSTIBLE, CON CUBIERTA	G-1123F	81125030042
15.2, 15.24, 16.2, 16.24 con motor/M.A.N. D2556			16.256 con motor/M.A.N. D2538			AIRE	GA-405	81082050005
COMBUSTIBLE	G-1121	81125030041	COMBUSTIBLE	G-1121	81125030041	16.322, 17.272, 17.322, 19.262, 19.272 con motor/M.A.N. D2865		
COMBUSTIBLE	G-1123	81125030042	COMBUSTIBLE	G-1123	81125030042	COMBUSTIBLE	G-1123	81125030042
COMBUSTIBLE	G-1121F	81125030050	ACEITE	G-143	81055040041	ACEITE	G-143	81055040041
COMBUSTIBLE, CON CUBIERTA	G-1123F	81125030042	COMBUSTIBLE	G-1121F	81125030050	COMBUSTIBLE, CON CUBIERTA	G-1123F	81125030042
			COMBUSTIBLE, CON CUBIERTA	G-1123F	81125030042	COMBUSTIBLE	GPP-1122	81125030075
15.212 con motor/A DIESEL			16.256 con motores/M.A.N. D2146, M.A.N. D2156, M.A.N. D2356			AIRE	GA-467	81083040038
ACEITE	G-31	81055040008	COMBUSTIBLE	G-1123	81125030042	16.331 con motor/M.A.N. D2866		
COMBUSTIBLE	G-1123	81125030042	COMBUSTIBLE	G-1123	81125030042	COMBUSTIBLE	G-1123	81125030042
COMBUSTIBLE, CON CUBIERTA	G-1123F	81125030042	16.256U, 16.320U con motor/M.A.N. D3256BXUL (U12D)			COMBUSTIBLE, CON CUBIERTA	G-1123F	81125030042
			COMBUSTIBLE	G-1123	81125030042	AIRE	GA-467	81083040043
15.216 con motor/M.A.N. D0836M2			16.272 con motor/M.A.N. D2865			16.332, 16.362 con motor/M.A.N. D2866		
COMBUSTIBLE	G-1121	81125030041	COMBUSTIBLE	G-1123	81125030042	COMBUSTIBLE	G-1123	81125030021
			ACEITE	G-143	81055040041	ACEITE	G-143	81055040039
15.22 con motor/M.A.N. D2566			COMBUSTIBLE, CON CUBIERTA	G-1123F	81125030042	COMBUSTIBLE	GPP-1122	81125030075
COMBUSTIBLE	G-1123	81125030042	AIRE	GA-467	81083040038	AIRE	GA-467	81083040043
ACEITE	G-143	81055040041	16.275 con motores/M.A.N. D2658, M.A.N. D2758			16.372 con motor/M.A.N. D2866		
COMBUSTIBLE, CON CUBIERTA	G-1123F	81125030042	COMBUSTIBLE	G-1123	81125030042	COMBUSTIBLE	G-1123	81125030042
AIRE, CUMMINS	GA-106	1142150460	16.28 con motor/M.A.N. D2566MT			ACEITE	G-143	81055040041
AIRE, KOMATSU	GA-326	1142150460	COMBUSTIBLE	G-1123	81125030042	COMBUSTIBLE, CON CUBIERTA	G-1123F	81125030042
AIRE	GA-206	81083040050	ACEITE	G-143	81055040041	AIRE	GA-467	81083040038
			COMBUSTIBLE, CON CUBIERTA	G-1123F	81125030042	17.136 con motor/M.A.N. D0226MF		
1580 con motor/A DIESEL			AIRE	GA-405	81082050005	COMBUSTIBLE	GP-1122	WDK724
ACEITE	G-31	81055040008	AIRE	GA-467	81083040038	17.17 con motor/M.A.N. D0226MKF		
COMBUSTIBLE	G-1123	81125030042	16.281, 16.321 con motores/M.A.N. D2566MK, M.A.N. D2566MKF			COMBUSTIBLE	GP-1122	51125030012
COMBUSTIBLE, CON CUBIERTA	G-1123F	81125030042	COMBUSTIBLE	G-1123	81125030042	17.192 con motores/M.A.N. D0826T SERIES, M.A.N. D0226MKF, M.A.N. D0226MKM		
			ACEITE	G-143	81055040041	COMBUSTIBLE	GPP-1122	81125030075
16.136 con motores/R.V.I. 597, R.V.I. 797			COMBUSTIBLE, CON CUBIERTA	G-1123F	81125030042			
COMBUSTIBLE	G-1123	81125030042	AIRE	GA-467	81083040038	17.22, 19.24 con motor/M.A.N. D2566		
			16.168 con motor/M.A.N. D0846			COMBUSTIBLE	G-1123	81125030042
ACEITE	G-834	81055040040	COMBUSTIBLE	G-1123	81125030042	ACEITE	G-143	81055040041
COMBUSTIBLE	G-1121	81125030041	ACEITE	G-143	81055040041			
COMBUSTIBLE	G-1121F	81125030050	COMBUSTIBLE, CON CUBIERTA	G-1123F	81125030042			
			AIRE	GA-467	81083040038			

MARCA-MODELO-MOTOR MAKE-MODEL-ENGINE	GONHER GONHER	OEM OEM	MARCA-MODELO-MOTOR MAKE-MODEL-ENGINE	GONHER GONHER	OEM OEM	MARCA-MODELO-MOTOR MAKE-MODEL-ENGINE	GONHER GONHER	OEM OEM
M.A.N. (continuación)			M.A.N. (continuación)			M.A.N. (continuación)		
CAMIONES, TRACTOCAMIONES Y AUTOBUSES			CAMIONES, TRACTOCAMIONES Y AUTOBUSES			CAMIONES, TRACTOCAMIONES Y AUTOBUSES		
COMBUSTIBLE, CON CUBIERTA	G-1123F	81125030042	COMBUSTIBLE	GPP-1122	81125030075	ACEITE	G-143	81055040041
17.232 con motor/M.A.N. D0826L			19.240U con motor/U12D			COMBUSTIBLE, CON CUBIERTA	G-1123F	81125030042
COMBUSTIBLE	GPP-1122	81125030075	COMBUSTIBLE	G-1123	81125030042	COMBUSTIBLE	GPP-1122	81125030075
17.292, 19.242 con motor/M.A.N. D2866			ACEITE	G-143	81055040041	AIRE	GA-467	81083040038
COMBUSTIBLE	G-1123	81125030042	COMBUSTIBLE, CON CUBIERTA	G-1123F	81125030042	19.33, 19.36 con motores/M.A.N. D2530, M.A.N. D2530MTXF		
ACEITE	G-143	81055040041	COMBUSTIBLE	GPP-1122	81125030075	COMBUSTIBLE	G-1123	81125030042
COMBUSTIBLE, CON CUBIERTA	G-1123F	81125030042	19.241U con motor/M.A.N. D2566			COMBUSTIBLE, CON CUBIERTA	G-1123F	81125030042
COMBUSTIBLE	GPP-1122	81125030075	COMBUSTIBLE	G-1123	81125030042	AIRE	GA-467	81083040038
AIRE	GA-467	81083040038	ACEITE	G-143	81055040041	19.330FT con motor/M.A.N. D2530MF		
17.322, 17.362 con motor/M.A.N. D2866			COMBUSTIBLE, CON CUBIERTA	G-1123F	81125030042	COMBUSTIBLE	G-1123	81125030042
COMBUSTIBLE	G-1123	81125030021	AIRE	GA-405	81083040041	ACEITE	G-143	81055040041
ACEITE	G-143	81055040039	19.275 con motor/M.A.N. D2865			COMBUSTIBLE, CON CUBIERTA	G-1123F	81125030042
COMBUSTIBLE	GPP-1122	81125030075	COMBUSTIBLE	G-1123	81125030042	19.331 con motor/M.A.N. D2866		
AIRE	GA-467	81083040043	19.28 con motor/M.A.N. D2566MT			COMBUSTIBLE	G-1123	81125030042
17.372 con motor/M.A.N. D2866			COMBUSTIBLE	G-1123	81125030042	COMBUSTIBLE, CON CUBIERTA	G-1123F	81125030042
COMBUSTIBLE	G-1123	81125030042	ACEITE	G-143	81055040041	AIRE	GA-467	81083040038
ACEITE	G-143	81055040041	COMBUSTIBLE, CON CUBIERTA	G-1123F	81125030042	19.332, 19.362 con motor/M.A.N. D2866		
COMBUSTIBLE, CON CUBIERTA	G-1123F	81125030042	AIRE	GA-405	81082050005	COMBUSTIBLE	G-1123	81125030021
AIRE	GA-467	81083040038	AIRE	GA-467	81083040038	ACEITE	G-143	81055040039
18.224, 18.264 con motor/M.A.N. D0826			19.280U con motor/U12D			COMBUSTIBLE	GPP-1122	81125030075
COMBUSTIBLE	GP-1122	WDK274	COMBUSTIBLE	G-1123	81125030042	AIRE	GA-467	81083040043
18.284 con motor/M.A.N. D0836			19.281, 19.321 con motor/M.A.N. D2566			19.343, 19.323, 19.342 con motor/M.A.N. D2865		
COMBUSTIBLE	GP-1122	WDK724	COMBUSTIBLE	G-1123	81125030042	COMBUSTIBLE	GP-1122	WDK724
18.362 con motor/M.A.N. D2866			ACEITE	G-143	81055040041	19.36 con motor/M.A.N. D2540MTF (1982)		
COMBUSTIBLE	G-1123	81125030021	COMBUSTIBLE, CON CUBIERTA	G-1123F	81125030042	COMBUSTIBLE	G-1123	81125030042
ACEITE	G-143	81055040039	AIRE	GA-467	81083040038	ACEITE	G-143	81055040041
COMBUSTIBLE	GPP-1122	81125030075	19.291 con motor/M.A.N. D2866			COMBUSTIBLE, CON CUBIERTA	G-1123F	81125030042
AIRE	GA-467	81083040043	COMBUSTIBLE	G-1123	81125030042	AIRE	GA-467	81083040043
18.372 con motor/M.A.N. D2866			COMBUSTIBLE, CON CUBIERTA	G-1123F	81125030042	ACEITE	G-750	81055040048
COMBUSTIBLE	G-1123	81125030042	AIRE	GA-467	81083040043	19.360F con motores/M.A.N. D2530, M.A.N. D2530MTXF		
ACEITE	G-143	81055040041	19.292 con motor/M.A.N. D2866			COMBUSTIBLE	G-1123	81125030042
COMBUSTIBLE, CON CUBIERTA	G-1123F	81125030042	COMBUSTIBLE	G-1123	81125030042	ACEITE	G-143	81055040041
AIRE	GA-467	81083040038	ACEITE	G-143	81055040041	COMBUSTIBLE, CON CUBIERTA	G-1123F	81125030042
19.168 con motor/M.A.N. D2555			COMBUSTIBLE, CON CUBIERTA	G-1123F	81125030042	19.361 con motor/M.A.N. D2866		
COMBUSTIBLE	G-1121	81125030041	COMBUSTIBLE	GPP-1122	81125030075	COMBUSTIBLE	G-1123	81125030042
COMBUSTIBLE	G-1123	81125030042	AIRE	GA-467	81083040038	ACEITE	G-143	81055040041
COMBUSTIBLE	G-1121F	81125030050	19.293 con motor/M.A.N. D2865			COMBUSTIBLE, CON CUBIERTA	G-1123F	81125030042
COMBUSTIBLE, CON CUBIERTA	G-1123F	81125030042	COMBUSTIBLE	GP-1122	WDK724	AIRE	GA-467	81083040038
19.2, 19.24 con motor/M.A.N. D2556			19.304 con motores/M.A.N. D2758, M.A.N. D2858			ACEITE	G-750	81055040048
COMBUSTIBLE	G-1121	81125030041	COMBUSTIBLE	G-1123	81125030042	19.361U con motor/M.A.N. D2866		
COMBUSTIBLE	G-1123	81125030042	19.314, 19.364, 19.373 con motor/M.A.N. D2866			COMBUSTIBLE	G-1123	81125030042
COMBUSTIBLE	G-1121F	81125030050	COMBUSTIBLE	GP-1122	WDK724	ACEITE	G-143	81055040041
COMBUSTIBLE, CON CUBIERTA	G-1123F	81125030042	19.320U con motor/M.A.N. D3256BXUL (U12D)			COMBUSTIBLE, CON CUBIERTA	G-1123F	81125030042
19.215, 19.25 con motores/M.A.N. D2356, M.A.N. D2146, M.A.N. D2156			COMBUSTIBLE	G-1123	81125030042	AIRE	GA-467	81083040038
COMBUSTIBLE	G-1123	81125030042	19.321U con motor/M.A.N. D2566			19.372 con motor/M.A.N. D2866		
19.23, 19.256 con motores/M.A.N. D2146, M.A.N. D2156, M.A.N. D2356			COMBUSTIBLE	G-1123	81125030042	COMBUSTIBLE	G-1123	81125030042
COMBUSTIBLE	G-1123	81125030042	ACEITE	G-143	81055040041	ACEITE	G-143	81055040041
19.24 con motor/U12D			COMBUSTIBLE, CON CUBIERTA	G-1123F	81125030042	COMBUSTIBLE, CON CUBIERTA	G-1123F	81125030042
COMBUSTIBLE	G-1123	81125030042	AIRE	GA-467	81083040038	AIRE	GA-467	81083040038
ACEITE	G-143	81055040041	19.322 con motor/M.A.N. D2865			19.39 con motor/M.A.N. D2540MTF		
COMBUSTIBLE, CON CUBIERTA	G-1123F	81125030042	COMBUSTIBLE	G-1123	81125030042	COMBUSTIBLE	G-1123	81125030042

SERVICIO PESADO

MARCA-MODELO-MOTOR MAKE-MODEL-ENGINE	GONHER GONHER	OEM OEM	MARCA-MODELO-MOTOR MAKE-MODEL-ENGINE	GONHER GONHER	OEM OEM	MARCA-MODELO-MOTOR MAKE-MODEL-ENGINE	GONHER GONHER	OEM OEM
M.A.N. (continuación)			M.A.N. (continuación)			M.A.N. (continuación)		
CAMIONES, TRACTOCAMIONES Y AUTOBUSES			CAMIONES, TRACTOCAMIONES Y AUTOBUSES			CAMIONES, TRACTOCAMIONES Y AUTOBUSES		
AIRE	GA-467	81083040038	COMBUSTIBLE, CON CUBIERTA	G-1123F	81125030042	22.240U con motores/M.A.N. D2566, U12D		
ACEITE	G-750	81055040048	AIRE	GA-405	81082050005	COMBUSTIBLE	G-1123	81125030042
19.402, 19.403, 19.414, 19.423 con motor/M.A.N. D2866			20.32 con motor/M.A.N. D3530			ACEITE	G-143	81055040041
COMBUSTIBLE	GP-1122	WDK724	COMBUSTIBLE	G-1123	81125030042	COMBUSTIBLE, CON CUBIERTA	G-1123F	81125030042
19.422 con motor/M.A.N. D2866			ACEITE	G-143	81055040041	22.241UNL con motor/M.A.N. D2566		
COMBUSTIBLE	G-1123	81125030042	COMBUSTIBLE, CON CUBIERTA	G-1123F	81125030042	COMBUSTIBLE	G-1123	81125030042
ACEITE	G-143	81055040041	20.322 con motor/M.A.N. D2865			ACEITE	G-143	81055040041
COMBUSTIBLE, CON CUBIERTA	G-1123F	81125030042	COMBUSTIBLE	G-1123	81125030042	COMBUSTIBLE, CON CUBIERTA	G-1123F	81125030042
COMBUSTIBLE	GPP-1122	81125030075	ACEITE	G-143	81055040041	AIRE	GA-405	81083040041
AIRE	GA-467	81083040038	COMBUSTIBLE, CON CUBIERTA	G-1123F	81125030042	22.242 con motor/M.A.N. D2866		
19.462, 19.502 con motor/M.A.N. D2840			COMBUSTIBLE	GPP-1122	81125030075	COMBUSTIBLE	G-1123	81125030042
COMBUSTIBLE	G-1123	81125030042	AIRE	GA-467	81083040038	ACEITE	G-143	81055040041
ACEITE	G-143	81055040041	20.331 con motor/M.A.N. D2866			COMBUSTIBLE, CON CUBIERTA	G-1123F	81125030042
COMBUSTIBLE, CON CUBIERTA	G-1123F	81125030042	COMBUSTIBLE	G-1123	81125030042	COMBUSTIBLE	GPP-1122	81125030075
COMBUSTIBLE	GP-1122	51125030004	COMBUSTIBLE, CON CUBIERTA	G-1123F	81125030042	AIRE	GA-467	81083040038
AIRE	GA-405	81082050005	AIRE	GA-467	81083040038	22.256 con motores/M.A.N. D2146, M.A.N. D2156, M.A.N. D2356		
19.463, 19.464 con motor/M.A.N. D2876			20.361 con motor/M.A.N. D2866			COMBUSTIBLE	G-1123	81125030042
COMBUSTIBLE	GP-1122	WDK724	COMBUSTIBLE	G-1123	81125030042	22.262 con motor/M.A.N. D2865		
19.603 con motor/M.A.N. D2840			ACEITE	G-143	81055040041	COMBUSTIBLE	G-1123	81125030042
COMBUSTIBLE	GP-1122	WDK724	COMBUSTIBLE, CON CUBIERTA	G-1123F	81125030042	ACEITE	G-143	81055040041
20.224, 20.264 con motor/M.A.N. D0826			AIRE	GA-467	81083040038	COMBUSTIBLE, CON CUBIERTA	G-1123F	81125030042
COMBUSTIBLE	GP-1122	WDK724	ACEITE	G-750	81055040048	COMBUSTIBLE	GPP-1122	81125030075
20.24 con motor/M.A.N. D2566			2180 con motor/A DIESEL			AIRE	GA-467	81083040038
COMBUSTIBLE	G-1123	81125030042	ACEITE	G-31	81055040008	22.28 con motor/M.A.N. D2566MT		
ACEITE	G-143	81055040041	COMBUSTIBLE	G-1123	81125030042	COMBUSTIBLE	G-1123	81125030042
COMBUSTIBLE, CON CUBIERTA	G-1123F	81125030042	COMBUSTIBLE, CON CUBIERTA	G-1123F	81125030042	ACEITE	G-143	81055040041
20.24 con motor/U12D			22.192 con motor/M.A.N. D2555			COMBUSTIBLE, CON CUBIERTA	G-1123F	81125030042
COMBUSTIBLE	G-1123	81125030042	COMBUSTIBLE	G-1121	81125030041	AIRE	GA-405	81082050005
ACEITE	G-143	81055040041	COMBUSTIBLE	G-1123	81125030042	AIRE	GA-467	81083040038
COMBUSTIBLE, CON CUBIERTA	G-1123F	81125030042	COMBUSTIBLE, CON CUBIERTA	G-1121F	81125030050	22.280U con motor/U12D		
COMBUSTIBLE	GPP-1122	81125030075	COMBUSTIBLE, CON CUBIERTA	G-1123F	81125030042	COMBUSTIBLE	G-1123	81125030042
20.28 con motor/M.A.N. D2566MT			22.192 con motores/M.A.N. D2146, M.A.N. D2156, M.A.N. D2356			22.281, 22.321 con motor/M.A.N. D2566		
COMBUSTIBLE	G-1123	81125030042	COMBUSTIBLE	G-1123	81125030042	COMBUSTIBLE	G-1123	81125030042
ACEITE	G-143	81055040041	22.215 con motores/M.A.N. D2356, M.A.N. D2146, M.A.N. D2156			ACEITE	G-143	81055040041
COMBUSTIBLE, CON CUBIERTA	G-1123F	81125030042	COMBUSTIBLE	G-1123	81125030042	COMBUSTIBLE, CON CUBIERTA	G-1123F	81125030042
AIRE	GA-405	81082050005	22.22, 22.24 con motor/M.A.N. D2566			AIRE	GA-467	81083040038
AIRE	GA-467	81083040043	COMBUSTIBLE	G-1123	81125030042	22.291 con motor/M.A.N. D2866		
20.281, 20.321 con motor/M.A.N. D2566			ACEITE	G-143	81055040041	COMBUSTIBLE	G-1123	81125030042
COMBUSTIBLE	G-1123	81125030042	COMBUSTIBLE, CON CUBIERTA	G-1123F	81125030042	COMBUSTIBLE, CON CUBIERTA	G-1123F	81125030042
ACEITE	G-143	81055040041	22.23 con motores/M.A.N. D2356, M.A.N. D2146, M.A.N. D2156			AIRE	GA-467	81083040043
COMBUSTIBLE, CON CUBIERTA	G-1123F	81125030042	COMBUSTIBLE	G-1123	81125030042	22.292 con motor/M.A.N. D2866		
AIRE	GA-467	81083040038	22.24 con motor/M.A.N. D2556			COMBUSTIBLE	G-1123	81125030042
20.284 con motor/M.A.N. D0836			COMBUSTIBLE	G-1121	81125030041	ACEITE	G-143	81055040041
COMBUSTIBLE	GP-1122	WDK724	COMBUSTIBLE	G-1123	81125030042	COMBUSTIBLE, CON CUBIERTA	G-1123F	81125030042
20.291 con motor/M.A.N. D2866			COMBUSTIBLE	G-1121F	81125030050	COMBUSTIBLE	GPP-1122	81125030075
COMBUSTIBLE	G-1123	81125030042	COMBUSTIBLE, CON CUBIERTA	G-1123F	81125030042	AIRE	GA-467	81083040038
COMBUSTIBLE, CON CUBIERTA	G-1123F	81125030042	22.24 con motor/U12D			22.304 con motor/M.A.N. D2858		
AIRE	GA-467	81083040038	COMBUSTIBLE	G-1123	81125030042	COMBUSTIBLE	G-1123	81125030042
20.32 con motor/M.A.N. D2530			ACEITE	G-143	81055040041	22.32 con motor/M.A.N. D2530		
COMBUSTIBLE	G-1121	81125030041	COMBUSTIBLE, CON CUBIERTA	G-1123F	81125030042	COMBUSTIBLE	G-1121	81125030041
COMBUSTIBLE	G-1123	81125030042	COMBUSTIBLE	GPP-1122	81125030075	COMBUSTIBLE	G-1123	81125030042
COMBUSTIBLE	G-1121F	81125030050				COMBUSTIBLE	G-1121F	81125030050
COMBUSTIBLE, CON CUBIERTA	G-1123F	81125030042				COMBUSTIBLE, CON CUBIERTA	G-1123F	81125030042
AIRE	GA-405	81082050005				AIRE	GA-405	81082050005

MARCA-MODELO-MOTOR MAKE-MODEL-ENGINE	GONHER GONHER	OEM OEM	MARCA-MODELO-MOTOR MAKE-MODEL-ENGINE	GONHER GONHER	OEM OEM	MARCA-MODELO-MOTOR MAKE-MODEL-ENGINE	GONHER GONHER	OEM OEM
M.A.N. (continuación)			M.A.N. (continuación)			M.A.N. (continuación)		
CAMIONES, TRACTOCAMIONES Y AUTOBUSES			CAMIONES, TRACTOCAMIONES Y AUTOBUSES			CAMIONES, TRACTOCAMIONES Y AUTOBUSES		
22.32 con motor/M.A.N. D3530			23.293, 23.343 con motor/M.A.N. D2865			24.462, 24.502 con motor/M.A.N. D2866		
COMBUSTIBLE	G-1123	81125030042	COMBUSTIBLE	GP-1122	WDK724	COMBUSTIBLE	G-1123	81125030042
ACEITE	G-143	81055040041				ACEITE	G-143	81055040041
COMBUSTIBLE, CON CUBIERTA	G-1123F	81125030042	23.314, 23.364, 23.402, 23.403, 23.414 con motor/M.A.N. D2866			COMBUSTIBLE, CON CUBIERTA	G-1123F	81125030042
			COMBUSTIBLE	GP-1122	WDK724	COMBUSTIBLE	GPP-1122	81125030075
22.320U con motor/M.A.N. D3256BXUL (U12D)						AIRE	GA-405	81082050005
COMBUSTIBLE	G-1123	81125030042	23.321 con motor/M.A.N. D2566			24.463, 24.464, 27.403, 27.414, 27.463, 27.464, 29.414 con motores/M.A.N. D2866, M.A.N. D2876		
			COMBUSTIBLE	G-1123	81125030042	COMBUSTIBLE	GP-1122	WDK724
22.321UNL con motor/M.A.N. D2566			ACEITE	G-143	81055040041	COMBUSTIBLE, CON CUBIERTA	G-1123F	81125030042
COMBUSTIBLE	G-1123	81125030042	COMBUSTIBLE, CON CUBIERTA	G-1123F	81125030042	AIRE	GA-405	81082050005
ACEITE	G-143	81055040041	AIRE	GA-467	81083040038	25.22, 25.24 con motor/M.A.N. D2566		
COMBUSTIBLE, CON CUBIERTA	G-1123F	81125030042	23.372 con motor/M.A.N. D2866			COMBUSTIBLE	G-1123	81125030042
AIRE	GA-467	81083040038	COMBUSTIBLE	GP-1122	WDK724	ACEITE	G-143	81055040041
22.322 con motor/M.A.N. D2865						COMBUSTIBLE, CON CUBIERTA	G-1123F	81125030042
COMBUSTIBLE	G-1123	81125030042	23.463, 23.464 con motor/M.A.N. D2876			25.332 con motor/M.A.N. D2566		
ACEITE	G-143	81055040041	COMBUSTIBLE	GP-1122	WDK724	COMBUSTIBLE	G-1123	81125030021
COMBUSTIBLE, CON CUBIERTA	G-1123F	81125030042	24.232 con motor/M.A.N. D0826L			ACEITE	G-143	81055040039
COMBUSTIBLE	GPP-1122	81125030075	COMBUSTIBLE	GPP-1122	81125030075	COMBUSTIBLE	GPP-1122	81125030075
22.331 con motor/M.A.N. D2866			24.242, 24.292 con motor/M.A.N. D2866			AIRE	GA-467	81083040043
COMBUSTIBLE	G-1123	81125030042	COMBUSTIBLE	G-1123	81125030042	25.361 con motor/M.A.N. D2866		
COMBUSTIBLE, CON CUBIERTA	G-1123F	81125030042	ACEITE	G-143	81055040041	COMBUSTIBLE	G-1123	81125030042
AIRE	GA-467	81083040038	COMBUSTIBLE, CON CUBIERTA	G-1123F	81125030042	ACEITE	G-143	81055040041
22.332, 22.362 con motor/M.A.N. D2866			COMBUSTIBLE	GPP-1122	81125030075	COMBUSTIBLE, CON CUBIERTA	G-1123F	81125030042
COMBUSTIBLE	G-1123	81125030021	AIRE	GA-467	81083040038	AIRE	GA-467	81083040038
ACEITE	G-143	81055040039	24.262, 24.272 con motor/M.A.N. D2865			ACEITE	G-750	81055040048
COMBUSTIBLE	GPP-1122	81125030075	COMBUSTIBLE	G-1123	81125030042	25.372 con motor/M.A.N. D2866		
AIRE	GA-467	81083040043	ACEITE	G-143	81055040041	COMBUSTIBLE	G-1123	81125030042
22.361 con motor/M.A.N. D2866			COMBUSTIBLE, CON CUBIERTA	G-1123F	81125030042	ACEITE	G-143	81055040041
COMBUSTIBLE	G-1123	81125030042	COMBUSTIBLE	GPP-1122	81125030075	COMBUSTIBLE, CON CUBIERTA	G-1123F	81125030042
ACEITE	G-143	81055040041	AIRE	GA-467	81083040038	AIRE	GA-467	81083040043
COMBUSTIBLE, CON CUBIERTA	G-1123F	81125030042	24.293, 24.343, 24.323, 24.342 con motor/M.A.N. D2865			256.25 con motores/M.A.N. D0026M2, M.A.N. D1546M4		
AIRE	GA-467	81083040043	COMBUSTIBLE	GP-1122	WDK724	COMBUSTIBLE	G-1121	81125030041
ACEITE	G-750	81055040048	24.314, 24.373, 24.402 con motor/M.A.N. D2866			26.23, 30.256 con motores/M.A.N. D2356, M.A.N. D2146, M.A.N. D2156		
22.361U con motor/M.A.N. D2866			COMBUSTIBLE	GP-1122	WDK724	COMBUSTIBLE	G-1123	81125030042
COMBUSTIBLE	G-1123	81125030042	24.332, 24.362 con motor/M.A.N. D2866			26.24 con motor/M.A.N. D2556		
ACEITE	G-143	81055040041	COMBUSTIBLE	G-1123	81125030021	COMBUSTIBLE	G-1121	81125030041
COMBUSTIBLE, CON CUBIERTA	G-1123F	81125030042	ACEITE	G-143	81055040041	COMBUSTIBLE	G-1123	81125030042
AIRE	GA-467	81083040038	COMBUSTIBLE	GPP-1122	81125030075	COMBUSTIBLE	G-1121F	81125030050
22.372, 22.422 con motor/M.A.N. D2866			AIRE	GA-467	81083040043	COMBUSTIBLE, CON CUBIERTA	G-1123F	81125030042
COMBUSTIBLE	G-1123	81125030042	24.372 con motor/M.A.N. D2866			26.256, 30.23 con motores/M.A.N. D2146, M.A.N. D2156, M.A.N. D2356		
ACEITE	G-143	81055040041	COMBUSTIBLE	G-1123	81125030042	COMBUSTIBLE	G-1123	81125030042
COMBUSTIBLE, CON CUBIERTA	G-1123F	81125030042	ACEITE	G-143	81055040041	26.272 con motor/M.A.N. D2865		
AIRE	GA-467	81083040038	COMBUSTIBLE, CON CUBIERTA	G-1123F	81125030042	COMBUSTIBLE	G-1123	81125030042
22.462 con motor/M.A.N. D2866			AIRE	GA-467	81083040038	ACEITE	G-143	81055040041
COMBUSTIBLE	G-1123	81125030042	24.414, 24.364, 24.403 con motores/M.A.N. D2866, M.A.N. D2876			COMBUSTIBLE, CON CUBIERTA	G-1123F	81125030042
ACEITE	G-143	81055040041	COMBUSTIBLE	GP-1122	WDK724	COMBUSTIBLE	GPP-1122	81125030075
COMBUSTIBLE, CON CUBIERTA	G-1123F	81125030042	24.422 con motor/M.A.N. D2866			AIRE	GA-467	81083040043
COMBUSTIBLE	GPP-1122	81125030075	COMBUSTIBLE	G-1123	81125030021	26.273 con motores/M.A.N. D2865, M.A.N. D2875		
AIRE	GA-405	81082050005	ACEITE	G-143	81055040041	COMBUSTIBLE	GP-1122	WDK724
2280 con motores/M.A.N. D0026M2, M.A.N. D1546M4			COMBUSTIBLE, CON CUBIERTA	G-1123F	81125030042	26.28 con motor/M.A.N. D2566MT		
COMBUSTIBLE	G-1121	81125030041	AIRE	GA-467	81083040043	COMBUSTIBLE	G-1123	81125030042
23.284, 14.284L con motor/M.A.N. D0836			24.423 con motor/M.A.N. D2866			ACEITE	G-143	81055040041
COMBUSTIBLE	GP-1122	WDK724	COMBUSTIBLE	GPP-1122	81125030075	COMBUSTIBLE, CON CUBIERTA	G-1123F	81125030042

SERVICIO PESADO

MARCA-MODELO-MOTOR MAKE-MODEL-ENGINE	GONHER GONHER	OEM OEM	MARCA-MODELO-MOTOR MAKE-MODEL-ENGINE	GONHER GONHER	OEM OEM	MARCA-MODELO-MOTOR MAKE-MODEL-ENGINE	GONHER GONHER	OEM OEM
M.A.N. (continuación)			M.A.N. (continuación)			M.A.N. (continuación)		
CAMIONES, TRACTOCAMIONES Y AUTOBUSES			CAMIONES, TRACTOCAMIONES Y AUTOBUSES			CAMIONES, TRACTOCAMIONES Y AUTOBUSES		
AIRE	GA-405	81082050005	COMBUSTIBLE, CON CUBIERTA	G-1123F	81125030042	30.28 con motor/M.A.N. D2566MT		
AIRE	GA-467	81083040043	COMBUSTIBLE	GPP-1122	81125030075	COMBUSTIBLE	G-1123	81125030042
26.281, 26.321 con motor/M.A.N. D2566MK			AIRE	GA-467	81083040043	ACEITE	G-143	81055040041
COMBUSTIBLE	G-1123	81125030042	26.365 con motor/M.A.N. D2840			COMBUSTIBLE, CON CUBIERTA	G-1123F	81125030042
ACEITE	G-143	81055040041	COMBUSTIBLE	G-1123	81125030042	AIRE	GA-405	81082050005
COMBUSTIBLE, CON CUBIERTA	G-1123F	81125030042	ACEITE	G-143	81055040041	AIRE	GA-467	81083040038
AIRE	GA-467	81083040038	COMBUSTIBLE, CON CUBIERTA	G-1123F	81125030042	30.281 con motor/M.A.N. D2566MK		
26.291 con motor/M.A.N. D2866			AIRE	GA-467	81083040038	COMBUSTIBLE	G-1123	81125030042
COMBUSTIBLE	G-1123	81125030042	ACEITE	G-750	81055040048	ACEITE	G-143	81055040041
COMBUSTIBLE, CON CUBIERTA	G-1123F	81125030042	26.372 con motor/M.A.N. D2866			COMBUSTIBLE, CON CUBIERTA	G-1123F	81125030042
AIRE	GA-467	81083040043	COMBUSTIBLE	G-1123	81125030042	AIRE	GA-467	81083040038
26.293, 26.323, 26.342, 26.343, 27.293, 27.323 con motor/M.A.N. D2865			ACEITE	G-143	81055040041	30.291, 30.331 con motor/M.A.N. D2866		
COMBUSTIBLE	GP-1122	WDK724	COMBUSTIBLE, CON CUBIERTA	G-1123F	81125030042	COMBUSTIBLE	G-1123	81125030042
26.304 con motor/M.A.N. D2858			AIRE	GA-467	81083040038	COMBUSTIBLE, CON CUBIERTA	G-1123F	81125030042
COMBUSTIBLE	G-1123	81125030042	26.462, 26.502 con motor/M.A.N. D2840			AIRE	GA-467	81083040038
26.314, 26.364, 26.373, 26.402, 26.403, 26.414, 26.423, 27.314, 27.364, 27.373 con motor/M.A.N. D2866			COMBUSTIBLE	G-1123	81125030042	30.293 con motor/M.A.N. D2865		
COMBUSTIBLE	GP-1122	WDK724	ACEITE	G-143	81055040041	ACEITE	G-162H	81473016005
26.32 con motor/M.A.N. D3530			COMBUSTIBLE, CON CUBIERTA	G-1123F	81125030042	30.304 con motor/M.A.N. D2858		
COMBUSTIBLE	G-1123	81125030042	COMBUSTIBLE	GP-1122	81125030004	COMBUSTIBLE	G-1123	81125030042
ACEITE	G-143	81055040041	AIRE	GA-405	81082050005	30.314, 30.343, 30.364, 30.403, 30.414 con motor/M.A.N. D2866		
COMBUSTIBLE, CON CUBIERTA	G-1123F	81125030042	26.463, 26.464, 27.423, 28.463, 28.464 con motor/M.A.N. D2876			ACEITE	G-162H	81473016005
26.32 con motores/M.A.N. D2530, M.A.N. D2538			COMBUSTIBLE	GP-1122	WDK724	30.32 con motor/M.A.N. D2530		
COMBUSTIBLE	G-1121	81125030041	26.603, 27.603 con motor/M.A.N. D2840			COMBUSTIBLE	G-1121	81125030041
COMBUSTIBLE	G-1123	81125030042	COMBUSTIBLE	GP-1122	WDK724	COMBUSTIBLE	G-1123	81125030042
ACEITE	G-143	81055040041	27.342, 27.343 con motor/M.A.N. D2865			COMBUSTIBLE	G-1121F	81125030050
COMBUSTIBLE	G-1121F	81125030050	COMBUSTIBLE	GP-1122	WDK724	COMBUSTIBLE, CON CUBIERTA	G-1123F	81125030042
COMBUSTIBLE, CON CUBIERTA	G-1123F	81125030042	27.365 con motor/M.A.N. D2840			AIRE	GA-405	81082050005
AIRE	GA-405	81082050005	COMBUSTIBLE	G-1123	81125030042	30.463, 30.464 con motor/M.A.N. D2876		
26.322 con motor/M.A.N. D2865			ACEITE	G-143	81055040041	ACEITE	G-162H	81473016005
COMBUSTIBLE	G-1123	81125030042	COMBUSTIBLE, CON CUBIERTA	G-1123F	81125030042	32.24 con motores/M.A.N. D2566, U12D		
ACEITE	G-143	81055040041	AIRE	GA-467	81083040038	COMBUSTIBLE	G-1123	81125030042
COMBUSTIBLE, CON CUBIERTA	G-1123F	81125030042	ACEITE	G-750	81055040048	ACEITE	G-143	81055040041
COMBUSTIBLE	GPP-1122	81125030075	27.372 con motor/M.A.N. D2866			COMBUSTIBLE, CON CUBIERTA	G-1123F	81125030042
AIRE	GA-467	81083040038	ACEITE	G-143	81055040041	32.242 con motor/M.A.N. D2866		
26.331 con motor/M.A.N. D2866			COMBUSTIBLE	GP-1122	WDK724	COMBUSTIBLE	G-1123	81125030042
COMBUSTIBLE	G-1123	81125030042	AIRE	GA-467	C30850/2	ACEITE	G-143	81055040041
COMBUSTIBLE, CON CUBIERTA	G-1123F	81125030042	27.402 con motor/M.A.N. D2866			COMBUSTIBLE, CON CUBIERTA	G-1123F	81125030042
AIRE	GA-467	81083040038	COMBUSTIBLE	GP-1122	WDK724	COMBUSTIBLE	GPP-1122	81125030075
26.332 con motor/M.A.N. D2866			28.293, 28.314, 28.343, 28.403 con motores/M.A.N. D2865, M.A.N. D2866			AIRE	GA-467	81083040038
COMBUSTIBLE	G-1123	81125030021	COMBUSTIBLE	GP-1122	WDK724	32.262, 32.272 con motor/M.A.N. D2865		
ACEITE	G-143	81055040041	29.464 con motores/M.A.N. D2866, M.A.N. D2876			COMBUSTIBLE	G-1123	81125030042
COMBUSTIBLE	GPP-1122	81125030075	COMBUSTIBLE	GP-1122	WDK724	ACEITE	G-143	81055040041
AIRE	GA-467	81083040043	30.24 con motor/M.A.N. D2556			COMBUSTIBLE, CON CUBIERTA	G-1123F	81125030042
26.361 con motor/M.A.N. D2866			COMBUSTIBLE	G-1121	81125030041	COMBUSTIBLE	GPP-1122	81125030075
COMBUSTIBLE	G-1123	81125030042	COMBUSTIBLE	G-1123	81125030042	AIRE	GA-467	81083040038
ACEITE	G-143	81055040041	COMBUSTIBLE	G-1121F	81125030050	32.28 con motor/M.A.N. D2566MT		
COMBUSTIBLE, CON CUBIERTA	G-1123F	81125030042	COMBUSTIBLE, CON CUBIERTA	G-1123F	81125030042	COMBUSTIBLE	G-1123	81125030042
AIRE	GA-467	81083040038	30.24 con motor/M.A.N. D2566			ACEITE	G-143	81055040041
ACEITE	G-750	81055040048	COMBUSTIBLE	G-1123	81125030042	COMBUSTIBLE, CON CUBIERTA	G-1123F	81125030042
26.362 con motor/M.A.N. D2866			COMBUSTIBLE	G-1123	81125030042	AIRE	GA-405	81082050005
COMBUSTIBLE	G-1123	81125030042	ACEITE	G-143	81055040041	AIRE	GA-467	81083040038
ACEITE	G-143	81055040041	COMBUSTIBLE, CON CUBIERTA	G-1123F	81125030042			

MARCA-MODELO-MOTOR MAKE-MODEL-ENGINE	GONHER GONHER	OEM OEM	MARCA-MODELO-MOTOR MAKE-MODEL-ENGINE	GONHER GONHER	OEM OEM	MARCA-MODELO-MOTOR MAKE-MODEL-ENGINE	GONHER GONHER	OEM OEM
M.A.N. (continuación)			M.A.N. (continuación)			M.A.N. (continuación)		
CAMIONES, TRACTOCAMIONES Y AUTOBUSES			CAMIONES, TRACTOCAMIONES Y AUTOBUSES			CAMIONES, TRACTOCAMIONES Y AUTOBUSES		
32.281 con motor/M.A.N. D2566			AIRE	GA-467	81083040038	33.343DF, 35.343VF con motor/M.A.N. D2865LF21		
COMBUSTIBLE	G-1123	81125030042	ACEITE	G-750	81055040048	COMBUSTIBLE	GP-1122	51125030031
ACEITE	G-143	81055040041	32.364 con motor/M.A.N. D2866LF34			33.364 con motor/M.A.N. D2866		
COMBUSTIBLE, CON CUBIERTA	G-1123F	81125030042	COMBUSTIBLE	GP-1122	51125030031	COMBUSTIBLE	GP-1122	51125030031
AIRE	GA-467	81083040038	32.365 con motor/M.A.N. D2840			33.365 con motor/M.A.N. D2840		
32.291 con motor/M.A.N. D2866			COMBUSTIBLE	G-1123	81125030042	COMBUSTIBLE	G-1123	81125030042
COMBUSTIBLE	G-1123	81125030042	ACEITE	G-143	81055040039	ACEITE	G-143	81055040039
COMBUSTIBLE, CON CUBIERTA	G-1123F	81125030042	COMBUSTIBLE, CON CUBIERTA	G-1123F	81125030042	COMBUSTIBLE, CON CUBIERTA	G-1123F	81125030042
AIRE	GA-467	81083040043	AIRE	GA-467	81083040038	AIRE	GA-467	81083040038
32.292 con motor/M.A.N. D2866			ACEITE	G-750	81055040048	ACEITE	G-750	81055040048
COMBUSTIBLE	G-1123	81125030042	32.372, 32.422 con motor/M.A.N. D2866			33.372 con motor/M.A.N. D2866		
ACEITE	G-143	81055040041	COMBUSTIBLE	G-1123	81125030042	COMBUSTIBLE	G-1123	81125030042
COMBUSTIBLE, CON CUBIERTA	G-1123F	81125030042	ACEITE	G-143	81055040039	ACEITE	G-143	81055040039
COMBUSTIBLE	GPP-1122	81125030075	COMBUSTIBLE, CON CUBIERTA	G-1123F	81125030042	COMBUSTIBLE, CON CUBIERTA	G-1123F	81125030042
AIRE	GA-467	81083040038	AIRE	GA-467	81083040038	AIRE	GA-467	81083040038
32.293VF con motor/M.A.N. D2865LF24			32.402 con motor/M.A.N. D2866			33.373, 33.402 con motor/M.A.N. D2866		
COMBUSTIBLE	GP-1122	51125030031	COMBUSTIBLE	GP-1122	WDK724	COMBUSTIBLE	GP-1122	WDK724
32.314F, 32.314VF con motor/M.A.N. D2866LF34			32.414F, 32.414VF con motores/M.A.N. D2866, M.A.N. D2876			33.403DF con motor/M.A.N. D2866LF20		
COMBUSTIBLE	GP-1122	51125030031	COMBUSTIBLE	GP-1122	51125030031	COMBUSTIBLE	GP-1122	51125030031
32.32 con motor/M.A.N. D2530			32.462, 32.502 con motor/M.A.N. D2840			33.414 con motores/M.A.N. D2866, M.A.N. D2876		
COMBUSTIBLE	G-1121	81125030041	COMBUSTIBLE	G-1123	81125030042	COMBUSTIBLE	GP-1122	51125030031
COMBUSTIBLE	G-1123	81125030042	ACEITE	G-143	81055040041	COMBUSTIBLE, CON CUBIERTA	G-1123F	81125030042
COMBUSTIBLE	G-1121F	81125030050	COMBUSTIBLE, CON CUBIERTA	G-1123F	81125030042	AIRE	GA-405	81082050005
COMBUSTIBLE, CON CUBIERTA	G-1123F	81125030042	AIRE	GA-405	81082050005	33.422 con motor/M.A.N. D2866		
AIRE	GA-405	81082050005	32.464, 32.403, 32.463 con motores/M.A.N. D2866, M.A.N. D2876			COMBUSTIBLE	G-1123	81125030021
32.321 con motores/M.A.N. D2566MK, M.A.N. D2566MKF			COMBUSTIBLE	GP-1122	51125030031	ACEITE	G-143	81055040039
COMBUSTIBLE	G-1123	81125030042	32XFG con motor/M.A.N. D2876LF03			AIRE	GA-467	81083040038
ACEITE	G-143	81055040041	ACEITE	G-143	51-05504-0039	33.423 con motor/M.A.N. D2866		
COMBUSTIBLE, CON CUBIERTA	G-1123F	81125030042	33.242, 33.292 con motor/M.A.N. D2866			COMBUSTIBLE	GP-1122	WDK724
AIRE	GA-467	81083040038	COMBUSTIBLE	G-1123	81125030042	33.462, 33.502 con motor/M.A.N. D2840		
32.322 con motor/M.A.N. D2865			ACEITE	G-143	81055040041	COMBUSTIBLE	G-1123	81125030042
COMBUSTIBLE	G-1123	81125030042	COMBUSTIBLE, CON CUBIERTA	G-1123F	81125030042	ACEITE	G-143	81055040041
ACEITE	G-143	81055040041	COMBUSTIBLE	GPP-1122	81125030075	COMBUSTIBLE, CON CUBIERTA	G-1123F	81125030042
COMBUSTIBLE, CON CUBIERTA	G-1123F	81125030042	AIRE	GA-467	81083040038	AIRE	GA-405	81082050005
COMBUSTIBLE	GPP-1122	81125030075	33.272, 33.322 con motor/M.A.N. D2865			33.463DF con motor/M.A.N. D2876LF02		
AIRE	GA-467	81083040038	COMBUSTIBLE	G-1123	81125030042	COMBUSTIBLE	GP-1122	51125030031
32.331 con motor/M.A.N. D2866			ACEITE	G-143	81055040041	33.464 con motores/M.A.N. D2866, M.A.N. D2876		
COMBUSTIBLE	G-1123	81125030042	COMBUSTIBLE, CON CUBIERTA	G-1123F	81125030042	COMBUSTIBLE	GP-1122	51125030031
COMBUSTIBLE, CON CUBIERTA	G-1123F	81125030042	COMBUSTIBLE	GPP-1122	81125030075	33.603, 33.604, 36.604, 40.603, 40.604, 41.603, 41.604 con motor/M.A.N. D2840		
AIRE	GA-467	81083040038	AIRE	GA-467	81083040038	COMBUSTIBLE	GP-1122	WDK724
32.332, 32.362 con motor/M.A.N. D2866			33.321 con motores/M.A.N. D2566MK, M.A.N. D2566MKF			35.364F, 35.364VF con motor/M.A.N. D2865LF35		
COMBUSTIBLE	G-1123	81125030021	COMBUSTIBLE	G-1123	81125030042	COMBUSTIBLE	GP-1122	51125030031
ACEITE	G-143	81055040039	ACEITE	G-143	81055040041	35.402, 40.402, 40.403, 40.414, 41.364, 41.414, 41.402VF con motor/M.A.N. D2866		
COMBUSTIBLE	GPP-1122	81125030075	COMBUSTIBLE, CON CUBIERTA	G-1123F	81125030042	COMBUSTIBLE	GP-1122	WDK724
AIRE	GA-467	81083040038	AIRE	GA-467	81083040038	35.403VF con motor/M.A.N. D2866		
32.342 con motor/M.A.N. D2865			33.323, 33.342 con motor/M.A.N. D2865			COMBUSTIBLE	GP-1122	WDK724
COMBUSTIBLE	GP-1122	WDK724	COMBUSTIBLE	GP-1122	WDK724	35.414, 35.464, 41.403, 41.463, 42.414, 42.464 con motores/M.A.N. D2866, M.A.N. D2876		
32.343 con motor/M.A.N. D2865LF24			33.332, 33.362 con motor/M.A.N. D2866			COMBUSTIBLE	GP-1122	WDK724
COMBUSTIBLE	GP-1122	51125030031	COMBUSTIBLE	G-1123	81125030021	35.403VF con motor/M.A.N. D2866		
32.361 con motor/M.A.N. D2866			ACEITE	G-143	81055040039	COMBUSTIBLE	GP-1122	WDK724
COMBUSTIBLE	G-1123	81125030042	COMBUSTIBLE	GPP-1122	81125030075	35.414, 35.464, 41.403, 41.463, 42.414, 42.464 con motores/M.A.N. D2866, M.A.N. D2876		
ACEITE	G-143	81055040039	AIRE	GA-467	81083040038	COMBUSTIBLE	GP-1122	WDK724
COMBUSTIBLE, CON CUBIERTA	G-1123F	81125030042						

SERVICIO PESADO

MARCA-MODELO-MOTOR MAKE-MODEL-ENGINE	GONHER GONHER	OEM OEM	MARCA-MODELO-MOTOR MAKE-MODEL-ENGINE	GONHER GONHER	OEM OEM	MARCA-MODELO-MOTOR MAKE-MODEL-ENGINE	GONHER GONHER	OEM OEM
M.A.N. (continuación)			M.A.N. (continuación)			M.A.N. (continuación)		
CAMIONES, TRACTOCAMIONES Y AUTOBUSES			CAMIONES, TRACTOCAMIONES Y AUTOBUSES			CAMIONES, TRACTOCAMIONES Y AUTOBUSES		
35.463VF con motor/M.A.N. D2876LF02			40.365 con motor/M.A.N. D2840			COMBUSTIBLE	GPP-1122	81125030075
COMBUSTIBLE	GP-1122	51125030031	COMBUSTIBLE	G-1123	81125030042	AIRE	GA-467	81083040043
			ACEITE	G-143	81055040041	41.343, 35.342, 41.342 con motor/M.A.N. D2865		
360.32 con motores/M.A.N. D0026M2, M.A.N. D1546M4			COMBUSTIBLE, CON CUBIERTA	G-1123F	81125030042	COMBUSTIBLE	GP-1122	WDK724
COMBUSTIBLE	G-1121	81125030041	AIRE	GA-467	81083040038			
			ACEITE	G-750	81055040048	41.361 con motor/M.A.N. D2866		
38.32 con motor/M.A.N. D2530			40.372 con motor/M.A.N. D2866			COMBUSTIBLE	G-1123	81125030042
COMBUSTIBLE	G-1121	81125030041	COMBUSTIBLE	G-1123	81125030042	ACEITE	G-143	81055040041
COMBUSTIBLE	G-1123	81125030042	ACEITE	G-143	81055040041	COMBUSTIBLE, CON CUBIERTA	G-1123F	81125030042
COMBUSTIBLE	G-1121F	81125030050	COMBUSTIBLE, CON CUBIERTA	G-1123F	81125030042	AIRE	GA-467	81083040038
COMBUSTIBLE, CON CUBIERTA	G-1123F	81125030042	AIRE	GA-467	81083040038	ACEITE	G-750	81055040048
AIRE	GA-405	81082050005				41.372 con motor/M.A.N. D2866		
4.7 con motor/R.V.I. 712			40.4 con motor/M.A.N. D2530 TURBO			COMBUSTIBLE	G-1123	81125030042
COMBUSTIBLE	G-296	81125030038	COMBUSTIBLE	G-1123	81125030042	ACEITE	G-143	81055040039
			ACEITE	G-143	81055040041	COMBUSTIBLE, CON CUBIERTA	G-1123F	81125030042
40.242 con motor/M.A.N. D2866			COMBUSTIBLE, CON CUBIERTA	G-1123F	81125030042	AIRE	GA-467	81083040038
COMBUSTIBLE	G-1123	81125030042	AIRE	GA-405	81082050005	415 con motor/A DIESEL		
ACEITE	G-143	81055040041				COMBUSTIBLE	G-1121	81125030041
COMBUSTIBLE, CON CUBIERTA	G-1123F	81125030042	40.4, 40.44 con motor/M.A.N. D2540			COMBUSTIBLE	G-1123	81125030041
COMBUSTIBLE	GPP-1122	81125030075	COMBUSTIBLE	G-1123	81125030042	COMBUSTIBLE	G-1121F	81125030050
AIRE	GA-467	81083040038	40.422 con motor/M.A.N. D2866			415.25, 420 con motores/M.A.N. D0026M2, M.A.N. D1546M4		
40.262, 40.272 con motor/M.A.N. D2865			COMBUSTIBLE	G-1123	81125030042	COMBUSTIBLE	G-1121	81125030041
COMBUSTIBLE	G-1123	81125030042	ACEITE	G-143	81055040039	48.242, 48.292 con motor/M.A.N. D2866		
ACEITE	G-143	81055040041	COMBUSTIBLE, CON CUBIERTA	G-1123F	81125030042	COMBUSTIBLE	G-1123	81125030042
COMBUSTIBLE, CON CUBIERTA	G-1123F	81125030042	COMBUSTIBLE	GPP-1122	81125030075	ACEITE	G-143	81055040041
COMBUSTIBLE	GPP-1122	81125030075	AIRE	GA-467	81083040043	COMBUSTIBLE, CON CUBIERTA	G-1123F	81125030042
AIRE	GA-467	81083040038				AIRE	GA-467	81083040038
40.28 con motor/M.A.N. D2865			40.462, 40.502 con motor/M.A.N. D2840			48.321 con motor/M.A.N. D2566		
COMBUSTIBLE	G-1123	81125030042	COMBUSTIBLE	G-1123	81125030042	COMBUSTIBLE	G-1123	81125030042
ACEITE	G-143	81055040041	ACEITE	G-143	81055040039	ACEITE	G-143	81055040041
COMBUSTIBLE, CON CUBIERTA	G-1123F	81125030042	COMBUSTIBLE, CON CUBIERTA	G-1123F	81125030042	COMBUSTIBLE, CON CUBIERTA	G-1123F	81125030042
AIRE	GA-405	81082050005	COMBUSTIBLE	GP-1122	51125030005	AIRE	GA-467	81083040038
AIRE	GA-467	81083040038	AIRE	GA-405	81082050005			
40.292 con motor/M.A.N. D2866			40.463, 40.464 con motor/M.A.N. D2876			48.322 con motor/M.A.N. D2865		
COMBUSTIBLE	G-1123	81125030042	COMBUSTIBLE	GP-1122	WDK724	COMBUSTIBLE	G-1123	81125030042
ACEITE	G-143	81055040041	400, 520 con motor/A DIESEL			ACEITE	G-143	81055040041
COMBUSTIBLE, CON CUBIERTA	G-1123F	81125030042	COMBUSTIBLE	G-1121	81125030041	COMBUSTIBLE, CON CUBIERTA	G-1123F	81125030042
COMBUSTIBLE	GPP-1122	81125030075	41.262, 41.272 con motor/M.A.N. D2865			AIRE	GA-467	81083040038
AIRE	GA-467	81083040038	COMBUSTIBLE	G-1123	81125030042			
40.32 con motor/M.A.N. D2530			ACEITE	G-143	81055040041	48.331 con motor/M.A.N. D2866		
COMBUSTIBLE	G-1121	81125030041	COMBUSTIBLE, CON CUBIERTA	G-1123F	81125030042	COMBUSTIBLE	G-1123	81125030042
COMBUSTIBLE	G-1123	81125030042	COMBUSTIBLE	GP-1122	81125030075	ACEITE	G-143	81055040041
COMBUSTIBLE	G-1121F	81125030050	AIRE	GA-467	81083040038	COMBUSTIBLE	GPP-1122	81125030075
COMBUSTIBLE, CON CUBIERTA	G-1123F	81125030042				AIRE	GA-467	81083040038
AIRE	GA-405	81082050005	41.292 con motor/M.A.N. D2866					
40.322 con motor/M.A.N. D2865			COMBUSTIBLE	G-1123	81125030042	48.332, 48.362 con motor/M.A.N. D2866		
COMBUSTIBLE	G-1123	81125030042	ACEITE	G-143	81055040041	COMBUSTIBLE	G-1123	81125030021
ACEITE	G-143	81055040041	COMBUSTIBLE, CON CUBIERTA	G-1123F	81125030042	ACEITE	G-143	81055040041
COMBUSTIBLE, CON CUBIERTA	G-1123F	81125030042	AIRE	GA-467	81083040038	COMBUSTIBLE	GPP-1122	81125030075
COMBUSTIBLE	GPP-1122	81125030075				AIRE	GA-467	81083040038
AIRE	GA-467	81083040038	41.322 con motor/M.A.N. D2865					
40.332, 40.362 con motor/M.A.N. D2866			COMBUSTIBLE	G-1123	81125030042	48.372, 48.422 con motor/M.A.N. D2866		
COMBUSTIBLE	G-1123	81125030021	ACEITE	G-143	81055040041	COMBUSTIBLE	G-1123	81125030042
ACEITE	G-143	81055040041	COMBUSTIBLE, CON CUBIERTA	G-1123F	81125030042	ACEITE	G-143	81055040041
COMBUSTIBLE	GPP-1122	81125030075	AIRE	GA-467	81083040038	COMBUSTIBLE, CON CUBIERTA	G-1123F	81125030042
AIRE	GA-467	81083040043				AIRE	GA-467	81083040038
			41.332, 41.362 con motor/M.A.N. D2866					
			COMBUSTIBLE	G-1123	81125030021			
			ACEITE	G-143	81055040041			

MARCA-MODELO-MOTOR MAKE-MODEL-ENGINE	GONHER GONHER	OEM OEM	MARCA-MODELO-MOTOR MAKE-MODEL-ENGINE	GONHER GONHER	OEM OEM	MARCA-MODELO-MOTOR MAKE-MODEL-ENGINE	GONHER GONHER	OEM OEM
M.A.N. (continuación)			M.A.N. (continuación)			M.A.N. (continuación)		
CAMIONES, TRACTOCAMIONES Y AUTOBUSES			CAMIONES, TRACTOCAMIONES Y AUTOBUSES			CAMIONES, TRACTOCAMIONES Y AUTOBUSES		
48.462, 48.502 con motor/M.A.N. D2840			6.115 con motor/M.A.N. D0026			760UO con motor/M.A.N. D1546M1U		
COMBUSTIBLE	G-1123	81125030042	COMBUSTIBLE	G-1121	81125030041	COMBUSTIBLE	G-1121	81125030041
ACEITE	G-143	81055040041						
COMBUSTIBLE, CON CUBIERTA	G-1123F	81125030042	6.126, 6.136 con motores/R.V.I. 597, R.V.I. 797			780, 830, 835, 845, 860, 758, 770 con motor/A DIESEL		
COMBUSTIBLE	GP-1122	51125030004	COMBUSTIBLE	G-1123	81125030042	ACEITE	G-31	81055040008
AIRE	GA-405	81082050005				COMBUSTIBLE	G-1123	81125030042
			6.9 con motor/M.A.N. D0224M			COMBUSTIBLE, CON CUBIERTA	G-1123F	81125030042
48.7 con motor/M.A.N. D2842			COMBUSTIBLE	GP-1122	51125030004			
COMBUSTIBLE	G-1123	81125030042				790 con motor/SAVIEM		
ACEITE	G-143	81055040041	6.90F con motor/M.A.N. D0224M			COMBUSTIBLE	G-296	81125030038
COMBUSTIBLE, CON CUBIERTA	G-1123F	81125030042	COMBUSTIBLE	GP-1122	51125030004			
AIRE	GA-467	81083040038				8.1 con motor/M.A.N. D0824		
			620, 630, 750 con motor/A DIESEL			COMBUSTIBLE	GP-1122	WDK724
5.126, 5.136 con motores/R.V.I. 597, R.V.I. 797			ACEITE	G-31	81055040008			
COMBUSTIBLE	G-1123	81125030042	COMBUSTIBLE	G-1123	81125030042	8.136 con motor/M.A.N. D0226MF		
			COMBUSTIBLE, CON CUBIERTA	G-1123F	81125030042	COMBUSTIBLE	GP-1122	WDK724
5.70F con motor/R.V.I. 712								
COMBUSTIBLE	G-296	81125030038	626, 635 con motor/M.A.N. D0836M2			8.136 con motores/R.V.I. 597, R.V.I. 797		
			COMBUSTIBLE	G-1121	81125030041	COMBUSTIBLE	G-1123	81125030042
50.373, 50.403, 50.414 con motor/M.A.N. D2866								
COMBUSTIBLE	GP-1122	WDK724	630L2A, 630L2AE con motor/A DIESEL			8.136F con motor/M.A.N. D0224M		
			ACEITE	G-31	81055040008	COMBUSTIBLE	GP-1122	51125030004
50.463, 50.464 con motor/M.A.N. D2876			COMBUSTIBLE	G-1121	81125030041			
COMBUSTIBLE	GP-1122	WDK724	COMBUSTIBLE	G-1123	81125030042	8.15 con motor/M.A.N. D0826F		
			COMBUSTIBLE, CON CUBIERTA	G-1123F	81125030042	COMBUSTIBLE	GP-1122	51125030004
50.603, 50.604 con motor/M.A.N. D2840								
COMBUSTIBLE	GP-1122	WDK724	640, 750 con motores/M.A.N. D0836HM7H, M.A.N. D0836HM9U			8.156 con motores/M.A.N. D0836, M.A.N. D0836M2		
			ACEITE	G-834	81055040023	COMBUSTIBLE	G-1121	81125030041
530 con motor/M.A.N. D0026M			COMBUSTIBLE	G-1121	81125030041			
ACEITE	G-31	81055040008	COMBUSTIBLE	G-1121F	81125030050	8.16 con motor/A DIESEL		
COMBUSTIBLE	G-1123	81125030042	ACEITE	G-162H	81473016005	ACEITE	G-31	81055040008
COMBUSTIBLE, CON CUBIERTA	G-1123F	81125030042				COMBUSTIBLE	G-1123	81125030042
			690 con motor/R.V.I. 720			COMBUSTIBLE	G-1123F	81125030011
530 con motor/M.A.N. D1546M3			COMBUSTIBLE	G-296	81125030038			
COMBUSTIBLE	G-1123	81125030042				8.9 con motor/M.A.N. D0224M		
			7.126 con motores/R.V.I. 597, R.V.I. 797			COMBUSTIBLE	GP-1122	51125030005
535 con motor/M.A.N. D0026M			COMBUSTIBLE	G-1123	81125030042			
ACEITE	G-31	81055040008				8.90F con motor/M.A.N. D0224M		
COMBUSTIBLE	G-1123	81125030042	7.135 con motores/M.A.N. D0836, M.A.N. D0836M2			COMBUSTIBLE	GP-1122	51125030005
COMBUSTIBLE, CON CUBIERTA	G-1123F	81125030042	COMBUSTIBLE	G-1121	81125030041			
						850 con motor/M.A.N. D0836M2		
535 con motores/M.A.N. D0836HM7H, M.A.N. D0836HM9U			7.136, 8.126 con motores/R.V.I. 597, R.V.I. 797			COMBUSTIBLE	G-1121	81125030041
ACEITE	G-834	81055040023	COMBUSTIBLE	G-1123	81125030042			
COMBUSTIBLE	G-1121	81125030041				890 con motores/M.A.N. D2146HM51U, A DIESEL, M.A.N. D1246HM5U		
COMBUSTIBLE	G-1121F	81125030050	735 con motor/M.A.N. D0836M2			COMBUSTIBLE	G-1123	81125030042
ACEITE	G-162H	81473016005	COMBUSTIBLE	G-1121	81125030041			
						9.126 con motores/R.V.I. 597, R.V.I. 797		
535HOR10, 535HOU10 con motor/M.A.N. D0836M3H			750 con motores/M.A.N. D2146HM51U, M.A.N. D2146HM5U			COMBUSTIBLE	G-1121F	81125030042
ACEITE	G-834	81055040023	COMBUSTIBLE	G-1123	81125030042			
COMBUSTIBLE	G-1123	81125030042				9.135 con motor/A DIESEL		
COMBUSTIBLE, CON CUBIERTA	G-1123F	81125030042	750 STANDARBUS VOV con motores/M.A.N. D0836HM91U, M.A.N. D0836HM95U			COMBUSTIBLE	G-1123	81125030041
			ACEITE	G-834	81055040023			
545 con motor/M.A.N. D0026M			COMBUSTIBLE	G-1121	81125030041	9.135 con motores/M.A.N. D0836HM7H, M.A.N. D0836HM9U		
ACEITE	G-31	51055040008	COMBUSTIBLE	G-1121F	81125030050	ACEITE	G-834	81055040023
COMBUSTIBLE	G-1123	81125030042				COMBUSTIBLE	G-1121	81125030041
COMBUSTIBLE, CON CUBIERTA	G-1123F	81125030042	760 con motores/M.A.N. D0026M2, M.A.N. D1546M4			COMBUSTIBLE	G-1121F	81125030050
			COMBUSTIBLE	G-1121	81125030041	ACEITE	G-162H	81473016005
560 con motores/M.A.N. D0026M2, M.A.N. D1546M4								
COMBUSTIBLE	G-1121	81125030041	760 con motores/M.A.N. D0836HM7H, M.A.N. D0836HM9U			9.136 con motor/M.A.N. D0226MF		
			ACEITE	G-834	81055040023	COMBUSTIBLE	GP-1122	51125030004
5R280 con motor/A DIESEL			COMBUSTIBLE	G-1121	81125030041			
COMBUSTIBLE	G-1123	81125030042	COMBUSTIBLE	G-1121F	81125030050	9.136 con motores/R.V.I. 597, R.V.I. 797		
			COMBUSTIBLE	G-162H	81473016005	COMBUSTIBLE	G-1121F	81125030042
6.1, 12.163 L con motor/M.A.N. D0824								
COMBUSTIBLE	GP-1122	WDK724						

SERVICIO PESADO

MARCA-MODELO-MOTOR MAKE-MODEL-ENGINE	GONHER GONHER	OEM OEM	MARCA-MODELO-MOTOR MAKE-MODEL-ENGINE	GONHER GONHER	OEM OEM	MARCA-MODELO-MOTOR MAKE-MODEL-ENGINE	GONHER GONHER	OEM OEM
M.A.N. (continuación)			M.A.N. (continuación)			M.A.N. (continuación)		
CAMIONES, TRACTOCAMIONES Y AUTOBUSES			CAMIONES, TRACTOCAMIONES Y AUTOBUSES			MOTORES		
9.136F con motor/M.A.N. D0224 SERIES			SG240, SG240H con motor/M.A.N. D2566			COMBUSTIBLE	G-1123	81125030042
COMBUSTIBLE	GP-1122	51125030005	COMBUSTIBLE	G-1123	81125030042	COMBUSTIBLE, CON CUBIERTA	G-1123F	81125030042
9.15 con motor/M.A.N. D0826F			ACEITE	G-143	81055040041	D0216 SERIES		
COMBUSTIBLE	GP-1122	51125030005	COMBUSTIBLE, CON CUBIERTA	G-1123F	81125030042	COMBUSTIBLE	G-296	81125030038
9.156 con motor/M.A.N. D0836M2			SG242, SG242H, SG290, SG290H con motor/M.A.N. D2866			COMBUSTIBLE	G-296-B	81125030038
COMBUSTIBLE	G-1121	81125030041	COMBUSTIBLE	G-1123	81125030018	ACEITE	GP-3569	A5000041045
9.16 con motor/A DIESEL			ACEITE	G-143	81055040041	D0224M, D0224MF		
ACEITE	G-31	81055040008	COMBUSTIBLE	GPP-1122	81125030075	COMBUSTIBLE	G-1123	81125030042
COMBUSTIBLE	G-1123	81125030042	SL160 con motor/M.A.N. D0846			COMBUSTIBLE, CON CUBIERTA	G-1123F	81125030042
COMBUSTIBLE, CON CUBIERTA	G-1123F	81125030042	COMBUSTIBLE	G-1121	81125030041	COMBUSTIBLE	GP-1122	81125030004
9.186 con motores/M.A.N. D2146, M.A.N. D2156, M.A.N. D2356			SL192 con motor/A DIESEL			D0226, D0226MF, D0226MKF, D0836 SERIES, D1546 SERIES, D2146		
COMBUSTIBLE	G-1123	81125030042	COMBUSTIBLE	G-1123	81125030042	SERIES, D2156 SERIES, D2356 SERIES, D2356HM-2 IMPORTA-		
9.216 con motor/M.A.N. D0836M2			SL195 con motor/U11D			DO, D2538MT IMPORTADO, D2540, D2540MTF, D2542, D2548,		
COMBUSTIBLE	G-1121F	81125030050	COMBUSTIBLE	G-1123	81125030042	D2556MT IMPORTADO, D2565, D2658, D2758, D2855 (U10D),		
EL202 con motor/M.A.N. D0826			SL202 con motor/M.A.N. D2866			D2858, D3256 SERIES (U12D), U10D, U12D, U7D		
COMBUSTIBLE	GPP-1122	81125030075	COMBUSTIBLE	G-1123	81125030018	COMBUSTIBLE	G-1123	P811
FRH462 con motor/M.A.N. D2876			SL202 con motor/M.A.N. D2866			D0824 SERIES, D0826 SERIES, D2866L SERIES, D2876 SERIES,		
COMBUSTIBLE	GP-1122	WDK724	COMBUSTIBLE	G-1123	81125030018	D2876LF SERIES, D2886L, D2886LF, E2886 SERIES		
NL202 con motor/M.A.N. D0826			SL202, SR280, SR321 con motor/M.A.N. D2566			COMBUSTIBLE	GPP-1122	81125030075
COMBUSTIBLE	GPP-1122	81125030075	COMBUSTIBLE	G-1123	81125030042	D0846 SERIES		
NL363 con motor/M.A.N. D2866			COMBUSTIBLE	G-1123	81125030042	ACEITE	G-834	81055040023
COMBUSTIBLE	GP-1122	WDK724	ACEITE	G-143	81055040041	COMBUSTIBLE	G-1121	81125030041
RH460, RH463 con motor/M.A.N. D2876			COMBUSTIBLE, CON CUBIERTA	G-1123F	81125030042	COMBUSTIBLE	G-1121F	81125030050
COMBUSTIBLE	GP-1122	WDK724	AIRE	GA-467	81083040038	COMBUSTIBLE	G-1121F	81125030050
RU240, RU290 con motor/M.A.N. D2866			SL220 con motor/A DIESEL			D1246M1 IMPORTADO		
COMBUSTIBLE	G-1123	81125030018	COMBUSTIBLE, PRIMARIO	G-1121	81125030016	ACEITE	G-31	81055040008
ACEITE	G-143	81055040041	SR361 con motor/M.A.N. D2866KF			D2530 SERIES, D2555 SERIES, D2556 SERIES		
COMBUSTIBLE	GPP-1122	81125030075	COMBUSTIBLE	G-1123	81125030042	COMBUSTIBLE	G-1121	81125030041
SD200 con motores/M.A.N. D2556, M.A.N. D2566MUM			ACEITE	G-143	81055040041	COMBUSTIBLE	G-1123	81125030042
COMBUSTIBLE	G-1121	81125030051	COMBUSTIBLE, CON CUBIERTA	G-1123F	81125030042	COMBUSTIBLE	G-1121F	81125030050
COMBUSTIBLE	G-1123	81125030042	AIRE	GA-467	81083040038	COMBUSTIBLE, CON CUBIERTA	G-1123F	81125030042
ACEITE	G-143	81055040041	SU211 con motor/U11D			D2538 SERIES		
COMBUSTIBLE	G-1121F	81125030050	COMBUSTIBLE	G-1123	81125030042	COMBUSTIBLE	G-1121	81125030041
COMBUSTIBLE, CON CUBIERTA	G-1123F	81125030042	SU230 con motor/A DIESEL			COMBUSTIBLE	G-1123	81125030042
SG192 con motor/A DIESEL			COMBUSTIBLE	G-1123	81125030042	ACEITE	G-143	81055040041
COMBUSTIBLE	G-1123	81125030042	SU240, SL200, SR240 con motores/M.A.N. D2556, M.A.N. D2566MUM			COMBUSTIBLE	G-1121F	81125030050
SG220 con motores/M.A.N. D2556, M.A.N. D2566MUM			COMBUSTIBLE	G-1121	81125030051	COMBUSTIBLE, CON CUBIERTA	G-1123F	81125030042
COMBUSTIBLE	G-1121	81125030051	COMBUSTIBLE	G-1123	81125030042	D2566 SERIES, D3530		
COMBUSTIBLE	G-1123	81125030042	ACEITE	G-143	81055040041	COMBUSTIBLE	G-1123	81125030042
ACEITE	G-143	81055040041	COMBUSTIBLE	G-1121F	81125030050	ACEITE	G-143	81055040041
COMBUSTIBLE	G-1121F	81125030050	COMBUSTIBLE, CON CUBIERTA	G-1123F	81125030042	COMBUSTIBLE, CON CUBIERTA	G-1123F	81125030042
COMBUSTIBLE, CON CUBIERTA	G-1123F	81125030042	UL242, UL272 con motor/M.A.N. D2866			D2840 SERIES		
SG240, SG240H con motor/M.A.N. D2556			COMBUSTIBLE	G-1123	81125030018	COMBUSTIBLE	G-1123	81125030042
COMBUSTIBLE	G-1121	81125030041	ACEITE	G-143	81055040041	ACEITE	G-143	81055040041
COMBUSTIBLE	G-1123	81125030042	COMBUSTIBLE	GPP-1122	81125030075	COMBUSTIBLE, CON CUBIERTA	G-1123F	81125030042
ACEITE	G-143	81055040041	M.A.N.			COMBUSTIBLE	GPP-1122	81125030042
COMBUSTIBLE	G-1121F	81125030050	MOTORES			ACEITE	G-750	81055040048
COMBUSTIBLE, CON CUBIERTA	G-1123F	81125030042	0022M IMPORTADO, D0024M IMPORTADO, D0024M1 IMPORTADO,			D2842, D2865 SERIES, D2866 SERIES		
SG240, SG240H con motor/M.A.N. D2556			D0026, D0026M1 IMPORTADO, D0026M2, D0836 IMPORTADO,			COMBUSTIBLE	G-1123	81125030042
COMBUSTIBLE	G-1121	81125030041	D0836M2 IMPORTADO, D0843M IMPORTADO, D0846 IMPORTADO,			ACEITE	G-143	81055040041
COMBUSTIBLE	G-1123	81125030042	D1546M IMPORTADO, D1548M1 IMPORTADO, D1548MT IMPOR-			COMBUSTIBLE, CON CUBIERTA	G-1123F	81125030042
ACEITE	G-143	81055040041	TADO			COMBUSTIBLE	GPP-1122	81125030042
COMBUSTIBLE	G-1121F	81125030050	COMBUSTIBLE	G-1121	81125030041	D720 IMPORTADO, D727 IMPORTADO		
COMBUSTIBLE, CON CUBIERTA	G-1123F	81125030042	COMBUSTIBLE	G-1121	81125030041	COMBUSTIBLE	G-296	81125030038
			D0026M					
			ACEITE	G-31	81055040008			

MARCA-MODELO-MOTOR GONHER OEM
MAKE-MODEL-ENGINE GONHER OEM

M.A.N. (continuación)

MOTORES

TD232 V6, TD232 V8		
ACEITE	G-191	90-80119-5131
W6-617 IMPORTADO, W6L617 IMPORTADO		
ACEITE	G-225	H6017

MACK

CAMIONES, TRACTOCAMIONES Y AUTOBUSES

B43X, B53, B61, B61T, B63, B65, B67, B67T, B75, B81, B82S, B82SX, B83, B83SX, B85SX, B87SX, C33, C37, C41, C45, C49, B33, B41, B43, B43S con motor/A DIESEL	G-500	236GB36
CH SERIES con motor/MACK E7-300 ETECH		
ACEITE	GP-51	485GB3191C
COMBUSTIBLE	GP-83	483GB444
COMBUSTIBLE	GP-85	483GB440
AGUA	GP-2015W	25MF435B
CH600 con motor/MACK E7-350		
ACEITE	GP-51	485GB3191C
COMBUSTIBLE, PRIMARIO	GP-83	483GB444
COMBUSTIBLE, SECUNDARIO	GP-85	483GB440
AGUA	GP-2015W	25MF435B
CH613 con motor/MACK E7-427 E-TECH		
COMBUSTIBLE	G-128	301SD19B
ACEITE	GP-51	485GB3191C
AGUA	GP-2015W	25MF435B
CH613 con motor/MACK E7-454		
ACEITE	GP-51	485GB3191C
COMBUSTIBLE	GP-83	483GB444
COMBUSTIBLE	GP-85	483GB440
CH613 con motores/MACK E7-330, MACK E7-350		
ACEITE	GP-51	485GB3191C
COMBUSTIBLE	GP-83	483GB444
AGUA	GP-2015W	25MF435B
CH613 con motores/MACK E7-355/380 E-TECH, MACK E7-460 E-TECH		
ACEITE	GP-51	485GB3191C
CL SERIES con motor/MACK E7-300 ETECH		
ACEITE	GP-51	485GB3191C
CL613 con motor/MACK E7-400		
ACEITE	GP-51	485GB3191C
COMBUSTIBLE, PRIMARIO	GP-83	483GB444
COMBUSTIBLE, SECUNDARIO	GP-85	483GB440
AGUA	GP-2015W	25MF435B
CL613 con motor/MACK E9-500		
ACEITE	GP-51	485GB3191C
COMBUSTIBLE, PRIMARIO	GP-83	483GB444
COMBUSTIBLE, SECUNDARIO	GP-85	483GB440
AGUA	GP-2022W	25MF436B
CL653 con motor/CATERPILLAR 3406C		
ACEITE, CUMPLE CON MEDI-DAS ORIGINALES	GP-691	1R0716
ACEITE, SEGUNDA OPCION	GP-52	1R0716
COMBUSTIBLE, SECUNDARIO	GP-110	1R-0712
AGUA	GP-2071W	3I1288

MARCA-MODELO-MOTOR GONHER OEM
MAKE-MODEL-ENGINE GONHER OEM

MACK (continuación)

CAMIONES, TRACTOCAMIONES Y AUTOBUSES

CL653 con motor/MACK E7 E-TECH		
ACEITE	GP-51	485GB3191B
CL713 con motor/MACK E7-460 E-TECH		
ACEITE	GP-51	485GB3191C
CL713 con motor/MACK E9-500		
ACEITE	GP-51	485GB3191C
COMBUSTIBLE	GP-83	483GB444
COMBUSTIBLE	GP-85	483GB440
AGUA	GP-2022W	25MF436B
CL713 con motores/MACK E7-350, MACK E7-454		
ACEITE	GP-51	485GB3191C
COMBUSTIBLE	GP-83	483GB444
AGUA	GP-2015W	25MF435B
CM400 BABY 8 con motor/CUMMINS 6CTA8.3		
COMBUSTIBLE	GP-1122	3903640
ACEITE	GP-43	3313281
AGUA	GP-2071W	3315116
COMBUSTIBLE	GPP-18	3925274
CRUISE-LINER con motor/CATERPILLAR 3406		
ACEITE, CUMPLE CON MEDI-DAS ORIGINALES	GP-691	1R0716
ACEITE, SEGUNDA OPCION	GP-52	1R0716
COMBUSTIBLE, OPCIONAL	GP-110	1P2299
AGUA	GP-2071W	3I1288
CRUISE-LINER con motor/CUMMINS		
ACEITE	G-566	257528
ACEITE	GP-14	4041959
COMBUSTIBLE	GPP-14	3315847
COMBUSTIBLE	GP-1101	154711
ACEITE	GP-53	3313287
COMBUSTIBLE	GP-55	3313306
COMBUSTIBLE	GPP-11	3600980
AIRE	GA-39	255963
ACEITE	G-750	139096
CRUISE-LINER con motor/GMC 8V-92		
ACEITE	G-33	5573013
COMBUSTIBLE, OPCIONAL	GP-26	6438837
COMBUSTIBLE	GP-27	6438838
CRUISE-LINER con motores/MACK ENDT675, MACK ENDT676, MACK ENDT865, MACK ENDT866, MACK ET673, MACK ETAZ673A		
ACEITE	GP-51	485GB3191C
COMBUSTIBLE, PRIMARIO	GP-83	483GB444
COMBUSTIBLE, SECUNDARIO	GP-84	483GB218C
COMBUSTIBLE, SECUNDARIO	GP-85	483GB440
AGUA	GP-2015W	25MF435B
AGUA	GP-2022W	25MF436B
CS200 con motor/A DIESEL		
ACEITE	GP-51	485GB3191B
COMBUSTIBLE, PRIMARIO	GP-83	483GB444
COMBUSTIBLE, SECUNDARIO	GP-84	483GB441
TRANSMISION	GP-9586	LF3342
AGUA	GP-2015W	25MF435B
CS200P con motor/R.V.I.		
ACEITE	GP-51	485GB3191C
COMBUSTIBLE	GP-83	483GB444

MARCA-MODELO-MOTOR GONHER OEM
MAKE-MODEL-ENGINE GONHER OEM

MACK (continuación)

CAMIONES, TRACTOCAMIONES Y AUTOBUSES

COMBUSTIBLE	GP-84	483GB218C
AGUA	GP-2015W	25MF314B
AIRE	GA-373	57MD27
CS200P, CS250P con motor/MACK E3-190 DIESEL		
ACEITE	GP-51	485GB3191B
COMBUSTIBLE, PRIMARIO	GP-83	483GB444
COMBUSTIBLE, SECUNDARIO	GP-84	483GB441
AGUA	GP-2015W	25MF435
CS250 con motor/A DIESEL		
ACEITE	GP-51	485GB3191B
COMBUSTIBLE, PRIMARIO	GP-83	483GB444
COMBUSTIBLE, SECUNDARIO	GP-84	483GB441
TRANSMISION	GP-9586	LF3342
AGUA	GP-2015W	25MF435B
CS250P con motor/R.V.I.		
ACEITE	GP-51	485GB3191C
COMBUSTIBLE	GP-83	483GB444
COMBUSTIBLE	GP-84	483GB218C
AGUA	GP-2015W	25MF314B
AIRE	GA-373	57MD27
CS300 con motor/A DIESEL		
ACEITE	GP-51	485GB3191B
COMBUSTIBLE, PRIMARIO	GP-83	483GB444
COMBUSTIBLE, SECUNDARIO	GP-84	483GB441
TRANSMISION	GP-9586	LF3342
AGUA	GP-2015W	25MF435
CS300P con motor/MACK E3-220		
ACEITE	GP-51	485GB3191B
COMBUSTIBLE, PRIMARIO	GP-83	483GB444
COMBUSTIBLE, SECUNDARIO	GP-84	483GB441
AGUA	GP-2015W	25MF435
CS300P, CS300T con motor/R.V.I.		
ACEITE	GP-51	485GB3191C
COMBUSTIBLE	GP-83	483GB444
COMBUSTIBLE	GP-84	483GB218C
AGUA	GP-2015W	25MF314B
AIRE	GA-373	57MD27
CV712, CV713 con motores/MACK AMI SERIES, MACK ASET AI		
AGUA	GP-2015W	25MF435B
CX613 con motor/MACK ASET AC427		
AGUA	GP-2015W	25MF435B
CX613 con motor/MACK E7-355/380 E-TECH		
ACEITE	GP-51	485GB3191C
CX613 con motor/MACK E7-427 E-TECH		
COMBUSTIBLE	G-128	301SD19B
ACEITE	GP-51	485GB3191C
AGUA	GP-2015W	25MF435B
DM400 con motor/CATERPILLAR3208		
ACEITE	GP-36	9L9200
GASOLINA	G-293	6N7617
COMBUSTIBLE	GP-110	1P2299
ACEITE	GP-9586	9N5570

SERVICIO PESADO

MARCA-MODELO-MOTOR MAKE-MODEL-ENGINE	GONHER GONHER	OEM OEM	MARCA-MODELO-MOTOR MAKE-MODEL-ENGINE	GONHER GONHER	OEM OEM	MARCA-MODELO-MOTOR MAKE-MODEL-ENGINE	GONHER GONHER	OEM OEM
MACK (continuación)			MACK (continuación)			MACK (continuación)		
CAMIONES, TRACTOCAMIONES Y AUTOBUSES			CAMIONES, TRACTOCAMIONES Y AUTOBUSES			CAMIONES, TRACTOCAMIONES Y AUTOBUSES		
DM400 con motor/MACK ENDT475			AGUA	GP-2015W	25MF435B	AGUA	GP-2015W	25MF435B
ACEITE, FORD	GP-9	6432PER17				DM895, DM897, F900 SERIES con motor/MACK ENDT865		
COMBUSTIBLE	GP-83	483GB444	DM612 con motor/MACK ETAZ673A (1972 EN ADELANTE)			AIRE	GA-378	57MD33
COMBUSTIBLE	GP-84	483GB218C	COMBUSTIBLE, SECUNDARIO	GP-84	483GB218C	DMM4006 con motor/MACK ENDT475		
AGUA	GP-2015W	25MF435B	DM612 con motor/MACK ETAZ673A (1977 EN ADELANTE)			COMBUSTIBLE	GP-83	483GB444
ACEITE	GP-81	6432PER17	ACEITE	GP-51	485GB3191C	COMBUSTIBLE	GP-84	483GB218C
			COMBUSTIBLE, PRIMARIO	GP-83	483GB444	AGUA	GP-2015W	25MF435B
DM487 con motor/MACK ETZ477			COMBUSTIBLE, SECUNDARIO	GP-85	483GB440	ACEITE	GP-81	6432PER17
ACEITE, FORD	GP-9	6432PER17	AGUA	GP-2022W	25MF436B	DMM600 EX SERIES, DMM600 S SERIES con motor/MACK E7 E-TECH		
COMBUSTIBLE	GP-83	483GB444	DM685, DM686, DMM685, DMM686 con motor/A DIESEL			ACEITE	GP-51	485GB3191B
COMBUSTIBLE	GP-84	483GB218C	AIRE	GAK-403	2MD455-AP2	DMM6006 con motores/MACK END673E, MACK END676, MACK END673C, MACK ENDT673C, MACK ENDT675		
ACEITE	GP-81	6432PER17	AIRE	GA-378	57MD33	ACEITE	GP-51	485GB3191C
AIRE	GA-229	2MD3129	AIRE	GA-229	57MD26	COMBUSTIBLE, PRIMARIO	GP-83	483GB444
						COMBUSTIBLE, SECUNDARIO	GP-84	483GB218C
DM492 con motor/CATERPILLAR 3208			DM800 con motores/MACK ENDT673 (1972 EN ADELANTE), MACK ENDT676 (1972 EN ADELANTE), MACK ENDT865 (1972 EN ADELANTE), MACK ENDT866 (1972 EN ADELANTE), MACK ENDT673C (1972 EN ADELANTE), MACK ENDT675 (1972 EN ADELANTE)			COMBUSTIBLE, SECUNDARIO	GP-85	483GB440
ACEITE	GP-36	9L9200	ACEITE	GP-51	485GB3191C	AGUA	GP-2015W	25MF435B
GASOLINA	G-293	6N7617	COMBUSTIBLE, PRIMARIO	GP-83	483GB444	AGUA	GP-2022W	25MF436B
COMBUSTIBLE	GP-110	1P2299	COMBUSTIBLE, SECUNDARIO	GP-85	483GB440	DMM6005 con motor/MACK EM6-275L		
ACEITE	GP-9586	9N5570	AGUA	GP-2022W	25MF436B	ACEITE	GP-51	485GB3191C
AIRE	GA-229	2MD3129				COMBUSTIBLE, PRIMARIO	GP-83	483GB444
			DM600 con motores/MACK END673E (1977 EN ADELANTE), MACK ENDT673 (1977 EN ADELANTE), MACK ENDT675 (1977 EN ADELANTE), MACK ENDT676 (1977 EN ADELANTE), MACK ENDTL673C			COMBUSTIBLE, SECUNDARIO	GP-85	483GB440
ACEITE	GP-51	485GB3191C	DM800 con motores/MACK ENDT673 (1977 EN ADELANTE), MACK ENDT866 (1977 EN ADELANTE), MACK ENDT673C (1977 EN ADELANTE), MACK ENDT675 (1977 EN ADELANTE), MACK ENDT676 (1977 EN ADELANTE), MACK ENDT865 (1977 EN ADELANTE)			AGUA	GP-2022W	25MF436B
COMBUSTIBLE, PRIMARIO	GP-83	483GB444	COMBUSTIBLE, SECUNDARIO	GP-84	483GB218C	DMM611 con motor/MACK ET673		
COMBUSTIBLE, SECUNDARIO	GP-85	483GB440	AGUA	GP-2015W	25MF435B	AIRE	GAK-403	2MD455-AP2
AGUA	GP-2022W	25MF436B	DM800 SERIES con motores/CUMMINS NTA400, CUMMINS NTC350			DMM611 con motor/MACK ET673 (1972 EN ADELANTE)		
			COMBUSTIBLE	GPP-14	3315847	ACEITE	GP-51	485GB3191C
DM600 con motores/MACK ENDT676 (1972 EN ADELANTE), MACK ENDT673E (1972 EN ADELANTE), MACK ENDT675 (1972 EN ADELANTE)			ACEITE	GP-53	3313287	COMBUSTIBLE, PRIMARIO	GP-83	483GB444
COMBUSTIBLE, SECUNDARIO	GP-84	483GB218C	COMBUSTIBLE	GP-55	3313306	COMBUSTIBLE, SECUNDARIO	GP-84	483GB218C
			COMBUSTIBLE	GPP-11	3600980	AGUA	GP-2015W	25MF435B
DM6006S, DM600X, DM600S, DM600SX con motor/MACK EM6-275L			AIRE	GA-39	255963	F700 con motores/GMC 6-71, GMC 6V-92, GMC 8V-71, GMC 8V-92		
ACEITE	GP-51	485GB3191C	ACEITE	G-750	139096	ACEITE	G-33	5573013
COMBUSTIBLE, PRIMARIO	GP-83	483GB444	DM811 con motor/MACK ET673			COMBUSTIBLE, OPCIONAL	GP-26	6438837
COMBUSTIBLE, SECUNDARIO	GP-85	483GB440	AIRE	GAK-403	2MD455-AP2	COMBUSTIBLE	GP-27	6438838
AGUA	GP-2022W	25MF436B	DM811 con motor/MACK ET673 (1977 EN ADELANTE)			ACEITE	GP-53	25010449
			ACEITE	GP-51	485GB3191C	F700 con motores/MACK ENDT676, MACK ET673, MACK ETAZ673A, MACK END673E, MACK ENDT675		
DM607 con motor/MACK ENDT673E (1972 EN ADELANTE)			COMBUSTIBLE, PRIMARIO	GP-83	483GB444	ACEITE	GP-51	485GB3191C
COMBUSTIBLE, SECUNDARIO	GP-84	483GB218C	COMBUSTIBLE, SECUNDARIO	GP-85	483GB440	COMBUSTIBLE, PRIMARIO	GP-83	483GB444
			AGUA	GP-2022W	25MF436B	COMBUSTIBLE, SECUNDARIO	GP-84	483GB218C
DM607 con motor/MACK ENDT673E (1977 EN ADELANTE)			DM812 con motor/MACK ETAZ673A (1977 EN ADELANTE)			COMBUSTIBLE, SECUNDARIO	GP-85	483GB440
ACEITE	GP-51	485GB3191C	COMBUSTIBLE, SECUNDARIO	GP-85	483GB440	AGUA	GP-2015W	25MF435B
COMBUSTIBLE, PRIMARIO	GP-83	483GB444	DM885 con motor/MACK ENDT675			AGUA	GP-2022W	25MF436B
COMBUSTIBLE, SECUNDARIO	GP-85	483GB440	AIRE	GAK-403	2MD455-AP2	F700 con motores/MACK ENDTL673C, MACK ENDT865 (1972 EN ADELANTE), MACK ENDT866 (1972 EN ADELANTE)		
AGUA	GP-2022W	25MF436B				ACEITE	GP-51	485GB3191C
AIRE	GA-229	2MD3129	DM885 con motor/MACK ENDT675 (1972 EN ADELANTE)			COMBUSTIBLE, PRIMARIO	GP-83	483GB444
			ACEITE	GP-51	485GB3191C	COMBUSTIBLE, SECUNDARIO	GP-84	483GB218C
DM609 con motor/MACK ENDT711			COMBUSTIBLE, PRIMARIO	GP-83	483GB444	COMBUSTIBLE, SECUNDARIO	GP-85	483GB440
AIRE	GAK-403	2MD455-AP2	COMBUSTIBLE, SECUNDARIO	GP-84	483GB218C	AGUA	GP-2015W	25MF435B
			AGUA	GP-2015W	25MF435B	AGUA	GP-2015W	25MF435B
DM609 con motor/MACK ENDT711 (1972 EN ADELANTE)			DM885 con motor/MACK ENDT675 (1977 EN ADELANTE)			F711 con motor/MACK ET673		
ACEITE	GP-51	485GB3191C	COMBUSTIBLE, SECUNDARIO	GP-85	483GB440	AIRE	GA-378	2MD4121
COMBUSTIBLE, PRIMARIO	GP-83	483GB444	DM895, DM897 con motor/MACK ENDT865 (1972 EN ADELANTE)			F711 con motor/MACK ET673 (1977 EN ADELANTE)		
COMBUSTIBLE, SECUNDARIO	GP-84	483GB218C	ACEITE	GP-51	485GB3191C	COMBUSTIBLE, SECUNDARIO	GP-85	483GB440
AGUA	GP-2015W	25MF435B	COMBUSTIBLE, PRIMARIO	GP-83	483GB444			
			COMBUSTIBLE, SECUNDARIO	GP-84	483GB218C			
DM611 con motor/MACK ET673			AGUA	GP-2015W	25MF435B			
AIRE	GAK-403	2MD455-AP2	DM885 con motor/MACK ENDT675 (1977 EN ADELANTE)					
			COMBUSTIBLE, SECUNDARIO	GP-85	483GB440			
DM611 con motor/MACK ET673 (1972 EN ADELANTE)			DM895, DM897 con motor/MACK ENDT865 (1972 EN ADELANTE)					
ACEITE	GP-51	485GB3191C	ACEITE	GP-51	485GB3191C			
COMBUSTIBLE, PRIMARIO	GP-83	483GB444	COMBUSTIBLE, PRIMARIO	GP-83	483GB444			
COMBUSTIBLE, SECUNDARIO	GP-84	483GB218C	COMBUSTIBLE, SECUNDARIO	GP-84	483GB218C			
			AGUA	GP-2015W	25MF435B			

MARCA-MODELO-MOTOR MAKE-MODEL-ENGINE	GONHER GONHER	OEM OEM	MARCA-MODELO-MOTOR MAKE-MODEL-ENGINE	GONHER GONHER	OEM OEM	MARCA-MODELO-MOTOR MAKE-MODEL-ENGINE	GONHER GONHER	OEM OEM
MACK (continuación)			MACK (continuación)			MACK (continuación)		
CAMIONES, TRACTOCAMIONES Y AUTOBUSES			CAMIONES, TRACTOCAMIONES Y AUTOBUSES			CAMIONES, TRACTOCAMIONES Y AUTOBUSES		
F711, F712 SERIES con motor/MACK ET673 (1972 EN ADELANTE)			COMBUSTIBLE, SECUNDARIO GP-84 483GB218C			COMBUSTIBLE, PRIMARIO GP-83 483GB444		
ACEITE	GP-51	485GB3191C	AGUA	GP-2015W	25MF435B	COMBUSTIBLE, SECUNDARIO	GP-84	483GB218C
COMBUSTIBLE, PRIMARIO	GP-83	483GB444	F800 SERIES con motores/MACK ENDT673 (1977 EN ADELANTE), MACK ENDT676 (1977 EN ADELANTE), MACK ENDT865 (1977 EN ADELANTE), MACK ENDT866 (1977 EN ADELANTE), MACK ENDT673C (1977 EN ADELANTE), MACK ENDT675 (1977 EN ADELANTE)			AGUA	GP-2015W	25MF435B
COMBUSTIBLE, SECUNDARIO	GP-84	483GB218C	COMBUSTIBLE, SECUNDARIO GP-85 483GB440			FS700 con motores/CATERPILLAR 1693T, CATERPILLAR 1693TA		
AGUA	GP-2015W	25MF435B	F8006, F9006 SERIES con motores/MACK END673E, MACK ENDT673, MACK ENDT673C, MACK ENDT675, MACK ENDT676, MACK ENDT865			ACEITE	G-238	550485
F712 SERIES con motor/MACK ET673			ACEITE GP-51 485GB3191C			COMBUSTIBLE	G-1166	6H5931
AIRE	GA-378	2MD4121	COMBUSTIBLE, PRIMARIO GP-83 483GB444			ACEITE, CUMPLE CON MEDI-DAS ORIGINALES	GP-691	1R0716
F712 SERIES con motor/MACK ET673 (1977 EN ADELANTE)			COMBUSTIBLE, SECUNDARIO GP-84 483GB218C			ACEITE, SEGUNDA OPCION	GP-52	1R0716
COMBUSTIBLE, SECUNDARIO	GP-85	483GB440	COMBUSTIBLE, SECUNDARIO GP-85 483GB440			COMBUSTIBLE	GP-110	1P2299
F747 con motor/CUMMINS NTC290			AGUA GP-2015W 25MF435B			AIRE	GA-135	9L2169
COMBUSTIBLE	GPP-14	3315847	AGUA GP-2022W 25MF436B			FS700 con motores/MACK ENDT676, MACK ET673, MACK ETA-Z673A, MACK END673E, MACK ENDT675		
ACEITE	GP-53	3313287	F900 SERIES con motor/MACK ENDT865 (1972 EN ADELANTE)			ACEITE	GP-51	485GB3191C
COMBUSTIBLE	GP-55	3313306	ACEITE GP-51 485GB3191C			COMBUSTIBLE, PRIMARIO	GP-83	483GB444
COMBUSTIBLE	GPP-11	3600980	COMBUSTIBLE, PRIMARIO GP-83 483GB444			COMBUSTIBLE, SECUNDARIO	GP-84	483GB218C
AIRE	GA-39	255963	COMBUSTIBLE, SECUNDARIO GP-84 483GB218C			COMBUSTIBLE, SECUNDARIO	GP-85	483GB440
AIRE	GA-378	57MD33	AGUA GP-2015W 25MF435B			AGUA	GP-2015W	25MF435B
AIRE	GA-229	57MD26	FCM-SERIES con motor/MACK E7 E-TECH			AGUA	GP-2022W	25MF436B
ACEITE	G-750	139096	ACEITE GP-51 485GB3191B			GRANITE CV-SERIES con motor/CUMMINS ISL		
F767 con motor/CUMMINS NTC350			COMBUSTIBLE, SECUNDARIO GP-84 483GB218C			ACEITE	GP-3001	3401544
COMBUSTIBLE	GPP-14	3315847	FDM con motor/A DIESEL			ACEITE	GP-3000	3318853
ACEITE	GP-53	3313287	HIDRAULICO GP-34 LF757			COMBUSTIBLE, SEPARADOR DE AGUA	GPP-1022S	3800394
COMBUSTIBLE	GP-55	3313306	FL700 con motores/CATERPILLAR 1693T, CATERPILLAR 1693TA			GRANITE CV-SERIES con motor/MACK E7 E-TECH		
COMBUSTIBLE	GPP-11	3600980	ACEITE G-238 550485			ACEITE	GP-51	485GB3191C
AIRE	GA-39	255963	COMBUSTIBLE G-1166 6H5931			H61, H67, H61T, H63, H63ST, H63T con motor/A DIESEL		
AIRE	GA-378	57MD33	ACEITE, CUMPLE CON MEDI-DAS ORIGINALES GP-691 1R0716			ACEITE	G-500	236GB36
AIRE	GA-229	57MD26	ACEITE, SEGUNDA OPCION GP-52 1R0716			HMM685 con motor/A DIESEL		
ACEITE	G-750	139096	COMBUSTIBLE GP-110 1P2299			AIRE	GAK-403	2MD455-AP2
F773 con motor/GMC 8V-71			AIRE GP-135 9L2169			AIRE	GA-378	57MD33
ACEITE	G-33	5573013	FL700 con motores/MACK END673E, MACK ENDT675, MACK ENDT676, MACK ET673, MACK ETAZ673A			AIRE	GA-229	57MD26
COMBUSTIBLE, OPCIONAL	GP-26	6438837	ACEITE GP-51 485GB3191C			HMM6856 con motores/MACK END673E, MACK ENDT675, MACK ENDT676, MACK END865, MACK ENDT673, MACK ENDT673C		
COMBUSTIBLE	GP-27	6438838	COMBUSTIBLE, PRIMARIO GP-83 483GB444			ACEITE	GP-51	485GB3191C
AIRE	GA-378	57MD33	COMBUSTIBLE, SECUNDARIO GP-84 483GB218C			COMBUSTIBLE, PRIMARIO	GP-83	483GB444
AIRE	GA-229	57MD26	COMBUSTIBLE, SECUNDARIO GP-85 483GB440			COMBUSTIBLE, SECUNDARIO	GP-84	483GB218C
F785 con motor/MACK ENDT675			AGUA GP-2015W 25MF435B			COMBUSTIBLE, SECUNDARIO	GP-85	483GB440
ACEITE	GP-51	485GB3191C	AGUA GP-2022W 25MF436B			AGUA	GP-2015W	25MF435B
COMBUSTIBLE, PRIMARIO	GP-83	483GB444	FL700 con motores/MACK ENDTL673C, MACK ENDT865 (1972 EN ADELANTE), MACK ENDT866 (1972 EN ADELANTE)			AGUA	GP-2022W	25MF436B
COMBUSTIBLE, SECUNDARIO	GP-84	483GB218C	ACEITE GP-51 485GB3191C			LE SERIES con motor/MACK E5-250		
AGUA	GP-2015W	25MF435B	COMBUSTIBLE, PRIMARIO GP-83 483GB444			ACEITE	GP-51	485GB3191B
F785 con motor/MACK ENDT675 (1972 EN ADELANTE)			COMBUSTIBLE, SECUNDARIO GP-84 483GB218C			COMBUSTIBLE, PRIMARIO	GP-83	483GB444
ACEITE	GP-51	485GB3191C	COMBUSTIBLE, SECUNDARIO GP-85 483GB440			COMBUSTIBLE, SECUNDARIO	GP-84	483GB441
COMBUSTIBLE, PRIMARIO	GP-83	483GB444	AGUA GP-2015W 25MF435B			AGUA	GP-2022W	25MF436B
COMBUSTIBLE, SECUNDARIO	GP-84	483GB218C	AGUA GP-2022W 25MF436B			LE SERIES con motor/MACK E7 E-TECH		
AGUA	GP-2015W	25MF435B	FL700 con motores/MACK ENDTL673C, MACK ENDT865 (1972 EN ADELANTE), MACK ENDT866 (1972 EN ADELANTE)			ACEITE	GP-51	485GB3191B
F785 con motor/MACK ENDT675 (1977 EN ADELANTE)			ACEITE GP-51 485GB3191C			COMBUSTIBLE, PRIMARIO	GP-83	483GB444
COMBUSTIBLE, SECUNDARIO	GP-85	483GB440	COMBUSTIBLE, PRIMARIO GP-83 483GB444			COMBUSTIBLE, SECUNDARIO	GP-84	483GB441
F795, F797 con motor/MACK ENDT866			COMBUSTIBLE, SECUNDARIO GP-84 483GB218C			AGUA	GP-2022W	25MF436B
AIRE	GA-378	57MD33	AGUA GP-2015W 25MF435B			LE SERIES con motor/MACK EM7-275 ETECH		
F795, F797 con motor/MACK ENDT866 (1972 EN ADELANTE)			ACEITE GP-51 485GB3191C			ACEITE	GP-51	485GB3191C
ACEITE	GP-51	485GB3191C	ACEITE G-191 1R0659			COMBUSTIBLE	GP-83	483GB444
COMBUSTIBLE, PRIMARIO	GP-83	483GB444	ACEITE, CUMPLE CON MEDI-DAS ORIGINALES GP-691 1R0716			AGUA	GP-2015W	25MF435
COMBUSTIBLE, SECUNDARIO	GP-84	483GB218C	ACEITE, SEGUNDA OPCION GP-52 1R0716			LT con motor/MACK END673		
AGUA	GP-2015W	25MF435B	COMBUSTIBLE GP-110 1P2299			ACEITE	G-500	236GB36
F800 SERIES con motores/MACK ENDT673 (1972 EN ADELANTE), MACK ENDT673C (1972 EN ADELANTE), MACK ENDT675 (1972 EN ADELANTE), MACK ENDT676 (1972 EN ADELANTE), MACK ENDT865 (1972 EN ADELANTE), MACK ENDT866 (1972 EN ADELANTE)			AIRE GP-135 9L2169			LE SERIES con motor/MACK E7 E-TECH		
ACEITE	GP-51	485GB3191C	AIRE (ESTANDAR) GA-3551 P153551			ACEITE	GP-51	485GB3191C
COMBUSTIBLE, PRIMARIO	GP-83	483GB444	AIRE (HEAVY DUTY) GA-3551 XT P153551			FS700 con motor/MACK ENDTL673C		
F800 SERIES con motores/MACK ENDT673 (1972 EN ADELANTE), MACK ENDT673C (1972 EN ADELANTE), MACK ENDT675 (1972 EN ADELANTE), MACK ENDT676 (1972 EN ADELANTE), MACK ENDT865 (1972 EN ADELANTE), MACK ENDT866 (1972 EN ADELANTE)			FS700 con motor/MACK ENDTL673C			ACEITE	GP-51	485GB3191C
ACEITE	GP-51	485GB3191C	ACEITE GP-51 485GB3191C					
COMBUSTIBLE, PRIMARIO	GP-83	483GB444						

SERVICIO PESADO

MARCA-MODELO-MOTOR MAKE-MODEL-ENGINE	GONHER GONHER	OEM OEM	MARCA-MODELO-MOTOR MAKE-MODEL-ENGINE	GONHER GONHER	OEM OEM	MARCA-MODELO-MOTOR MAKE-MODEL-ENGINE	GONHER GONHER	OEM OEM
MACK (continuación)			MACK (continuación)			MACK (continuación)		
CAMIONES, TRACTOCAMIONES Y AUTOBUSES			CAMIONES, TRACTOCAMIONES Y AUTOBUSES			CAMIONES, TRACTOCAMIONES Y AUTOBUSES		
M25XT, M30X, M60X, M65X con motor/GMC 16V-71N			AIRE	GA-229	2MD3129	ACEITE	GP-53	3313287
ACEITE	G-31	1595410				ACEITE	GP-57	3304232
M-65AX FUERA DE CARRETERA con motor/DETROIT DIESEL 16V-71T			MB685 con motor/A DIESEL	GAK-403	2MD455-AP2	AGUA	GP-2071W	3315116
AIRE	GA-135	279GB210	AIRE	GA-378	57MD33	ACEITE	G-750	139096
			AIRE	GA-229	57MD26	MH602 con motores/CUMMINS KT450, CUMMINS KTA525		
MB400 con motor/CATERPILLAR3208			MC400 con motor/CATERPILLAR3208			COMBUSTIBLE	GP-1101	154711
ACEITE	GP-36	9L9200	ACEITE	GP-36	9L9200	ACEITE	GP-53	3313287
GASOLINA	G-293	6N7617	GASOLINA	G-293	6N7617	ACEITE	GP-57	3304232
COMBUSTIBLE	GP-110	1P2299	COMBUSTIBLE	GP-110	1P2299	AGUA	GP-1011Q	25MF214P2
ACEITE	GP-9586	9N5570	ACEITE	GP-9586	9N5570	ACEITE	G-750	139096
MB400 con motor/MACK ENDT475			MC400 con motor/MACK ETZ477			MH602 con motores/CUMMINS NTC400, CUMMINS NTC350		
ACEITE, FORD	GP-9	6432PER17	ACEITE, FORD	GP-9	6432PER17	COMBUSTIBLE	GP-1101	154711
COMBUSTIBLE	GP-83	483GB444	COMBUSTIBLE	GP-83	483GB444	ACEITE	GP-53	3313287
COMBUSTIBLE	GP-84	483GB218C	COMBUSTIBLE	GP-84	483GB218C	ACEITE	GP-57	3304232
AGUA	GP-2015W	25MF435B	COMBUSTIBLE	GP-84	483GB218C	AGUA	GP-2071W	3315116
ACEITE	GP-81	6432PER17	ACEITE	GP-81	6432PER17	ACEITE	G-750	139096
MB400 con motor/MACK ETZ477			MC400P, MC400S con motor/MACK E4-210			MH602 con motores/MACK EC6, MACK EM6, MACK EMC6 SERIES		
ACEITE, FORD	GP-9	6432PER17	ACEITE, FORD	GP-9	6432PER17	ACEITE	GP-51	485GB3191C
COMBUSTIBLE	GP-83	483GB444	COMBUSTIBLE	GP-83	483GB444	COMBUSTIBLE, PRIMARIO	GP-83	483GB444
COMBUSTIBLE	GP-84	483GB218C	COMBUSTIBLE	GP-84	483GB218C	COMBUSTIBLE, SECUNDARIO	GP-85	483GB440
ACEITE	GP-81	6432PER17	ACEITE	GP-81	6432PER17	AGUA	GP-2022W	25MF436B
MB487 con motor/MACK ETZ477			MC600 con motores/MACK E6-315, MACK E6-350, MACK EC6-350, MACK EM6-237, MACK EM6-250, MACK EM6-275, MACK EM6-285, MACK EMC6-250L, MACK EMC6-285, MACK ENDT675 (1977 EN ADELANTE), MACK ENDT676 (1977 EN ADELANTE), MACK E6-200, MACK E6-250			MH602, MH603 con motor/CATERPILLAR 3406		
ACEITE, FORD	GP-9	6432PER17	ACEITE	GP-51	485GB3191C	ACEITE, CUMPLE CON MEDI-DAS ORIGINALES	GP-691	1R0716
COMBUSTIBLE	GP-83	483GB444	COMBUSTIBLE, PRIMARIO	GP-83	483GB444	ACEITE, SEGUNDA OPCION	GP-52	1R0716
COMBUSTIBLE	GP-84	483GB218C	COMBUSTIBLE, SECUNDARIO	GP-85	483GB440	COMBUSTIBLE, OPCIONAL	GP-110	1P2299
ACEITE	GP-81	6432PER17	AGUA	GP-2022W	25MF436B	MH603 con motor/DETROIT DIESEL		
AIRE	GA-229	2MD3129				ACEITE	G-33	5573014
MB492 con motor/CATERPILLAR 3208			MC600 con motores/MACK ENDT675 (1972 EN ADELANTE), MACK ENDT676 (1972 EN ADELANTE)			COMBUSTIBLE, OPCIONAL	GP-26	6438837
ACEITE	GP-36	9L9200	COMBUSTIBLE, SECUNDARIO	GP-84	483GB218C	COMBUSTIBLE	GP-27	6438838
GASOLINA	G-293	6N7617	MD250P con motor/R.V.I.			ACEITE	GP-53	25010449
COMBUSTIBLE	GP-110	1P2299	ACEITE	GP-51	485GB3191C	MH603 con motores/CUMMINS 400, CUMMINS NTC300, CUMMINS NTC350, CUMMINS NTC400, CUMMINS FORMULA 300, CUMMINS FORMULA 350		
ACEITE	GP-9586	9N5570	COMBUSTIBLE	GP-83	483GB444	COMBUSTIBLE	GP-1101	154711
AIRE	GA-229	2MD3129	COMBUSTIBLE	GP-84	483GB218C	ACEITE	GP-53	3313287
MB600 con motores/MACK END673E (1972 EN ADELANTE), MACK ENDT675 (1972 EN ADELANTE), MACK ENDT676 (1972 EN ADELANTE)			AGUA	GP-2015W	25MF314B	ACEITE	GP-57	3304232
COMBUSTIBLE, SECUNDARIO	GP-84	483GB218C	AIRE	GA-373	57MD27	AGUA	GP-2071W	3315116
MB600 con motores/MACK ENDT676 (1977 EN ADELANTE), MACK ENDTL673C						ACEITE	G-750	139096
ACEITE	GP-51	485GB3191C	MH602 con motor/DETROIT DIESEL			MH603 con motores/MACK E6, MACK EC6, MACK EM6, MACK EMC6 SERIES		
COMBUSTIBLE, PRIMARIO	GP-83	483GB444	ACEITE	G-33	5573014	ACEITE	GP-51	485GB3191C
COMBUSTIBLE, SECUNDARIO	GP-85	483GB440	COMBUSTIBLE, OPCIONAL	GP-26	6438837	COMBUSTIBLE, PRIMARIO	GP-83	483GB444
AGUA	GP-2022W	25MF436B	COMBUSTIBLE	GP-27	6438838	COMBUSTIBLE, SECUNDARIO	GP-85	483GB440
MB600 con motores/MACK ET673, MACK END673E (1977 EN ADELANTE), MACK ENDT673, MACK ENDT673C, MACK ENDT675 (1977 EN ADELANTE)			ACEITE	GP-53	25010449	AGUA	GP-2022W	25MF436B
ACEITE	GP-51	485GB3191C	MH602 con motor/MACK E6			MH603 SERIES con motor/MACK E9-440		
COMBUSTIBLE, PRIMARIO	GP-83	483GB444	ACEITE	GP-51	485GB3191C	ACEITE	GP-51	485GB3191C
COMBUSTIBLE, SECUNDARIO	GP-85	483GB440	COMBUSTIBLE, PRIMARIO	GP-83	483GB444	COMBUSTIBLE, PRIMARIO	GP-83	483GB444
AGUA	GP-2022W	25MF436B	COMBUSTIBLE, SECUNDARIO	GP-85	483GB440	COMBUSTIBLE, SECUNDARIO	GP-84	483GB218C
MB607 con motor/MACK END673E (1972 EN ADELANTE)			AGUA	GP-2022W	25MF436B	AGUA	GP-2015W	25MF435B
ACEITE	GP-51	485GB3191C	MH602 con motor/MACK E9-440			MH603 SERIES con motores/CUMMINS KT450, CUMMINS KTA525		
COMBUSTIBLE, SECUNDARIO	GP-84	483GB218C	ACEITE	GP-51	485GB3191C	COMBUSTIBLE	GP-1101	154711
MB607 con motor/MACK END673E (1977 EN ADELANTE)			COMBUSTIBLE, PRIMARIO	GP-83	483GB444	ACEITE	GP-53	3313287
ACEITE	GP-51	485GB3191C	COMBUSTIBLE, SECUNDARIO	GP-85	483GB440	ACEITE	GP-57	3304232
COMBUSTIBLE, PRIMARIO	GP-83	483GB444	AGUA	GP-2015W	25MF435B	AGUA	GP-1011Q	25MF214P2
COMBUSTIBLE, SECUNDARIO	GP-85	483GB440	MH602 con motores/CUMMINS 400, CUMMINS FORMULA 300, CUMMINS FORMULA 350			ACEITE	G-750	139096
AGUA	GP-2022W	25MF436B	COMBUSTIBLE	GP-1101	154711			

MARCA-MODELO-MOTOR MAKE-MODEL-ENGINE	GONHER GONHER	OEM OEM	MARCA-MODELO-MOTOR MAKE-MODEL-ENGINE	GONHER GONHER	OEM OEM	MARCA-MODELO-MOTOR MAKE-MODEL-ENGINE	GONHER GONHER	OEM OEM
MACK (continuación)			MACK (continuación)			MACK (continuación)		
CAMIONES, TRACTOCAMIONES Y AUTOBUSES			CAMIONES, TRACTOCAMIONES Y AUTOBUSES			CAMIONES, TRACTOCAMIONES Y AUTOBUSES		
MR600P con motor/MACK EM6-275L			GASOLINA	G-293	6N7617	R607 con motor/MACK END673E (1977 EN ADELANTE)		
ACEITE	GP-51	485GB3191C	COMBUSTIBLE	GP-110	1P2299	ACEITE	GP-51	485GB3191C
COMBUSTIBLE, PRIMARIO	GP-83	483GB444	ACEITE	GP-9586	9N5570	COMBUSTIBLE, PRIMARIO	GP-83	483GB444
COMBUSTIBLE, SECUNDARIO	GP-85	483GB440				COMBUSTIBLE, SECUNDARIO	GP-85	483GB440
AGUA	GP-2022W	25MF436B	R400 con motor/MACK ENDT475			AGUA	GP-2022W	25MF436B
			ACEITE, FORD	GP-9	6432PER17	AIRE	GA-229	2MD3129
MR600P SERIES con motor/MACK E5-250			COMBUSTIBLE	GP-83	483GB444			
ACEITE	GP-51	485GB3191B	COMBUSTIBLE	GP-84	483GB218C	R609 SERIES con motor/MACK END711		
COMBUSTIBLE, PRIMARIO	GP-83	483GB444	AGUA	GP-2015W	25MF435B	AIRE	GAK-403	2MD455-AP2
COMBUSTIBLE, SECUNDARIO	GP-84	483GB441	ACEITE	GP-81	6432PER17			
AGUA	GP-2022W	25MF436B				R609 SERIES con motor/MACK END711 (1972 EN ADELANTE)		
			R400 SERIES con motor/MACK ETZ477			ACEITE	GP-51	485GB3191C
MR600P SERIES, MR600S SERIES con motor/MACK E7 E-TECH			ACEITE, FORD	GP-9	6432PER17	COMBUSTIBLE, PRIMARIO	GP-83	483GB444
ACEITE	GP-51	485GB3191B	COMBUSTIBLE	GP-83	483GB444	COMBUSTIBLE, SECUNDARIO	GP-84	483GB218C
			COMBUSTIBLE	GP-84	483GB218C	AGUA	GP-2015W	25MF435B
MR600S con motor/MACK EM6-275L			ACEITE	GP-81	6432PER17			
ACEITE	GP-51	485GB3191C				R611 con motor/MACK ET673		
COMBUSTIBLE, PRIMARIO	GP-83	483GB444	R400P SERIES con motor/MACK E4-210			AIRE	GAK-403	2MD455-AP2
COMBUSTIBLE, SECUNDARIO	GP-85	483GB440	ACEITE, FORD	GP-9	6432PER17			
AGUA	GP-2022W	25MF436B	COMBUSTIBLE	GP-83	483GB444	R611 con motor/MACK ET673 (1972 EN ADELANTE)		
			COMBUSTIBLE	GP-84	483GB218C	ACEITE	GP-51	485GB3191C
MR600S SERIES con motor/MACK E5-250			COMBUSTIBLE	GP-81	6432PER17	COMBUSTIBLE, PRIMARIO	GP-83	483GB444
ACEITE	GP-51	485GB3191B	ACEITE	GP-81	6432PER17	COMBUSTIBLE, SECUNDARIO	GP-84	483GB218C
COMBUSTIBLE, PRIMARIO	GP-83	483GB444				AGUA	GP-2015W	25MF435B
COMBUSTIBLE, SECUNDARIO	GP-84	483GB441	R487 con motor/MACK ETZ477					
AGUA	GP-2022W	25MF436B	ACEITE, FORD	GP-9	6432PER17	R612 con motor/MACK ETAZ673A (1972 EN ADELANTE)		
			COMBUSTIBLE	GP-83	483GB444	COMBUSTIBLE, SECUNDARIO	GP-84	483GB218C
MR600S SERIES con motor/MACK E5-250			COMBUSTIBLE	GP-84	483GB218C			
ACEITE	GP-51	485GB3191B	ACEITE	GP-81	6432PER17	R612 con motor/MACK ETAZ673A (1977 EN ADELANTE)		
COMBUSTIBLE, PRIMARIO	GP-83	483GB444	AIRE	GA-229	2MD3129	ACEITE	GP-51	485GB3191C
COMBUSTIBLE, SECUNDARIO	GP-84	483GB441				COMBUSTIBLE, PRIMARIO	GP-83	483GB444
AGUA	GP-2022W	25MF436B	R492 con motor/CATERPILLAR 3208			COMBUSTIBLE, SECUNDARIO	GP-85	483GB440
			ACEITE	GP-36	9L9200	AGUA	GP-2022W	25MF436B
MS200, MS250 con motor/A DIESEL			GASOLINA	G-293	6N7617			
ACEITE	GP-51	485GB3191B	COMBUSTIBLE	GP-110	1P2299	R65 con motor/MACK MAXIDYNE 300		
COMBUSTIBLE, PRIMARIO	GP-83	483GB444	ACEITE	GP-9586	9N5570	ACEITE	GP-51	485GB3191C
COMBUSTIBLE, SECUNDARIO	GP-84	483GB441	AIRE	GA-229	2MD3129	COMBUSTIBLE	GP-83	483GB444
TRANSMISION	GP-9586	LF3342				COMBUSTIBLE	GP-84	483GB218C
AGUA	GP-2015W	25MF435	R600 con motor/MACK ETZ673A (1972 EN ADELANTE)					
AIRE	GA-373	57MD27	ACEITE	GP-51	485GB3191C	R685, RD686, R686, RD685 con motor/A DIESEL		
			GASOLINA	G-293	6N7617	AIRE	GAK-403	2MD455-AP2
MS200P, MS250P con motor/MACK E3-190 DIESEL			COMBUSTIBLE	GP-110	1P2299	AIRE	GA-378	57MD33
ACEITE	GP-51	485GB3191B	ACEITE	GP-9586	9N5570	AIRE	GA-229	57MD26
COMBUSTIBLE, PRIMARIO	GP-83	483GB444	AIRE	GA-229	2MD3129			
COMBUSTIBLE, SECUNDARIO	GP-84	483GB441				R700 con motores/GMC 6-71, GMC 6V-92, GMC 8V-71, GMC 8V-92		
AGUA	GP-2015W	25MF435	R600 con motores/MACK E6-200, MACK E6-250, MACK E6-315, MACK E6-350, MACK EC6-350, MACK EM6-237, MACK EM6-250, MACK EM6-275, MACK EM6-285, MACK EMC6-250L, MACK EMC6-285, MACK END673E (1977 EN ADELANTE), MACK ENDT673, MACK ENDT673C, MACK ENDT675 (1977 EN ADELANTE), MACK ENDT676 (1977 EN ADELANTE), MACK ENDTL673C, MACK ET673			ACEITE	G-33	5573013
			ACEITE	GP-51	485GB3191C	COMBUSTIBLE, OPCIONAL	GP-26	6438837
MS300 con motor/A DIESEL			COMBUSTIBLE, PRIMARIO	GP-83	483GB444	COMBUSTIBLE	GP-27	6438838
TRANSMISION	G-200	P550141	COMBUSTIBLE, SECUNDARIO	GP-85	483GB440	ACEITE	GP-53	25010449
ACEITE	GP-51	485GB3191B	AGUA	GP-2015W	25MF435B			
COMBUSTIBLE, PRIMARIO	GP-83	483GB444				R700 con motores/MACK ENDT865 (1972 EN ADELANTE), MACK ENDT866 (1972 EN ADELANTE)		
COMBUSTIBLE, SECUNDARIO	GP-84	483GB441	R600 con motores/MACK E6-200, MACK E6-250, MACK E6-315, MACK E6-350, MACK EC6-350, MACK EM6-237, MACK EM6-250, MACK EM6-275, MACK EM6-285, MACK EMC6-250L, MACK EMC6-285, MACK END673E (1977 EN ADELANTE), MACK ENDT673, MACK ENDT673C, MACK ENDT675 (1977 EN ADELANTE), MACK ENDT676 (1977 EN ADELANTE), MACK ENDTL673C, MACK ET673			ACEITE	GP-51	485GB3191C
TRANSMISION	GP-9586	LF3342	ACEITE	GP-51	485GB3191C	COMBUSTIBLE, PRIMARIO	GP-83	483GB444
AGUA	GP-2015W	25MF435	COMBUSTIBLE, PRIMARIO	GP-83	483GB444	COMBUSTIBLE, SECUNDARIO	GP-84	483GB218C
AIRE	GA-373	57MD27	COMBUSTIBLE, SECUNDARIO	GP-85	483GB440	AGUA	GP-2015W	25MF435B
			AGUA	GP-2022W	25MF436B			
MS300P con motor/MACK E3-220						R773 SERIES con motor/GMC 8V-71		
ACEITE	GP-51	485GB3191B	R600T con motor/MACK EM6-275L			ACEITE	G-33	5573013
COMBUSTIBLE, PRIMARIO	GP-83	483GB444	ACEITE	GP-51	485GB3191C	COMBUSTIBLE, OPCIONAL	GP-26	6438837
COMBUSTIBLE, SECUNDARIO	GP-84	483GB441	COMBUSTIBLE, PRIMARIO	GP-83	483GB444	COMBUSTIBLE	GP-27	6438838
AGUA	GP-2015W	25MF435	COMBUSTIBLE, SECUNDARIO	GP-85	483GB440	AIRE	GA-378	57MD33
			AGUA	GP-2022W	25MF436B	AIRE	GA-229	57MD26
MS300T, MS200P, MS250P, MS250T, MS300P con motor/R.V.I.								
ACEITE	GP-51	485GB3191C	R607 con motor/MACK END673E (1972 EN ADELANTE)					
COMBUSTIBLE	GP-83	483GB444	COMBUSTIBLE, SECUNDARIO	GP-84	483GB218C			
COMBUSTIBLE	GP-84	483GB218C						
AGUA	GP-2015W	25MF314B						
AIRE	GA-373	57MD27						
R400 con motor/CATERPILLAR3208								
ACEITE	GP-36	9L9200						

SERVICIO PESADO

MARCA-MODELO-MOTOR MAKE-MODEL-ENGINE	GONHER GONHER	OEM OEM	MARCA-MODELO-MOTOR MAKE-MODEL-ENGINE	GONHER GONHER	OEM OEM	MARCA-MODELO-MOTOR MAKE-MODEL-ENGINE	GONHER GONHER	OEM OEM
MACK (continuación)			MACK (continuación)			MACK (continuación)		
CAMIONES, TRACTOCAMIONES Y AUTOBUSES			CAMIONES, TRACTOCAMIONES Y AUTOBUSES			CAMIONES, TRACTOCAMIONES Y AUTOBUSES		
R795, R797 con motor/MACK ENDT866			AGUA	GP-2022W	25MF463B	COMBUSTIBLE	GP-55	3313306
AIRE	GA-378	57MD33				ACEITE	GP-57	3304232
R795, R797 con motor/MACK ENDT866 (1972 EN ADELANTE)			RD600 SERIES con motor/MACK E7 E-TECH			COMBUSTIBLE	GPP-11	3600980
ACEITE	GP-51	485GB3191C	ACEITE	GP-51	485GB3191B	AGUA	GP-2071W	3315116
COMBUSTIBLE, PRIMARIO	GP-83	483GB444	RD600P, RD600S con motor/MACK EM6-275L			AIRE	GA-39	255963
COMBUSTIBLE, SECUNDARIO	GP-84	483GB218C	ACEITE	GP-51	485GB3191C	ACEITE	G-750	139096
AGUA	GP-2015W	25MF435B	COMBUSTIBLE, PRIMARIO	GP-83	483GB444	RD795, RD797 con motor/MACK ENDT866		
RB SERIES con motor/MACK EM7-250 VMAC			COMBUSTIBLE, SECUNDARIO	GP-85	483GB440	AIRE	GA-378	57MD33
ACEITE, FLUJO TOTAL (FULL FLOW) (REQUIERE 2)	GP-51	485GB3232	AGUA	GP-2022W	25MF436B	RD795, RD797 con motor/MACK ENDT866 (1972 EN ADELANTE)		
RB600S-SERIES con motor/MACK E5-250			RD607 con motor/MACK END673E (1972 EN ADELANTE)			ACEITE	GP-51	485GB3191C
ACEITE	GP-51	485GB3191B	COMBUSTIBLE, SECUNDARIO	GP-84	483GB218C	COMBUSTIBLE, PRIMARIO	GP-83	483GB444
COMBUSTIBLE, PRIMARIO	GP-83	483GB444	RD607 con motor/MACK END673E (1977 EN ADELANTE)			COMBUSTIBLE, SECUNDARIO	GP-84	483GB218C
COMBUSTIBLE, SECUNDARIO	GP-84	483GB441	ACEITE	GP-51	485GB3191C	AGUA	GP-2015W	25MF435B
AGUA	GP-2022W	25MF463B	COMBUSTIBLE, PRIMARIO	GP-83	483GB444	RD800 SERIES con motor/MACK E7 E-TECH		
RB600S-SERIES con motor/MACK E7 E-TECH			COMBUSTIBLE, SECUNDARIO	GP-85	483GB440	ACEITE	GP-51	485GB3191B
ACEITE	GP-51	485GB3191B	AGUA	GP-2022W	25MF436B	RD8006S, RD8006SX, RD800S con motor/MACK EM6-275L		
RD400 con motor/MACK ENDT475			AIRE	GA-229	2MD3129	ACEITE	GP-51	485GB3191C
ACEITE, FORD	GP-9	6432PER17	RD611 SERIES con motor/MACK ET673			COMBUSTIBLE, PRIMARIO	GP-83	483GB444
COMBUSTIBLE	GP-83	483GB444	AIRE	GAK-403	2MD455-AP2	COMBUSTIBLE, SECUNDARIO	GP-85	483GB440
COMBUSTIBLE	GP-84	483GB218C	RD611 SERIES con motor/MACK ET673 (1972 EN ADELANTE)			AGUA	GP-2022W	25MF436B
AGUA	GP-2015W	25MF435B	ACEITE	GP-51	485GB3191C	RL400 con motor/CUMMINS		
ACEITE	GP-81	6432PER17	COMBUSTIBLE, PRIMARIO	GP-83	483GB444	COMBUSTIBLE	GP-1101	154711
RD400 SERIE con motor/CATERPILLAR3208			COMBUSTIBLE, SECUNDARIO	GP-84	483GB218C	ACEITE	GP-53	3313287
ACEITE	GP-36	9L9200	AGUA	GP-2015W	25MF435B	COMBUSTIBLE	GP-55	3313306
GASOLINA	G-293	6N7617	RD612 con motor/MACK ET673 (1972 EN ADELANTE)			COMBUSTIBLE	GPP-11	3600980
COMBUSTIBLE	GP-110	1P2299	COMBUSTIBLE, SECUNDARIO	GP-84	483GB218C	AIRE	GA-39	255963
ACEITE	GP-9586	9N5570	RD612 con motor/MACK ET673A (1977 EN ADELANTE)			ACEITE	G-750	139096
RD487 con motor/MACK ETZ477			ACEITE	GP-51	485GB3191C	RL400 con motor/GMC 6V-53		
ACEITE, FORD	GP-9	6432PER17	COMBUSTIBLE, PRIMARIO	GP-83	483GB444	ACEITE	G-31	1595410
COMBUSTIBLE	GP-83	483GB444	COMBUSTIBLE, SECUNDARIO	GP-85	483GB440	ACEITE	G-33	5573013
COMBUSTIBLE	GP-84	483GB218C	AGUA	GP-2022W	25MF436B	COMBUSTIBLE, SECUNDARIO	G-1173	3290851
ACEITE	GP-81	6432PER17	RD690S con motor/MACK EM7-300			RL400, RS400 SERIES con motores/CATERPILLAR 1150, CATERPILLAR 1160		
AIRE	GA-229	2MD3129	ACEITE	GP-51	485GB3191C	ACEITE	GP-36	9L9200
RD492 con motor/CATERPILLAR 3208			COMBUSTIBLE, PRIMARIO	GP-83	483GB444	RL600 con motor/CUMMINS V903		
ACEITE	GP-36	9L9200	COMBUSTIBLE, SECUNDARIO	GP-85	483GB440	ACEITE	G-566	257528
GASOLINA	G-293	6N7617	AGUA	GP-2015W	25MF435B	COMBUSTIBLE	GP-1101	154711
COMBUSTIBLE	GP-110	1P2299	AIRE	GA-229	57MD26	ACEITE	GP-53	3313287
ACEITE	GP-9586	9N5570	RD700 con motores/GMC 6-71, GMC 6V-92, GMC 8V-71, GMC 8V-92			AGUA	GP-2071W	3315116
AIRE	GA-229	2MD3129	ACEITE	G-33	5573013	ACEITE	G-750	139096
RD600 con motores/MACK END673E (1972 EN ADELANTE), MACK ENDT675 (1972 EN ADELANTE), MACK ENDT676 (1972 EN ADELANTE)			COMBUSTIBLE, OPCIONAL	GP-26	6438837	RL600 con motor/GMC 6V-92		
COMBUSTIBLE, SECUNDARIO	GP-84	483GB218C	COMBUSTIBLE	GP-27	6438838	ACEITE	G-33	5573013
RD600 con motores/MACK END673E (1977 EN ADELANTE), MACK ENDT673, MACK ENDT673C, MACK ENDT675 (1977 EN ADELANTE), MACK ENDT676 (1977 EN ADELANTE), MACK ENDTL673C, MACK ET673			ACEITE	GP-53	25010449	COMBUSTIBLE, OPCIONAL	GP-26	6438837
ACEITE	GP-51	485GB3191C	RD700 con motores/MACK ENDT865 (1972 EN ADELANTE), MACK ENDT866 (1972 EN ADELANTE)			ACEITE	GP-53	25010449
COMBUSTIBLE, PRIMARIO	GP-83	483GB444	ACEITE	GP-51	485GB3191C	RL600 con motor/MACK ET673A		
COMBUSTIBLE, SECUNDARIO	GP-85	483GB440	COMBUSTIBLE, PRIMARIO	GP-83	483GB444	ACEITE	GP-51	485GB3191C
AGUA	GP-2022W	25MF436B	COMBUSTIBLE, SECUNDARIO	GP-84	483GB218C	COMBUSTIBLE, PRIMARIO	GP-83	483GB444
RD600 SERIES con motor/MACK E5-250			AGUA	GP-2015W	25MF435B	COMBUSTIBLE, SECUNDARIO	GP-84	483GB218C
ACEITE	GP-51	485GB3191B	RD700, RL700, RS700, RWL700, RWS700, WL700, F700, FL700, WS700 SERIES, FS700, R700 con motor/CUMMINS			AGUA	GP-2015W	25MF435B
COMBUSTIBLE, PRIMARIO	GP-83	483GB444	ACEITE	G-566	257528	RL600 con motores/GMC 6V-71N, GMC 8V-71N		
COMBUSTIBLE, SECUNDARIO	GP-85	483GB440	ACEITE	GP-14	4041959	ACEITE	G-31	1595410
AGUA	GP-2022W	25MF436B	COMBUSTIBLE	GPP-14	3315847	ACEITE	G-33	5573013
RD600 SERIES con motor/MACK E5-250			COMBUSTIBLE	GP-1101	154711	COMBUSTIBLE, SECUNDARIO	G-1175	D88913
ACEITE	GP-51	485GB3191B	COMBUSTIBLE	GP-53	3313287	COMBUSTIBLE, OPCIONAL	GP-26	6438837
COMBUSTIBLE, PRIMARIO	GP-83	483GB444						
COMBUSTIBLE, SECUNDARIO	GP-84	483GB441						

MARCA-MODELO-MOTOR	GONHER	OEM	MARCA-MODELO-MOTOR	GONHER	OEM	MARCA-MODELO-MOTOR	GONHER	OEM
MAKE-MODEL-ENGINE	GONHER	OEM	MAKE-MODEL-ENGINE	GONHER	OEM	MAKE-MODEL-ENGINE	GONHER	OEM
MACK (continuación)			MACK (continuación)			MACK (continuación)		
CAMIONES, TRACTOCAMIONES Y AUTOBUSES			CAMIONES, TRACTOCAMIONES Y AUTOBUSES			CAMIONES, TRACTOCAMIONES Y AUTOBUSES		
ACEITE	GP-53	25010449	RW703 con motor/CUMMINS			RWS700 con motores/GMC 6-71, GMC 6V-92, GMC 8V-71, GMC 8V-92		
RW602 con motores/MACK E6, MACK EC6, MACK EM6, MACK EMC6 SERIES			ACEITE, CUMPLE CON MEDIDAS ORIGINALES	GP-691	P554005	ACEITE	G-33	5573013
ACEITE	GP-51	485GB3191C	COMBUSTIBLE	GPP-14	3315847	COMBUSTIBLE, OPCIONAL	GP-26	6438837
COMBUSTIBLE, PRIMARIO	GP-83	483GB444	ACEITE, SEGUNDA OPCION	GP-52	P554005	COMBUSTIBLE	GP-27	6438838
COMBUSTIBLE, SECUNDARIO	GP-85	483GB440	ACEITE	GP-57	3304232	ACEITE	GP-53	25010449
AGUA	GP-2022W	25MF436B						
RW602, RW603 con motor/CATERPILLAR 3406			RW703 con motor/MACK			RWS700 con motores/MACK E6-250, MACK E6-315, MACK E6-350, MACK EC6-350, MACK EM6-250, MACK EM6-285, MACK EMC6-250L, MACK EMC6-250R, MACK EMC6-285		
ACEITE, CUMPLE CON MEDIDAS ORIGINALES	GP-691	1R0716	ACEITE	GP-51	485GB3191C	ACEITE	GP-51	485GB3191C
ACEITE, SEGUNDA OPCION	GP-52	1R0716	COMBUSTIBLE, PRIMARIO	GP-83	483GB444	COMBUSTIBLE, PRIMARIO	GP-83	483GB444
COMBUSTIBLE, OPCIONAL	GP-110	1P2299	COMBUSTIBLE, SECUNDARIO	GP-85	483GB440	COMBUSTIBLE, SECUNDARIO	GP-85	483GB440
RW602, RW603 con motores/CUMMINS 400, CUMMINS NTC400, CUMMINS FORMULA 300, CUMMINS FORMULA 350, CUMMINS NTC300, CUMMINS NTC350			AGUA	GP-2022W	25MF436B	AGUA	GP-2022W	25MF436B
COMBUSTIBLE	GP-1101	154711	RWL700 con motor/CATERPILLAR 3406			RWS700 SERIES con motor/MACK E9-440		
ACEITE	GP-53	3313287	ACEITE, CUMPLE CON MEDIDAS ORIGINALES	GP-691	1R0716	ACEITE	GP-51	485GB3191C
ACEITE	GP-57	3304232	ACEITE, SEGUNDA OPCION	GP-52	1R0716	COMBUSTIBLE, PRIMARIO	GP-83	483GB444
AGUA	GP-2071W	3315116	COMBUSTIBLE, OPCIONAL	GP-110	1P2299	COMBUSTIBLE, SECUNDARIO	GP-84	483GB218C
ACEITE	G-750	139096	AGUA	GP-2071W	31288	AGUA	GP-2015W	25MF435B
RW603 SERIES con motor/DETROIT DIESEL			RWL700 con motor/MACK E9-440			RWS700 SERIES con motor/MACK ET673		
ACEITE	G-33	5573014	ACEITE	GP-51	485GB3191C	ACEITE	GP-51	485GB3191C
COMBUSTIBLE, OPCIONAL	GP-26	6438837	COMBUSTIBLE, PRIMARIO	GP-83	483GB444	COMBUSTIBLE, PRIMARIO	GP-83	483GB444
COMBUSTIBLE	GP-27	6438838	COMBUSTIBLE, SECUNDARIO	GP-84	483GB218C	COMBUSTIBLE, SECUNDARIO	GP-85	483GB440
ACEITE	GP-53	25010449	AGUA	GP-2015W	25MF435B	AGUA	GP-2022W	25MF436B
RW603 SERIES con motores/MACK E6, MACK EC6, MACK EM6, MACK EMC6 SERIES			RWL700 con motor/MACK ET673			RWS700 SERIES con motor/MACK ET673A		
ACEITE	GP-51	485GB3191C	ACEITE	GP-51	485GB3191C	ACEITE	GP-51	485GB3191C
COMBUSTIBLE, PRIMARIO	GP-83	483GB444	COMBUSTIBLE, PRIMARIO	GP-83	483GB444	COMBUSTIBLE, PRIMARIO	GP-83	483GB444
COMBUSTIBLE, SECUNDARIO	GP-85	483GB440	COMBUSTIBLE, SECUNDARIO	GP-85	483GB440	COMBUSTIBLE, SECUNDARIO	GP-84	483GB218C
AGUA	GP-2022W	25MF436B	AGUA	GP-2022W	25MF436B	AGUA	GP-2015W	25MF435B
RW702 con motor/CATERPILLAR 3406			RWL700 con motor/MACK ET673A			RWS700 SERIES con motores/MACK ENDT675, MACK ENDT676		
ACEITE, CUMPLE CON MEDIDAS ORIGINALES	GP-691	1R0716	ACEITE	GP-51	485GB3191C	ACEITE	GP-51	485GB3191C
ACEITE, SEGUNDA OPCION	GP-52	1R0716	COMBUSTIBLE, PRIMARIO	GP-83	483GB444	COMBUSTIBLE, PRIMARIO	GP-83	483GB444
COMBUSTIBLE, OPCIONAL	GP-110	1P2299	COMBUSTIBLE, SECUNDARIO	GP-84	483GB218C	COMBUSTIBLE, SECUNDARIO	GP-85	483GB440
AGUA	GP-2071W	311288	AGUA	GP-2015W	25MF435B	AGUA	GP-2022W	25MF436B
RW702 con motor/CUMMINS			RWL700 con motores/GMC 6-71, GMC 6V-92, GMC 8V-71, GMC 8V-92			RWS700 SERIES con motores/MACK ENDT865, MACK ENDT866		
ACEITE, CUMPLE CON MEDIDAS ORIGINALES	GP-691	P554005	ACEITE	G-33	5573013	ACEITE	GP-51	485GB3191C
COMBUSTIBLE	GPP-14	3315847	COMBUSTIBLE, OPCIONAL	GP-26	6438837	COMBUSTIBLE, PRIMARIO	GP-83	483GB444
ACEITE, SEGUNDA OPCION	GP-52	P554005	COMBUSTIBLE	GP-27	6438838	COMBUSTIBLE, SECUNDARIO	GP-84	483GB218C
ACEITE	GP-57	3304232	ACEITE	GP-53	25010449	AGUA	GP-2015W	25MF435B
RW702 con motor/MACK			RWL700 con motores/MACK E6-250, MACK E6-315, MACK E6-350			SUPER-LINER con motor/CATERPILLAR 3406		
ACEITE	GP-51	485GB3191C	ACEITE	GP-51	485GB3191C	ACEITE, CUMPLE CON MEDIDAS ORIGINALES	GP-691	1R0716
COMBUSTIBLE, PRIMARIO	GP-83	483GB444	COMBUSTIBLE, PRIMARIO	GP-83	483GB444	ACEITE, SEGUNDA OPCION	GP-52	1R0716
COMBUSTIBLE, SECUNDARIO	GP-85	483GB440	COMBUSTIBLE, SECUNDARIO	GP-85	483GB440	COMBUSTIBLE, OPCIONAL	GP-110	1P2299
AGUA	GP-2022W	25MF436B	AGUA	GP-2022W	25MF436B	AGUA	GP-2071W	311288
RW702, RW703 con motor/DETROIT DIESEL			RWL700 con motores/MACK EC6-350, MACK EM6-250, MACK EM6-285, MACK EMC6-250L, MACK EMC6-250R, MACK EMC6-285, MACK ENDT675, MACK ENDT676			SUPER-LINER con motor/CUMMINS		
COMBUSTIBLE, OPCIONAL	GP-26	6438837	ACEITE	GP-51	485GB3191C	ACEITE	G-566	257528
COMBUSTIBLE	GP-27	6438838	COMBUSTIBLE, PRIMARIO	GP-83	483GB444	COMBUSTIBLE	GP-1101	154711
ACEITE	GP-53	25010449	COMBUSTIBLE, SECUNDARIO	GP-85	483GB440	ACEITE	GP-53	3313287
RW703 con motor/CATERPILLAR 3406			AGUA	GP-2022W	25MF436B	AGUA	GP-2071W	3315116
ACEITE, CUMPLE CON MEDIDAS ORIGINALES	GP-691	1R0716	RWL700 con motores/MACK ENDT865, MACK ENDT866			ACEITE	G-750	139096
ACEITE, SEGUNDA OPCION	GP-52	1R0716	ACEITE	GP-51	485GB3191C	SUPER-LINER con motor/GMC 8V-92		
COMBUSTIBLE, OPCIONAL	GP-110	1P2299	COMBUSTIBLE, PRIMARIO	GP-83	483GB444	ACEITE	G-33	5573013
AGUA	GP-2071W	311288	COMBUSTIBLE, SECUNDARIO	GP-84	483GB218C	COMBUSTIBLE, OPCIONAL	GP-26	6438837
			AGUA	GP-2015W	25MF435B	COMBUSTIBLE	GP-27	6438838
						SUPER-LINER con motor/MACK ET673 (1977 EN ADELANTE)		
						ACEITE	GP-51	485GB3191C

MARCA-MODELO-MOTOR MAKE-MODEL-ENGINE	GONHER GONHER	OEM OEM	MARCA-MODELO-MOTOR MAKE-MODEL-ENGINE	GONHER GONHER	OEM OEM	MARCA-MODELO-MOTOR MAKE-MODEL-ENGINE	GONHER GONHER	OEM OEM
MACK (continuación)			MACK (continuación)			MACK (continuación)		
CAMIONES, TRACTOCAMIONES Y AUTOBUSES			CAMIONES, TRACTOCAMIONES Y AUTOBUSES			CAMIONES, TRACTOCAMIONES Y AUTOBUSES		
COMBUSTIBLE, PRIMARIO	GP-83	483GB444	U607 SERIES con motor/MACK END673E (1977 EN ADELANTE)			AGUA	GP-2022W	25MF436B
COMBUSTIBLE, SECUNDARIO	GP-85	483GB440	ACEITE	GP-51	485GB3191C	WL700 con motores/MACK ENDT865 (1972 EN ADELANTE), MACK ENDT866 (1972 EN ADELANTE), MACK ENDTL673C		
AGUA	GP-2022W	25MF436B	COMBUSTIBLE, PRIMARIO	GP-83	483GB444	ACEITE	GP-51	485GB3191C
SUPER-LINER con motor/MACK MAXIDYNE 300			COMBUSTIBLE, SECUNDARIO	GP-85	483GB440	COMBUSTIBLE, PRIMARIO	GP-83	483GB444
ACEITE	GP-51	485GB3191C	AGUA	GP-2022W	25MF436B	COMBUSTIBLE, SECUNDARIO	GP-84	483GB218C
COMBUSTIBLE	GP-83	483GB444	AIRE	GA-229	2MD3129	AGUA	GP-2015W	25MF435B
COMBUSTIBLE	GP-84	483GB218C	U612 SERIES con motor/MACK ETAZ673A (1972 EN ADELANTE)			WS700 con motor/MACK ENDTL673C		
AGUA	GP-2022W	25MF436B	COMBUSTIBLE, SECUNDARIO	GP-84	483GB218C	ACEITE	GP-51	485GB3191C
U400 SERIES con motor/MACK ENDT475			U612 SERIES con motor/MACK ETAZ673A (1977 EN ADELANTE)			COMBUSTIBLE, PRIMARIO	GP-83	483GB444
ACEITE, FORD	GP-9	6432PER17	ACEITE	GP-51	485GB3191C	COMBUSTIBLE, SECUNDARIO	GP-84	483GB218C
COMBUSTIBLE	GP-83	483GB444	COMBUSTIBLE, PRIMARIO	GP-83	483GB444	AGUA	GP-2015W	25MF435B
COMBUSTIBLE	GP-84	483GB218C	COMBUSTIBLE, SECUNDARIO	GP-85	483GB440	WS700 SERIES con motor/CATERPILLAR 3406		
AGUA	GP-2015W	25MF435B	AGUA	GP-2022W	25MF436B	ACEITE, CUMPLE CON MEDI- DAS ORIGINALES	GP-691	1R0716
ACEITE	GP-81	6432PER17	U685, U686 SERIES con motor/A DIESEL			ACEITE, SEGUNDA OPCION	GP-52	1R0716
U492 SERIES con motor/CATERPILLAR 3208			AIRE	GAK-403	2MD455-AP2	COMBUSTIBLE, OPCIONAL	GP-110	1P2299
ACEITE	GP-36	9L9200	AIRE	GA-378	57MD33	AGUA	GP-2071W	3I1288
GASOLINA	G-293	6N7617	AIRE	GA-229	57MD26	WS700 SERIES con motores/GMC 6-71, GMC 6V-92, GMC 8V-71, GMC 8V-92		
COMBUSTIBLE	GP-110	1P2299	U700 con motores/MACK ENDT865 (1972 EN ADELANTE), MACK ENDT866 (1972 EN ADELANTE)			ACEITE	G-33	5573013
ACEITE	GP-9586	9N5570	ACEITE	GP-51	485GB3191C	COMBUSTIBLE, OPCIONAL	GP-26	6438837
AIRE	GA-229	2MD3129	COMBUSTIBLE, PRIMARIO	GP-83	483GB444	COMBUSTIBLE	GP-27	6438838
U600 con motores/MACK EC6-350, MACK EM6-285R, MACK EMC6- 285, MACK E6-315, MACK E6-350			COMBUSTIBLE, SECUNDARIO	GP-84	483GB218C	ACEITE	GP-53	25010449
ACEITE	GP-51	485GB3191C	AGUA	GP-2015W	25MF435B	WS700 SERIES con motores/MACK END673E, MACK ENDT675, MACK ENDT676, MACK ET673, MACK ETAZ673A		
COMBUSTIBLE, PRIMARIO	GP-83	483GB444	VISION CX SERIES con motor/MACK ASET AC-310/330			ACEITE	GP-51	485GB3191C
COMBUSTIBLE, SECUNDARIO	GP-85	483GB440	AGUA	GP-2015W	25MF435B	COMBUSTIBLE, PRIMARIO	GP-83	483GB444
AGUA	GP-2022W	25MF436B	VISION CX SERIES con motor/MACK E7 E-TECH			COMBUSTIBLE, SECUNDARIO	GP-84	483GB218C
U600 SERIES con motor/GMC 6V-92			ACEITE	GP-51	485GB3191B	COMBUSTIBLE, SECUNDARIO	GP-85	483GB440
ACEITE	G-33	5573013	VISION CX613CAMION con motor/MACK E7-355/380 E-TECH			AGUA	GP-2015W	25MF435B
COMBUSTIBLE, OPCIONAL	GP-26	6438837	ACEITE	GP-51	485GB3191B	AGUA	GP-2022W	25MF436B
ACEITE	GP-53	25010449	VISION CX613CAMION con motor/MACK E7-427 E-TECH			WS700 SERIES con motores/MACK ENDT865 (1972 EN ADELANTE), MACK ENDT866 (1972 EN ADELANTE)		
U600 SERIES con motor/MACK ETAZ673A			ACEITE	GP-51	485GB3191B	ACEITE	GP-51	485GB3191C
ACEITE	GP-51	485GB3191C	VISION CX613CAMION con motor/MACK E7-460 E-TECH			COMBUSTIBLE, PRIMARIO	GP-83	483GB444
COMBUSTIBLE, PRIMARIO	GP-83	483GB444	COMBUSTIBLE	G-128	301DS19	COMBUSTIBLE, SECUNDARIO	GP-84	483GB218C
COMBUSTIBLE, SECUNDARIO	GP-84	483GB218C	ACEITE	GP-51	485GB3191B	AGUA	GP-2015W	25MF435B
AGUA	GP-2015W	25MF435B	AGUA	GP-2015W	25MF435B	WL700 con motor/CATERPILLAR 3406		
U600 SERIES con motores/MACK E6-200, MACK EM6-250, MACK EM6-275, MACK EM6-285, MACK EMC6-250L, MACK END673E (1977 EN ADELANTE), MACK ENDT673, MACK ENDT673C, MACK ENDT675 (1977 EN ADELANTE), MACK ENDT676 (1977 EN ADE- LANTE), MACK ENDTL673C, MACK ET673, MACK E6-250, MACK EM6-237			ACEITE, CUMPLE CON MEDI- DAS ORIGINALES	GP-691	1R0716	ACEITE, SEGUNDA OPCION	GP-52	1R0716
ACEITE	GP-51	485GB3191C	ACEITE, SEGUNDA OPCION	GP-52	1R0716	COMBUSTIBLE, OPCIONAL	GP-110	1P2299
COMBUSTIBLE, PRIMARIO	GP-83	483GB444	COMBUSTIBLE, OPCIONAL	GP-110	1P2299	AGUA	GP-2071W	3I1288
COMBUSTIBLE, SECUNDARIO	GP-85	483GB440	AGUA	GP-2015W	25MF435B	WS700 SERIES con motores/MACK ENDT865 (1972 EN ADELANTE), MACK ENDT866 (1972 EN ADELANTE)		
AGUA	GP-2022W	25MF436B	WL700 con motores/GMC 6-71, GMC 6V-92, GMC 8V-71, GMC 8V-92			ACEITE	GP-51	5000133555
U600 SERIES con motores/MACK END673E (1972 EN ADELANTE), MACK ENDT675 (1972 EN ADELANTE), MACK ENDT676 (1972 EN ADELANTE)			ACEITE	G-33	5573013	COMBUSTIBLE, PRIMARIO	GP-83	5000541768
COMBUSTIBLE, SECUNDARIO	GP-84	483GB218C	COMBUSTIBLE, OPCIONAL	GP-26	6438837	COMBUSTIBLE, SECUNDARIO	GP-84	5000133546
U600ST, U600T con motor/MACK EM6-275L			COMBUSTIBLE	GP-27	6438838	AGUA	GP-2022W	5000133551
ACEITE	GP-51	485GB3191C	ACEITE	GP-53	25010449	E4-210 A DIESEL		
COMBUSTIBLE, PRIMARIO	GP-83	483GB444	WL700 con motores/MACK ENDT676, MACK ET673, MACK ETA- Z673A, MACK END673E, MACK ENDT675			ACEITE, FORD	GP-9	6432PER17
COMBUSTIBLE, SECUNDARIO	GP-85	483GB440	ACEITE	GP-51	485GB3191C	COMBUSTIBLE	GP-83	483GB444
AGUA	GP-2022W	25MF436B	COMBUSTIBLE, PRIMARIO	GP-83	483GB444	COMBUSTIBLE	GP-84	483GB218C
U607 SERIES con motor/MACK END673E (1972 EN ADELANTE)			COMBUSTIBLE, SECUNDARIO	GP-84	483GB218C	COMBUSTIBLE	GP-81	6432PER17
COMBUSTIBLE, SECUNDARIO	GP-84	483GB218C	COMBUSTIBLE, SECUNDARIO	GP-85	483GB440	ACEITE		
			COMBUSTIBLE, SECUNDARIO	GP-85	483GB440			
			AGUA	GP-2015W	25MF435B			

SERVICIO PESADO

MARCA-MODELO-MOTOR GONHER OEM
MAKE-MODEL-ENGINE GONHER OEM

MACK (continuación)

MOTORES

E6-200 A DIESEL, E6-250 A DIESEL, E6-275 A DIESEL, E6-350R A DIESEL, E7-250 A DIESEL, E7-275 A DIESEL, E7-300 A DIESEL, E7-350 A DIESEL, E7-400 A DIESEL, E9-400 A DIESEL, E9-450 A DIESEL, E9-500 A DIESEL, EC6-350 A DIESEL, EC6-350R A DIESEL, EM6-237 A DIESEL, EM6-237R A DIESEL, EM6-275L A DIESEL, EM6-275M A DIESEL, EM6-285R A DIESEL, EM6-300 A DIESEL, EM6-300R A DIESEL, EM6-300T A DIESEL, EMC6-250 A DIESEL, EMC6-250L A DIESEL, EMC6-285 A DIESEL, EMC6-285R A DIESEL

ACEITE GP-51 485GB3191C

COMBUSTIBLE, PRIMARIO GP-83 483GB444

COMBUSTIBLE, SECUNDARIO GP-85 483GB440

AGUA GP-2022W 25MF436B

E6-315 A DIESEL, E6-350 A DIESEL

ACEITE GP-51 485GB3191C

COMBUSTIBLE, PRIMARIO GP-83 483GB444

COMBUSTIBLE, SECUNDARIO GP-84 483GB441

COMBUSTIBLE, SECUNDARIO GP-85 483GB440

AGUA GP-2015W 25MF435

AGUA GP-2022W 25MF436B

E7 E-TECH (12 LITROS) A DIESEL, END673 A DIESEL, END673A A DIESEL

ACEITE GP-51 485GB3191B

E9-440 A DIESEL, END673B A DIESEL, END673C A DIESEL, END673D A DIESEL, END673P A DIESEL, END711 A DIESEL, END711B A DIESEL, END864 A DIESEL, ENDDT865 A DIESEL, ENDL711 A DIESEL, ENDLT673 A DIESEL, ENDLT673C A DIESEL, ENDLT673A A DIESEL, ENDLT673B A DIESEL, ENDLT673C A DIESEL, ENDLT673A A DIESEL, ENDT864A A DIESEL, ENDT864 B A DIESEL, ENDT865 A DIESEL, ENDT865C A DIESEL, ENDT865 A DIESEL

ACEITE GP-51 485GB3191C

COMBUSTIBLE, PRIMARIO GP-83 483GB444

COMBUSTIBLE, SECUNDARIO GP-84 483GB218C

AGUA GP-2015W 25MF435B

EM6-250 A DIESEL, EM6-250R A DIESEL, EM6-275 A DIESEL, EM6-285 A DIESEL

ACEITE GP-51 485GB3191C

COMBUSTIBLE, PRIMARIO GP-83 483GB444

COMBUSTIBLE, SECUNDARIO GP-85 483GB440

AGUA GP-2015W 25MF435

AGUA GP-2022W 25MF436B

EM7-250 A DIESEL, EM7-275 A DIESEL, EM7-300 A DIESEL, EM7-350 A DIESEL, EM7-400 A DIESEL

ACEITE GP-51 485GB3191B

COMBUSTIBLE, PRIMARIO GP-83 483GB444

COMBUSTIBLE, SECUNDARIO GP-85 483GB440

AGUA GP-2015W 25MF435

EN414 A GASOLINA

GASOLINA GG-20 221176

END673 A DIESEL, END673A A DIESEL, END673B A DIESEL, END673C A DIESEL, END673D A DIESEL, END673P A DIESEL, END675 SERIES A DIESEL, ENDLT673 A DIESEL, ENDLT673C A DIESEL, ENDLT673 A DIESEL, ENDLT673A A DIESEL, ENDLT673B A DIESEL, ENDLT673C A DIESEL, ENDLT673A A DIESEL

ACEITE G-500 236GB36

END673E A DIESEL, ENDT675 SERIES A DIESEL, ENDT676 SERIES A DIESEL, ENDT675 A DIESEL, ENDT676 A DIESEL, ET673 A DIESEL, ET673A A DIESEL, ET673B A DIESEL, ET673C A DIESEL

AIRE GAK-403 2MD455-AP2

AIRE GA-378 2MD473P1

AIRE GA-229 2MD3129

END675 SERIES A DIESEL, ENDDT865 A DIESEL, ENDT865 A DIESEL, ENDT865C A DIESEL

COMBUSTIBLE G-1163 483GB215

MARCA-MODELO-MOTOR GONHER OEM
MAKE-MODEL-ENGINE GONHER OEM

MACK (continuación)

MOTORES

END711 A DIESEL, END711B A DIESEL, END864 A DIESEL, ENDL711 A DIESEL, ENDT864 A DIESEL, ENDT864A A DIESEL, ENDT865 A DIESEL

AIRE GAK-403 2MD455-AP2

ENDT475 A DIESEL

COMBUSTIBLE GP-83 483GB444

COMBUSTIBLE GP-84 483GB218C

AGUA GP-2015W 25MF435B

ACEITE GP-81 6432PER17

ENDT866 A DIESEL, ENDT866C A DIESEL

ACEITE GP-51 485GB3191B

COMBUSTIBLE, PRIMARIO GP-83 483GB219A

COMBUSTIBLE, SECUNDARIO GP-84 483GB218C

AGUA GP-2015W 25MF435

ACEITE G-750 237GB27

ETB673 A DIESEL

AGUA GP-2022W 25MF436B

ETZ475 A DIESEL

COMBUSTIBLE, PRIMARIO GP-83 483GB219A

COMBUSTIBLE, SECUNDARIO GP-84 483GB218C

ACEITE, TURBO GP-81 6432PER17

ETZ477 A DIESEL

COMBUSTIBLE GP-83 483GB444

COMBUSTIBLE GP-84 483GB218C

ACEITE GP-81 6432PER17

AIRE GA-378 P116918

AIRE GA-229 2MD3129

EZ4-210 SCANIA A DIESEL

ACEITE, FORD GP-9 6432PER17

COMBUSTIBLE GP-83 483GB444

COMBUSTIBLE GP-84 483GB218C

ACEITE GP-81 6432PER17

MASSEY-FERGUSON

CARGADORAS

MF100 RETROEXCAVADORA con motor/PERKINS DIESEL

ACEITE G-813 894975-M91

COMBUSTIBLE G-296 1077260-M91

COMBUSTIBLE G-296-B 1077260-M91

MF11 con motor/PERKINS 4.248

ACEITE G-871 1896149-M91

COMBUSTIBLE G-296 1077260-M91

COMBUSTIBLE G-296-B 1077260-M91

MF200 RETROEXCAVADORA con motor/PERKINS V8 DIESEL

ACEITE G-813 894975-M91

COMBUSTIBLE G-296 1077260-M91

COMBUSTIBLE G-296-B 1077260-M91

AIRE GA-18 1026131-M91

MF33 con motor/PERKINS 4.248 DIESEL

ACEITE, CONVERTIDOR DE TORSION G-33 1087415-M91

ACEITE, CARTUCHO G-871 835995-M91

ACEITE, SELLADO GP-1 1447048-M1

COMBUSTIBLE G-296 1077260-M91

COMBUSTIBLE G-297 1896432-M91

COMBUSTIBLE G-296-B 1077260-M91

MARCA-MODELO-MOTOR GONHER OEM
MAKE-MODEL-ENGINE GONHER OEM

MASSEY-FERGUSON(continuación)

CARGADORAS

COMBUSTIBLE G-297-B 1896432-M91

AIRE GAK-16 1024947-M91

MF44 con motor/PERKINS 6.354

ACEITE, CONVERTIDOR DE TORSION G-33 1087415-M91

ACEITE GP-31 1447031-M1

COMBUSTIBLE G-296 1077260-M91

COMBUSTIBLE G-296-B 1077260-M91

AIRE GAK-403 102559-M91

MF470 SERIES PALA con motor/4 CYL DIESEL

ACEITE G-871 1896149-M91

MF50A con motor/PERKINS 4.203

ACEITE, CARTUCHO G-813 894975-M91

COMBUSTIBLE G-296 1077260-M91

ACEITE, SELLADO GP-3600 1447082-M1

COMBUSTIBLE G-296-B 1077260-M91

AIRE, PRIMARIO GA-18 1026131-M92

MF55 con motor/PERKINS V8.510

ACEITE, CONVERTIDOR DE TORSION G-33 1087415-M91

HIDRAULICO G-33 835514-M91

ACEITE G-834 1883288-M91

COMBUSTIBLE G-296 1077260-M91

COMBUSTIBLE G-296-B 1077260-M91

AIRE GAK-20 1087810-M91

MF650, MF660 con motor/PERKINS 1004.4

ACEITE GP-31 1447031-M1

MF66 con motor/GMC 6V-53

ACEITE, DERIVACION (BY PASS) G-31 1004894-M91

ACEITE, FLUJO TOTAL (FULL FLOW) G-33 1087415-M91

TRANSMISION G-33 1087415-M91

COMBUSTIBLE G-1173 1005435-M91

AIRE, PRIMARIO GA-106 1089774-M91

AIRE, SECUNDARIO GA-206 1089937-M91

MF66, MF77 con motor/CUMMINS

TRANSMISION G-33 1087415-M91

ACEITE, FLUJO TOTAL (FULL FLOW) CARTUCHO G-566 257528

ACEITE, TURBOCARGADOR GP-14 P779146

COMBUSTIBLE, 5 3/4 IN GPP-14 1055915-M2

COMBUSTIBLE, 5 17/32 IN GP-1101 158172

ACEITE, FLUJO TOTAL (FULL FLOW) SELLADO GP-53 1055914-M1

COMBUSTIBLE, 11 15/32 IN GP-55 3313306

COMBUSTIBLE, SEPARADOR DE AGUA GPP-11 3308638

AIRE, RESPIRADOR GA-39 255963

AIRE, PRIMARIO GA-360 525611-M1

AIRE, SECUNDARIO GA-361 525612-M1

ACEITE, DERIVACION (BY PASS) G-750 101679

MF70 con motor/PERKINS 4.318

ACEITE G-871 1896149-M91

COMBUSTIBLE G-296 1077260-M91

COMBUSTIBLE G-296-B 1077260-M91

AIRE GAK-16 1024947-M91

MF77 con motor/GMC 6V-71

ACEITE, DERIVACION (BY PASS) G-31 1004894-M91

MARCA-MODELO-MOTOR MAKE-MODEL-ENGINE	GONHER GONHER	OEM OEM	MARCA-MODELO-MOTOR MAKE-MODEL-ENGINE	GONHER GONHER	OEM OEM	MARCA-MODELO-MOTOR MAKE-MODEL-ENGINE	GONHER GONHER	OEM OEM
MASSEY-FERGUSON(continuación)			MASSEY-FERGUSON(continuación)			MASSEY-FERGUSON(continuación)		
CARGADORAS			COMBINADAS			COMBINADAS		
ACEITE, FLUJO TOTAL (FULL FLOW)	G-33	1087415-M91	COMBUSTIBLE, PRIMARIO	G-296	835994-M92	COMBUSTIBLE	G-296	1077260-M91
TRANSMISION	G-33	1087415-M91	COMBUSTIBLE, SECUNDARIO	G-296	1077260-M91	COMBUSTIBLE	G-296-B	1077260-M91
COMBUSTIBLE, SECUNDARIO	G-1175	5574508	COMBUSTIBLE, PRIMARIO	G-296-B	835994-M92	AIRE, PRIMARIO	GAK-625	1041911-M91
AIRE, PRIMARIO	GA-106	1089774-M91	COMBUSTIBLE, SECUNDARIO	G-296-B	1077260-M91	760 con motor/PERKINS AV8.540		
AIRE, SECUNDARIO	GA-206	1089937-M91	AIRE	GAK-16	1024947-M91	ACEITE	GP-1	1447048-M1
MF80 con motor/PERKINS A6.354			300SP con motor/A GASOLINA			ACEITE	GP-31	1447031-M1
ACEITE	GP-31	1447031-M1	ACEITE, CARTUCHO	G-236	835984-M91	AIRE, PRIMARIO	GAK-625	1042412-M91
COMBUSTIBLE	G-296	1077260-M91	ACEITE, SELLADO	GP-1	836064-M91	8570 con motor/CUMMINS 6CTA8.3		
ACEITE	GP-66	1088209-M91	AIRE	GAK-16	1024947-M91	COMBUSTIBLE, SECUNDARIO	GP-1122	2871513-M1
COMBUSTIBLE	G-296-B	1077260-M91	GASOLINA, PLASTICO	GG-5	800848-M91	ACEITE, FLUJO TOTAL (FULL FLOW)	GP-43	1076750-M1
MF88 con motor/CUMMINS			GASOLINA, LAMINA	GG-5 L	800848-M91	ACEITE, DOBLE FLUJO	GP-3000	1077749-M1
TRANSMISION	G-33	1087415-M91	303 con motor/A DIESEL			COMBUSTIBLE, PRIMARIO	GPP-18	1076748-M1
ACEITE, FLUJO TOTAL (FULL FLOW) CARTUCHO	G-566	257528	AIRE	GAK-16	1024947-M91	COMBUSTIBLE, SEPARADOR DE AGUA	GPP-1000	74394407
ACEITE, TURBOCARGADOR	GP-14	P779146	410 con motor/A DIESEL			AIRE, PRIMARIO	GA-106	1089774-M91
COMBUSTIBLE, 5 3/4 IN	GPP-14	1055915-M2	ACEITE	G-834	1883288-M91	AIRE, SECUNDARIO	GA-206	1089937-M91
COMBUSTIBLE, 5 17/32 IN	GP-1101	158172	COMBUSTIBLE	G-296	1851890-M1	8590, 9720 con motor/PERKINS 8.640		
ACEITE, FLUJO TOTAL (FULL FLOW) SELLADO	GP-53	1055914-M1	COMBUSTIBLE	G-296-B	1851890-M1	ACEITE	GP-31	1447031-M1
COMBUSTIBLE, 11 15/32 IN	GP-55	3313306	AIRE, SIN ASPAS	GA-403	1030542-M91	8780 con motor/CUMMINS 6CT8.3		
COMBUSTIBLE, SEPARADOR DE AGUA	GPP-11	3308638	AIRE, CON ASPAS	GAK-403	1025569-M91	COMBUSTIBLE, SECUNDARIO	GP-1122	2871513-M1
AIRE, RESPIRADOR	GA-39	255963	410 con motor/GMC 6 CILINDROS A GASOLINA			COMBUSTIBLE, SEPARADOR DE AGUA OPCIONAL	GPP-1122	1057951-M1
ACEITE, DERIVACION (BY PASS)	G-750	101679	ACEITE	GP-13	1025280-M91	ACEITE, DOBLE FLUJO	GP-3000	72501533
MF88 con motor/GMC 8V-71			AIRE, SIN ASPAS	GA-403	1030542-M91	COMBUSTIBLE, PRIMARIO	GPP-18	1076748-M1
ACEITE, DERIVACION (BY PASS)	G-31	1004894-M91	AIRE, CON ASPAS	GAK-403	1025569-M91	AIRE, PRIMARIO	GA-106	P181046
ACEITE, FLUJO TOTAL (FULL FLOW)	G-33	1087415-M91	GASOLINA, PLASTICO	GG-5	800848-M91	AIRE, SECUNDARIO	GA-206	P119373
TRANSMISION	G-33	1087415-M91	GASOLINA, LAMINA	GG-5 L	800848-M91	8780 XP con motor/CUMMINS QSC8.3		
COMBUSTIBLE, SECUNDARIO	G-1175	5574508	410SP, 510SP con motor/A DIESEL			ACEITE, DOBLE FLUJO	GP-3000	1077749-M1
MASSEY-FERGUSON			ACEITE, CARTUCHO	G-834	1883288-M91	9690 con motor/CUMMINS QSC8.3		
COMBINADAS			ACEITE, SELLADO	GP-31	1034065-M91	ACEITE, DOBLE FLUJO	GP-3001	3401544
205 con motor/A DIESEL			COMBUSTIBLE, PRIMARIO	G-296	1077260-M91	COMBUSTIBLE, SEPARADOR DE AGUA	GPP-10225	3800394
ACEITE	GP-1	1447048-M1	COMBUSTIBLE, SECUNDARIO	G-296	1077260-M91	AIRE, PRIMARIO	GA-106	P181046
205G con motor/A DIESEL			COMBUSTIBLE, PRIMARIO	G-296-B	1077260-M91	AIRE, SECUNDARIO	GA-206	P119373
ACEITE, CARTUCHO	G-236	835984-M91	COMBUSTIBLE, SECUNDARIO	G-296-B	1077260-M91	9790 con motor/CUMMINS QSL9		
300 con motor/A DIESEL			COMBUSTIBLE, PRIMARIO	G-296-B	1077260-M91	ACEITE, DOBLE FLUJO	GP-3001	3401544
ACEITE, CARTUCHO	G-813	894975-M91	COMBUSTIBLE, SECUNDARIO	G-296-B	1077260-M91	AIRE, PRIMARIO	GA-106	P181046
COMBUSTIBLE	G-296	1851890-M1	AIRE	GAK-403	1025569-M91	AIRE, SECUNDARIO	GA-206	P119373
ACEITE, SELLADO	GP-3600	1447082-M1	GASOLINA, PLASTICO	GG-5	800848-M91	MF36 con motor/CHEVROLET 194		
COMBUSTIBLE	G-296-B	1851890-M1	GASOLINA, LAMINA	GG-5 L	800848-M91	ACEITE	GP-13	1025280-M91
AIRE	GAK-16	1024947-M91	510 con motor/PERKINS 6.354			AIRE	GAK-16	1024947-M91
300 con motor/CHRYSLER SLANT SIX			ACEITE, CARTUCHO	G-834	1883288-M91	GASOLINA, PLASTICO	GG-5	800848-M91
ACEITE, CARTUCHO	G-236	835984-M91	ACEITE, SELLADO	GP-31	1447031-M1	GASOLINA, LAMINA	GG-5 L	800848-M91
ACEITE, SELLADO	GP-1	1447048-M1	COMBUSTIBLE	G-296	1077260-M91	MF410 con motor/GM 6-292 GASOLINA		
AIRE	GAK-16	1024947-M91	COMBUSTIBLE	G-296-B	1077260-M91	ACEITE	GP-13	1025280-M91
GASOLINA, PLASTICO	GG-5	800848-M91	AIRE, SIN ASPAS	GA-403	10310542-M91	ACEITE	GP-205	1025280-M91
GASOLINA, LAMINA	GG-5 L	800848-M91	AIRE, CON ASPAS	GAK-403	1025569-M91	AIRE	GAK-403	1025569-M91
300D con motor/A DIESEL			655SP con motor/A GASOLINA			GASOLINA, PLASTICO	GG-5	800848-M91
ACEITE, CARTUCHO	G-813	894975-M91	ACEITE	GP-1	836064-M91	GASOLINA, LAMINA	GG-5 L	800848-M91
COMBUSTIBLE	G-296	1077260-M91	755 con motor/CHRYSLER GASOLINA			MF410 con motor/GM V8-327 GASOLINA		
ACEITE, SELLADO	GP-3600	1447082-M1	ACEITE	GP-1	1447048-M1	ACEITE	G-200	1900376-M91
COMBUSTIBLE	G-296-B	1077260-M91	760 con motor/PERKINS AT6.354			AIRE	GAK-403	1025569-M91
AIRE	GAK-16	1024947-M91	ACEITE, S/N 174009413 EN ADELANTE	GP-1	1447048-M1	GASOLINA, PLASTICO	GG-5	800848-M91
300SP con motor/A DIESEL			ACEITE, HASTA S/N 174009413	GP-31	1447031-M1	GASOLINA, LAMINA	GG-5 L	800848-M91
ACEITE	G-813	894975-M91						

SERVICIO PESADO

MARCA-MODELO-MOTOR GONHER
MAKE-MODEL-ENGINE GONHER

OEM MARCA-MODELO-MOTOR GONHER OEM
OEM MAKE-MODEL-ENGINE GONHER OEM

MARCA-MODELO-MOTOR GONHER OEM
MAKE-MODEL-ENGINE GONHER OEM

MASSEY-FERGUSON(continuación)

COMBINADAS

MF510 con motor/A DIESEL		
ACEITE	GP-31	1447031-M1
COMBUSTIBLE	G-296	835994-M92
COMBUSTIBLE	G-296-B	835994-M92
AIRE	GAK-403	1025569-M91
MF510 con motor/A GASOLINA		
AIRE	GAK-403	1025569-M91
GASOLINA, PLASTICO	GG-5	800848-M91
GASOLINA, LAMINA	GG-5 L	800848-M91
MF540 con motor/PERKINS 4.318		
ACEITE	GP-1	1447048-M1
COMBUSTIBLE	G-296	1077260-M91
COMBUSTIBLE	G-296-B	1077260-M91
AIRE	GAK-1532	1040764-M91
MF550 con motor/PERKINS 6.354		
ACEITE, SELLADO	GP-31	1447031-M1
COMBUSTIBLE	G-296	1077260-M91
COMBUSTIBLE	G-296-B	1077260-M91
MF5650 con motor/A DIESEL		
ACEITE	GP-1	1447048-M1
MF7250, MF7252, MF7254, MF7264 con motor/SISU A DIESEL		
COMBUSTIBLE	G-297	1896287-M91
MF750 con motor/CHEVROLET V8-350		
ACEITE	GP-13	1255280-M91
AIRE, PRIMARIO	GAK-1532	1040764-M91
GASOLINA, PLASTICO	GG-5	800848-M91
GASOLINA, LAMINA	GG-5 L	800848-M91
MF750 con motor/PERKINS DIESEL		
ACEITE, CARTUCHO	G-834	1883288-M91
ACEITE, SELLADO	GP-1	1447048-M1
ACEITE, SELLADO	GP-31	1447031-M1
COMBUSTIBLE	G-296	1077260-M91
COMBUSTIBLE	G-296-B	1077260-M91
AIRE, PRIMARIO	GAK-625	1042412-M91
MF760 con motor/PERKINS DIESEL		
ACEITE	GP-1	1042412-M91
COMBUSTIBLE	G-296	1447031-M1
COMBUSTIBLE	G-296-B	1447031-M1
AIRE, PRIMARIO	GAK-625	1042412-M91
MF850 con motor/CHEVROLET A GASOLINA		
ACEITE	GP-13	1025280-M91
AIRE, PRIMARIO	GAK-1532	1040764-M91
GASOLINA, PLASTICO	GG-5	800848-M91
GASOLINA, LAMINA	GG-5 L	800848-M91
MF850 con motor/PERKINS A6.354		
ACEITE, CARTUCHO	G-834	1883288-M91
ACEITE, SELLADO	GP-1	1447048-M1
COMBUSTIBLE	G-296	1077260-M91
COMBUSTIBLE	G-296-B	1077260-M91
AIRE, PRIMARIO	GAK-625	1042412-M91
MF850 con motor/PERKINS A6.372		
ACEITE	GP-31	1447031-M1
COMBUSTIBLE	G-296	1077260-M91
COMBUSTIBLE	G-296-B	1077260-M91

MASSEY-FERGUSON(continuación)

COMBINADAS

MF855 con motor/PERKINS		
ACEITE	GP-1	1447048-M1
COMBUSTIBLE	G-296	1077260-M91
HIDROSTATIC	GP-66	1033356-M1
COMBUSTIBLE	G-296-B	1077260-M91
AIRE, PRIMARIO	GAK-625	1042412-M91
MF8560 con motor/CUMMINS		
COMBUSTIBLE, SECUNDARIO	GPP-1122	1057951-M1
COMBUSTIBLE, PRIMARIO	GPP-18	1076748-M1
ACEITE	GP-178	3890710
MF8570 con motor/A DIESEL		
ACEITE	GP-43	1076750-M1
MF8590 con motor/A DIESEL		
ACEITE	GP-31	2654407
MF860 con motor/PERKINS V8.540		
ACEITE	GP-31	1447031-M1
MF860, MF865 con motor/PERKINS 6.354		
ACEITE	GP-1	1447048-M1
COMBUSTIBLE	G-296	1077260-M91
COMBUSTIBLE	G-296-B	1077260-M91
AIRE, PRIMARIO	GAK-625	1042412-M91
MF865 con motor/PERKINS V8.540		
ACEITE	GP-31	1447031-M1
COMBUSTIBLE	G-296	1077260-M91
COMBUSTIBLE	G-296-B	1077260-M91
AIRE, PRIMARIO	GAK-625	1042412-M91
MF885 con motor/A GASOLINA		
AIRE, 1024947-M91	GAK-16	1024947-M91
MF885 con motor/PERKINS		
ACEITE	GP-1	1447048-M1
COMBUSTIBLE	G-296	1077260-M91
COMBUSTIBLE	G-296-B	1077260-M91
AIRE	GAK-1532	1040764-M91
MF9720 con motor/A DIESEL		
ACEITE	GP-31	2654407
SUPER 92 con motor/A DIESEL		
ACEITE	G-834	1883288-M91
COMBUSTIBLE	G-296	1077260-M91
COMBUSTIBLE	G-296-B	1077260-M91
SUPER 92SP con motor/A DIESEL		
COMBUSTIBLE, PRIMARIO	G-296	835994-M92
COMBUSTIBLE, SECUNDARIO	G-296	1077260-M91
COMBUSTIBLE, PRIMARIO	G-296-B	835994-M92
COMBUSTIBLE, SECUNDARIO	G-296-B	1077260-M91
SUPER 92SP con motor/PERKINS		
ACEITE	G-834	1883288-M91

MASSEY-FERGUSON

EQUIPO FORESTAL

MF220 con motor/PERKINS 4.248		
ACEITE	G-871	1896149-M91

MASSEY-FERGUSON(continuación)

EQUIPO FORESTAL

COMBUSTIBLE	G-296	1077260-M91
COMBUSTIBLE	G-296-B	1077260-M91
MF4000 con motor/PERKINS AD3.152		
COMBUSTIBLE, PRIMARIO	G-11816	1850450-M1

MASSEY-FERGUSON

EXCAVADORAS

MF350 con motor/PERKINS 4.248 DIESEL		
ACEITE	G-871	1896149-M91
COMBUSTIBLE	G-296	1077260-M91
COMBUSTIBLE	G-296-B	1077260-M91
MF450, MF450S con motor/PERKINS A6.354 DIESEL		
ACEITE, CARTUCHO	G-834	836980-M91
ACEITE, SELLADO	GP-31	1447031-M1
COMBUSTIBLE	G-296	1077260-M91
COMBUSTIBLE	G-296-B	1077260-M91

MASSEY-FERGUSON

MONTACARGAS

MF2200, MF2500 con motor/PERKINS AD3.152		
ACEITE, CARTUCHO	G-813	837595-M91
COMBUSTIBLE, PRIMARIO	G-11816	1850450-M1
COMBUSTIBLE, PRIMARIO	G-296	1851890-M1
COMBUSTIBLE, SECUNDARIO	G-296	1851890-M1
ACEITE, SELLADO	GP-3600	1447082-M1
COMBUSTIBLE, PRIMARIO	G-296-B	1851890-M1
COMBUSTIBLE, SECUNDARIO	G-296-B	1851890-M1
AIRE	GA-18	1026131-M91
MF2500 con motor/CONTINENTAL		
AIRE	GA-18	1026131-M92
MF4500 con motor/GM GASOLINA		
AIRE	GA-18	1094056-M91
MF4500 con motor/PERKINS DIESEL		
COMBUSTIBLE	G-297	1896432-M91
ACEITE	GP-3600	1447082-M1
COMBUSTIBLE	G-297-B	1896432-M91
MF6500 con motor/PERKINS 4.236 DIESEL		
ACEITE	GP-1	1447048-M1
COMBUSTIBLE	G-297	1896287-M91
COMBUSTIBLE	G-297-B	1896287-M91
MF6500 con motor/PERKINS 4.236 GASOLINA		
COMBUSTIBLE	G-297	1896287-M91
COMBUSTIBLE	G-297-B	1896287-M91
AIRE	GA-18	1094056-M91

MASSEY-FERGUSON

MOTOTRILLA

1205, 1235 con motor/ISEKI		
ACEITE	GP-157	62132400020
2675, 2705 con motor/PERKINS 6.354		
COMBUSTIBLE	G-11816	32543
ACEITE	GP-1	1447048-M1
ACEITE	GP-31	1447031-M1
COMBUSTIBLE	G-296	7111/296

MARCA-MODELO-MOTOR GONHER OEM
MAKE-MODEL-ENGINE GONHER OEM

MASSEY-FERGUSON(continuación)

MOTOTRILLA

ACEITE	GP-3600	1447082-M1
2745 con motor/PERKINS AV8.540		
ACEITE	GP-31	2654407
2775, 2805 con motores/PERKINS TV8.640, PERKINS V8.640		
ACEITE	GP-31	2654407
COMBUSTIBLE	G-296	7111/296
COMBUSTIBLE	GPP-1122	1057951-M1
COMBUSTIBLE	G-297-B	7111/796
6255, 6265 con motor/PERKINS 1004.4TW		
ACEITE	GP-31	1447031-M1
MF2704 con motor/PERKINS		
ACEITE	GP-1	1447048-M1
MF3525, MF3545 con motor/PERKINS 6.354		
ACEITE	GP-1	1447048-M1
COMBUSTIBLE	G-297	1896432-M91
COMBUSTIBLE	G-297-B	1896432-M91
MF99 con motor/PERKINS		
ACEITE	GP-31	1447031-M1

MASSEY-FERGUSON

RASPADORAS

MF40E con motor/PERKINS		
COMBUSTIBLE	G-296	1077260-M91
ACEITE	GP-3600	1447082-M1
COMBUSTIBLE	G-296-B	1077260-M91

MASSEY-FERGUSON

TRACTORES

1005 con motor/PERKINS ATC6.354 DIESEL		
ACEITE	GP-31	1447031-M1
COMBUSTIBLE	G-296	1851890-M1
COMBUSTIBLE	G-296-B	1851890-M1
1010 SERIE COMPACTA con motor/A DIESEL		
ACEITE	GP-58	3283341-M1
1045 SERIE COMPACTA, 3330F con motor/A DIESEL		
COMBUSTIBLE	G-296	1077260-M91
174-4S con motor/A DIESEL		
ACEITE	GP-1	1447048-M1
COMBUSTIBLE	G-296	1077260-M91
COMBUSTIBLE	G-296-B	1077260-M91
AIRE, SECUNDARIO	GA-416	1073508-M91
194-4F con motor/A DIESEL		
ACEITE	GP-1	1447048-M1
COMBUSTIBLE	G-296	1077260-M91
COMBUSTIBLE	G-296-B	1077260-M91
20, 22, 23, 16 PACER, 20K, 22GR, 22K, 30GR, 30K, 30, 11 PONY con motor/A DIESEL		
COMBUSTIBLE, SECUNDARIO	G-1173	1005435-M91
231 con motor/A DIESEL		
ACEITE	GP-3600	1447082-M1

MARCA-MODELO-MOTOR GONHER OEM
MAKE-MODEL-ENGINE GONHER OEM

MASSEY-FERGUSON(continuación)

TRACTORES

240 con motor/A DIESEL		
COMBUSTIBLE	G-296	1077260-M91
243 con motor/PERKINS		
COMBUSTIBLE	G-296	1077260-M91
245 con motor/CONTINENTAL GASOLINA		
COMBUSTIBLE	G-297	1896287-M91
245 con motor/PERKINS DIESEL		
COMBUSTIBLE	G-297	1896287-M91
ACEITE	GP-3600	1447082-M1
COMBUSTIBLE	G-297-B	1896287-M91
253 con motor/A DIESEL		
COMBUSTIBLE	G-296	1077260-M91
ACEITE	GP-3600	1447082-M1
COMBUSTIBLE	G-296-B	1077260-M91
263 con motor/PERKINS 3.152 SERIES		
COMBUSTIBLE	G-296	1077260-M91
ACEITE	GP-3600	1447082-M1
COMBUSTIBLE	G-296-B	1077260-M91
283 con motor/A DIESEL		
ACEITE	GP-1	1447048-M1
COMBUSTIBLE	G-297	1896287-M91
COMBUSTIBLE	G-297-B	1896287-M91
3050 con motor/A DIESEL		
COMBUSTIBLE	G-297	1896287-M91
3070 con motor/A DIESEL		
ACEITE	GP-1	1447048-M1
COMBUSTIBLE	G-297	1896287-M91
COMBUSTIBLE	G-297-B	1896287-M91
3075 con motor/PERKINS		
ACEITE	GP-31	1447031-M1
3080, 3085 con motor/PERKINS 6.354		
ACEITE	GP-31	1447031-M1
COMBUSTIBLE	G-296	3405418-M1
COMBUSTIBLE	G-296-B	3405418-M1
3090 con motor/A DIESEL		
ACEITE	GP-31	1447031-M1
COMBUSTIBLE	G-296	1077260-M91
COMBUSTIBLE	G-296-B	1077260-M91
3245 SOBRE RUEDAS con motor/PERKINS		
ACEITE	GP-1	1447048-M1
COMBUSTIBLE	G-296	3405418-M1
COMBUSTIBLE	G-296-B	3405418-M1
AIRE, RADIAL PRIMARIO	GA-853R	3540051-M1
33 con motor/A DIESEL		
HIDRAULICO	G-33	1087415-M91
ACEITE, FLUJO TOTAL (FULL FLOW)	G-870	1881442-M1
COMBUSTIBLE, PRIMARIO	G-1173	1005435-M91
COMBUSTIBLE	G-296	1077260-M91
COMBUSTIBLE	G-296-B	1077260-M91
AIRE	GAK-16	1024947-M91

MARCA-MODELO-MOTOR GONHER OEM
MAKE-MODEL-ENGINE GONHER OEM

MASSEY-FERGUSON(continuación)

TRACTORES

333, 444, COLT con motor/A DIESEL		
COMBUSTIBLE, SECUNDARIO	G-1173	1005435-M91
3630, 3650 con motor/A DIESEL		
ACEITE	GP-1	1447048-M1
COMBUSTIBLE	G-297	1896287-M91
COMBUSTIBLE	G-297-B	1896287-M91
364S, 374S, 384S con motor/A DIESEL		
COMBUSTIBLE	G-296	1077260-M91
ACEITE	GP-3600	1447082-M1
COMBUSTIBLE	G-296-B	1077260-M91
393/2, 393/4 con motor/PERKINS AT4.236		
ACEITE	GP-1	1447048-M1
COMBUSTIBLE	G-297	3405419-M1
COMBUSTIBLE	G-297-B	3405419-M1
394S con motor/A DIESEL		
COMBUSTIBLE	G-296	1077260-M91
ACEITE	GP-3600	1447082-M1
COMBUSTIBLE	G-296-B	1077260-M91
396/2, 396/4 con motor/PERKINS 6.1006		
ACEITE	GP-1	1447048-M1
COMBUSTIBLE, SECUNDARIO	GPP-425	26560144
COMBUSTIBLE, PRIMARIO	GPP-419	26560143
4215, 4220 con motores/PERKINS 903.27, PERKINS 903.27T		
ACEITE	GP-1	1447048-M1
4215A, 4220A con motores/PERKINS 903.27, PERKINS 903.27T		
ACEITE	GP-1	1447048-M1
4225, 4325, 4335 con motor/PERKINS 1004.40		
ACEITE	GP-1	1447048-M1
COMBUSTIBLE	G-296	1077260-M91
COMBUSTIBLE	GPP-1122	1057951-M1
COMBUSTIBLE	G-296-B	1077260-M91
4225A con motor/PERKINS 1004.40		
ACEITE	GP-1	1447048-M1
COMBUSTIBLE	G-296	1077260-M91
COMBUSTIBLE	GPP-1122	1057951-M1
COMBUSTIBLE	G-296-B	1077260-M91
4233, 4235 con motor/PERKINS 1004.42		
ACEITE	GP-1	1447048-M1
COMBUSTIBLE	G-296	1077260-M91
COMBUSTIBLE	G-296-B	1077260-M91
4243, 4245, 4253, 4255 con motor/PERKINS 1004.4TW		
ACEITE	GP-1	1447048-M1
COMBUSTIBLE	G-296	1077260-M91
COMBUSTIBLE	G-296-B	1077260-M91
4260, 4263, 4270 con motor/PERKINS 1006.60 SERIES		
ACEITE	GP-1	1447048-M1
COMBUSTIBLE, SEPARADOR DE AGUA	GPP-425	26560144
COMBUSTIBLE	GPP-419	26560143
4260A, 4270A con motor/PERKINS 1006 SERIES		
ACEITE	GP-31	1447031-M1
COMBUSTIBLE	G-296	1077260-M91

SERVICIO PESADO

MARCA-MODELO-MOTOR MAKE-MODEL-ENGINE	GONHER GONHER	OEM OEM	MARCA-MODELO-MOTOR MAKE-MODEL-ENGINE	GONHER GONHER	OEM OEM	MARCA-MODELO-MOTOR MAKE-MODEL-ENGINE	GONHER GONHER	OEM OEM
MASSEY-FERGUSON(continuación)			MASSEY-FERGUSON(continuación)			MASSEY-FERGUSON(continuación)		
TRACTORES			TRACTORES			TRACTORES		
COMBUSTIBLE	GPP-1122	1057951-M1	AIRE, PRIMARIO	GA-697R	4271467-M1	MF1045 con motor/A DIESEL		
COMBUSTIBLE	G-296-B	1077260-M91				COMBUSTIBLE	G-296	1077260-M91
4345, 4355 con motor/PERKINS 1004.4TW			775/CARGADORA con motor/CHRYSLER H225			ACEITE	GP-28	3280185-M91
ACEITE	GP-31	1034065-M91	ACEITE	GP-1	836064-M91	COMBUSTIBLE	G-296-B	1077260-M91
COMBUSTIBLE	G-296	1077260-M91	HIDRAULICO	GP-66	1033356-M1	HIDRAULICO	GP-166	3437036-M1
COMBUSTIBLE	G-296-B	1077260-M91	AIRE, SIN ASPAS	GA-33	P101275	AIRE, PRIMARIO	GAK-16	3438718-M1
			GASOLINA, PLASTICO	GG-5	800848-M91			
			GASOLINA, LAMINA	GG-5 L	800848-M91	MF1080 con motor/PERKINS 4.318 DIESEL		
4360, 4370 con motor/PERKINS 1006.6 SERIES			8110 con motor/PERKINS 1006.6			ACEITE, CARTUCHO	G-871	1896149-M91
ACEITE	GP-31	1034065-M91	ACEITE	GP-31	1447031-M1	ACEITE, SELLADO	GP-1	1447048-M1
44 con motor/A DIESEL			COMBUSTIBLE	G-296	1077260-M91	COMBUSTIBLE	G-296	1077260-M91
COMBUSTIBLE	G-1173	1005435-M91	COMBUSTIBLE	GPP-1122	1057951-M1	COMBUSTIBLE	G-296-B	1077260-M91
			COMBUSTIBLE	G-296-B	1077260-M91			
55 con motor/A DIESEL			8120 con motor/PERKINS 1006.6T			MF1080 con motor/PERKINS A4.318		
ACEITE	G-31	1004894-M91	ACEITE	GP-1	1447048-M1	ACEITE	G-871	1881442-M1
HIDRAULICO	G-33	1087415-M91	COMBUSTIBLE	G-296	1077260-M91	COMBUSTIBLE, PRIMARIO	G-296	1077260-M91
ACEITE	G-834	1852331-M1	COMBUSTIBLE	GPP-1122	1057951-M1	COMBUSTIBLE, SECUNDARIO	G-296	1077260-M91
COMBUSTIBLE, PRIMARIO	G-1173	1005435-M91	COMBUSTIBLE	G-296-B	1077260-M91	COMBUSTIBLE, PRIMARIO	G-296-B	1077260-M91
AIRE	GAK-20	1087810-M91				COMBUSTIBLE, SECUNDARIO	G-296-B	1077260-M91
			8140, 8150, 8160 con motor/VALMET 620DS					
555C con motor/A DIESEL			COMBUSTIBLE	G-297	1896432-M91	MF1080 con motor/PERKINS AD4.236		
ACEITE	GP-54	1871722-M1				ACEITE, CARTUCHO	G-870	1881442-M1
			8210, 8220 con motor/PERKINS 1006.6TW			ACEITE, SELLADO	GP-31	1446675-M91
55G, 55K, 55LP con motor/A DIESEL			ACEITE	GP-1	1447048-M1	COMBUSTIBLE	G-296	1077260-M91
ACEITE	G-31	1004894-M91				COMBUSTIBLE	G-296-B	1077260-M91
			8270, 8280 con motor/VALMET 645 (8.4L)			AIRE	GA-18	1026131-M91
6150 con motor/PERKINS 1004.4			COMBUSTIBLE	G-296	1077260-M91	MF1085 con motor/A DIESEL		
ACEITE	GP-31	1447031-M1				ACEITE, CARTUCHO	G-871	1896149-M91
			FE35 con motor/PERKINS DIESEL			ACEITE, SELLADO	GP-1	1447048-M1
6170 con motor/PERKINS 1006.6			ACEITE	G-813	894975-M91	COMBUSTIBLE	G-296	1077260-M91
ACEITE	GP-1	1447048-M1	COMBUSTIBLE	G-11816	1850450-M1	COMBUSTIBLE	G-296-B	1077260-M91
COMBUSTIBLE	G-296	1077260-M91	COMBUSTIBLE, PRIMARIO	G-296	1077260-M91			
COMBUSTIBLE	G-296-B	1077260-M91	COMBUSTIBLE, SECUNDARIO	G-296	1077260-M91	MF1094 con motor/A DIESEL		
			COMBUSTIBLE, PRIMARIO	G-296-B	1077260-M91	AIRE	GA-18	1094056-M91
6180 SERIES con motor/PERKINS 1006.6T			COMBUSTIBLE, SECUNDARIO	G-296-B	1077260-M91			
ACEITE	GP-1	1447048-M1	COMBUSTIBLE, SECUNDARIO	G-296-B	1077260-M91	MF11 con motor/PERKINS 4.248		
COMBUSTIBLE	G-296	1077260-M91				HIDRAULICO	G-33	PF132W
COMBUSTIBLE	G-296-B	1077260-M91	FE35D con motor/23 STD DIESEL			ACEITE, CARTUCHO	G-870	1881442-M1
			ACEITE	G-870	26540218	ACEITE, SELLADO	GP-1	1447048-M1
6290, 6270, 6280 con motor/PERKINS 1006.60T			MF10 con motor/TECUMSEH			COMBUSTIBLE	G-296	1077260-M91
ACEITE	GP-31	1447031-M1	TRANSMISION	GP-9	1015511-M92	COMBUSTIBLE	G-297	1896432-M91
COMBUSTIBLE	G-296	1077260-M91	AIRE	GA-7	1034214-M91	COMBUSTIBLE	G-296-B	1077260-M91
COMBUSTIBLE	GPP-1122	1057951-M1	AIRE	GA-3445	32355	COMBUSTIBLE	G-297-B	1896432-M91
COMBUSTIBLE	G-296-B	1077260-M91				AIRE	GA-403	1025569-M91
			MF1005 con motor/PERKINS 6.354			AIRE	GAK-16	1024947-M91
6465 con motor/PERKINS 1106C			ACEITE	GP-31	1447031-M1	MF1100 con motor/PERKINS 6.354		
COMBUSTIBLE, SEPARADOR DE AGUA	GPP-425	3780299-M1	COMBUSTIBLE	G-296	1851890-M1	ACEITE	GP-1	1447048-M1
			COMBUSTIBLE	G-296-B	1851890-M1	ACEITE	GP-31	1447031-M1
6475, 6480 con motor/PERKINS 1106C						COMBUSTIBLE, PRIMARIO	G-296	1077260-M91
ACEITE, REQUIERE 2 PIEZAS	GP-1	1447048-M1	MF1020, MF1020 HIDRO con motor/A DIESEL			COMBUSTIBLE, SECUNDARIO	G-296	1077260-M91
COMBUSTIBLE, SEPARADOR DE AGUA	GPP-425	3780299-M1	ACEITE	GP-490	3435171-M1	COMBUSTIBLE, PRIMARIO	G-296-B	1077260-M91
AIRE, PRIMARIO	GA-697R	4271467-M1				COMBUSTIBLE, SECUNDARIO	G-296-B	1077260-M91
			MF1030, MF1030L con motor/A DIESEL					
7465 con motor/PERKINS 1106C			ACEITE	GP-490	3435171-M1	MF1100 con motor/WAUKESHA F320G		
ACEITE, REQUIERE 2 PIEZAS	GP-1	2654342				COMBUSTIBLE	G-296	1851890-M1
COMBUSTIBLE, SEPARADOR DE AGUA	GPP-425	3780299-M1	MF1035 con motor/A DIESEL			COMBUSTIBLE	G-297	1896287-M91
AIRE, PRIMARIO	GA-697R	4271467-M1	ACEITE	GP-37	1447082-M1	COMBUSTIBLE	G-296-B	1851890-M1
						COMBUSTIBLE	G-297-B	1896287-M91
7475, 7480 con motor/PERKINS 1106C			MF1040 con motor/A DIESEL			MF1105 con motor/PERKINS 6.354		
ACEITE, REQUIERE 2 PIEZAS	GP-1	1447048-M1	ACEITE	GP-28	3280185-M91	ACEITE	GP-31	1447031-M1
COMBUSTIBLE, SEPARADOR DE AGUA	GPP-425	3780299-M1	HIDRAULICO	GP-166	3437036-M1	COMBUSTIBLE	G-296	1077260-M91
			AIRE, PRIMARIO SIN ASPAS	GA-33	579873-M1	COMBUSTIBLE	G-296-B	1077260-M91

MARCA-MODELO-MOTOR MAKE-MODEL-ENGINE	GONHER GONHER	OEM OEM	MARCA-MODELO-MOTOR MAKE-MODEL-ENGINE	GONHER GONHER	OEM OEM	MARCA-MODELO-MOTOR MAKE-MODEL-ENGINE	GONHER GONHER	OEM OEM
MASSEY-FERGUSON(continuación)			MASSEY-FERGUSON(continuación)			MASSEY-FERGUSON(continuación)		
TRACTORES			TRACTORES			TRACTORES		
MF1105 con motor/PERKINS ATC6.354			MF130 con motor/PERKINS 4.107			MF165 con motor/PERKINS AD4.203		
ACEITE	GP-31	1034065-M91	ACEITE	G-801	1896149-M91	ACEITE, CARTUCHO	G-813	894975-M91
COMBUSTIBLE	G-296	1851890-M1	ACEITE	G-836	32578	COMBUSTIBLE, PRIMARIO	G-296	1077260-M91
COMBUSTIBLE	G-296-B	1851890-M1	COMBUSTIBLE	G-11816	1850450-M1	COMBUSTIBLE, SECUNDARIO	G-296	1077260-M91
MF1125, MF1140, MF1145 con motor/A DIESEL			MF135 con motor/PERKINS AD3.152			ACEITE, SELLADO	GP-3600	1447082-M1
ACEITE	GP-58	3704178-M1	ACEITE, CARTUCHO	G-813	894975-M91	COMBUSTIBLE, PRIMARIO	G-296-B	1077260-M91
MF1130 con motor/PERKINS TURBO 6.354			COMBUSTIBLE, PRIMARIO	G-296	1077260-M91	COMBUSTIBLE, SECUNDARIO	G-296-B	1077260-M91
ACEITE	GP-1	1447048-M1	COMBUSTIBLE, SECUNDARIO	G-296	1077260-M91	AIRE, PRIMARIO	GA-18	1026131-M91
ACEITE	GP-31	1447031-M1	ACEITE, SELLADO	GP-3600	1447082-M1	MF165 con motor/PERKINS AG4.212		
ACEITE, DERIVACION (BY PASS)	GP-50	1032015-M91	COMBUSTIBLE, PRIMARIO	G-296-B	1077260-M91	ACEITE, CARTUCHO	G-871	1896149-M91
COMBUSTIBLE, PRIMARIO	G-296	1077260-M91	COMBUSTIBLE, SECUNDARIO	G-296-B	1077260-M91	ACEITE, SELLADO	GP-1	1447048-M1
COMBUSTIBLE, SECUNDARIO	G-296	1077260-M91	MF135 con motor/PERKINS AG3.153			AIRE, PRIMARIO	GA-18	1026131-M92
COMBUSTIBLE, PRIMARIO	G-296-B	1077260-M91	ACEITE	G-813	894975-M91	GASOLINA	GG-19	521251-M92
COMBUSTIBLE, SECUNDARIO	G-296-B	1077260-M91	MF14 con motor/KOHLER K321S			MF174-4S con motor/PERKINS DIESEL		
MF1135 con motor/PERKINS 6.354			TRANSMISION	GP-9	1015511-M92	ACEITE	GP-1	1447048-M1
ACEITE	GP-31	1447031-M1	ACEITE	GP-22	492932	COMBUSTIBLE	G-296	1077260-M91
COMBUSTIBLE	G-296	1077260-M91	AIRE	GA-7	1034214-M91	COMBUSTIBLE	G-296-B	1077260-M91
COMBUSTIBLE	G-296-B	1077260-M91	MF142 con motor/A DIESEL			AIRE, PRIMARIO	GAK-216	1070329-M91
MF1135 con motor/PERKINS AT6.354			COMBUSTIBLE, PRIMARIO	G-1121	153187003	AIRE, SECUNDARIO	GA-416	1073508-M91
ACEITE	GP-1	1447048-M1	COMBUSTIBLE, SECUNDARIO	G-1121	153187003	MF175 con motor/PERKINS AG4.236		
ACEITE	GP-31	1034065-M91	ACEITE	GP-1	1447048-M1	ACEITE, CARTUCHO	G-801	835995-M92
COMBUSTIBLE	G-296	1851890-M1	MF145 con motor/A DIESEL			ACEITE	G-813	894975-M91
COMBUSTIBLE	G-296-B	1851890-M1	COMBUSTIBLE	G-297	1896432-M91	ACEITE, SELLADO	GP-1	1447048-M1
MF1150 con motor/PERKINS AV8.510			ACEITE	GP-3600	1447082-M1	COMBUSTIBLE	G-296	1077260-M91
ACEITE, CARTUCHO	G-834	1883288-M91	COMBUSTIBLE	G-297-B	1896432-M91	COMBUSTIBLE	G-296-B	1077260-M91
ACEITE, SELLADO	GP-31	1447031-M1	MF150 con motor/A GASOLINA			AIRE	GA-18	1026131-M92
COMBUSTIBLE	G-296	1077260-M91	AIRE, PRIMARIO	GA-18	1026131-M92	MF175, MF180 con motor/CONTINENTAL G206		
COMBUSTIBLE	G-296-B	1077260-M91	MF150 con motor/CATERPILLAR 3150			ACEITE	G-236	835984-M91
MF1155 con motor/PERKINS AV8.540			AIRE	GA-360	1040830-M91	MF175, MF180 con motor/PERKINS AD4.236		
ACEITE	GP-31	1447031-M1	MF150 con motor/CONTINENTAL Z145-13			ACEITE, CARTUCHO	G-871	1896149-M91
MF12 con motor/TECUMSEH			AIRE	GA-18	1026131-M91	ACEITE, SELLADO	GP-1	1447048-M1
TRANSMISION	GP-9	1034065-M91	MF150 con motor/PERKINS AD3.152			COMBUSTIBLE	G-296	1077260-M91
AIRE	GA-7	1034214-M91	ACEITE	G-813	1851766-M1	COMBUSTIBLE	G-296-B	1077260-M91
AIRE	GA-3445	32355	COMBUSTIBLE, PRIMARIO	G-296	1077260-M91	AIRE, PRIMARIO	GA-18	1026131-M92
MF1200 con motor/PERKINS A6.354			COMBUSTIBLE, SECUNDARIO	G-296	1077260-M91	MF180 con motor/PERKINS AG4.236		
ACEITE, CARTUCHO	G-834	1883288-M91	ACEITE	GP-3600	1447082-M1	ACEITE, CARTUCHO	G-801	835995-M92
ACEITE, SELLADO 5 13/32 IN	GP-1	1447048-M1	COMBUSTIBLE, PRIMARIO	G-296-B	1077260-M91	ACEITE, SELLADO	GP-1	1447048-M1
ACEITE, SELLADO 7 17/32 IN	GP-31	1447031-M1	COMBUSTIBLE, SECUNDARIO	G-296-B	1077260-M91	AIRE	GA-18	1026131-M92
COMBUSTIBLE	G-296	1077260-M91	AIRE	GA-18	1026131-M91	MF1800 con motor/CATERPILLAR 3160		
COMBUSTIBLE	G-296-B	1077260-M91	MF150 con motor/PERKINS AG3.153			ACEITE	GP-36	9L9200
MF1205, MF1205H con motor/ISEKI			ACEITE	G-813	1851766-M1	AIRE, PRIMARIO	GA-360	P106587
COMBUSTIBLE	G-297	3708675-M1	MF154-4, MF154-4S con motor/PERKINS DIESEL			AIRE, SECUNDARIO	GA-361	P106834
MF1210, MF1433, MF1215, MF1215H, MF1220, MF1225, MF1230, MF1235, MF1417, MF1423 con motor/A DIESEL			ACEITE, CARTUCHO	G-813	894975-M91	MF1805 con motor/CATERPILLAR 3208		
COMBUSTIBLE	G-297	3708675-M1	COMBUSTIBLE	G-296	1077260-M91	ACEITE	GP-36	9L9200
MF1260 con motor/A DIESEL			ACEITE, SELLADO	GP-3600	1447082-M1	GASOLINA, SEPARADOR DE AGUA	G-293	6N7617
ACEITE	GP-58	3704178-M1	COMBUSTIBLE	G-296-B	1077260-M91	COMBUSTIBLE	GP-110	1P2299
MF130 con motor/A DIESEL			AIRE, PRIMARIO	GAK-216	1070329-M91	ACEITE	GP-9586	9N5570
ACEITE	G-813	894975-M91	AIRE, SECUNDARIO	GA-416	1073508-M91	AIRE, PRIMARIO	GA-360	1040830-M91
COMBUSTIBLE	G-296	1077260-M91	MF165 con motor/CONTINENTAL G-176			AIRE, SECUNDARIO	GA-361	1040919-M91
COMBUSTIBLE	G-296-B	1077260-M91	ACEITE	G-813	894975-M91	MF184-4 con motor/PERKINS DIESEL		
			COMBUSTIBLE	G-296	1077260-M91	ACEITE, CARTUCHO	G-813	894975-M91
			COMBUSTIBLE	G-296-B	1077260-M91	COMBUSTIBLE	G-296	1077260-M91
			AIRE	GA-18	1026131-M91	ACEITE, SELLADO	GP-3600	1447082-M1
						COMBUSTIBLE	G-296-B	1077260-M91

MARCA-MODELO-MOTOR MAKE-MODEL-ENGINE	GONHER GONHER	OEM OEM	MARCA-MODELO-MOTOR MAKE-MODEL-ENGINE	GONHER GONHER	OEM OEM	MARCA-MODELO-MOTOR MAKE-MODEL-ENGINE	GONHER GONHER	OEM OEM
MASSEY-FERGUSON(continuación)			MASSEY-FERGUSON(continuación)			MASSEY-FERGUSON(continuación)		
TRACTORES			TRACTORES			TRACTORES		
MF194-4S con motor/PERKINS DIESEL			MF20D/CARGADORA con motor/PERKINS AD3.152			MF230 con motor/CONTINENTAL Z145G		
ACEITE	GP-1	1447048-M1	COMBUSTIBLE	G-296	1077260-M91	ACEITE, DERIVACION (BY PASS)	GP-50	1032015-M91
COMBUSTIBLE	G-296	1077260-M91	ACEITE	GP-3600	1447082-M1	MF230 con motor/PERKINS AD3.152		
COMBUSTIBLE	G-296-B	1077260-M91	COMBUSTIBLE	G-296-B	1077260-M91	COMBUSTIBLE	G-297	1896287-M91
MF20 con motor/A GASOLINA			MF20E/CARGADORA, MF20F/CARGADORA, MF20S/CARGADORA con motor/PERKINS			ACEITE	GP-3600	1447082-M1
ACEITE, CARTUCHO	G-813	837595-M91	COMBUSTIBLE	G-296	1077260-M91	COMBUSTIBLE	G-297-B	1896287-M91
MF20 con motor/PERKINS D3.152			ACEITE	GP-3600	1447082-M1	MF231 con motor/PERKINS AD3.152		
ACEITE, CARTUCHO	G-813	894975-M91	COMBUSTIBLE	G-296-B	1077260-M91	ACEITE	GP-1	1447048-M1
COMBUSTIBLE	G-296	1077260-M91	MF210 con motor/A DIESEL			COMBUSTIBLE	G-296	1077260-M91
ACEITE, SELLADO	GP-3600	1447082-M1	ACEITE	GP-28	3280185-M91	COMBUSTIBLE	G-296-B	1077260-M91
COMBUSTIBLE	G-296-B	1077260-M91	MF2135 con motor/A DIESEL			MF235 con motor/CONTINENTAL A GASOLINA		
MF20/CARGADORA con motor/A DIESEL			ACEITE	G-813	894975-M91	ACEITE, DERIVACION (BY PASS)	GP-50	1032015-M91
COMBUSTIBLE	G-296	1896096-M91	COMBUSTIBLE, SECUNDARIO	G-296	1077260-M91	MF235 con motor/PERKINS		
ACEITE, SELLADO	GP-3600	1447082-M1	HIDRAULICO	GP-66	1033356-M1	COMBUSTIBLE	G-297	7111/796
COMBUSTIBLE	G-296-B	1896096-M91	COMBUSTIBLE, SECUNDARIO	G-296-B	1077260-M91	ACEITE	GP-3600	1447082-M1
AIRE	GA-18	250C55	AIRE	GA-18	1026131-M92	COMBUSTIBLE	G-297-B	7111/796
MF200 con motor/CONTINENTAL Z134			MF2135, MF2155, MF2200 con motor/A GASOLINA			MF24 con motor/A DIESEL		
AIRE	GA-18	1026131-M92	HIDRAULICO	GP-66	1033356-M1	ACEITE	GP-1	1447048-M1
MF200B, MF200C, MF200D con motor/A DIESEL			MF2155, MF2200 con motor/A DIESEL			COMBUSTIBLE	G-297	1896432-M91
COMBUSTIBLE	G-297	1896432-M91	ACEITE	G-813	894975-M91	COMBUSTIBLE	G-297-B	1896432-M91
COMBUSTIBLE	G-297-B	1896432-M91	COMBUSTIBLE, PRIMARIO	G-11816	1850450-M1	MF240 con motor/PERKINS		
AIRE, SECUNDARIO	GA-892	1037735-M91	COMBUSTIBLE, SECUNDARIO	G-296	1077260-M91	COMBUSTIBLE	G-296	1077260-M91
MF202 con motor/A DIESEL			HIDRAULICO	GP-66	1033356-M1	ACEITE	GP-3600	1447082-M1
ACEITE	G-813	837595-M91	COMBUSTIBLE, SECUNDARIO	G-296-B	1077260-M91	COMBUSTIBLE	G-296-B	1077260-M91
COMBUSTIBLE, PRIMARIO	G-11816	1850450-M2	AIRE	GA-18	1026131-M92	MF240 S, MF240 S BB con motor/PERKINS T3.152		
COMBUSTIBLE, SECUNDARIO	G-296	1077260-M91	MF220 con motor/A DIESEL			COMBUSTIBLE	G-296	26560017
COMBUSTIBLE, SECUNDARIO	G-296-B	1077260-M91	ACEITE	G-870	835995-M91	ACEITE	GP-3600	2654408
MF203 con motor/A DIESEL			COMBUSTIBLE	G-296	1077260-M91	COMBUSTIBLE	G-296-B	26560017
ACEITE	G-813	894975-M91	COMBUSTIBLE	G-296-B	1077260-M91	AIRE	GAK-403	1025569-M91
COMBUSTIBLE, PRIMARIO	G-11816	1850450-M2	MF2203, MF2205, MF2244 SOBRE ORUGAS con motor/PERKINS 3.152			MF245 con motor/CONTINENTAL A GASOLINA		
COMBUSTIBLE, SECUNDARIO	G-296	1077260-M91	ACEITE	G-813	894975-M91	ACEITE, DERIVACION (BY PASS)	GP-50	1032015-M91
COMBUSTIBLE, SECUNDARIO	G-296-B	1077260-M91	COMBUSTIBLE	G-296	1077260-M91	MF245 con motores/PERKINS AB3.152, PERKINS AD3.152		
MF204 con motor/A DIESEL			COMBUSTIBLE	G-296-B	1077260-M91	COMBUSTIBLE	G-297	7111/796
ACEITE	G-813	837595-M91	MF2244 con motor/PERKINS AD3.152			ACEITE	GP-3600	1447082-M1
COMBUSTIBLE, PRIMARIO	G-11816	1850450-M2	ACEITE	G-813	894975-M91	COMBUSTIBLE	G-297-B	7111/796
COMBUSTIBLE, SECUNDARIO	G-296	1077260-M91	COMBUSTIBLE, PRIMARIO	G-11816	1850450-M1	MF25 con motor/A DIESEL		
COMBUSTIBLE, SECUNDARIO	G-296-B	1077260-M91	COMBUSTIBLE, SECUNDARIO	G-296	1077260-M91	ACEITE, CARTUCHO	G-813	894975-M91
MF205 SOBRE RUEDAS con motor/A DIESEL			ACEITE	GP-3600	1447082-M1	COMBUSTIBLE, PRIMARIO	G-11816	1881471-M1
ACEITE	GP-490	3281019-M1	COMBUSTIBLE, SECUNDARIO	G-296-B	1077260-M91	COMBUSTIBLE, SECUNDARIO	G-296	1077260-M91
MF20C con motor/CONTINENTAL Z145			MF225 con motor/PERKINS A GASOLINA			ACEITE, SELLADO	GP-3600	1447082-M1
ACEITE, SELLADO	GP-50	1032015-M91	ACEITE	GP-1	1447048-M1	COMBUSTIBLE, SECUNDARIO	G-296-B	1077260-M91
MF20C con motor/PERKINS AD3.152			MF225 con motor/PERKINS AD4.203 DIESEL			AIRE	GA-18	1026131-M92
COMBUSTIBLE	G-297	1896432-M91	ACEITE	GP-3600	1447082-M1	MF250, MF254-4, MF253-2, MF253-4 con motor/PERKINS		
ACEITE, SELLADO	GP-3600	1447082-M1	MF22C con motor/A DIESEL			COMBUSTIBLE	G-296	1077260-M91
COMBUSTIBLE	G-297-B	1896432-M91	ACEITE	GP-1	1447048-M1	ACEITE	GP-3600	1447082-M1
MF20C/CARGADORA con motor/CONTINENTAL Z145			COMBUSTIBLE	G-297	1896432-M91	COMBUSTIBLE	G-296-B	1077260-M91
ACEITE	GP-50	1032015-M91	COMBUSTIBLE	G-297-B	1896432-M91	MF2500 con motor/A DIESEL		
MF20C/CARGADORA con motor/PERKINS AD3.152			AIRE	GA-892	1037735-M91	ACEITE, CARTUCHO	G-813	894975-M91
COMBUSTIBLE	G-297	1896287-M91	MF230 con motor/CONTINENTAL 145 A GASOLINA			COMBUSTIBLE	G-296	1077260-M91
ACEITE	GP-3600	1447082-M1	ACEITE	GP-50	1032015-M91	HIDRAULICO	GP-66	1033356-M1
COMBUSTIBLE	G-297-B	1896287-M91				ACEITE, SELLADO	GP-3600	1447082-M1
						COMBUSTIBLE	G-296-B	1077260-M91
						AIRE	GA-18	1026131-M92

MARCA-MODELO-MOTOR MAKE-MODEL-ENGINE	GONHER GONHER	OEM OEM	MARCA-MODELO-MOTOR MAKE-MODEL-ENGINE	GONHER GONHER	OEM OEM	MARCA-MODELO-MOTOR MAKE-MODEL-ENGINE	GONHER GONHER	OEM OEM
MASSEY-FERGUSON(continuación)			MASSEY-FERGUSON(continuación)			MASSEY-FERGUSON(continuación)		
TRACTORES			TRACTORES			TRACTORES		
MF2500 con motor/A GASOLINA			MF274, MF274-4 con motor/PERKINS			MF294 con motor/PERKINS		
COMBUSTIBLE	G-296	1077260-M91	ACEITE	GP-1	1447048-M1	ACEITE	GP-1	1447048-M1
HIDRAULICO	GP-66	1033356-M1	COMBUSTIBLE	G-296	1851890-M1	COMBUSTIBLE	G-296	1851890-M1
COMBUSTIBLE	G-296-B	1077260-M91	COMBUSTIBLE	G-296-B	1851890-M1	COMBUSTIBLE	G-297	1896287-M91
AIRE	GA-18	1026131-M92				COMBUSTIBLE	G-296-B	1851890-M1
			MF2745 con motor/PERKINS AV8.540			COMBUSTIBLE	G-297-B	1896287-M91
MF255 con motor/PERKINS A4.236			ACEITE	GP-31	1447031-M1	MF294-4 con motor/PERKINS		
COMBUSTIBLE	G-297	7111/796	COMBUSTIBLE	G-297	1896432-M91	ACEITE	GP-1	1447048-M1
ACEITE	GP-3600	1447082-M1	COMBUSTIBLE	G-297-B	1896432-M91	COMBUSTIBLE	G-296	1851890-M1
COMBUSTIBLE	G-297-B	7111/796				COMBUSTIBLE	G-297-B	1896287-M91
MF255 con motor/PERKINS AD4.236			MF275 con motor/PERKINS A4.248			MF298 con motor/PERKINS		
ACEITE	GP-1	1447048-M1	ACEITE	GP-1	1447048-M1	ACEITE	GP-1	1447048-M1
			MF275 con motor/PERKINS T4.236			COMBUSTIBLE	G-296	1077260-M91
MF255T con motor/PERKINS T3.152			ACEITE	GP-1	1447048-M1	COMBUSTIBLE	G-296-B	1077260-M91
COMBUSTIBLE	G-296	26560017	COMBUSTIBLE	G-297	1896287-M91			
ACEITE	GP-3600	2654408	ACEITE	GP-3600	1447082-M1	MF30 con motor/PERKINS		
COMBUSTIBLE	G-296-B	26560017	COMBUSTIBLE	G-297-B	1896287-M91	ACEITE, CARTUCHO	G-813	894975-M91
AIRE	GAK-403	1025569-M91	GASOLINA	GG-19	521251-M92	COMBUSTIBLE, PRIMARIO	G-11816	1881471-M1
						COMBUSTIBLE, SECUNDARIO	G-296	1077260-M91
MF256, MF261/2 con motor/PERKINS AD4.236			MF2770, MF2775, MF2800, MF2805 con motor/PERKINS AV8.640			COMBUSTIBLE, SECUNDARIO	G-296-B	1077260-M91
ACEITE	GP-1	1447048-M1	ACEITE	GP-31	1447031-M1	AIRE, PRIMARIO	GA-18	1026131-M92
COMBUSTIBLE	G-296	1077260-M91	COMBUSTIBLE	G-297	1896287-M91			
COMBUSTIBLE	G-296-B	1077260-M91	COMBUSTIBLE	G-297-B	1896287-M91	MF30/CARGADORA con motor/PERKINS DIESEL		
						ACEITE, CARTUCHO	G-813	894975-M91
MF25D con motor/A DIESEL			MF2775, MF2805 con motores/PERKINS TV8.640, PERKINS V8.640			COMBUSTIBLE	G-296	1077260-M91
ACEITE, CARTUCHO	G-813	894975-M91	ACEITE	GP-31	1447031-M1	ACEITE, SELLADO	GP-3600	1447082-M1
COMBUSTIBLE, SECUNDARIO	G-296	1077260-M91	COMBUSTIBLE	G-296	7111/296	COMBUSTIBLE	G-296-B	1077260-M91
ACEITE, SELLADO	GP-3600	1447082-M1	COMBUSTIBLE	GPP-1122	1057951-M1	AIRE, PRIMARIO	GA-18	1026131-M92
COMBUSTIBLE, SECUNDARIO	G-296-B	1077260-M91	COMBUSTIBLE	G-297	7111/796			
AIRE	GA-18	1026131-M92	COMBUSTIBLE	G-296-B	7111/296	MF30/CARGADORA con motor/PERKINS GASOLINA		
			COMBUSTIBLE	G-297-B	7111/796	ACEITE, CARTUCHO	G-871	1896149-M91
MF2620, MF2640 con motor/PERKINS A6.354						ACEITE, SELLADO	GP-1	1447048-M1
ACEITE	GP-31	2654407	MF282, MF283 con motor/PERKINS A4.248			AIRE, PRIMARIO	GA-18	1026131-M92
COMBUSTIBLE	G-296	1851890-M1	ACEITE	GP-1	1447048-M1	GASOLINA	GG-19	521251-M92
COMBUSTIBLE	G-296-B	1851890-M1	COMBUSTIBLE	G-296	1077260-M91			
			COMBUSTIBLE	G-297	1896287-M91	MF300 con motor/A DIESEL		
MF265 con motor/PERKINS 4.236			COMBUSTIBLE	G-296-B	1077260-M91	ACEITE	G-813	894975-M91
ACEITE	GP-1	1447048-M1	COMBUSTIBLE	G-297-B	1896287-M91	COMBUSTIBLE, PRIMARIO	G-11816	1850450-M1
COMBUSTIBLE	G-297	1896432-M91				COMBUSTIBLE, SECUNDARIO	G-296	1077260-M91
COMBUSTIBLE	G-297-B	1896432-M91	MF285 con motor/PERKINS A4.318			COMBUSTIBLE, SECUNDARIO	G-296-B	1077260-M91
			ACEITE, CARTUCHO	G-871	1882916-M91	AIRE	GA-18	1026131-M92
MF2675, MF2705 con motor/PERKINS 6.354			ACEITE, SELLADO	GP-1	1447048-M1			
COMBUSTIBLE	G-11816	32543	COMBUSTIBLE	G-296	1077260-M91	MF302 con motor/A DIESEL		
ACEITE, 5 15/32 IN	GP-1	1447048-M1	COMBUSTIBLE	G-296-B	1077260-M91	ACEITE, CARTUCHO	G-813	894975-M91
ACEITE, 7 17/32 IN	GP-31	2654407				COMBUSTIBLE, PRIMARIO	G-296	1077260-M91
COMBUSTIBLE	G-296	7111/296	MF2850 con motor/PERKINS AV8.640			COMBUSTIBLE, SECUNDARIO	G-296	1077260-M91
ACEITE, 4 45/64 IN	GP-3600	1447082-M1	ACEITE	GP-31	1447031-M1	COMBUSTIBLE, PRIMARIO	G-296-B	1077260-M91
COMBUSTIBLE	G-296-B	7111/296				COMBUSTIBLE, SECUNDARIO	G-296-B	1077260-M91
			MF2880 con motor/PERKINS AV8.640			ACEITE, SELLADO	GP-81	1015511-M92
MF2680 con motor/PERKINS A6.354			ACEITE	GP-31	1447031-M1	AIRE	GA-18	1026131-M92
ACEITE	GP-31	2654407	COMBUSTIBLE	G-297	1896432-M91			
COMBUSTIBLE	G-296	1851890-M1	COMBUSTIBLE	G-297-B	1896432-M91	MF302 con motor/A GASOLINA		
COMBUSTIBLE	G-296-B	1851890-M1				AIRE	GA-18	1026131-M92
			MF290 con motor/PERKINS					
MF270 con motor/PERKINS AD4.236			ACEITE	GP-1	1447048-M1	MF303 con motor/A DIESEL		
ACEITE	GP-1	1447048-M1	COMBUSTIBLE	G-297	1896287-M91	COMBUSTIBLE, SECUNDARIO	G-1173	1005435-M91
COMBUSTIBLE	G-297	1896432-M91	COMBUSTIBLE	G-297-B	1896287-M91			
COMBUSTIBLE	G-297-B	1896432-M91				MF304 con motor/A DIESEL		
			MF292 con motor/PERKINS T4.248			ACEITE, CARTUCHO	G-813	894975-M91
MF2720 con motor/PERKINS A6.354			ACEITE	GP-1	1447048-M1	COMBUSTIBLE, PRIMARIO	G-296	1077260-M91
ACEITE	GP-31	2654407	COMBUSTIBLE	G-297	1896287-M91	COMBUSTIBLE, SECUNDARIO	G-296	1077260-M91
COMBUSTIBLE	G-296	1851890-M1	COMBUSTIBLE	G-297-B	1896287-M91	COMBUSTIBLE, PRIMARIO	G-296-B	1077260-M91
COMBUSTIBLE	G-296-B	1851890-M1				COMBUSTIBLE, SECUNDARIO	G-296-B	1077260-M91

SERVICIO PESADO

MARCA-MODELO-MOTOR MAKE-MODEL-ENGINE	GONHER GONHER	OEM OEM	MARCA-MODELO-MOTOR MAKE-MODEL-ENGINE	GONHER GONHER	OEM OEM	MARCA-MODELO-MOTOR MAKE-MODEL-ENGINE	GONHER GONHER	OEM OEM
MASSEY-FERGUSON(continuación)			MASSEY-FERGUSON(continuación)			MASSEY-FERGUSON(continuación)		
TRACTORES			TRACTORES			TRACTORES		
ACEITE, SELLADO	GP-81	1015511-M92	MF3165 con motor/A DIESEL			COMBUSTIBLE	G-296	1077260-M91
AIRE	GA-18	1026131-M91	ACEITE	G-813	894975-M91	COMBUSTIBLE	G-296-B	1077260-M91
MF304 con motor/A GASOLINA			COMBUSTIBLE, SECUNDARIO	G-296	1077260-M91	MF333, MF3330 con motor/A DIESEL		
AIRE	GA-18	1026131-M91	HIDRAULICO	GP-66	1033356-M1	COMBUSTIBLE, SECUNDARIO	G-1173	1005435-M91
MF3050, MF3070, MF3060, MF3065 con motor/A DIESEL			COMBUSTIBLE, SECUNDARIO	G-296-B	1077260-M91	MF3366 con motor/PERKINS 4A.300		
ACEITE	GP-1	1447048-M1	AIRE	GA-18	1026131-M92	ACEITE	G-834	1883288-M91
COMBUSTIBLE	G-297	1896287-M91	MF3165 con motor/A GASOLINA			ACEITE	G-870	835995-M92
COMBUSTIBLE	G-297-B	1896287-M91	HIDRAULICO	GP-66	1033356-M1	COMBUSTIBLE	G-296	1851890-M1
MF3090 con motor/PERKINS			AIRE	GA-18	1026131-M92	COMBUSTIBLE	G-296-B	1851890-M1
ACEITE	GP-31	1447031-M1	MF32 con motor/A DIESEL			MF34 con motor/A DIESEL		
COMBUSTIBLE	G-296	1077260-M91	ACEITE	G-813	894975-M91	ACEITE	G-813	894975-M91
COMBUSTIBLE	G-296-B	1077260-M91	MF320 con motor/PERKINS A4.318			COMBUSTIBLE	G-296	1077260-M91
MF308 con motor/3 Cyl. DIESEL			ACEITE	GP-31	1447031-M1	COMBUSTIBLE	G-296-B	1077260-M91
COMBUSTIBLE	G-297	18966287-M91	COMBUSTIBLE	G-296	1077260-M91	MF34A con motor/A DIESEL		
ACEITE	GP-3600	1447082-M1	COMBUSTIBLE	G-296-B	1077260-M91	AIRE	GA-18	1094056-M91
COMBUSTIBLE	G-297-B	1896287-M91	MF3255 SOBRE RUEDAS con motor/A DIESEL			MF35 con motor/PERKINS DIESEL		
AIRE	GA-18	1094056-M91	AIRE, RADIAL PRIMARIO	GA-853R	3540051-M1	ACEITE	G-813	894975-M91
MF308 con motor/A GASOLINA			MF3303 con motor/PERKINS 4.203			COMBUSTIBLE, PRIMARIO	G-11816	1850450-M1
ACEITE	GP-50	1032015-M91	ACEITE, CARTUCHO	G-813	894975-M91	HASTA S/N 240398		
MF30B/CARGADORA con motor/CONTINENTAL Z145			COMBUSTIBLE	G-296	1077260-M91	COMBUSTIBLE, PRIMARIO	G-296	1077260-M91
ACEITE	GP-50	1032015-M91	ACEITE, SELLADO	GP-3600	1447082-M1	COMBUSTIBLE, SECUNDARIO	G-296	1077260-M91
MF30B/CARGADORA con motor/PERKINS AD3.152			COMBUSTIBLE	G-296-B	1077260-M91	COMBUSTIBLE, PRIMARIO	G-296-B	1077260-M91
COMBUSTIBLE	G-297	1896432-M91	AIRE	GA-18	1026131-M91	COMBUSTIBLE, SECUNDARIO	G-296-B	1077260-M91
ACEITE	GP-3600	1447082-M1	MF3303 con motor/PERKINS 4.212			MF350 con motor/A DIESEL		
COMBUSTIBLE	G-297-B	1896432-M91	ACEITE, CARTUCHO	G-870	1896149-M91	ACEITE	G-870	1881442-M1
MF30D con motor/A DIESEL			COMBUSTIBLE	G-296	1077260-M91	COMBUSTIBLE	G-296	1077260-M91
COMBUSTIBLE	G-297	1896432-M91	ACEITE, SELLADO	GP-3600	1447082-M1	COMBUSTIBLE	G-296-B	1077260-M91
ACEITE	GP-3600	1447082-M1	COMBUSTIBLE	G-296-B	1077260-M91	MF3505 con motor/PERKINS 6.354		
COMBUSTIBLE	G-297-B	1896287-M91	AIRE	GA-18	1026131-M91	ACEITE	GP-31	1447031-M1
MF30E/CARGADORA, MF30H/CARGADORA con motor/PERKINS			MF3305 con motor/PERKINS 4.203			COMBUSTIBLE	G-297	1896432-M91
COMBUSTIBLE	G-296	1077260-M91	ACEITE, CARTUCHO	G-813	894975-M91	COMBUSTIBLE	G-297-B	1896432-M91
ACEITE	GP-3600	1447082-M1	COMBUSTIBLE	G-296	1077260-M91	MF350D con motor/A DIESEL		
COMBUSTIBLE	G-296-B	1077260-M91	ACEITE, SELLADO	GP-3600	1447082-M1	ACEITE	G-801	1881442-M1
MF31 con motor/A DIESEL			COMBUSTIBLE	G-296-B	1077260-M91	COMBUSTIBLE, PRIMARIO	G-296	1077260-M91
ACEITE	G-871	1896149-M91	AIRE	GA-18	1026131-M91	COMBUSTIBLE, SECUNDARIO	G-296	1077260-M91
COMBUSTIBLE	G-296	1077260-M91	MF3305 con motor/PERKINS 4.212			COMBUSTIBLE, PRIMARIO	G-296-B	1077260-M91
COMBUSTIBLE	G-296-B	1077260-M91	ACEITE, CARTUCHO	G-871	1896149-M91	COMBUSTIBLE, SECUNDARIO	G-296-B	1077260-M91
AIRE	GA-18	1026131-M92	COMBUSTIBLE	G-296	1077260-M91	MF354V, MF354GE, MF354S con motor/PERKINS AD3.1525		
MF3120 con motor/PERKINS 1006.6 SERIES			ACEITE, SELLADO	GP-3600	1447082-M1	ACEITE	GP-1	1447048-M1
ACEITE	GP-31	1447031-M1	COMBUSTIBLE	G-296-B	1077260-M91	COMBUSTIBLE	G-296	1077260-M91
COMBUSTIBLE	G-296	1077260-M91	AIRE	GA-18	1026131-M91	ACEITE	GP-3600	1447082-M1
COMBUSTIBLE	G-296-B	1077260-M91	MF3305 con motor/PERKINS 4.213			COMBUSTIBLE	G-296-B	1077260-M91
MF3120 con motor/PERKINS 365 (6L)			ACEITE, CARTUCHO	G-870	1881442-M1	MF356 con motor/A DIESEL		
ACEITE	GP-31	1447031-M1	COMBUSTIBLE	G-296	1851890-M1	ACEITE	G-813	894975-M91
MF3140 con motor/A DIESEL			COMBUSTIBLE	G-296-B	1851890-M1	COMBUSTIBLE, PRIMARIO	G-296	1077260-M91
ACEITE	GP-1	1447048-M1	AIRE	GA-18	1026131-M92	COMBUSTIBLE, SECUNDARIO	G-296	1077260-M91
COMBUSTIBLE	G-296	1077260-M91	MF3306 con motor/PERKINS 4.300			COMBUSTIBLE, PRIMARIO	G-296-B	1077260-M91
COMBUSTIBLE	G-296-B	1077260-M91	ACEITE, CARTUCHO	G-834	1852331-M1	COMBUSTIBLE, SECUNDARIO	G-296-B	1077260-M91
MF3140 con motor/PERKINS TURBO 365 (6L)			ACEITE, CARTUCHO	G-870	1851815-M1	MF35D con motor/23 STD DIESEL		
ACEITE	GP-1	1447048-M1	ACEITE, SELLADO	GP-1	1447048-M1	ACEITE	G-870	26540218
COMBUSTIBLE	G-296	1077260-M91	COMBUSTIBLE	G-296	1077260-M91	MF360 con motor/A DIESEL		
COMBUSTIBLE	G-296-B	1077260-M91	COMBUSTIBLE	G-296-B	1077260-M91	COMBUSTIBLE	G-296	1077260-M91
MF3140 con motor/PERKINS TURBO 365 (6L)			AIRE	GA-18	1026131-M92	ACEITE	GP-3600	1447082-M1
ACEITE	GP-1	1447048-M1	MF3315, MF3325 con motor/PERKINS 903.27					
			ACEITE	GP-1	1447048-M1			

MARCA-MODELO-MOTOR MAKE-MODEL-ENGINE	GONHER GONHER	OEM OEM	MARCA-MODELO-MOTOR MAKE-MODEL-ENGINE	GONHER GONHER	OEM OEM	MARCA-MODELO-MOTOR MAKE-MODEL-ENGINE	GONHER GONHER	OEM OEM
MASSEY-FERGUSON(continuación)			MASSEY-FERGUSON(continuación)			MASSEY-FERGUSON(continuación)		
TRACTORES			TRACTORES			TRACTORES		
COMBUSTIBLE	G-296-B	1077260-M91	MF392S con motor/PERKINS 4.236			COMBUSTIBLE	G-296	1077260-M91
MF362 con motor/A DIESEL			ACEITE	GP-1	1447048-M1	COMBUSTIBLE	G-296-B	1077260-M91
ACEITE	GP-1	1447048-M1	COMBUSTIBLE	G-296	1077260-M91	MF44, MF44B con motor/A DIESEL		
COMBUSTIBLE	G-296	1077260-M91	COMBUSTIBLE	G-296-B	1077260-M91	ACEITE	G-33	1087415-M91
COMBUSTIBLE	G-296-B	1077260-M91	MF394GE con motor/PERKINS T4.236			ACEITE	GP-31	1034065-M91
MF3630 con motor/A DIESEL			COMBUSTIBLE	G-296	1077260-M91	COMBUSTIBLE	G-296	1077260-M91
ACEITE	GP-1	1447048-M1	ACEITE	GP-3600	2654408	COMBUSTIBLE	G-296-B	1077260-M91
COMBUSTIBLE	G-297	1896287-M91	COMBUSTIBLE	G-296-B	1077260-M91	AIRE	GAK-403	1025569-M91
COMBUSTIBLE	G-297-B	1896287-M91	AIRE	GAK-403	1025569-M91	MF444 con motor/A DIESEL		
MF364G, MF364S, MF364V con motor/PERKINS AT3.152S			MF394S, MF394GE, MF394H con motor/A DIESEL			COMBUSTIBLE, PRIMARIO (2ND STAGE)	G-1173	1005435-M91
ACEITE	GP-1	1447048-M1	ACEITE	GP-1	1447048-M1	MF444D con motor/A DIESEL		
COMBUSTIBLE	G-296	1077260-M91	COMBUSTIBLE	G-296	1077260-M91	COMBUSTIBLE, SECUNDARIO	G-1173	1005435-M91
ACEITE	GP-3600	1447082-M1	COMBUSTIBLE	G-296-B	1077260-M91	MF44C con motor/A DIESEL		
COMBUSTIBLE	G-296-B	1077260-M91	MF398 con motor/A DIESEL			COMBUSTIBLE	G-296	1077260-M91
MF365 con motor/PERKINS 4.236			ACEITE	GP-1	1447048-M1	COMBUSTIBLE, SECUNDARIO	GP-1122	2871513-M91
ACEITE	GP-1	1447048-M1	COMBUSTIBLE	G-297	3405419-M1	COMBUSTIBLE	G-296-B	1077260-M91
COMBUSTIBLE	G-296	1077260-M91	COMBUSTIBLE	G-297-B	3405419-M1	AIRE, PRIMARIO	GAK-625	1042412-M91
COMBUSTIBLE	G-296-B	1077260-M91	MF398 con motor/PERKINS T4.236			MF450, MF450S con motor/PERKINS 6.354		
MF3650 con motor/A DIESEL			ACEITE	GP-1	1447048-M1	ACEITE, CARTUCHO	G-834	1883288-M91
ACEITE	GP-1	1447048-M1	COMBUSTIBLE	G-296	26560017	ACEITE, SELLADO	GP-1	881304-M91
COMBUSTIBLE	G-297	1896287-M91	COMBUSTIBLE	G-296-B	26560017	ACEITE, SELLADO	GP-31	881446-M91
COMBUSTIBLE	G-297-B	1896287-M91	AIRE	GAK-403	1025569-M91	COMBUSTIBLE, PRIMARIO	G-296	1077260-M91
MF3660 con motor/PERKINS TURBO 365 (6L)			MF399 con motor/PERKINS 6.354			COMBUSTIBLE, SECUNDARIO	G-296	1077260-M91
ACEITE	GP-1	1447048-M1	ACEITE	GP-31	1447031-M1	COMBUSTIBLE, PRIMARIO	G-296-B	1077260-M91
COMBUSTIBLE	G-297	1896287-M91	COMBUSTIBLE	G-296	1077260-M91	COMBUSTIBLE, SECUNDARIO	G-296-B	1077260-M91
COMBUSTIBLE	G-297-B	1896287-M91	COMBUSTIBLE	G-296-B	1077260-M91	MF470 con motor/A DIESEL		
MF3670, MF3690 con motor/A DIESEL			MF399 con motor/PERKINS 6.3544			ACEITE	G-801	1881442-M1
COMBUSTIBLE	G-297	1896432-M91	ACEITE	GP-31	1447031-M1	COMBUSTIBLE	G-11816	1850450-M1
MF3680 con motor/PERKINS 452 (7.4L)			MF40 con motor/A DIESEL			AIRE	GA-18	1026131-M91
COMBUSTIBLE	G-297	1896432-M91	ACEITE	G-813	894975-M91	MF4800 con motor/CUMMINS VT903		
MF374G, MF374S, MF374V con motor/PERKINS A4.236			COMBUSTIBLE	G-296	1077260-M91	COMBUSTIBLE	GPP-14	1055915-M2
ACEITE	GP-1	1447048-M1	ACEITE	GP-3600	1447082-M1	ACEITE, FLUJO TOTAL (FULL FLOW)	GP-53	1055914-M1
COMBUSTIBLE	G-297	1077260-M91	COMBUSTIBLE	G-296-B	1077260-M91	ACEITE, DERIVACION (BY PASS)	GP-57	771308-M1
COMBUSTIBLE	G-297-B	1077260-M91	MF40 PARA CESPED con motor/A DIESEL			AGUA	GP-2071W	3315116
MF375 con motor/PERKINS 4.236			COMBUSTIBLE	G-296	1077260-M91	MF4840 con motor/CUMMINS V903		
ACEITE	GP-1	1447048-M1	ACEITE	GP-3600	1447082-M1	COMBUSTIBLE, PRIMARIO	GPP-14	1055915-M2
COMBUSTIBLE	G-297	1077260-M91	COMBUSTIBLE	G-296-B	1077260-M91	ACEITE, FLUJO TOTAL (FULL FLOW)	GP-53	1055914-M1
COMBUSTIBLE	G-297-B	3405419-M1	MF400 SOBRE ORUGAS con motor/PERKINS A6.354 DIESEL			ACEITE, DERIVACION (BY PASS)	GP-57	771308-M1
MF383 con motor/PERKINS 4.248			ACEITE, CONVERTIDOR DE TORSION	G-33	1087415-M91	AGUA	GP-2071W	3315116
ACEITE	GP-1	1447048-M1	ACEITE, SELLADO	GP-31	1447031-M1	MF4880 con motor/CUMMINS VT903		
COMBUSTIBLE	G-297	1077260-M91	COMBUSTIBLE	G-296	1077260-M91	COMBUSTIBLE	GPP-14	1055915-M2
COMBUSTIBLE	G-297-B	3405419-M1	COMBUSTIBLE	G-296-B	1077260-M91	ACEITE, FLUJO TOTAL (FULL FLOW)	GP-53	1055914-M1
MF384GE, MF384V, MF384H, MF384S con motor/PERKINS A4.236			MF40B/CARGADORA con motor/PERKINS D4.203			ACEITE, DERIVACION (BY PASS)	GP-57	771308-M1
ACEITE	GP-1	1447048-M1	ACEITE	GP-1	1447048-M1	AGUA	GP-2071W	3315116
COMBUSTIBLE	G-296	1077260-M91	COMBUSTIBLE	G-297	1896432-M91	MF4900 con motor/CUMMINS VT903		
COMBUSTIBLE	G-296-B	1077260-M91	COMBUSTIBLE	G-297-B	1896432-M91	COMBUSTIBLE	GPP-14	1055915-M2
MF390, MF390T con motor/A DIESEL			MF40EL con motor/A DIESEL			ACEITE, FLUJO TOTAL (FULL FLOW)	GP-53	1055914-M1
ACEITE	GP-1	1447048-M1	COMBUSTIBLE	G-296	1077260-M91	ACEITE, DERIVACION (BY PASS)	GP-57	771308-M1
COMBUSTIBLE	G-297	3405419-M1	ACEITE	GP-3600	1447082-M1	AGUA	GP-1011Q	3315115
COMBUSTIBLE	G-297-B	3405419-M1	COMBUSTIBLE	G-296-B	1077260-M91	MF50 con motor/A DIESEL		
			MF4315, MF4320 con motor/PERKINS 903.27			ACEITE	G-813	894975-M91
			ACEITE	GP-1	1447048-M1			

SERVICIO PESADO

MARCA-MODELO-MOTOR	GONHER	OEM	MARCA-MODELO-MOTOR	GONHER	OEM	MARCA-MODELO-MOTOR	GONHER	OEM
MAKE-MODEL-ENGINE	GONHER	OEM	MAKE-MODEL-ENGINE	GONHER	OEM	MAKE-MODEL-ENGINE	GONHER	OEM
MASSEY-FERGUSON(continuación)			MASSEY-FERGUSON(continuación)			MASSEY-FERGUSON(continuación)		
TRACTORES			TRACTORES			TRACTORES		
COMBUSTIBLE	G-296	1077260-M91	MF6235, MF6245, MF6255 con motor/PERKINS 1004.40T			MF77 con motor/DETROIT DIESEL		
COMBUSTIBLE	G-296-B	1077260-M91	ACEITE	GP-31	1034065-M91	TRANSMISION	G-33	1087415-M91
AIRE	GA-18	1026131-M92	COMBUSTIBLE	G-296	1077260-M91	AIRE, PRIMARIO	GA-106	1089774-M91
MF50/CARGADORA con motor/A GASOLINA			COMBUSTIBLE	GPP-1122	1057951-M1	AIRE, SECUNDARIO	GA-206	1089937-M91
AIRE	GA-18	1026131-M92	COMBUSTIBLE	G-296-B	1077260-M91	MF775/CARGADORA con motor/CHRYSLER 6 CYL.		
MF500 SOBRE ORUGAS con motor/PERKINS AV8.510 DIESEL			MF6260 con motor/PERKINS 1006.60NA			ACEITE	GP-1	1447048-M1
ACEITE, CARTUCHO	G-834	1883288-M91	ACEITE	GP-31	1034065-M91	HIDRAULICO	GP-66	1043939-M91
ACEITE, SELLADO	GP-31	1447031-M1	COMBUSTIBLE	G-296	1077260-M91	AIRE, SIN ASPAS	GA-33	1031436-M91
COMBUSTIBLE, SECUNDARIO	G-296	1077260-M91	COMBUSTIBLE	GPP-1122	1057951-M1	GASOLINA, PLASTICO	GG-5	800848-M91
COMBUSTIBLE, SECUNDARIO	G-296-B	1077260-M91	COMBUSTIBLE	G-296-B	1077260-M91	GASOLINA, LAMINA	GG-5 L	800848-M91
MF500B con motor/PERKINS V8.510			MF6265 con motor/PERKINS 1004.4TW			MF785/CARGADORA con motor/CHRYSLER H225		
ACEITE	G-834	1883288-M91	ACEITE	GP-31	1034065-M91	HIDRAULICO	GP-66	1043939-M91
ACEITE	GP-31	1447031-M1	COMBUSTIBLE	G-296	1077260-M91	ACEITE	GP-81	1015511-M92
COMBUSTIBLE	G-296	1896096-M91	COMBUSTIBLE	GPP-1122	1057951-M1	AIRE, SIN ASPAS	GA-33	1031436-M91
COMBUSTIBLE	G-296-B	1896096-M91	COMBUSTIBLE	G-296-B	1077260-M91	GASOLINA, PLASTICO	GG-5	800848-M91
MF50A con motor/PERKINS AD4.203			MF655/CARGADORA con motor/CHRYSLER 6-225			GASOLINA, LAMINA	GG-5 L	800848-M91
COMBUSTIBLE	G-296	1077260-M91	ACEITE	GP-1	1447048-M1	MF80 con motor/PERKINS A6.354		
ACEITE	GP-3600	1447082-M1	MF65D con motor/PERKINS			ACEITE	GP-31	1447031-M1
COMBUSTIBLE	G-296-B	1077260-M91	ACEITE	G-813	894975-M91	COMBUSTIBLE	G-296	1077260-M91
AIRE	GA-18	1026131-M92	COMBUSTIBLE	G-296	1077260-M91	COMBUSTIBLE	G-296-B	1077260-M91
MF50C/CARGADORA, MF50D/CARGADORA con motor/PERKINS AD4.236			COMBUSTIBLE	G-296-B	1077260-M91	MF811 con motor/PERKINS 4.108		
ACEITE	GP-1	1447048-M1	MF66 con motor/CUMMINS			ACEITE	GP-1	1447048-M1
COMBUSTIBLE	G-297	1896432-M91	TRANSMISION	G-33	1087415-M91	COMBUSTIBLE	G-296	1077260-M91
COMBUSTIBLE	G-297-B	1896432-M91	MF66 con motor/DETROIT DIESEL			ACEITE	GP-66	1043939-M91
MF50E/CARGADORA con motor/PERKINS			TRANSMISION	G-33	1087415-M91	COMBUSTIBLE	G-296-B	1077260-M91
ACEITE	GP-1	1447048-M1	AIRE, PRIMARIO	GA-106	1089774-M91	AIRE, SIN ASPAS	GA-33	P101275
COMBUSTIBLE	G-297	1896432-M91	AIRE, SECUNDARIO	GA-206	1089937-M91	MF8120 con motor/A DIESEL		
COMBUSTIBLE	G-297-B	1896432-M91	MF670, MF690 con motor/PERKINS			ACEITE	GP-1	1447048-M1
MF50F/CARGADORA, MF50H/HX/CARGADORA con motor/PERKINS AD4.236			ACEITE	GP-1	1447048-M1	MF8140, MF8150 con motor/A DIESEL		
ACEITE	GP-1	1447048-M1	COMBUSTIBLE	G-297	1896432-M91	COMBUSTIBLE	G-297	1896287-M91
COMBUSTIBLE	G-297	1896432-M91	COMBUSTIBLE	G-297-B	1896432-M91	MF85, MF88 con motor/CONTINENTAL HD297		
COMBUSTIBLE	G-297-B	1896432-M91	MF698 con motor/PERKINS			HIDRAULICO	G-33	1087415-M91
AIRE	GA-18	1897151-M1	ACEITE	GP-1	1447048-M1	ACEITE, LUBRICACION DE MOTOR	G-33	1087415-M91
MF555, MF55D, MF55G, MF55K, MF55LP con motor/A DIESEL			COMBUSTIBLE	G-296	1077260-M91	COMBUSTIBLE, PRIMARIO	G-11816	1850450-M1
ACEITE	G-31	1004894-M91	COMBUSTIBLE	G-296-B	1077260-M91	MF85, MF88 con motores/CONTINENTAL E223, CONTINENTAL E242		
MF555D con motor/A DIESEL			MF699 con motor/PERKINS			HIDRAULICO	G-33	1087415-M91
ACEITE	G-31	1004894-M91	ACEITE	GP-31	1034065-M91	MF90 SUPER con motor/A DIESEL		
MF55C con motor/A DIESEL			COMBUSTIBLE	G-296	1077260-M91	ACEITE	G-834	1883288-M91
ACEITE	GP-31	1447031-M1	COMBUSTIBLE	G-296-B	1077260-M91	COMBUSTIBLE	G-296	1077260-M91
COMBUSTIBLE	G-296	1896096-M91	MF7 con motor/A DIESEL			COMBUSTIBLE	G-296-B	1077260-M91
ACEITE	GP-54	971238001	TRANSMISION	GP-9	1015511-M92	MF95 con motor/A DIESEL		
COMBUSTIBLE	G-296-B	1896096-M91	MF70 con motor/A DIESEL			COMBUSTIBLE, SECUNDARIO	G-1173	1005435-M91
MF60/CARGADORA, MF60H/CARGADORA con motor/PERKINS AD4.236			ACEITE	G-801	1881442-M1	ACEITE, SELLADO	GP-9	1015511-M92
ACEITE	GP-31	1447031-M1	COMBUSTIBLE	G-296	1077260-M91	COMBUSTIBLE	G-296	1077260-M91
COMBUSTIBLE	G-296	1077260-M91	COMBUSTIBLE	G-296-B	1077260-M91	COMBUSTIBLE	G-296-B	1077260-M91
COMBUSTIBLE	G-297	1896287-M91	AIRE	GAK-16	1024947-M91	MF97 con motor/A DIESEL		
COMBUSTIBLE	G-296-B	1077260-M91	MF77 con motor/CUMMINS			COMBUSTIBLE, SECUNDARIO	G-1173	1005435-M91
COMBUSTIBLE	G-297-B	1896287-M91	TRANSMISION	G-33	1087415-M91	MF97D, MF97LP con motor/A DIESEL		
AIRE, PRIMARIO	GA-18	1897151-M1	AIRE, PRIMARIO	GA-360	1040830-M91	ACEITE, CARTUCHO	G-813	894975-M91
MF6150, MF6170, MF6180 con motor/A DIESEL			AIRE, SECUNDARIO	GA-361	1040919-M91	COMBUSTIBLE, SECUNDARIO	G-1173	1005435-M91
ACEITE	GP-31	1447031-M1				ACEITE, SELLADO	GP-81	1015511-M92

MARCA-MODELO-MOTOR GONHER OEM
MAKE-MODEL-ENGINE GONHER OEM

MASSEY-FERGUSON(continuación)

TRACTORES

MF98 con motor/A DIESEL		
ACEITE, DERIVACION (BY PASS)	G-31	1004894-M91
COMBUSTIBLE, SECUNDARIO	G-1173	1005435-M91
COMBUSTIBLE, PRIMARIO	G-1174	835787-M91
MFC44C con motor/A DIESEL		
COMBUSTIBLE	G-296	1077260-M91
COMBUSTIBLE, SECUNDARIO	GP-1122	2871513-M1
COMBUSTIBLE	G-296-B	1077260-M91
AIRE, PRIMARIO	GAK-625	1042412-M91
MUSTANG, PACEMAKER con motor/A DIESEL		
COMBUSTIBLE, SECUNDARIO	G-1173	1005435-M91
PITBULL con motor/A DIESEL		
COMBUSTIBLE, PRIMARIO	G-1173	1005435-M91
SUPER 90 con motor/A DIESEL		
ACEITE, MOTORES PERKINS	G-813	835568-M92
ACEITE, MOTORES DIESEL EST-NDAR	G-834	1852331-M1
COMBUSTIBLE	G-296	1077260-M91
COMBUSTIBLE	G-296-B	1077260-M91
TEA-20 con motor/A GASOLINA		
ACEITE	G-870	26540218
TO20, TO30 con motor/A DIESEL		
COMBUSTIBLE, SECUNDARIO	G-1173	1005435-M91
TO35 con motor/PERKINS DIESEL		
ACEITE	G-813	894975-M91
COMBUSTIBLE, PRIMARIO HASTA S/N 240398	G-11816	1850450-M1
COMBUSTIBLE, PRIMARIO	G-296	1077260-M91
COMBUSTIBLE, SECUNDARIO	G-296	1077260-M91
COMBUSTIBLE, PRIMARIO	G-296-B	1077260-M91
COMBUSTIBLE, SECUNDARIO	G-296-B	1077260-M91
TO35D con motor/23 STD DIESEL		
ACEITE	G-870	26540218
W-450C con motor/A DIESEL		
ACEITE	GP-54	971238001

MASSEY-FERGUSON

TRACTORES PEQUEÑOS Y PARA JARDIN

2616H con motor/BRIGGS & STRATTON 16 HP		
ACEITE	GP-58	492932
2716H, 2720H con motores/BRIGGS & STRATTON 16 HP, BRIGGS & STRATTON 18 HP, BRIGGS & STRATTON 20 HP		
ACEITE	GP-58	492932
2718H con motores/BRIGGS & STRATTON 20 HP, BRIGGS & STRATTON 16 HP, BRIGGS & STRATTON 18 HP		
ACEITE	GP-58	492932
TRACTOR DE JARDIN con motor/KOHLER K1815		
AIRE	GA-12	231847

MARCA-MODELO-MOTOR GONHER OEM
MAKE-MODEL-ENGINE GONHER OEM

MCCORMICK

TRACTORES

MTX120, MTX135, MTX150 con motor/6.75		
AIRE, PRIMARIO	GA-697R	433893A1
MTX140, MTX110, MTX125 con motor/PERKINS 6.0L TURBO		
ACEITE, REQUIERE 2 PIEZAS	GP-31	2254347
MTX155, MTX175 con motor/PERKINS 1006-60 TURBO		
ACEITE, REQUIERE 2 PIEZAS	GP-31	2254347

MERCEDES BENZ

CAMIONES, TRACTOCAMIONES Y AUTOBUSES

1013 con motor/MERCEDES BENZ OM355		
ACEITE, HASTA 3/78	G-31	1846725
COMBUSTIBLE	G-1121F	3524700092
COMBUSTIBLE	G-1123F	4220900051
DIRECCION	G-162H	4660604
ACEITE, 4/78 EN ADELANTE	G-989	11845625
1013 con motores/MERCEDES BENZ OM346, MERCEDES BENZ OM352		
ACEITE, DERIVACION (BY PASS)	G-31	1846725
COMBUSTIBLE	G-1121F	3444777215
COMBUSTIBLE	G-1123F	4220900051
DIRECCION	G-162H	4660604
1017 ATEGO, 1117 ATEGO, 1217 ATEGO, 1317 ATEGO con motor/MERCEDES BENZ OM904LA		
DIRECCION	G-162H	4660604
1017 con motor/MERCEDES BENZ OM352A		
COMBUSTIBLE	G-1121	3524700092
1023 ATEGO, 1223 ATEGO, 1225 ATEGO, 1228 ATEGO, 1325 ATEGO, 1328 ATEGO, 1523 ATEGO, 1528 ATEGO, 2523 ATEGO, 2528 ATEGO, 2628 ATEGO con motor/MERCEDES BENZ OM906LA		
DIRECCION	G-162H	4660604
1113 con motor/MERCEDES BENZ OM346		
ACEITE, DERIVACION (BY PASS)	G-31	1846725
COMBUSTIBLE	G-1121F	3524700092
COMBUSTIBLE	G-1123F	4220900051
DIRECCION	G-162H	4660604
1113 con motor/MERCEDES BENZ OM352		
ACEITE	G-31	1846725
COMBUSTIBLE	G-1121F	3444777215
COMBUSTIBLE	G-1123F	4220900051
DIRECCION	G-162H	4660604
1113, 1213, 1313, 1317, 1319 con motor/MERCEDES BENZ OM355		
ACEITE, HASTA 3/78	G-31	1846725
COMBUSTIBLE	G-1121F	3524700092
COMBUSTIBLE	G-1123F	4220900051
DIRECCION	G-162H	4660604
ACEITE, 4/78 EN ADELANTE	G-989	11845625
1114 con motor/MERCEDES BENZ OM366		
COMBUSTIBLE	G-1121F	3524700092
1117 con motor/MERCEDES BENZ OM366A		
COMBUSTIBLE	G-1121F	3524700092
1120 con motor/MERCEDES BENZ OM366LA		
COMBUSTIBLE	G-1121F	3524700092

MARCA-MODELO-MOTOR GONHER OEM
MAKE-MODEL-ENGINE GONHER OEM

MERCEDES BENZ (continuación)

CAMIONES, TRACTOCAMIONES Y AUTOBUSES

1124 con motor/MERCEDES BENZ OM366LA		
COMBUSTIBLE	G-1121	3444777215
COMBUSTIBLE	G-1121F	3444777215
DIRECCION	G-162H	4660604
1213 con motor/MERCEDES BENZ OM346		
ACEITE, DERIVACION (BY PASS)	G-31	1846725
COMBUSTIBLE	G-1121F	3524700092
COMBUSTIBLE	G-1123F	4220900051
DIRECCION	G-162H	4660604
1213 con motor/MERCEDES BENZ OM352		
ACEITE, DERIVACION (BY PASS)	G-31	1846725
COMBUSTIBLE	G-1121F	3444777215
COMBUSTIBLE	G-1123F	4220900051
DIRECCION	G-162H	4660604
1217 con motor/MERCEDES BENZ OM352A		
COMBUSTIBLE	G-1121	3524700092
1218 con motores/MERCEDES BENZ OM366A, MERCEDES BENZ OM906		
AIRE	GA-864R	A6345280306
1219 con motor/MERCEDES BENZ OM401		
COMBUSTIBLE	G-1121F	3524700092
1222 con motores/MERCEDES BENZ OM421, MERCEDES BENZ OM441		
ACEITE	G-143	4031840025
COMBUSTIBLE	G-1123F	4220900051
DIRECCION	G-162H	4660604
1224 con motor/MERCEDES BENZ OM366LA		
COMBUSTIBLE	G-1121	3444777215
COMBUSTIBLE	G-1121F	3444777215
DIRECCION	G-162H	4660604
1313 con motores/MERCEDES BENZ OM346, MERCEDES BENZ OM352		
ACEITE	G-31	1846725
COMBUSTIBLE	G-1121F	3444777215
COMBUSTIBLE	G-1123F	4220900051
DIRECCION	G-162H	4660604
1314 con motor/MERCEDES BENZ OM366		
COMBUSTIBLE	G-1121F	3524700092
1317 con motor/MERCEDES BENZ OM346		
ACEITE, DERIVACION (BY PASS)	G-31	1846725
COMBUSTIBLE	G-1121F	3524700092
COMBUSTIBLE	G-1123F	4220900051
DIRECCION	G-162H	4660604
1317 con motor/MERCEDES BENZ OM366A		
COMBUSTIBLE	G-1121F	3524700092
1317, 1319 con motor/MERCEDES BENZ OM352		
ACEITE	G-31	1846725
COMBUSTIBLE	G-1121F	3524700092
COMBUSTIBLE	G-1123F	4220900051
DIRECCION	G-162H	4660604
1319 con motor/MERCEDES BENZ OM360		
ACEITE, DERIVACION (BY PASS)	G-31	1846725
COMBUSTIBLE	G-1123F	4220900051

SERVICIO PESADO

MARCA-MODELO-MOTOR MAKE-MODEL-ENGINE	GONHER GONHER	OEM OEM	MARCA-MODELO-MOTOR MAKE-MODEL-ENGINE	GONHER GONHER	OEM OEM	MARCA-MODELO-MOTOR MAKE-MODEL-ENGINE	GONHER GONHER	OEM OEM
MERCEDES BENZ (continuación)			MERCEDES BENZ (continuación)			MERCEDES BENZ (continuación)		
CAMIONES, TRACTOCAMIONES Y AUTOBUSES			CAMIONES, TRACTOCAMIONES Y AUTOBUSES			CAMIONES, TRACTOCAMIONES Y AUTOBUSES		
DIRECCION	G-162H	4660604	1420 con motor/MERCEDES BENZ OM366LA			DIRECCION	G-162H	4660604
1319 con motores/MERCEDES BENZ 190E, MERCEDES BENZ OM366LA			COMBUSTIBLE	G-1121F	3524700092	1517 con motor/MERCEDES BENZ OM352		
ACEITE	GP-88	31841701	1422 con motor/MERCEDES BENZ OM421			ACEITE	G-31	1846725
1320 con motor/MERCEDES BENZ OM366LA			ACEITE	G-143	4031840025	COMBUSTIBLE	G-1121F	3524700092
COMBUSTIBLE	G-1121F	3524700092	COMBUSTIBLE	G-1123F	4220900051	COMBUSTIBLE	G-1123F	4220900051
1324 con motor/MERCEDES BENZ OM366LA (1990)			DIRECCION	G-162H	4660604	DIRECCION	G-162H	4660604
COMBUSTIBLE	G-1121F	3524700092	1422 con motor/MERCEDES BENZ OM441			1517 con motor/MERCEDES BENZ OM366A		
1413 con motor/MERCEDES BENZ OM346			COMBUSTIBLE	G-1123F	4220900051	COMBUSTIBLE	G-1121F	3524700092
ACEITE, DERIVACION (BY PASS)	G-31	1846725	1424 con motor/MERCEDES BENZ OM355			1518 con motor/MERCEDES BENZ OM346		
COMBUSTIBLE	G-1121F	3444777215	ACEITE, HASTA 4/78	G-31	1846725	ACEITE, DERIVACION (BY PASS)	G-31	1846725
COMBUSTIBLE	G-1123F	4220900051	COMBUSTIBLE	G-1123F	4220900051	COMBUSTIBLE	G-1121F	3524700092
DIRECCION	G-162H	4660604	DIRECCION	G-162H	4660604	COMBUSTIBLE	G-1123F	4220900051
1413 con motor/MERCEDES BENZ OM352			ACEITE, 4/78 EN ADELANTE	G-989	11845625	DIRECCION	G-162H	4660604
ACEITE	G-31	1846725	1424 con motor/MERCEDES BENZ OM402			1518 con motor/MERCEDES BENZ OM352		
COMBUSTIBLE	G-1121F	3444777215	ACEITE	G-143	4031840025	ACEITE	G-31	1846725
COMBUSTIBLE	G-1123F	4220900051	1425 con motor/MERCEDES BENZ OM422			COMBUSTIBLE	G-1121F	3524700092
DIRECCION	G-162H	4660604	ACEITE, FLUJO TOTAL (FULL FLOW)	G-143	4031840025	COMBUSTIBLE	G-1123F	4220900051
1413 con motor/MERCEDES BENZ OM355			COMBUSTIBLE	G-1121F	3524700092	DIRECCION	G-162H	4660604
ACEITE, HASTA 3/78	G-31	1846725	COMBUSTIBLE	G-1123F	4220900051	1519 con motor/MERCEDES BENZ OM346		
COMBUSTIBLE	G-1121F	3444777215	DIRECCION	G-162H	4660604	ACEITE, DERIVACION (BY PASS)	G-31	1846725
COMBUSTIBLE	G-1123F	4220900051	1426 con motor/MERCEDES BENZ OM442			COMBUSTIBLE	G-1121F	3524700092
DIRECCION	G-162H	4660604	ACEITE	G-143	4031840025	COMBUSTIBLE	G-1123F	4220900051
ACEITE, 4/78 EN ADELANTE	G-989	11845625	COMBUSTIBLE	G-1123F	4220900051	DIRECCION	G-162H	4660604
1414 con motor/MERCEDES BENZ OM366			DIRECCION	G-162H	4660604	1519 con motor/MERCEDES BENZ OM352		
COMBUSTIBLE	G-1121F	3524700092	1427 con motor/MERCEDES BENZ OM401LA			ACEITE	G-31	1846725
1417 con motor/MERCEDES BENZ OM366A			COMBUSTIBLE	G-1121	3444777215	COMBUSTIBLE	G-1121F	3524700092
COMBUSTIBLE	G-1121F	3524700092	COMBUSTIBLE	G-1121F	3444777215	COMBUSTIBLE	G-1123F	4220900051
1418 con motor/MERCEDES BENZ OM346			DIRECCION	G-162H	4660604	DIRECCION	G-162H	4660604
ACEITE, DERIVACION (BY PASS)	G-31	1846725	1513 con motor/MERCEDES BENZ OM346			1520 con motor/MERCEDES BENZ OM366LA		
COMBUSTIBLE	G-1121F	3524700092	ACEITE, DERIVACION (BY PASS)	G-31	1846725	COMBUSTIBLE	G-1121F	3524700092
COMBUSTIBLE	G-1123F	4220900051	COMBUSTIBLE	G-1121F	3444777215	1524 con motor/MERCEDES BENZ OM366LA		
DIRECCION	G-162H	46606604	COMBUSTIBLE	G-1123F	4220900051	COMBUSTIBLE	G-1121F	3524700092
1418 con motor/MERCEDES BENZ OM352			DIRECCION	G-162H	4660604	1613 con motor/MERCEDES BENZ OM346		
ACEITE	G-31	1846725	1513 con motor/MERCEDES BENZ OM352			ACEITE	G-31	1846725
COMBUSTIBLE	G-1121F	3524700092	ACEITE	G-31	1846725	COMBUSTIBLE	G-1121F	3524700092
COMBUSTIBLE	G-1123F	4220900051	COMBUSTIBLE	G-1121F	3444777215	COMBUSTIBLE	G-1121F	3524700092
DIRECCION	G-162H	4660604	COMBUSTIBLE	G-1123F	4220900051	DIRECCION	G-162H	4660604
1418 con motor/MERCEDES BENZ OM355			DIRECCION	G-162H	4660604	1613 con motor/MERCEDES BENZ OM352 (DESDE 1978)		
ACEITE, HASTA 3/78	G-31	1846725	1513 con motor/MERCEDES BENZ OM352			COMBUSTIBLE	G-1121	3444777215
COMBUSTIBLE	G-1121F	3524700092	ACEITE, HASTA 4/78	G-31	1846725	COMBUSTIBLE	G-1121F	3444777215
COMBUSTIBLE	G-1123F	4220900051	COMBUSTIBLE	G-1121F	3524700092	DIRECCION	G-162H	4660604
DIRECCION	G-162H	4660604	COMBUSTIBLE	G-1123F	4220900051	1613 con motor/MERCEDES BENZ OM352 (HASTA 1977)		
ACEITE, 4/78 EN ADELANTE	G-989	11845625	DIRECCION	G-162H	4660604	ACEITE	G-31	1846725
1419 con motor/MERCEDES BENZ OM362LA			ACEITE, 4/78 EN ADELANTE	G-989	11845625	1614 con motor/MERCEDES BENZ OM366		
COMBUSTIBLE	G-1121F	3524700092	1514 con motor/MERCEDES BENZ OM366			COMBUSTIBLE	G-1121F	3524700092
1419 con motor/MERCEDES BENZ OM366			ACEITE	G-143	4031840025	1617 con motor/MERCEDES BENZ OM366A		
COMBUSTIBLE	G-1121F	922705	COMBUSTIBLE	G-1121F	3524700092	COMBUSTIBLE	G-1121F	3524700092
1419 con motor/MERCEDES BENZ OM401			DIRECCION	G-162H	4660604	1619 con motor/MERCEDES BENZ OM346		
COMBUSTIBLE	G-1121F	3524700092	1517 con motor/MERCEDES BENZ OM346			ACEITE, DERIVACION (BY PASS)	G-31	1846725
			ACEITE, DERIVACION (BY PASS)	G-31	1846725	COMBUSTIBLE	G-1121F	3524700092
			COMBUSTIBLE	G-1121F	3524700092			
			COMBUSTIBLE	G-1123F	4220900051			

MARCA-MODELO-MOTOR MAKE-MODEL-ENGINE	GONHER GONHER	OEM OEM	MARCA-MODELO-MOTOR MAKE-MODEL-ENGINE	GONHER GONHER	OEM OEM	MARCA-MODELO-MOTOR MAKE-MODEL-ENGINE	GONHER GONHER	OEM OEM
MERCEDES BENZ (continuación)			MERCEDES BENZ (continuación)			MERCEDES BENZ (continuación)		
CAMIONES, TRACTOCAMIONES Y AUTOBUSES			CAMIONES, TRACTOCAMIONES Y AUTOBUSES			CAMIONES, TRACTOCAMIONES Y AUTOBUSES		
COMBUSTIBLE	G-1123F	4220900051	DIRECCION	G-162H	4660604	1633 con motor/MERCEDES BENZ OM422A		
DIRECCION	G-162H	4660604	ACEITE, 3/78 EN ADELANTE	G-989	3551800009	ACEITE	G-143	4031840025
1619 con motor/MERCEDES BENZ OM352			1622 con motor/MERCEDES BENZ OM421			COMBUSTIBLE	G-1123F	4220900051
ACEITE	G-31	1846725	ACEITE	G-143	4031840025	DIRECCION	G-162H	4660604
COMBUSTIBLE	G-1121F	3524700092	COMBUSTIBLE	G-1123F	4220900051	1635 con motores/MERCEDES BENZ OM442A, MERCEDES BENZ OM442LA		
COMBUSTIBLE	G-1123F	4220900051	DIRECCION	G-162H	1902137	COMBUSTIBLE	G-1123	4220900051
DIRECCION	G-162H	4660604	1622 con motor/MERCEDES BENZ OM441			ACEITE	G-143	4021800009
1619 con motor/MERCEDES BENZ OM355			COMBUSTIBLE	G-1123F	4220900051	COMBUSTIBLE	G-1123F	4220900051
ACEITE, HASTA 4/78	G-31	1846725	1623 con motor/MERCEDES BENZ OM346			DIRECCION	G-162H	4660604
COMBUSTIBLE	G-1121F	3524700092	ACEITE, DERIVACION (BY PASS)	G-31	1846725	AIRE, PRIMARIO	GA-467	30941504
COMBUSTIBLE	G-1123F	4220900051	COMBUSTIBLE	G-1121F	3524700092	1636 con motor/MERCEDES BENZ OM423		
DIRECCION	G-162H	4660604	COMBUSTIBLE	G-1123F	4220900051	ACEITE	G-143	4031840025
ACEITE, 4/78 EN ADELANTE	G-989	11845625	DIRECCION	G-162H	4660604	COMBUSTIBLE	G-1123F	4220900051
1619 con motor/MERCEDES BENZ OM360			1623 con motor/MERCEDES BENZ OM352			DIRECCION	G-162H	4660604
ACEITE, DERIVACION (BY PASS)	G-31	1846725	ACEITE	G-31	1846725	1638 con motor/MERCEDES BENZ OM422LA		
COMBUSTIBLE	G-1123F	4220900051	COMBUSTIBLE	G-1121F	3524700092	ACEITE	G-143	4021800009
DIRECCION	G-162H	4660604	COMBUSTIBLE	G-1123F	4220900051	COMBUSTIBLE	G-1123F	4220900051
1619 con motor/MERCEDES BENZ OM362LA			DIRECCION	G-162H	4660604	DIRECCION	G-162H	4660604
COMBUSTIBLE	G-1121F	3524700092	1623 con motor/MERCEDES BENZ OM355			1644 con motor/MERCEDES BENZ OM442LA		
1619 con motor/MERCEDES BENZ OM401			ACEITE, HASTA 4/78	G-31	1846725	ACEITE	G-143	4031840025
COMBUSTIBLE	G-1121F	3524700092	COMBUSTIBLE	G-1121F	3524700092	COMBUSTIBLE	G-1121F	3524700092
1620 con motor/MERCEDES BENZ OM346			COMBUSTIBLE	G-1123F	4220900051	DIRECCION	G-162H	4660604
ACEITE, DERIVACION (BY PASS)	G-31	1846725	DIRECCION	G-162H	4660604	AIRE	GA-467	30941504
COMBUSTIBLE	G-1121F	3524700092	ACEITE, 4/78 EN ADELANTE	G-989	11845625	1717 con motor/MERCEDES BENZ OM366A		
COMBUSTIBLE	G-1123F	4220900051	1624 con motor/MERCEDES BENZ OM355			COMBUSTIBLE	G-1121F	3524700092
DIRECCION	G-162H	4660604	ACEITE, HASTA 4/78	G-31	1846725	1719 con motor/MERCEDES BENZ OM401		
1620 con motor/MERCEDES BENZ OM352			COMBUSTIBLE	G-1123F	4220900051	COMBUSTIBLE	G-1121F	3524700092
ACEITE	G-31	1846725	DIRECCION	G-162H	4660604	1720 con motor/MERCEDES BENZ OM366LA		
COMBUSTIBLE	G-1121F	3524700092	ACEITE, 4/78 EN ADELANTE	G-989	11845625	COMBUSTIBLE	G-1121F	3524700092
COMBUSTIBLE	G-1123F	4220900051	1624 con motor/MERCEDES BENZ OM402			1722SK con motor/MERCEDES BENZ OM441		
DIRECCION	G-162H	4660604	ACEITE	G-143	4031840025	COMBUSTIBLE	G-1123F	4220900051
1620 con motor/MERCEDES BENZ OM355			1625 con motor/MERCEDES BENZ OM422			1726 con motor/MERCEDES BENZ OM442		
ACEITE, HASTA 4/78	G-31	1846725	ACEITE, FLUJO TOTAL (FULL FLOW)	G-143	4031840025	ACEITE	G-143	4031840025
COMBUSTIBLE	G-1121F	3444777215	COMBUSTIBLE	G-1121F	3524700092	COMBUSTIBLE	G-1123F	4220900051
COMBUSTIBLE	G-1123F	4220900051	COMBUSTIBLE	G-1123F	4220900051	DIRECCION	G-162H	1902137
DIRECCION	G-162H	4660604	DIRECCION	G-162H	4660604	1729 con motor/MERCEDES BENZ OM442		
ACEITE, 4/78 EN ADELANTE	G-989	3551800009	1626 con motores/MERCEDES BENZ OM402, MERCEDES BENZ OM403			ACEITE	G-143	4021800009
1620 con motor/MERCEDES BENZ OM366LA			ACEITE	G-143	4031840025	COMBUSTIBLE	G-1123F	4220900051
COMBUSTIBLE	G-1121F	3524700092	COMBUSTIBLE	G-1121F	3524700092	DIRECCION	G-162H	4660604
1621 con motor/MERCEDES BENZ OM346			COMBUSTIBLE	G-1123F	4220900051	1733 con motor/MERCEDES BENZ OM441LA (1988)		
ACEITE, DERIVACION (BY PASS)	G-31	1846725	1628 con motor/MERCEDES BENZ OM422			COMBUSTIBLE	G-1123F	4220900051
COMBUSTIBLE	G-1121F	3524700092	ACEITE	G-143	4021800009	DIRECCION	G-162H	4660604
COMBUSTIBLE	G-1123F	4220900051	COMBUSTIBLE	G-1121F	3524700092	AIRE	GA-467	30941504
DIRECCION	G-162H	4660604	DIRECCION	G-1123F	4220900051	1735 con motores/MERCEDES BENZ OM442A, MERCEDES BENZ OM442LA		
1621 con motor/MERCEDES BENZ OM352			1632 con motor/MERCEDES BENZ OM403			ACEITE	G-143	4021800009
ACEITE	G-31	1846725	ACEITE, FLUJO TOTAL (FULL FLOW)	G-143	4013840025	COMBUSTIBLE	G-1123F	4220900051
COMBUSTIBLE	G-1121F	3524700092	COMBUSTIBLE	G-1121F	3524700092	DIRECCION	G-162H	1902137
COMBUSTIBLE	G-1123F	4220900051	DIRECCION	G-162H	4660604	AIRE	GA-467	30941504
DIRECCION	G-162H	4660604	1632 con motor/MERCEDES BENZ OM403			1748 con motor/MERCEDES BENZ OM442A		
1621 con motor/MERCEDES BENZ OM355			ACEITE, FLUJO TOTAL (FULL FLOW)	G-143	4013840025	ACEITE	G-143	4021800009
ACEITE, HASTA 3/78	G-31	1846725	COMBUSTIBLE	G-1121F	3524700092	COMBUSTIBLE	G-1121F	3524700092
COMBUSTIBLE	G-1121F	3524700092	COMBUSTIBLE	G-1123F	4220900051			
COMBUSTIBLE	G-1123F	4220900051						

SERVICIO PESADO

MARCA-MODELO-MOTOR MAKE-MODEL-ENGINE	GONHER GONHER	OEM OEM	MARCA-MODELO-MOTOR MAKE-MODEL-ENGINE	GONHER GONHER	OEM OEM	MARCA-MODELO-MOTOR MAKE-MODEL-ENGINE	GONHER GONHER	OEM OEM
MERCEDES BENZ (continuación)			MERCEDES BENZ (continuación)			MERCEDES BENZ (continuación)		
CAMIONES, TRACTOCAMIONES Y AUTOBUSES			CAMIONES, TRACTOCAMIONES Y AUTOBUSES			CAMIONES, TRACTOCAMIONES Y AUTOBUSES		
DIRECCION	G-162H	4660604	1831 con motor/MERCEDES BENZ OM501LA			1853 ACTROS, 1857 ACTROS con motor/MERCEDES BENZ OM502LA		
AIRE, PRIMARIO	GA-467	30941504	DIRECCION	G-162H	1902137	DIRECCION	G-162H	1902137
1748 con motor/MERCEDES BENZ OM442LA			1833-CP con motor/MERCEDES BENZ OM926			1853 con motor/MERCEDES BENZ OM442LA		
ACEITE	G-143	1843825	HIDRAULICO	G-162H	A 000 466 06 04	COMBUSTIBLE	G-1123F	4220900051
1748 con motor/MERCEDES BENZ OM442LA (1990 EN ADELANTE)			ACEITE, FLUJO TOTAL (FULL FLOW)	G-3754	A0001801709	1919, 2219 con motor/MERCEDES BENZ OM401		
COMBUSTIBLE	G-1121	3444777215	DIESEL, CARTUCHO	G-1046	A9060920305	COMBUSTIBLE	G-1121F	3524700092
COMBUSTIBLE	G-1121F	3444777215	COMBUSTIBLE, SEPARADOR DE AGUA	GPP-1060	9794770015	1921 con motor/MERCEDES BENZ OM346		
DIRECCION	G-162H	4660604	COMBUSTIBLE, SEPARADOR DE AGUA	GPP-1061	WK 1060/1	ACEITE, DERIVACION	G-31	1846725
1813 con motor/MERCEDES BENZ OM346			1834 con motor/MERCEDES BENZ OM441LA			COMBUSTIBLE	G-1121F	3524700092
ACEITE, DERIVACION (BY PASS)	G-31	1846725	COMBUSTIBLE	G-1121F	4220900051	COMBUSTIBLE	G-1123F	4220900051
COMBUSTIBLE	G-1121F	3444777215	1835 ACTROS, 1840 ACTROS, 1843 ACTROS con motor/MERCEDES BENZ OM501LA			DIRECCION	G-162H	4660604
COMBUSTIBLE	G-1123F	4220900051	DIRECCION	G-162H	11842225	1921 con motor/MERCEDES BENZ OM352		
DIRECCION	G-162H	4660604	1835 con motor/MERCEDES BENZ OM501LA			ACEITE, HASTA 1978	G-31	1846725
1813 con motor/MERCEDES BENZ OM352			DIRECCION	G-162H	4660604	COMBUSTIBLE	G-1121F	3524700092
ACEITE	G-31	1846725	1838 con motor/MERCEDES BENZ OM402LA			COMBUSTIBLE	G-1123F	4220900051
COMBUSTIBLE	G-1121F	3444777215	COMBUSTIBLE	G-1121F	3524700092	DIRECCION	G-162H	4660604
COMBUSTIBLE	G-1123F	4220900051	1840 con motor/MERCEDES BENZ OM402			ACEITE, 3/78 EN ADELANTE	G-989	3551800009
DIRECCION	G-162H	4660604	COMBUSTIBLE	G-1121F	3524700092	1922 con motor/MERCEDES BENZ OM421		
ACEITE, HASTA 4/78	G-989	11845625	1840 con motor/MERCEDES BENZ OM402LA			ACEITE	G-143	4031840025
1819 con motor/MERCEDES BENZ OM346			COMBUSTIBLE	G-1121F	3444777215	COMBUSTIBLE	G-1123F	4220900051
ACEITE, DERIVACION (BY PASS)	G-31	1846725	1840 con motor/MERCEDES BENZ OM442LA			DIRECCION	G-162H	1902137
COMBUSTIBLE	G-1121F	3524700092	COMBUSTIBLE	G-1121	3524700092	1922 con motor/MERCEDES BENZ OM441		
COMBUSTIBLE	G-1123F	4220900051	COMBUSTIBLE	G-1121F	3524700092	COMBUSTIBLE	G-1123F	4220900051
DIRECCION	G-162H	4660604	AIRE	GA-467	30941504	1922SK con motor/MERCEDES BENZ OM441		
1819 con motor/MERCEDES BENZ OM352			1840, 1843 con motor/MERCEDES BENZ OM501LA			COMBUSTIBLE	G-1123F	4220900051
ACEITE, HASTA 1977	G-31	1846725	DIRECCION	G-162H	4660604	1923 con motor/MERCEDES BENZ OM346		
COMBUSTIBLE	G-1121F	3524700092	1844 con motor/MERCEDES BENZ OM442LA			ACEITE, DERIVACION	G-31	1846725
COMBUSTIBLE	G-1123F	4220900051	ACEITE, HASTA 8/90	G-143	4031840025	COMBUSTIBLE	G-1121F	3524700092
DIRECCION	G-162H	4660604	COMBUSTIBLE	G-1121F	3524700092	COMBUSTIBLE	G-1123F	4220900051
ACEITE, 4/78 EN ADELANTE	G-989	11845625	DIRECCION	G-162H	4660604	DIRECCION	G-162H	4660604
1819 con motor/MERCEDES BENZ OM352			AIRE, S/N 5343252 EN ADELANTE	GA-467	30941504	1923 con motor/MERCEDES BENZ OM352		
ACEITE, HASTA 4/78	G-31	1846725	1846 ACTROS con motor/MERCEDES BENZ OM501LA			ACEITE, HASTA 1978	G-31	1846725
COMBUSTIBLE	G-1121F	3524700092	DIRECCION	G-162H	1902137	COMBUSTIBLE	G-1121F	3524700092
COMBUSTIBLE	G-1123F	4220900051	1848 ACTROS con motor/MERCEDES BENZ OM502LA			COMBUSTIBLE	G-1123F	4220900051
DIRECCION	G-162H	4660604	DIRECCION	G-162H	11842225	DIRECCION	G-162H	4660604
ACEITE, 4/78 EN ADELANTE	G-989	11845625	1850 con motor/MERCEDES BENZ OM402			1923 con motor/MERCEDES BENZ OM355		
1819 con motor/MERCEDES BENZ OM360			COMBUSTIBLE	G-1121F	3524700092	ACEITE, HASTA 4/78	G-31	1846725
ACEITE, DERIVACION (BY PASS)	G-31	1846725	1850 con motor/MERCEDES BENZ OM402LA			COMBUSTIBLE	G-1121F	3524700092
COMBUSTIBLE	G-1123F	4220900051	COMBUSTIBLE	G-1121F	3444777215	COMBUSTIBLE	G-1123F	4220900051
DIRECCION	G-162H	4660604	1850 con motor/MERCEDES BENZ OM442LA			DIRECCION	G-162H	4660604
1820 con motor/MERCEDES BENZ OM366LA			COMBUSTIBLE	G-1121	3524700092	ACEITE, 4/78 EN ADELANTE	G-989	11845625
COMBUSTIBLE	G-1121F	3524700092	COMBUSTIBLE	G-1121F	3524700092	1924 con motor/MERCEDES BENZ OM355		
1821 con motor/MERCEDES BENZ OM366A			DIRECCION	G-162H	4660604	ACEITE, HASTA 4/78	G-31	1846725
COMBUSTIBLE	G-1121F	3524700092	AIRE	GA-467	30941504	COMBUSTIBLE	G-1123F	4220900051
1827 con motor/MERCEDES BENZ OM401A			1850 con motor/MERCEDES BENZ OM442LA			DIRECCION	G-162H	4660604
COMBUSTIBLE	G-1123F	4220900051	COMBUSTIBLE	G-1121	3524700092	ACEITE, 4/78 EN ADELANTE	G-989	11845625
1827, 1831 con motor/MERCEDES BENZ OM401LA			COMBUSTIBLE	G-1121F	3524700092			
COMBUSTIBLE	G-1121F	3524700092	DIRECCION	G-162H	4660604			

MARCA-MODELO-MOTOR GONHER OEM
MAKE-MODEL-ENGINE GONHER OEM

MARCA-MODELO-MOTOR GONHER OEM
MAKE-MODEL-ENGINE GONHER OEM

MARCA-MODELO-MOTOR GONHER OEM
MAKE-MODEL-ENGINE GONHER OEM

MERCEDES BENZ (continuación)

MERCEDES BENZ (continuación)

MERCEDES BENZ (continuación)

CAMIONES, TRACTOCAMIONES Y AUTOBUSES

CAMIONES, TRACTOCAMIONES Y AUTOBUSES

CAMIONES, TRACTOCAMIONES Y AUTOBUSES

1926 con motores/MERCEDES BENZ OM402, MERCEDES BENZ OM403		
ACEITE	G-143	4031840025
COMBUSTIBLE	G-1121F	3524700092
COMBUSTIBLE	G-1123F	4220900051
1928 con motor/MERCEDES BENZ OM422		
ACEITE	G-143	4021800009
COMBUSTIBLE, HASTA 7/82	G-1121F	3524700092
COMBUSTIBLE, 7/82 EN ADELANTE	G-1123F	4220900051
DIRECCION	G-162H	4660604
1929 con motor/MERCEDES BENZ OM442		
ACEITE, HASTA 8/90	G-143	4021800009
COMBUSTIBLE	G-1123F	4220900051
DIRECCION	G-162H	4660604
1932 con motor/MERCEDES BENZ OM403 SERIES		
ACEITE	G-143	4031840025
COMBUSTIBLE	G-1121F	3524700092
COMBUSTIBLE	G-1123F	4220900051
1933 con motor/MERCEDES BENZ OM422A		
ACEITE	G-143	4031840025
COMBUSTIBLE	G-1123F	4220900051
DIRECCION	G-162H	4660604
1933 con motor/MERCEDES BENZ OM441LA (1988)		
COMBUSTIBLE	G-1123F	4220900051
DIRECCION	G-162H	1902137
AIRE	GA-467	30941504
1935 con motores/MERCEDES BENZ OM442A, MERCEDES BENZ OM442LA		
ACEITE, HASTA 8/90	G-143	4021800009
COMBUSTIBLE	G-1123F	4220900051
DIRECCION	G-162H	1902137
AIRE, PRIMARIO	GA-467	30941504
1936 con motor/MERCEDES BENZ OM423		
ACEITE	G-143	4031840025
COMBUSTIBLE	G-1123F	4220900051
DIRECCION	G-162H	1902137
1938 con motor/MERCEDES BENZ OM422LA		
ACEITE	G-143	4021800009
COMBUSTIBLE	G-1123F	4220900051
DIRECCION	G-162H	4660604
1940 con motores/MERCEDES BENZ OM402, MERCEDES BENZ OM442LA		
COMBUSTIBLE	G-1121F	3524700092
1943 ACTROS, 2546 ACTROS, 2031K ACTROS, 2035A ACTROS, 2040K ACTROS, 2046 ACTROS con motor/MERCEDES BENZ OM501LA		
DIRECCION	G-162H	4660604
1944 con motor/MERCEDES BENZ OM442LA		
ACEITE, HASTA 8/90	G-143	4031840025
COMBUSTIBLE	G-1121F	3524700092
DIRECCION	G-162H	4660604
AIRE	GA-467	30941504
1948 con motor/MERCEDES BENZ OM442A		
ACEITE, HASTA 8/90	G-143	4021800009
COMBUSTIBLE	G-1121F	3524700092

DIRECCION	G-162H	4660604
AIRE, PRIMARIO	GA-467	30941504
2020 con motor/MERCEDES BENZ OM346		
ACEITE, DERIVACION	G-31	1846725
COMBUSTIBLE	G-1121F	3524700092
COMBUSTIBLE	G-1123F	4220900051
DIRECCION	G-162H	4660604
2020 con motor/MERCEDES BENZ OM352		
ACEITE, HASTA 1978	G-31	1846725
COMBUSTIBLE	G-1121F	3524700092
COMBUSTIBLE	G-1123F	4220900051
DIRECCION	G-162H	4660604
2020 con motor/MERCEDES BENZ OM355		
ACEITE, HASTA 4/78	G-31	1846725
COMBUSTIBLE	G-1121F	3524700092
COMBUSTIBLE	G-1123F	4220900051
DIRECCION	G-162H	4660604
ACEITE, 4/78 EN ADELANTE	G-989	3551800009
2023 con motor/MERCEDES BENZ OM346		
ACEITE, DERIVACION	G-31	1846725
COMBUSTIBLE	G-1121F	3524700092
COMBUSTIBLE	G-1123F	4220900051
DIRECCION	G-162H	4660604
2023 con motor/MERCEDES BENZ OM352		
ACEITE, HASTA 1978	G-31	1846725
COMBUSTIBLE	G-1121F	3524700092
COMBUSTIBLE	G-1123F	4220900051
DIRECCION	G-162H	4660604
2023 con motor/MERCEDES BENZ OM355		
ACEITE, HASTA 4/78	G-31	1846725
COMBUSTIBLE	G-1121F	3524700092
COMBUSTIBLE	G-1123F	4220900051
DIRECCION	G-162H	4660604
ACEITE, 4/78 EN ADELANTE	G-989	11845625
2024 con motor/MERCEDES BENZ OM355		
ACEITE, HASTA 4/78	G-31	1846725
COMBUSTIBLE	G-1123F	4220900051
DIRECCION	G-162H	4660604
ACEITE, 4/78 EN ADELANTE	G-989	11845625
2025 con motor/MERCEDES BENZ OM422		
ACEITE, FLUJO TOTAL (FULL FLOW)	G-143	4031840025
COMBUSTIBLE, HASTA 7/82	G-1121F	3524700092
COMBUSTIBLE, 7/82 EN ADELANTE	G-1123F	4220900051
DIRECCION	G-162H	4660604
2026 con motor/MERCEDES BENZ OM402		
ACEITE	G-143	4031840025
2028 con motor/MERCEDES BENZ OM422		
ACEITE	G-143	4021800009
COMBUSTIBLE, HASTA 7/82	G-1121F	3524700092
COMBUSTIBLE, 7/82 EN ADELANTE	G-1123F	4220900051
DIRECCION	G-162H	4660604

2028 LS (6x2), 2028 LS (6x4), 2033 LS (6x2), 2033 LS (6x4) con motor/MERCEDES BENZ OM422A		
ACEITE	G-143	4021800009
COMBUSTIBLE	G-1123F	4220900051
DIRECCION	G-162H	4660604
2032 con motor/MERCEDES BENZ OM403		
COMBUSTIBLE	G-1121	3524700092
2033 con motor/MERCEDES BENZ OM422A		
ACEITE	G-143	4031840025
COMBUSTIBLE	G-1123F	4220900051
DIRECCION	G-162H	4660604
2035 con motores/MERCEDES BENZ OM442A, MERCEDES BENZ OM442LA		
ACEITE, HASTA 8/90	G-143	4021800009
COMBUSTIBLE, 8/990 EN ADELANTE	G-1123F	4220900051
DIRECCION	G-162H	1902137
AIRE, PRIMARIO	GA-467	30941504
2036 con motor/MERCEDES BENZ OM423		
ACEITE	G-143	4031840025
COMBUSTIBLE	G-1123F	4220900051
DIRECCION	G-162H	1902137
2038 con motor/MERCEDES BENZ OM402LA		
COMBUSTIBLE	G-1121F	3444777215
2044 con motor/MERCEDES BENZ OM442LA		
ACEITE, HASTA 8/90	G-143	4031840025
COMBUSTIBLE	G-1121F	3524700092
DIRECCION	G-162H	4660604
AIRE	GA-467	30941504
2050 con motores/MERCEDES BENZ OM402, MERCEDES BENZ OM442LA		
COMBUSTIBLE	G-1121F	3524700092
2053S ACTROS con motor/MERCEDES BENZ OM502LA		
DIRECCION	G-162H	4660604
206D con motor/A DIESEL		
COMBUSTIBLE	G-1121	3444777215
2219 con motor/MERCEDES BENZ OM360		
ACEITE, DERIVACION	G-31	1846725
COMBUSTIBLE	G-1123F	4220900051
DIRECCION	G-162H	4660604
2219 con motor/MERCEDES BENZ OM362LA		
COMBUSTIBLE	G-1121F	3524700092
2220 con motor/MERCEDES BENZ OM346		
ACEITE, DERIVACION	G-31	1846725
COMBUSTIBLE	G-1121F	3524700092
COMBUSTIBLE	G-1123F	4220900051
DIRECCION	G-162H	4660604
2220 con motor/MERCEDES BENZ OM352		
ACEITE, HASTA 1978	G-31	1846725
COMBUSTIBLE	G-1121F	3524700092
COMBUSTIBLE	G-1123F	4220900051
DIRECCION	G-162H	4660604

SERVICIO PESADO

MARCA-MODELO-MOTOR MAKE-MODEL-ENGINE	GONHER GONHER	OEM OEM	MARCA-MODELO-MOTOR MAKE-MODEL-ENGINE	GONHER GONHER	OEM OEM	MARCA-MODELO-MOTOR MAKE-MODEL-ENGINE	GONHER GONHER	OEM OEM
MERCEDES BENZ (continuación)			MERCEDES BENZ (continuación)			MERCEDES BENZ (continuación)		
CAMIONES, TRACTOCAMIONES Y AUTOBUSES			CAMIONES, TRACTOCAMIONES Y AUTOBUSES			CAMIONES, TRACTOCAMIONES Y AUTOBUSES		
2220 con motor/MERCEDES BENZ OM355			DIRECCION	G-162H	4660604	2433 con motor/MERCEDES BENZ OM441LA (1988)		
ACEITE, HASTA 4/78	G-31	1846725				COMBUSTIBLE	G-1123F	4220900051
COMBUSTIBLE	G-1121F	3524700092	2232 con motor/MERCEDES BENZ OM403			DIRECCION	G-162H	1902137
COMBUSTIBLE	G-1123F	4220900051	ACEITE, FLUJO TOTAL (FULL FLOW)	G-143	4031840025	AIRE	GA-467	30941504
DIRECCION	G-162H	4660604	COMBUSTIBLE	G-1121F	3524700092	2435 con motores/MERCEDES BENZ OM442A, MERCEDES BENZ OM442LA		
ACEITE, 4/78 EN ADELANTE	G-989	3551800009	COMBUSTIBLE	G-1123F	4220900051	ACEITE, HASTA 8/90	G-143	4021800009
						COMBUSTIBLE	G-1123F	4220900051
2220 con motor/MERCEDES BENZ OM366LA			2233 con motor/MERCEDES BENZ OM422A			DIRECCION	G-162H	1902137
COMBUSTIBLE	G-1121F	3524700092	ACEITE	G-143	4031840025	AIRE, PRIMARIO	GA-467	30941504
			COMBUSTIBLE	G-1123F	4220900051	2440 con motores/MERCEDES BENZ OM442A, MERCEDES BENZ OM442LA		
2222 con motor/MERCEDES BENZ OM421			DIRECCION	G-162H	4660604	AIRE	GA-467	30941504
ACEITE	G-143	4031840025				2448 con motor/MERCEDES BENZ OM442A		
COMBUSTIBLE	G-1123F	4220900051	2235 con motores/MERCEDES BENZ OM442A, MERCEDES BENZ OM442LA			ACEITE, HASTA 8/90	G-143	4021800009
DIRECCION	G-162H	1902137	ACEITE, HASTA 8/90	G-143	4021800009	COMBUSTIBLE	G-1121F	3524700092
			COMBUSTIBLE, 8/90 EN ADELANTE	G-1123F	4220900051	DIRECCION	G-162H	4660604
2222 con motor/MERCEDES BENZ OM441			DIRECCION	G-162H	1902137	AIRE, PRIMARIO	GA-467	30941504
COMBUSTIBLE	G-1123F	4220900051	AIRE, PRIMARIO	GA-467	30941504	2527 con motor/MERCEDES BENZ OM401A		
			2236 con motor/MERCEDES BENZ OM423			COMBUSTIBLE	G-1123F	4220900051
2223 con motor/MERCEDES BENZ OM346			ACEITE	G-143	4031840025	2527 con motor/MERCEDES BENZ OM401LA		
ACEITE, DERIVACION	G-31	1846725	COMBUSTIBLE	G-1123F	4220900051	COMBUSTIBLE	G-1121F	3444777215
COMBUSTIBLE	G-1121F	3524700092	DIRECCION	G-162H	1902137	2531 ACTROS, 2535 ACTROS con motor/MERCEDES BENZ OM501LA		
COMBUSTIBLE	G-1123F	4220900051				DIRECCION	G-162H	1902137
DIRECCION	G-162H	4660604	2238 con motor/MERCEDES BENZ OM422LA					
			ACEITE	G-143	4021800009	2531 con motor/MERCEDES BENZ OM401LA		
2223 con motor/MERCEDES BENZ OM352			COMBUSTIBLE	G-1123F	4220900051	COMBUSTIBLE	G-1121F	3524700092
ACEITE, HASTA 1978	G-31	1846725	DIRECCION	G-162H	4660604	2533 con motor/MERCEDES BENZ OM422A		
COMBUSTIBLE	G-1121F	3524700092				ACEITE	G-143	4031840025
COMBUSTIBLE	G-1123F	4220900051	2244 con motor/MERCEDES BENZ OM442LA			COMBUSTIBLE	G-1123F	4220900051
DIRECCION	G-162H	4660604	ACEITE, HASTA 8/90	G-143	4031840025	DIRECCION	G-162H	4660604
			COMBUSTIBLE	G-1121F	3524700092	2533 con motor/MERCEDES BENZ OM401LA		
2223 con motor/MERCEDES BENZ OM355			DIRECCION	G-162H	4660604	COMBUSTIBLE	G-1121F	3524700092
ACEITE, HASTA 4/78	G-31	1846725	AIRE	GA-467	30941504	2538 con motor/MERCEDES BENZ OM402		
COMBUSTIBLE	G-1121F	3524700092	2419 con motor/MERCEDES BENZ OM401			COMBUSTIBLE	G-1121	3524700092
COMBUSTIBLE	G-1123F	4220900051	COMBUSTIBLE	G-1121F	3524700092	COMBUSTIBLE	G-1121F	3524700092
DIRECCION	G-162H	4660604	2422 con motor/MERCEDES BENZ OM421			AIRE	GA-467	30941504
ACEITE, 4/78 EN ADELANTE	G-989	11845625	ACEITE	G-143	4031840025	2538 con motor/MERCEDES BENZ OM402LA		
			COMBUSTIBLE	G-1123F	4220900051	AIRE	GA-467	30941504
2224 con motor/MERCEDES BENZ OM355			DIRECCION	G-162H	1902137	2538 con motor/MERCEDES BENZ OM402LA		
ACEITE, HASTA 4/78	G-31	1846725				AIRE	GA-467	30941504
COMBUSTIBLE	G-1123F	4220900051	2424 con motor/MERCEDES BENZ OM442LA			2538 con motor/MERCEDES BENZ OM442LA		
COMBUSTIBLE	G-1123F	4220900051	ACEITE, HASTA 8/90	G-143	4031840025	COMBUSTIBLE	G-1121F	3524700092
DIRECCION	G-162H	4660604	COMBUSTIBLE	G-1121F	3524700092	2540 ACTROS con motor/MERCEDES BENZ OM501LA		
ACEITE, 4/78 EN ADELANTE	G-989	11845625	DIRECCION	G-162H	4660604	DIRECCION	G-162H	11842225
			AIRE	GA-467	30941504	2540 con motores/MERCEDES BENZ OM402, MERCEDES BENZ OM402LA		
2224 con motor/MERCEDES BENZ OM402			2426 con motor/MERCEDES BENZ OM442			COMBUSTIBLE	G-1121F	3444777215
ACEITE	G-143	4031840025	ACEITE	G-143	4031840025	2543 ACTROS con motor/MERCEDES BENZ OM501LA		
			COMBUSTIBLE	G-1123F	4220900051	DIRECCION	G-162H	1902137
2225 con motor/MERCEDES BENZ OM422			DIRECCION	G-162H	1902137	2544 con motor/MERCEDES BENZ OM442LA		
ACEITE, FLUJO TOTAL (FULL FLOW)	G-143	4031840025				ACEITE, HASTA 8/90	G-143	4031840025
COMBUSTIBLE, HASTA 7/82	G-1121F	3524700092	2428 con motor/MERCEDES BENZ OM422			COMBUSTIBLE	G-1121F	3524700092
COMBUSTIBLE, 7/82 EN ADELANTE	G-1123F	4220900051	ACEITE	G-143	4031840025			
DIRECCION	G-162H	4660604	COMBUSTIBLE, HASTA 7/82	G-1121F	3524700092			
			COMBUSTIBLE, 7/82 EN ADELANTE	G-1123F	4220900051			
2226 con motores/MERCEDES BENZ OM402, MERCEDES BENZ OM403			DIRECCION	G-162H	4660604			
COMBUSTIBLE	G-1123	4220900051						
ACEITE	G-143	4031840025	2429 con motor/MERCEDES BENZ OM442					
COMBUSTIBLE	G-1121F	3524700092	ACEITE, HASTA 8/90	G-143	4021800009			
COMBUSTIBLE	G-1123F	4220900051	COMBUSTIBLE	G-1123F	4220900051			
			DIRECCION	G-162H	4660604			
2228 con motor/MERCEDES BENZ OM422								
ACEITE	G-143	4021800009						
COMBUSTIBLE, HASTA 7/82	G-1121F	3524700092						
COMBUSTIBLE, 7/82 EN ADELANTE	G-1123F	4220900051						

MARCA-MODELO-MOTOR MAKE-MODEL-ENGINE	GONHER GONHER	OEM OEM	MARCA-MODELO-MOTOR MAKE-MODEL-ENGINE	GONHER GONHER	OEM OEM	MARCA-MODELO-MOTOR MAKE-MODEL-ENGINE	GONHER GONHER	OEM OEM
MERCEDES BENZ (continuación)			MERCEDES BENZ (continuación)			MERCEDES BENZ (continuación)		
CAMIONES, TRACTOCAMIONES Y AUTOBUSES			CAMIONES, TRACTOCAMIONES Y AUTOBUSES			CAMIONES, TRACTOCAMIONES Y AUTOBUSES		
DIRECCION	G-162H	4660604	2632 con motor/MERCEDES BENZ OM403 SERIES			2653 con motor/MERCEDES BENZ OM442LA		
AIRE	GA-467	30941504	ACEITE, FLUJO COMPLETO (FULL FLOW)	G-143	4031840025	COMBUSTIBLE	G-1123F	4220900051
2548 ACTROS con motor/MERCEDES BENZ OM502LA			COMBUSTIBLE	G-1121F	3524700092	2831 ACTROS con motor/MERCEDES BENZ OM501LA		
DIRECCION	G-162H	1902137	COMBUSTIBLE	G-1123F	4220900051	DIRECCION	G-162H	1902137
2550 con motores/MERCEDES BENZ OM402, MERCEDES BENZ OM442LA			2633 con motor/MERCEDES BENZ OM422A			302, 305 con motor/A DIESEL		
COMBUSTIBLE	G-1121F	3524700092	ACEITE	G-143	4031840025	ACEITE	G-31	1846725
2553 ACTROS con motor/MERCEDES BENZ OM502LA			COMBUSTIBLE	G-1123F	4220900051	COMBUSTIBLE, SIN CUBIERTA	G-1123	4774015
DIRECCION	G-162H	11842225	DIRECCION	G-162H	4660604	COMBUSTIBLE, CON CUBIERTA	G-1123F	4774015
2553 con motor/MERCEDES BENZ OM442LA			2635 con motores/MERCEDES BENZ OM442A, MERCEDES BENZ OM442LA			3025, 3028 con motor/MERCEDES BENZ OM422		
COMBUSTIBLE	G-1123F	4220900051	ACEITE, HASTA 8/90	G-143	4021800009	ACEITE, FLUJO COMPLETO (FULL FLOW)	G-143	4031840025
2553 con motor/MERCEDES BENZ OM502LA			COMBUSTIBLE	G-1123F	4220900051	COMBUSTIBLE, HASTA 7/82	G-1121F	3524700092
DIRECCION	G-162H	1902137	DIRECCION	G-162H	1902137	COMBUSTIBLE, 7/82 EN ADELANTE	G-1123F	4220900051
2557 ACTROS con motor/MERCEDES BENZ OM502LA			AIRE, PRIMARIO	GA-467	30941504	DIRECCION	G-162H	4660604
DIRECCION	G-162H	1902137	2636 con motor/MERCEDES BENZ OM423			3032 con motor/MERCEDES BENZ OM403 SERIES		
2623 con motor/MERCEDES BENZ OM346			ACEITE	G-143	4031840025	ACEITE, FLUJO COMPLETO (FULL FLOW)	G-143	4031840025
ACEITE	G-31	1846725	COMBUSTIBLE	G-1123F	4220900051	COMBUSTIBLE	G-1121F	3524700092
COMBUSTIBLE	G-1121	3444777215	DIRECCION	G-162H	4660604	COMBUSTIBLE	G-1123F	4220900051
COMBUSTIBLE	G-1121F	3444777215	2638 con motor/MERCEDES BENZ OM422LA			3033 con motor/MERCEDES BENZ OM442A		
DIRECCION	G-162H	4660604	ACEITE	G-143	4021800009	ACEITE	G-143	4031840025
2623 con motor/MERCEDES BENZ OM352			COMBUSTIBLE	G-1123F	4220900051	COMBUSTIBLE	G-1123F	4220900051
ACEITE, HASTA 1978	G-31	1846725	DIRECCION	G-162H	4660604	DIRECCION	G-162H	4660604
COMBUSTIBLE	G-1121F	3524700092	AIRE	GA-467	30941504	3050 con motores/MERCEDES BENZ OM402, MERCEDES BENZ OM442LA		
COMBUSTIBLE	G-1123F	4220900051	2644 con motor/MERCEDES BENZ OM442LA			COMBUSTIBLE	G-1121F	3524700092
DIRECCION	G-162H	4660604	ACEITE, HASTA 8/90	G-143	4031840025	3053 con motor/MERCEDES BENZ OM442LA		
2623 con motor/MERCEDES BENZ OM355			COMBUSTIBLE	G-1121F	3524700092	COMBUSTIBLE	G-1123F	4220900051
ACEITE, HASTA 4/78	G-31	1846725	DIRECCION	G-162H	4660604	306D con motor/A DIESEL		
COMBUSTIBLE	G-1121F	3524700092	AIRE	GA-467	30941504	COMBUSTIBLE	G-1121	3444777215
COMBUSTIBLE	G-1123F	4220900051	2646 ACTROS, 2631 ACTROS, 2635 ACTROS, 2640 ACTROS, 2643 ACTROS con motor/MERCEDES BENZ OM501LA			3131 ACTROS, 3143 ACTROS, 3135 ACTROS, 3140 ACTROS con motor/MERCEDES BENZ OM501LA		
DIRECCION	G-162H	4660604	DIRECCION	G-162H	1902137	DIRECCION	G-162H	1902137
ACEITE, 4/78 EN ADELANTE	G-989	11845625	2648 ACTROS con motor/MERCEDES BENZ OM502LA			AIRE	GA-405	10947904
2624 con motor/MERCEDES BENZ OM355			DIRECCION	G-162H	11842225	AIRE	GA-467	5410920305
ACEITE, HASTA 4/78	G-31	1846725	2648 con motor/MERCEDES BENZ OM442A			3148 ACTROS con motor/MERCEDES BENZ OM502LA		
COMBUSTIBLE	G-1123F	4220900051	ACEITE, HASTA 8/90	G-143	4021800009	DIRECCION	G-162H	1902137
DIRECCION	G-162H	4660604	COMBUSTIBLE	G-1121F	3524700092	3153 ACTROS, 3157 ACTROS con motor/MERCEDES BENZ OM502LA		
ACEITE, 4/78 EN ADELANTE	G-989	11845625	DIRECCION	G-162H	4660604	DIRECCION	G-162H	192137
2626 con motor/MERCEDES BENZ OM402			AIRE, PRIMARIO	GA-467	30941504	319 con motor/A DIESEL		
ACEITE	G-143	4031840025	2648 con motor/MERCEDES BENZ OM442LA (1990 EN ADELANTE)			ACEITE	G-225	1842225
2628 con motor/MERCEDES BENZ OM422			ACEITE	G-143	1843825	319D con motor/MERCEDES BENZ OM366 VIII		
ACEITE	G-143	4021800009	DIRECCION	G-162H	4660604	COMBUSTIBLE	G-1121F	3524700092
COMBUSTIBLE, HASTA 7/82	G-1121F	3524700092	AIRE	GA-467	30941504	319D con motor/MERCEDES BENZ OM626 VII		
COMBUSTIBLE, 7/82 EN ADELANTE	G-1123F	4220900051	2648 con motor/MERCEDES BENZ OM502LA			COMBUSTIBLE	G-1121	3524700092
DIRECCION	G-162H	4660604	DIRECCION	G-162H	1902137	319DB con motor/MERCEDES BENZ OM363 VIII		
2628 ECONIC, 1823 ECONIC, 1828 ECONIC con motor/MERCEDES BENZ OM906			2650 con motores/MERCEDES BENZ OM402, MERCEDES BENZ OM442LA			COMBUSTIBLE	G-1121	3524700092
DIRECCION	G-162H	4660604	COMBUSTIBLE	G-1121F	3524700092	319DB con motor/MERCEDES BENZ OM626 VII		
2629 con motor/MERCEDES BENZ OM442			2653 ACTROS, 2657 ACTROS con motor/MERCEDES BENZ OM502LA			COMBUSTIBLE	G-1121	3524700092
ACEITE, HASTA 8/90	G-143	4021800009	DIRECCION	G-162H	1902137	319DB con motor/MERCEDES BENZ OM626 VII		
COMBUSTIBLE	G-1123F	4220900051				COMBUSTIBLE	G-1121F	3524700092
DIRECCION	G-162H	4660604						

SERVICIO PESADO

MARCA-MODELO-MOTOR MAKE-MODEL-ENGINE	GONHER GONHER	OEM OEM	MARCA-MODELO-MOTOR MAKE-MODEL-ENGINE	GONHER GONHER	OEM OEM	MARCA-MODELO-MOTOR MAKE-MODEL-ENGINE	GONHER GONHER	OEM OEM
MERCEDES BENZ (continuación)			MERCEDES BENZ (continuación)			MERCEDES BENZ (continuación)		
CAMIONES, TRACTOCAMIONES Y AUTOBUSES			CAMIONES, TRACTOCAMIONES Y AUTOBUSES			CAMIONES, TRACTOCAMIONES Y AUTOBUSES		
614D, 615D VARIO, 614D VARIO, 615D con motor/MERCEDES BENZ OM904LA			810 con motor/MERCEDES BENZ OM352			912 con motor/A DIESEL		
DIRECCION	G-162H	4660604	ACEITE	G-31	1846725	COMBUSTIBLE	G-1123F	4220900051
709 con motores/MERCEDES BENZ M314, MERCEDES BENZ OM364			COMBUSTIBLE, SIN CUBIERTA	G-1121	3440927005	913 con motor/MERCEDES BENZ OM346		
COMBUSTIBLE	G-1121F	3524700092	COMBUSTIBLE, CON CUBIERTA	G-1121F	3440927005	ACEITE	G-31	1846725
709D con motor/MERCEDES BENZ OM364			DIRECCION	G-162H	1902137	COMBUSTIBLE	G-1121	3444777215
COMBUSTIBLE	G-1121F	3524700092	811 con motor/MERCEDES BENZ OM354LA			COMBUSTIBLE	G-1121F	3444777215
710 con motores/MERCEDES BENZ OM346, MERCEDES BENZ OM352			COMBUSTIBLE	G-1121	3444777215	913 con motor/MERCEDES BENZ OM352		
ACEITE	G-31	1846725	811, 911 con motores/MERCEDES BENZ OM346, MERCEDES BENZ OM352			COMBUSTIBLE	G-1121	3444777215
COMBUSTIBLE, SIN CUBIERTA	G-1121	2440927005	ACEITE	G-31	1846725	COMBUSTIBLE	G-1121F	3444777215
COMBUSTIBLE, CON CUBIERTA	G-1121F	2440927005	COMBUSTIBLE, SIN CUBIERTA	G-1121	3440927005	DIRECCION	G-162H	4660604
DIRECCION	G-162H	4660604	COMBUSTIBLE, CON CUBIERTA	G-1121F	3440927005	913 con motor/MERCEDES BENZ OM352 (HASTA1977)		
710, 810, 811, 813, 911, 913 con motor/MERCEDES BENZ OM355			DIRECCION	G-162H	1902137	ACEITE	G-31	1846725
ACEITE	G-31	1846725	811D con motor/MERCEDES BENZ OM354LA			913 con motor/MERCEDES BENZ OM352X		
COMBUSTIBLE	G-1121	3444777215	COMBUSTIBLE	G-1121	3444777215	COMBUSTIBLE	G-1121F	3524700092
COMBUSTIBLE	G-1121F	3444777215	811D con motor/MERCEDES BENZ OM364A			914 con motor/A DIESEL		
DIRECCION	G-162H	4660604	COMBUSTIBLE	G-1121F	3524700092	COMBUSTIBLE	G-1123F	4220900051
ACEITE	G-989	11845625	812 ATEGO con motor/MERCEDES BENZ OM904LA			914 con motor/MERCEDES BENZ OM366		
711 con motor/MERCEDES BENZ OM354LA			DIRECCION	G-162H	4660604	COMBUSTIBLE	G-1121F	3524700092
COMBUSTIBLE	G-1121	3444777215	813 con motor/MERCEDES BENZ OM346			917 ATEGO con motor/MERCEDES BENZ OM904LA		
711 con motor/MERCEDES BENZ OM364A			ACEITE	G-31	1846725	DIRECCION	G-162H	4660604
COMBUSTIBLE	G-1121	3524700092	COMBUSTIBLE	G-1121	3444777215	917 con motor/MERCEDES BENZ OM366A		
7112 con motor/MERCEDES BENZ OM354LA			COMBUSTIBLE	G-1121F	3444777215	COMBUSTIBLE	G-1121F	3524700092
COMBUSTIBLE	G-1121	3444777215	813 con motor/MERCEDES BENZ OM352			923 ATEGO, 925 ATEGO con motor/MERCEDES BENZ OM906LA		
711D con motor/MERCEDES BENZ OM354LA			COMBUSTIBLE	G-1121	3444777215	DIRECCION	G-162H	4660604
COMBUSTIBLE	G-1121	3524700092	COMBUSTIBLE	G-1121F	3444777215	ACTROS 1831 con motor/MERCEDES BENZ OM501LA		
711D con motor/MERCEDES BENZ OM364A			DIRECCION	G-162H	4660604	DIRECCION	G-162H	11842225
COMBUSTIBLE	G-1121F	3524700092	813 con motor/MERCEDES BENZ OM352 (HASTA 1977)			ALLEGRO con motor/MERCEDES BENZ OM906		
712 ATEGO, 715 ATEGO con motor/MERCEDES BENZ OM904LA			ACEITE	G-31	1846725	HIDRAULICO	G-162H	A 000 466 06 04
DIRECCION	G-162H	4660604	813 con motor/MERCEDES BENZ OM352X			ACEITE	G-3754	A0001801709
808D con motor/MERCEDES BENZ OM314			COMBUSTIBLE	G-1121F	3524700092	COMBUSTIBLE, CARTUCHO	G-1046	A9060920305
COMBUSTIBLE	G-1121	3524700092	814 con motor/MERCEDES BENZ OM366			COMBUSTIBLE, SEPARADOR DE AGUA	GPP-1060	9794770015
COMBUSTIBLE	G-1121F	3524700092	COMBUSTIBLE	G-1121F	3524700092	COMBUSTIBLE, SEPARADOR DE AGUA	GPP-1061	WK 1060/1
DIRECCION	G-162H	4660604	814D con motor/MERCEDES BENZ OM364LA			AIRE, PRIMARIO	GA-682R	RS3518
809 con motor/MERCEDES BENZ OM314			COMBUSTIBLE	G-1121F	3524700092	ANDARE 1628 con motor/MERCEDES BENZ OM906		
COMBUSTIBLE	G-1121F	3524700092	815 ATEGO, 815D, 815D VARIO, 817 ATEGO con motor/MERCEDES BENZ OM904LA			HIDRAULICO	G-162H	A 000 466 06 04
809 con motor/MERCEDES BENZ OM364			DIRECCION	G-162H	4660604	ACEITE	G-3754	A0001801709
COMBUSTIBLE	G-1121F	3524700092	817 con motor/A DIESEL (S/N 923826 EN ADELANTE)			DIESEL, CARTUCHO	G-1046	A9060920305
809D con motor/MERCEDES BENZ OM364			ACEITE	G-163	4011800009	COMBUSTIBLE, SEPARADOR DE AGUA	GPP-1060	9794770015
COMBUSTIBLE	G-1121	3524700092	817 con motor/MERCEDES BENZ OM366A			COMBUSTIBLE, SEPARADOR DE AGUA	GPP-1061	WK 1060/1
809D, 811D, 813D, 814D con motor/A DIESEL			COMBUSTIBLE	G-1121F	3524700092	AIRE, SECUNDARIO	GA-905R	RS4587
COMBUSTIBLE, CARTUCHO	G-1123F	4220900051	817D, 917D con motor/A DIESEL			AIRE, PRIMARIO	GA-904R	645 862 56 100
DIRECCION	G-162H	1902137	COMBUSTIBLE	G-1123F	4220900051	ANDARE 1728 con motor/MERCEDES BENZ OM906LA		
COMBUSTIBLE, SELLADO	GPP-1122	WK8426	823 ATEGO con motor/MERCEDES BENZ OM906LA			HIDRAULICO	G-162H	A 000 466 06 04
810 con motor/MERCEDES BENZ OM346			DIRECCION	G-162H	4660604	ACEITE	G-3754	A0001801709
ACEITE	G-31	1846725	911 con motor/MERCEDES BENZ OM352A			DIESEL, CARTUCHO	G-1046	A9060920305
COMBUSTIBLE, SIN CUBIERTA	G-1121	3440927005	COMBUSTIBLE	G-1121	3524700092			
COMBUSTIBLE, CON CUBIERTA	G-1121F	3524700092						
DIRECCION	G-162H	1902137						

SERVICIO PESADO

MARCA-MODELO-MOTOR MAKE-MODEL-ENGINE	GONHER GONHER	OEM OEM	MARCA-MODELO-MOTOR MAKE-MODEL-ENGINE	GONHER GONHER	OEM OEM	MARCA-MODELO-MOTOR MAKE-MODEL-ENGINE	GONHER GONHER	OEM OEM
MERCEDES BENZ (continuación)			MERCEDES BENZ (continuación)			MERCEDES BENZ (continuación)		
CAMIONES, TRACTOCAMIONES Y AUTOBUSES			CAMIONES, TRACTOCAMIONES Y AUTOBUSES			CAMIONES, TRACTOCAMIONES Y AUTOBUSES		
COMBUSTIBLE, SEPARADOR DE AGUA	GPP-1060	9794770015	FL-80 con motor/CUMMINS ISC			ACEITE	G-989	11845625
COMBUSTIBLE, SEPARADOR DE AGUA	GPP-1061	WK 1060/1	COMBUSTIBLE, SEPARADOR DE AGUA	GPP-1060	9794770015	AIRE	GA-405	10947904
AIRE, SECUNDARIO	GA-905R	RS4587	COMBUSTIBLE, SEPARADOR DE AGUA	GPP-1061	WK 1060/1	L2521, L1218, L1518 con motores/MERCEDES BENZ OM366A, MERCEDES BENZ OM906		
AIRE, PRIMARIO	GA-904R	645 862 56 100	ACEITE	GP-3000	3919562	AIRE	GA-864R	A6345280306
ATEGO 1323 con motor/MERCEDES BENZ OM906LA1			FLD-112 con motor/CUMMINS M11			L296D con motor/A DIESEL		
ACEITE	G-3754	A0001801709	ACEITE	GP-3000	3919562	COMBUSTIBLE	G-1121	3524700092
ATEGO 1823, ATEGO 1828 con motor/MERCEDES BENZ OM906LA			G CONCERTO con motor/MERCEDES BENZ OM447HLA			L306 con motores/MERCEDES BENZ M121.926, MERCEDES BENZ M121.941		
DIRECCION	G-162H	4660604	ACEITE	G-143	4031840025	COMBUSTIBLE	G-1121	3444777215
BOXER con motor/MERCEDES BENZ OM904			DIRECCION	G-162H	4660604	L306D con motor/A DIESEL		
HIDRAULICO	G-162H	A 000 466 06 04	AIRE	GA-405	10947904	COMBUSTIBLE	G-1121	3524700092
ACEITE, FLUJO TOTAL (FULL FLOW)	G-3827	A0001801609	H CONCERTO con motor/MERCEDES BENZ OM447HLA			L406 con motores/MERCEDES BENZ M121.926, MERCEDES BENZ M121.941		
DIESEL, CARTUCHO	G-1046	A9060920305	ACEITE	G-143	4031840025	COMBUSTIBLE	G-1121	3444777215
COMBUSTIBLE, SEPARADOR DE AGUA	GPP-1060	9794770015	DIRECCION	G-162H	4660604	L406D con motor/A DIESEL		
COMBUSTIBLE, SEPARADOR DE AGUA	GPP-1061	WK 1060/1	AIRE	GA-405	10947904	COMBUSTIBLE	G-1121	3524700092
AIRE, SECUNDARIO	GA-905R	RS4587	L1013 con motor/A DIESEL			L407, L408 con motores/MERCEDES BENZ M121.926, MERCEDES BENZ M121.941		
AIRE, PRIMARIO	GA-904R	645 862 56 100	COMBUSTIBLE	G-1121	3444777215	COMBUSTIBLE	G-1121	3444777215
C CONCERTO con motor/MERCEDES BENZ OM447HLA			DIRECCION	G-162H	4660604	L406D con motor/A DIESEL		
ACEITE	G-143	4031840025	AIRE	G-926	3445868090	COMBUSTIBLE	G-1121	3444777215
DIRECCION	G-162H	4660604	L1013 con motor/MERCEDES BENZ OM352			LO915 MIDIBUS con motor/MERCEDES BENZ OM904LA		
AIRE	GA-405	10947904	COMBUSTIBLE, SIN CUBIERTA	G-1121	3444777215	ACEITE	G-3827	1801609
CAMIONES CON CARCAZA REYTOR IT2000 con motor/MERCEDES BENZ BR904			ACEITE	G-143	3445868090	COMBUSTIBLE	G-1046	901251
ACEITE	G-3827	CH5957	COMBUSTIBLE, CON CUBIERTA	G-1121F	3444777215	AIRE, PRIMARIO	GA-3095R	A3740947401
AIRE, SECUNDARIO	GA-905R	IT2000S	DIRECCION	G-162H	4660604	AIRE, SECUNDARIO	GA-3096R	A3740947204
AIRE, PRIMARIO	GA-904R	IT2000	L1013 con motor/MERCEDES BENZ OM352A			LP1219, LP1419 con motor/MERCEDES BENZ OM366LA		
CAMIONES CON CARCAZA REYTOR IT2002 con motor/MERCEDES BENZ BR904			COMBUSTIBLE	G-1121	3444777215	COMBUSTIBLE	GP-110	3900920001
ACEITE	G-3827	CH5957	ACEITE	G-143	3445868090	LPS1525 con motor/MERCEDES BENZ OM429LA		
AIRE, SECUNDARIO	GA-802R	IT2002S	COMBUSTIBLE	G-1121F	3444777215	COMBUSTIBLE, SIN CUBIERTA	G-1123	4220900051
AIRE, PRIMARIO	GA-801R	IT2002	DIRECCION	G-162H	4660604	COMBUSTIBLE, CON CUBIERTA	G-1123F	4220900051
CAMIONES CON CARCAZA REYTOR IT2004 con motor/MERCEDES BENZ BR904			L1117, L1319 con motor/MERCEDES BENZ OM366LA			AIRE	GA-209	3660940004
ACEITE	G-3827	CH5957	COMBUSTIBLE	GP-110	3900920001	LS1418 con motor/MERCEDES BENZ OM355		
AIRE, SECUNDARIO	GA-802R	IT2002S	L-1200/39, L-1200/52, L-1400/52, L-1400/59 con motor/MERCEDES BENZ OM904LA			COMBUSTIBLE, SIN CUBIERTA	G-1123	4220900051
AIRE, PRIMARIO	GA-801R	IT2002	HIDRAULICO	G-162H	A 000 466 06 04	MB 01400/60, LK-1300/34, LK-1400/34, MB 01000/44, MB 01200/52 con motor/MERCEDES BENZ OM904LA		
CAMIONES CON CARCAZA REYTOR IT2056 con motor/MERCEDES BENZ BR906			ACEITE	G-3754	A0001801709	HIDRAULICO	G-162H	A 000 466 06 04
ACEITE	G-3754	CH9389	DIESEL, CARTUCHO	G-1046	A9060920305	ACEITE	G-3827	A0001801609
AIRE, SECUNDARIO	GA-907R	IT2056S	COMBUSTIBLE, SEPARADOR DE AGUA	GPP-1060	9794770015	DIESEL, CARTUCHO	G-1046	A9060920305
AIRE, PRIMARIO	GA-906R	IT2056	COMBUSTIBLE, SEPARADOR DE AGUA	GPP-1061	WK 1060/1	COMBUSTIBLE, SEPARADOR DE AGUA	GPP-1060	9794770015
E CONCERTO con motor/MERCEDES BENZ OM447HLA			AIRE, SECUNDARIO	GA-905R	RS4587	COMBUSTIBLE, SEPARADOR DE AGUA	GPP-1061	WK 1060/1
ACEITE	G-143	4031840025	AIRE, PRIMARIO	GA-904R	645 862 56 100	AIRE, SECUNDARIO	GA-905R	RS4587
DIRECCION	G-162H	4660604	L1317, L1113, L1116, L1117, L1316 con motor/MERCEDES BENZ OM352			AIRE, PRIMARIO	GA-904R	645 862 56 100
AIRE	GA-405	10947904	COMBUSTIBLE, SIN CUBIERTA	G-1121	3444777215	MB 01600/70 con motor/MERCEDES BENZ OM906LA		
FL-60 con motor/CUMMINS ISB			COMBUSTIBLE, CON CUBIERTA	G-1121F	3444777215	HIDRAULICO	G-162H	A 000 466 06 04
COMBUSTIBLE, SEPARADOR DE AGUA	GPP-1060	9794770015	ACEITE	G-926	3445868090	ACEITE	G-3754	A0001801709
FL-70 con motor/CUMMINS ISB			L1418 con motor/MERCEDES BENZ OM355			DIESEL, CARTUCHO	G-1046	A9060920305
COMBUSTIBLE, SEPARADOR DE AGUA	GPP-1060	9794770015	COMBUSTIBLE, SIN CUBIERTA	G-1123	4220900051	COMBUSTIBLE, SEPARADOR DE AGUA	GPP-1060	9794770015
COMBUSTIBLE, SEPARADOR DE AGUA	GPP-1061	WK 1060/1	L1928, L2628, L3828 con motores/MERCEDES BENZ OM355, MERCEDES BENZ OM355LA			COMBUSTIBLE, SEPARADOR DE AGUA	GPP-1061	WK 1060/1
AIRE, PRIMARIO	GA-966R	RS3517	COMBUSTIBLE	G-1123F	4220900051	COMBUSTIBLE, SEPARADOR DE AGUA	GPP-1061	WK 1060/1
			DIRECCION	G-162H	4660604			

MARCA-MODELO-MOTOR MAKE-MODEL-ENGINE	GONHER GONHER	OEM OEM	MARCA-MODELO-MOTOR MAKE-MODEL-ENGINE	GONHER GONHER	OEM OEM	MARCA-MODELO-MOTOR MAKE-MODEL-ENGINE	GONHER GONHER	OEM OEM
MERCEDES BENZ (continuación)			MERCEDES BENZ (continuación)			MERCEDES BENZ (continuación)		
CAMIONES, TRACTOCAMIONES Y AUTOBUSES			CAMIONES, TRACTOCAMIONES Y AUTOBUSES			CAMIONES, TRACTOCAMIONES Y AUTOBUSES		
MBO 1019/44, MBO 1219/52, MBO 1419/60 con motor/MERCEDES BENZ OM904LA			O319B con motor/A DIESEL			O407H con motor/MERCEDES BENZ OM427HA		
HIDRAULICO	G-162H	A 000 466 06 04	COMBUSTIBLE	G-1121	3524700092	ACEITE	G-143	1843825
ACEITE	G-3827	A0001801609	O319D con motores/MERCEDES BENZ M121, MERCEDES BENZ OM913, MERCEDES BENZ M929, MERCEDES BENZ OM621			O520 CITO con motor/MERCEDES BENZ OM904LA		
DIESEL, CARTUCHO	G-1046	A9060920305	COMBUSTIBLE	G-1121F	3524700092	DIRECCION	G-162H	4660604
COMBUSTIBLE, SEPARADOR DE AGUA	GPP-1060	9794770015	O321H con motor/MERCEDES BENZ OM352			O530 CITARO con motor/MERCEDES BENZ OM457HLA		
COMBUSTIBLE, SEPARADOR DE AGUA	GPP-1061	WK 1060/1	ACEITE, DERIVACION (BY PASS)	G-31	1846725	DIRECCION	G-162H	9061800009
AIRE, SECUNDARIO	GA-905R	RS4587	O321H con motores/MERCEDES BENZ OM322, MERCEDES BENZ OM346			O530 CITO con motor/MERCEDES BENZ OM906LA		
AIRE, PRIMARIO	GA-904R	645 862 56 100	COMBUSTIBLE, SECUNDARIO	G-1123	4774515	DIRECCION	G-162H	4660604
AIRE, SECUNDARIO	GA-802R	IT2002S	O322 con motor/MERCEDES BENZ OM352			O609D con motor/MERCEDES BENZ OM364		
AIRE, PRIMARIO	GA-801R	IT2002	ACEITE, DERIVACION (BY PASS)	G-31	1846725	COMBUSTIBLE	G-1121F	3444777215
O301 con motor/MERCEDES BENZ OM366A			O322 con motores/MERCEDES BENZ OM322, MERCEDES BENZ OM346			O611D, O614D con motores/MERCEDES BENZ OM364A, MERCEDES BENZ OM364LA		
COMBUSTIBLE	G-1121F	3444777215	COMBUSTIBLE, SECUNDARIO	G-1123	4774515	COMBUSTIBLE	G-1121F	3444777215
O302 con motor/A DIESEL			O340 con motor/MERCEDES BENZ OM441LA			OH SERIES con motor/MERCEDES BENZ OM366LA		
COMBUSTIBLE	G-1123F	4220900051	COMBUSTIBLE	G-1123F	4220900051	COMBUSTIBLE	G-1121F	3524700092
O303 con motor/MERCEDES BENZ OM403			DIRECCION	G-162H	4660604	OMC 1119/40 TORINO, OMC 1419/51 TORINO, OMC 1419/51L TORINO con motor/MERCEDES BENZ OM904LA		
ACEITE	G-143	4031840025	AIRE	GA-467	30941504	ACEITE	G-3827	CH5957
COMBUSTIBLE	G-1121F	3444777215	O402 con motor/MERCEDES BENZ OM366			AIRE, SECUNDARIO	GA-802R	IT2002S
AIRE	GA-405	10947904	COMBUSTIBLE	G-1121F	3524700092	AIRE, PRIMARIO	GA-801R	IT2002
O303 con motores/MERCEDES BENZ OM401, MERCEDES BENZ OM402			O404 con motor/MERCEDES BENZ OM442LA			OMC 1400/51 con motor/MERCEDES BENZ OM906LA		
ACEITE	G-143	1843825	COMBUSTIBLE	G-1123F	4220900051	HIDRAULICO	G-162H	A 000 466 06 04
COMBUSTIBLE	G-1121F	3444777215	O404 con motores/MERCEDES BENZ OM401LA, MERCEDES BENZ OM402A			ACEITE	G-3754	A0001801709
AIRE	GA-405	10947904	COMBUSTIBLE	G-1123F	4220900051	DIESEL, CARTUCHO	G-1046	A9060920305
O303 con motores/MERCEDES BENZ OM421, MERCEDES BENZ OM422, MERCEDES BENZ OM422A			O404 con motores/MERCEDES BENZ OM402LA, MERCEDES BENZ OM441LA			COMBUSTIBLE, SEPARADOR DE AGUA	GPP-1060	9794770015
ACEITE	G-143	1843825	DIRECCION	G-162H	4660604	COMBUSTIBLE, SEPARADOR DE AGUA	GPP-1061	WK 1060/1
O305-13 con motor/A DIESEL			O405 con motor/MERCEDES BENZ OM407A			S CONCERTO con motor/MERCEDES BENZ OM447HLA		
COMBUSTIBLE	G-1123F	4220900051	ACEITE	G-143	1843825	ACEITE	G-143	4031840025
O305G con motor/MERCEDES BENZ OM407A			O405 con motor/MERCEDES BENZ OM407HA			DIRECCION	G-162H	4660604
ACEITE	G-143	1843825	ACEITE	G-143	1843825	AIRE	GA-405	10947904
O305G con motor/MERCEDES BENZ OM407HA			O405 con motor/MERCEDES BENZ OM407HA			SPRINTER 208D, SPRINTER 210D, SPRINTER 212D, SPRINTER 308D, SPRINTER 310D, SPRINTER 312D, SPRINTER 408D, SPRINTER 410D, SPRINTER 412D con motores/MERCEDES BENZ OM601, MERCEDES BENZ OM602		
ACEITE	G-143	11843825	ACEITE	G-143	11843825	AIRE, CON FIELTRO	GA-5876	A003094830467
O305G, O305ST, O307 con motor/MERCEDES BENZ OM407H			O405G con motor/MERCEDES BENZ OM427H			SPRINTER 214, SPRINTER 314, SPRINTER 414 con motor/MERCEDES BENZ M111		
ACEITE	G-143	4031840025	ACEITE	G-143	11843825	AIRE, CON FIELTRO	GA-5876	A003094830467
COMBUSTIBLE	G-1121F	3524700092	DIRECCION	G-162H	4660204	SPRINTER 313CDI, SPRINTER 316CDI, SPRINTER 411CDI, SPRINTER 208CDI, SPRINTER 211CDI, SPRINTER 213CDI, SPRINTER 216CDI, SPRINTER 308CDI, SPRINTER 311CDI con motores/MERCEDES BENZ OM611, MERCEDES BENZ OM612		
COMBUSTIBLE	G-1123F	4220900051	AIRE	GA-405	10947904	AIRE, CON FIELTRO	GA-5876	A003094830467
O309B con motor/A DIESEL			O405G con motores/MERCEDES BENZ OM407A, MERCEDES BENZ OM407HA			SPRINTER 408CDI, SPRINTER 413CDI, SPRINTER 416CDI con motor/MERCEDES BENZ OM611		
COMBUSTIBLE	G-1121F	3524700092	ACEITE	G-143	11843825	DIESEL	GPP-612	A6120920001
O309D con motor/MERCEDES BENZ OM314			O405N con motor/MERCEDES BENZ OM447			AIRE, CON FIELTRO	GA-5876	A003094830467
COMBUSTIBLE	G-1123F	4220900051	AIRE	GA-405	10947904	AIRE, SIN FIELTRO	GA-475	A0040942604
O309D con motor/MERCEDES BENZ OM352			O407H con motor/MERCEDES BENZ OM427H			SPRINTER 408CDI, SPRINTER 413CDI, SPRINTER 416CDI con motor/MERCEDES BENZ OM612		
ACEITE	G-31	1846725	ACEITE	G-143	11843825	ACEITE	G-918	000 180 2309
O309D con motor/MERCEDES BENZ OM615			O405G con motores/MERCEDES BENZ OM407A, MERCEDES BENZ OM407HA					
COMBUSTIBLE	G-1121F	3524700092	ACEITE	G-143	11843825			
O317 con motor/MERCEDES BENZ OM326			O405N con motor/MERCEDES BENZ OM447					
COMBUSTIBLE	G-1123F	4220900051	AIRE	GA-405	10947904			
O317 con motor/MERCEDES BENZ OM355HA			O407H con motor/MERCEDES BENZ OM427H					
COMBUSTIBLE	G-1123F	4220900051	ACEITE	G-143	4031840025			

SERVICIO PESADO

MARCA-MODELO-MOTOR	GONHER	OEM	MARCA-MODELO-MOTOR	GONHER	OEM	MARCA-MODELO-MOTOR	GONHER	OEM
MAKE-MODEL-ENGINE	GONHER	OEM	MAKE-MODEL-ENGINE	GONHER	OEM	MAKE-MODEL-ENGINE	GONHER	OEM
MERCEDES BENZ (continuación)			MERCEDES BENZ (continuación)			MERCEDES BENZ (continuación)		
CAMIONES, TRACTOCAMIONES Y AUTOBUSES			CAMIONES, TRACTOCAMIONES Y AUTOBUSES			CAMIONES, TRACTOCAMIONES Y AUTOBUSES		
DIESEL	GPP-612	A6120920001				U2050 UNIMOG (437), U2150 UNIMOG (437) con motores/MERCEDES BENZ OM356A (N. SER. 286114 EN ADELANTE), MERCEDES BENZ OM356LA (N. SER. 286114 EN ADELANTE), MERCEDES BENZ OM366LA (N. SER. 286114 EN ADELANTE)		
AIRE, CON FIELTRO	GA-5876	A003094830467	U1300 UNIMOG con motores/MERCEDES BENZ OM356 (1988 EN ADELANTE), MERCEDES BENZ OM366A (1998 EN ADELANTE)			COMBUSTIBLE	G-1121	3524700092
AIRE, SIN FIELTRO	GA-475	A0040942604				ACEITE	G-225	1842225
			COMBUSTIBLE	G-1121F	3524700090	COMBUSTIBLE	G-1121F	3524700092
SPRINTER 616CDI con motor/MERCEDES BENZ OM612						ACEITE	G-225	1842225
AIRE, CON FIELTRO	GA-5876	A003094830467				COMBUSTIBLE	G-1121F	3524700092
TORINO con motor/MERCEDES BENZ OM904LA			U1350 L UNIMOG con motores/MERCEDES BENZ OM352 (N. SER. 286115 EN ADELANTE), MERCEDES BENZ OM352A (N. SER. 286115 EN ADELANTE), MERCEDES BENZ OM353 (N. SER. 286115 EN ADELANTE)			COMBUSTIBLE	G-1121	3524700092
ACEITE	G-3827	CH5957				ACEITE	G-225	1842225
AIRE, SECUNDARIO	GA-802R	IT2002S	COMBUSTIBLE	G-1121F	3524700092	COMBUSTIBLE	G-1121F	3524700092
AIRE, PRIMARIO	GA-801R	IT2002				ACEITE	G-225	1842225
			COMBUSTIBLE	G-1121F	3524700092			
TORINO con motor/MERCEDES BENZ OM906								
HIDRAULICO	G-162H	A 000 466 06 04	U1350 L UNIMOG con motores/MERCEDES BENZ OM356 (1988 EN ADELANTE), MERCEDES BENZ OM366A (1998 EN ADELANTE)			COMBUSTIBLE	G-1121	3524700092
ACEITE	G-3754	A0001801709				ACEITE	G-225	1842225
DIESEL, CARTUCHO	G-1046	A9060920305	COMBUSTIBLE	G-1121	3524700092	COMBUSTIBLE	G-1121F	3524700090
COMBUSTIBLE, SEPARADOR DE AGUA	GPP-1060	9794770015	ACEITE	G-225	1842225			
COMBUSTIBLE, SEPARADOR DE AGUA	GPP-1061	WK 1060/1	COMBUSTIBLE	G-1121F	3524700090			
AIRE, SECUNDARIO	GA-907R	CF9615						
AIRE, PRIMARIO	GA-906R	CF9614	U140 UNIMOG (418) con motor/MERCEDES BENZ OM364.982LA			COMBUSTIBLE	G-1121	3524700092
			COMBUSTIBLE	G-1121	3524700092			
U100 T UNIMOG (416) con motor/A DIESEL			U1400 UNIMOG (427), U1450 UNIMOG (427) con motores/MERCEDES BENZ OM356 (N. SER. 286115 EN ADELANTE), MERCEDES BENZ OM366A (N. SER. 286115 EN ADELANTE)			COMBUSTIBLE	G-1121	3524700092
COMBUSTIBLE	G-1121	3524700092				ACEITE	G-225	1842225
			COMBUSTIBLE	G-1121F	3524700092	COMBUSTIBLE	G-1121F	3524700092
U1000 T UNIMOG (424 & 427), U1000 UNIMOG (424 & 427) con motor/MERCEDES BENZ OM366.915			ACEITE	G-225	1842225			
COMBUSTIBLE	G-1121	4774715	COMBUSTIBLE	G-1121F	3524700092			
U110 UNIMOG (404.0), U110 UNIMOG (404.1) con motor/A DIESEL (HASTA 1958)			U150 UNIMOG (425), U120 UNIMOG (425), U125 UNIMOG (425) con motor/MERCEDES BENZ OM353			COMBUSTIBLE	G-1121	3524700092
ACEITE	G-225	1842225						
			COMBUSTIBLE	G-1121	3524700092			
U110 UNIMOG (418) con motor/MERCEDES BENZ OM364A			U1500 L UNIMOG, U1550 UNIMOG con motores/MERCEDES BENZ OM352, MERCEDES BENZ OM352A, MERCEDES BENZ OM353			COMBUSTIBLE	G-1121	3524700092
COMBUSTIBLE	G-1121	3524700092				ACEITE	G-225	1842225
			COMBUSTIBLE	G-1121F	3524700092	COMBUSTIBLE	G-1121F	3524700092
			ACEITE	G-225	1842225			
U1100 L UNIMOG (416), U1150 L UNIMOG (417), U1150 UNIMOG (416), U1150 UNIMOG (417), U1100 L UNIMOG (417), U1100 T UNIMOG (416), U1100 T UNIMOG (417), U1100 UNIMOG (416), U1100 UNIMOG (417), U1150 L UNIMOG (416) con motores/MERCEDES BENZ OM352 (1977-88), MERCEDES BENZ OM353 (1977-88)			COMBUSTIBLE	G-1121F	3524700092			
COMBUSTIBLE	G-1121	3444777215						
			U1500 UNIMOG con motores/MERCEDES BENZ OM353, MERCEDES BENZ OM352, MERCEDES BENZ OM352A			COMBUSTIBLE	G-1121F	3524700092
			COMBUSTIBLE	G-1121	3524700092			
			ACEITE	G-225	1842225	UNIMOG U1200 con motores/MERCEDES BENZ OM352, MERCEDES BENZ OM352A		
U1200 UNIMOG, U1250 UNIMOG con motores/MERCEDES BENZ OM352, MERCEDES BENZ OM352A, MERCEDES BENZ OM366A (1998-ON DESDE S/N. 286115)			COMBUSTIBLE	G-1121F	3524700092	COMBUSTIBLE	G-1121F	3524700092
COMBUSTIBLE	G-1121	3524700092						
			U1600 UNIMOG, U1650 UNIMOG (427) con motores/MERCEDES BENZ OM356, MERCEDES BENZ OM366			UNIMOG U1500, UNIMOG U1500L con motor/A DIESEL		
			COMBUSTIBLE	G-1121	3524700092	ACEITE	G-143	4031840025
U1300 L UNIMOG con motores/MERCEDES BENZ OM352 (N. SER. 286115 EN ADELANTE), MERCEDES BENZ OM352A (N. SER. 286115 EN ADELANTE), MERCEDES BENZ OM353 (N. SER. 286115 EN ADELANTE)			U1700 con motor/A DIESEL			UNIMOG U34 (411), UNIMOG U120 (425), UNIMOG U1300, UNIMOG U1300L, UNIMOG U150 (425) con motor/A DIESEL		
COMBUSTIBLE	G-1121	3524700092	COMBUSTIBLE	G-1121F	3524700092	COMBUSTIBLE	G-1121F	3524700092
ACEITE	G-225	1842225						
COMBUSTIBLE	G-1121F	3524700092						
			U1700 UNIMOG, U1750 UNIMOG con motores/MERCEDES BENZ OM356, MERCEDES BENZ OM366			UNIMOG U40 (421), UNIMOG U52 (421), UNIMOG U600L, UNIMOG U60T (421) con motores/MERCEDES BENZ OM615, MERCEDES BENZ OM616, MERCEDES BENZ OM621		
			COMBUSTIBLE	G-1121	3524700092	COMBUSTIBLE	G-1121F	3524700092
			ACEITE	G-225	1842225			
U1300 L UNIMOG con motores/MERCEDES BENZ OM356 (1988 EN ADELANTE), MERCEDES BENZ OM366A (1998 EN ADELANTE)			COMBUSTIBLE	G-1121F	3524700092	UNIMOG U500 con motor/MERCEDES BENZ OM906		
COMBUSTIBLE	G-1121	3524700092				ACEITE	G-3754	A0001801709
ACEITE	G-225	1842225						
COMBUSTIBLE	G-1121F	3524700092				UNIMOG U54 (403), UNIMOG U66 (403), UNIMOG U72 (403), UNIMOG U72 (406), UNIMOG U80 (413) con motor/A DIESEL		
			U2000 UNIMOG (437), U2100 UNIMOG (437) con motores/MERCEDES BENZ OM366LA (N. SER. 286114 EN ADELANTE), MERCEDES BENZ OM356A (N. SER. 286114 EN ADELANTE), MERCEDES BENZ OM356LA (N. SER. 286114 EN ADELANTE)			COMBUSTIBLE	G-1121F	3524700092
			COMBUSTIBLE	G-1121	3524700092			
			ACEITE	G-225	1842225	UNIMOG U600T, UNIMOG U45 (421), UNIMOG U600 con motores/MERCEDES BENZ OM621, MERCEDES BENZ OM615, MERCEDES BENZ OM616		
U1300 UNIMOG con motores/MERCEDES BENZ OM352 (N. SER. 286115 EN ADELANTE), MERCEDES BENZ OM352A (N. SER. 286115 EN ADELANTE), MERCEDES BENZ OM353 (N. SER. 286115 EN ADELANTE)			COMBUSTIBLE	G-1121F	3524700092	COMBUSTIBLE	G-1121F	3524700092
COMBUSTIBLE	G-1121	3524700092						
ACEITE	G-225	1842225				UNIMOG U70 (406), UNIMOG U95, UNIMOG U80 (406), UNIMOG U80 (416), UNIMOG U84 (406), UNIMOG U84 (416), UNIMOG U90 (416), UNIMOG U900 con motor/A DIESEL		
COMBUSTIBLE	G-1121F	3524700092						

MARCA-MODELO-MOTOR	GONHER	OEM
MAKE-MODEL-ENGINE	GONHER	OEM
MERCEDES BENZ (continuación)		
CAMIONES, TRACTOCAMIONES Y AUTOBUSES		
COMBUSTIBLE	G-1121F	3524700092
UNIMOG U800, UNIMOG U800L con motor/MERCEDES BENZ OM314		
COMBUSTIBLE	G-1121F	3524700092
UNIMOGD con motor/A DIESEL		
COMBUSTIBLE, SIN CUBIERTA	G-1121	3524700092
V 230 con motor/MERCEDES BENZ M111.978		
GASOLINA	GG-251	24772701
V200, V220 con motor/MERCEDES BENZ OM611		
AIRE, CON FIELTRO	GA-5876	A003094830467
VITO 108CDI, VITO 110CDI, VITO 112CDI con motor/MERCEDES BENZ OM611		
DIESEL	GPP-612	A6120920001
AIRE, CON FIELTRO	GA-5876	A003094830467
AIRE, SIN FIELTRO	GA-475	A0040942604
VITO 113, VITO 114 con motores/MERCEDES BENZ M111.948, MERCEDES BENZ M111.978		
GASOLINA	GG-251	24772701

MERCEDES BENZ		
MOTORES		
121-B111 A DIESEL, M180-110 A DIESEL		
ACEITE	G-225	1842225
846 A A DIESEL, 846 AB A DIESEL, LK315 A DIESEL, M315 A DIESEL, MB846A A DIESEL, MB846AB A DIESEL, OM315 A DIESEL, OM321 A DIESEL, OM322 A DIESEL, OM326 A DIESEL, OM421 A DIESEL, OM429LA A DIESEL		
COMBUSTIBLE	G-1123	4220900051
851 A DIESEL, 852 A DIESEL, 853 A DIESEL, 854 A DIESEL, 856 A DIESEL, 861 A DIESEL, 862 A DIESEL, 863 A DIESEL, 864 A DIESEL, 866 A DIESEL, L311 A DIESEL, L312 A DIESEL, L315 A DIESEL, L325 A DIESEL, LK31 A DIESEL, LK311 A DIESEL, LK325 A DIESEL, M202B A DIESEL, M203B A DIESEL, M204B A DIESEL, MB851 A DIESEL, MB852 A DIESEL, MB853 A DIESEL, MB854 A DIESEL, MB856 A DIESEL, MB861 A DIESEL, MB862 A DIESEL, MB863 A DIESEL, MB864 A DIESEL, MB866 A DIESEL, OM312 A DIESEL, OM314 A DIESEL, OM400 A DIESEL, OM401 A DIESEL, OM402 A DIESEL, OM403 A DIESEL, OM404 A DIESEL, OM407 A DIESEL, OM616 A DIESEL, OM617 A DIESEL		
COMBUSTIBLE, PRIMARIO SIN CUBIERTA	G-1121	3444777215
COMBUSTIBLE, SECUNDARIO SIN CUBIERTA	G-1123	4220900051
COMBUSTIBLE, PRIMARIO CON CUBIERTA	G-1121F	3444777215
COMBUSTIBLE, SECUNDARIO CON CUBIERTA	G-1123F	4220900051
904 (4.25L) A DIESEL, 906 (6.4L) A DIESEL, E 900 A DIESEL, MBE904 (4.3L) A DIESEL, MBE906 (6.4L) A DIESEL, MBE924 (4.8L) A DIESEL, MBE926 (7.2L) A DIESEL, OM906LA A DIESEL, OM926LA A DIESEL		
ACEITE	G-3754	A0001801709
CM636V13 A DIESEL, L319 A DIESEL, O319 A DIESEL		
COMBUSTIBLE, SIN CUBIERTA	G-1121	3524700092
ACEITE	G-225	1842225
COMBUSTIBLE, CON CUBIERTA	G-1121F	3524700092
D3250 A DIESEL, L3000D A DIESEL, MB253 A DIESEL, OM362 LA A DIESEL, OM362A A DIESEL, OM364 A DIESEL, OM366A A DIESEL, OM615 A DIESEL, OM621 A DIESEL		
COMBUSTIBLE, SIN CUBIERTA	G-1121	3524700092

MARCA-MODELO-MOTOR	GONHER	OEM
MAKE-MODEL-ENGINE	GONHER	OEM
MERCEDES BENZ (continuación)		
MOTORES		
MBE600 5 CYL (2.7L) TURBO DIESEL A DIESEL		
ACEITE	G-918	6111800009
MBE900 SERIES A DIESEL		
ACEITE	G-3754	A0001801709
COMBUSTIBLE	G-1046	A0000901551
COMBUSTIBLE, PURGADOR	GPP-1291	FS1291
COMBUSTIBLE, SEPARADOR DE AGUA CON ROSCA PARA TAZON	S 3226 P	S3226P
OM327 A DIESEL		
ACEITE	G-31	1846725
COMBUSTIBLE, PRIMARIO SIN CUBIERTA	G-1121	4774715
COMBUSTIBLE, PRIMARIO CON CUBIERTA	G-1121F	4774715
OM346 A DIESEL, OM352A A DIESEL, OM360 A DIESEL		
ACEITE, DERIVACION (BY PASS)	G-31	1846725
COMBUSTIBLE, PRIMARIO SIN CUBIERTA	G-1121	3440927005
COMBUSTIBLE, SECUNDARIO SIN CUBIERTA	G-1123	4773115
COMBUSTIBLE, PRIMARIO CON CUBIERTA	G-1121F	3444777215
COMBUSTIBLE, SECUNDARIO CON CUBIERTA	G-1123F	4773115
ACEITE, FLUJO TOTAL (FULL FLOW)	G-926	11843925
OM352 A DIESEL		
ACEITE, 1977-78	G-31	1846725
COMBUSTIBLE, PRIMARIO SIN CUBIERTA	G-1121	4774715
COMBUSTIBLE, SIN CUBIERTA	G-1123	4773115
COMBUSTIBLE, PRIMARIO CON CUBIERTA	G-1121F	4774715
COMBUSTIBLE, CON CUBIERTA	G-1123F	4773115
OM352X A DIESEL, OM364 A DIESEL, OM366 A DIESEL		
COMBUSTIBLE	G-1121	3524700092
COMBUSTIBLE	G-1121F	3524700092
ACEITE	GP-88	31841701
OM355 A DIESEL		
ACEITE, FLUJO TOTAL (FULL FLOW) HASTA 3/78	G-31	1846725
COMBUSTIBLE, PRIMARIO SIN CUBIERTA	G-1121	3440927005
COMBUSTIBLE, SECUNDARIO SIN CUBIERTA	G-1123	4773115
COMBUSTIBLE, PRIMARIO CON CUBIERTA	G-1121F	3440927005
COMBUSTIBLE, SECUNDARIO CON CUBIERTA	G-1123F	4773115
ACEITE, FLUJO TOTAL (FULL FLOW) 3/78 EN ADELANTE	G-989	3551800009
OM366LA A DIESEL, OM457 A DIESEL		
HIDRAULICO	G-162H	A 000 466 06 04
OM407 A A DIESEL, OM407 HA A DIESEL, OM422 A A DIESEL, OM422 A DIESEL, OM422 LA A DIESEL		
COMBUSTIBLE	G-1121	3524700092
ACEITE	G-143	4031840025
COMBUSTIBLE	G-1121F	3524700092
OM423 A DIESEL, OM424 A DIESEL, OM427 A DIESEL, OM442 A DIESEL, OM444 A DIESEL		
COMBUSTIBLE, SIN CUBIERTA	G-1123	4220900051

MARCA-MODELO-MOTOR	GONHER	OEM
MAKE-MODEL-ENGINE	GONHER	OEM
MERCEDES BENZ (continuación)		
MOTORES		
ACEITE	G-143	4031840025
COMBUSTIBLE, CON CUBIERTA	G-1123F	4220900051
OM423 LA A DIESEL, OM424 A A DIESEL, OM427 H A DIESEL, OM427 HA A DIESEL, OM442 A A DIESEL, OM442 LA A DIESEL, OM444 A A DIESEL, OM444 LA A DIESEL, OM457A A DIESEL, OM477 h LA A DIESEL		
ACEITE	G-143	4021800009
OM447 LA A DIESEL		
ACEITE, FLUJO TOTAL (FULL FLOW)	G-143	4031840025
COMBUSTIBLE, CARTUCHO, PRIMARIO	G-1123F	4774515
HIDRAULICO	G-162H	A 000 466 06 04
COMBUSTIBLE, SEPARADOR DE AGUA	GPP-1060	9794770015
OM449 A A DIESEL		
ACEITE, FLUJO TOTAL (FULL FLOW)	G-163	4011840025
COMBUSTIBLE, CARTUCHO, PRIMARIO	G-1123F	4774515
HIDRAULICO	G-162H	A 000 466 06 04
COMBUSTIBLE, SEPARADOR DE AGUA	GPP-1060	9794770015
OM636 A DIESEL		
COMBUSTIBLE, SECUNDARIO 4 17/32 IN SIN CUBIERTA	G-1121	3524700092
COMBUSTIBLE, SECUNDARIO 5 49/64 IN SIN CUBIERTA	G-1123	4220900051
ACEITE	G-225	1842225
COMBUSTIBLE, SECUNDARIO 4 17/32 IN CON CUBIERTA	G-1121F	3524700092
COMBUSTIBLE, SECUNDARIO 5 49/64 IN CON CUBIERTA	G-1123F	4220900051
OM904 A DIESEL		
HIDRAULICO	G-162H	A 000 466 06 04
COMBUSTIBLE, CARTUCHO	G-1046	A9060920305
COMBUSTIBLE, SEPARADOR DE AGUA	GPP-1060	9794770015
OM904LA A DIESEL, OM905LA A DIESEL, OM907LA A DIESEL		
ACEITE	G-3827	A0001801609
OM906 A DIESEL		
HIDRAULICO	G-162H	A 000 466 06 04
ACEITE, FLUJO TOTAL (FULL FLOW)	G-3754	A0001801709
COMBUSTIBLE, CARTUCHO	G-1046	A9060920305
COMBUSTIBLE, SEPARADOR DE AGUA	GPP-1060	9794770015
OM924LA A DIESEL		
ACEITE	G-3827	1801609
COMBUSTIBLE	G-1046	A0000901551
COMBUSTIBLE, SEPARADOR DE AGUA	GPP-1061	A0004771302

MERCEDES BENZ		
TRACTORES		
1000 con motor/MERCEDES BENZ OM366		
COMBUSTIBLE, SIN CUBIERTA	G-1121	3524700092
1100 con motor/MERCEDES BENZ OM366		
COMBUSTIBLE, SIN CUBIERTA	G-1121	3524700092

SERVICIO PESADO

MARCA-MODELO-MOTOR MAKE-MODEL-ENGINE	GONHER GONHER	OEM OEM	MARCA-MODELO-MOTOR MAKE-MODEL-ENGINE	GONHER GONHER	OEM OEM	MARCA-MODELO-MOTOR MAKE-MODEL-ENGINE	GONHER GONHER	OEM OEM
MERCEDES BENZ (continuación)			MICHIGAN (continuación)			MICHIGAN (continuación)		
TRACTORES			CARGADORAS			CARGADORAS		
1300 TURBO, 1400 TURBO, 1600 TURBO con motor/MERCEDES BENZ OM366A			AIRE, RESPIRADOR	GA-39	945354	ACEITE, FLUJO TOTAL (FULL FLOW)	G-566	946011
COMBUSTIBLE, SIN CUBIERTA	G-1121	3524700092	ACEITE, DERIVACION (BY PASS)	G-750	947293	COMBUSTIBLE, SELLADO	GP-1101	158172
1300, 1500 con motor/A DIESEL			125A SERIES I con motor/GMC 4-71			175A SERIES I con motor/GMC 4-71		
COMBUSTIBLE, SIN CUBIERTA	G-1121	3524700092	ACEITE, DERIVACION (BY PASS)	G-31	P3H4120	DIRECCION	G-33	945580
1800 con motor/A DIESEL			DIRECCION	G-33	945580	ACEITE, FLUJO TOTAL (FULL FLOW)	G-33	215502
COMBUSTIBLE	G-1121	3524700092	ACEITE, FLUJO TOTAL (FULL FLOW)	G-33	215502	HIDRAULICO	G-33	945580
1800 INTER-COOLER con motor/MERCEDES BENZ OM366LA			HIDRAULICO	G-33	945580	TRANSMISION	G-33	215502
COMBUSTIBLE, SIN CUBIERTA	G-1121	4774715	TRANSMISION	G-33	215502	COMBUSTIBLE, SECUNDARIO	G-1173	945354
65/70 con motor/MERCEDES BENZ OM314			COMBUSTIBLE, SECUNDARIO	G-1173	945354	175A SERIES I con motor/GMC 6V-53		
COMBUSTIBLE	G-1121	3524700092	125A SERIES II con motor/GMC 6V-53			ACEITE, DERIVACION (BY PASS)	G-31	P3H4120
COMBUSTIBLE	G-1121F	3524700092	ACEITE, DERIVACION (BY PASS)	G-31	P3H4120	DIRECCION	G-33	945580
AIRE	GA-49	10944504	DIRECCION	G-33	215502	ACEITE, FLUJO TOTAL (FULL FLOW)	G-33	215502
65/75, 700G, 700K, 700S con motor/A DIESEL			ACEITE, FLUJO TOTAL (FULL FLOW)	G-33	215502	HIDRAULICO	G-33	945580
COMBUSTIBLE, SIN CUBIERTA	G-1121	3524700092	HIDRAULICO	G-33	945580	TRANSMISION	G-33	215502
COMBUSTIBLE, CON CUBIERTA	G-1121F	3524700092	TRANSMISION	G-33	945580	COMBUSTIBLE, SECUNDARIO	G-1173	945354
AIRE	GA-49	10944504	COMBUSTIBLE, SECUNDARIO	G-1175	945445	175A SERIES I con motor/WAUKESHA 135DKB DIESEL		
700 con motor/MERCEDES BENZ OM364			AIRE, PRIMARIO	GA-106	946897	ACEITE	G-31	P3H4120
COMBUSTIBLE, SIN CUBIERTA	G-1121	3524700092	AIRE	GAK-20	944954	DIRECCION	G-33	945580
800 con motor/MERCEDES BENZ OM364			AIRE, SECUNDARIO	GA-206	1911724	HIDRAULICO	G-33	945580
COMBUSTIBLE, SIN CUBIERTA	G-1121	3524700092	125A SERIES II con motores/CUMMINS C160C1, CUMMINS C175C1			TRANSMISION	G-33	215502
COMBUSTIBLE, CON CUBIERTA	G-1121F	3524700092	DIRECCION	G-33	215502	COMBUSTIBLE, SECUNDARIO	G-1176	940221
DIRECCION	G-162H	1902137	HIDRAULICO	G-33	945580	175A SERIES I con motor/WAUKESHA 135GKB A GASOLINA		
900 con motor/MERCEDES BENZ OM364A			TRANSMISION	G-33	945580	ACEITE	G-31	P3H4120
COMBUSTIBLE, SIN CUBIERTA	G-1121	3524700092	ACEITE, FLUJO TOTAL (FULL FLOW)	G-566	946011	DIRECCION	G-33	945580
900 TURBO con motor/MERCEDES BENZ OM364A			COMBUSTIBLE	GP-1101	158172	HIDRAULICO	G-33	945580
COMBUSTIBLE, SIN CUBIERTA	G-1121	3524700092	AIRE, RESPIRADOR	GA-39	945354	TRANSMISION	G-33	945580
95/105 con motor/A DIESEL			AIRE, SIN ASPAS	GA-24	945059	175A SERIES II con motor/CUMMINS V8R240C1		
COMBUSTIBLE	G-1121	3444777215	AIRE, PRIMARIO	GA-106	946897	DIRECCION	G-33	945580
			AIRE, SECUNDARIO	GA-206	1911724	HIDRAULICO	G-33	945580
			ACEITE, DERIVACION (BY PASS)	G-750	947293	TRANSMISION	G-33	215502
			125C con motor/CUMMINS			ACEITE, FLUJO TOTAL (FULL FLOW)	G-566	946011
			ACEITE, FLUJO TOTAL (FULL FLOW) CARTUCHO	G-566	946011	COMBUSTIBLE	G-1143	946010
			COMBUSTIBLE	GP-1101	158172	AIRE, RESPIRADOR	GA-39	945354
			ACEITE, FLUJO TOTAL (FULL FLOW) SELLADO	GP-53	961172	AIRE, SIN ASPAS	GA-27	945059
			ACEITE, DERIVACION (BY PASS)	GP-57	963023	ACEITE, DERIVACION (BY PASS)	G-750	947293
			AGUA	GP-2071W	E4099799	175A SERIES II con motor/DETROIT DIESEL 4-71		
			AIRE, PRIMARIO	GA-106	12968382	ACEITE, CONVERTIDOR DE TORSION	G-33	215502
			AIRE, SECUNDARIO	GA-206	1911724	HIDRAULICO	G-33	953989
			125C con motor/DETROIT DIESEL 6V-71			AIRE, PRIMARIO	GA-106	946897
			ACEITE, FLUJO TOTAL (FULL FLOW) CARTUCHO	G-33	215502	AIRE, SECUNDARIO	GA-206	1911724
			TRANSMISION	G-33	215502	175A SERIES II con motor/DETROIT DIESEL 8V-71		
			COMBUSTIBLE, PRIMARIO	GP-26	3576059	AIRE, SIN ASPAS	GA-24	945059
			COMBUSTIBLE, SECUNDARIO	GP-27	3576061	175A SERIES II con motor/WAUKESHA 135DKB		
			ACEITE, FLUJO TOTAL (FULL FLOW) SELLADO	GP-43	192235	ACEITE, CONVERTIDOR DE TORSION	G-33	215502
			AIRE, PRIMARIO	GA-106	12968382	HIDRAULICO	G-33	945580
			AIRE, SECUNDARIO	GA-206	1911724	COMBUSTIBLE, SECUNDARIO	G-1176	940221
			12B con motores/WAUKESHA 180DLC DIESEL, WAUKESHA 180GKB GASOLINA, WAUKESHA 180GLB			175A SERIES II con motor/WAUKESHA 135DKBS		
			AIRE, SIN ASPAS	GA-33	889098	ACEITE, DERIVACION (BY PASS)	G-31	P3H4120
			175A SERIES I con motor/CUMMINS C175C1			ACEITE, CONVERTIDOR DE TORSION	G-33	215502
			DIRECCION	G-33	945580	HIDRAULICO	G-33	945580
			HIDRAULICO	G-33	945580	COMBUSTIBLE, SECUNDARIO	G-1176	940221
			TRANSMISION	G-33	215502			

MICHIGAN

CARGADORAS

125 SERIES III ARTICULADA con motor/CUMMINS		
TRANSMISION	G-33	215502
ACEITE, FLUJO TOTAL (FULL FLOW) CARTUCHO	G-566	946011
COMBUSTIBLE	G-1143	946010
ACEITE, FLUJO TOTAL (FULL FLOW) SELLADO	GP-53	961172
AIRE, RESPIRADOR	GA-39	945354
AIRE	GA-106	946897
ACEITE, DERIVACION (BY PASS)	G-750	947293
125 SERIES III ARTICULADA con motor/GMC 6V-71N		
ACEITE, FLUJO TOTAL (FULL FLOW)	G-33	215502
TRANSMISION	G-33	215502
COMBUSTIBLE, SECUNDARIO	G-1175	945445
AIRE	GA-106	946897
125A SERIES I con motor/CUMMINS JN6C1		
DIRECCION	G-33	945580
HIDRAULICO	G-33	945580
TRANSMISION	G-33	215502
ACEITE, FLUJO TOTAL (FULL FLOW)	G-566	946011

MARCA-MODELO-MOTOR MAKE-MODEL-ENGINE	GONHER GONHER	OEM OEM	MARCA-MODELO-MOTOR MAKE-MODEL-ENGINE	GONHER GONHER	OEM OEM	MARCA-MODELO-MOTOR MAKE-MODEL-ENGINE	GONHER GONHER	OEM OEM
MICHIGAN (continuación)			MICHIGAN (continuación)			MICHIGAN (continuación)		
CARGADORAS			CARGADORAS			CARGADORAS		
175A SERIES II con motor/WAUKESHA 135GK			AIRE, PRIMARIO	GA-6129	946857	COMBUSTIBLE, SECUNDARIO	G-1175	945445
ACEITE, CONVERTIDOR DE TORSION	G-33	215502	275A con motor/CUMMINS NTO6C1			35C con motor/GMC 3-53		
			DIRECCION	G-33	945580	ACEITE, FLUJO TOTAL (FULL FLOW) CARTUCHO	G-119	946008
175A SERIES II con motores/GMC 6V-71, GMC 6V-71N			HIDRAULICO	G-33	945580	COMBUSTIBLE, SECUNDARIO CARTUCHO	G-1173	945354
DIRECCION	G-33	945580	TRANSMISION	G-33	215502	COMBUSTIBLE, PRIMARIO SELLADO	GP-92	1992217
ACEITE, FLUJO TOTAL (FULL FLOW)	G-33	215502	ACEITE, FLUJO TOTAL (FULL FLOW)	G-566	946011	COMBUSTIBLE, SECUNDARIO SELLADO	GP-93	1992215
HIDRAULICO	G-33	945580	ACEITE, TURBOCARGADOR	GP-14	W93640	ACEITE, FLUJO TOTAL (FULL FLOW) SELLADO	GP-43	1992235
TRANSMISION	G-33	215502	COMBUSTIBLE, SELLADO	GP-1101	158172	AIRE, PRIMARIO	GAK-625	961000
COMBUSTIBLE, SECUNDARIO	G-1175	945445	AIRE	GA-5648	944398			
AIRE, SIN ASPAS	GA-24	945059	ACEITE, DERIVACION (BY PASS)	G-750	947293			
			275A con motor/GMC 8V-71			35C con motor/PERKINS 4.248		
175A SERIES III ARTICULADA con motor/GMC 6V-71N			DIRECCION	G-33	945580	ACEITE	GP-1	6511766
AIRE, SECUNDARIO	GA-6127	949363	ACEITE, FLUJO TOTAL (FULL FLOW)	G-33	215502			
			HIDRAULICO	G-33	945580	375 con motor/CUMMINS NRTO6C1		
175A SERIES III con motor/CUMMINS V8R140C1			TRANSMISION	G-33	215502	HIDRAULICO	G-33	945580
DIRECCION	G-33	945580	COMBUSTIBLE, SECUNDARIO	G-1175	945445	TRANSMISION	G-33	215502
TRANSMISION	G-33	215502	275A SERIES II con motor/CUMMINS NTO310C1			ACEITE, FLUJO TOTAL (FULL FLOW)	G-566	946011
ACEITE, FLUJO TOTAL (FULL FLOW) CARTUCHO	G-566	946011	DIRECCION	G-33	945580	ACEITE, TURBOCARGADOR	GP-14	W93640
COMBUSTIBLE	G-1143	946010	HIDRAULICO	G-33	945580	COMBUSTIBLE, SELLADO	GP-1101	158172
ACEITE, FLUJO TOTAL (FULL FLOW) SELLADO	GP-53	961172	TRANSMISION	G-33	215502	AIRE, RESPIRADOR	GA-39	945354
AIRE, RESPIRADOR	GA-39	945354	ACEITE, FLUJO TOTAL (FULL FLOW)	G-566	946011			
AIRE, SIN ASPAS	GA-27	944809	COMBUSTIBLE	G-1143	946010	440, 443 con motor/A DIESEL		
ACEITE, DERIVACION (BY PASS)	G-750	947293	ACEITE, TURBOCARGADOR	GP-14	W93640	HIDRAULICO	GP-761H	6599543
			AIRE, SECUNDARIO	GA-6127	949363			
175A SERIES III con motor/DETROIT DIESEL 4-71			AIRE, PRIMARIO	GA-6129	1529585	45A con motor/GMC 3-53		
ACEITE, CONVERTIDOR DE TORSION	G-33	215502	ACEITE, DERIVACION (BY PASS)	G-750	947293	ACEITE, FLUJO TOTAL (FULL FLOW)	G-119	946008
HIDRAULICO	G-33	953989						
AIRE, PRIMARIO	GA-106	946897	275A SERIES II con motor/GMC 8V-71			475 SERIES III ARTICULADA con motor/CUMMINS V12-635C1		
AIRE, SECUNDARIO	GA-206	1911724	DIRECCION	G-33	945580	TRANSMISION	G-33	215502
			ACEITE, FLUJO TOTAL (FULL FLOW)	G-33	215502	ACEITE, FLUJO TOTAL (FULL FLOW) CARTUCHO	G-566	946011
175A SERIES III con motor/DETROIT DIESEL 8V-71			HIDRAULICO	G-33	945580	COMBUSTIBLE	G-1143	946010
DIRECCION	G-33	945580	TRANSMISION	G-33	215502	ACEITE, TURBOCARGADOR	GP-14	W93640
HIDRAULICO	G-33	945580	COMBUSTIBLE, SECUNDARIO	G-1175	945445	ACEITE, FLUJO TOTAL (FULL FLOW) SELLADO	GP-53	961172
TRANSMISION	G-33	215502	AIRE, SECUNDARIO	GA-6127	949363	AGUA	GP-2071W	E4099799
AIRE, SIN ASPAS	GA-27	944809	AIRE, PRIMARIO	GA-6129	1529585	AIRE, SECUNDARIO	GA-6127	949363
AIRE, PRIMARIO	GA-106	946897				AIRE, PRIMARIO	GA-6129	946857
AIRE, SECUNDARIO	GA-6127	949363	275A SERIES III ARTICULADA con motor/CUMMINS NT335C1			ACEITE, DERIVACION (BY PASS)	G-750	947293
AIRE, PRIMARIO	GA-6129	1529585	TRANSMISION	G-33	215502			
AIRE, SECUNDARIO	GA-206	1911724	ACEITE, FLUJO TOTAL (FULL FLOW) CARTUCHO	G-566	946011	475 SERIES IIIA con motor/CUMMINS		
			COMBUSTIBLE	G-1143	946010	TRANSMISION	G-33	215502
175A SERIES III con motor/GMC 6V-71N			ACEITE, FLUJO TOTAL (FULL FLOW) SELLADO	GP-53	961172	ACEITE, FLUJO TOTAL (FULL FLOW) CARTUCHO	G-566	946011
DIRECCION	G-33	945580	AIRE	GA-6129	946857	COMBUSTIBLE	G-1143	946010
ACEITE, FLUJO TOTAL (FULL FLOW)	G-33	215502	ACEITE, DERIVACION (BY PASS)	G-750	947293	ACEITE, FLUJO TOTAL (FULL FLOW) SELLADO	GP-53	961172
TRANSMISION	G-33	215502				AGUA	GP-2071W	E4099799
COMBUSTIBLE, SECUNDARIO	G-1175	945445	275A SERIES III con motor/CUMMINS NT310C1			AIRE, SECUNDARIO	GA-6127	949363
AIRE, SIN ASPAS	GA-27	944809	DIRECCION	G-33	945580	AIRE, PRIMARIO	GA-6129	946857
			TRANSMISION	G-33	215502	ACEITE, DERIVACION (BY PASS)	G-750	947293
175C con motor/CUMMINS			ACEITE, FLUJO TOTAL (FULL FLOW) CARTUCHO	G-566	946011			
COMBUSTIBLE	GP-1101	158172	COMBUSTIBLE	G-1143	946010	543, 843 con motor/A DIESEL		
ACEITE, FLUJO TOTAL (FULL FLOW)	GP-53	961172	ACEITE, FLUJO TOTAL (FULL FLOW) SELLADO	GP-53	961172	HIDRAULICO	GP-761H	6599543
ACEITE, DERIVACION (BY PASS)	GP-57	963023	AIRE	GA-6129	946857			
AGUA	GP-2071W	E4099799	ACEITE, DERIVACION (BY PASS)	G-750	947293	55 SERIES II con motor/CONTINENTAL F244 A GASOLINA		
						DIRECCION	G-33	945580
175C con motor/DETROIT DIESEL 8V-71			275A SERIES III con motor/GMC 8V-71N			HIDRAULICO	G-33	945580
ACEITE, FLUJO TOTAL (FULL FLOW)	G-33	215502	DIRECCION	G-33	945580	TRANSMISION	G-33	215502
TRANSMISION	G-33	215502	ACEITE, FLUJO TOTAL (FULL FLOW)	G-33	215502			
COMBUSTIBLE, PRIMARIO	GP-26	3576059	TRANSMISION	G-33	215502			
COMBUSTIBLE, SECUNDARIO	GP-27	3576061						
AIRE, SECUNDARIO	GA-6127	949363						

MARCA-MODELO-MOTOR MAKE-MODEL-ENGINE	GONHER GONHER	OEM OEM	MARCA-MODELO-MOTOR MAKE-MODEL-ENGINE	GONHER GONHER	OEM OEM	MARCA-MODELO-MOTOR MAKE-MODEL-ENGINE	GONHER GONHER	OEM OEM
MICHIGAN (continuación)			MICHIGAN (continuación)			MICHIGAN (continuación)		
CARGADORAS			CARGADORAS			CARGADORAS		
55 SERIES II con motor/GMC 3-53			AIRE	GAK-20	944954	85 SERIES II con motor/WAUKESHA 135GZ DIESEL		
DIRECCION	G-33	945580				ACEITE	G-31	P3H4120
HIDRAULICO	G-33	945580	75 SERIES II con motores/WAUKESHA F283 A GASOLINA, WAUKESHA F283G A GASOLINA			DIRECCION	G-33	945580
TRANSMISION	G-33	215502	DIRECCION	G-33	945580	HIDRAULICO	G-33	945580
ACEITE, FLUJO TOTAL (FULL FLOW)	G-119	946008	HIDRAULICO	G-33	945580	TRANSMISION	G-33	215502
COMBUSTIBLE, SECUNDARIO	G-1173	945354	TRANSMISION	G-33	215502	AIRE	GAK-20	944954
			ACEITE, SELLADO	GP-1	946161			
55 SERIES III con motor/GMC 3-53			75 SERIES III con motor/CUMMINS			85 SERIES II con motores/CUMMINS JN130C1, CUMMINS JN6C1		
TRANSMISION	G-33	215502	TRANSMISION	G-33	215502	DIRECCION	G-33	945580
ACEITE, FLUJO TOTAL (FULL FLOW)	G-119	946008	ACEITE, FLUJO TOTAL (FULL FLOW) CARTUCHO	G-566	946011	HIDRAULICO	G-33	945580
COMBUSTIBLE, SECUNDARIO	G-1173	945354	COMBUSTIBLE	G-1143	946010	TRANSMISION	G-33	215502
			ACEITE, FLUJO TOTAL (FULL FLOW) SELLADO	GP-53	961172	ACEITE, FLUJO TOTAL (FULL FLOW) CARTUCHO	G-566	946011
55 SERIES III con motores/CONTINENTAL F265 A GASOLINA, WAUKESHA			AIRE	GAK-20	944954	COMBUSTIBLE	GP-1101	158172
TRANSMISION	G-33	215502	ACEITE, DERIVACION (BY PASS)	G-750	947293	AIRE, RESPIRADOR	GA-39	945354
						AIRE	GAK-20	944954
55 SERIES IIIA con motor/CUMMINS			75 SERIES III con motor/GMC 4-53			85 SERIES III con motor/CUMMINS C160C1		
TRANSMISION	G-33	215502	ACEITE, FLUJO TOTAL (FULL FLOW)	G-33	215502	TRANSMISION	G-33	215502
ACEITE, FLUJO TOTAL (FULL FLOW)	G-613	949096	TRANSMISION	G-33	215502	ACEITE, FLUJO TOTAL (FULL FLOW) CARTUCHO	G-566	946011
COMBUSTIBLE	GP-1101	158172	COMBUSTIBLE, SECUNDARIO	G-1173	945354	COMBUSTIBLE	G-1143	946010
ACEITE, DERIVACION (BY PASS)	G-500	213527				ACEITE, FLUJO TOTAL (FULL FLOW) SELLADO	GP-53	961172
			75 SERIES III con motor/WAUKESHA 195GK A GASOLINA			AIRE	GAK-20	944954
55 SERIES IIIA, 55 SERIES IIIB con motor/GMC DIESEL			TRANSMISION	G-33	215502	ACEITE, DERIVACION (BY PASS)	G-750	947293
ACEITE, FLUJO TOTAL (FULL FLOW)	G-33	215502	75 SERIES III con motor/WAUKESHA F283 A GASOLINA			85 SERIES III con motor/GMC 4-53		
TRANSMISION	G-33	215502	TRANSMISION	G-33	215502	ACEITE, FLUJO TOTAL (FULL FLOW)	G-33	215502
COMBUSTIBLE, SECUNDARIO	G-1173	945354	ACEITE, FLUJO TOTAL (FULL FLOW)	GP-1	946161	TRANSMISION	G-33	215502
			AIRE	GAK-20	944954	COMBUSTIBLE, SECUNDARIO	G-1173	945354
55 SERIES IIIA, 55 SERIES IIIB con motor/PERKINS 4.152						AIRE	GAK-20	944954
TRANSMISION	G-33	215502	75C con motor/CUMMINS V504C			85 SERIES IIIA con motor/GMC DIESEL		
			TRANSMISION	G-33	215502	ACEITE, FLUJO TOTAL (FULL FLOW)	G-33	215502
55 SERIES IIIB con motor/CUMMINS			COMBUSTIBLE	GP-1101	158172	TRANSMISION	G-33	215502
TRANSMISION	G-33	215502	ACEITE, FLUJO TOTAL (FULL FLOW)	GP-53	961172	COMBUSTIBLE, SECUNDARIO	G-1175	945445
ACEITE	G-613	949096	ACEITE, DERIVACION (BY PASS)	GP-57	963023	AIRE	GA-106	946897
COMBUSTIBLE	GP-1101	158172	AGUA	GP-2071W	960978			
ACEITE	G-500	213527	AIRE	GA-360	993688	85A SERIES I con motores/WAUKESHA 195GK A GASOLINA, WAUKESHA 197DLCS DIESEL		
			AIRE	GA-361	993689	ACEITE	G-31	P3H4120
55C con motor/CUMMINS V378						BL60 RETROEXCAVADORA/CARGADORA con motor/CONTINENTAL F244 A GASOLINA		
ACEITE, FLUJO TOTAL (FULL FLOW) CARTUCHO	G-613	949096	75C con motor/DETROIT DIESEL 4-71T			AIRE	GAK-16	886525
COMBUSTIBLE	GP-1101	158172	TRANSMISION	G-33	215502	BL700 TRASERA con motor/GMC 3-53		
ACEITE, DERIVACION (BY PASS)	GP-57	963023	COMBUSTIBLE, PRIMARIO	GP-26	3576059	ACEITE	G-119	946008
ACEITE, FLUJO TOTAL (FULL FLOW) SELLADO	GP-43	192235	COMBUSTIBLE, SECUNDARIO	GP-27	3576061			
AGUA	GP-2071W	E4099799	ACEITE, FLUJO TOTAL (FULL FLOW)	GP-43	961172			
AIRE, PRIMARIO	GAK-625	961000	AIRE	GA-251	961605			
			85 SERIES I con motor/CUMMINS JF6C1					
55C con motor/DETROIT DIESEL			AIRE, RESPIRADOR	GA-39	945354			
ACEITE, CARTUCHO	G-33	215502	85 SERIES I con motor/GMC 4-53					
COMBUSTIBLE, SECUNDARIO	G-1173	945354	ACEITE, FLUJO TOTAL (FULL FLOW)	G-33	215502			
COMBUSTIBLE, PRIMARIO	G-1174	945444						
COMBUSTIBLE, PRIMARIO	GP-92	1992217	85 SERIES II con motor/GMC 4-53					
COMBUSTIBLE, SECUNDARIO	GP-93	1992215	DIRECCION	G-33	945580			
ACEITE, SELLADO	GP-43	961711	ACEITE, FLUJO TOTAL (FULL FLOW)	G-33	215502			
			AIRE, SECUNDARIO	G-33	945580			
75 A.B.R. SERIES I con motor/WAUKESHA 190DLC DIESEL			AIRE, PRIMARIO	GAK-20	944954			
ACEITE	G-31	P3H4120						
			75 SERIES II con motor/GMC 4-53					
75 SERIES II con motor/GMC 4-53			DIRECCION	G-33	945580			
DIRECCION	G-33	945580	ACEITE, FLUJO TOTAL (FULL FLOW)	G-33	215502			
ACEITE, FLUJO TOTAL (FULL FLOW)	G-33	215502	HIDRAULICO	G-33	945580			
HIDRAULICO	G-33	945580	TRANSMISION	G-33	215502			
TRANSMISION	G-33	215502	COMBUSTIBLE, SECUNDARIO	G-1173	945354			
COMBUSTIBLE, SECUNDARIO	G-1173	945354	AIRE	GAK-20	944954			

MICHIGAN

COMPACTADORAS

CS270 DE BASURA con motor/DETROIT DIESEL 6-71		
ACEITE, CONVERTIDOR DE TORSION	G-33	215502
AIRE, SECUNDARIO	GA-6127	949363
AIRE, PRIMARIO	GA-6129	1529585
CS70 con motores/GMC 6-71, GMC 8V-71N		
ACEITE	G-31	P3H4120
ACEITE	G-33	215502
ACEITE, CONVERTIDOR DE TORSION	G-33	215502
COMBUSTIBLE	G-1175	945445
AIRE, SECUNDARIO	GA-6127	P106641

MARCA-MODELO-MOTOR MAKE-MODEL-ENGINE	GONHER GONHER	OEM OEM	MARCA-MODELO-MOTOR MAKE-MODEL-ENGINE	GONHER GONHER	OEM OEM	MARCA-MODELO-MOTOR MAKE-MODEL-ENGINE	GONHER GONHER	OEM OEM
MICHIGAN (continuación)			MICHIGAN (continuación)			MICHIGAN (continuación)		
COMPACTADORAS			EQUIPO PARA CONSTRUCCION			EQUIPO PARA CONSTRUCCION		
AIRE	GA-6129	P106632	125A SERIES II, 125A SERIES III con motor/WAUKESHA 195GK			AIRE	GA-5648	944398
CS70 DE BASURA con motor/GMC 3-53			ACEITE, CONVERTIDOR DE TORSION	G-33	215502	280 SERIES III-A con motor/CUMMINS		
ACEITE, CONVERTIDOR DE TORSION	G-33	215502	125A SERIES III con motor/DETROIT DIESEL 4-71			TRANSMISION	G-33	215502
CS70 DE BASURA con motor/GMC 4-53			DIRECCION	G-33	945580	280 SERIES III-A con motor/DETROIT DIESEL		
ACEITE, FLUJO TOTAL (FULL FLOW)	G-33	215502	TRANSMISION	G-33	215502	TRANSMISION	G-33	215502
TRANSMISION	G-33	215502	AIRE, PRIMARIO	GA-106	946897	310 con motores/CUMMINS, DETROIT DIESEL		
COMBUSTIBLE, SECUNDARIO	G-1173	945354	AIRE, SECUNDARIO	GA-206	1911724	ACEITE, CONVERTIDOR DE TORSION	G-33	215502
RS60 con motor/DEUTZ F2L812			125A SERIES III con motor/DETROIT DIESEL 6V-71			35AWS con motor/PERKINS 4-248		
COMBUSTIBLE, SECUNDARIO	G-1121	Q05H4115	AIRE, SIN ASPAS	GA-27	944809	ACEITE	GP-1	2654403
RW140 con motor/A DIESEL			AIRE, PRIMARIO	GA-106	946897	ACEITE	GP-31	2654407
COMBUSTIBLE, CARTUCHO	G-1123	BF310-03	AIRE, SECUNDARIO	GA-206	1911724	COMBUSTIBLE	G-296	6211585-2
ACEITE	GP-54	P557207	125A SERIES III con motor/WAUKESHA 197DLCS			COMBUSTIBLE	G-296-B	26560017
COMBUSTIBLE, SELLADO	GP-1122	466987-5	ACEITE, CONVERTIDOR DE TORSION	G-33	215502	AIRE	GAK-403	1624567
AIRE	GAK-403	1624567	HIDRAULICO	G-33	945580	375A con motor/CUMMINS		
RW180, RW181 con motor/A DIESEL			COMBUSTIBLE	GPP-11	12003653	HIDRAULICO	G-33	945580
ACEITE, CARTUCHO	G-31	P3H4120	125ART SERIES III con motores/CUMMINS, DETROIT DIESEL 6V-71N			380 con motores/CUMMINS, DETROIT DIESEL		
COMBUSTIBLE, CARTUCHO	G-1123	BF310-03	TRANSMISION	G-33	215502	DIRECCION	G-33	945580
ACEITE, SELLADO	GP-54	P557207	175A SERIES III con motor/WAUKESHA 135DKB			HIDRAULICO	G-33	945580
COMBUSTIBLE, SELLADO	GP-1122	466987-5	ACEITE, CONVERTIDOR DE TORSION	G-33	215502	TRANSMISION	G-33	215502
AIRE	GAK-20	944954	HIDRAULICO	G-33	945580	AIRE	GA-5648	944398
MICHIGAN			COMBUSTIBLE, SECUNDARIO	G-1176	940221	475 con motor/CUMMINS		
EQUIPO PARA CONSTRUCCION			175A SERIES III con motor/WAUKESHA 135DKBS			ACEITE, CONVERTIDOR DE TORSION	G-33	215502
110 con motor/WAUKESHA			ACEITE, DERIVACION (BY PASS)	G-31	P3H4120	TRANSMISION	G-33	215502
ACEITE, DERIVACION (BY PASS)	G-31	P3H4120	ACEITE, CONVERTIDOR DE TORSION	G-33	215502	AGUA	GP-2071W	E4099799
ACEITE, CONVERTIDOR DE TORSION	G-33	215502	HIDRAULICO	G-33	945580	AIRE, SECUNDARIO	GA-6127	949363
HIDRAULICO	G-33	945580	COMBUSTIBLE, SECUNDARIO	G-1176	940221	AIRE, PRIMARIO	GA-6129	946857
COMBUSTIBLE, SECUNDARIO	G-1176	940221	175A SERIES III con motor/WAUKESHA 135GK			475ART SERIES III con motor/CUMMINS		
110 con motores/CUMMINS C175, DETROIT DIESEL 6V-53			ACEITE, CONVERTIDOR DE TORSION	G-33	215502	TRANSMISION	G-33	215502
ACEITE, CONVERTIDOR DE TORSION	G-33	215502	175B con motor/DETROIT DIESEL 8V-71			480 con motores/CUMMINS, DETROIT DIESEL		
110-12 SERIES IIIH con motor/DETROIT DIESEL 6V-71N			ACEITE, CONVERTIDOR DE TORSION	G-33	215502	DIRECCION	G-33	945580
DIRECCION	G-33	945580	TRANSMISION	G-33	215502	HIDRAULICO	G-33	945580
TRANSMISION	G-33	215502	AGUA	GP-2071W	963798	TRANSMISION	G-33	215502
AIRE, SIN ASPAS	GA-27	944809	AIRE, SECUNDARIO	GA-6127	949363	55 SERIES II con motor/CONTINENTAL F226		
110-9 con motor/CUMMINS V504			AIRE, PRIMARIO	GA-6129	946857	DIRECCION	G-33	945580
TRANSMISION	G-33	215502	210 con motor/CUMMINS			HIDRAULICO	G-33	945580
125A SERIES II con motor/DETROIT DIESEL 4-71			ACEITE, CONVERTIDOR DE TORSION	G-33	215502	TRANSMISION	G-33	215502
DIRECCION	G-33	945580	210 con motor/DETROIT DIESEL 8V-71			55A SERIES III con motores/CUMMINS V878C, DETROIT DIESEL, PERKINS		
HIDRAULICO	G-33	945580	ACEITE, CONVERTIDOR DE TORSION	G-33	215502	TRANSMISION	G-33	215502
TRANSMISION	G-33	215502	HIDRAULICO	G-33	953989	55B SERIES III con motores/PERKINS, CUMMINS V878C, DETROIT DIESEL		
AIRE, PRIMARIO	GA-106	946897	AIRE, SECUNDARIO	GA-6127	949363	TRANSMISION	G-33	215502
AIRE, SECUNDARIO	GA-206	1911724	AIRE, PRIMARIO	GA-6129	529585	675A con motor/DETROIT DIESEL		
125A SERIES II con motor/DETROIT DIESEL 6V-71			210HB con motor/CUMMINS			ACEITE	G-33	953989
AIRE, SIN ASPAS	GA-27	944809	AIRE, PRIMARIO	GA-356	1564833	75 ART SERIES III con motor/CUMMINS		
AIRE, PRIMARIO	GA-106	946897	275A SERIES I con motores/CUMMINS, DETROIT DIESEL 8V-71			TRANSMISION	G-33	215502
AIRE, SECUNDARIO	GA-206	1911724	DIRECCION	G-33	945580	75A con motor/DETROIT DIESEL 4-53		
125A SERIES II con motor/WAUKESHA 197DLCS			HIDRAULICO	G-33	945580	HIDRAULICO	G-33	945580
ACEITE, CONVERTIDOR DE TORSION	G-33	215502	TRANSMISION	G-33	215502			
HIDRAULICO	G-33	945580						
COMBUSTIBLE	GPP-11	12003653						

SERVICIO PESADO

MARCA-MODELO-MOTOR MAKE-MODEL-ENGINE	GONHER GONHER	OEM OEM	MARCA-MODELO-MOTOR MAKE-MODEL-ENGINE	GONHER GONHER	OEM OEM	MARCA-MODELO-MOTOR MAKE-MODEL-ENGINE	GONHER GONHER	OEM OEM
MICHIGAN (continuación)			MICHIGAN (continuación)			MICHIGAN (continuación)		
EQUIPO PARA CONSTRUCCION			EQUIPO PARA CONSTRUCCION			EQUIPO PARA CONSTRUCCION		
75A SERIES II con motor/WAUKESHA F283G			L180 con motor/VOLVO TD122			L70 con motor/VOLVO TD45B		
TRANSMISION	G-33	215502	ACEITE, FLUJO TOTAL (FULL FLOW)	GP-51	466634-3	COMBUSTIBLE	GP-1122	466987-5
75A SERIES II, 75A SERIES III con motor/DETROIT DIESEL 4-53			COMBUSTIBLE	GP-1122	466987-5	L90, L90B con motor/VOLVO TD61GB		
ACEITE, CONVERTIDOR DE TORSION	G-33	215502	ACEITE, DERIVACION (BY PASS)	GP-57	471392-1	ACEITE	GP-51	466634-3
HIDRAULICO	G-33	945580	ACEITE	GP-761H	11036607-7			
AIRE	GAK-20	9449541	AIRE	GA-467	11033128-7			
75A SERIES III con motor/CUMMINS			L190, L190B con motor/CUMMINS NT855					
TRANSMISION	G-33	215502	COMBUSTIBLE	GPP-14	949095			
75A SERIES III con motor/WAUKESHA 190DLC			ACEITE, FLUJO TOTAL (FULL FLOW)	GP-53	961172	100 con motores/CUMMINS, DETROIT DIESEL		
COMBUSTIBLE	GPP-11	12003653	ACEITE, DERIVACION (BY PASS)	GP-57	1996228-0	TRANSMISION	GP-66	6516722
75A SERIES III con motor/WAUKESHA 195GK A GASOLINA			AGUA	GP-2071W	963798	101 con motores/CUMMINS V378, DETROIT DIESEL 4-53		
TRANSMISION	G-33	215502	L270, L270B con motor/CUMMINS			TRANSMISION	G-33	215502
75A SERIES III con motor/WAUKESHA F283G			COMBUSTIBLE	GPP-14	949095	180 SERIES I con motor/CUMMINS C175C1		
TRANSMISION	G-33	215502	AGUA	GP-1010Q	12968028	DIRECCION	G-33	945580
75A, 75A SERIES II con motor/WAUKESHA 190DLC			ACEITE, FLUJO TOTAL (FULL FLOW)	GP-53	961172	HIDRAULICO	G-33	945580
COMBUSTIBLE	GPP-11	12003653	ACEITE, DERIVACION (BY PASS)	GP-57	1996228-0	TRANSMISION	G-33	215502
75A, 75A SERIES II con motor/WAUKESHA 195GK A GASOLINA			AIRE, PRIMARIO	GA-356	4881174-9	ACEITE, FLUJO TOTAL (FULL FLOW) CARTUCHO	G-566	946011
TRANSMISION	G-33	215502	AIRE, SECUNDARIO	GA-357	1564832	COMBUSTIBLE, SELLADO	GP-1101	158172
85A SERIES III con motor/CUMMINS			L30 con motor/PERKINS 4.236			180 SERIES I con motor/GMC 6V-53		
DIRECCION	G-33	945580	COMBUSTIBLE	G-296	6211585-2	DIRECCION	G-33	945580
HIDRAULICO	G-33	945580	COMBUSTIBLE	G-297	11993378-6	ACEITE, FLUJO TOTAL (FULL FLOW)	G-33	215502
TRANSMISION	G-33	215502	COMBUSTIBLE	G-296-B	26560017	HIDRAULICO	G-33	945580
AIRE	GAK-20	944954	COMBUSTIBLE	G-297-B	11993378-6	TRANSMISION	G-33	215502
85A SERIES III con motor/DETROIT DIESEL			ACEITE	GP-171	4804651	COMBUSTIBLE, SECUNDARIO	G-1175	945445
DIRECCION	G-33	945580	L320 con motor/CUMMINS			AIRE, SIN ASPAS	GA-27	944809
HIDRAULICO	G-33	945580	COMBUSTIBLE	GPP-14	949095	180 SERIES I con motor/WAUKESHA 135DKBS DIESEL		
TRANSMISION	G-33	215502	AGUA	GP-1010Q	12968028	ACEITE	G-31	P3H4120
AIRE	GA-106	946897	ACEITE, FLUJO TOTAL (FULL FLOW)	GP-53	961172	HIDRAULICO	G-33	215502
85A SERIES III con motor/WAUKESHA 135GZ			ACEITE, DERIVACION (BY PASS)	GP-57	11996228-0	TRANSMISION	G-33	215502
DIRECCION	G-33	945580	AIRE, PRIMARIO	GA-356	4881174-9	COMBUSTIBLE, SECUNDARIO	G-1175	945445
HIDRAULICO	G-33	945580	AIRE, SECUNDARIO	GA-357	1564832	180 SERIES III con motor/CUMMINS C175C1		
TRANSMISION	G-33	215502	L480 con motor/CUMMINS			DIRECCION	G-33	945580
AIRE	GAK-20	944954	AGUA	GP-1010Q	12968028	HIDRAULICO	G-33	945580
85A, 85A SERIES II con motores/CUMMINS, WAUKESHA 135GZ			ACEITE, FLUJO TOTAL (FULL FLOW)	GP-53	961172	TRANSMISION	G-33	215502
DIRECCION	G-33	945580	COMBUSTIBLE	GP-55	2560232	ACEITE, FLUJO TOTAL (FULL FLOW) CARTUCHO	G-566	946011
HIDRAULICO	G-33	945580	ACEITE, DERIVACION (BY PASS)	GP-57	11996228-0	COMBUSTIBLE	GP-1101	158172
TRANSMISION	G-33	215502	AIRE, PRIMARIO	GA-356	4881174-9	AIRE, SIN ASPAS	GA-24	945059
AIRE	GAK-20	944954	AIRE, SECUNDARIO	GA-357	1564832	180 SERIES III con motor/GMC 6V-53		
L120, L120B con motor/VOLVO TD71G			L480T con motor/CUMMINS			DIRECCION	G-33	945580
ACEITE, FLUJO TOTAL (FULL FLOW)	GP-51	466634-3	AGUA	GP-1010Q	2560232	ACEITE, FLUJO TOTAL (FULL FLOW)	G-33	215502
COMBUSTIBLE	GP-1122	466987-5	ACEITE, DERIVACION (BY PASS)	GP-53	961172	HIDRAULICO	G-33	945580
ACEITE, DERIVACION (BY PASS)	GP-57	471392-1	COMBUSTIBLE	GP-55	2560232	TRANSMISION	G-33	215502
L140 con motor/CUMMINS LT10			ACEITE, FLUJO TOTAL (FULL FLOW)	GP-57	11996228-0	COMBUSTIBLE, SECUNDARIO	G-1175	945445
COMBUSTIBLE	GPP-14	12003653	AIRE, PRIMARIO	GA-356	4881174-9	AIRE, SIN ASPAS	GA-27	944809
ACEITE	GP-3000	12969457	AIRE, SECUNDARIO	GA-357	1564832	180 SERIES III con motor/WAUKESHA		
AGUA	GP-2071W	E4099799	L50 con motor/VOLVO			ACEITE, DERIVACION (BY PASS)	G-31	P3H4120
L150, L160 con motor/VOLVO TD102GC			COMBUSTIBLE, SECUNDARIO	GP-1122	466987-5	HIDRAULICO	G-33	953989
ACEITE	GP-51	466634-3	L50B con motor/VOLVO			TRANSMISION	G-33	215502
			ACEITE	GP-31	11998008-4	COMBUSTIBLE, SECUNDARIO	G-1176	940221
			ACEITE	GP-66	4787923-4	185AD/RASPADORA con motor/A DIESEL		
			COMBUSTIBLE	G-297	11999066-1	ACEITE	G-31	P3H4120
			COMBUSTIBLE	G-297-B	11999066-1			

MARCA-MODELO-MOTOR MAKE-MODEL-ENGINE	GONHER GONHER	OEM OEM	MARCA-MODELO-MOTOR MAKE-MODEL-ENGINE	GONHER GONHER	OEM OEM	MARCA-MODELO-MOTOR MAKE-MODEL-ENGINE	GONHER GONHER	OEM OEM
MICHIGAN (continuación)			MICHIGAN (continuación)			MICHIGAN (continuación)		
NIVELADORAS			NIVELADORAS			NIVELADORAS		
200 con motores/CUMMINS C160, DETROIT DIESEL 4-71			380 SERIES II, 380 SERIES III con motor/GMC 12V-71			ACEITE, FLUJO TOTAL (FULL FLOW)	G-566	946011
TRANSMISION	GP-66	6516722	DIRECCION	G-33	945580	COMBUSTIBLE, CARTUCHO	G-1143	946010
280 SERIES I con motor/CUMMINS NTO6B1			ACEITE, FLUJO TOTAL (FULL FLOW)	G-33	215502	COMBUSTIBLE, SELLADO	GP-1101	158172
DIRECCION	G-33	945580	HIDRAULICO	G-33	945580	ACEITE, DERIVACION (BY PASS)	G-750	947293
HIDRAULICO	G-33	945580	TRANSMISION	G-33	215502	501 con motores/DETROIT DIESEL 6V-71N, CUMMINS VT55		
TRANSMISION	G-33	215502	AIRE	GA-5648	944398	TRANSMISION	G-33	215502
ACEITE, FLUJO TOTAL (FULL FLOW)	G-566	946011	380 SERIES III con motores/CUMMINS, DETROIT DIESEL			501S con motor/GMC		
COMBUSTIBLE, CARTUCHO	G-1143	946010	DIRECCION	G-33	945580	ACEITE, FLUJO TOTAL (FULL FLOW)	G-33	215502
COMBUSTIBLE, SELLADO	GP-1101	158172	HIDRAULICO	G-33	945580	COMBUSTIBLE, PRIMARIO	GP-26	3576059
AIRE	GA-5648	944398	TRANSMISION	G-33	215502	COMBUSTIBLE, SECUNDARIO	GP-27	3576061
280 SERIES I con motor/GMC 8V-71			AIRE	GA-5648	944398	CS270 con motor/DETROIT DIESEL 6-71		
DIRECCION	G-33	945580	380 SERIES IIIA con motor/CUMMINS			ACEITE, DERIVACION (BY PASS)	G-31	P3H4120
ACEITE, FLUJO TOTAL (FULL FLOW)	G-33	215502	TRANSMISION	G-33	215502	ACEITE, CONVERTIDOR DE TORSION	G-33	215502
HIDRAULICO	G-33	945580	ACEITE, FLUJO TOTAL (FULL FLOW) CARTUCHO	G-566	946011	ACEITE, FLUJO TOTAL (FULL FLOW)	G-33	945580
TRANSMISION	G-33	215502	COMBUSTIBLE	G-1143	946010	COMBUSTIBLE, SECUNDARIO	G-1175	945445
COMBUSTIBLE, SECUNDARIO	G-1175	945445	ACEITE, FLUJO TOTAL (FULL FLOW) SELLADO	GP-53	961172	AIRE, SECUNDARIO	GA-6127	949363
280 SERIES III con motor/CUMMINS NT310			AIRE, SECUNDARIO	GA-6127	949363	AIRE, PRIMARIO	GA-6129	1529585
DIRECCION	G-33	945580	AIRE, PRIMARIO	GA-6129	946857	CS70 con motor/CUMMINS		
HIDRAULICO	G-33	945580	ACEITE, DERIVACION (BY PASS)	G-750	947293	ACEITE	G-33	215502
TRANSMISION	G-33	215502	380 SERIES IIIA con motor/DETROIT DIESEL			CS70 con motor/DETROIT DIESEL 3-53		
ACEITE, FLUJO TOTAL (FULL FLOW) CARTUCHO	G-566	946011	TRANSMISION	G-33	215502	ACEITE, CONVERTIDOR DE TORSION	G-33	215502
COMBUSTIBLE	G-1143	946010	AIRE, SECUNDARIO	GA-6127	949363			
ACEITE, FLUJO TOTAL (FULL FLOW) SELLADO	GP-53	961172	AIRE, PRIMARIO	GA-6129	946857			
ACEITE, DERIVACION (BY PASS)	G-750	947293	380B con motor/CUMMINS VT17106					
280 SERIES III con motor/GMC 8V-71N			TRANSMISION	G-33	215502			
DIRECCION	G-33	945580	ACEITE, FLUJO TOTAL (FULL FLOW)	GP-53	961172			
ACEITE, FLUJO TOTAL (FULL FLOW)	G-33	215502	COMBUSTIBLE	GP-55	2560232			
HIDRAULICO	G-33	945580	ACEITE, DERIVACION (BY PASS)	G-750	947293			
TRANSMISION	G-33	215502	400, 500 con motores/CUMMINS, DETROIT DIESEL					
COMBUSTIBLE, SECUNDARIO	G-1175	945445	TRANSMISION	GP-66	6516722			
AIRE, SECUNDARIO	GA-6127	949363	410/RASPADORA con motor/CUMMINS					
AIRE, PRIMARIO	GA-6129	529585	DIRECCION	G-33	215502			
300 con motor/CUMMINS C160			HIDRAULICO	G-33	215502			
TRANSMISION	GP-66	6516722	TRANSMISION	G-33	215502			
300 con motor/DETROIT DIESEL 4-71			ACEITE, FLUJO TOTAL (FULL FLOW) CARTUCHO	G-566	946011			
TRANSMISION	GP-66	6516722	COMBUSTIBLE	G-1143	946010			
301 con motores/CUMMINS V504, DETROIT DIESEL 4-71N, DETROIT DIESEL 6V-71N			ACEITE, FLUJO TOTAL (FULL FLOW) SELLADO	GP-53	961172			
TRANSMISION	G-33	215502	410/RASPADORA con motor/DETROIT DIESEL					
380 SERIES I con motor/CUMMINS NRTO6B1			DIRECCION	G-33	945580			
TRANSMISION	G-33	215502	HIDRAULICO	G-33	945580			
ACEITE, FLUJO TOTAL (FULL FLOW)	G-566	946011	TRANSMISION	G-33	215502			
COMBUSTIBLE, SELLADO	GP-1101	158172	480TD con motor/GMC 16V-71					
ACEITE, DERIVACION (BY PASS)	G-750	947293	DIRECCION	G-33	945580			
380 SERIES II con motor/CUMMINS NVH12			ACEITE, FLUJO TOTAL (FULL FLOW)	G-33	215502			
DIRECCION	G-33	945580	HIDRAULICO	G-33	945580			
HIDRAULICO	G-33	945580	TRANSMISION	G-33	215502			
TRANSMISION	G-33	215502	480TD con motores/CUMMINS VT700, CUMMINS VT12-635C1					
ACEITE, FLUJO TOTAL (FULL FLOW)	G-566	946011	DIRECCION	G-33	945580			
COMBUSTIBLE	G-1143	946010	HIDRAULICO	G-33	945580			
AIRE	GA-5648	944398	TRANSMISION	G-33	215502			
ACEITE, DERIVACION (BY PASS)	G-750	947293						

MICHIGAN

RASPADORAS

110 SERIES I, 110 SERIES III con motor/CUMMINS C175			DIRECCION	G-33	945580
HIDRAULICO	G-33	945580	TRANSMISION	G-33	215502
ACEITE, FLUJO TOTAL (FULL FLOW) CARTUCHO	G-566	946011	COMBUSTIBLE, CARTUCHO	G-1143	946010
COMBUSTIBLE, SELLADO	GP-1101	158172	COMBUSTIBLE, SELLADO	GP-1101	158172
110 SERIES I, 110 SERIES III con motor/GMC 6V-53			DIRECCION	G-33	945580
ACEITE, FLUJO TOTAL (FULL FLOW) CARTUCHO	G-33	215502	ACEITE, FLUJO TOTAL (FULL FLOW) CARTUCHO	G-33	215502
HIDRAULICO	G-33	945580	TRANSMISION	G-33	215502
COMBUSTIBLE, SECUNDARIO	G-1175	945445	AIRE, S/N 3TG10 EN ADELANTE	GA-27	944809
AIRE, S/N 3TG10 EN ADELANTE	GA-27	944809	AIRE, S/N 2TG101-2TG999	GA-5648	944398
110-11 con motor/GMC DIESEL			ACEITE, FLUJO TOTAL (FULL FLOW)	G-33	215502
TRANSMISION	G-33	215502	COMBUSTIBLE, SECUNDARIO	G-1173	945354
110-11B con motor/CUMMINS			TRANSMISION	G-33	215502
ACEITE, FLUJO TOTAL (FULL FLOW)	G-613	949096	COMBUSTIBLE	GP-1101	158172
COMBUSTIBLE	GP-1101	158172	AIRE, S/N 2TC31 EN ADELANTE	GA-360	1990248
AIRE, S/N 2TC31 EN ADELANTE	GA-360	1990248	ACEITE, DERIVACION (BY PASS)	G-500	213527

SERVICIO PESADO

MARCA-MODELO-MOTOR MAKE-MODEL-ENGINE	GONHER GONHER	OEM OEM	MARCA-MODELO-MOTOR MAKE-MODEL-ENGINE	GONHER GONHER	OEM OEM	MARCA-MODELO-MOTOR MAKE-MODEL-ENGINE	GONHER GONHER	OEM OEM
MICHIGAN (continuación)			MICHIGAN (continuación)			MICHIGAN (continuación)		
RASPADORAS			RASPADORAS			TRACTORES		
110-12 SERIES IIIH con motor/GMC 6V-53			HIDRAULICO	G-33	945580	TRANSMISION	G-33	215502
DIRECCION	G-33	945580	TRANSMISION	G-33	215502	COMBUSTIBLE, SECUNDARIO	G-1173	945354
ACEITE, FLUJO TOTAL (FULL FLOW)	G-33	215502	COMBUSTIBLE, SECUNDARIO	G-1175	945445	AIRE, RASPADORA	GA-5648	944398
TRANSMISION	G-33	215502	210 SERIES IIIH con motor/CUMMINS			125AD/EXCAVADORA con motores/WAUKESHA 195GK, WAUKESHA 197DLCS		
COMBUSTIBLE, SECUNDARIO	G-1175	945445	DIRECCION	G-33	945580	ACEITE	G-31	P3H4120
AIRE, SIN ASPAS	GA-27	944809	TRANSMISION	G-33	215502	125B/EXCAVADORA con motor/CUMMINS		
110-14 SERIES IIIH con motor/GMC 6V-71N			ACEITE, FLUJO TOTAL (FULL FLOW) CARTUCHO	G-566	946011	TRANSMISION	G-33	215502
DIRECCION	G-33	945580	COMBUSTIBLE	G-1143	946010	ACEITE, FLUJO TOTAL (FULL FLOW)	G-566	946011
ACEITE, FLUJO TOTAL (FULL FLOW)	G-33	215502	ACEITE, FLUJO TOTAL (FULL FLOW) SELLADO	GP-53	961172	ACEITE, FLUJO TOTAL (FULL FLOW)	G-613	949096
TRANSMISION	G-33	215502	ACEITE, DERIVACION (BY PASS)	G-750	947293	COMBUSTIBLE	GP-1101	158172
COMBUSTIBLE, SECUNDARIO	G-1175	945445	210H con motor/CUMMINS			AGUA	GP-2071W	949418
110-15 con motor/GMC DIESEL			TRANSMISION	G-33	215502	AIRE, PRIMARIO	GA-106	960243
ACEITE, FLUJO TOTAL (FULL FLOW)	G-33	215502	ACEITE, FLUJO TOTAL (FULL FLOW) CARTUCHO	G-566	946011	AIRE, SECUNDARIO	GA-206	1911724
TRANSMISION	G-33	215502	COMBUSTIBLE	G-1143	946010	ACEITE, DERIVACION (BY PASS)	G-500	213527
COMBUSTIBLE, SECUNDARIO	G-1175	945445	ACEITE, FLUJO TOTAL (FULL FLOW) SELLADO	GP-53	961172	125B/EXCAVADORA con motor/GMC DIESEL		
AIRE, PRIMARIO	GA-356	1564833	AGUA	GP-1011Q	961028	ACEITE, FLUJO TOTAL (FULL FLOW)	G-33	215502
AIRE, SECUNDARIO	GA-357	1564832	ACEITE, DERIVACION (BY PASS)	G-750	947293	TRANSMISION	G-33	215502
110-9B con motor/CUMMINS			310 SERIES I con motor/CUMMINS NT380			COMBUSTIBLE, PRIMARIO	GP-26	3576059
ACEITE, FLUJO TOTAL (FULL FLOW)	G-613	949096	TRANSMISION	G-33	215502	COMBUSTIBLE, SECUNDARIO	GP-27	3576061
COMBUSTIBLE	GP-1101	158172	ACEITE, FLUJO TOTAL (FULL FLOW)	G-566	946011	AIRE, PRIMARIO	GA-106	960243
AIRE, HAUSING SIMPLE	GA-360	1990248	COMBUSTIBLE, SELLADO	GP-1101	158172	AIRE, SECUNDARIO	GA-206	1911724
ACEITE, DERIVACION (BY PASS)	G-500	213527	AIRE	GA-5648	944398	175B/EXCAVADORA con motor/CUMMINS		
110HTB con motor/DOS MOTORES DETROIT DIESEL			ACEITE, DERIVACION (BY PASS)	G-750	947293	TRANSMISION	G-33	215502
ACEITE, FLUJO TOTAL (FULL FLOW)	G-33	215502	310 SERIES I con motor/GMC 12V-71N			ACEITE, FLUJO TOTAL (FULL FLOW) CARTUCHO	G-566	946011
TRANSMISION	G-33	215502	ACEITE, FLUJO TOTAL (FULL FLOW)	G-33	215502	ACEITE, FLUJO TOTAL (FULL FLOW) CARTUCHO	G-613	949096
COMBUSTIBLE, SECUNDARIO	G-1173	945354	TRANSMISION	G-33	215502	COMBUSTIBLE, CARTUCHO	G-1143	946010
210 SERIES I con motor/CUMMINS NTO6			AIRE	GA-5648	944398	COMBUSTIBLE, SELLADO	GP-1101	158172
DIRECCION	G-33	945580	310 SERIES III con motor/GMC 12V-71N			ACEITE, FLUJO TOTAL (FULL FLOW) SELLADO	GP-53	961172
HIDRAULICO	G-33	945580	ACEITE, FLUJO TOTAL (FULL FLOW)	G-33	215502	AGUA	GP-2071W	E4099799
TRANSMISION	G-33	215502	310H con motor/GMC DIESEL			AIRE, SECUNDARIO	GA-6127	949363
ACEITE, FLUJO TOTAL (FULL FLOW)	G-566	946011	ACEITE, CONVERTIDOR DE TORSION	G-33	215502	AIRE, PRIMARIO	GA-6129	946857
COMBUSTIBLE, CARTUCHO	G-1143	946010	ACEITE, FLUJO TOTAL (FULL FLOW)	G-33	215502	ACEITE, DERIVACION (BY PASS)	G-750	947293
COMBUSTIBLE, SELLADO	GP-1101	158172	TRANSMISION	G-33	215502	175B/EXCAVADORA con motor/GMC DIESEL		
AIRE	GA-5648	944398	MICHIGAN			ACEITE, FLUJO TOTAL (FULL FLOW)	G-33	215502
ACEITE, DERIVACION (BY PASS)	G-750	947293	REMOVEDORES DE TIERRA			TRANSMISION	G-33	215502
210 SERIES I con motor/GMC 8V-71			35A EQUIPO, 35AWS EQUIPO, 35B EQUIPO con motor/GMC 3-53			COMBUSTIBLE, SECUNDARIO	G-1175	945445
DIRECCION	G-33	945580	ACEITE, FLUJO TOTAL (FULL FLOW)	G-119	946008	AIRE, SECUNDARIO	GA-6127	949363
ACEITE, FLUJO TOTAL (FULL FLOW)	G-33	215502	EQUIPO con motor/CON COMPRESOR DE AIRE BENDIX-WESTING-HOUSE			AIRE, PRIMARIO	GA-6129	946857
HIDRAULICO	G-33	945580	AIRE	GA-135	243009	275B/EXCAVADORA con motor/CUMMINS		
TRANSMISION	G-33	215502	EQUIPO con motor/CON COMPRESOR DE AIRE MIDLAND ROSS			ACEITE, CONVERTIDOR DE TORSION	G-33	215502
COMBUSTIBLE, SECUNDARIO	G-1175	945445	AIRE	GA-135	8875051	TRANSMISION	G-33	215502
210 SERIES III con motor/CUMMINS NT335C1			MICHIGAN			ACEITE, FLUJO TOTAL (FULL FLOW) CARTUCHO	G-566	946011
TRANSMISION	G-33	215502	TRACTORES			COMBUSTIBLE, CARTUCHO	G-1143	946010
ACEITE, FLUJO TOTAL (FULL FLOW) CARTUCHO	G-566	946011	110HT/RASPADORA con motor/GMC DIESEL			COMBUSTIBLE, SELLADO	GP-1101	158172
COMBUSTIBLE	G-1143	946010	ACEITE, FLUJO TOTAL (FULL FLOW) SELLADO	G-33	215502	ACEITE, FLUJO TOTAL (FULL FLOW) SELLADO	GP-53	961172
ACEITE, FLUJO TOTAL (FULL FLOW) SELLADO	GP-53	961172	TRANSMISION	G-33	215502	AGUA	GP-2071W	963798
ACEITE, DERIVACION (BY PASS)	G-750	947293	MICHIGAN			AIRE, SECUNDARIO	GA-6127	949363
210 SERIES III con motor/GMC 8V-71N			TRACTORES			AIRE, PRIMARIO	GA-6129	946857
DIRECCION	G-33	945580	110HT/RASPADORA con motor/GMC DIESEL			ACEITE, DERIVACION (BY PASS)	G-750	947293
ACEITE, FLUJO TOTAL (FULL FLOW)	G-33	215502	ACEITE, FLUJO TOTAL (FULL FLOW)	G-33	215502			

MARCA-MODELO-MOTOR GONHER OEM
MAKE-MODEL-ENGINE GONHER OEM

MICHIGAN (continuación)

TRACTORES

275B/EXCAVADORA con motor/DETROIT DIESEL		
TRANSMISION	G-33	945580
275C/EXCAVADORA con motor/CUMMINS KT1150C		
TRANSMISION	G-33	215502
COMBUSTIBLE	GP-1101	158172
ACEITE, FLUJO TOTAL (FULL FLOW)	GP-53	961172
ACEITE, DERIVACION (BY PASS)	GP-57	963023
AGUA	GP-1011Q	961028
AIRE, PRIMARIO	GA-356	1564833
AIRE, SECUNDARIO	GA-357	1564832
45B/EXCAVADORA con motor/CUMMINS		
ACEITE, FLUJO TOTAL (FULL FLOW)	G-566	946011
COMBUSTIBLE	GP-1101	158172
AGUA	GP-2071W	949418
AIRE	GAK-20	944954
ACEITE, DERIVACION (BY PASS)	G-500	213527
45B/EXCAVADORA con motor/GMC		
ACEITE, FLUJO TOTAL (FULL FLOW)	G-33	945580
COMBUSTIBLE, SECUNDARIO	G-1173	945354
AIRE, PRIMARIO	GA-360	993688
AIRE, SECUNDARIO	GA-361	993689
45B/EXCAVADORA con motor/PERKINS 6.354		
TRANSMISION	G-33	953989
ACEITE	G-834	26540153
COMBUSTIBLE	G-296	6211585-2
COMBUSTIBLE	G-296-B	26560017
AIRE	GAK-403	1624567
AIRE	GAK-20	944954
45C/EXCAVADORA con motor/DETROIT DIESEL		
ACEITE, CARTUCHO	G-33	215502
COMBUSTIBLE, SECUNDARIO	G-1173	945354
COMBUSTIBLE, PRIMARIO	G-1174	945444
COMBUSTIBLE, PRIMARIO	GP-92	963938
COMBUSTIBLE, SECUNDARIO	GP-93	1992215
ACEITE, SELLADO	GP-43	961711
45C/EXCAVADORA con motor/PERKINS 6.354		
ACEITE	GP-31	11998008-4
COMBUSTIBLE	G-297	961048
COMBUSTIBLE	G-297-B	961048
AIRE, PRIMARIO	GAK-625	961000
475B/EXCAVADORA con motor/CUMMINS		
TRANSMISION	G-33	215502
COMBUSTIBLE, CARTUCHO	G-1143	946010
ACEITE, FLUJO TOTAL (FULL FLOW)	GP-53	961172
COMBUSTIBLE, SELLADO	GP-55	2560232
AGUA	GP-2071W	E4099799
AIRE, SECUNDARIO	GA-6127	949363
AIRE, PRIMARIO	GA-6129	946857
ACEITE, DERIVACION (BY PASS)	G-750	947293
475B/EXCAVADORA con motor/GMC DIESEL		
ACEITE, FLUJO TOTAL (FULL FLOW)	G-33	215502

MARCA-MODELO-MOTOR GONHER OEM
MAKE-MODEL-ENGINE GONHER OEM

MICHIGAN (continuación)

TRACTORES

475C/EXCAVADORA con motor/CUMMINS		
ACEITE, FLUJO TOTAL (FULL FLOW)	GP-53	961172
COMBUSTIBLE	GP-55	2560232
AGUA	GP-1011Q	961028
ACEITE, DERIVACION (BY PASS)	G-750	947293
675B/EXCAVADORA con motor/CUMMINS		
COMBUSTIBLE	G-1143	946010
ACEITE, FLUJO TOTAL (FULL FLOW)	GP-53	961172
AGUA	GP-2071W	961028
AIRE, PRIMARIO	GA-356	1564833
AIRE, SECUNDARIO	GA-357	564832
ACEITE, DERIVACION (BY PASS)	G-750	947293
675C/EXCAVADORA con motor/DOS MOTORES CUMMINS VT1710C		
ACEITE, FLUJO TOTAL (FULL FLOW)	GP-53	961172
COMBUSTIBLE	GP-55	2560232
AGUA	GP-1011Q	961028
ACEITE, DERIVACION (BY PASS)	G-750	947293
75B/EXCAVADORA con motor/CUMMINS V504C		
TRANSMISION	G-33	215502
ACEITE, FLUJO TOTAL (FULL FLOW)	G-613	949096
COMBUSTIBLE	GP-1101	158172
AIRE, PRIMARIO	GA-360	993688
AIRE, SECUNDARIO	GA-361	993689
ACEITE, DERIVACION (BY PASS)	G-500	213527
75B/EXCAVADORA con motor/GMC DIESEL		
ACEITE, FLUJO TOTAL (FULL FLOW)	G-33	215502
TRANSMISION	G-33	215502
COMBUSTIBLE, SECUNDARIO	G-1173	945354
AIRE, PRIMARIO	GA-106	960243
AIRE, HAUSING SIMPLE	GA-360	993688
AIRE, SECUNDARIO	GA-206	1911724
C16/EXCAVADORA con motor/GMC 2-71		
ACEITE	G-31	P3H4120

MID BUS
CAMIONES, TRACTOCAMIONES Y AUTOBUSES

CUT-AWAY CHASSIS con motor/FORD 6.0L TURBO DIESEL		
ACEITE	G-3752	3C3-6731-AA
CUT-AWAY CHASSIS con motor/GM 5.7L GASOLINA		
ACEITE	GP-205	25160561
AIRE	GA-392	25042562
AIRE	GA-192	6419892
AIRE	GA-413R	15153904
COMBUSTIBLE	GG-46	25121792
COMBUSTIBLE	GG-581	25121801
CUT-AWAY CHASSIS con motor/GM 6.5L DIESEL		
ACEITE	GP-205	25160561
COMBUSTIBLE	GPP-419	12552214
AIRE	GA-392	25042562
CUT-AWAY CHASSIS con motor/GM V8 6.6L DURAMAX		
AIRE	GA-135	2467368

MARCA-MODELO-MOTOR GONHER OEM
MAKE-MODEL-ENGINE GONHER OEM

MID BUS (continuación)

CAMIONES, TRACTOCAMIONES Y AUTOBUSES

CUT-AWAY CHASSIS con motor/GM V8 8.1L		
ACEITE	GP-408	25324052
AIRE	GA-348	25313349
COMBUSTIBLE	GG-46	25171792
CUT-AWAY CHASSIS con motores/GM V8 4.8L VORTEC, GM V8 6.0L VORTEC		
ACEITE	GP-44	88984215
AIRE	GA-413R	15153904
COMBUSTIBLE, ROSCAS EN AMBOS EXTREMOS	GG-46	25171792
COMBUSTIBLE, ROSCA EN UN SOLO EXTREMO	GG-66	25121293
GRAND GUIDE con motor/GM 6.0L		
ACEITE, 2007 EN ADELANTE	GP-406	89017524
ACEITE, 2003-2006	GP-44	6439857
AIRE	GA-413R	15153904
GASOLINA, 2003-2005 (ROSCA EN AMBOS EXTREMOS)	GG-46	25055046
GASOLINA, 2003-2005 (ROSCA EN UN EXTREMO)	GG-66	25121293
GUIDE con motor/GM 4.8L		
ACEITE, 2006 EN ADELANTE	GP-406	89017524
ACEITE, 2003-2005	GP-44	6439857
AIRE	GA-413R	15153904
GASOLINA, 2003-2005 (ROSCA EN AMBOS EXTREMOS)	GG-46	25055046
GASOLINA, 2003-2005 (ROSCA EN UN EXTREMO)	GG-66	25121293
GUIDE con motor/GM 6.0L		
ACEITE, 2007 EN ADELANTE	GP-406	89017524
ACEITE, 2003-2006	GP-44	6439857
AIRE	GA-413R	15153904
GASOLINA, 2003-2005 (ROSCA EN AMBOS EXTREMOS)	GG-46	25055046
GASOLINA, 2003-2005 (ROSCA EN UN EXTREMO)	GG-66	25121293
SUPER GUIDE con motor/GM 6.0L		
ACEITE, 2007 EN ADELANTE	GP-406	89017524
ACEITE, 2003-2006	GP-44	6439857
AIRE	GA-413R	15153904
GASOLINA, 2003-2005 (ROSCA EN AMBOS EXTREMOS)	GG-66	25121293
GASOLINA, 2003-2005 (ROSCA EN UN EXTREMO)	GG-66	25121293
MINNEAPOLIS-MOLINE		
COMBINADAS		
2890 con motor/CHRYSLER 6 CYL		
AIRE	GAK-16	CM910
2890 con motor/CHRYSLER V8 A GASOLINA		
ACEITE	G-236	1557376
3490, 4290, 4292 con motor/A GASOLINA 6 CYL		
AIRE	GAK-16	2710837
3496 con motor/A GASOLINA 6 CYL		
ACEITE	GP-1	159045A
4292 con motor/CHRYSLER V8 A GASOLINA		
ACEITE, SELLADO	GP-1	159045A
AIRE	GAK-403	10P2913

SERVICIO PESADO

MARCA-MODELO-MOTOR	GONHER	OEM
MAKE-MODEL-ENGINE	GONHER	OEM

MINNEAPOLIS-MOLINE (continuación)

COMBINADAS

GASOLINA	GG-5 L	C1DZ-9155-A
4293 con motor/CHRYSLER V8-318 A GASOLINA		
ACEITE, SELLADO	GP-1	159045A
AIRE	GAK-403	10P2913
GASOLINA	GG-5 L	C1DZ-9155-A
4293, 4296 con motor/CHRYSLER 6 CYL		
AIRE	GAK-16	2710837
4296 con motor/CHRYSLER V8-318 A GASOLINA		
ACEITE, CARTUCHO	G-236	1557376
ACEITE, SELLADO	GP-1	159045A
AIRE	GAK-403	10P2913
GASOLINA	GG-5 L	C1DZ-9155-A
5297 con motor/CHRYSLER V8-318 A GASOLINA		
ACEITE	GP-1	159045A
AIRE	GAK-403	10P2913
GASOLINA	GG-5 L	C1DZ-9155-A
5297 con motor/CHRYSLER V8-383		
ACEITE	GP-1	159045A
7600 con motor/CHRYSLER V8 A GASOLINA		
ACEITE	GP-1	159045-AS
GASOLINA	GG-5	C1DZ-9155-A
GASOLINA	GG-5 L	C1DZ-9155-A
MBS con motor/FORD V-4		
ACEITE	GP-81	10A14489
GASOLINA	GG-20	C4AZ-9365-A
GASOLINA	GG-5 L	C1DZ-9155-A
MSB con motor/FORD 4 CYL		
ACEITE	GP-1	159045A
S24D con motor/A DIESEL		
COMBUSTIBLE	G-1173	10A3366

MINNEAPOLIS-MOLINE

MONTACARGAS

MOBILIFT E, MOBILIFT F, MOBILITOW 40 con motores/MINNEAPOLIS-MOLINE 206M4, MINNEAPOLIS-MOLINE D206A-4		
TRANSMISION	G-6	35P32
COMBUSTIBLE	G-1173	10A3366
ACEITE	GP-81	10A14489
MOBILIFT MA30, MOBILIFT MA40, MOBILIFT MA50 con motor/A DIESEL		
ACEITE	GP-1	159045A
MO-TRAC con motor/MINNEAPOLIS-MOLINE 206M4		
TRANSMISION	G-33	10P786
MO-TRAC con motor/MINNEAPOLIS-MOLINE D206A-4		
TRANSMISION	G-33	10P786
COMBUSTIBLE	G-1173	10A3366
ACEITE	GP-81	10A14489
MY40, MY60 con motor/A DIESEL		
ACEITE	GP-81	10A14489

MARCA-MODELO-MOTOR	GONHER	OEM
MAKE-MODEL-ENGINE	GONHER	OEM

MINNEAPOLIS-MOLINE

MOTORES

165A A GASOLINA, 165A4 A GASOLINA, 206L4 A GASOLINA, 206M4 A GASOLINA, 206N4 A GASOLINA, 220-4 A GASOLINA, 220-4A A GASOLINA, 220A4 A GASOLINA, 504A6 A GASOLINA, HD220-4A A GASOLINA, HD504-6A A GASOLINA, HD504A6A A GASOLINA, M220B-4 A GASOLINA, M220B-4A A GASOLINA		
ACEITE	GP-81	10A14489
425A6 A DIESEL, 425A-6A A DIESEL, 425B-6 A DIESEL, 504-6 A DIESEL, 504-6A A DIESEL, D206 A DIESEL, D206-4 A DIESEL, D206A-4 A DIESEL, D206B4 A DIESEL, D283 A DIESEL, D283-4A A DIESEL, D336 A DIESEL, D336-4 A DIESEL, D336-4A A DIESEL, D336-A A DIESEL, D336A-4 A DIESEL, D336A-4A A DIESEL, D425 A DIESEL, D425-6A A DIESEL, D425A-6 A DIESEL, D425B-6 A DIESEL, D504-6 A DIESEL, D504A-6 A DIESEL, DD206B-4 A DIESEL, DHD504-6A A DIESEL		
COMBUSTIBLE	G-1173	10A3366
605A6A A GASOLINA, 605B6A A GASOLINA		
ACEITE, SELLADO	GP-1	159045A

MINNEAPOLIS-MOLINE

TRACTORES

335, 5 STAR con motor/A DIESEL		
COMBUSTIBLE, SECUNDARIO	G-1173	10A3366
4 STAR, 4 STAR SUPER con motor/MINNEAPOLIS-MOLINE 206L-4		
ACEITE	GP-81	10A14489
4 STAR, 4 STAR SUPER con motor/MINNEAPOLIS-MOLINE D206-4		
COMBUSTIBLE, SECUNDARIO	G-1173	10A3366
400 con motor/MINNEAPOLIS-MOLINE 206L-4		
COMBUSTIBLE	G-1173	10A3366
400 con motor/MINNEAPOLIS-MOLINE D206-4		
COMBUSTIBLE, SECUNDARIO	G-1173	10A3366
445 con motor/A DIESEL		
COMBUSTIBLE, SECUNDARIO	G-1173	10A3366
A4T1350D con motor/A DIESEL		
COMBUSTIBLE	G-296	259044AS
A4T1400 con motor/A DIESEL		
COMBUSTIBLE	G-296	159044AS
COMBUSTIBLE	G-295	20-0006803
COMBUSTIBLE	G-296-B	159044AS
AIRE, RESPIRADOR	GA-39	10A31255
A4T1400, A4T1600 con motor/MINNEAPOLIS-MOLINE 504 LPG		
AIRE, RESPIRADOR	GA-39	10A31255
A4T1400D con motor/A DIESEL		
COMBUSTIBLE	G-296	E7NN-9176-AA
A4T1600 con motor/A DIESEL		
ACEITE, SELLADO	GP-36	C9DZ-6731-A
COMBUSTIBLE	G-296	159044AS
COMBUSTIBLE	G-295	20-0006803
COMBUSTIBLE	G-296-B	159044AS
AIRE, RESPIRADOR	GA-39	10A31255
A4T1600 con motor/MINNEAPOLIS-MOLINE LP800-6		
ACEITE	GP-1	35A5533
AIRE, RESPIRADOR	GA-39	10A31255
AIRE, SIN ASPAS	GA-24	10P2652

MARCA-MODELO-MOTOR	GONHER	OEM
MAKE-MODEL-ENGINE	GONHER	OEM

MINNEAPOLIS-MOLINE (continuación)

TRACTORES

BIG MO 500, BIG MO 600 con motor/MINNEAPOLIS-MOLINE 206-4 DIESEL		
COMBUSTIBLE, SECUNDARIO	G-1173	10A3366
BIG MO 500, BIG MO 600 con motor/MINNEAPOLIS-MOLINE 206-4 GASOLINA		
ACEITE	GP-81	10A14489
G1000 con motor/A DIESEL		
COMBUSTIBLE	G-296	E7NN-9176-AA
COMBUSTIBLE	G-296-B	259044AS
AIRE	GAK-403	10P2913
G1000 VISTA con motor/MINNEAPOLIS-MOLINE 504-6 DIESEL		
COMBUSTIBLE	G-296	10P2832
COMBUSTIBLE	G-296-B	10P2832
AIRE	GAK-403	10P2913
G1000 VISTA con motor/MINNEAPOLIS-MOLINE 504-6 GASOLINA		
AIRE	GAK-403	10P2913
G1050 con motor/MINNEAPOLIS-MOLINE 504-6		
COMBUSTIBLE, HASTA S/N 43100631	G-296	159044AS
COMBUSTIBLE, S/N 20-0006803 EN ADELANTE	G-295	20-0006803
COMBUSTIBLE, HASTA S/N 43100631	G-296-B	159044AS
ACEITE, SELLADO	GP-81	10A14489
AIRE, RESPIRADOR	GA-39	10A31255
G1350 con motor/MINNEAPOLIS-MOLINE 504-6		
COMBUSTIBLE, HASTA S/N 43300254	G-296	259044AS
COMBUSTIBLE, S/N 43300254 EN ADELANTE	G-295	20-006803
COMBUSTIBLE, HASTA S/N 43300254	G-296-B	259044AS
ACEITE, SELLADO	GP-81	10A14489
AIRE, RESPIRADOR	GA-39	10A31255
G1355 con motor/A GAS LPG		
TRANSMISION	GP-81	256513A
G1355 con motor/MINNEAPOLIS-MOLINE 585		
HIDRAULICO	GP-9	156513-AS
ACEITE, SELLADO	GP-36	C9DZ-6731-A
COMBUSTIBLE	G-295	20-0006803
TRANSMISION	GP-81	10A14489
G550 con motor/A DIESEL		
COMBUSTIBLE, PRIMARIO	G-1174	C2TZ-9155-C
G550 con motor/A GASOLINA		
ACEITE	GP-50	WP93110
G6, G704 con motor/A DIESEL		
COMBUSTIBLE, SECUNDARIO	G-1173	10A3366
G705, G950, G706, G900 con motor/A DIESEL		
COMBUSTIBLE, SECUNDARIO	G-1173	10A3366
ACEITE	GP-81	10A14489
AIRE	GAK-403	10P2913
G707, G708 con motor/MINNEAPOLIS-MOLINE 504-6 DIESEL		
COMBUSTIBLE	G-296	159044AS
COMBUSTIBLE	G-296-B	159044AS
ACEITE	GP-81	10A14373

MARCA-MODELO-MOTOR MAKE-MODEL-ENGINE	GONHER GONHER	OEM OEM	MARCA-MODELO-MOTOR MAKE-MODEL-ENGINE	GONHER GONHER	OEM OEM	MARCA-MODELO-MOTOR MAKE-MODEL-ENGINE	GONHER GONHER	OEM OEM
MINNEAPOLIS-MOLINE(continuación)			MINNEAPOLIS-MOLINE(continuación)			MINNEAPOLIS-MOLINE		
TRACTORES			TRACTORES			TRACTORES PEQUEÑOS Y PARA JARDIN		
AIRE	GAK-403	10P2913	JET STAR 3 con motor/A DIESEL			108 con motor/KOHLER		
G707, G708 con motor/MINNEAPOLIS-MOLINE 504-6 GASOLINA			ACEITE	GP-1	159045A	AIRE	GA-7	32008
ACEITE	GP-81	10A14373	COMBUSTIBLE, S/N 28400467 EN ADELANTE	G-296	159044AS	AIRE	GA-11	230840
G709, G-VI con motor/A DIESEL			COMBUSTIBLE, S/N 28400467 EN ADELANTE	G-296-B	159044AS	AIRE	GA-3445	32355
COMBUSTIBLE, SECUNDARIO	G-1173	10A3366	AIRE	GAK-403	10P2913	110, 112 con motor/TECUMSEH		
G750 con motor/A DIESEL			JET STAR 3 con motor/A GASOLINA			AIRE	GA-7	32008
TRANSMISION	GP-1	159045A	ACEITE	GP-81	10A14489	AIRE	GA-11	230840
COMBUSTIBLE, SECUNDARIO	G-296	E7NN-9176-AA	JET STAR con motor/MINNEAPOLIS-MOLINE 206L-4			AIRE	GA-3445	32355
COMBUSTIBLE, PRIMARIO	G-297	78GB-9150-AA	ACEITE	GP-81	10A14489	NAVISTAR INT.		
COMBUSTIBLE, SECUNDARIO	G-296-B	259044AS	JET STAR con motor/MINNEAPOLIS-MOLINE D206-4			CAMIONES, TRACTOCAMIONES Y AUTOBUSES		
COMBUSTIBLE, PRIMARIO	G-297-B	78GB-9150-AA	ACEITE	G-33	10P786	300 RE con motor/INTERNATIONAL DT466		
G750 con motor/A GASOLINA			COMBUSTIBLE, SECUNDARIO	G-1173	10A3366	ACEITE	GP-152	1819452C1
TRANSMISION	GP-1	159045A	ACEITE	GP-81	10A14489	AIRE	GA-209	476741-C1
G850 con motor/A DIESEL			M5 con motor/MINNEAPOLIS-MOLINE D336-A			AIRE	GA-210	482644-C1
COMBUSTIBLE, SECUNDARIO	G-296	E7NN-9176-AA	COMBUSTIBLE, SECUNDARIO	G-1173	10A3366	4300 195 con motor/INTERNATIONAL DT466		
COMBUSTIBLE	G-295	20-0006803	M602 con motor/A DIESEL			ACEITE	GP-152	P164200
COMBUSTIBLE, PRIMARIO	G-297	78GB-9150-AA	AIRE	GAK-403	10P2913	AIRE	GA-209	476741-C1
COMBUSTIBLE, SECUNDARIO	G-296-B	259044AS	M602D con motor/A DIESEL			AIRE	GA-210	482644-C1
COMBUSTIBLE, PRIMARIO	G-297-B	78GB-9150-AA	COMBUSTIBLE, SECUNDARIO	G-1173	10A3366	4400 con motor/INTERNATIONAL DT466		
G940 con motor/A DIESEL			M604 con motor/A DIESEL			ACEITE	G-152	P164200
COMBUSTIBLE, SECUNDARIO	G-296	E7NN-9176-AA	AIRE	GAK-403	10P2913	AIRE	GA-209	476741-C1
COMBUSTIBLE, PRIMARIO	G-297	78GB-9150-AA	M604D con motor/A DIESEL			AIRE	GA-210	482644-C1
COMBUSTIBLE, SECUNDARIO	G-296-B	259044AS	COMBUSTIBLE, SECUNDARIO	G-1173	10A3366	466 E URBANO con motor/A DIESEL		
COMBUSTIBLE, PRIMARIO	G-297-B	78GB-9150-AA	M670 con motor/A DIESEL			COMBUSTIBLE	GP-78	1809789C1
G940 con motor/A GASOLINA			COMBUSTIBLE	G-296	159044AS	ACEITE	GP-152	1819452C1
ACEITE	GP-1	159045A	AIRE	GAK-16	CM910	AIRE	GA-197R	1691027-C1
G950 con motor/A GASOLINA			M670D con motor/A DIESEL			AIRE	GA-768R	P527680
ACEITE	GP-81	10A14489	COMBUSTIBLE	G-296	159044AS	4700 FBC, 4700 SCD con motor/INTERNATIONAL DT466		
G950G con motor/MINNEAPOLIS-MOLINE 451			AIRE	GAK-16	CM910	ACEITE	G-152	P164200
COMBUSTIBLE	G-296	1841890	M670D con motor/A DIESEL			AIRE	GA-209	476741-C1
COMBUSTIBLE	G-295	20-0006803	COMBUSTIBLE	G-296	E7NN-9176-AA	AIRE	GA-210	482644-C1
COMBUSTIBLE	G-296-B	1841890	MM-600 con motor/A DIESEL			4700 SCD 444 con motor/INTERNATIONAL DT444		
G955 con motor/A DIESEL			COMBUSTIBLE	G-1173	10A3366	AGUA	GP-2071W	WF2071
COMBUSTIBLE	G-296	1841890	S24 con motor/A DIESEL			AIRE	GA-209	476741-C1
COMBUSTIBLE	G-296-B	1841890	COMBUSTIBLE, SECUNDARIO	G-1173	10A3366	AIRE	GA-210	482644-C1
TRANSMISION	GP-81	256513A	S24 con motor/A GASOLINA			530 E con motor/A DIESEL		
GB con motor/A DIESEL			ACEITE	GP-81	10A14489	ACEITE	G-152	P164200
COMBUSTIBLE, SECUNDARIO	G-1173	10A3366	U, UB, UBS, UM, UTI, UTIL, UTS con motor/A DIESEL			9200 i con motor/CUMMINS ISM 370		
GT con motor/A DIESEL			COMBUSTIBLE, SECUNDARIO	G-1173	10A3366	COMBUSTIBLE	GPP-1003S	3406889
COMBUSTIBLE	G-1173	10A3366	U302 con motor/A DIESEL			9400 i con motor/CUMMINS ISX		
GTB con motor/A DIESEL			ACEITE	GP-1	159045A	COMBUSTIBLE	GPP-1003S	3406889
COMBUSTIBLE, SECUNDARIO	G-1173	10A3366	U302D con motor/A DIESEL			DAY CAB con motor/CUMMINS ISM 330		
H12 con motor/MINNEAPOLIS-MOLINE D336-A			COMBUSTIBLE, SECUNDARIO	G-1173	10A3366	COMBUSTIBLE	GPP-1003S	3406889
COMBUSTIBLE, SECUNDARIO	G-1173	10A3366	UNITRACTOR con motor/A DIESEL			DAY CAB con motor/DETROIT DIESEL SERIES 60		
HD504A con motor/A DIESEL			ACEITE	G-33	10P786	ACEITE	GP-53	1212622H1
AIRE	GAK-403	10P2913	COMBUSTIBLE, SECUNDARIO	G-1173	10A3366	ACEITE	GP-57	1212621H1
HD800-6A con motor/A DIESEL			ACEITE	GP-81	10A14489	ACEITE	GP-193	23518480
AIRE, SIN ASPAS	GA-24	10P2652				AIRE	GA-682R	3540117-C1
						DT408 NGD con motor/INTERNATIONAL DT408 NGD		
						COMBUSTIBLE	GP-78	1809789C1
						ACEITE	GP-152	1819452C1

SERVICIO PESADO

MARCA-MODELO-MOTOR GONHER OEM
MAKE-MODEL-ENGINE GONHER OEM

NAVISTAR INT. (continuación)

CAMIONES, TRACTOCAMIONES Y AUTOBUSES

AIRE	GA-209	476741-C1
AIRE	GA-210	482644-C1
DT466 E con motor/INTERNATIONAL DT466 E		
ACEITE	GP-152	1819452C1
AIRE	GA-209	476741-C1
AIRE	GA-210	482644-C1
DT466 NGD con motor/INTERNATIONAL DT466 NGD		
ACEITE	GP-152	1819452C1
AIRE	GA-209	476741-C1
AIRE	GA-210	482644-C1
TRACTO MODELO 1999 con motor/DETROIT DIESEL SERIES 60 425		
ACEITE	GP-53	1212622H1
ACEITE	GP-57	1212621H1
ACEITE	GP-193	23518480
TRACTO MODELOS 1997-99 con motor/CUMMINS M11 671		
COMBUSTIBLE	GP-11	3300901
AGUA	GP-2071W	WF2071
COMBUSTIBLE	GPP-1000	702256C1
COMBUSTIBLE	GPP-1003S	3406889
AIRE	GA-221R	2005895-C1
TRACTO MODELOS 1998-99 con motor/CUMMINS N14 855		
AGUA	GP-2071W	WF2071

NAVISTAR INT.

MOTORES

4-152 A GASOLINA, 4-196 A GASOLINA		
ACEITE	G-333	214731R91
ACEITE	GP-1	918266R93
GASOLINA	GG-5 L	417917C91
530NGD A DIESEL, DT-408 NGD A DIESEL		
COMBUSTIBLE, SECUNDARIO	GP-78	1809789C1
6.9 LITROS A DIESEL		
ACEITE	GP-3766	1804442C1
6-220 A GASOLINA, BD-220 INDUSTRIAL, BD-240 INDUSTRIAL, BD-264 INDUSTRIAL, BD-282 INDUSTRIAL, BD-308 INDUSTRIAL, BG-220 INDUSTRIAL, BG-241 INDUSTRIAL, BG-265 INDUSTRIAL		
ACEITE	G-333	214731R91
6-232 A GASOLINA, 6-258 A GASOLINA, V8-400 A GASOLINA		
ACEITE	GP-20	384843C2
7.3 LITROS A DIESEL		
ACEITE	GP-3766	1804442C1
COMBUSTIBLE	GP-155	1804459C1
COMBUSTIBLE	GPP-1287	1816568C91
9.0 LITROS A DIESEL		
ACEITE	GP-10	427207C2
COMBUSTIBLE, PRIMARIO	GP-1101	625625C1
ACEITE	GP-3766	970165R1
COMBUSTIBLE, SECUNDARIO	GP-78	672602C2
BD-269 INDUSTRIAL, RD-372 INDUSTRIAL, RD-406 INDUSTRIAL, RD-450 INDUSTRIAL, RD-501 INDUSTRIAL		
GASOLINA	GG-5 L	417917C91
C-157 A DIESEL, C-175 A DIESEL, C-200 A DIESEL, D-179 A DIESEL		

MARCA-MODELO-MOTOR GONHER OEM
MAKE-MODEL-ENGINE GONHER OEM

NAVISTAR INT. (continuación)

MOTORES

ACEITE	GP-54	398080R2
D-150 A DIESEL, D-170 A DIESEL, D-190 A DIESEL, DV-462 A DIESEL, UD-170 A DIESEL, UD-817B A DIESEL, UDT1-817B A DIESEL, UDT-817B A DIESEL, UDT-817C A DIESEL		
COMBUSTIBLE, PRIMARIO	GP-1108	702251C1
D-155 A DIESEL, D-239 A DIESEL		
COMBUSTIBLE	G-296	3144477R92
ACEITE	GP-54	398080R2
COMBUSTIBLE, PRIMARIO	GPP-1122	3136187R91
COMBUSTIBLE, SECUNDARIO	GPP-1122	3136187R91
D-188 A DIESEL, D-301 A DIESEL, UB-240 A DIESEL, UB-264 A DIESEL, UC-221 A DIESEL, UC-263 A DIESEL, UC-301 A DIESEL, UD-301 A DIESEL		
ACEITE	G-335	323827R91
D-268 A DIESEL, D-392 A DIESEL		
ACEITE	GP-10	528250R1
D-310 A DIESEL		
ACEITE	GP-10	528250R1
COMBUSTIBLE	G-296	3144477R92
COMBUSTIBLE, PRIMARIO	GPP-1122	3136187R91
COMBUSTIBLE, SECUNDARIO	GPP-1122	3132428R1
D-345 A DIESEL, U-446 A DIESEL		
ACEITE	GP-1	918266R3
D-354 A DIESEL		
COMBUSTIBLE	G-296	3044506R91
D-358 A DIESEL, DT-358 A DIESEL		
ACEITE	GP-10	528250R1
COMBUSTIBLE, PRIMARIO	GPP-1122	3136187R91
COMBUSTIBLE, SECUNDARIO	GPP-1122	3132428R1
DT-360 A DIESEL, DTA-360 A DIESEL		
ACEITE	GP-69	675616C91
COMBUSTIBLE	GPP-11	FFR-8105D
ACEITE	GP-88	1811953C1
COMBUSTIBLE	GP-78	1809789C1
DT408 A DIESEL		
COMBUSTIBLE	GP-1122	FF5052
DT-408 PLN A DIESEL, DT-466 E A DIESEL, DT466 NGD A DIESEL, DT-466 PLN A DIESEL, I-530 E A DIESEL, I-530 PLN A DIESEL		
ACEITE	GP-152	1819452C1
DT-466 A DIESEL, DTA-466 A DIESEL, DTI-466 A DIESEL		
COMBUSTIBLE, PRIMARIO	GP-1101	625625C1
ACEITE	GP-69	675616C91
COMBUSTIBLE, PRIMARIO	GP-1108	625627C1
COMBUSTIBLE	GPP-11	FFR-8105D
ACEITE	GP-88	1811953-C1
COMBUSTIBLE, SECUNDARIO	GP-78	1809789C1
DV-550 A DIESEL		
ACEITE	GP-10	427207C1
COMBUSTIBLE, PRIMARIO	GPP-11	625627C1
COMBUSTIBLE, SECUNDARIO	GP-78	672603C2
DVT-573 A DIESEL, DVT-573 B A DIESEL		
COMBUSTIBLE, PRIMARIO	GPP-11	702251C1

MARCA-MODELO-MOTOR GONHER OEM
MAKE-MODEL-ENGINE GONHER OEM

NAVISTAR INT. (continuación)

MOTORES

T444E 7.3L A DIESEL		
AGUA	GP-2071W	WF2071
U-301 A DIESEL, UD-166 A DIESEL		
ACEITE	G-335	323827R91
COMBUSTIBLE, PRIMARIO	G-1163	306353R91
COMBUSTIBLE, SECUNDARIO	G-1163	304101R91
UD-144A A DIESEL		
ACEITE	G-801	705730R91
UD-236 A DIESEL, UD-282 A DIESEL, UD-361 A DIESEL, UDT-361 A DIESEL		
ACEITE	G-335	323827R91
COMBUSTIBLE, PRIMARIO	G-1163	306353R91
COMBUSTIBLE, SECUNDARIO	G-1163	304101R91
COMBUSTIBLE, PRIMARIO	GP-1105	702143C1
COMBUSTIBLE, PRIMARIO	GP-1108	702251C1
COMBUSTIBLE, SECUNDARIO	GP-110	702142C1
UD-312 A DIESEL		
ACEITE	GP-69	675616C91
UD-360 A DIESEL, UDT-360 A DIESEL		
ACEITE	GP-69	675616C91
COMBUSTIBLE, PRIMARIO	GP-1105	625626C1
COMBUSTIBLE, PRIMARIO	GP-1108	625627C1
COMBUSTIBLE, SECUNDARIO	GP-78	1809789C1
UD-407 A DIESEL, UDT-407 A DIESEL		
ACEITE	G-335	323827R91
COMBUSTIBLE, PRIMARIO	GP-1105	702143C1
COMBUSTIBLE, PRIMARIO	GP-1108	702251C1
COMBUSTIBLE, SECUNDARIO	GP-110	702142C1
UD-414 A DIESEL, UDT-414 A DIESEL, UDT-436 A DIESEL		
ACEITE	GP-69	675616C91
COMBUSTIBLE, PRIMARIO	GP-1105	625626C1
COMBUSTIBLE, SECUNDARIO	GP-78	1809789C1
UD-466 A DIESEL, UDT-466 A DIESEL		
ACEITE	GP-69	675617C91
COMBUSTIBLE, PRIMARIO	GP-1105	625626C1
COMBUSTIBLE, PRIMARIO	GP-1108	625627C1
ACEITE	GP-88	1811953C1
COMBUSTIBLE, SECUNDARIO	GP-78	672603C2
UDT-429 A DIESEL		
COMBUSTIBLE, PRIMARIO	G-1163	306353R91
COMBUSTIBLE, SECUNDARIO	G-1163	304101R91
COMBUSTIBLE, PRIMARIO	GP-1105	702143C1
COMBUSTIBLE, PRIMARIO	GP-1108	702251C1
COMBUSTIBLE, SECUNDARIO	GP-110	702142C1
UDT-573 A DIESEL, UDT-573B A DIESEL, UDV-573 A DIESEL		
COMBUSTIBLE, PRIMARIO	G-1163	306353R91
COMBUSTIBLE, SECUNDARIO	G-1163	304101R91
COMBUSTIBLE, PRIMARIO	GP-1108	702251C1
COMBUSTIBLE, PRIMARIO	GP-1108	702251C1
COMBUSTIBLE, SECUNDARIO	GP-78	674293C1
UDV-800 A DIESEL, V-800 A DIESEL		
AGUA	GP-1010Q	A151931
COMBUSTIBLE, PRIMARIO	GP-1105	625626C1
COMBUSTIBLE, PRIMARIO	GP-1108	702251C1
COMBUSTIBLE, SECUNDARIO	GP-78	672603C2

MARCA-MODELO-MOTOR GONHER OEM
MAKE-MODEL-ENGINE GONHER OEM

NAVISTAR INT. (continuación)

MOTORES

V-537 A DIESEL, V8-537 A GASOLINA		
ACEITE	GP-10	427207C2
V8-266 A GASOLINA, V8-304 A GASOLINA		
ACEITE	G-333	214731R91
ACEITE	GP-1	918266R93
ACEITE	GP-10	427207C1
GASOLINA	GG-5 L	417917C91
V8-345 A GASOLINA, V8-392 A GASOLINA		
ACEITE	G-333	214731R91
ACEITE	GP-1	918266R93
ACEITE	GP-10	427207C1
V8-404 A GASOLINA, V8-446 A GASOLINA		
ACEITE	GP-1	918266R93
ACEITE	GP-10	427207C2
GASOLINA	GG-20	FFR-8114
GASOLINA	GG-5 L	417917C91

NAVISTAR INT.

TRACTORES

1800 con motor/INTERNATIONAL D358		
COMBUSTIBLE	G-296	3144477R92
AIRE	GA-109	478974-C1
AIRE	GA-119	530776-C1

NEW HOLLAND

APLANADORAS

RG170, RG200 con motor/A DIESEL		
ACEITE	GP-3000	9703112
RG80 con motor/A DIESEL		
ACEITE	GP-1	87800083

NEW HOLLAND

CAMIONES, TRACTOCAMIONES Y AUTOBUSES

AD250 DE VOLTEO con motor/A DIESEL		
ACEITE	GP-3000	9703112

NEW HOLLAND

CARGADORAS

1049 SUPER ARRASTRADOR con motor/FORD 361HD A GASOLINA		
ACEITE	G-6	CPN6731AB
ACEITE	GP-1	8780003
HIDRAULICO	GP-34	636843
AIRE	GAK-403	75495
GASOLINA	GG-20	500660
555E con motor/A DIESEL		
ACEITE	GP-1	87800083
B95TC, B110, B115, B95, B95LR con motor/NEW HOLLAND 445T/M2		
COMBUSTIBLE	GPP-1122	1930010
ACEITE	GP-737	87803260
HIDRAULICO	GP-761H	86989733
AIRE, PRIMARIO	GA-853R	87418364
C185 con motor/NEW HOLLAND 334TM2 (3.4L)		
COMBUSTIBLE, SEPARADOR DE AGUA	GPP-1122	87803264

MARCA-MODELO-MOTOR GONHER OEM
MAKE-MODEL-ENGINE GONHER OEM

NEW HOLLAND (continuación)

CARGADORAS

ACEITE, TANQUE HIDRAULICO	GP-761H	9842392
AIRE ACONDICIONADO / CALEFACCION	GA-271	86504784
C190 con motor/NEW HOLLAND 445M2 (4.5L)		
ACEITE	GP-737	87803260
ACEITE, ALT. 6 IN. PARA TANQUE HIDRAULICO	GP-761H	9842392
AIRE ACONDICIONADO / CALEFACCION	GA-271	86504784
L140, L150, LS140, LS150 con motores/NEW HOLLAND N843, NEW HOLLAND N843H		
ACEITE, 10/1/1996 EN ADELANTE (8-12 PSI)	GP-58	87415600
COMBUSTIBLE, SEPARADOR DE AGUA	GPP-1122	86504140
ACEITE, HASTA 10/1/1996	GP-81	86546618
ACEITE, TANQUE HIDRAULICO	GP-761H	9842392
AIRE DE CABINA	GA-271	86504784
GASOLINA	GG-124	9611973
L160, L170 con motor/NEW HOLLAND N844T		
ACEITE, 8-12 PSI	GP-58	87415600
COMBUSTIBLE, SEPARADOR DE AGUA	GPP-1122	87036044
ACEITE, TANQUE HIDRAULICO	GP-761H	9842392
AIRE DE CABINA	GA-271	86504784
GASOLINA	GG-124	9611973
L180, L185 con motores/IVECO 334M2 (3.4L), IVECO 334TM2 (3.4L)		
COMBUSTIBLE, SEPARADOR DE AGUA	GPP-1122	87803264
ACEITE, TANQUE HIDRAULICO	GP-761H	9842392
AIRE ACONDICIONADO / CALEFACCION	GA-271	86504784
L190 con motor/NEW HOLLAND 445M2 (4.5L)		
ACEITE	GP-737	87803260
HIDRAULICO (ALT. 6 IN.)	GP-761H	9842392
AIRE ACONDICIONADO / CALEFACCION	GA-271	86504784
L225 con motor/WISCONSIN TJD		
HIDRAULICO	GP-34	262546
L250 con motor/A DIESEL		
AIRE	GA-33	217490
L250 con motor/ONAN B43G		
ACEITE	GP-58	507107
ACEITE	GP-3600	507107
AIRE, SIN ASPAS	GA-33	217490
L250 con motor/ONAN P218G		
ACEITE	GP-3600	507631
L255 con motor/A DIESEL		
ACEITE	GP-2951	PH2858
L325 con motor/KOHLER K582		
HIDRAULICO	GP-34	636843
L325, L425 con motor/WISCONSIN VH4D		
HIDRAULICO	GP-34	636843
L35 con motor/DEUTZ F3L912		
AIRE	GAK-1532	P119538

MARCA-MODELO-MOTOR GONHER OEM
MAKE-MODEL-ENGINE GONHER OEM

NEW HOLLAND (continuación)

CARGADORAS

L35 con motor/WISCONSIN VG4D A GASOLINA		
GASOLINA	GG-5 L	P550012
L425 con motor/KOHLER		
ACEITE	GP-3600	276513
L445 con motor/DEUTZ F2L411		
COMBUSTIBLE	GP-1122	276515
L445 con motor/DEUTZ F2L511		
HIDRAULICO	GP-34	636843
COMBUSTIBLE	GP-1122	276515
ACEITE	GP-3816	276514
L445 con motor/WISCONSIN VH4D		
HIDRAULICO	GP-34	636843
L451 con motor/DEUTZ F2L511		
COMBUSTIBLE	GP-1122	276515
ACEITE	GP-66	783733
ACEITE	GP-3816	276514
L451 con motor/DEUTZ F2L511D		
HIDRAULICO	GP-34	636843
L452 con motor/WISCONSIN VH4D		
HIDRAULICO	GP-34	636843
ACEITE	GP-66	783733
AIRE, SIN ASPAS	GA-33	217490
L454 con motor/CONTINENTAL TM13		
ACEITE	GP-1	508129
L454 con motor/FORD VSG411 A GASOLINA		
HIDRAULICO	GP-34	636843
ACEITE	GP-3600	E4FZ-6731-A
GASOLINA	GG-87	E3FZ-9155-F
L455 con motor/KUBOTA B1402B		
ACEITE, FORD	GP-9	503202
COMBUSTIBLE	G-296	EDPN-9N074-AA
COMBUSTIBLE	G-296-B	EDPN-9N074-AA
ACEITE, CHRYSLER	GP-81	503202
L455 con motor/KUBOTA D1402B		
ACEITE, FORD	GP-9	503202
COMBUSTIBLE	G-296	500625
HIDRAULICO	GP-34	636843
COMBUSTIBLE	G-296-B	500625
ACEITE, CHRYSLER	GP-81	503202
L464 con motor/FORD VSG413 A GASOLINA		
ACEITE	GP-3600	E4FZ-6731-A
L465 con motor/A DIESEL		
COMBUSTIBLE, SEPARADOR DE AGUA (SELLADO)	GPP-1122	86504140
ACEITE	GP-81	86546618
HIDRAULICO	GP-761H	9842392
GASOLINA	GG-124	9611973
L465 con motor/NEW HOLLAND N843		
ACEITE	GP-9	E9NN-6714-AA

SERVICIO PESADO

MARCA-MODELO-MOTOR MAKE-MODEL-ENGINE	GONHER GONHER	OEM OEM	MARCA-MODELO-MOTOR MAKE-MODEL-ENGINE	GONHER GONHER	OEM OEM	MARCA-MODELO-MOTOR MAKE-MODEL-ENGINE	GONHER GONHER	OEM OEM
NEW HOLLAND (continuación)			NEW HOLLAND (continuación)			NEW HOLLAND (continuación)		
CARGADORAS			CARGADORAS			CARGADORAS		
L553 con motor/KUBOTA V1902			GASOLINA	GG-20	500660	ACEITE	GP-737	87803260
ACEITE, FORD	GP-9	503202	L779 con motor/FORD 6-200 A GASOLINA			HIDRAULICO	GP-761H	86989733
COMBUSTIBLE	G-296	1909100	ACEITE	GP-9	501547	AIRE, PRIMARIO	GA-853R	87418364
COMBUSTIBLE	G-296-B	1909100	HIDRAULICO	GP-34	636843	LB115, LB75 con motor/A DIESEL		
ACEITE, CHRYSLER	GP-81	503202	AIRE	GAK-1532	221409	ACEITE	GP-1	87800083
L553, L555 con motor/KUBOTA V1902B			GASOLINA	GG-20	500660	LB115.B con motor/NEW HOLLAND F4GE0484G*D (4.5L)		
ACEITE, FORD	GP-9	503202	L779 con motor/PERKINS 4.203			COMBUSTIBLE	GPP-1122	1930010
COMBUSTIBLE	G-296	500625	COMBUSTIBLE	G-296	1909100	ACEITE	GP-737	87803260
HIDRAULICO	GP-34	636843	HIDRAULICO	GP-34	636843	HIDRAULICO	GP-761H	86989733
COMBUSTIBLE	G-296-B	500625	ACEITE	GP-3600	2654408	AIRE, PRIMARIO	GA-853R	87418364
ACEITE, CHRYSLER	GP-81	503202	COMBUSTIBLE	G-296-B	1909100	LB600 con motor/ONAN L423		
L554 con motor/CONTINENTAL TM20			AIRE	GAK-1532	221409	COMBUSTIBLE	G-296	83937061
ACEITE, FORD	GP-9	508129	L781 con motor/DEUTZ F3L912			COMBUSTIBLE	G-296-B	83937061
HIDRAULICO	GP-34	636843	ACEITE	GP-36	276516	ACEITE, OPCIONAL	GP-68	785F-6714-AA3A
ACEITE	GP-81	508129	HIDRAULICO	GP-34	636843	AIRE	GAK-16	279180
L555 con motor/KUBOTA V1902			COMBUSTIBLE	GP-1122	276515	LB620 con motor/ONAN L423		
ACEITE, FORD	GP-9	508129	AIRE	GAK-1532	221409	COMBUSTIBLE	G-296	EDPN-9N074-AA
COMBUSTIBLE	G-296	1909100	L783 con motor/FORD BSD333 DIESEL			COMBUSTIBLE	G-296-B	EDPN-9N074-AA
COMBUSTIBLE	G-296-B	1909100	ACEITE	GP-1	E7NN-3714-AA	ACEITE, OPCIONAL	GP-68	507407
ACEITE, CHRYSLER	GP-81	503202	COMBUSTIBLE	G-296	3937061	LB90 con motor/NEW HOLLAND 4BT4.5 TURBO		
L555 con motor/PERKINS 4.108			HIDRAULICO	GP-34	636843	ACEITE	GP-737	87803260
ACEITE	GP-1	8780003	COMBUSTIBLE	G-296-B	3937061	HIDRAULICO	GP-761H	86989733
COMBUSTIBLE	G-296	1909100	AIRE	GAK-1532	221409	AIRE, PRIMARIO	GA-853R	87418364
HIDRAULICO	GP-34	636843	L783 con motor/PERKINS 4.203			LB90.B con motor/NEW HOLLAND 445TA/M2		
COMBUSTIBLE	G-296-B	1909100	COMBUSTIBLE	G-296	500625	COMBUSTIBLE	GPP-1122	1930010
L565 con motor/A DIESEL			HIDRAULICO	GP-34	636843	ACEITE	GP-737	87803260
COMBUSTIBLE, SEPARADOR DE AGUA	GPP-1122	86504140	ACEITE	GP-3600	505260	HIDRAULICO	GP-761H	86989733
ACEITE	GP-81	86546618	COMBUSTIBLE	G-296-B	500625	AIRE, PRIMARIO	GA-853R	87418364
HIDRAULICO	GP-761H	9842392	AIRE	GAK-1532	221409	LM415A con motor/NEW HOLLAND 4.5L TURBO		
AIRE DE CABINA	GA-271	86504784	L784 con motor/FORD 6-200 A GASOLINA			ACEITE	GP-737	87803260
GASOLINA	GG-124	9611973	ACEITE	GP-9	501547	LM430 CON MANGO TELESCOPICO con motor/IVECO		
L565 con motor/NEW HOLLAND N844			HIDRAULICO	GP-34	636843	COMBUSTIBLE	GPP-1122	1902138
ACEITE	GP-9	E9NN-6714-AA	AIRE	GAK-1532	221409	LM435A TELESCOPICO con motor/NEW HOLLAND 4.5L		
L600 con motor/ONAN L423			GASOLINA	GG-20	500660	ACEITE	GP-737	87803260
COMBUSTIBLE	G-296	1909100	L785 con motor/FORD BSD333 DIESEL			LM445A con motor/NEW HOLLAND 4.5L TURBO		
HIDRAULICO	GP-34	636843	ACEITE	GP-1	E7NN-3714-AA	ACEITE	GP-737	87803260
COMBUSTIBLE	G-296-B	1909100	COMBUSTIBLE	G-296	3937061	LM630 CON MANGO TELESCOPICO, LM640 CON MANGO TELESCO-PICO con motor/IVECO 8045 (3.9L)		
ACEITE, OPCIONAL	GP-68	785F-6714-AA3A	HIDRAULICO	GP-34	636843	COMBUSTIBLE	GPP-1122	1930010
AIRE	GAK-16	279180	COMBUSTIBLE	G-296-B	3937061	LM840 CON MANGO TELESCOPICO, LM860 CON MANGO TELESCO-PICO con motor/A DIESEL		
L775 con motor/DEUTZ F3L912			AIRE	GAK-1532	221409	ACEITE	GP-1	87800083
ACEITE	GP-36	A1H4123	L785 con motor/PERKINS 4.203			COMBUSTIBLE	G-296	83937061
COMBUSTIBLE	GP-1122	276515	COMBUSTIBLE	G-296	500625	COMBUSTIBLE	G-296-B	83937061
AIRE	GAK-1532	221409	HIDRAULICO	GP-34	636843	LM850 CON MANGO TELESCOPICO con motor/PERKINS 809-20		
L778 con motor/FORD 192 A DIESEL			ACEITE	GP-3600	505260	ACEITE	GP-1	87800083
ACEITE	GP-9	501547	COMBUSTIBLE	G-296-B	500625	COMBUSTIBLE	G-296	83937061
COMBUSTIBLE	G-296	1909100	AIRE	GAK-1532	221409	COMBUSTIBLE	G-296-B	83937061
HIDRAULICO	GP-34	262546	L865, L885 con motor/A DIESEL			LM850 CON MANGO TELESCOPICO con motor/PERKINS 809-20		
COMBUSTIBLE	G-296-B	1909100	ACEITE	GP-81	87800068	ACEITE	GP-1	87800083
AIRE	GAK-1532	221409	HIDRAULICO	GP-761H	9842392	COMBUSTIBLE	G-296	83937061
L778 con motor/FORD 192 A GASOLINA			AIRE, RADIAL PRIMARIO	GA-853R	86555826	COMBUSTIBLE	G-296-B	83937061
ACEITE	GP-9	501547	L885 con motor/A GASOLINA			LM125, ARRASTADOR Y GUIADOR con motor/ISM E673		
HIDRAULICO	GP-34	262546	GASOLINA	GG-124	9611973	ACEITE	GP-156	86546623
AIRE	GAK-1532	221409	LB110.B con motor/NEW HOLLAND 445TA/M2					
			COMBUSTIBLE	GPP-1122	1930010			

MARCA-MODELO-MOTOR MAKE-MODEL-ENGINE	GONHER GONHER	OEM OEM	MARCA-MODELO-MOTOR MAKE-MODEL-ENGINE	GONHER GONHER	OEM OEM	MARCA-MODELO-MOTOR MAKE-MODEL-ENGINE	GONHER GONHER	OEM OEM
NEW HOLLAND (continuación)			NEW HOLLAND (continuación)			NEW HOLLAND (continuación)		
CARGADORAS			CARGADORAS			CARGADORAS		
LS125, ARRASTRADOR Y GUIADOR con motor/NEW HOLLAND E673 A GASOLINA			LW170.B con motor/CUMMINS 8.3L			W130 con motor/NEW HOLLAND 6.8L		
GASOLINA	GG-124	9611973	ACEITE	GP-737	87803260	ACEITE	GP-737	87803260
LS160, LS170 con motor/NEW HOLLAND N844T			LW190B con motor/IVECO			NEW HOLLAND		
ACEITE, 8-12 PSI	GP-58	87415600	ACEITE	GP-737	2992242	COMBINADAS		
COMBUSTIBLE, SEPARADOR DE AGUA	GPP-1122	87036044	LW230 con motor/CUMMINS 8.3L			1400 con motor/A GASOLINA		
ACEITE, TANQUE HIDRAULICO	GP-761H	9842392	ACEITE	GP-3000	9703112	AIRE	GA-892	377059
AIRE DE CABINA	GA-271	86504784	LW270 con motor/CUMMINS M11			1500 con motor/A DIESEL		
GASOLINA	GG-124	9611973	COMBUSTIBLE	GPP-11	V79080	GASOLINA	G-293	703631
LS160, LS170, LS180, LS140, LS150 con motor/CUMMINS ISM			ACEITE	GP-3000	9703112	AIRE, PRIMARIO	GA-360	227456
ACEITE	GP-9000	441700A1	ACEITE	GP-761H	76074218	AIRE, SECUNDARIO	GA-361	227671
LS180 con motor/NEW HOLLAND BSD332T			AIRE	GA-206	1930748	1500 con motor/CATERPILLAR 3208		
ACEITE	GP-81	87800068	LW50, LW50B con motor/PERKINS 700 SERIES			ACEITE	GP-36	919200
HIDRAULICO	GP-761H	9842392	COMBUSTIBLE	G-296	83937061	COMBUSTIBLE	GP-110	1R0712
AIRE, RADIAL PRIMARIO	GA-853R	86555826	LW80 con motor/PERKINS			ACEITE	GP-9586	9N5570
LINEA DE COMBUSTIBLE	GG-124	9611973	ACEITE	GP-1	8780003	AIRE, PRIMARIO	GA-360	227456
LS180.B con motor/NEW HOLLAND 334M2 (3.4L)			LX465 con motor/A DIESEL			AIRE, SECUNDARIO	GA-361	227671
COMBUSTIBLE, SEPARADOR DE AGUA	GPP-1122	87803264	COMBUSTIBLE, SEPARADOR DE AGUA (SELLADO)	GPP-1122	86504140	1500 con motor/FORD 391 A GASOLINA		
HIDRAULICO	GP-761H	9842392	ACEITE	GP-81	86546618	ACEITE	GP-1	8780003
AIRE ACONDICIONADO / CALEFACCION	GA-271	86504784	HIDRAULICO	GP-761H	9842392	1880 con motor/CATERPILLAR 3160		
LS185B con motor/NEW HOLLAND 334TM2 (3.4L)			GASOLINA	GG-124	9611973	AIRE, PRIMARIO	GA-360	P117439
COMBUSTIBLE	GPP-1122	87803264	LX485, LX665 TURBO con motor/A DIESEL			975, 980 con motor/FORD 240 A GASOLINA		
HIDRAULICO	GP-761H	9842392	COMBUSTIBLE, SEPARADOR DE AGUA	GPP-1122	86504140	ACEITE	GP-1	8780003
AIRE ACONDICIONADO / CALEFACCION	GA-271	86504784	ACEITE	GP-81	86546618	985 con motor/FORD 363 DIESEL		
LS190 con motor/CASE 5.0L			HIDRAULICO	GP-761H	9842392	ACEITE	G-834	321091
ACEITE	GP-1	87800083	GASOLINA	GG-124	9611973	COMBUSTIBLE	G-296	505776
HIDRAULICO	GP-761H	9842392	LX565 con motor/A DIESEL			COMBUSTIBLE	G-296-B	500625
AIRE, RADIAL PRIMARIO	GA-853R	86555826	COMBUSTIBLE, SEPARADOR DE AGUA	GPP-1122	86504140	985 con motor/FORD 6-300 A GASOLINA		
LS190.B con motor/NEW HOLLAND 445M2 (4.5L)			ACEITE	GP-81	86546618	ACEITE	G-330	COTE6744A
ACEITE	GP-737	87803260	HIDRAULICO	GP-761H	9842392	ACEITE	GP-1	8780003
HIDRAULICO (ALT. 6 IN.)	GP-761H	9842392	AIRE DE CABINA	GA-271	86504784	ACEITE, OPCIONAL	GP-68	785F-671A-AA3A
AIRE ACONDICIONADO / CALEFACCION	GA-271	86504784	GASOLINA	GG-124	9611973	GASOLINA	GG-20	500660
LT185.B con motor/NEW HOLLAND 334TM2 (3.4L)			LX865, LX885 con motor/A DIESEL			990 con motor/FORD 300 A GASOLINA		
COMBUSTIBLE	GPP-1122	87803264	ACEITE	GP-81	87800068	ACEITE	GP-1	8780003
HIDRAULICO	GP-761H	9842392	HIDRAULICO	GP-761H	9842392	AIRE	GAK-403	75495
AIRE ACONDICIONADO / CALEFACCION	GA-271	86504784	AIRE, RADIAL PRIMARIO	GA-853R	86555826	GASOLINA	GG-20	500660
LT190.B con motor/NEW HOLLAND 445M2 (4.5L)			LX885 con motor/A GASOLINA			995 con motor/FORD 363 DIESEL		
ACEITE	GP-737	87803260	GASOLINA	GG-124	9611973	ACEITE	G-834	321091
HIDRAULICO (ALT. 6 IN.)	GP-761H	9842392	LX985 con motor/NEW HOLLAND 5.0L			995 con motor/FORD 6-300 A GASOLINA		
AIRE ACONDICIONADO / CALEFACCION	GA-271	86504784	ACEITE (CON ENFRIADOR DE ACEITE)	GP-1	87800083	ACEITE	GP-1	8780003
LW110, LW130 con motor/FIAT 8065			HIDRAULICO	GP-761H	9842392	ACEITE, OPCIONAL	GP-68	785F-671A-AA3A
COMBUSTIBLE	GPP-1122	1930010	AIRE, RADIAL PRIMARIO	GA-853R	86555826	GASOLINA	GG-20	500660
LW160 con motor/CUMMINS 8.3L			LINEA DE COMBUSTIBLE	GG-124	9611973	995 con motor/PERKINS		
COMBUSTIBLE	GP-1122	276515	U80 con motor/NEW HOLLAND 439			ACEITE	G-834	321091
AGUA	GP-1011Q	83957719	COMBUSTIBLE, SEPARADOR DE AGUA	GPP-1122	73175965	COMBUSTIBLE	G-296	1909100
ACEITE	GP-3000	9703112	HIDRAULICO	GP-761H	9821387	COMBUSTIBLE	G-296-B	1909100
COMBUSTIBLE	GPP-18	25850	AIRE, RADIAL PRIMARIO (CON TURBO)	GA-853R	82981152	BW28 con motor/NEW HOLLAND 6.8L		
LW170, LW190 con motor/CUMMINS 8.3L						HIDRAULICO	GP-34	86632018
ACEITE	GP-3000	9703112				CR920 con motor/NEW HOLLAND 7.5L		
						ACEITE, RETORNO HIDRAULICO	GP-761H	9821387

SERVICIO PESADO

MARCA-MODELO-MOTOR MAKE-MODEL-ENGINE	GONHER GONHER	OEM OEM	MARCA-MODELO-MOTOR MAKE-MODEL-ENGINE	GONHER GONHER	OEM OEM	MARCA-MODELO-MOTOR MAKE-MODEL-ENGINE	GONHER GONHER	OEM OEM
NEW HOLLAND (continuación)			NEW HOLLAND (continuación)			NEW HOLLAND (continuación)		
COMBINADAS			COMBINADAS			COMBINADAS		
TRANSMISION	GP-761H	84074777	FX58 con motor/CATERPILLAR 3406E			TR75 con motor/FORD A DIESEL		
COMBUSTIBLE	GPP-1287	84446332	COMBUSTIBLE	GP-749	1R0749	ACEITE	G-834	321091
AIRE DE CABINA, RADIAL	GA-853R	84036676	ACEITE	GP-52	1R0716	COMBUSTIBLE	G-296	83937061
CR940 con motor/NEW HOLLAND 7.5L TURBO			AIRE DE CABINA, RADIAL	GA-853R	84036676	HIDRAULICO	GP-34	636843
ACEITE, RETORNO HIDRAULICO	GP-761H	9821387	HW305, HW305S con motor/NEW HOLLAND 4.5L TURBO DIESEL			COMBUSTIBLE	G-296-B	83937061
TRANSMISION	GP-761H	84074777	HIDRAULICO (REQUIERE 2)	GP-34	86632018	AIRE, PRIMARIO	GA-360	227456
COMBUSTIBLE, SEPARADOR DE AGUA	GPP-1287	84446332	COMBUSTIBLE, SEPARADOR DE AGUA	GPP-1122	86555246	AIRE, SECUNDARIO	GA-361	227671
AIRE DE CABINA, RADIAL	GA-853R	84036676	ACEITE	GP-737	87803260	TR80 con motor/CATERPILLAR 3208		
CR960 con motor/NEW HOLLAND 7.8L TURBO			HW325 con motor/NEW HOLLAND 4.5L			AIRE	GA-361	227671
ACEITE, RETORNO HIDRAULICO	GP-761H	9821387	HIDRAULICO (REQUIERE 2)	GP-34	86632018	TR85 con motor/CATERPILLAR 3208		
TRANSMISION	GP-761H	84031880	COMBUSTIBLE, SEPARADOR DE AGUA	GPP-1122	86555246	ACEITE	GP-36	9L9200
COMBUSTIBLE, SEPARADOR DE AGUA	GPP-1287	84446332	ACEITE	GP-737	87803260	GASOLINA	G-293	8N9803
AIRE DE CABINA, RADIAL	GA-853R	84036676	AIRE DE CABINA, RADIAL	GA-853R	84036676	HIDRAULICO	GP-34	636843
CR970 con motor/NEW HOLLAND 10.3L TURBO			HW345 con motor/NEW HOLLAND 7.5L			COMBUSTIBLE	GP-110	1R0712
ACEITE, RETORNO HIDRAULICO	GP-761H	9821387	HIDRAULICO (REQUIERE 2)	GP-34	86632018	ACEITE	GP-9586	9N5570
TRANSMISION	GP-761H	84031880	HW365 con motor/NEW HOLLAND 7.5L TURBO			AIRE, PRIMARIO	GA-360	227456
COMBUSTIBLE, PRIMARIO	GPP-1287	84446332	HIDRAULICO (REQUIERE 2)	GP-34	86632018	AIRE, SECUNDARIO	GA-361	227671
AIRE DE CABINA, RADIAL	GA-853R	84036676	TR70 con motor/CATERPILLAR 3208			TR86 con motor/CATERPILLAR 3208		
CX720 con motor/A DIESEL			ACEITE	GP-36	9L9200	HIDRAULICO	GP-34	681786
HIDRAULICO	GP-761H	81863799	GASOLINA	G-293	8N9803	TRANSMISION	GP-34	636843
TRANSMISION	GP-761H	84074777	COMBUSTIBLE	GP-110	1R0712	COMBUSTIBLE	GP-110	1R0712
COMBUSTIBLE, SEPARADOR DE AGUA	GPP-1287	84446332	ACEITE	GP-9586	9N5570	AGUA	GP-2071W	3954809
AIRE DE CABINA, RADIAL	GA-853R	84036676	AIRE, PRIMARIO	GA-360	227456	AIRE, PRIMARIO	GA-360	227456
CX840 con motor/NEW HOLLAND 7.5L TURBO			AIRE, SECUNDARIO	GA-361	227671	AIRE, SECUNDARIO	GA-361	227671
ACEITE, RETORNO HIDRAULICO	GP-761H	81863799	TR70 con motor/FORD 2704ET			TR86 con motor/FORD 678HT DIESEL		
TRANSMISION	GP-761H	84074777	ACEITE	G-834	C77Z-6731-B	ACEITE	GP-36	E9HN-6714-BA
COMBUSTIBLE, SEPARADOR DE AGUA	GPP-1287	84446332	COMBUSTIBLE	G-296	DONN-9N074-B	HIDRAULICO	GP-34	636843
AIRE DE CABINA, RADIAL	GA-853R	84036676	GASOLINA	G-293	P559803	TRANSMISION	GP-34	636843
CX860 con motor/NEW HOLLAND 7.8L TURBO			COMBUSTIBLE	G-296-B	703631	COMBUSTIBLE	GP-1122	9613344
ACEITE, RETORNO HIDRAULICO	GP-761H	9821387	AIRE, PRIMARIO	GA-360	227456	AGUA	GP-2071W	3954809
TRANSMISION	GP-761H	84074777	AIRE, SECUNDARIO	GA-361	227671	TR87 con motor/FORD 678HTA DIESEL		
COMBUSTIBLE, SEPARADOR DE AGUA	GPP-1287	84446332	TR70 con motor/FORD 361 A GASOLINA			ACEITE	GP-36	9L9200
AIRE DE CABINA, RADIAL	GA-853R	84036676	ACEITE	GP-1	8780003	HIDRAULICO	GP-34	636843
CX880 con motor/NEW HOLLAND 10.3L TURBO			AIRE	GAK-625	375273	COMBUSTIBLE	GP-1122	9613344
ACEITE, RETORNO HIDRAULICO	GP-761H	9821387	GASOLINA	GG-20	500660	AGUA	GP-2071W	3954809
TRANSMISION	GP-761H	84074777	TR70 con motor/FORD 363TD DIESEL			TR87 con motor/FORD 678HTA DIESEL		
COMBUSTIBLE, SEPARADOR DE AGUA	GPP-1287	84446332	ACEITE	G-834	321091	ACEITE	GP-36	9L9200
AIRE DE CABINA, RADIAL	GA-853R	84036676	COMBUSTIBLE	G-296	83937061	HIDRAULICO	GP-34	636843
FX25, FX45, FX28, FX38 con motor/A DIESEL			COMBUSTIBLE	G-296-B	83937061	COMBUSTIBLE	GP-1122	9613344
AIRE DE CABINA, RADIAL	GA-853R	84036676	AIRE, PRIMARIO	GA-360	227456	TR95 con motor/CATERPILLAR 3208		
FX30 con motor/NEW HOLLAND 10.3L TURBO			AIRE, SECUNDARIO	GA-361	227671	GASOLINA	G-293	703631
HIDROESTATICO	GP-761H	84074777	TR75 con motor/CATERPILLAR 3208			HIDRAULICO	GP-34	636843
COMBUSTIBLE, SEPARADOR DE AGUA	GPP-1287	84446332	HIDRAULICO	GP-34	636843	TRANSMISION	GP-34	636843
AIRE DE CABINA, RADIAL	GA-853R	84036676	COMBUSTIBLE	GP-110	1R0712	COMBUSTIBLE	GP-110	1R0712
FX40 con motor/NEW HOLLAND 12.9L TURBO			ACEITE	GP-9586	9N5570	AIRE, CUMMINS	GA-106	276766
HIDROESTATICO	GP-761H	84074777	AIRE, PRIMARIO	GA-360	227456	AIRE, KOMATSU	GA-326	276766
			AIRE, SECUNDARIO	GA-361	227671	AIRE	GA-206	276767
			TR75 con motor/CATERPILLAR 636			TR96 con motor/FORD 678HT		
			ACEITE	GP-36	9L9200	ACEITE	GP-36	9L9200
			COMBUSTIBLE	GP-110	1R0712	COMBUSTIBLE	GP-1122	9613344
			AIRE, PRIMARIO	GA-360	227456	AIRE, CUMMINS	GA-106	276766
			AIRE, SECUNDARIO	GA-361	227671	AIRE, KOMATSU	GA-326	276766

MARCA-MODELO-MOTOR MAKE-MODEL-ENGINE	GONHER GONHER	OEM OEM	MARCA-MODELO-MOTOR MAKE-MODEL-ENGINE	GONHER GONHER	OEM OEM	MARCA-MODELO-MOTOR MAKE-MODEL-ENGINE	GONHER GONHER	OEM OEM
NEW HOLLAND (continuación)			NEW HOLLAND (continuación)			NEW HOLLAND (continuación)		
MONTACARGAS			TRACTORES			TRACTORES		
1116 con motor/PERKINS 4.236			3830 con motor/A DIESEL			ACEITE	GP-3000	9703112
ACEITE	GP-1	2654403	COMBUSTIBLE	GPP-1122	E7NN-6714-AA	9282 con motor/CUMMINS 6CTA8.3		
COMBUSTIBLE	G-296	500625				ACEITE	GP-3000	9703112
COMBUSTIBLE	G-295	707226	3930 con motor/A DIESEL			9384 con motor/CUMMINS M11		
COMBUSTIBLE	G-296-B	500625	ACEITE	GP-1	E7NN-6714-AA	ACEITE	GP-3001	LF9009
AIRE, PRIMARIO	GAK-1532	221409						
1118 con motor/FORD A DIESEL			4030, 4230, 4430 con motor/A DIESEL			946 con motor/CUMMINS NTA855		
ACEITE	GP-1	E7NN-6714-AA	COMBUSTIBLE	GPP-1122	1930010	COMBUSTIBLE	GPP-14	V608T118
ACEITE	GP-9	E8NN-6714-AA				ACEITE	GP-53	3310445
COMBUSTIBLE	G-296	EDPN-9N074-AA	4835, 5635 con motor/A DIESEL			ACEITE	GP-57	V57124
COMBUSTIBLE	G-297	D8NN-9176-AA	COMBUSTIBLE	GPP-1122	1930010	COMBUSTIBLE	GPP-11	V79080
COMBUSTIBLE	G-296-B	EDPN-9N074-AA				ACEITE	GP-3000	9703112
COMBUSTIBLE	G-297-B	D8NN-9176-AA	545D CARGADOR con motor/A DIESEL					
			ACEITE	GP-81	87800068	9482 con motor/CUMMINS M11		
2450, 2550 con motor/A DIESEL						ACEITE	GP-3000	9703112
ACEITE	GP-36	F0NN-4714-AA	5530, 6530 con motor/A DIESEL					
HIDRAULICO	GP-34	936843	COMBUSTIBLE	G-296	1909100	950 con motor/CUMMINS VT903		
COMBUSTIBLE, SECUNDARIO	GPP-1122	F0NN-9176-BA				COMBUSTIBLE	GPP-14	V608T118
903, 905, 907, 909 con motor/FORD 172 A GASOLINA			60-86, 62-86 con motor/IVECO 8035E			ACEITE	GP-53	3310445
ACEITE	G-6	CPN6731AB	COMBUSTIBLE	GPP-1122	1930010	ACEITE	GP-57	V57124
						COMBUSTIBLE	GPP-11	V79080
907 con motor/FORD 256 DIESEL			6635 con motor/FIAT 3.9L DIESEL			AGUA	GP-2071W	9672301
ACEITE	G-5000	500464	COMBUSTIBLE	GPP-1122	1930010			
ACEITE	GP-9	501180				955, 975 con motor/CUMMINS NTA855		
COMBUSTIBLE	G-296	500625	7010 con motor/A DIESEL			COMBUSTIBLE	GPP-14	V608T118
COMBUSTIBLE	G-296-B	500625	AIRE	GA-588	E0NN-9R500-AA	ACEITE	GP-53	3310445
						ACEITE	GP-57	V57124
910, 912 con motores/A GASOLINA 4 CYL, FORD 4 CYL DIESEL			70-86, 72-86 con motor/IVECO 8045.06			COMBUSTIBLE	GPP-11	V79080
ACEITE	GP-1	505511	COMBUSTIBLE	GPP-1122	1930010	AGUA	GP-2071W	9672301
COMBUSTIBLE	G-296	7111/296						
COMBUSTIBLE	G-296-B	7111/296	7530 con motor/A DIESEL			956 con motor/CUMMINS NTA855		
AIRE	GAK-1532	215630	COMBUSTIBLE (REQUIERE 2)	GPP-1122	1930010	ACEITE	GP-53	3310445
						ACEITE	GP-57	V57124
			7610S con motor/A DIESEL			COMBUSTIBLE	GPP-11	V79080
			COMBUSTIBLE, SEPARADOR DE AGUA	GPP-1122	87800220	AGUA	GP-2071W	9672301
			HIDRAULICO	GP-166	D8NN-8486-CA	AIRE	GA-758	V95611
			AIRE, SECUNDARIO	GA-588	D1NN-9R500-A	AIRE, SECUNDARIO	GA-759	V95612
			AIRE, PRIMARIO	GA-589	E9NN-9601-AA			
			AIRE, RADIAL PRIMARIO	GA-853R	82981152	9682 con motor/CUMMINS N14		
						COMBUSTIBLE	GPP-11	V79080
			7635 con motor/A DIESEL					
			COMBUSTIBLE	GPP-1122	1930010	9684, 9884 con motor/CUMMINS N14		
						ACEITE	GP-3000	9703112
			80-66 con motor/IVECO 8035E			AGUA	GP-2071W	9672301
			COMBUSTIBLE	G-296	1909100	COMBUSTIBLE	GPP-1000	3329289
			COMBUSTIBLE	G-296-B	1909100	AIRE	GA-758	V95611
			AIRE	GAK-16	1909139	AIRE, SECUNDARIO	GA-759	V95612
			846 con motor/CUMMINS LT10			976 con motor/CUMMINS NTA855		
			COMBUSTIBLE	GPP-14	V608T118	COMBUSTIBLE	GPP-14	V608T118
			ACEITE	GP-53	3310445	ACEITE	GP-53	3310445
			ACEITE	GP-57	V57124	ACEITE	GP-57	V57124
			COMBUSTIBLE	GPP-11	V79080	COMBUSTIBLE	GPP-11	V79080
			ACEITE	GP-3000	9703112	ACEITE	GP-3000	9703112
			8670, 8970, 8770, 8870 con motor/NEW HOLLAND 675TA			9820 con motor/CUMMINS L10		
			AGUA	GP-1012Q	861361	COMBUSTIBLE	GPP-11	V79080
						ACEITE	GP-3000	9703112
			876 con motor/CUMMINS LTA10			AGUA	GP-2071W	9672301
			COMBUSTIBLE	GPP-14	V608T118			
			ACEITE	GP-53	3310445	9880, 9840, 9860 con motor/CUMMINS NTA855		
			ACEITE	GP-57	V57124	COMBUSTIBLE	GPP-11	V79080
			COMBUSTIBLE	GPP-11	V79080	ACEITE	GP-3000	9703112

NEW HOLLAND

NIVELADORAS

D75, D85 con motor/NEW HOLLAND 445T/M2		
ACEITE	GP-737	87803260
D95 con motor/NEW HOLLAND 667T/M2		
ACEITE	GP-737	87803260
DC180 con motor/A DIESEL		
AGUA	GP-1011Q	V104040
DC80 con motor/A DIESEL		
ACEITE	GP-390	73177276

NEW HOLLAND

TRACTORES

1150, 1156 con motor/CUMMINS KTA1150		
ACEITE	GP-53	3310445
COMBUSTIBLE	GP-55	V61559
ACEITE	GP-57	V57124
AGUA	GP-2071W	9672301
1530, 1925, 1630, 1725 con motor/A DIESEL		
ACEITE	GP-81	86546618
3010 con motor/A DIESEL		
AIRE	GA-588	E0NN-9R500-AA

MARCA-MODELO-MOTOR MAKE-MODEL-ENGINE	GONHER GONHER	OEM OEM	MARCA-MODELO-MOTOR MAKE-MODEL-ENGINE	GONHER GONHER	OEM OEM	MARCA-MODELO-MOTOR MAKE-MODEL-ENGINE	GONHER GONHER	OEM OEM
NEW HOLLAND (continuación)			NEW HOLLAND (continuación)			NISSAN (continuación)		
TRACTORES			TRACTORES			CAMIONES, TRACTOCAMIONES Y AUTOBUSES		
AGUA	GP-2071W	9672301	TL80A con motor/NEW HOLLAND 4.5L			CLA83, CMA83 con motores/NISSAN FE6, NISSAN FE6T		
S12 con motor/KOHLER 12 HP			AIRE, PRIMARIO	GA-853R	47132343	ACEITE	GP-51	15208-29006
ACEITE, FORD	GP-9	178562	TL90 con motor/IVECO			CPB12 con motor/NISSAN NE6		
ACEITE, CHRYSLER	GP-81	178562	COMBUSTIBLE	GPP-1122	1930010	AGUA	GP-1011Q	FL915-99003
AIRE	GA-7	213188	TL90A con motor/NEW HOLLAND 4.5L TURBO			CPB12 con motor/NISSAN NE6 (1986-88)		
S14 con motor/KOHLER 14 HP			AIRE, PRIMARIO	GA-853R	47132343	COMBUSTIBLE	GP-110	1644499425
ACEITE, FORD	GP-9	178562	TN75S, TN65, TN65D, TN65S, TN70, TN70D, TN70S, TN75, TN75D con motor/A DIESEL			CPB12 con motor/NISSAN NE6T		
ACEITE, CHRYSLER	GP-81	178562	COMBUSTIBLE	GPP-1122	1930010	AGUA	GP-1011Q	FL915-99003
AIRE	GA-7	213188	TN85A con motor/NEW HOLLAND 4.5L			CPB12 con motor/NISSAN NE6T (1986-88)		
T6030, T6050, T6070 con motor/6.75L TURBO			AIRE, RADIAL PRIMARIO	GA-853R	P828889	COMBUSTIBLE	GP-110	1644499425
TRANSMISION	GP-761H	81863799	TN85DA con motor/NEW HOLLAND 4.5L TURBO DIESEL			CPC12 con motor/NISSAN NE6		
TB100, TB110 con motor/NEW HOLLAND 5.0L TURBO			AIRE, PRIMARIO	GA-853R	47132343	AGUA	GP-1011Q	FL915-99003
ACEITE, BOMBA HIDRAULICA	GP-166	D8NN-B486-CA	TN90, TN90D, TN90S con motor/A DIESEL			COMBUSTIBLE	GP-110	1644499425
TB120 con motor/NEW HOLLAND 7.5L TURBO			COMBUSTIBLE	GPP-1122	1930010	CPC12 con motor/NISSAN NE6T		
ACEITE, BOMBA HIDRAULICA	GP-166	D8NN-B486-CA	TN95F, TN95FA con motor/NEW HOLLAND 4 CIL. 3.9L TURBO			AGUA	GP-1011Q	FL915-99003
TC18, TC21, TC21D, TC24D con motor/A DIESEL			COMBUSTIBLE	GPP-1122	1930010	CPC12 con motor/NISSAN NE6T (1986-88)		
ACEITE	GP-156	86546623	AIRE, SECUNDARIO	GA-459	1909117	COMBUSTIBLE	GP-110	1644499425
TC29D, TC33, TC33D, TC25, TC25D, TC27D, TC29 con motor/A DIESEL			AIRE DE CABINA, RADIAL (REQUIERE 2)	GA-853R	84036676	CPC12 con motor/NISSAN NE6T		
ACEITE (8-12 PSI)	GP-58	87415600	TS115A con motor/6.7L HIDRAULICO, CAJA DE CAMBIOS			AGUA	GP-1011Q	FL915-99003
TC35, TC35D con motor/A DIESEL			HIDRAULICO, CAJA DE CAMBIOS	GP-761H	81863799	CPC12BT con motor/NISSAN NE6		
ACEITE (8-12 PSI)	GP-58	SBA140517020	TS125A con motor/6.7L COMBUSTIBLE			AGUA	GP-1011Q	FL915-99003
TC40, TC40D, TC45, TC45D con motor/A DIESEL			COMBUSTIBLE	GP-548	87803197	CPC12BT con motor/NISSAN NE6 (1986-88)		
ACEITE (8-12 PSI)	GP-58	87415600	HIDRAULICO, CAJA DE CAMBIOS	GP-761H	81863799	COMBUSTIBLE	GP-110	1644499425
TJ275 con motor/CUMMINS 8.3L			AIRE, PRIMARIO	GA-697R	82034628	CPC12BT con motor/NISSAN NE6T		
AGUA	GP-2071W	9672301	TS130A con motor/3.7L HIDRAULICO, CAJA DE CAMBIOS			AGUA	GP-1011Q	FL915-99003
TJ325 con motor/CUMMINS 9.0L			HIDRAULICO, CAJA DE CAMBIOS	GP-761H	81863799	CPC12BT con motor/NISSAN NE6T (1986-88)		
AGUA	GP-2071W	9672301	TS135A con motor/3.7L COMBUSTIBLE			COMBUSTIBLE	GP-110	1644499425
TJ375, TJ375HD con motor/CUMMINS QSX15			COMBUSTIBLE	GP-548	87803197	CWA45, CWA45HD, CWA45PH con motor/NISSAN PE6T		
AGUA	GP-2071W	9672301	HIDRAULICO, CAJA DE CAMBIOS	GP-761H	81863799	AIRE	GA-6127	16546-97005
ACEITE	GP-9000	441700A1	AIRE, PRIMARIO	GA-697R	82034628	TFA21G, TFA21K con motor/NISSAN PD6		
AGUA	GP-2126Q	441702A1	TT55 con motor/NEW HOLLAND 2.7L			AIRE	GA-360	16546-96016
COMBUSTIBLE	GPP-10075	441701A1	COMBUSTIBLE	GPP-1122	1930010	UD1100 con motor/NISSAN FD35T		
TJ425, TJ450, TJ500 con motor/CUMMINS QSX15			COMBUSTIBLE	GPP-1122	1930010	ACEITE	GP-54	15209-01D20
ACEITE	GP-9000	441700A1	TT65 con motor/IVECO 3 CIL. DIESEL			UD1200 con motor/NISSAN FD46TA		
AGUA	GP-2126Q	441702A1	COMBUSTIBLE	GPP-1122	1930010	COMBUSTIBLE	GP-1101	BF40399013
COMBUSTIBLE	GPP-10075	441701A1	TT75 con motor/NEW HOLLAND 3.6L			ACEITE, OPCIONAL	GP-66	BF209-29D01
TL100 con motor/IVECO 8045.25			COMBUSTIBLE	GPP-1122	1930010	ACEITE, DERIVACION (BY PASS)	GP-171	BF208-29D01
AIRE, RADIAL PRIMARIO	GA-853R	1930589	NISSAN			UD1200, UD1400 con motor/NISSAN FD46T		
TL100, TL90 con motor/NEW HOLLAND 3.9L			CAMIONES, TRACTOCAMIONES Y AUTOBUSES			COMBUSTIBLE	GP-1101	16403-99013
COMBUSTIBLE	GPP-1122	1930010	CDA45T, CDA45U, CKA45, CKA45CT con motor/NISSAN PE6T			UD1300 con motor/NISSAN TD42T		
AIRE, SECUNDARIO	GA-459	1930825	AIRE	GA-6127	16546-97005	ACEITE, FORD	GP-9	FL208-05D01
AIRE, RADIAL PRIMARIO	GA-853R	1930589	CK40, CK45 con motores/NISSAN PD6T, NISSAN PE6T			ACEITE	GP-3985	15208-05D00
TL100A con motor/NEW HOLLAND 4.5L TURBO			AIRE	GA-6127	16546-97005	ACEITE, CHRYSLER	GP-81	FL208-05D01
AIRE, RADIAL PRIMARIO	GA-853R	P828889	NISSAN			UD1400 con motor/NISSAN FD46TA		
TL70, TL80 con motor/IVECO			CAMIONES, TRACTOCAMIONES Y AUTOBUSES			COMBUSTIBLE	GP-1101	BF40399013
COMBUSTIBLE	GPP-1122	1930010	CDA45T, CDA45U, CKA45, CKA45CT con motor/NISSAN PE6T			ACEITE, OPCIONAL	GP-66	BF209-29D01
			AIRE	GA-6127	16546-97005	ACEITE, DERIVACION (BY PASS)	GP-171	BF208-29D01

SERVICIO PESADO

MARCA-MODELO-MOTOR MAKE-MODEL-ENGINE	GONHER GONHER	OEM OEM	MARCA-MODELO-MOTOR MAKE-MODEL-ENGINE	GONHER GONHER	OEM OEM	MARCA-MODELO-MOTOR MAKE-MODEL-ENGINE	GONHER GONHER	OEM OEM
NISSAN (continuación)			NISSAN			NISSAN (continuación)		
CAMIONES, TRACTOCAMIONES Y AUTOBUSES			EXCAVADORAS			MONTACARGAS		
UD1400 con motor/NISSAN TD42T			N-06 con motor/A DIESEL			C6000-8000 con motor/A DIESEL		
ACEITE, FORD	GP-9	FL208-05D01	ACEITE	GP-40	438-20003	ACEITE	GP-36	58396-47601
ACEITE	GP-3985	15208-05D00	N-11 con motor/A DIESEL			C6000-8000 con motor/NISSAN H30		
ACEITE, CHRYSLER	GP-81	D6546-01D20	ACEITE	GP-149	430-01000	ACEITE	GP-3682	15208-H8911
UD1800 con motor/NISSAN FE6TA			N-120, N-1502 con motor/A DIESEL			C9 con motor/A DIESEL		
COMBUSTIBLE	GP-110	16444-99525	ACEITE	GP-40	438-20003	ACEITE	G-870	1520832200
UD1800 con motores/NISSAN FE6, NISSAN FE6T			N-21 con motor/A DIESEL			CD40 con motor/A DIESEL		
ACEITE	GP-51	15208-Z9007	ACEITE	GP-149	430-01000	ACEITE	GP-36	58396-47601
UD1800CS con motor/NISSAN FD46T			N-220 con motor/A DIESEL			CD4000, CD5000 con motor/A DIESEL		
COMBUSTIBLE	GP-1101	16403-99013	ACEITE	GP-149	430-01000	ACEITE	GP-36	58396-47601
UD1800CS con motor/NISSAN FD46TA			N-260 con motor/A DIESEL			ACEITE	GP-38	15209-J1800
COMBUSTIBLE	GP-1101	BF40399013	ACEITE	GP-40	438-20003	ACEITE	GP-58	31725-L1000
ACEITE, OPCIONAL	GP-66	BF209-29D01	N-2602, N-31 con motor/A DIESEL			AIRE	GAD-30	16546-L3000
ACEITE, DERIVACION (BY PASS)	GP-171	BF208-29D01	AIRE, SIN ASPAS	GA-33	440-06010	CD40K, CD50K con motor/NISSAN SD25		
UD1800HD con motor/NISSAN FE46TA			N-41, N-45, N-450 con motor/A DIESEL			ACEITE	GP-3682	15208-55Y00
COMBUSTIBLE	GP-1101	BF40399013	AIRE	GAK-16	440-07010	CD50 con motor/A DIESEL		
UD2000 con motores/NISSAN FE6, NISSAN FE6T			N-80 con motor/A DIESEL			ACEITE	GP-36	58396-47601
ACEITE	GP-51	15208-Z9007	ACEITE	GP-149	430-01000	ACEITE	GP-58	31725-L1000
UD2000, UD2800, UD2300, UD2600 con motor/NISSAN FE6TA			NISSAN			AIRE	GAD-30	16546-L3000
COMBUSTIBLE	GP-110	16444-99525	MONTACARGAS			CF01, CF02 con motor/A DIESEL		
UD2800, UD2300, UD2600 con motores/NISSAN FE6, NISSAN FE6T			9000 con motor/A DIESEL			AIRE	GAD-30	16546-L3000
ACEITE	GP-51	15208-Z9006	ACEITE	G-870	1520832200	CF01, PFO2 con motor/NISSAN J15		
UD3000 con motor/NISSAN FE6TA			BF03A33U, BGF03A40U, BF03A33V, BF03A35U, BF03A35V, BGF03A40V con motor/NISSAN TB42			ACEITE	GP-36	58396-47601
COMBUSTIBLE	GP-1101	BF403-99013	ACEITE, FORD	GP-9	15208-W1103	ACEITE	GP-58	31725-L1000B
COMBUSTIBLE	GP-110	D6546-Z9007	HIDRAULICO	GP-36	58396-47601	ACEITE	GP-3682	15208-55Y00
AGUA	GP-1011Q	FL9159-9003	ACEITE, CHRYSLER	GP-81	15208-W1103	AIRE	GAD-3	16546-L3200
UD3000 con motor/NISSAN NE6			BF05A50U, BF05A70V, BF05A50V, BF05A60U, BF05A60V, BF05A70U con motor/NISSAN TB42			AIRE	GAD-30	16546-76016
COMBUSTIBLE	GP-110	1644499425	ACEITE, FORD	GP-9	15208-W1103	CPFO2 con motor/NISSAN H20		
UD3000 con motor/NISSAN NE6T			HIDRAULICO	GP-36	58396-47601	ACEITE	GP-36	58396-47601
COMBUSTIBLE	GP-110	16444-99525	ACEITE, CHRYSLER	GP-81	15208-W1103	ACEITE	GP-58	31725-L1000B
UD3000HD, UD3000SD con motores/NISSAN FE6TA, NISSAN NE6TA			AIRE	GAK-403	16546-L9010	ACEITE	GP-3682	15208-55Y00
COMBUSTIBLE	GP-110	16444-99525	C2000-3500 con motor/NISSAN J15			AIRE	GAD-30	16546-L3000B
UD3300 con motor/NISSAN FE6TA			ACEITE	GP-36	58396-47601	CUM01L10S con motor/ELECTRICO		
COMBUSTIBLE	GP-1101	BF40399013	ACEITE	GP-58	31725-L1000	ACEITE	GP-36	58396-47601
UD3300 con motores/NISSAN NE6, NISSAN NE6T, NISSAN NE6TA			ACEITE	GP-3682	15208-H8911	DF05A50U, DF05A50V, DF05A60U, DF05A60V, DF05A70U, DF05A70V, DF05N50U, DF05N50V, DF05N60U, DF05N60V, DF05N70U, DF05N70V con motor/NISSAN FD6		
COMBUSTIBLE	GP-110	16444-99525	C3 con motor/NISSAN D11			HIDRAULICO	GP-36	58396-47601
UD550T con motor/NISSAN NE6T			ACEITE	GP-38	15208-13210	ACEITE	GP-51	15208-Z9007
COMBUSTIBLE	GP-110	1644499425	C4000-6000 con motor/NISSAN H20			AIRE	GAK-403	16546-L9010
UD600T con motor/NISSAN NE6TA			ACEITE	GP-36	58396-47601	F02 con motor/A DIESEL		
COMBUSTIBLE	GP-110	1644499425	ACEITE	GP-58	31725-L1000	AIRE	GAD-30	16546-L3000B
URVAN con motor/NISSAN 2.3L			ACEITE	GP-3682	15208-H8911	F03, F05 con motor/NISSAN P40 A GASOLINA		
ACEITE	GP-1	1520865002	C40K, C50KLP, C40KLP, C50K con motor/NISSAN SD25			ACEITE	GP-1	15208-W1123
			ACEITE	GP-3682	15208-55Y00	F2 con motor/A DIESEL		
			C5000 con motor/A DIESEL			ACEITE	G-870	1520832200
			ACEITE	GP-58	15208Y1700	F302 con motor/A DIESEL		
						ACEITE	GP-36	5839647601
						FD005, FD006, FD007 con motor/NISSAN SD33		
						ACEITE	GP-10	15209-J2000

MARCA-MODELO-MOTOR MAKE-MODEL-ENGINE	GONHER GONHER	OEM OEM	MARCA-MODELO-MOTOR MAKE-MODEL-ENGINE	GONHER GONHER	OEM OEM	MARCA-MODELO-MOTOR MAKE-MODEL-ENGINE	GONHER GONHER	OEM OEM
NISSAN (continuación)			NISSAN (continuación)			NISSAN (continuación)		
MONTACARGAS			MONTACARGAS			MONTACARGAS		
FG001, FG002, FG003 con motor/NISSAN D11			MF05A50TU, MF05N60TU, MF05A60TU, MF05N50TU con motor/NISSAN SD33T			HIDRAULICO	GP-36	58396-47601
ACEITE	GP-3682	15208-H8903	HIDRAULICO	GP-36	58396-47601	AIRE	GAK-403	16546-L9010
FG004, FG005 con motor/NISSAN H20			NFO1M15 con motor/NISSAN J15			WF03A33U, WGF03A40V, WF03A33V, WF03A35U, WF03A35V, WGF03A40U con motor/NISSAN TD42		
ACEITE	GP-3682	15208-H8903	ACEITE	GP-3682	15208-H8903	ACEITE, FORD	GP-9	15208-W1103
FG006 con motor/NISSAN H30			AIRE	GAD-3	16546-18000	HIDRAULICO	GP-36	58396-47601
ACEITE	GP-3682	15208-H8903	GASOLINA	GG-45	16400-H8501	ACEITE, CHRYSLER	GP-81	15208-W1103
FG007 con motor/NISSAN H30			OFO1 con motor/NISSAN SD22			WF05A50U, WF05N70U, WF05A60U, WF05A70U, WF05N50U, WF05N60U con motor/NISSAN TD42		
ACEITE	G-870	1520832200	AIRE	GAD-30	16546-76016	ACEITE, FORD	GP-9	15208-W3401
ACEITE	GP-3682	15208-H8903	P11000-14000 con motor/A DIESEL			HIDRAULICO	GP-36	58396-47601
GASOLINA	GG-196	16400-E5200	ACEITE	GP-1	15208-65011	ACEITE, CHRYSLER	GP-81	15208-W3401
FG101, FG102 con motor/NISSAN D11			ACEITE	GP-36	58396-47601	AIRE	GAK-403	16546-L9010
ACEITE	GP-3682	15208-H8903	ACEITE	GP-58	31725-L1000			
AIRE	GAD-3	16546-L3200	P2000-3500 con motor/NISSAN J15					
GASOLINA	GG-45	16400-H5801	ACEITE	GP-3682	15208-55Y00			
FG103 con motores/NISSAN D11, NISSAN J15			ACEITE					
ACEITE	GP-3682	15208-H8903	P2000-3500 con motor/NISSAN SD22					
AIRE	GAD-3	16546-L3200	ACEITE	GP-38	1520813201			
GASOLINA	GG-45	16400-H5801	P2000-3500, P7000-9000 con motor/A DIESEL					
FG104, FG105 con motor/NISSAN H20			ACEITE	GP-36	58396-47601			
ACEITE	GP-3682	15208-H8903	P3 con motor/NISSAN D11					
FG204 con motor/NISSAN J15			ACEITE	GP-38	15208-13210			
ACEITE	GP-3682	15208-H8903	P4000, P5000, P6000 con motor/A DIESEL					
AIRE	GAD-3	16546-18000	ACEITE	GP-58	15208Y1700			
GASOLINA	GG-45	16400-H5801	P4000-6000 con motor/A GASOLINA					
FG2300 con motor/A DIESEL			ACEITE	GP-36	58396-47601			
ACEITE	G-870	1520832200	ACEITE	GP-38	1520813201			
FO1, FO2 con motor/NISSAN J15			ACEITE	GP-58	31725-L1000			
ACEITE	GP-36	58396-47601	ACEITE	GP-3682	15208-55Y00			
ACEITE	GP-58	31725-L1000B	GASOLINA	GG-45	16400E3001			
ACEITE	GP-3682	15208-55Y00	P7000-9000 con motor/NISSAN P40					
AIRE	GAD-3	16546-L3200	ACEITE	GP-1	1520865002			
AIRE	GAD-30	16546-76016	P7000-9000 con motor/NISSAN SD33T					
FO3 con motor/A DIESEL			ACEITE	GP-69	15209C8602			
ACEITE	GP-171	15208W1101	P8, P9 con motor/A DIESEL 6 CYL					
H01, H02 con motor/NISSAN Z24			ACEITE	G-870	15208-32250			
ACEITE	GP-36	58396-47601	PFO1 con motor/A DIESEL					
H25K con motor/A DIESEL			AIRE	GAD-30	16546-L3000B			
AIRE, RADIAL PRIMARIO	GA-880R	P821575	PFO2 con motor/NISSAN H20					
H01 10-18, H01 20-35 con motor/A DIESEL			ACEITE	GP-36	58396-47601			
ACEITE	GP-36	58396-47601	ACEITE	GP-58	31725-L1000B			
H01 con motor/NISSAN H20			ACEITE	GP-3682	15208-55Y00			
ACEITE	GP-36	58396-47601	AIRE	GAD-30	16546-L3000B			
H02 con motor/NISSAN H20			PFO2, QGFO2 con motor/NISSAN SD22					
ACEITE	GP-36	58396-47601	AIRE	GAD-30	16546-76016			
KHO1, KHO2 con motores/NISSAN H20 II, NISSAN H25			S-2B25, S-2B30 con motor/A DIESEL					
ACEITE	GP-36	58396-47601	AIRE	GAK-16	440-07010			
			UF05A50U, UF05A70V, UF05A50V, UF05A60U, UF05A60V, UF05A70U con motor/NISSAN P40					
			ACEITE	GP-1	15208-65011			

NISSAN

MOTORES

FEG A DIESEL, FE6T A DIESEL		
ACEITE	GP-51	15208-29006
FE6TA A DIESEL, NE6TA A DIESEL		
COMBUSTIBLE	GP-110	16444-99525
NE6 A DIESEL, NE6T A DIESEL		
COMBUSTIBLE	GP-1101	16444-99425
ACEITE	GP-51	15274-99626
AGUA	GP-2071W	21915-95000
NISSAN FD35T A DIESEL		
ACEITE	GP-54	15209-01D20
NISSAN FD42T A DIESEL		
ACEITE	GP-3985	15208-05D00
NSF 18/15 2 CIL. 4 TIEMPOS MARINO FUERA DE BORDA, NSF 30/25 3 CIL. 4 TIEMPOS FUERA DE BORDA, NSF9.9 2 CIL. 4 TIEMPOS FUERA DE BORDA		
ACEITE	GP-6811	3R007-6150M
SD16 A DIESEL, SD22 A DIESEL, SD25 A DIESEL		
ACEITE	GP-38	1520813201
VAN CON A DIESEL		
ACEITE	GP-3682	420337110

NORTHERN LIGHTS

GENERADORES

NL445T1, NL445T2 con motor/A DIESEL		
ACEITE	GP-754	24-01002

NUFFIELDS

CAMIONES, TRACTOCAMIONES Y AUTOBUSES

300, 350, 600, 800X con motor/A DIESEL		
COMBUSTIBLE	G-296	7111/44
650, 680, 850, 944 con motor/A DIESEL		
COMBUSTIBLE	G-296	7111/44
BEAVER, CHEETAH con motor/A DIESEL		
ACEITE	G-31	607488
BIG J4T con motor/ROLLS ROYCE 265		
COMBUSTIBLE	G-296	7111/296

MARCA-MODELO-MOTOR MAKE-MODEL-ENGINE	GONHER GONHER	OEM OEM	MARCA-MODELO-MOTOR MAKE-MODEL-ENGINE	GONHER GONHER	OEM OEM	MARCA-MODELO-MOTOR MAKE-MODEL-ENGINE	GONHER GONHER	OEM OEM
NUFFIELDS (continuación)			NUFFIELDS (continuación)			NUFFIELDS (continuación)		
CAMIONES, TRACTOCAMIONES Y AUTOBUSES			CAMIONES, TRACTOCAMIONES Y AUTOBUSES			TRACTORES		
COMBUSTIBLE	G-296-B	601980	SUPER CONSTRUCTOR 6x6 con motores/ROLLS ROYCE 260, ROLLS ROYCE 280			244, 253 con motor/LEYLAND 4-98		
AIRE	GA-106	ACU3426	COMBUSTIBLE	G-296	7111/296	ACEITE	G-870	ABU8912
BIG J8 con motor/ROLLS ROYCE 205			COMBUSTIBLE	G-296-B	601980	COMBUSTIBLE	G-296	7111/296
COMBUSTIBLE	G-296	7111/296	AIRE	GA-360	10906079	COMBUSTIBLE	G-296-B	601980
COMBUSTIBLE	G-296-B	601980	TRUNKER 3 con motores/ROLLS ROYCE 200, ROLLS ROYCE 220			245, 255 con motor/LEYLAND		
AIRE	GA-360	10906079	AIRE	GA-106	ACU3426	COMBUSTIBLE	G-296	7111/296
CONSTRUCTOR 30.19, CONSTRUCTOR 30.25, CONSTRUCTOR S26 con motores/ROLLS ROYCE 265L, ROLLS ROYCE 265Li			NUFFIELDS			253 con motor/LEYLAND 6.8L		
AIRE	GA-6129	ABU8514	MOTORES			ACEITE	G-834	26540153
CONSTRUCTOR T45 con motores/GARDNER 6LXC, ROLLS ROYCE 220, ROLLS ROYCE 265L			2.2L INDUSTRIAL, CHIEF 25 MARINO, CHIEF 40 MARINO, OE138 INDUSTRIAL, SKIPPER 100 MARINO, SKIPPER 60 MARINO, VEDETTE GASOLINA 950CC MARINO			COMBUSTIBLE	G-296	601980
AIRE	GA-106	ACU3426	ACEITE	G-870	ABU8912	COMBUSTIBLE	G-296-B	601980
CRUSADER 4x2 con motores/ROLLS ROYCE 200, ROLLS ROYCE 220, ROLLS ROYCE 260, ROLLS ROYCE 280, ROLLS ROYCE 290			5.7L INDUSTRIAL			270 con motor/LEYLAND 4-98		
AIRE	GA-106	ACU3426	ACEITE	G-834	26540153	ACEITE	G-870	ABU8912
CRUSADER con motores/ROLLS ROYCE 260, ROLLS ROYCE 280, ROLLS ROYCE 290, ROLLS ROYCE 200, ROLLS ROYCE 220			600 INDUSTRIAL, 650 INDUSTRIAL, 680 INDUSTRIAL, 800X INDUSTRIAL, 850 INDUSTRIAL, 944 HIPPO INDUSTRIAL, CAPTAIN DIESEL 1.5L MARINO, NAVIGATOR GASOLINA 1500CC MARINO, SEA LORD 5.1 LITROS MARINO, SEA LORD 5.7 LITROS MARINO			COMBUSTIBLE	G-296	7111/296
AIRE	GA-106	ACU3426	COMBUSTIBLE	G-296	7111/296	COMBUSTIBLE	G-296-B	601980
HANDYMAN con motor/ROLLS ROYCE 220			AD400 INDUSTRIAL, COMMODORE DIESEL 3.4L MARINO, COMMODORE DIESEL 3.8L MARINO			COMBUSTIBLE	G-296-B	601980
AIRE	GA-360	10906079	ACEITE	G-870	ABU8912	285 con motor/LEYLAND 4-98		
MARATHON con motores/ROLLS ROYCE 220, ROLLS ROYCE 250, ROLLS ROYCE 260, ROLLS ROYCE 265, ROLLS ROYCE 280			COMBUSTIBLE	G-296	7111/296	ACEITE	G-870	ABU8912
AIRE	GA-106	ACU3436	COMBUSTIBLE	G-296-B	601980	COMBUSTIBLE	G-296	7111/296
AIRE	GA-360	10906079	COMBUSTIBLE	G-296-B	601980	COMBUSTIBLE	G-296-B	601980
AIRE	GA-6129	ABU8514	BEAVER INDUSTRIAL, CHEETAH INDUSTRIAL, PDI INDUSTRIAL, PSI INDUSTRIAL			285 con motor/LEYLAND 6.8L		
OE138 con motor/A DIESEL			ACEITE	G-31	607488	ACEITE	G-834	26540153
ACEITE	G-870	ABU8912	COMMANDER DIESEL 2.2L MARINO			COMBUSTIBLE	G-296	601980
PD1, PS1 con motor/A DIESEL			ACEITE	G-870	ABU8912	COMBUSTIBLE	G-296-B	601980
ACEITE	G-31	607488	COMBUSTIBLE	G-11816	ABU8554	COMBUSTIBLE	G-296	601980
ROADRUNNER con motor/CUMMINS 6BT5.9			COMBUSTIBLE	G-296	601980	COMBUSTIBLE	G-296-B	601980
COMBUSTIBLE, SECUNDARIO	GP-1122	BBU6932	COMBUSTIBLE	G-296-B	601980	344 con motor/LEYLAND 3.4L		
COMBUSTIBLE, SEPARADOR DE AGUA	GPP-18	P550868	NUFFIELDS			ACEITE	G-870	ABU8912
ACEITE	GP-178	CBU1124	TRACTORES			COMBUSTIBLE	G-296	7111/296
ROADTRAIN 16.25 con motores/ROLLS ROYCE 290, ROLLS ROYCE 300Li, ROLLS ROYCE 340Li			154 con motor/LEYLAND 1.5L			COMBUSTIBLE	G-296	7111/296
COMBUSTIBLE	G-296	7111/296	COMBUSTIBLE	G-296	7111/296	COMBUSTIBLE	G-296-B	601980
COMBUSTIBLE	G-296-B	601980	COMBUSTIBLE	G-296-B	601980	COMBUSTIBLE	G-296-B	601980
AIRE	GA-106	ACU3426	AIRE	GA-18	37H4920	AIRE	GA-18	37H4920
ROADTRAIN con motor/CUMMINS			15615 con motor/A DIESEL			384 con motor/LEYLAND 3.8L		
COMBUSTIBLE	GPP-14	154711	ACEITE	G-870	ABU8912	ACEITE	G-870	ABU8912
ACEITE	GP-53	CU299670	COMBUSTIBLE	G-296	601980	COMBUSTIBLE	G-296	7111/296
ACEITE	GP-57	CU3304232	COMBUSTIBLE	G-296-B	601980	COMBUSTIBLE	G-296-B	601980
COMBUSTIBLE, SEPARADOR DE AGUA	GPP-11	C3308638	16711, 24016, 3DL 8-6 LITROS con motor/A DIESEL			4CLY con motor/A GASOLINA		
ROADTRAIN, ROADTRAIN 16.29 con motores/ROLLS ROYCE 340Li, ROLLS ROYCE 290, ROLLS ROYCE 300Li			ACEITE	G-870	ABU8912	ACEITE	G-801	AJC5122
COMBUSTIBLE	G-296	7111/296	2100, 4100 con motor/LEYLAND 6.8L			4DM 3-4L, 4DM 3-8L con motor/A DIESEL		
COMBUSTIBLE	G-296-B	601980	ACEITE	G-834	26540153	ACEITE	G-870	ABU8912
AIRE	GA-106	ACU3426	COMBUSTIBLE	G-296	7111/296	4M, 4PM con motor/A GASOLINA		
ROUTEMAN con motor/ROLLS ROYCE 220			COMBUSTIBLE	G-296-B	601980	ACEITE	G-801	AJC5122
AIRE	GA-360	10906079	22190, 22920 con motor/A DIESEL			DAF 825 con motor/A DIESEL		
			COMBUSTIBLE	G-296	7111/296	COMBUSTIBLE	GP-1122	BBU6932
			244 con motor/LEYLAND 6.8L					
			ACEITE	G-834	26540153			

MARCA-MODELO-MOTOR MAKE-MODEL-ENGINE	GONHER GONHER	OEM OEM	MARCA-MODELO-MOTOR MAKE-MODEL-ENGINE	GONHER GONHER	OEM OEM	MARCA-MODELO-MOTOR MAKE-MODEL-ENGINE	GONHER GONHER	OEM OEM
NUFFIELDS (continuación)			OLIVER (continuación)			OLIVER (continuación)		
TRACTORES			TRACTORES			TRACTORES		
MINI con motor/NUFFIELDS 948cc DIESEL			1250A con motor/A DIESEL			1600 con motor/A DIESEL		
COMBUSTIBLE	G-296	601980	ACEITE	GP-1	159045-A	ACEITE	GP-31	155618A
OLIVER			COMBUSTIBLE	G-296	159044-AS	ACEITE, CONVERTIDOR DE TORSION	GP-81	156513-A
COMBINADAS			COMBUSTIBLE	G-296-B	159044AS	HIDRAULICO	GP-81	156513-A
109, 429, 110, 111, 112, 115, 132, 137 con motor/A DIESEL			1255, 1265, 1355 con motor/A DIESEL			TRANSMISION	GP-81	156513-A
ACEITE, FLUJO TOTAL (FULL FLOW)	G-236	1557376	ACEITE	GP-1	159045-A	AIRE	GAK-16	159012-A
422 con motor/CHRYSLER			COMBUSTIBLE	G-296	159044-AS	1600D con motor/A DIESEL		
ACEITE, FLUJO TOTAL (FULL FLOW)	G-236	1557376	COMBUSTIBLE	G-296-B	159044-AS	COMBUSTIBLE, PRIMARIO	G-1174	156289-AS
430, 431 con motor/CHRYSLER 265			1365 con motor/A DIESEL			ACEITE	GP-31	155618A
ACEITE, FLUJO TOTAL (FULL FLOW)	G-236	1557376	ACEITE	GP-31	155618-A	ACEITE, CONVERTIDOR DE TORSION	GP-81	156513-A
AIRE, SIN ASPAS	GA-162 EXP	2203311	COMBUSTIBLE	G-296	163953-AS	HIDRAULICO	GP-81	156513-A
AIRE, CON ASPAS	GAK-16	2710837	HIDRAULICO	GP-66	P779655	TRANSMISION	GP-81	159013-A
432 con motor/A DIESEL			COMBUSTIBLE	G-296-B	163953-AS	1650 con motor/A DIESEL		
AIRE	GAK-16	2710837	1450 con motor/A DIESEL			ACEITE, CONVERTIDOR DE TORSION	GP-1	159045-A
542 con motor/V8 A GASOLINA			ACEITE, SELLADO	GP-1	159045-A	TRANSMISION	GP-1	105234-A
ACEITE, SELLADO	GP-1	159045-A	1455 con motor/A DIESEL			ACEITE	GP-31	155618A
AIRE	GAK-403	10P2913	ACEITE	GP-1	159045-A	ACEITE, CONVERTIDOR DE TORSION	GP-81	156513-A
GASOLINA, PLASTICO	GG-5	5214626	1465 con motor/A DIESEL			HIDRAULICO	GP-81	156513-A
GASOLINA, LAMINA	GG-5 L	5214626	ACEITE	GP-31	155618-A	TRANSMISION	GP-81	156513-A
545, SP545 con motor/V8 A GASOLINA			COMBUSTIBLE	G-296	163953-AS	AIRE	GAK-16	159012-A
ACEITE, CARTUCHO	G-236	1557376	COMBUSTIBLE	G-296-B	163953-AS	1650 con motor/A GASOLINA		
ACEITE, SELLADO	GP-1	159045-A	1514 con motor/A DIESEL			ACEITE	GP-31	155618A
AIRE	GAK-403	10P2913	COMBUSTIBLE	G-296	159044-AS	HIDRAULICO	GP-81	156513-A
GASOLINA, PLASTICO	GG-5	5214626	HIDRAULICO	GP-66	P779655	AIRE	GAK-16	2710837
GASOLINA, LAMINA	GG-5 L	5214626	COMBUSTIBLE	G-296-B	159044AS	1650 con motor/WAUKESHA DIESEL SERIES A		
5542 con motor/A GASOLINA 6 CYL			1550 con motores/A DIESEL, A GASOLINA			COMBUSTIBLE, PRIMARIO	G-296	159044-AS
AIRE	GAK-16	2710837	ACEITE	GP-50	104397-A	COMBUSTIBLE, SECUNDARIO	G-296	159044-AS
5555 con motor/CHRYSLER V8-383			ACEITE, CONVERTIDOR DE TORSION	GP-81	156513-A	COMBUSTIBLE, PRIMARIO	G-296-B	159044AS
ACEITE	GP-1	159045-A	HIDRAULICO	GP-81	156513-A	COMBUSTIBLE, SECUNDARIO	G-296-B	159044AS
BGS con motor/HERCULES JXD			TRANSMISION	GP-81	156513-A	HIDRAULICO	GP-81	156513-A
ACEITE	G-31	140302	AIRE	GAK-16	159012-A	1650D con motor/A DIESEL		
SP109, SP110, SP112, SP115, SP132, SP137, SP420, SP427, SP428, SP429, SP430, SP431, SP525 con motor/A DIESEL			1550D con motor/A DIESEL			COMBUSTIBLE, PRIMARIO	G-1174	156289-AS
ACEITE, FLUJO TOTAL (FULL FLOW)	G-236	1557376	COMBUSTIBLE, PRIMARIO	G-1174	156289-AS	ACEITE, CONVERTIDOR DE TORSION	GP-81	156513-A
OLIVER			ACEITE, DERIVACION (BY PASS)	GP-50	104397-A	HIDRAULICO	GP-81	156513-A
MOTORES			HIDRAULICO	GP-81	156513-A	TRANSMISION	GP-81	156513-A
1250, 1850			AIRE	GAK-16	159012-A	1655 con motor/OLIVER 232D		
ACEITE, SELLADO	GP-1	159045-A	1555 con motor/OLIVER 232D			COMBUSTIBLE, SECUNDARIO	G-296	163953-AS
1550, 1800			COMBUSTIBLE, PRIMARIO	G-1174	156289-AS	COMBUSTIBLE	G-295	20-0006803
ACEITE, SELLADO	GP-50	104397-A	ACEITE	GP-50	104397-A	COMBUSTIBLE, PRIMARIO	G-297	163956AS
1600, 1650			COMBUSTIBLE	G-295	20-0006803	COMBUSTIBLE, SECUNDARIO	G-296-B	163953-AS
ACEITE	GP-31	155618A	ACEITE, CONVERTIDOR DE TORSION	GP-81	156513-A	COMBUSTIBLE, PRIMARIO	G-297-B	163956AS
OLIVER			HIDRAULICO	GP-81	156513-A	ACEITE, CONVERTIDOR DE TORSION	GP-81	156513-A
TRACTORES			TRANSMISION	GP-81	156513-A	HIDRAULICO	GP-81	156513-A
1250 con motor/A GASOLINA			AIRE	GAK-16	159012A	TRANSMISION	GP-81	156513-A
ACEITE	GP-1	159045-A	1555 con motor/OLIVER 232G			AIRE	GAK-16	159012-A
			ACEITE	GP-50	104397-A	1655 con motor/OLIVER 232G		
			ACEITE, CONVERTIDOR DE TORSION	GP-81	156513-A	ACEITE, CONVERTIDOR DE TORSION	GP-81	156513-A
			HIDRAULICO	GP-81	156513-A	HIDRAULICO	GP-81	156513-A
			TRANSMISION	GP-81	156513-A	TRANSMISION	GP-81	156513-A
			AIRE	GAK-16	159012-A	AIRE	GAK-16	159012-A
			1678 con motor/A DIESEL			COMBUSTIBLE, SECUNDARIO	G-296	159044-AS

SERVICIO PESADO

MARCA-MODELO-MOTOR MAKE-MODEL-ENGINE	GONHER GONHER	OEM OEM	MARCA-MODELO-MOTOR MAKE-MODEL-ENGINE	GONHER GONHER	OEM OEM	MARCA-MODELO-MOTOR MAKE-MODEL-ENGINE	GONHER GONHER	OEM OEM
OLIVER (continuación)			OLIVER (continuación)			OLIVER (continuación)		
TRACTORES			TRACTORES			TRACTORES		
COMBUSTIBLE, PRIMARIO	G-297	163956AS	1800D con motor/A DIESEL			1950 con motor/GMC DIESEL		
COMBUSTIBLE, SECUNDARIO	G-296-B	159044AS	COMBUSTIBLE, SECUNDARIO	G-1174	156289-AS	ACEITE	G-33	105256AS
COMBUSTIBLE, PRIMARIO	G-297-B	163956AS	ACEITE, FLUJO TOTAL (FULL FLOW)	GP-1	159045-A	COMBUSTIBLE, SECUNDARIO	G-1173	147363A
1750 con motor/A DIESEL			TRANSMISION	GP-1	159045-A	TRANSMISION	GP-81	156513-A
COMBUSTIBLE, PRIMARIO	G-297	163956AS	ACEITE, DERIVACION (BY PASS)	GP-50	104397-A	AIRE	GAK-403	157985A
COMBUSTIBLE, PRIMARIO	G-297-B	163956AS	HIDRAULICO	GP-81	156513-A	1950D con motor/DETROIT DIESEL		
HIDRAULICO	GP-81	156513-A	AIRE	GAK-403	157985-A	ACEITE	G-33	105256AS
TRANSMISION	GP-81	156513-A	1800D SERIES B, 1800D SERIES C con motor/A DIESEL			ACEITE, CONVERTIDOR DE TORSION	GP-1	159045-A
1750 con motor/WAUKESHA DIESEL			COMBUSTIBLE, SECUNDARIO	G-1174	156289-AS	HIDRAULICO	GP-81	156513-A
COMBUSTIBLE, SECUNDARIO	G-296	159044-AS	TRANSMISION	GP-1	105234-A	TRANSMISION	GP-81	156513-A
COMBUSTIBLE, PRIMARIO	G-297	163956AS	HIDRAULICO	GP-81	156513-A	AIRE	GAK-403	157985-A
COMBUSTIBLE, SECUNDARIO	G-296-B	159044AS	AIRE	GAK-403	157985-A	1950T con motor/A DIESEL		
COMBUSTIBLE, PRIMARIO	G-297-B	163956AS	1850 con motor/PERKINS 6.354 DIESEL			COMBUSTIBLE, SECUNDARIO	G-296	867014
HIDRAULICO SELLADO	GP-81	156513AS	COMBUSTIBLE, PRIMARIO	G-1174	156289-AS	COMBUSTIBLE, PRIMARIO	G-297	163956AS
1750, 1850, 1855 con motor/A GASOLINA			ACEITE, CONVERTIDOR DE TORSION	GP-1	159045-A	COMBUSTIBLE, SECUNDARIO	G-296-B	867014
HIDRAULICO	GP-81	156513-A	ACEITE, SELLADO	GP-1	159045-A	COMBUSTIBLE, PRIMARIO	G-297-B	163956AS
1755 con motor/A DIESEL			COMBUSTIBLE, SECUNDARIO	G-296	163953-AS	HIDRAULICO	GP-81	156513-A
COMBUSTIBLE, SECUNDARIO	G-296	163953-AS	COMBUSTIBLE, SECUNDARIO	G-296-B	163953-AS	TRANSMISION	GP-81	156513-A
COMBUSTIBLE	G-295	20-0006803	HIDRAULICO	GP-81	156513-A	AIRE	GAK-16	159012-A
COMBUSTIBLE, PRIMARIO	G-297	163956AS	TRANSMISION	GP-81	156513-A	1955 con motor/A DIESEL		
COMBUSTIBLE, SECUNDARIO	G-296-B	163953-AS	1855 con motor/A DIESEL			COMBUSTIBLE, SECUNDARIO	G-296	867014
COMBUSTIBLE, PRIMARIO	G-297-B	163956AS	COMBUSTIBLE, SECUNDARIO	G-296	163953-AS	COMBUSTIBLE	G-295	20-0006803
HIDRAULICO	GP-81	156513-A	COMBUSTIBLE	G-295	20-0006803	COMBUSTIBLE, PRIMARIO	G-297	163956AS
TRANSMISION	GP-81	156513-A	COMBUSTIBLE, PRIMARIO	G-297	163956AS	COMBUSTIBLE, SECUNDARIO	G-296-B	867014
1755 con motor/OLIVER 283G			COMBUSTIBLE, SECUNDARIO	G-296-B	163953-AS	COMBUSTIBLE, PRIMARIO	G-297-B	163956AS
HIDRAULICO	GP-81	156513-A	COMBUSTIBLE, PRIMARIO	G-297-B	163956AS	HIDRAULICO	GP-81	156513-A
1800 con motor/A GASOLINA			HIDRAULICO	GP-81	159045-A	TRANSMISION	GP-81	156513-A
ACEITE	GP-50	104397-A	TRANSMISION	GP-81	159045-A	2050, 2150 con motor/HERCULES D-4800		
ACEITE, CONVERTIDOR DE TORSION	GP-81	156513-A	1865 con motor/A DIESEL			COMBUSTIBLE, PRIMARIO	GP-1108	30-3073157
HIDRAULICO	GP-81	156513-A	COMBUSTIBLE	G-296	163953-AS	COMBUSTIBLE, SECUNDARIO	GP-78	40-0002-510
TRANSMISION	GP-81	156513-A	1870 con motor/A DIESEL			HIDRAULICO	GP-81	156513-A
1800 SERIES B, 1800 SERIES C con motor/A DIESEL			COMBUSTIBLE	G-295	20-0006803	TRANSMISION	GP-81	156513-A
COMBUSTIBLE, SECUNDARIO	G-1174	156289-AS	1900 SERIES B, 1900 SERIES C con motor/A DIESEL			2055 con motor/A DIESEL		
TRANSMISION	GP-1	159045-A	ACEITE	G-33	105256AS	COMBUSTIBLE	G-296	159044-AS
HIDRAULICO	GP-81	156513-A	COMBUSTIBLE, SECUNDARIO	G-1173	147363A	COMBUSTIBLE	G-296-B	159044AS
AIRE	GAK-403	157985-A	COMBUSTIBLE, PRIMARIO	G-1174	156289-AS	TRANSMISION	GP-81	156513-A
1800 SERIES B, 1800 SERIES C con motor/A GASOLINA			TRANSMISION	GP-1	159045-A	2155 con motor/A DIESEL		
ACEITE, CONVERTIDOR DE TORSION	GP-81	156513-A	HIDRAULICO	GP-81	156513-A	COMBUSTIBLE	G-296	163953-AS
HIDRAULICO	GP-81	156513-A	AIRE	GAK-403	157985-A	COMBUSTIBLE	G-295	20-0006803
TRANSMISION	GP-81	156513-A	1900D con motor/A DIESEL			COMBUSTIBLE	G-296-B	163953-AS
1800A con motor/A DIESEL			ACEITE, DERIVACION (BY PASS)	G-31	140302	TRANSMISION	GP-81	156513-A
ACEITE, SELLADO	GP-31	155618A	ACEITE, FLUJO TOTAL (FULL FLOW)	G-33	105256AS	2250 con motor/CATERPILLAR 3150		
ACEITE, CONVERTIDOR DE TORSION	GP-81	156513-A	COMBUSTIBLE, SECUNDARIO	G-1173	147363A	ACEITE	GP-36	9N5680
HIDRAULICO	GP-81	156513-A	TRANSMISION	GP-81	156513-A	2255 con motor/CATERPILLAR 3150		
TRANSMISION	GP-81	156513-A	AIRE	GAK-403	157985A	ACEITE	GP-36	9N5680
1800A con motor/A GASOLINA			1950 con motor/A GASOLINA			COMBUSTIBLE, SELLADO	GP-110	1P2299
ACEITE, DERIVACION (BY PASS)	GP-50	104397-A	ACEITE	G-33	105256AS	HIDRAULICO	GP-81	156513-A
1800B, 1800C con motor/A DIESEL			ACEITE, CONVERTIDOR DE TORSION	GP-1	159045-A	TRANSMISION	GP-81	156513-A
ACEITE, SELLADO	GP-31	155618A	HIDRAULICO	GP-81	156513-A	2455, 2655 con motor/A DIESEL		
1800B, 1800C con motor/A GASOLINA			TRANSMISION	GP-81	156513-A	COMBUSTIBLE	G-296	163953-AS
HIDRAULICO	GP-81	156513-A	AIRE	GAK-403	157985-A	30 con motor/A DIESEL		
						COMBUSTIBLE, SECUNDARIO	G-1173	147363A

MARCA-MODELO-MOTOR MAKE-MODEL-ENGINE	GONHER GONHER	OEM OEM	MARCA-MODELO-MOTOR MAKE-MODEL-ENGINE	GONHER GONHER	OEM OEM	MARCA-MODELO-MOTOR MAKE-MODEL-ENGINE	GONHER GONHER	OEM OEM
OLIVER (continuación)			OLIVER (continuación)			P & H CO. (continuación)		
TRACTORES			TRACTORES			EXCAVADORAS		
40 con motor/A DIESEL			OC4-3D, OC4-3G con motor/A DIESEL			W225 DE CABLE, W250 DE CABLE con motor/CATERPILLAR 3208		
COMBUSTIBLE, SECUNDARIO	G-1173	147363A	COMBUSTIBLE, SECUNDARIO	G-1173	147363A	ACEITE	GP-36	9L9200
40D4 con motor/PERKINS P4			OC46 con motor/HERCULES DD130			GASOLINA	G-293	8N9803
ACEITE	G-871	26540055	COMBUSTIBLE, PRIMARIO	G-1163	TO17503	COMBUSTIBLE	GP-110	10462544
430, 431 con motor/CHRYSLER 265			OC46-3G con motor/A DIESEL			ACEITE	GP-9586	9N5570
ACEITE	G-236	1557376	ACEITE, DERIVACION (BY PASS)	GP-50	104397-A	P & H CO.		
44PD con motor/PERKINS P4			OC4D, OC4G con motor/A DIESEL			GRÚAS		
ACEITE	G-871	26540055	COMBUSTIBLE, SECUNDARIO	G-1173	147363A	100 con motor/INTERNATIONAL DT-817		
50 con motor/A DIESEL			OC9 con motor/A DIESEL			TRANSMISION	G-33	45060
COMBUSTIBLE, SECUNDARIO	G-1173	147363A	ACEITE	GP-50	104397-A	1015 con motor/CATERPILLAR D337		
500D con motor/A DIESEL			OC96D, OC9D con motor/A DIESEL			ACEITE	G-238	1046289
COMBUSTIBLE, PRIMARIO	G-11816	32543	ACEITE, DERIVACION (BY PASS)	GP-50	104397-A	1015 con motor/GMC 6-110		
550 con motor/HERCULES DD198			OC9G con motor/A DIESEL			ACEITE	G-33	5573013
COMBUSTIBLE, SECUNDARIO	G-1163	TO17503	ACEITE	GP-50	104397-A	1025A con motor/CATERPILLAR D343		
560 con motor/A DIESEL			OL175 con motor/CUMMINS			ACEITE	G-238	1046289
ACEITE	G-834	26540153	ACEITE, TURBOCARGADOR	GP-14	30-3483584	1025A con motor/GMC 6-110		
570 con motor/A DIESEL			COMBUSTIBLE, 5 47/64 IN	GPP-14	BM78672	ACEITE	G-33	5573013
COMBUSTIBLE, SECUNDARIO	G-1163	TO17503	COMBUSTIBLE, 4 3/8 IN	GP-1101	126517	1055 con motor/CATERPILLAR D343		
660, 770, 880 con motor/A DIESEL			ACEITE, FLUJO TOTAL (FULL FLOW) SELLADO	GP-53	3313287	ACEITE	G-238	1046289
ACEITE, CONVERTIDOR DE TORSION	GP-81	156513-A	COMBUSTIBLE, 11 1/2 IN	GP-55	3313306	1055 con motor/CATERPILLAR D375		
77, 880D, 88, 770D con motor/A DIESEL			COMBUSTIBLE, SEPARADOR DE AGUA	GPP-11	3308638	ACEITE	G-238	1046289
ACEITE, CONVERTIDOR DE TORSION	GP-81	156513-A	AIRE, RESPIRADOR CON TURBO	GA-39	255963	1055B con motor/CATERPILLAR D343		
950 con motor/A DIESEL			ACEITE, DERIVACION (BY PASS)	G-750	C41783A	ACEITE	G-238	1046289
ACEITE	G-31	140302	SUPER 66, SUPER 77, SUPER 88 con motor/A DIESEL			1055B con motor/GMC 6-110		
990, 995 con motor/A DIESEL			ACEITE, CONVERTIDOR DE TORSION	GP-81	156513-A	ACEITE	G-33	5573013
ACEITE	G-31	140302	SUPER 99 con motor/A DIESEL			1055BLC con motor/CUMMINS NVH12		
99D, AD con motor/A DIESEL			ACEITE	G-31	140302	ACEITE	G-566	10462205
COMBUSTIBLE, SECUNDARIO	G-1173	147363A	SUPER 99D con motor/A DIESEL			ACEITE	GP-14	1046272
AG6, AG6H, B con motor/A DIESEL			COMBUSTIBLE, SECUNDARIO	G-1176	7A5351	COMBUSTIBLE	GPP-14	3315847
ACEITE, DERIVACION (BY PASS)	G-31	140302	SUPER 99GM con motor/A DIESEL			COMBUSTIBLE	GP-1101	10462144
BD con motor/A DIESEL			ACEITE	G-31	140302	COMBUSTIBLE	GPP-11	3308638
COMBUSTIBLE, SECUNDARIO	G-1173	147363A	P & H CO.			AIRE	GA-39	1046266
HB25 con motor/A DIESEL			CAMIONES, TRACTOCAMIONES Y AUTOBUSES			ACEITE	G-750	1046268
ACEITE, DERIVACION (BY PASS)	G-31	140302	255A GRUA con motor/P & H 487C18			1055BLC con motor/GMC 6-110		
OC12D con motor/A DIESEL			ACEITE, DERIVACION (BY PASS)	G-31	40056	ACEITE	G-33	5573013
COMBUSTIBLE, SECUNDARIO	G-1173	147363A	595TC GRUA con motor/P & H 487C18			1055BLC, 1025A, 1055B con motor/CUMMINS NT335		
OC12G, OC15 con motor/A DIESEL			ACEITE, DERIVACION (BY PASS)	G-31	40056	ACEITE	G-566	10462205
ACEITE, DERIVACION (BY PASS)	G-31	140302	P & H CO.			COMBUSTIBLE	GPP-14	3315847
OC156 con motor/A DIESEL			EXCAVADORAS			ACEITE	GP-53	10462315
ACEITE, DERIVACION (BY PASS)	G-31	140302	2250 con motor/DETROIT DIESEL 16V-149			ACEITE	G-750	1046268
OC18 con motor/A DIESEL			ACEITE	GP-53	10462315	1055BLC, 1055LC con motor/CATERPILLAR D343		
ACEITE	G-31	140302	255 con motor/P & H 387C18			ACEITE	G-238	1046289
COMBUSTIBLE, PRIMARIO	G-1143	107368	ACEITE, DERIVACION (BY PASS)	G-31	40056	105ATC con motor/A DIESEL		
COMBUSTIBLE, SECUNDARIO	G-1176	7A5351	P & H CO.			ACEITE, DERIVACION (BY PASS)	G-31	40056
			EXCAVADORAS			105ATC, 105B, 155A con motor/CATERPILLAR D311 SERIES		
						ACEITE	G-191	8N4301
						105ATC, 105B, 155A con motor/GMC 2-71		
						ACEITE	G-31	40056

SERVICIO PESADO

MARCA-MODELO-MOTOR MAKE-MODEL-ENGINE	GONHER GONHER	OEM OEM	MARCA-MODELO-MOTOR MAKE-MODEL-ENGINE	GONHER GONHER	OEM OEM	MARCA-MODELO-MOTOR MAKE-MODEL-ENGINE	GONHER GONHER	OEM OEM
P & H CO. (continuación)			P & H CO. (continuación)			P & H CO. (continuación)		
GRÚAS			GRÚAS			GRÚAS		
ACEITE	G-33	5573013	325TC UPPER FRAME con motor/WAUKESHA 195GK			565ATC, 585ATC, 595TC con motor/P & H 387C18		
COMBUSTIBLE, SECUNDARIO	G-1175	41350	ACEITE	G-31	40056	ACEITE, DERIVACION (BY PASS)	G-31	40056
105ATC, 105B, 155A con motor/P & H 278C18			420, 425, 440, 525, 535 con motores/CUMMINS HR6, CUMMINS JN6			6250TC con motor/CATERPILLAR 5310		
ACEITE	G-31	40056	ACEITE	G-566	10462205	ACEITE	GP-36	10462544
1200 HOE, 5300A con motor/CUMMINS			ACEITE	GP-14	1046272	6250TC con motor/CUMMINS NT380		
ACEITE	G-566	10462205	COMBUSTIBLE	GPP-14	3315847	ACEITE, CONVERTIDOR DE TORSION	G-33	45060
COMBUSTIBLE	GPP-14	3315847	COMBUSTIBLE	GP-1101	10462144	ACEITE	G-566	10462205
ACEITE	GP-53	10462315	COMBUSTIBLE	GPP-11	3308638	COMBUSTIBLE	G-1143	252193
ACEITE	G-750	1046268	AIRE	GA-39	1046266	ACEITE	GP-14	1046272
122, 128 con motor/DETROIT DIESEL 8.2L			ACEITE	G-750	1046268	COMBUSTIBLE	GPP-14	3315847
ACEITE	GP-13	6438384	420, 525, 425, 440 con motor/CATERPILLAR D330A			COMBUSTIBLE	GP-1101	10462144
COMBUSTIBLE	GP-92	1046A524	ACEITE	G-191	8N4301	COMBUSTIBLE	GPP-11	3308638
COMBUSTIBLE	GP-93	1046Z467	420, 650TC UPPER FRAME, 425, 440, 525, 535 con motor/GMC 4-71			AIRE	GA-39	1046266
1400DE, 1500DE con motor/CUMMINS			ACEITE	G-31	40056	ACEITE	G-750	1046268
ACEITE	G-566	10462205	ACEITE	G-33	5573013	6250TC UPPER FRAME con motor/CUMMINS NT380		
ACEITE	GP-14	1046272	COMBUSTIBLE, SECUNDARIO	G-1173	40058	ACEITE	G-566	10462205
COMBUSTIBLE	GPP-14	3315847	445BTC, 555ATC, 555CTC, 355BTC, 355CTC con motor/P & H 387C18			COMBUSTIBLE	G-1143	252193
COMBUSTIBLE	GP-1101	10462144	ACEITE, DERIVACION (BY PASS)	G-31	40056	ACEITE	GP-53	10462315
ACEITE	GP-53	10462315	5100 con motor/CUMMINS			AGUA	GP-2071W	10462620
COMBUSTIBLE	GP-55	3313306	ACEITE	G-566	10462205	ACEITE	G-750	1046268
COMBUSTIBLE	GPP-11	3308638	COMBUSTIBLE	GPP-14	3315847	670WLC con motor/GMC 4-71N		
AIRE	GA-39	1046266	ACEITE	G-500	10462389	ACEITE	G-33	5573013
ACEITE	G-750	1046268	525 con motor/CATERPILLAR D333C			755B, 775ATC, 855BLC con motor/DETROIT DIESEL 4-53N		
150 con motor/CUMMINS 6CT8.3			ACEITE	G-191	8N4301	ACEITE, DERIVACION (BY PASS)	G-31	40056
COMBUSTIBLE	GP-1122	1160243	535 con motor/CATERPILLAR 3306			9125A-TC con motor/CUMMINS NTF365 CARRIER		
ACEITE	GP-43	3313281	ACEITE	GP-51	1R0658	ACEITE	G-566	10462205
COMBUSTIBLE	GPP-18	1046Z571	535 con motor/CATERPILLAR D330A			COMBUSTIBLE	GP-1101	10462144
155ATC con motor/P & H 278C18			ACEITE	G-191	8N4301	ACEITE	GP-53	10462315
ACEITE, DERIVACION (BY PASS)	G-31	40056	535 con motor/CATERPILLAR D333C			ACEITE	G-750	1046268
225 DIGGER con motor/P & H 387C18			ACEITE	G-191	8N4301	9125A-TC con motor/CUMMINS V903 UPPER FRAME		
ACEITE	G-31	40056	550 con motor/CATERPILLAR D333			ACEITE	G-566	10462205
225A con motor/P & H 487C18			ACEITE	G-191	8N4301	COMBUSTIBLE	GP-1101	10462144
ACEITE	G-31	40056	550 con motor/CUMMINS			ACEITE	GP-53	10462315
2355 DRAGLINE con motor/CATERPILLAR 3306			ACEITE	G-191	8N4301	AGUA	GP-2071W	10462620
ACEITE	GP-51	1R0658	550 con motor/CUMMINS			ACEITE	G-750	1046268
255, 655B con motor/P & H 387C18			ACEITE	G-566	10462205	955, 1010 con motor/CATERPILLAR D337		
ACEITE, DERIVACION (BY PASS)	G-31	40056	ACEITE	GP-14	1046272	ACEITE	G-238	1046289
255ALC con motor/P & H 387C18			COMBUSTIBLE	GPP-14	3315847	955, 1010 con motor/GMC 6-110		
ACEITE, DERIVACION (BY PASS)	G-31	40056	COMBUSTIBLE	GP-1101	10462144	ACEITE	G-33	5573013
255ATC con motor/CUMMINS			ACEITE	GP-53	10462315	955, 1010, 1015 con motor/CUMMINS NHRS6		
ACEITE	G-566	10462205	COMBUSTIBLE	GP-55	3313306	ACEITE	G-566	10462205
ACEITE	GP-14	1046272	COMBUSTIBLE	GPP-11	3308638	ACEITE	GP-14	1046272
COMBUSTIBLE	GP-1101	10462144	AIRE	GA-39	255963	COMBUSTIBLE	GPP-14	3315847
ACEITE	GP-53	10462315	ACEITE	G-750	1046268	COMBUSTIBLE	GP-1101	10462144
COMBUSTIBLE	GP-55	3313306	550TC UPPER FRAME, 325TC UPPER FRAME, 535TC UPPER FRAME, 540TC UPPER FRAME, 550 UPPER FRAME con motor/GMC 4-71			COMBUSTIBLE	GPP-11	3308638
COMBUSTIBLE	GPP-11	3308638	ACEITE	G-31	40056	COMBUSTIBLE	GP-1101	10462144
AIRE	GA-39	25593	ACEITE	GP-53	10462315	AIRE	GA-39	1046266
ACEITE	G-750	1046268	COMBUSTIBLE	GP-55	3313306	ACEITE	G-750	1046268
GASOLINA, LAMINA	GG-8 L	P550474	COMBUSTIBLE	GPP-11	3308638	CN150 con motor/CUMMINS 5.9L		
315, 320 con motor/CATERPILLAR 3304			AIRE	GA-39	255963	COMBUSTIBLE	GP-1122	1160243
ACEITE	GP-51	1R0658	ACEITE	G-750	1046268	COMBUSTIBLE	GPP-18	1046Z571
			55ATC con motor/A DIESEL			ACEITE	GP-178	1046Z572
			ACEITE, DERIVACION (BY PASS)	G-31	40056	AIRE, CUMMINS	GA-106	221046Z38
			55ATC con motor/P & H 278C18					
			ACEITE	G-31	40056			

MARCA-MODELO-MOTOR MAKE-MODEL-ENGINE	GONHER GONHER	OEM OEM	MARCA-MODELO-MOTOR MAKE-MODEL-ENGINE	GONHER GONHER	OEM OEM	MARCA-MODELO-MOTOR MAKE-MODEL-ENGINE	GONHER GONHER	OEM OEM
P & H CO. (continuación)			PERKINS (continuación)			PERKINS (continuación)		
GRÚAS			MOTORES			MOTORES		
AIRE, KOMATSU	GA-326	22104628	3.152, 3.152Y, 3AB.152			4.203		
AIRE	GA-206	221046239	ACEITE, CARTUCHO	G-813	32527	ACEITE, CARTUCHO OPCIONAL	G-813	32527
M.T. 13.6, M.T. 16.3, M.T. 18.2 con motor/DETROIT DIESEL 4-53N			ACEITE, CARTUCHO OPCIONAL	G-836	32578	ACEITE, CARTUCHO	G-834	26540153
AIRE	GA-360	P117439	COMBUSTIBLE	G-296	26561117	ACEITE, CARTUCHO OPCIONAL	G-836	26540154
OMEGA 100 con motor/CUMMINS 6BT5.9			ACEITE, SELLADO	GP-3600	2654186	ACEITE, CARTUCHO OPCIONAL	G-871	30211
COMBUSTIBLE	GP-1122	1160243	COMBUSTIBLE	G-296-B	26561117	COMBUSTIBLE	G-11816	32543
COMBUSTIBLE	GPP-18	10462571	3A.152			ACEITE, SELLADO 5 13/32 IN	GP-1	2654403
ACEITE	GP-178	10462572	ACEITE	G-813	32527	ACEITE, SELLADO 7 17/32 IN	GP-31	2654407
AIRE	GA-360	10462283	ACEITE, OPCIONAL	G-836	32578	COMBUSTIBLE	G-296	711/296
OMEGA 18 con motor/GMC 4-53N			COMBUSTIBLE	G-11816	32543	COMBUSTIBLE	G-296-B	711/296
ACEITE	G-33	5573013	4.107, 4.107M			4.236, 4.236M		
COMBUSTIBLE, SECUNDARIO	G-1173	40058	ACEITE, CARTUCHO OPCIONAL	G-813	32527	ACEITE, CARTUCHO	G-871	30211
COMBUSTIBLE, SECUNDARIO	G-1175	41350	ACEITE, CARTUCHO	G-836	26540154	COMBUSTIBLE	G-11816	32543
AIRE	GA-360	10462283	ACEITE, CARTUCHO OPCIONAL	G-871	30211	ACEITE, SELLADO 5 13/32 IN	GP-1	2654403
OMEGA 20, OMEGA 25 con motor/GMC 4-53N SERIES			COMBUSTIBLE	G-11816	32543	ACEITE, SELLADO 7 17/32 IN	GP-31	2654407
ACEITE	G-33	5573013	ACEITE, SELLADO	GP-1	2654403	COMBUSTIBLE	G-296	711/296
COMBUSTIBLE, SECUNDARIO	G-1173	40058	COMBUSTIBLE	G-296	26561117	COMBUSTIBLE	G-296-B	711/296
COMBUSTIBLE, SECUNDARIO	G-1175	41350	COMBUSTIBLE	G-296-B	26561117	4.248		
OMEGA 40 con motor/GMC 6V-53			4.1077			ACEITE, CARTUCHO OPCIONAL	G-813	32527
ACEITE	G-33	5573013	ACEITE	G-836	32578	ACEITE, CARTUCHO	G-871	30211
R150 con motor/GMC 4-53			COMBUSTIBLE	G-296	26561117	ACEITE, SELLADO 5 13/32 IN	GP-1	2654403
ACEITE	G-33	5573013	COMBUSTIBLE	G-296-B	26561117	ACEITE, SELLADO 7 17/32 IN	GP-31	2654407
COMBUSTIBLE, SECUNDARIO	G-1173	40058	4.108			COMBUSTIBLE	G-296	2656621
COMBUSTIBLE, SECUNDARIO	G-1175	41350	ACEITE, CARTUCHO OPCIONAL	G-813	26540132	COMBUSTIBLE	G-296-B	2656621
S20, S88 con motor/DEUTZ BF6L913			ACEITE, CARTUCHO OPCIONAL	G-836	30212	4.27, 4.270D		
COMBUSTIBLE	GP-1122	1160243	COMBUSTIBLE	G-11816	30232	ACEITE	G-834	26540153
T650 con motor/CUMMINS LTA10			ACEITE, SELLADO	GP-1	2654403	COMBUSTIBLE	G-11816	32543
COMBUSTIBLE	GPP-14	3315847	COMBUSTIBLE	G-296	26561117	COMBUSTIBLE	G-296	2656621
ACEITE	GP-53	10462315	COMBUSTIBLE	G-296-B	26561117	COMBUSTIBLE	G-296-B	2656621
ACEITE	GP-57	10462587	COMBUSTIBLE	G-297-B	26560602	4.288		
P & H CO.			COMBUSTIBLE	G-296-B	7111/296	ACEITE, 1964 EN ADELANTE	G-834	26540153
MOTORES			COMBUSTIBLE	G-297-B	26560602	4.2L PRIMA SERIES		
287C INDUSTRIAL, 287C18 INDUSTRIAL, 287C18A INDUSTRIAL, 387 INDUSTRIAL, 387C18 INDUSTRIAL, 387C18A INDUSTRIAL, 387C18T INDUSTRIAL, 387H18 INDUSTRIAL, 387H18T INDUSTRIAL, 487C INDUSTRIAL, 487C18 INDUSTRIAL, 487C18A INDUSTRIAL, 487C18T INDUSTRIAL, 487H18 INDUSTRIAL, 487H18T INDUSTRIAL, 687C INDUSTRIAL, 687C18 INDUSTRIAL, 687C18A INDUSTRIAL, 687C18T INDUSTRIAL, 687H18 INDUSTRIAL, 687H18T INDUSTRIAL			4.154M			COMBUSTIBLE	GPP-1122	2651118
ACEITE	G-31	40056	ACEITE	GP-31	2654407	4.3		
PERKINS			COMBUSTIBLE	G-296	26560017	ACEITE, CARTUCHO	G-834	26540153
MOTORES			COMBUSTIBLE	G-296	26560017	ACEITE, CARTUCHO OPCIONAL	G-871	30211
1000 SERIES			COMBUSTIBLE	G-297-B	26560017	ACEITE, SELLADO 5 13/32 IN	GP-1	2654403
ACEITE	GP-1	2654403	COMBUSTIBLE	G-296-B	26560017	ACEITE, SELLADO 7 17/32 IN	GP-31	2654407
COMBUSTIBLE	G-296	26561117	COMBUSTIBLE	G-297-B	26560602	COMBUSTIBLE	G-296	26560017
COMBUSTIBLE	G-296-B	26561117	COMBUSTIBLE	G-296-B	26560017	COMBUSTIBLE	G-296-B	26560017
1004.40T TURBO CARGADO (3.99L), 1006-6TW			COMBUSTIBLE	G-297-B	26560602	4.318		
ACEITE	GP-1	2654343	4.165			ACEITE, CARTUCHO	G-813	32527
COMBUSTIBLE, SECUNDARIO	GPP-425	26560145	ACEITE	GP-1	2654403	ACEITE, CARTUCHO	G-871	2654154
COMBUSTIBLE, PRIMARIO	GPP-419	26560143	COMBUSTIBLE	GP-31	2654407	ACEITE, SELLADO	GP-31	2654407
1004-40 SERIES, 1004-42, 1004-4T, 1004-4T TURBOCARGADO 3.99L			COMBUSTIBLE	G-296	26560017	COMBUSTIBLE	G-296	26560017
ACEITE	GP-1	2654343	COMBUSTIBLE	G-297	26560602	COMBUSTIBLE	G-297	26560602
			COMBUSTIBLE	G-296-B	26560017	COMBUSTIBLE	G-296-B	26560017
			COMBUSTIBLE	G-297-B	26560602	COMBUSTIBLE	G-297-B	26560602
			4.192			4.40 PHASER		
			ACEITE, CARTUCHO	G-813	32527	ACEITE	GP-1	2654403
			ACEITE, CARTUCHO OPCIONAL	G-834	26540153	ACEITE	GP-31	2654407
			ACEITE, CARTUCHO OPCIONAL	G-836	26540154	COMBUSTIBLE	G-296	26560017
			ACEITE, CARTUCHO OPCIONAL	G-871	30211	COMBUSTIBLE	G-296-B	26560017
			COMBUSTIBLE	G-11816	32543	COMBUSTIBLE	G-296-B	26560017
			COMBUSTIBLE	G-296	7111/296	4.99		
			COMBUSTIBLE	G-296-B	7111/296	ACEITE, OPCIONAL	G-813	32527
						ACEITE	G-836	32578

SERVICIO PESADO

MARCA-MODELO-MOTOR MAKE-MODEL-ENGINE	GONHER GONHER	OEM OEM	MARCA-MODELO-MOTOR MAKE-MODEL-ENGINE	GONHER GONHER	OEM OEM	MARCA-MODELO-MOTOR MAKE-MODEL-ENGINE	GONHER GONHER	OEM OEM
PERKINS (continuación)			PERKINS (continuación)			PERKINS (continuación)		
MOTORES			MOTORES			MOTORES		
COMBUSTIBLE	G-11816	30232	ACEITE, SELLADO 5 13/32 IN	GP-1	2654343	A4.318		
COMBUSTIBLE	G-296	26560017	ACEITE, SELLADO 7 17/32 IN	GP-31	2654407	ACEITE	GP-1	2654403
COMBUSTIBLE	G-296-B	26560017	COMBUSTIBLE	G-296	711/296	ACEITE	GP-31	2654407
4A.192			ACEITE, SELLADO 4 45/64 IN	GP-3600	2654186	COMBUSTIBLE	G-296	26560017
ACEITE, CARTUCHO	G-813	32527	COMBUSTIBLE	G-296-B	711/296	COMBUSTIBLE	G-297	26560602
ACEITE, CARTUCHO OPCIONAL	G-834	26540153	6.3544 RANGE 4 SERIES, AV8.540			COMBUSTIBLE	G-296-B	26560017
ACEITE, CARTUCHO OPCIONAL	G-836	26540154	ACEITE	GP-31	2654407	COMBUSTIBLE	G-297-B	26560602
ACEITE, CARTUCHO OPCIONAL	G-871	30211	COMBUSTIBLE	G-296	26560017	AD3.152		
COMBUSTIBLE	G-11816	32543	COMBUSTIBLE	G-296-B	26560017	ACEITE, CARTUCHO	G-813	32527
COMBUSTIBLE	G-296	7111/296	6.354M, A6.354			ACEITE, CARTUCHO OPCIONAL	G-836	32578
COMBUSTIBLE	G-296-B	7111/296	ACEITE, CARTUCHO	G-834	26540153	COMBUSTIBLE	G-296	26561117
4A.203, AD4.203			COMBUSTIBLE	G-11816	32543	ACEITE, SELLADO	GP-3600	2654186
ACEITE, CARTUCHO OPCIONAL	G-813	32527	ACEITE, SELLADO 5 13/32 IN	GP-1	2654343	COMBUSTIBLE	G-296-B	26561117
ACEITE, CARTUCHO	G-834	26540153	ACEITE, SELLADO 7 17/32 IN	GP-31	2654407	AD4.248, AG3.152		
ACEITE, CARTUCHO OPCIONAL	G-836	26540154	COMBUSTIBLE	G-296	711/296	ACEITE	GP-1	2654403
ACEITE, CARTUCHO OPCIONAL	G-871	30211	ACEITE, SELLADO 4 45/64 IN	GP-3600	2654186	COMBUSTIBLE	G-296	26560017
COMBUSTIBLE	G-11816	32543	COMBUSTIBLE	G-296-B	711/296	COMBUSTIBLE	G-297	26560602
ACEITE, SELLADO 5 13/32 IN	GP-1	2654403	6.372			COMBUSTIBLE	G-296-B	26560017
ACEITE, SELLADO 7 17/32 IN	GP-31	2654407	ACEITE, CARTUCHO	G-834	26540153	COMBUSTIBLE	G-297-B	26560602
COMBUSTIBLE	G-296	711/296	ACEITE, SELLADO	GP-31	2654407	AT3.152		
COMBUSTIBLE	G-296-B	711/296	COMBUSTIBLE	G-296	26560017	ACEITE, CARTUCHO	G-813	32527
4A.270D			COMBUSTIBLE	G-296-B	26560017	ACEITE, CARTUCHO OPCIONAL	G-836	32578
ACEITE	G-871	30211	6.44			COMBUSTIBLE	G-296	26561117
4A.99			ACEITE	GP-31	2654407	ACEITE, SELLADO	GP-3600	2654186
ACEITE, OPCIONAL	G-813	32527	COMBUSTIBLE	G-297	26560602	COMBUSTIBLE	G-296-B	26561117
ACEITE	G-836	32578	COMBUSTIBLE	G-297-B	26560602	AT4.236		
COMBUSTIBLE	G-11816	30232	6.60 PHASER			ACEITE, CARTUCHO	G-871	30211
COMBUSTIBLE	G-296	26560017	ACEITE	GP-1	2654403	COMBUSTIBLE	G-11816	32543
COMBUSTIBLE	G-296-B	26560017	ACEITE	GP-31	2654407	ACEITE, SELLADO 5 13/32 IN	GP-1	2654403
4A107, 4A99			COMBUSTIBLE	G-296	26560017	ACEITE, SELLADO 7 17/32 IN	GP-31	2654407
ACEITE	G-813	26540132	COMBUSTIBLE	G-296-B	26560017	COMBUSTIBLE	G-296	711/296
4A236			COMBUSTIBLE	G-296-B	26560017	COMBUSTIBLE	G-296-B	711/296
ACEITE, CARTUCHO	G-801	26560090	A4.107			AT4.248		
ACEITE, CARTUCHO	G-813	26540132	ACEITE, CARTUCHO OPCIONAL	G-813	32527	ACEITE, CARTUCHO OPCIONAL	G-813	32527
COMBUSTIBLE	G-11816	32543	ACEITE, CARTUCHO	G-836	26540154	ACEITE, CARTUCHO	G-871	30211
ACEITE, SELLADO	GP-1	2654403	ACEITE, CARTUCHO OPCIONAL	G-871	30211	ACEITE, SELLADO 5 13/32 IN	GP-1	2654403
ACEITE, SELLADO	GP-31	2654407	COMBUSTIBLE	G-11816	32543	ACEITE, SELLADO 7 17/32 IN	GP-31	2654407
COMBUSTIBLE	G-296	26560017	ACEITE, SELLADO	GP-1	2654403	COMBUSTIBLE	G-296	2656621
COMBUSTIBLE	G-297	26560602	A4.212, A4-212, AG4.212			COMBUSTIBLE	G-296-B	2656621
COMBUSTIBLE	G-296-B	26560017	ACEITE	GP-1	2654403	AV8.640		
COMBUSTIBLE	G-297-B	26560602	COMBUSTIBLE	G-296	26560017	ACEITE	GP-31	2654407
4A270D			COMBUSTIBLE	G-296-B	26560017	COMBUSTIBLE	GP-1122	26437001
ACEITE	G-834	26540153	A4.236			COMBUSTIBLE	G-297	26560602
COMBUSTIBLE	G-11816	32543	ACEITE, CARTUCHO	G-871	30211	COMBUSTIBLE	G-297-B	26560602
COMBUSTIBLE	G-296	26560017	COMBUSTIBLE	G-11816	32543	B3.152		
COMBUSTIBLE	G-296-B	26560017	ACEITE, SELLADO 5 13/32 IN	GP-1	2654403	ACEITE	G-813	32527
6.247, 6.354.2			ACEITE, SELLADO 7 17/32 IN	GP-31	2654407	ACEITE, OPCIONAL	G-836	32578
ACEITE	GP-1	2654403	COMBUSTIBLE	G-296	711/296	COMBUSTIBLE	G-11816	32543
6.288, 6.305			COMBUSTIBLE	G-296-B	711/296	C305, C6.305		
ACEITE	G-834	26540153	A4.300			ACEITE	G-834	26540153
COMBUSTIBLE	G-296	26561117	ACEITE, CARTUCHO	G-834	26540153	D3.152		
COMBUSTIBLE	G-296-B	26561117	ACEITE, CARTUCHO OPCIONAL	G-871	30211	ACEITE, CARTUCHO	G-813	32527
6.354			ACEITE, SELLADO 5 13/32 IN	GP-1	2654403	ACEITE, CARTUCHO OPCIONAL	G-836	32578
ACEITE, CARTUCHO	G-834	26540153	ACEITE, SELLADO 7 17/32 IN	GP-31	2654407	COMBUSTIBLE	G-296	26561117
COMBUSTIBLE	G-11816	32543	COMBUSTIBLE	G-296	26560017	ACEITE, SELLADO	GP-3600	2654186
			COMBUSTIBLE	G-296-B	26560017	COMBUSTIBLE	G-296-B	26561117

MARCA-MODELO-MOTOR MAKE-MODEL-ENGINE	GONHER GONHER	OEM OEM	MARCA-MODELO-MOTOR MAKE-MODEL-ENGINE	GONHER GONHER	OEM OEM	MARCA-MODELO-MOTOR MAKE-MODEL-ENGINE	GONHER GONHER	OEM OEM
PERKINS (continuación)			PERKINS (continuación)			PETERBILT (continuación)		
MOTORES			MOTORES			CAMIONES, TRACTOCAMIONES Y AUTOBUSES		
D4.203, P4.203			ACEITE, CARTUCHO OPCIONAL	G-871	30211	22-210 MID-RANGER con motor/CUMMINS 6CT8.3		
ACEITE, CARTUCHO OPCIONAL	G-813	32527	COMBUSTIBLE	G-11816	32543	COMBUSTIBLE, SECUNDARIO	GP-1122	3903640
ACEITE, CARTUCHO	G-834	26540153	COMBUSTIBLE	G-296	7111/296	ACEITE	GP-43	3313281
ACEITE, CARTUCHO OPCIONAL	G-836	26540154	COMBUSTIBLE	G-296-B	7111/296	COMBUSTIBLE, PRIMARIO	GPP-18	3903410
ACEITE, CARTUCHO OPCIONAL	G-871	30211	P6, R6, S6			AIRE	GA-209	P129545
COMBUSTIBLE	G-11816	32543	ACEITE	G-834	26540153	270 con motor/CUMMINS ISB 5.9L		
ACEITE, SELLADO 5 13/32 IN	GP-1	2654403	ACEITE, OPCIONAL	G-871	30347	ACEITE	GP-3937	3937144
ACEITE, SELLADO 7 17/32 IN	GP-31	2654407	COMBUSTIBLE	G-296	711/296	COMBUSTIBLE, CARTUCHO	GS-1261	3942470
COMBUSTIBLE	G-296	711/296	COMBUSTIBLE	G-296-B	711/296	SEPARADOR DE AGUA	GA-197R	P527484
COMBUSTIBLE	G-296-B	711/296	COMBUSTIBLE			AIRE		
F3			ST6.3544 RANGE 4 SERIES, T6.3544 RANGE 4 SERIES, V8.540			277 con motor/CUMMINS 6CT8.3		
ACEITE	G-813	32527	ACEITE	GP-31	2654407	COMBUSTIBLE, SECUNDARIO	GP-1122	3903640
ACEITE, OPCIONAL	G-871	30211	COMBUSTIBLE	G-296	265600017	COMBUSTIBLE, SEPARADOR	GPP-1122	3903202
COMBUSTIBLE	G-11816	32543	COMBUSTIBLE	G-296-B	265600017	DE AGUA OPCIONAL	GP-43	3313281
F3.152, P3.152			TV8.540, V8.605			ACEITE	GP-18	3903410
ACEITE	G-813	32527	ACEITE	GP-31	2654407	COMBUSTIBLE, PRIMARIO	GPP-18	3903410
ACEITE, OPCIONAL	G-836	32578	TV8.640, V8.640			282 con motor/CATERPILLAR 3406		
COMBUSTIBLE	G-11816	325443	ACEITE	GP-31	2654407	ACEITE, CUMPLE CON MEDI-	GP-691	1R1808
COMBUSTIBLE	G-296	2656621	COMBUSTIBLE	G-296	711/296	DAS ORIGINALES	GP-52	1R1808
COMBUSTIBLE	G-296-B	2656621	COMBUSTIBLE	G-297	711/796	ACEITE, SEGUNDA OPCION	GP-1108	1R0712
F4			COMBUSTIBLE	G-296-B	711/296	COMBUSTIBLE		
ACEITE	G-813	32527	COMBUSTIBLE	G-297-B	711/796	282, 289 con motor/CATERPILLAR 1693T		
H6.354, H6.354M, HT6.354, HT6.354M, T6.354, T6.354M			V6.440			ACEITE, CARTUCHO	G-238	55485
ACEITE, CARTUCHO	G-834	26540153	ACEITE	GP-31	2654407	COMBUSTIBLE, CARTUCHO	G-1166	6H5931
COMBUSTIBLE	G-11816	32543	COMBUSTIBLE	G-297	26560602	ACEITE, SELLADO (CUMPLE	GP-691	1R1808
ACEITE, SELLADO 5 13/32 IN	GP-1	2654343	COMBUSTIBLE	G-297-B	26560602	CON MEDIDAS ORIGINALES)	GP-52	1R1808
ACEITE, SELLADO 7 17/32 IN	GP-31	2654407	V8.510			ACEITE, SELLADO (SEGUNDA	GP-110	1R-0740
COMBUSTIBLE	G-296	711/296	ACEITE, CARTUCHO	G-834	26540153	OPCION)	GP-110	1R-0740
ACEITE, SELLADO 4 45/64 IN	GP-3600	2654186	ACEITE, CARTUCHO OPCIONAL	G-836	32578	AIRE, RESPIRADOR DEL	GA-135	9L2169
COMBUSTIBLE	G-296-B	711/296	ACEITE, SELLADO	GP-31	2654407	COMPRESOR		
L4, L4M			COMBUSTIBLE	G-296	711/296	282, 289 con motor/GMC 12V-71N		
ACEITE, OPCIONAL	G-813	32527	COMBUSTIBLE	G-296-B	711/296	ACEITE, DERIVACION (BY PASS)	G-31	1595410
ACEITE	G-834	26540153	PETERBILT			282, 349H, 352H, 288, 289, 351, 353, 358, 359, 362, 383 con motor/		
ACEITE, OPCIONAL	G-871	30211	CAMIONES, TRACTOCAMIONES Y AUTOBUSES			CUMMINS		
M20, M25, M30			13-210 MID-RANGER con motor/CUMMINS 6CT8.3			ACEITE, FLUJO TOTAL (FULL	G-566	PB516
ACEITE	GP-2951	140516190	COMBUSTIBLE, SECUNDARIO	GP-1122	3903640	FLOW) CARTUCHO	GP-14	152499
M50, M60, M80T			ACEITE	GP-43	3313281	ACEITE, TURBOCARGADOR	GPP-14	BM78255
ACEITE	GP-3985	P502039	COMBUSTIBLE, PRIMARIO	GPP-18	3903410	COMBUSTIBLE, 5 3/4 IN	GP-1101	3315844
P3, P3.144			AIRE	GA-209	P129545	COMBUSTIBLE, 5 17/32 IN	GP-53	PB670
ACEITE	G-813	32527	200 con motor/GMC 6V-53			ACEITE, FLUJO TOTAL (FULL	GP-55	3313306
COMBUSTIBLE	G-11816	32543	ACEITE, FLUJO TOTAL (FULL	G-33	PB509N	FLOW) SELLADO	GP-57	1W8845
COMBUSTIBLE	G-296	26560017	FLOW)			COMBUSTIBLE, 11 15/32 IN	GPP-11	175-2949
COMBUSTIBLE	G-296-B	26560017	200-30 MID-RANGER con motor/CUMMINS 6BT5.9			ACEITE, DERIVACION (BY PASS)	GP-11	175-2949
P3.143			COMBUSTIBLE, SECUNDARIO	GP-1122	3903640	SELLADO	GPP-11	175-2949
ACEITE	G-834	30267	COMBUSTIBLE, SEPARADOR	GPP-1122	3903202	COMBUSTIBLE, SEPARADOR	GP-3000	3825970
P4			DE AGUA OPCIONAL	GPP-1122	3903202	DE AGUA	GP-2071W	9N3368
ACEITE	G-801	26560090	COMBUSTIBLE, PRIMARIO	GPP-18	3903410	ACEITE, DOBLE FLUJO	GP-3000	3825970
ACEITE	G-871	30211	ACEITE	GP-178	3914395	AGUA	GP-2071W	9N3368
COMBUSTIBLE	G-11816	32543	200-30 MID-RANGER, 224 MID-RANGER, 227 MID-RANGER, 265			AIRE, RESPIRADOR CON	GA-39	255963
P4.192, P4.192Y			MID-RANGER con motor/CUMMINS 6CT8.3			TURBO	G-750	23-2436
ACEITE, CARTUCHO	G-813	32527	COMBUSTIBLE, SECUNDARIO	GP-1122	3903640	ACEITE, DERIVACION (BY PASS)		
ACEITE, CARTUCHO OPCIONAL	G-834	26540153	COMBUSTIBLE, SEPARADOR	GPP-1122	3903202	CARTUCHO		
ACEITE, CARTUCHO OPCIONAL	G-836	26540154	DE AGUA OPCIONAL	GPP-1122	3903202	289 con motor/CATERPILLAR 3408		
			ACEITE	GP-43	3313281	ACEITE, CUMPLE CON MEDI-	GP-691	1R1808
			COMBUSTIBLE, PRIMARIO	GPP-18	3903410	DAS ORIGINALES	GP-52	1R1808
			AIRE	GA-209	P129545	ACEITE, SEGUNDA OPCION	GP-1108	1R0712
						COMBUSTIBLE	GP-2071W	9N3368
						AGUA	GA-1203	5L1203
						AIRE		

SERVICIO PESADO

MARCA-MODELO-MOTOR MAKE-MODEL-ENGINE	GONHER GONHER	OEM OEM	MARCA-MODELO-MOTOR MAKE-MODEL-ENGINE	GONHER GONHER	OEM OEM	MARCA-MODELO-MOTOR MAKE-MODEL-ENGINE	GONHER GONHER	OEM OEM
PETERBILT (continuación)			PETERBILT (continuación)			PETERBILT (continuación)		
CAMIONES, TRACTOCAMIONES Y AUTOBUSES			CAMIONES, TRACTOCAMIONES Y AUTOBUSES			CAMIONES, TRACTOCAMIONES Y AUTOBUSES		
300 con motor/GMC 6V-53			320 con motor/CUMMINS LTA10 SERIES			348, 352 con motor/CATERPILLAR 1693T		
ACEITE, FLUJO TOTAL (FULL FLOW)	G-33	PB509N	COMBUSTIBLE	GP-1101	3315844	ACEITE, CARTUCHO	G-238	55485
			ACEITE, FLUJO TOTAL (FULL FLOW)	GP-53	PB670	COMBUSTIBLE, CARTUCHO	G-1166	6H5931
			ACEITE, DERIVACION (BY PASS)	GP-57	1W8845	ACEITE, SELLADO (CUMPLE CON MEDIDAS ORIGINALES)	GP-691	1R1808
310 con motor/CUMMINS LTA10 SERIES			320 con motor/DETROIT DIESEL 6-71			ACEITE, SELLADO (SEGUNDA OPCION)		
COMBUSTIBLE	GP-1101	3315844	COMBUSTIBLE, PRIMARIO	GP-26	25014274	COMBUSTIBLE, SELLADO	GP-110	1R-0740
ACEITE, FLUJO TOTAL (FULL FLOW)	GP-53	PB670	COMBUSTIBLE, SECUNDARIO	GP-27	25014342	AIRE, RESPIRADOR DEL COMPRESOR	GA-135	9L2169
ACEITE, DERIVACION (BY PASS)	GP-57	1W8845	ACEITE	GP-43	3313281	349A, 349B con motor/CATERPILLAR 3306		
310 con motor/CUMMINS NTC240			320 con motores/CATERPILLAR C10, CATERPILLAR C11			GASOLINA, SEPARADOR DE AGUA		
ACEITE, FLUJO TOTAL (FULL FLOW) CARTUCHO	G-566	PB516	COMBUSTIBLE	GP-749	1R0749	ACEITE	G-293	6N7617
COMBUSTIBLE	GP-1101	3315844	ACEITE, CUMPLE CON MEDIDAS ORIGINALES	GP-691	1R1808	COMBUSTIBLE	GP-110	1R-0740
ACEITE, FLUJO TOTAL (FULL FLOW) SELLADO	GP-53	PB670	ACEITE, SEGUNDA OPCION	GP-52	1R1808	AIRE	GA-9334	4M9334
ACEITE, DERIVACION (BY PASS) SELLADO	GP-57	1W8845	AIRE, SIN ASPAS	GA-27	P181000	349H con motor/CATERPILLAR 3306		
AGUA	GP-2071W	9N3368	AIRE	GA-376	7C8309	GASOLINA, SEPARADOR DE AGUA	G-293	6N7617
ACEITE, DERIVACION (BY PASS) CARTUCHO	G-750	23-2436	320 con motores/CUMMINS ISC, CUMMINS ISL			ACEITE	GP-51	1R0739
310 con motor/GMC 6V-92 SERIES			ACEITE, DOBLE FLUJO			COMBUSTIBLE	GP-110	1R-0740
ACEITE, FLUJO TOTAL (FULL FLOW) CARTUCHO	G-33	PB509N	AGUA	GP-2071W	9N3368	COMBUSTIBLE	GP-110	1R-0740
COMBUSTIBLE, PRIMARIO	GP-26	25014274	COMBUSTIBLE, SEPARADOR DE AGUA	GPP-10225	3944269	AIRE	GA-9334	4M9334
COMBUSTIBLE, SECUNDARIO	GP-27	25014342	330 con motor/CATERPILLAR 3126			349H con motor/DETROIT DIESEL		
ACEITE, FLUJO TOTAL (FULL FLOW) SELLADO	GP-43	3313281	ACEITE	GP-51	1R0739	ACEITE, FLUJO TOTAL (FULL FLOW) CARTUCHO	G-33	PB509N
320 con motor/CATERPILLAR 3126B			COMBUSTIBLE, 5 13/32 IN	GP-62	1R0751	COMBUSTIBLE, PRIMARIO	GP-26	25014274
ACEITE	GP-51	1R0739	COMBUSTIBLE, 7 17/32 IN	GP-1109	1R0751	COMBUSTIBLE, SECUNDARIO	GP-27	25014342
COMBUSTIBLE	GP-110	1R-0740	AIRE	GA-197R	P527484	ACEITE, FLUJO TOTAL (FULL FLOW) SELLADO	GP-43	3313281
AIRE, SIN ASPAS	GA-27	P181000	330 con motor/CUMMINS 6CT8.3			349W con motor/CATERPILLAR 3306		
AIRE	GA-376	7C8309	COMBUSTIBLE, SECUNDARIO	GP-1122	3903640	ACEITE	GP-51	1R0739
320 con motor/CATERPILLAR 3306C			ACEITE, FLUJO TOTAL (FULL FLOW)	GP-43	3313281	COMBUSTIBLE	GP-110	1R-0740
ACEITE	GP-51	1R0739	ACEITE, DOBLE FLUJO	GP-3000	3825970	AIRE	GA-9334	4M9334
COMBUSTIBLE	GP-110	1R-0740	COMBUSTIBLE, PRIMARIO	GPP-18	3903410	352 con motor/CATERPILLAR 3406		
AIRE, SIN ASPAS	GA-27	P181000	AIRE	GA-197R	P527484	ACEITE, CUMPLE CON MEDIDAS ORIGINALES	GP-691	1R1808
320 con motor/CATERPILLAR C13			330 con motor/CUMMINS ISB 5.9L			ACEITE, SEGUNDA OPCION	GP-52	1R1808
TRANSMISION, SELLADO, OPCIONAL	GP-1	17237	ACEITE	GP-3937	3937144	COMBUSTIBLE	GP-1108	1R0712
COMBUSTIBLE	GP-749	1R0749	TRANSMISION	GP-3937	3937144	352H con motor/CATERPILLAR 1693T		
ACEITE	GP-52	1R1808	AIRE	GA-197R	P527484	ACEITE, CARTUCHO	G-238	55485
AGUA, SISTEMA DE ENFRIAMIENTO	GP-2071W	WF2071	330, 335 con motor/CUMMINS ISC			COMBUSTIBLE, CARTUCHO	G-1166	6H5931
COMBUSTIBLE, SEPARADOR DE AGUA	GPP-1000	FS1000	ACEITE, DOBLE FLUJO	GP-3001	3401544	ACEITE, SELLADO (CUMPLE CON MEDIDAS ORIGINALES)	GP-691	1R1808
AIRE, PRIMARIO	GA-885	P181057	COMBUSTIBLE, SEPARADOR DE AGUA	GPP-10225	3944269	ACEITE, SELLADO (SEGUNDA OPCION)	GP-52	1R1808
320 con motor/CUMMINS 6CT8.3			AIRE	GA-197R	P527484	COMBUSTIBLE, SELLADO	GP-110	1R-0740
COMBUSTIBLE, SECUNDARIO	GP-1122	3903640	335 con motor/CATERPILLAR C7			AIRE, RESPIRADOR DEL COMPRESOR	GA-135	9L2169
ACEITE, FLUJO TOTAL (FULL FLOW)	GP-43	3313281	ACEITE	GP-51	1R0739	352H con motor/CATERPILLAR 3406		
AGUA	GP-2071W	9N3368	COMBUSTIBLE, 5 13/32 IN	GP-62	1R0751	ACEITE, CUMPLE CON MEDIDAS ORIGINALES	GP-691	1R1808
COMBUSTIBLE, PRIMARIO	GPP-18	3903410	COMBUSTIBLE, 7 17/32 IN	GP-1109	1R0751	ACEITE, SEGUNDA OPCION	GP-52	1R1808
320 con motor/CUMMINS ISM			346, 348 con motor/CATERPILLAR 1160			COMBUSTIBLE	GP-1108	1R0712
TRANSMISION, SELLADO, OPCIONAL	GP-1	17237	ACEITE	GP-36	10-960	352H con motor/CATERPILLAR 3408		
AGUA, SISTEMA DE ENFRIAMIENTO	GP-2071W	WF2071	346, 348 con motor/CATERPILLAR 3306			ACEITE, FLUJO TOTAL (FULL FLOW) SELLADO	GP-110	1R-0740
COMBUSTIBLE, SEPARADOR DE AGUA	GPP-1000	FS1000	GASOLINA, SEPARADOR DE AGUA	G-293	6N7617	AIRE, RESPIRADOR DEL COMPRESOR	GA-135	9L2169
ACEITE, DOBLE FLUJO	GP-9001	LF9001	ACEITE	GP-51	1R0739	352H con motor/CATERPILLAR 3406		
AIRE, PRIMARIO	GA-885	P181057	COMBUSTIBLE	GP-110	1R-0740	ACEITE, CUMPLE CON MEDIDAS ORIGINALES	GP-691	1R1808
			AIRE	GA-9334	4M9334	ACEITE, SEGUNDA OPCION	GP-52	1R1808
						COMBUSTIBLE	GP-1108	1R0712
						AGUA	GP-2071W	9N3368
						AIRE	GA-1203	5L1203

MARCA-MODELO-MOTOR MAKE-MODEL-ENGINE	GONHER GONHER	OEM OEM	MARCA-MODELO-MOTOR MAKE-MODEL-ENGINE	GONHER GONHER	OEM OEM	MARCA-MODELO-MOTOR MAKE-MODEL-ENGINE	GONHER GONHER	OEM OEM
PETERBILT (continuación)			PETERBILT (continuación)			PETERBILT (continuación)		
CAMIONES, TRACTOCAMIONES Y AUTOBUSES			CAMIONES, TRACTOCAMIONES Y AUTOBUSES			CAMIONES, TRACTOCAMIONES Y AUTOBUSES		
352H con motor/DETROIT DIESEL			COMBUSTIBLE, SEPARADOR DE AGUA	GPP-1000	3889716	ACEITE, FLUJO TOTAL (FULL FLOW) (SEGUNDA OPCION)	GP-52	1R1808
ACEITE	G-33	PB509N				AIRE, ALT. 23 7/16 IN	GA-518R	RS3516
COMBUSTIBLE	GP-26	25014274	357 con motor/CATERPILLAR C9			357 con motores/CATERPILLAR C15, CATERPILLAR C16		
COMBUSTIBLE	GP-27	25014342	COMBUSTIBLE, MONTAJE REMOTO	GP-1101	3315844	COMBUSTIBLE	GP-749	1R0749
ACEITE	GP-43	3313281	HIDRAULICO	GP-34	1E2377	ACEITE, CUMPLE CON MEDIDAS ORIGINALES	GP-691	1R1808
352H con motor/GMC 12V-71N			COMBUSTIBLE, 5 13/32 IN	GP-62	1R0751	ACEITE, SEGUNDA OPCION	GP-52	1R1808
ACEITE, DERIVACION (BY PASS)	G-31	1595410	COMBUSTIBLE, 7 17/32 IN	GP-1109	1R0751	AIRE	GA-539R	P534816
357 con motor/CATERPILLAR 3176			AGUA	GP-2071W	9N3368	357 con motores/CUMMINS ISC, CUMMINS ISL		
ACEITE, FLUJO TOTAL (FULL FLOW) (CUMPLE CON MEDIDAS ORIGINALES)	GP-691	1R1808	AIRE	GA-518R	RS3516	ACEITE, DOBLE FLUJO	GP-3001	3401544
ACEITE, FLUJO TOTAL (FULL FLOW) (SEGUNDA OPCION)	GP-52	1R1808	357 con motor/CUMMINS 6CT8.3			AGUA	GP-2071W	9N3368
COMBUSTIBLE	GP-1108	1R0712	ACEITE, DOBLE FLUJO	GP-3001	3401544	COMBUSTIBLE, SEPARADOR DE AGUA	GPP-1022S	3944269
ACEITE, DERIVACION (BY PASS)	GP-57	1W8845	COMBUSTIBLE, SECUNDARIO	GP-1122	3903640	AIRE	GA-518R	P534096
357 con motor/CATERPILLAR 3306			COMBUSTIBLE, SEPARADOR DE AGUA	GPP-1122	3903202	359 con motor/CATERPILLAR 1693T		
GASOLINA, SEPARADOR DE AGUA	G-293	6N7617	ACEITE, FLUJO TOTAL (FULL FLOW)	GP-43	3313281	ACEITE, CARTUCHO	G-238	5S485
ACEITE	GP-51	1R0739	ACEITE, DOBLE FLUJO	GP-3000	3318853	COMBUSTIBLE, CARTUCHO	G-1166	6H5931
COMBUSTIBLE	GP-110	1R-0740	AGUA	GP-2071W	9N3368	ACEITE, SELLADO (CUMPLE CON MEDIDAS ORIGINALES)	GP-691	1R1808
AIRE	GA-9334	4M9334	COMBUSTIBLE, PRIMARIO	GPP-18	3903410	ACEITE, SELLADO (SEGUNDA OPCION)	GP-52	1R1808
357 con motor/CATERPILLAR 3406E			357 con motor/CUMMINS ISM			COMBUSTIBLE, SELLADO	GP-110	1R-0740
COMBUSTIBLE	GP-749	1R0749	AGUA	GP-2071W	9N3368	AIRE, RESPIRADOR DEL COMPRESOR	GA-135	9L2169
ACEITE, FLUJO TOTAL (FULL FLOW) (CUMPLE CON MEDIDAS ORIGINALES)	GP-691	1R1808	ACEITE, DOBLE FLUJO	GP-9001	3101869	359 con motor/CATERPILLAR 3406E		
ACEITE, FLUJO TOTAL (FULL FLOW) (SEGUNDA OPCION)	GP-52	1R1808	COMBUSTIBLE, SEPARADOR DE AGUA	GPP-1022S	3944269	COMBUSTIBLE	GP-749	1R0749
AGUA, PRE-CARGA	GP-1013Q	311292	AIRE	GA-518R	P534096	ACEITE, FLUJO TOTAL (FULL FLOW) (CUMPLE CON MEDIDAS ORIGINALES)	GP-691	1R1808
AGUA, MANTENIMIENTO	GP-2071W	9N3368	357 con motor/CUMMINS ISX			ACEITE, FLUJO TOTAL (FULL FLOW) (SEGUNDA OPCION)	GP-52	1R1808
AIRE	GA-377	P522293	AGUA	GP-2127W	3680434	AGUA, PRE-CARGA	GP-1013Q	311292
AIRE	GA-694	P150694	ACEITE, 13 7/8 IN	GP-9000	3406810	AGUA, MANTENIMIENTO	GP-2071W	9N3368
357 con motor/CATERPILLAR 3406TA			AGUA	GP-2126Q	4907485	AIRE	GA-377	P522293
ACEITE, FLUJO TOTAL (FULL FLOW) (CUMPLE CON MEDIDAS ORIGINALES)	GP-691	1R1808	ACEITE, 11 23/32 IN	GP-9001	3101869	AIRE	GA-694	P150694
ACEITE, FLUJO TOTAL (FULL FLOW) (SEGUNDA OPCION)	GP-52	1R1808	COMBUSTIBLE	GPP-1007S	3331096	359 con motor/DETROIT DIESEL		
AGUA	GP-2071W	9N3368	357 con motor/CUMMINS M11			ACEITE	G-33	PB509N
AIRE	GA-378	XLP182008	COMBUSTIBLE, SEPARADOR DE AGUA	GPP-11	175-2949	COMBUSTIBLE	GP-26	25014274
357 con motor/CATERPILLAR C10			357 con motor/CUMMINS N14			COMBUSTIBLE	GP-27	25014342
AGUA	GP-2127W	3680434	COMBUSTIBLE	GP-1101	3315844	ACEITE	GP-43	3313281
COMBUSTIBLE	GP-749	1R0749	ACEITE, FLUJO TOTAL (FULL FLOW)	GP-53	PB670	359, 383 con motor/GMC 12V-71N		
ACEITE, FLUJO TOTAL (FULL FLOW) (CUMPLE CON MEDIDAS ORIGINALES)	GP-691	1R1808	ACEITE, DERIVACION (BY PASS)	GP-57	1W8845	ACEITE, DERIVACION (BY PASS)	G-31	1595410
ACEITE, FLUJO TOTAL (FULL FLOW) (SEGUNDA OPCION)	GP-52	1R1808	COMBUSTIBLE, SEPARADOR DE AGUA	GPP-11	175-2949	362 con motor/CATERPILLAR 3408		
COMBUSTIBLE, SECUNDARIO	GP-1108	1R0712	ACEITE, DOBLE FLUJO	GP-3000	3825970	ACEITE, FLUJO TOTAL (FULL FLOW) (CUMPLE CON MEDIDAS ORIGINALES)	GP-691	1R1808
ACEITE, DERIVACION (BY PASS)	GP-57	1W8845	357 con motor/CUMMINS N14 PLUS			ACEITE, FLUJO TOTAL (FULL FLOW) (SEGUNDA OPCION)	GP-52	1R1808
COMBUSTIBLE, SEPARADOR DE AGUA	GPP-1000	3889716	COMBUSTIBLE	GP-1101	3315844	COMBUSTIBLE	GP-1108	1R0712
AIRE	GA-539R	P534816	ACEITE	GP-3000	3318853	362 con motor/DETROIT DIESEL 60 SERIES		
357 con motor/CATERPILLAR C12			COMBUSTIBLE	GPP-1000	3889716	COMBUSTIBLE, PRIMARIO	GP-26	25014274
AGUA	GP-2127W	3680434	357 con motor/DETROIT DIESEL			COMBUSTIBLE, SECUNDARIO	GP-27	25014342
COMBUSTIBLE	GP-749	1R0749	ACEITE	G-33	PB509N	ACEITE, DERIVACION (BY PASS) HASTA 1993	GP-57	1W8845
ACEITE, FLUJO TOTAL (FULL FLOW) (CUMPLE CON MEDIDAS ORIGINALES)	GP-691	1R1808	COMBUSTIBLE	GP-26	25014274	ACEITE, FLUJO TOTAL (FULL FLOW) HASTA 1993	GP-43	3313281
ACEITE, FLUJO TOTAL (FULL FLOW) (SEGUNDA OPCION)	GP-52	1R1808	ACEITE	GP-27	25014342	ACEITE, HASTA 1993	GP-193	25014505
COMBUSTIBLE, SECUNDARIO	GP-1108	1R0712	COMBUSTIBLE	GP-43	3313281	362 con motores/CATERPILLAR C10, CATERPILLAR C12		
ACEITE, DERIVACION (BY PASS)	GP-57	1W8845	357 con motores/CATERPILLAR C13, CATERPILLAR C11			AGUA	GP-2127W	3680434
COMBUSTIBLE, SEPARADOR DE AGUA	GPP-1000	3889716	AGUA	GP-2127W	3680434			
AIRE	GA-539R	P534816	COMBUSTIBLE	GP-749	1R0749			
357 con motor/CATERPILLAR C12			ACEITE, FLUJO TOTAL (FULL FLOW) (CUMPLE CON MEDIDAS ORIGINALES)	GP-691	1R1808			
AGUA	GP-2127W	3680434						
COMBUSTIBLE	GP-749	1R0749						
ACEITE, FLUJO TOTAL (FULL FLOW) (CUMPLE CON MEDIDAS ORIGINALES)	GP-691	1R1808						
ACEITE, FLUJO TOTAL (FULL FLOW) (SEGUNDA OPCION)	GP-52	1R1808						
COMBUSTIBLE, SECUNDARIO	GP-1108	1R0712						
ACEITE, DERIVACION (BY PASS)	GP-57	1W8845						

SERVICIO PESADO

MARCA-MODELO-MOTOR MAKE-MODEL-ENGINE	GONHER GONHER	OEM OEM	MARCA-MODELO-MOTOR MAKE-MODEL-ENGINE	GONHER GONHER	OEM OEM	MARCA-MODELO-MOTOR MAKE-MODEL-ENGINE	GONHER GONHER	OEM OEM
PETERBILT (continuación)			PETERBILT (continuación)			PETERBILT (continuación)		
CAMIONES, TRACTOCAMIONES Y AUTOBUSES			CAMIONES, TRACTOCAMIONES Y AUTOBUSES			CAMIONES, TRACTOCAMIONES Y AUTOBUSES		
COMBUSTIBLE	GP-749	1R0749	ACEITE, FLUJO TOTAL (FULL FLOW) HASTA 1993	GP-43	3313281	COMBUSTIBLE, SEPARADOR DE AGUA	GPP-1000	3889716
ACEITE, FLUJO TOTAL (FULL FLOW) (CUMPLE CON MEDIDAS ORIGINALES)	GP-691	1R1808	ACEITE, HASTA 1993	GP-193	25014505	AIRE	GA-377	P522293
ACEITE, FLUJO TOTAL (FULL FLOW) (SEGUNDA OPCION)	GP-52	1R1808	375 con motor/CATERPILLAR 3176			AIRE	GA-694	P150694
ACEITE, DERIVACION (BY PASS)	GP-57	1W8845	ACEITE, FLUJO TOTAL (FULL FLOW) (CUMPLE CON MEDIDAS ORIGINALES)	GP-691	1R1808	377A/E con motor/CUMMINS N14		
COMBUSTIBLE, SEPARADOR DE AGUA	GPP-1000	3889716	ACEITE, FLUJO TOTAL (FULL FLOW) (SEGUNDA OPCION)	GP-52	1R1808	COMBUSTIBLE	GP-1101	3315844
362 con motores/CATERPILLAR C13, CATERPILLAR C11			COMBUSTIBLE	GP-1108	1R0712	ACEITE, FLUJO TOTAL (FULL FLOW)	GP-53	PB670
AGUA	GP-2127W	3680434	COMBUSTIBLE, SEPARADOR DE AGUA	GP-57	1W8845	ACEITE, DERIVACION (BY PASS)	GP-57	1W8845
COMBUSTIBLE	GP-749	1R0749	ACEITE, DERIVACION (BY PASS)	GP-57	1W8845	COMBUSTIBLE, SEPARADOR DE AGUA	GPP-11	175-2949
ACEITE, FLUJO TOTAL (FULL FLOW) (CUMPLE CON MEDIDAS ORIGINALES)	GP-691	1R1808	375 con motor/CATERPILLAR 3306			ACEITE, DOBLE FLUJO	GP-3000	3825970
ACEITE, FLUJO TOTAL (FULL FLOW) (SEGUNDA OPCION)	GP-52	1R1808	GASOLINA, SEPARADOR DE AGUA	G-293	6N7617	378 con motor/CATERPILLAR C10		
362, 372, 375 con motor/CATERPILLAR 3406E			ACEITE	GP-51	1R0739	AGUA	GP-2127W	3680434
COMBUSTIBLE	GP-749	1R0749	COMBUSTIBLE	GP-110	1R-0740	COMBUSTIBLE	GP-749	1R0749
ACEITE, FLUJO TOTAL (FULL FLOW) (CUMPLE CON MEDIDAS ORIGINALES)	GP-691	1R1808	AIRE	GA-9334	4M9334	ACEITE, FLUJO TOTAL (FULL FLOW) (CUMPLE CON MEDIDAS ORIGINALES)	GP-691	1R1808
ACEITE, FLUJO TOTAL (FULL FLOW) (SEGUNDA OPCION)	GP-52	1R1808	375 con motor/CATERPILLAR C15			ACEITE, FLUJO TOTAL (FULL FLOW) (SEGUNDA OPCION)	GP-52	1R1808
AGUA, PRE-CARGA	GP-1013Q	3I1292	COMBUSTIBLE	GP-749	1R0749	ACEITE, DERIVACION (BY PASS)	GP-57	1W8845
AGUA, MANTENIMIENTO	GP-2071W	9N3368	ACEITE, CUMPLE CON MEDIDAS ORIGINALES	GP-691	1R1808	COMBUSTIBLE, SEPARADOR DE AGUA	GPP-1000	3889716
COMBUSTIBLE, SEPARADOR DE AGUA	GPP-1000	3889716	ACEITE, SEGUNDA OPCION	GP-52	1R1808	378 con motor/CATERPILLAR C12		
AIRE	GA-377	P522293	AGUA	GP-2071W	9N3368	AGUA	GP-2127W	3680434
AIRE	GA-694	P150694	AIRE	GA-608	P181186	COMBUSTIBLE	GP-749	1R0749
362E con motor/CATERPILLAR C10			375 con motor/CUMMINS N14			ACEITE, FLUJO TOTAL (FULL FLOW) (CUMPLE CON MEDIDAS ORIGINALES)	GP-691	1R1808
ACEITE, DERIVACION (BY PASS) (CUMPLE CON MEDIDAS ORIGINALES)	GP-691	1R-0716	COMBUSTIBLE	GP-1101	3315844	ACEITE, FLUJO TOTAL (FULL FLOW) (SEGUNDA OPCION)	GP-52	1R1808
ACEITE, DERIVACION (BY PASS) (SEGUNDA OPCION)	GP-52	1R-0716	ACEITE, FLUJO TOTAL (FULL FLOW)	GP-53	PB670	COMBUSTIBLE	GP-1108	1R0712
COMBUSTIBLE, SECUNDARIO	GP-1108	1R0712	ACEITE, DERIVACION (BY PASS)	GP-57	1W8845	ACEITE, DERIVACION (BY PASS)	GP-57	1W8845
ACEITE, FLUJO TOTAL (FULL FLOW)	GP-57	1W8845	COMBUSTIBLE, SEPARADOR DE AGUA	GPP-11	175-2949	COMBUSTIBLE, SEPARADOR DE AGUA	GPP-1000	3889716
AIRE	GA-389	P154575	ACEITE, DOBLE FLUJO	GP-3000	3825970	378 con motor/CUMMINS ISM		
362E con motor/CUMMINS N14			376 con motor/CUMMINS 6CT8.3			AGUA	GP-2071W	9N3368
COMBUSTIBLE	GP-1101	3315844	COMBUSTIBLE, SECUNDARIO	GP-1122	3903640	ACEITE, DOBLE FLUJO	GP-9000	3406810
ACEITE, FLUJO TOTAL (FULL FLOW)	GP-53	PB670	ACEITE, FLUJO TOTAL (FULL FLOW)	GP-43	3313281	COMBUSTIBLE, SEPARADOR DE AGUA	GPP-10225	3944269
ACEITE, DERIVACION (BY PASS)	GP-57	1W8845	AGUA	GP-2071W	9N3368	AIRE	GA-377	P522293
COMBUSTIBLE, SEPARADOR DE AGUA	GPP-11	175-2949	COMBUSTIBLE, PRIMARIO	GPP-18	3903410	378 con motor/CUMMINS ISX		
ACEITE, DOBLE FLUJO	GP-3000	3825970	377 con motor/CATERPILLAR 3306			AGUA	GP-2127W	3680434
362E con motor/CUMMINS N14 PLUS			GASOLINA, SEPARADOR DE AGUA	G-293	6N7617	ACEITE, 13 7/8 IN	GP-9000	3406810
ACEITE	GP-3000	3318853	ACEITE	GP-51	1R0739	AGUA	GP-2126Q	4907485
372 con motor/CUMMINS N14			COMBUSTIBLE	GP-110	1R-0740	ACEITE, 11 23/32 IN	GP-9001	3101869
COMBUSTIBLE	GP-1101	3315844	AIRE	GA-9334	4M9334	COMBUSTIBLE, SEPARADOR DE AGUA	GPP-10075	3331096
ACEITE, FLUJO TOTAL (FULL FLOW)	GP-53	PB670	377 con motor/DETROIT DIESEL 60 SERIES			AIRE	GA-539R	P534816
ACEITE, DERIVACION (BY PASS)	GP-57	1W8845	COMBUSTIBLE, PRIMARIO	GP-26	25014274	378 con motor/CUMMINS N14		
COMBUSTIBLE, SEPARADOR DE AGUA	GPP-11	175-2949	COMBUSTIBLE, SECUNDARIO	GP-27	25014342	COMBUSTIBLE	GP-1101	3315844
ACEITE, DOBLE FLUJO	GP-3000	3825970	ACEITE, DERIVACION (BY PASS) HASTA 1993	GP-57	1W8845	ACEITE, FLUJO TOTAL (FULL FLOW)	GP-53	PB670
362E con motor/CUMMINS N14 PLUS			ACEITE, FLUJO TOTAL (FULL FLOW) HASTA 1993	GP-43	3313281	ACEITE, DERIVACION (BY PASS)	GP-57	1W8845
ACEITE	GP-3000	3318853	ACEITE, HASTA 1993	GP-193	25014505	COMBUSTIBLE, SEPARADOR DE AGUA	GPP-11	175-2949
372 con motor/CUMMINS N14			377A/E con motor/CATERPILLAR 3406E			ACEITE, DOBLE FLUJO	GP-3000	3825970
COMBUSTIBLE	GP-1101	3315844	COMBUSTIBLE	GP-749	1R0749	378 con motores/CATERPILLAR C13, CATERPILLAR C11		
ACEITE, FLUJO TOTAL (FULL FLOW)	GP-53	PB670	ACEITE, FLUJO TOTAL (FULL FLOW) (CUMPLE CON MEDIDAS ORIGINALES)	GP-691	1R1808	AGUA	GP-2127W	3680434
ACEITE, DERIVACION (BY PASS)	GP-57	1W8845	ACEITE, FLUJO TOTAL (FULL FLOW) (SEGUNDA OPCION)	GP-52	1R1808	COMBUSTIBLE	GP-749	1R0749
COMBUSTIBLE, SEPARADOR DE AGUA	GPP-11	175-2949	AGUA, PRE-CARGA	GP-1013Q	3I1292	ACEITE, FLUJO TOTAL (FULL FLOW) (CUMPLE CON MEDIDAS ORIGINALES)	GP-691	1R1808
ACEITE, DOBLE FLUJO	GP-3000	3825970	AGUA, MANTENIMIENTO	GP-2071W	9N3368			

MARCA-MODELO-MOTOR MAKE-MODEL-ENGINE	GONHER GONHER	OEM OEM	MARCA-MODELO-MOTOR MAKE-MODEL-ENGINE	GONHER GONHER	OEM OEM	MARCA-MODELO-MOTOR MAKE-MODEL-ENGINE	GONHER GONHER	OEM OEM
PETERBILT (continuación)			PETERBILT (continuación)			PETERBILT (continuación)		
CAMIONES, TRACTOCAMIONES Y AUTOBUSES			CAMIONES, TRACTOCAMIONES Y AUTOBUSES			CAMIONES, TRACTOCAMIONES Y AUTOBUSES		
ACEITE, FLUJO TOTAL (FULL FLOW) (SEGUNDA OPCION)	GP-52	1R1808	AGUA, SISTEMA DE ENFRIAMIENTO (OPCIONAL)	GP-2071W	9N3368	379 con motor/CUMMINS N14 PLUS		
AIRE	GA-539R	P534816	AIRE, ESTANDAR (OPCIONAL)	GA-608	VF160R	ACEITE, DOBLE FLUJO	GP-3001	3401544
			AIRE, RADIAL (OPCIONAL)	GA-534R	P534925	COMBUSTIBLE, SEPARADOR DE AGUA	GPP-11	175-2949
378 con motores/CATERPILLAR C15, CATERPILLAR C16						AIRE	GA-539R	P534816
AGUA	GP-2127W	3680434	379 con motor/CATERPILLAR C16			379 con motor/DETROIT DIESEL 60 SERIES		
COMBUSTIBLE	GP-749	1R0749	COMBUSTIBLE	G-128	P550463	COMBUSTIBLE, PRIMARIO	GP-26	25014274
ACEITE, CUMPLE CON MEDI-DAS ORIGINALES	GP-691	1R1808	COMBUSTIBLE	GP-749	1R0749	COMBUSTIBLE, SECUNDARIO	GP-27	25014342
ACEITE, SEGUNDA OPCION	GP-52	1R1808	ACEITE, CUMPLE CON MEDI-DAS ORIGINALES	GP-691	1R1808	ACEITE	GP-193	25014505
COMBUSTIBLE, SEPARADOR DE AGUA	GPP-1000	3889716	ACEITE, SEGUNDA OPCION	GP-52	1R1808	AIRE	GA-539R	P534816
AIRE	GA-539R	P534816				379 con motores/CATERPILLAR C13, CATERPILLAR C11		
379 con motor/CATERPILLAR 3406E			379 con motor/CUMMINS ISC			COMBUSTIBLE	GP-749	1R0749
COMBUSTIBLE	GP-749	1R0749	ACEITE, OPCIONAL. TRANSMISION (OPCIONAL)	GP-1	17237	ACEITE, CUMPLE CON MEDI-DAS ORIGINALES	GP-691	1R1808
ACEITE, FLUJO TOTAL (FULL FLOW) (CUMPLE CON MEDI-DAS ORIGINALES)	GP-691	1R1808	ACEITE, LUBRICACION DE DOBLE FLUJO (OPCIONAL)	GP-3001	3401544	ACEITE, SEGUNDA OPCION	GP-52	1R1808
ACEITE, FLUJO TOTAL (FULL FLOW) (SEGUNDA OPCION)	GP-52	1R1808	ACEITE, LUBRICACION DE DOBLE FLUJO (OPCIONAL)	GP-3000	3318853	AGUA	GP-2071W	9N3368
COMBUSTIBLE, SEPARADOR DE AGUA OPCIONAL	GPP-11	175-2949	AGUA, SISTEMA DE ENFRIAMIENTO (OPCIONAL)	GP-2071W	3315116	AIRE	GA-539R	P534816
COMBUSTIBLE, SEPARADOR DE AGUA OPCIONAL	GPP-1000	3889716	COMBUSTIBLE, SEPARADOR DE AGUA (SELLADO) (OPCIONAL)	GPP-10225	3800394	379X con motor/CATERPILLAR C10		
AIRE	GA-539R	P534816	AIRE, RADIAL (OPCIONAL)	GA-534R	P534925	COMBUSTIBLE, SEPARADOR DE AGUA (CARTUCHO) (OPCIONAL)	G-1143	311106
379 con motor/CATERPILLAR C10						ACEITE, OPCIONAL. TRANSMISION (OPCIONAL)	GP-1	17237
COMBUSTIBLE, SEPARADOR DE AGUA (CARTUCHO) (OPCIONAL)	G-1143	311106	379 con motor/CUMMINS ISL			COMBUSTIBLE, SELLADO	GP-749	1R0749
TRANSMISION (OPCIONAL)	GP-1	17237	ACEITE, OPCIONAL. TRANSMISION (OPCIONAL)	GP-1	17237	ACEITE, FLUJO TOTAL (FULL FLOW) (OPCIONAL)	GP-52	1R0716
COMBUSTIBLE, SELLADO	GP-749	1R0749	ACEITE, LUBRICACION DE DOBLE FLUJO (OPCIONAL)	GP-3001	3401544	ACEITE, DERIVACION (BY PASS) (OPCIONAL)	GP-57	9Y4468
ACEITE, FLUJO TOTAL (FULL FLOW)	GP-52	1R0716	COMBUSTIBLE	GP-1109	FF5488	AGUA, SISTEMA DE ENFRIAMIENTO (OPCIONAL)	GP-2071W	9N3368
ACEITE, DERIVACION (BY PASS)	GP-57	9Y4468	ACEITE, LUBRICACION DE DOBLE FLUJO (OPCIONAL)	GP-3000	3318853	AIRE, RADIAL	GA-534R	P534925
AGUA, SISTEMA DE ENFRIAMIENTO (OPCIONAL)	GP-2071W	9N3368	AGUA, SISTEMA DE ENFRIAMIENTO (OPCIONAL)	GP-2071W	3315116	379X con motor/CATERPILLAR C12		
AIRE, RADIAL (OPCIONAL)	GA-534R	P534925	COMBUSTIBLE, SEPARADOR DE AGUA (SELLADO) (OPCIONAL)	GPP-10225	3800394	COMBUSTIBLE, SEPARADOR DE AGUA (CARTUCHO) (OPCIONAL)	G-1143	311106
379 con motor/CATERPILLAR C12			AIRE, RADIAL (OPCIONAL)	GA-534R	P534925	ACEITE, OPCIONAL. TRANSMISION (OPCIONAL)	GP-1	17237
COMBUSTIBLE, SEPARADOR DE AGUA (CARTUCHO) (OPCIONAL)	G-1143	311106	379 con motor/CUMMINS ISM			COMBUSTIBLE, SELLADO	GP-749	1R0749
ACEITE, OPCIONAL. TRANSMISION (OPCIONAL)	GP-1	17237	ACEITE, OPCIONAL. TRANSMISION (OPCIONAL)	GP-1	17237	ACEITE, FLUJO TOTAL (FULL FLOW) (OPCIONAL)	GP-52	1R0716
COMBUSTIBLE, SELLADO (OPCIONAL)	GP-749	1R0749	AGUA, SISTEMA DE ENFRIAMIENTO (OPCIONAL)	GP-2071W	3315116	ACEITE, DERIVACION (BY PASS) (OPCIONAL)	GP-57	9Y4468
ACEITE, FLUJO TOTAL (FULL FLOW) (OPCIONAL)	GP-52	1R0716	ACEITE, LUBRICACION DE DOBLE FLUJO (OPCIONAL)	GP-9000	3406810	AGUA, SISTEMA DE ENFRIAMIENTO	GP-2071W	WF2071
ACEITE, DERIVACION (BY PASS) (OPCIONAL)	GP-57	9Y4468	COMBUSTIBLE, SEPARADOR DE AGUA (SELLADO) (OPCIONAL)	GPP-10225	3800394	AIRE, RADIAL	GA-534R	P534925
AGUA, SISTEMA DE ENFRIAMIENTO (OPCIONAL)	GP-2071W	9N3368	AIRE, RADIAL (OPCIONAL)	GA-534R	P534925	379X con motor/CATERPILLAR C15		
AIRE, RADIAL (OPCIONAL)	GA-534R	P534925	379 con motor/CUMMINS ISX			COMBUSTIBLE, SEPARADOR DE AGUA (CARTUCHO) (DAVCO)	G-128	380087
379 con motor/CATERPILLAR C15			ACEITE, OPCIONAL. TRANSMISION (OPCIONAL)	GP-1	17237	ACEITE, OPCIONAL. TRANSMISION	GP-1	17237
COMBUSTIBLE, SEPARADOR DE AGUA (CARTUCHO) (OPCIONAL)	G-128	380087	AGUA, SISTEMA DE ENFRIAMIENTO (OPCIONAL)	GP-2127W	WF2127	COMBUSTIBLE, SELLADO (MONTAJE EN EL MOTOR)	GP-749	1R0749
ACEITE, OPCIONAL. TRANSMISION (OPCIONAL)	GP-1	17237	COMBUSTIBLE	GP-1101	FF2203	COMBUSTIBLE, SELLADO (MONTAJE EN MARCO)	GP-1101	FF105
COMBUSTIBLE, SELLADO (OPCIONAL)	GP-749	1R0749	ACEITE, 13 7/8 IN. LUBRICACION DE DOBLE FLUJO (OPCIONAL)	GP-9000	3406810	ACEITE, FLUJO TOTAL (FULL FLOW)	GP-52	1R0716
COMBUSTIBLE, SELLADO (OPCIONAL)	GP-1101	FF2203	AGUA, SISTEMA DE ENFRIAMIENTO (OPCIONAL)	GP-2126Q	WF2126	ACEITE, DERIVACION (BY PASS)	GP-57	9Y4468
ACEITE, FLUJO TOTAL (FULL FLOW) (OPCIONAL)	GP-52	1R0716	ACEITE, 11 23/32 IN. LUBRICACION DE DOBLE FLUJO (OPCIONAL)	GP-9001	3406809	COMBUSTIBLE, SEPARADOR DE AGUA (SELLADO)	GPP-11	9Y4432
ACEITE, DERIVACION (BY PASS) (OPCIONAL)	GP-57	9Y4468	COMBUSTIBLE, SEPARADOR DE AGUA (OPCIONAL)	GPP-10075	FS1007	AGUA, SISTEMA DE ENFRIAMIENTO	GP-2071W	9N3368
COMBUSTIBLE, SEPARADOR DE AGUA (SELLADO) (OPCIONAL)	GPP-11	9Y4432	COMBUSTIBLE, SEPARADOR DE AGUA (OPCIONAL)	GPP-10225	3800394	AIRE, ESTANDAR	GA-608	VF160R
			AIRE, RADIAL (OPCIONAL)	GA-534R	P534925	AIRE, RADIAL	GA-534R	P534925

SERVICIO PESADO

MARCA-MODELO-MOTOR MAKE-MODEL-ENGINE	GONHER GONHER	OEM OEM	MARCA-MODELO-MOTOR MAKE-MODEL-ENGINE	GONHER GONHER	OEM OEM	MARCA-MODELO-MOTOR MAKE-MODEL-ENGINE	GONHER GONHER	OEM OEM
PETERBILT (continuación)			PETERBILT (continuación)			PETERBILT (continuación)		
CAMIONES, TRACTOCAMIONES Y AUTOBUSES			CAMIONES, TRACTOCAMIONES Y AUTOBUSES			CAMIONES, TRACTOCAMIONES Y AUTOBUSES		
379X con motor/CUMMINS ISC			ACEITE, FLUJO TOTAL (FULL FLOW)	GP-52	1R1808	COMBUSTIBLE, SEPARADOR DE AGUA	GPP-1022S	3944269
ACEITE, OPCIONAL. TRANSMISION	GP-1	17237	COMBUSTIBLE, SEPARADOR DE AGUA	GPP-1000	FS1000	AIRE	GA-518R	P534096
ACEITE, LUBRICACION DE DOBLE FLUJO	GP-3001	3401544	AIRE	GA-518R	P185106	385 con motor/CUMMINS ISX		
ACEITE, LUBRICACION DE DOBLE FLUJO	GP-3000	3318853	384 con motor/CATERPILLAR C9			AGUA	GP-2127W	3680434
AGUA, SISTEMA DE ENFRIAMIENTO	GP-2071W	3315116	ACEITE, OPCIONAL. TRANSMISION	GP-1	17237	ACEITE, 13 7/8 IN	GP-9000	3406810
COMBUSTIBLE, SEPARADOR DE AGUA (SELLADO)	GPP-1022S	3800394	ACEITE	GP-52	1R1808	AGUA	GP-2126Q	4907485
AIRE, RADIAL	GA-534R	P534925	DIESEL	GP-1109	1R0751	ACEITE, 11 23/32 IN	GP-9001	3101869
379X con motor/CUMMINS ISL			COMBUSTIBLE, SEPARADOR DE AGUA	GPP-1000	FS1000	COMBUSTIBLE, SEPARADOR DE AGUA	GPP-1007S	3331096
ACEITE, OPCIONAL. TRANSMISION	GP-1	17237	AIRE	GA-518R	P185106	AIRE	GA-518R	P534096
ACEITE, LUBRICACION DE DOBLE FLUJO	GP-3001	3401544	384 con motor/CUMMINS ISM			385 con motor/CUMMINS M11		
COMBUSTIBLE, LUBRICACION DE DOBLE FLUJO	GP-1109	FF5488	ACEITE, OPCIONAL. TRANSMISION	GP-1	17237	ACEITE, DOBLE FLUJO	GP-3000	3318853
ACEITE, LUBRICACION DE DOBLE FLUJO	GP-3000	3318853	AGUA, REFRIGERANTE	GP-2127W	WF2127	AGUA	GP-2071W	9N3368
AGUA, SISTEMA DE ENFRIAMIENTO	GP-2071W	3315116	COMBUSTIBLE, SEPARADOR DE AGUA	GPP-1000	FS1000	COMBUSTIBLE, SEPARADOR DE AGUA	GPP-1000	3889716
COMBUSTIBLE, SEPARADOR DE AGUA (SELLADO)	GPP-1022S	3800394	ACEITE, DOBLE FLUJO	GP-9001	LF9001	AIRE	GA-518R	P534096
AIRE, RADIAL	GA-534R	P534925	AIRE	GA-518R	P185106	385 con motores/CATERPILLAR C13, CATERPILLAR C15		
379X con motor/CUMMINS ISM			385 con motor/CATERPILLAR 3176B			COMBUSTIBLE	GP-749	1R0749
ACEITE, OPCIONAL. TRANSMISION	GP-1	17237	ACEITE, CUMPLE CON MEDIDAS ORIGINALES	GP-691	1R1808	ACEITE, CUMPLE CON MEDIDAS ORIGINALES	GP-691	1R1808
AGUA, SISTEMA DE ENFRIAMIENTO	GP-2071W	3315116	ACEITE, SEGUNDA OPCION	GP-52	1R1808	AGUA	GP-2071W	9N3368
ACEITE, LUBRICACION DE DOBLE FLUJO	GP-9000	3406810	COMBUSTIBLE	GP-1108	1R0712	AIRE	GA-518R	P534096
COMBUSTIBLE, SEPARADOR DE AGUA (SELLADO)	GPP-1022S	3800394	385 con motor/CATERPILLAR C10			386 con motor/CATERPILLAR C13		
AIRE, RADIAL	GA-534R	P534925	ACEITE, FLUJO TOTAL (FULL FLOW) (CUMPLE CON MEDIDAS ORIGINALES)	GP-691	1R1808	ACEITE, OPCIONAL. TRANSMISION	GP-1	17237
379X con motor/CUMMINS ISX			ACEITE, FLUJO TOTAL (FULL FLOW) (SEGUNDA OPCION)	GP-52	1R1808	DIESEL	GP-749	1R0749
ACEITE, OPCIONAL. TRANSMISION	GP-1	17237	COMBUSTIBLE, SECUNDARIO	GP-1108	1R0712	DIESEL, MARCO MONTADO	GP-1101	1R0749
AGUA, SISTEMA DE ENFRIAMIENTO (SIN UNIDADES)	GP-2127W	WF2127	ACEITE, DERIVACION (BY PASS)	GP-57	1W8845	ACEITE, FLUJO TOTAL (FULL FLOW)	GP-51	1R1808
COMBUSTIBLE	GP-1101	FF2203	COMBUSTIBLE, SEPARADOR DE AGUA	GPP-1000	3889716	ACEITE, OPCIONAL. TRANSMISION	GP-58	4304827
ACEITE, 13 7/8 IN. LUBRICACION DE DOBLE FLUJO (OPCIONAL)	GP-9000	3406810	AIRE	GA-518R	P534096	AGUA, REFRIGERANTE	GP-2071W	9N3368
AGUA, SISTEMA DE ENFRIAMIENTO (11 1/2 UNIDADES)	GP-2126Q	WF2126	385 con motor/CATERPILLAR C11			COMBUSTIBLE, SEPARADOR DE AGUA	GPP-1000	256-8753
ACEITE, 11 23/32 IN. LUBRICACION DE DOBLE FLUJO (OPCIONAL)	GP-9001	3406809	COMBUSTIBLE	GP-749	1R0749	AIRE	GA-518R	AF25219
COMBUSTIBLE, SEPARADOR DE AGUA (ROSCA MILIMETRICA)	GPP-1007S	FS1007	ACEITE, CUMPLE CON MEDIDAS ORIGINALES	GP-691	1R1808	386 con motor/CATERPILLAR C15		
COMBUSTIBLE, SEPARADOR DE AGUA (ROSCA ESTANDAR)	GPP-1022S	3800394	ACEITE, SEGUNDA OPCION	GP-52	1R1808	ACEITE, OPCIONAL. TRANSMISION	GP-1	17237
AIRE, RADIAL	GA-534R	P534925	AIRE	GA-518R	P534096	DIESEL, MONTAJE EN EL MOTOR	GP-749	1R0749
379X con motores/CATERPILLAR C13, CATERPILLAR C11			385 con motor/CATERPILLAR C12			DIESEL, MARCO MONTADO	GP-1101	FF105
COMBUSTIBLE	GP-749	1R0749	ACEITE, FLUJO TOTAL (FULL FLOW) (CUMPLE CON MEDIDAS ORIGINALES)	GP-691	1R1808	ACEITE	GP-52	1R1808
ACEITE, CUMPLE CON MEDIDAS ORIGINALES	GP-691	1R1808	ACEITE, FLUJO TOTAL (FULL FLOW) (SEGUNDA OPCION)	GP-52	1R1808	ACEITE, OPCIONAL. TRANSMISION	GP-58	4304827
ACEITE, SEGUNDA OPCION	GP-52	1R1808	COMBUSTIBLE, SECUNDARIO	GP-1108	1R0712	COMBUSTIBLE, SEPARADOR DE AGUA	GPP-11	FS1212
AGUA	GP-2071W	9N3368	ACEITE, DERIVACION (BY PASS)	GP-57	1W8845	AGUA, REFRIGERANTE	GP-2071W	9N3368
AIRE	GA-539R	P534816	COMBUSTIBLE, SEPARADOR DE AGUA	GPP-1000	3889716	COMBUSTIBLE, SEPARADOR DE AGUA	GPP-1000	FS1000
384 con motor/CATERPILLAR C13			385 con motor/CUMMINS ISL			AIRE	GA-518R	EAF5106
ACEITE, OPCIONAL. TRANSMISION	GP-1	17237	ACEITE, DOBLE FLUJO	GP-3001	3401544	386 con motor/CUMMINS ISM		
COMBUSTIBLE	GP-749	1R0749	AGUA	GP-2071W	9N3368	ACEITE, OPCIONAL. TRANSMISION	GP-1	17237
379X con motor/CUMMINS ISC			COMBUSTIBLE, SEPARADOR DE AGUA	GPP-1022S	3944269	ACEITE, OPCIONAL. TRANSMISION	GP-58	4304827
ACEITE, OPCIONAL. TRANSMISION	GP-1	17237	AIRE	GA-518R	P534096	COMBUSTIBLE, SEPARADOR DE AGUA, SELLADO	GPP-1000	FS1000
ACEITE, LUBRICACION DE DOBLE FLUJO	GP-3001	3401544	384 con motor/CUMMINS ISM			ACEITE, DOBLE FLUJO	GP-9001	LF9001
ACEITE, LUBRICACION DE DOBLE FLUJO	GP-3000	3318853	AGUA	GP-2071W	9N3368	AIRE	GA-518R	P185106
AGUA, SISTEMA DE ENFRIAMIENTO	GP-2071W	3315116	ACEITE, DOBLE FLUJO	GP-9000	3406810			
COMBUSTIBLE, SEPARADOR DE AGUA (SELLADO)	GPP-1022S	3800394						
AIRE, RADIAL	GA-534R	P534925						

MARCA-MODELO-MOTOR MAKE-MODEL-ENGINE	GONHER GONHER	OEM OEM	MARCA-MODELO-MOTOR MAKE-MODEL-ENGINE	GONHER GONHER	OEM OEM	MARCA-MODELO-MOTOR MAKE-MODEL-ENGINE	GONHER GONHER	OEM OEM
SCANIA (continuación)			SCANIA (continuación)			SCANIA (continuación)		
CAMIONES, TRACTOCAMIONES Y AUTOBUSES			CAMIONES, TRACTOCAMIONES Y AUTOBUSES			CAMIONES, TRACTOCAMIONES Y AUTOBUSES		
ACEITE	GP-171	173171	AIRE, SECUNDARIO	GA-206	310814	LB111 con motor/SCANIA D11		
G113 con motor/SCANIA DS11 TURBO			AIRE, PRIMARIO	GA-405	219517	COMBUSTIBLE, SECUNDARIO	G-1123	152875
COMBUSTIBLE	GP-1122	364624	L140 con motor/SCANIA DS14 TURBO			COMBUSTIBLE, PRIMARIO	G-1123F	152875
AGUA	GP-1011Q	378396	COMBUSTIBLE	GP-1122	364624	DIRECCION	G-162H	153468
ACEITE	GP-171	173171	ACEITE	GP-171	173171	LB111, LBS111, LBT111 con motor/SCANIA DS11 TURBO		
G143 con motor/SCANIA DS14			AIRE, PRIMARIO	GA-405	217517	DIRECCION	G-162H	153468
COMBUSTIBLE	GP-1122	364624	L141 con motor/SCANIA DS14 TURBO			COMBUSTIBLE	GP-1122	364624
AGUA	GP-1011Q	378396	COMBUSTIBLE	GP-1122	364624	ACEITE	GP-171	173171
ACEITE	GP-171	173171	L146 con motor/A DIESEL			AIRE, PRIMARIO PARA CUMMINS	GA-106	310813
G82 con motores/SCANIA DN8, SCANIA DS8			COMBUSTIBLE	GP-1122	326065	AIRE, PRIMARIO PARA KOMATSU	GA-326	310813
COMBUSTIBLE	GP-1122	364624	COMBUSTIBLE, OPCIONAL	GPP-1122	P550588	AIRE, SECUNDARIO	GA-206	310814
AGUA	GP-1011Q	378396	ACEITE	GP-171	P550318	AIRE, PRIMARIO	GA-405	217517
ACEITE	GP-171	173171	L36 con motor/A DIESEL			LB140, LBS140 con motor/SCANIA DS14 TURBO		
G92 con motor/SCANIA DS9			ACEITE, SELLADO	GP-58	9144445	DIRECCION	G-162H	153468
COMBUSTIBLE	GP-1122	364624	L50 con motores/SCANIA D5, SCANIA D55			COMBUSTIBLE	GP-1122	364624
AGUA	GP-1011Q	378396	COMBUSTIBLE	G-296	181642	ACEITE	GP-171	173171
ACEITE	GP-171	173171	L51, L66, L55, L56 con motor/A DIESEL			AIRE	GA-436	211589
G93 con motor/SCANIA DS9 TURBO			COMBUSTIBLE	G-296	7111/296	LB81 con motor/SCANIA D8		
COMBUSTIBLE	GP-1122	364624	L76, LB76, LBS76, LS76, B65, L75 con motor/A DIESEL			COMBUSTIBLE, SECUNDARIO	G-1123	152875
AGUA	GP-1011Q	378396	COMBUSTIBLE	G-1123	152875	COMBUSTIBLE, PRIMARIO	G-1123F	152875
ACEITE	GP-171	P550318	L80 con motor/SCANIA DS8 TURBO			DIRECCION	G-162H	153468
K112 con motor/SCANIA DS11			DIRECCION	G-162H	153468	ACEITE	GP-171	173171
COMBUSTIBLE	GP-1122	364624	COMBUSTIBLE	GP-1122	364624	LB86 con motor/SCANIA D8		
AGUA	GP-1011Q	378396	ACEITE	GP-171	173171	COMBUSTIBLE, SECUNDARIO	G-1123	152875
ACEITE	GP-171	173171	AIRE	GA-436	309443	COMBUSTIBLE, PRIMARIO	G-1123F	152875
AIRE	GA-436	309443	K310 IB 4X2 NB, K94 IB 4X2 NB310 con motor/SCANIA DC11 06			DIRECCION	G-162H	153468
K82 con motor/SCANIA DS18 TURBO			HIDRAULICO	G-162H	153468	LB86 con motor/SCANIA DS8 TURBO		
COMBUSTIBLE	GP-1122	364624	K82 con motor/SCANIA DS18 TURBO			DIRECCION	G-162H	153468
AGUA	GP-1011Q	378396	COMBUSTIBLE	GP-1122	364624	COMBUSTIBLE	GP-1122	364624
ACEITE	GP-171	173171	AGUA	GP-1011Q	378396	ACEITE	GP-171	173171
AIRE	GA-436	309443	ACEITE	GP-171	173171	AIRE	GA-405	217517
K92 con motores/SCANIA DS9, SCANIA DSC9			AIRE	GA-436	309443	LB86 con motor/SCANIA DS8 TURBO		
COMBUSTIBLE	GP-1122	364624	L110 con motor/SCANIA D11			DIRECCION	G-162H	153468
AGUA	GP-1011Q	378396	COMBUSTIBLE, SECUNDARIO	G-1123	152875	COMBUSTIBLE, PRIMARIO	G-1123F	152875
ACEITE	GP-171	173171	COMBUSTIBLE, PRIMARIO	G-1123F	152875	DIRECCION	G-162H	153468
AIRE	GA-436	309443	DIRECCION	G-162H	153468	LB86 con motor/SCANIA D8		
L110 con motor/SCANIA D11			L81 con motor/SCANIA D8			COMBUSTIBLE, SECUNDARIO	G-1123	152875
COMBUSTIBLE, SECUNDARIO	G-1123	152875	COMBUSTIBLE, SECUNDARIO	G-1123	152875	COMBUSTIBLE, PRIMARIO	G-1123F	152875
COMBUSTIBLE, PRIMARIO	G-1123F	152875	COMBUSTIBLE, PRIMARIO	G-1123F	152875	DIRECCION	G-162H	153468
DIRECCION	G-162H	153468	DIRECCION	G-162H	153468	LB86 con motor/SCANIA DS8 TURBO		
L110 con motor/SCANIA DS11 TURBO			ACEITE	GP-171	173171	DIRECCION	G-162H	153468
COMBUSTIBLE	GP-1122	364624	L86 con motor/A DIESEL			LB86 con motor/SCANIA DS8 TURBO		
ACEITE	GP-171	173171	DIRECCION	G-162H	153468	DIRECCION	G-162H	153468
AIRE	GA-405	217517	LB110 con motor/SCANIA D11			COMBUSTIBLE	GP-1122	364624
L111 con motor/SCANIA D11			COMBUSTIBLE, SECUNDARIO	G-1123	152875	ACEITE	GP-171	173171
COMBUSTIBLE, SECUNDARIO	G-1123	152875	COMBUSTIBLE, PRIMARIO	G-1123F	152875	AIRE	GA-405	217517
COMBUSTIBLE, PRIMARIO	G-1123F	152875	DIRECCION	G-162H	153468	LB86 con motor/SCANIA DS8 TURBO		
DIRECCION	G-162H	153468	ACEITE	GP-171	173171	DIRECCION	G-162H	153468
AIRE, PRIMARIO PARA CUMMINS	GA-106	P182046	AIRE	GA-405	217517	COMBUSTIBLE	GP-1122	364624
AIRE, PRIMARIO PARA KOMATSU	GA-326	P182046	LB110 con motor/SCANIA DS11 TURBO			ACEITE	GP-171	173171
			COMBUSTIBLE	GP-1122	364624	AIRE	GA-405	217517

MARCA-MODELO-MOTOR MAKE-MODEL-ENGINE	GONHER GONHER	OEM OEM	MARCA-MODELO-MOTOR MAKE-MODEL-ENGINE	GONHER GONHER	OEM OEM	MARCA-MODELO-MOTOR MAKE-MODEL-ENGINE	GONHER GONHER	OEM OEM
SCANIA (continuación)			SCANIA (continuación)			SCANIA (continuación)		
CAMIONES, TRACTOCAMIONES Y AUTOBUSES			CAMIONES, TRACTOCAMIONES Y AUTOBUSES			CAMIONES, TRACTOCAMIONES Y AUTOBUSES		
LBT111 con motor/SCANIA D11			LT111 con motor/SCANIA D11			P112 con motor/SCANIA DS11		
COMBUSTIBLE, SECUNDARIO	G-1123	152875	COMBUSTIBLE, SECUNDARIO	G-1123	152875	COMBUSTIBLE	GP-1122	364624
COMBUSTIBLE, PRIMARIO	G-1123F	152875	COMBUSTIBLE, PRIMARIO	G-1123F	152875	AGUA	GP-1011Q	378396
DIRECCION	G-162H	153468	DIRECCION	G-162H	153468	ACEITE	GP-171	173171
LBT140, LBT141, LBT141S, LB141, LB141S, LBS141, LBS141S con motor/SCANIA DS14 TURBO			AIRE, PRIMARIO PARA CUMMINS	GA-106	P182046	P112 con motor/SCANIA DSC1006		
COMBUSTIBLE	GP-1122	364624	AIRE, PRIMARIO PARA KOMATSU	GA-326	P182046	COMBUSTIBLE	GP-1122	326065
LKT141H con motor/A DIESEL			AIRE, SECUNDARIO	GA-206	310814	ACEITE	GP-171	P550318
AIRE, SECUNDARIO	GA-6127	310817	AIRE, PRIMARIO	GA-405	219517	AIRE, PRIMARIO PARA CUMMINS	GA-106	310813
LS111 con motor/SCANIA D11			LT111, SBAT111 con motor/SCANIA DS11 TURBO			AIRE, PRIMARIO PARA KOMATSU	GA-326	AF1905
COMBUSTIBLE, SECUNDARIO	G-1123	152875	DIRECCION	G-162H	153468	AIRE, SECUNDARIO	GA-206	310814
COMBUSTIBLE, PRIMARIO	G-1123F	152875	COMBUSTIBLE	GP-1122	364624	P113 con motor/A DIESEL		
DIRECCION	G-162H	153468	ACEITE	GP-171	173171	COMBUSTIBLE	GP-1122	210970
AIRE, PRIMARIO PARA CUMMINS	GA-106	P182046	AIRE, PRIMARIO PARA CUMMINS	GA-106	310813	AIRE, PRIMARIO PARA CUMMINS	GA-106	310813
AIRE, PRIMARIO PARA KOMATSU	GA-326	P182046	AIRE, PRIMARIO PARA KOMATSU	GA-326	310813	AIRE, PRIMARIO PARA KOMATSU	GA-326	310813
AIRE, SECUNDARIO	GA-206	310814	AIRE, SECUNDARIO	GA-206	310814	AIRE, SECUNDARIO	GA-206	310814
AIRE, PRIMARIO	GA-405	219517	AIRE, PRIMARIO	GA-405	217517	P113 con motor/SCANIA DS11 TURBO		
LS111 con motor/SCANIA DS11 TURBO			LT145 con motor/SCANIA D14			COMBUSTIBLE	GP-1122	364624
DIRECCION	G-162H	153468	COMBUSTIBLE, SECUNDARIO	G-1123	152875	AGUA	GP-1011Q	378396
COMBUSTIBLE	GP-1122	364624	COMBUSTIBLE, PRIMARIO	G-1123F	152875	ACEITE	GP-171	173171
ACEITE	GP-171	173171	DIRECCION	G-162H	153468	P113 con motor/SCANIA DSC11		
AIRE, PRIMARIO PARA CUMMINS	GA-106	310813	LT145 con motor/SCANIA DS14 TURBO			DIRECCION	G-162H	153468
AIRE, PRIMARIO PARA KOMATSU	GA-326	310813	DIRECCION	G-162H	153468	COMBUSTIBLE	GP-1122	WK723/1
AIRE, SECUNDARIO	GA-206	310814	COMBUSTIBLE	GP-1122	364624	COMBUSTIBLE, CON PURGADOR	GPP-1122	WK842
AIRE, PRIMARIO	GA-405	217517	ACEITE	GP-171	173171	ACEITE	GP-171	W920/7
LS140 con motor/SCANIA DS14 TURBO			LT145S con motor/SCANIA D14			P114 con motores/SCANIA DC11 (EURO3) (03/99-10/04), SCANIA DSC11 (EURO2) (10/96-10/04)		
COMBUSTIBLE	GP-1122	364624	COMBUSTIBLE, SECUNDARIO	G-1123	152875	DIRECCION	G-162H	1902137
ACEITE	GP-171	173171	COMBUSTIBLE, PRIMARIO	G-1123F	152875	ACEITE	GP-51	1117285
AIRE, PRIMARIO	GA-405	217517	DIRECCION	G-162H	153468	AIRE, RADIAL (SISTEMA DE AIRE DONALDSON)	GA-517R	1421022
LS141 con motor/SCANIA DS14 TURBO			LT145S con motor/SCANIA DS14 TURBO			P114 SERIES 4 con motor/SCANIA DSC11		
COMBUSTIBLE	GP-1122	364624	DIRECCION	G-162H	153468	DIRECCION	G-162H	153468
LS5, LS55 con motor/SCANIA DS10			COMBUSTIBLE	GP-1122	364624	ACEITE	GP-51	1117285
ACEITE, CARTUCHO	G-225	153465	ACEITE	GP-171	173171	AGUA	GP-1011Q	378396
LS56 con motor/A DIESEL			LT146 con motor/SCANIA DS14 TURBO			P124 con motor/SCANIA DSC12		
COMBUSTIBLE	G-296	7111/296	COMBUSTIBLE	GP-1122	364624	DIRECCION	G-162H	1902137
LS86 con motor/SCANIA D8			LT146 con motor/SCANIA DS14 TURBO			ACEITE	GP-51	1117285
COMBUSTIBLE, SECUNDARIO	G-1123	152875	LTK141, P142, R142 con motor/A DIESEL			AGUA, ENFRIAMIENTO	GP-1011Q	378396
COMBUSTIBLE, PRIMARIO	G-1123F	152875	AIRE, SECUNDARIO	GA-6127	310817	AIRE, RADIAL	GA-517R	1421022
DIRECCION	G-162H	153468	N112A con motor/SCANIA DS11			P124 con motores/SCANIA DC12 (EURO3) (03/99-10/04), SCANIA DC1203 (EURO3-1) (10/02-10/04), SCANIA DSC12 (EURO2) (01/96-10/04), SCANIA DT1202/08 (EURO3) (02/01-10/04)		
LS86 con motor/SCANIA DS8 TURBO			COMBUSTIBLE	GP-1122	364624	DIRECCION	G-162H	1902137
COMBUSTIBLE, SECUNDARIO	G-1123	152872	AGUA	GP-1011Q	378396	ACEITE	GP-51	1117285
COMBUSTIBLE, PRIMARIO	G-1123F	152875	ACEITE	GP-171	173171	AIRE, RADIAL (SISTEMA DE AIRE DONALDSON)	GA-517R	1421022
DIRECCION	G-162H	153468	AIRE	GA-436	309443	P124 SERIES 4 con motor/SCANIA DSC12		
ACEITE	GP-171	173171	N112DR con motor/SCANIA DN11			DIRECCION	G-162H	1902137
LT110 con motor/SCANIA DS11 TURBO			COMBUSTIBLE	GP-1122	364624	ACEITE	GP-51	1117285
COMBUSTIBLE	GP-1122	364624	AGUA	GP-1011Q	378396	AGUA	GP-1011Q	378396
ACEITE	GP-171	173171	AIRE	GA-436	309443	P124 con motor/SCANIA DSC12		
AIRE	GA-405	217517	P112 con motor/A DIESEL			DIRECCION	G-162H	1902137
			AGUA	GP-1013Q	350986	ACEITE	GP-51	1117285
			COMBUSTIBLE	GP-1122	210970	AGUA	GP-1011Q	378396
			AIRE, PRIMARIO PARA CUMMINS	GA-106	310813			
			AIRE, PRIMARIO PARA KOMATSU	GA-326	310813			
			AIRE, SECUNDARIO	GA-206	310814			

SERVICIO PESADO

MARCA-MODELO-MOTOR MAKE-MODEL-ENGINE	GONHER GONHER	OEM OEM	MARCA-MODELO-MOTOR MAKE-MODEL-ENGINE	GONHER GONHER	OEM OEM	MARCA-MODELO-MOTOR MAKE-MODEL-ENGINE	GONHER GONHER	OEM OEM
SCANIA (continuación)			SCANIA (continuación)			SCANIA (continuación)		
CAMIONES, TRACTOCAMIONES Y AUTOBUSES			CAMIONES, TRACTOCAMIONES Y AUTOBUSES			CAMIONES, TRACTOCAMIONES Y AUTOBUSES		
P143 con motor/SCANIA DS14			P92 con motor/SCANIA DS9			R112 con motor/SCANIA DS11		
COMBUSTIBLE	GP-1122	364624	COMBUSTIBLE	GP-1122	364624	COMBUSTIBLE	GP-1122	364624
AGUA	GP-1011Q	378396	AGUA	GP-1011Q	378396	AGUA	GP-1011Q	378396
ACEITE	GP-171	173171	ACEITE	GP-171	173171	ACEITE	GP-171	173171
P144 con motor/SCANIA DSC14			P93 con motor/SCANIA DS9 TURBO			R112 con motor/SCANIA DSC1006		
DIRECCION	G-162H	1902137	COMBUSTIBLE	GP-1122	364624	COMBUSTIBLE	GP-1122	326065
ACEITE	GP-51	1117285	AGUA	GP-1011Q	378396	ACEITE	GP-171	P550318
COMBUSTIBLE, CON PURGADOR	GPP-1122	WK842	ACEITE	GP-171	P550318	AIRE, PRIMARIO PARA CUMMINS	GA-106	310813
AGUA, ENFRIAMIENTO	GP-1011Q	378396	P93 con motor/SCANIA DSC9			AIRE, PRIMARIO PARA KOMATSU	GA-326	AF1905
AIRE, RADIAL	GA-517R	1335679	DIRECCION	G-162H	153468	AIRE, SECUNDARIO	GA-206	310814
P230 con motores/SCANIA DC9 13-230 (EURO3) (09/04 EN ADELANTE), SCANIA DC9 16-230 (EURO4) (10/05 EN ADELANTE)			COMBUSTIBLE	GP-1122	457431326	R113 con motor/A DIESEL		
DIRECCION	G-162H	1902137	COMBUSTIBLE, CON PURGADOR	GPP-1122	WK842	COMBUSTIBLE	GP-1122	210970
ACEITE	GP-51	1117285	ACEITE	GP-171	W920/7	AIRE, PRIMARIO PARA CUMMINS	GA-106	310813
AIRE, RADIAL (SISTEMA DE AIRE DONALDSON)	GA-517R	1421022	P94 con motores/SCANIA DC9 (EURO3) (03/99-10/04), SCANIA DSC9 (EURO2) (10/95-10/04)			AIRE, PRIMARIO PARA KOMATSU	GA-326	310813
P270 con motores/SCANIA DC9 17-270 (EURO4) (10/05 EN ADELANTE), SCANIA DC9 13-230 (EURO3) (09/04 EN ADELANTE), SCANIA DC9 12-270 (EURO3) (09/04 EN ADELANTE)			DIRECCION	G-162H	1902137	AIRE, SECUNDARIO	GA-206	310814
DIRECCION	G-162H	1902137	ACEITE	GP-51	1117285	R113 con motor/SCANIA DS11 TURBO		
ACEITE	GP-51	1117285	AIRE, RADIAL (SISTEMA DE AIRE DONALDSON)	GA-517R	1421022	COMBUSTIBLE	GP-1122	364624
AIRE, RADIAL (SISTEMA DE AIRE DONALDSON)	GA-517R	1421022	P94 SERIES 4 con motor/SCANIA DSC9			AGUA	GP-1011Q	378396
P310 con motores/SCANIA DC9 (EURO3) 13-230 (09/04 EN ADELANTE), SCANIA DC9 11-310 (EURO3) (09/04 EN ADELANTE), SCANIA DC9 18-310 (11/05 EN ADELANTE)			DIRECCION	G-162H	1902137	ACEITE	GP-171	173171
DIRECCION	G-162H	1902137	ACEITE	GP-51	1117285	R113 con motor/SCANIA DSC11		
ACEITE	GP-51	1117285	AGUA	GP-1011Q	378396	DIRECCION	G-162H	153468
AIRE, RADIAL (SISTEMA DE AIRE DONALDSON)	GA-517R	1421022	PR114 con motor/A DIESEL			COMBUSTIBLE	GP-1122	WK723/1
P340 con motores/SCANIA DC11-340 (EURO3) (09/04 EN ADELANTE), SCANIA DC12-340 (EURO4) (05/06 EN ADELANTE)			DIRECCION	G-162H	153468	COMBUSTIBLE, CON PURGADOR	GPP-1122	WK842
DIRECCION	G-162H	1902137	AGUA, ENFRIAMIENTO, CON 8 UNIDADES	GP-1011Q	378396	ACEITE	GP-171	W920/7
ACEITE	GP-51	1117285	ACEITE, TURBOCARGADOR	GP-171	173171	R114 con motores/SCANIA DC11 (EURO3) (03/99-10/04), SCANIA DSC11 (EURO2) (10/96-10/04)		
AIRE, RADIAL (SISTEMA DE AIRE DONALDSON)	GA-517R	1421022	AIRE, RADIAL (SISTEMA DE AIRE DONALDSON)	GA-517R	1421022	DIRECCION	G-162H	1902137
P380 con motores/SCANIA DC11-340 (EURO3) (09/04 EN ADELANTE), SCANIA DC12-380 (EURO4) (10/05 EN ADELANTE)			PR124 con motor/A DIESEL			ACEITE	GP-51	1117285
DIRECCION	G-162H	1902137	DIRECCION	G-162H	1335679	AIRE, RADIAL (SISTEMA DE AIRE DONALDSON)	GA-517R	1421022
ACEITE	GP-51	1117285	ACEITE	GP-51	1117285	R114 GA, R114 LA con motor/SCANIA DSC12 02		
AIRE, RADIAL (SISTEMA DE AIRE DONALDSON)	GA-517R	1421022	AGUA, ENFRIAMIENTO, CON 8 UNIDADES	GP-1011Q	153468	HIDRAULICO	G-162H	153468
P420 con motores/SCANIA DT12-420 (EURO4) (09/04 EN ADELANTE), SCANIA DC12 14-240 (09/04 EN ADELANTE), SCANIA DC12 15-420 (EURO5) (05/06 EN ADELANTE)			AIRE, RADIAL (SISTEMA DE AIRE DONALDSON)	GA-517R	1421022	ACEITE	GP-51	1117285
DIRECCION	G-162H	1902137	PR94 con motor/A DIESEL			COMBUSTIBLE, SEPARADOR DE AGUA	GPP-1061	WK 1060/1
ACEITE	GP-51	1117285	DIRECCION	G-162H	1421022	ACEITE	GP-171	LF3371
AIRE, RADIAL (SISTEMA DE AIRE DONALDSON)	GA-517R	1421022	ACEITE	GP-51	378396	AIRE, PRIMARIO	GA-516R	1423414
P470 con motor/SCANIA DT12 (EURO4) (09/04 EN ADELANTE)			AGUA, ENFRIAMIENTO, CON 8 UNIDADES	GP-1011Q	1335679	R114 SERIES 4 con motor/SCANIA DSC11		
DIRECCION	G-162H	1902137	AIRE, RADIAL (SISTEMA DE AIRE DONALDSON)	GA-517R	1117285	DIRECCION	G-162H	1902137
ACEITE	GP-51	1117285	R/T124 con motores/SCANIA DC1203 (EURO3-1) (10/02-10/04), SCANIA DSC12 (EURO2) (11/95-10/04), SCANIA DT1202/08 (EURO3) (02/01-10/04)			ACEITE	GP-51	1117285
AIRE, RADIAL (SISTEMA DE AIRE DONALDSON)	GA-517R	1421022	DIRECCION	G-162H	1902137	AGUA	GP-1011Q	378396
P82 con motores/SCANIA DN8, SCANIA DS8			ACEITE	GP-51	1117285	R124 con motor/SCANIA DSC12		
COMBUSTIBLE	GP-1122	364624	AIRE, RADIAL (SISTEMA DE AIRE DONALDSON)	GA-517R	1421022	DIRECCION	G-162H	1902137
AGUA	GP-1011Q	378396	R112 con motor/A DIESEL			ACEITE	GP-51	1117285
ACEITE	GP-171	173171	AGUA	GP-1013Q	350986	AGUA, ENFRIAMIENTO	GP-1011Q	378396
			COMBUSTIBLE	GP-1122	210970	COMBUSTIBLE, SEPARADOR DE AGUA	GPP-1061	WK 1060/1
			AIRE, PRIMARIO PARA CUMMINS	GA-106	310813	AIRE, RADIAL	GA-517R	1335679
			AIRE, PRIMARIO PARA KOMATSU	GA-326	310813	R124 GA, R124 LA con motor/SCANIA DSC12 02		
			AIRE, SECUNDARIO	GA-206	310814	HIDRAULICO	G-162H	153468
						ACEITE	GP-51	1117285
						COMBUSTIBLE, SEPARADOR DE AGUA	GPP-1061	WK 1060/1

MARCA-MODELO-MOTOR MAKE-MODEL-ENGINE	GONHER GONHER	OEM OEM	MARCA-MODELO-MOTOR MAKE-MODEL-ENGINE	GONHER GONHER	OEM OEM	MARCA-MODELO-MOTOR MAKE-MODEL-ENGINE	GONHER GONHER	OEM OEM
SCANIA (continuación)			SCANIA (continuación)			SCANIA (continuación)		
CAMIONES, TRACTOCAMIONES Y AUTOBUSES			CAMIONES, TRACTOCAMIONES Y AUTOBUSES			CAMIONES, TRACTOCAMIONES Y AUTOBUSES		
ACEITE	GP-171	LF3371	AIRE, PRIMARIO PARA KOMATSU	GA-326	310813	T142 con motor/A DIESEL		
AIRE, PRIMARIO	GA-516R	1423414	AIRE, SECUNDARIO	GA-206	310814	AIRE, SECUNDARIO	GA-6127	310817
R124 SERIES 4 con motor/SCANIA DSC12			T112 con motor/SCANIA DSC1103 TURBO			T142E, T142H con motor/SCANIA DS14 TURBO		
DIRECCION	G-162H	1902137	COMBUSTIBLE	GP-1122	326065	COMBUSTIBLE	GP-1122	364624
ACEITE	GP-51	1117285	COMBUSTIBLE, OPCIONAL	GPP-1122	P550588	AGUA	GP-1011Q	378396
AGUA	GP-1011Q	378396	ACEITE	GP-171	P550318	ACEITE	GP-171	173171
R142MA, R142H, R142M con motor/SCANIA DS14 TURBO			AIRE, SECUNDARIO			T143 con motor/SCANIA DS14		
COMBUSTIBLE	GP-1122	364624	AIRE, PRIMARIO	GA-6127	P119372	COMBUSTIBLE	GP-1122	3644624
AGUA	GP-1011Q	378396		GA-6129	P181002	AGUA	GP-1011Q	378396
ACEITE	GP-171	173171	T112H con motor/SCANIA DN11			ACEITE	GP-171	173171
R143 con motor/SCANIA DS14			COMBUSTIBLE			T143 con motor/SCANIA DSC14		
COMBUSTIBLE	GP-1122	364624	COMBUSTIBLE, OPCIONAL	GPP-1122	P550588	DIRECCION	G-162H	153468
AGUA	GP-1011Q	378396	AIRE	GA-436	309443	T144 con motor/SCANIA DSC14		
ACEITE	GP-171	173171	T112M, T112, T112E con motores/SCANIA DN11, SCANIA DS11			DIRECCION	G-162H	1902137
R143 con motor/SCANIA DSC14			COMBUSTIBLE			ACEITE	GP-51	1117285
DIRECCION	G-162H	153468	T113 con motor/A DIESEL			COMBUSTIBLE, CON PURGADOR	GPP-1122	WK842
COMBUSTIBLE	GP-1122	457431326	COMBUSTIBLE	GP-1122	210970	AGUA, ENFRIAMIENTO	GP-1011Q	378396
COMBUSTIBLE, CON PURGADOR	GPP-1122	WK842	AIRE, PRIMARIO PARA CUMMINS	GA-106	310813	AIRE, RADIAL	GA-517R	1335679
ACEITE	GP-171	W920/7	AIRE, PRIMARIO PARA KOMATSU	GA-326	310813	T145, T146 con motor/A DIESEL		
R144 con motor/SCANIA DSC14			AIRE, SECUNDARIO	GA-206	310814	COMBUSTIBLE	GP-1122	210970
DIRECCION	G-162H	1902137	T113 con motor/SCANIA DS11 TURBO			COMBUSTIBLE, OPCIONAL	GPP-1122	P550588
ACEITE	GP-51	1117285	COMBUSTIBLE	GP-1122	364624	ACEITE	GP-171	173171
COMBUSTIBLE, CON PURGADOR	GPP-1122	WK842	AGUA	GP-1011Q	378396	T340, T380 con motor/SCANIA DC11 (EURO3) (09/04-12/05)		
AGUA, ENFRIAMIENTO	GP-1011Q	378396	ACEITE	GP-171	173171	DIRECCION	G-162H	1902137
AIRE, RADIAL	GA-517R	1335679	T113 con motor/SCANIA DSC11			ACEITE	GP-51	1117285
R144 SERIES 4 con motor/SCANIA DSC14			DIRECCION	G-162H	153468	AIRE, RADIAL (SISTEMA DE AIRE DONALDSON)	GA-517R	1421022
DIRECCION	G-162H	1902137	COMBUSTIBLE	GP-1122	WK723/1	T420 con motores/SCANIA DC12 14-420 (EURO3) (09/04-12/05), SCANIA DT12 (09/04-12/05)		
ACEITE	GP-51	1117285	COMBUSTIBLE, CON PURGADOR	GPP-1122	WK842	DIRECCION	G-162H	1902137
AGUA	GP-1011Q	378396	ACEITE	GP-171	W920/7	ACEITE	GP-51	1117285
R92 con motor/SCANIA DS9			T114 con motor/SCANIA DC11 (EURO3) (03/98-10/04)			AIRE, RADIAL (SISTEMA DE AIRE DONALDSON)	GA-517R	1421022
COMBUSTIBLE	GP-1122	364624	DIRECCION	G-162H	1902137	T470 con motor/SCANIA DT12 (09/04-12/05)		
AGUA	GP-1011Q	378396	ACEITE	GP-51	1117285	DIRECCION	G-162H	1902137
ACEITE	GP-171	173171	AIRE, RADIAL (SISTEMA DE AIRE DONALDSON)	GA-517R	1421022	ACEITE	GP-51	1117285
R93 con motor/SCANIA DS9 TURBO			T124 con motor/SCANIA DSC12			AIRE, RADIAL (SISTEMA DE AIRE DONALDSON)	GA-517R	1421022
COMBUSTIBLE	GP-1122	364624	DIRECCION	G-162H	1902137	T82 con motores/SCANIA DN8, SCANIA DS8		
AGUA	GP-1011Q	378396	ACEITE	GP-51	1117285	COMBUSTIBLE	GP-1122	364624
ACEITE	GP-171	P550318	AGUA, ENFRIAMIENTO	GP-1011Q	378396	AGUA	GP-1011Q	378396
R94 con motor/SCANIA DSC9			COMBUSTIBLE, SEPARADOR DE AGUA	GPP-1061	WK 1060/1	ACEITE	GP-171	173171
DIRECCION	G-162H	1902137	AIRE, RADIAL	GA-517R	1335679	T92 con motor/SCANIA DS9		
R94 SERIES 4 con motor/SCANIA DSC9			T124 GA con motor/SCANIA DSC12 03			COMBUSTIBLE	GP-1122	364624
DIRECCION	G-162H	1902137	HIDRAULICO	G-162H	153468	AGUA	GP-1011Q	378396
ACEITE	GP-51	1117285	ACEITE	GP-51	1117285	ACEITE	GP-171	173171
AGUA	GP-1011Q	378396	COMBUSTIBLE, SEPARADOR DE AGUA	GPP-1061	WK 1060/1	T93 con motor/SCANIA DS9 TURBO		
SBA111 con motor/SCANIA D11			AIRE, PRIMARIO	GA-516R	1423414	COMBUSTIBLE	GP-1122	364624
COMBUSTIBLE, SECUNDARIO	G-1123	152875	T124 LA con motor/SCANIA DSC12 02			AGUA	GP-1011Q	378396
COMBUSTIBLE, PRIMARIO	G-1123F	152875	HIDRAULICO	G-162H	153468	ACEITE	GP-171	P550318
DIRECCION	G-162H	153468	ACEITE	GP-51	1117285	T93 con motor/SCANIA DSC9		
T112 con motor/A DIESEL			COMBUSTIBLE, SEPARADOR DE AGUA	GPP-1061	WK 1060/1	DIRECCION	G-162H	153468
AGUA	GP-1013Q	350986	AIRE, PRIMARIO	GA-516R	1423414	COMBUSTIBLE	GP-1122	457431326
COMBUSTIBLE	GP-1122	210970						
AIRE, PRIMARIO PARA CUMMINS	GA-106	310813						

MARCA-MODELO-MOTOR MAKE-MODEL-ENGINE	GONHER GONHER	OEM OEM	MARCA-MODELO-MOTOR MAKE-MODEL-ENGINE	GONHER GONHER	OEM OEM	MARCA-MODELO-MOTOR MAKE-MODEL-ENGINE	GONHER GONHER	OEM OEM
SCANIA (continuación)			STERLING (continuación)			STERLING (continuación)		
CAMIONES, TRACTOCAMIONES Y AUTOBUSES			CAMIONES, TRACTOCAMIONES Y AUTOBUSES			CAMIONES, TRACTOCAMIONES Y AUTOBUSES		
COMBUSTIBLE, CON PURGADOR	GPP-1122	WK842	COMBUSTIBLE, SECUNDARIO	GP-1108	1R-0712	COMBUSTIBLE	GPP-1007S	3331096
ACEITE	GP-171	W920/7	ACEITE, DERIVACION (BY PASS)	GP-57	1W-8845	A9500 con motor/DETROIT DIESEL 60 SERIES		
T94 con motor/SCANIA DC9 (EURO3) (03/99-10/04)			A9500 con motor/CATERPILLAR C11			COMBUSTIBLE, PRIMARIO	GP-26	23518481
DIRECCION	G-162H	1902137	COMBUSTIBLE	GP-749	1R0749	COMBUSTIBLE, SECUNDARIO	GP-27	23518482
ACEITE	GP-51	1117285	ACEITE, CUMPLE CON MEDIDAS ORIGINALES	GP-691	1R0716	ACEITE	GP-193	23518480
AIRE, RADIAL (SISTEMA DE AIRE DONALDSON)	GA-517R	1421022	ACEITE, SEGUNDA OPCION	GP-52	1R0716	COMBUSTIBLE, SEPARADOR DE AGUA CON PURGADOR	GPP-1291	FS1291
T94 con motor/SCANIA DSC9 (EURO2) (10/96-10/04)			AIRE	GA-930R	P533930	AIRE	GA-682R	P527682
DIRECCION	G-162H	1902137	A9500 con motor/CATERPILLAR C12			COMBUSTIBLE, SEPARADOR DE AGUA CON ROSCA PARA TAZON	S 3226 P	S3226P
ACEITE	GP-51	1117285	ACEITE, CUMPLE CON MEDIDAS ORIGINALES	GP-691	1R-0716	A9500 con motor/MERCEDES BENZ MBE4000		
AIRE, RADIAL PRIMARIO (SISTEMA DE AIRE DONALDSON)	GA-517R	C301240	COMBUSTIBLE, PRIMARIO	GP-26	E6HT-9155-AA	COMBUSTIBLE, SEPARADOR DE AGUA	GPP-1000	P551000
			ACEITE, SEGUNDA OPCION	GP-52	1R-0716	ACTERRA 5500 con motor/CATERPILLAR 3126B		
			COMBUSTIBLE, SECUNDARIO	GP-1108	1R-0712	ACEITE	GP-51	1R-0739
			ACEITE, DERIVACION (BY PASS)	GP-57	1W-8845	COMBUSTIBLE	GP-1109	1R-0751
			AGUA	GP-2071W	111-2370	AIRE	GA-197R	P185067
			A9500 con motor/CATERPILLAR C13			ACTERRA 5500 con motor/CUMMINS ISB		
			COMBUSTIBLE	GP-749	1R0749	ACEITE	GP-3937	3937144
			ACEITE, CUMPLE CON MEDIDAS ORIGINALES	GP-691	1R0716	COMBUSTIBLE, SEPARADOR DE AGUA	GS-1261	3942470
			ACEITE, SEGUNDA OPCION	GP-52	1R0716	AIRE	GA-197R	P185067
			COMBUSTIBLE, PURGADOR	GPP-1291	FS1291	ACTERRA 5500, ACTERRA 6500 con motor/MERCEDES BENZ MBE900 DIESEL		
			COMBUSTIBLE, ROSCA PARA TAZON	S 3226 P	S3226P	ACEITE	G-3754	000 180 1709
			A9500 con motor/CATERPILLAR C15			COMBUSTIBLE, SECUNDARIO	G-1046	000 090 1551
			COMBUSTIBLE	GP-749	1R0749	COMBUSTIBLE, SEPARADOR DE AGUA CON PURGADOR	GPP-1291	FS1291
			ACEITE, CUMPLE CON MEDIDAS ORIGINALES	GP-691	1R0716	AIRE	GA-197R	P527484
			ACEITE, SEGUNDA OPCION	GP-52	1R0716	COMBUSTIBLE, SEPARADOR DE AGUA CON ROSCA PARA TAZON	S 3226 P	S3226P
			AGUA	GP-2071W	9N3368	ACTERRA 5500, ACTERRA 6500, ACTERRA 7500, ACTERRA 8500 con motor/CUMMINS ISC		
			COMBUSTIBLE, SEPARADOR DE AGUA	GPP-1000	17001-4406	ACEITE	GP-3001	3401544
			COMBUSTIBLE, PURGADOR	GPP-1291	FS1291	ACEITE	GP-3000	3318853
			AIRE, PRIMARIO	GA-682R	AF25139M	COMBUSTIBLE, SEPARADOR DE AGUA	GPP-1022S	3800394
			AIRE, SECUNDARIO	GA-683R	AD25345	AIRE	GA-197R	P185067
			COMBUSTIBLE, ROSCA PARA TAZON	S 3226 P	S3226P	ACTERRA 6500 con motor/CATERPILLAR 3126B		
			A9500 con motor/CATERPILLAR C9			ACEITE	GP-51	1R-0739
			ACEITE, CUMPLE CON MEDIDAS ORIGINALES	GP-691	1R0716	COMBUSTIBLE	GP-1109	1R-0751
			ACEITE, SEGUNDA OPCION	GP-52	1R0716	AIRE	GA-197R	P185067
			COMBUSTIBLE	GP-1109	1R0751	ACTERRA 7500 con motor/CATERPILLAR 3126B		
			A9500 con motor/CUMMINS ISM			ACEITE	GP-51	1R-0739
			ACEITE	GP-9000	3406810	COMBUSTIBLE, SEPARADOR DE AGUA	GPP-1022S	3800394
			ACEITE	GP-9001	3406809	AIRE	GA-197R	P185067
			COMBUSTIBLE, SEPARADOR DE AGUA	GPP-1022S	3406889	ACTERRA 6500 con motor/CUMMINS ISB		
			A9500 con motor/CUMMINS ISX			ACEITE	GP-3937	3937144
			ACEITE	GP-9000	3406810	COMBUSTIBLE, SEPARADOR DE AGUA	GS-1261	3942470
			ACEITE	GP-9001	3406809	AIRE	GA-197R	P185067
			COMBUSTIBLE	GPP-1007S	3331096	ACTERRA 7500 con motor/CATERPILLAR 3126B		
			A9500 con motor/CUMMINS N14 PLUS			ACEITE	GP-51	1R-0739
			ACEITE	GP-3001	3401544	COMBUSTIBLE	GP-1109	1R-0751
			ACEITE	GP-3000	3318853	AIRE	GA-197R	P185067
			COMBUSTIBLE, SEPARADOR DE AGUA	GPP-1000	3889716	ACTERRA 7500 con motor/CATERPILLAR C7		
			A9500 con motor/CATERPILLAR C10			ACEITE	GP-51	1R0739
			ACEITE, CUMPLE CON MEDIDAS ORIGINALES	GP-691	1R-0716	COMBUSTIBLE	GP-1109	1R0751
			ACEITE, SEGUNDA OPCION	GP-52	1R-0716	AIRE	GA-197R	EAF5067

MARCA-MODELO-MOTOR MAKE-MODEL-ENGINE	GONHER GONHER	OEM OEM	MARCA-MODELO-MOTOR MAKE-MODEL-ENGINE	GONHER GONHER	OEM OEM	MARCA-MODELO-MOTOR MAKE-MODEL-ENGINE	GONHER GONHER	OEM OEM
STERLING (continuación)			STERLING (continuación)			STERLING (continuación)		
CAMIONES, TRACTOCAMIONES Y AUTOBUSES			CAMIONES, TRACTOCAMIONES Y AUTOBUSES			CAMIONES, TRACTOCAMIONES Y AUTOBUSES		
ACTERRA 7500 con motor/CUMMINS ISB			ACEITE, SEGUNDA OPCION	GP-52	F6HZ-9601-CA	AT9500 con motor/CUMMINS SIGNATURE 600		
ACEITE	GP-3937	3937144	COMBUSTIBLE, SEPARADOR DE AGUA	GPP-1000	1R-0749	ACEITE	GP-9000	3406810
COMBUSTIBLE, SEPARADOR DE AGUA	GS-1261	3942470				ACEITE	GP-9001	3406809
AIRE	GA-197R	P185067	AT9500 con motor/CATERPILLAR C10			COMBUSTIBLE	GPP-1007S	3331096
ACTERRA 7500 con motor/MERCEDES BENZ MBE900 DIESEL			ACEITE, CUMPLE CON MEDIDAS ORIGINALES	GP-691	1R-0716	AT9500 con motor/DETROIT DIESEL 60 SERIES		
ACEITE	G-3754	000 180 1709	ACEITE, SEGUNDA OPCION	GP-52	1R-0716	COMBUSTIBLE, PRIMARIO	GP-26	23518481
COMBUSTIBLE, SECUNDARIO	G-1046	000 090 1551	COMBUSTIBLE, SECUNDARIO	GP-1108	1R-0712	COMBUSTIBLE, SECUNDARIO	GP-27	23518482
COMBUSTIBLE, SEPARADOR DE AGUA CON VALVULA DE DRENAJE	GPP-1291	S3226FL02	ACEITE, DERIVACION (BY PASS)	GP-57	1W-8845	ACEITE	GP-193	23518480
AIRE	GA-197R	P527484	AT9500 con motor/CATERPILLAR C11			COMBUSTIBLE, SEPARADOR DE AGUA CON PURGADOR	GPP-1291	FS1291
COMBUSTIBLE, SEPARADOR DE AGUA CON ROSCA PARA TAZON	S 3226 P	S3226P	COMBUSTIBLE	GP-749	1R0749	AIRE	GA-682R	P527682
ACTERRA 8500 con motor/CATERPILLAR 3126B			ACEITE, CUMPLE CON MEDIDAS ORIGINALES	GP-691	1R0716	COMBUSTIBLE, SEPARADOR DE AGUA CON ROSCA PARA TAZON	S 3226 P	S3226P
ACEITE	GP-51	1R-0739	ACEITE, SEGUNDA OPCION	GP-52	1R0716	AT9500 con motor/MERCEDES BENZ MBE4000		
COMBUSTIBLE	GP-1109	1R-0751	AIRE	GA-930R	P533930	COMBUSTIBLE, SEPARADOR DE AGUA	GPP-1000	P551000
AIRE	GA-197R	P185067	AT9500 con motor/CATERPILLAR C12			AT9500, CONDOR con motor/CATERPILLAR C13		
ACTERRA 8500 con motor/CATERPILLAR C7			ACEITE, CUMPLE CON MEDIDAS ORIGINALES	GP-691	1R-0716	COMBUSTIBLE	GP-749	1R0749
ACEITE	GP-51	1R0739	COMBUSTIBLE, PRIMARIO	GP-26	E6HT-9155-AA	ACEITE, CUMPLE CON MEDIDAS ORIGINALES	GP-691	1R0716
COMBUSTIBLE	GP-1109	1R0751	ACEITE, SEGUNDA OPCION	GP-52	1R-0716	ACEITE, SEGUNDA OPCION	GP-52	1R0716
AIRE	GA-197R	EAF5067	COMBUSTIBLE, SECUNDARIO	GP-1108	1R-0712	COMBUSTIBLE, SEPARADOR DE AGUA CON PURGADOR	GPP-1291	FS1291
ACTERRA 8500 con motor/CUMMINS ISB			ACEITE, DERIVACION (BY PASS)	GP-57	1W-8845	COMBUSTIBLE, SEPARADOR DE AGUA CON ROSCA PARA TAZON	S 3226 P	S3226P
ACEITE	GP-3937	3937144	AGUA	GP-2071W	111-2370	AT9513 con motor/CATERPILLAR C12		
COMBUSTIBLE, SEPARADOR DE AGUA	GS-1261	3942470	AT9500 con motor/CATERPILLAR C15			ACEITE, CUMPLE CON MEDIDAS ORIGINALES	GP-691	1R0716
AIRE	GA-197R	P185067	COMBUSTIBLE, CARTUCHO SEPARADOR DE AGUA	G-128	P176160	ACEITE, SEGUNDA OPCION	GP-52	1R0716
ACTERRA 8500 con motor/MERCEDES BENZ MBE900 DIESEL			COMBUSTIBLE	GP-749	1R0749	AGUA	GP-2071W	9N3368
ACEITE	G-3754	000 180 1709	ACEITE, CUMPLE CON MEDIDAS ORIGINALES	GP-691	1R0716	COMBUSTIBLE, SEPARADOR DE AGUA	GPP-1000	17001-4406
COMBUSTIBLE, SECUNDARIO	G-1046	000 090 1551	ACEITE, SEGUNDA OPCION	GP-52	1R0716	COMBUSTIBLE, SEPARADOR DE AGUA	GPP-1291	FS1291
COMBUSTIBLE, SEPARADOR DE AGUA CON PURGADOR	GPP-1291	FS1291	AGUA	GP-2071W	9N3368	COMBUSTIBLE, SEPARADOR DE AGUA CON PURGADOR	GPP-1291	FS1291
AIRE	GA-197R	P527484	COMBUSTIBLE, SEPARADOR DE AGUA CON PURGADOR	GPP-1291	17001-4406	AIRE, PRIMARIO	GA-682R	AF25139M
COMBUSTIBLE, SEPARADOR DE AGUA CON ROSCA PARA TAZON	S 3226 P	S3226P	AIRE, PRIMARIO	GA-682R	AF25139M	AIRE, SECUNDARIO	GA-683R	AD25345
A-LINE con motor/CATERPILLAR C15			AIRE, SECUNDARIO	GA-683R	AD25345	COMBUSTIBLE, SEPARADOR DE AGUA CON ROSCA PARA TAZON	S 3226 P	S3226P
ACEITE, OPCIONAL PARA TRANSMISION	GP-1	17237	COMBUSTIBLE, SEPARADOR DE AGUA	GPP-1000	17001-4406	AT9500 con motor/CATERPILLAR C9		
ACEITE, ALGUNOS EJES TRASEROS	GP-3	3280-V-5040	COMBUSTIBLE, SEPARADOR DE AGUA	GPP-1000	17001-4406	ACEITE, CUMPLE CON MEDIDAS ORIGINALES	GP-691	1R0716
COMBUSTIBLE	GP-749	1R0749	COMBUSTIBLE, SEPARADOR DE AGUA	GPP-1000	17001-4406	ACEITE, SEGUNDA OPCION	GP-52	1R0716
ACEITE, LUBRICACION DEL MOTOR (1/04 EN ADELANTE)	GP-52	1R1808	COMBUSTIBLE, SEPARADOR DE AGUA	GPP-1000	17001-4406	COMBUSTIBLE	GP-1109	1R0751
AGUA, SISTEMA DE ENFRIAMIENTO	GP-2071W	9N3368	AT9500 con motor/CUMMINS ISM			AT9500 con motor/CUMMINS ISM		
COMBUSTIBLE, SEPARADOR DE AGUA SELLADO	GPP-1000	17001-4406	ACEITE	GP-9000	3406810	ACEITE	GP-9001	3406809
COMBUSTIBLE, SEPARADOR DE AGUA SELLADO CON PURGADOR	GPP-1291	FS1291	ACEITE	GP-9001	3406809	COMBUSTIBLE, SEPARADOR DE AGUA	GPP-1022S	3406889
AIRE, SECUNDARIO	GA-682R	AF25139M	COMBUSTIBLE, SEPARADOR DE AGUA	GPP-1022S	3406889	AT9500 con motor/CUMMINS ISX		
AIRE, PRIMARIO	GA-683R	AF25345	AT9500 con motor/CUMMINS ISX			ACEITE	GP-9000	3406810
COMBUSTIBLE, SEPARADOR DE AGUA SELLADO CON ROSCA PARA TAZON	S 3226 P	S3226P	ACEITE	GP-9001	3406809	ACEITE	GP-9001	3406809
AT9500 con motor/CATERPILLAR 3306			COMBUSTIBLE	GPP-1007S	3331096	COMBUSTIBLE	GPP-1007S	3331096
ACEITE	GP-51	1R-0739	AT9500 con motor/CUMMINS N14 PLUS			AT9522 con motor/CATERPILLAR C12		
AT9500 con motor/CATERPILLAR 3406			ACEITE	GP-3001	3401544	ACEITE, CUMPLE CON MEDIDAS ORIGINALES	GP-691	1R0716
COMBUSTIBLE	GP-749	1R-0716	ACEITE	GP-3000	3318853	ACEITE, SEGUNDA OPCION	GP-52	1R0716
ACEITE, CUMPLE CON MEDIDAS ORIGINALES	GP-691	F6HZ-9601-CA	COMBUSTIBLE, SEPARADOR DE AGUA	GPP-1000	3889716	COMBUSTIBLE	GP-1108	1R0712
						AIRE	GA-930R	P533930

SERVICIO PESADO

MARCA-MODELO-MOTOR MAKE-MODEL-ENGINE	GONHER GONHER	OEM OEM	MARCA-MODELO-MOTOR MAKE-MODEL-ENGINE	GONHER GONHER	OEM OEM	MARCA-MODELO-MOTOR MAKE-MODEL-ENGINE	GONHER GONHER	OEM OEM
STERLING (continuación)			STERLING (continuación)			STERLING (continuación)		
CAMIONES, TRACTOCAMIONES Y AUTOBUSES			CAMIONES, TRACTOCAMIONES Y AUTOBUSES			CAMIONES, TRACTOCAMIONES Y AUTOBUSES		
AT9522 con motor/CUMMINS M11			L7500 con motor/CATERPILLAR 3126B			L7501 con motor/CUMMINS		
ACEITE	GP-3000	3318853	COMBUSTIBLE, PRIMARIO	GP-26	FD828	AIRE	GA-930R	P533930
COMBUSTIBLE, SEPARADOR DE AGUA	GPP-1000	3329289	ACEITE	GP-51	1R-0739	L8500 con motor/CATERPILLAR 3126B		
AIRE, PRIMARIO	GA-682R	P526947	COMBUSTIBLE, SECUNDARIO	GP-1109	1R-0751	ACEITE	GP-51	1R-0739
AIRE, SECUNDARIO	GA-683R	P527683	AIRE	GA-930R	P533930	COMBUSTIBLE, SECUNDARIO	GP-1109	1R-0751
						AIRE	GA-966R	P532966
AT9522 con motor/DETROIT DIESEL 60 SERIES			L7500 con motor/CATERPILLAR C11			L8500 con motor/CATERPILLAR C11		
COMBUSTIBLE, SECUNDARIO	GP-27	23518530	COMBUSTIBLE	GP-749	1R0749	COMBUSTIBLE	GP-749	1R0749
AGUA, SISTEMA DE ENFRIAMIENTO (REQUIERE 2)	GP-1013Q	23507189	ACEITE, CUMPLE CON MEDI-DAS ORIGINALES	GP-691	1R0716	ACEITE, CUMPLE CON MEDI-DAS ORIGINALES	GP-691	1R0716
ACEITE, REQUIERE 2	GP-193	23527033	ACEITE, SEGUNDA OPCION	GP-52	1R0716	ACEITE, SEGUNDA OPCION	GP-52	1R0716
AIRE, SECUNDARIO	GA-682R	P526947	L7500 con motor/CATERPILLAR C7			L8500 con motor/CATERPILLAR C7		
AIRE, PRIMARIO	GA-683R	AF25345	ACEITE	GP-51	1R0739	ACEITE	GP-51	1R0739
COMBUSTIBLE, SEPARADOR DE AGUA CON ROSCA PARA TAZON	S 3202	23512317	L7500 con motor/CATERPILLAR C9			L8500 con motor/CATERPILLAR C9		
			ACEITE, CUMPLE CON MEDI-DAS ORIGINALES	GP-691	1R0716	ACEITE, CUMPLE CON MEDI-DAS ORIGINALES	GP-691	1R0716
CONDOR con motor/CATERPILLAR 3126B			ACEITE, SEGUNDA OPCION	GP-52	1R0716	ACEITE, SEGUNDA OPCION	GP-52	1R0716
ACEITE	GP-51	1R-0739	COMBUSTIBLE	GP-1109	1R0751	COMBUSTIBLE	GP-1109	1R0751
			L7500 con motor/CUMMINS ISB			L8500 con motor/CUMMINS ISC		
CONDOR con motor/CATERPILLAR C7			ACEITE	GP-3937	3937144	ACEITE	GP-3001	3401544
ACEITE	GP-51	1R0739	COMBUSTIBLE, SEPARADOR DE AGUA	GS-1261	3942470	ACEITE	GP-3000	3318853
			AIRE	GA-966R	P532966	COMBUSTIBLE, SEPARADOR DE AGUA	GPP-1022S	3800394
CONDOR con motor/CATERPILLAR C9			L7500 con motor/DETROIT DIESEL 60 SERIES			AIRE	GA-966R	P532966
ACEITE, CUMPLE CON MEDI-DAS ORIGINALES	GP-691	1R0716	ACEITE	GP-193	23518480	L8500 con motor/MERCEDES BENZ MBE900 DIESEL		
ACEITE, SEGUNDA OPCION	GP-52	1R0716	L7500 con motor/MERCEDES BENZ MBE900 DIESEL			ACEITE	G-3754	1801709
COMBUSTIBLE	GP-1109	1R0751	ACEITE	G-3754	1801709	L8500, LT7500 con motor/DETROIT DIESEL 60 SERIES		
			L7500 con motores/CUMMINS ISC, CUMMINS ISL			ACEITE	GP-193	23518480
CONDOR con motor/CUMMINS ISB			ACEITE	GP-3001	3401544	L9500 con motor/CATERPILLAR 3306		
ACEITE	GP-3937	3937736	ACEITE	GP-3000	3318853	ACEITE	GP-51	1R-0739
			COMBUSTIBLE, SEPARADOR DE AGUA	GPP-1022S	3800394	L9500 con motor/CATERPILLAR 3406		
CONDOR con motor/CUMMINS ISC			AIRE	GA-966R	P532966	COMBUSTIBLE	GP-749	1R-0716
ACEITE	GP-3001	3401544	L7500, L8500 con motor/CATERPILLAR C15			ACEITE, CUMPLE CON MEDI-DAS ORIGINALES	GP-691	F6HZ-9601-CA
ACEITE	GP-3000	3318853	ACEITE, CUMPLE CON MEDI-DAS ORIGINALES	GP-691	1R0716	ACEITE, SEGUNDA OPCION	GP-52	F6HZ-9601-CA
COMBUSTIBLE, SEPARADOR DE AGUA	GPP-1022S	3800394	ACEITE, SEGUNDA OPCION	GP-52	1R0716	COMBUSTIBLE, SEPARADOR DE AGUA	GPP-1000	1R-0749
			COMBUSTIBLE, SEPARADOR DE AGUA CON PURGADOR	GPP-1291	FS1291	L9500 con motor/CATERPILLAR C10		
CONDOR con motor/CUMMINS ISL			AIRE	GA-682R	AF25139M	ACEITE, CUMPLE CON MEDI-DAS ORIGINALES	GP-691	1R-0716
ACEITE	GP-3001	3401544	COMBUSTIBLE, SEPARADOR DE AGUA CON ROSCA PARA TAZON	S 3226 P	S3226P	ACEITE, SEGUNDA OPCION	GP-52	1R-0716
ACEITE	GP-3000	3318853	L7500, L8500, L9500, LT7500, LT8500 con motor/CATERPILLAR C13			COMBUSTIBLE, SECUNDARIO	GP-1108	1R-0712
COMBUSTIBLE, SEPARADOR DE AGUA	GPP-1022S	3355903	COMBUSTIBLE	GP-749	1R0749	ACEITE, DERIVACION (BY PASS)	GP-57	1W-8845
			ACEITE, CUMPLE CON MEDI-DAS ORIGINALES	GP-691	1R0716	L9500 con motor/CATERPILLAR C11		
CONDOR con motor/CUMMINS ISM			ACEITE, SEGUNDA OPCION	GP-52	1R0716	COMBUSTIBLE	GP-749	1R0749
ACEITE	GP-9001	3406809	COMBUSTIBLE, SEPARADOR DE AGUA CON PURGADOR	GPP-1291	FS1291	ACEITE, CUMPLE CON MEDI-DAS ORIGINALES	GP-691	1R0716
			AIRE	GA-682R	AF25139M	ACEITE, SEGUNDA OPCION	GP-52	1R-0712
CONDOR con motores/CATERPILLAR C10, CATERPILLAR C12			COMBUSTIBLE, SEPARADOR DE AGUA CON ROSCA PARA TAZON	S 3226 P	S3226P	ACEITE, SEGUNDA OPCION	GP-52	1R0716
ACEITE, CUMPLE CON MEDI-DAS ORIGINALES	GP-691	1R-0716	L7501 con motor/CATERPILLAR 3126			L9500 con motor/CATERPILLAR C12		
ACEITE, SEGUNDA OPCION	GP-52	1R-0716	ACEITE	GP-51	1R0658	ACEITE, CUMPLE CON MEDI-DAS ORIGINALES	GP-691	1R-0716
COMBUSTIBLE, SECUNDARIO	GP-1108	1R-0712	COMBUSTIBLE	GP-1109	1R0759	COMBUSTIBLE, PRIMARIO	GP-26	E6HT-9155-AA
ACEITE, DERIVACION (BY PASS)	GP-57	1W-8845	AIRE	GA-930R	P533930	ACEITE, SEGUNDA OPCION	GP-52	1R-0716
						COMBUSTIBLE, SECUNDARIO	GP-1108	1R-0712
DD115 con motor/A DIESEL						ACEITE, DERIVACION (BY PASS)	GP-57	1W-8845
ACEITE	G-31	196646				AGUA	GP-2071W	111-2370
HC155, HC115, HC115H, HC144, HC147 con motor/A DIESEL								
ACEITE	G-31	196646						
HCS297H con motor/A DIESEL								
ACEITE, DERIVACION (BY PASS)	G-750	LF750						
HD145, HWS160 con motor/A DIESEL								
ACEITE	G-31	196646						

APLICACIONES SERVICIO PESADO
HEAVY DUTY APPLICATIONS



MARCA-MODELO-MOTOR MAKE-MODEL-ENGINE	GONHER GONHER	OEM OEM	MARCA-MODELO-MOTOR MAKE-MODEL-ENGINE	GONHER GONHER	OEM OEM	MARCA-MODELO-MOTOR MAKE-MODEL-ENGINE	GONHER GONHER	OEM OEM
STERLING (continuación)			STERLING (continuación)			STERLING (continuación)		
CAMIONES, TRACTOCAMIONES Y AUTOBUSES			CAMIONES, TRACTOCAMIONES Y AUTOBUSES			CAMIONES, TRACTOCAMIONES Y AUTOBUSES		
L9500 con motor/CATERPILLAR C7			ACEITE, SEGUNDA OPCION	GP-52	1R0716	LT9500 con motor/CATERPILLAR 3306		
ACEITE	GP-51	1R0739	LT7500 con motor/CATERPILLAR C7			ACEITE	GP-51	1R-0739
			ACEITE	GP-51	1R0739	LT9500 con motor/CATERPILLAR 3406		
L9500 con motor/CATERPILLAR C9			LT7500 con motor/CATERPILLAR C9			COMBUSTIBLE	GP-749	1R-0716
ACEITE, CUMPLE CON MEDIDAS ORIGINALES	GP-691	1R0716	ACEITE, CUMPLE CON MEDIDAS ORIGINALES	GP-691	1R0716	ACEITE, CUMPLE CON MEDIDAS ORIGINALES	GP-691	F6HZ-9601-CA
ACEITE, SEGUNDA OPCION	GP-52	1R0716	ACEITE, SEGUNDA OPCION	GP-52	1R0716	ACEITE, SEGUNDA OPCION	GP-52	F6HZ-9601-CA
COMBUSTIBLE	GP-1109	1R0751	COMBUSTIBLE	GP-1109	1R0751	COMBUSTIBLE, SEPARADOR DE AGUA	GPP-1000	1R-0749
L9500 con motor/CUMMINS ISM			LT7500 con motor/CUMMINS ISB			LT9500 con motor/CATERPILLAR C10		
ACEITE	GP-9000	3406810	ACEITE	GP-3937	3937144	ACEITE, CUMPLE CON MEDIDAS ORIGINALES	GP-691	1R-0716
ACEITE	GP-9001	3406809	COMBUSTIBLE, SEPARADOR DE AGUA	GS-1261	3942470	ACEITE, SEGUNDA OPCION	GP-52	1R-0716
COMBUSTIBLE, SEPARADOR DE AGUA	GPP-1022S	3406889	AIRE	GA-966R	P532966	COMBUSTIBLE, SECUNDARIO	GP-1108	1R-0712
L9500 con motor/CUMMINS ISX			LT7500 con motor/MERCEDES BENZ MBE900 DIESEL			ACEITE, DERIVACION (BY PASS)	GP-57	1W-8845
ACEITE	GP-9000	3406810	ACEITE	G-3754	1801709	LT9500 con motor/CATERPILLAR C11		
ACEITE	GP-9001	3406809	LT7500 con motores/CUMMINS ISC, CUMMINS ISL			COMBUSTIBLE	GP-749	1R0749
COMBUSTIBLE	GPP-1007S	3331096	ACEITE	GP-3001	3401544	ACEITE, CUMPLE CON MEDIDAS ORIGINALES	GP-691	1R0716
L9500 con motor/CUMMINS N14 PLUS			ACEITE	GP-3000	3318853	ACEITE, SEGUNDA OPCION	GP-52	1R0716
ACEITE	GP-3001	3401544	COMBUSTIBLE, SEPARADOR DE AGUA	GPP-1022S	3800394	LT9500 con motor/CATERPILLAR C12		
ACEITE	GP-3000	3318853	AIRE	GA-966R	P532966	COMBUSTIBLE	GP-749	1R0749
COMBUSTIBLE, SEPARADOR DE AGUA	GPP-1000	3889716	LT7501 con motor/CATERPILLAR 3126			ACEITE, CUMPLE CON MEDIDAS ORIGINALES	GP-691	1R-0716
L9500 con motor/CUMMINS SIGNATURE 600			ACEITE	GP-51	1R0658	COMBUSTIBLE, PRIMARIO	GP-26	E6HT-9155-AA
ACEITE	GP-9000	3406810	COMBUSTIBLE	GP-1109	1R0759	ACEITE, SEGUNDA OPCION	GP-52	1R-0716
ACEITE	GP-9001	3406809	AIRE	GA-930R	P533930	COMBUSTIBLE, SECUNDARIO	GP-1108	1R-0712
COMBUSTIBLE	GPP-1007S	3331096	LT7501 con motor/CUMMINS			ACEITE, DERIVACION (BY PASS)	GP-57	1W-8845
L9500 con motor/DETROIT DIESEL 60 SERIES			AIRE	GA-930R	P533930	AGUA	GP-2071W	111-2370
COMBUSTIBLE, PRIMARIO	GP-26	23518481	LT8500 con motor/CATERPILLAR 3126B			COMBUSTIBLE, SEPARADOR DE AGUA CON PURGADOR	GPP-1291	FS1291
COMBUSTIBLE, SECUNDARIO	GP-27	23518482	ACEITE	GP-51	1R-0739	COMBUSTIBLE, SEPARADOR DE AGUA CON ROSCA PARA TAZON	S 3226 P	S3226P
ACEITE	GP-193	23518480	COMBUSTIBLE, SECUNDARIO	GP-1109	1R-0751	LT9500 con motor/CATERPILLAR C13		
COMBUSTIBLE, SEPARADOR DE AGUA CON PURGADOR	GPP-1291	FS1291	AIRE	GA-966R	P532966	COMBUSTIBLE	GP-749	1R0749
AIRE	GA-682R	P527682	LT8500 con motor/CATERPILLAR C11			ACEITE, CUMPLE CON MEDIDAS ORIGINALES	GP-691	1R0716
COMBUSTIBLE, SEPARADOR DE AGUA CON ROSCA PARA TAZON	S 3226 P	S3226P	COMBUSTIBLE	GP-749	1R0749	ACEITE, SEGUNDA OPCION	GP-52	1R0716
L9500 con motor/MERCEDES BENZ MBE900 DIESEL			ACEITE, CUMPLE CON MEDIDAS ORIGINALES	GP-691	1R0716	COMBUSTIBLE, SEPARADOR DE AGUA CON PURGADOR	GPP-1291	FS1291
ACEITE	G-3754	1801709	ACEITE, SEGUNDA OPCION	GP-52	1R0716	AIRE	GA-930R	P533930
L9500, LT7500, LT8500 con motor/CATERPILLAR C15			LT8500 con motor/CATERPILLAR C7			COMBUSTIBLE, SEPARADOR DE AGUA CON ROSCA PARA TAZON	S 3226 P	S3226P
ACEITE, CUMPLE CON MEDIDAS ORIGINALES	GP-691	1R0716	ACEITE	GP-51	1R0739	LT9500 con motor/CATERPILLAR C15		
ACEITE, SEGUNDA OPCION	GP-52	1R0716	LT8500 con motor/CATERPILLAR C9			ACEITE, CUMPLE CON MEDIDAS ORIGINALES	GP-691	1R0716
COMBUSTIBLE, SEPARADOR DE AGUA	GPP-1000	17001-4406	ACEITE, CUMPLE CON MEDIDAS ORIGINALES	GP-691	1R0716	ACEITE, SEGUNDA OPCION	GP-52	1R0716
COMBUSTIBLE, SEPARADOR DE AGUA CON PURGADOR	GPP-1291	FS1291	ACEITE, SEGUNDA OPCION	GP-52	1R0716	COMBUSTIBLE, SEPARADOR DE AGUA	GPP-1000	17001-4406
AIRE	GA-682R	AF25139M	COMBUSTIBLE	GP-1109	1R0751	COMBUSTIBLE, SEPARADOR DE AGUA CON PURGADOR	GPP-1291	FS1291
COMBUSTIBLE, SEPARADOR DE AGUA CON ROSCA PARA TAZON	S 3226 P	S3226P	LT8500 con motor/CUMMINS ISC			AIRE	GA-682R	AF25139M
LT7500 con motor/CATERPILLAR 3126B			ACEITE	GP-3001	3401544	COMBUSTIBLE, SEPARADOR DE AGUA CON ROSCA PARA TAZON	S 3226 P	S3226P
COMBUSTIBLE, PRIMARIO	GP-26	FD828	ACEITE	GP-3000	3318853	LT9500 con motor/CATERPILLAR C7		
ACEITE	GP-51	1R-0739	COMBUSTIBLE, SEPARADOR DE AGUA	GPP-1022S	3800394	ACEITE	GP-51	1R0739
COMBUSTIBLE, SECUNDARIO	GP-1109	1R-0751	AIRE	GA-966R	P532966			
AIRE	GA-930R	P533930	LT8500 con motor/DETROIT DIESEL 60 SERIES					
LT7500 con motor/CATERPILLAR C11			ACEITE	GP-193	23518480			
COMBUSTIBLE	GP-749	1R0749	LT8500 con motor/MERCEDES BENZ MBE900 DIESEL					
ACEITE, CUMPLE CON MEDIDAS ORIGINALES	GP-691	1R0716	ACEITE	G-3754	1801709			

SERVICIO PESADO

MARCA-MODELO-MOTOR MAKE-MODEL-ENGINE	GONHER GONHER	OEM OEM	MARCA-MODELO-MOTOR MAKE-MODEL-ENGINE	GONHER GONHER	OEM OEM	MARCA-MODELO-MOTOR MAKE-MODEL-ENGINE	GONHER GONHER	OEM OEM
STERLING (continuación)			STERLING (continuación)			TEREX (continuación)		
CAMIONES, TRACTOCAMIONES Y AUTOBUSES			CAMIONES, TRACTOCAMIONES Y AUTOBUSES			CAMIONES, TRACTOCAMIONES Y AUTOBUSES		
LT9500 con motor/CATERPILLAR C9			SILVER STAR con motor/CUMMINS N14 PLUS			ACEITE	GP-53	3310445
ACEITE, CUMPLE CON MEDIDAS ORIGINALES	GP-691	1R0716	ACEITE	GP-3001	3401544	ACEITE, DERIVACION (BY PASS)	GP-57	3304232
ACEITE, SEGUNDA OPCION	GP-52	1R0716	ACEITE	GP-3000	3318853	COMBUSTIBLE, SEPARADOR DE AGUA	GPP-11	15266846
COMBUSTIBLE	GP-1109	1R0751	COMBUSTIBLE, SEPARADOR DE AGUA	GPP-1000	3889716	ACEITE, DOBLE FLUJO	GP-3000	15266844
LT9500 con motor/CUMMINS ISM			SILVER STAR con motor/CUMMINS SIGNATURE 600			AIRE, SECUNDARIO	GA-6127	9034223
ACEITE	GP-9000	3406810	ACEITE	GP-9000	3406810	AIRE, PRIMARIO	GA-6129	9396294
ACEITE	GP-9001	3406809	ACEITE	GP-9001	3406809	33-03 FUERA DE CARRETERA con motor/DETROIT DIESEL		
COMBUSTIBLE, SEPARADOR DE AGUA	GPP-10225	3406889	COMBUSTIBLE	GPP-10075	3331096	AIRE, PRIMARIO PARA CUMMINS	GA-106	674416
LT9500 con motor/CUMMINS ISX			SILVER STAR con motor/DETROIT DIESEL 60 SERIES			AIRE, PRIMARIO PARA KOMATSU	GA-326	2010262
ACEITE	GP-9000	3406810	COMBUSTIBLE, PRIMARIO	GP-26	23518481	AIRE, SECUNDARIO	GA-206	9377816
ACEITE	GP-9001	3406809	COMBUSTIBLE, SECUNDARIO	GP-27	23518482	33-07 DE VOLTEO con motor/CUMMINS KTA19C		
COMBUSTIBLE	GPP-10075	3331096	ACEITE	GP-193	23518480	COMBUSTIBLE	GP-1101	138626
LT9500 con motor/CUMMINS N14 PLUS			SILVER STAR con motores/CATERPILLAR C15, CATERPILLAR C16			ACEITE	GP-53	3310445
ACEITE	GP-3001	3401544	COMBUSTIBLE	GP-749	1R-0749	ACEITE, DERIVACION (BY PASS)	GP-57	3304232
ACEITE	GP-3000	3318853	ACEITE, CUMPLE CON MEDIDAS ORIGINALES	GP-691	1R-0716	33-07 DE VOLTEO con motor/DETROIT DIESEL 12V-71T		
COMBUSTIBLE, SEPARADOR DE AGUA	GPP-1000	3889716	ACEITE, SEGUNDA OPCION	GP-52	1R-0716	ACEITE, CARTUCHO	G-33	5577106
LT9500 con motor/CUMMINS SIGNATURE 600			SPORTS CHASIS 6500 con motor/CATERPILLAR 3126B			TRANSMISION	G-33	5577106
ACEITE	GP-9000	3406810	ACEITE	GP-51	1R0658	ACEITE, SELLADO	GP-53	25010042
ACEITE	GP-9001	3406809	COMBUSTIBLE	GP-1109	1R0759	33-09 FUERA DE CARRETERA con motor/DETROIT DIESEL 16V-71T		
COMBUSTIBLE	GPP-10075	3331096	COMBUSTIBLE, SEPARADOR DE AGUA CON PURGADOR	GPP-1291	FS1291	TRANSMISION	G-33	5573014
LT9500 con motor/DETROIT DIESEL 60 SERIES			AIRE	GA-197R	P185067	33-11D FUERA DE CARRETERA con motor/DETROIT DIESEL 16V-92TA		
COMBUSTIBLE, PRIMARIO	GP-26	23518481	COMBUSTIBLE, SEPARADOR DE AGUA CON ROSCA PARA TAZON	R 90 P	R90P	TRANSMISION	G-33	5573014
COMBUSTIBLE, SECUNDARIO	GP-27	23518482	COMBUSTIBLE, ROSCA PARA TAZON	R 90 T	FS1291	33-11E DE VOLTEO con motor/CUMMINS KTA38C		
ACEITE	GP-193	23518480	ST9500 con motor/DETROIT DIESEL 60 SERIES			ACEITE	GP-53	3310445
COMBUSTIBLE, SEPARADOR DE AGUA CON PURGADOR	GPP-1291	FS1291	ACEITE	GP-193	23518480	33-60 DE VOLTEO con motor/CUMMINS KTTA19C		
AIRE	GA-682R	P527682				COMBUSTIBLE	GPP-14	3315847
COMBUSTIBLE, SEPARADOR DE AGUA CON ROSCA PARA TAZON	S 3226 P	S3226P	TEREX			ACEITE	GP-53	3310445
LT9500 con motor/MERCEDES BENZ MBE4000			CAMIONES, TRACTOCAMIONES Y AUTOBUSES			ACEITE, DERIVACION (BY PASS)	GP-57	3304232
AIRE	GA-682R	P527682	23-66 DE VOLTEO, 25-66 DE VOLTEO con motor/DEUTZ BF6L413FR			COMBUSTIBLE, SEPARADOR DE AGUA	GPP-11	15266846
LT9500 con motor/MERCEDES BENZ MBE900 DIESEL			ACEITE	GP-54	1162921	350C PAYHAULER DE VOLTEO con motor/CUMMINS QSK19C		
ACEITE	G-3754	1801709	COMBUSTIBLE	GP-1122	1180597	ACEITE, DOBLE FLUJO	GP-3000	15266844
LT9522 con motor/CATERPILLAR C12			AIRE, PRIMARIO PARA CUMMINS	GA-106	2352341	40-66B DE VOLTEO, 40-66C DE VOLTEO con motor/DETROIT DIESEL SERIES 60		
ACEITE, CUMPLE CON MEDIDAS ORIGINALES	GP-691	1R0716	AIRE, PRIMARIO PARA KOMATSU	GA-326	2352341	COMBUSTIBLE, SECUNDARIO	GP-27	23518482
ACEITE, SEGUNDA OPCION	GP-52	1R0716	AIRE, SECUNDARIO	GA-206	9377816	ACEITE	GP-53	25010042
COMBUSTIBLE	GP-1108	1R0712	2366 FUERA DE CARRETERA con motor/DEUTZ BF6L413FR			ACEITE, DERIVACION (BY PASS)	GP-57	23518672
AIRE	GA-930R	P533930	ACEITE	GP-54	1162921	TA40 DE VOLTEO con motor/DETROIT DIESEL SERIES 60		
RWS160, RWS23S, RWS262 con motor/A DIESEL			AIRE, PRIMARIO PARA CUMMINS	GA-106	2352341	COMBUSTIBLE, SECUNDARIO	GP-27	23518482
ACEITE	G-31	196646	AIRE, PRIMARIO PARA KOMATSU	GA-326	2352341	ACEITE	GP-53	25010042
SC7000 (CARGO) con motor/CUMMINS ISB			AIRE, SECUNDARIO	GA-206	9377816	ACEITE, DERIVACION (BY PASS)	GP-57	23518672
ACEITE	GP-3937	3937144	25-66B DE VOLTEO, 30-66 DE VOLTEO con motor/CUMMINS L10			ACEITE	GP-193	23518480
COMBUSTIBLE, SEPARADOR DE AGUA	GS-1261	3942470	COMBUSTIBLE	GPP-14	3315847	TR100 DE VOLTEO con motor/CUMMINS KTA38C		
AIRE	GA-197R	P530300	ACEITE	GP-53	3310445	ACEITE	GP-53	3310445
SC8000 (CARGO) con motor/CUMMINS ISB			ACEITE, DERIVACION (BY PASS)	GP-57	3304232	COMBUSTIBLE	GP-55	3313306
ACEITE	GP-3937	3937144	COMBUSTIBLE, SEPARADOR DE AGUA	GPP-11	15266846	ACEITE, DERIVACION (BY PASS)	GP-57	3304232
SILVER STAR con motor/CUMMINS ISX			ACEITE, DOBLE FLUJO	GP-3000	15266844	TR35 DE VOLTEO con motor/CUMMINS M11		
ACEITE	GP-9000	3406810	25-66C DE VOLTEO, 30-66C DE VOLTEO con motores/CUMMINS LT10, CUMMINS LTA10			ACEITE, DOBLE FLUJO	GP-3000	15266844
ACEITE	GP-9001	3406809	COMBUSTIBLE	GPP-14	3315847	TR40 DE VOLTEO con motor/CUMMINS N14		
COMBUSTIBLE	GPP-10075	3331096				COMBUSTIBLE	GPP-14	3315847
						ACEITE, DOBLE FLUJO	GP-3000	15266844

MARCA-MODELO-MOTOR MAKE-MODEL-ENGINE	GONHER GONHER	OEM OEM
TEREX (continuación)		
CAMIONES, TRACTOCAMIONES Y AUTOBUSES		
COMBUSTIBLE, SEPARADOR DE AGUA	GPP-1000	3329289
TR45 DE VOLTEO, TR60 DE VOLTEO con motor/CUMMINS QSK19		
ACEITE, DOBLE FLUJO	GP-3000	15266844

TEREX
CARGADORAS

650B FRONTAL con motor/PERKINS 1004-4		
ACEITE	GP-1	2654343
72-21 FRONTAL, 72-41 FRONTAL con motor/GMC DIESEL		
ACEITE, DERIVACION (BY PASS)	G-31	5572263
ACEITE	G-33	5573013
COMBUSTIBLE, SECUNDARIO	G-1173	9045087
72-31 FRONTAL con motor/GMC DIESEL		
ACEITE, DERIVACION (BY PASS)	G-31	5572263
ACEITE	G-33	5573013
COMBUSTIBLE, SECUNDARIO CARTUCHO	G-1173	9045087
COMBUSTIBLE, PRIMARIO	GP-26	6438839
COMBUSTIBLE, SECUNDARIO SELLADO	GP-27	6438836
AIRE, SIN ASPAS	GA-27	9030895
AIRE, PRIMARIO	GA-251	9052907
72-31B FRONTAL con motor/DETROIT DIESEL 4-71		
ACEITE, CARTUCHO	G-33	5577106
COMBUSTIBLE, SECUNDARIO CARTUCHO	G-1175	3244142
ACEITE, SELLADO	GP-53	25010042
COMBUSTIBLE, PRIMARIO SELLADO	GP-92	23518527
COMBUSTIBLE, SECUNDARIO SELLADO	GP-93	23518526
AIRE, PRIMARIO	GA-251	9052907
72-51 FRONTAL con motor/GMC 6-71N		
ACEITE, DERIVACION (BY PASS)	G-31	5572263
ACEITE	G-33	5573013
COMBUSTIBLE, SECUNDARIO CARTUCHO	G-1175	3244142
72-51B FRONTAL con motor/GMC DIESEL		
ACEITE	G-33	5573013
TRANSMISION	G-33	5573013
COMBUSTIBLE, SECUNDARIO CARTUCHO	G-1175	3244142
COMBUSTIBLE, PRIMARIO	GP-26	6438839
COMBUSTIBLE, SECUNDARIO SELLADO	GP-27	6438836
72-61 FRONTAL con motor/DETROIT DIESEL 8V-71T		
ACEITE	G-33	5577106
COMBUSTIBLE, PRIMARIO	GP-26	6438839
COMBUSTIBLE, SECUNDARIO	GP-27	23518482
72-71 FRONTAL con motor/GMC 8V-71T		
ACEITE, DERIVACION (BY PASS)	G-31	5572263
ACEITE	G-33	5573013
COMBUSTIBLE, SECUNDARIO	G-1175	3244142
72-71AA FRONTAL con motor/A DIESEL		
ACEITE	G-33	5577106
ACEITE, CONVERTIDOR DE TORSION	G-33	5577106

MARCA-MODELO-MOTOR MAKE-MODEL-ENGINE	GONHER GONHER	OEM OEM
TEREX (continuación)		
CARGADORAS		
COMBUSTIBLE, PRIMARIO	GP-26	6438839
COMBUSTIBLE, SECUNDARIO	GP-27	FF5206
72-71B FRONTAL con motor/DETROIT DIESEL 8V-92T		
TRANSMISION	G-33	5577106
COMBUSTIBLE, PRIMARIO	GP-26	6438839
COMBUSTIBLE, SECUNDARIO	GP-27	23518482
AIRE, PRIMARIO	GA-563	9053259
72-81 FRONTAL con motor/GMC DIESEL		
ACEITE, DERIVACION (BY PASS)	G-31	5572263
ACEITE	G-33	5573013
AIRE, SECUNDARIO	GA-6127	9034223
90C FRONTAL con motor/CUMMINS		
ACEITE	GP-53	3310445
ACEITE, DERIVACION (BY PASS)	GP-57	3304232
COMBUSTIBLE	GPP-11	15266846
90C FRONTAL con motor/DETROIT DIESEL 12V-71		
ACEITE, CARTUCHO	G-33	5577106
SCL515 FRONTAL con motor/DEUTZ F4L1011F		
ACEITE	GP-28	117434
SKL834 FRONTAL con motor/DEUTZ F4M2011		
ACEITE	GP-3816	1163420
SKL873 FRONTAL con motor/PERKINS 1006-60T		
ACEITE	GP-1	2654343
THS15 FRONTAL con motor/DETROIT DIESEL SERIES 60		
COMBUSTIBLE, PRIMARIO	GP-26	6438839
COMBUSTIBLE, SECUNDARIO	GP-27	23518482
ACEITE	GP-193	23518480
AIRE, PRIMARIO	GA-356	P182039
AIRE, SECUNDARIO	GA-357	P114931
TX750, TX870, TX760, TX860B con motor/PERKINS		
ACEITE	GP-1	2654403
COMBUSTIBLE	G-296	26561117
COMBUSTIBLE	G-296-B	26561117
HIDRAULICO	GP-761H	3515328-M92
AIRE, RADIAL PRIMARIO	GA-853R	6190627-M1
TX760B con motor/PERKINS 1104C		
ACEITE	GP-31	2654407
HIDRAULICO	GP-761H	3515328-M92
AIRE, RADIAL PRIMARIO	GA-853R	6190627-M1
TX860, TX860SB con motor/PERKINS 1004-40T		
ACEITE	GP-1	2654403
COMBUSTIBLE	G-296	26561117
COMBUSTIBLE	G-296-B	26561117
HIDRAULICO	GP-761H	3515328-M92
AIRE, RADIAL PRIMARIO	GA-853R	6190627-M1

TEREX
EXCAVADORAS

HR18 con motor/MITSUBISHI S4Q2		
ACEITE	GP-462	5527662013
HR20 con motor/A DIESEL		
ACEITE	GP-462	5527662013

MARCA-MODELO-MOTOR MAKE-MODEL-ENGINE	GONHER GONHER	OEM OEM
TEREX (continuación)		
EXCAVADORAS		
HR32 SOBRE ORUGAS con motor/DEUTZ BF4M1012		
ACEITE	GP-54	1162921

TEREX
GRÚAS

AC400 con motor/A DIESEL		
AIRE	GA-697R	P781039
HC275 con motor/CUMMINS QSL9-C TURBO		
ACEITE	GP-9	P550226
TX5519 TELESCOPICA con motor/PERKINS 700 SERIES		
ACEITE	GP-9	2654412

TEREX
MONTACARGAS

SS1056C, TH842, SS842C, TH1056C con motor/JOHN DEERE 4045T POWERTECH		
COMBUSTIBLE	GPP-420	RE60021
SS636C con motor/JOHN DEERE 4045T POWERTECH		
ACEITE	GP-754	RE59754
TB85 con motor/CUMMINS 3.9L		
ACEITE	GP-390	3903224
THS22C TURBO con motor/CUMMINS B3.3		
ACEITE, OPCIONAL	GP-58	P550534
TM200R, TM250R con motor/PERKINS 1004-40T TURBO		
ACEITE	GP-1	2654343
TX51-19M con motor/PERKINS 700 SERIES (2.9L)		
ACEITE	GP-9	2654412

TEREX
NIVELADORAS

D700A con motor/DETROIT DIESEL 6V-71		
ACEITE, CARTUCHO	G-33	5577106
COMBUSTIBLE, PRIMARIO	GP-26	6438839
COMBUSTIBLE, SECUNDARIO	GP-27	23518482
ACEITE, SELLADO	GP-53	25010042
D750 con motor/DETROIT DIESEL 8V-71		
ACEITE, CARTUCHO	G-33	5577106
COMBUSTIBLE, PRIMARIO	GP-26	6438839
COMBUSTIBLE, SECUNDARIO	GP-27	23518482
ACEITE, SELLADO	GP-53	25010042
D800 con motor/DETROIT DIESEL 12V-71		
ACEITE, CARTUCHO	G-33	5577106

TEREX
RASPADORAS

S11E con motor/GMC 4-71N		
ACEITE, DERIVACION (BY PASS)	G-31	5572263
ACEITE	G-33	5573013
COMBUSTIBLE, SECUNDARIO	G-1173	9045087

SERVICIO PESADO

MARCA-MODELO-MOTOR MAKE-MODEL-ENGINE	GONHER GONHER	OEM OEM	MARCA-MODELO-MOTOR MAKE-MODEL-ENGINE	GONHER GONHER	OEM OEM	MARCA-MODELO-MOTOR MAKE-MODEL-ENGINE	GONHER GONHER	OEM OEM
TEREX (continuación)			TEREX (continuación)			TEREX (continuación)		
RASPADORAS			RASPADORAS			RASPADORAS		
S11E, S11E SERIES B con motor/DETROIT DIESEL			ACEITE	G-33	5577106	AIRE, SECUNDARIO	GA-357	9049488
ACEITE, CONVERTIDOR DE TORSION	G-33	5573014	TRANSMISION	G-33	5577106	TS24B con motor/DETROIT DIESEL 12V-71		
S17E con motor/DETROIT DIESEL SERIES 40			COMBUSTIBLE, SECUNDARIO	G-1175	3244142	TRANSMISION	G-33	5573014
COMBUSTIBLE	GP-78	6439163	COMBUSTIBLE, PRIMARIO	GP-26	6438839	AIRE, PRIMARIO	GA-356	9038900
S23E con motor/DETROIT DIESEL 8V-71			COMBUSTIBLE, SECUNDARIO	GP-27	6438836	AIRE, SECUNDARIO	GA-357	9049448
TRANSMISION	G-33	5573014	TS14G con motor/DOS MOTORES DETROIT DIESEL SERIES 40			TS24B con motor/DETROIT DIESEL 12V-71T		
AIRE, PRIMARIO	GA-356	9038900	COMBUSTIBLE	GP-78	6439163	ACEITE	G-33	5577106
AIRE, SECUNDARIO	GA-357	9049448	TS18 con motor/GMC 6V-71N			TS24B con motor/DETROIT DIESEL 6V-71T		
S23E con motor/GMC 8V-71T			ACEITE, DERIVACION (BY PASS)	G-31	5572263	ACEITE	G-33	5577106
ACEITE, DERIVACION (BY PASS)	G-31	5572263	ACEITE	G-33	5573013	COMBUSTIBLE, PRIMARIO	GP-26	6438839
ACEITE	G-33	5573013	TRANSMISION	G-33	5573013	COMBUSTIBLE, SECUNDARIO	GP-27	23518482
ACEITE, CONVERTIDOR DE TORSION	G-33	5573013	COMBUSTIBLE, SECUNDARIO	G-1175	3244142	AIRE, PRIMARIO	GA-356	9038900
TRANSMISION	G-33	5573013	COMBUSTIBLE, PRIMARIO	GP-26	6438839	TS24D con motor/DOS MOTORES DETROIT DIESEL SERIES 60		
COMBUSTIBLE, PRIMARIO	GP-26	6438839	COMBUSTIBLE, SECUNDARIO	GP-27	6438836	ACEITE	GP-193	23518480
COMBUSTIBLE, SECUNDARIO	GP-27	6438836	TS18 con motor/GMC 8V-71N			TS32 con motor/DETROIT DIESEL 12V-71		
AIRE	GA-356	9038900	ACEITE, DERIVACION (BY PASS)	G-31	5572263	AIRE, SIN ASPAS	GA-27	P101240
S24 con motor/GMC 12V-71T			ACEITE	G-33	5573013	TS32 con motor/DETROIT DIESEL 8V-71		
ACEITE, DERIVACION (BY PASS)	G-31	5572263	TRANSMISION	G-33	5573013	TRANSMISION	G-33	5577106
ACEITE	G-33	5573013	COMBUSTIBLE, SECUNDARIO	G-1175	3244142	TS32 con motor/GMC 12V-71T		
TRANSMISION	G-33	5573013	COMBUSTIBLE, PRIMARIO	GP-26	6438839	ACEITE, DERIVACION (BY PASS)	G-31	5572263
S24, S32 con motor/DETROIT DIESEL 12V-71			COMBUSTIBLE, SECUNDARIO	GP-27	6438836	ACEITE	G-33	5573013
TRANSMISION	G-33	5577106	AIRE, SECUNDARIO	GA-357	9035993	TRANSMISION	G-33	5573013
S24B con motor/DETROIT DIESEL 12V-71			TS24 con motor/CUMMINS NTC310			TS32 con motor/GMC 8V-71T		
TRANSMISION	G-33	5573014	TRANSMISION	G-33	5577106	ACEITE, DERIVACION (BY PASS)	G-31	5572263
AIRE, PRIMARIO	GA-356	9038900	ACEITE	G-566	158139	ACEITE	G-33	5573013
AIRE, SECUNDARIO	GA-357	9049448	COMBUSTIBLE, CARTUCHO	G-1143	252193	TRANSMISION	G-33	5573013
S24B con motor/DETROIT DIESEL 12V-71T			COMBUSTIBLE, SELLADO	GP-1101	138626	COMBUSTIBLE, SECUNDARIO	G-1175	3244142
ACEITE	G-33	5577106	ACEITE, DERIVACION (BY PASS)	G-750	101679	TS24 con motor/DETROIT DIESEL 12V-71		
COMBUSTIBLE, PRIMARIO	GP-26	6438839	TS24 con motor/DETROIT DIESEL 12V-71			TRANSMISION	G-33	5577106
COMBUSTIBLE, SECUNDARIO	GP-27	23518482	TRANSMISION	G-33	5577106	AIRE, PRIMARIO	GA-356	9038900
AIRE	GA-356	9038900	AIRE, PRIMARIO	GA-356	9038900	AIRE, SECUNDARIO	GA-357	9049488
S32 con motor/DETROIT DIESEL 16V-71			AIRE, SECUNDARIO	GA-357	9049488	TS24 con motor/GMC 12V-71N		
TRANSMISION	G-33	5577106	TS24 con motor/GMC 12V-71N			ACEITE, DERIVACION (BY PASS)	G-31	5572263
S32 con motor/GMC 12V-71T			ACEITE, DERIVACION (BY PASS)	G-31	5572263	ACEITE	G-33	5573013
ACEITE, DERIVACION (BY PASS)	G-31	5572263	ACEITE	G-33	5573013	TRANSMISION	G-33	5573013
ACEITE	G-33	5573013	TRANSMISION	G-33	5573013	COMBUSTIBLE, SECUNDARIO	G-1175	3244142
TRANSMISION	G-33	5573013	COMBUSTIBLE, PRIMARIO	GP-26	6438839	COMBUSTIBLE, SECUNDARIO	GP-27	6438836
S35E con motor/DETROIT DIESEL 12V-71			COMBUSTIBLE, SECUNDARIO	GP-27	6438836	TS24 con motor/GMC 6-71N		
TRANSMISION	G-33	5573014	TS24 con motor/GMC 6-71N			ACEITE, DERIVACION (BY PASS)	G-31	5572263
S35E con motor/GMC 12V-71T			ACEITE, DERIVACION (BY PASS)	G-31	5572263	ACEITE	G-33	5573013
ACEITE, DERIVACION (BY PASS)	G-31	5572263	ACEITE	G-33	5573013	TRANSMISION	G-33	5573013
ACEITE	G-33	5573013	TRANSMISION	G-33	5573013	COMBUSTIBLE, SECUNDARIO	G-1175	3244142
TRANSMISION	G-33	5573013	COMBUSTIBLE, SECUNDARIO	G-1175	3244142	COMBUSTIBLE, PRIMARIO	GP-26	6438839
SS-24 con motor/DETROIT DIESEL 12V-71			COMBUSTIBLE, SECUNDARIO	GP-27	6438836	COMBUSTIBLE, SECUNDARIO	GP-27	6438836
TRANSMISION	G-33	5577106	TS24 con motor/GMC 8V-71			TS24 con motor/GMC 8V-71		
TANDEM 14, TS14 con motor/DETROIT DIESEL			ACEITE, DERIVACION (BY PASS)	G-31	5572263	ACEITE, DERIVACION (BY PASS)	G-31	5572263
TRANSMISION	G-33	5577106	ACEITE	G-33	5573013	ACEITE	G-33	5573013
TS14B con motor/DETROIT DIESEL 8V-71N			TRANSMISION	G-33	5573013	TRANSMISION	G-33	5573013
AIRE, PRIMARIO	GA-356	9035992	COMBUSTIBLE, SECUNDARIO	G-1175	3244142	COMBUSTIBLE, SECUNDARIO	GP-27	23518482
TS14B con motor/DOS MOTORES GMC 4-71N			COMBUSTIBLE, PRIMARIO	GP-26	6438839	ACEITE, CARTUCHO	G-33	5577106
ACEITE, DERIVACION (BY PASS)	G-31	5572263	COMBUSTIBLE, SECUNDARIO	GP-27	6438836	33-09 CARGADOR con motor/A DIESEL		
			SELLADO	GP-27	6438836	AIRE, PRIMARIO	GA-879	AA2906
			AIRE, PRIMARIO	GA-356	9038900	33-09AA CARGADOR, 33-11 CARGADOR con motor/DETROIT DIESEL 16V-71		
						ACEITE, CARTUCHO	G-33	5577106
						33-09B con motor/CUMMINS		
						ACEITE	GP-53	3310445

TEREX
TRACTORES

33-03B CARGADOR con motor/DETROIT DIESEL 6-71			ACEITE, CARTUCHO	G-33	5577106
COMBUSTIBLE, PRIMARIO	GP-26	6438839	COMBUSTIBLE, SECUNDARIO	GP-27	23518482
ACEITE, SELLADO	GP-53	25010042	33-05 CARGADOR, 33-05B CARGADOR con motor/DETROIT DIESEL 8V-71		
COMBUSTIBLE, PRIMARIO	GP-26	6438839	COMBUSTIBLE, SECUNDARIO	GP-27	23518482
COMBUSTIBLE, SECUNDARIO	GP-27	23518482	ACEITE	GP-53	25010042
33-07 END DUMP con motor/GMC 12V-71			33-07 END DUMP con motor/GMC 12V-71		
ACEITE	G-33	5573013	ACEITE	G-33	5573013
ACEITE, CONVERTIDOR DE TORSION	G-33	5573013	ACEITE, CONVERTIDOR DE TORSION	G-33	5573013
TRANSMISION	G-33	5573013	TRANSMISION	G-33	5573013
33-09 CARGADOR con motor/A DIESEL			33-09 CARGADOR con motor/A DIESEL		
AIRE, PRIMARIO	GA-879	AA2906	AIRE, PRIMARIO	GA-879	AA2906
33-09AA CARGADOR, 33-11 CARGADOR con motor/DETROIT DIESEL 16V-71			33-09AA CARGADOR, 33-11 CARGADOR con motor/DETROIT DIESEL 16V-71		
ACEITE, CARTUCHO	G-33	5577106	ACEITE, CARTUCHO	G-33	5577106
33-09B con motor/CUMMINS			33-09B con motor/CUMMINS		
ACEITE	GP-53	3310445	ACEITE	GP-53	3310445

MARCA-MODELO-MOTOR MAKE-MODEL-ENGINE	GONHER GONHER	OEM OEM	MARCA-MODELO-MOTOR MAKE-MODEL-ENGINE	GONHER GONHER	OEM OEM	MARCA-MODELO-MOTOR MAKE-MODEL-ENGINE	GONHER GONHER	OEM OEM
TEREX (continuación)			TEREX (continuación)			THERMO KING (continuación)		
TRACTORES			TRACTORES			CAMIONES, TRACTOCAMIONES Y AUTOBUSES		
COMBUSTIBLE	GP-55	3313306	82-50 con motor/GMC 12V-71			ACEITE	GP-54	114565
ACEITE, DERIVACION (BY PASS)	GP-57	3304232	ACEITE	G-33	5573013	CGSM253 con motor/A DIESEL		
AGUA	GP-2071W	15264311	82-50 SOBRE ORUGAS con motor/DETROIT DIESEL 12V-71			COMBUSTIBLE, PRIMARIO	GPP-14	FF198
33-11C CARGADOR con motor/DETROIT DIESEL 16V-92			TRANSMISION	G-33	6439400	ACEITE	GP-54	114565
ACEITE, CARTUCHO	G-33	5577106	82-80 con motor/DOS MOTORES GMC 6-71N			COMBUSTIBLE, SECUNDARIO	GP-62	119098
33-11D con motor/DETROIT DIESEL 16V-92TA			ACEITE, DERIVACION (BY PASS)	G-31	5572263	CGSM29, CGSM31 con motor/A DIESEL		
ACEITE, FLUJO TOTAL (FULL FLOW)	GP-53	25013192	ACEITE	G-33	5577106	COMBUSTIBLE, PRIMARIO	G-1174	112230
33-14 CARGADOR con motor/DETROIT DIESEL 12V-149			ACEITE, CONVERTIDOR DE TORSION	G-33	5577106	COMBUSTIBLE, SECUNDARIO	G-1175	113068
ACEITE, CARTUCHO	G-33	5577106	TRANSMISION	G-33	5577106	ACEITE	GP-54	114565
33-15 CARGADOR, 33-15B CARGADOR con motor/DETROIT DIESEL 16V-149			COMBUSTIBLE, SECUNDARIO	G-1175	3244142	CGSM43 con motor/A DIESEL		
ACEITE, CARTUCHO	G-33	5577106	82-80 SOBRE ORUGAS con motor/DETROIT DIESEL 6-71			COMBUSTIBLE, PRIMARIO	GPP-14	FF198
34-11C CARGADOR con motor/DETROIT DIESEL 16V-92			TRANSMISION	G-33	6439400	ACEITE	GP-54	114565
ACEITE, CARTUCHO	G-33	5577106	92-20 SOBRE ORUGAS con motor/A DIESEL			COMBUSTIBLE, SECUNDARIO	GP-62	119098
66C con motor/HANOMAG D963B			ACEITE	G-33	5577106	CROWN 500, NWD, RMS, SB2, SB-III, SNWD, SUPER UWD, UWD, XNWD con motores/MERCEDES BENZ OM636, ISUZU C201, MERCEDES BENZ C201		
ACEITE	GP-54	922604	COMBUSTIBLE, PRIMARIO	GP-26	6438839	ACEITE, CARTUCHO PARA DERIVACION (BY PASS)	G-31	112685
82-20 SOBRE ORUGAS con motor/DETROIT DIESEL 6-71			COMBUSTIBLE, SECUNDARIO	GP-27	FF5206	COMBUSTIBLE, PRIMARIO	G-1174	112230
ACEITE	G-33	5577106	THERMO KING			COMBUSTIBLE, SECUNDARIO	G-1175	113068
82-20B SOBRE ORUGAS con motor/DETROIT DIESEL 6V-71			CAMIONES, TRACTOCAMIONES Y AUTOBUSES			COMBUSTIBLE, PRIMARIO	GPP-14	FF198
ACEITE, CARTUCHO	G-33	5577106	C201 con motor/A DIESEL			ACEITE, SELLADO	GP-54	114565
COMBUSTIBLE, PRIMARIO	GP-26	6438839	ACEITE, FLUJO COMPLETO (FULL FLOW) ESTANDAR	GP-54	114565	COMBUSTIBLE, SECUNDARIO	GP-62	119098
COMBUSTIBLE, SECUNDARIO	GP-27	23518482	DIESEL, SECUNDARIO (ESTANDAR)	GP-62	119098	COMBUSTIBLE, SECUNDARIO	GP-1107	1390084
ACEITE, SELLADO	GP-53	25010042	DIESEL, PRIMARIO (ESTANDAR)	GP-1105	113725	COMBUSTIBLE, PRIMARIO	GP-1108	115704
82-20B SOBRE ORUGAS con motor/DETROIT DIESEL 6V-71T			DIESEL, SECUNDARIO (HEAVY DUTY)	GP-1107	1390084	ACEITE, SELLADO OPCIONAL	GP-88	1191-00
ACEITE	G-33	5573014	DIESEL, PRIMARIO (HEAVY DUTY)	GP-1108	115704	ACEITE, SELLADO PARA DERIVACION (BY PASS)	GP-67	1191-01
82-30 con motor/GMC			ACEITE, FLUJO COMPLETO (FULL FLOW) HEAVY DUTY	GP-88	1191-00	FB2M5, FB2M6 con motor/MERCEDES BENZ OM636		
ACEITE, DERIVACION (BY PASS)	G-31	5572263	ACEITE, DERIVACION (BY PASS)	GP-67	1191-01	COMBUSTIBLE, PRIMARIO	G-1174	112230
ACEITE	G-33	5573013	AIRE	GA-2804 T	30-01077-00	HK con motor/A DIESEL		
TRANSMISION	G-33	5573013	CGS1250, GS1250, RMN, RMU, SB-II, SENTRY, SUPER NWD, SUWD, UWTD con motores/ISUZU C201, MERCEDES BENZ C201, MERCEDES BENZ OM636			COMBUSTIBLE	GP-62	119098
COMBUSTIBLE, SECUNDARIO	G-1175	3244142	ACEITE, CARTUCHO PARA DERIVACION (BY PASS)	G-31	112685	ACEITE	GP-24	114928
82-30 SOBRE ORUGAS, 82-30B SOBRE ORUGAS con motor/DETROIT DIESEL 6-71			COMBUSTIBLE, PRIMARIO	G-1174	112230	ACEITE, DERIVACION (BY PASS)	GP-67	1191-01
TRANSMISION	G-33	5577106	COMBUSTIBLE, SECUNDARIO	G-1175	113068	KD con motor/THERMO KING TK353		
AIRE, SECUNDARIO	GA-6127	9034223	COMBUSTIBLE, PRIMARIO	GPP-14	FF198	COMBUSTIBLE	GP-62	119098
AIRE, PRIMARIO	GA-6129	9034222	ACEITE, SELLADO	GP-54	114565	KD-II, KD-II MAX con motor/A DIESEL		
82-30B con motor/GMC DIESEL			COMBUSTIBLE, SECUNDARIO	GP-62	119098	COMBUSTIBLE	GP-62	119098
ACEITE, CARTUCHO	G-33	5573013	COMBUSTIBLE, SECUNDARIO	GP-1107	1390084	LR con motor/THERMO KING TK353		
COMBUSTIBLE, PRIMARIO	GP-26	6438839	COMBUSTIBLE, PRIMARIO	GP-1108	115704	COMBUSTIBLE	GP-62	119098
COMBUSTIBLE, SECUNDARIO	GP-27	6438836	ACEITE, SELLADO OPCIONAL	GP-88	1191-00	COMBUSTIBLE, SECUNDARIO	GP-1107	1390084
ACEITE, SELLADO	GP-53	25010042	ACEITE, SELLADO PARA DERIVACION (BY PASS)	GP-67	1191-01	ACEITE	GP-24	114928
82-30T, 82-40, 82-40T con motor/GMC			CGSM122, CGSM152, CGSM129, CGSM142, CGSM145, CGSM147, CGSM150, CGSM151 con motor/A DIESEL			ACEITE, DERIVACION (BY PASS)	GP-67	1191-01
ACEITE, DERIVACION (BY PASS)	G-31	5572263	COMBUSTIBLE, PRIMARIO	GPP-14	FF198	MAGNUM con motor/THERMO KING 486		
ACEITE	G-33	5573013	ACEITE	GP-54	114565	ACEITE	GP-642	127382
TRANSMISION	G-33	5573013	COMBUSTIBLE, SECUNDARIO	GP-62	119098	MD con motor/THERMO KING TK353		
COMBUSTIBLE, SECUNDARIO	G-1175	3244142	CGSM1250, CGSM16, CGSM22 con motor/A DIESEL			COMBUSTIBLE	GP-62	119098
82-40 SOBRE ORUGAS con motor/DETROIT DIESEL 8V-71			COMBUSTIBLE, PRIMARIO	G-1174	112230	MD II con motor/A DIESEL		
TRANSMISION	G-33	5577106	COMBUSTIBLE, SECUNDARIO	G-1175	113068	COMBUSTIBLE	GP-62	119098
AIRE, SECUNDARIO	GA-6127	9034223	CGSM18, CGSM19 con motor/A DIESEL			MD SERIES con motor/THERMO KING 3.66		
AIRE, PRIMARIO	GA-6129	9034222	COMBUSTIBLE, PRIMARIO	G-1174	112230	COMBUSTIBLE	GP-62	119098
			COMBUSTIBLE, SECUNDARIO	G-1175	113068			

SERVICIO PESADO

MARCA-MODELO-MOTOR MAKE-MODEL-ENGINE	GONHER GONHER	OEM OEM	MARCA-MODELO-MOTOR MAKE-MODEL-ENGINE	GONHER GONHER	OEM OEM	MARCA-MODELO-MOTOR MAKE-MODEL-ENGINE	GONHER GONHER	OEM OEM
THERMO KING (continuación)			THERMO KING (continuación)			THERMO KING (continuación)		
CAMIONES, TRACTOCAMIONES Y AUTOBUSES			CAMIONES, TRACTOCAMIONES Y AUTOBUSES			CAMIONES, TRACTOCAMIONES Y AUTOBUSES		
MD1 con motor/THERMO KING TK235			DIESEL	G-276	116285	ACEITE, SELLADO	GP-54	114565
COMBUSTIBLE, SECUNDARIO	GP-62	119098	AIRE	GA-2804 T	30-01077-00	COMBUSTIBLE, SECUNDARIO	GP-62	119098
RCD50 con motor/A DIESEL			SB-III con motor/YANMAR TK486			COMBUSTIBLE, SECUNDARIO	GP-1107	1390084
COMBUSTIBLE, PRIMARIO	G-1174	112230	ACEITE	GP-642	117382	COMBUSTIBLE, PRIMARIO	GP-1108	115704
COMBUSTIBLE, SECUNDARIO	G-1175	113068	SB-III MAX con motor/ISUZU FE 2.2L			ACEITE, SELLADO OPCIONAL	GP-88	1191-00
ACEITE, SELLADO	GP-54	114565	COMBUSTIBLE, SEPARADOR DE AGUA	G-278	117264	ACEITE, SELLADO PARA DERIVACION (BY PASS)	GP-67	1191-01
RD con motor/THERMO KING TK353			ACEITE	GP-642	127382	UMD, URD con motor/THERMO KING TK353		
COMBUSTIBLE	GP-62	119098	DIESEL	G-276	116285	COMBUSTIBLE	GP-62	119098
RD1 con motor/THERMO KING TK235			AIRE	GA-2804 T	30-01077-00	VWD30C con motor/MERCEDES BENZ		
COMBUSTIBLE, SECUNDARIO	GP-62	119098	SB-III SR+ con motor/ISUZU 2.2L			COMBUSTIBLE, PRIMARIO	G-1174	112230
RD-I con motor/THERMO KING 3.66			ACEITE	GP-642	127382	COMBUSTIBLE, SECUNDARIO	G-1175	113068
COMBUSTIBLE	GP-62	119098	SB-III SRT con motor/ISUZU FE 2.2L			COMBUSTIBLE	G-1121	112243
SB-I con motor/ISUZU C201			COMBUSTIBLE, SEPARADOR DE AGUA	G-278	117264	COMBUSTIBLE	G-1123	11-1690
ACEITE, FLUJO TOTAL (FULL FLOW)	GP-54	114565	ACEITE	GP-642	127382	COMBUSTIBLE	GP-1107	FF209
DIESEL, SECUNDARIO	GP-62	119098	DIESEL	G-276	116285	XMD con motor/A DIESEL		
DIESEL, PRIMARIO	GP-1105	113725	AIRE	GA-2804 T	30-01077-00	COMBUSTIBLE, PRIMARIO	GPP-14	FF198
DIESEL, PRIMARIO	GP-1107	1390084	SL100, SL400, SL200, SL300 con motor/A DIESEL			ACEITE	GP-54	114565
DIESEL, SECUNDARIO	GP-1107	1390084	ACEITE	GP-642	127382	COMBUSTIBLE, SECUNDARIO	GP-62	119098
DIESEL, PRIMARIO	GP-1108	115704	SMX, SMX II SR, SMX SR con motor/A DIESEL			ACEITE	GP-3600	114948
ACEITE, FLUJO TOTAL (FULL FLOW)	GP-88	1191-00	COMBUSTIBLE, SEPARADOR DE AGUA	G-278	117264	THERMO KING		
ACEITE, DERIVACION (BY PASS)	GP-67	1191-01	ACEITE	GP-642	127382	MOTORES		
AIRE, HOUSING DESECHABLE	GA-2804 T	30-01077-00	DIESEL	G-276	116285	DI 2.2L		
SB-I con motores/MERCEDES BENZ C201, MERCEDES BENZ OM636			AIRE	GA-2804 T	30-01077-00	ACEITE, FLUJO TOTAL (FULL FLOW), ESTANDAR	GP-54	114565
ACEITE, CARTUCHO PARA DERIVACION (BY PASS)	G-31	112685	SS-VI con motor/A DIESEL			DIESEL, ESTANDAR	GP-62	119098
COMBUSTIBLE, PRIMARIO	G-1174	112230	COMBUSTIBLE, SECUNDARIO	GP-1107	1390084	DIESEL, HEAVY DUTY	GP-1107	1390084
COMBUSTIBLE, SECUNDARIO	G-1175	113068	ACEITE, DERIVACION (BY PASS)	GP-67	1191-01	ACEITE, FLUJO TOTAL (FULL FLOW), HEAVY DUTY	GP-88	1191-00
COMBUSTIBLE, PRIMARIO	GPP-14	FF198	COMBUSTIBLE, PRIMARIO	GPP-1000	FS1000	ACEITE, DERIVACION (BY PASS)	GP-67	1191-01
ACEITE, SELLADO	GP-54	114565	SUPER II con motor/A DIESEL			AIRE	GA-2804 T	30-01077-00
COMBUSTIBLE, SECUNDARIO	GP-62	119098	ACEITE	GP-54	114565	THERMO KING		
COMBUSTIBLE, SECUNDARIO	GP-1107	1390084	ACEITE, DERIVACION (BY PASS)	GP-67	1191-01	UNIDADES DE REFRIGERACIÓN		
COMBUSTIBLE, PRIMARIO	GP-1108	115704	COMBUSTIBLE, SEPARADOR DE AGUA	G-277	116286	LND con motor/LND		
ACEITE, SELLADO OPCIONAL	GP-88	1191-00	COMBUSTIBLE	G-276	116285	ACEITE	GP-462	1564305
ACEITE, SELLADO PARA DERIVACION (BY PASS)	GP-67	1191-01	SUPER-II con motor/THERMO KING 2.2L			LND II con motor/LND II		
SB-I, SB-II, SB-III con motor/ISUZU FE 2.2L			ACEITE, SELLADO OPCIONAL	GP-88	1191-00	ACEITE	GP-462	1564305
ACEITE	GP-642	127382	ACEITE, SELLADO PARA DERIVACION (BY PASS)	GP-67	1191-01	RD II con motor/RD II		
SB-I, SB-II, SB-III, SENTRY con motor/THERMO KING 2.2L			COMBUSTIBLE	G-277	116286	ACEITE, FLUJO TOTAL (FULL FLOW)	GP-462	1564305
ACEITE, SELLADO	GP-54	114565	COMBUSTIBLE	G-276	116285	RS II SR con motor/RS II SR		
COMBUSTIBLE, SECUNDARIO	GP-62	119098	TD con motor/A DIESEL			ACEITE, FLUJO TOTAL (FULL FLOW)	GP-462	1564305
COMBUSTIBLE, SECUNDARIO	GP-1107	1390084	COMBUSTIBLE	GP-62	113726	SDZ con motor/SDZ		
COMBUSTIBLE, SEPARADOR DE AGUA	GPP-11	115947	TD1 FUEL SAVER con motor/THERMO KING TK353			ACEITE, FLUJO TOTAL (FULL FLOW)	GP-462	1564305
ACEITE, SELLADO OPCIONAL	GP-88	1191-00	COMBUSTIBLE	GP-62	119098	SUPER II SR con motor/SUPER II SR		
ACEITE, SELLADO PARA DERIVACION (BY PASS)	GP-67	1191-01	TD-I con motor/THERMO KING 3.66			COMBUSTIBLE, SEPARADOR DE AGUA	G-278	117264
SB-II MAX con motor/A DIESEL			COMBUSTIBLE, SECUNDARIO	GP-62	119098	ACEITE	GP-642	127382
COMBUSTIBLE, SECUNDARIO	G-1175	113068	TWD, UWDT con motores/ISUZU C201, MERCEDES BENZ C201			DIESEL	G-276	116285
COMBUSTIBLE, SECUNDARIO	GP-1107	1390084	ACEITE, CARTUCHO PARA DERIVACION (BY PASS)	G-31	112685	AIRE	GA-2804 T	30-01077-00
ACEITE, OPCIONAL	GP-88	1191-00	COMBUSTIBLE, PRIMARIO	G-1174	112230	TD II con motor/TD II		
ACEITE, DERIVACION (BY PASS)	GP-67	1191-01	COMBUSTIBLE, SECUNDARIO	G-1175	113068	ACEITE, FLUJO TOTAL (FULL FLOW)	GP-462	1564305
SB-III con motor/ISUZU 2.2L			COMBUSTIBLE, PRIMARIO	GPP-14	FF198			
COMBUSTIBLE, SEPARADOR DE AGUA	G-278	117264						
ACEITE	GP-642	127382						

MARCA-MODELO-MOTOR GONHER OEM
MAKE-MODEL-ENGINE GONHER OEM

THERMO KING (continuación)		
UNIDADES DE REFRIGERACIÓN		
TS500 con motor/TS500		
ACEITE, FLUJO TOTAL (FULL FLOW)	GP-462	1564305
TS600 con motor/TS600		
ACEITE, FLUJO TOTAL (FULL FLOW)	GP-462	1564305
XDS SR SERIES con motor/XDS SR		
ACEITE	GP-462	1564305

THOMAS BUS
CAMIONES, TRACTOCAMIONES Y AUTOBUSES

CONVENTIONAL con motor/CATERPILLAR 3126B		
ACEITE	GP-51	1R0739
CONVENTIONAL con motor/CUMMINS ISB		
ACEITE	GP-3937	3937144
CONVENTIONAL con motor/FORD 6.6L DIESEL		
AGUA, SISTEMA DE ENFRIAMIENTO	GP-1010Q	E7HZ-8A424-B
COMBUSTIBLE, SECUNDARIO, REQUIERE 2 PIEZAS	GP-1122	E7HZ-9365-A
ACEITE, REQUIERE 2 PIEZAS, 1986 SOLAMENTE	GP-77	FL781
SEPARADOR DE COMBUSTIBLE, CON PURGADOR	GPP-1287	F1HZ-9365-A
ACEITE, DERIVACION (BY PASS)	G-750	FL750
SEPARADOR DE COMBUSTIBLE, ROSCA PARA TAZON	R 60 P	F1HZ-9365-A
CONVENTIONAL con motor/FORD FD1060 5.9L		
COMBUSTIBLE	GP-1122	F3HZ-9365-E
AGUA, SISTEMA DE ENFRIAMIENTO	GP-2071W	F3HZ-8A424-C
ACEITE	GP-178	F3HZ-6731-B
CONVENTIONAL con motor/GM V8 366 GASOLINA		
ACEITE	GP-23	PF832
ACEITE	GP-205	25160561
COMBUSTIBLE, CON CARBURADOR	GG-20	5650030
COMBUSTIBLE, CON SISTEMA DE INYECCION DE COMBUSTIBLE	GG-46	25121792
CONVENTIONAL con motor/INTERNATIONAL 7.3L		
DIRECCION	G-162H	1691121C1
DIRECCION	G-169	279294C92
COMBUSTIBLE	G-293	FSR-81205
COMBUSTIBLE, SEPARADOR DE AGUA, CON PURGADOR	GPP-547	1677004C91
ACEITE	GP-3766	1804442C1
COMBUSTIBLE	GP-155	1804459C1
AIRE	GA-422	588213C1
AIRE, PRIMARIO	GA-209	476741C1
AIRE, SECUNDARIO	GA-210	482644C1
AIRE	GA-197R	1691027C1
COMBUSTIBLE, SEPARADOR DE AGUA, ROSCA PARA TAZON	R 60 P	1677004C91
CONVENTIONAL con motor/INTERNATIONAL DT360		
COMBUSTIBLE	GPP-14	FFR-8105D
COMBUSTIBLE	G-293	FSR-81205
SEPARADOR DE COMBUSTIBLE, CON PURGADOR	GPP-547	1677004C91

MARCA-MODELO-MOTOR GONHER OEM
MAKE-MODEL-ENGINE GONHER OEM

THOMAS BUS (continuación)		
CAMIONES, TRACTOCAMIONES Y AUTOBUSES		
ACEITE, REQUIERE 2 PIEZAS	GP-88	1811953C1
COMBUSTIBLE	GP-78	1809789C1
SEPARADOR DE COMBUSTIBLE, ROSCA PARA TAZON	R 60 P	1677004C91
CONVENTIONAL con motor/INTERNATIONAL DT408		
SEPARADOR DE COMBUSTIBLE, CON PURGADOR	GPP-547	1677004C91
COMBUSTIBLE, SECUNDARIO	GP-1122	FF5052
AGUA, SISTEMA DE ENFRIAMIENTO	GP-2071W	1822313C1
COMBUSTIBLE	GP-78	1822588C1
ACEITE	GP-152	1819452C1
SEPARADOR DE COMBUSTIBLE, ROSCA PARA TAZON	R 60 P	1677004C91
CONVENTIONAL con motor/INTERNATIONAL DT466		
COMBUSTIBLE	GP-78	1822588C1
CONVENTIONAL con motor/INTERNATIONAL T444E		
SEPARADOR DE COMBUSTIBLE, 1998 EN ADELANTE	G-862	1825864C92
SEPARADOR DE COMBUSTIBLE, HASTA 1997	G-178	1822631C91
ACEITE	GP-562	1814562C1
CONVENTIONAL con motor/MERCEDES BENZ MBE900		
ACEITE	G-3754	000 180 1709
CUT-AWAY CHASSIS con motor/FORD 6.0 TURBO DIESEL		
ACEITE	G-3752	3C3Z-6731-AA
CUT-AWAY CHASSIS con motor/FORD 7.3L TURBO DIESEL		
SEPARADOR DE COMBUSTIBLE, CON CARBURADOR	G-862	F81A-9Z184-AB
SEPARADOR DE COMBUSTIBLE	G-178	F4TZ-9Z-184-B
ACEITE	GP-562	F4TZ-6731-A
AIRE, REQUIERE 2 PIEZAS	GAVW-620	F5UZ-9601-A
CUT-AWAY CHASSIS con motor/FORD V8 5.4L		
ACEITE	GP-68	F1AZ-6731-BD
AIRE	GA-1615	F6ZZ-9601-A
COMBUSTIBLE	GG-986	G89Z-9155-A
CUT-AWAY CHASSIS con motor/GM 5.7L GASOLINA		
ACEITE	GP-205	25160561
AIRE	GA-392	25042562
AIRE	GA-192	6419892
AIRE	GA-413R	15153904
COMBUSTIBLE	GG-46	25121792
COMBUSTIBLE	GG-581	25121801
CUT-AWAY CHASSIS con motor/GM 6.5L DIESEL		
ACEITE	GP-205	25160561
COMBUSTIBLE	GPP-419	12552214
AIRE	GA-392	25043562
CUT-AWAY CHASSIS con motor/GM V8 6.6L DURAMAX		
AIRE	GA-135	2467368
CUT-AWAY CHASSIS con motor/GM V8 8.1L		
ACEITE	GP-408	25324052
AIRE	GA-135	2467368
AIRE	GA-348	25313349
COMBUSTIBLE	GG-46	25171792

MARCA-MODELO-MOTOR GONHER OEM
MAKE-MODEL-ENGINE GONHER OEM

THOMAS BUS (continuación)		
CAMIONES, TRACTOCAMIONES Y AUTOBUSES		
CUT-AWAY CHASSIS con motores/GM V8 4.8L VORTEC, GM V8 6.0L VORTEC		
ACEITE	GP-44	88984215
AIRE	GA-413R	15153904
COMBUSTIBLE, ROSCAS EN AMBOS EXTREMOS	GG-46	25171792
COMBUSTIBLE, ROSCA EN UN SOLO EXTREMO	GG-66	25121293
FS-65 CONVENTIONAL BUS con motor/CUMMINS ISB 5.9L		
ACEITE	GP-3937	3937144
TRANSIT FE con motor/CATERPILLAR 3126B		
ACEITE	GP-51	1R0739
TRANSIT FE con motor/CUMMINS ISB		
ACEITE	GP-3937	3937144
TRANSIT RE con motor/CATERPILLAR 3116		
ACEITE	GP-51	1R0739
TRANSIT RE con motor/CATERPILLAR 3126B		
ACEITE	GP-51	1R0739
TRANSIT RE con motor/CUMMINS ISB		
ACEITE	GP-3937	3937144
TRANSIT RE con motor/CUMMINS ISC		
ACEITE	GP-3001	3401544
ACEITE	GP-3000	3318853
SEPARADOR DE COMBUSTIBLE	GPP-1003S	3800394
SEPARADOR DE COMBUSTIBLE	GPP-1022S	3800394
TRANSIT RE con motor/MERCEDES BENZ MBE900		
ACEITE	G-3754	000 180 1709

TIMBERJACK
EQUIPO FORESTAL

1110D con motor/6068		
COMBUSTIBLE	GPP-419	RE509031

TOYOTA
MONTACARGAS

02-2FDC20, 02-2FDC30 con motor/TOYOTA 2J A DIESEL		
ACEITE	GP-1	15601-78101-71
TRANSMISION PARA FORD	GP-9	40150-30370-71
TRANSMISION PARA CHRYSLER	GP-81	40150-30370-71
AIRE, PRIMARIO	GAK-16	17752-20540-71
02-2FDC25 con motor/TOYOTA 2J A DIESEL		
ACEITE	GP-1	15601-78101-71
TRANSMISION PARA FORD	GP-9	40150-30370-71
TRANSMISION	GP-58	32670-12620-71
TRANSMISION PARA CHRYSLER	GP-81	40150-30370-71
AIRE, PRIMARIO	GAK-16	17752-20540-71
02-3FD10, 02-3FD14, 02-3FD15, 02-3FD18 con motor/TOYOTA 2J A DIESEL		
ACEITE	GP-1	15601-78101-71
ACEITE, CONVERTIDOR DE TORSION PARA FORD	GP-9	40150-30370-71
ACEITE, CONVERTIDOR DE TORSION PARA CHRYSLER	GP-81	40150-30370-71
AIRE, PRIMARIO	GAK-16	17752-20540-71

SERVICIO PESADO

MARCA-MODELO-MOTOR MAKE-MODEL-ENGINE	GONHER GONHER	OEM OEM	MARCA-MODELO-MOTOR MAKE-MODEL-ENGINE	GONHER GONHER	OEM OEM	MARCA-MODELO-MOTOR MAKE-MODEL-ENGINE	GONHER GONHER	OEM OEM
TOYOTA (continuación)			TOYOTA (continuación)			TOYOTA (continuación)		
MONTACARGAS			MONTACARGAS			MONTACARGAS		
3FG50, 3FG60 con motor/TOYOTA 2H A DIESEL			42-5FG20, 42-5FG23 con motor/TOYOTA 4Y			TRANSMISION PARA CHRYSLER	GP-81	40150-30370-71
TRANSMISION PARA FORD	GP-9	40150-30370-71	TRANSMISION PARA FORD	GP-9	40150-30370-71	52-6FGCU45 con motor/GMC V6-4.3L		
			ACEITE	GP-38	15601-76001-71	TRANSMISION	GP-58	32670-12620-71
			TRANSMISION PARA CHRYSLER	GP-81	40150-30370-71	5FBC15, 5FBC18, 5FBC20, 5FBC25, 5FBC28, 5FBC30 con motor/A DIESEL		
3FGC30 con motor/TOYOTA 5P			42-5FG25 con motor/TOYOTA 4Y			AIRE	GAK-403	17702-30750-71
ACEITE	GP-1	15601-78101-71	TRANSMISION PARA FORD	GP-9	40150-30370-71	5FD10, 5FD14, 5FD15, 5FD18 con motor/TOYOTA 1DZ A DIESEL		
			ACEITE	GP-38	15601-76001-71	ACEITE	GP-1	15600-76003-71
40-2FG7 con motor/TOYOTA 4P			TRANSMISION OPCIONAL	GP-58	32670-12620-71	5FD10, 5FD14, 5FD15, 5FD18 con motor/TOYOTA 4P		
ACEITE, FORD	GP-9	40150-30370-71	ACEITE	GP-156	90915-YZZA1	ACEITE, FORD	GP-9	40150-30370-71
			TRANSMISION PARA CHRYSLER	GP-81	40150-30370-71	ACEITE, CHRYSLER	GP-81	40150-30370-71
40-2FG7 con motor/TOYOTA 5K A GASOLINA			42-5FG30, 42-5FG14, 42-5FG15, 42-5FG18, 42-5FG28 con motor/A DIESEL			AIRE	GAK-16	17802-23000-71
ACEITE	GP-156	90915-10002	ACEITE	GP-38	15601-33021	5FD10, 5FD18, 5FD14, 5FD15 con motor/TOYOTA 2J		
			42-5FG25 con motor/A DIESEL			ACEITE	GP-1	15601-96101
40-2FG9 con motor/TOYOTA 4P			ACEITE	GP-38	15601-33021	5FD20 con motor/TOYOTA 1Z		
ACEITE, FORD	GP-9	40150-30370-71	42-6FG25 con motor/A DIESEL			ACEITE	GP-1	15601-96101
ACEITE	GP-156	90915-10002	TRANSMISION OPCIONAL	GP-58	32670-12620-71	5FD20 con motor/TOYOTA 4P		
ACEITE, CHRYSLER	GP-81	40150-30370-71	42-6FGCU25 con motor/A DIESEL			ACEITE, FORD	GP-9	40150-30370-71
40-3FD50, 40-3FD60 con motor/TOYOTA 2D			TRANSMISION OPCIONAL	GP-58	32670-12620-71	5FD23 con motor/TOYOTA 1Z		
TRANSMISION PARA FORD	GP-9	40150-30370-71	42-FG18, 42-FG23 con motor/TOYOTA 5R A GASOLINA			ACEITE	GP-1	15601-96101
			ACEITE, CONVERTIDOR DE TORSION PARA FORD	GP-9	40150-30370-71	5FD23 con motor/TOYOTA 4P		
40-4FGC20, 40-4FGC25 con motor/TOYOTA 5R A GASOLINA			42-FGC18, 42-FGC23 con motor/TOYOTA 5R A GASOLINA			ACEITE, FORD	GP-9	40150-30370-71
AIRE	GAK-16	17752-20540-71	TRANSMISION PARA FORD	GP-9	40150-30370-71	5FD25 con motor/TOYOTA 1Z		
			TRANSMISION PARA CHRYSLER	GP-81	40150-30370-71	ACEITE	GP-1	15601-96101
40-5FG10, 40-5FG18, 40-5FG14, 40-5FG15 con motor/TOYOTA 4Y A GASOLINA			AIRE	GAK-16	17802-23000-71	5FD25 con motor/TOYOTA 4P		
ACEITE	GP-38	15601-76001-71	4FD20, 4FD23 con motor/TOYOTA 2J DIESEL			ACEITE, FORD	GP-9	40150-30370-71
			ACEITE	GP-1	15601-78101-71	5FD28, 5FD30 con motor/TOYOTA 1Z		
40-5FG20, 40-5FG23, 40-5FG25 con motor/TOYOTA 4Y			4FD25 con motor/TOYOTA 2J			ACEITE	GP-1	15601-96101
TRANSMISION PARA FORD	GP-9	40150-30370-71	ACEITE	GP-1	15601-78101-71	TRANSMISION PARA FORD	GP-9	40150-30370-71
ACEITE	GP-38	15601-76001-71	4FG10, 4FG14 con motor/TOYOTA 4P A GASOLINA			TRANSMISION PARA CHRYSLER	GP-81	40150-30370-71
TRANSMISION PARA CHRYSLER	GP-81	40150-30370-71	ACEITE	GP-1	15601-78101-71	AIRE	GAK-16	17802-23000-71
			4FG15 con motor/A DIESEL			5FD28, 5FD30 con motor/TOYOTA 2J		
40-FG25 con motor/A DIESEL			ACEITE	GP-171	15601-44011	ACEITE	GP-1	15601-96101
AIRE, SIN ASPAS	GA-33	17791-11120-71	4FG15, 4FG18 con motor/TOYOTA 4P A GASOLINA			TRANSMISION PARA FORD	GP-9	40150-30370-71
			ACEITE	GP-1	15601-78101-71	TRANSMISION PARA CHRYSLER	GP-81	40150-30370-71
40-FGC18, 40-FGC23 con motor/TOYOTA 5R A GASOLINA			4FG20, 4FG23, 4FG25 con motor/TOYOTA 4P A GASOLINA			AIRE	GAK-16	17802-23000-71
AIRE	GAK-16	17752-20540-71	ACEITE, FORD	GP-9	40150-30370-71	5FD33, 5FD45, 5FD35, 5FD40 con motor/TOYOTA 11Z A DIESEL		
			4FG20, 4FG23, 4FG25 con motor/TOYOTA 4P A GASOLINA			ACEITE	GP-1	15600-41010
42-3FG20, 42-3FG25 con motor/TOYOTA 5R A GASOLINA			ACEITE, FORD	GP-9	40150-30370-71	TRANSMISION PARA FORD	GP-9	40150-30370-71
TRANSMISION PARA FORD	GP-9	40150-30370-71	4FGC20, 4FGC25 con motor/TOYOTA 4P A GASOLINA			TRANSMISION PARA CHRYSLER	GP-81	40150-30370-71
			ACEITE, FORD	GP-9	40150-30370-71	5FD50, 5FD60 con motor/TOYOTA 12Z A DIESEL		
42-4FG10, 42-4FG18, 42-4FG14, 42-4FG15 con motor/TOYOTA 5R A GASOLINA			ACEITE, CHRYSLER	GP-81	40150-30370-71	ACEITE	GP-1	15600-41010
ACEITE, CONVERTIDOR DE TORSION PARA FORD	GP-9	40150-30370-71	AIRE	GAK-16	17802-23000-71	5FD70 con motor/TOYOTA 12Z A DIESEL		
			4FGL20 con motor/A DIESEL			ACEITE	GP-1	15600-41010
42-4FG20, 42-4FG23, 42-4FG25 con motor/TOYOTA 5R A GASOLINA			ACEITE	GP-171	15601-44011	5FD80 con motor/A DIESEL		
TRANSMISION PARA FORD	GP-9	40150-30370-71	50-4FD20, 50-4FD23, 50-4FD25 con motor/TOYOTA 2JT A DIESEL			AIRE	GAK-403	17702-30750-71
			ACEITE	GP-1	15601-78101-71	5FDC20, 5FDC25 con motor/TOYOTA 2J A DIESEL		
TRANSMISION PARA CHRYSLER	GP-81	40150-30370-71	52-4FD20, 52-4FD23, 52-4FD25 con motor/TOYOTA 2JT A DIESEL			ACEITE	GP-1	15601-96101
AIRE	GAK-16	17802-23000-71	ACEITE	GP-1	15601-78101-71			
			TRANSMISION PARA FORD	GP-9	40150-30370-71			

SERVICIO PESADO

MARCA-MODELO-MOTOR MAKE-MODEL-ENGINE	GONHER GONHER	OEM OEM	MARCA-MODELO-MOTOR MAKE-MODEL-ENGINE	GONHER GONHER	OEM OEM	MARCA-MODELO-MOTOR MAKE-MODEL-ENGINE	GONHER GONHER	OEM OEM
TOYOTA (continuación)			TOYOTA (continuación)			TOYOTA (continuación)		
MONTACARGAS			MONTACARGAS			MONTACARGAS		
TRANSMISION PARA FORD	GP-9	40150-30370-71	ACEITE, CHRYSLER	GP-81	15601-78001-71	5FGC30 con motor/TOYOTA 4Y A GASOLINA		
ACEITE	GP-38	15601-33021				TRANSMISION PARA FORD	GP-9	15601-78001-71
TRANSMISION PARA CHRYSLER	GP-81	40150-30370-71	5FGC10, 5FGC13, 5FGC15 con motor/TOYOTA 4Y A GASOLINA			ACEITE	GP-38	15601-33021
AIRE	GAK-16	17802-23000-71	ACEITE	GP-38	15601-33021	TRANSMISION PARA CHRYSLER	GP-81	15601-78001-71
			5FGC18 con motor/TOYOTA 2J A DIESEL			5GF10 con motor/TOYOTA 4P A GASOLINA		
5FDC20, 5FDC25 con motor/TOYOTA 4Y A GASOLINA			ACEITE	GP-1	15600-41010	ACEITE, FORD	GP-9	40150-30370-71
TRANSMISION PARA FORD	GP-9	40150-30370-71	ACEITE, FORD	GP-9	15601-78001-71			
ACEITE	GP-38	15601-33021	ACEITE, CHRYSLER	GP-81	15601-78001-71	5GF10 con motor/TOYOTA 5K A GASOLINA		
TRANSMISION PARA CHRYSLER	GP-81	40150-30370-71				ACEITE	GP-156	90915-03004
AIRE	GAK-16	17802-23000-71	5FGC18 con motor/TOYOTA 4Y			60-3FG20, 60-3FG25, 60-4FG20, 60-4FG23, 60-4FG25, 60-FG23 con motor/TOYOTA 5P A GASOLINA		
			ACEITE, FORD	GP-9	15601-78001-71	ACEITE	GP-1	15601-78101-71
5FDC25 con motor/TOYOTA G1600			ACEITE	GP-38	15601-33021			
ACEITE	GP-1	15601-96101	ACEITE, CHRYSLER	GP-81	15601-78001-71	60-4FG15, 60-4FG18, 60-FG18, 60-4FG10, 60-4FG14 con motor/TOYOTA 5P A GASOLINA		
			AIRE	GAK-16	17802-23000-71	ACEITE	GP-1	15601-78101-71
5FDC30 con motor/TOYOTA 2J			5FGC2 con motor/TOYOTA 2J A DIESEL			60-4FGC20, 60-4FGC25, 60-FGC18, 60-FGC23 con motor/TOYOTA 5P A GASOLINA		
ACEITE	GP-1	15601-78101-71	ACEITE	GP-1	15600-41010	ACEITE, FORD	GP-9	40150-30370-71
TRANSMISION PARA FORD	GP-9	40150-30370-1	TRANSMISION PARA FORD	GP-9	15601-78001-71	ACEITE, CHRYSLER	GP-81	40150-30370-71
TRANSMISION PARA CHRYSLER	GP-81	40150-30370-1	TRANSMISION PARA CHRYSLER	GP-81	15601-78001-71	AIRE	GAK-16	17752-20540-71
AIRE	GAK-16	17802-23000-71	5FGC2 con motor/TOYOTA 4Y A GASOLINA			60-5FD20, 60-5FD23, 60-5FD25, 60-5FD28, 60-5FD30 con motor/TOYOTA 1DZ		
			ACEITE	GP-38	15601-33021	ACEITE	GP-1	15601-78101-71
5FDC30 con motor/TOYOTA 4Y			TRANSMISION PARA CHRYSLER	GP-81	15601-78001-71	62-3FG20, 62-FG23, 62-3FG25, 62-4FG20, 62-4FG23, 62-4FG25 con motor/TOYOTA 5P A GASOLINA		
TRANSMISION PARA FORD	GP-9	40150-30370-71	5FGC20 con motor/TOYOTA 2J A DIESEL			ACEITE	GP-1	15601-78101-71
ACEITE	GP-38	15601-33021	ACEITE	GP-1	15600-41010	TRANSMISION PARA FORD	GP-9	40150-30370-71
TRANSMISION PARA CHRYSLER	GP-81	40150-30370-71	TRANSMISION PARA FORD	GP-9	15601-78001-71	TRANSMISION PARA CHRYSLER	GP-81	40150-30370-71
AIRE	GAK-16	17802-23000-71	TRANSMISION PARA CHRYSLER	GP-81	15601-78001-71	62-4FG10, 62-4FG14, 62-4FG15, 62-4FG18, 62-FG18 con motor/TOYOTA 5P A GASOLINA		
			5FGC23 con motor/TOYOTA 4Y A GASOLINA			ACEITE	GP-1	15601-78101-71
5FG10, 5FG25, 5FG20, 5FG23 con motor/TOYOTA 4P			ACEITE	GP-38	15601-33021	ACEITE, CONVERTIDOR DE TORSION PARA FORD	GP-9	40150-30370-71
ACEITE, FORD	GP-9	15601-78001-71	TRANSMISION PARA FORD	GP-9	15601-78001-71	ACEITE, CONVERTIDOR DE TORSION PARA CHRYSLER	GP-81	40150-30370-71
ACEITE, CHRYSLER	GP-81	15601-78001-71	TRANSMISION PARA CHRYSLER	GP-81	15601-78001-71	AIRE	GAK-16	17752-20540-71
AIRE	GAK-16	17802-23000-71	5FGC25 con motor/TOYOTA 2J A DIESEL			62-4FGC20, 62-FGC23, 62-4FGC25, 62-FGC18 con motor/TOYOTA 5P A GASOLINA		
			ACEITE	GP-1	15600-41010	ACEITE, FORD	GP-9	40150-30370-71
5FG14, 5FG15, 5FG18 con motor/TOYOTA 4P A GASOLINA			TRANSMISION PARA FORD	GP-9	15601-78001-71	TRANSMISION PARA FORD	GP-9	40150-30370-71
ACEITE, FORD	GP-9	15601-78001-71	TRANSMISION PARA CHRYSLER	GP-81	15601-78001-71	ACEITE, CHRYSLER	GP-81	40150-30370-71
ACEITE, CHRYSLER	GP-81	15601-78001-71	5FGC25 con motor/TOYOTA 4Y A GASOLINA			TRANSMISION PARA CHRYSLER	GP-81	40150-30370-71
AIRE	GAK-16	17802-23000-71	TRANSMISION PARA FORD	GP-9	15601-78001-71	AIRE	GAK-16	17752-20540-71
			TRANSMISION PARA CHRYSLER	GP-81	15601-78001-71	62-5FD25, 62-5FD20, 62-5FD23 con motor/TOYOTA 1DZ		
5FG14, 5FG15, 5FG18 con motor/TOYOTA 5K A GASOLINA			5FGC28 con motor/TOYOTA 2J A DIESEL			ACEITE	GP-1	15601-78101-71
ACEITE	GP-156	90915-03004	ACEITE	GP-38	15601-33021	TRANSMISION PARA FORD	GP-9	40150-30370-71
			TRANSMISION PARA FORD	GP-9	15601-78001-71	TRANSMISION PARA CHRYSLER	GP-81	40150-30370-71
5FG25, 5FG20, 5FG23 con motor/TOYOTA 5K			TRANSMISION PARA CHRYSLER	GP-81	15601-78001-71	62-5FD28, 62-5FD30 con motor/TOYOTA 12		
ACEITE	GP-156	90915-03004	5FGC25 con motor/TOYOTA 4Y A GASOLINA			ACEITE	GP-1	15601-78101-71
			TRANSMISION PARA FORD	GP-9	15601-78001-71	TRANSMISION PARA FORD	GP-9	40150-30370-71
5FG28 con motor/TOYOTA 1Z			TRANSMISION PARA CHRYSLER	GP-81	15601-78001-71	TRANSMISION PARA CHRYSLER	GP-81	40150-30370-71
AIRE	GAK-16	17802-23000-71	TRANSMISION PARA FORD	GP-9	15601-78001-71	AIRE	GAK-16	17752-20540-71
			ACEITE	GP-38	15601-33021	62-5FD28, 62-5FD30 con motor/TOYOTA 12		
5FG28 con motor/TOYOTA 4Y			TRANSMISION PARA CHRYSLER	GP-81	15601-78001-71	ACEITE	GP-1	15601-78101-71
ACEITE	GP-38	15601-76001-71	5FGC28 con motor/TOYOTA 4Y A GASOLINA			TRANSMISION PARA FORD	GP-9	40150-30370-71
			TRANSMISION PARA FORD	GP-9	15601-78001-71	TRANSMISION PARA CHRYSLER	GP-81	40150-30370-71
5FG30 con motor/TOYOTA 1Z			TRANSMISION PARA CHRYSLER	GP-81	15601-78001-71	7FDU30 con motor/TOYOTA 1DZ		
AIRE	GAK-16	17802-23000-71	5FGC30 con motor/TOYOTA 2J A DIESEL			ACEITE, OPCIONAL	GP-58	32670-12620-71
			ACEITE	GP-1	15600-41010	7FGCU20 con motor/A DIESEL		
5FG30 con motor/TOYOTA 4Y			TRANSMISION PARA FORD	GP-9	15601-78001-71	ACEITE	GP-156	892202002
ACEITE	GP-38	15601-76001-71	TRANSMISION PARA CHRYSLER	GP-81	15601-78001-71			
			5FGC28 con motor/TOYOTA 4Y A GASOLINA					
5FG33, 5FG35, 5FG40, 5FG45 con motor/TOYOTA 11Z DIESEL			TRANSMISION PARA FORD	GP-9	15601-78001-71			
ACEITE	GP-1	15600-41010	ACEITE	GP-38	15601-33021			
TRANSMISION PARA FORD	GP-9	40150-30370-71	TRANSMISION PARA CHRYSLER	GP-81	15601-78001-71			
TRANSMISION PARA CHRYSLER	GP-81	40150-30370-71	5FGC30 con motor/TOYOTA 2J A DIESEL					
			ACEITE	GP-1	15600-41010			
5FG50, 5FG60 con motor/A DIESEL			TRANSMISION PARA FORD	GP-9	15601-78001-71			
AIRE	GAK-403	17702-30750-71	TRANSMISION PARA CHRYSLER	GP-81	15601-78001-71			
			5FGC10, 5FGC13, 5FGC15 con motor/TOYOTA 4P A GASOLINA					
ACEITE, FORD	GP-9	15601-78001-71	ACEITE, FORD	GP-9	15601-78001-71			
TRANSMISION	GP-58	32623-12620-71	TRANSMISION	GP-58	32623-12620-71			

MARCA-MODELO-MOTOR MAKE-MODEL-ENGINE	GONHER GONHER	OEM OEM
TOYOTA (continuación)		
MONTACARGAS		
7FGCU20 con motor/TOYOTA 4Y A GASOLINA		
TRANSMISION	GP-58	32670-12620-71
FD18 con motor/TOYOTA 2J A DIESEL		
ACEITE	GP-1	15601-78101-71
FD23, FDT25 con motor/TOYOTA 2J A DIESEL		
ACEITE	GP-1	15601-78101-71
FD70 con motor/TOYOTA 2D		
TRANSMISION PARA FORD	GP-9	40150-30370-71
FDC18 con motor/TOYOTA 2J A DIESEL		
ACEITE	GP-1	15601-78101-71
FDC20 con motor/A DIESEL		
ACEITE	GP-1	15601-78101-71
FDC23, FDC28 con motor/TOYOTA 2J DIESEL		
ACEITE	GP-1	15601-78101-71
FDC33, FDC45, FDC35, FDC40 con motor/TOYOTA 2F A GASOLINA		
ACEITE	GP-1	15600-41010
TRANSMISION PARA FORD	GP-9	40150-30370-71
TRANSMISION PARA CHRYSLER	GP-81	40150-30370-71
FDC33, FDC45, FDC35, FDC40 con motor/TOYOTA 2H A DIESEL		
ACEITE, FORD	GP-9	40150-30370-71
FG18 con motor/TOYOTA 4P A GASOLINA		
ACEITE	GP-1	15601-78101-71
FG20, FG23 con motor/TOYOTA 4P		
ACEITE, FORD	GP-9	15601-96001
FG25 con motor/TOYOTA 5R		
ACEITE	GP-171	15601-44011
FGC10, FGC15 con motor/TOYOTA 5R		
ACEITE	GP-1	15601-78101-71
FGC18, FGC23 con motor/TOYOTA 4P A GASOLINA		
ACEITE, FORD	GP-9	15601-96001
ACEITE, CHRYSLER	GP-81	15601-96001
AIRE	GAK-16	17752-20540-71
FGC20 con motor/TOYOTA 5R		
ACEITE	GP-1	15600-41010
FGC25 con motor/TOYOTA 5R		
ACEITE	GP-1	15601-96101
FGC28 con motor/TOYOTA 5P A GASOLINA		
ACEITE	GP-1	15601-78101-71
FGC33, FGC35, FGC40, FGC45 con motor/TOYOTA 2F A GASOLINA		
ACEITE	GP-1	15600-41010
TRANSMISION PARA FORD	GP-9	40150-30370-71
TRANSMISION PARA CHRYSLER	GP-81	40150-30370-71
FGC33, FGC45, FGC35, FGC40 con motor/TOYOTA 2H A DIESEL		
ACEITE, FORD	GP-9	40150-30370-71
RK101 SERIES, RS50, RU10 con motor/A DIESEL		
ACEITE, FORD	GP-9	115010-0290

MARCA-MODELO-MOTOR MAKE-MODEL-ENGINE	GONHER GONHER	OEM OEM
TRANS TECH		
CAMIONES, TRACTOCAMIONES Y AUTOBUSES		
4500, SRW con motor/GM 6.0L		
ACEITE, 2007 EN ADELANTE	GP-406	89017524
ACEITE, 2003-2006	GP-44	6439857
AIRE	GA-413R	15153904
GASOLINA, 2003-2005 (ROSCA EN AMBOS EXTREMOS)	GG-46	25055046
GASOLINA, 2003-2005 (ROSCA EN UN EXTREMO)	GG-66	25121293
SRW con motor/GM 4.8L		
ACEITE, 2006 EN ADELANTE	GP-406	89017524
ACEITE, 2003-2005	GP-44	6439857
AIRE	GA-413R	15153904
GASOLINA, 2003-2005 (ROSCA EN AMBOS EXTREMOS)	GG-46	25055046
GASOLINA, 2003-2005 (ROSCA EN UN EXTREMO)	GG-66	25121293

VOLKSWAGEN		
CAMIONES, TRACTOCAMIONES Y AUTOBUSES		
CONSTELLATION / 17.250 con motor/CUMMINS 6 ISBE		
ACEITE, DIRECCION	G-162H	HF6162
AGUA, SISTEMA DE ENFRIAMIENTO	GP-2071W	WF2070
AIRE, PRIMARIO	GA-864R	250129620
CONSTELLATION / 19-320 con motor/CUMMINS ISC320		
ACEITE, DIRECCION	G-162H	HF6162
ACEITE	GP-3001	LF9009
AIRE, PRIMARIO	GA-864R	250129620
CONSTELLATION / 24.250 con motor/CUMMINS 6 ISBE		
ACEITE, DIRECCION	G-162H	HF6162
AGUA, SISTEMA DE ENFRIAMIENTO	GP-2071W	WF2070
AIRE, PRIMARIO	GA-864R	250129620
CONSTELLATION / 25.370 con motor/VOLKSWAGEN NGD 370		
ACEITE, DIRECCION	G-162H	HF6162
CONSTELLATION / 31.320 con motor/CUMMINS ISC		
ACEITE, DIRECCION	G-162H	HF6162
ACEITE	GP-3001	LF9009
AIRE, PRIMARIO	GA-864R	250129620
WORKER 24-250E con motor/CUMMINS INTERACT 5.9		
COMBUSTIBLE, PRIMARIO	GP-548	3978040
ACEITE	GP-737	2R0 115 403
COMBUSTIBLE, SECUNDARIO	GPP-103	3355903
AIRE	GA-864R	250129620
WORKER 8-150 con motor/CUMMINS INTERACT 3.9L (4 CIL.)		
COMBUSTIBLE, HASTA MOD-LOS 2007	GPP-103	3355903

VOLVO		
APLANADORAS		
G60, G66 con motor/CUMMINS 4B3.9		
COMBUSTIBLE, SECUNDARIO	GP-1122	36845
COMBUSTIBLE, SEPARADOR DE AGUA	GPP-11	36849
AGUA	GP-2071W	45674
COMBUSTIBLE, PRIMARIO	GPP-18	36846
ACEITE	GP-178	36844

MARCA-MODELO-MOTOR MAKE-MODEL-ENGINE	GONHER GONHER	OEM OEM
VOLVO (continuación)		
APLANADORAS		
G710, G710 VHP, G716 VHP con motor/CUMMINS 6B75.9		
COMBUSTIBLE, SECUNDARIO	GP-1122	36845
COMBUSTIBLE, PRIMARIO	GP-18	36846
ACEITE	GP-178	36844
AIRE, SECUNDARIO	GA-398	28121
GASOLINA	GG-213	59115
G710B, G720B, G726B, G730B con motor/VOLVO D7D		
ACEITE	GP-54	3831236
G720, G720 VHP, G726 VHP, G730, G730 VHP, G736 VHP con motor/CUMMINS 6C8.3		
COMBUSTIBLE, SECUNDARIO	GP-1122	36845
AGUA	GP-1011Q	34654
ACEITE	GP-3000	54429
AGUA	GP-2071W	45674
COMBUSTIBLE, PRIMARIO	GPP-18	36846
AIRE, SECUNDARIO	GA-398	28121
GASOLINA	GG-213	59115
G740, G780 VHP, G740 VHP, G780 con motor/CUMMINS M11		
COMBUSTIBLE, SEPARADOR DE AGUA	GPP-11	36849
AGUA	GP-1011Q	34654
ACEITE	GP-3000	54429
AGUA	GP-2071W	45674
G740B, G746B, G780B con motor/VOLVO D10D		
COMBUSTIBLE, PRIMARIO	GP-96	8193841
COMBUSTIBLE, SEPARADOR DE AGUA	GPP-1291	8159975
ACEITE, DERIVACION (BY PASS)	GP-556	477556
G80, G86 con motor/CUMMINS 4B3.9		
COMBUSTIBLE, SECUNDARIO	GP-1122	36845
COMBUSTIBLE, SEPARADOR DE AGUA	GPP-11	36849
AGUA	GP-2071W	45674
COMBUSTIBLE, PRIMARIO	GPP-18	36846
ACEITE	GP-178	36844

VOLVO		
CAMIONES, TRACTOCAMIONES Y AUTOBUSES		
412 DE VOLTEO, 412B DE VOLTEO con motor/SCANIA		
TRANSMISION	G-162H	3496191
COMBUSTIBLE	G-296	2366284
COMBUSTIBLE	GP-1122	434061
COMBUSTIBLE	G-296-B	236628
ACEITE, TURBOCARGADOR	GP-171	79078234
414 DE VOLTEO, 414B DE VOLTEO con motor/SCANIA		
TRANSMISION	G-162H	3496191
COMBUSTIBLE	GP-1122	434061
ACEITE, TURBOCARGADOR	GP-171	79078234
AIRE, PRIMARIO PARA CUMMINS	GA-106	475081
AIRE, PRIMARIO PARA KOMATSU	GA-326	12000189
AIRE, SECUNDARIO	GA-206	475082
AIRE, SIMPLE	GA-436	309443
420 con motor/CUMMINS N14 PLUS		
ACEITE	GP-3001	LF9009
420 con motor/DETROIT DIESEL SERIES 60		
ACEITE	GP-193	23518480

SERVICIO PESADO

MARCA-MODELO-MOTOR MAKE-MODEL-ENGINE	GONHER GONHER	OEM OEM	MARCA-MODELO-MOTOR MAKE-MODEL-ENGINE	GONHER GONHER	OEM OEM	MARCA-MODELO-MOTOR MAKE-MODEL-ENGINE	GONHER GONHER	OEM OEM
VOLVO (continuación)			VOLVO (continuación)			VOLVO (continuación)		
CAMIONES, TRACTOCAMIONES Y AUTOBUSES			CAMIONES, TRACTOCAMIONES Y AUTOBUSES			CAMIONES, TRACTOCAMIONES Y AUTOBUSES		
420 con motor/VOLVO VED12B			AIRE, PRIMARIO	GA-356	79200549	8500, 8700, 9900 con motor/VOLVO DH12D		
AIRE, PRIMARIO	GA-435R	8076195	AIRE, SECUNDARIO	GA-357	79200556	ACEITE	GP-51	W11102/4
420 DE VOLTEO con motor/SCANIA			610 con motor/DETROIT DIESEL SERIES 60			9300 con motor/VOLVO D9A		
TRANSMISION	G-33	40141558	COMBUSTIBLE, SECUNDARIO	GP-27	23518482	ACEITE	GP-556	119962280
COMBUSTIBLE, PRIMARIO	G-1123	233897	ACEITE	GP-193	23518480	A20 DE VOLTEO con motor/VOLVO TD71G		
COMBUSTIBLE, SECUNDARIO	G-1123	233897	COMBUSTIBLE, SEPARADOR DE AGUA	GPP-1291	P550554	ACEITE	GP-51	4666343
COMBUSTIBLE, SECUNDARIO	G-1123F	7233239	AIRE, PRIMARIO	GA-435R	8076195	COMBUSTIBLE	GP-1122	434061
COMBUSTIBLE	GP-1122	434061	610 con motor/VOLVO VED12			ACEITE, DERIVACION (BY PASS)	GP-556	4084262
ACEITE, TURBOCARGADOR	GP-171	79078234	COMBUSTIBLE	GP-96	8193841	AIRE, PRIMARIO	GA-405	4785748-7
425 DE VOLTEO, 425B DE VOLTEO con motor/SCANIA DS11			ACEITE	GP-51	4666343	A20C DE VOLTEO con motor/A DIESEL		
TRANSMISION	G-33	40141558	COMBUSTIBLE, SEPARADOR DE AGUA	GPP-1291	P550554	ACEITE	GP-51	466634-3
COMBUSTIBLE	GP-1122	434061	ACEITE, DERIVACION (BY PASS)	GP-556	477556	COMBUSTIBLE	GP-1122	466987-5
ACEITE, TURBOCARGADOR	GP-171	79078234	660 con motor/VOLVO			ACEITE, DERIVACION (BY PASS)	GP-556	477556
435 DE VOLTEO con motor/CUMMINS KT1150			COMBUSTIBLE, SEPARADOR DE AGUA	GPP-1291	P550554	AIRE, PRIMARIO	GA-405	4785748-7
TRANSMISION	G-33	40141558	7350 con motor/VOLVO D7C			A25 DE VOLTEO, A25B DE VOLTEO con motor/VOLVO TD71K		
COMBUSTIBLE	GPP-14	12003653	HIDRAULICO	G-162H	4110239	ACEITE	GP-51	466634-3
ACEITE	GP-53	79250015	DIESEL	GP-96	420799-9	COMBUSTIBLE	GP-1122	434061
ACEITE, SELLADO PARA DERIVACION (BY PASS)	GP-57	3131750	COMBUSTIBLE, SEPARADOR DE AGUA	GPP-1061	WK 1060/1	ACEITE, DERIVACION (BY PASS)	GP-556	4084262
AGUA	GP-2071W	3131751	ACEITE	GP-556	119962280	AIRE, PRIMARIO	GA-405	4785748-7
ACEITE, CARTUCHO PARA DERIVACION (BY PASS)	G-750	79199824	7550 con motor/VOLVO N12			A25C DE VOLTEO con motor/A DIESEL		
440 DE VOLTEO con motor/CUMMINS NT855			HIDRAULICO	G-162H	4110239	ACEITE	GP-51	466634-3
TRANSMISION	G-33	40141558	DIESEL	GP-96	420799-9	COMBUSTIBLE	GP-1122	466987-5
ACEITE, TURBOCARGADOR	GP-14	818511	COMBUSTIBLE, SEPARADOR DE AGUA	GPP-1061	WK 1060/1	ACEITE, DERIVACION (BY PASS)	GP-556	477556
COMBUSTIBLE	GPP-14	12003653	ACEITE	GP-556	119962280	AIRE, PRIMARIO	GA-405	4785748-7
ACEITE	GP-53	79250015	770 con motor/CUMMINS ISM			A25D DE VOLTEO con motor/VOLVO D10		
ACEITE, SELLADO PARA DERIVACION (BY PASS)	GP-57	3131750	ACEITE	GP-9000	3406810	COMBUSTIBLE	GP-96	8193841
AGUA	GP-2071W	3131751	770 con motor/CUMMINS ISX			COMBUSTIBLE, SEPARADOR DE AGUA	GPP-1291	8159975
ACEITE, CARTUCHO PARA DERIVACION (BY PASS)	G-750	79199824	ACEITE	GP-9000	3406810	ACEITE, DERIVACION (BY PASS)	GP-556	477556
441 DE VOLTEO, 442 DE VOLTEO, 442B DE VOLTEO, 443 DE VOLTEO con motor/SCANIA DS14A			770 con motor/CUMMINS N14 PLUS			A30 DE VOLTEO con motor/VOLVO TD102 SERIES		
TRANSMISION	G-33	40141558	ACEITE	GP-3001	TECXLF75000	ACEITE	GP-51	466634-3
COMBUSTIBLE	GP-1122	434061	770 con motor/DETROIT DIESEL SERIES 60			ACEITE	GP-54	6211489-7
ACEITE, TURBOCARGADOR	GP-171	79078234	COMBUSTIBLE, SECUNDARIO	GP-27	23518482	COMBUSTIBLE	GP-1122	466987-5
AIRE	GA-356	79200549	ACEITE	GP-193	23518480	AIRE, PRIMARIO	GA-405	4785748-7
AIRE	GA-357	79200556	COMBUSTIBLE, SEPARADOR DE AGUA	GPP-1291	P550554	AIRE, BAJA EMISION	GA-467	11033128-7
445 DE VOLTEO con motor/GMC 12V-71T			AIRE, PRIMARIO	GA-435R	8076195	A30C DE VOLTEO con motores/VOLVO TD103, VOLVO TD104		
ACEITE	G-33	5573013	770 con motor/VOLVO VED12			ACEITE	GP-51	466634-3
TRANSMISION	G-33	5573013	COMBUSTIBLE	GP-96	8193841	ACEITE	GP-54	6211489-7
ACEITE, TURBOCARGADOR	GP-171	79078234	ACEITE	GP-51	4666343	COMBUSTIBLE	GP-1122	466987-5
AIRE	GA-356	79200549	COMBUSTIBLE, SEPARADOR DE AGUA	GPP-1291	P550554	COMBUSTIBLE, PRE-FILTRO	GPP-1291	8159975-5
AIRE	GA-357	79200556	ACEITE, DERIVACION (BY PASS)	GP-556	477556	ACEITE, DERIVACION (BY PASS)	GP-556	477556-5
540 DE VOLTEO con motor/CUMMINS KT1150			8300 con motor/VOLVO D9A			A30D DE VOLTEO con motor/VOLVO D10B		
TRANSMISION	G-33	40141558	HIDRAULICO	GP-317H	3177754	COMBUSTIBLE	GP-96	8193841
COMBUSTIBLE	GPP-14	12003653	8300, 9700 con motor/VOLVO DH12			A30D DE VOLTEO con motor/VOLVO D9		
ACEITE	GP-53	79250015	HIDRAULICO	G-162H	4110239	ACEITE, DERIVACION (BY PASS)	GP-556	477556
ACEITE, DERIVACION (BY PASS)	GP-57	3131750	DIESEL	GP-96	420799-9	A35 DE VOLTEO con motor/VOLVO TD121G		
COMBUSTIBLE, SEPARADOR DE AGUA	GPP-11	3132887	COMBUSTIBLE, SEPARADOR DE AGUA	GPP-1061	WK 1060/1	ACEITE	GP-51	466634-3
AGUA	GP-2071W	3131751	ACEITE	GP-556	119962280	ACEITE	GP-54	6211489-7
AIRE, PRIMARIO	GA-356	79200549	8300 con motor/VOLVO D9A			COMBUSTIBLE	GP-1122	434061
AIRE, SECUNDARIO	GA-357	79200556	HIDRAULICO	G-162H	4110239	ACEITE, RETORNO DEL SISTEMA DE FRENOS	GP-171	3517857-3
550 DE VOLTEO con motor/GMC 16V-71N			DIESEL	GP-96	420799-9	ACEITE, DERIVACION (BY PASS)	GP-556	11996228-0
ACEITE	G-33	5573013	COMBUSTIBLE, SEPARADOR DE AGUA	GPP-1061	WK 1060/1	AIRE, PRIMARIO	GA-356	4881174-9
TRANSMISION	G-33	5573013	ACEITE	GP-556	119962280	AIRE, SECUNDARIO	GA-357	4881175-6

MARCA-MODELO-MOTOR MAKE-MODEL-ENGINE	GONHER GONHER	OEM OEM	MARCA-MODELO-MOTOR MAKE-MODEL-ENGINE	GONHER GONHER	OEM OEM	MARCA-MODELO-MOTOR MAKE-MODEL-ENGINE	GONHER GONHER	OEM OEM
VOLVO (continuación)			VOLVO (continuación)			VOLVO (continuación)		
CAMIONES, TRACTOCAMIONES Y AUTOBUSES			CAMIONES, TRACTOCAMIONES Y AUTOBUSES			CAMIONES, TRACTOCAMIONES Y AUTOBUSES		
A35A PAYHAULER DE VOLTEO con motor/A DIESEL			B10M con motores/VOLVO THD100EC, VOLVO TD100, VOLVO TD100B			B59 con motores/VOLVO D50A, VOLVO HD100A, VOLVO THD100A		
ACEITE	GP-51	4666343	TRANSMISION	G-33	66175068	COMBUSTIBLE, SECUNDARIO	G-1123	233897
COMBUSTIBLE	GP-1122	434061	ACEITE	GP-51	466634	ACEITE	GP-54	423135
ACEITE, DERIVACION (BY PASS)	GP-57	3131750	ACEITE	GP-54	423135	COMBUSTIBLE, SELLADO	GP-1122	243004
AIRE, PRIMARIO	GA-356	79200549	COMBUSTIBLE	GP-1122	243004	COMBUSTIBLE, SEPARADOR DE AGUA OPCIONAL	GPP-1122	838593
AIRE, SECUNDARIO	GA-357	79200556	COMBUSTIBLE, SEPARADOR DE AGUA OPCIONAL	GPP-1122	838593	B6 con motores/VOLVO D60A, VOLVO D60B, VOLVO TD60A, VOLVO TD60B		
A35C DE VOLTEO con motor/VOLVO TD122 SERIES			B10R con motor/VOLVO THD100DB			ACEITE	GP-51	4666343
AGUA, SISTEMA DE ENFRIAMIENTO	GP-2108W	20532237	HIDRAULICO CARTUCHO	G-33	267518	ACEITE	GP-54	469954
ACEITE, FLUJO TOTAL (FULL FLOW), REQUIERE 2 PIEZAS	GP-51	466634-3	TRANSMISION	G-33	66175068	COMBUSTIBLE	GP-1122	4669875
ACEITE, VENTILADOR DE ENFRIAMIENTO	GP-54	6211489-7	ACEITE	GP-51	466634	B615 con motor/VOLVO VDC		
COMBUSTIBLE, REQUIERE 2 PIEZAS	GP-1122	466987-5	ACEITE	GP-54	469954	COMBUSTIBLE, SECUNDARIO	G-1123	233897
SEPARADOR DE COMBUSTIBLE	GPP-1291	8159975	COMBUSTIBLE	GP-1122	4669875	B635 con motores/VOLVO D96AS, VOLVO VDF		
ACEITE, DERIVACION (BY PASS)	GP-556	477556	HIDRAULICO SELLADO	GP-9586	1193976	COMBUSTIBLE, SECUNDARIO	G-1121	233988
AIRE, PRIMARIO, ESTANDAR	GA-356	4881174-9	B1200 con motor/VOLVO D70B			COMBUSTIBLE, SECUNDARIO	G-1123	233897
AIRE, SECUNDARIO, ESTANDAR	GA-357	4881175-6	ACEITE	GP-54	423135	COMBUSTIBLE, PRIMARIO	G-1121F	702582
AIRE, PRIMARIO, S/N 93016	GA-563	11033950	COMBUSTIBLE	GP-1122	4669875	COMBUSTIBLE, PRIMARIO	G-1123F	7233239
A35D DE VOLTEO con motor/VOLVO D12C			COMBUSTIBLE, SEPARADOR DE AGUA OPCIONAL	GPP-1122	838593	B655 con motores/VOLVO D96AS, VOLVO D96L		
COMBUSTIBLE	GP-96	8193841	B54 con motores/VOLVO D50, VOLVO TD50			COMBUSTIBLE, SECUNDARIO	G-1121	233898
COMBUSTIBLE, PRE-FILTRO	GPP-1291	8159975	COMBUSTIBLE, SECUNDARIO	G-1123	233897	B705 con motor/VOLVO TD47A		
ACEITE, DERIVACION (BY PASS)	GP-556	477556	ACEITE	GP-54	469954	COMBUSTIBLE, SECUNDARIO	G-1123	233897
A40 DE VOLTEO con motor/VOLVO TD122			COMBUSTIBLE	GP-1122	4669875	B725 con motores/VOLVO D96AS, VOLVO D96L		
AGUA, SISTEMA DE ENFRIAMIENTO	GP-2108W	20532237	B54 con motores/VOLVO D50A, VOLVO HD100A, VOLVO THD100A, VOLVO THD100D			COMBUSTIBLE, SECUNDARIO	G-1121	233898
ACEITE, FLUJO TOTAL (FULL FLOW), REQUIERE 2 PIEZAS	GP-51	466634-3	COMBUSTIBLE, SECUNDARIO	G-1123	233897	B755 con motor/A DIESEL		
ACEITE, VENTILADOR DE ENFRIAMIENTO	GP-54	6211489-7	ACEITE	GP-54	423135	COMBUSTIBLE, SECUNDARIO	G-1123	233897
COMBUSTIBLE, REQUIERE 2 PIEZAS	GP-1122	466987-5	COMBUSTIBLE	GP-1122	243004	B9M con motor/A DIESEL		
SEPARADOR DE COMBUSTIBLE	GPP-1291	8159975-5	COMBUSTIBLE, SEPARADOR DE AGUA OPCIONAL	GPP-1122	838593	HIDRAULICO CARTUCHO	G-33	267518
ACEITE, DERIVACION (BY PASS)	GP-556	477556-5	B57, B7, BB57 con motores/VOLVO D70A, VOLVO D70B, VOLVO TD70A, VOLVO TD70B, VOLVO TD70E, VOLVO TD70H			ACEITE	GP-54	469954
AIRE, PRIMARIO, ESTANDAR	GA-563	11033950-4	COMBUSTIBLE	G-296	236628	COMBUSTIBLE	GP-1122	4669875
A40D DE VOLTEO con motor/VOLVO D10B			ACEITE	GP-51	466634	HIDRAULICO SELLADO	GP-9586	1193976
COMBUSTIBLE	GP-96	8193841	ACEITE	GP-54	469954	C10M con motor/A DIESEL		
ACEITE	GP-51	466634-3	COMBUSTIBLE	GP-1122	243004	ACEITE	GP-51	4666343
COMBUSTIBLE, SEPARADOR DE AGUA	GPP-1291	8159975	COMBUSTIBLE, SEPARADOR DE AGUA OPCIONAL	GPP-1122	838593	COMBUSTIBLE	GP-1122	2430049
ACEITE, DERIVACION (BY PASS)	GP-556	477556-5	COMBUSTIBLE	G-296-B	236628	ACEITE, DERIVACION (BY PASS)	GP-556	477556
A40D DE VOLTEO con motor/VOLVO D12C			B58 con motores/VOLVO HD100A, VOLVO THD100A, VOLVO THD100D			C11-R con motor/CUMMINS ISB		
COMBUSTIBLE	GP-96	8193841	COMBUSTIBLE, SECUNDARIO	G-1123	233897	COMBUSTIBLE, SEPARADOR DE AGUA	GPP-1060	WK-1060
B10 con motor/VOLVO DH10A			ACEITE	GP-54	469954	COMBUSTIBLE, SEPARADOR DE AGUA	GPP-1061	WK 1060/1
DIRECCION	G-162H	349619	COMBUSTIBLE, SELLADO	GP-1122	4669875	ACEITE	GP-3937	3937144
ACEITE	GP-51	466634	COMBUSTIBLE, SEPARADOR DE AGUA OPCIONAL	GPP-1122	838593	COMBUSTIBLE	GS-1261	3942470
TRANSMISION	GP-22	3517857	B59 con motor/A DIESEL			AIRE, SECUNDARIO	GA-908R	CA9721SY
B10 con motores/VOLVO TD100, VOLVO TD100B, VOLVO THD100EC			ACEITE	GP-54	432135	AIRE, PRIMARIO	GA-909R	AF26111
TRANSMISION	G-33	66175068	COMBUSTIBLE	GP-1122	434061	CITY BUS con motor/VOLVO THD100EA		
ACEITE	GP-51	466634	COMBUSTIBLE, SEPARADOR DE AGUA OPCIONAL	GPP-1122	838593	ACEITE	GP-54	4231353
ACEITE	GP-54	423135	B59 con motor/VOLVO THD100D			COMBUSTIBLE	GP-1122	2430049
COMBUSTIBLE	GP-1122	243004	ACEITE	GP-54	423135	COMBUSTIBLE, SEPARADOR DE AGUA OPCIONAL	GPP-1122	838593
COMBUSTIBLE, SEPARADOR DE AGUA OPCIONAL	GPP-1122	838593	COMBUSTIBLE, SELLADO	GP-1122	241672	DR826 DE VOLTEO con motor/A DIESEL		
B10M con motor/A DIESEL			COMBUSTIBLE, SEPARADOR DE AGUA OPCIONAL	GPP-1122	838593	COMBUSTIBLE, CARTUCHO	G-1121	233574
HIDRAULICO CARTUCHO	G-33	267518				ACEITE	GP-54	4785974-9
ACEITE	GP-54	469954				COMBUSTIBLE, SELLADO	GP-1122	434061
COMBUSTIBLE	GP-1122	4669875						
HIDRAULICO SELLADO	GP-9586	1193976						

SERVICIO PESADO

MARCA-MODELO-MOTOR MAKE-MODEL-ENGINE	GONHER GONHER	OEM OEM	MARCA-MODELO-MOTOR MAKE-MODEL-ENGINE	GONHER GONHER	OEM OEM	MARCA-MODELO-MOTOR MAKE-MODEL-ENGINE	GONHER GONHER	OEM OEM
VOLVO (continuación)			VOLVO (continuación)			VOLVO (continuación)		
CAMIONES, TRACTOCAMIONES Y AUTOBUSES			CAMIONES, TRACTOCAMIONES Y AUTOBUSES			CAMIONES, TRACTOCAMIONES Y AUTOBUSES		
DR860S DE VOLTEO con motor/A DIESEL			F65 con motores/VOLVO TD60A, VOLVO TD60B, VOLVO TD60C			F86 con motores/VOLVO D70A, VOLVO D70B, VOLVO D70C, VOLVO D70D		
COMBUSTIBLE, CARTUCHO	G-1121	233574	DIRECCION	G-162H	349619	COMBUSTIBLE	G-296	2366284
ACEITE	GP-54	4785974-9	ACEITE	GP-51	466634	ACEITE	GP-54	423135
COMBUSTIBLE, SELLADO	GP-1122	434061	ACEITE	GP-54	423135	COMBUSTIBLE, SELLADO	GP-1122	466987
TRANSMISION	GP-66	4787923-4	COMBUSTIBLE	GP-1122	4669875	COMBUSTIBLE	G-296-B	2366284
AIRE	GA-405	4785748-7	F7 con motores/VOLVO TD70F, VOLVO TD70G			ACEITE, DERIVACION (BY PASS)	G-750	1517575
DR860T DE VOLTEO, DR861 DE VOLTEO, DR860TC DE VOLTEO, DR860TL DE VOLTEO con motor/A DIESEL			DIRECCION	G-162H	349619	F86 con motores/VOLVO TD70A, VOLVO TD70E		
COMBUSTIBLE, CARTUCHO	G-1121	233574	ACEITE	GP-51	466634	COMBUSTIBLE	G-296	2366284
ACEITE	GP-54	4785974-9	COMBUSTIBLE	GP-1122	4669875	ACEITE	GP-54	423135
COMBUSTIBLE, SELLADO	GP-1122	434061	ACEITE, DERIVACION (BY PASS)	G-750	1517575	COMBUSTIBLE, SELLADO	GP-1122	466987
TRANSMISION	GP-66	4787923-4	F8 con motor/VOLVO TD70E			COMBUSTIBLE	G-296-B	2366284
F10 con motores/VOLVO TD100, VOLVO TD101, VOLVO TD102			ACEITE	GP-54	423135	ACEITE, DERIVACION (BY PASS)	G-750	1517575
DIRECCION	G-162H	349619	COMBUSTIBLE	GP-1122	2430049	F86T con motor/VOLVO TD100		
ACEITE	GP-51	466634	COMBUSTIBLE, SEPARADOR DE AGUA OPCIONAL	GPP-1122	838593	COMBUSTIBLE, SECUNDARIO	G-1123	233897
ACEITE	GP-54	423135	F82, F82B con motor/A DIESEL			COMBUSTIBLE, PRIMARIO	G-1123F	7233239
HIDRAULICO	GP-54	423135	ACEITE	G-870	482051	ACEITE	GP-54	423135
COMBUSTIBLE	GP-1122	466987	COMBUSTIBLE	G-296	236628	COMBUSTIBLE, SELLADO	GP-1122	243004
F12 con motor/VOLVO TD100			COMBUSTIBLE	G-296-B	236628	COMBUSTIBLE, SEPARADOR DE AGUA OPCIONAL	GPP-1122	838593
DIRECCION	G-162H	349619	F82S con motor/A DIESEL			F87 con motores/VOLVO D70A, VOLVO D70D, VOLVO TD70A, VOLVO TD70E, VOLVO D70B, VOLVO D70C		
ACEITE	GP-54	423135	ACEITE	GP-1	484074	COMBUSTIBLE	G-296	2366284
HIDRAULICO	GP-54	423135	COMBUSTIBLE	G-296	236628	ACEITE	GP-54	423135
COMBUSTIBLE	GP-1122	466987	COMBUSTIBLE	G-296-B	236628	COMBUSTIBLE, SELLADO	GP-1122	466987
F12 con motores/VOLVO TD101, VOLVO TD102, VOLVO TD121, VOLVO TD122			F83, F83B con motor/A DIESEL			COMBUSTIBLE	G-296-B	2366284
DIRECCION	G-162H	349619	ACEITE	G-870	482051	ACEITE, DERIVACION (BY PASS)	G-750	1517575
ACEITE	GP-51	466634	COMBUSTIBLE	G-296	236628	F88, F88B con motores/VOLVO D120, VOLVO TD120		
HIDRAULICO	GP-54	423135	COMBUSTIBLE	G-296-B	236628	ACEITE	GP-54	423135
COMBUSTIBLE	GP-1122	466987	F83S con motor/A DIESEL			COMBUSTIBLE, SELLADO	GP-1122	466987
F16 con motor/VOLVO TD162			ACEITE	GP-1	484074	COMBUSTIBLE, SEPARADOR DE AGUA OPCIONAL	GPP-1122	838593
HIDRAULICO	G-162H	349619	COMBUSTIBLE	G-296	236628	F88, F88T con motores/VOLVO TD100A, VOLVO TD100B		
TRANSMISION PARA FORD	GP-9	1266286	COMBUSTIBLE	G-296-B	236628	COMBUSTIBLE, SECUNDARIO	G-1123	233897
ACEITE	GP-51	466634	F84 con motores/VOLVO D50, VOLVO TD50, VOLVO TD60			COMBUSTIBLE, PRIMARIO	G-1123F	7233239
COMBUSTIBLE	GP-1122	4669875	COMBUSTIBLE, SECUNDARIO	G-1123	233897	ACEITE	GP-54	423135
TRANSMISION PARA CHRYSLER	GP-81	1266286	ACEITE	GP-54	423135	COMBUSTIBLE, SELLADO	GP-1122	466987
ACEITE, DERIVACION (BY PASS)	GP-556	477556	COMBUSTIBLE	GP-1122	466987	COMBUSTIBLE, SEPARADOR DE AGUA OPCIONAL	GPP-1122	838593
F4 con motor/VOLVO D39C			F84, F85, F85M, F85T con motor/VOLVO TD100			F88, F88T, FB88 con motores/VOLVO D100, VOLVO TD100		
DIRECCION	G-162H	349619	COMBUSTIBLE, SECUNDARIO	G-1123	233897	COMBUSTIBLE, SECUNDARIO	G-1123	233897
ACEITE	GP-1	484074	COMBUSTIBLE, PRIMARIO	G-1123F	7233239	COMBUSTIBLE, PRIMARIO	G-1123F	7233239
COMBUSTIBLE	G-296	2366284	ACEITE	GP-54	423135	ACEITE	GP-54	423135
COMBUSTIBLE	G-296-B	2366284	COMBUSTIBLE, SELLADO	GP-1122	243004	COMBUSTIBLE, SELLADO	GP-1122	466987
F4 con motor/VOLVO TD40			COMBUSTIBLE, SEPARADOR DE AGUA OPCIONAL	GPP-1122	838593	F89 con motor/VOLVO D120		
HIDRAULICO	G-162H	349619	F85 con motores/VOLVO D50, VOLVO TD50, VOLVO TD60			ACEITE	GP-54	423135
F6 con motor/VOLVO D60			COMBUSTIBLE, SECUNDARIO	G-1123	233897	COMBUSTIBLE, SELLADO	GP-1122	466987
DIRECCION	G-162H	349619	ACEITE	GP-54	423135	COMBUSTIBLE, SEPARADOR DE AGUA OPCIONAL	GPP-1122	838593
F6 con motores/VOLVO TD60A, VOLVO TD60B, VOLVO TD60C			COMBUSTIBLE, SELLADO	GP-1122	466987	FB86 con motores/VOLVO D70A, VOLVO D70D, VOLVO TD70A, VOLVO TD70E, VOLVO D70B, VOLVO D70C		
DIRECCION	G-162H	349619	COMBUSTIBLE, SEPARADOR DE AGUA OPCIONAL	GPP-1122	838593	COMBUSTIBLE	G-296	2366284
ACEITE	GP-51	466634	F86 con motor/VOLVO TD100			ACEITE	GP-54	423135
ACEITE	GP-54	423135	COMBUSTIBLE, SECUNDARIO	G-1123	233897	COMBUSTIBLE, SELLADO	GP-1122	466987
COMBUSTIBLE	GP-1122	4669875	COMBUSTIBLE, PRIMARIO	G-1123F	7233239	COMBUSTIBLE	G-296-B	2366284
F6 SERIES con motor/A DIESEL			ACEITE	GP-54	423135	ACEITE, DERIVACION (BY PASS)	G-750	1517575
ACEITE	GP-51	4666343	COMBUSTIBLE, SELLADO	GP-1122	243004			
ACEITE	GP-54	432135	COMBUSTIBLE, SEPARADOR DE AGUA OPCIONAL	GPP-1122	838593			
COMBUSTIBLE	GP-1122	434061						
ACEITE, DERIVACION (BY PASS)	G-500	16950073						

APLICACIONES SERVICIO PESADO
HEAVY DUTY APPLICATIONS



MARCA-MODELO-MOTOR MAKE-MODEL-ENGINE	GONHER GONHER	OEM OEM	MARCA-MODELO-MOTOR MAKE-MODEL-ENGINE	GONHER GONHER	OEM OEM	MARCA-MODELO-MOTOR MAKE-MODEL-ENGINE	GONHER GONHER	OEM OEM
VOLVO (continuación)			VOLVO (continuación)			VOLVO (continuación)		
CAMIONES, TRACTOCAMIONES Y AUTOBUSES			CAMIONES, TRACTOCAMIONES Y AUTOBUSES			CAMIONES, TRACTOCAMIONES Y AUTOBUSES		
FB88, FB88T con motores/VOLVO TD100A, VOLVO TD100B			COMBUSTIBLE	GP-1122	4669875	HIDRAULICO PARA CHRYSLER	GP-81	1266286
COMBUSTIBLE, SECUNDARIO	G-1123	233897	TRANSMISION	GP-171	3517857-3	ACEITE, DERIVACION (BY PASS)	G-750	1517575
COMBUSTIBLE, PRIMARIO	G-1123F	7233239	ACEITE, DERIVACION (BY PASS)	GP-556	477556			
ACEITE	GP-54	423135				N10 con motor/VOLVO TD102		
COMBUSTIBLE, SELLADO	GP-1122	466987	FL10 con motores/VOLVO TD101, VOLVO TD102			DIRECCION	G-162H	349619
COMBUSTIBLE, SEPARADOR DE AGUA OPCIONAL	GPP-1122	838593	ACEITE	GP-51	4666343	ACEITE	GP-51	4666343
			COMBUSTIBLE	GP-1122	4669875	COMBUSTIBLE	GP-1122	466987
			ACEITE, DERIVACION (BY PASS)	GP-556	477556			
FE42 con motor/CATERPILLAR 3116			FL4 con motor/VOLVO TD41			N10 con motores/VOLVO TD100, VOLVO TD101		
ACEITE	GP-51	1R0658	DIRECCION	G-162H	349619	DIRECCION	G-162H	349619
COMBUSTIBLE, SEPARADOR DE AGUA OPCIONAL	GPP-11	3132887	ACEITE	GP-54	4231353	ACEITE	GP-51	4666343
COMBUSTIBLE	GP-110	1R0711	COMBUSTIBLE	GPP-1122	12572012	COMBUSTIBLE	GP-1122	466987
						ACEITE, DERIVACION (BY PASS)	G-750	1517575
FE42 con motor/VOLVO VE7			FL6 con motores/VOLVO TD61F, VOLVO TD61G, VOLVO TD61GS			N12 con motor/VOLVO TD120GA		
ACEITE	GP-51	466634	DIRECCION	G-162H	349619	DIRECCION	G-162H	349619
COMBUSTIBLE	GP-1122	466987	ACEITE	GP-51	466634			
ACEITE, DERIVACION (BY PASS)	GP-556	477556	COMBUSTIBLE	GP-1122	466987	N12 con motores/VOLVO TD120, VOLVO TD121, VOLVO TD122		
						DIRECCION	G-162H	349619
FE42, FE42T, FE64 con motor/CATERPILLAR 3176			FL7 con motores/VOLVO TD71, VOLVO TD72			HIDRAULICO PARA FORD	GP-9	1266286
COMBUSTIBLE	GP-749	1R0749	DIRECCION	G-162H	349619	ACEITE	GP-54	423135
ACEITE, CUMPLE CON MEDI-DAS ORIGINALES	GP-691	172015003	ACEITE	GP-51	4666343	COMBUSTIBLE	GP-1122	466987
ACEITE, SEGUNDA OPCION	GP-52	172015003	COMBUSTIBLE	GP-1122	4669875	ACEITE, SELLADO PARA DERIVACION (BY PASS)	GP-57	471392
ACEITE, DERIVACION (BY PASS)	GP-57	3131750	ACEITE, DERIVACION (BY PASS)	GP-556	477556	HIDRAULICO PARA CHRYSLER	GP-81	1266286
						ACEITE, CARTUCHO PARA DERIVACION (BY PASS)	G-750	1517575
FE6 con motor/A DIESEL			FM12 con motor/VOLVO D12C (08/98-01/02)			N12 con motores/VOLVO TD120E, VOLVO TD120G		
ACEITE	GP-51	466634	DIRECCION (ALT. 100 MM)	G-162H	349619	ACEITE	GP-51	4666343
COMBUSTIBLE	GP-1122	466987	COMBUSTIBLE	GP-96	420799			
ACEITE, DERIVACION (BY PASS)	GP-57	471392	ACEITE, FLUJO TOTAL (FULL FLOW) (REQUIERE 2)	GP-51	4666343	N7 con motor/VOLVO TD70G		
			COMBUSTIBLE, SEPARADOR DE AGUA CON PURGADOR	GPP-1291	81599755	DIRECCION	G-162H	349619
FE7 con motor/A DIESEL			ACEITE, DERIVACION (BY PASS)	GP-556	477556	ACEITE	GP-51	4666343
ACEITE	GP-51	466634	COMBUSTIBLE, SEPARADOR DE AGUA CON ROSCA PARA TAZON	R 90 T	R90T	COMBUSTIBLE	GP-1122	466987
COMBUSTIBLE	GP-1122	466987						
ACEITE, DERIVACION (BY PASS)	GP-556	477556	FM12 con motor/VOLVO D12D			N7 con motores/VOLVO TD70B, VOLVO TD70E		
			DIRECCION	G-162H	V349619	DIRECCION	G-162H	349619
FH12 con motor/VOLVO D12A			ACEITE	GP-51	4666343	ACEITE	GP-54	423135
COMBUSTIBLE	GP-96	WK962/7	COMBUSTIBLE	GP-1122	4669875	COMBUSTIBLE	GP-1122	466987
ACEITE	GP-51	4666343	TRANSMISION	GP-171	3517857-3			
ACEITE, DERIVACION (BY PASS)	GP-556	477556	ACEITE, DERIVACION (BY PASS)	GP-556	477556	N84 con motor/VOLVO TD100		
						COMBUSTIBLE, SECUNDARIO	G-1123	233897
FH12 con motor/VOLVO D12D SERIES			FM9 con motor/VOLVO D9A			COMBUSTIBLE, PRIMARIO	G-1123F	7233239
ACEITE, DERIVACION (BY PASS)	GP-556	477556	ACEITE, DERIVACION (BY PASS)	GP-556	477556-5	ACEITE	GP-54	423135
						COMBUSTIBLE, SELLADO	GP-1122	243004
FH16 con motor/VOLVO D16A (08/93-12/03)			G88 con motores/VOLVO D100, VOLVO TD100			COMBUSTIBLE, SEPARADOR DE AGUA OPCIONAL	GPP-1122	838593
TRANSMISION	GP-430	15261886	COMBUSTIBLE, SECUNDARIO	G-1123	233897			
ACEITE, FLUJO TOTAL (FULL FLOW) (REQUIERE 2)	GP-51	466634	COMBUSTIBLE, PRIMARIO	G-1123F	7233239	N84 con motores/VOLVO D50, VOLVO TD50, VOLVO TD60		
COMBUSTIBLE	GP-1122	4669875	ACEITE	GP-54	423135	COMBUSTIBLE, SECUNDARIO	G-1123	233897
COMBUSTIBLE, SEPARADOR DE AGUA CON PURGADOR	GPP-1291	81599755	COMBUSTIBLE, SELLADO	GP-1122	466987	ACEITE	GP-54	423135
ACEITE, DERIVACION (BY PASS)	GP-556	477556				COMBUSTIBLE	GP-1122	466987
COMBUSTIBLE, SEPARADOR DE AGUA CON ROSCA PARA TAZON	R 90 T	R90T	G89 con motor/VOLVO TD120			N86 con motor/VOLVO TD100		
			ACEITE	GP-54	423135	COMBUSTIBLE, SECUNDARIO	G-1123	233897
FH16 con motores/VOLVO D16C-550 (06/03 EN ADELANTE), VOLVO D16C-610 (02/06 EN ADELANTE), VOLVO D16E-580 (06/03 EN ADELANTE), VOLVO D16E-660 (02/06 EN ADELANTE)			COMBUSTIBLE, SELLADO	GP-1122	466987	COMBUSTIBLE, PRIMARIO	G-1123F	7233239
ACEITE, FLUJO TOTAL (FULL FLOW)	GP-51	4787362	COMBUSTIBLE, SEPARADOR DE AGUA OPCIONAL	GPP-1122	838593	ACEITE	GP-54	423135
ACEITE, DERIVACION (BY PASS)	GP-556	4775565	L420, L430 con motor/A DIESEL			COMBUSTIBLE, SELLADO	GP-1122	243004
AIRE, PRIMARIO	GA-624R	20411815	ACEITE	G-836	41415	COMBUSTIBLE, SEPARADOR DE AGUA OPCIONAL	GPP-1122	838593
FL10 con motor/VOLVO D10A			N10 con motor/VOLVO TD100B			N86 con motor/VOLVO TD70B		
DIRECCION	G-162H	V349619	DIRECCION	G-162H	349619	COMBUSTIBLE	G-296	2366284
ACEITE	GP-51	4666343	HIDRAULICO PARA FORD	GP-9	1266286	ACEITE	GP-54	423135
			ACEITE	GP-54	423135	COMBUSTIBLE, SELLADO	GP-1122	466987
			COMBUSTIBLE	GP-1122	466987			

SERVICIO PESADO

MARCA-MODELO-MOTOR MAKE-MODEL-ENGINE	GONHER GONHER	OEM OEM	MARCA-MODELO-MOTOR MAKE-MODEL-ENGINE	GONHER GONHER	OEM OEM	MARCA-MODELO-MOTOR MAKE-MODEL-ENGINE	GONHER GONHER	OEM OEM
VOLVO (continuación)			VOLVO (continuación)			VOLVO (continuación)		
CAMIONES, TRACTOCAMIONES Y AUTOBUSES			CAMIONES, TRACTOCAMIONES Y AUTOBUSES			CAMIONES, TRACTOCAMIONES Y AUTOBUSES		
COMBUSTIBLE	G-296-B	2366284	NB88T con motores/VOLVO TD100A, VOLVO TD100B			VHD200 con motor/VOLVO VED12		
N86 con motores/VOLVO D70A, VOLVO D70B, VOLVO D70C, VOLVO D70D			COMBUSTIBLE, SECUNDARIO	G-1123	233897	DIRECCION	G-159	85108880
COMBUSTIBLE	G-296	2366284	COMBUSTIBLE, PRIMARIO	G-1123F	7233239	ACEITE, OPCIONAL PARA TRANSMISION	GP-1	17237
ACEITE	GP-54	423135	ACEITE	GP-54	423135	ALGUNOS COMBUSTIBLES	GP-96	8193841
COMBUSTIBLE, SELLADO	GP-1122	466987	COMBUSTIBLE, SELLADO	GP-1122	466987	ACEITE, FLUJO TOTAL (FULL FLOW) REQUIERE 2	GP-51	478736-2
COMBUSTIBLE	G-296-B	2366284	COMBUSTIBLE, SEPARADOR DE AGUA OPCIONAL	GPP-1122	838593	COMBUSTIBLE, SEPARADOR DE AGUA CON PURGADOR	GPP-1291	81599755
ACEITE, DERIVACION (BY PASS)	G-750	1517575	NF87 con motores/VOLVO D70A, VOLVO D70D, VOLVO TD70A, VOLVO TD70E, VOLVO D70B, VOLVO D70C			ACEITE, LUBRICACION DE DOBLE FLUJO	GP-9001	LF9001
N86 con motores/VOLVO TD70A, VOLVO TD70E			COMBUSTIBLE	G-296	2366284	ACEITE, DERIVACION (BY PASS)	GP-556	477556
COMBUSTIBLE	G-296	2366284	ACEITE	GP-54	423135	AIRE, PRIMARIO	GA-624R	20411815
ACEITE	GP-54	423135	COMBUSTIBLE, SELLADO	GP-1122	466987	COMBUSTIBLE, SEPARADOR DE AGUA CON ROSCA PARA TAZON	R 90 P	R90P
COMBUSTIBLE, SELLADO	GP-1122	466987	COMBUSTIBLE	G-296-B	2366284	VHD64 con motor/VOLVO VED12		
COMBUSTIBLE	G-296-B	2366284	ACEITE, DERIVACION (BY PASS)	G-750	1517575	ACEITE	GP-51	4666343
ACEITE, DERIVACION (BY PASS)	G-750	1517575	NL10 con motores/VOLVO TD102, VOLVO TD103			VHD64BT con motor/VOLVO VED12		
N88 con motor/VOLVO TD100			ACEITE	GP-51	466634	ACEITE	GP-51	4666343
COMBUSTIBLE, SECUNDARIO	G-1123	233897	NL12 con motor/VOLVO TD123E			COMBUSTIBLE, SEPARADOR DE AGUA	GPP-1291	P550554
COMBUSTIBLE, PRIMARIO	G-1123F	7233239	ACEITE	GP-51	466634	AIRE	GA-435R	8076195
ACEITE	GP-54	423135	TF10 con motores/VOLVO TD101F, VOLVO TD101G			VN SERIES con motor/CUMMINS ISX		
COMBUSTIBLE, SELLADO	GP-1122	243004	ACEITE	GP-51	4666343	DIRECCION	G-162H	349619
COMBUSTIBLE, SEPARADOR DE AGUA OPCIONAL	GPP-1122	838593	COMBUSTIBLE	GP-1122	434061	ACEITE, OPCIONAL PARA TRANSMISION	GP-1	17237
N88, NB88 con motores/VOLVO TD100A, VOLVO TD100B			ACEITE, DERIVACION (BY PASS)	GP-556	4084262	AGUA, SISTEMA DE ENFRIAMIENTO	GP-2127W	WF2127
COMBUSTIBLE, SECUNDARIO	G-1123	233897	TF12 con motores/VOLVO TD121F, VOLVO TD121G			ACEITE, LUBRICACION DE DOBLE FLUJO	GP-9001	LF9001
ACEITE	GP-54	4231353	ACEITE	GP-51	4666343	COMBUSTIBLE, SEPARADOR DE AGUA SELLADO	GPP-10075	FS1040
COMBUSTIBLE, SELLADO	GP-1122	4669875	COMBUSTIBLE	GP-1122	434061	AIRE, PRIMARIO	GA-435R	8076195
N88T con motores/VOLVO D100, VOLVO TD100			ACEITE, DERIVACION (BY PASS)	GP-556	4084262	AIRE, PRIMARIO	GA-624R	20411815
COMBUSTIBLE, SECUNDARIO	G-1123	233897	VH200 con motor/VOLVO VED12			VN SERIES con motor/DETROIT DIESEL		
COMBUSTIBLE, PRIMARIO	G-1123F	7233239	DIRECCION	G-159	85108880	AIRE	GA-435R	8076195
ACEITE	GP-54	423135	ACEITE, OPCIONAL PARA TRANSMISION	GP-1	17237	VN SERIES con motor/VOLVO VED11		
COMBUSTIBLE, SELLADO	GP-1122	466987	ALGUNOS COMBUSTIBLES	GP-96	8193841	DIRECCION	G-162H	349619
N88T con motores/VOLVO TD100A, VOLVO TD100B			ACEITE, FLUJO TOTAL (FULL FLOW) REQUIERE 2	GP-51	478736-2	ACEITE, OPCIONAL PARA TRANSMISION	GP-1	17237
COMBUSTIBLE, SECUNDARIO	G-1123	233897	ACEITE, DERIVACION (BY PASS)	GP-556	477556	AGUA, SISTEMA DE ENFRIAMIENTO	GP-2108W	3945411
COMBUSTIBLE, PRIMARIO	G-1123F	7233239	AIRE, PRIMARIO	GA-624R	20411815	ACEITE, FLUJO TOTAL (FULL FLOW) REQUIERE 2	GP-51	4787362
ACEITE	GP-54	423135	VHD con motor/VOLVO VED12			ACEITE, DERIVACION (BY PASS)	GP-556	477556-5
COMBUSTIBLE, SELLADO	GP-1122	466987	DIRECCION	G-159	85108880	AIRE, PRIMARIO	GA-624R	20411815
COMBUSTIBLE, SEPARADOR DE AGUA OPCIONAL	GPP-1122	838593	ACEITE, OPCIONAL PARA TRANSMISION	GP-1	17237	VN SERIES con motor/VOLVO VED12		
NB86 con motores/VOLVO D70A, VOLVO D70B, VOLVO TD70A, VOLVO TD70B			ALGUNOS COMBUSTIBLES	GP-96	8193841	DIRECCION	G-162H	349619
COMBUSTIBLE	G-296	2366284	ACEITE, FLUJO TOTAL (FULL FLOW) REQUIERE 2	GP-51	478736-2	ACEITE, OPCIONAL PARA TRANSMISION	GP-1	17237
ACEITE	GP-54	423135	ACEITE, DERIVACION (BY PASS)	GP-556	477556	AGUA, SISTEMA DE ENFRIAMIENTO (ALT. 5 15/32 IN)	GP-2127W	WF2127
COMBUSTIBLE, SELLADO	GP-1122	466987	AIRE, PRIMARIO	GA-624R	20411815	COMBUSTIBLE, PRIMARIO	GP-96	8193841
COMBUSTIBLE	G-296-B	2366284	VHD con motor/VOLVO VED12			ACEITE, FLUJO TOTAL (FULL FLOW) REQUIERE 2	GP-51	478736
NB88 con motor/VOLVO TD100			DIRECCION	G-159	85108880	ACEITE, DERIVACION (BY PASS)	GP-556	477556
COMBUSTIBLE, SECUNDARIO	G-1123	233897	ACEITE, OPCIONAL PARA TRANSMISION	GP-1	17237	AIRE, PRIMARIO	GA-435R	8076195
COMBUSTIBLE, PRIMARIO	G-1123F	7233239	ALGUNOS COMBUSTIBLES	GP-96	8193841	AIRE, PRIMARIO	GA-624R	20411815
ACEITE	GP-54	423135	ACEITE, FLUJO TOTAL (FULL FLOW) REQUIERE 2	GP-51	478736-2	VN SERIES con motor/VOLVO VED13		
COMBUSTIBLE, SELLADO	GP-1122	243004	COMBUSTIBLE, SEPARADOR DE AGUA CON ROSCA PARA TAZON	GPP-1291	81599755	DIRECCION	G-162H	349619
COMBUSTIBLE, SEPARADOR DE AGUA OPCIONAL	GPP-1122	838593	ACEITE, LUBRICACION DE DOBLE FLUJO	GP-9001	LF9001	COMBUSTIBLE, PRIMARIO	GP-96	8193841
NB88T con motores/VOLVO D100, VOLVO TD100			ACEITE, DERIVACION (BY PASS)	GP-556	477556-5	ACEITE, FLUJO TOTAL (FULL FLOW) REQUIERE 2	GP-51	478736
COMBUSTIBLE, SECUNDARIO	G-1123	233897	AIRE, PRIMARIO	GA-624R	20411815	ACEITE, DERIVACION (BY PASS)	GP-556	477556
COMBUSTIBLE, PRIMARIO	G-1123F	7233239	VHD, VHD200 con motor/VOLVO VED13			AIRE, PRIMARIO	GA-435R	8076195
ACEITE	GP-54	423135	DIRECCION	G-159	85108880	AIRE, PRIMARIO	GA-624R	20411815
COMBUSTIBLE, SELLADO	GP-1122	466987	COMBUSTIBLE	G-128	FF5369	VN SERIES con motor/VOLVO VED13		
NB88T con motores/VOLVO D100, VOLVO TD100			ACEITE, OPCIONAL PARA TRANSMISION	GP-1	17237	DIRECCION	G-162H	349619
COMBUSTIBLE, SECUNDARIO	G-1123	233897	ACEITE, FLUJO TOTAL (FULL FLOW) REQUIERE 2	GP-51	4787362	COMBUSTIBLE, PRIMARIO	G-128	FF5369
COMBUSTIBLE, PRIMARIO	G-1123F	7233239	ACEITE, DERIVACION (BY PASS)	GP-556	477556-5	COMBUSTIBLE, PRIMARIO (CARTUCHO)		
ACEITE	GP-54	423135	AIRE, PRIMARIO	GA-624R	20411815			
COMBUSTIBLE, SELLADO	GP-1122	466987						

APLICACIONES SERVICIO PESADO
HEAVY DUTY APPLICATIONS



MARCA-MODELO-MOTOR MAKE-MODEL-ENGINE	GONHER GONHER	OEM OEM	MARCA-MODELO-MOTOR MAKE-MODEL-ENGINE	GONHER GONHER	OEM OEM	MARCA-MODELO-MOTOR MAKE-MODEL-ENGINE	GONHER GONHER	OEM OEM
VOLVO (continuación)			VOLVO (continuación)			VOLVO (continuación)		
CAMIONES, TRACTOCAMIONES Y AUTOBUSES			CAMIONES, TRACTOCAMIONES Y AUTOBUSES			CAMIONES, TRACTOCAMIONES Y AUTOBUSES		
ACEITE, OPCIONAL PARA TRANSMISION	GP-1	17237	VN610 CAB con motor/CUMMINS ISX			COMBUSTIBLE, SEPARADOR DE AGUA	GPP-1291	3945966
ACEITE, FLUJO TOTAL (FULL FLOW) REQUIERE 2	GP-51	4787362	ACEITE	GP-9000	3406810	ACEITE, DERIVACION (BY PASS)	GP-556	477556
ACEITE, DERIVACION (BY PASS)	GP-556	477556-5	ACEITE	GP-9001	3406809	AIRE	GA-435R	8076195
VN SERIES con motor/VOLVO VED16			COMBUSTIBLE, SEPARADOR DE AGUA	GPP-1022S	3406889	VN670 con motor/VOLVO VED12		
DIRECCION	G-162H	349619	AIRE	GA-435R	8076195	DIRECCION	G-162H	349619
ACEITE, OPCIONAL PARA TRANSMISION	GP-1	17237	VN610 CAB con motor/CUMMINS N14 PLUS			ACEITE, OPCIONAL PARA TRANSMISION	GP-1	17237
AGUA, SISTEMA DE ENFRIAMIENTO	GP-2108W	3945411	ACEITE	GP-3001	3401544	ALGUNOS COMBUSTIBLES	GP-96	8193841
ACEITE, FLUJO TOTAL (FULL FLOW) REQUIERE 2	GP-51	478736	ACEITE	GP-3000	3318853	ACEITE, FLUJO TOTAL (FULL FLOW) REQUIERE 2	GP-51	478736-2
ACEITE, DERIVACION (BY PASS)	GP-556	477556	COMBUSTIBLE, SEPARADOR DE AGUA	GPP-1000	3889716	COMBUSTIBLE, SEPARADOR DE AGUA SELLADO CON PURGADOR	GPP-1291	81599755
AIRE, PRIMARIO	GA-624R	20411815	AIRE	GA-435R	8076195	ACEITE, DERIVACION (BY PASS)	GP-556	477556-5
VN420 CAB con motor/CUMMINS N14 PLUS			VN610 CAB con motor/DETROIT DIESEL 60 SERIES			AIRE, PRIMARIO	GA-624R	20411815
ACEITE	GP-3001	3401544	COMBUSTIBLE, PRIMARIO	GP-26	23518481	COMBUSTIBLE, SEPARADOR DE AGUA SELLADO CON ROSCA PARA TAZON	R 90 P	R90P
ACEITE	GP-3000	3318853	COMBUSTIBLE, SECUNDARIO	GP-27	23518482			
COMBUSTIBLE, SEPARADOR DE AGUA	GPP-1000	3889716	ACEITE	GP-193	23518480	VN670, VN730 con motor/CUMMINS ISX		
AIRE	GA-435R	8076195	AIRE	GA-435R	8076195	DIRECCION	G-162H	349619
VN420 CAB con motor/DETROIT DIESEL 60 SERIES			VN630 con motor/CUMMINS ISX			ACEITE, OPCIONAL PARA TRANSMISION	GP-1	17237
COMBUSTIBLE, PRIMARIO	GP-26	23518481	DIRECCION	G-162H	349619	AGUA, SISTEMA DE ENFRIAMIENTO	GP-2127W	WF2127
COMBUSTIBLE, SECUNDARIO	GP-27	23518482	ACEITE, OPCIONAL PARA TRANSMISION	GP-1	17237	ACEITE, LUBRICACION DE DOBLE FLUJO	GP-9001	LF9001
ACEITE	GP-193	23518480	AGUA, SISTEMA DE ENFRIAMIENTO	GP-2127W	WF2127	AIRE, PRIMARIO	GA-624R	20411815
AIRE	GA-435R	8076195	ACEITE, LUBRICACION DE DOBLE FLUJO	GP-9001	LF9001	VN730 con motor/VOLVO VED12		
VN420 CAB con motores/CUMMINS ISM, CUMMINS ISX			AIRE, PRIMARIO	GA-624R	20411815	DIRECCION	G-162H	349619
ACEITE	GP-9000	3406810	VN630 con motor/VOLVO VED12			ACEITE, OPCIONAL PARA TRANSMISION	GP-1	17237
ACEITE	GP-9001	3406809	DIRECCION	G-162H	349619	ALGUNOS COMBUSTIBLES	GP-96	8193841
COMBUSTIBLE, SEPARADOR DE AGUA	GPP-1022S	3406889	ACEITE, OPCIONAL PARA TRANSMISION	GP-1	17237	ACEITE, FLUJO TOTAL (FULL FLOW) REQUIERE 2	GP-51	478736
AIRE	GA-435R	8076195	ALGUNOS COMBUSTIBLES	GP-96	8193841	ACEITE, DERIVACION (BY PASS)	GP-556	477556
VN420 CAB, VN610 CAB con motor/VOLVO VED12			ACEITE, FLUJO TOTAL (FULL FLOW) REQUIERE 2	GP-51	478736	AIRE, PRIMARIO	GA-624R	20411815
COMBUSTIBLE	GP-96	420799	COMBUSTIBLE, SEPARADOR DE AGUA CON PURGADOR	GPP-1291	81599755	VN730 con motor/VOLVO VED13		
ACEITE	GP-51	478736-2	ACEITE, DERIVACION (BY PASS)	GP-556	477556	DIRECCION	G-162H	349619
COMBUSTIBLE, SEPARADOR DE AGUA	GPP-1291	3945966	AIRE, PRIMARIO	GA-624R	20411815	COMBUSTIBLE, SEPARADOR DE AGUA, CARTUCHO	G-128	85105574
ACEITE, DERIVACION (BY PASS)	GP-556	477556	COMBUSTIBLE, SEPARADOR DE AGUA CON ROSCA PARA TAZON	R 90 P	R90P	ACEITE, OPCIONAL PARA TRANSMISION	GP-1	17237
AIRE	GA-435R	8076195	VN660 CAB con motor/CUMMINS ISX			ACEITE, FLUJO TOTAL (FULL FLOW) REQUIERE 2	GP-51	4787362
VN430 con motor/VOLVO VED12			ACEITE	GP-9000	3406810	ACEITE, DERIVACION (BY PASS)	GP-556	4775565
DIRECCION	G-162H	349619	ACEITE	GP-9001	3406809	AIRE, PRIMARIO	GA-624R	20411815
TRANSMISION	GP-1	17237	COMBUSTIBLE, SEPARADOR DE AGUA	GPP-1022S	3406889	VN730 con motor/VOLVO VED16		
COMBUSTIBLE	GP-96	8193841	AIRE	GA-435R	8076195	DIRECCION	G-162H	349619
AGUA, REFRIGERANTE	GP-2108W	3945411	VN660 CAB con motor/CUMMINS N14 PLUS			COMBUSTIBLE	G-128	FF5369
ACEITE, FLUJO TOTAL (FULL FLOW) (REQUIERE 2)	GP-51	478736	ACEITE	GP-3001	3401544	ACEITE, OPCIONAL PARA TRANSMISION	GP-1	17237
ACEITE, DERIVACION (BY PASS)	GP-556	477556	ACEITE	GP-3000	3318853	AGUA, SISTEMA DE ENFRIAMIENTO	GP-2108W	3945411
AIRE, PRIMARIO	GA-435R	8076195	COMBUSTIBLE, SEPARADOR DE AGUA	GPP-1000	3889716	ACEITE, FLUJO TOTAL (FULL FLOW) REQUIERE 2	GP-51	478736
VN430 con motor/VOLVO VED16			AIRE	GA-435R	8076195	ACEITE, DERIVACION (BY PASS)	GP-556	477556
DIRECCION	G-162H	349619	VN660 CAB con motor/DETROIT DIESEL 60 SERIES			AIRE, PRIMARIO	GA-624R	20411815
COMBUSTIBLE, SEPARADOR DE AGUA, CARTUCHO	G-128	85105574	COMBUSTIBLE, PRIMARIO	GP-26	23518481	VN770 CAB con motor/CUMMINS ISX		
ACEITE, OPCIONAL PARA TRANSMISION	GP-1	17237	COMBUSTIBLE, SECUNDARIO	GP-27	23518482	ACEITE	GP-9000	3406810
AGUA, SISTEMA DE ENFRIAMIENTO (8 UNIDADES BTE)	GP-2108W	3945411	ACEITE	GP-193	23518480	ACEITE	GP-9001	3406809
ACEITE, FLUJO TOTAL (FULL FLOW) REQUIERE 2	GP-51	478736	AIRE	GA-435R	8076195	COMBUSTIBLE, SEPARADOR DE AGUA	GPP-1022S	3406889
ACEITE, DERIVACION (BY PASS)	GP-556	477556	VN660 CAB con motor/VOLVO VED12			AIRE	GA-435R	8076195
AIRE, PRIMARIO	GA-624R	20411815	COMBUSTIBLE	GP-96	420799			
			ACEITE	GP-51	478736-2			

SERVICIO PESADO

MARCA-MODELO-MOTOR MAKE-MODEL-ENGINE	GONHER GONHER	OEM OEM	MARCA-MODELO-MOTOR MAKE-MODEL-ENGINE	GONHER GONHER	OEM OEM	MARCA-MODELO-MOTOR MAKE-MODEL-ENGINE	GONHER GONHER	OEM OEM
VOLVO (continuación)			VOLVO (continuación)			VOLVO (continuación)		
CAMIONES, TRACTOCAMIONES Y AUTOBUSES			CAMIONES, TRACTOCAMIONES Y AUTOBUSES			CAMIONES, TRACTOCAMIONES Y AUTOBUSES		
VN770 CAB con motor/CUMMINS N14 PLUS			ACEITE, DERIVACION (BY PASS)	GP-556	477556	AGUA, SISTEMA DE ENFRIAMIENTO (11 1/2 UNIDADES BTA+)	GP-2126Q	WF2126
ACEITE	GP-3001	3401544	AIRE	GA-435R	8076195	ACEITE, LUBRICACION DE DOBLE FLUJO	GP-9001	3101869
ACEITE	GP-3000	3318853	VNL DAYCAB con motores/CUMMINS ISM, CUMMINS ISX			AIRE, PRIMARIO	GA-624R	20411815
COMBUSTIBLE, SEPARADOR DE AGUA	GPP-1000	3889716	ACEITE	GP-9000	3406810	VNL300 con motor/VOLVO VED11		
AIRE	GA-435R	8076195	ACEITE	GP-9001	3406809	DIRECCION	G-162H	349619
VN770 CAB con motor/DETROIT DIESEL 60 SERIES			COMBUSTIBLE, SEPARADOR DE AGUA	GPP-10225	3406889	ACEITE, OPCIONAL PARA TRANSMISION	GP-1	17237
COMBUSTIBLE, PRIMARIO	GP-26	23518481	AIRE	GA-435R	8076195	AGUA, SISTEMA DE ENFRIAMIENTO	GP-2108W	3945411
COMBUSTIBLE, SECUNDARIO	GP-27	23518482	VNL SERIES con motor/CUMMINS ISX			ACEITE, FLUJO TOTAL (FULL FLOW) REQUIERE 2	GP-51	4787362
ACEITE	GP-193	23518480	DIRECCION	G-162H	349619	COMBUSTIBLE, SEPARADOR DE AGUA CON PURGADOR	GPP-1291	81599755
AIRE	GA-435R	8076195	ACEITE, OPCIONAL PARA TRANSMISION	GP-1	17237	ACEITE, DERIVACION (BY PASS)	GP-556	477556-5
VN770 CAB con motor/VOLVO VED12			AGUA, SISTEMA DE ENFRIAMIENTO	GP-2127W	WF2127	AIRE, PRIMARIO	GA-624R	20411815
COMBUSTIBLE	GP-96	420799	ACEITE, LUBRICACION DE DOBLE FLUJO	GP-9001	3101869	COMBUSTIBLE, SEPARADOR DE AGUA CON ROSCA PARA TAZON	R 90 P	R90P
ACEITE	GP-51	478736-2	AIRE, PRIMARIO	GA-435R	8076195	VNL300 con motor/VOLVO VED12		
COMBUSTIBLE, SEPARADOR DE AGUA	GPP-1291	3945966	AIRE, PRIMARIO	GA-624R	20411815	DIRECCION	G-162H	349619
ACEITE, DERIVACION (BY PASS)	GP-556	477556	VNL SERIES con motor/VOLVO VED11			ACEITE, OPCIONAL PARA TRANSMISION	GP-1	17237
AIRE	GA-435R	8076195	DIRECCION	G-162H	349619	AGUA, SISTEMA DE ENFRIAMIENTO	GP-2108W	3945411
VN780 con motor/CUMMINS ISX			ACEITE, FLUJO TOTAL (FULL FLOW) REQUIERE 2	GP-51	4787362	ALGUNOS COMBUSTIBLES	GP-96	8193841
DIRECCION	G-162H	349619	ACEITE, DERIVACION (BY PASS)	GP-556	477556-5	ACEITE, FLUJO TOTAL (FULL FLOW) REQUIERE 2	GP-51	4787362
ACEITE, OPCIONAL PARA TRANSMISION	GP-1	17237	AIRE, PRIMARIO	GA-624R	20411815	COMBUSTIBLE, SEPARADOR DE AGUA SELLADO CON PURGADOR	GPP-1291	81599755
AGUA, SISTEMA DE ENFRIAMIENTO	GP-2127W	WF2127	VNL SERIES con motor/VOLVO VED12			ACEITE, LUBRICACION DE DOBLE FLUJO	GP-9001	LF9001
ACEITE, LUBRICACION DE DOBLE FLUJO	GP-9001	LF9001	DIRECCION	G-162H	349619	ACEITE, DERIVACION (BY PASS)	GP-556	4775565
COMBUSTIBLE, SEPARADOR DE AGUA	GPP-10075	FS1040	ACEITE, OPCIONAL PARA TRANSMISION	GP-1	17237	AIRE, PRIMARIO	GA-624R	20411815
AIRE	GA-435R	8076195	COMBUSTIBLE	GP-96	8193841	COMBUSTIBLE, SEPARADOR DE AGUA SELLADO CON ROSCA PARA TAZON	R 90 P	R90P
AIRE, PRIMARIO	GA-624R	20411815	ACEITE, LUBRICACION DE DOBLE FLUJO	GP-9001	LF9001	VNL300 con motor/VOLVO VED13		
VN780 con motor/VOLVO VED12			AIRE, PRIMARIO	GA-624R	20411815	DIRECCION	G-162H	349619
DIRECCION	G-162H	349619	VNL SERIES con motor/VOLVO VED13			COMBUSTIBLE	G-128	FF5369
ACEITE, OPCIONAL PARA TRANSMISION	GP-1	17237	DIRECCION	G-162H	349619	ACEITE, OPCIONAL PARA TRANSMISION	GP-1	17237
COMBUSTIBLE	GP-96	8193841	COMBUSTIBLE, SEPARADOR DE AGUA, CARTUCHO	G-128	85105574	ACEITE, FLUJO TOTAL (FULL FLOW) REQUIERE 2	GP-51	4787362
ACEITE, FLUJO TOTAL (FULL FLOW) REQUIERE 2	GP-51	4787362	ACEITE, OPCIONAL PARA TRANSMISION	GP-1	17237	ACEITE, DERIVACION (BY PASS)	GP-556	477556-5
COMBUSTIBLE, SEPARADOR DE AGUA SELLADO CON PURGADOR	GPP-1291	81599755	ACEITE, FLUJO TOTAL (FULL FLOW) REQUIERE 2	GP-51	4787362	AIRE, PRIMARIO	GA-624R	20411815
ACEITE, DERIVACION (BY PASS)	GP-556	477556-5	ACEITE, DERIVACION (BY PASS)	GP-556	477556-5	VNL300 con motor/VOLVO VED16		
AIRE, PRIMARIO	GA-624R	20411815	AIRE, PRIMARIO	GA-624R	20411815	DIRECCION	G-162H	349619
COMBUSTIBLE, SEPARADOR DE AGUA SELLADO CON ROSCA PARA TAZON	R 90 P	R90P	VNL SERIES con motor/VOLVO VED16			ACEITE, OPCIONAL PARA TRANSMISION	GP-1	17237
VNL DAYCAB con motor/CUMMINS N14 PLUS			DIRECCION	G-162H	349619	AGUA, SISTEMA DE ENFRIAMIENTO	GP-2108W	3945411
ACEITE	GP-3001	3401544	COMBUSTIBLE, SEPARADOR DE AGUA, CARTUCHO	G-128	85105574	ACEITE, FLUJO TOTAL (FULL FLOW) REQUIERE 2	GP-51	478736
ACEITE	GP-3000	3318853	AGUA, SISTEMA DE ENFRIAMIENTO	GP-2108W	3945411	ACEITE, DERIVACION (BY PASS)	GP-556	477556
COMBUSTIBLE, SEPARADOR DE AGUA	GPP-1000	3889716	ACEITE, FLUJO TOTAL (FULL FLOW) REQUIERE 2	GP-51	478736	AIRE, PRIMARIO	GA-624R	20411815
AIRE	GA-435R	8076195	ACEITE, DERIVACION (BY PASS)	GP-556	477556	VNL420 con motor/VOLVO VED12		
VNL DAYCAB con motor/DETROIT DIESEL 60 SERIES			AIRE, PRIMARIO	GA-624R	20411815	COMBUSTIBLE	GP-96	FF5272
COMBUSTIBLE, PRIMARIO	GP-26	23518481	VNL300 con motor/CUMMINS ISX			ACEITE	GP-51	4666343
COMBUSTIBLE, SECUNDARIO	GP-27	23518482	DIRECCION	G-162H	349619	ACEITE, DERIVACION (BY PASS)	GP-556	4084262
ACEITE	GP-193	23518480	ACEITE, OPCIONAL PARA TRANSMISION	GP-1	17237	AIRE, PRIMARIO	GA-435R	8076195
AIRE	GA-435R	8076195	AGUA, SISTEMA DE ENFRIAMIENTO (SIN QUIMICOS)	GP-2127W	WF2127	VNL430 con motor/CUMMINS ISX		
VNL DAYCAB con motor/VOLVO VED12						ACEITE	GP-9001	3406809
COMBUSTIBLE	GP-96	420799						
AGUA	GP-2108W	3945411						
ACEITE	GP-51	478736-2						
COMBUSTIBLE, SEPARADOR DE AGUA	GPP-1291	3945966						

APLICACIONES SERVICIO PESADO
HEAVY DUTY APPLICATIONS



MARCA-MODELO-MOTOR MAKE-MODEL-ENGINE	GONHER GONHER	OEM OEM	MARCA-MODELO-MOTOR MAKE-MODEL-ENGINE	GONHER GONHER	OEM OEM	MARCA-MODELO-MOTOR MAKE-MODEL-ENGINE	GONHER GONHER	OEM OEM
VOLVO (continuación)			VOLVO (continuación)			VOLVO (continuación)		
CAMIONES, TRACTOCAMIONES Y AUTOBUSES			CAMIONES, TRACTOCAMIONES Y AUTOBUSES			CAMIONES, TRACTOCAMIONES Y AUTOBUSES		
VNL430 con motor/VOLVO VED12			VNL630 con motor/VOLVO VED12			COMBUSTIBLE, SEPARADOR DE AGUA SELLADO CON PURGADOR	GPP-1291	81599755
DIRECCION	G-162H	349619	DIRECCION	G-162H	349619	AGUA, SISTEMA DE ENFRIAMIENTO (11 1/2 UNIDADES BTA+)	GP-2126Q	WF2126
TRANSMISION	GP-1	17237	COMBUSTIBLE, SEPARADOR DE AGUA, CARTUCHO	G-128	FF5369	ACEITE, LUBRICACION DE DOBLE FLUJO	GP-9001	LF9001
COMBUSTIBLE	GP-96	8193841	ACEITE, OPCIONAL PARA TRANSMISION	GP-1	17237	ACEITE, DERIVACION (BY PASS)	GP-556	477556
AGUA, REFRIGERANTE	GP-2108W	20458769	ALGUNOS COMBUSTIBLES	GP-96	8193841	AIRE, PRIMARIO	GA-624R	20411815
ACEITE, FLUJO TOTAL (FULL FLOW) (REQUIERE 2)	GP-51	478736	ACEITE, FLUJO TOTAL (FULL FLOW) REQUIERE 2	GP-51	478736	COMBUSTIBLE, SEPARADOR DE AGUA SELLADO CON ROSCA PARA TAZON	R 90 P	R90P
ACEITE, LUBRICACION DE DOBLE FLUJO	GP-9001	LF9001	COMBUSTIBLE, SEPARADOR DE AGUA SELLADO CON PURGADOR	GPP-1291	81599755	ACEITE, LUBRICACION DE DOBLE FLUJO	GP-9001	LF9001
ACEITE, DERIVACION (BY PASS)	GP-556	477556	ACEITE, LUBRICACION DE DOBLE FLUJO	GP-9001	LF9001	ACEITE, DERIVACION (BY PASS)	GP-556	477556
AIRE, PRIMARIO	GA-435R	8076195	AIRE, PRIMARIO	GA-624R	20411815	AIRE, PRIMARIO	GA-624R	20411815
VNL430 con motor/VOLVO VED16			COMBUSTIBLE, SEPARADOR DE AGUA, CARTUCHO	R 90 P	R90P	VNL670 con motor/VOLVO VED13		
DIRECCION	G-162H	349619	ACEITE, OPCIONAL PARA TRANSMISION	GP-1	17237	DIRECCION	G-162H	349619
COMBUSTIBLE, SEPARADOR DE AGUA, CARTUCHO	G-128	85105574	AGUA, SISTEMA DE ENFRIAMIENTO (8 UNIDADES BTE)	GP-2108W	3945411	COMBUSTIBLE	G-128	FF5369
ACEITE, FLUJO TOTAL (FULL FLOW) REQUIERE 2	GP-51	478736	ACEITE, FLUJO TOTAL (FULL FLOW) REQUIERE 2	GP-51	478736	ACEITE, OPCIONAL PARA TRANSMISION	GP-1	17237
ACEITE, DERIVACION (BY PASS)	GP-556	477556	ACEITE, DERIVACION (BY PASS)	GP-556	477556	AGUA, SISTEMA DE ENFRIAMIENTO (8 UNIDADES BTE)	GP-2108W	20458769
AIRE, PRIMARIO	GA-624R	20411815	AIRE, PRIMARIO	GA-624R	20411815	ACEITE, FLUJO TOTAL (FULL FLOW) REQUIERE 2	GP-51	478736
VNL610 con motor/CUMMINS ISX			VNL630 con motor/VOLVO VED13			ACEITE, DERIVACION (BY PASS)	GP-556	477556
ACEITE	GP-9001	3406809	COMBUSTIBLE, SEPARADOR DE AGUA, CARTUCHO	G-128	85105574	AIRE, PRIMARIO	GA-624R	20411815
COMBUSTIBLE, SEPARADOR DE AGUA	GPP-1007S	FS1040	ACEITE, OPCIONAL PARA TRANSMISION	GP-1	17237	VNL670 con motor/VOLVO VED16		
AIRE, PRIMARIO	GA-435R	8076195	AGUA, SISTEMA DE ENFRIAMIENTO	GP-2108W	3945411	DIRECCION	G-162H	349619
VNL610 con motor/CUMMINS N14			ACEITE, FLUJO TOTAL (FULL FLOW) REQUIERE 2	GP-51	478736	COMBUSTIBLE, SEPARADOR DE AGUA, CARTUCHO	G-128	85105574
ACEITE	GP-3000	991218853	ACEITE, DERIVACION (BY PASS)	GP-556	477556	ACEITE, OPCIONAL PARA TRANSMISION	GP-1	17237
COMBUSTIBLE, SEPARADOR DE AGUA	GPP-1000	FS1000	AIRE, PRIMARIO	GA-624R	20411815	AGUA, SISTEMA DE ENFRIAMIENTO (8 UNIDADES BTE)	GP-2108W	3945411
COMBUSTIBLE, SEPARADOR DE AGUA	GPP-1291	P550554	VNL630 con motor/VOLVO VED16			ACEITE, FLUJO TOTAL (FULL FLOW) REQUIERE 2	GP-51	478736
VNL610 con motor/VOLVO VED12			ACEITE, OPCIONAL PARA TRANSMISION	GP-1	17237	ACEITE, DERIVACION (BY PASS)	GP-556	477556
COMBUSTIBLE	GP-96	8193841	AGUA, SISTEMA DE ENFRIAMIENTO	GP-2108W	3945411	AIRE, PRIMARIO	GA-624R	20411815
ACEITE, FLUJO TOTAL (FULL FLOW) REQUIERE 2	GP-51	4787362	ACEITE, FLUJO TOTAL (FULL FLOW) REQUIERE 2	GP-51	478736	VNL670, VNL730 con motor/CUMMINS ISX		
COMBUSTIBLE, SEPARADOR DE AGUA CON PURGADOR	GPP-1291	81599755	ACEITE, DERIVACION (BY PASS)	GP-556	477556	DIRECCION	G-162H	349619
ACEITE, DERIVACION (BY PASS)	GP-556	477556	AIRE, PRIMARIO	GA-624R	20411815	COMBUSTIBLE, SEPARADOR DE AGUA, CARTUCHO	G-128	85105574
AIRE, PRIMARIO	GA-624R	20411815	VNL64T con motor/CUMMINS ISX			ACEITE, OPCIONAL PARA TRANSMISION	GP-1	17237
COMBUSTIBLE, SEPARADOR DE AGUA CON ROSCA PARA TAZON	R 90 P	R90P	COMBUSTIBLE, SEPARADOR DE AGUA, CARTUCHO	G-128	FF5369	AGUA, SISTEMA DE ENFRIAMIENTO (8 UNIDADES BTE)	GP-2108W	3945411
VNL630 con motor/CUMMINS ISX			ACEITE	GP-51	4787362	ACEITE, FLUJO TOTAL (FULL FLOW) REQUIERE 2	GP-51	478736
ACEITE, OPCIONAL PARA TRANSMISION	GP-1	17237	AIRE, PRIMARIO	GA-624R	20411815	ACEITE, DERIVACION (BY PASS)	GP-556	477556
AGUA, SISTEMA DE ENFRIAMIENTO	GP-2127W	WF2127	VNL64T con motor/VOLVO VED12			AIRE, PRIMARIO	GA-624R	20411815
ACEITE, LUBRICACION DE DOBLE FLUJO	GP-9001	3101869	COMBUSTIBLE, SEPARADOR DE AGUA, CARTUCHO	G-128	FF5369	VNL670, VNL730 con motor/VOLVO VED12		
AIRE, PRIMARIO	GA-624R	20411815	ACEITE	GP-51	4787362	DIRECCION	G-162H	349619
VNL630 con motor/VOLVO VED11			AIRE, PRIMARIO	GA-624R	20411815	COMBUSTIBLE, SEPARADOR DE AGUA, CARTUCHO	G-128	85105574
ACEITE, OPCIONAL PARA TRANSMISION	GP-1	17237	VNL660 con motor/CUMMINS ISX			ACEITE, OPCIONAL PARA TRANSMISION	GP-1	17237
AGUA, SISTEMA DE ENFRIAMIENTO	GP-2108W	3945411	AGUA	GP-2126Q	WF2126	ALGUNOS COMBUSTIBLES	GP-96	8193841
ACEITE, FLUJO TOTAL (FULL FLOW) REQUIERE 2	GP-51	478736	ACEITE	GP-9001	3406809	ACEITE, LUBRICACION DE DOBLE FLUJO	GP-9001	LF9001
ACEITE, DERIVACION (BY PASS)	GP-556	477556	COMBUSTIBLE, SEPARADOR DE AGUA	GPP-1007S	3331096	AIRE, PRIMARIO	GA-624R	20411815
AIRE, PRIMARIO	GA-624R	20411815	AIRE, PRIMARIO	GA-435R	8076195	VNL730 con motor/VOLVO VED16		
VNL630 con motor/VOLVO VED12			VNL670 con motor/VOLVO VED12			DIRECCION	G-162H	349619
ACEITE, OPCIONAL PARA TRANSMISION	GP-1	17237	DIRECCION	G-162H	349619	COMBUSTIBLE	G-128	FF5369
AGUA, SISTEMA DE ENFRIAMIENTO	GP-2108W	3945411	COMBUSTIBLE, SEPARADOR DE AGUA, CARTUCHO	G-128	FF5369	ACEITE, OPCIONAL PARA TRANSMISION	GP-1	17237
ACEITE, FLUJO TOTAL (FULL FLOW) REQUIERE 2	GP-51	478736	ACEITE, OPCIONAL PARA TRANSMISION	GP-1	17237	AGUA, SISTEMA DE ENFRIAMIENTO	GP-2108W	3945411
ACEITE, DERIVACION (BY PASS)	GP-556	477556	AGUA, SISTEMA DE ENFRIAMIENTO (SIN QUIMICOS)	GP-2127W	WF2127	ACEITE, FLUJO TOTAL (FULL FLOW) REQUIERE 2	GP-51	478736
AIRE, PRIMARIO	GA-624R	20411815	COMBUSTIBLE	GP-96	8193841	ACEITE, DERIVACION (BY PASS)	GP-556	477556
VNL630 con motor/VOLVO VED12			ACEITE, FLUJO TOTAL (FULL FLOW) REQUIERE 2	GP-51	478736-2	AIRE, PRIMARIO	GA-624R	20411815
ACEITE, OPCIONAL PARA TRANSMISION	GP-1	17237						

SERVICIO PESADO

MARCA-MODELO-MOTOR MAKE-MODEL-ENGINE	GONHER GONHER	OEM OEM	MARCA-MODELO-MOTOR MAKE-MODEL-ENGINE	GONHER GONHER	OEM OEM	MARCA-MODELO-MOTOR MAKE-MODEL-ENGINE	GONHER GONHER	OEM OEM
VOLVO (continuación)			VOLVO (continuación)			VOLVO (continuación)		
CAMIONES, TRACTOCAMIONES Y AUTOBUSES			CAMIONES, TRACTOCAMIONES Y AUTOBUSES			CAMIONES, TRACTOCAMIONES Y AUTOBUSES		
VNL770 con motor/VOLVO VED12			VNM DAYCAB con motor/CUMMINS N14 PLUS			ACEITE, LUBRICACION DE DOBLE FLUJO	GP-9001	LF9001
COMBUSTIBLE	GP-96	FF5272	ACEITE	GP-3001	3401544	AIRE, PRIMARIO	GA-624R	20411815
ACEITE	GP-51	4666343	ACEITE	GP-3000	3318853	VNM200 con motor/VOLVO VED11		
ACEITE, DERIVACION (BY PASS)	GP-556	4084262	COMBUSTIBLE, SEPARADOR DE AGUA	GPP-1000	3889716	DIRECCION	G-162H	349619
AIRE, PRIMARIO	GA-435R	8076195	AIRE	GA-435R	8076195	ACEITE, OPCIONAL PARA TRANSMISION	GP-1	17237
VNL780 con motor/CUMMINS ISX			VNM DAYCAB con motor/DETROIT DIESEL 60 SERIES			AGUA, SISTEMA DE ENFRIAMIENTO	GP-2108W	3945411
DIRECCION	G-159	84148A	COMBUSTIBLE, PRIMARIO	GP-26	23518481	ACEITE, FLUJO TOTAL (FULL FLOW) REQUIERE 2	GP-51	4787362
DIRECCION	G-162H	349619	COMBUSTIBLE, SECUNDARIO	GP-27	23518482	ACEITE, DERIVACION (BY PASS)	GP-556	477556-5
COMBUSTIBLE, SEPARADOR DE AGUA, CARTUCHO	G-128	FS1029	ACEITE	GP-193	23518480	AIRE, PRIMARIO	GA-624R	20411815
ACEITE, OPCIONAL PARA TRANSMISION	GP-1	17237	AIRE	GA-435R	8076195	VNM200 con motor/VOLVO VED12		
AGUA, SISTEMA DE ENFRIAMIENTO	GP-2127W	WF2127	VNM DAYCAB con motor/VOLVO VED12			DIRECCION	G-162H	349619
ACEITE, LUBRICACION DE DOBLE FLUJO	GP-9001	3101869	COMBUSTIBLE	GP-96	420799	COMBUSTIBLE, SEPARADOR DE AGUA	G-128	85105574
AIRE, PRIMARIO	GA-624R	20411815	AGUA	GP-2108W	3945411	ACEITE, OPCIONAL PARA TRANSMISION	GP-1	17237
VNL780 con motor/VOLVO VED12			ACEITE	GP-51	478736-2	ALGUNOS COMBUSTIBLES	GP-96	8193841
DIRECCION	G-162H	349619	COMBUSTIBLE, SEPARADOR DE AGUA	GPP-1291	3945966	ACEITE, LUBRICACION DE DOBLE FLUJO	GP-9001	LF9001
ACEITE, OPCIONAL PARA TRANSMISION	GP-1	17237	ACEITE, DERIVACION (BY PASS)	GP-556	477556	AIRE, PRIMARIO	GA-624R	20411815
AGUA, SISTEMA DE ENFRIAMIENTO	GP-2127W	WF2127	AIRE	GA-435R	8076195	VNM200 con motor/VOLVO VED13		
ALGUNOS COMBUSTIBLES	GP-96	8193841	VNM SERIES con motor/CUMMINS N14			DIRECCION	G-162H	349619
ACEITE, FLUJO TOTAL (FULL FLOW) REQUIERE 2	GP-51	478736	DIRECCION	G-162H	349619	COMBUSTIBLE	G-128	FF5369
COMBUSTIBLE, SEPARADOR DE AGUA SELLADO CON PURGADOR	GPP-1291	81599755	DIRECCION	G-169	1742317	ACEITE, OPCIONAL PARA TRANSMISION	GP-1	17237
ACEITE, LUBRICACION DE DOBLE FLUJO	GP-9001	LF9001	TRANSMISION, OPCIONAL	GP-1	17237	ACEITE, FLUJO TOTAL (FULL FLOW) REQUIERE 2	GP-51	4787362
ACEITE, DERIVACION (BY PASS)	GP-556	477556	DIESEL	GPP-14	154789	ACEITE, DERIVACION (BY PASS)	GP-556	477556-5
AIRE, PRIMARIO	GA-624R	20411815	ACEITE, DERIVACION (BY PASS)	GP-57	3304232	AIRE, PRIMARIO	GA-624R	20411815
COMBUSTIBLE, SEPARADOR DE AGUA SELLADO CON ROSCA PARA TAZON	R 90 P	R90P	AIRE, TAPA METALICA	GA-1095	220055039	VNM420 con motor/CUMMINS M11		
VNL780 con motor/VOLVO VED13			AIRE, RADIAL	GA-435R	8076195	ACEITE	GP-3000	991218853
DIRECCION	G-159	84148A	VNM SERIES con motor/VOLVO VED11			VNM430 con motor/VOLVO VED12		
DIRECCION	G-162H	349619	TRANSMISION	G-162H	349619	DIRECCION	G-162H	349619
COMBUSTIBLE	G-128	FF5369	ACEITE, OPCIONAL PARA TRANSMISION	GP-1	17237	ACEITE, OPCIONAL PARA TRANSMISION	GP-1	17237
ACEITE, OPCIONAL PARA TRANSMISION	GP-1	17237	AGUA, SISTEMA DE ENFRIAMIENTO	GP-2108W	3945411	ALGUNOS COMBUSTIBLES	GP-96	8193841
ACEITE, FLUJO TOTAL (FULL FLOW) REQUIERE 2	GP-51	4787362	ACEITE, FLUJO TOTAL (FULL FLOW) REQUIERE 2	GP-51	4787362	AGUA, SISTEMA DE ENFRIAMIENTO (CON QUIMICOS)	GP-2108W	WF2108
ACEITE, DERIVACION (BY PASS)	GP-556	477556-5	ACEITE, DERIVACION (BY PASS)	GP-556	477556-5	ACEITE, FLUJO TOTAL (FULL FLOW) REQUIERE 2	GP-51	478736-2
AIRE, PRIMARIO	GA-624R	20411815	AIRE, PRIMARIO	GA-624R	20411815	ACEITE, LUBRICACION DE DOBLE FLUJO	GP-9001	LF9001
VNL780 con motor/VOLVO VED16			VNM SERIES con motor/VOLVO VED12			ACEITE, DERIVACION (BY PASS)	GP-556	477556
DIRECCION	G-159	84148A	DIRECCION	G-162H	349619	AIRE, PRIMARIO	GA-624R	20411815
DIRECCION	G-162H	349619	COMBUSTIBLE, SEPARADOR DE AGUA, CARTUCHO	G-128	85105574	VNM630 con motor/VOLVO VED12		
COMBUSTIBLE, SEPARADOR DE AGUA, CARTUCHO	G-128	85105574	ACEITE, OPCIONAL PARA TRANSMISION	GP-1	17237	DIRECCION	G-162H	349619
ACEITE, OPCIONAL PARA TRANSMISION	GP-1	17237	ACEITE, FLUJO TOTAL (FULL FLOW) REQUIERE 2	GP-51	478736	ACEITE, OPCIONAL PARA TRANSMISION	GP-1	17237
AGUA, SISTEMA DE ENFRIAMIENTO	GP-2108W	3945411	ACEITE, DERIVACION (BY PASS)	GP-556	477556-5	ALGUNOS COMBUSTIBLES	GP-96	8193841
ACEITE, FLUJO TOTAL (FULL FLOW) REQUIERE 2	GP-51	478736	AIRE, PRIMARIO	GA-624R	20411815	AGUA, SISTEMA DE ENFRIAMIENTO (CON QUIMICOS)	GP-2108W	20458769
ACEITE, DERIVACION (BY PASS)	GP-556	477556	VNM SERIES con motor/VOLVO VED13			ACEITE, FLUJO TOTAL (FULL FLOW) REQUIERE 2	GP-51	478736-2
AIRE, PRIMARIO	GA-624R	85105574	DIRECCION	G-162H	349619	ACEITE, LUBRICACION DE DOBLE FLUJO	GP-9001	LF9001
VNM DAYCAB con motor/CUMMINS ISM			COMBUSTIBLE	G-128	FF5369	ACEITE, DERIVACION (BY PASS)	GP-556	477556
ACEITE	GP-9000	3406810	ACEITE, OPCIONAL PARA TRANSMISION	GP-1	17237	AIRE, PRIMARIO	GA-624R	20411815
ACEITE	GP-9001	3406809	ACEITE, FLUJO TOTAL (FULL FLOW) REQUIERE 2	GP-51	4787362	VNM64T con motor/VOLVO VED12		
COMBUSTIBLE, SEPARADOR DE AGUA	GPP-10225	3406889	ACEITE, DERIVACION (BY PASS)	GP-556	477556-5	COMBUSTIBLE, SEPARADOR DE AGUA	G-128	P176160
AIRE	GA-435R	8076195	AIRE, PRIMARIO	GA-624R	20411815			
			VNM SERIES, VNM430 con motor/CUMMINS ISX					
			DIRECCION	G-162H	349619			
			ACEITE, OPCIONAL PARA TRANSMISION	GP-1	17237			
			AGUA, SISTEMA DE ENFRIAMIENTO	GP-2127W	WF2127			

APLICACIONES SERVICIO PESADO
HEAVY DUTY APPLICATIONS



MARCA-MODELO-MOTOR MAKE-MODEL-ENGINE	GONHER GONHER	OEM OEM	MARCA-MODELO-MOTOR MAKE-MODEL-ENGINE	GONHER GONHER	OEM OEM	MARCA-MODELO-MOTOR MAKE-MODEL-ENGINE	GONHER GONHER	OEM OEM
VOLVO (continuación)			VOLVO (continuación)			VOLVO		
CAMIONES, TRACTOCAMIONES Y AUTOBUSES			CAMIONES, TRACTOCAMIONES Y AUTOBUSES			CARGADORAS		
ACEITE	GP-51	4666343	ACEITE, OPCIONAL PARA TRANSMISION	GP-58	4304827	4200 con motor/A DIESEL		
AIRE	GA-435R	8076195	ACEITE, LUBRICACION DE DOBLE FLUJO	GP-9001	3101869	ACEITE	GP-1	484874
VT SERIES con motor/VOLVO VED16			AIRE, PRIMARIO	GA-624R	20411815	COMBUSTIBLE	G-296	6211585
DIRECCION	G-162H	349619	VT880 con motor/VOLVO VED16			COMBUSTIBLE	G-296-B	6211585
AGUA, SISTEMA DE ENFRIAMIENTO	GP-2108W	3945411	DIRECCION	G-162H	349619	4200B con motor/A DIESEL		
ACEITE, FLUJO TOTAL (FULL FLOW) REQUIERE 2	GP-51	478736	ACEITE, OPCIONAL PARA TRANSMISION	GP-1	17237	COMBUSTIBLE	GP-1122	466987-5
ACEITE, DERIVACION (BY PASS)	GP-556	477556	AGUA, SISTEMA DE ENFRIAMIENTO	GP-2108W	20458769	4300, 4300B con motor/A DIESEL		
AIRE, PRIMARIO	GA-624R	20411815	ACEITE, FLUJO TOTAL (FULL FLOW) REQUIERE 2	GP-51	478736-2	COMBUSTIBLE	G-296	2366284
VT SERIES, VT800 con motor/CUMMINS ISX			ACEITE, OPCIONAL PARA TRANSMISION	GP-58	4304827	COMBUSTIBLE	GP-1122	434061
DIRECCION	G-162H	349619	COMBUSTIBLE, SEPARADOR DE AGUA CON PURGADOR	GPP-1291	81599755	TRANSMISION	GP-66	4787923-4
COMBUSTIBLE, SEPARADOR DE AGUA, CARTUCHO	G-128	85105574	ACEITE, DERIVACION (BY PASS)	GP-556	477556	COMBUSTIBLE	G-296-B	236628
ACEITE, OPCIONAL PARA TRANSMISION	GP-1	17237	AIRE, PRIMARIO	GA-624R	20411815	4400, 4500 con motor/A DIESEL		
AGUA, SISTEMA DE ENFRIAMIENTO	GP-2127W	WF2127	COMBUSTIBLE, SEPARADOR DE AGUA CON ROSCA PARA TAZON	R 90 P	R90P	COMBUSTIBLE	G-296	2366284
ACEITE, OPCIONAL PARA TRANSMISION	GP-58	4304827	WG42 con motor/CUMMINS M11			ACEITE	GP-54	4785974-9
ACEITE, LUBRICACION DE DOBLE FLUJO	GP-9001	3101869	DIRECCION	G-162H	V349619	COMBUSTIBLE	GP-1122	434061
AIRE, PRIMARIO	GA-624R	20411815	TRANSMISION, OPCIONAL	GP-1	17237	TRANSMISION	GP-66	4787923-4
VT800 con motor/VOLVO VED16			ACEITE, DOBLE FLUJO	GP-3001	LF9009	COMBUSTIBLE	G-296-B	236628
COMBUSTIBLE	G-128	FF5369	ACEITE, DOBLE FLUJO	GP-3000	3318853	AIRE	GA-405	4785748-7
ACEITE, OPCIONAL PARA TRANSMISION	GP-1	17237	AIRE, TAPA METALICA	GA-1095	22005-3201	4600, 4600B con motor/A DIESEL		
AGUA, SISTEMA DE ENFRIAMIENTO	GP-2108W	3945411	AIRE, RADIAL	GA-682R	V1117576	ACEITE	GP-51	466634-3
ACEITE, FLUJO TOTAL (FULL FLOW) REQUIERE 2	GP-51	478736	WG42 con motor/CUMMINS N14			ACEITE	GP-54	4785974-9
ACEITE, OPCIONAL PARA TRANSMISION	GP-58	4304827	DIRECCION	G-162H	V349619	COMBUSTIBLE	GP-1122	434061
ACEITE, DERIVACION (BY PASS)	GP-556	477556	COMBUSTIBLE	GP-14	154789	TRANSMISION	GP-66	4787923-4
AIRE, PRIMARIO	GA-624R	20411815	ACEITE, DERIVACION (BY PASS)	GP-57	3304232	AIRE	GA-405	4785748-7
VT830 con motor/CUMMINS ISX			ACEITE, DOBLE FLUJO	GP-3000	3318853	5350 con motor/A DIESEL		
DIRECCION	G-162H	349619	AIRE	GA-1095	22005-3201	ACEITE	GP-51	466634-3
ACEITE, OPCIONAL PARA TRANSMISION	GP-1	17237	WG42 con motor/DETROIT DIESEL SERIES 60			COMBUSTIBLE	GP-1122	434061
AGUA, SISTEMA DE ENFRIAMIENTO	GP-2127W	WF2127	DIRECCION	G-162H	349619	AIRE	GA-405	4785748-7
ACEITE, OPCIONAL PARA TRANSMISION	GP-58	4304827	TRANSMISION, OPCIONAL	GP-1	17237	BL60, BL71, BL61, BL70 con motor/VOLVO D4D		
ACEITE, LUBRICACION DE DOBLE FLUJO	GP-9001	3101869	ACEITE, REQUIERE 2 PIEZAS	GP-193	23518480	COMBUSTIBLE	GP-1122	11706667
AIRE, PRIMARIO	GA-624R	20411815	AIRE, TAPA METALICA	GA-1095	22005-5039	ACEITE	GP-54	4804406
VT830 con motor/VOLVO VED16			AIRE, RADIAL	GA-682R	V1117576	COMBUSTIBLE	GP-1122	466987
DIRECCION	G-162H	349619	WG64 con motor/CUMMINS ISM			TRANSMISION	GP-66	4787923
ACEITE, OPCIONAL PARA TRANSMISION	GP-1	17237	TRANSMISION, OPCIONAL	GP-1	17237	EL70C con motor/VOLVO TD48		
AGUA, SISTEMA DE ENFRIAMIENTO	GP-2108W	3945411	ACEITE, DOBLE FLUJO	GP-9001	LF9001	TRANSMISION	GP-66	4787923
ACEITE, FLUJO TOTAL (FULL FLOW) REQUIERE 2	GP-51	478736	AIRE	GA-1095	22005-3201	L110E, L120E con motor/VOLVO D7D		
ACEITE, OPCIONAL PARA TRANSMISION	GP-58	4304827	WG64 con motor/CUMMINS N14			ACEITE	GP-54	3831236
ACEITE, DERIVACION (BY PASS)	GP-556	477556	DIRECCION	G-169	1742317	L120 con motor/A DIESEL		
AIRE, PRIMARIO	GA-624R	20411815	TRANSMISION, OPCIONAL	GP-1	17237	ACEITE	GP-51	466634-3
VT880 con motor/CUMMINS ISX			ACEITE, DERIVACION (BY PASS)	GP-57	3304232	COMBUSTIBLE	GP-1122	466987-5
DIRECCION	G-162H	349619	AIRE	GA-1095	22005-3201	ACEITE, DERIVACION (BY PASS)	GP-556	477556
COMBUSTIBLE, SEPARADOR DE AGUA, CARTUCHO	G-128	85105574	WG64 con motor/VOLVO VED7			AIRE, PRIMARIO	GA-405	4785748-7
ACEITE, OPCIONAL PARA TRANSMISION	GP-1	17237	ACEITE	GP-51	4666343	L120B con motor/A DIESEL		
AGUA, SISTEMA DE ENFRIAMIENTO	GP-2108W	3945411	COMBUSTIBLE	GP-1122	434061	ACEITE	GP-51	466634-3
ACEITE, FLUJO TOTAL (FULL FLOW) REQUIERE 2	GP-51	478736	ACEITE, DERIVACION (BY PASS)	GP-556	477556	AGUA	GP-1013Q	1661964
ACEITE, OPCIONAL PARA TRANSMISION	GP-58	4304827	WX (REFUSE HAULER) con motor/VOLVO VE275			COMBUSTIBLE	GP-1122	466987-5
ACEITE, DERIVACION (BY PASS)	GP-556	477556	COMBUSTIBLE	GP-96	420799	ACEITE, DERIVACION (BY PASS)	GP-556	477556-5
AIRE, PRIMARIO	GA-624R	20411815	ACEITE	GP-51	478736-2	AIRE, PRIMARIO	GA-405	4785748-7
VT880 con motor/CUMMINS ISX			COMBUSTIBLE, SEPARADOR DE AGUA	GPP-1291	3945966	L120C SOBRE RUEDAS con motor/VOLVO TD73		
DIRECCION	G-162H	349619	ACEITE, DERIVACION (BY PASS)	GP-556	477556	ACEITE	GP-51	466634-3
COMBUSTIBLE, SEPARADOR DE AGUA, CARTUCHO	G-128	85105574	ACEITE, DERIVACION (BY PASS)	GP-556	477556	COMBUSTIBLE	GP-1122	466987-5
ACEITE, OPCIONAL PARA TRANSMISION	GP-1	17237	WX (REFUSE HAULER) con motor/VOLVO VE275			ACEITE, DERIVACION (BY PASS)	GP-556	477556-5
AGUA, SISTEMA DE ENFRIAMIENTO	GP-2127W	WF2127	COMBUSTIBLE	GP-96	420799	AIRE, PRIMARIO	GA-405	4785748-7
			ACEITE	GP-51	478736-2	L120C SOBRE RUEDAS con motor/VOLVO TD73		
			COMBUSTIBLE, SEPARADOR DE AGUA	GPP-1291	3945966	ACEITE	GP-51	466634-3
			ACEITE, DERIVACION (BY PASS)	GP-556	477556	COMBUSTIBLE	GP-1122	466987-5
			ACEITE, DERIVACION (BY PASS)	GP-556	477556	ACEITE, DERIVACION (BY PASS)	GP-556	477556-5
						AIRE, PRIMARIO	GA-405	4785748-7

SERVICIO PESADO

MARCA-MODELO-MOTOR MAKE-MODEL-ENGINE	GONHER GONHER	OEM OEM	MARCA-MODELO-MOTOR MAKE-MODEL-ENGINE	GONHER GONHER	OEM OEM	MARCA-MODELO-MOTOR MAKE-MODEL-ENGINE	GONHER GONHER	OEM OEM
VOLVO (continuación)			VOLVO (continuación)			VOLVO (continuación)		
CARGADORAS			CARGADORAS			CARGADORAS		
L120D SOBRE RUEDAS con motor/VOLVO TD73			ACEITE, DERIVACION (BY PASS)	GP-556	477556-5	AIRE	GA-356	4881174-9
ACEITE	GP-51	466634	L180E con motor/VOLVO D12C			AIRE	GA-357	4881175-6
COMBUSTIBLE	GP-1122	466987	COMBUSTIBLE	GP-96	8193841	L35B con motor/DEUTZ BF4L1011F		
COMBUSTIBLE, SEPARADOR DE AGUA	GPP-1291	8159975	COMBUSTIBLE, SEPARADOR DE AGUA	GPP-1291	8159975	ACEITE	GP-28	1526187
ACEITE, DERIVACION (BY PASS)	GP-556	477556	ACEITE, DERIVACION (BY PASS)	GP-556	477556-5	COMBUSTIBLE, CON PURGADOR	GPP-1122	838593
L140 con motor/A DIESEL			L190 con motor/CUMMINS NTA855			COMBUSTIBLE	G-297	32102097
COMBUSTIBLE	GPP-14	949095	ACEITE	GP-53	79250015	COMBUSTIBLE	G-297-B	32102097
ACEITE	GP-53	961172	AGUA	GP-1013Q	12565210	L40B, L45B con motor/DEUTZ BF4M1013E		
ACEITE, DERIVACION (BY PASS)	GP-556	477556	COMBUSTIBLE	GPP-1122	838593	ACEITE	GP-54	432135
L150 con motor/VOLVO TD102GC			ACEITE, DERIVACION (BY PASS)	GP-57	3131750	L50 con motor/A DIESEL		
ACEITE	GP-51	4666343	L190B con motor/VOLVO			ACEITE	GP-54	4804406-9
AGUA	GP-1013Q	1661964	ACEITE	GP-51	4666343	COMBUSTIBLE	GP-1122	466987-5
COMBUSTIBLE	GP-1122	434061	AGUA	GP-1013Q	1661964	TRANSMISION	GP-66	4787923-4
AIRE, PRIMARIO	GA-405	4785748	COMBUSTIBLE	GP-1122	434061	L50C SOBRE RUEDAS con motor/VOLVO TD40 SERIES		
L150C SOBRE RUEDAS con motor/VOLVO TD103			L220D SOBRE RUEDAS con motor/VOLVO TD122			ACEITE	GP-51	478736
ACEITE	GP-51	466634-3	ACEITE	GP-51	466634-3	COMBUSTIBLE	GP-1122	466987-5
COMBUSTIBLE	GP-1122	466987-5	COMBUSTIBLE	GP-1122	466987-5	HIDRAULICO	GP-66	4787923-4
COMBUSTIBLE, SEPARADOR DE AGUA	GPP-1291	8159975	COMBUSTIBLE, SEPARADOR DE AGUA	GPP-1291	8159975	TRANSMISION	GP-66	4787923
ACEITE, DERIVACION (BY PASS)	GP-556	477556-5	ACEITE, DERIVACION (BY PASS)	GP-556	477556	COMBUSTIBLE	G-297	11999066-1
AIRE, PRIMARIO	GA-467	11033128-7	L220E con motor/VOLVO D12C			COMBUSTIBLE	G-297-B	11999066-1
L150D SOBRE RUEDAS con motor/VOLVO TD103			COMBUSTIBLE	GP-96	8193841	L50D SOBRE RUEDAS con motor/VOLVO TD40 SERIES		
ACEITE	GP-51	466634-3	COMBUSTIBLE, SEPARADOR DE AGUA	GPP-1291	8159975	ACEITE	GP-51	478736
COMBUSTIBLE	GP-1122	466987-5	ACEITE, DERIVACION (BY PASS)	GP-556	477556	HIDRAULICO	GP-66	4787923-4
COMBUSTIBLE, SEPARADOR DE AGUA	GPP-1291	8159975	L30 con motor/PERKINS 4.236			COMBUSTIBLE, SEPARADOR DE AGUA	GPP-1291	8159975
ACEITE, DERIVACION (BY PASS)	GP-556	477556-5	ACEITE	GP-1	484874	L60E, L70E con motor/VOLVO D6D		
L150E con motor/VOLVO D10B			COMBUSTIBLE	G-296	2366284	ACEITE	GP-54	3831236
COMBUSTIBLE	GP-96	8193841	COMBUSTIBLE	G-296-B	236628	L70 con motor/A DIESEL		
COMBUSTIBLE, SEPARADOR DE AGUA	GPP-1291	8159975	L30B con motor/DEUTZ BF4L1011F			ACEITE	GP-54	4804406-9
ACEITE, DERIVACION (BY PASS)	GP-556	477556-5	ACEITE	GP-28	1526187	COMBUSTIBLE	GP-1122	466987-5
L160 con motor/A DIESEL			COMBUSTIBLE	G-297	32102097	TRANSMISION	GP-66	4787923-4
ACEITE	GP-51	466634-3	COMBUSTIBLE	G-297-B	32102097	L70B con motor/VOLVO TD61		
COMBUSTIBLE	GP-1122	466987-5	L320 con motor/A DIESEL			ACEITE	GP-51	466634-3
TRANSMISION	GP-66	4787923-4	ACEITE, DERIVACION (BY PASS)	GP-556	11996228-0	COMBUSTIBLE	GP-1122	466987-5
AIRE, PRIMARIO	GA-405	4785748-7	AIRE	GA-356	4881174-9	TRANSMISION	GP-66	4787923
L180 con motor/VOLVO TD122			AIRE	GA-357	4881175-6	L70C SOBRE RUEDAS con motores/VOLVO TD61, VOLVO TD63		
ACEITE	GP-51	4666343	L32B con motor/DEUTZ BF4L1011F			ACEITE	GP-51	466634-3
AGUA	GP-1013Q	1661964	ACEITE	GP-28	1526187	COMBUSTIBLE	GP-1122	466987-5
COMBUSTIBLE	GP-1122	434061	COMBUSTIBLE	G-297	32102097	HIDRAULICO	GP-66	4787923
ACEITE, DERIVACION (BY PASS)	GP-556	4084262	COMBUSTIBLE	G-297-B	32102097	TRANSMISION	GP-66	4787923
AIRE, PRIMARIO	GA-405	4785748	L330C SOBRE RUEDAS, L330D SOBRE RUEDAS con motor/VOLVO TD164			L70D SOBRE RUEDAS con motor/VOLVO TD63		
AIRE, PRIMARIO	GA-467	11033128-7	ACEITE	GP-51	478736	ACEITE	GP-51	466634
L180C SOBRE RUEDAS con motor/VOLVO TD122			COMBUSTIBLE	GP-1122	466987-5	COMBUSTIBLE	GP-1122	466987
ACEITE	GP-51	466634-3	COMBUSTIBLE, SEPARADOR DE AGUA	GPP-1291	8159975	HIDRAULICO	GP-66	4787923
COMBUSTIBLE	GP-1122	466987-5	ACEITE, DERIVACION (BY PASS)	GP-556	477556-5	TRANSMISION	GP-66	4787923
COMBUSTIBLE, SEPARADOR DE AGUA	GPP-1291	8159975	AIRE	GA-356	4881174-9	AIRE, PRIMARIO	GA-697R	11110215
ACEITE, DERIVACION (BY PASS)	GP-556	477556-5	AIRE	GA-357	4881175-6	L90, L90B con motor/VOLVO TD61		
AIRE, PRIMARIO	GA-467	11033128-7	L330E con motor/VOLVO D16B			ACEITE	GP-51	466634-3
L180D SOBRE RUEDAS con motor/VOLVO TD122			COMBUSTIBLE	GP-96	8193841	L90C SOBRE RUEDAS con motor/VOLVO TD63		
ACEITE	GP-51	466634-3	COMBUSTIBLE, SEPARADOR DE AGUA	GPP-1291	8159975	ACEITE	GP-51	466634-3
COMBUSTIBLE	GP-1122	466987-5	ACEITE, DERIVACION (BY PASS)	GP-556	477556-5	L90D SOBRE RUEDAS con motor/VOLVO TD63		
COMBUSTIBLE, SEPARADOR DE AGUA	GPP-1291	8159975	AIRE	GA-356	4881174-9	ACEITE	GP-51	466634-3
ACEITE, DERIVACION (BY PASS)	GP-556	477556-5	AIRE	GA-357	4881175-6			
AIRE, PRIMARIO	GA-467	11033128-7						

MARCA-MODELO-MOTOR MAKE-MODEL-ENGINE	GONHER GONHER	OEM OEM	MARCA-MODELO-MOTOR MAKE-MODEL-ENGINE	GONHER GONHER	OEM OEM	MARCA-MODELO-MOTOR MAKE-MODEL-ENGINE	GONHER GONHER	OEM OEM
VOLVO (continuación)			VOLVO (continuación)			VOLVO (continuación)		
CARGADORAS			CARGADORAS			EXCAVADORAS		
COMBUSTIBLE	GP-1122	466987-5	ZL302C con motor/DEUTZ F4M1008			EC240B, EC290B con motor/VOLVO D7D		
COMBUSTIBLE, SEPARADOR DE AGUA	GPP-1291	8159975	COMBUSTIBLE	G-297	2905298	ACEITE	GP-54	3831236
			COMBUSTIBLE	G-297-B	2905298			
L90E con motor/VOLVO D6D			ACEITE	GP-461	2900776	EC280 con motor/VOLVO TD73		
ACEITE	GP-54	3831236	ZL402C con motor/DEUTZ F3L1011F			ACEITE	GP-51	466634-3
			ACEITE	GP-28	1526187	COMBUSTIBLE	GP-1122	466987-5
LM1240 con motor/VOLVO D70B			ZL502C con motor/DEUTZ F4L1011F			COMBUSTIBLE, SEPARADOR DE AGUA	GPP-1291	8159975-5
ACEITE	GP-54	432135	COMBUSTIBLE	G-297	32102097	ACEITE, DERIVACION (BY PASS)	GP-556	477556-5
			COMBUSTIBLE	G-297-B	32102097	EC290 con motor/CUMMINS 8.3L		
LM1254 con motor/A DIESEL			ACEITE	GP-6811	PH6811	COMBUSTIBLE, SECUNDARIO	GP-1122	9912-03640
TRANSMISION	G-33	6617506-8	VOLVO			AGUA	GP-1011Q	9912-15115
COMBUSTIBLE	G-1123	7233897	EQUIPO FORESTAL			ACEITE	GP-3000	9912-18853
ACEITE	GP-54	423135	SM971, SM980 con motor/A DIESEL			COMBUSTIBLE, PRIMARIO	GPP-18	9912-03410
COMBUSTIBLE	GP-1122	243004	ACEITE	GP-54	432135	EC330B con motor/VOLVO D10B		
			VOLVO			COMBUSTIBLE	GP-96	8193841
LM1640, LM1641 con motores/VOLVO D100, VOLVO TD100			EXCAVADORAS			EC340, EC390 con motor/A DIESEL		
ACEITE	GP-54	423135	ESCO con motor/PERKINS 104-22			ACEITE	GP-51	466634-3
			ACEITE	GP-171	7413694	COMBUSTIBLE	GP-1122	466987-5
LM218 con motor/BOLINDER 3 CYL			EC130C, EC150C con motor/VOLVO TD40			ACEITE, DERIVACION (BY PASS)	GP-556	477556-5
COMBUSTIBLE	G-1121	233574	COMBUSTIBLE	G-297	11999066-1	EC360 con motor/CUMMINS M11		
ACEITE	GP-31	6612598	EC140 con motor/CUMMINS 4B3.9			AGUA	GP-1013Q	9912-18318
COMBUSTIBLE	G-296	2366284	COMBUSTIBLE, SECUNDARIO	GP-1122	9912-03640	EC360B con motor/VOLVO D10B		
COMBUSTIBLE	G-296-B	236628	COMBUSTIBLE, PRIMARIO	GPP-18	9912-03410	COMBUSTIBLE	GP-96	8193841
			AIRE, PRIMARIO	GA-360	9912-45700	EC45 con motor/MITSUBISHI K4N		
LM422 con motor/PERKINS			AIRE, SECUNDARIO	GA-361	9912-45800	ACEITE	GP-462	7417534
ACEITE	G-813	6612069	EC150 con motor/CUMMINS 4BTA3.9			EC450 con motor/A DIESEL		
			COMBUSTIBLE, SECUNDARIO	GP-1122	9912-03640	ACEITE	GP-51	466634-3
LM620, LM642, LM621, LM622, LM640, LM641 con motor/A DIESEL 3 CYL			COMBUSTIBLE, PRIMARIO	GPP-18	9912-03410	COMBUSTIBLE	GP-1122	466987-5
COMBUSTIBLE	G-1121	233574	AIRE, PRIMARIO	GA-360	9912-45700	ACEITE, DERIVACION (BY PASS)	GP-556	477556-5
ACEITE	GP-31	6612598	AIRE, SECUNDARIO	GA-361	9912-45800	AIRE, PRIMARIO	GA-467	11033128-7
COMBUSTIBLE	G-296	2366284	EC160 con motor/A DIESEL			EC460 con motor/CUMMINS M11		
ACEITE	GP-54	432135	ACEITE	GP-51	478736	AGUA	GP-1013Q	9912-18318
TRANSMISION	GP-66	4787923-4	EC200 con motores/VOLVO TD61, VOLVO TD63			EC460B con motor/VOLVO D12C		
COMBUSTIBLE	G-296-B	236628	ACEITE	GP-51	466634-3	COMBUSTIBLE	GP-96	8193841
			COMBUSTIBLE	GP-1122	466987-5	EC55 con motor/YANMAR 4TNE94		
LM840 con motor/BOLINDER 6 CYL			ACEITE, DERIVACION (BY PASS)	GP-556	477556	ACEITE	GP-6811	12915035151
COMBUSTIBLE	G-1121	233574	EC210 con motor/CUMMINS 6B5.9			EC55B con motor/YANMAR 4TNN94L		
			COMBUSTIBLE, SECUNDARIO	GP-1122	9912-03640	ACEITE	GP-6811	1195-30030
LM841, LM845, LM846 con motor/A DIESEL			COMBUSTIBLE, PRIMARIO	GPP-18	9912-03410	EC650 con motores/A DIESEL, VOLVO TD122		
COMBUSTIBLE	G-1121	233574	ACEITE	GP-178	9912-90710	ACEITE	GP-51	466634-3
ACEITE	GP-54	432135	AIRE, PRIMARIO	GA-360	9912-45700	COMBUSTIBLE	GP-1122	466987-5
COMBUSTIBLE	GP-1122	434061	AIRE, SECUNDARIO	GA-361	9912-45800	ACEITE, DERIVACION (BY PASS)	GP-556	477556-5
AIRE	GAK-403	6621505	EC230B con motores/VOLVO TD61, VOLVO TD63			AIRE, PRIMARIO	GA-467	11033128-7
			ACEITE	GP-51	466634-3	AIRE, SECUNDARIO	GA-361	9912-45800
MC110B, MC90B con motor/VOLVO D3.4A			EC240 con motor/CUMMINS 6C8.3			EW130 con motor/CUMMINS 4BTA3.9		
ACEITE, RETORNO HIDRAULICO	GP-761H	11036607	COMBUSTIBLE, SECUNDARIO	GP-1122	9912-03640	COMBUSTIBLE, SECUNDARIO	GP-1122	9912-03640
			AGUA	GP-1011Q	9912-15115	COMBUSTIBLE, PRIMARIO	GPP-18	9912-03410
MC70B con motor/VOLVO D2.0A			ACEITE	GP-3000	9912-18853	ACEITE	GP-178	9912-90710
ACEITE, RETORNO HIDRAULICO	GP-761H	11036607	AIRE, PRIMARIO	GA-360	9912-45700	AIRE, PRIMARIO	GA-360	9912-45700
			AIRE, SECUNDARIO	GA-361	9912-45800	AIRE, SECUNDARIO	GA-361	9912-45800
MC80B con motor/VOLVO D3.4A			EC240 con motor/VOLVO D47B					
AIRE, RADIAL PRIMARIO	GA-853R	11883618	COMBUSTIBLE	G-1123	233897			
P654 con motor/VOLVO D50A								
HIDRAULICO	G-33	40141558						
ACEITE	GP-54	432135						
COMBUSTIBLE	GP-1122	434061						

SERVICIO PESADO

MARCA-MODELO-MOTOR	GONHER	OEM
MAKE-MODEL-ENGINE	GONHER	OEM

VOLVO (continuación)		
EXCAVADORAS		
EW130C con motor/VOLVO TD40		
COMBUSTIBLE	G-297	11999066-1
EW140B con motor/VOLVO D5D		
ACEITE	GP-54	3831236
EW150C con motor/VOLVO TD40		
COMBUSTIBLE	G-297	11999066-1
EW160 con motor/A DIESEL		
ACEITE	GP-51	478736
EW160B, EW180B con motor/VOLVO D6D		
ACEITE	GP-54	3831236
EW170, EW180 con motor/CUMMINS B5.9		
COMBUSTIBLE, SECUNDARIO	GP-1122	9912-03640
COMBUSTIBLE, PRIMARIO	GPP-18	9912-03410
ACEITE	GP-178	9912-90710
AIRE, PRIMARIO	GA-360	9912-45700
AIRE, SECUNDARIO	GA-361	9912-45800
EW200 con motores/VOLVO TD61, VOLVO TD63		
ACEITE	GP-51	466634-3
EW200B con motor/VOLVO D6D		
ACEITE	GP-54	3831236
EW230B con motores/VOLVO TD61, VOLVO TD63		
ACEITE	GP-51	466634-3
EW50 con motor/PERKINS 104-22		
ACEITE	GP-171	7413694
EX290LC con motor/CUMMINS 8.3L		
COMBUSTIBLE, SECUNDARIO	GP-1122	9912-03640
AGUA	GP-1011Q	9912-15115
ACEITE	GP-3000	9912-18853
COMBUSTIBLE, PRIMARIO	GPP-18	9912-03410
KL121, KL131, KL121B, KL130 con motor/A DIESEL		
ACEITE	GP-54	432135

VOLVO
GRÚAS

MK690, MK693, MK691, MK692 con motor/A DIESEL		
COMBUSTIBLE	G-296	2366284

VOLVO
MOTORES

12D SERIES A DIESEL, 9A (9.4L) A DIESEL, V9A (9.4L) A DIESEL		
ACEITE, DERIVACION (BY PASS)	GP-556	477556-5
D100 A DIESEL, D120 A DIESEL, D120A A DIESEL, D50 A DIESEL, D50A A DIESEL, D50B A DIESEL, D70 A DIESEL, D70A A DIESEL, D70B A DIESEL TAD720GE A DIESEL, TD100 A DIESEL, TD120A A DIESEL, TD50 A DIESEL, TD50A A DIESEL, TD50B A DIESEL, TD70A A DIESEL, TD70B A DIESEL, TD70C A DIESEL, TD70D A DIESEL, TD720GE A DIESEL		
ACEITE	GP-54	423135
D100A A DIESEL, D60 A DIESEL, D60A A DIESEL, TD100A A DIESEL, TD100B A DIESEL, TD100C A DIESEL, TD60 A DIESEL, TD60A A DIESEL, TD60C A DIESEL, TD60D A DIESEL		
ACEITE	GP-51	466634

MARCA-MODELO-MOTOR	GONHER	OEM
MAKE-MODEL-ENGINE	GONHER	OEM

VOLVO (continuación)		
MOTORES		
ACEITE	GP-54	423135
COMBUSTIBLE	GP-1122	434061
D11 A DIESEL, D16 A DIESEL, VD16 A DIESEL, VED11 A DIESEL, VED16 A DIESEL		
AGUA, REFRIGERANTE	GP-2108W	3945411
ACEITE, FLUJO TOTAL (FULL FLOW) (REQUIERE 2)	GP-51	4787362
ACEITE, DERIVACION (BY PASS)	GP-556	477556-5
F6 A DIESEL		
ACEITE	GP-51	466634
COMBUSTIBLE	GP-1122	466987
ACEITE, DERIVACION (BY PASS)	G-500	1695007
F7 A DIESEL		
ACEITE	GP-51	466634
COMBUSTIBLE	GP-1122	466987
ACEITE, DERIVACION (BY PASS)	G-750	1517575
FE6 A DIESEL, FE7 A DIESEL		
ACEITE	GP-51	466634
COMBUSTIBLE	GP-1122	466987
ACEITE, DERIVACION (BY PASS)	GP-556	477556
TD100G A DIESEL, TD100GPP A DIESEL, TD101F A DIESEL, TD101G A DIESEL, TD120C A DIESEL, TD120D A DIESEL, TD120E A DIESEL, TD120F A DIESEL, TD120G A DIESEL, TD120HD A DIESEL, TD121F A DIESEL, TD121G A DIESEL, TD164KAE A DIESEL, TD70F A DIESEL, TD70G A DIESEL, TD70H A DIESEL, TD100KG A DIESEL, TD100KPP A DIESEL, TD162AG A DIESEL, VED12-310 A DIESEL, VED12-335 A DIESEL, VED12-370 A DIESEL, VED12-415 A DIESEL		
ACEITE	GP-51	466634
TD120 A DIESEL, TD121 A DIESEL, TD122 A DIESEL, TD123 A DIESEL, TD61A A DIESEL, TD61AG A DIESEL, TD61AP A DIESEL, TD61AW A DIESEL		
ACEITE	GP-54	423135
COMBUSTIBLE	GP-1122	434061
ACEITE, DERIVACION (BY PASS)	GP-556	477556
TD60B A DIESEL		
ACEITE	GP-51	466634
ACEITE	GP-54	423135
COMBUSTIBLE	GP-1122	434061
ACEITE, DERIVACION (BY PASS)	G-500	1695007
TD70 A DIESEL, TD70E A DIESEL		
ACEITE	GP-54	423135
COMBUSTIBLE	GP-1122	466987
ACEITE, DERIVACION (BY PASS)	G-750	1517575

TD73 A DIESEL, TD71AG A DIESEL, VD7 A DIESEL, VE12 A DIESEL, VE12-300 A DIESEL, VE12-330 A DIESEL, VE12-360 A DIESEL, VE12-410 A DIESEL, VE250 A DIESEL, VE275 A DIESEL, VE300 A DIESEL, VE7-215A A DIESEL, VE7-250B A DIESEL, VED7 A DIESEL		
ACEITE	GP-51	466634
COMBUSTIBLE	GP-1122	466987
ACEITE, DERIVACION (BY PASS)	GP-556	477556
VED12 365-465 HP A DIESEL, VED12 A DIESEL		
COMBUSTIBLE	GP-96	8193841
ACEITE	GP-51	4666343
COMBUSTIBLE, SEPARADOR DE AGUA	GPP-1291	3945966
ACEITE, DERIVACION (BY PASS)	GP-556	477556-5

MARCA-MODELO-MOTOR	GONHER	OEM
MAKE-MODEL-ENGINE	GONHER	OEM

VOLVO		
TRACTORES		
470 con motor/A DIESEL		
COMBUSTIBLE	G-1121	233574
BM350 con motor/A DIESEL		
COMBUSTIBLE	G-1121	233574
BM819 con motor/A DIESEL		
ACEITE	GP-54	432135
T230 con motor/A DIESEL		
COMBUSTIBLE	G-1121	233574
T31, T32, T33, T34 con motor/A DIESEL		
ACEITE	G-31	408695
T35 con motor/A DIESEL		
COMBUSTIBLE, SECUNDARIO	G-1123	233897
T350 con motor/A DIESEL		
COMBUSTIBLE	G-1121	233574
T36 con motor/A DIESEL		
COMBUSTIBLE, SECUNDARIO	G-1123	233897
T42 con motor/A DIESEL		
ACEITE	G-31	408695
T55 con motor/A DIESEL		
COMBUSTIBLE, SECUNDARIO	G-1123	233897
T800, T810 con motor/VOLVO 313		
ACEITE	GP-54	432135
T850 con motor/A DIESEL		
COMBUSTIBLE	G-1121	233574
TD70E con motor/A DIESEL		
ACEITE	GP-10	423135
COMBUSTIBLE	GP-1122	466987
ACEITE, DERIVACION (BY PASS)	G-750	1517575
VHD con motor/VOLVO VED12		
COMBUSTIBLE	GP-96	420799
ACEITE	GP-51	478736-2
COMBUSTIBLE, SEPARADOR DE AGUA	GPP-1291	3945966
ACEITE, DERIVACION (BY PASS)	GP-556	477556

VOLVO
TRANSMISIONES

R1700, SR1700, R62, R63 con motor/A GASOLINA		
TRANSMISION PARA FORD	GP-9	1266286

WABCO
APLANADORAS

555 con motor/A DIESEL		
ACEITE, DERIVACION (BY PASS)	G-31	TD6776
HIDRAULICO	G-33	PB5038
COMBUSTIBLE, PRIMARIO	GP-26	PB1612
COMBUSTIBLE, SECUNDARIO	GP-27	PB1613

MARCA-MODELO-MOTOR MAKE-MODEL-ENGINE	GONHER GONHER	OEM OEM	MARCA-MODELO-MOTOR MAKE-MODEL-ENGINE	GONHER GONHER	OEM OEM	MARCA-MODELO-MOTOR MAKE-MODEL-ENGINE	GONHER GONHER	OEM OEM
WABCO			WABCO (continuación)			WABCO (continuación)		
CAMIONES, TRACTOCAMIONES Y AUTOBUSES			CAMIONES, TRACTOCAMIONES Y AUTOBUSES			CAMIONES, TRACTOCAMIONES Y AUTOBUSES		
120B DE ACARREO con motor/CATERPILLAR			150CW DE ACARREO con motores/GMC 16V-149T, GMC 16V-149TI			COMBUSTIBLE (CARTUCHO) (REQUIERE 2)	G-1143	729206
AIRE, PRIMARIO	GA-879	VS2186	AIRE, PRIMARIO	GA-879	6947176	ACEITE, FLUJO TOTAL (FULL FLOW) SELLADO (REQUIERE 3)	GP-53	3307885
120B DE ACARREO con motor/DETROIT DIESEL 12V-149			170CW DE VOLTEO con motor/DETROIT DIESEL 12V-149			AIRE, RESPIRADOR CON TURBO	GA-39	255963
ACEITE, CARTUCHO	G-33	SP6298	ACEITE, CARTUCHO	G-33	SP6298	ACEITE, DERIVACION (BY PASS) CARTUCHO	G-750	256345
120C DE ACARREO con motor/CUMMINS KTA2300			35C DE ACARREO con motor/CUMMINS KT1150C			60 DE ACARREO, 75B DE ACARREO con motores/CUMMINS VT1710C, CUMMINS VTA1710C		
COMBUSTIBLE, SELLADO	GP-55	VC0046	COMBUSTIBLE	GP-1101	158172	TRANSMISION	G-33	VZ2854
ACEITE, DERIVACION (BY PASS), SELLADO	GP-57	VS7035	ACEITE, FLUJO TOTAL (FULL FLOW)	GP-53	VJ8003	ACEITE, FLUJO TOTAL (FULL FLOW) CARTUCHO	G-566	V7401
AGUA, SISTEMA DE ENFRIA- MIENTO	GP-1011Q	WA1718	AGUA	GP-1011Q	WA1718	COMBUSTIBLE, CARTUCHO	G-1143	VJ8004
AIRE, PRIMARIO	GA-879	VS2186	ACEITE, DERIVACION (BY PASS)	G-750	SD1311	ACEITE, FLUJO TOTAL (FULL FLOW) SELLADO	GP-53	VJ8003
120C DE ACARREO con motores/CATERPILLAR D349, GMC 12V-149T, GMC 12V-149TI			35C DE ACARREO con motor/CUMMINS NTA855C			COMBUSTIBLE, SELLADO	GP-55	VS7352
AIRE, PRIMARIO	GA-879	VS2186	TRANSMISION	G-33	SP6298	AGUA	GP-1011Q	WA1718
120CH DE ACARREO con motor/GMC 16V-71T			ACEITE, FLUJO TOTAL (FULL FLOW) CARTUCHO	G-566	VF7401	ACEITE, DERIVACION (BY PASS)	G-750	SD1311
ACEITE, FLUJO TOTAL (FULL FLOW)	G-33	SP6298	COMBUSTIBLE, CARTUCHO	G-1143	VC8812	60 DE ACARREO, 75B DE ACARREO, 85C DE ACARREO con motores/ GMC 16V-71N, GMC 16V-71T		
120CM DE ACARREO con motor/CUMMINS KTA2300			HIDRAULICO	G-222	VY2195	ACEITE, FLUJO TOTAL (FULL FLOW) SELLADO	G-33	SP6298
COMBUSTIBLE, SELLADO	GP-55	VC0046	COMBUSTIBLE, SELLADO	GP-1101	158172	ACEITE, FLUJO TOTAL (FULL FLOW) SELLADO		
ACEITE, DERIVACION (BY PASS) SELLADO	GP-57	VS7035	ACEITE, FLUJO TOTAL (FULL FLOW) SELLADO	GP-53	VJ8003	AGUA		
AGUA, SISTEMA DE ENFRIA- MIENTO	GP-1011Q	WA1718	AGUA	GP-2071W	VJ7034	ACEITE, FLUJO TOTAL (FULL FLOW)		
AIRE, PRIMARIO	GA-879	VS2186	AIRE, PRIMARIO	GA-356	VJ5139	60B DE ACARREO con motor/CUMMINS VTA-1710C		
120CM DE ACARREO con motor/GMC 12V-149T			AIRE, SECUNDARIO	GA-357	VJ2437	TRANSMISION	G-33	PB5038
ACEITE, FLUJO TOTAL (FULL FLOW)	G-33	SP6298	ACEITE, DERIVACION (BY PASS)	G-750	SD1311	ACEITE, FLUJO TOTAL (FULL FLOW)	GP-53	VJ8003
120CM DE ACARREO con motor/GMC 12V-149T			35C DE ACARREO con motor/DETROIT DIESEL 12V-71N			COMBUSTIBLE, PRIMARIO	GP-55	VJ8004
AIRE, PRIMARIO	GA-879	VS2186	ACEITE	G-33	LWVZ-2854	ACEITE, DERIVACION (BY PASS)	GP-57	VS7035
120D DE ACARREO, 130CW DE ACARREO con motor/A DIESEL			35C DE ACARREO con motor/GMC DIESEL			AIRE, PRIMARIO	GA-356	VJ5139
COMBUSTIBLE, SELLADO	GP-55	VJ8004	ACEITE DE MOTOR	G-33	SP6298	AIRE, SECUNDARIO	GA-357	VJ2437
ACEITE, DERIVACION (BY PASS), SELLADO	GP-57	VS7035	HIDRAULICO	G-33	PB5038	75C DE ACARREO con motor/CUMMINS		
AIRE, PRIMARIO	GA-879	VS2186	TRANSMISION	G-33	SP6298	TRANSMISION	G-33	PB5038
120G DE ACARREO con motor/CATERPILLAR D348			35D DE ACARREO con motor/CUMMINS KT19			ACEITE, FLUJO TOTAL (FULL FLOW)	GP-53	VJ8003
AIRE	GAP-379	6L-4714	COMBUSTIBLE	GPP-14	DA1467	COMBUSTIBLE	GP-55	VJ8004
150B DE ACARREO con motores/GMC 16V-149T, GMC 16V-149TI			ACEITE, FLUJO TOTAL (FULL FLOW)	GP-53	VJ8003	ACEITE, DERIVACION (BY PASS)	GP-57	VS7035
AIRE, PRIMARIO	GA-879	VS2186	ACEITE, DERIVACION (BY PASS)	GP-57	VS7035	AGUA	GP-1011Q	WA1718
150CH DE ACARREO con motores/GMC 12V-149T, GMC 12V-149TI			AIRE, PRIMARIO	GA-356	VJ5139	AIRE, PRIMARIO	GA-356	VJ5139
AIRE, PRIMARIO	GA-879	VS2186	AIRE, SECUNDARIO	GA-357	VJ2437	AIRE, SECUNDARIO	GA-357	VJ2437
150CW DE ACARREO con motor/CATERPILLAR D349			35D DE ACARREO con motor/CUMMINS NTA855C			75C DE ACARREO con motor/GMC		
AIRE, PRIMARIO	GA-879	VS2186	AIRE, PRIMARIO	GA-356	P109155	TRANSMISION	G-33	PB5038
150CW DE ACARREO con motor/CUMMINS KTA2300			35D DE ACARREO con motor/GMC			ACEITE	GP-43	VS7283
COMBUSTIBLE, SELLADO	GP-55	VC0046	ACEITE, FLUJO TOTAL (FULL FLOW) CARTUCHO	G-33	SP6298	AIRE, PRIMARIO	GA-356	VJ5139
ACEITE, DERIVACION (BY PASS), SELLADO	GP-57	VS7035	ACEITE, FLUJO TOTAL (FULL FLOW) SELLADO	GP-43	VS7283	AIRE, SECUNDARIO	GA-357	VJ2437
AGUA, SISTEMA DE ENFRIA- MIENTO	GP-1011Q	WA1718	AIRE, PRIMARIO	GA-356	VJ5139	85C DE ACARREO con motor/CATERPILLAR D348		
AIRE, PRIMARIO	GA-879	VS2186	AIRE, SECUNDARIO	GA-357	VJ2437	ACEITE, FLUJO TOTAL (FULL FLOW)	G-191	PB0502
150CW DE ACARREO con motor/DETROIT DIESEL 16V-149			50 FUERA DE CARRETERA con motor/GMC 12V-71			AIRE, PRIMARIO	GA-356	VJ5139
HIDRAULICO	G-222	VY2195	ACEITE, FLUJO TOTAL (FULL FLOW)	G-33	SP6298	AIRE	GAP-379	6L-4714
150CW DE ACARREO con motores/GMC 12V-149T, GMC 12V-149TI			50 FUERA DE CARRETERA con motor/GMC 16V-71			AIRE, SECUNDARIO	GA-357	VJ2437
AIRE, PRIMARIO	GA-879	VS2186	ACEITE, FLUJO TOTAL (FULL FLOW)	G-33	SP6298	85C DE ACARREO con motor/CUMMINS KT2300C		
150CW DE ACARREO con motor/CUMMINS KTA2300			50 FUERA DE CARRETERA con motores/CUMMINS V16, CUMMINS V1710C, CUMMINS VT1710C			ACEITE, FLUJO TOTAL (FULL FLOW) CARTUCHO	G-566	VF7401
COMBUSTIBLE, SELLADO	GP-55	VC0046	TRANSMISION (REQUIERE 2)	G-33	253621	COMBUSTIBLE, CARTUCHO	G-1143	VC8812
ACEITE, DERIVACION (BY PASS), SELLADO	GP-57	VS7035	ACEITE, FLUJO TOTAL (FULL FLOW) CARTUCHO	G-566	252916	ACEITE, FLUJO TOTAL (FULL FLOW) SELLADO	GP-53	VJ8003
AGUA, SISTEMA DE ENFRIA- MIENTO	GP-1011Q	WA1718	150CW DE ACARREO con motores/GMC 12V-149T, GMC 12V-149TI			COMBUSTIBLE, SELLADO	GP-55	VS7352
AIRE, PRIMARIO	GA-879	VS2186	AIRE, PRIMARIO	GA-879	VS2186	AGUA	GP-1011Q	WA1718
150CW DE ACARREO con motor/DETROIT DIESEL 16V-149			150CW DE ACARREO con motores/GMC 12V-149T, GMC 12V-149TI			AIRE, PRIMARIO	GA-356	VJ5139
HIDRAULICO	G-222	VY2195	AIRE, PRIMARIO	GA-879	VS2186	AIRE, SECUNDARIO	GA-357	VJ5175
150CW DE ACARREO con motores/GMC 12V-149T, GMC 12V-149TI			ACEITE, DERIVACION (BY PASS)	G-750	SD1311	ACEITE, DERIVACION (BY PASS)	G-750	SD1311
AIRE, PRIMARIO	GA-879	VS2186						

SERVICIO PESADO

MARCA-MODELO-MOTOR GONHER OEM
MAKE-MODEL-ENGINE GONHER OEM

WABCO (continuación)

CAMIONES, TRACTOCAMIONES Y AUTOBUSES

85C DE ACARREO con motor/GMC 12V-149T		
ACEITE, FLUJO TOTAL (FULL FLOW)	G-33	SP6298
85C DE ACARREO con motor/GMC 16V-92T		
ACEITE, FLUJO TOTAL (FULL FLOW)	G-33	SP6298
AIRE, PRIMARIO	GA-356	VJ5139
AIRE, SECUNDARIO	GA-357	VJ2437

85C DE ACARREO con motores/CUMMINS VT1710C, CUMMINS VTA1710C		
TRANSMISION	G-33	VZ2854
ACEITE, FLUJO TOTAL (FULL FLOW) CARTUCHO	G-566	V7401
COMBUSTIBLE, CARTUCHO	G-1143	VJ8004
ACEITE, FLUJO TOTAL (FULL FLOW) SELLADO	GP-53	VJ8003
COMBUSTIBLE, SELLADO	GP-55	VS7352
AGUA	GP-1011Q	WA1718
ACEITE, DERIVACION (BY PASS)	G-750	SD1311

WABCO CARGADORAS

1200 con motor/CUMMINS V1710C		
ACEITE, FLUJO TOTAL (FULL FLOW) CARTUCHO	G-566	V7401
COMBUSTIBLE	G-1143	VC8812
ACEITE, FLUJO TOTAL (FULL FLOW) SELLADO	GP-53	VJ8003
AGUA	GP-1011Q	WA1718
ACEITE, DERIVACION (BY PASS)	G-750	SD1311

500B con motores/CUMMINS N855C, CUMMINS NT855C		
ACEITE, FLUJO TOTAL (FULL FLOW) CARTUCHO	G-566	V7401
COMBUSTIBLE	GP-1101	158172
ACEITE, FLUJO TOTAL (FULL FLOW) SELLADO	GP-53	VJ8003
AGUA	GP-2071W	VJ7034
ACEITE, DERIVACION (BY PASS)	G-750	SD1311

WABCO COMPRESORES

600SD1C, 900SD1 con motor/GMC DIESEL		
ACEITE	G-33	SP6298
777B DE AIRE con motor/CUMMINS		
HIDRAULICO	G-33	SP6298
TRANSMISION	G-33	SP6298
AIRE	GA-360	P106587

WABCO GRÚAS

60B con motor/DETROIT DIESEL 16V-71		
ACEITE, CARTUCHO	G-33	SP6298
85D con motor/CUMMINS KT2300C		
TRANSMISION	G-33	PB5038
ACEITE, FLUJO TOTAL (FULL FLOW) SELLADO	GP-53	VJ8003
COMBUSTIBLE	GP-55	VS7352
ACEITE, DERIVACION (BY PASS) SELLADO	GP-57	VS7035
AGUA	GP-2071W	VJ7034

MARCA-MODELO-MOTOR GONHER OEM
MAKE-MODEL-ENGINE GONHER OEM

WABCO (continuación)

GRÚAS

ACEITE, DERIVACION (BY PASS) CARTUCHO	G-750	SD1311
85D con motor/DETROIT DIESEL 16V-92		
ACEITE, CARTUCHO	G-33	SP6298
TRANSMISION	G-33	PB5038
ACEITE, SELLADO	GP-43	VS7283
CM50 con motor/GMC 12V-71T		
ACEITE, FLUJO TOTAL (FULL FLOW)	G-33	SP6298

WABCO MONTACARGAS

101F con motor/A DIESEL		
ACEITE, FLUJO TOTAL (FULL FLOW)	G-613	VS1969
ACEITE, TURBOCARGADOR	GP-14	P779146
COMBUSTIBLE	GPP-14	DA1467
ACEITE, DERIVACION (BY PASS)	G-500	SH8986

252FT con motor/A DIESEL		
ACEITE DE MOTOR DELANTERO	G-33	SP6298
ACEITE DE MOTOR TRASERO	G-33	PB5038
HIDRAULICO	G-33	PB5038
COMBUSTIBLE, PRIMARIO MOTOR TRASERO	GP-26	PB1612
COMBUSTIBLE, SECUNDARIO MOTOR TRASERO	GP-27	PB1613

353FT con motor/DETROIT DIESEL		
ACEITE, FLUJO TOTAL (FULL FLOW)	G-33	PB5038
HIDRAULICO	G-33	PB5038
AIRE, PRIMARIO	GA-356	VJ5139
AIRE, SECUNDARIO	GA-357	VJ2437

B333F con motor/GMC 12V-71N		
ACEITE, FLUJO TOTAL (FULL FLOW)	G-33	SP6298
HIDRAULICO	G-33	SP6298
TRANSMISION	G-33	PB5038

WABCO NIVELADORAS

120 DE CARBON con motor/A DIESEL		
ACEITE, FLUJO TOTAL (FULL FLOW) CARTUCHO	G-566	V7401
COMBUSTIBLE, CARTUCHO	G-1143	VC8812
HIDRAULICO	G-222	VY2195
ACEITE, FLUJO TOTAL (FULL FLOW) SELLADO	GP-53	VJ8003
COMBUSTIBLE, SELLADO	GP-55	VJ8004
ACEITE, DERIVACION (BY PASS)	G-750	SD1311

150CT con motor/CATERPILLAR D348		
AIRE	GAP-379	6L-4714

150CT con motor/DETROIT DIESEL 16V-92		
ACEITE, CARTUCHO	G-33	SP6298

150CT con motor/GMC 12V-149T		
ACEITE, FLUJO TOTAL (FULL FLOW)	G-33	SP6298

MARCA-MODELO-MOTOR GONHER OEM
MAKE-MODEL-ENGINE GONHER OEM

WABCO (continuación)

NIVELADORAS

150CT con motor/GMC 12V-149TI		
AIRE, PRIMARIO	GA-879	VS2186

150CT, 170CW con motores/CUMMINS KT2300C, CUMMINS KTA2300C		
ACEITE, FLUJO TOTAL (FULL FLOW)	GP-53	VJ8003
COMBUSTIBLE	GP-55	VJ8004
ACEITE, DERIVACION (BY PASS)	G-750	SD1311

170C con motor/CUMMINS KTA3067C		
ACEITE, FLUJO TOTAL (FULL FLOW)	GP-53	VJ8003
COMBUSTIBLE, SELLADO	GP-55	VC0046
AGUA, SISTEMA DE ENFRIAMIENTO	GP-1011Q	WA1718
AIRE, PRIMARIO	GA-879	VS2186

170C con motor/DETROIT DIESEL 12V-149		
ACEITE, CARTUCHO	G-33	SP6298

170C con motor/DETROIT DIESEL 16V-149		
HIDRAULICO	G-222	VY2195

170C con motor/GMC 16V-149TI		
AIRE, PRIMARIO	GA-879	VS2186

170CW con motor/DETROIT DIESEL 16V-149		
ACEITE, SELLADO	GP-53	VJ8003

170D con motor/CUMMINS KTA3067C		
ACEITE, FLUJO TOTAL (FULL FLOW)	GP-53	VJ8003
COMBUSTIBLE	GP-55	VC0046
ACEITE, DERIVACION (BY PASS), SELLADO	GP-57	VS7035
AIRE, PRIMARIO	GA-879	VS2186

170D con motor/DETROIT DIESEL 16V-149		
ACEITE, CARTUCHO	G-33	SP6298

35 con motor/DETROIT DIESEL 8V-71		
TRANSMISION	G-33	PB5038

444 con motor/CUMMINS H743C		
ACEITE, FLUJO TOTAL (FULL FLOW)	G-566	V7401
COMBUSTIBLE	G-1143	VC8812
ACEITE, TURBOCARGADOR	GP-14	P779146

444 con motor/CUMMINS N855		
ACEITE, FLUJO TOTAL (FULL FLOW) CARTUCHO	G-566	V7401
COMBUSTIBLE	GP-1101	158172
ACEITE, FLUJO TOTAL (FULL FLOW) SELLADO	GP-53	VJ8003
AGUA	GP-2071W	VJ7034
ACEITE, DERIVACION (BY PASS)	G-750	SD1311

444 con motor/GMC 4-71HT		
ACEITE, FLUJO TOTAL (FULL FLOW)	G-33	SP6298

555 con motores/CUMMINS N855C, CUMMINS NT855C		
ACEITE, FLUJO TOTAL (FULL FLOW) CARTUCHO	G-566	V7401
COMBUSTIBLE	GP-1101	158172
ACEITE, FLUJO TOTAL (FULL FLOW) SELLADO	GP-53	VJ8003

MARCA-MODELO-MOTOR MAKE-MODEL-ENGINE	GONHER GONHER	OEM OEM
WABCO (continuación)		
NIVELADORAS		
AGUA	GP-2071W	VJ7034
ACEITE, DERIVACION (BY PASS)	G-750	SD1311
888 con motor/GMC 8V-71		
ACEITE, FLUJO TOTAL (FULL FLOW)	G-33	SP6298
COMBUSTIBLE, SECUNDARIO	G-1175	TC7838
AIRE, PRIMARIO	GA-360	VJ1882
AIRE, SECUNDARIO	GA-361	8994765

WABCO		
RASPADORAS		
222H con motor/DETROIT DIESEL 8V-71		
HIDRAULICO	G-33	SP6298
TRANSMISION	G-33	SP6298
AIRE, PRIMARIO	GA-356	P109155
AIRE, SECUNDARIO	GA-357	P109159
229H con motor/DETROIT DIESEL 8V-71		
HIDRAULICO	G-33	SP6298
252FT con motor/DETROIT DIESEL 8V-71T		
TRANSMISION	G-33	LWVZ-2854
333CSF con motor/GMC 12V-71T		
ACEITE, FLUJO TOTAL (FULL FLOW)	G-33	SP6298
333FT con motor/DOS GMC 12V-71T		
ACEITE, FLUJO TOTAL (FULL FLOW)	G-33	SP6298

WABCO		
REMOVEDORES DE TIERRA		
101G con motor/CUMMINS		
ACEITE, FLUJO TOTAL (FULL FLOW)	G-613	VS1969
COMBUSTIBLE	GPP-14	DA1467
AGUA	GP-2071W	VJ7034
AIRE	GA-360	VJ1882
ACEITE, DERIVACION (BY PASS)	G-500	SH8986
210M con motor/CUMMINS		
ACEITE, DERIVACION (BY PASS)	GP-57	VS7035
222F con motor/A DIESEL		
TRANSMISION	G-33	SP6298
222FT con motor/DOS GMC 8V-71T		
ACEITE, FLUJO TOTAL (FULL FLOW)	G-33	SP6298
TRANSMISION	G-33	VZ2854
COMBUSTIBLE, SECUNDARIO	G-1175	TC7838
AIRE, SECUNDARIO MOTOR DELANTERO	GA-6127	VS1764
AIRE, PRIMARIO MOTOR DELANTERO	GA-6129	VS0048
222G con motor/A DIESEL		
ACEITE, FLUJO TOTAL (FULL FLOW)	G-33	SP6298
TRANSMISION	G-33	PB5038
HIDRAULICO	G-222	VY2195
AIRE, PRIMARIO	GA-356	VS1353
AIRE, SECUNDARIO	GA-357	VS1352

MARCA-MODELO-MOTOR MAKE-MODEL-ENGINE	GONHER GONHER	OEM OEM
WABCO (continuación)		
REMOVEDORES DE TIERRA		
222H con motor/A DIESEL		
ACEITE DE MOTOR	G-33	SP6298
TRANSMISION	G-33	PB5038
COMBUSTIBLE, PRIMARIO	GP-26	PB1612
COMBUSTIBLE, SECUNDARIO	GP-27	PB1613
AIRE, PRIMARIO	GA-356	P109155
AIRE, SECUNDARIO	GA-357	VJ2437
35 con motor/CUMMINS NT380		
HIDRAULICO	G-33	SP6298
TRANSMISION	G-33	PB5038
ACEITE, FLUJO TOTAL (FULL FLOW) CARTUCHO	G-566	V7401
COMBUSTIBLE	GP-1101	158172
ACEITE, FLUJO TOTAL (FULL FLOW) SELLADO	GP-53	VJ8003
ACEITE, DERIVACION (BY PASS)	G-750	SD1311
830 con motor/CUMMINS		
ACEITE	GP-53	VJ8003
B339F con motor/GMC 12V-71		
ACEITE, FLUJO TOTAL (FULL FLOW)	G-33	SP6298
HIDRAULICO	G-33	SP6298
TRANSMISION	G-33	PB5038
BT333F con motor/GMC 12V-71		
ACEITE, FLUJO TOTAL (FULL FLOW)	G-33	SP6298
HIDRAULICO	G-33	SP6298
TRANSMISION	G-33	PB5038
AIRE	GA-6129	VS0048

C222F con motor/GMC 8V-71		
ACEITE, FLUJO TOTAL (FULL FLOW)	G-33	SP6298
HIDRAULICO	G-33	SP6298
COMBUSTIBLE, SECUNDARIO	G-1175	TC7838
C229F con motor/GMC 8V-71		
ACEITE, FLUJO TOTAL (FULL FLOW)	G-33	SP6298
TRANSMISION	G-33	PB5038
COMBUSTIBLE, SECUNDARIO	G-1175	TC7838
HIDRAULICO	G-222	VY2195
D111A con motor/GMC 4-71		
ACEITE, DERIVACION (BY PASS)	G-31	TD6776
ACEITE, FLUJO TOTAL (FULL FLOW)	G-33	SP6298
HIDRAULICO	G-33	SP6298
TRANSMISION	G-33	PB5038
COMBUSTIBLE, SECUNDARIO	G-1173	VS3493
HAMMERS con motor/LeRoi D226		
ACEITE	GP-1	43-465

WESTERN STAR		
CAMIONES, TRACTOCAMIONES Y AUTOBUSES		
4964, 4964SX, 4964EX, 4964FX con motor/CATERPILLAR 3406E		
COMBUSTIBLE	GP-749	1R0749
ACEITE	GP-52	8T7452
AGUA, SISTEMA DE ENFRIAMIENTO	GP-2071W	WF2071
SEPARADOR DE COMBUSTIBLE	GPP-1000	FS1000
AIRE	GA-493	22005-4401

MARCA-MODELO-MOTOR MAKE-MODEL-ENGINE	GONHER GONHER	OEM OEM
WESTERN STAR (continuación)		
CAMIONES, TRACTOCAMIONES Y AUTOBUSES		
6900XD con motor/DETROIT DIESEL SERIES 60		
DIRECCION	G-159	84148A
TRANSMISION, SELLADO, OPCIONAL	GP-1	17237
TRANSMISION, SELLADO	GP-58	4304827
ACEITE, REQUIERE 2 PIEZAS	GP-193	23530573
ACEITE, EJE TRASERO, ALGUNOS	GP-81	3280-V-8394
SEPARADOR DE COMBUSTIBLE	GPP-1000	170014406
AIRE, REQUIERE 2 PIEZAS	GA-493	AF1616

6900XD con motores/CATERPILLAR C15, CATERPILLAR C16		
DIRECCION	G-159	84148A
TRANSMISION, OPCIONAL	GP-1	17237
COMBUSTIBLE	GP-749	1R0749
ACEITE	GP-52	1R0716
TRANSMISION	GP-58	4304827
SEPARADOR DE COMBUSTIBLE	GPP-1000	17001-4406
SEPARADOR DE COMBUSTIBLE CON PURGADOR	GPP-1291	S3226P
AIRE, REQUIERE 2 PIEZAS	GA-493	AF1616
SEPARADOR DE COMBUSTIBLE CON ROSCA PARA TAZON	S 3226 P	S3226P
WESTERN STAR con motores/GMC 6-71, GMC 6V-92, GMC 8V-71, GMC 8V-92		
COMBUSTIBLE, PRIMARIO	GP-26	25010776
COMBUSTIBLE, SECUNDARIO	GP-27	25010777
ACEITE, FLUJO TOTAL (FULL FLOW)	GP-53	25010971
AIRE	GA-493	22005-4401

WHITE		
CAMIONES, TRACTOCAMIONES Y AUTOBUSES		
1500 SERIES, 2000 SERIES con motor/PERKINS 6-354 DIESEL		
ACEITE	G-834	26540153
COMBUSTIBLE	G-296	867014
COMBUSTIBLE	G-296-B	266537
ACL64FT con motor/CATERPILLAR 3406E		
COMBUSTIBLE	GP-749	1R0749
ACEITE, CUMPLE CON MEDI-DAS ORIGINALES	GP-691	1R0716
ACEITE, SEGUNDA OPCION	GP-52	1R0716
AGUA	GP-1013Q	207010002
CONVENTIONAL con motor/CUMMINS		
COMBUSTIBLE	GP-1101	892168
ACEITE	GP-53	3310445
ACEITE, DERIVACION (BY PASS)	GP-57	172015777
AGUA	GP-2071W	27073723
ACEITE, DERIVACION (BY PASS)	G-750	280611
FE64 con motor/VOLVO VED7		
ACEITE, FLUJO TOTAL (FULL FLOW)	GP-51	466634-3
COMBUSTIBLE (REQUIERE 2)	GP-1122	72430044
COMBUSTIBLE, SEPARADOR DE AGUA OPCIONAL	GPP-11	4084196
ACEITE, DERIVACION (BY PASS)	GP-556	477556
AIRE, SECUNDARIO	GA-682R	V1117576
AIRE, PRIMARIO	GA-683R	AF25345
HIGH CABOVER, INTEGRAL, INTEGRAL TALL SLEEPER con motor/CUMMINS		
COMBUSTIBLE	GP-1101	892168

SERVICIO PESADO

MARCA-MODELO-MOTOR MAKE-MODEL-ENGINE	GONHER GONHER	OEM OEM	MARCA-MODELO-MOTOR MAKE-MODEL-ENGINE	GONHER GONHER	OEM OEM	MARCA-MODELO-MOTOR MAKE-MODEL-ENGINE	GONHER GONHER	OEM OEM
WHITE (continuación)			WHITE (continuación)			WHITE (continuación)		
CAMIONES, TRACTOCAMIONES Y AUTOBUSES			CAMIONES, TRACTOCAMIONES Y AUTOBUSES			CAMIONES, TRACTOCAMIONES Y AUTOBUSES		
ACEITE	GP-53	3310445	ROAD XPEDITOR con motor/CATERPILLAR 1160			AIRE, PRIMARIO	GA-683R	AF25345
ACEITE	GP-57	172015777	ACEITE	GP-36	303119475	WG64T con motor/CUMMINS M11		
AGUA	GP-2071W	27073723	ROAD XPEDITOR con motor/GMC DIESEL			COMBUSTIBLE, SEPARADOR DE AGUA	GPP-11	3308638
ACEITE	G-750	280611	ACEITE, DERIVACION (BY PASS)	G-31	1291A6	ACEITE, LUBRICACION DE DOBLE FLUJO	GP-3000	3825970
ROAD BOSS 2, ROAD COMMANDER 2 con motores/CATERPILLAR 3306, CATERPILLAR 3406			ACEITE	G-33	5573013	AIRE, PRIMARIO	GA-682R	V1117576
GASOLINA, SEPARADOR DE AGUA	G-293	8N9803	COMBUSTIBLE, SECUNDARIO 3 1/4 IN	G-1173	52067	AIRE, SECUNDARIO	GA-683R	P527683
ACEITE	GP-51	1R0658	COMBUSTIBLE, SECUNDARIO 7 3/8 IN	G-1175	892975	WIA con motor/VOLVO VED12		
COMBUSTIBLE	GP-110	303498387	ROAD XPEDITOR, ROAD XPEDITOR 2, XPEDITOR con motor/CUMMINS			ACEITE	GP-51	466634
AIRE	GA-2984	22005-0002	ACEITE	G-566	892161	WIA64T, WIA64TTES con motor/DETROIT DIESEL SERIES 60		
ROAD BOSS, ROAD BOSS 2 con motor/GMC DIESEL			ACEITE, TURBOCARGADOR	GP-14	892575	COMBUSTIBLE, PRIMARIO	GP-26	27076199
ACEITE	G-33	5573013	COMBUSTIBLE, 5 47/64 IN	GPP-14	891733	COMBUSTIBLE, SECUNDARIO	GP-27	27076198
COMBUSTIBLE, PRIMARIO	GP-26	27076199	COMBUSTIBLE, 5 13/32 IN	GP-1101	892168	ACEITE	GP-193	23518480
COMBUSTIBLE, SECUNDARIO	GP-27	27076198	ACEITE	GP-53	3310445	WIA64TES con motor/VOLVO VE12		
AIRE	GA-2984	22005-0002	COMBUSTIBLE, 11 1/2 IN	GP-55	3313306	ACEITE, FLUJO TOTAL (FULL FLOW), REQUIERE 2 PIEZAS	GP-51	4666343
ROAD BOSS, ROAD COMMANDER 2, ROAD BOSS 2, ROAD COMMANDER con motor/CUMMINS			ACEITE, SELLADO PARA DERIVACION (BY PASS)	GP-57	172015777	COMBUSTIBLE, REQUIERE 2 PIEZAS	GP-1122	466987-5
ACEITE	G-566	892161	COMBUSTIBLE, SEPARADOR DE AGUA	GPP-11	3308638	ACEITE, DERIVACION (BY PASS)	GP-556	477556
ACEITE, TURBOCARGADOR	GP-14	892575	AIRE, RESPIRADOR	GA-39	255963	AIRE	GA-1095	22005-5039
COMBUSTIBLE, 5 47/64 IN	GPP-14	891733	AIRE	GA-372	22005-0008	WIA64TES con motor/VOLVO VED12		
COMBUSTIBLE, 5 13/32 IN	GP-1101	892168	AIRE	GA-2984	22005-0002	COMBUSTIBLE	GP-96	8193841
ACEITE	GP-53	3310445	ACEITE, CARTUCHO PARA DERIVACION (BY PASS)	G-750	280611	ACEITE, FLUJO TOTAL (FULL FLOW), REQUIERE 2 PIEZAS	GP-51	466634-3
COMBUSTIBLE, 11 1/2 IN	GP-55	3313306	WCA64T con motor/CUMMINS M11			ACEITE, DERIVACION (BY PASS)	GP-556	477556
COMBUSTIBLE, SEPARADOR DE AGUA	GPP-11	3308638	COMBUSTIBLE, SEPARADOR DE AGUA	GPP-11	3308638	AIRE	GA-1095	XLP184109
AIRE, RESPIRADOR	GA-39	255963	ACEITE, LUBRICACION DE DOBLE FLUJO	GP-3000	3825970	WIA64TTES con motor/CUMMINS N14		
AIRE	GA-2984	22005-0002	AIRE, PRIMARIO	GA-682R	V1117576	COMBUSTIBLE	GPP-14	891733
ACEITE, DERIVACION (BY PASS)	G-750	280611	AIRE, SECUNDARIO	GA-683R	P527683	ACEITE	GP-53	3310445
ROAD BOSS, ROAD XPEDITOR 2, ROAD BOSS 2, ROAD COMMANDER, ROAD COMMANDER 2, ROAD XPEDITOR con motor/CATERPILLAR 3208			WG con motor/VOLVO VE12-360E			ACEITE, DERIVACION (BY PASS)	GP-57	172015777
ACEITE	GP-36	9L9200	ACEITE	GP-51	466634	COMBUSTIBLE, SEPARADOR DE AGUA	GPP-11	3308638
GASOLINA, SEPARADOR DE AGUA	G-293	8N9803	COMBUSTIBLE	GP-1122	466987-5	ACEITE, DOBLE FLUJO	GP-3000	303506517
COMBUSTIBLE	GP-110	303498387	ACEITE, DERIVACION (BY PASS)	GP-556	477556	AGUA	GP-2071W	27073723
ACEITE	GP-9586	9N5570	AIRE, PRIMARIO	GA-682R	V1117576	WX64 SERIES con motor/CUMMINS L10		
AIRE	GA-2984	22005-0002	WG con motor/VOLVO VED7			COMBUSTIBLE	GPP-14	891733
ROAD COMMANDER 2, ROAD XPEDITOR 2 con motor/DETROIT DIESEL			ACEITE	GP-51	466634	ACEITE	GP-53	3310445
ACEITE, CARTUCHO	G-33	290306	COMBUSTIBLE	GP-1122	466987-5	ACEITE, DERIVACION (BY PASS)	GP-57	172015777
COMBUSTIBLE, PRIMARIO	GP-26	27076199	ACEITE, DERIVACION (BY PASS)	GP-556	477556	COMBUSTIBLE, SEPARADOR DE AGUA	GPP-11	3308638
COMBUSTIBLE, SECUNDARIO	GP-27	27076198	WG42 SERIES, WG64 con motor/CUMMINS L10			ACEITE, DOBLE FLUJO	GP-3000	303506517
ACEITE, SELLADO	GP-53	25010042	COMBUSTIBLE	GPP-14	3843447	WHITE		
AIRE	GA-372	22005-0008	ACEITE, FLUJO TOTAL (FULL FLOW)	GP-53	3307885	CARGADORAS		
AIRE	GA-2984	22005-0002	ACEITE, DERIVACION (BY PASS)	GP-57	3309637	200 GIRATORIA con motor/A DIESEL		
ROAD COMMANDER con motor/CATERPILLAR 1674			COMBUSTIBLE, SEPARADOR DE AGUA OPCIONAL	GPP-11	3315843	ACEITE, FORD	GP-9	10A14373
ACEITE	G-191	848012	ACEITE, LUBRICACION DE DOBLE FLUJO	GP-3000	3825970	COMBUSTIBLE	G-296	867014
COMBUSTIBLE	GP-110	303498387	AIRE, SECUNDARIO	GA-682R	V1117576	COMBUSTIBLE	G-296-B	266537
AIRE, RESPIRADOR	GA-135	278500	AIRE, PRIMARIO	GA-683R	AF25345	ACEITE, CHRYSLER	GP-81	10A14373
ROAD COMMANDER con motores/GMC 6-71, GMC 8V-71 SERIES			WG64 con motor/VOLVO VED7			AIRE	GAK-16	2710837
ACEITE, DERIVACION (BY PASS)	G-31	1291A6	ACEITE, FLUJO TOTAL (FULL FLOW)	GP-51	466634-3	4-30-L con motor/A GASOLINA		
ACEITE	G-33	5573013	COMBUSTIBLE (REQUIERE 2)	GP-1122	72430044	GASOLINA	GG-5 L	2726107
COMBUSTIBLE, SECUNDARIO	G-1175	5574508	COMBUSTIBLE, SEPARADOR DE AGUA OPCIONAL	GPP-11	4084196			
ROAD XPEDITOR 2 con motor/CATERPILLAR 3306			ACEITE, DERIVACION (BY PASS)	GP-556	477556			
GASOLINA, SEPARADOR DE AGUA	G-293	8N9803	AIRE, SECUNDARIO	GA-682R	V1117576			
ACEITE	GP-51	1R0658						
COMBUSTIBLE	GP-110	303498387						
AIRE	GA-2984	22005-0002						

MARCA-MODELO-MOTOR MAKE-MODEL-ENGINE	GONHER GONHER	OEM OEM	MARCA-MODELO-MOTOR MAKE-MODEL-ENGINE	GONHER GONHER	OEM OEM	MARCA-MODELO-MOTOR MAKE-MODEL-ENGINE	GONHER GONHER	OEM OEM
WHITE			WHITE (continuación)			WHITE (continuación)		
COMBINADAS			COMBINADAS			COMBINADAS		
100, 120, 140 con motor/CUMMINS 5.9L			2-160, 2-185 con motor/A DIESEL			GASOLINA, SEPARADOR DE AGUA	G-293	8N9803
COMBUSTIBLE, SECUNDARIO	GP-1122	303437574	COMBUSTIBLE	GP-1122	303437574	COMBUSTIBLE	GP-110	1R0740
COMBUSTIBLE, PRIMARIO	GPP-18	303437582	TRANSMISION	GP-66	197412A	ACEITE	GP-9586	9N5570
ACEITE	GP-178	303455696	ACEITE	GP-43	303436861	TRANSMISION PARA CHRYSLER	GP-81	156513A
11720 con motor/ISUZU			2-180 con motor/CATERPILLAR 3208			4-175 con motor/CATERPILLAR 3208		
ACEITE	GP-3985	5132110181	ACEITE	GP-36	9L9200	TRANSMISION PARA FORD	GP-9	156513A
125, 145 con motor/CUMMINS 5.9L			TRANSMISION	GP-36	30-3119475	ACEITE	GP-36	9L9200
COMBUSTIBLE, SECUNDARIO	GP-1122	303437574	GASOLINA, SEPARADOR DE AGUA	G-293	8N9803	TRANSMISION	GP-36	30-3119475
COMBUSTIBLE, SEPARADOR DE AGUA	GPP-1122	3903202	COMBUSTIBLE	GP-110	303498387	GASOLINA, SEPARADOR DE AGUA	G-293	8N9803
COMBUSTIBLE, PRIMARIO	GPP-18	303437582	ACEITE	GP-9586	30-3498409	COMBUSTIBLE	GP-110	303498387
ACEITE	GP-178	303455696	2-50 FIELD BOSS, 2-60 FIELD BOSS con motor/4 CYL DIESEL			ACEITE	GP-9586	9N5570
160, 170, 195 con motor/CUMMINS 8.3L			ACEITE	GP-1	34A5532	TRANSMISION PARA CHRYSLER	GP-81	156513A
COMBUSTIBLE, SECUNDARIO	GP-1122	303437574	COMBUSTIBLE	G-296	867014	4-180 FIELD BOSS con motor/CATERPILLAR 3208		
ACEITE	GP-43	303436861	COMBUSTIBLE	G-296-B	266537	TRANSMISION PARA FORD	GP-9	156513A
COMBUSTIBLE, PRIMARIO	GPP-18	303437582	2500 AGCO/WHITE con motor/CUMMINS 8.3L			TRANSMISION	GP-31	155618A
185 con motor/CUMMINS 8.3L			COMBUSTIBLE, SECUNDARIO	GP-1122	303437574	ACEITE	GP-36	9L9200
HIDRAULICO	GP-36	30-3119475	ACEITE	GP-43	303436861	GASOLINA, SEPARADOR DE AGUA	G-293	8N9803
COMBUSTIBLE, SECUNDARIO	GP-1122	303437574	COMBUSTIBLE, PRIMARIO	GPP-18	303437582	COMBUSTIBLE	GP-110	1R0740
ACEITE	GP-43	303436861	COMBUSTIBLE, SEPARADOR DE AGUA	GPP-1000	170014406	ACEITE	GP-9586	9N5570
AGUA	GP-2071W	27073723	2-63-17 con motor/A DIESEL			TRANSMISION PARA CHRYSLER	GP-81	156513A
COMBUSTIBLE, PRIMARIO	GPP-18	303437582	ACEITE	GP-1	34A5532	4-210 con motor/CATERPILLAR 3208		
2-105 con motor/PERKINS 354			2-70 FIELD BOSS con motor/6 CYL A DIESEL			ACEITE	GP-36	9L9200
TRANSMISION PARA FORD	GP-9	156513A	TRANSMISION PARA FORD	GP-9	156513A	TRANSMISION	GP-36	30-3119475
ACEITE	GP-31	155618A	COMBUSTIBLE	G-295	200006803	GASOLINA, SEPARADOR DE AGUA	G-293	8N9803
COMBUSTIBLE	G-296	867014	TRANSMISION PARA CHRYSLER	GP-81	156513A	COMBUSTIBLE	GP-110	303498387
COMBUSTIBLE	G-296-B	266537	2-70 FIELD BOSS con motor/A GASOLINA 6 CYL			ACEITE	GP-9586	9N5570
TRANSMISION PARA CHRYSLER	GP-81	156513A	TRANSMISION PARA FORD	GP-9	156513A	TRANSMISION PARA CHRYSLER	GP-81	156513A
2-110 con motor/PERKINS			TRANSMISION PARA CHRYSLER	GP-81	156513A	4-225 con motor/CATERPILLAR 3208		
ACEITE	GP-1	34A5532	AIRE	GAK-16	159012A	ACEITE	GP-36	30-3119475
TRANSMISION PARA FORD	GP-9	156513A	2-80-17 con motor/WHITE 283DB DIESEL			GASOLINA, SEPARADOR DE AGUA	G-293	8N9803
COMBUSTIBLE	G-296	867014	COMBUSTIBLE	G-295	200006803	COMBUSTIBLE	GP-110	303498387
GASOLINA, SEPARADOR DE AGUA	G-293	P559803	2-85 FIELD BOSS con motor/PERKINS 354			ACEITE	GP-51	1R0658
COMBUSTIBLE	G-296-B	266537	TRANSMISION PARA FORD	GP-9	156513A	COMBUSTIBLE	GP-110	303498387
TRANSMISION PARA CHRYSLER	GP-81	156513A	ACEITE	GP-31	155618A	AGUA	GP-1011Q	27073724
2-115 con motor/DETROIT DIESEL 4-53			COMBUSTIBLE	G-296	867014	4-78-17, 4-78LL con motor/A DIESEL		
ACEITE	G-33	290306	COMBUSTIBLE	G-296-B	266537	COMBUSTIBLE	G-296	867014
COMBUSTIBLE, PRIMARIO	GP-26	27076199	TRANSMISION PARA CHRYSLER	GP-81	156513A	4-80-17 con motor/WHITE 283DB		
COMBUSTIBLE, SECUNDARIO	GP-27	27076198	32174 con motor/PERKINS			COMBUSTIBLE	G-295	200006803
ACEITE, CUANDO SE HACE LA CONVERSION A SELLADO	GP-53	25010042	ACEITE	GP-1	34A5532	5542 con motor/A GASOLINA		
2-120 con motor/CUMMINS			COMBUSTIBLE	G-296	867014	ACEITE	GP-1	159045-A
COMBUSTIBLE, SECUNDARIO	GP-1122	303437574	GASOLINA, SEPARADOR DE AGUA	G-293	P559803	60, 80 con motor/CUMMINS 3.9L		
COMBUSTIBLE, PRIMARIO	GPP-18	303437582	COMBUSTIBLE	G-296-B	266537	COMBUSTIBLE, SECUNDARIO	GP-1122	303437574
ACEITE	GP-178	303455696	4-115 con motor/DETROIT DIESEL 4-53			COMBUSTIBLE, PRIMARIO	GPP-18	303437582
2-135, 2-155 con motor/A DIESEL			ACEITE	G-33	290306	ACEITE	GP-390	390322A
TRANSMISION	GP-36	303119475	COMBUSTIBLE, PRIMARIO	GP-26	27076199	6144 con motor/CUMMINS 6BTA5.9		
GASOLINA, SEPARADOR DE AGUA	G-293	P559803	COMBUSTIBLE, SECUNDARIO	GP-27	27076198	COMBUSTIBLE, SECUNDARIO	GP-1122	303437574
COMBUSTIBLE	G-295	200006803	ACEITE, CUANDO SE HACE LA CONVERSION A SELLADO	GP-53	25010042	COMBUSTIBLE, PRIMARIO	GPP-18	303437582
2-150 FIELD BOSS con motor/WHITE 585 (9.6L)			4-150 FIELD BOSS con motor/CATERPILLAR 3208			ACEITE	GP-178	303455696
TRANSMISION PARA FORD	GP-9	156513A	TRANSMISION PARA FORD	GP-9	156513A	COMBUSTIBLE, SEPARADOR DE AGUA	GPP-1000	74394407
TRANSMISION	GP-36	303119475	ACEITE	GP-36	9L9200			
COMBUSTIBLE	G-295	200006803						
TRANSMISION PARA CHRYSLER	GP-81	156513A						

SERVICIO PESADO

MARCA-MODELO-MOTOR MAKE-MODEL-ENGINE	GONHER GONHER	OEM OEM	MARCA-MODELO-MOTOR MAKE-MODEL-ENGINE	GONHER GONHER	OEM OEM	MARCA-MODELO-MOTOR MAKE-MODEL-ENGINE	GONHER GONHER	OEM OEM
WHITE (continuación)			WHITE (continuación)			WHITE (continuación)		
COMBINADAS			COMBINADAS			MONTACARGAS		
7300 con motor/A DIESEL			9700 con motor/PERKINS TB8-640			COMBUSTIBLE	G-296	867014
ACEITE	GP-1	34A5532	ACEITE	GP-31	2654407	COMBUSTIBLE	G-296-B	266537
TRANSMISION	GP-1	34A5532	9700 ROTARY con motor/PERKINS V8-354			MA-30, MA-60, MA-40, MA-50 con motor/CONTINENTAL F163		
COMBUSTIBLE	G-296	867014	ACEITE	GP-31	31-2752257	ACEITE	GP-1	35A-5533
HIDRAULICO	GP-66	197412A	COMBUSTIBLE	G-297	7111-796	TRANSMISION	GP-1	35A-5533
COMBUSTIBLE	G-296-B	266537	COMBUSTIBLE	G-297-B	7111-796	AIRE	GA-33	664578
AIRE	GAK-16	2710837	AIRE, PRIMARIO PARA CUMMINS	GA-106	31-2772597	MY40 con motor/A DIESEL		
7300 con motor/A GASOLINA			AIRE, PRIMARIO PARA KOMATSU	GA-326	31-2772597	TRANSMISION	G-6	439216
ACEITE	GP-1	159045-A	AIRE, SECUNDARIO	GA-206	31-2772607	ACEITE, FORD	GP-9	865701
HIDRAULICO	GP-66	197412A	9720 con motor/PERKINS TV8.640			ACEITE, CHRYSLER	GP-81	10A-14489
AIRE	GAK-403	1156603	ACEITE	GP-31	155618A	MY50 con motor/A DIESEL		
GASOLINA	GG-5 L	2726107	AIRE, PRIMARIO PARA CUMMINS	GA-106	3938H2	TRANSMISION	GP-1	40-0000407
7600 con motor/A DIESEL			AIRE, PRIMARIO PARA KOMATSU	GA-326	27074252	ACEITE, FORD	GP-9	865701
ACEITE	GP-1	159045-A	AIRE, SECUNDARIO	GA-206	10A31417	ACEITE, CHRYSLER	GP-81	10A-14489
TRANSMISION	GP-1	34A5532	C62 GLEANER con motor/CUMMINS C8.3			MY80D con motor/PERKINS DIESEL		
COMBUSTIBLE	G-296	867014	COMBUSTIBLE, SECUNDARIO	GP-1122	303437574	ACEITE	GP-31	155618A
COMBUSTIBLE	G-296-B	266537	ACEITE	GP-43	303436861	COMBUSTIBLE	G-296	867014
AIRE	GAK-16	2710837	ACEITE, DOBLE FLUJO	GP-3000	303506517	COMBUSTIBLE	G-296-B	266537
7600 con motor/CHRYSLER A GASOLINA			COMBUSTIBLE, PRIMARIO	GPP-18	303437582	AIRE	GAK-16	2710837
ACEITE	GP-1	34A5532	COMBUSTIBLE, SEPARADOR DE AGUA	GPP-1000	74394407	MYD60B con motor/PERKINS GASOLINA		
AIRE	GAK-403	21710837	FB16 con motor/MITSUBISHI			ACEITE	GP-31	155618A
GASOLINA	GG-5 L	2726107	ACEITE	GP-6811	MZ690116	COMBUSTIBLE	G-296	867014
7800 con motor/A DIESEL			FB185 con motor/CUMMINS			COMBUSTIBLE	G-296-B	266537
ACEITE	GP-1	159045-A	COMBUSTIBLE, SECUNDARIO	GP-1122	303437574	AIRE	GAK-16	2710837
TRANSMISION	GP-1	34A5532	TRANSMISION	GP-66	197412A	MYD60B con motor/PERKINS GASOLINA		
COMBUSTIBLE	G-296	867014	ACEITE	GP-43	303436861	ACEITE	GP-31	155618A
COMBUSTIBLE	G-296-B	266537	COMBUSTIBLE, PRIMARIO	GPP-18	303437582	WHITE		
AIRE	GAK-20	311558043	FB21 con motor/ISEKI			MOTORES		
7800 con motor/CHRYSLER A GASOLINA			ACEITE	GP-58	330083836	370A A DIESEL, 450A A DIESEL, 470A A DIESEL, 490A A DIESEL, 6-186A A DIESEL		
ACEITE	GP-1	34A5532	FB31 con motor/ISEKI			ACEITE, DERIVACION (BY PASS)	G-750	858750
8600 con motor/CHRYSLER A GASOLINA			ACEITE	GP-3600	303483606	CV4-180 A DIESEL		
ACEITE	GP-1	34A5532	FB37 con motor/ISUZU			AIRE	GA-105	112644
AIRE	GAK-625	31-2755007	ACEITE	GP-3985	5132110181	D1500 A DIESEL, D1700 A DIESEL, D2000 A DIESEL, D2300 A DIESEL, D3000 A DIESEL, D3000T A DIESEL		
GASOLINA	GG-5 L	2726107	FB43 con motor/ISUZU			COMBUSTIBLE, SECUNDARIO	G-1173	52067
8600, 8800 con motor/PERKINS DIESEL			ACEITE	G-870	303497577	COMBUSTIBLE, 2 49/64 IN	G-296	266547AS
ACEITE, CARTUCHO	G-834	866155	WHITE			COMBUSTIBLE, 4 25/64 IN	G-297	266536
ACEITE, SELLADO	GP-31	31-2752257	MONTACARGAS			COMBUSTIBLE, 2 49/64 IN	G-296-B	266547AS
COMBUSTIBLE	G-296	159044AS	225 con motor/PERKINS			COMBUSTIBLE, 4 25/64 IN	G-297-B	266536
COMBUSTIBLE	G-296-B	159044AS	ACEITE	GP-31	155618A	D298H A DIESEL, D298HT A DIESEL, D339H A DIESEL, DD298 A DIESEL, DD339 A DIESEL		
8700 con motor/PERKINS DIESEL			2-44FL con motor/A DIESEL			ACEITE	G-33	290283DS
ACEITE	GP-31	31-2752257	COMBUSTIBLE, SECUNDARIO	G-1175	892975	D3400 A DIESEL		
8800 con motor/CHRYSLER A GASOLINA			2-63FL con motor/A DIESEL			ACEITE	G-33	290306
ACEITE	GP-1	34A5532	ACEITE	GP-1	34A5532	COMBUSTIBLE, SECUNDARIO	G-1173	83249BS
8900 con motor/A DIESEL			MA-100, MA-90, MA-70, MA-80 con motor/CONTINENTAL F227			COMBUSTIBLE	G-296	266537
ACEITE	GP-1	2654403	ACEITE	GP-1	35A-5533	COMBUSTIBLE	G-297	266526
COMBUSTIBLE	G-296	7111296	MA120D con motor/PERKINS DIESEL			COMBUSTIBLE	G-296-B	266537
COMBUSTIBLE	G-296-B	7111296	ACEITE	GP-31	155618A	COMBUSTIBLE	G-297-B	266526
8920 con motor/PERKINS						D4800 A DIESEL		
ACEITE	GP-1	34A5532				COMBUSTIBLE, SECUNDARIO	GP-1107	FF209
COMBUSTIBLE	G-296	867014				DD130 A DIESEL, DD149 A DIESEL, DD149H A DIESEL, DD169 A DIESEL, DD169H A DIESEL, DD173 A DIESEL, DD198 A DIESEL, DD198H A DIESEL, DD226 A DIESEL, DD226H A DIESEL, DD260 A DIESEL, TCD283M MARINO		
COMBUSTIBLE	G-296-B	266537				COMBUSTIBLE, SECUNDARIO	G-1173	52067

MARCA-MODELO-MOTOR MAKE-MODEL-ENGINE	GONHER GONHER	OEM OEM	MARCA-MODELO-MOTOR MAKE-MODEL-ENGINE	GONHER GONHER	OEM OEM	MARCA-MODELO-MOTOR MAKE-MODEL-ENGINE	GONHER GONHER	OEM OEM
WHITE (continuación)			WHITE (continuación)			WHITE (continuación)		
MOTORES			TRACTORES			TRACTORES		
DFHX MARINO, HXB A DIESEL, HXC A DIESEL, HXCL A DIESEL, HXD A DIESEL, HXE A DIESEL, HXLD A DIESEL, HXLE A DIESEL, JXLAZER MILITAR, QXD3 A DIESEL, QXLDER MILITAR, RXB A DIESEL, RXC A DIESEL, RXLC A DIESEL, RXLD A DIESEL, RXLDH A DIESEL, TCD1468 A DIESEL, TDXB A DIESEL, TDXC A DIESEL, WX A DIESEL, WXL A DIESEL			GASOLINA, SEPARADOR DE AGUA	G-293	P559803	TRANSMISION	GP-66	197412A
ACEITE	G-31	1291A6	COMBUSTIBLE	G-296-B	266537	ACEITE	GP-43	303436861
DRXC A DIESEL			TRANSMISION PARA CHRYSLER	GP-81	156513A	2-50 FIELD BOSS con motor/4 CYL DIESEL		
COMBUSTIBLE, SECUNDARIO	G-1176	107369	2-110 con motor/PERKINS			ACEITE	GP-1	40-0000407
G1400 A GASOLINA			ACEITE	GP-1	34A5532	COMBUSTIBLE	G-296	867014
ACEITE	GP-1	34A5532	TRANSMISION PARA FORD	GP-9	156513A	COMBUSTIBLE	G-296-B	867014
IXLB A DIESEL			COMBUSTIBLE	G-296	867014	2-60 FIELD BOSS con motor/4 CYL DIESEL		
ACEITE	G-6	439216	GASOLINA, SEPARADOR DE AGUA	G-293	P559803	ACEITE	GP-1	40-0000407
V8-327 THE TREND A DIESEL			COMBUSTIBLE	G-296-B	266537	COMBUSTIBLE	G-296	867014
ACEITE	G-200	2143138	TRANSMISION PARA CHRYSLER	GP-81	156513A	COMBUSTIBLE	G-296-B	266537
WHITE			TRACTORES			TRACTORES		
100, 120, 140 con motor/CUMMINS 5.9L			2-115 con motor/DETROIT DIESEL 4-53			2-63-17 con motor/A DIESEL		
COMBUSTIBLE, SECUNDARIO	GP-1122	303437574	ACEITE	G-33	290306	ACEITE	GP-1	40-0000407
COMBUSTIBLE, PRIMARIO	GPP-18	303437582	COMBUSTIBLE, PRIMARIO	GP-26	27076199	2-70 FIELD BOSS con motor/6 CYL A DIESEL		
ACEITE	GP-178	303455696	COMBUSTIBLE, SECUNDARIO	GP-27	27076198	TRANSMISION PARA FORD	GP-9	156513A
10990, 12816 con motor/ISEKI 3 CYL			ACEITE, CUANDO SE HACE LA CONVERSION A SELLADO	GP-53	25010042	COMBUSTIBLE	G-295	177429
ACEITE	GP-3682	P550711	2-120 con motor/CUMMINS			TRANSMISION PARA CHRYSLER	GP-81	156513A
11720 con motor/ISUZU			COMBUSTIBLE, SECUNDARIO	GP-1122	303437574	AIRE	GAK-16	159012A
ACEITE	GP-3985	5132110181	COMBUSTIBLE, PRIMARIO	GPP-18	303437582	2-80-17 con motor/WHITE 283DB DIESEL		
125 WORKHORSE, 145 WORKHORSE con motor/CUMMINS			ACEITE	GP-178	303455696	ACEITE, CONVERTIDOR DE TORSION PARA FORD	GP-9	40-0000409
COMBUSTIBLE, SECUNDARIO	GP-1122	30-3437574	2-125 con motor/A DIESEL			COMBUSTIBLE	G-295	200006803
125, 145, 6145T con motor/CUMMINS 5.9L			ACEITE	GP-66	30-3119475	ACEITE, CONVERTIDOR DE TORSION PARA CHRYSLER	GP-81	40-0000409
COMBUSTIBLE, SECUNDARIO	GP-1122	303437574	2-135 con motor/A DIESEL			2-85 FIELD BOSS con motor/PERKINS 354		
COMBUSTIBLE, SEPARADOR DE AGUA	GPP-1122	3903202	TRANSMISION	GP-36	303119475	TRANSMISION PARA FORD	GP-9	156513A
COMBUSTIBLE, PRIMARIO	GPP-18	303437582	GASOLINA, SEPARADOR DE AGUA	G-293	40-302519	ACEITE	GP-31	155618A
ACEITE	GP-178	303455696	COMBUSTIBLE	G-295	200006803	COMBUSTIBLE	G-296	867014
160, 170, 195 con motor/CUMMINS 8.3L			2-150 FIELD BOSS con motor/WHITE 585 (9.6L)			GASOLINA, SEPARADOR DE AGUA	G-293	P559803
COMBUSTIBLE, SECUNDARIO	GP-1122	303437574	HIDRAULICO PARA FORD	GP-9	40-0000409	COMBUSTIBLE	G-296-B	266537
ACEITE	GP-43	303436861	TRANSMISION PARA FORD	GP-9	156513A	TRANSMISION PARA CHRYSLER	GP-81	156513A
COMBUSTIBLE, PRIMARIO	GPP-18	303437582	ACEITE	GP-36	303119475	28522 con motor/A DIESEL		
170 WORKHORSE, 195 WORKHORSE con motor/CUMMINS			COMBUSTIBLE	G-295	200006803	COMBUSTIBLE, SECUNDARIO	G-296	867014
COMBUSTIBLE, SECUNDARIO	GP-1122	3034-37574	2-155 con motor/A DIESEL			32174 con motor/PERKINS		
ACEITE	GP-3000	30-3506517	TRANSMISION	GP-36	303119475	ACEITE	GP-1	34A5532
COMBUSTIBLE, PRIMARIO	GPP-18	30-3437582	GASOLINA, SEPARADOR DE AGUA	G-293	P559803	TRANSMISION PARA FORD	GP-9	10A14373
185 con motor/CUMMINS 8.3L			COMBUSTIBLE	G-295	200006803	COMBUSTIBLE	G-296	867014
HIDRAULICO	GP-36	30-3119475	2-160 con motor/A DIESEL			GASOLINA, SEPARADOR DE AGUA	G-293	P559803
COMBUSTIBLE, SECUNDARIO	GP-1122	303437574	TRANSMISION	GP-36	303119475	COMBUSTIBLE	G-296-B	266537
ACEITE	GP-43	303436861	COMBUSTIBLE	GP-1122	303437574	TRANSMISION PARA CHRYSLER	GP-81	10A14373
AGUA	GP-2071W	27073723	TRANSMISION	GP-66	197412A	4-115 con motor/DETROIT DIESEL 4-53		
COMBUSTIBLE, PRIMARIO	GPP-18	303437582	ACEITE	GP-43	303436861	ACEITE	G-33	290306
1850D con motor/PERKINS 6.354			2-180 con motor/CATERPILLAR 3208			COMBUSTIBLE, PRIMARIO	GP-26	27076199
ACEITE	GP-1	31-2770467	ACEITE	GP-36	9L9200	COMBUSTIBLE, SECUNDARIO	GP-27	27076198
2-105 con motor/PERKINS 6.354			TRANSMISION	GP-36	30-3119475	ACEITE, CUANDO SE HACE LA CONVERSION A SELLADO	GP-53	25010042
TRANSMISION PARA FORD	GP-9	156513A	GASOLINA, SEPARADOR DE AGUA	G-293	8N9803	4-150 FIELD BOSS con motor/CATERPILLAR 3208		
ACEITE	GP-31	155618A	HIDRAULICO	GP-66	197412A	HIDRAULICO PARA FORD	GP-9	40-0000409
COMBUSTIBLE	G-296	867014	COMBUSTIBLE	GP-110	303498387	TRANSMISION PARA FORD	GP-9	156513A
			ACEITE	GP-9586	30-3498409	ACEITE	GP-36	9L9200
			2-185 con motor/A DIESEL			GASOLINA, SEPARADOR DE AGUA	G-293	8N9803
			COMBUSTIBLE	GP-1122	303437574			

MARCA-MODELO-MOTOR MAKE-MODEL-ENGINE	GONHER GONHER	OEM OEM	MARCA-MODELO-MOTOR MAKE-MODEL-ENGINE	GONHER GONHER	OEM OEM	MARCA-MODELO-MOTOR MAKE-MODEL-ENGINE	GONHER GONHER	OEM OEM
WHITE (continuación)			WHITE (continuación)			WHITE (continuación)		
TRACTORES			TRACTORES			TRACTORES		
COMBUSTIBLE	GP-110	1R0740	60 AMERICAN SERIES, 80 AMERICAN SERIES con motor/CUMMINS			6215 con motor/CUMMINS 6CTA8.3		
ACEITE	GP-9586	9N5570	COMBUSTIBLE, SECUNDARIO	GP-1122	30-3437574	COMBUSTIBLE, SECUNDARIO	GP-1122	303437574
HIDRAULICO PARA CHRYSLER	GP-81	40-0000409				ACEITE	GP-43	30-3436861
TRANSMISION PARA CHRYSLER	GP-81	156513A	60, 80 con motor/CUMMINS 3.9L			ACEITE, DOBLE FLUJO	GP-3000	303506517
4-155 con motor/A DIESEL			COMBUSTIBLE, SECUNDARIO	GP-1122	303437574	AGUA	GP-2071W	27073723
GASOLINA, SEPARADOR DE AGUA	G-293	40-302519	COMBUSTIBLE, PRIMARIO	GPP-18	303437582	COMBUSTIBLE, PRIMARIO	GPP-18	303437582
			ACEITE	GP-390	3903224	COMBUSTIBLE, SEPARADOR DE AGUA	GPP-1000	74394407
4-175 con motor/CATERPILLAR 3208			6045 con motor/A DIESEL			6410, 6510 con motor/CUMMINS 4B3.9		
TRANSMISION PARA FORD	GP-9	156513A	ACEITE, FORD	GP-9	72217092-5	COMBUSTIBLE, SECUNDARIO	GP-1122	303437574
ACEITE	GP-36	9L9200	COMBUSTIBLE	G-296	70251397-9	COMBUSTIBLE, PRIMARIO	GPP-18	303437582
TRANSMISION	GP-36	30-3119475	COMBUSTIBLE	G-296-B	70251397-9	ACEITE	GP-390	3903224
GASOLINA, SEPARADOR DE AGUA	G-293	8N9803	ACEITE, CHRYSLER	GP-81	72217092-5	6710, 6810 con motor/CUMMINS 5.9L		
COMBUSTIBLE	GP-110	303498387	6065C, 6065R con motor/A DIESEL			COMBUSTIBLE, SECUNDARIO	GP-1122	303437574
ACEITE	GP-9586	9N5570	ACEITE, FORD	GP-9	72217092-5	COMBUSTIBLE, PRIMARIO	GPP-18	303437582
TRANSMISION PARA CHRYSLER	GP-81	156513A	COMBUSTIBLE	G-296	70251397-9	ACEITE	GP-178	303455696
			COMBUSTIBLE	G-296-B	70251397-9	8310, 8410 con motor/CUMMINS 6B5.9		
4-180 FIELD BOSS con motor/CATERPILLAR 3208			ACEITE, CHRYSLER	GP-81	72217092-5	COMBUSTIBLE, SECUNDARIO	GP-1122	303437574
HIDRAULICO PARA FORD	GP-9	40-0000409	6085 con motor/A DIESEL			COMBUSTIBLE, PRIMARIO	GPP-18	303437582
TRANSMISION PARA FORD	GP-9	156513A	COMBUSTIBLE	G-296	70251397-9	ACEITE	GP-178	303455696
TRANSMISION	GP-31	155618A	6124 con motor/CUMMINS 5.9L			8510, 8610 con motor/CUMMINS 8.3L		
ACEITE	GP-36	9L9200	COMBUSTIBLE, SECUNDARIO	GP-1122	303437574	COMBUSTIBLE, SECUNDARIO	GP-1122	303437574
GASOLINA, SEPARADOR DE AGUA	G-293	8N9803	COMBUSTIBLE, PRIMARIO	GPP-18	303437582	COMBUSTIBLE, SEPARADOR DE AGUA	GPP-1122	3903202
COMBUSTIBLE	GP-110	1R0740	ACEITE	GP-178	303455696	ACEITE, DOBLE FLUJO	GP-3000	303506517
ACEITE	GP-9586	9N5570	COMBUSTIBLE, SEPARADOR DE AGUA	GPP-1000	74394407	COMBUSTIBLE, PRIMARIO	GPP-18	303437582
HIDRAULICO PARA CHRYSLER	GP-81	40-0000409	6125 con motor/CUMMINS 6BT5.9L			8710, 8810 con motor/CUMMINS 6CTA8.3		
TRANSMISION PARA CHRYSLER	GP-81	156513A	COMBUSTIBLE, SECUNDARIO	GP-1122	303437574	COMBUSTIBLE, SECUNDARIO	GP-1122	303437574
			COMBUSTIBLE, SEPARADOR DE AGUA	GPP-1122	3903202	COMBUSTIBLE, SEPARADOR DE AGUA	GPP-1122	3903202
4-210 con motor/CATERPILLAR 3208			COMBUSTIBLE, PRIMARIO	GPP-18	303437582	ACEITE, DOBLE FLUJO	GP-3000	303506517
ACEITE	GP-36	9L9200	ACEITE	GP-178	303455696	COMBUSTIBLE, PRIMARIO	GPP-18	303437582
TRANSMISION	GP-36	30-3119475	6144 con motor/CUMMINS 6BTA5.9			C62 GLEANER con motor/CUMMINS C8.3		
GASOLINA, SEPARADOR DE AGUA	G-293	8N9803	COMBUSTIBLE, SECUNDARIO	GP-1122	303437574	COMBUSTIBLE, SECUNDARIO	GP-1122	303437574
COMBUSTIBLE	GP-110	303498387	COMBUSTIBLE, PRIMARIO	GPP-18	303437582	ACEITE	GP-43	303436861
ACEITE	GP-9586	9N5570	ACEITE	GP-178	303455696	ACEITE, DOBLE FLUJO	GP-3000	303506517
			COMBUSTIBLE, SEPARADOR DE AGUA	GPP-1000	74394407	COMBUSTIBLE, PRIMARIO	GPP-18	303437582
4-225 con motor/CATERPILLAR 3208			6145 con motor/CUMMINS 6BTA5.9			COMBUSTIBLE, SEPARADOR DE AGUA	GPP-1000	74394407
ACEITE	GP-36	30-3119475	COMBUSTIBLE, SECUNDARIO	GP-1122	72501530	FB16 con motor/MITSUBISHI		
GASOLINA, SEPARADOR DE AGUA	G-293	8N9803	COMBUSTIBLE, PRIMARIO	GPP-18	303437582	ACEITE	GP-6811	MZ690116
COMBUSTIBLE	GP-110	303498387	ACEITE	GP-178	303455696	FB185 con motor/CUMMINS		
			COMBUSTIBLE, SEPARADOR DE AGUA	GPP-1000	74394407	COMBUSTIBLE, SECUNDARIO	GP-1122	303437574
4-270 con motor/CATERPILLAR 3306			6175 con motor/CUMMINS 6CT8.3L			TRANSMISION	GP-66	197412A
GASOLINA, SEPARADOR DE AGUA	G-293	8N9803	COMBUSTIBLE, SECUNDARIO	GP-1122	303437574	ACEITE	GP-43	303436861
ACEITE	GP-51	1R0658	COMBUSTIBLE, PRIMARIO	GPP-18	303437582	COMBUSTIBLE, PRIMARIO	GPP-18	303437582
COMBUSTIBLE	GP-110	303498387	ACEITE	GP-43	30-3436861	FB21 con motor/ISEKI		
AGUA	GP-1011Q	27073724	ACEITE, DOBLE FLUJO	GP-3000	303506517	ACEITE	GP-58	330083836
			AGUA	GP-2071W	27073723	FB31 con motor/ISEKI		
4-78-17 con motor/A DIESEL			COMBUSTIBLE, PRIMARIO	GPP-18	303437582	ACEITE	GP-38	P500078
TRANSMISION PARA FORD	GP-9	40-0000409	COMBUSTIBLE, SEPARADOR DE AGUA	GPP-1000	74394407	FB37 con motor/ISUZU		
COMBUSTIBLE	G-296	867014	6195 con motor/CUMMINS 6CTA8.3L			ACEITE	GP-31	155618A
COMBUSTIBLE	G-296-B	266537	COMBUSTIBLE, SECUNDARIO	GP-1122	303437574	FB43 con motor/ISUZU		
TRANSMISION PARA CHRYSLER	GP-81	40-0000409	COMBUSTIBLE, PRIMARIO	GPP-18	303437582	ACEITE	G-870	303497577
			COMBUSTIBLE, SEPARADOR DE AGUA	GPP-1000	74394407			
4-78LL con motor/A DIESEL			6195 con motor/CUMMINS 6CTA8.3L					
COMBUSTIBLE	G-296	867014	COMBUSTIBLE, SECUNDARIO	GP-1122	303437574			
			ACEITE	GP-43	30-3436861			
4-80-17 con motor/WHITE 283DB			ACEITE, DOBLE FLUJO	GP-3000	303506517			
ACEITE, CONVERTIDOR DE TORSION PARA FORD	GP-9	40-0000409	AGUA	GP-2071W	27073723			
COMBUSTIBLE	G-295	200006803	COMBUSTIBLE, PRIMARIO	GPP-18	303437582			
ACEITE, CONVERTIDOR DE TORSION PARA CHRYSLER	GP-81	40-0000409	COMBUSTIBLE, SEPARADOR DE AGUA	GPP-1000	74394407			

MARCA-MODELO-MOTOR GONHER OEM
MAKE-MODEL-ENGINE GONHER OEM

WHITE (continuación)

TRACTORES

GT1650 con motor/BRIGGS & STRATTON
TRANSMISION PARA FORD GP-9 10A14373

WHITE

TRACTORES PEQUEÑOS Y PARA JARDIN

FST14 con motor/BRIGGS & STRATTON 14 HP
ACEITE GP-58 492932

GT205, Z200 con motor/BRIGGS & STRATTON 20 HP
ACEITE GP-58 492932

GT225 con motor/BRIGGS & STRATTON 22 HP
ACEITE GP-58 492932

GT2550, GT180, GT185 con motor/BRIGGS & STRATTON
ACEITE GP-58 492932

LT13 con motor/BRIGGS & STRATTON 13 HP
ACEITE GP-58 492932

LT145 con motor/BRIGGS & STRATTON 14.5 HP
ACEITE GP-58 492932

LT165, FST16, LT16 con motor/BRIGGS & STRATTON 16 HP
ACEITE GP-58 492932

LT175 con motor/BRIGGS & STRATTON 17 HP
ACEITE GP-58 492932

LT18, LT185 con motor/BRIGGS & STRATTON 18 HP
ACEITE GP-58 492932

LT19 con motor/BRIGGS & STRATTON 19 HP
ACEITE GP-58 492932

WINNEBAGO

CAMIONES, TRACTOCAMIONES Y AUTOBUSES

ADVENTURER, BRAVE con motor/GM 7.4L GASOLINA
ACEITE GP-408 25324052

ADVENTURER, CHIEFTAIN, MINNIE WINNIE (FORD E450) con motor/
FORD V10 6.8L GASOLINA
ACEITE GP-68 F1AZ-6731-BD
AIRE GA-1615 F6ZZ-9601-A
COMBUSTIBLE GG-1872 F0TZ-9155-B

CHIEFTAIN con motor/CUMMINS ISB DIESEL
ACEITE GP-3937 3937144

JOURNEY con motor/CUMMINS ISB DIESEL
ACEITE GP-3937 3937144

LESHARO con motor/RENAULT 2.0L DIESEL
COMBUSTIBLE, SECUNDARIO GPP-1122 77 00 700 092

MINNIE (GM G3500, FORD E3/450) con motor/FORD 7.3L TURBO
DIESEL
SEPARADOR DE COMBUSTIBLE G-862 F81Z-9N184-AA
ACEITE GP-562 F4TZ-6731-A
AIRE GAVW-620 F5UZ-9601-A

MARCA-MODELO-MOTOR GONHER OEM
MAKE-MODEL-ENGINE GONHER OEM

WINNEBAGO (continuación)

CAMIONES, TRACTOCAMIONES Y AUTOBUSES

MINNIE (GM G3500, FORD E3/450) con motor/FORD V10 6.8L
GASOLINA
ACEITE GP-68 F1AZ-6731-BD
AIRE GA-1615 F2ZZ-9601-A
COMBUSTIBLE GG-1872 F0TZ-9155-B

MINNIE (GM G3500, FORD E3/450) con motor/GM 7.4L GASOLINA
ACEITE GP-408 25324052
AIRE GA-392 25042562
COMBUSTIBLE GG-581 25121801

MINNIE WINNIE (FORD E450) con motor/FORD 7.3L TURBO DIESEL
SEPARADOR DE COMBUSTIBLE G-862 F81Z-9N184-AA
ACEITE GP-562 F4TZ-6731-A
AIRE GAVW-620 F5UZ-9601-A

WINPOWER

GENERADORES

DR13014, DR17514 con motor/IVECO NEF67 TE2X
ACEITE GP-737 2992242

DR9014 con motor/IVECO NEF45 TM1X
ACEITE GP-737 2992242

MARCA-MODELO-MOTOR GONHER OEM
MAKE-MODEL-ENGINE GONHER OEM

SERVICIO PESADO

MARCA-MODELO-MOTOR
MAKE-MODEL-ENGINE

GONHER
GONHER

OEM MARCA-MODELO-MOTOR
OEM MAKE-MODEL-ENGINE

GONHER
GONHER

OEM MARCA-MODELO-MOTOR
OEM MAKE-MODEL-ENGINE

GONHER
GONHER

OEM
OEM

Referencia Cruzada

Cross Reference

Codigo	Fabricante	Codigo	Fabricante	Codigo	Fabricante	Codigo	Fabricante
Code	Manufacturer	Code	Manufacturer	Code	Manufacturer	Code	Manufacturer
AAPA	ADVANCE AUTO PARTS	ARIE	ARIENS	BLAR	BELARUS	CESS	CESSNA
ABAC	ABAC	ARMA	ARMAX	BLAW	BLAW-KNOX	CEWF	CEW FILTERS
ABG	ABG	ARMS	ARMSTRONG-SIDDELEY	BLDW	BALDWIN	CHAB	CHAMBERLAIN
ABHN	AUTOBAHN	ARNO	ARNOLD	BLEY	BRITISH LEYLAND	CHAI	CHAIN BELT
AC	AC	ARO	ARCO FILTERS	BLKS	BLACKSTONE	CHAM	CHAMPION
ACAD	ACADIA	ARRO	ARROW MFG. CO.	BLKW	BLACKWELDERS	CHEK	CHECKER
ACC	ACCURATE PARTS	ASAH	ASAHI	BLMI	BLMI	CHGN	CHANGAN
ACD	ACDELCO	ASKA	ASHIKA	BLOU	BLOUNT	CHIC	CHICAGO-PNEUMATIC
ACE	ACE	ASTN	ASTON MARTIN	BLUE	BLUE BIRD	CHMA	CHARLES MACHINE WORKS
ACFB	ACF-BRILL	ASTR	ASTRA	BMW	BMW	CHP	CHAMPION LABS
ACKL	ACKLANDS	ATCO	ATLAS COPCO	BOG	BOSCH	CHRY	CHRYSLER
ACT	ACT	ATEC	AUTO TECH	BOGE	BOGE	CHVR	CHEVRON
ACUR	ACURA	ATHY	ATHEY	BOLI	BOLINDER-MUNKTELL	CIGO	CITGO
ADAM	ADAMS	ATL	ATLAS	BOLN	BOLENS	CIM	CIM-TEK
ADGE	AUTOEDGE	ATOX	AUTOX	BOMB	BOMBARDIER	CITR	CITROEN
ADL	ADL	ATSA	ATSA	BOMG	BOMAG	CLAA	CLAAS
ADP	ADP	ATWE	ATLAS-WEYHAUSEN	BONS	BONSER	CLEA	CLEAVER-BROOKS
ADVA	ADVANCE MACHINE CO.	AUDI	AUDI	BORG	BORGWARD	CLEF	CLEAN FUEL
AEC	A.E.C.	AUP	AUTOPAR	BORR	BORG-WARNER	CLEN	CLEAN
AERO	AERO-COACH	AUPD	AUTO PRIDE	BOUR	BOURGOIN	CLEV	CLEVELAND
AFIL	ARMAFILT	AUPT	AUTOPART	BOWE	BOWEN	CLI	CLINTON
AGCH	AG-CHEM EQUIPMENT	AUST	AUSTIN	BRAN	BRANSON	CLIM	CLIMAX
AGCO	AGCO	AUSW	AUSTIN-WESTERN	BRAU	BRAUD	CLIN	CLINE MINING TRUCKS
AGON	AG-ONE	AUTC	AUTOCAR	BRAV	BRAVO	CLM	CLM
AGRA	AGRIA	AUTE	AUTO EXPRESS	BRAY	BRAY	CLRK	CLARK
AGRI	AGRIFUL	AUTG	AUTOGEM	BRGG	BRIGGS	CLTA	CLETRAC
AHLM	AHLMAN	AUTN	AUTOTUNE	BRGS	BURGESS	CLUB	CLUB CAR
AIM	AIR MAZE	AUTO	AUTO PRODUCTS	BRIG	BRIGGS & STRATTON	CMI	CMI
AIR	AIR REFINER	AUTP	AUTOPACE	BRM	BRIMOT	CNTM	CONTINENTAL (MEXICO)
AIRE	AIR ENERGIE	AUTT	AUTOMATIC TRANSPOTATION	BROK	BROCKWAY	COBE	COOPER BESSEMER
AIRT	AIRTEX	AUTV	AUTOVALUE	BROM	BROOM & WADE	COBR	COBRA
AJAW	AMERICAN JAWA	AUW	AUTOWIZE	BROS	BROS	COCT	COCKSHUTT
ALAS	ALASKA DIESEL	AUWA	AUWAERTER	BROW	BROWN	COFA	COFAM
ALBA	ALBARET	AVAI	AVAILABLE	BROY	BROYT	COLS	COLES
ALBN	ALBIN	AVAT	AVATAR	BUCY	BUCYRUS-ERIE	COLT	COLT INDUSTRIES
ALCA	ALLCAR	AVCO	AVCO	BUFF	BUFFALO-SPRINGFIELD	COM	COMMERCIAL
ALCH	ALLIS CHALMERS	AVEL	AVELING-BARFORD	BUMP	BUMPER TO BUMPER	COMA	COMPAIR
ALCO	ALCO	AVLY	AVCO-LYCOMING	BUNG	BUNGARTZ	COMP	COMPACTO
ALFA	ALFA ROMEO	AWAR	AWARD	BUSH	BUSH HOG	CON	CONOCO
ALFI	A.L. FILTERS	AWD	A.W.D. TRUCKS	BUSS	BUSSING	CONF	CONAIR/FRANKLIN
ALL	ALLOMATIC	BAKR	BAKER	BWLA	B & W LATHROP	CONP	CONSOLIDATED
ALLI	ALLISON	BANR	BANNER INDUSTRIES	BWMN	BOWMAN	CONS	CONSOLIDATED DIESEL
ALMN	ALLMAND	BAP	BAP/GEON	BWS	BOWES	CONT	CONTINENTAL
ALNC	ALLIANCE	BARA	BARAD	CAC	CARCARE	CONV	CONVEYANCER
ALST	AHLSTROM	BARB	BARBER-GREENE	CALI	CALIFORNIA CUSTOM	COO	COOPERS
ALTE	ALTEC INDUSTRIES	BARH	BARHO-HYDRAULICS	CALS	CALSA	COP	CO-OP
ALUP	ALUP KOMPRESSOREN	BARS	BARREIROS	CAM2	CAM2	CORB	CORBITT
ALY	ALLOY	BAUD	BAUDOUIN	CAMP	CHAMP	COUA	COUACH
AMBA	AMBAC	BAUR	BAUER	CAN	CAN-FLO	COVE	COVENTRY CLIMAX
AMBO	AMERICAN BOSCH	BAUT	BAUTZ	CANC	CAN-CAR	CRAN	CRANE CARRIER
AMCO	AMERICAN MOTORS	BAYC	BAY CITY SHOVEL	CANF	CANADIAN FILTER CO.	CRIS	CHRIS-CRAFT
AMG	AM GENERAL	BBR	BOWSER-BRIGGS	CANT	CANADIAN TIRE	CRM	CRUISEMASTER
AMHO	AMERICAN HOIST & DERRICK	BDGR	BADGER	CAP	CAPITAL	CRO	CROSLAND
AMLA	AMERICAN LAFRANCE	BEAM	BEAM	CAPA	CAPA	CRON	CROWN COACH
AMP	AMERICAN PARTS	BECK	BECKER KOMPRESSOREN	CAR	CARTER	CRQ	CARQUEST
AMS	AMSOIL	BEDF	BEDFORD	CARO	CARRARO	CRQR	CARQUEST RED
ANSA	ANSALDO	BEK	BECK/ARNLEY	CARR	CARRIER-TRANSCOLD	CRSS	CROSS MFG.
APC	AMPCO	BELL	BELL	CASE	CASE	CRUS	CRUSADER
APCO	APCO	BENA	BENATI	CASI	CASITE	CSP	CHAMPION SPARK PLUG
APF	AP FILTERS	BENE	BENELLI	CAST	CASTROL	CSYS	COMPRESSOR SYSTEMS
APL	AP-LOCKHEED	BENF	BENFRA	CATP	CATERPILLAR	CTOL	CURTIS TOLEDO
APOL	APOLLO	BENG	BENGBU	CAV	C.A.V.	CUB	CUB CADET
APRO	AUTOPRO	BENX	BENDIX-WESTINGHOUSE	CBM	CBM (CAR BUS MANS)	CUMM	CUMMINS
AQUP	AQUA POWER	BERL	BERLIET	CCO	CANADIAN CO-OP	CURT	CURTISS-WRIGHT
ARAL	ARAL	BERN	BERNARD	CECC	CECCATO	CUSH	CUSHMAN
ARAP	AIR PLANE	BEUT	BEUTHLING	CEDR	CEDAR RAPIDS	CUST	CUSTOM VACUUM
ARC	ATLANTIC RICHFIELD CO.	BFOR	BENFORD	CENE	CENEX	CYC	CYCLONE
ARCT	ARCTIC TRAVELER	BGA	BIG A	CERL	CERLIST DIESEL	DAEW	DAEWOO

Código de Fabricantes Manufacturer's Codes



Codigo	Fabricante	Codigo	Fabricante	Codigo	Fabricante	Codigo	Fabricante
Code	Manufacturer	Code	Manufacturer	Code	Manufacturer	Code	Manufacturer
DAF	DAF	ERO	EUROFILTER	FRML	FARMLAND	GUSA	GONHER USA
DAGN	DAGENHAM DIESEL	ESSE	ESSEX	FSN	FIRESTONE	HAGI	HAGIE
DAIM	DAIMLER	EUCL	EUCLID	FTA	FIAT-ALLIS	HAHN	HAHN
DANT	DRANT	EVGR	EVERGARD	FTEC	FILTER TECHNOLOGIES	HALL	HALL-SCOTT
DATT	DART TRUCKS	EXCL	EXCEL	FTRO	FILTRON	HALM	HAULAMATIC
DAVC	DAVCO	EXXE	EXXEL	FUCH	FUCHS	HAMA	HAMARAQ
DAVI	DAVID BROWN	EZGO	E-ZGO CAR DIV.	FUEL	FUELGUARD	HAMM	HAMM
DAVS	DAVIS	FACE	FACET	FUJI	FUJI	HANO	HANOMAG-HENSCHEL
DAVY	DAVEY	FAHR	FAHR	FULR	FULLER	HARL	HARLEY-DAVIDSON
DEAR	DEARBORN	FAI	FAI	FUNK	FUNK	HARM	HARMO
DECH	DECHENTREITER	FAIR	FAIRMONT	FURU	FURUKAWA	HARR	HARRIS HARVESTER
DEFS	DEFENSE	FALK	FALK	FWDX	FWD CORP.	HART	HART-CARTER PACIFIC
DEL	DELUXE	FAME	FAMEL	GALN	GALION	HARV	HARVARD
DELA	DELAWARE MANITOU	FAPO	FAPOFIL	GAR	GUARDIAN FILTER CO.	HAS	HASTINGS PREMIUM
DEMA	DEMAG	FARB	FAIRBANKS-MORSE	GARD	GARDNER-DENVER	HATR	HATRA
DEMP	DEMPSTER	FARM	FARMHAND	GARE	GARDNER ENGINES	HATZ	HATZ
DENN	DENNIS	FAUN	FAUN FRISCH	GARI	GARRISON	HAVO	HAVOLINE
DENS	DENSO	FAY	FAIREY-ARLON	GARW	GARWOOD-BUCKEYE	HAWK	HAWKER SIDDELEY ENGINES
DERR	DERRUPE	FCAR	FILCAR	GASO	GAS-O-LINE	HAYD	HAYDEN
DETR	DETROIT DIESEL	FCL	FILTER CONTROL LTD.	GC	GC	HDA	HEAVY DUTY AIR
DEUS	DEUTSCH	FDY	FILTER DYNAMICS	GEC	GEC	HEAT	HEAHFIELD ENGINEERING
DIA	DIAMOND	FEDE	FEDERATED	GEHL	GEHL	HECK	HECKS
DIAM	DIAMOND REO	FEDL	FEDERAL	GEMI	GEMINI	HEDE	HEDEN
DIEX	DIEXA	FELD	FIELD QUEEN	GENC	GENERAC	HEIL	HEIL
DIGT	DIGITAL-EQUIPMENT	FEND	FENDIT	GENE	GENERAL ELECTRIC	HEIN	HEIN-WARNER
DINA	DINA	FENW	FENWICK	GENI	GENIE	HEN	HENGST
DITC	DITCH WITCH	FERG	FERGUSON	GERL	GERLINGER	HEND	HENDERICKSON
DITX	DITEX	FERI	FERRARI	GETM	GETMAN	HENL	HENLEY
DIVC	DIVCO	FERR	FERRIS	GFF	GFF	HENS	HENSCHEL
DLSL	DL STEEL	FFIL	FIL FILTER	GGER	GRAINGER	HERC	HERCULES
DOGE	DODGE	FGR	FIATAGRI	GIFF	GIF FILTER	HERI	HERITAGE
DOMI	DOMINION	FIA	FIAAM	GILB	GILBARCO	HESS	HESSE CARRIAGE
DON	DONALDSON	FIAT	FIAT	GILC	GILCREST FILTER	HEST	HESSTON
DONT	DONIT	FIBA	FIBA FILTER	GILS	GILSON	HFFE	HOFFER
DORM	DORMAN	FIL	FILT	GIS	GIESSE	HFIL	HYDROFILT
DPHI	DELPHI	FILC	FILTER CLONE	GKIN	GK INDUSTRIES	HIAB	HIAB
DRES	DRESSER	FILG	FILGA	GLD	GOULD	HIFI	HI-FI
DRIL	DRILTECH	FILP	FILTER PRODUCTS CORP.	GLEN	GLEANER HARVESTER	HILL	HILL
DRON	DRONNINGBORG	FILS	FILTRATION SYSTEMS	GLOB	GLOBAL	HINO	HINO
DROT	DROTT	FILT	FILTRAL	GMCX	GENERAL MOTORS	HITA	HITACHI
DTSU	DAIHATSU	FILX	FILTRX	GMEI	GMEINDER	HLER	HUSTLER
DUCA	DUCATI	FINI	FINI	GOL	GOLDONI	HOBT	HOBART
DUPX	DUPLEX	FINN	FINN	GONH	GONHER	HODR	HOLDER
DUTN	DUTTON-LAINSON	FISP	FISPA	GOTT	GOTTWALD	HOKU	HOKUETSU KOGYO
DUTZ	DEUTZ	FITZ	FITZJOHN	GOY	GOODYEAR	HOLL	HOLLAND
DYLI	DYNALIFE	FLAG	FLAGSHIP	GPAR	GEN PART	HOLM	HOLMAN
DYNA	DYNAHOE	FLEE	FLEETLIFE	GPC	GPC	HOLY	HOLLEY
DYNM	DYNAMIC IND.	FLG	FLEETGUARD	GRAD	GRADALL	HOME	HOMELITE
DYPA	DYNAPAC	FLK	FILKO	GRAF	GRAFT & STIFT	HOMR	HOMER
EAIR	ECOAIR	FLL	FLO-LINE	GRAM	GRAHAM	HOND	HONDA
EATN	EATON	FLOM	FLOTTMAN	GRAN	GRAND PRIX	HOPE	HOPE
ECH	ECHLIN	FLR	FLEETRITE	GRAV	GRAVELY	HOUG	HOUGH
ECO	ECO	FLT	FILTERS, INC.	GRAY	GRAY MARINE	HUBR	HUBER-WARCO
ECOL	ECONO LUBE N TUNE	FLUI	FLUID POWER, INC.	GREA	GREASE MONKEY	HUMB	HUMBER
EICH	EICHER	FLUT	FLUITEK	GREE	GREEN	HUR	HURLIMANN
ELGN	ELGIN	FLUX	FLUXFILTER	GRES	GRESEN	HUT	HUTCHENS
EMCO	EIMCO	FLXI	FLXIBLE	GREY	GREYFRIARS	HYC	HYCON
EMD	E.M.D.	FMC	FMC	GRIM	GRIMMER SCHMIDT	HYDA	HY-DYNAMIC
ENCA	ENSIGN CARBURETOR	FMEX	FILTRO MEX	GROV	GROVE	HYDO	HYDRO-AX
ENDU	ENDUSTR	FNIG	FRANIG	GRP	GROUP 7	HYDR	HYDRA-MAC
ENGR	ENGINE RENEW	FODN	FODEN	GUAS	GUASCOR	HYDS	HYDRAULIC SPECIALISTS
ENLI	ENGINE LIFE	FORD	FORD MOTOR CO.	GUD	G.U.D.	HYDX	HYDRAX
ENTR	ENTERPRISE	FRAN	FRANKLIN	GUIO	GUIOT	HYHH	HYDAC
ENUM	ENUMCLAW MFG. CO.	FRED	FRED'S	GUL	GULF	HYMA	HYMAC
ENV	ENGINE VENT	FREI	FREIGHTLINER	GULD	GULDNER	HYST	HYSTER
EPE	EPE	FRF	FORD FINSOCODE	GUP	GUARANTEED PARTS	HYUN	HYUNDAI
ERF	ERF	FRIG	FRIGIKING	GUR	GUR	HYVA	HYDROVANE
ERIC	ERICKSON	FRM	FRAM	GURI	GURIA	IAPC	IAPCO

REFERENCIA CRUZADA

Codigo	Fabricante	Codigo	Fabricante	Codigo	Fabricante	Codigo	Fabricante
Code	Manufacturer	Code	Manufacturer	Code	Manufacturer	Code	Manufacturer
IHCO	INT HARVESTER	KIA	KIA	LYS	FILTROS LYS	MOTF	MOTOR FILTER
IMPC	IMPCO	KIKU	KIKU FILTER	MACD	MACDON	MOTX	MOTRIX
IMPL	IMPERIAL MACHINE	KINB	KING BEARING	MACH	MATCH	MOXY	MOXY
IMPW	IMPORT CAR WORLD	KIOT	KIOTI	MACK	MACK	MPA	MPA
INDE	INDENOR	KIRK	KIRK ALDIE	MACO	MACO MEUDON	MPFI	MP FILTRI
INDUCL	INDUCONTROL	KLAV	KLAVER	MAGI	MAGIRUS	MPL	MARINE PERFORMANCE
INGR	INGERSOLL-RAND	KMA	K-MART	MAHL	MAHLE	MPP	M.P. PRODUCTS
INJ	INJECTOR	KMG	KERR-MCGEE	MAIR	MICRON AIR	MTM	MTM
INNO	INNOCENTI	KND	KENDALL	MAN	M.A.N.	MTOR	MCI-MOTOR COACH IND.
INSL	INSLEY	KNE	KNECHT	MANI	MANITOWOC	MTR	MOTORCRAFT
INTE	INTERCONTINENTAL	KNUD	KNUDSON	MANO	MANITOU	MTRV	MOTORVATOR
INTF	INTERFIL	KOBL	KOBELCO	MAR	MARATHON	MTU	M.T.U.
INTM	INTERCEPTOR	KOEH	KOEHRING	MARI	MARION	MUIR	MUIR-HILL
INTR	INTRUPA	KOHL	KOHLER	MARK	MARK	MULH	MULTIHOE
IOWA	IOWA MANUFACTURING	KOMA	KOMATSU	MARP	MARINE POWER	MULP	MULTIPART
IPC	IPC GLOBAL	KORO	KORODY COLYER	MARS	MARSHALL	MUNC	MUNCIE
IPD	IPD	KRA	KRALINATOR	MASE	MASTER PARTS	MURY	MURPHY
IPEC	INPECA	KRAM	KRAMER	MAST	MASTER	MVM	MOTORI VM
IPS	INTERNATIONAL PARTS	KRAU	KRAUSS MAFEI	MASY	MASSEY FERGUSON	MWGC	M & W GEAR CO.
IRLE	IRLEMP	KRUP	KRUPP	MATB	MATBRO	MWM	MWM
ISEK	ISEKI	KS	KS	MATT	MATTEI	MXLI	MAXLIFE
ISHI	ISHIKAWAJIMA HARIMA IND.	KUBO	KUBOTA	MAXI	MAXIBILT	MXLU	MAX LUBE
ISUZ	ISUZU	KUSS	KUSS	MBNZ	MERCEDES-BENZ	MZDA	MAZDA
ITAL	INSTALLEREDGE	LACR	LACRE	MCAB	MCCABE	NACC	NACCO
ITM	ITM	LADA	LADA	MCCU	MCCULLOCH	NAFI	NAFIL
IVEC	IVECO	LAMB	LAMBORGHINI	MCG	MICROGUARD	NALC	NALCOOL
JACK	JACKSON	LANC	LANCIA	MCNE	MCNEILUS	NAM	NAM POONG FILTER
JACO	JACOBSEN	LAND	LAND ROVER	MEAD	MEADOWS	NANN	NANNI DIESEL
JAEG	JAEGER	LANI	LANDINI	MECC	MECHANIC S CIRCLE	NAP	NAPA GOLD
JAGU	JAGUAR	LANS	LANSING BAGNALL	MECF	MECAFILTER	NAPI	NAPA IMPORTS
JAPA	JAPAN PARTS	LANZ	LANZ	MEDC	MEDCO	NAPS	NAPA SILVER
JAPN	JAPAN FILTER CO.	LAPL	LAPLANTE-CHOATE	MEDO	MEAT & DORIA	NATW	NATION WISE
JAT	JAT	LAUS	LAUSON-TECUMSEH	MEI	MEIJER	NEL	NELSON-WINSLOW
JCBM	JCB (J.C. BAMFORD)	LAUT	LAUTRETTE	MELR	MELROE-BOBCAT	NEM	NEM
JCP	JC PENNEY	LAWN	LAWN BOY	MEN	MENA FILTER	NEUS	NEUSON
JEEP	JEEP	LAZO	LAZORLITE	MENA	MENARINI	NEWH	NEW HOLLAND
JEFF	JEFFREY	LBFI	L.B. FILTER	MENG	MENGELE	NEWI	NEW IDEA
JENB	JENBACHER WERKE	LBHR	LIEBHERR	MERC	MERCUISER	NIPP	NIPPON
JENS	JENSEN	LEDR	LEDERER	MFI	M.F.I.	NIPT	NIPPARTS
JFL	JIFFY LUBE	LEE	LEE	MFIL	M FILTER	NISS	NISSAN
JHFC	JUNE HEUNG FILTER CO., LTD	LEEM	LEE MAXI	MIC	MICHIANA	NKK	NKK
JLGI	JLG INDUSTRIES INC.	LEM	LEMPCO	MICF	MICRO-FILTER	NLSN	NELSON
JOHT	JOHNSTON	LEMN	LEHMAN	MICG	MICRO-GARD	NNSE	NAPA (NASCAR SELECT)
JONA	JONAS WOODHEAD	LENZ	LENZ	MICP	MICRO PORE	NODA	NODA
JONB	JOHN BEAN	LETR	LETOURNEAU-MARATHON	MIDL	MIDLAND STEEL	NOEQ	NORMAN EQUIPMENT
JOND	JOHN DEERE	LEVE	LEVE	MIDS	MIDAS	NOF	NIEHOFF
JOY	JOY	LEYL	LEYLAND	MIFP	MICHIGAN	NORB	NORDBERG NORSEMAN
JPAR	JAKOPARTS	LHA	LHA	MIGH	MIGHTY	NORT	NORTHWEST
JSCB	J & C CARBURETOR	LIN	LINDE	MIL	MILITARY	NSN	NATIONAL STOCK NUMBER
JSWS	JAPAN STEEL WORKS	LINC	LINCOLN ELECTRIC	MILE	MILEGUARD	NSU	NSU
JURA	JURASSIC	LINK	LINK-BELT	MILL	MILLER ELECTRIC	NUE	NU-TECH
KAES	KAESER	LNCR	LANCER BOSS	MINL	MINIT LUBE	OFSA	OFSA
KAIS	KAISER	LOCK	LOCKWOOD	MINN	MINNEAPOLIS-MOLINE	OHFC	OHIO FILTER COMPANY
KALA	KALAMAZOO MFG	LOMB	LOMBARDINI	MIOF	MIOFILTRE	OK	O & K
KALB	KAELBLE	LONF	LONGLIFE	MITS	MITSUBISHI	OLIV	OLIVER
KALM	KALMAR	LONG	LONG	MMAN	MUSTANG MANUFACTURING	ONAN	ONAN
KAMP	KAMPER	LORA	LORAIN	MNH	MANN & HUMMEL	OPEL	OPEL
KASB	KASSBOHRER	LOSE	LOSENHAUSEN	MOB	MOBIL	OQIP	OMNIQUIP
KAWA	KAWASAKI	LPM	LIFT PARTS MFG.	MODI	MODINA	OREN	ORENSTEIN & KOPPEL
KAYS	KAYSER	LROI	LEROI	MOHA	MOHAWK	OSGO	OSGOOD
KBLU	KOOL BLUE	LSTR	LISTER	MON	MONROE	OSHK	OSHKOSH
KDCP	KDC PARTS	LTH	LTH	MOND	MONARK DIESEL	OTIS	OTIS MATERIAL HANDLING
KELG	KELLOGG AMERICAN	LUC	LUCAS	MONW	MONTGOMERY WARD	OTUR	ORTURBO
KELV	KELVIN MARINE ENGINES	LUER	LUGGER	MOP	MOPAR	OUTB	OUTBOARD MARINE
KEM	KEM	LUF	LUBER-FINER	MORB	MORBARK	OWEN	OWENS YACHT
KENG	K & N ENGINEERING	LULL	LULL	MORE	MORETTI	OWTN	OWATONNA
KENW	KENWORTH	LUW	LETOURNEAU-WESTINGHOUSE	MOSK	MOTO-SKI	PACF	PACIFIC CAR & FOUNDRY
KHDF	KHD	LYCO	LYCOMING	MOTA	MOTAQUIP	PACK	PACKARD

Código de Fabricantes Manufacturer's Codes



Codigo	Fabricante	Codigo	Fabricante	Codigo	Fabricante	Codigo	Fabricante
Code	Manufacturer	Code	Manufacturer	Code	Manufacturer	Code	Manufacturer
PAI	PAI	RALL	RALLEY	SCHW	SCHWING	TAMR	TAMROCK
PAL	PALL	RAMA	RAMA	SCT	SCT	TARG	TARGET
PALM	PALMER	RAND	RAND	SEAB	SEABOARD MARINE INC.	TAYL	TAYLOR MACHINE
PAMO	PARTMO	RANG	RANGER	SEAG	SEAGRAVE	TCI	TCI
PAR	PARR FILTERS	RANS	RANSOMES, SIMMS & JEFFERIES	SEAT	SEAT	TCLD	TRANSICOLD
PARK	PARKER	RAR	RACOR	SECU	SECURITY	TCM	TCM
PARM	PARTS MASTER	RAYG	RAYGO	SEDN	SEDDON	TEC	TECALEMIT
PARP	PARTS PLUS	RAYM	RAYMOND	SEFA	SHEFA	TECF	TECAFILTERS
PART	PARTNER	READ	READY-POWER	SER	SERIES 2	TECU	TECUMSEH-LAUSON
PBLT	PETERBILT	REF	REFILCO	SERC	SERVICE CHAMP	TEHO	TEHO
PBR	PBR	REK	REK	SERP	SERVICE PRO	TELE	TELEDYNE
PCAR	PACCAR	RENA	RENAULT	SERV	SERVICE 1	TENN	TENNANT
PDX	P & D	REOT	REO	SFFI	SF FILTER	TERA	TERRA COBRA
PEGA	PEGASO	REPC	REPCO	SHAN	SHANGHAI FILTER	TERB	TERBERG
PELJ	PELJOB	REVL	REVLEY	SHE	SHELL	TERE	TEREX
PEN	PENNZOIL	REX	REX	SHEP	SHEPPARD	TERR	TERRAMITE
PENN	PENNSYLVANIA	REXN	REXNORD	SHIB	SHIBAURA	TETR	TEXTRON
PEP	PEP BOYS	RICI	RICHER	SHIN	SHINKO ZOKI	TEX	TEXACO
PER	PERRY	RIET	RIETSCHLE	SICA	SICARD	TFIL	TEC-FIL
PERK	PERKINS	RIKL	RICKEL MFG.	SIEG	SIEG	TFS	TECHNICAL FILTRATION
PERL	PERLINI	RIPL	RIPLY	SIER	SIERRA	THER	THERMO KING
PERM	PERMATIC	RKHL	ROCKHILL	SIFO	SIFO	THOM	THOMAS EQUIPMENT LTD.
PETI	PETTIBONE-MULLIKEN	ROAD	ROAD-X	SIMC	SIMCA	THWA	THWAITES
PETT	PETTER	ROB	ROBERT BOSCH	SIMM	SIMMS	TIKO	TAISCI KOGYO
PEUG	PEUGEOT	ROBI	ROBIN	SIMP	SIMPLICITY	TIMB	TIMBERJACK
PFAC	PUROLATOR-FACET	ROBN	ROBIN NODWELL	SISU	SISU	TIMC	TIMBCO
PFMX	PERFORMAX	ROCK	ROCKWELL	SKOD	SKODA	TIMK	TIMKEN
PFX	PURFLUX	ROGR	ROGERS	SLAN	SLANZI	TIRP	TIRES PLUS
PHHR	P & H	ROLK	ROL-PAK	SLIN	SILVERLINE	TLFT	TOTALIFT
PHI	PHILLIPS 66	ROLS	ROLLS-ROYCE	SLP	STAR LIFT PARTS	TNC	TECNOCAR
PHOE	PHOENIX	ROMA	ROMAN	SMH	SYSTEMS MATERIAL HANDLING	TNFI	TECNIFIL LTDA
PIPE	PIPER CROSS	ROO	ROOSAMASTER	SMRT	SMART	TOKO	TOKYO
PMC	PACIFIC MFG. CO. (P.M.C.)	ROOT	ROOTES	SOFI	SOFILTRA	TOKY	TOKYO ROKI
POCL	POCLAIN	ROS	ROSES	SOFM	SOFIMA	TOMI	TOMI
POFI	POWERFIL	ROTA	ROTARY GAS	SOPA	SOPARIS	TORI	TORIT
POLA	POLARIS	ROTO	ROTOCOMP	SPEC	SPECIALIST'S CHOICE	TORO	TORO
PORS	PORSCHE	ROVE	ROVER	SPLT	SERVICEABLE PARTS LTD	TOSH	TOYOSHA
POWB	POWER BOSS	RPRO	ROAD PRO	SPRI	SPRINGFIELD	TOTL	TOTAL SOURCE
POWF	POWERFLO	RPS	RPS	SRN	SORENSEN	TOWM	TOWMOTOR
POWP	POWER PARTS	RRP	R & R PRODUCTS	SROB	SABO ROBERINE	TOYK	TOYO KOGYO
POWT	POWER TRAIN	RUGG	RUGGERINI	SRS	SEARS	TOYO	TOYOTA
PPM	PPM	RUST	RUSTON DIESELS	SSYO	SSANGYONG	TRAB	TRABON
PPRO	PUREPRO	RYCO	RYCO	STAM	STANDARD MOTOR PRODUCTS	TRAI	TRAIL MOBILE
PREM	PREMIER	RYTR	REYTOR	STAN	STANDARD IMPORT CARS	TRAK	TRAK INTERNATIONAL
PRET	PRECISION TUNE	S&B	S & B	STAU	STAUFF	TRAN	TRANE
PRIE	PRIESTMAN	S500	SELECT 500	STDY	STANADYNE	TRCA	TRUCK CARE
PRIL	PRIMELINE	SAAB	SAAB-SCANIA	STEC	SEPARATION TECHNOLOGIES	TRCP	TRACTO PARTES
PRIN	PRINCE	SACO	SACO-LOWELL	STECH	SUPER TECH	TROJ	TROJAN
PRMT	PROMOTIVE	SAFE	SAFEGWAY	STEI	STEIGER	TRS	TRS
PROB	PRO-BUILT	SAK	SAFETY-KLEEN	STER	STERLING	TRU	TRU-AIR
PROF	PROFESSIONALS CHOICE	SAKA	SAKAI	STES	STENS	TRUS	TRUST
PROG	PRO/GAUGE	SAKU	SAKURA	STEY	STEYR	TSUC	TSUCHIYA
PROL	PROLINE	SALM	SALMSON	STIL	STILL	TUXC	TUXCO CADDY
PROM	PROMATCH	SAMB	SAMBRON	STOL	STOLPER	TVH	TVH
PRON	PRONTO	SAME	SAME	STP	STP	TVI	TVI
PROT	PRO-TEC	SAMS	SAMSUNG	STR	STAY READY	TWDC	TWIN DISC
PSIL	PARTS SERVICE INT.	SATO	SATOH	STUD	STUDEBAKER	TWIN	TWIN COACH
PTI	P.T.I.	SATU	SATURN	SUBA	SUBARU	TYLR	TYLER
PUMX	PUROMEX	SAUR	SAURER	SULL	SULLAIR	TYMC	TYMCO
PUR	PUROLATOR	SAVA	SAVARA	SUMI	SUMITOMO	UAC	UNITED AIR CLEANER
PURF	PURE FLOW	SAVI	SAVIEM	SUN	SUNOCO	UCAL	UNOCAL
QAP	QAP FILTERS	SAXB	SAXBY-TRACMA	SUND	SUNDSTRAND	UCC	U.C.C. HYDRAULIC
QIFA	QIF AIR	SCAM	SCAMMELL	SURE	SURE FILTER TECHNOLOGY	UFI	U.F.I.
QKS	QUAKER STATE	SCHA	SCHAEFF-NAMCO	SUZU	SUZUKI	UJAP	UNION JAPAN
QTEE	QUALITEE	SCHL	SCHLUTER	SVIK	SANDVIK	UNFI	UNIFILTER
QUIC	QUICKWAY SHOVEL	SCHM	SCHRAMM	TADA	TADANO	UNI	UNITED ENGINE LIFE
QUIN	QUINCY	SCHR	SCHROEDER	TAKI	TAKEUCHI	UNIC	UNICO
RACN	RACINE	SCHU	SCHUPP	TALB	TALBOT	UNID	UNI DIESEL

REFERENCIA CRUZADA

Codigo	Fabricante	Codigo	Fabricante	Codigo	Fabricante	Codigo	Fabricante
Code	Manufacturer	Code	Manufacturer	Code	Manufacturer	Code	Manufacturer
UNIT	UNIT	WING	WINGET				
UNIV	UNIVERSAL FILTERS	WIPA	WIPAC				
UNN	UNION 76	WISC	WISCONSIN				
UNP	UNIPART	WITT	WITTE				
UNSR	UNISOURCE	WIX	WIX				
UNVC	UNIVERSAL COACH	WLM	WAL-MART				
UNVP	UNIVERSAL POWER CONV.	WMP	WM. PENN				
URIG	UNIT RIG	WOOD	WOODS & COPELAND				
USX	USX	WOOG	WOODGATE				
VAG	VAG	WORL	WORLD MARK				
VALM	VALMET	WORT	WORTHINGTON				
VALQ	VALQUEST	WOW	WOWIDE FILTER				
VALU	VALUTEST	WPT	WORLDPARTS				
VALV	VALVOLINE	WST	WESTWRN STAR TRUCK				
VAND	VANDEL	XSV	XSV				
VANH	VAN HOOL	YALE	YALE & TOWNE				
VAPM	VAPORMATIC	YAMH	YAMAHA				
VAPR	VAPOR	YELC	YELLOW COACH				
VAUX	VAUXHALL	YNMR	YANMAR				
VCRA	VALUCRAFT	YOBW	YORK-BORG-WARNER				
VERA	VERA	YORK	YORK				
VERM	VERMEER	YUGO	YUGO				
VERS	VERSATILE	YUIL	YUIL FILTERS				
VESC	VESCOR	YUMB	YUMBO				
VETU	VETUS	ZAST	ZASTAVA				
VIC	VIC	ZETO	ZETOR				
VICK	VICKERS	ZETT	ZETTELMAYER				
VIRG	VIRGIS	ZF	ZF				
VMAC	VMAC	ZING	ZINGA				
VME	V.M.E. (VOLVO-MICHIGAN-EUCLID)						
VMEN	VM ENGINES						
VOK	VOKES						
VOLK	VOLKSWAGEN						
VOLV	VOLVO						
VOR	VORTOX						
VOX	VOX						
VRS	VARSATILE						
WABC	WABCO						
WACK	WACKER						
WAGR	WAGNER						
WAIN	WAIN ROY						
WAKO	WAKO						
WALD	WALDON						
WALM	WALMI						
WARD	WARD LAFRANCE						
WARN	WARNER						
WASW	WARNER SWASEY						
WAUK	WAIKESHA						
WAYN	WAYNE						
WEAT	WEATHERHILL						
WEB	WEB						
WEBB	WEBB						
WELA	WELLS AMPCO						
WELE	WEBSTER ELECTRIC						
WELL	WELLWORTHY						
WERK	WERKLUST						
WES	WESTERN TOOL CO.						
WESA	WESTERN AUTO						
WESF	WESFIL						
WEST	WESTERBEKE						
WEUR	WIX (EUROPE)						
WGB	WGB						
WHEL	WHEEL HORSE						
WHIL	WHITLOCK						
WHIT	WHITE						
WHOR	WORKHORSE						
WILY	WILLYS						
WIN	WINSLOW						

Notas de Superíndice para Referencia Cruzada
Superscript Notes for Cross Reference



Código	Significado	Código	Significado
Code	Meaning	Code	Meaning
1	1 ORIFICIO	69	ISUZU
2	10 MICRAS	70	ISUZU, NISSAN
3	11-17 PSI	71	KOMATSU
4	12-16 PSI	72	KOMATSU PRIMARIO
5	2 ORIFICIOS	73	KOMATSU SECUNDARIO
6	28-32 PSI	74	KUBOTA
7	30 MICRAS	75	KUBOTA, YANMAR
8	30 PSI	76	LARGO
9	8-12 PSI	77	LISTER
10	ACEITE HIDRAULICO	78	MAZDA
11	ACEITE PARA MOTOR	79	MERCEDES BENZ
12	AF	80	METALICO
13	ALT. 11 23/64 IN	81	MEXICO
14	ALT. 18 1/32 IN	82	MITSUBISHI
15	ALT. 3 11/32 IN	83	MOTORES VOLKSWAGEN
16	ALT. 3 21/32 IN	84	MOTORES VOLKSWAGEN (28-32 PSI)
17	ALT. 3 3/16 IN	85	MOTORES VOLKSWAGEN (30 PSI)
18	ALT. 3 45/64 IN	86	MWM, VW
19	ALT. 3 47/64 IN	87	NISSAN
20	ALT. 5 13/32 IN	88	NISSAN, SUBARU
21	ALT. 6 43/64 IN	89	NISSAN, TOYOTA
22	ALT. 7 13/32 IN	90	OPCIONAL
23	ALT. 7 23/32 IN	91	OPCIONAL PRIMARIO
24	ALT. 7 27/32 IN	92	OPCIONAL SECUNDARIO
25	AMC	93	OPCIONAL, EMPAQUE AL CENTRO
26	BOBCAT, PINTO	94	OTROS
27	CAPRI, PINTO	95	OTROS (28-32 PSI)
28	CARBON ACTIVADO	96	OTROS (30 PSI)
29	CASE	97	OTROS (ACEITE HIDRAULICO)
30	CATERPILLAR	98	OTROS (ACEITE PARA MOTOR)
31	CHRYSLER	99	PARA DIRECCION
32	COALECENTE	100	PARA TRANSMISION
33	COMM GMC HSG	101	PEUGEOT
34	CON ASPAS	102	PINTO
35	CON FIELTRO	103	PLASTICO
36	CON MANGUERA 5 IN MAS LARGA	104	PRIMARIO
37	CON MANGUERA DE 6 IN DE LARGO	105	RENAULT
38	CON MANGUERA DE 9 1/8 IN DE LARGO	106	REUTILIZE EL TAMIZ DEL EQUIPO ORIGINAL
39	CON PURGADOR	107	ROVER
40	CON ROSCA PARA TAZON	108	SECUNDARIO
41	CON ROSCA PARA TAZON (1RA OPCION)	109	SECUNDARIO FRAM HOUSING
42	CON ROSCA PARA TAZON (2DA OPCION)	110	SEGUNDA OPCION
43	CON SOPORTE	111	SEPARADOR
44	CON VALVULA ANTI-DRENAJE	112	SIN ASPAS
45	CORTO	113	SIN FIELTRO
46	CUMMINS	114	SIN MANGUERA
47	CUMMINS PRIMARIO	115	SIN RESORTE
48	CUMPLE CON MEDIDAS ORIGINALES	116	SIN SOPORTE
49	DAIHATSU	117	SIN VALVULA ANTI-DRENAJE
50	DETROIT DIESEL	118	SOLO ESTADOS UNIDOS (ROSCA PARA TAZON)
51	DEUTZ	119	SUBARU
52	DIESEL	120	SUZUKI
53	EMPAQUE A LA ORILLA	121	THERMO KING
54	EMPAQUE AL CENTRO	122	TOYOTA
55	ESTANDAR	123	TURBO
56	EXCEPTO JEEP	124	USA
57	EXCEPTO MEXICO	125	VW
58	FORD	126	YANMAR
59	FORD AUTOMOTRIZ		
60	FORD, MASSEY, PERKINS		
61	GASOLINA		
62	GEO, SUZUKI		
63	GMC, ISUZU		
64	HEAVY DUTY		
65	HIDRAULICO		
66	HONDA		
67	IHC		
68	INTERNATIONAL		

REFERENCIA CRUZADA

Number	Gonher	Code	Number	Gonher	Code	Number	Gonher	Code	Number	Gonher	Code
Números Nuevos											
0 450 902 161	GG-291	BOG	02388-1	GA-33	AMCO	041-0266	GP-81	BEK	041-8020	GP-42	BEK
0 451 103 079	GP-46	BOG	023881A	GA-33	ASTR	041-0324	GP-81	BEK	041-8038	GP-81	BEK
0 986 800 021	GP-46	BOG	023881A	GA-33	ATHY	041-0332	GP-1	BEK	041-8039	GP-1	BEK
000 180 16 09	G-3827	MBNZ	0239518-4	GA-33	ALCH	041-0340	GP-36	BEK	041-8041	GP-36	BEK
000 180 17 09	G-3754	MBNZ	0243163-2	GAK-16	ALCH	041-0365	GP-1	BEK	041-8043	G-834	BEK
000 180 2209	G-180	MBNZ	0243163-3	GAK-16	ALCH	041-0399	G-870	BEK	041-8044	GP-3531 EXP	BEK
000 180 2309	G-180	MBNZ	0244728-1	GAK-20	ALCH	041-0407	GP-42	BEK	041-8046	GP-28	BEK
000 180 2309	G-180	MBNZ	0244728-2	GAK-20	ALCH	041-0423	GP-1	BEK	041-8050	GP-28	BEK
000 180 2309	G-918	MBNZ	0249-23-603	GA-349	MZDA	041-0449	GP-46	BEK	041-8052	GP-157	BEK
000 180 2609	G-180	MBNZ	0253-23-603	GA-349	MZDA	041-0548	GP-3531 EXP	BEK	041-8052	GP-58	BEK
000 180 2609	G-918	MBNZ	0258522-M91	GA-892	MASY	041-0563	GP-1	BEK	041-8054	GP-3985	BEK
000 180 3109	G-180	MBNZ	0259-14-300	GP-42	MZDA	041-0571	GP-40	BEK	041-8055	GP-91	BEK
000 180 3109	G-918	MBNZ	0259-23-603	GA-349	MZDA	041-0589	GP-40	BEK	041-8056	GP-3985	BEK
0000-23-0370	GP-91	MZDA	026-127-177B	GG-262	VOLK	041-0597	GP-28	BEK	041-8058	GP-3569	BEK
000-090-12-51	G-1046	MBNZ	026133837A	GAVW-2	VOLK	041-0605	GP-81	BEK	041-8058	GP-3600	BEK
000-090-15-51	G-1046	MBNZ	026133837B	GAVW-2	VOLK	041-0613	GP-1	BEK	041-8059	GP-58	BEK
000-091-511A	GP-81	VOLK	02-7000142	GPP-14	WHIT	041-0639	GP-149	BEK	041-8060	GP-22	BEK
000-1024-V-001	GA-2136	SMRT	02-7000615	GA-361	WHIT	041-0639	GP-40	BEK	041-8062	GP-149	BEK
000-3123-V-007	GA-2136	SMRT	02-7009245	GP-1108	WHIT	041-0639	GP-91	BEK	041-8062	GP-91	BEK
000-3124-V-001	GA-2136	SMRT	02-7013005	GP-1101	WHIT	041-0647	GP-1	BEK	041-8063	GP-46	BEK
000-4591-V-001	GA-2136	SMRT	027-05420	GAK-16	LSTR	041-0670	GP-157	BEK	041-8064	GP-149	BEK
000-6731-F	G-200	FORD	027-05421	GAK-403	LSTR	041-0688	GP-3531 EXP	BEK	041-8065	GP-157	BEK
000-6731-G	GP-20	FORD	02-7070278	GA-27	WHIT	041-0696	GP-81	BEK	041-8066	GP-157	BEK
000-6731-G	GP-5	FORD	02-707198	GP-27	WHIT	041-0697	GP-22	BEK	041-8070	GP-22	BEK
0006A	GAK-16	BOG	02-7073723	GP-2071W	WHIT	041-0698	GP-28	BEK	041-8072	GP-212	BEK
000-9997-V-001	GA-2136	SMRT	02-7073724	GP-1010Q	WHIT	041-0699	GP-28	BEK	041-8074	GP-91	BEK
00120-97262	GP-81	YALE	02-7073989	G-500	WHIT	041-0703	GP-1	BEK	041-8075	GP-149	BEK
00130-00011	GA-3566	TOYO	02-7073991	G-750	WHIT	041-0703	GP-81	BEK	041-8076	GP-91	BEK
001-ELE-01	G-296	FRIG	02-7074037	GP-2071W	WHIT	041-0704	GP-28	BEK	041-8077	GP-58	BEK
001-ELE-01	G-296-B	FRIG	02-7074038	GP-1010Q	WHIT	041-0706	GP-149	BEK	041-8078	GP-157	BEK
002-477-26-01	GG-431	CHRY	02-7074039	GP-2071W	WHIT	041-0706	GP-40	BEK	041-8079	GP-3985	BEK
002-477-26-01	GG-431	MBNZ	02-7074164	GA-360	WHIT	041-0706	GP-91	BEK	041-8093	GP-28	BEK
002-477-27-01	GG-431	CHRY	02-7074452	GA-26	WHIT	041-0707	GP-3985	BEK	041-8098	GP-81	BEK
002-477-27-01	GG-431	MBNZ	02-7074454	GA-27	WHIT	041-0708	GP-28	BEK	041-8100	GP-81	BEK
002-477-28-01	GG-431	CHRY	02-7074457	GA-31	WHIT	041-0709	GP-3816	BEK	041-8134	GP-1	BEK
002-477-28-01	GG-431	MBNZ	02-7074458	GAK-360	WHIT	041-0710	GP-3985	BEK	041-8135	GP-149	BEK
002-477-30-01	GG-420	CHRY	02-7074467	GA-885	WHIT	041-0711	GP-3985	BEK	041-8136	GP-91	BEK
002-477-30-01	GG-420	MBNZ	02-7074819	GA-26	WHIT	041-0712	GP-28	BEK	041-8139	GP-3569	BEK
002-477-31-01	GG-420	CHRY	02-7075128	GA-6129	WHIT	041-0714	GP-28	BEK	041-8141	GP-1	BEK
002-477-31-01	GG-420	MBNZ	02-7075224	GA-26	WHIT	041-0718	GP-1	BEK	041-8142	GP-452	BEK
002-477-31-01	GG-420	CHRY	02-7076194	GA-26	WHIT	041-0718	GP-3569	BEK	041-8143	GP-28	BEK
002-477-39-01	GG-411	CHRY	02-7076198	GP-27	WHIT	041-0719	GP-3985	BEK	041-8158	GP-3569	BEK
002-477-39-01	GG-411	MBNZ	02-7076199	GP-26	WHIT	041-0720	GP-149	BEK	041-8190	G-912	BEK
003 094 68 04	GA-2184	CHRY	02-7076750	G-750	WHIT	041-0720	GP-91	BEK	041-8681	GP-46	BEK
003 094 68 04	GA-2184	MBNZ	02-7077318	GA-378	WHIT	041-0722	GP-28	BEK	041-8707	GP-149	BEK
003 094 83 04	GA-2175	MBNZ	02-7077520	GP-1010Q	WHIT	041-0730	GP-1	BEK	041-8707	GP-40	BEK
003 094 83 04 67	GA-5876	MBNZ	02-7077521	GP-1010Q	WHIT	041-0735	GP-28	BEK	041-8707	GP-91	BEK
003 094 8304	GA-5876	MBNZ	02-7077522	GP-2015W	WHIT	041-0736	GP-3985	BEK	041-8715	GP-40	BEK
003 094 8304 6	GA-5876	MBNZ	02-7077554	GA-229	WHIT	041-0737	GP-1	BEK	041-8723	GP-28	BEK
004-094-16-04	GA-2179	CHRY	02-7087462	GA-31	WHIT	041-0738	GP-40	BEK	041-8731	GP-28	BEK
004-094-16-04	GA-2179	MBNZ	02-7088230	GP-1	WHIT	041-0739	GP-3985	BEK	041-8731	GP-81	BEK
004PS-253	GAK-403	CHIC	02-7088627	GA-885	WHIT	041-0739	GP-40	BEK	041-8749	GP-81	BEK
004PS-254	GA-5648	CHIC	02-7088752	GA-31	WHIT	041-0743	GP-81	BEK	041-8756	GP-1	BEK
005PS-2690	GAK-20	CHIC	02-7090093	GA-31	WHIT	041-0744	GP-81	BEK	041-8764	GP-28	BEK
00A-115-466	G-971	VAG	02-7090278	GP-27	WHIT	041-0749	GP-149	BEK	041-8772	GP-28	BEK
00V26199	GP-2015W	NEWH	02-7090917	GP-1010Q	WHIT	041-0749	GP-91	BEK	041-8798	GP-157	BEK
00V26199	GP-2015W	VERS	02-7101209	GA-6129	WHIT	041-0750	GP-157	BEK	041-8798	GP-3816	BEK
01/01/3976	GP-178	PARM	02-7101701	GA-26	WHIT	041-0751	GP-58	BEK	041-8806	GP-22	BEK
01/03/3747	GG-408	PARM	02-7111480	GA-27	WHIT	041-0752	GP-3985	BEK	041-8814	GP-81	BEK
01/04/8095	GG-408	IPS	02-7118239	GP-1013Q	WHIT	041-0752	GP-40	BEK	041-8822	GP-157	BEK
01/04/8097	GG-408	IPS	02-7122218	GA-26	WHIT	041-0753	GP-91	BEK	041-8855	GP-50	BEK
01/04/8129	GG-408	IPS	027-133-843	GA-277	VOLK	041-0754	GP-149	BEK	041-8889	GP-81	BEK
010070-AB	G-31	CASE	028-115-561E	GP-1	VOLK	041-0754	GP-91	BEK	041-8921	G-870	BEK
010071-AB	G-31	CASE	030115561D	GP-28	VOLK	041-0755	GP-149	BEK	041-8970	GP-81	BEK
010283-AB	G-1174	CASE	030-115-561T	GP-428	VOLK	041-0758	GP-157	BEK	041-8988	GP-157	BEK
01-1020	G-225	THER	0305-23-603	GA-2740	MZDA	041-0759	GP-157	BEK	041-8988	GP-58	BEK
0110281-11	GA-356	PERL	0324-14-300	GP-40	MZDA	041-0760	GP-40	BEK	041-8996	GP-3600	BEK
0110281-7	GA-357	PERL	0324-23-802	GP-149	MZDA	041-0765	GP-58	BEK	042-0018	GA-3300	BEK
0128889-1A	GP-81	LEYL	0324-23-802	GP-91	MZDA	041-0766	GP-58	BEK	042-0299	GAVW-4	BEK
0130-00011	GA-3566	TOYO	0326483T	GA-33	HYST	041-0767	GP-157	BEK	042-0323	GA-277	BEK
0154451-A	G-31	WAUK	034115561A	GP-28 ⁹	VAG	041-0768	GP-91	BEK	042-0349	GA-2740	BEK
02/910970	GP-178	JCBM	034115561A	GP-430 ⁹	VAG	041-0769	GP-149	BEK	042-0406	GA-200	BEK
021-115-351A	GP-81	VOLK	034115561A	GP-28 ⁹	VOLK	041-0772	GP-28	BEK	042-0471	GAD-1	BEK
021-115-561B	G-112	VOLK	034115561A	GP-430 ⁹	VOLK	041-0774	GP-58	BEK	042-0596	GA-71	BEK
021-115-562A	G-112	VOLK	03415561A	GP-28	VOLK	041-0776	GP-1	BEK	042-0620	GA-303	BEK
021-115-562B	G-112	VOLK	0346610-C	GAK-16	HERC	041-0777	GP-28	BEK	042-0646	GA-3300	BEK
021116351A	GP-81	VOLK	0346610-CS	GAK-16	HERC	041-0778	GP-149	BEK	042-0711	GA-56	BEK
021-129-620	GAVW-4	VOLK	035-115-561	GP-28	VOLK	041-0778	GP-91	BEK	042-0778	GA-349	BEK
021129620D	GAVW-4	VOLK	035-115-591	GP-3816	VOLK	041-0779	GP-28	BEK	042-0786	GA-2740	BEK
0222-14-300	GP-42	MZDA	035-133-843	GAVW-2	VOLK	041-0780	GP-157	BEK	042-0794	GA-70	BEK
02250118-495	GPP-425	SULL	036 129 620	GAVW-623	VOLK	041-0788	GP-171	BEK	042-0810	GA-4303	BEK
			036 129 620D	GAVW-623	VOLK	041-0789	GP-149	BEK	042-0828	GA-349	BEK
			036-4464	GP-1	CATP	041-0792	GP-28	BEK	042-0828	GA-75	BEK
			0370-23-802	GP-149	MZDA	041-0795	GP-58	BEK	042-0885	GA-70	BEK
			0370-23-802	GP-91	MZDA	041-0796	GP-46	BEK	042-0919	GAD-1	BEK
			0370-23-803	GP-40	MZDA	041					

Referencia Cruzada por Numero de Parte

Cross Reference by Part Number



Numero	Gonher	Fabricante	Numero	Gonher	Fabricante	Numero	Gonher	Fabricante	Numero	Gonher	Fabricante
Number	Gonher	Manufacturer	Number	Gonher	Manufacturer	Number	Gonher	Manufacturer	Number	Gonher	Manufacturer
042-1255	GA-2740	BEK	0-450-905-403	GG-246	BOG	0-457-429-808	GAD-1	BOG	071 115 562	G-466	PORS
042-1263	GA-2740	BEK	0-450-905-405	GG-189	BOG	04781452AA	GP-3600	CHRY	071 115 562	G-466	VOLK
042-1297	GA-3566	BEK	0-450-905-603	GG-189	BOG	04781452BB	GP-3600	CHRY	071 115 562A	G-466	AUDI
042-1297	GAD-1	BEK	0-450-905-604	GG-189	BOG	04861480AA	GA-248	CHRY	071 115 562A	G-466	PORS
042-1305	GA-140	BEK	0-450-905-916	GG-160	BOG	04864442AB	GA-240	CHRY	071 115 562A	G-466	VOLK
042-1313	GAVW-4	BEK	0-451-102-001	GP-3816	BOG	04884899AB	GP-68	CHRY	071 115 562B	G-466	AUDI
042-1321	GA-349	BEK	0-451-102-001	GP-58	BOG	04884899AB	GP-68	MOP	071 115 562B	G-466	PORS
042-1339	GA-3490	BEK	0-451-102-002	GP-81	BOG	04884900AB	GP-406	MOP	071 115 562B	G-466	VOLK
042-1347	GA-2740	BEK	0-451-103-001	GP-81	BOG	04891097AA	GA-278R	CHRY	0727-23-820	G-834	MZDA
042-1348	GA-3566	BEK	0-451-103-002	GP-81	BOG	04891176AA	GA-258	CHRY	0727-23-820A	G-834	MZDA
042-1351	GAVW-4	BEK	0-451-103-003	GP-81	BOG	04891691AA	GA-492	CHRY	0727-23-821A	G-834	MZDA
042-1-371	GA-33	BLKW	0-451-103-004	GP-58	BOG	04891694AA	GA-489	CHRY	074-129-620	GAVW-626	VOLK
042-1399	GA-4958	BEK	0-451-103-006	GP-81	BOG	04891713AA	GA-248	CHRY	0746-222	GAK-403	FAUN
042-1433	GA-390	BEK	0-451-103-007	GP-1	BOG	04891916AA	GA-248	CHRY	0746-233	GAK-20	FAUN
042-1448	GA-142	BEK	0-451-103-008	GP-81	BOG	04892339AA	GP-406	MOP	0746-305	GA-26	FAUN
042-1466	GA-382	BEK	0-451-103-011	GP-81	BOG	05080244AA	G-180	CHRY	0746-385	GA-356	FAUN
042-1482	GA-215	BEK	0-451-103-011	GP-9	BOG	05083285AA	GP-178	CHRY	0746-385	GA-436	FAUN
042-1493	GA-386	BEK	0-451-103-012	GP-81	BOG	05083285AA	GP-178	MOP	0746-389	GA-467	FAUN
042-1523	GA-322	BEK	0-451-103-013	GP-28	BOG	05097052-AA	GG-420	MOP	0746-760	GP-66	FAUN
042-1524	GA-381	BEK	0-451-103-022	GP-81	BOG	05098424-AA	GA-2161	CHRY	0746-870	GP-57	FAUN
042-1-531	GAK-403	BLKW	0-451-103-022	GP-9	BOG	05183748AA	G-180	CHRY	0746-911	GA-436	FAUN
042-1533	GA-2184	BEK	0-451-103-023	GP-1	BOG	055129620A	GAVW-10	VOLK	0746-916	GA-106 ⁶⁶	FAUN
042-1549	GA-432	BEK	0-451-103-025	GP-81	BOG	059115561A	GP-28	VOLK	0746-916	GA-326 ⁷¹	FAUN
042-1551	GA-2195	BEK	0-451-103-032	GP-37	BOG	059115561B	GP-28	VOLK	0746-920	GP-1122	FAUN
042-1554	GA-514	BEK	0-451-103-033	GP-28	BOG	059-115-561C	GP-28	VOLK	0746-928	GA-467	FAUN
042-1562	GA-2118	BEK	0-451-103-043	GP-3816	BOG	059-129-620	GA-2740	VOLK	0747-075	GAK-625	FAUN
042-1567	GA-434	BEK	0-451-103-044	GP-81	BOG	0595-10	G-871	MNH	075-115-561	GP-1	VOLK
042-1580	GA-384	BEK	0-451-103-044	GP-9	BOG	0595-17	G-870	MNH	077 115 561	GP-452	AUDI
042-1581	GA-384	BEK	0-451-103-046	GP-28	BOG	060-129-620	GA-49	VOLK	077 115 561	GP-452	PORS
042-1668	GAVW-616	BEK	0-451-103-050	GP-3816	BOG	060-999-620	GA-49	VOLK	077 115 561	GP-452	VOLK
042-2015	GAC-6	BEK	0-451-103-057	GP-81	BOG	061-115-561	GP-31	VOLK	077 115 561C	GP-452	AUDI
042-8340	GA-2740	BEK	0-451-103-062	GP-171	BOG	061-198-552	G-296	VOLK	077 115 561C	GP-452	PORS
043-0816	GG-213	BEK	0-451-103-062	GP-81	BOG	061-198-552	G-296-B	VOLK	077 115 561C	GP-452	VOLK
043-0817	GG-408	BEK	0-451-103-074	GP-28	BOG	0626-23-821	G-834	MZDA	077 115 561E	GP-452	AUDI
043-0819	GG-261	BEK	0-451-103-074	GP-3600	BOG	0628-00	G-871	MNH	077 115 561E	GP-452	PORS
043-0821	GG-220	BEK	0-451-103-084	GP-3816	BOG	0636-23-802	G-834	MZDA	077 115 561E	GP-452	VOLK
043-0887	GG-220	BEK	0-451-103-084	GP-81	BOG	0636-23820A	G-834	NISS	077 115 561G	GP-452	AUDI
043-0902	GG-232	BEK	0-451-103-122	GP-81	BOG	0636-23-821	G-834	MZDA	077 115 561G	GP-452	PORS
043-0906	GG-39	BEK	0-451-103-126	GP-81	BOG	0639050-7	GAK-16	ALCH	077 115 561G	GP-452	VOLK
043-0915	GG-148	BEK	0-451-103-136	GP-22	BOG	0644-14-300	GP-42	MZDA	077-115-561-F	G-932	VAG
043-0926	GG-220	BEK	0-451-103-140	GP-46	BOG	0659095-0	GA-360	ALCH	077-115-561-F	G-932	VOLK
043-0937	GG-115	BEK	0-451-103-219	GP-171	BOG	0659095-4	GA-360	ALCH	077-129-620-A	GA-2141	AUDI
043-0939	GG-151	BEK	0-451-103-256	GP-1	BOG	065953-3	GA-106 ⁶⁶	ALCH	077-129-620-A	GA-2141	VAG
043-0940	GG-146	BEK	0-451-103-259	GP-28	BOG	065953-3	GA-326 ⁷¹	ALCH	077-129-620-A	GA-2141	VOLK
043-0951	GG-227	BEK	0-451-103-316	GP-149	BOG	0659533-4	GA-106 ⁶⁶	ALCH	077-129-620-B	GA-2141	AUDI
043-0961	GG-150	BEK	0-451-103-316	GP-91	BOG	0659533-4	GA-326 ⁷¹	ALCH	077-129-620-B	GA-2141	VAG
043-0972	GG-232	BEK	0-451-103-903	GP-81	BOG	0659533-7	GA-106 ⁶⁶	ALCH	077-129-620-B	GA-2141	VOLK
043-0981	GG-247	BEK	0-451-103-903	GP-9	BOG	0659533-7	GA-326 ⁷¹	ALCH	077-129-620-D	GA-2141	AUDI
043-0982	GG-136	BEK	0-451-103-904	GP-28	BOG	0660360-1	GA-360	ALCH	077-129-620-D	GA-2141	VAG
043-0987	GG-220	BEK	0-451-104-001	GP-1	BOG	0660360-9	GA-360	ALCH	077-129-620-D	GA-2141	VOLK
043-0996	GG-164	BEK	0-451-104-002	GP-13	BOG	0662607-1	GA-360	ALCH	077-198-563	G-932	VAG
043-1006	GG-164	BEK	0-451-104-002	GP-205	BOG	0664577-00	GAK-16	YALE	0776-773	GP-66	FAUN
043-1009	GG-146	BEK	0-451-104-003	GP-1	BOG	0664578-00	GA-33	YALE	0778-23-802	GP-42	MZDA
043-1015	GG-164	BEK	0-451-104-004	GP-36	BOG	068 115 561	GP-3569	AUDI	078115561B	GP-1	VOLK
044-094-16-04	GA-2179	CHRY	0-451-104-005	GP-14	BOG	068 115 561	GP-3569	PORS	078-115-561D	GP-1	VOLK
044-094-16-04	GA-2179	MBNZ	0-451-104-004	GP-205	BOG	068 115 561	GP-3569	VOLK	078-115-561J	GP-81	VOLK
045 115 466	G-466	AUDI	0-451-104-064	GP-3	BOG	068 115 561B	GP-3569	AUDI	078-115-561K	GP-28	VOLK
045 115 466	G-466	PORS	0-451-104-065	GP-1	BOG	068 115 561B	GP-3569	PORS	078-115-561-K	GP-430	VAG
045 115 466	G-466	VOLK	0-451-104-066	GP-36	BOG	068 115 561B	GP-3569	VOLK	0794-007	GA-27	FAUN
045 115 466A	G-466	AUDI	0-451-104-066	GP-66	BOG	068 115 561E	GP-3569	AUDI	0794-367	G-31	FAUN
045 115 466A	G-466	PORS	0-451-105-001	GP-54	BOG	068 115 561E	GP-3569	PORS	07K 129 620	GAVW-625	AUDI
045 115 466A	G-466	VOLK	0-451-105-067	GP-54	BOG	068 115 561E	GP-3569	PORS	07K 129 620	GAVW-625	PORS
0-450-203-010	GP-31	BOG	0-451-105-067	GP-66	BOG	0681-08130	GP-20	CRIS	07K-129-620	GAVW-625	VOLK
0-450-903-003	GG-5 L	BOG	0-451-105-182	GP-54	BOG	06-811-5561	GP-3569	LIN	0801096-00	G-330	YALE
0-450-904-061	GG-5 L	BOG	0-451-105-182	GP-66	BOG	068-115-561	GP-1	VOLK	0809496-00	G-236	YALE
0-450-905-004	GG-189	BOG	0-451-105-188	GP-54	BOG	068115561A	GP-1	VOLK	0813-23-802A	GP-40	MZDA
0-450-905-009	GG-246	BOG	0-451-105-188	GP-66	BOG	068-115-561C	GP-1	VOLK	0813-23-802B	GP-40	MZDA
0-450-905-010	GG-246	BOG	0-451-202-001	GP-50	BOG	068-127-177	GPP-1122	VOLK	08152AB	G-1163	BAKR
0-450-905-021	GG-246	BOG	0-451-202-055	GP-37	BOG	068127177B	GP-1122	VOLK	0837-23-672	GA-70	MZDA
0-450-905-025	GG-246	BOG	0-451-202-055	GP-50	BOG	068-127-177B	GPP-1122	VOLK	0839-14-300	GP-40	MZDA
0-450-905-027	GG-246	BOG	0-451-203-001	GP-31	BOG	068-127-401	GPP-1122	VOLK	0839-23-672	GA-70	MZDA
0-450-905-030	GG-251	BOG	0-451-203-002	GP-54	BOG	068129620A	GAVW-2	VOLK	0855-23-802	GP-40	MZDA
0-450-905-031	GG-251	BOG	0-451-203-006	GP-81	BOG	0684733-9	GA-360	ALCH	0866-23-803	GP-40	MZDA
0-450-905-032	GG-246	BOG	0-451-203-008	GP-1	BOG	069 115 561	GP-3569	AUDI	0892-02001	GP-157	TOYO
0-450-905-033	GG-251	BOG	0-451-203-009	GP-1	BOG	069 115 561	GP-3569	PORS	0892-02002	GP-157	TOYO
0-450-905-063	GG-251	BOG	0-451-203-010	GP-31	BOG	069 115 561	GP-3569	VOLK	0892-02004	GP-58	TOYO
0-450-905-064	GG-246	BOG	0-451-203-011	GP-81	BOG	069-115-561	GP-1	VOLK	0892-02005	GP-157	TOYO
0-450-905-065	GG-246	BOG	0-451-203-012	GP-1	BOG	069-129-620	GAVW-2	VOLK	0892-02010	GP-58	TOYO
0-450-905-067	GG-246	BOG	0-451-203-061	GP-1	BOG	06A-115-561	GP-430	VAG	0892-02011	GP-58	TOYO
0-450-905-079	GG-246	BOG	0-451-203-081	GP-20	BOG	06A-115-561	GP-28	VOLK	09-020	GA-106 ⁶⁶	STEI
0-450-905-087	GG-246	BOG	0-451-203-081	GP-5	BOG	06A-115-561B	GP-28	VOLK	09-020	GA-326	

Numero	Gonher	Fabricante	Numero	Gonher	Fabricante	Numero	Gonher	Fabricante	Numero	Gonher	Fabricante
Number	Gonher	Manufacturer	Number	Gonher	Manufacturer	Number	Gonher	Manufacturer	Number	Gonher	Manufacturer
0-986-450-119	GG-46	BOG	10-00389	GP-430 ⁸	VERA	1002065	GP-52 ¹⁰	DRIL	101011	GA-1286	OREN
0-986-450-135	GG-986	BOG	100-040	GA-7	STES	1002065	GP-691 ⁸	DRIL	10102	GA-360	ERO
0-986-452-005	GP-81	BOG	10-00454	G-162H	VERA	1002162-A	GA-26	WHIT	101035	GA-403	OREN
0-986-452-007	GP-149	BOG	10-00462	GP-40	VERA	10028	GA-49	ERO	101035	GAK-403	OREN
0-986-452-009	GP-42	BOG	10005140	GA-879	SICA	100280020	GA-6129	SHIN	101039A	GA-360	OREN
0-986-452-015	GP-3531	EXP	10-00587	G-834	VERA	100280030	GA-6127	SHIN	101045	GA-33	OREN
0-986-452-016	GP-40	BOG	10006	GP-3	SCHM	1002879	GA-26	WHIT	10-105	GP-1101	UNI
0-986-452-017	GP-157	BOG	10-00611	G-834	VERA	10029	G-1174	WITT	101054	GA-6127	OREN
0-986-452-017	GP-58	BOG	10-00694	G-871	VERA	1002984	GP-1	INTM	101056	GA-6129	OREN
0-986-452-020	GP-40	BOG	10-00702	G-870	VERA	10034G1	GG-1	ENCA	101058	GA-361	OREN
0-986-452-023	GP-37	BOG	10-00710	G-870	VERA	10034G1	GG-4	ENCA	101068	GA-206	OREN
0-986-452-024	GP-171	BOG	10-00710	G-871	VERA	10034G1	GG-5	L EZGO	101072	GA-356	OREN
0-986-452-024	GP-81	BOG	100-073	GA-42	STES	1003879	G-1174	MASY	101076	GA-483	OREN
0-986-452-028	GP-157	BOG	10-00744	G-871	VERA	1004	GA-403	AMP	101078	GA-7716	OREN
0-986-452-036	GP-149	BOG	10-00777	G-870	VERA	1004	GAK-403	AMP	101084	GA-357	OREN
0-986-452-041	GP-40	BOG	10-00793	G-870	VERA	1004	GA-403	BGA	10119577	GG-177	GMCX
0-986-452-044	GP-58	BOG	10007-A6	G-750	DIAM	1004	GAK-403	BGA	101222	GA-16	NEL
0-986-452-061	GP-91	BOG	10007-A6	G-750	WHIT	1004	G-6	NAP	101222	GAK-16	NEL
0-986-452-903	GP-81	BOG	10008	GA-405	ERO	10042	GA-467	ERO	101234	GA-20	NEL
0-986-452-908	GP-40	BOG	10-00819	GP-81	VERA	1004421-3	GA-403	ALCH	101234	GAK-20	NEL
0-986-452-909	GP-42	BOG	10-00819	GP-9	VERA	1004421-3	GAK-403	ALCH	101237	GA-24	NEL
0986B03003	GA-864R	BOG	10-00827	GP-81	VERA	100462	GP-66	CHAM	101240	GA-27	NEL
0-987-452-904	GP-28	BOG	10-00827	GP-9	VERA	10-0462	GP-40	VERA	101243	GA-26 ¹²	NEL
0-987-452-909	GP-42	BOG	10-00835	GP-46	VERA	1004652	GA-403	ALCH	101246	GA-403	NEL
099-105-0	G-1121	CLAA	10-00843	G-871	VERA	1004652	GAK-403	ALCH	101246	GAK-403	NEL
OFRS60X25M	GP-34	VICK	10-00876	GP-22	VERA	1004652	GA-403	FIAT	101253	GA-44	BAKR
OK201-13-Z00	GA-434	KIA	10-00884	GP-22	VERA	1004652	GAK-403	FIAT	101254	GP-50	BAKR
OK201-20-490	GG-150	KIA	10-00918	GP-40	VERA	1004652-2	GA-403	ALCH	101275	GA-33	NEL
OK2A5-13-Z40A	GA-304	KIA	10-00926	GP-58	VERA	1004652-2	GAK-403	ALCH	10127F	GP-81	HAYD
			10-00942	GP-46	VERA	10048	GA-11	LAUS	10127F	GP-9	HAYD
			10-00960	GP-36	PBLT	10048	GA-11	TECU	1013	G-1173	COM
			1000965	GA-206	PBLT	100-48	GA-11	LAWN	1013121-M91	G-870	MASY
			1000965	GA-206	PERL	1004891M1	G-31	MASY	10133	GP-28 ⁶	IPD
			1000967	GA-106 ⁶	PERL	1004891M91	G-31	MASY	10133	GP-430 ⁸	IPD
			1000967	GA-326 ⁷¹	PERL	1004894M1	G-31	MASY	10138	G-834	IPD
			10-00967	GP-310	VERA	1004894M91	G-31	MASY	1013891M1	G-296	MASY
			10-00983	GP-3682	VERA	1004894M92	G-31	MASY	1013891M1	G-296-B	MASY
			10-00983	GP-37	VERA	1004895	G-31	MASY	10140514	GG-256	GMCX
			10-00991	GP-171	VERA	1004895M1	G-31	MASY	10141	G-834	IPD
			1000FE	GS-2033	RAR	1004895M2	G-31	MASY	1014120	GP-3600	ALCH
			1000FG	GS-2033	RAR	1004895M91	G-31	MASY	1014120-8	GP-3600	ALCH
			1000FH	GS-2033	RAR	1005069-8	G-296	ALCH	1014308C1	GP-42	HICO
			1000MA	GS-2033	RAR	1005069-8	G-296-B	ALCH	10149549	G-294	GMCX
			1001	G-133	CRO	1005078-8	G-296	ALCH	1015	GA-3300	AMP
			1001	G-989	CRO	1005078-8	G-296-B	ALCH	1015	GA-3300	BGA
			1001	GP-81	HAYD	1005078-9	G-296	ALCH	1015	GP-1	NAP
			1001	GP-9	HAYD	1005078-9	G-296-B	ALCH	1015426	GA-3916	CLUB
			10-01006	GP-38	VERA	1005365	GA-403	ALCH	1015511M91	GP-81	MASY
			10-01063	GP-3985	VERA	1005365	GAK-403	ALCH	1015511M91	GP-9	MASY
			10-01071	GP-3985	VERA	1005435M1	G-1173	MASY	1015511M92	GP-81	MASY
			10011	GA-106 ⁶	ERO	1005435M91	G-1173	MASY	1015511M92	GP-9	MASY
			10011	GA-326 ⁷¹	ERO	1005511M91	GP-81	MASY	1015511M91	GP-81	MASY
			10-01105	GP-3569	VERA	1005511M91	GP-9	MASY	1015511M91	GP-9	MASY
			10-01105	GP-3816	VERA	100-5593	GPP-419	CATP	1015561	GA-24	WHIT
			10-01113	GP-3985	VERA	10057778	GA-16	GENC	1015713M91	G-31	MASY
			10-01139	GP-3985	VERA	10057778	GAK-16	GENC	1015840	G-1174	MASY
			10-01147	GP-28 ⁸	VERA	10059	GA-7	LAUS	1015840M1	G-1174	MASY
			10-01147	GP-430 ⁸	VERA	10059	GA-7	TECU	1015840M1	G-1174	NISS
			10-01154	GP-462	VERA	100-59	GA-7	LAWN	1015840M91	G-1174	MASY
			100116	GP-77	JENB	1006	G-200	JCP	1016	GP-1	NAP
			10-01-195	G-25	ASKA	10060	GA-12	KOHL	101606	G-836	PERK
			10-01246	GP-3569	VERA	10060	GA-12	LAUS	101617	G-222	TIMB
			10-01261	GP-22	VERA	10060	GA-12	TECU	1016467	GP-157	CLUB
			10-01287	GA-40	VERA	100-60	GA-12	LAWN	10165197	GA-20	FWDX
			10013	GP-3816	IPD	100620	GP-66	TIMB	10165197	GAK-20	FWDX
			100130	G-31	CUMM	100-6374	GPP-425	CATP	101679	G-750	CUMM
			10-01303	GP-91	VERA	10065641	GG-256	GMCX	101679	G-750	DIAM
			100-131	GA-6	STES	100696A	GA-135	MIDL	101679	G-750	EMCO
			10-01311	GP-462	VERA	1007	GA-376	AMP	101679	G-750	WAUK
			10-01337	GP-2951	VERA	1007	GA-376	BGA	10170	G-1175	WITT
			10-01337	GP-58	VERA	10070AB	G-31	CASE	10171	G-1174	WITT
			10-01352	GP-2951	VERA	10071-AB	G-31	CASE	101713	G-31	CLRK
			10-01352	GP-58	VERA	100783	GA-135	BENX	101713	G-31	WAUK
			10-01394	GP-157	VERA	1008	GA-7360	AMP	101731	G-31	WAUK
			10-01402	GP-2951	VERA	1008	GA-7360	BGA	101737	G-31	CLRK
			10-01402	GP-58	VERA	1008	GP-5	JCP	101737	G-31	DUPX
			10-01451	G-816	VERA	10087	GA-239	ERO	101737	G-31	WAUK
			10-01469	GP-2951	VERA	10088	GA-329	ERO	101737A	G-31	WAUK
			10-01469	GP-58	VERA	1009064	G-31	MASY	10175478	GA-37	FWDX
			10015	GA-356	ERO	1009064M91	G-31	MASY	10175479	GA-37	FWDX
			10-01568	GP-28 ⁸	VERA	1009111A	G-1175	WITT	10175526	GA-26	FWDX
			10-01568	GP-430 ⁸	VERA	10091780	GG-580	GMCX	10175548	GA-26 ¹²	FWDX
			10-01600	GP-462	VERA	1009271	G-1143	WHIT	10175562	GA-26	FWDX
			10-016-18	GP-157	VERA	10093250	GG-177	GMCX	10175568	GA-24	FWDX
			10-01626	GP-156	VERA	100964M91	G-31	MASY	10175588	GA-360	FWDX
			1001653	G-816	LANS	10097	GA-31	ERO	10175594	GA-106 ⁶	FWDX
			10-01659	GP-212	VERA	100CP2206	G-162H	LEVL	10175594	GA-326 ⁷¹	FWDX
			10-01675	GP-28 ⁸	VERA	100X49	GA-24	CLIM	10175603	GA-206	FWDX
			10-01675	GP-430 ⁸	VERA	100X50	GA-27	CLIM	1018121	G-870	MASY
			10-01691	GP-46	VERA	101	G-870	CRO	1018121M91	G-870	MASY
			10-01709	GP-91	VERA	101	GP-1	PROT	101855	G-750	CUMM
			10-01733	GP-91	VERA	101	GP-1	SAK	1019	GP-81	JCP
			10018	GA-6129	ERO	101	GA-57	WIX	1019	GP-9	JCP
			1001894M1	G-31	MASY	10100-01	GP-1	TOYO	1019347M1	GA-70	MASY
			1002	GP-81	HAYD	101-00-0631700D	G-871	ALFA	101948	G-152	TIMB
			1002	GP-9	HAYD	101008	GA-9334	OREN	101963	G-870	LEVL

1

Números Nuevos

1 451 103 366	GP-112	BOG
1 457 429 284	G-25	BOG
1 457 433 227	GA-2160	BOG
1 457 433 325	GA-2184	BOG
1 457 433 424	GA-2160	BOG
1 457 433 424-48N	GA-2160	BOG
1 457 433 795	GA-410	BOG
1 987 429 190	GAVW-616	BOG
1.052.175.136	GP-291	LOMB
1.072.175.107	GP-291	LOMB
1.072.175.117	GP-291	LOMB
1.152.175.136	GP-291	LOMB
10	GP-13	WIX
1000	GP-1	JCP
1000000	GP-66	CONT
1000000	GP-66	TELE
10000018	GA-26	KENW
10000025	GA-33	KALA
10000041	GA-16	KALA
10000041	GAK-16	KALA
10-000-041379	GA-403	CRON
10-000-041379	GAK-403	CRON
10-00017	GP-24 ²⁶	VERA
10-00017	GP-462	VERA
10-00041	GP-81	VERA
10-00041	GP-9	VERA
10-00074	GP-1	VERA
10-00082	GP-81	VERA
10-00082	GP-9	VERA
10-00108	GP-28 ⁸	VERA
10-00108	GP-430 ⁸	VERA
10-00116	GP-3531	EXP
10-00124	GP-42	VERA
10-00132	GP-310	VERA
10-00140	G-870	VERA
10002	GA-360	ERO
10002280	GA-26	KENW
10-00231	GP-81	VERA
10-00256	GP-1	VERA
10-00272	GP-20	VERA
10-00280	GP-1	VER

Referencia Cruzada por Numero de Parte

Cross Reference by Part Number



Numero	Gonher	Fabricante	Numero	Gonher	Fabricante	Numero	Gonher	Fabricante	Numero	Gonher	Fabricante
Number	Gonher	Manufacturer	Number	Gonher	Manufacturer	Number	Gonher	Manufacturer	Number	Gonher	Manufacturer
101963	G-870	STAM	102623	G-296	OREN	103258	GA-106 ⁹⁸	GALN	104071001	GP-390	VERM
101962	G-870	STAN	102623	G-296-B	OREN	103258	GA-326 ⁷¹	GALN	1040764M91	GAK-1532	MASY
10196H2	GA-27	DIAM	102625	GP-1101	OREN	103259	GA-206	GALN	1040830M1	GA-360	MASY
10196H2	GA-27	DIGT	102649	GP-1122	OREN	103259	GA-206	KOMA	1040830M91	GA-360	MASY
10196H2	GA-27	REOT	102660F	GA-357	PERL	103261R91	G-31	IHCO	1040919M1	GA-361	MASY
10196H2	GA-27	WHIT	1027028	GAK-16	GRAD	10326R91	G-31	IHCO	1040919M91	GA-361	MASY
10198H2	GA-31	DIAM	102713	GA-16	GALN	103-2977	GP-54	CATP	1040MP	GP-46	NAP
10198H2	GA-31	DIGT	102713	GAK-16	GALN	1033	GAP-379	AMP	1041	GG-19	JCP
10198H2	GA-31	REOT	10272331	GP-3985	LNCR	1033	GAP-379	BGA	1041	GP-44	NAP
10198H2	GA-31	WHIT	1027460	GP-66	ELGN	1033	G-971	CRO	1041175M1	GA-7	MASY
101MP	GP-1	PROT	1027804	GAK-403	GRAD	103318-M91	GP-66	MASY	104-1296	GPP-111	CATP
102	GP-3	PROT	1027937	GA-361	GRAD	103-3229	GA-16	CATP	104-1296	GPP-524	CATP
102	GP-5	PROT	1028	GA-416	AMP	103-3229	GAK-16	CATP	104-1426	GP-149	CATP
1020	GP-3	SAK	1028	GA-416	BGA	1033318-M91	GP-66	MASY	1041427001	G-870	LIN
102058	GA-20	WEAT	1028103	GA-20	REXN	1033356-M1	GP-66	MASY	1041429	GP-81	MASY
102058	GAK-20	WEAT	1028103	GAK-20	REXN	103344	GAK-625	VERS	1041429	GP-9	MASY
102074	GA-403	WEAT	10281032	GA-26	CHAI	103-3496	GA-403	CATP	1041429M1	GP-81	MASY
102074	GAK-403	WEAT	10281032	GA-20	REXN	103-3496	GAK-403	CATP	1041429M1	GP-9	MASY
1020817	GA-16	REXN	10281032	GAK-20	REXN	103356-M1	GP-66	MASY	104146	GA-6129	ASTR
1020817	GAK-16	REXN	10281770	GA-16	REXN	1034	G-112	CRO	104147	GA-206	ASTR
1020817701	GA-16	REXN	10281770	GAK-16	REXN	1034	GP-3600	NAP	104159-A	G-1174	WHIT
1020817701	GAK-16	REXN	102817701	GA-16	REXN	1034065M91	GP-31	MASY	104170	GA-16	BAKR
1020953030	GA-251	REXN	102817701	GAK-16	REXN	1034065M92	GP-31	MASY	104170	GAK-16	BAKR
1020EO	GS-2033	RAR	10281780	GA-403	REXN	1034214M91	GA-7	MASY	104170	GA-16	OTIS
1021	G-238	CRO	10281780	GAK-403	REXN	103443	GA-135	BUCY	104170	GAK-16	OTIS
1021	GP-20	JCP	102819	GP-81	WHEL	10349827	GP-81	INGR	104-180-01-09	G-971	CHRY
1021	G-31	NAP	102819	GP-9	WHEL	10349827	GP-9	INGR	104-180-01-09	G-971	MBNZ
1021006610	GA-6129	REXN	10282100	GA-27	REXN	10349868	GA-33	INGR	1041-800109	G-971	SSYO
1021006611	GA-6127	REXN	102821003	GA-27	REXN	1035	G-984	CRO	104-184-02-25	G-971	CHRY
102111	G-31	BLDW	10282103	GA-27	CHAI	10351258	GA-6479 ⁹⁰	GMCX	104-184-02-25	G-971	MBNZ
102111	G-31	WAUK	10282103	GA-27	REXN	1035278	G-870	LANS	104-184-03-25	G-971	CHRY
1021238004	GP-9	BORR	1028281M1	G-236	MASY	1035337	G-296	LANS	104-184-03-25	G-971	MBNZ
102127	GP-66	HUBR	102830460	G-33	REXN	1035337	G-296-B	LANS	104-184-04-25	G-971	CHRY
1021350	G-296	MASY	10283AB	G-1174	CASE	10353985	GP-34	INGR	104-184-04-25	G-971	MBNZ
1021350	G-296-B	MASY	1028646	GAK-20	GRAD	1035485	GP-761H	TRAI	104-184-08-25	G-971	CHRY
1021351	G-296	MASY	1029	GA-229	AMP	10354942	GA-164	GMCX	104-184-08-25	G-971	MBNZ
1021351	G-296-B	MASY	1029	GA-229	BGA	1035591M1	GA-7	MASY	1042	GG-6	JCP
10214	G-31	WITT	10290491	GG-290	GMCX	10355991M91	GA-7	MASY	1042	GP-44	NAP
1021-5-1	G-1174	COM	10291210	GA-24	REXN	1035637	GP-3	MASY	104200830	GP-317H	SAMS
1021731	GA-459	SAME	10292090	GA-20	REXN	1035637M91	GP-3	MASY	1042175104	GP-462	CARO
1021840101	GP-38	MBNZ	10292090	GAK-20	REXN	1035991M91	GA-11	MASY	1042412M91	GAK-625	MASY
1021840201	GP-38	MBNZ	102957	GA-20	HYDA	1036	GP-3980	NAP	10424212M91	GAK-625	MASY
1021840301	GP-38	MBNZ	102957	GAK-20	HYDA	1036064M91	GP-1	MASY	1043939-M91	GP-66	MASY
102189903	GA-26	REXN	102-957	GA-20	DYNA	103629	GA-135	CUMM	104397A	GP-50	AGCO
10218991	GA-26	REXN	102-957	GAK-20	DYNA	103679	GA-135	CUMM	104397A	GP-50	COCT
10218993	GA-26	REXN	10298K1	G-169	DIAM	1036MP	GP-3980 ⁴⁴	NAP	104397A	GP-50	OLIV
102-1899-3	GA-26	CHAI	10298K1	G-169	REOT	1037	GP-46	NAP	104397A	GP-50	WHIT
1022	GA-679	AMP	10298K1	G-169	WHIT	10373	GP-3682	IPD	1044	GG-7	JCP
1022	GA-679	BGA	10299146	GG-299	GMCX	10373	GP-37	IPD	104403	GP-2071W	OREN
10220	GP-462	IPD	102A0036	GA-27	CRAN	10375022	G-31	FWDX	104-403	GA-24	DYNA
10221	GP-212	IPD	102A0113	GA-378	CRAN	10375047	G-1143	FWDX	1044167	GP-66	DRIL
1022145M91	G-236	MASY	102A0131	GA-24	CRAN	1037735M91	GA-892	HANO	1045	GP-3429	NAP
1022567M1	G-1173	MASY	102A114	GA-229	CRAN	1037735M91	GA-892	MASY	104508005	GP-761H	EATN
102260F	GA-357	PERL	102A133	GA-237	CRAN	103801	G-500	OREN	104516	GA-24	BUCY
102264P	GA-356	PERL	102A165	GA-378	CRAN	103804	G-33	OREN	104516	GA-24	DYNA
102-2822	GP-761H	CATP	102A24	GA-26	CRAN	103804001	GP-27	VERM	104516	GA-24	HYDA
102-2828	GP-761H	CATP	102A36	GA-27	CRAN	103808	G-566	OREN	1046	GP-46	NAP
102283M1	G-1173	MASY	102A52	GA-26	CRAN	103816	GP-1	OREN	10462554	GP-761H	PHHR
1023	GA-880	AMP	102A53	GA-26	CRAN	103818	G-152	OREN	1046A523	GA-20	PHHR
1023	GA-880	BGA	102A54	GA-27	CRAN	103820	G-191	OREN	1046A523	GAK-20	PHHR
102327	GA-360	WEAT	102A62	GA-26	CRAN	103823	G-870	OREN	1046A524	GP-92	PHHR
102-3765	GA-758	CATP	102A66	GA-27	CRAN	103833	G-813	OREN	10462102	G-1166	PHHR
102387001	GP-110	VERM	102A67	GA-27	CRAN	103834	G-834	OREN	10462119	G-1175	PHHR
1024	GA-891	AMP	103	GP-5	DEL	103837	G-222	OREN	10462126	G-1173	PHHR
1024	GA-891	BGA	103	GP-20	PROT	103838	G-613	OREN	10462129	G-1173	PHHR
1024280M1	GP-13	MASY	103	GP-200	SAK	103847	GP-51	OREN	10462144	GP-1101	PHHR
1024386M1	G-296	MASY	103004001	GP-178	VERM	10385	GP-171 ¹⁶	IPD	10462167	G-750	PHHR
1024386M1	G-296-B	MASY	1030-0477	G-31	ATCO	103850	GP-53	OREN	10462188	G-33	PHHR
102470A	GA-24	EATN	1030-0882	GP-81	ATCO	103852	GP-14	OREN	10462205	G-566	PHHR
1024947	GA-16	MASY	1030-0882	GP-9	ATCO	103854	GP-52 ¹⁰⁰	OREN	1046221	G-1173	PHHR
1024947	GAK-16	MASY	1030-1068	GP-81	ATCO	103854	GP-691 ⁴⁸	OREN	104622325	GP-92	PHHR
1024947M91	GA-16	MASY	1030-1068	GP-9	ATCO	103856	GP-3600	OREN	104622326	GP-93	PHHR
1024947M91	GAK-16	MASY	1030541M91	GA-403	MASY	103857	GP-1	OREN	10462248	GP-27	PHHR
1025	GA-6880	AMP	1030542M91	GA-403	MASY	103870	G-750	OREN	10462249	GP-26	PHHR
1025	GA-6880	BGA	103059	GAK-403	TIMB	103876	GP-57	OREN	10462283	GA-360	PHHR
1025280	GP-3	MASY	1031	GG-5	JCP	103882	GP-53	OREN	1046229	GP-1101	PHHR
1025280M1	GP-3	MASY	1031337M91	GP-1	MASY	103894	GP-54	OREN	10462293	GA-27	PHHR
1025280M91	GP-13	MASY	103136	GA-403	HYDA	103909	GP-54 ⁴¹	OREN	10462294	GA-135	PHHR
102540V	GA-206	PERL	103136	GAK-403	HYDA	103909	GP-66 ⁴⁰	OREN	10462315	GP-53	PHHR
102542X	GA-106 ⁴⁶	PERL	103-136	GA-403	DYNA	10392H2	GA-31	DIAM	10462329	GA-106 ⁴⁶	PHHR
102542X	GA-326 ⁷¹	PERL	103-136	GAK-403	DYNA	10392H2	GA-31	REOT	10462329	GA-326 ⁷¹	PHHR
1025569M91	GAK-403	MASY	1031436	GA-33	MASY	10392H2	GA-31	WHIT	10462382	GP-1122	PHHR
1025921	G-813	LANS	1031436M91	GA-33	MASY	103948	G-331	OREN	10462389	G-500	PHHR
1025931	G-11816	LANS	103144	GP-3682	EATN	103GAS	GG-1	DEL	1046243	GA-29	PHHR
102599	G-6	HUBR	103144	GP-37	EATN	103GAS	GG-4	DEL	10462459	GP-53	PHHR
102606	G-1174	OREN	103144	GP-3682	YALE	104	GA-39	AMP	10462466	GP-92	PHHR
102607	G-1143	OREN	103144	GP-37	YALE	104	GA-39	BGA	10462467	GP-93	PHHR
1026131	GA-18	MASY	1031855M91	GA-24	MASY	104	GP-81	PROT	1046247	G-1166	PHHR
1026131M91	GA-18	MASY	1031885M91	GA-24	MASY	104	GP-9	PROT	1046249	G-1173	PHHR
1026131M92	GA-18	MASY	1032015	GP-50	MASY	104	G-1173	REF	10462511	GP-1122	PHHR
102614	G-1166	OREN	1								

Numero	Gonher	Fabricante	Numero	Gonher	Fabricante	Numero	Gonher	Fabricante	Numero	Gonher	Fabricante
Number	Gonher	Manufacturer	Number	Gonher	Manufacturer	Number	Gonher	Manufacturer	Number	Gonher	Manufacturer
10462572	GP-178	PHHR	10514-0603004-06	G-870	ALFA	10593	GA-2719B	CAC	1077749M1	GP-3000	MASY
10462573	GP-390	PHHR	105-14-0603004-30	G-870	ALFA	105946216	GA-5648	HANO	1077A12300	GA-24	COMA
10462587	GP-57	PHHR	105-14-0603030	G-870	ALFA	106	G-1121	CRO	1077A12300	GA-24	HOLM
10462591	GAK-403	PHHR	105-14-0604000	G-870	ALFA	106	G-1121F	CRO	107807	GP-1123	SAME
10462591	GAK-403	PHHR	105-14-0604000	G-870	ALFA	106	G-330	DEL	1078A30930	GA-106 ⁴⁶	COMA
10462606	GP-54 ¹¹	PHHR	105-14-0630000	G-870	ALFA	106	GP-310	PROT	1078A30930	GA-326 ⁷¹	COMA
10462606	GAK-16	PHHR	105-14-0630004	G-870	ALFA	106	GP-3	SAK	1078A31300	GA-360	COMA
10462607	GA-16	PHHR	105-14-063005	G-870	ALFA	1060	GA-20	AMP	1078A31300	GA-360	HOLM
10462620	GP-2071W	PHHR	105-14-063006	G-870	ALFA	1060	GAK-20	AMP	107A	GP-1175	REF
10462634	GP-54 ¹¹	PHHR	105-14-0631700	G-870	ALFA	1060	GA-20	BGA	107MP	GP-46	PROT
10462634	GP-66 ¹⁰	PHHR	105-14-0640000	G-870	ALFA	1060	GAK-20	BGA	108	GP-81	DEL
10462635	GP-1011Q	PHHR	1051689-M1	GP-66	MASY	1060	GA-113	HOLY	108	GP-9	DEL
10462639	GP-1122	PHHR	1052	GP-50	NAP	1060	GP-205	NAP	108	G-1175	REF
1046266	GA-39	PHHR	10520	GA-77	CAC	106-00-006030-00	GP-1	ALFA	108	GP-43	SAK
1046268	G-750	PHHR	10521	GA-80	CAC	106-00-0603000	GP-1	ALFA	108046	GP-66	RANS
1046272	GP-14	PHHR	10521	GP-178	CUMM	106-00-0603002	GP-1	ALFA	108046	GP-66	TETR
1046274	GA-44	PHHR	10522	GA-78	CAC	10600-14800	GAD-1	NISS	1080656C	GA-7	AUTT
1046282	G-119	PHHR	105234A	GP-1	OLIV	10601980	G-296	LEYL	1080656D	GA-7	AUTT
1046289	G-238	PHHR	105234A	GP-1	WHIT	10601980	G-296-B	LEYL	1080656D	GA-7	EATN
1046295	G-238	PHHR	10524	GA-85	CAC	1061	GP-13	NAP	1080656D	GA-7	YALE
1046299	G-1175	PHHR	10525	GA-303	CAC	1062	GA-21	AMP	10808724	GP-78	LEYL
1047	G-1143	NAP	105256A5	G-33	COCT	1062099C1	GP-38	CASE	108280	G-31	HYST
104790	G-1175	CUMM	105256A5	G-33	OLIV	1062099-C1	GP-38	IHCO	108323	GP-43	VERS
1049	GP-5	NAP	105256AS	G-33	WHIT	1063	GP-13	NAP	108-3810	GA-880R	TORO
104905	GA-360	HUBR	10526	G-33	WHIT	10630G	GA-26	OSHK	1083A67607	GA-7	THER
104926	G-750	BROK	10526	GA-3300	CAC	106338	G-31	AERO	1083A67G07	GA-7	THER
104926	G-750	CLRK	10527	GA-86	CAC	106387	GP-3600	MANO	1084	GP-81	NAP
104926	G-750	CUMM	10528	GA-349	CAC	106-3969	GA-600R	CATP	1084	GP-9	NAP
104926	G-750	DATT	105286	G-870	STAM	1064	GP-91	NAP	10840993	GA-360	LEYL
104926	G-750	DIAM	105286	G-870	STAN	106467	GPP-1122	MILL	1085	GP-81	NAP
104926	G-750	EMCO	1053	GP-54	AMP	1065	GP-58 ¹⁵	NAP	1085	GP-34	SULL
104926	G-750	KENW	10530	GA-75	CAC	106587	GA-360	NEL	1085666	GP-3985	MANO
104952AS	G-1174	COCT	10534	GA-74	CAC	106621	G-500	CUMM	1085MP	GP-81	NAP
104952AS	G-1174	OLIV	105370	GA-27	HUBR	106622	G-500	CUMM	108614W91	GPP-103 ⁹	MASY
104952AS	G-1174	WHIT	10540	GA-70	CAC	106632	GA-6129	NEL	108614W91	GPP-11 ³⁹	MASY
104976AS	G-1174	OLIV	10541	GA-71	CAC	106641	GA-6127	NEL	108615W1	GPP-103 ⁹	MASY
104976AS	G-1174	WHIT	10543	GA-730	CAC	106769	GA-106 ⁴⁶	NEL	108615W1	GPP-11 ³⁹	MASY
1049939M1	G-296	MASY	105435M91	G-1173	MASY	106769	GA-326 ⁷¹	NEL	1087	GP-68	NAP
1049939M1	G-296-B	MASY	105481A	GA-27	EATN	106775	GA-206	NEL	1087415M91	G-33	MASY
1049939M91	G-296	MASY	105-48-3206101	GG-5 L	ALFA	1068	GP-81	NAP	108775	GG-1	GALN
1049939M91	G-296-B	MASY	105-48-3206102	GG-5 L	ALFA	1068	GP-9	NAP	108775	GG-4	GALN
1049939T91	G-296	MASY	1055	GP-5	NAP	106823	G-1175	CUMM	1087810	GA-20	HANO
1049939T91	G-296-B	MASY	105-50-0408200	G-836	ALFA	106832	GA-37	CUMM	1087810	GAK-20	HANO
105	GP-3429	PROT	105508	GP-3816	MANO	106833	GA-37	CUMM	1087810M91	GA-20	MASY
105	GP-20	SAK	105509	G-152	OREN	106834	GA-361	NEL	1087810M91	GAK-20	MASY
1050	GP-50	NAP	105510	G-222	OREN	106837	GA-37	AUTC	1088	GP-28 ⁶	NAP
10500	GA-56	CAC	1055493M91	GAK-216	MASY	106837	GA-37	CUMM	1088	GP-430 ⁸	NAP
105-00-0603000	GP-1	ALFA	1055494M91	GA-416	MASY	106837	GA-37	IHCO	1088215	GA-16	MASY
105-00-0604000	GPP-426	ALFA	105-55-060300	GP-81	ALFA	1069	GP-3	NAP	1088215	GAK-16	MASY
105-00-0631700	GPP-426	ALFA	105-55-060300	GP-9	ALFA	106-940	GA-27	DYNA	1088215M91	GAK-16	MASY
10-50041	GP-81	VERA	105-55-0603000	GP-81	ALFA	106954	GA-27	HYDA	1088216M91	GA-16	MASY
10-50041	GP-9	VERA	105-55-0603001	GP-81	ALFA	106-954	GA-27	DYNA	1088216M91	GAK-16	MASY
10-50082	GP-81	VERA	105-55-0603002	GP-9	ALFA	1069954M91	GP-50	MASY	1089774M91	GA-106 ⁴⁶	MASY
10-50082	GP-9	VERA	105-55-0603002	GP-81	ALFA	10606	GA-18	UAC	1089774M91	GA-326 ⁷¹	MASY
10501	GA-50	CAC	105-55-0603002	GP-9	ALFA	106-D6	GA-18	UNI	1089937M91	GA-206	JOND
10-50116	GP-3531 EXP	VERA	105-55-0603002	GP-81	ALFA	106D7	GA-18	UAC	1089937M91	GA-206	MASY
10-50132	GP-310	VERA	105-55-060302	GP-9	ALFA	106-D7	GA-18	UNI	1090109M91	GA-360	MASY
10502	GA-55	CAC	1055914M1	GP-53	MASY	107	G-169	DEL	1090204	G-1121	MBNZ
105025	GA-403	EATN	1055915M1	GPP-14	MASY	107	GP-46	PROT	10920234	GP-31	CHRY
105025	GAK-403	EATN	1055915M2	GPP-14	MASY	107	GP-81	SAK	1093060	GP-166 ⁴⁵	TOWM
105025	GA-403	TIMB	1055915M91	GPP-14	MASY	107	GP-9	SAK	1093060	GP-3937 ¹¹	TOWM
105025	GAK-403	TIMB	1055916M1	GP-2071W	MASY	107020	GP-58	UNP	109-0360	GP-166 ⁴⁵	CATP
105025	GA-403	YALE	1055916M91	GAK-625	MASY	1070229M1	GA-106 ⁴⁶	MASY	109-0360	GP-3937 ¹¹	CATP
105025	GAK-403	YALE	1056070M91	GAK-625	MASY	1070229M1	GA-326 ⁷¹	MASY	1090690	G-31	CHRY
10-50322	GP-310	VERA	105615	G-296	MANI	1070230M1	GA-206	MASY	1090707	G-31	CHRY
10-50322	GP-3569	VERA	105615	G-296-B	MANI	107-0266	GA-240	CATP	1090708	G-31	CHRY
10-50355	GP-81	VERA	105615	G-296	MANO	1070329M91	GAK-216	MASY	109155	GA-356	NEL
10-50389	GP-28 ⁸	VERA	105616	G-296-B	MANO	1070756M91	GP-36	MASY	109159	GA-357	NEL
10-50389	GP-430 ⁸	VERA	105616	G-834	MANO	1072175107	GP-291	SROB	1092	GA-26	AMP
10504	GA-59	CAC	105-64-0406001	G-296	ALFA	10722-21400	GA-20	HINO	1092	GA-26	BGA
10-50405	GP-3816	VERA	105-64-0406001	G-296-B	ALFA	10722-21400	GAK-20	HINO	1092170	G-1173	WHIT
1050495	GP-761H	AMHO	105-64-0406001-02	G-296	ALFA	1072417M1	GP-178	MASY	109271	G-1143	WHIT
10505	GA-57	CAC	105-64-0406001-02	G-296-B	ALFA	107249	GP-66	FORD	109271A	G-1143	OLIV
10505-45	G-33	POCL	105-64-0406002	G-296	ALFA	1073508M91	GA-416	MASY	1093	GA-106 ⁴⁶	AMP
10505-95	GP-1122	POCL	105-64-0406002	G-296-B	ALFA	107368	G-1143	OLIV	1093	GA-326 ⁷¹	AMP
10506	GA-85	CAC	105-64-0406002	G-296	ALFA	107368	G-1143	WHIT	1093	GA-106 ⁴⁶	BGA
105067	GA-37	CUMM	105-64-0406001	G-296-B	ALFA	1073680	G-1143	WHIT	1093	GA-326 ⁷¹	BGA
105067	GA-37	IHCO	105-64-060001	G-296	ALFA	107369	G-1176	WHIT	1093-320	GA-27	DYNA
10507	GA-50	CAC	105-64-060001	G-296-B	ALFA	107428	GA-70	BEAM	109342	GP-1176	WHIT
10508	GA-50	CAC	105-64-060002	G-296	ALFA	107445	GA-20	EATN	10937118	GA-106 ⁴⁶	LEYL
1050864	GG-63	PARM	105-64-060002	G-296-B	ALFA	107445	GAK-20	EATN	10937118	GA-326 ⁷¹	LEYL
10-50900	GP-462	VERA	105687	G-31	HOUG	107461	G-31	CASE	1094	GA-55	JCP
10-50918	GP-40	VERA	105687H1	G-31	HOUG	107580	GP-81	MANO	10944504	GA-49	DIAM
10-50926	GP-58	VERA	105687-H1	G-31	IHCO	107580	GP-9	MANO	10944504	GA-49	MBNZ
10-50983	GP-3682	VERA	10572	GAD-3	CAC	1076	G-236	NAP	10945104	GA-405	MTU
10-50983	GP-37	VERA	10579	GA-879	AIR	107611001	GPP-18	VERM	10947904	GA-405	DAIM
10-50991	GP-171	VERA	1057951M1	GPP-1122	MASY	1076748M1	GPP-18	MASY	10947904	GA-405	MBNZ
1051	GP-50	NAP	1058	GA-100	HOLY	1076749M1	GP-1122	MASY	10948004	GA-436	DAIM
105113	GP-1	THER	10580	GAD-3	CAC	1076750M1	GP-43	MASY	10948004	GA-436	MBNZ

Referencia Cruzada por Numero de Parte

Cross Reference by Part Number



Numero	Gonher	Fabricante	Numero	Gonher	Fabricante	Numero	Gonher	Fabricante	Numero	Gonher	Fabricante
Number	Gonher	Manufacturer	Number	Gonher	Manufacturer	Number	Gonher	Manufacturer	Number	Gonher	Manufacturer
1096417M91	GA-6127	MASY	10P2832	G-296	MINN	110-0911	GA-390	ITM	11-02308	GA-2110	ITM
10965	GA-33	BERN	10P2832	G-296-B	MINN	1100914	GA-390	REPC	11-02308	GAVW-2	VERA
1097	GA-78	JCP	10P2832	G-296	WHIT	11-00914	GA-390	ITM	11-02332	GA-78	VERA
1097000-M91	GA-357	MASY	10P2832	G-296-B	WHIT	11-00918	GA-382	ITM	11-02340	GA-4828	VERA
1097001M91	GA-356	HANO	10P2881	GA-16	MINN	11-00924	GA-4365	VERA	11-02464	GA-390	VERA
1097001M91	GA-356	MASY	10P2881	GAK-16	MINN	11-00932	GAVW-2	VERA	11-02472	GA-139	VERA
1097077	GP-28 ⁸	FORD	10P2881	GA-16	WHIT	11-00981	GAVW-2	VERA	11-02472	GA-139	VERA
1097077	GP-3600 ⁹	FORD	10P2881	GAK-16	WHIT	11-00999	GA-56	VERA	11-02480	GA-471	VERA
1097077	GP-28 ⁸	MTR	10P2913	GA-403	MINN	1101	GA-85	JCP	11-02500	GA-303	REPC
1097077	GP-3600 ⁹	MTR	10P2913	GAK-403	MINN	11-01004	GA-3300	VERA	11-02500	GA-303	BAP
109726	GA-31	NEL	10P2913	GA-403	WHIT	11-01038	GA-277	VERA	11-02500	GA-303	ITM
10974	GA-20	AIRE	10P2913	GAK-403	WHIT	11-01087	GA-303	VERA	11-02501	GA-3425	BAP
10974	GAK-20	AIRE	10P786	G-33	MINN	11-01100	GA-2740	BAP	11-02501	GA-3425	ITM
10974	GA-20	BERN	10P786	G-33	WHIT	11-01103	GA-2740	BAP	11-02514	GAD-15	VERA
10974	GAK-20	BERN	10R1293	G-296	MINN	1101107	GAD-3	REPC	1102604C1	GA-3588	VERA
10981	GA-403	AIRE	10R1293	G-296-B	MINN	11-01107	GAD-3	BAP	11-02696	GA-2110	VERA
10981	GAK-403	AIRE	10R1293	G-296	WHIT	1101109	GA-2740	REPC	11-02704	GA-216	VERA
10981	GA-403	BERN	10R1293	G-296-B	WHIT	11-01109	GA-2740	BAP	11-02712	GA-216	VERA
10981	GAK-403	BERN	10R1327	GP-81	WHIT	11-01109	GA-2740	ITM	11-02720	GA-362	VERA
1099	G-834	NAP	10R1327	GP-9	WHIT	1101110	GA-2740	REPC	11028	G-870	DAIM
109A	GA-3425	GREY	10R1328	GP-1	MINN	11-01110	GA-2740	BAP	11028	G-870	LEYL
10A12102	G-33	MINN	10R1328	GP-1	WHIT	11-01110	GA-2740	ITM	1102811	GA-356	PERL
10A12102	G-33	WHIT	10R1334	G-1173	MINN	11-01111	GA-230	VERA	1102817	GA-357	PERL
10A14373	GP-81	AGCO	10R1334	G-1173	WHIT	1101114	GA-471	REPC	11-02901	GA-50	ITM
10A14373	GP-9	AGCO	10R4	G-1173	COM	11-01115	GA-471	BAP	11-02910	GAD-1	VERA
10A14373	GP-81	MINN	10R6	G-1174	COM	1101116	GA-216	REPC	11-02951	GA-4828	VERA
10A14373	GP-9	MINN	10R8	G-1175	COM	11-01116	GA-216	BAP	11-02977	GA-140	VERA
10A14373	GP-81	WHIT	10S	GA-20	ASAH	11-01129	GAVW-4	VERA	1102A	GA-2194	GREY
10A14373	GP-9	WHIT	10S	GAK-20	ASAH	11-01137	GA-200	VERA	1103	GA-70	JCP
10A14489	GP-81	MINN	11	GP-5	FACE	11-01137	GA-218	VERA	11-03065	GA-382	VERA
10A14489	GP-9	MINN	11	GP-6	LONF	11-01145	GAVW-4	VERA	11-03099	GA-2194	VERA
10A14489	GP-81	WHIT	11	GP-81	SUN	11-01203	GA-3490	BAP	11-03123	GA-2106	VERA
10A14489	GP-9	WHIT	11	GP-9	SUN	11-01212	GA-44	VERA	11-03131	GA-142	VERA
10A15625	GA-33	MINN	11	GP-1	WIX	11-01301	GA-4303	BAP	11-03156	GA-195	VERA
10A15625	GA-33	WHIT	11 42 1 432 097	G-975	BMW	11-01301	GA-140	ITM	11-03164	GA-139	VERA
10A19471	GA-24	MINN	11 42 1 716 121	G-975	BMW	1101302	GA-4303	REPC	1103300	GAVW-2	REPC
10A19471	GA-24	WHIT	11 42 1 716 192	G-975	BMW	11-01302	GA-4303	BAP	11-03300	GAVW-2	BAP
10A19708	GA-403	MINN	11 42 1 743 398	G-975	BMW	11-01335	GA-2194	VERA	11033128	GA-467	VME
10A19708	GAK-403	MINN	11 42 7 557 012	G-341	BMW	110145	GP-1107	KDCP	11033128	GA-467	VOLV
10A19708	GA-403	WHIT	110	GA-135	AMP	11-01483	GA-200	VERA	11033128-7	GA-467	VOLV
10A19708	GAK-403	WHIT	110	GP-20	AUTP	11-01483	GA-218	VERA	11033950	GA-563	VOLV
10A21112	GA-16	MINN	110	GA-135	BGA	11-01500	GA-3566	ITM	11033950-4	GA-563	VOLV
10A21112	GAK-16	MINN	110	GP-3980	SAK	1101502	GA-27198	REPC	11036607	GP-761H	VME
10A21113	GA-16	MASY	11-00000	GAD-1	BAP	11-01502	GA-27198	BAP	11036607	GP-761H	VOLV
10A21113	GAK-16	MASY	11-00000	GAD-1	REPC	11-01503	GA-27198	BAP	110366077	GP-761H	VME
10A21113	GA-16	WHIT	11-00001	GA-3490	BAP	1101512	GA-180	REPC	110366077	GP-761H	VOLV
10A21113	GAK-16	WHIT	11-00001	GA-3490	REPC	11-01513	GA-27198	BAP	110371	G-191	DAF
10A2113	GA-16	MINN	1100010	GA-2740	REPC	11-01525	GAVW-2	VERA	110376	GA-376	DAF
10A2113	GAK-16	MINN	11-00010	GA-2740	BAP	1101526	GA-139	REPC	1104	GA-325	JCP
10A2113	GA-16	WHIT	11-00010	GA-2740	ITM	11-01541	GA-4365	VERA	11041	GP-10	CRUS
10A2113	GAK-16	WHIT	11-000103	GA-3566	ITM	11-01590	GA-2740	VERA	11042	GP-78	CRUS
10A2170	G-1173	MINN	1100020	GAD-3	REPC	11-01616	GA-3490	VERA	11043	GP-1101	CRUS
10A2170	G-1173	WHIT	11-00020	GAD-3	BAP	11-01624	GA-3445	VERA	1106302	GA-50	REPC
10A22624	GA-403	MINN	110-0102	GA-3566	ITM	11-01657	GA-3566	VERA	11-06302	GA-50	BAP
10A22624	GAK-403	MINN	11-00105	GA-142	ITM	11-01673	GA-2740	VERA	11-06310	GA-44	BAP
10A22624	GA-403	WHIT	11-00163	GA-3425	VERA	11-01681	GA-140	VERA	11-06310	GA-44	ITM
10A22624	GAK-403	WHIT	11-00262	GA-27198	VERA	11-01707	GA-2740	VERA	110-6326	GA-853R	CATP
10A22670	GA-16	MINN	11-00288	GAD-1	VERA	11-01707	GA-4325	VERA	1107200	GA-3523	REPC
10A22670	GAK-16	MINN	11-00296	GAD-1	VERA	11-01715	GA-3490	VERA	11-07200	GA-3523	BAP
10A22670	GA-16	WHIT	11-00301	GA-4325	BAP	11-01723	GAD-3	VERA	1107411	G-31	CHRY
10A22670	GAK-16	WHIT	1100303	GA-4325	REPC	11-01756	GAVW-2	VERA	11-07600	GA-271	BAP
10A25869	GA-16	MINN	11-00307	GA-3490	BAP	11-01830	GA-180	VERA	11-07600	GA-271	REPC
10A25869	GAK-16	MINN	11-00353	GAD-3	VERA	11-01830	GAD-30	VERA	11-07800	GA-734 ⁴¹	BAP
10A25869	GA-16	WHIT	11-00395	GA-2740	VERA	11-01848	GAD-30	VERA	11-07800	GA-735 ²⁴	BAP
10A25869	GAK-16	WHIT	11-00403	GA-3490	VERA	11-01863	GAVW-4	VERA	11-07800	GA-734 ⁴¹	REPC
10A27893	GA-20	WHIT	11-00437	GAD-1	VERA	11-01897	GAD-1	VERA	11-07800	GA-735 ²⁴	REPC
10A27893	GAK-20	WHIT	11-00452	GAD-3	VERA	11-01900	GAD-1	BAP	1107801	GA-274	REPC
10A28694	GA-24	WHIT	11-00486	GA-71	VERA	11-01902	GAD-1	BAP	11-07801	GA-274	BAP
10A31255	GA-39	WHIT	11-00501	GA-71	BAP	11-01906	GAD-15	BAP	1108	GA-71	JCP
10A31417	GA-106 ⁴⁶	WHIT	11-00501	GA-71	ITM	11-01947	GA-3490	VERA	11-08500	GA-71	BAP
10A31417	GA-206	WHIT	11-00501	GA-71	REPC	11-01962	GAD-15	VERA	11-08500	GA-71	ITM
10A31417	GA-326 ⁷¹	WHIT	11-00504	GAD-1	BAP	1101998	GG-213	PARM	11-08503	GA-2740	BAP
10A3366	G-1173	AMHO	11-00508	GA-4303	BAP	1102	GA-56	JCP	11-08700	GA-7	BAP
10A3366	G-1173	COMP	11-00508	GA-4303	REPC	11-020	G-225	THER	11-08700	GA-7	ITM
10A3366	G-1173	MINN	11-00510	GAD-1	BAP	110200	GP-9	VAUX	1108A	GAVW-2	GREY
10A3366	G-1173	WHIT	11-00510	GA-4303	VERA	110200	GP-81	VOLV	1109	GA-135	BGA
10A3367	G-1173	MINN	11-00512	GAD-1	BAP	1102000	GA-277	REPC	1109	GA-303	JCP
10A3367	G-1173	WHIT	11-00513	GAD-3	BAP	11-02000	GA-277	BAP	1109	GA-180	UNN
10CX49	GA-24	CLIM	1100517	GAD-15	REPC	11-02001	GAVW-4	BAP	1109.R6	G-141	PEUG
10CX50	GA-27	CLIM	11-00517	GAD-15	BAP	11-02007	GA-230	BAP	1109.R7	G-141	CITR
10F	G-1163	CHP	1100520	GAD-30	REPC	11-02007	GA-230	INTM	1109-06	GP-46	PEUG
10P02592	GA-403	WHIT	11-00520	GAD-30	BAP	11-02019	GP-3	VERA	110910	G-870	BRAU
10P02592	GAK-403	WHIT	11-00569	GAD-1	VERA	1102030	GAVW-2	REPC	1109101	GA-230	REPC
10P1786	G-33	MINN	11-00585	GAVW-2	VERA	11-02030	GAVW-2	BAP	11-09101	GA-230	ITM
10P1786	G-33	WHIT	11-00593	GAVW-2	VERA	11-02043	GA-230	VERA	1109-13	GP-46	PEUG
10P1876	G-33	WHIT	11-00619	GA-50	VERA	11-02051	GAVW-4	BAP	11-09147	GA-2740	VERA
10P2170	G-1173	MINN	11-00684	GA-71	VERA	11-02056	GAD-15	VERA	1109-16	GP-46	PEUG
10P2529	GAK-403	MINN	11-00692	GA-230	VERA	11-02100	GA-4958	VERA	1109-17	GP-46	PEUG
10P2529	GA-403	WHIT	11-00783	GA-39	VERA	11-0212	GP-44	VERA	1109-18	GP-46	PEUG
10P2529	GAK-403	WHIT	11-00801								

Numero	Gonher	Fabricante	Numero	Gonher	Fabricante	Numero	Gonher	Fabricante	Numero	Gonher	Fabricante
Number	Gonher	Manufacturer	Number	Gonher	Manufacturer	Number	Gonher	Manufacturer	Number	Gonher	Manufacturer
1109305	GA-56	REPC	11-10700	GP-24 ²⁶	BAP	11-18301	GP-46	REPC	11268	G-836	WEST
11-09305	GA-56	BAP	11-10700	GP-462 ²⁴	BAP	11-18302	GP-46	BAP	112685	G-31	THER
1109306	GA-4365	REPC	1110800	GP-91	REPC	11-18305	GP-3985	BAP	1126A	GA-2156	GREY
11-09306	GA-4365	BAP	1110900	GP-42	REPC	111836	GP-81	CUSH	1127	GA-86	JCP
1109-33	GP-46	PEUG	11-10900	GP-42	BAP	111836	GP-9	CUSH	112850069	GP-3985	DUTZ
1109-35	GP-46	PEUG	1110901	GP-3531 EXP	REPC	111836	GP-81	OUTB	1129	GP-81	NAP
1109-36	GP-46	PEUG	11-10901	GP-3531 EXP	BAP	111836	GP-9	OUTB	113	GP-13	AUTV
1109-39	GP-46	PEUG	11-10903	GP-42	BAP	11-18500	GP-22	BAP	113	GP-13	PARM
1109-43	GP-46	PEUG	11-10904	GP-3531 EXP	BAP	1118501	GP-91	REPC	113	GA-86	WIX
1109-44	GP-46	PEUG	11-10907	GP-462	BAP	11-18501	GP-91	BAP	1130	GA-482	BGA
1109-45	GP-81	PEUG	11-10908	GP-212	ITM	11-18502	GP-22	BAP	1130	G-33	NAP
1109-45	GP-9	PEUG	111-094-02-04	GA-2109	CHRY	111888000	GP-54 ³¹	OREN	11-30000	GG-5 L	BAP
1109-49	GP-46	PEUG	111-094-02-04	GA-2109	MBNZ	111888000	GP-66 ³⁰	OREN	11-30000	GG-5 L	ITM
1109-51	GP-40	PEUG	1110A	GAVW-2	GREY	1119700	GP-2951	REPC	1130001	GG-45	REPC
1109-59	GP-46	PEUG	1111	GP-66	MPFI	11-19700	GP-2951	BAP	11-30001	GG-45	BAP
1109-65	GP-46	PEUG	11-11010	GP-24 ²⁶	BAP	11-19800	GA-12	BAP	11-30001	GG-45	ITM
1109-67	GP-40	PEUG	11-11010	GP-462 ²⁴	BAP	11-19800	GP-81	BAP	1130100	GG-204	REPC
110968	GP-40	PEUG	11-11100	GP-24 ²⁶	BAP	1119802	GP-28 ⁸	BAP	1130103	GG-76	REPC
1109-71	GP-46	PEUG	11-11100	GP-462 ²⁴	BAP	1119802	GP-430 ⁸	REPC	11-30103	GG-76	BAP
1109-72	GP-46	PEUG	11-11101	GP-24 ²⁶	BAP	11-19802	GP-28 ⁸	BAP	11-30103	GG-76	ITM
1109-75	GP-3985	PEUG	11-11101	GP-462 ²⁴	BAP	11-19802	GP-430 ⁸	BAP	1130104	GG-203	REPC
1109-78	GP-81	PEUG	11-11102	GP-3985	BAP	11-19805	GP-1	BAP	1130301	GG-196	REPC
1109-78	GP-9	PEUG	11-11103	GP-24 ²⁶	BAP	1119806	GP-1	REPC	11-30301	GG-196	BAP
11-09806	GA-303	BAP	11-11103	GP-462 ²⁴	BAP	1119809	GP-9	REPC	11-30301	GG-196	ITM
1109807	GA-230	REPC	1112101	GP-3985	REPC	11-19809	GP-81	BAP	11-30303	GG-185	ITM
11-09807	GA-230	BAP	11-12101	GP-3985	BAP	11-19809	GP-9	BAP	1130501	GG-45	BAP
11-09807	GA-230	ITM	1111-622935900	GA-49	FAHR	1119813	GP-310	REPC	11-30502	GG-76	BAP
1109808	GA-3300	REPC	1111901	GP-3985	REPC	11-19813	GP-310	BAP	11-30502	GG-76	REPC
11-09808	GA-3300	BAP	11-11901	GP-3985	BAP	11-19813	GP-3569	ITM	11-30503	GG-196	BAP
1109-81	GP-3985	PEUG	1111902	GP-3985	REPC	11-19816	G-834	BAP	11-30504	GG-94	BAP
11-09810	GA-3445	ITM	11-11902	GP-3985	BAP	11-19816	G-834	ITM	11-30504	GG-94	REPC
11-09812	GA-50	BAP	11-11902	GP-3985	ITM	1119818	GP-22	REPC	11-30511	GG-5 L	BAP
11-09812	GA-50	ITM	1112	GA-229	ERO	11-19818	GP-22	BAP	1130512	GG-63	REPC
1109817	GA-200	REPC	1112002	GP-3816	REPC	11-19818	GP-22	ITM	11-30512	GG-63	BAP
1109817	GA-218	REPC	11-12002	GP-3816	BAP	111-D1	GA-827	UNI	113068	G-1175	THER
11-09817	GA-200	BAP	11-12006	G-225	BAP	111-D4	GA-827	UNI	1130800	GG-196	REPC
11-09817	GA-218	BAP	111202	GA-33	HUBR	111M	GG-20	REF	11-30900	GG-1	BAP
1109-82	GP-3985	PEUG	11-12100	GP-3569	ITM	111S3090	GA-26 ¹¹²	AMLA	11-30900	GG-4	BAP
1109-84	GP-40	PEUG	1112101	GP-28 ⁸	REPC	112	GA-100	AMP	11-30901	GG-5 L	BAP
1109850	GAVW-2	REPC	1112101	GP-430 ⁸	REPC	112	GA-100	BGA	11-30903	GG-5 L	BAP
11-09850	GAVW-2	BAP	11-12101	GP-28 ⁸	BAP	112	GG-5 L	FACE	11-30904	GG-5 L	BAP
11-09851	GAVW-4	BAP	11-12101	GP-430 ⁸	BAP	112 094 01 04	GA-2164	CHRY	11-30905	GG-5 L	BAP
1109-86	GP-3985	PEUG	11-12300	GP-3816	BAP	112 094 01 04	GA-2164	MBNZ	11-30909	GG-208	BAP
1109910	G-870	BRAU	1112302	GP-28 ⁸	REPC	112 094 02 04	GA-2164	CHRY	11-30909	GG-208	ITM
1109-A1	GP-22	PEUG	1112302	GP-430 ⁸	REPC	112 094 02 04	GA-2164	MBNZ	11-30912	GG-215	BAP
1109-A4	GP-3985	PEUG	11-12369	GP-2071W	CATP	112 094 0304	GA-2161	CHRY	11-30912	GG-215	ITM
1109-C1	GP-28 ⁸	PEUG	11-12370	GP-2071W	CATP	112 094 0304	GA-2161	MBNZ	11-30912	GG-215	REPC
1109-C1	GP-430 ⁸	PEUG	11-12708	GP-28 ⁸	BAP	112 094 04 04	GA-2170	CHRY	11-30913	GG-214	ITM
1109-C2	GP-3985	PEUG	11-12708	GP-430 ⁸	BAP	112 094 04 04	GA-2170	MBNZ	1130914	GG-215	REPC
1109-C5	GP-3816	PEUG	11-13109	GP-171 ¹⁶	BAP	112 180 0009	G-180	MBNZ	11-30914	GG-215	BAP
1109J8	GP-40	CITR	11-13109	GP-171 ¹⁶	ITM	112 180 0009	G-918	MBNZ	11-30914	GG-215	ITM
1109-N2	GP-3985	PEUG	1113300	GP-28 ⁸	REPC	112 184 0025	G-180	MBNZ	11-30917	GG-181	ITM
1109-N2	GP-461	PEUG	1113300	GP-430 ⁸	REPC	112 184 0225	G-180	MBNZ	11-30922	GG-214	ITM
1109N3	GP-461	CITR	11-13300	GP-28 ⁸	BAP	112 184 0225	G-918	MBNZ	11-30924	GG-181	ITM
1109-RO	GP-461	PEUG	11-13300	GP-430 ⁸	BAP	112 184 0525	G-180	MBNZ	11-30925	GG-190	ITM
1109-R1	GP-461	CITR	111346	G-31	WAUK	112 184 0525	G-918	MBNZ	1130940004	GA-2198 ⁷⁹	MBNZ
1109-R1	GP-461	PEUG	11-14005	G-870	BAP	112 184 0625	G-180	MBNZ	1130940004	GA-438 ³¹	MBNZ
1109-RO	GP-461	PEUG	11-14006	G-870	BAP	112 184 0625	G-918	MBNZ	1131	GA-483	AMP
1109-TO	GP-461	PEUG	11-14006	G-870	ITM	112065	G-1121F	THER	1131	GA-483	BGA
1109-TO	GP-462	PEUG	11-14014	GP-81	BAP	112065	G-1121F	THER	11-31000	GG-214	ITM
1109-T1	GP-461	CITR	11-14014	GP-9	BAP	112-094-00-04	GA-2198 ⁷⁹	CHRY	1131100	GG-217	REPC
1109-TO	GP-461	PEUG	1115	G-1173	COM	112-094-00-04	GA-438 ³¹	CHRY	11-31100	GG-217	BAP
1109-TO	GP-462	PEUG	1115006	G-870	VMEN	112-094-00-04	GA-2198 ⁷⁹	MBNZ	11-31100	GG-217	ITM
1109-X1	GP-461	CITR	1115016	GP-68	VMEN	112-094-00-04	GA-438 ³¹	MBNZ	1131102	GG-76	REPC
1109-X2	GP-461	CITR	11-15401	GP-28	BAP	1120940404	GA-2161	MBNZ	11-31102	GG-76	BAP
1109-X3	G-341	PEUG	11-15603	G-870	BAP	112-094-06-04	GA-2198 ⁷⁹	CHRY	11-31109	GG-142	ITM
1109-X4	G-341	CITR	1115A	GAVW-2	GREY	112-094-06-04	GA-438 ³¹	CHRY	11-31120	GG-150	ITM
1109-Z1	G-341	PEUG	1116	GA-77	JCP	112-094-06-04	GA-2198 ⁷⁹	MBNZ	113129620	GAVW-2	AUDI
1109-Z2	G-341	CITR	1116000	GP-81	REPC	112-094-06-04	GA-438 ³¹	MBNZ	113129620	GAVW-2	VAG
111	GP-3	AUTP	1116000	GP-9	REPC	1121	GA-16	BGA	113129620	GAVW-2	VOLK
111	GA-106 ¹⁶	ERO	11-16000	GP-81	BAP	1121	GAK-16	BGA	11-31300	GG-188	ITM
111	GA-326 ⁷¹	ERO	11-16000	GP-9	BAP	1121983	GA-3490	WORL	11-31302	GG-202	BAP
11-10001	GP-3985	BAP	11-16305	GP-50	BAP	1122	GA-59	JCP	11-31302	GG-202	ITM
11-10003	GP-1	BAP	11-1690	G-1123	THER	112209	G-1123	THER	11-31304	GG-208	BAP
11-10003	GP-1	ITM	11-1690	G-1123F	THER	112210	G-1163	THER	11-31304	GG-208	ITM
11-10003	GP-1	REPC	11-1691	G-1123	THER	112229	G-1175	THER	1131502	GG-76	REPC
1110004	GP-91	REPC	11-1691	G-1123F	THER	112230	G-1174	THER	11-31502	GG-76	BAP
11-10004	GP-91	BAP	1116945	GA-4958	PARM	112243	G-1121F	THER	11-31503	GG-45	REPC
1110005	GA-139	PARM	1117	GA-50	JCP	112243	G-1121F	THER	11-31503	GG-45	BAP
11-10010	GP-24 ²⁶	BAP	1117200	GP-46	REPC	112245	GPP-1122	LEYL	11-31503	GG-45	ITM
11-10010	GP-462 ²⁴	BAP	11-17200	GP-46	BAP	11225042001	G-1123	MTU	1131504	GG-203	REPC
11-10100	GP-3985	BAP	11-17201	GP-3985	BAP	11225042001	G-1123F	MTU	11-31504	GG-203	BAP
11-10103	GP-2951	BAP	11-1726	G-6	THER	11225802	GP-58	FORD	11-31509	GG-203	ITM
11-10103	GP-58	BAP	1117285	GP-51	SAAB	1123	GA-57	JCP	1131517	GG-203	REPC
111016	GP-28 ⁸	JOND	1117576	GA-682R	VOLV	112353	GA-7	THER	11-31517	GG-203	BAP
111016	GP-430 ⁸	JOND	1117600	GP-2951	REPC	1124	GP-66	FLUT	11-31519	GG-202	BAP
111016	GP-28 ⁸	LANZ	1117600	GP-58	REPC	1124	GA-730	JCP	1131530	GG-185	REPC
111016	GP-430 ⁸	LANZ	11-17600	GP-2951	BAP	1-1240	G-870	ARMS	11-31530	GG-185	BAP
11-10300	GP-40	BAP	11-17600	GP-58	BAP	1124160	G-70	FRF	11-31530	GG-185	ITM
1110501	G-870	REPC	1117801	GP-3600	REPC	1125	GA-75	JCP	1131534	GG-185	REPC
11-10501	G-870	BAP	11-17801	GP-3300	BAP	1126	GA-3300	JCP	11-31534	GG-185	BAP
11-10503	GP-28 ⁸	BAP	1118	GA-80	JCP	112644	GA-105	HERC	11-31534	GG-185	ITM
11-10503	GP-430 ⁸	BAP	1118300	GP-46	REPC	112644	GA-105	LYCO	1131649	GA-179	FRF
11-10504	GP-1	BAP	11-18300	GP-46	BAP	112644	GA-105	WHIT	1131649	GA-179	MTR
1110505	GP-38	REPC	11-18300	GP-46	ITM	112664	GA-105	HERC	1131900	GG-196	REPC
1110509	GP-171	REPC	11-18301	GP-46	BAP	1126661	GA-27198	WORL	11-31900	GG-196	BAP

Referencia Cruzada por Numero de Parte

Cross Reference by Part Number



Numero	Gonher	Fabricante	Numero	Gonher	Fabricante	Numero	Gonher	Fabricante	Numero	Gonher	Fabricante
Number	Gonher	Manufacturer	Number	Gonher	Manufacturer	Number	Gonher	Manufacturer	Number	Gonher	Manufacturer
11-31900	GG-196	ITM	11-39800	GG-246	ITM	11425814	GP-66 ¹⁰	WORT	11501-01220	GP-2951	KAWA
11-31902	GPP-111	BAP	11-39800	GG-408	ITM	114275	GA-7	THER	11501-01220	GP-2951	NIPP
11-31902	GPP-524	BAP	11-39802	GG-1	BAP	11-42-7-509-430	G-954	BMW	11501-01220	GP-2951	TOYO
1131904	GG-196	REPC	11-39802	GG-4	BAP	11-42-7-510-716	G-984	BMW	11501-01250	GP-2951	NIPP
11-31904	GG-196	BAP	11-39804	GG-5 L	BAP	11-42-7-510-717	G-984	BMW	11501-01250	GP-2951	TOYO
11-31904	GG-196	ITM	11-39805	GG-251	BAP	11-42-7-512-300	G-954	BMW	11501-01270	GP-2951	TOYO
1131905	GG-203	REPC	11-39814	GPP-1122	ITM	11427512301	G-954	BMW	11501-01291	GP-157	NIPP
11-31905	GG-203	BAP	11-39816	GG-19	ITM	11429061197	GP-58	BMW	11501-01291	GP-157	TOYO
11-31905	GG-203	ITM	11-39816	GG-19	ITM	11429061198	GP-28 ⁹	BMW	11501-01301	GP-58	TOYO
1-13200-487-0	GP-51	ISUZ	11-39823	GG-1	BAP	11429061198	GP-430 ⁸	BMW	11501-01390	GP-156	NIPP
1-13200-487-1	GP-51	ISUZ	11-39823	GG-4	BAP	1143	GA-86	AMP	11501-01390	GP-156	TOYO
1-13200-487-2	GP-51	ISUZ	114	GA-113	AMP	1143	GA-200	NAP	11501-016020	GP-157	NIPP
1132005	GG-246	REPC	114	GA-113	BGA	114359	GA-403	GALN	11501-01610	GP-157	NIPP
11-32005	GG-246	BAP	114	GA-113	BGA	114359	GAK-403	GALN	11501-01660	GP-156	NIPP
11-32005	GG-246	ITM	1140	GA-105	AMP	114360	GA-403	GALN	11501-01660	GP-156	TOYO
11-32005	GG-408	ITM	1140	GA-105	BGA	114360	GAK-403	GALN	11501-01670	GP-156	TOYO
11-32011	GG-246	BAP	11403	G-31	DIAM	11436936	GP-81	SAAB	11501-01780	GP-156	NIPP
11-32011	GG-246	ITM	11405640	GP-58	FORD	11436936	GP-9	SAAB	1150101800	GP-157	DENS
11-32012	GG-226	BAP	114069200	GA-103	BOMB	1143747	GA-16	ALCH	11501-01860	GP-157	NIPP
11-32012	GG-226	ITM	114069200	GAK-403	BOMB	1143747	GAK-16	ALCH	11501-01870	GP-156	NIPP
1-13224-008-90	GP-55	ISUZ	1140887	GA-403	ALCH	11437472	GAK-16	ALCH	11501-02030	GP-157	NIPP
11324-001	2010PM-OR ⁷	ISUZ	1140887	GAK-403	ALCH	1144	GAVW-2	AMP	1150102191	GP-58	DENS
11324-001	2010TM-OR ⁷	ISUZ	1140888	GA-16	ALCH	1144	GAVW-2	BGA	115010-5350	GP-58 ⁹	DENS
1-13240-044-0	GPP-11	ISUZ	1140888	GAK-16	ALCH	11448231	GA-303	FORD	1150105400	GP-3682	DENS
1-13240-044-1	GPP-11	ISUZ	1140889	GA-33	ALCH	1145	G-971	NAP	11501-05470	GP-58 ⁹	NIPP
1-13240-046-2	GP-43	ISUZ	1140889	GA-33	ALCH	11450	G-238	WIN	1150243	GP-1122	FIAT
1-13240-064-2	GP-43	ISUZ	1141	G-200	NAP	114565	GP-54	THER	115029	GA-356	NEL
1-13240-067-0	GP-57	ISUZ	114113900	GA-24	BOMB	11450	G-238	WIN	115053	G-836	CLAA
1-13240-103-0	GP-57	ISUZ	1-141215-085-0	GA-398	ISUZ	11464231	GA-303	FORD	1150530	G-836	CLAA
11-32701	G-1121	BAP	11420251964	G-834	BMW	11464467	GP-81	FORD	115054	G-813	CLAA
11-32701	G-1121F	BAP	11420561207	G-6	BMW	11464467	GP-9	FORD	1150540	G-813	CLAA
11-32702	GG-3	ITM	11420661135	G-225	BMW	11464497	GP-81	FORD	11505-84	GP-1122	POCL
11-32707	GG-261	ITM	11421250534	GP-3816	BMW	11464497	GP-9	FORD	1150622	GP-14	GRAD
1133	GA-33	NAP	11421251964	G-834	BMW	11464498	GP-81	FORD	115069	GA-879	NLSN
1133274R1	G-870	CASE	11421256260	G-225	BMW	11464498	GP-9	FORD	11507425101	G-162H	BMW
1133274-R1	G-870	IHCO	11421256402	G-834	BMW	1146873	GP-3	ALCH	11507425104	G-225	BMW
1133274R2	G-870	CASE	11421258039	GP-3816	BMW	1146873-3	GP-3	ALCH	1150C	G-1143	WIN
1133274-R2	G-870	IHCO	114-21-2580390	GP-58	ALFA	1146873-6	GP-3	ALCH	1151	GA-3501	AMP
1133278R1	GP-81	IHCO	11421265945	G-834	BMW	1147	GP-27	FACE	1151	GA-3501	BGA
1133278R1	GP-9	IHCO	11421266773	GP-28 ⁹	BMW	1147	GP-331	NAP	1151	G-335	NAP
1133280R1	G-296	IHCO	11421266773	GP-430 ⁸	BMW	11471186	GP-1122	DEMA	11525472	GP-81	FORD
1133280R1	G-296-B	IHCO	11421267597	GP-58	BMW	114747	GA-98 ¹¹²	NEL	11525472	GP-9	FORD
113331	GA-33	THER	11421272604	GP-3816	BMW	1147684	GA-2740	IPS	11531-00042	GP-81	TOYO
1133493R1	GPP-1122	IHCO	11421276850	GP-58	BMW	114786	GP-54 ¹¹	DAF	11531-00042	GP-9	TOYO
1133494R1	GPP-1122	CASE	11421276850	GP-58	MBNZ	114786	GP-66 ¹⁰	DAF	115310-0260	GP-58 ⁹	DENS
11334F	GS-1133	CHP	11421278059	GP-3816	BMW	114868	G-296	GEHL	1153430	GP-54 ¹¹	FIAT
11338-38020	GP-44	TOYO	11421287836	GP-28 ⁹	BMW	114868	G-296-B	GEHL	1153430	GP-66 ¹⁰	FIAT
1133F	GC-1133	CHP	11421287836	GP-430 ⁸	BMW	11487-031-2100	GAD-30	TSUC	115360	GP-1	FIAT
1133MP	G-33	NAP	11-42-1-427-908	G-954	BMW	11487-03121-00	GAD-30	NISS	1154948	G-834	FORD
1135983	GA-16	COCT	1-14215-006-0	GA-20	ISUZ	114924119	GP-1122	HANO	1155	GA-426	AMP
1135983	GAK-16	COCT	1-14215-006-0	GAK-20	ISUZ	114924119	GP-1122	MASY	1155	GA-426	BGA
1135983	GA-16	WHIT	1-14215-006-1	GA-20	ISUZ	114924133	G-296	HANO	1155167	G-295	GRAD
1135983	GAK-16	WHIT	1-14215-006-1	GAK-20	ISUZ	114924133	G-296-B	HANO	1156	GA-425	AMP
11-36102	G-296	BAP	1-14215-007-1	GA-360	ISUZ	114924143	GP-1122	HANO	1156	GA-425	BGA
11-36102	G-296-B	BAP	1-14215-007-2	GA-360	ISUZ	114924144	GPP-1122	HANO	1156	G-333	NAP
113692	GP-1105	THER	1-14215-009-0	GA-27	ISUZ	114924160	G-1123	HANO	1156603	GA-403	COCT
113693	GP-62	THER	1-14215-012-0	GA-24	ISUZ	114924160	G-1123F	HANO	1156603	GAK-403	COCT
113712	GP-66	THER	1-14215-014-0	GA-33	ISUZ	114924188	G-296	HANO	1156603	GA-403	WHIT
1137200	GG-16	REPC	1-14215-020-0	GA-27	ISUZ	114924188	G-296-B	HANO	1156603	GAK-403	WHIT
11-37200	GG-16	BAP	1-14215-028-0	GA-403	ISUZ	114924188	G-296	MASY	1157	G-871	NAP
11-37200	GG-16	ITM	1-14215-028-0	GAK-403	ISUZ	114924188	G-296-B	MASY	115703	GP-67	THER
1137201	GG-17	REPC	1-14215-032-0	GA-403	ISUZ	11492-4188	G-296	NISS	115704	GP-1108	THER
11-37201	GG-17	BAP	1-14215-032-0	GAK-403	ISUZ	11492-4188	G-296-B	NISS	115705	GP-1107	THER
11-37201	GG-17	ITM	1-14215-033-0	GA-206	ISUZ	114929-HX	G-31	IHCO	115947	GPP-103	THER
113725	GP-1105	THER	1-14215-033-1	GA-206	ISUZ	114946183	G-31	IHCO	115947	GPP-11	THER
113726	G-1175	CUMM	1-14215-034-0	GA-206	ISUZ	114946183	GA-16	HANO	115978	GA-2804 T	THR
113726	GP-62	THER	1-14215-036-0	GA-206	ISUZ	114946183	GAK-16	HANO	116	GA-113	AMP
113727	GP-69	THER	1-14215-043-0	GA-27	ISUZ	114946183	GA-16	MASY	116	GA-113	BGA
113746	GP-67	THER	1-14215-043-1	GA-27	ISUZ	114946183	GAK-16	MASY	116	GP-81	PARM
113747	GP-67	THER	1-14215-046-0	GA-106 ⁴⁶	ISUZ	1149461831	GA-16	HANO	116	GP-9	PARM
1137603	GG-6	REPC	1-14215-046-0	GA-326 ⁷¹	ISUZ	1149461831	GAK-16	HANO	116	GP-3600	PROT
11-37603	GG-6	BAP	1-14215-046-1	GA-106 ⁴⁶	ISUZ	114948	GP-3600	THER	116	GA-85	WIX
11-37603	GG-6	ITM	1-14215-046-1	GA-326 ⁷¹	ISUZ	114530	GA-26	AMLA	1160	G-963	NAP
1137800	GG-87	REPC	1-14215-047-0	GA-361	ISUZ	115	GA-113	AMP	1160024	GP-36	BGA
11-37800	GG-87	ITM	1-14215-056-0	GA-758	ISUZ	115	GA-113	BGA	1160024	GP-36	AHLM
1138	G-119	NAP	1-14215-083-0	GA-26	ISUZ	115	GA-356	ERO	1160024	GP-36	ATCO
1138501	GG-79	REPC	1-14215-095-0	GA-24	ISUZ	11501-00025	GP-1	TOYO	1160024	GP-36	BOMG
11-38501	GG-79	BAP	1-14215-097-0	GA-27	ISUZ	11501-00027	GP-1	TOYO	1160024	GP-36	CLAA
11-38501	GG-79	ITM	1-14215-099-0	GA-403	ISUZ	11501-00290	GP-1	TOYO	1160024	GP-36	CLRK
113854	GP-1108	THER	1-14215-099-0	GAK-403	ISUZ	11501-00290	GP-81	TOYO	1160024	GP-36	DUTZ
113855	GP-1107	THER	1-14215-116-0	GA-758	ISUZ	11501-00290	GP-9	TOYO	1160024	GP-36	EICH
113855	GP-1109	THER	1-14215-117-0	GA-758	ISUZ	11501-00392	GP-1	NIPP	1160024	GP-36	FAHR
113858	GP-62	THER	1-14215-135-0	GA-16	ISUZ	11501-00392	GP-1	TOYO	1160024	GP-36	FIAT
1138627	GP-1101	CLRK	1-14215-135-0	GAK-16	ISUZ	11501-00393	GP-1	NIPP	1160024	GP-36	FLOM
113871	GP-88	THER	1-14215-183-0	GA-403	ISUZ	11501-00520	GP-157	TOYO	1160024	GP-36	IVEC
1139101	GG-246	REPC	1-14215-183-0	GAK-403	ISUZ	11501-00530	GP-2951	TOYO	1160024	GP-36	KHDF
11-39101	GG-246	BAP	11-42-1-711-568	G-963							

Numero	Gonher	Fabricante	Numero	Gonher	Fabricante	Numero	Gonher	Fabricante	Numero	Gonher	Fabricante
Number	Gonher	Manufacturer	Number	Gonher	Manufacturer	Number	Gonher	Manufacturer	Number	Gonher	Manufacturer
1160025	GP-66 ¹⁰	DUTZ	116520	GP-1122	IVEC	1173430EE	GP-66 ¹⁰	DUTZ	1181	GA-3425	AMP
1160025	GP-54 ¹¹	FAHR	116520	GP-1122	KHDF	1173430EE	GP-54 ¹¹	KHDF	1181	GA-3425	BGA
1160025	GP-66 ¹⁰	FAHR	1165581	GA-3566	IPS	1173430EE	GP-66 ¹⁰	KHDF	1181245	GP-1122	MNH
1160025	GP-54 ¹¹	FIAT	11664669	G-1143 ³⁰	AMG	117345	GP-58	THER	118173	GA-20	OREN
1160025	GP-66 ¹⁰	FIAT	1166A	GA-2146	GREY	1173481	GP-36	DUTZ	118173	GAK-20	OREN
1160025	GP-54 ¹¹	GULD	1167	G-152	NAP	1173481	GP-36	FIAT	1181749	GP-54 ¹¹	DUTZ
1160025	GP-66 ¹⁰	GULD	116-76-0469600	GPP-1122	ALFA	1173481	GP-36	IVEC	1181749	GP-66 ¹⁰	DUTZ
1160025	GP-54 ¹¹	IVEC	116-76-0469601	GPP-1122	ALFA	1173481	GP-36	KHDF	1181917	GP-1122	DUTZ
1160025	GP-66 ¹⁰	IVEC	116-76-0469602	GPP-1122	ALFA	1173481	GP-36	MANO	1182	GA-85	AMP
1160025	GP-54 ¹¹	KHDF	116-76-0603000	GP-9	ALFA	117370	G-1176	WAUK	1182	GA-85	BGA
1160025	GP-66 ¹⁰	KHDF	1167807	GA-16	ALCH	117382	GP-642	THER	1183	GP-871	NAP
1160025	GP-54 ¹¹	KRAM	1167807	GAK-16	ALCH	1174	GA-239	AMP	11840225	G-163	MBNZ
1160025	GP-66 ¹⁰	KRAM	1167807	GA-16	FIAT	1174	GA-239	BGA	11840425	G-163	MBNZ
1160025	GP-54 ¹¹	LIN	1167807	GAK-16	FIAT	117400	GA-2804 T	THER	11840525	G-163	MBNZ
1160025	GP-66 ¹⁰	LIN	1167808	GA-16	FIAT	117-4089	GPP-424	CATP	11840625	G-143	MBNZ
1160025	GP-54 ¹¹	OREN	1167808	GAK-16	FIAT	117434	GP-28 ⁵	DUTZ	11842225	G-162H	DAIM
1160025	GP-66 ¹⁰	OREN	1167808-3	GA-16	ALCH	117434	GP-430 ⁸	DUTZ	11842225	G-225	DAIM
1160033	G-1121	DUTZ	1167808-3	GAK-16	ALCH	117434	GP-28 ⁵	FIAT	11842225	G-162H	MBNZ
1160033	G-1121F	DUTZ	1168	G-238	NAP	117434	GP-430 ⁸	FIAT	11842225	G-225	MBNZ
1160033	G-1121	IVEC	1168398	G-1123	ABG	117434	GP-28 ⁵	KHDF	1184225	G-225	MBNZ
1160033	G-1121F	IVEC	1168398	G-1123	AHLM	117434	GP-430 ⁸	KHDF	11843325	G-133	MBNZ
1160033	G-1121	KHDF	1168398	G-1123	ATCO	1174391	GP-3816	DUTZ	11843325	G-989	MBNZ
1160033	G-1121F	KHDF	1168398	G-1123	DUTZ	1174391	GPP-1122	DUTZ	11843625	G-926	MBNZ
1160034	G-1123F	DUTZ	1168398	G-1123	EICH	1174391	GP-1122	KHDF	11843825	G-143	ASTR
1160034	G-1123F	FIAT	1168398	G-1123	FAHR	1174416	GP-3816	DUTZ	11843825	G-143	DAIM
1160034	G-1123F	IVEC	1168398	G-1123	IVEC	1174416	GP-3816	FIAT	11843825	G-143	MBNZ
1160034	G-1123F	KHDF	1168398	G-1123	KHDF	1174417	GP-28 ⁵	DUTZ	11843925	G-926	MBNZ
1160217	G-1121	DUTZ	1168403	G-1121F	DUTZ	1174417	GP-430 ⁸	DUTZ	11845625	G-133	DAIM
1160217	G-1121	EICH	1168403	G-1121F	FIAT	1174417	GP-28 ⁵	FIAT	11845625	G-989	DAIM
1160217	G-1121	FAHR	1168403	G-1121F	KHDF	1174417	GP-430 ⁸	FIAT	11845625	G-133	MBNZ
1160217	G-1121	FIAT	1168407	G-1123F	ABG	1174417	GP-28 ⁵	KHDF	11845625	G-989	MBNZ
1160217	G-1121	IVEC	1168407	G-1123F	ATCO	1174417	GP-430 ⁸	KHDF	11846625	G-750	MBNZ
1160217	G-1121	KHDF	1168407	G-1123F	DUTZ	1174421	GP-54 ¹¹	AGCO	11847490001	GA-24	MWM
1160217	G-1121	KRAM	1168407	G-1123F	FIAT	1174421	GP-66 ¹⁰	AGCO	1184-7490002	GA-20	MWM
1160217	G-1121	LANZ	1168407	G-1123F	IVEC	1174421	GP-54 ¹¹	DUTZ	1184-7490002	GAK-20	MWM
1160243	GP-1122	ABG	1168407	GP-1123F	KHDF	1174421	GP-66 ¹⁰	DUTZ	11849601	GP-54 ¹¹	DAIM
1160243	GP-1122	AHLM	1168408	G-1123F	DUTZ	1174421	GP-54 ¹¹	FIAT	11849601	GP-66 ¹⁰	DAIM
1160243	GP-1122	ATCO	1168408	G-1123F	KHDF	1174421	GP-54 ¹¹	FIAT	11849601	GP-54 ¹¹	MBNZ
1160243	GP-1122	CLAA	1168409	G-1123F	DUTZ	1174421	GP-54 ¹¹	KHDF	11849601	GP-54	MBNZ
1160243	GP-1122	CLRK	1168409	G-1123F	KHDF	1174421	GP-66 ¹⁰	KHDF	11849601	GP-66 ¹⁰	MBNZ
1160243	GP-1122	DUTZ	1168443	G-330	DUTZ	1174422	GP-1122	DUTZ	1185669	GA-4365	IPS
1160243	GP-1122	EICH	1168443	G-330	FIAT	1174422	GP-1122	KHDF	1186	G-984	NAP
1160243	GP-1122	FAHR	1168444	G-834	DUTZ	1174423	GP-1122	AGCO	1186034	GA-2740	IPS
1160243	GP-1122	FIAT	1168444	G-834	FIAT	1174423	GP-1122	DUTZ	118-6322	GP-761H	CATP
1160243	GP-1122	FLOM	1168444	G-834	IVEC	1174423	GP-1122	FIAT	1186400	GA-3566	IPS
1160243	GP-1122	GULD	1168444	G-834	KHDF	1174423	GP-1122	IVEC	1186430	GA-3566	IPS
1160243	GP-1122	IVEC	1168470	G-1143	DUTZ	1174423	GP-1122	KHDF	1187495	GA-2194	IPS
1160243	GP-1122	KHDF	1168470	G-1143	KHDF	117443	GA-6129	NEL	1188	GA-377	AMP
1160243	GP-1122	KRAM	1-1690	G-11816	CARR	1174484	GP-28 ⁵	DUTZ	1188	GA-377	BGA
1160243	GP-1122	LIN	1-1690	G-11816	TCLD	1174484	GP-430 ⁸	DUTZ	1188	G-813	NAP
1160243	GP-1122	MANO	1169078	GA-16	DUTZ	1174484	GP-28 ⁵	FIAT	11883618	GA-853R	VOLV
1160243	GP-1122	OREN	1169078	GAK-16	DUTZ	1174484	GP-430 ⁸	FIAT	1189	GA-372	AMP
1160243-894117	GP-1122	POCL	116918	GA-378	NEL	1174576	GP-54 ¹¹	FIAT	1189	GA-372	BGA
1160287	GP-1122	KRAM	1169466	G-31	KHDF	1174576	GP-66 ¹⁰	FIAT	1189	GP-81	NAP
1161	G-191	NAP	1169467	G-31	KHDF	1174576	GP-54	KHDF	1189	GP-9	NAP
1161003	GP-1122	DUTZ	1169468	G-31	KHDF	1174577	GP-54 ¹¹	FIAT	118H1105	GA-403	INGR
1161003	GP-1122	KHDF	1169469	G-31	DUTZ	1174577	GP-66 ¹⁰	FIAT	118H1105	GAK-403	INGR
116-12-0603000	GP-81	ALFA	1169469	G-31	FAHR	117528	G-296	THER	118H1106	GA-24	INGR
116-12-0603000	GP-9	ALFA	1169469	GP-31	FIAT	117528	G-296-B	THER	118H1144	GA-106 ⁹	INGR
1161212	G-191	DUTZ	1169469	G-31	IVEC	1175577	GP-66	KHDF	118H1154	GA-360	INGR
1161212	G-191	KHDF	1169469	G-31	KHDF	1176	G-33	NAP	118K	GP-1	ASAH
11614	G-1173	WEST	1-16A	GP-81	PARM	11767	G-31	WITT	119	GA-100	FACE
1161543	G-31	KHDF	1-16A	GP-9	PARM	1177	GA-679	AMP	1190	GP-3980	NAP
1161582	GP-1122	DUTZ	116MP	GP-3600	PROT	1177	GA-679	BGA	119005-35100	GP-462	YNMR
1161934	GP-54	DUTZ	117	G-225	DEL	117792	GG-261	FERI	1190153	GA-403	COCT
1161934	GP-54	IVEC	117	GA-26	ERO	117797	GA-229	NEL	1190153	GAK-403	COCT
11626	GA-16 ¹²	MACH	117	GA-77	UNN	1178	GA-680	AMP	1190153	GA-403	WHIT
11626	GAK-16 ²⁴	MACH	1170	GAK-1532	AMP	1178	GA-680	BGA	1190153	GAK-403	WHIT
116274	GP-81	CUSH	1170	GAK-1532	BGA	11781186	GP-54 ¹¹	DEMA	1190507-R91	G-1173	IHCO
116274	GP-9	CUSH	117079	GP-9	THER	11781186	GP-66 ¹⁰	DEMA	1190839	G-871	LANC
1162757	GP-54 ¹¹	DUTZ	11708550	G-3827	VOLV	1178753	GG-3	KHDF	119098	GP-62	THER
1162757	GP-66 ¹⁰	DUTZ	117201	GP-3985	REPC	117889	G-1173	QUIC	1190-99	GP-66	THER
1162757	GP-54 ¹¹	FIAT	1172346	GP-28 ⁵	DUTZ	117889	G-1173	WAUK	1190-99	GP-69	THER
1162757	GP-66 ¹⁰	FIAT	1172346	GP-430 ⁸	DUTZ	1179	GA-3424	AMP	1191	GP-310	NAP
1162757	GP-54 ¹¹	KHDF	1172346	GP-28 ⁵	FIAT	1179	GA-3424	BGA	1191	GP-3569	NAP
1162757	GP-66 ¹⁰	KHDF	1172346	GP-430 ⁸	FIAT	117900	G-1173	CLRK	1191-00	GP-88	THER
116285	G-276	THER	1172346	GP-28 ⁵	GMCX	117900	G-1173	WAUK	1191-01	GP-67	THER
116286	G-277	THER	1172346	GP-430 ⁸	GMCX	117924708	G-296	HANO	1191-02	GP-1108	THER
1162921	GP-54 ¹¹	DUTZ	1172346	GP-28 ⁵	KHDF	117924708	G-296-B	HANO	1191-03	GP-1107	THER
1162921	GP-66 ¹⁰	DUTZ	1172346	GP-430 ⁸	KHDF	117924708	G-813	HANO	119-11-3204500	GG-5 L	ALFA
1162921	GP-54 ¹¹	FIAT	1172520	GA-2194	IPS	117987	GP-6811	THER	119-11-3206100	GG-251	ALFA
1162921	GP-66 ¹⁰	FIAT	117264	G-278	THER	118	GA-6129	ERO	119-11-3206104	GG-251	ALFA
1162921	GP-54 ¹¹	KHDF	1173	GA-329	AMP	1180	GA-86	AMP	119117-12560	GA-853R	TAKI
1162921	GP-66 ¹⁰	KHDF	1173	GA-329	BGA	1180	GA-86	BGA	1191879	GA-403	VOLV
1163	G-152	NAP	117327	GA-31	NEL	1180392	GPP-1122	DUTZ	1191879	GAK-403	VOLV
11630417	GP-9	AMG	1173430	GP-54 ¹¹	DUTZ	1180392	GPP-1122	KHDF	1192657	GG-20	GRAD
11630417	GP-9	VICK	1173430	GP-66 ¹⁰	DUTZ	118047	GA-376	NEL	1192A		

Referencia Cruzada por Numero de Parte

Cross Reference by Part Number



Numero	Gonher	Fabricante	Numero	Gonher	Fabricante	Numero	Gonher	Fabricante	Numero	Gonher	Fabricante
Number	Gonher	Manufacturer	Number	Gonher	Manufacturer	Number	Gonher	Manufacturer	Number	Gonher	Manufacturer
1196	GA-251	AMP	12-00658	GG-246	VERA	1207	GA-891	AMP	122-0445	GP-3600	ONAN
1196	GA-251	BGA	12-00690	GG-19	VERA	1207	GA-891	BGA	122-0468	GP-3600	ONAN
1196	GP-66	NAP	12-00740	G-1121	VERA	1207219	GA-218	IPS	122-0469	GP-3600	ONAN
1196112	GA-33	BRM	12-00773	G-296	VERA	1207605H2	GP-2071W	HOUG	122-0550	GP-68	ONAN
119660-35150	GP-91	YNMR	12-00773	G-296-B	VERA	1207606-H1	GP-1011Q	IHCO	122-0582	GP-68	ONAN
1196-60-35150	GP-91	KOMA	12-00922	GG-196	VERA	1207606H2	GP-1011Q	HOUG	122-0608	GP-3600	ONAN
1196733	GA-403	COCT	12-00930	GPP-1122	VERA	12080	G-1175	KOHL	122-0645	GP-58	ONAN
1196733	GAK-403	COCT	12-00948	GG-45	VERA	1208548	GA-372	OSHK	122-0679	GP-58	ONAN
1196733	GA-403	WHIT	12-00955	GG-76	VERA	120876	GA-885	NLSN	122-0680	GP-3600	ONAN
1196733	GAK-403	WHIT	12-00963	GG-202	VERA	120877	G-750	CLRK	122-0681	GA-12	ONAN
1197	G-222	NAP	12-00971	GG-203	VERA	120877	G-750	CUMM	122-0703	GP-57	ONAN
1197946146	GA-24	HANO	12-00989	GG-203	VERA	120877	G-750	DIAM	122-0712	GP-390	ONAN
1198	GA-29	AMP	12-01044	GG-1	VERA	120877	G-750	EMCO	122-0737	GP-157	ONAN
1198	GA-29	BGA	12-01044	GG-4	VERA	120877	G-750	FORD	122-0756	GP-43	ONAN
119808-12520	GA-880R	TAKI	12-01069	G-1121	VERA	120877	G-750	KENW	122-0757	GP-53	ONAN
119808-12520	GA-880R	YNMR	12-01101	GG-94	VERA	120877	G-750	LETR	122-0777	GP-57	ONAN
119816	GG-19	AMP	12-01119	G-296	VERA	120877	G-750	WHIT	122-0827	GP-91	ONAN
11991879	GA-403	VME	12-01119	G-296-B	VERA	1209	GAK-625	AMP	122-0833	GP-91	ONAN
11991879	GAK-403	VME	12-01127	GG-204	VERA	120948702	GA-405	DAIM	122128H1	G-31	HOUG
119933786	G-297	VOLV	12-01135	GG-6	VERA	120948702	GA-405	MBNZ	122128-H1	G-31	IHCO
119933786	G-297-B	VOLV	12-01168	GG-45	VERA	12097262	GP-81	GREY	122-2449	GPP-14	ONAN
119935430	GP-54 ¹¹	VOLV	12-01176	GG-208	VERA	12097262	GP-9	GREY	1223	G-954	NAP
119935430	GP-66 ¹⁰	VOLV	12-01184	GG-196	VERA	12097262	GP-81	YALE	122407	G-31	RENA
11993545	GP-54 ¹¹	VOLV	12013	GP-28 ⁸	IPD	12097262	GP-9	YALE	122497	GP-149	GEHL
11993545	GP-66 ¹⁰	VOLV	12013	GP-430 ⁸	IPD	120-985	GP-58 ¹⁵	STES	1224973	G-200	JOY
11996228	GP-57	VOLV	12-01366	GG-194	VERA	120MP	GP-3980	PROT	1225001	G-1121	RENA
119962280	GP-556	VME	12-01416	GG-246	VERA	121	G-871	CRO	1225001	G-1121F	RENA
119962280	GP-556	VOLV	12-01416	GG-408	VERA	1210053	GP-81	GRAD	122500100	G-1121F	RENA
119990661	G-297	VOLV	12-01424	GG-188	VERA	1210AF	GAK-625	GREY	1225406	G-1121	PERK
119990661	G-297-B	VOLV	12-01432	GG-208	VERA	121120-12901	GA-33	YNMR	1225406	G-1121F	PERK
11A-18662-A	G-31	FORD	12-01457	GG-251	VERA	12-117	G-31	ACD	1225406	G-1121	RENA
11CX0004	G-236	CONT	12-01473	GG-76	VERA	1212	GA-892	AMP	1225406	G-1121F	RENA
11E170230	GPP-103	HYUN	12-01507	GG-251	VERA	1212	GA-892	BGA	122540600	G-1121F	RENA
11K	GP-91	ASAH	12-01523	GG-208	VERA	1212	G-112	NAP	1225776	G-870	RENA
11K115	G-870	LEYL	12-01531	GG-76	VERA	121253-12510	GA-33	YNMR	122577600	G-870	RENA
11N870110	GP-3937	HYUN	12-01564	GG-196	VERA	121256-12510	GA-33	YNMR	1225961	G-870	RENA
11O2501	GA-3425	REPC	12-01598	GG-185	VERA	1212621-H1	GP-57	FURU	122596100	G-870	RENA
11O31-391-2100	GAD-1	TSUC	12-01671	GG-63	VERA	1212621-H1	GP-57	IHCO	122596100	G-871	RENA
11R4	G-1173	COM	12-01721	GG-213	VERA	1212621-H1	GP-57	KOMA	1226	G-180	NAP
11R6	G-1174	COM	1201734-H1	GA-206	KOMA	1212622-H1	GP-53	FURU	1226176	G-870	RENA
11TS-18632	G-31	FORD	12-01754	GG-185	VERA	1212622-H2	GP-53	IHCO	122617600	G-871	RENA
11TS-18658-A	G-31	FORD	12-01788	GG-226	VERA	1212622-H3	GP-53	KOMA	1226727	G-870	RENA
11TS-18658-B	G-31	FORD	12-01838	GG-215	VERA	1212623-H1	GP-1101	IHCO	1226728	G-870	RENA
11TS-18662	G-31	FORD	12-01846	GG-79	VERA	121262H1	GP-57	HOUG	122672800	G-871	RENA
11W-18658	G-31	FORD	12019-02120-01	GP-1	NISS	1213	G-975	NAP	122731	G-6	HERC
11W-18658-A	G-31	FORD	12-01903	GG-8-L	VERA	12-132	G-33	ACD	122731	G-6	IHCO
11W-18658-B	G-31	FORD	12-01929	GG-189	VERA	12-132W	G-33	ACD	122731M1	G-6	IHCO
11W-18660	G-31	FORD	12-01937	GG-189	VERA	12134152	GA-27	FLXI	1228	GP-457	NAP
11W-18662-B	G-31	FORD	12-01945	GG-76	VERA	121-3661	GA-880R	CATP	1228022	GP-1	CHRY
11W-18662-W	G-31	FORD	12-01952	GG-181	VERA	1214	GP-3600	NAP	1228022	GP-9	MOTA
11W-18697	G-31	FORD	120198	GP-53	BLOU	12-141	G-200	ACD	1228080	GP-1	ROOT
11WA-1866-2B	G-31	FORD	12-02033	GG-220	VERA	121433	GP-462	GEHL	1228337-1	GP-66	JOY
11WA-1866-2W	G-31	FORD	12-02041	GG-217	VERA	121471001	GP-749	VERM	1228337-2	GP-66	JOY
11X15031A	GA-20	JOND	12-02090	GG-203	VERA	121482001	GP-52 ¹⁰	VERM	1228371	GP-66	JOY
11X15031A	GAK-20	JOND	12-02124	GG-1	VERA	121482001	GP-691 ⁴⁸	VERM	1228372	GP-66	JOY
12	GA-360	ERO	12-02124	GG-4	VERA	121491-001	GP-749	VERM	12291448	G-1121F	RENA
12	GG-7	FACE	12-02157	GG-208	VERA	121491011	GP-749	VERM	1229148	G-1121	RENA
12	GG-7	LONF	12-02181	GG-194	VERA	1214920-H1	GPP-11	IHCO	1229148	G-1121F	RENA
12	GP-68	PARM	12-02199	GG-63	VERA	1214920-H1	GPP-11	KOMA	122914800	G-1121F	RENA
12	GP-46	WIX	12-02215	GG-232	VERA	1214921-H1	GP-55	IHCO	122-A185	GP-81	ONAN
12 78 6800	GA-646	GMXC	12-02439	GG-246	VERA	1214921-H1	GP-55	KOMA	122-A185	GP-9	ONAN
12 78 6800	GA-646	SAAB	1202445-H1	G-1123F	KOMA	1214939-H1	G-566	HOUG	122-A323	GP-3600	ONAN
120	GA-113	AMP	12-02496	GG-181	VERA	1214939-H1	G-566	IHCO	122-B185	GP-81	ONAN
120	G-813	DEL	12-02504	GG-190	VERA	1214939-H1	G-566	KOMA	122-B185	GP-9	ONAN
120	GP-3980	PROT	12-02538	GG-142	VERA	1215	GP-58	NAP	122-B193	GP-1	ONAN
120	G-5000	WES	12-02546	GG-46	VERA	1215254	GA-216	IPS	122-B323	GP-3600	ONAN
12000-001	GP-1	TOYO	12-02561	GG-148	VERA	1216	GA-16 ¹¹²	AMP	122-B338	GP-58	ONAN
12000189	GA-106 ⁴⁶	VOLV	12-02603	GG-185	VERA	1216	GAK-16 ³⁴	AMP	122-P193	GP-1	ONAN
12000189	GA-326 ⁷¹	VOLV	12-02611	GG-189	VERA	1216	GA-16 ¹¹²	BGA	122-P229	G-330	ONAN
12000200	GP-53	VME	12-02611	GG-251	VERA	1216	GAK-16 ³⁴	BGA	122-P297	G-6	ONAN
12000200	GP-53	VOLV	12-02637	GG-214	VERA	1216	G-1173	COM	123	GA-27198	UNN
12000206	GP-55	VOLV	12-02645	GG-214	VERA	1216400521	GP-53	SISU	123085-C2	GP-34	IHCO
12-00021	GG-5-L	VERA	12-02652	GG-185	VERA	1216400531	GP-57	SISU	1231108	G-296	RENA
120015	GP-54 ¹¹	SIFO	12-02660	GG-261	VERA	1216400541	GP-3000	SISU	1231108	G-296-B	RENA
120015	GP-66 ¹⁰	SIFO	1202-8496	GP-54 ¹¹	ATCO	1216410100	G-750	SISU	123110800	G-296	RENA
12002743	G-1176	FARB	1202-8496	GP-66 ¹⁰	ATCO	12-1690	G-1123	THER	123110800	G-296-B	RENA
12002745	G-1143	FARB	1202-8496-00	GP-54 ¹¹	ATCO	1216907	GA-196	MTR	123110800	G-296	SAVI
12003653	GPP-14	VME	1202-8496-00	GP-66 ¹⁰	ATCO	12-1691	G-1123	THER	123110800	G-296-B	SAVI
12003653	GP-14	VOLV	1202-8497	GP-28 ⁸	ATCO	12-1726	G-6	THER	123123700	G-870	RENA
120036538	GPP-14	VME	1202-8497	GP-430 ⁸	ATCO	1217446	GA-139	IPS	1231357	G-870	RENA
12-00377	GG-1	VERA	1202-8497-00	GP-28 ⁸	ATCO	1218382301	GP-66	TCM	123135700	G-870	RENA
12-00377	GG-4	VERA	1202-8497-00	GP-430 ⁸	ATCO	12187	GP-53	STEI	123135700	G-871	RENA
12004	GP-81	IPD	120301	GP-1107	GALN	121965	GP-81	GEHL	1231544	G-11816	RENA
12004	GP-9	IPD	120302	GP-1105	GALN	121965	GP-9	GEHL	123154400	G-11816	RENA
12-00419	GG-196	VERA	120303	GP-69	GALN	122-01193	GP-310	ONAN	1231545	G-813	RENA
12-00427	GG-45	VERA	1203566	GA-2740	IPS	122-0126	G-6	ONAN	123154500	G-813	RENA
12-00476	GG-1	VERA	1203A	GA-206	GREY	122-0185	GP-81	ONAN	123239	G-1175	EUCL
12-00476	GG-4	VERA	1-204-459	GAC-11	FORD	122-0185	GP-9	ONAN	12326462	GP-171 ¹⁶	GMXC
12-00518	G-1121	VERA	120-483	GP-58 ¹⁵							

Numero	Gonher	Fabricante	Numero	Gonher	Fabricante	Numero	Gonher	Fabricante	Numero	Gonher	Fabricante
Number	Gonher	Manufacturer	Number	Gonher	Manufacturer	Number	Gonher	Manufacturer	Number	Gonher	Manufacturer
12337451	GA-174	GMCX	124217	G-296-B	HYST	126501	GA-405	SOFI	1279	GA-405	SULL
12337453	GA-176	GMCX	124217-12	G-296	HYST	126517	GP-1101	AUTC	128	GA-49	ERO
12337462	GAD-15	GMCX	124217-12	G-296-B	HYST	126517	GP-1101	BROK	12800	G-31	MIC
12337526	GA-2110	GMCX	124219	G-296	HOUG	126517	GP-1101	CASE	1281327-H1	GP-761H	IHCO
12337531	GA-2106	GMCX	124219	G-296-B	HOUG	126517	GP-1101	CLRK	1281327-H1	GP-761H	IHCO
12337780	GA-3901	GMCX	1243	GA-54	AMP	126517	GP-1101	CUMM	128132-H1	GP-761H	IHCO
12339037	GP-462	GMCX	1243	GA-54	BGA	126517	GP-1101	DATT	12-814	G-333	ACD
12339044	GG-243	GMCX	1243	GP-14	NAP	126517	GP-1101	DIAM	1282	GA-55	AMP
12339909	GP-462	GMCX	12430	G-236	VERS	126517	GP-1101	EMCO	128239	G-1175	EUCL
12339993	GP-156	GMCX	1243000H1	GG-1	HOUG	126517	GP-1101	EUCL	128299	GA-6880	NEL
12339994	GP-3682	GMCX	1243000H1	GG-4	HOUG	126517	GP-1101	FWDX	1283	GA-75	AMP
12339994	GP-37	GMCX	12430780	G-33	BAUD	126517	GP-1101	HOUG	1283	GA-75	BGA
12339995	GP-157	GMCX	124335	GA-20	KOEH	126517	GP-1101	IHCO	128407	GA-563	NEL
123501	GA-33	SOFI	124335	GA-20	KOEH	126517	GP-1101	KENW	12844	GP-81	PARM
12351012	GG-142	GMCX	124348	GA-24	KOEH	126517	GP-1101	LETR	12844	GP-9	PARM
123511	GA-33	SOFI	124357	GA-403	FWDX	126517	GP-1101	LINK	128494	GA-493 ¹⁰⁸	NEL
12351174	GP-54 ⁹⁰	GMCX	124357	GAK-403	FWDX	126517	GP-1101	MACK	12850069	GP-461	DUTZ
1235A	GA-4365	GREY	124381	GA-826	KOEH	126517	GP-1101	OLIV	12856	GP-3985	PARM
123601	GA-16	SOFI	1244483-H1	GP-1101	KOMA	126517	GP-1101	REOT	12856	GP-40	PARM
123601	GAK-16	SOFI	124450-35100	GP-91	YNMR	126517	GP-1101	STER	128609	GPP-1122	MANO
123611	GA-16	SOFI	1245	GA-2984	AMP	126517	GP-1101	WHIT	128637	GP-1101	CUMM
123611	GAK-16	SOFI	1245	GA-2984	BGA	1265176	GP-1101	ALCH	12865	GP-42	PARM
12361424	GG-146	GMCX	124550-35110	GA-24	YNMR	1265510-C1	GA-16	IHCO	12867	GP-149	PARM
123-6855	GA-712R	CATP	1246	GA-826	AMP	1265510-C1	GAK-16	IHCO	12868	GP-91	PARM
12-3692A	GP-1105	THER	1246	GA-826	BGA	1266091-H1	GA-326 ⁷¹	KOMA	128680	GP-54 ¹¹	MANO
12-3693A	GP-62	THER	124602	GA-892	SOFI	1266286	GP-81	VOLV	128680	GP-66 ¹⁰	MANO
12-3712A	GP-54	THER	124602S	GA-892	SOFI	1266286-2	GP-9	VOLV	1287	GA-3490	AMP
123716	GA-39	ADAM	124610-12620	GA-403	YNMR	126650	GA-436	SOFI	1287	GA-3490	BGA
123716	GA-39	AUST	124610-12620	GAK-403	YNMR	126650-12620	GA-20	YNMR	1-2870A	GP-28 ⁹	AUTV
123716	GA-39	AUSW	124617	G-500	CUMM	126650-12620	GAK-20	YNMR	1-2870A	GP-430 ⁸	AUTV
123716	GA-39	BROK	1247	GA-827	AMP	126652-12620	GA-360	YNMR	1-2870A	GP-28 ⁹	PARM
123716	GA-39	CHRY	1247	GA-827	BGA	126654-12620	GA-206	YNMR	1-2870A	GP-430 ⁸	PARM
123716	GA-39	CLRK	12476276	GG-266	GMCX	126654-12630	GA-106 ⁹⁵	YNMR	1-2870B	GP-28 ⁹	PARM
123716	GA-39	CUMM	1248	GP-9586	NAP	126654-12630	GA-326 ⁷¹	YNMR	1-2870B	GP-430 ⁸	PARM
123716	GA-39	DIAM	12482805	GA-164	GMCX	1266751-H2	GP-761H	DRES	1288	GA-2740	AMP
123716	GA-39	EMCO	124861	GA-251	NEL	1266751-H2	GP-761H	IHCO	1288	GA-2740	BGA
123716	GA-39	EUCL	1249	GAVW-2	AMP	126716CS	G-1175	HERC	1288	GP-3816	NAP
123716	GA-39	FORD	1249	GAVW-2	BGA	126716-CS	G-1175	WHIT	128889	GP-81	LEYL
123716	GA-39	GALN	1249058H1	GA-398	GALN	1267602	GA-6129	SOFI	128889	GP-9	LEYL
123716	GA-39	GMCX	1249058-H1	GA-398	DRES	1267900	GA-230	DUTZ	1288891A	GP-81	LEYL
123716	GA-39	GRAD	1249058-H1	GA-398	FURU	1267900	GA-230	FIAT	1288891A	GP-9	LEYL
123716	GA-39	HEND	1249058-H1	GA-398	IHCO	1267900	GA-230	IVEC	1289	GAD-3	AMP
123716	GA-39	HOUG	1249058-H1	GA-398	KOMA	1267900	GA-230	KHDF	1289	GAD-3	BGA
123716	GA-39	HUBR	124914-H1	GA-398	IHCO	1268	GP-9586	NAP	128903	G-33	CUMM
123716	GA-39	IHCO	124939-H1	G-566	IHCO	12682313	GG-251	BMW	12891	GP-28 ⁹	PARM
123716	GA-39	JOY	124K	GP-38	ASAH	1268821	G-31	CHRY	12891	GP-430 ⁸	PARM
123716	GA-39	KENW	125	GP-20	AUTV	1268821	G-31	WHIT	1289132	GP-2071W	DAF
123716	GA-39	LETR	125	G-836	DEL	1269483	G-31	CHRY	128971	GP-1122	MANO
123716	GA-39	LEYL	125	GP-20	PARM	1269483	G-31	WHIT	129	GP-3	DEL
123716	GA-39	LORA	1250323	GP-81	GRAD	12695483	GG-251	BMW	1290006-H1	GP-3000	FURU
123716	GA-39	MACK	1250534	GP-3816	BMW	127010	GA-20	SOFI	129010	GP-171	MANO
123716	GA-39	OLIV	1251528-H1	GA-679	IHCO	127010	GAK-20	SOFI	12-915	GP-26	ACD
123716	GA-39	OSHK	1251528-H1	GA-679	KOMA	127012	GA-24	SOFI	129150-12510	GA-33	YNMR
123716	GA-39	PETI	1251529-H1	GA-680	IHCO	127013	GA-360	SOFI	129150-35150	GP-40	YNMR
123716	GA-39	PETT	1251529-H1	GA-680	KOMA	127014	GA-229	SOFI	129150-35151	GP-6811	YNMR
123716	GA-39	WABC	125202	GA-361	SOFI	1271	G-330	NAP	12-916	GP-27	ACD
123716	GA-39	WHIT	125282A1	GP-462	CASE	127202	GA-360	SOFI	1291-A6	G-31	WHIT
1-23716	GA-39	WARD	1253	GP-122	NAP	1272051-C1	GP-761H	IHCO	1292	GAD-3	AMP
123730	GA-33	HYST	1253	G-338	NAP	1272051X1	GP-761H	CASE	1292	GAD-3	BGA
12-3746A	GP-67	THER	1254	GAK-216	AMP	1272051-X1	GP-761H	IHCO	12-921	GP-26	ACD
123801	GA-403	SOFI	1254	GAK-216	BGA	1272063X1	GP-761H	CASE	1293400121	GA-372	SISU
123801	GAK-403	SOFI	12544543	GA-768R	GMCX	1272063-X1	GP-761H	IHCO	1293400192	GA-377	SISU
123802	GA-98 ¹¹²	SOFI	12552	GG-48	ARMS	127211	GA-24	SOFI	129396	GA-377	NEL
123811	GA-403	SOFI	12554082	GPP-419	GMCX	12722-0PA-6661	GA-3490	HOND	1294153-H1	GP-3000	IHCO
123811	GAK-403	SOFI	125602	GA-6127	SOFI	127222	GA-360	SOFI	1294153-H1	GP-3000	KOMA
123828	GPP-1122	GEHL	125602S	GA-6127	SOFI	12722P1	GP-1	GRAV	129472	GA-372	NEL
12-3855A	GP-1107	THER	12-5702A	GP-88	THER	12722P1	GP-9	GRAV	1295	GAVW-4	AMP
1239	G-31	NAP	12-5703A	GP-67	THER	127239BS	G-1173	HERC	1295	GAVW-4	BGA
123922	GAK-625	SOFI	12-5704A	GP-1108	THER	127239-B5	G-1173	WHIT	12951	GP-58	PARM
124	GA-101	AMP	12-5705A	GP-1107	THER	1273010051	GP-1101	SISU	1295155-H1	GP-3000 ¹³	IHCO
124	GA-101	BGA	1257201	GPP-1122	VOLV	1273134-C91	GA-33	IHCO	1295155-H1	GP-3000 ¹³	KOMA
124	GA-113	FACE	1257201-2	GPP-1122	VOLV	127335	GA-229	SOFI	1295224-H1	GP-3000	KOMA
124001	GA-20	SOFI	1257305	GAVW-4	VOLV	1273400311	GP-14	SISU	1295263H1	GP-1012Q	HOUG
124001	GAK-20	SOFI	12573051	GAVW-4	VOLV	1273410200	G-1143 ⁹⁰	SISU	129544	GA-107	NEL
1240134	GP-110	GRAD	1257492	GP-310	VOLV	127355	GA-229	SOFI	129545	GA-209	NEL
1240388H1	GP-178	HOUG	1257492-7	GP-310	VOLV	12736	G-1173	COM	1296	GA-277	AMP
1240388-H1	GP-178	IHCO	1257492-7	GP-3569	VOLV	127382	GP-642	THER	1296	GA-277	BGA
1240388-H1	GP-178	INGR	12579143	G-49	GMCX	1274834	G-31	CHRY	12967020	GP-1010Q	VME
1240619-H1	GPP-1122	DRES	1257937-H1	GP-1010Q	FURU	1274838	G-31	CHRY	1296851	GPP-1291 ³⁹	DAF
1240619-H1	GPP-1122	HOUG	1257937-H1	GP-1010Q	KOMA	1274838	G-31	WHIT	1296851	PFF831 ⁴¹	DAF
1240619-H1	GPP-1122	IHCO	1257972H1	GP-55	IHCO	1275	GP-54	NAP	1296851	R 90 P ⁴²	DAF
1240619-H1	GPP-1122	KOMA	1258	GP-20	NAP	1275229-C1	GP-91	IHCO	1297646	G-33	EATN
1240621-H1	GP-178	KOMA	12580254	G-49	GMCX	127564	GP-53	KOMA	1297646	G-33	YALE
1240621-H2	GPP-1122	KOMA	12582255	GP-149	SATU	1275810	G-72	VOLV	1298	GA-4303	AMP
124085-35111	GP-462	YNMR	1258389H1	GP-2071W	IHCO	1275811	G-72	VOLV	1298	GA-4303	BGA
1240892H1	GP-43	HOUG	1258389-H1	GP-2071W	KOMA	1275811-6	G-72	VOLV	1298	GP-66	NAP
1240892-H1	GP-43	FURU	125846	GA-33	HYST	1276050	GG-246	VOLV	129887	GP-1122	MANO
1240892-H1	GP-43	IHCO	1259	GP-66	NAP	127622	GA-6129	SOFI	129888	GPP-1122	MANO
1240892-H1	GP-43	KOMA	12593333	G-765	GMCX	127644	GP-3	HYST	129971	GP-1122	MANO
1240893-H1	GP-2071W	KOMA	126126000 97	GP-212	STER	127644-12	GP-3	HYST	12A1191	G-870	LEYL
1241160-H1	GP-3000 ¹³	FURU	12-601P	G-119	DYNA	127674	GP-1101	CUMM	12A31	GA-20	LINK
1242	GA-3523	AMP	1261	GP-36	NAP	1276810C1	GP-66	CASE	12A31	GAK-20	LINK
1242	GA-3523	BGA	1261387H1	GP-2071W	IHCO	1276864	GG-246	VOLV	12A310	GA-20	LINK
1242	G-139	NAP	1261388H1	GP-1011Q	HOUG	1276864	GG-408	VOLV	12A310	GAK-20	LINK
124201	GA-24	SOFI	1261388-H1	GP-1011Q	KOMA	12777488	GA-71	VOLV	12ACN260-138	GP-171 ¹⁶	CONF
124217	G-296	HYST	126144	GA-49	SOFI	1279	G-5000	NAP	12AT10C	GP-66	PARK

Referencia Cruzada por Numero de Parte

Cross Reference by Part Number



Numero	Gonher	Fabricante	Numero	Gonher	Fabricante	Numero	Gonher	Fabricante	Numero	Gonher	Fabricante
Number	Gonher	Manufacturer	Number	Gonher	Manufacturer	Number	Gonher	Manufacturer	Number	Gonher	Manufacturer
12G400	GP-3816	LEYL	131401	GP-42	NIPT	132401	GA-3490	NIPT	13420025	GA-356 ¹⁰⁴	RAYG
12H1191	G-870	LEYL	131406	GP-462	NAP	1-32401-631	GP-57	ISUZ	13420025	GA-357 ¹⁰⁸	RAYG
12H3274	GP-81	LEYL	131406	GP-462	NIPT	132402	GA-2740	NIPT	13420031	GA-356 ¹⁰⁴	RAYG
12H3274	GP-9	LEYL	131470H1	G-33	HOUUG	13242R	G-1163	PALM	13420031	GA-357 ¹⁰⁸	RAYG
12K	GP-91	ASAH	131470-H1	G-33	IHCO	13247R	G-335	PALM	13420033	G-1175	RAYG
12P51	G-31	CORB	1315	GP-128	NAP	132502	GA-3490	NIPT	1342008	GA-20	RAYG
12R6	G-1174	COM	131-55-9401	G-870	ALFA	132504	GA-4325	NIPT	1342008	GAK-20	RAYG
12S	GA-24	ASAH	131-55-9402	G-870	ALFA	132514	GA-16	NIPT	13420089	GA-20	RAYG
12X11987A	GA-403	JOND	131-55-9405	G-870	ALFA	132514	GAK-16	NIPT	13420089	GAK-20	RAYG
12X11987A	GAK-403	JOND	131-55-9405-1	G-870	ALFA	132575302	GP-761H	CASE	13420176	GP-9586	RAYG
12X20957A	GA-98 ¹¹²	JOND	131-55-9411	G-870	ALFA	1326352	GA-4365	VOLV	13429	GP-3429	AUTV
13	GP-13	FACE	131-55-9701	G-870	ALFA	13263520	GA-4365	VOLV	13429	GP-3429	PARM
13	GP-44	WIX	131570	G-33	CUMM	132710	GAD-15	NIPT	134311	G-816	LEYL
13 71 1 247 405	GA-2193	BMW	131570H1	G-33	HOUUG	132716	GA-39	ADAM	1344	GP-462	NAP
13 72 1 247 404	GA-2193	BMW	131570-H1	G-33	IHCO	1327905	GP-31	HYST	1345	GP-3682	NAP
13 72 1 247 405	GA-2193	BMW	13-16	GP-81	NAP	1327905-12	GP-31	HYST	1346	GP-28	NAP
13 72 1 247 637	GA-2193	BMW	13-16	GP-9	NAP	13280185-M91	GP-28	MASY	1346028C1	GP-761H	CASE
130	GP-3	AUTV	131601	GP-58	NIPT	1328047	GAVW-4	VOLV	1346028-C1	GP-761H	IHCO
130	GP-3	PARM	131604	GP-156	NIPT	1328047-4	GAVW-4	VOLV	1347	GP-24 ²⁰	NAP
130	GP-2951	PROT	1316-04-8210	G-222	KOMA	1328126	GP-310	VOLV	1347	GP-462 ²⁴	NAP
130	GP-58	PROT	1316489	GP-46	HYST	13281611	GP-310	VOLV	1348	GP-2951	NAP
130	GA-105	UNN	1316602	GP-1	KALM	1328162	GP-171 ¹⁶	VOLV	1348	GP-58	NAP
130-00011	GA-3566	TOYO	1317	GA-89	AMP	1328691	GP-171 ¹⁶	HYST	134827	G-296	FORD
130-0002	GP-66	BEUT	1317	GA-89	BGA	1328691-12	GP-171 ¹⁶	HYST	134827	G-296-B	FORD
1302	G-870	NAP	13170900	GG-1	TALB	1328692	GP-81	HYST	1348MP	GP-58	NAP
13028	GP-34	CHAM	13170900	GG-4	TALB	1328692	GP-9	HYST	134K	GP-58	ASAH
1303 476	G-341	FORD	1318209	GA-33	ATWE	1328692-10	GP-81	HYST	135	GP-2015W	AMP
130336070	G-296	SHIB	131852	GA-403	GEHL	1328692-10	GP-9	HYST	135	GP-2015W	BGA
130336070	G-296-B	SHIB	131852	GA-403	GEHL	1329038-C1	GP-1011Q	IHCO	1350-16	G-31	MIC
130-3536	GP-2071W	ONAN	131-8902	GA-853R	CATP	1329038-C2	GP-1011Q	CASE	1350160	G-31	LINK
130-3537	GP-2071W	ONAN	1319	GP-81	NAP	1329039-C1	GP-2071W	CASE	1350-160	G-31	MIC
130-3539	GP-1011Q	ONAN	1319	GP-9	NAP	132M	G-33	REF	1350-260	G-31	MIC
130355	GP-81	JACO	131901	GP-3985	NIPT	133	GA-78	FACE	1350-3062	G-1175	LMC
130355	GP-9	JACO	131902	G-870	NIPT	1330	GA-42	AMP	13503166	G-296	LPM
1304106	GP-66	MIGH	131903	GP-3985	NIPT	1330310	G-31	CLAA	13503166	G-296-B	LPM
130-4678	GA-697R	CATP	1319159	GP-1122	DAF	1330311	G-31	CLAA	1350-3166	G-296-B	LPM
1304800-H1	GPP-14	KOMA	13198981	GA-967R	INGR	133035	G-1123F	CLAA	1350-3271	GG-20	LPM
1304953	GG-5 L	HYST	13198999	GA-966R	INGR	133038	G-1123	CLAA	1350-4110	GA-105	LPM
1305	G-836	NAP	1319A6	G-31	DIAM	1330380	G-1123	CLAA	1350-4126	GA-403	LPM
130555	GP-81	JACO	1319A6	G-31	REOT	133105	GG-76	NIPT	1350-4126	GAK-403	LPM
130555	GP-9	JACO	1319-A6	G-31	WHIT	13312	GP-31	FARB	13504222	GA-16	LPM
130573	GA-5648	CUMM	131A	GAD-3	GREY	13312	G-31	PHHR	13504222	GAK-16	LPM
1306-01-8790	G-222	KOMA	131K	GP-171	ASAH	13321268231	GG-251	BMW	1350-4234	GA-20	LPM
1306-01-8880	G-222	KOMA	132	GP-2071W	AMP	13321269548	GG-251	BMW	1350-4234	GAK-20	LPM
1306-04-8140	G-222	KOMA	132	GP-2071W	BGA	13321270038	GG-251	BMW	1350-4276	GA-33	LPM
130614	GP-3985	LEYL	132	GP-13	PROT	13321277481	GG-3	BMW	13504279	GA-33	LPM
1306331	GPP-1122	HYST	1320	GA-154	AMP	13321278272	GG-1	BMW	1350-4371	GA-44	LPM
1306530	GG-261	VOLV	1320	GA-154	BGA	13321278272	GG-4	BMW	1350-4505	GA-18	LPM
1306530-5	GG-261	VOLV	1320000	GP-3980	HYST	13321278481	GG-3	BMW	1350-5008	G-6	LPM
1306530-7	GG-261	VOLV	132000-093	GG-5 L	ISUZ	13321332756	GP-1122	BMW	13505015	GP-1	LPM
1307	GP-81	NAP	13201	GP-38	ISUZ	13-32-1-405-092	GG-409	BMW	1350-5015	GP-1	LPM
1307	GP-9	NAP	13201-1	GP-171	ISUZ	13-32-1-702-632	GG-351	BMW	1350-5050	GP-50	LPM
1309106	GP-66	MIGH	13201-2	GP-1	ISUZ	13-32-1-702-633	GG-351	BMW	1350-5084	GP-81	LPM
1309-108	GP-54	HYDR	13202	GP-38	ISUZ	13-32-1-702-635	GG-351	BMW	1350-5084	GP-9	LPM
1309-108	GP-66	HYDR	132023	GP-3816	GEHL	13-32-1-740-985	GG-351	BMW	1350-5133	G-33	LPM
130924116	G-1121	HANO	132024	GPP-1122	GEHL	13-32-1-740-986	GG-351	BMW	1350-5168	G-238	LPM
130924119	G-1121	HANO	1321	GA-3588	AMP	13322999000	GG-124	BMW	1350-5188	G-813	LPM
130959	GA-373	NEL	1321	GA-3588	BGA	13329063165	GG-251	BMW	1350-5190	GP-81	LPM
130K	GP-81	ASAH	132101	GAD-1	NIPT	1332A	GA-853R	GREY	1350-5190	GP-9	LPM
130K	GP-9	ASAH	13210-13211	GP-3682	NISS	133-3538	GP-1010Q	ONAN	13505269	GP-54	LPM
130MP	GP-2951	PROT	132102	GAD-3	NIPT	1334	GP-91	NAP	13505344	GP-3682	LPM
130MP	GP-58	PROT	132104	GA-4303	NIPT	133405	GP-1	NIPT	13505344	GP-37	LPM
131	GP-2071W	AMP	132108	GAD-15	NIPT	133405	GG-4	NIPT	1350-5344	GP-3682	LPM
131	GP-2071W	BGA	132110	GAD-30	NIPT	133407	GG-76	NIPT	1350-5344	GP-37	LPM
1310	GA-271	AMP	1321111	GP-66	ALCH	1334MP	GP-91	NAP	1350-5381	GP-3985	LPM
1310	GA-271	BGA	132117	GAD-30	NIPT	1335	GP-22	NAP	1350-5381	GP-40	LPM
1311	GA-70	BGA	132118	GA-16	NIPT	133501	GG-196	NIPT	13505764	GP-3600	LPM
131103	GP-171	NIPT	132118	GAK-16	NIPT	133537	G-1121F	CLAA	13506	GP-44	PARM
131105	GP-3682	NIPT	132120	GAD-1	NIPT	1335370	G-1121F	CLAA	1351AF	GA-16 ¹¹²	GREY
131107	GP-38	NIPT	13212-13213	GP-3682	NISS	1335679	GA-517R	SAAB	1351AF	GAK-16 ¹⁴	GREY
131111	GP-3682	NIPT	132301	GAD-3	NIPT	133575	G-813	HYST	13531	GP-3531 EXP	PARM
131112	GP-171	NIPT	132302	GA-2740	NIPT	133575-12	G-813	HYST	13535	GP-3980	PARM
1311281001	G-31	SAUR	1323-6002-6	GP-1122	ATCO	1336020	G-1123	CLAA	1354823	GP-310	FIAT
131141	GA-16	FORD	1324	GP-3985	NAP	1336188-C1	GP-81	IHCO	1354828	GP-1	FIAT
131141	GAK-16	FORD	13240-001	2010PM-OR ²	ISUZ	1336188-C1	GP-9	IHCO	1355360	GP-3000	ERF
131141	GA-16	NEWH	13240-001	2010TM-OR ²	ISUZ	1336290	G-143	CLAA	1355399	GP-2071W	ERF
131141	GAK-16	NEWH	13240-00-36	G-870	KOMA	133748	GP-1122	STIL	1355891	R120P	DAF
131-1812	GPP-421	CATP	13240016	G-870	KOMA	133755	GP-1	MANO	1356	GP-149	NAP
1312	GP-81	NAP	13240-016	G-870	ISUZ	1338	GP-462	NAP	1356338	GP-53	ERF
1312	GP-9	NAP	13240-016-000	G-870	HOND	133803	GG-76	NIPT	1357	GP-91	NAP
131206	GP-1	NIPT	13240-017	GP-38	ISUZ	1338438	GP-3985	HYST	1358	GP-91	NAP
131214	GP-156	NIPT	13240-021	GPP-11	ISUZ	1-3387A	GP-46	AUTV	135946120	GA-16	HANO
1312208	GA-694	HYST	13240-022	G-870	ISUZ	1-3387A	GP-46	PARM	135946120	GAK-16	HANO
131261275	GG-1	VOLK	13240-022-000	G-870	HOND	133K	GP-2951	ASAH	135946120	GA-16	MASY
131261275	GG-4	VOLK	13240032	GPP-111	GMCX	133K	GP-58	ASAH	135946120	GAK-16	MASY
131261275A	GG-1	VOLK	13240032	GPP-524	GMCX	134	GP-2071W	AMP	135A	GAD-1	GREY
131261275A	GG-4	VOLK	13240036	G-870	KOMA	134	GP-2071W	BGA	135P52690	GA-26	CHIC
131283	GA-891	NEL	13240-036	G-870	ISUZ	134	GP-81	PROT	136	GP-2071W	AMP
1313	GA-735 ¹²⁴	AMP	13240-036-000	G-870	HOND	134	GP-9	PROT	136	GA-55	FACE
1313	GA-735 ¹²⁴	BGA	1-32400-421	GP-57	ISUZ	134	GA-71	UNN	136	GP-28 ⁶	PROT
131302	GP-462	NIPT									

Numero	Gonher	Fabricante	Numero	Gonher	Fabricante	Numero	Gonher	Fabricante	Numero	Gonher	Fabricante
Number	Gonher	Manufacturer	Number	Gonher	Manufacturer	Number	Gonher	Manufacturer	Number	Gonher	Manufacturer
1361	GA-209	BGA	138267	GP-1101	ALCH	140-1188	GA-12	ONAN	140-B495	GA-44	ONAN
1361	GP-3682	NAP	138267-8	GP-1101	ALCH	140-1204	GA-16	ONAN	140-B601	GA-105	ONAN
136163	GP-81	MANO	138-3098	GPP-419	CATP	140-1204	GAK-16	ONAN	140-C1010	GA-16	ONAN
136163	GP-9	MANO	138-3100	GPP-425	CATP	140-1346	GA-229	ONAN	140-C1010	GAK-16	ONAN
136197	GS-1133	CUMM	1386	GP-3985	NAP	140-1376	GA-229	ONAN	140-P1055	GA-7	ONAN
136198	GC-1133	CUMM	138626	GP-1101	CUMM	140-1454	GA-403	ONAN	140-P1171	GA-16	ONAN
1362	GA-210	AMP	138627	GP-1101	AUTC	140-1454	GAK-403	ONAN	140-P1171	GAK-16	ONAN
1362	GA-210	BGA	138627	GP-1101	BROK	140-1540	GAK-1532	ONAN	140-P126	GA-44	ONAN
1362	GP-81	NAP	138627	GP-1101	CASE	140-1621	GAK-625	ONAN	140-P721	GA-33	ONAN
1362	GP-9	NAP	138627	GP-1101	CHRY	140-1631	GA-251	ONAN	140-P765	GA-33	ONAN
136201	GS-1133	CUMM	138627	GP-1101	CLRK	140-1735	GA-16	ONAN	141	GP-2022W	AMP
136255	GA-679	NEL	138627	GP-1101	CUMM	140-1735	GAK-16	ONAN	141	GP-2022W	BGA
136390	GA-18	NEL	138627	GP-1101	DIAM	140-1786	GA-16	ONAN	141	G-200	LEDR
1364	GP-38	NAP	138627	GP-1101	EMCO	140-1786	GAK-16	ONAN	141	G-200	OHFC
1365	GP-91	NAP	138627	GP-1101	EUCL	14018100152	GA-229	FLXI	1410546	GA-24	FMC
136500	G-500	CUMM	138627	GP-1101	FWDX	14018100164	GA-229	FLXI	1410546	GA-24	FORD
136500	G-500	IHCO	138627	GP-1101	HOUQ	14018100166	GA-229	FLXI	1410546	GA-24	JONB
136517	GP-1101	CUMM	138627	GP-1101	KENW	14018115	GA-229	FLXI	1410546	GA-24	LINK
1-3651A	GP-171	PARM	138627	GP-1101	LETR	140181152	GA-229	FLXI	1410903	GA-33	FMC
136551	G-566	CUMM	138627	GP-1101	LINK	140-1869	GA-16	ONAN	1410903	GA-33	FORD
1366	GP-58	NAP	138627	GP-1101	OLIV	140-1869	GAK-16	ONAN	1410903	GA-33	JONB
1366330	GA-33	FIAT	138627	GP-1101	REOT	140-1886	GA-26	ONAN	1410903	GA-33	LINK
1367	GP-3682	NAP	138627	GP-1101	WHIT	140-1888	GA-26 ¹²	ONAN	141151110	GP-81	KHDF
13675	GP-44	PARM	1387	GA-509 ¹⁴	AMP	140-1905	GAK-20	ONAN	141151110	GP-9	KHDF
136750	G-750	AUTC	1387	GA-509 ¹⁴	BGA	140-1932	GAK-20	ONAN	141141110	GP-81	KHDF
136750	G-750	CUMM	138767	GP-1101	CUMM	140200	GP-42	SATO	1411448	GP-490	GEHL
136750	G-750	ERF	1389	GA-679	AMP	140-2001	GA-27	ONAN	141151110	GP-81	KHDF
136750	G-750	FORD	1389	GA-679	BGA	140-2160	GA-588	ONAN	141-15-11-10	GP-81	DUTZ
136750	G-750	IHCO	1389450	GG-261	VOLV	140-2161	GA-589	ONAN	141-15-11-10	GP-9	DUTZ
136750	G-750	LETR	1389450-6	GG-261	VOLV	140-2162	GA-588	ONAN	141151201	GP-171	KHDF
136750	G-750	REOT	1389562	GG-246	VOLV	140-2225	GA-2984	ONAN	141-15-12-01	GP-171	DUTZ
136750	G-750	WHIT	1389562-8	GG-261	VOLV	140237	GA-27	BUCY	1411636	GA-33	YALE
13682	GP-3682	PARM	138K	GP-58	ASAH	140-2371	GA-2984	ONAN	141231	GA-27	FLXI
136853	G-330	HYST	139	GA-357	ERO	140302	G-31	OLIV	14123152	GA-27	FLXI
1369	GA-39	AMP	139 3640	GPP-1061	SAAB	14031	G-25	MEDO	14123153	GA-27	FLXI
1369	GA-39	BGA	1390	GP-42	NAP	140382	G-31	CLTA	14124	GA-27	FLXI
13691	GP-1011Q	LEYL	1390054	GP-1107	THER	140382	G-31	OLIV	141319	GA-680	NEL
13692	GP-2071W	LEYL	1390073	GP-1107	CARR	140382	G-31	WHIT	14133152	GA-27	FLXI
136K	GP-58	ASAH	1390084	GP-1107	THER	1404	G-333	NAP	141341-52	GA-27	FLXI
137	GP-1011Q	AMP	1390103	GP-1107	CARR	1404533	GA-49	OREN	141351-52	GA-27	FLXI
137-094-00-04	GA-2192	CHRY	139096	G-500	CUMM	1404840	GA-20	JONB	1413608	GP-1013Q	OREN
137-094-00-04	GA-2192	MBNZ	139096	G-750	CUMM	1404840	GAK-20	JONB	1413768	GA-563	OREN
137-094-01-04	GA-2192	CHRY	139097	G-1143	CUMM	1404880	GA-20	JONB	1414541	G-296	OREN
137-094-01-04	GA-2192	MBNZ	139097	G-1143	YALE	1404880	GAK-20	JONB	1414541	G-296-B	OREN
13-71-1-247-465	GA-2110	BMW	139097Y	G-1143	CUMM	1404920	GA-20	JONB	14174	G-31	READ
13711736675	GAVW-622	BMW	139097Y	G-1143	KOMA	1404920	GAK-20	JONB	141758	GP-310	STIL
13-71-2-960-105	GA-2194	BMW	13909Y	G-1143	KOMA	140-495	GA-44	ONAN	1419010	GA-33	JONB
137147	GP-1122	MANO	1391	GP-490	NAP	140516010	GP-38	ALAS	1419132	GPP-11	OREN
13717505007	GA-241	BMW	1391A6	G-31	DIAM	140516010	GP-38	SHIB	1419455	GA-20	FORD
13717526008	GA-241	BMW	1391A6	G-31	REOT	140516030	GP-42	ALAS	1419455	GAK-20	FORD
1372	GP-68	NAP	1392	GP-23	DEL	140516030	GP-42	FORD	14195	GA-33	CHAM
13-72-1-247-465	GA-2110	BMW	1392	GP-3531	EXP	140516030	GP-42	SHIB	141A	GA-71	GREY
13721257764	GA-3300	BMW	1392611	GP-462	THER	140516040	GP-38	FORD	142	GP-42	PROT
13-72-1-702-012	GA-2194	BMW	1393	GP-430 ⁸	NAP	140516040	GP-38	SHIB	142	GA-3566	UCAL
13721261254	GA-2194	BMW	1393	GP-58 ⁸	NAP	140516060	GP-38	FORD	14200	GG-123	CAC
13721271254	GA-2194	BMW	1394	GP-157	NAP	140516060	GP-38	SHIB	14201	GG-6	CAC
13721278139	GA-2194	BMW	1395	GP-157	NAP	140516090	GP-38	SHIB	14202	GG-7	CAC
13721289650	GA-2110	BMW	139564	GA-5648	CUMM	140516110	GP-38	SHIB	14203	GG-19	CAC
13-72-1-702-907	GA-2105	BMW	139565	GA-5648	CUMM	140516120	GP-42	SHIB	1420377-M91	GA-403	MASY
13721707050	GA-2110	BMW	1396	GP-156	NAP	140516130	GP-9	MASY	1420377-M91	GAK-403	MASY
13721715880	GA-2110	BMW	13963	GP-81	PARM	140516170	GP-171	SHIB	14208	GG-1	CAC
13721715881	GA-2110	BMW	13963	GP-9	PARM	140516180	GP-3600	SHIB	14208	GG-4	CAC
13721730946	GA-2114	BMW	139690	GA-5648	CUMM	140516190	GP-3682	PERK	142-2093	G-152	CATP
13-72-1-738-462	GA-2114	BMW	13980	GP-3980	PARM	140516190	GP-38	SHIB	142100	GA-371	NEL
13-72-1-742-201	GA-2105	BMW	13-984	G-33	STEI	140516250	GP-156	PERK	1421022	GA-517R	SAAB
13721744869	GA-2114	BMW	13-984T1	G-33	STEI	140517000	GP-3600	PERK	14213	GG-45	CAC
1372MP	GP-68	NAP	13985	GP-3985	PARM	14058	G-25	MEDO	14215-003	GAD-1	ISUZ
1373	G-128	AMP	1399494	GP-737	DAF	140-60-300-30	G-870	ALFA	1-42150-030	GAD-1	ISUZ
1373	G-128	BGA	1399760	GP-548	DAF	140-60-300430	G-870	ALFA	14215-006	GA-20	ISUZ
1373 667	GA-27161	FORD	139A	GA-2740	GREY	140617	GP-1101	CUMM	14215-006	GAK-20	ISUZ
13736	G-1175	ALCH	1394	GA-1173	COM	1406849	GA-27	JONB	14215-014	GA-33	ISUZ
1374	GP-58	NAP	1396	G-1174	COM	1406961	GA-27	FMC	14215-017	GAD-30	ISUZ
13766	GP-3766	PARM	1398	G-1175	COM	1406961	GA-27	FORD	14215-116	GA-758	ISUZ
1377	GA-107	BGA	14	GA-24	ERO	1406961	GA-27	JONB	14215-126	GAD-1	ISUZ
1377-59	G-870	POCL	14	GP-24 ²⁶	WIX	1406961	GA-27	LINK	14215-132	GA-20	ISUZ
137769	GP-3985	KALM	14	GP-462 ²⁴	WIX	14071064	G-294	GMCC	14215-132	GAK-20	ISUZ
1378	GP-212	NAP	140	GP-40	PROT	14071934	G-294	GMCC	14215-133	GAD-1	ISUZ
13780-61A00	GA-166	SUZU	140	GA-4325	UNN	14075347	G-294	GMCC	14215-134	GA-27	ISUZ
13780-61AA0	GA-166	SUZU	1400	GA-360	AMP	140773H1	G-33	HOUQ	14215-137	GAD-30	ISUZ
13780-65D10	GA-244	SUZU	1400	GA-360	BGA	140773H1	G-33	IHCO	14215-144	GA-26	ISUZ
13780-77E00	GA-244	SUZU	14000436	GP-34	MCNE	1408923	GP-57	OREN	14215-152	GA-16	ISUZ
13780-77E00	GA-244	SUZU	140-0126	GA-44	ONAN	1409260	GAK-403	JONB	14215-152	GAK-16	ISUZ
13780-85200	GA-328	SUZU	140024	GG-48	ALMN	1409266	GAK-403	FMC	14215-183	GA-403	ISUZ
13780-86000	GA-142	DENS	1400318	GP-54	ALST	1409266	GAK-403	FORD	14215-183	GAK-403	ISUZ
13780-86000	GA-142	NIPP	140033	GP-58	ALMN	1409266	GAK-403	JONB	14215-193	GA-24	ISUZ
13780-86000	GA-142	SUZU	1400354	GP-81	ALST	1409266	GAK-403	LINK	14215-196	GA-403	ISUZ
13780-860A0	GA-142	SUZU	140-0419	GA-44	ONAN	1409488	GA-20	FMC	14215-196	GAK-403	ISUZ
13786	GP-562	PARM	140-0495	GA-44	ONAN	1409488	GAK-20	FMC	14215-604	GAD-3	ISUZ
137A	GAD-3	GREY	140-0601	GA-105	ONAN	1409488	GA-20	FORD	1422	GA-758	AMP
138	GP-24 ²⁶	PROT	140-0765	GA-33	ONAN	1409488	GAK-20	FORD	1423	GA-373	AMP
138	GP-462 ²⁴	PROT	1401	GA-361	AMP	1409488	GA-20	JONB	1423	GA-373	BGA
138032	GP-432	NEUS	1401	GA-361	BGA	1409488	GAK-20	JONB	1423414	GA-516R	SAAB
1381	GP-91	NAP	14010	G-25	MEDO	1409488	GA-20	LINK	1423477	G-296	FORD
138196	G-296	MANO	140-1010	GA-16	ONAN	1409488	GAK-20	LINK	1423477	G-296-B	FORD
138196	G-296-B	MANO	140-1010	GAK-16	ONAN	1409921	GP-54 ¹⁹	OREN	1423477	G-296	HYST
138196	G-296-B	MANO	140-1055	GA-7	ONAN	1409921	GP-66 ¹⁹	OREN	1423477	G-296-B	HYST

Referencia Cruzada por Numero de Parte

Cross Reference by Part Number



Numero	Gonher	Fabricante	Numero	Gonher	Fabricante	Numero	Gonher	Fabricante	Numero	Gonher	Fabricante
Number	Gonher	Manufacturer	Number	Gonher	Manufacturer	Number	Gonher	Manufacturer	Number	Gonher	Manufacturer
14240-030	GG-196	EXXE	1444-85	GA-2160	PEUG	1-457-429-117	G-813	BOG	1-457-429-957	GA-277	BOG
142413	GP-81	GILS	1444-86	GA-2173	PEUG	1-457-429-120	G-330	BOG	1-457-429-961	GAVW-4	BOG
142413	GP-9	GILS	1444-A4	GA-2156	CITR	1-457-429-122	G-971	BOG	1-457-429-964	GA-2110	BOG
14246	GA-357	ERO	1444-A7	GA-2160	CITR	1-457-429-146	G-870	BOG	1-457-429-969	GA-467	BOG
1426	G-33	NAP	1444-A9	GA-2156	PEUG	1-457-429-161	G-31	BOG	1-457-429-971	GAVW-2	BOG
1427	GA-70	CHEK	1444-E7	GA-2123	PEUG	1-457-429-180	G-31	BOG	1-457-429-973	GA-277	BOG
1427	GA-70	NAP	1444-F6	GA-2123	CITR	1-457-429-180-001	G-31	BOG	1-457-429-975	GA-405	BOG
1427510	GPP-11	OREN	1444-F7	GA-2123	PEUG	1-457-429-181	G-31	BOG	1-457-429-976	GA-360	BOG
142784	GP-110	CUMM	1444G2	GA-2123	CITR	1-457-429-205	G-11816	BOG	1-457-429-977	GA-106 ⁴⁶	BOG
1427991	GA-403	AUTC	1444-G9	GA-2159	PEUG	1-457-429-209	G-11816	BOG	1-457-429-977	GA-326 ⁷¹	BOG
1427991	GAK-403	AUTC	1444-H3	GA-2159	PEUG	1-457-429-215	G-296	BOG	1-457-429-984	GA-4365	BOG
1427991	GA-403	BAKR	1444-J5	GA-2159	CITR	1-457-429-215	G-296-B	BOG	1-457-429-994	GAVW-4	BOG
1427991	GAK-403	BAKR	1444-K4	GA-2121	CITR	1-457-429-219	G-296	BOG	1-457-429-997	GAVW-4	BOG
142799-1	GA-403	WHIT	1444-P1	GA-2173	CITR	1-457-429-219	G-296-B	BOG	1-457-431-020	G-1123F	BOG
142799-1	GAK-403	WHIT	1444-P9	GA-134	CITR	1-457-429-225	GG-1	BOG	1-457-431-021	G-1123F	BOG
1428	GA-229	AMP	1444-Q5	GA-2182	CITR	1-457-429-225	GG-4	BOG	1-457-431-030	G-1121F	BOG
1428	GA-229	BGA	1444W2	GA-215	PEUG	1-457-429-245	G-31	BOG	1-457-431-086	G-1121	BOG
142879	G-33	CUMM	1445-02	GA-2156	PEUG	1-457-429-246	G-31	BOG	1-457-431-101	G-1123	BOG
142897	G-33	CUMM	1445-08	GA-2156	PEUG	1-457-429-255	G-143	BOG	1-457-431-113	G-133	BOG
1429961-M1	G-870	MASY	1446675-M91	GP-31	MASY	1-457-429-354	G-1123F	BOG	1-457-431-113	G-989	BOG
143	GP-81	AUTV	144-6691	GP-761H	CATP	1-457-429-359	G-1121F	BOG	1-457-431-115	G-1123	BOG
143	GP-9	AUTV	1447	GP-761H	NAP	1-457-429-440	G-836	BOG	1-457-431-116	G-1123F	BOG
143	GP-81	PARM	1447031	GP-31	MASY	1-457-429-441	G-836	BOG	1-457-431-144	G-1123F	BOG
143	GP-9	PARM	1447031-M1	GP-31	MASY	1-457-429-445	G-834	BOG	1-457-431-147	G-1121F	BOG
143	GA-3637	UNN	1447031M91	GP-31	MASY	1-457-429-449	G-834	BOG	1-457-431-156	G-1123F	BOG
143110	GP-14	GURI	1447048	GP-1	MASY	1-457-429-465	G-33	BOG	1-457-431-158	G-1121F	BOG
1431A6	G-31	DIAM	1447048-M1	GP-1	MASY	1-457-429-469	G-33	BOG	1-457-431-159	G-1123F	BOG
1431A6	G-31	REOT	1447048-M92	GP-1	MASY	1-457-429-470	G-191	BOG	1-457-431-164	G-1121F	BOG
1431-A6	G-31	WHIT	1447082-M1	GP-3600	MASY	1-457-429-474	G-191	BOG	1-457-431-169	G-1121F	BOG
143-2003	GA-2106	DENS	1447082-M91	GP-3600	MASY	1-457-429-490	G-870	BOG	1-457-431-190	G-1123F	BOG
143-2007	GA-471	DENS	1447982-M1	GP-1	MASY	1-457-429-493	G-870	BOG	1-457-431-202	G-1123	BOG
143-2009	GA-2106	DENS	1448	GP-761H	NAP	1-457-429-494	G-870	BOG	1-457-431-223	G-31	BOG
143-2011	GA-5466	DENS	144808	GP-149	KALM	1-457-429-500	G-870	BOG	1-457-431-240	G-1123	BOG
143-2015	GA-2740	DENS	1448080	GP-54 ¹¹	OREN	1-457-429-502	G-870	BOG	1-457-431-250	G-1123	BOG
143-2020	GA-386	DENS	1448080	GP-66 ¹⁰	OREN	1-457-429-503	G-870	BOG	1-457-431-261	G-1121	BOG
143-2021	GA-382	DENS	1449	GP-761H	NAP	1-457-429-515	G-225	BOG	1-457-431-261	G-1121	ROB
143-2022	GA-381	DENS	145	G-834	DEL	1-457-429-550	G-834	BOG	1-457-431-261-400	G-1121	BOG
143-2037	GA-390	DENS	1450	GP-761H	NAP	1-457-429-555	G-834	BOG	1-457-431-270	G-1123	BOG
143-2038	GA-4958	DENS	1451	GA-493 ¹⁰⁸	AMP	1-457-429-556	G-834	BOG	1-457-431-271	G-1123	BOG
143-2044	GA-7142	DENS	1451	GA-493 ¹⁰⁸	BGA	1-457-429-557	G-834	BOG	1-457-431-273	G-1123	BOG
143-2046	GA-607	DENS	1451	GP-761H	NAP	1-457-429-559	G-834	BOG	1-457-431-300	G-1121	BOG
143-2048	GA-605	DENS	1451200	GP-761H	OREN	1-457-429-590	G-191	BOG	1-457-431-311	G-1121	BOG
143-2051	GA-362	DENS	145166	GA-16	OREN	1-457-429-600-001	G-133	BOG	1-457-431-313	G-1123	BOG
143-2060	GA-384	DENS	145166	GAK-16	OREN	1-457-429-600-001	G-989	BOG	1-457-431-320	G-1123	BOG
143-2065	GA-244	DENS	1452	GP-310	NAP	1-457-429-638	G-963	BOG	1-457-431-325	G-1121	BOG
143-2070	GA-142	DENS	1452	GP-3569	NAP	1-457-429-675	GP-1122	BOG	1-457-431-326	G-1123	BOG
143-2072	GA-195	DENS	14523962	GP-462	VOLV	1-457-429-678	G-297	BOG	1-457-431-336	G-1123	BOG
143-2076	GA-5466	DENS	14529	G-1123	OK	1-457-429-678	G-297-B	BOG	1-457-431-356	G-31	BOG
143-2080	GA-6690	DENS	1452-92-2430	G-191	KOMA	1-457-429-678-650	G-297	BOG	1-457-431-360	G-1123	BOG
143-2081	GA-322	DENS	1452MP	GP-3569	NAP	1-457-429-678-650	G-297-B	BOG	1-457-431-426	G-225	BOG
143-2083	GA-286	DENS	145321	GA-616	GURI	1-457-429-705	G-870	BOG	1-457-431-428	G-813	BOG
143-2086	GA-264	DENS	145322	GA-398	GURI	1-457-429-706	G-870	BOG	1-457-431-429	G-330	BOG
143-2092	GA-139	DENS	1453887M91	G-870	LAND	1-457-429-709	G-870	BOG	1-457-431-458	G-1121F	BOG
143-2100	GA-3566	DENS	145388-M91	G-870	MASY	1-457-429-740	G-143	BOG	1-457-431-479	G-31	BOG
1432-87	G-296	POCL	145-4501	GPP-423	CATP	1-457-429-740-001	G-143	BOG	1-457-431-481	G-31	BOG
1432-87	G-296-B	POCL	1454-92-2430	G-191	KOMA	1-457-429-741	G-143	BOG	1-457-431-485	G-31	BOG
1433697	GA-697R	DAF	1454-93-2420	G-191	KOMA	1-457-429-750	G-870	BOG	1-457-432-100	GA-71	BOG
14363A	G-1173	HERC	1454-93-2430	G-191	KOMA	1457429762	G-25	BOG	1-457-432-106	GA-200	BOG
14363-A	G-1173	WHIT	1455	GP-761H	NAP	1-457-429-777	GAVW-120	BOG	1-457-432-106	GA-218	BOG
143644	GA-24	FORD	1456	GP-761H	NAP	1-457-429-800	GAD-1	BOG	1-457-432-108	GA-230	BOG
143644	GA-24	NEWH	14564103	GP-54 ¹¹	RENA	1-457-429-800-850	GAD-1	BOG	1-457-432-157	GAVW-2	BOG
1437	GA-109	AMP	14564103	GP-66 ¹⁰	RENA	1-457-429-801	GAD-3	BOG	1-457-432-193	GAK-625	BOG
1437	GA-109	BGA	145699	GA-6129	NEL	1-457-429-806	GA-2740	BOG	1457432284	GA-516R	BOG
1437991	GA-403	BAKR	1457	GP-761H	NAP	1-457-429-806-850	GA-2740	BOG	1-457-433-004	GA-2114	BOG
1437991	GAK-403	BAKR	145700	GA-106 ⁴⁶	NEL	1-457-429-807	GAD-3	BOG	1-457-433-023	GAVW-121	BOG
14386	GP-156	PARM	145700	GA-326 ⁷¹	NEL	1-457-429-807-850	GAD-3	BOG	1457433102	GAVW-617	BOG
1439204	GP-2071W	OREN	145701	GA-6127	NEL	1-457-429-810	GA-3490	BOG	1-457-433-200	GA-33	BOG
14397-A	GP-50	WHIT	145702	GA-6128	NEL	1-457-429-810-850	GA-3490	BOG	1-457-433-202	GA-361	BOG
144	G-11816	DEL	1-457-429-005	GA-200	BOG	1-457-429-812	GA-3490	BOG	1-457-433-203	GA-206	BOG
144	GP-44	PARM	1-457-429-005	GA-218	BOG	1-457-429-813	GAD-3	BOG	1-457-433-061	GPP-1122	BOG
144	GP-3531 EXP	PROT	1-457-429-007	GA-200	BOG	1-457-429-816	GA-2740	BOG	1-457-433-612	GAVW-121	BOG
144	GA-4958	UCAL	1-457-429-007	GA-218	BOG	1-457-429-816-850	GA-2740	BOG	1457433781	GA-2174	BOG
144109	G-295	GURI	1-457-429-007-850	GA-200	BOG	1-457-429-820	G-162H	BOG	1-457-434-011	G-296	BOG
1442	G-191	NAP	1-457-429-007-850	GA-218	BOG	1-457-429-822	GA-2110	BOG	1-457-434-011	G-296-B	BOG
144301	G-296	GURI	1-457-429-013	GA-71	BOG	1-457-429-868	GA-230	BOG	1-457-434-016	G-296	BOG
144301	G-296-B	GURI	1-457-429-013-850	GA-71	BOG	1-457-429-877	GAVW-622	BOG	1-457-434-016	G-296-B	BOG
1444.V2	GA-114	PEUG	1-457-429-027	GA-230	BOG	1-457-429-894	GAVW-622	BOG	1-457-434-017	G-296	BOG
14440-001	GA-361	EXXE	1-457-429-033	GA-403	BOG	1-457-429-899	GA-467	BOG	1-457-434-017	G-296-B	BOG
14440-002	GA-206	EXXE	1-457-429-033	GAK-403	BOG	1-457-429-907	GA-200	BOG	1-457-434-050	GP-1122	BOG
14440-004	GA-106 ⁴⁶	EXXE	1-457-429-035	GA-436	BOG	1-457-429-907	GA-218	BOG	1-457-434-052	GP-1122	BOG
14440-004	GA-326 ⁷¹	EXXE	1-457-429-041	GA-277	BOG	1-457-429-907-850	GA-200	BOG	1-457-434-053	GP-1122	BOG
14440-006	GA-6129	EXXE	1-457-429-042	GA-3425	BOG	1-457-429-907-850	GA-218	BOG			

Numero	Gonher	Fabricante	Numero	Gonher	Fabricante	Numero	Gonher	Fabricante	Numero	Gonher	Fabricante
Number	Gonher	Manufacturer	Number	Gonher	Manufacturer	Number	Gonher	Manufacturer	Number	Gonher	Manufacturer
1-457-434-092	GP-1122	BOG	1470275	GAK-20	FAUN	1494	GA-4828	AMP	1504	GG-1	PAR
1-457-434-093	GPP-1122	BOG	1470319	GP-54 ¹¹	FAUN	1494	GA-4828	BGA	1504	GG-4	PAR
1-457-434-094	GPP-1122	BOG	1470319	GP-66 ¹⁰	FAUN	1494	GP-761H	NAP	15040340W	GP-54 ¹¹	BAUD
1-457-434-096	G-1121	BOG	147037	GP-5	HYST	1495	GP-761H	NAP	15040340W	GP-66 ¹⁰	BAUD
1-457-434-097	GPP-1122	BOG	147037-12	GP-5	HYST	149534	GA-33	CASE	15040390W	GP-54 ¹¹	BAUD
1-457-434-099	GPP-1122	BOG	1470394	GP-1122	FAUN	149534	GA-33	DAVS	15040390W	GP-66 ¹⁰	BAUD
1-457-434-103	GPP-1122	BOG	1470637	GA-405	FAUN	1495414	GA-106 ⁴⁶	MASY	150-4140	GP-81	CATP
1-457-434-105	GPP-1122	BOG	1470695	GA-405	FAUN	1495414	GA-326 ⁷¹	MASY	150-4140	GP-9	CATP
1-457-434-106	GPP-1122	BOG	1470696	GA-467	FAUN	1495414M91	GA-206	MASY	1504256	G-31	GMCX
1-457-434-107	GPP-1122	BOG	1470718	GA-405	FAUN	1495439-M91	GA-360	MASY	1504314	G-31	GMCX
1-457-434-110	GPP-1122	BOG	1470730	GA-49	FAUN	1495439-M91	GA-361	MASY	1504347	G-31	GMCX
1-457-434-112	GP-1122	BOG	1470827	GP-1122	BOG	1495698	G-870	FORD	1504440	G-31	GMCX
1-457-434-116	GPP-1122	BOG	147221	G-870	CLAA	14957	GP-408	MERC	15047001	GP-1122	VERM
1-457-434-118	GPP-1122	BOG	1472210	G-870	CLAA	1495705	G-870	FORD	1505190	GA-209	FRAN
1-457-434-120	GP-1122	BOG	147222	GP-31	CLAA	1496	GP-761H	NAP	1505193	GA-210	FRAN
1-457-434-120-889	GP-1122	BOG	1472220	GP-31	CLAA	14967	GP-157	PARM	15052	GA-33	CHAM
1-457-434-121	GP-1122	BOG	147223	GP-1	CLAA	1498	GP-761H	NAP	1505-21	GP-54 ¹¹	POCL
1-457-434-150	GP-1122	BOG	1472230	GP-1	CLAA	1498017	GP-22	FORD	1505-21	GP-66 ¹⁰	POCL
1-457-434-154	GP-1122	BOG	147224	GP-1	CLAA	1498019	GP-46	FORD	1505-26	GP-1122	POCL
1-457-434-158	GPP-1122	BOG	1472240	GP-1	CLAA	1498021	GP-171	FORD	15053	GG-5 L	SEAB
1-457-434-159	GPP-1122	BOG	147225	GP-1	CLAA	1498022	GP-3816	FORD	1505310	G-31	GMCX
1-457-434-164	GP-1122	BOG	1472250	GP-1	CLAA	1498030	GP-50	FORD	1505-45	G-33	POCL
1-457-434-180	GP-110	BOG	1473017	G-296	ALST	1498432	GA-71	FORD	1505467	GP-93	FRAN
1-457-434-200	G-297	BOG	1473017	G-296-B	ALST	149-849	G-1176	ONAN	1505468	GP-92	FRAN
1-457-434-200	G-297-B	BOG	147362A	G-1173	HERC	149-855	G-1174	ONAN	1505-48	G-1175	POCL
1-457-434-201	G-296	BOG	147363A	G-1173	HERC	1499470	GP-3600	OREN	1505-49	GA-24	POCL
1-457-434-201	G-296-B	BOG	147363A	G-1173	OLIV	149-955	G-1175	ONAN	1505518	GP-53	FRAN
1-457-434-205	GG-189	BOG	147363B	G-1173	HERC	1499695	GA-467	OREN	150561	GA-20	OREN
1-457-434-900	G-296	BOG	1475	NAP	G-6	149-A1083	G-1173	ONAN	150561	GAK-20	OREN
1-457-434-900	G-296-B	BOG	1476271	GA-349	FORD	149-P1285	G-1173	ONAN	1505-61	GA-20	POCL
1-457-434-900	G-296	ROB	14772101	GG-3	MBNZ	149-P148	G-1173	ONAN	1505-61	GAK-20	POCL
1-457-434-900	G-296-B	ROB	14773301	GG-3	MBNZ	149-P848	G-1173	ONAN	150564	GP-1122	RENA
1-457-434-900-850	G-296	BOG	14774201	GG-3	MBNZ	149-P869	G-1173	ONAN	1505-64	GP-1122	POCL
1-457-434-900-850	G-296-B	BOG	14775601	GG-3	MBNZ	145	GA-27	ASAH	1505682	GP-761H	FRAN
1-457-434-900-867	G-296	BOG	14775901	GG-189	MBNZ	15	GP-205	PARM	150584	GA-31	CUMM
1-457-434-900-867	G-296-B	BOG	14776	G-296	WEST	15	GP-81	WIX	1505-88	GP-1122	POCL
1-457-434-901	G-296	BOG	14776	G-296-B	WEST	15	GP-9	WIX	1507	GA-589	AMP
1-457-434-901	G-296-B	BOG	14776901	GG-3	MBNZ	150	GG-1	AMP	1507	GA-589	BGA
1-457-434-902	G-296	BOG	14778401	GG-189	MBNZ	150	GG-4	AMP	1507032	GP-178	FRAN
1-457-434-902	G-296-B	BOG	14778701	GG-189	MBNZ	150	GP-1	AUTP	1507034	GP-1122	FRAN
1-457-434-903	G-296	BOG	14778901	GG-189	MBNZ	150	GG-1	BGA	1507153	GP-390	FRAN
1-457-434-903	G-296-B	BOG	14791202	GA-206	HEAT	150	GG-4	BGA	1507587	GP-761H	FRAN
1-457-434-904	G-296	BOG	147M	G-119	REF	150	GP-3682	PROT	1508	GA-588	AMP
1-457-434-904	G-296-B	BOG	148	GA-80	FACE	150	GP-37	PROT	1508	GA-588	BGA
1-457-434-905	G-296	BOG	148043	GA-377	NEL	1500	G-31	NAP	150836	GA-24	HYST
1-457-434-905	G-296-B	BOG	1482	GP-761H	NAP	15000-37101	GA-16	KUBO	1508831	GP-81	FORD
1-457-434-905-850	G-296	BOG	1482151	GP-81	FORD	15000-37101	GAK-16	KUBO	1508831	GP-9	FORD
1-457-434-905-850	G-296-B	BOG	1482151	GP-9	FORD	15000-689-004	GP-42	HOND	1509454	GP-1	MINN
1-457-434-909	G-296	BOG	1483	GP-761H	NAP	150011600	GP-81	EATN	151	GP-5	AUPT
1-457-434-909	G-296-B	BOG	148459	GP-81	CUMM	150011600	GP-9	EATN	151	G-1176	DEL
1-457-434-910	G-296	BOG	148459	GP-9	CUMM	1500116-00	GP-81	YALE	15101-32081	G-870	KUBO
1-457-434-910	G-296-B	BOG	148497	G-11816	HYST	1500116-00	GP-9	YALE	15101-32411	G-870	KUBO
1457512	GP-3816	FORD	1485	GP-761H	NAP	1500127	GA-33	YALE	15104-11080	GA-33	KUBO
1458211	GA-16	AUTC	1486	GA-135	AMP	1500127-00	GA-33	YALE	15111490	G-11816	LETR
1458211	GAK-16	AUTC	1486	GA-135	BGA	1500172-00	GP-81	YALE	151134	G-1175	WAUK
1458211	GA-16	BAKR	1486	GP-761H	NAP	1500172-00	GP-9	YALE	151137	G-1175	JONB
1458211	GAK-16	BAKR	1487	GA-251	AMP	1500229-00	GA-18	YALE	151137	G-1176	WAUK
145821-1	GA-16	WHIT	1487	GA-251	BGA	1500231	GA-33	YALE	1511C	GG-124	HEN
145821-1	GP-169	WHIT	1487	G-169	NAP	1500231-00	GA-33	YALE	1512	GP-38	NAP
14589	GA-24	AGCH	148786	G-295	ROO	1500344	G-1174	FRAN	15123627	GA-415	GMCX
14589	GA-24	AGCH	1489	GA-3637	AMP	1500346	G-1173	FRAN	1512903	GS-1133	CERL
1459	GA-3300	AMP	1489	GA-3637	BGA	1500591	G-33	FRAN	1512904	GC-1133	CERL
1459	GA-3300	BGA	1490	GA-3637	AMP	1500716-00	GA-33	YALE	1513-0160-00	GP-28 ⁶	ATCO
1459	GP-31	NAP	1490	GA-3637	BGA	15009-7502	GP-38	NISS	1513-0160-00	GP-430 ⁸	ATCO
145942	GP-761H	MACH	149-0128	G-1173	ONAN	150-1007	GP-3682	DENS	15144	GP-92	SEAB
1459-43-2430	G-191	KOMA	149-0148	G-1173	ONAN	15010-16020	GP-157	NIPP	1514580	GA-356 ¹⁰⁴	CLRK
145AX	GA-8	GREY	149-0206	GG-20	ONAN	15010-1660	GP-156	NIPP	1514580	GA-357 ¹⁰⁸	CLRK
146	GA-71	FACE	149-0848	G-1173	ONAN	15010333	GP-53	GMCX	1514669	GA-6127	CLRK
146	GA-4828	UNN	149-0849	G-1176	ONAN	1501433	G-836	FORD	1515	GP-9	NAP
1460	GP-3600	NAP	149-0855	G-1174	ONAN	1501434	G-836	FORD	1515160	GP-9	FORD
146049	GP-166 ⁶⁵	TVH	149-0869	G-1173	ONAN	1501435	G-836	FORD	1515162	G-6	CHRY
146049	GP-3937 ¹¹	TVH	149-0955	G-1175	ONAN	150-15-40-12	G-330	DUTZ	1515162	G-6	MOP
14612	GP-91	PARM	1491	GA-3647	AMP	150-15-43-07	G-330	DUTZ	15152-32091	GP-28 ⁶	KUBO
146149CS	G-1173	HERC	1491	GA-3647	BGA	15015509	GG-209	GMCX	15152-32091	GP-430 ⁸	KUBO
146149-CS	G-1173	WHIT	1491	GP-761H	NAP	150157510	GP-36	KHDF	151531	G-500	CUMM
1461524	G-613	FORD	149-1083	G-1173	ONAN	150157520	GP-54 ¹¹	KHDF	151531	G-750	CUMM
146290	GA-33	DAVS	149-1134	G-1173	ONAN	150157520	GP-66 ¹⁰	KHDF	151531	G-500	IHCO
146393-M1	GP-3	MASY	149-1183	G-1175	ONAN	150-15-75-20	GP-54 ¹¹	DUTZ	151531	G-750	IHCO
14640-050	GP-40	EXXE	149-1353	GG-19	ONAN	150-15-75-20	GP-66 ¹⁰	DUTZ	151531-H1	G-500	IHCO
14640-051	GP-3985	EXXE	149-1697	G-296	ONAN	1501676	GA-27	FRAN	151531-H1	G-750	IHCO
146419-CS	G-1173	HERC	149-1697	G-296-B	ONAN	1501676	GA-27	GMCX	15153904	GA-413R	GMCX
146696	GP-1	CASE	149-1754	G-295	ONAN	1501725	GA-24	FRAN	151570	GA-206	MOXY
1467	GA-70	CHEK	149-1758	GG-8	ONAN	1501725	GA-403	FRAN	151571	GA-106 ⁶	MOXY
146-7172	GA-880R	CATP	149-1758	GG-8 L	ONAN	1501725	GAK-403	FRAN	151571	GA-326 ⁷¹	MOXY
146-7472	GA-880R	CATP	149-1802	G-270	ONAN	1501725	GA-24	GMCX	1515MP	GP-1	NAP
146790	G-834	CLAA	149-2005	GG-1	ONAN	150176	G-870	IHCO	1516	GP-3600	NAP
1467900	G-834	CLAA	149-2005	GG-4	ONAN	1501936	G-119	FRAN	151692	GA-356	MOXY
146823	GC-1133	CUMM	149-2053	GP-1105	ONAN	1502155-C91	G-296	CASE	151693	GA-357	MOXY
146851	G-870	CLAA	149-2054	GP-62	ONAN	1502155-C91	G-296-B	CASE	15169849	GG-177	GMCX
1468510	G-870	CLAA	149-2206-01	GG-1	ONAN	1502255	GPP-1122	FORD	1516MP	GP-3600	NAP
146861	G-836	CLAA	149-2206-01	GG-4	ONAN	150234-A	GP-1	WHIT	1517575	G-750	VOLV
1468610	G-836	CLAA	149-2231	GPP-11	ONAN	1502484	G-834	FORD	15177575-5	G-750	VOLV
146990	GA-133	CUMM	149-2250	GPP-18	ONAN	1503	G-31	NAP	151831112	GP-1122	FIAT
1470265	GA-405	FAUN	149-2441	GG-5 L	ONAN	15036141	GA-414R	GMCX	151858	G-1143	CUMM
1470265	GAK-403	FAUN	1492P	G-33	MULH	15039040H	GP-1013Q	BAUD	1518700	GA-361	CLRK
1470275	GA-20	FAUN	1492P	G-119	PETI	15039050T	GP-1013Q	BAUD	151890	G-296	MASY

Referencia Cruzada por Numero de Parte

Cross Reference by Part Number



Numero	Gonher	Fabricante	Numero	Gonher	Fabricante	Numero	Gonher	Fabricante	Numero	Gonher	Fabricante
Number	Gonher	Manufacturer	Number	Gonher	Manufacturer	Number	Gonher	Manufacturer	Number	Gonher	Manufacturer
151890		G-296-B MASY	15208-F4600		GP-149 NISS	15220-PC6-004		GP-462 HOND	1538625		G-11816 FORD
151890-M1		G-296 MASY	15208-G3100		GP-3682 NISS	1522242009		GA-8047 KHDF	1538884		G-834 FORD
151890-M1		G-296-B MASY	15208-H1010		GP-38 NISS	152-22-42-009		GA-8047 DUTZ	154		GP-157 PROT
151940		G-1143 CASE	15208-H1011		GP-38 NISS	1522MP		GP-3675 NAP	154		GP-28 ⁸ SAK
151969		GA-16 CASE	15208-H1111		GP-171 NISS	1523494		GP-1 FORD	154		GP-430 ⁸ SAK
151969		GAK-16 CASE	15208H8703		GP-3682 NISS	1523775226		GA-357 WELE	15400-0061		GP-38 TOYO
151969		GA-16 DAVS	15208-H8901		GP-3682 NISS	15241-32090		GP-91 KUBO	15400-0090		GP-1 TOYO
151969		GAK-16 DAVS	15208-H8903		GP-3682 NISS	15241-32092		GP-91 KUBO	15400-111-0003		GP-91 HOND
1511M		GA-33 REF	15208-H8904		GP-3682 NISS	15241-32093		GP-91 KUBO	15400-579-003		GP-91 HOND
152		GG-5 L AMP	15208-H8910		GP-3682 NISS	15241-32099		GP-91 KUBO	15400-611-003		GP-91 HOND
152		GP-13 AUTP	15208-H8911		GP-3682 KOMA	15241-39092		GP-91 KUBO	15400-634-003		GP-42 HOND
152		GG-5 L BGA	15208-H8911		GP-3682 NISS	15246-32430		GP-28 ⁸ KUBO	15400-634-0030		GP-42 HOND
152		GP-91 PROT	15208-H8911		GP-3682 TCM	15246-32430		GP-430 ⁸ KUBO	15400-634-004		GP-42 HOND
152		GP-3531 EXP SAK	15208-H8911B		GP-3682 NISS	152499		GP-14 CUMM	15400-634-010		GP-42 HOND
152		GA-80 UNN	15208-H8912		GP-3682 NISS	1525		GP-1 NAP	15400-634-013		GP-42 HOND
15200060160		G-1121 FEND	15208-H8916		GP-3682 NISS	152528644		GG-124 WACK	15400-634-014		GP-42 HOND
15200060180		G-1121 FEND	15208-H8916		GP-3682 TCM	152553		GA-33 DAVS	15400-634-023		GP-42 HOND
15200-09400		G-870 NISS	15208-H8917		GP-3682 NISS	1526		G-870 JAGU	15400-634-024		GP-42 HOND
15202408		GA-415 GMXC	15208-H8920		GP-3682 KOMA	1526		G-870 LEYL	15400-634-033		GP-42 HOND
15208-00QAA		GP-291 NISS	15208-H8920		GP-38 NISS	1526187		GP-28 ⁸ VOLV	15400-634-505		GP-42 HOND
15208-05D00		GP-3985 NISS	15208H8923		GP-3682 NISS	1526187		GP-430 ⁸ VOLV	15400-67903		GP-91 HOND
15208-13012		GP-38 NISS	15208-H8993		GP-3682 NISS	1526188		GP-28 ⁸ VOLV	15400-67900-3		GP-91 KUBO
15208-13201		GP-38 NISS	15208-H8994		GP-3682 NISS	1526188		GP-430 ⁸ VOLV	15400-67900-004		GP-91 HOND
15208-13210		GP-38 KOMA	15208-J7525		GP-46 NISS	15261886		GP-28 ⁸ VOLV	15400-679-005		GP-91 HOND
15208-13210		GP-38 NISS	15208KA000		GP-91 SUBA	15261886		GP-430 ⁸ VOLV	15400-679-013		GP-91 HOND
15208-13210		GP-38 TCM	15208-KA010		GP-91 SUBA	1526270		GP-81 VOLV	15400-67901-3		GP-91 KUBO
15208-13211		GP-38 NISS	15208-N8912		GP-3682 NISS	1526270		GP-9 FORD	15400-679-023		GP-91 HOND
15208-13211		GP-38 TCM	15208-V4000		GP-28 ⁸ NISS	15264311		GP-2071W TERE	15400-689-003		GP-3531 EXP HOND
15208-13212		GP-38 NISS	15208-V4000		GP-430 ⁸ NISS	15266844		GP-3000 TERE	15400-689-004		GP-3531 EXP HOND
15208-13212		GP-38 SUBA	15208-W1101		GP-171 NISS	15266846		GPP-11 TERE	15400-689-03		GP-3531 EXP HOND
15208-13212		GP-38 TCM	15208-W1103		GP-171 NISS	15267311		GP-2071W TERE	15400-MG7-003		GP-91 HOND
15208-13212		GP-38 TOYO	15208-W1106		GP-171 KOMA	152-7217		GA-697R CATP	15400-MJ0-003		GP-91 HOND
15208-13212N		GP-38 NISS	15208-W1106		GP-171 NISS	152736		GA-356 GARD	15400-POH-305		GP-6811 HOND
15208-13213		GP-38 NISS	15208-W1111		GP-171 NISS	152737		GA-357 GARD	15400-PA6-003		GP-3531 EXP HOND
15208-29D00		GP-171 NISS	15208-W1113		GP-171 NISS	152749626		GP-51 IHCO	15400-PA6-004		GP-3531 EXP HOND
15208-31U00		GP-149 NISS	15208-W1115		GP-1 NISS	1527843		GG-5 L ECH	15400-PA6-005		GP-3531 EXP HOND
15208-31U01		GP-149 NISS	15208-W1116		GP-171 NISS	15282		GP-3682 ²¹ MACH	15400-PA6-305		GP-3531 EXP HOND
1520-83-2200		G-870 KOMA	15208-W1120		GP-1 NISS	1528288		GA-1287 GMXC	15400-PC6-000		GP-462 HOND
15208-32200		G-870 NISS	15208-W1120B		GP-1 NISS	15287-11080		GA-33 KOMA	15400-PC6-003		GP-462 HOND
15208-32225		G-870 NISS	15208-W1120L		GP-1 KOMA	15287-11081		GA-33 KUBO	15400-PC6-004		GP-462 HOND
15208-32250		G-870 NISS	15208-W1123		GP-1 NISS	152875		G-1123 SAAB	15400-PFB-004		GP-91 HOND
15208-43800		G-870 NISS	15208-W3401		GP-1 NISS	152875		G-1123F SAAB	15400-PH1-003		GP-462 HOND
15208-48916		GP-3682 NISS	15208-W3403		GP-1 NISS	1529-1		G-1174 COM	15400-PH1-004		GP-462 HOND
15208-53J00		GP-156 NISS	15208-W8916		GP-171 NISS	1529203		GS-1133 CLIM	15400-PH1-014		GP-462 HOND
15208-53J01		GP-156 NISS	15208-Y1700		GP-58 NISS	1529204		G-1173 CLIM	15400-PH1-F02		GP-462 HOND
15208-53J00		GP-156 NISS	15208-Y7502		GP-38 NISS	152943		GA-24 HYST	15400-PH3-004		GP-91 HOND
15208-55Y00		GP-3682 NISS	15208-Y9701		GP-1 NISS	1529585		GA-6129 CLRK	15400-PH9-004		GP-91 HOND
15208-5M300		G-25 NISS	15209-08602		GP-38 NISS	15295850		GA-6129 INGR	15400-P17-015		GP-91 HOND
15208-60000		GP-3682 NISS	15209-10H00		GP-38 NISS	1529622		GA-6129 CLRK	15400-PK1-003		GP-462 HOND
15208-60U00		GP-3682 NISS	15209-10H00B		GP-38 NISS	15296220		GA-6129 INGR	15400-PL2-004		GP-212 HOND
15208-60U01		GP-3682 NISS	15209-32250		GP-870 NISS	152MP		GP-91 PROT	15400-PL2-305		GP-212 HOND
15208-65000		GP-1 NISS	15209-76200		GP-10 NISS	153		GP-310 SAK	15400-PLC-004		GP-149 HOND
15208-65001		GP-1 NISS	15209-88602B		GP-69 NISS	153		GP-3569 SAK	15400-PLM-A00		GP-149 HOND
15208-65002		GP-1 NISS	15209-C8600		GP-10 NISS	1530004		GA-106 ⁴⁸ CLRK	15400-PLM-A01		GP-149 HOND
15208-65004		GP-1 NISS	15209-C8602		GP-69 NISS	1530004		GA-326 ²¹ CLRK	15400-PLM-A01PE		GP-149 HOND
15208-65010		GP-1 NISS	15209-C8602B		GP-69 NISS	15301-32431		GP-3985 KIOT	15400-PLMA02		GP-149 HOND
15208-65011		GP-1 NISS	15209-G9600		GP-10 NISS	1530196		G-870 GMXC	15400-PR3-004		GP-91 HOND
15208-65011		GP-9 TOYO	15209-J1800		GP-38 NISS	1530400		GG-19 ECH	15400-PR3-014		GP-91 HOND
15208-65012		GP-1 NISS	15209-J1800B		GP-38 NISS	1530755		G-870 GMXC	15400-PR3-406		GP-6811 HOND
15208-65014		GP-1 NISS	15209-J2000		GP-10 NISS	1530775		G-870 ARMS	15400-P77-005		GP-6811 HOND
15208-65016		GP-1 NISS	15209-J6500		GP-10 NISS	1530775		G-870 GMXC	15400-P77-006		GP-6811 HOND
15208-65F00		GP-91 NISS	15209-J6502		GP-1 NISS	1530811		G-11816 BEDF	15400ZJ		GP-149 HOND
15208-65F01		GP-91 NISS	15209-T9000		GP-54 ¹¹ NISS	1530811		G-11816 GMXC	15400-ZJ1-004		GP-149 HOND
1520865F0B		GP-91 NISS	15209-T9000		GP-66 ¹⁰ NISS	1530916		G-870 ASTN	15401-11080		GA-33 KUBO
15208-65F0C		GP-91 NISS	15209-T9001		GP-54 ¹¹ NISS	1530916		G-870 GMXC	15401-11081		GA-33 KUBO
15208-70U00		GP-156 NISS	15209-T9001		GP-66 ¹⁰ NISS	1531230		G-870 GMXC	15402-32090		GP-171 KUBO
15208-71U00		GP-3682 NISS	15209-T9002		GP-54 ¹¹ NISS	1531624		G-870 ASTN	15402-32091		GP-1 KUBO
15208-76200		GP-54 NISS	15209-T9002		GP-66 ¹⁰ NISS	1531624		G-870 GMXC	15402-32430		GP-171 KUBO
15208-77502		GP-38 NISS	15209-T9003		GP-54 ¹¹ NISS	1531639		G-834 BEDF	15402-32431		GP-38 KUBO
15208-78525		GP-58 ¹⁵ NISS	15209-T9003		GP-66 ¹⁰ NISS	1531639		G-834 GMXC	1540787		G-834 FORD
15208-78000		GP-149 NISS	15209-T9005		GP-54 ¹¹ NISS	1531639		G-834 MASY	15410-60800		GG-146 SUZU
15208-80W00		GP-171 NISS	15209-T9005		GP-66 ¹⁰ NISS	1531639		G-834 PERK	15410-60801		GG-146 SUZU
15208-81-3210		GP-38 KOMA	15209-T9006		GP-54 ¹¹ NISS	1531639		G-834 ROOT	15410-61A00		GG-151 SUZU
15208-9E000		GP-149 NISS	15209-T9006		GP-66 ¹⁰ NISS	153173000		G-1123 HANO	15410-65D00		GG-206 GMXC
15208-AA00		GP-91 SUBA	15209-Y1800		GP-38 NISS	1531787		G-813 FORD	15410-65D00		GG-206 SUZU
15208-AA000		GP-3682 NISS	15209-Y7500		GP-38 NISS	1531789		G-836 GMXC	15410-65D10		GG-206 SUZU
15208-AA000		GP-3682 SUBA	15209-Y7501		GP-38 NISS	153187002		G-1121 HANO	15410-82000		GG-76 SUZU
15208-AA001		GP-3682 SUBA	15209-Y7502		GP-38 NISS	153187002		G-1121 MASY	15410-82000-003		GP-91 HOND
15208-AA020		GP-91 SUBA	1521		GP-171 NAP	153187002		G-1121 MBNZ	15410-MB3-003		GP-91 HOND
15208-AA021		GP-91 SUBA	15212-03243-11		GP-28 ⁸ KUBO	153187003		G-1121 HANO	15410-MCI-000		GP-91 HOND
15208-AA022		GP-91 SUBA	15212-03243-11		GP-430 ⁸ KUBO	153187003		G-1121 MASY	15410-MCI-003		GP-91 HOND
15208-AA024		GP-91 SUBA	15212-32091		GP-28 ⁸ KUBO	153187003		G-1121 MBNZ	15410-MJ0-003		GP-91 HOND
15208-AA030		GP-91 SUBA	15212-32091		GP-430 ⁸ KUBO	153188		G-1143 WAUK	15410-MM9-003		GP-91 HOND
15208-AA060		GP-91 SUBA	15212-32431		GP-28 ⁸ KUBO	153189		G-1143 WAUK	15410-MM9-013		GP-91 HOND

Numero	Gonher	Fabricante	Numero	Gonher	Fabricante	Numero	Gonher	Fabricante	Numero	Gonher	Fabricante
Number	Gonher	Manufacturer	Number	Gonher	Manufacturer	Number	Gonher	Manufacturer	Number	Gonher	Manufacturer
1542811	GA-105	AMCO	1555451	GP-81	FORD	15601-41010-000	GP-1	DTSU	156513A	GP-9	OLIV
1542811	GA-105	CHRY	1555451	GP-9	FORD	15601-41030	GP-38	TOYO	156513-A	GP-81	WHIT
1542811	GA-105	STUD	155618A	GP-31	AGCO	15601-44010	GP-1	TOYO	156513-A	GP-9	WHIT
15430-50800	GG-146	TOYO	155618A	GP-31	OLIV	15601-44010-000	GP-1	DTSU	1565204	GP-31	FORD
15430-50G00	GG-146	SUZU	155618-A	GP-31	WHIT	15601-44010-83	GP-1	TOYO	1566	GA-2740	AMP
15430-65D10	GG-206	SUZU	155618AS	GP-31	MINN	15601-44011	GP-171	TOYO	1566	GA-2740	BGA
15437H576	G-296	LEYL	1556297	GP-9	FORD	15601-44011-000	GP-1	DTSU	1567	GA-3300	AMP
15437H576	G-296-B	LEYL	1556564	GP-9	FORD	15601-76003-71	GP-9	TOYO	1567	GA-3300	BGA
154431	G-1143	CUMM	1556906	GP-5	STUD	15601-76008-71	GP-156	TOYO	156711	GG-408	PEUG
154431H1	G-1143	IHCO	155702	G-1175	WAUK	15601-78001-71	GP-81	TOYO	1567-11	GG-246	PEUG
154431H1	G-1143	WAUK	15572850	GP-2071W	GMCX	15601-78001-71	GP-9	TOYO	156712	GG-261	PEUG
154440	G-31	WAUK	15572850	GP-2071W	MOHA	15601-78101	GP-1	TOYO	1567-13	GG-251	PEUG
154451-A	G-31	WAUK	1557376	G-236	CHRY	15601-78101-71	GP-1	TOYO	156773	GA-26 ¹²	CUMM
154495	G-1174	HYST	155748	GA-24	HYST	15601-78101-71	GP-58	DTSU	156774	GA-26 ¹²	CUMM
1545	GP-66	GRES	1557575	G-236	CHRY	15601-87103-000	GP-3816	DTSU	1567-87	GG-291	PEUG
1545	GP-171 ¹⁶	NAP	1557576	G-236	CHRY	15601-87104-000	GP-58	DTSU	1568	GG-462	NAP
154513	GA-20	HYST	1557576	G-236	KOP	15601-87105	GP-3682	DTSU	156839	G-500	CUMM
154513	GAK-20	HYST	15581-11081	GA-33	MUB	15601-87105-000	GP-38	DTSU	1568409	G-834	FORD
15451-43560	G-296	KUBO	15-585	G-500	STEI	15601-87101-000	GP-3816	DTSU	1568409	G-834	MANO
15451-43560	G-296-B	KUBO	15585879	GA-37	GMCX	15601-87202	GP-156	DTSU	1568410	G-836	FORD
15451A	G-31	WAUK	15586695	GA-229	GMCX	15601-87203	GP-58	DTSU	1568410	GG-836	MANO
154663	GA-403	WING	15586696	GA-229	GMCX	15601-87203-000	GP-3816	DTSU	156932101	GP-50	HANO
154663	GAK-403	WING	15586697	GA-378	GMCX	15601-87204	GP-81	DTSU	156-9328	GA-373	CATP
154700	GP-1101	SCAM	15586879	GA-37	GMCX	15601-87204	GP-9	DTSU	156938	GA-5648	CLRK
154709	GP-1101	CUMM	15586891	GA-376	GMCX	15601-87204	GP-91	TOYO	156952	G-813	HYST
154711	GP-1101	CUMM	15586904	GA-109	GMCX	15601-87204-000	GP-81	DTSU	15696245	GA-197R	GMCX
1547564	GA-105	STUD	15586905	GA-229	GMCX	15601-87204-000	GP-9	DTSU	156A	GA-8	GREY
1547813	GA-105	STUD	15586918	GA-372	GMCX	15601-87205-000	GP-81	DTSU	156A	GA-274	AMP
154789	GGP-14	CUMM	15586919	GA-373	GMCX	15601-87205-000	GP-9	DTSU	1570	GA-274	BGA
154813	GA-24	HYST	15587151	G-500	GMCX	15601-87306	GP-9	DTSU	1570143	G-31	GMCX
1549059	GA-20	GENE	15587164	G-566	GMCX	15601-87306-000	GP-1	DTSU	1570158	G-31	GMCX
1549059	GAK-20	GENE	15587314	G-750	GMCX	15601-87310	GP-462	TOYO	1571	GA-85	AMP
154908001	GP-58 ⁹	VERM	15587320	GP-57	GMCX	15601-87310	GP-58	DTSU	1572	GA-3681	AMP
1549102	GA-106 ⁴⁶	GENE	15587368	GP-53	GMCX	15601-87702-000	GP-3816	DTSU	1572	GA-3681	BGA
1549102	GA-326 ⁷¹	GENE	15588697	GA-378	GMCX	15601-87703	GP-157	DTSU	1572081	GP-1101	VOLV
1549102	GA-106 ⁴⁶	RUST	15588698	GA-378	GMCX	15601-87703	GP-91	TOYO	1572801	GP-1101	VOLV
1549102	GA-326 ⁷¹	RUST	1558876	GA-20	CUMM	15601-87703-000	GP-157	DTSU	1573	GAD-1	BGA
1549592	GP-66	CLRK	1558876	GAK-20	CUMM	15601-87705-000	GP-156	DTSU	1573	GAD-1	NAP
155	GG-20	AMCO	15590	GP-171 ¹⁶	CHAM	15601-96001	GP-81	TOYO	1574	GA-360	AMP
155	GG-20	BGA	155-910	GP-66	DITC	15601-96001	GP-9	TOYO	1574	GA-360	BGA
1550	GAP-381	BGA	155-938	GP-3600	DITC	15601-96101	GP-1	TOYO	157452	G-1173	HYST
1550	G-500	NAP	15593999	G-294	GMCX	15601-P87203	GP-58	DTSU	1574603	GA-3425	FORD
15500-4	G-31	MIC	155-952	GP-27	DITC	15601-U2120-71	GP-3	TOYO	1574618	GAVW-2	FORD
1551	GP-66	GRES	155-954	GP-34	DITC	15602-22010	GP-38	TOYO	1575	GAK-361	BGA
1551	GP-66	NAP	155-955	GP-1	DITC	15606-11080	GA-16	KUBO	15763-11081	GA-16	KUBO
1551000320	GP-317H	PELJ	155-966	GA-16	DITC	15606-11080	GAK-16	KUBO	15763-11081	GAK-16	KUBO
1551-001	GP-66	GRES	1559661	G-6	STUD	15606-11081	GA-16	KUBO	157854	G-1173	HYST
1551-002	GP-66	GRES	155-970	GA-34	DITC	15606-11081	GAK-16	KUBO	157893AS	GA-403	OLIV
1551020200	GP-317H	YNMR	1559937	GP-3816	FORD	15606-11211	GA-16	KUBO	157893AS	GAK-403	OLIV
15510-35110	GP-9586	TAKI	156	GP-3985	PROT	15606-11211	GAK-16	KUBO	157893-AS	GA-403	WHIT
155111662	G-750	GMCX	15600-01020	GP-156	TOYO	15607-1260	GP-462	HINO	157893-AS	GAK-403	WHIT
15511629	GA-251	GMCX	15600-13051	GP-58	TOYO	156071381	GP-43	HINO	157935A	GA-403	OLIV
1551238	GA-56	GMCX	15600-16010	GP-156	TOYO	15607-1430	GP-43	HINO	157935A	GAK-403	OLIV
15514175	GP-14	GMCX	15600-16020	GP-157	TOYO	15607-1470	GP-50	HINO	157935-A	GA-403	WHIT
15514352	GP-1122	GMCX	15600-20550	GP-81	TOYO	15607-1471	GP-50	HINO	157935-A	GAK-403	WHIT
155154012	G-330	KHDF	15600-20550	GP-9	TOYO	15607-1471A	GP-50	HINO	15798	G-566	VERS
155-15-40-12	G-330	DUTZ	15600-20560	GP-1	TOYO	15607-1820	GP-50 ²⁰	HINO	157985	GA-403	OLIV
15515589	GA-376	GMCX	15600-2501	GP-9	DTSU	1560A-41010	GP-1	HINO	157985	GAK-403	OLIV
15516187	GA-376	GMCX	15600-25010	GP-81	TOYO	15610-73000	GP-3816	DTSU	157985	GA-403	WHIT
15516983	GGP-11	GMCX	15600-25010	GP-9	TOYO	156-1200	GGP-420	CATP	157985	GAK-403	WHIT
1551MP	GP-66	NAP	15600-25010-000	GP-81	DTSU	1561644	GP-110	CUMM	157985A	GA-403	OLIV
1552	GP-66	NAP	15600-25010-000	GP-9	DTSU	156171	GP-110	CUMM	157985A	GAK-403	OLIV
15521-11080	GA-33	KUBO	15600-41010	GP-1	DTSU	156172	GGP-14	CUMM	157985-A	GA-403	WHIT
15521-32430	GP-81	KUBO	15600-41010	GP-1	TOYO	1561842	GA-77	STUD	157985-A	GAK-403	WHIT
15521-32430	GP-9	KUBO	15600-41020	GP-1	TOYO	15618921	S 3202 ⁴⁰	GMCX	157M	G-33	REF
15521-32431	GP-171	KUBO	15600-50010	GP-1	TOYO	15619013	GA-197R	GMCX	158	GG-5 L	AMP
15521-32439	GP-171	KUBO	15600-61030	GP-1	TOYO	1562	GA-230	AMP	158	GP-81	PROT
15524421	GP-1010Q	GMCX	15600-76003	GP-9	TOYO	1562	GA-230	BGA	15800986	GA-486	GMCX
15524422	GP-1011Q	GMCX	15600-87305-000	GP-81	DTSU	1562139	GP-20	STUD	15801	GP-34	VERS
15525633	G-500	GMCX	15600-87305-000	GP-9	DTSU	1562432	GA-357	CLRK	15802	GP-2071W	VERS
15525633	G-750	GMCX	15600-87307-000	GP-81	DTSU	156289A-AS	G-1174	WHIT	158079	GA-26	CUMM
15529143	GA-378	GMCX	15600-87307-000	GP-9	DTSU	156289AS	G-1174	COCT	1581	GA-563	AMP
1553	GP-66	GRES	15600-87320	GP-1	DTSU	156289AS	G-1174	MINN	1581	GA-563	BGA
1553	GP-66	NAP	15600-87320-000	GP-81	DTSU	156289AS	G-1174	OLIV	1581	GP-14	NAP
1553-001	GP-66	GRES	15600-87320-000	GP-9	DTSU	1563	GA-77	AMP	15812	GGP-18	TIMC
1553-002	GP-66	GRES	15600-96101	GP-1	TOYO	1563	GA-77	BGA	15813	GP-178	TIMC
1553105	GA-70	GMCX	15601	GP-66	FTEC	1563296	GA-77	STUD	158139	G-566	CUMM
1553370	GP-3816	FORD	15601-01010	GP-58	TOYO	156398	GA-5648	CLRK	158172	GP-1101	CUMM
15534438	GA-376	GMCX	15601-13010	GP-58	TOYO	1564	GA-277	AMP	1582092	GP-53	FORD
1553559	GA-105	GMCX	15601-13010-000	GP-58	TOYO	1564	GA-277	BGA	1582261	G-296	FORD
155365	G-1143	CUMM	15601-13011	GP-58	DTSU	1564133	GA-77	STUD	1582261	G-296-B	FORD
155365-H1	G-1143	IHCO	15601-13011	GP-58	TOYO	1564275	GP-462	HER	158324	G-31	WAUK
1553681	GA-7	GMCX	15601-13051	GP-58	TOYO	1564305	GP-462	HER	1583371	G-296	FORD
1553691	GA-7	GMCX	15601-20550	GP-58	TOYO	1564324	GP-462	CARR	1583371	G-296-B	FORD
1553916	GA-105	GMCX	15601-2201	GP-3682	DTSU	1564461	G-500	CLRK	15853-99170	GP-91	KUBO
1554	GP-66	GRES	15601-22010	GP-38	TOYO	1564644	GA-5648	CLRK	15853-99179	GP-91	KUBO
1554030	GA-56	GMCX	15601-2501	GP-9	DTSU	1564832	GA-357	CLRK	1585-45	G-33	POCL
1554095	GA-56	GMCX	15601-33010	GP							

Referencia Cruzada por Numero de Parte

Cross Reference by Part Number



Numero	Gonher	Fabricante	Numero	Gonher	Fabricante	Numero	Gonher	Fabricante	Numero	Gonher	Fabricante
Number	Gonher	Manufacturer	Number	Gonher	Manufacturer	Number	Gonher	Manufacturer	Number	Gonher	Manufacturer
15893542	GA-486	SATU	16010-SL5-A31	GG-214	HOND	1617A	GA-517R	GREY	162WA112	GA-24	CLRK
159	G-870	CRO	16010-SM4-932	GG-184	HOND	1618	GP-20	NAP	163000A	GG-5 L	WHIT
159	GP-3675	PARM	16010-SM4-A30	GG-184	HOND	1618385-C91	GPP-547 ³⁹	IHCO	1630209	G-1121	MASY
159	GP-68	PROT	16010-SMA-931	GG-184	HOND	1618385-C91	PFF831 ⁴¹	IHCO	1630209-M1	G-1121	MASY
1590009	G-293	DITC	16010-S50-931	GG-214	HOND	1618385-C91	R 60 P ⁴²	IHCO	16304-1010	GP-1011Q	HINO
159012A	GA-16 ¹²	OLIV	16010-S50-932	GG-214	HOND	1618386-C93	GPP-547 ³⁹	IHCO	16304-1011	GP-1011Q	HINO
159012A	GAK-16 ³⁴	OLIV	16010-S51-931	GG-234	HOND	1618386-C93	PFF831 ⁴¹	IHCO	16342	GA-2174	MEDO
159012A	GA-16	WAUK	16010-S55-931	GG-160	ACUR	1618386-C93	R 60 P ⁴²	IHCO	1634447	G-236	CHRY
159012A	GAK-16	WAUK	16010-S75-931	GG-160	HOND	1619	GP-166 ⁶⁵	NAP	1634447	G-236	MOP
159012-A	GA-16 ¹²	WHIT	16010-S75-932	GG-160	HOND	1619	GP-3937 ⁴¹	NAP	163-4465	GPP-425	CATP
159012-A	GAK-16 ³⁴	WHIT	16010-S75-933	GG-160	HOND	1619017-C1	GA-197R	IHCO	1634858	GA-142	PARM
159044AS	G-296	OLIV	1602	GP-390	NAP	1619079	GA-3425	FORD	1635103	G-296	FORD
159044AS	G-296-B	OLIV	1602113	GP-2071W	FORD	1619153	GA-382	PARM	1635103	G-296-B	FORD
159044-AS	G-296	WHIT	1602MP	GP-390	NAP	1619-1879	GA-24	ATCO	1635143-M1	G-870	MASY
159044-AS	G-296-B	WHIT	1603	GA-891	BGA	1619-1879-00	GA-24	ATCO	1635636	G-870	MASY
159045	GP-1	WHIT	1603209-M1	G-1121	MASY	1619-2627	GP-54 ⁴¹	ATCO	1635636-M91	G-870	MASY
159045A	GP-1	MINN	1603HE	G-834	BOG	1619-2627	GP-66 ¹⁰	ATCO	163631A	GA-26 ¹¹²	WAUK
159045A	GP-1	KUBO	1604	GP-178	NAP	1619-2627-00	GP-54 ⁴¹	ATCO	163631A	GA-26 ¹¹²	WAUK
15906-32090	GP-3816	KUBO	160413	G-870	COLS	1619-2627-00	GP-66 ¹⁰	ATCO	163641	GA-26	WAUK
159-074	GP-761H	DITC	160516040	GP-38	FORD	1619-2678	GP-1122	ATCO	1637	G-159	NAP
159076	G-31	WAUK	160624AS	GA-16 ¹²	OLIV	1619-2684	GP-1122	ATCO	16392	GP-36	PARM
15908916	GA-348	GMCX	160624AS	GAK-16 ³⁴	OLIV	1619-2716	GA-403	ATCO	163953AS	G-296	OLIV
15909	GP-1101	AGCH	160624-AS	GA-16 ¹²	WHIT	1619-2716	GAK-403	ATCO	163953AS	G-296-B	OLIV
159265	G-296	OLIV	160624-AS	GAK-16 ³⁴	WHIT	1619-2799	GA-405	ATCO	163953-AS	G-296	WHIT
159265	G-296-B	OLIV	1607	GP-178	NAP	1619-2799-00	GA-405	ATCO	163953-AS	G-296-B	WHIT
159265	G-296	WHIT	16070	GP-3000	TIMC	1619-3711	GA-229	ATCO	164	GP-149	PROT
159265	G-296-B	WHIT	1607-49441	GA-403	KUBO	1619-6227	GP-310	ATCO	16400-00-Q-AA	GG-291	NISS
1592854	G-1174	CLRK	1608537C91	GA-107	IHCO	161WA1059	GA-26	BLDW	16400-06W00	GG-194	NISS
15950115	GA-413R	GMCX	16088000000	GP-1122	CHAM	161WA111	GA-26	CLRK	16400-08000	GG-94	NISS
1595178	G-31	GMCX	1608926	GA-390	PARM	161WA1118	GA-26	BLDW	16400-08001	GG-94	NISS
1595310	G-31	GMCX	16097-1063	GP-91	KAWA	161WA1118	GA-26	CLRK	16400-0M200	GG-63	NISS
1595361	G-31	GMCX	16097-1064	GP-91	KAWA	161WA112	GA-24	BLDW	16400-0W005	GG-63	NISS
1595502	G-31	GMCX	160971072	GP-91	KAWA	161WA118	GA-26	CLRK	16400-0W010	GG-63	NISS
1595508	G-31	GMCX	16097-49441	GAK-403	KUBO	161WA258	GA-403	BLDW	16400-0W050	GG-63	NISS
1595883	G-31	GMCX	160A	GA-70	FACE	161WA258	GAK-403	BLDW	16400-10Y00	GG-137	NISS
159-6102	GPP-419	CATP	160-D6	GA-18	UNI	161WA258	GA-403	CLRK	16400-10Y00	GG-137	TOYO
1596584	GP-43	FORD	160-D7	GA-18	UNI	161WA258	GAK-403	CLRK	16400-18010	GG-45	NISS
159706	G-750	CUMM	160MA010P	GP-34	HYC	161WA292	GA-20	BLDW	16400-35500	GG-63	NISS
1598	GA-329	BGA	160MA020BN	GP-864H	HYHH	161WA292	GAK-20	BLDW	16400-41B00	GG-63	NISS
15986275	GA-732R	GMCX	161	G-870	CRO	161WA378	GA-20	BLDW	16400-41B00JP	GG-63	NISS
159876	G-120	CUMM	161087105	G-1121	HANO	161WA378	GAK-20	BLDW	16400-41B05	GG-63	NISS
159876	GAK-20	CUMM	161-100-0010	GP-1	USX	161WA378	GA-20	CLRK	16400-59A00	GG-39	NISS
15988574	GA-673R	GMCX	161-100-0035	GP-13	USX	161WA378	GAK-20	CLRK	16400-68201	GP-1011Q	NISS
159MP	GP-68	PROT	161-100-0225	GP-20	USX	161WA538	GA-20	BLDW	16400-70J00	GG-251	NISS
15A339	GA-33	CLRK	161-100-0280	GP-50	USX	161WA538	GAK-20	BLDW	16400-72L00	GG-137	NISS
15A339	GA-33	MEAD	161-100-0425	GP-51	USX	161WA699	GA-27	BLDW	16400-72L05	GG-137	NISS
15A339	GA-33	MELR	161-100-0435	GP-51	USX	161WA699	GA-27	CLAA	16400-72L10	GG-137	NISS
15A53CH	G-293	CATP	161-100-0535	G-238	USX	161WA699	GA-27	CLRK	16400-78010	GG-63	NISS
15A53CH	G-293	COM	161-100-0545	G-222	USX	162	GP-205	PROT	16400-9E000	GG-137	NISS
15A739	GA-33	CLRK	161-100-0640	GP-52 ¹⁰	USX	1620482-M1	GP-171	MASY	16400-A0600	GG-1	NISS
15A739	GA-33	MEAD	161-100-0640	GP-691 ⁴⁸	USX	162059708	G-31	ANSA	16400-A0600	GG-4	NISS
15A739	GA-33	MELR	161-100-1085	GP-28 ⁹	USX	162-05-9708	G-31	ALFA	16400-A0600	GG-124	TOYO
15D1357	GA-33	MELR	161-100-1085	GP-430 ⁸	USX	162097	GP-81	CUMM	16400-A0601	GG-1	NISS
15H665	GA-33	CLRK	161-100-1960	GP-178	USX	162097	GP-9	CUMM	16400-A0601	GG-4	NISS
15H665	GA-33	MEAD	161-100-3395	GP-55	USX	1621183	GP-54 ⁴¹	MASY	16400-A4201	GG-94	NISS
15H665	GA-33	MELR	161-100-4150	GPP-18	USX	1621183	GP-66 ¹⁰	MASY	16400-C6400	GG-196	NISS
15H668	GA-33	CLRK	161-100-4380	G-296	USX	16211-83	GP-54 ⁴¹	NISS	16400-D0100	GG-76	NISS
15H668	GA-33	MEAD	161-100-4380	G-296-B	USX	16211-83	GP-66 ¹⁰	NISS	16400-D0300	GG-63	NISS
15H668	GA-33	MELR	161-100-4425	GG-1	USX	1621183-M91	GP-54 ⁴¹	MASY	16400-E3000	GG-45	TCM
15R4	G-1173	COM	161-100-4425	GG-4	USX	1621183-M91	GP-66 ¹⁰	MASY	16400-E3000	GG-45	TOYO
15R6	G-1174	COM	161-100-6195	GA-16	USX	1621210M1	GA-49	EICH	16400-E3001	GG-45	NISS
15R8	G-1175	COM	161-100-6195	GAK-16	USX	1621224-M1	GP-310	MASY	16400-E3025	GG-45	NISS
16	GP-81	FACE	161-100-6825	GA-6129	USX	1622	GP-171 ¹⁸	NAP	16400-E3999	GG-45	NISS
16	GP-171	WIX	161-100-6980	GA-360	USX	162245	G-31	HOUG	16400-E5200	GG-196	NISS
160	GG-5 L	BGA	161-100-7040	GA-356	USX	162245	G-31	IHCO	16400-F1800	GA-5648	NISS
160	G-871	CRO	161-100-7100	GA-135	USX	162245H1	G-31	IHCO	16400-F5100	GG-63	NISS
160	GA-70	FACE	161-100-7785	GA-89	USX	162246	G-31	IHCO	16400-H8500	GG-45	NISS
16-0000001001	GP-54 ⁴¹	LIN	161-100-7865	GA-3647	USX	162246H1	G-31	IHCO	16400-H8500	GG-45	TCM
16-0000001001	GP-66 ¹⁰	LIN	161-100-8080	GA-5056	USX	1622833	GG-181	PARM	16400-H8501	GG-45	NISS
16000000201	GP-54 ⁴¹	LIN	161-100-8140	GA-174	USX	1622866	GP-1122	FORD	16400-H8501	GG-45	TCM
16000000201	GP-66 ¹⁰	LIN	161-100-8730	GA-7360	USX	162289A	G-1175	WAUK	16400-H8594	GG-45	NISS
16006108	GA-33	FARB	161-100-8730	GA-7360	USX	1623076	GP-761H	CHAM	16400-N1410	GG-94	NISS
16006109	GA-16	FARB	161-1008735	GAK-1532	USX	1623199	GG-39	PARM	16400-N4201	GG-94	NISS
16006109	GAK-16	FARB	161-100-8875	GA-483	USX	162-35-9728	G-1143	ALFA	16400-N7600	GG-94	NISS
16006110	GA-403	FARB	161-101-2975	GP-1011Q	USX	162-36-7712	G-1143	ALFA	16400-N8601	GG-94	NISS
16006110	GAK-403	FARB	161-101-2980	GP-1013Q	USX	1624	GP-81	NAP	16400-N9600	GG-94	NISS
16006111	GA-20	FARB	161-101-3740	GP-57	USX	1624	GP-9	NAP	16400-N9694	GG-94	NISS
16006111	GAK-20	FARB	1612	GP-14	NAP	16245	G-296	ROO	16400-P31G00	GG-1992	NISS
16006112	GA-27	FARB	1612313	GP-81	YUGO	16245	G-296-B	ROO	16400-Q0800	GG-94	NISS
16006113	GA-26	FARB	1612313	GP-9	YUGO	1624660	GG-256	PARM	16400-V2600	GG-63	NISS
16006114	GA-33	FARB	1612-3980	GP-54	ATCO	1625	GP-58	NAP	16400-V2700	GG-63	NISS
16006115	GA-16	FARB	1612-3980	GP-66	ATCO	1626	GP-3985	NAP	16400-W1100	GG-45	NISS
16006115	GAK-16	FARB	1612579	GP-761H	CHAM	1626	GP-38	NIPP	16400-W1105	GG-45	NISS
16006116	GA-403	FARB	1612A	GA-499R	GREY	162615	G-1175	WAUK	16400-W1110	GG-45	NISS
16006116	GAK-403	FARB	1613	GA-389	AMP	162709	GP-1	WAUK	16400-W7061	GG-94	NISS
16006117	GA-20	FARB	1613	G-613	NAP	162709-A	GP-1	WAUK	16403-99011	GP-110	NISS

Numero	Gonher	Fabricante	Numero	Gonher	Fabricante	Numero	Gonher	Fabricante	Numero	Gonher	Fabricante
Number	Gonher	Manufacturer	Number	Gonher	Manufacturer	Number	Gonher	Manufacturer	Number	Gonher	Manufacturer
1640996-M1	G-813	MASY	16546-16800	GAD-1	NISS	16546-S0100	GAD-1	NISS	1685359-C91	GPP-1287 ³⁹	IHCO
1640996-M91	G-813	MASY	16546-17800	GAD-117	NISS	16546-S0194	GAD-1	NISS	1685359-C91	PFF831 ⁴¹	IHCO
1640997	G-296	MASY	16546-17800	GAD-17	NISS	16546-TB000	GAD-118	NISS	1685359-C91	R 60 P ⁴²	IHCO
1640997	G-296-B	MASY	16546-17C1	GAD-29	NISS	16546-U6700	GA-75	NISS	168P	G-191	WIX
1640997-M91	G-296	MASY	16546-17C11	GAD-29	NISS	16546-U6710	GA-75	NISS	169	GG-6	AMP
1640997-M91	G-296-B	MASY	16546-18000	GAD-3	NISS	16546-V0100	GAD-15	NISS	169	GG-6	BGA
1641798	GA-195	PARM	16546-18000	GAD-3	TCM	16546-V0110	GAD-15	NISS	169	GP-128	PROT
1642	GP-51	NAP	16546-18001	GAD-3	NISS	16546-V01108	GAD-15	NISS	169	GA-50	UNN
1642645	GA-33 ¹¹²	CLRK	16546-18090	GAD-3	NISS	16546-V4910	GA-277	NISS	16900-584-G01	GG-161	HOND
1644-14-300	GP-42	MZDA	16546-18094	GAD-3	NISS	16546-V4960	GAVW-2	NISS	16900-584-G01	GG-161	HOND
16441-4300	GP-42	NISS	16546-1P100	GAD-129	NISS	16546-VV-600	GAD-34	NISS	16900-611-004	GG-1	HOND
164434	G-870	LEYL	16546-21000	GAD-3	NISS	16546-Y0351	GAD-15	NISS	16900-611-004	GG-4	HOND
1644499425	GP-110	IHCO	16546-21025	GAD-3	NISS	16546-Z2005	GA-20	NISS	16900-634-004	GG-1	HOND
16444-99425	GP-110	NISS	16546-21N00	GA-16	NISS	16546-Z2005	GAK-20	NISS	16900-634-004	GG-4	HOND
16444-99429	GP-110	NISS	16546-21N00	GAK-16	NISS	16546-Z5001	GA-20	NISS	16900-658-004	GG-1	HOND
16444-99525	GP-110	NISS	16546-22100	GAD-3	NISS	16546-Z5001	GAK-20	NISS	16900-658-004	GG-4	HOND
1644729	GA-20	CLRK	16546-22100	GAD-3	TCM	16547-60000	GAD-30	NISS	16900-SA0-023	GG-76	HOND
1644729	GAK-20	CLRK	16546-22125	GAD-3	NISS	1654K-A060	GAD-3	SUBA	16900-SA0-901	GG-76	HOND
16464	GA-410	MEDO	16546-23000	GAD-1	NISS	165505-H1	G-1163	IHCO	16900-SA0-902	GG-76	HOND
16470300	GP-14	BLAW	16546-30P00	GAD-117	NISS	165546-01T0A	GPP-523	NISS	16900-SA5-000	GG-208	HOND
16470400	G-295	BLAW	16546-30P00	GAD-17	NISS	165583-H1	G-119	IHCO	16900-SA5-003	GG-208	HOND
16475701	GAK-625	BLAW	1654641B01	GAD-315	NISS	1656-93-2630	G-152	KOMA	16900-SA5-0034	GG-208	HOND
164830	GP-1	WAUK	16546-50100	GAD-1	NISS	16575	GP-1101	TIMC	16900-SA5-004	GG-208	HOND
164832AS	GA-16 ¹¹²	OLIV	16546-53J00	GP-156	NISS	165807AS	GA-892	MINN	16900-SA5-005	GG-208	HOND
164832AS	GAK-16 ³⁴	OLIV	16546-60U00	GAD-129	NISS	1658B66	G-31	NEL	16900-SB2-681	GG-215	HOND
164832-AS	GA-16 ¹¹²	WHIT	16546-75000	GA-300	NISS	166	GP-3675	PROT	16900-SB2-684	GG-215	HOND
164832-AS	GAK-16 ³⁴	WHIT	16546-76000	GAD-30	NISS	1660	GP-556	NAP	16900-SB2-685	GG-215	ACUR
1649	GP-43	NAP	16546-76001	GAD-30	NISS	16607	GP-91	PARM	16900-SB2-685	GG-215	HOND
164A	GA-200	GREY	16546-76015	GAD-30	NISS	166-094-00-04	GA-2181	CHRY	16900-SD4-671	GG-214	HOND
164A	GA-218	GREY	16546-76016	GAD-30	NISS	166-094-00-04	GA-2181	MBNZ	16900-SD4-A50	GG-214	HOND
164A	GA-218	WOOO	16546-77A10	GA-6619 ¹	NISS	1661755-C91	GA-209	IHCO	16900-SD4-A51	GG-214	HOND
164WA112	GA-24	BLDW	16546-77A10	GA-6620 ²	NISS	166-180-00-09	G-910	CHRY	16900-SDA-50	GG-214	HOND
164WA112	GA-24	CLRK	16546-78000	GAD-118	NISS	166-180-00-09	G-910	MBNZ	16900-SDA-51	GG-214	HOND
165	GP-28 ⁸	PROT	16546-78001	GAD-118	NISS	166-180-01-09	G-910	CHRY	16900-SDA-671	GG-213	HOND
165	GP-430 ⁸	PROT	16546-80G00	GAD-30	NISS	166-180-01-09	G-910	MBNZ	16900-SE0-000	GG-208	HOND
1650363	GP-3	OPEL	16546-84A10	GA-6619 ¹	NISS	166-180-02-09	G-910	CHRY	16900-SE0-003	GG-208	HOND
16505	G-1163	IHCO	16546-84A10	GA-6620 ²	NISS	166-180-02-09	G-910	MBNZ	16900-SE0-004	GG-208	HOND
1650954	GP-81	ALCH	16546-86G00	GAD-294	NISS	166-180-07-10	G-910	CHRY	16900-SE0-A31	GG-181	HOND
1650954	GP-9	ALCH	16546-89W00	GA-3588	NISS	166-180-07-10	G-910	MBNZ	16900-SE0-G32	GG-181	HOND
1650954	GP-81	SIMP	16546-90112	GA-26	NISS	166-184-05-25	G-910	CHRY	16900-SF1-A32	GG-181	HOND
1650954	GP-9	SIMP	16546-90113	GA-27	NISS	166-184-05-25	G-910	MBNZ	16900-SF1-A33	GG-181	HOND
1650P	G-238	WIX	16546-90117	GA-27	NISS	1661964	GP-1013Q	VOLV	16900-SH3-A30	GG-190	HOND
16510-05A00	GP-58	SUZU	16546-95003	GA-24	NISS	166223	G-870	LEYL	16900-SH3-A31	GG-190	HOND
16510-60B10	GP-58	SUZU	16546-96010	GA-361	NISS	1663296	GA-77	STUD	16900-SH3-C30	GG-190	HOND
16510-60B11	GP-58	SUZU	16546-96011	GA-360	NISS	166392	GA-356	GARD	16900-SK7-A61	GG-234	HOND
16510-610A01	GP-156	SUZU	16546-96014	GA-206	NISS	166392	GA-357	GARD	16900-SL5-A31	GG-214	HOND
16510-61A01	GP-156	SUZU	16546-96016	GA-360	NISS	16655	GP-1	WEST	16900-SM3-A32	GG-184	HOND
16510-61A20	GP-156	SUZU	16546-96017	GA-106 ⁴⁶	NISS	1666053-C1	GP-57	IHCO	16900-SM4-A31	GG-184	HOND
16510-73000	GP-58	SUZU	16546-96017	GA-326 ⁷¹	NISS	166619	GA-135	CUMM	16900-SM4-A32	GG-184	HOND
16510-73001	GP-58	SUZU	16546-96025	GA-106 ⁴⁶	NISS	166765	GP-3600	TENN	16900-SM4-A33	GG-184	HOND
16510-73002	GP-2951	SUZU	16546-96025	GA-326 ⁷¹	NISS	16686917	GA-377	GMCC	1691027-C1	GA-197R	IHCO
16510-73010	GP-58	SUZU	16546-96027	GA-360	NISS	1669	GP-53	NAP	1691121-C1	G-162H	IHCO
16510-78J00	GP-406	SUZU	16546-96029	GA-360	NISS	1669437-C1	GA-376	IHCO	1692595	GG-190	PARM
16510-82001	GP-58	SUZU	16546-96060	GA-24	NISS	1669XD	GP-53	NAP	1693326	GG-142	PARM
16510-83011	GP-2951	SUZU	16546-96125	GA-106 ⁴⁶	NISS	166M	G-34	REF	169343	GA-5648	CUMM
16510-83012	GP-2951	SUZU	16546-96125	GA-326 ⁷¹	NISS	167	GP-44	PROT	169364	GA-21	CUMM
16510-85FA0	GP-2951	SUZU	16546-97004	GA-6129	NISS	1670	GP-53	NAP	169364	GA-221R	IHCO
16510-86CB1	GP-461	SUZU	16546-97005	GA-6127	NISS	16707001	GG-1	VERM	169467	GA-16	MANO
16510-86Z00	GP-461	SUZU	16546-97006	GA-6129	NISS	16707001	GG-4	VERM	169467	GAK-16	MANO
1651563	GP-1011Q	FORD	16546-97009	GA-360	NISS	167084A	G-1175	WAUK	169468	GA-33	MANI
1651866	G-31	WIN	16546-97015	GA-360	NISS	1670T	G-500	NEL	169469	GA-403	MANI
165245	G-31	HOUG	16546-97026	GA-6129	NISS	1670T	G-750	NEL	169469	GAK-403	MANI
165245	G-31	IHCO	16546-99112	GA-6129	NISS	1670T	G-500	WIN	169470	GA-361	MANI
165245H1	G-31	HOUG	16546-99205	GA-16	NISS	1670T	G-750	WIN	169476	GA-360	MANO
165245-H1	G-31	IHCO	16546-99205	GAK-16	NISS	167143AS	GP-3000	MINN	169478	GA-24	MANI
1653A6	G-31	DIAM	16546-95001	GAD-36	NISS	1672465	GA-465R	DAF	169479	GA-20	MANI
1653A6	G-31	REOT	16546-AA010	GA-4303	NISS	1673	GP-359	NAP	169479	GAK-20	MANI
1653-A6	G-31	WHIT	16546-AA010	GA-4303	SUBA	16734319-C1	GA-108	IHCO	169480	GA-49	MANO
1654-30P00	GAD-117	NISS	16546-AA020	GAD-15	SUBA	16734319-C2	GA-108	IHCO	169482	GA-37	MANI
16545-04N00	GAD-30	NISS	16546-AX600	GAD-315	NISS	16734320-C1	GA-107	IHCO	169485	GA-27	MANI
16545-89W00	GA-3588	NISS	16546-CK20S	GA-361	NISS	16734320-C2	GA-107	IHCO	16949P	GG-119	MULH
16545-AA010	GA-4303	SUBA	16546-CW40S	GA-206	NISS	167475	G-870	COLS	16949P	G-119	PETI
16546-00H03	GA-33	NISS	16546-EA000	GA-1546	NISS	167480	G-500	IHCO	1695007	G-500	VOLV
16546-00H03B	GA-33	NISS	16546-ED000	GAD-116	NISS	167480	G-750	IHCO	1695007-3	G-500	VOLV
1654600QAA	GA-291	NISS	16546-ET000	GA-1529	NISS	167488	GA-135	CUMM	16954-890-670	GG-19	HOND
16546-00QAB	GA-391	NISS	16546-F4100	GAD-117	NISS	167554	G-813	COLS	1695P	G-1174	MULH
16546-02N00	GA-16	NISS	16546F4101	GAD-117	NISS	1676546	GP-2108W	VOLV	1695P	G-1174	PETI
16546-02N00	GAK-16	NISS	16546F4101	GAD-17	NISS	1677004-C91	GPP-547 ³⁹	IHCO	1696265-C1	G-128	IHCO
16546-02N01	GA-16	NISS	16546-G9600	GA-49	NISS	1677004-C91	PFF831 ⁴¹	IHCO	1696300311	GP-2071W	SISU
16546-02N01	GAK-16	NISS	16546-JA00A	GA-1530	NISS	1677004-C91	R 60 P ⁴²	IHCO	1696300321	GP-1013Q	SISU
16546-04800	GAD-315	NISS	16546-KA120	GAD-3	SUBA	1677224	G-6	CHRY	1696300451	GP-2071W	SISU
16546-04N00	GAD-30	NISS	16546-L0700	GAD-1	NISS	1677224	G-6	MOP	169741	GP-1	HYST
16546-06N00	GAD-1	NISS	16546-L110	GAD-30	NISS	167A	GA-2122	GREY	169745	GA-24	WAUK
16546-08000	GAD-1	NISS	16546-L3000	GAD-30	NISS	168	G-1121	CRO	1698941-C1	GA-518R	IHCO
16546-08001	GAD-1	NISS	16546-L								

Referencia Cruzada por Numero de Parte

Cross Reference by Part Number



Numero	Gonher	Fabricante	Numero	Gonher	Fabricante	Numero	Gonher	Fabricante	Numero	Gonher	Fabricante
Number	Gonher	Manufacturer	Number	Gonher	Manufacturer	Number	Gonher	Manufacturer	Number	Gonher	Manufacturer
1700291-C1	GA-730	IHCO	1719859	GP-81	BOLN	172995	GA-1203	GARD	17772-22000	GA-16	TOYO
1700328	G-296	FORD	1719859	GP-9	BOLN	17309	GA-33	MILL	17772-22000	GAK-16	TOYO
1700328	G-296-B	FORD	172	GG-87	AMP	173174	G-613	CUMM	1777935	GP-171 ¹⁶	CLRK
170035001	GP-110	MINN	172	GG-87	BGA	17321-32430	GP-171	KUBO	17791-11120-71	GA-33	TOYO
170035001	GP-110	WHIT	172	GA-386	UCAL	17321-32431	GP-81	KUBO	17792-22000	GA-16	TOYO
170035-002	GP-78	WHIT	17200-671-000	GA-3490	HOND	17321-32431	GP-9	KUBO	17792-22000	GAK-16	TOYO
1700425	GA-403	FORD	17200-P9M-E00	GA-2174	HOND	173231	GP-1	OUTB	178	GA-680	ERO
1700425	GAK-403	FORD	172010-001	GP-10	WHIT	173232	GP-3	OUTB	178	GA-192	UNN
1700463-C92	GA-3501	IHCO	172010-001	GP-54	WHIT	173233	GP-13	OUTB	17801-0005A	GA-20	HINO
1700478-C91	GA-3501	IHCO	172010002	GP-53	MINN	17325-11080	GA-33	KUBO	17801-0005A	GAK-20	HINO
1700711-C92	GA-3501	IHCO	172015003	GP-52 ¹¹⁰	VOLV	1734	GP-562	NAP	17801-02020	GA-195	TOYO
1700712-C92	GA-3501	IHCO	172015003	GP-691 ⁴⁸	VOLV	173442	GA-356 ¹⁰⁴	GARD	17801-02030	GA-5466	TOYO
1700714-C91	GA-3501	IHCO	172015004	GP-53	VOLV	173442	GA-357 ¹⁰⁸	GARD	17801-03010	GA-322	TOYO
1700716-C91	GA-3501	IHCO	172015-777	GP-57	WHIT	1734MP	GP-562	NAP	17801-07010	GA-286	TOYO
170154609	GP-1122	KHDF	172066112	G-31	HANO	173834	GP-46	OUTB	17801-08010	GA-6690	TOYO
17016722	GP-66	MMAN	17208930	GA-277	ALUP	1738CT1	G-1173	COM	17801-0C010	GA-412R	TOYO
170-16722	GP-66	OWTN	172146-73710	GP-562	YNMR	1739547	GA-70	CHRY	17801-0D020	GA-263	TOYO
170200	GP-14	CUMM	1722	GP-52 ¹¹⁰	NAP	1739547	GA-70	MOP	178010D060	GA-265	TOYO
170319C1	GG-20	IHCO	1722	GP-691 ⁴⁸	NAP	1739548	GA-71	CHRY	17801-0H010	GA-264	TOYO
170-32342	GP-34	OWTN	17220-67100	GA-3490	HOND	1739548	GA-71	MOP	17801-0H020	GA-264	TOYO
17032346	GP-66	MMAN	17220-671-000	GA-3490	HOND	1739617	GP-1	CHRY	17801-0H050	GA-464	TOYO
170-32346	GP-66	OWTN	17220-671-004	GA-3490	HOND	1739618	GP-1	CHRY	17801-0P010	GA-380	TOYO
170-32375	GP-34	OWTN	17220-671-305	GA-3490	HOND	1739619	GP-1	CHRY	178010T030	GA-265	TOYO
170349-C1	GG-20	IHCO	17220-689-003	GA-2740	HOND	1740	GP-864H	NAP	17801-0W010	GA-198	TOYO
1704	GP-50 ³⁰	NAP	17220-689-004	GA-2740	HOND	1741	GP-3000 ¹³	NAP	17801-1020	GA-27	HINO
1704	GP-1	PAR	17220-689-005	GA-2740	HOND	17410	GAK-1532	THOM	17801-1020	GA-27	TOYO
1704	GG-4	PAR	17220-689-781	GA-2740	HOND	1742	GP-3766	NAP	17801-1050	GA-26	HINO
1704648	GG-67	PARM	17220-P07-000	GA-381	HOND	1743729	GG-220	PARM	17801-1090	GA-206	HINO
17055811	GG-6	GMCX	17220-P07-000	GA-381	HOND	174402-9	GA-27	WHIT	17801-1090A	GA-206	HINO
17058120	GG-16	GMCX	17220-P0A-A00	GA-514	HOND	1744825	GG-146	PARM	17801-1110	GA-106 ⁶⁶	HINO
17059120	GG-16	GMCX	17220-P2A-005	GA-384	HOND	1745190	GG-151	PARM	17801-1110	GA-326 ⁷¹	HINO
17059420	GG-16	GMCX	17220-P2F-A01	GA-384	HOND	1746	GP-34	NAP	17801-1110A	GA-106 ⁶⁶	HINO
17065026	GG-6	GMCX	17220-P2J-003	GA-172	HOND	174786	GP-13	OUTB	17801-1110A	GA-326 ⁷¹	HINO
17065579	GG-16	GMCX	17220-P2N-A01	GA-172	HOND	174787	GP-3	OUTB	17801-1130A	GA-360	HINO
17065588	GG-6	GMCX	17220-P5T-G00	GA-2174	HOND	1748	GP-3000	NAP	17801-1180	GA-361	HINO
17067151	GG-17	GMCX	17220-P8C-A00	GA-170	HOND	1748XD	GP-3001	NAP	17801-1180A	GA-361	HINO
17067964	GG-16	GMCX	17220-P8F-A00	GA-183	HOND	1749	GP-57	NAP	17801-1190	GA-360	HINO
170681	GA-403	HYST	17220-PA6-003	GA-3490	HOND	1749545	GA-6690	PARM	17801-1190A	GA-360	HINO
170681	GAK-403	HYST	17220-PA6-004	GA-3490	HOND	174A	GAVW-4	GREY	17801-123001-71	GA-16	TOYO
1709322	GP-54	HYMA	17220-PA6-013	GA-3490	HOND	175	GG-19	AMP	17801-123001-71	GAK-16	TOYO
1709322	GP-22	SIMP	17220-PA6-661	GA-3490	HOND	175	GG-19	BGA	17801-14050	GA-2719B	TOYO
170A	GA-303	GREY	17220-PAA-A00	GA-163	HOND	175	G-238	DEL	17801-1470	GA-27	HINO
170MP	GP-81	PROT	17220-PAA-A00	GA-163	HOND	1750	G-750	NAP	17801-14701	GA-27	HINO
171	GG-1	AMP	17220-PAO-003	GA-3490	HOND	1751	G-750	NAP	17801-1490	GA-20	HINO
171	GG-4	AMP	17220-PC2-611	GA-2740	HOND	17524	GP-22	RUGG	17801-1490	GAK-20	HINO
171	GG-1	BGA	17220-PC2-661	GA-2740	HOND	17529	GP-3600	RUGG	17801-1491	GA-20	HINO
171	GG-4	BGA	17220-PC3-601	GA-2740	HOND	175-2949	GPP-11	CATP	17801-1491	GAK-20	HINO
171064-12540	GA-16	YNMR	17220-PE0-661	GA-4958	HOND	1753	G-750	NAP	17801-15010	GA-3566	TOYO
171064-12540	GAK-16	YNMR	17220-PE0-663	GA-4958	HOND	1754	GP-54	NAP	17801-15070	GA-5466	TOYO
171105-001	G-500	WHIT	17220-PH4-305	GA-390	HOND	175475-R1	G-1174	IHCO	17801-1520	GA-27	HINO
171105-001	G-750	WHIT	17220-PH4-315	GA-390	HOND	175-49-11580	G-191	KOMA	17801-1560	GA-20	HINO
1712202	G-296	EICH	17220-PH4-661	GA-390	HOND	1755206-M1	G-33	MASY	17801-1560	GAK-20	HINO
1712202	G-296-B	EICH	17220-PJ2-003	GA-172	HOND	1755206-M91	G-33	MASY	17801-1710	GA-27	HINO
1712202	G-296	MASY	17220-PLC-000	GA-194	HOND	1756	GP-34	NAP	17801-1710A	GA-27	HINO
1712202	G-296-B	MASY	17220-PM7-000	GA-382	HOND	1758	GP-34	NAP	17801-1930A	GA-27	HINO
1712202M1	G-296	EICH	17220-PM7-F00	GA-382	HOND	1759	GP-34	NAP	17801-20040	GA-264	TOYO
1712202M1	G-296-B	EICH	17220-PNA-003	GA-184	HOND	176	GG-7	AMP	17801-2090	GA-27	HINO
1712202-M1	G-296	MASY	17220-PNB-003	GA-184	HOND	176	GG-7	BGA	17801-21030	GA-364	TOYO
1712202-M1	G-296-B	MASY	17220-PNB-Y01	GA-184	HOND	176	GA-105	UNN	1780121050	GA-265	TOYO
17131	GP-1	CRIS	17220-PT2-000	GA-386	HOND	1762	GP-3600	NAP	17801-2170	GA-758	HINO
171336-5	GP-31	WHIT	17220-PZD-A01	GA-184	HOND	1763	GP-69	NAP	17801-22020	GA-263	TOYO
171439	GP-81	SIMP	17220-R40-A00	GA-193	HOND	176348	GAK-16	WAUK	17801-2270	GA-398	HINO
171439	GP-9	SIMP	17220-R70-A00	GA-171	HOND	1764	GP-3600	NAP	17801-23000-71	GA-16 ¹²	SLP
171547	G-296	MANO	17220-RAA-A00	GA-138	HOND	176554	GP-50	WAUK	17801-23000-71	GAK-16 ¹⁴	SLP
171547	G-296-B	MANO	17220-RAA-Y00	GA-138	HOND	176755	G-31	WAUK	17801-23000-71	GA-16 ¹²	TOYO
171549	GP-1	MANO	17220-RAA-Y000	GA-138	HOND	1769	GP-69	NAP	17801-23000-71	GAK-16 ¹⁴	TOYO
1715758	G-870	FORD	17220-RCA-A00	GA-269	HOND	177	G-870	CRO	17801-2330	GA-24	HINO
1715762	G-11816	FORD	17220-RCB-Y00	GA-269	HOND	177	GP-81	DEL	17801-2460	GA-398	HINO
1717042	GP-1	CANT	17220-RCB-Y000	GA-269	HOND	177	GP-9	DEL	17801-2460A	GA-398	HINO
1717076	GP-46	CANT	17220-RCJ-A00	GA-269	HOND	177006	GA-16	WAUK	17801-2480B	GA-616	HINO
1717084	GP-157	CANT	17220-RD5-A00	GA-383	HOND	177006	GAK-16	WAUK	17801-2490	GA-758	HINO
1717092	GP-44	CANT	17220-RDA-A00	GA-269	HOND	17702-30690	GA-27	TOYO	17801-28010	GA-293	TOYO
1717106	GP-3980	CANT	17220-RGL-A00	GA-383	HOND	17702-30750	GA-403	TOYO	17801-28030	GA-464	TOYO
1717130	GP-3766	CANT	17220-RGL-A10	GA-383	HOND	17702-30750	GAK-403	TOYO	17801-31090	GA-380	TOYO
1717244	GP-157	CANT	17220-RNA-A00	GA-340	HOND	17702-30750-71	GA-403	TOYO	17801-31120	GA-320	TOYO
1717252	GP-3429	CANT	17220-RZA-000	GA-341	HOND	17702-30750-71	GAK-403	TOYO	17801-3502	GA-6690	TOYO
1717286	GP-20	CANT	17-22113312062	GP-54	BMW	17704-30710	GA-403	TOYO	17801-35020	GA-6690	TOYO
1717294	GP-13	CANT	17-22113312062	GP-66	BMW	17704-30710	GAK-403	TOYO	17801-35020-83	GA-6690	TOYO
1717340	GP-81	CANT	17221331206	GP-54 ¹¹	BMW	17704-30710-71	GA-403	TOYO	17801-37010	GA-2719B	TOYO
1717340	GP-9	CANT	17221331206	GP-66 ¹⁰	BMW	17704-30710-71	GAK-403	TOYO	17801-41050	GA-2719B	TOYO
1717358	GP-3	CANT	17232-PH4-661	GA-390	HOND	1771007	G-836	FORD	17801-41050-83	GA-2719B	TOYO
1718608	GP-3985	CANT	17237	GP-1	EATN	1771008	G-834	FORD	17801-41060	GA-2719B	TOYO
1718608	GP-40	CANT	17237	GP-1	FULR	1772	GP-54 ¹¹	NAP	17801-41090	GA-2719B	TOYO
1718624	GP-81	CANT	17237	GP-1	YALE	1772	GP-66 ¹⁰	NAP	17801-41090-83	GA-2719B	TOYO
1718624	GP-9	CANT	1723CT1	G-1173	COM	17722-41750	GA-27	TOYO	17801-41100	GAD-1	TOYO
1718770	GP-38	CANT	1724H2453	G-834	LEYL	1774	GP-54 ⁹⁰	NAP	17801-46060	GA-6</	

Numero	Gonher	Fabricante	Numero	Gonher	Fabricante	Numero	Gonher	Fabricante	Numero	Gonher	Fabricante
Number	Gonher	Manufacturer	Number	Gonher	Manufacturer	Number	Gonher	Manufacturer	Number	Gonher	Manufacturer
17801-74060	GA-322	TOYO	1802271	G-296-B	MASY	18-228P	GA-16	DYNA	1851658	GP-1	CHRY
17801-75010	GA-410	TOYO	1802271-M1	G-296	MASY	18-228P	GAK-16	DYNA	1851673	G-813	MASY
17801-87701	GAD-3	DTSU	1802271-M1	G-296-B	MASY	18-231	GA-16	DYNA	1851676	G-813	MASY
17801-AD010	GA-320	TOYO	180244DS	G-31	HERC	18-231	GAK-16	DYNA	1851676-M1	G-813	MASY
17801-OC010	GA-412R	TOYO	180255CS	G-1175	HERC	18-231P	GA-16	DYNA	185168-R9	GA-7	IHCO
17802-23000	GA-16	TOYO	180265B	G-1176	HERC	18-231P	GAK-16	DYNA	185168-R91	GA-7	IHCO
17802-23000	GAK-16	TOYO	180282	GP-50	HYST	1823386	GA-18	FORD	1851722	G-813	MASY
17802-23000-71	GA-16	TOYO	180282-12	GP-50	HYST	1823932	GA-588	FORD	1851766	G-813	MASY
17802-23000-71	GAK-16	TOYO	180283	GP-81	HYST	1823934	GA-589	FORD	1851766-M1	G-813	FERG
1780340	GP-1122	CLAA	180283	GP-9	HYST	1824	GP-35	NAP	1851766-M1	G-813	MASY
1783	G-122	NAP	180283-06	GP-81	HYST	18252331-M1	G-834	MASY	1851815-M1	G-870	MASY
1783	G-338	NAP	180283-06	GP-9	HYST	1825864-C92	G-862	IHCO	1851890	G-296	MASY
1784	GP-69	NAP	1803	GP-54	NAP	182855-H1	G-1175	IHCO	1851890	G-296-B	MASY
178459	G-1121	FORD	180320	GP-50	HYST	1829101	GP-1122	BENA	1851890-M1	G-296	MASY
178460	G-1121	FORD	1803991	GA-16	CLRK	1831101	G-33	BENA	1851890-M1	G-296-B	MASY
1785	GP-58	NAP	1803991	GAK-16	CLRK	18316	GP-128	PARM	185-2123	GP-91	ONAN
178562	GP-81	NEWH	1803993	GA-33	CLRK	1833121-C1	GP-152	IHCO	1852225-M91	G-813	MASY
178562	GP-9	NEWH	1804015	GAD-30	CLRK	1834101	G-813	BENA	1852251	G-813	MASY
17859	G-1121	FORD	1804084	GP-3682	CLRK	1834108	GP-1	BENA	1852251-M91	G-813	MASY
178624	GA-206	MENA	1804084	GP-37	CLRK	1835109	GP-28 ⁶	BENA	1852291-91	G-813	MASY
178625	GA-106 ⁴⁶	DAIM	1804142	GG-16	TLFT	1835109	GP-430 ⁴¹	BENA	1852291M91	G-813	MASY
178625	GA-326 ⁷¹	DAIM	1804144	GG-46	TLFT	18360	G-295	WPAUK	185233	G-834	MASY
178625	GA-106 ⁴⁶	MBNZ	1804198	GA-303	CLRK	1836103	G-33	BENA	1852331	G-834	IHCO
178625	GA-326 ⁷¹	MBNZ	1804227	GA-361	CLRK	1837145	G-5000	FORD	1852331	G-834	MASY
178625	GA-106 ⁴⁶	MENA	1804245	GA-37	CLRK	1838	G-49	NAP	1852331-M1	G-834	MASY
178625	GA-326 ⁷¹	MENA	1804250	GAK-216	CLRK	1839102	GP-54 ⁴¹	BENA	1852331-M91	G-834	MASY
178637	GA-106 ⁴⁶	OREN	1804251	GA-416	CLRK	1839102	GP-66 ⁴⁰	BENA	1852331R91	G-834	CASE
178637	GA-326 ⁷¹	OREN	1804259	GAK-1532	CLRK	1839106	GP-69	BENA	1852331-R91	G-834	IHCO
178638	GA-206	OREN	1804265	GA-7	CLRK	184	GP-1122	AMP	1852331-M1	G-834	MASY
178668	GA-24	WAUK	1804277	GA-44	CLRK	184	GP-1122	BGA	185233-R91	G-834	IHCO
178669	GA-27	WAUK	1804442-C1	GP-3766	IHCO	184	GA-77	FACE	1852781	G-238	MASY
1788	GP-51	NAP	180444-C1	GP-3766	IHCO	1840752-C91	G-3752	IHCO	1852781-M1	G-238	MASY
1789	GP-69	NAP	1804459-C1	GP-155	IHCO	1841890	G-296	MASY	1853196-M1	GA-18	MASY
1791	GP-51	NAP	1805045M2	GA-18	EICH	1841890	G-296-B	MASY	185319-M1	GA-18	MASY
1791XE	GP-51	NAP	1805045-M91	GA-18	MASY	1841890-M1	G-296	MASY	1854755-M1	G-813	MASY
1792	GP-52 ¹⁰	NAP	1805045-M92	GA-18	MASY	1841890-M1	G-296-B	MASY	1854766-M1	G-813	MASY
1792	GP-691 ⁴⁸	NAP	180595	GP-66	HYST	1841890-M91	G-296	MASY	1855409	GP-91	ONAN
1792278	GA-386	PARM	1806	GP-1	NAP	1841890-M91	G-296-B	MASY	185541	G-813	MASY
1792XD	GP-52 ¹⁰	NAP	1806088-M2	GA-18	MASY	1842225	G-225	DAIM	185-55-03	G-1121	STEY
1792XD	GP-691 ⁴⁸	NAP	1806088-M91	GA-18	MASY	1842225	G-225	MBNZ	185-55-04	G-1121	STEY
1792XE	GP-52 ¹⁰	NAP	18065	GA-5648	NEL	1842325	G-225	MBNZ	185551	G-813	MASY
1792XE	GP-691 ⁴⁸	NAP	1807	GP-54	NAP	1843059-C1	G-1047	IHCO	185-55-65	G-1123	STEY
1794	GP-23	NAP	1807257	GA-26	MASY	1843162-C91	G-862	IHCO	185-55-66	G-1123	STEY
1794446	GP-1	FORD	18072-57	GA-26	NISS	18-4360	GP-14	TORO	185-5835	GP-462	ONAN
1796	GP-390 ⁹³	NAP	1807257M1	GA-26	EICH	1843825	G-143	DAIM	185691	G-33	ALCH
1797	GP-10	NAP	1807257-M1	GA-26	MASY	1843825	G-143	MBNZ	185766-M1	G-813	MASY
1797MP	GP-10	NAP	18087	GP-3600	SUBA	1844588-C91	G-3752	IHCO	1858554	GG-20	CHRY
1798	GP-9	SULL	1808896-C1	GP-69	IHCO	1844701	G-225	MBNZ	1858554	GG-20	MOP
1799	GP-152	NAP	1808946-C1	GP-69	IHCO	1844901	G-162H	DAIM	1858555	GG-20	CHRY
179930	GA-24	HYST	1809	GP-642	NAP	1844901	G-225	DAIM	1858555	GG-20	MOP
179931	GA-33	HYST	18090	G-296	ROO	1844901	G-162H	MBNZ	185875-0	G-500	WHIT
179934	GA-27	HYST	18090	G-296-B	ROO	1844901	G-225	MBNZ	185875-0	G-750	WHIT
179955	GA-403	HYST	180939	GPP-1122	CLAA	1845766	G-813	MASY	185-P117	G-11816	ONAN
179955	GAK-403	HYST	1809390	GP-1122	CLAA	1845766M1	G-813	MASY	186	GPP-18	AMP
179961	GA-20	HYST	1809789-C1	GP-78	IHCO	1845776-M1	G-813	MASY	186	GPP-18	BGA
179961	GAK-20	HYST	1810404-M1	G-238	MASY	1845801	G-225	MBNZ	18610-00740	GG-185	NIPP
1799MP	GP-152	NAP	1810404-M91	G-238	MASY	1845825	G-225	MBNZ	18610-00740	GG-185	TOYO
17H1784	G-834	LEYL	1811	GP-53	NAP	1846301	G-225	MBNZ	18610-00822	GG-185	NIPP
17H2453	G-834	LEYL	1811953C1	GP-88 ⁹⁰	IHCO	1846725	G-31	ASTR	18610-00822	GG-185	TOYO
17H514	G-870	LEYL	1812	GP-43	NAP	1846725	G-31	MBNZ	18610-01091	GG-185	NIPP
17H541	G-871	LEYL	1812492	GP-66	BOLN	184756	GA-5648	ALCH	18610-01241	GG-217	NIPP
17H654	G-11816	LEYL	1813	GP-53	NAP	184756	GA-5648	FIAT	18610-01241	GG-217	TOYO
17H9452	G-296	LEYL	1813436	GP-81	FORD	184756-5	GA-5648	ALCH	186100-1261	GG-220	DENS
17H9452	G-296-B	LEYL	1814346	GP-9	FORD	184756-9	GA-5648	ALCH	18610-01721	GG-142	NIPP
17PS2690	GA-24	CHIC	1814562-C1	GP-562	IHCO	1848	GP-52 ¹⁰	NAP	18610-01721	GG-142	TOYO
17PS2690	GA-24	CONP	1815588-C1	GP-1012Q	IHCO	1848	GP-691 ⁴⁸	NAP	186100-1721	GG-142	DENS
17R4T	G-1173	COM	1816	GP-156	NAP	1849106	GA-106 ⁴⁶	BENA	186100-1820	GG-220	DENS
18	GA-405	ERO	18162F5	GA-26 ¹¹²	OSHA	1849106	GA-326 ⁷¹	BENA	18610-01890	GG-187	NIPP
18	G-200	WIX	181642	G-296	SAAB	1849107	GA-206	BENA	18610-02430	GG-185	NIPP
180	GG-1	AMP	181642	G-296-B	SAAB	1849108	GA-360	BENA	18610-02450	GG-185	NIPP
180	GG-4	AMP	181646	GP-1122	SAAB	1849109	GA-361	BENA	186100-2540	GG-227	DENS
180	GG-1	BGA	1816568-C91	GPP-1287 ³⁹	IHCO	1849114	GA-16	BENA	18610-02690	GG-185	NIPP
180	GG-4	BGA	1816568-C91	PPF831 ⁴¹	IHCO	1849114	GAK-16	BENA	18610-05010	GG-164	NIPP
180	G-1123	CRO	1816568-C91	R 60 P ⁴²	IHCO	1849115	GA-357	BENA	186149-M1	G-870	MASY
180	G-331	DEL	1817	GP-761H	NAP	1849116	GA-356	BENA	186149-M91	G-870	MASY
180 2209	G-180	MBNZ	181769	GP-50	HYST	1849117	GA-20	BENA	186162	GA-5648	ALCH
180 2309	G-180	MBNZ	1818471-M1	G-1123	MASY	1849117	GAK-20	BENA	186306H1	G-1143	HOUG
180 2309	G-918	MBNZ	1818541	G-6	CHRY	1849120	GA-6129	BENA	186306-H1	G-1143	IHCO
180 2609	G-180	MBNZ	1818893	G-5000	FORD	1849124	GA-892	BENA	1863399	GP-462	BOLN
180 2609	G-918	MBNZ	1819	GP-761H	NAP	1849125	GAK-625	BENA	186366	G-1175	HERC
180 3109	G-180	MBNZ	1819452-C1	GP-152	IHCO	1849148	GA-853R	FIAT	186366	G-1175	HOUG
180 3109	G-918	MBNZ	181A	GA-50	GREY	1849254	GA-403	BENA	186366	G-1175	WHIT
1800562	GA-44	CLRK	182	GG-8 ¹⁰³	AMP	1849254	GAK-403	BENA	1863799	GP-761H	NEWH
1800976	GP-50	CLRK	182	GG-8 L ⁸⁰	AMP	18498	GP-34	CASE	18637992	GP-761H	FORD
1800977	GP-1	CLRK	1820	GP-54 ⁴¹	NAP	18-498	GP-34	STEI	18638	G-295	ROO
1801088-C1	GP-1011Q	IHCO	1820	GP-66 ¹⁰	NAP	185	GP-19	AMP	18639	G-295	ROO
1801089-C1	GP-1011Q	IHCO	1820361-C1	GP-1012Q	IHCO	185	GPP-19	BGA	1866927	GA-589	FORD
1801090-C1	GP-2071W	IHCO	18215M91	GAK-16	MASY	18-502	GP-66	STEI	1867	G-339H	NAP
1801509	G-112	MBNZ	1822101	G-296	BENA	1850450-M2	G-11816	MASY	1868979	GA-7017	PARM
1801609	G-3827	MBNZ	1822101	G-296-B	BENA	1851168R9	GA-7	IHCO	1869	GP-53	NAP

Referencia Cruzada por Numero de Parte

Cross Reference by Part Number



Numero	Gonher	Fabricante	Numero	Gonher	Fabricante	Numero	Gonher	Fabricante	Numero	Gonher	Fabricante
Number	Gonher	Manufacturer	Number	Gonher	Manufacturer	Number	Gonher	Manufacturer	Number	Gonher	Manufacturer
1-87100-690	GA-27	ISUZ	18A	GAK-403	BOG	19251	GA-218	MIOF	195813	GP-1122	DITC
1871722-M1	GP-69	MASY	1-8A	GP-1	PARM	19-259P	G-1173 ¹⁰⁸	DYNA	195814	GP-36	DITC
1871933M91	GA-49	EICH	18A155	GA-26	LINK	19-261	G-1173 ¹⁰⁸	DYNA	195-817	GAK-16	DITC
1873	GP-53	NAP	18A252	GA-26	LINK	19-261P	G-1174 ¹⁰⁸	DYNA	195-849	GP-3816	DITC
1874139	GP-91	BOLN	18A3084	GA-26 ¹¹²	LINK	1926322	GA-381	PARM	195852	GP-1	HYST
18765	G-765	PARM	18A310	GA-20	LINK	1927	G-1173 ¹⁰⁸	COM	195852-12	GP-1	HYST
18772	G-33	BUFF	18A310	GAK-20	LINK	1930010	GPP-1122	FIAT	1959080C1	GP-1	IHCO
18772	G-33	GMCX	18A347	GA-26	LINK	1930213	GP-9	FIAT	1959198C	GP-91	CASE
18772	G-33	KOEH	18A559	GA-27	LINK	1930213	GP-9	IVEC	1959198C1	GP-462	CASE
1878046	GP-54	FORD	18R8	G-1175	COM	1930255	G-297-B	FIAT	1959198C1	GP-149	IHCO
1-87810-0220-0	G-500	ISUZ	19	GP-58	WIX	1930277	G-297-B	FIAT	195946137	GAK-20	HANO
1-87810-0220-0	G-750	ISUZ	190	G-1123	CRO	1930277	G-297-B	IVEC	195946201	GA-436	HANO
1-87810-068-0	GA-27	ISUZ	19000-1206	GP-81	KUBO	1930328	GP-310	FIAT	195946216	GA-5648	HANO
1-87810-069-0	GA-27	ISUZ	19000-1206	GP-9	KUBO	1930329	GP-310	FIAT	195946737	GAK-20	HANO
18-7855	GG-6	SIER	19002	GA-100	WELA	1930476	GA-361	FIAT	195946746	GA-5648	HANO
18-7858	G-296	SIER	19003	GA-100	WELA	1930549	GP-2071W	FIAT	1959757C1	GP-1 ⁹	CASE
18-7858	G-296-B	SIER	1900336-M91	GP-5	MASY	1930589	GA-853R	FIAT	1959757C1	GP-432 ⁴	CASE
18786	G-295	ROO	1900365-M91	GP-1	MASY	193065	G-1174 ¹⁰⁸	COM	1959757C1	GP-1 ⁹	IHCO
18-7875	GP-1	SIER	1900366-M91	GP-5	MASY	1930741	GP-53	FIAT	1959757C1	GP-432 ⁴	IHCO
18-7876	GP-13	SIER	1900371-M91	G-236	MASY	1930746	GA-361	FIAT	1959802-C1	G-295	CASE
18-7877	GP-3	SIER	1900372M91	G-236	MASY	1930747	GA-106 ⁶⁶	FIAT	1959802-C1	G-295	IHCO
18-7878	GP-81	SIER	1900374	GP-3	MASY	1930747	GA-326 ²¹	FIAT	196-094-00-024	GA-2181	CHRY
18-7878	GP-9	SIER	1900374-M91	GP-3	MASY	1930747	GA-106 ⁶⁶	IVEC	196-094-00-024	GA-2181	MBNZ
18-7879	GP-3980	SIER	1900376-M91	G-200	MASY	1930747	GA-326 ²¹	IVEC	1962769-C1	GP-40	IHCO
18-7885	GP-91	SIER	1900377	GP-50	MASY	1930748	GA-206	FIAT	1966279-C1	GP-81	IHCO
18-7886	GP-1	SIER	1900377-M91	GP-50	MASY	1930768	GPP-14	FIAT	196646	G-31	STER
18-7887	GP-31	SIER	1900378-M91	G-330	MASY	1930779	G-33	FIAT	1967094-C1	GPP-1122	IHCO
1879134	GP-54	NEWH	19004	GA-100	WELA	1930820	GP-1122	IVEC	196958	GA-27 ¹¹²	HYST
18-7936	GG-242	SIER	19006	GA-113	WELA	1930823	GP-9	FIAT	197	GG-45	AMP
1879513	G-296	PERK	19007	GA-100	WELA	1931137	GPP-423	CASE	197	GG-45	BGA
1879513	G-296-B	PERK	1900714	G-31	CHRY	1931137	GPP-423	IHCO	197	GA-31	ERO
1879519	GG-20	CHRY	19009	GA-100	WELA	1932	GA-70	CHEK	1970	GP-43 ³⁰	NAP
1879519	GG-20	MOP	19010	GA-100	WELA	1932100	GA-37	CHRY	1970	GP-53 ⁴⁶	NAP
188	G-5000	DEL	1901133	GP-1122	FIAT	1933282	G-6	CHRY	1970XD	GP-53	NAP
188	GA-329	ERO	1901133	GP-1122	IVEC	19348	G-871	SALM	1970XE	GP-53	NAP
188056	G-33	ALCH	1901602	GP-171	FIAT	193509	GP-66	FORD	1971	GP-193	NAP
188056-6	G-33	ALCH	1901602-546230	GP-171	FIAT	193598	GP-66	FORD	197121	G-33	ALCH
188144	GA-27	DAIM	1901606	GP-81	FIAT	19360	GA-230	MIOF	1971727C1	GP-761H	CASE
188144	GA-27	MBNZ	1901606	GP-9	FIAT	1937-1	G-1174 ¹⁰⁸	COM	1971MP	GP-193	NAP
1881442	G-870	MASY	1901606	GP-81	IVEC	19397	G-297-B	WEST	1971XD	GP-193	NAP
1881442-M1	G-870	MASY	1901606	GP-9	IVEC	194	GG-16	AMP	1972202C1	GP-3682	CASE
1881632	G-11816	MASY	1901608	G-33	FIAT	194	GG-16	BGA	1972202C1	GP-3682	IHCO
1881632-M91	G-11816	MASY	1901608	G-33	IVEC	194019	GA-37	FWDX	19725	G-295	ROO
1881840	G-870	MASY	1901629	G-296	FIAT	19404-11081	GA-33 ¹¹²	KUBO	1974	GAK-20	BERN
1881840-M1	G-870	MASY	1901629	G-296-B	FIAT	194196145	GAK-403	MASY	197412A	GP-66	NEWI
1881842	G-813	MASY	1901629	G-296	IVEC	19433-11081	GAK-16	KUBO	197412-A	GP-66	WHIT
1881842-M1	G-813	MASY	1901629	G-296-B	IVEC	194464-48310	GP-1	YNMR	197529	GA-27 ¹¹²	FWDX
188215	GA-16	MASY	1901687	G-296	FIAT	1944887	GP-1	CHRY	197559	GA-27 ¹¹²	FWDX
188215	GAK-16	MASY	1901687	G-296-B	FIAT	1944888	GP-1	CHRY	197569	GA-6127 ¹⁰⁸	ALCH
188215-M91	GA-16	MASY	1901687	G-296	HEST	1945199	GG-5 L	CHRY	197569	GA-6129 ¹⁰⁴	ALCH
188215-M91	GAK-16	MASY	1901687	G-296-B	HEST	19465	G-1121	HODR	197588	GA-6127	ALCH
1882916	G-870	MASY	1901687	G-296	IVEC	19468	GP-171	HODR	197588	GA-6127	FIAT
1882916-M91	G-801	MASY	1901687	G-296-B	IVEC	1947586	GG-5 L	CHRY	197588	GA-467	PEGA
1882916-M91	G-871	MASY	1901688	G-1173	FIAT	19478-11080	GA-33 ¹¹²	KUBO	197588-7	GA-6127	ALCH
1883258-M91	G-813	MASY	1901688	G-1173	IVEC	194807	GP-91	MOTA	197588-8	GA-6127	ALCH
1883288	G-834	MASY	1901689	G-1163	FIAT	194924133	G-296	HANO	1976	GP-2015W	NAP
1883288-M91	G-834	MASY	1901689	G-1163	HEST	194924133	G-296-B	HANO	1976	GP-51	NAP
1883288-M1	G-834	MASY	1901689	G-1163	IVEC	194924159	GP-1122	HANO	1976	GP-83 ¹⁰⁴	NAP
18-842	GP-34	STEI	1901698	G-1163	FIAT	194932128	GP-54 ⁴¹	HANO	1976	GP-84 ¹⁰⁸	NAP
1884769	GA-403	MASY	1901776	GP-1012Q	ASTR	194932128	GP-66 ¹⁰	HANO	197676	GA-880R	MILL
1884769	GAK-403	MASY	1901776	GP-1012Q	FIAT	194932128	GP-54 ⁴¹	MASY	19-774	G-293	STEI
1884769-M1	GA-403	MASY	1901776	GP-1012Q	IVEC	194932128	GP-66 ¹⁰	MASY	1977849	GG-66	PARM
1884769-M1	GAK-403	MASY	1901779	GA-405	FIAT	19493-2128	GP-54 ⁴¹	NISS	197785	G-297-B	PEGA
1884769M91	GA-403	MASY	1901779	GA-405	IVEC	19493-2128	GP-66 ¹⁰	NISS	197786	G-296	PEGA
1884769M91	GAK-403	MASY	1901919	GP-54 ⁴¹	DUTZ	194932159	GP-1122	HANO	197786	G-296-B	PEGA
1887474M91	GA-18	MASY	1901919	GP-66 ¹⁰	DUTZ	194932159	GP-1122	MASY	197822	GA-6129	ALCH
18884769-M1	GA-403	MASY	1901919	GP-54 ⁴¹	FIAT	194942201	GA-436	HANO	197946184	GA-361	HANO
18884769-M1	GAK-403	MASY	1901919	GP-66 ¹⁰	FIAT	194946145	GAK-403	HANO	197946185	GA-360	HANO
189	GA-50	FACE	1901919	GP-54 ⁴¹	IVEC	194946169	GAK-20	HANO	197946201	GA-436	HANO
189227	G-1143	CUMM	1901919	GP-66 ¹⁰	IVEC	194946201	GA-436	HANO	197946201	GA-436	MASY
189287-M91	G-297	MASY	1901919	GP-54 ⁴¹	KHDF	194993159	GP-1122	HANO	197946201	GA-436	PERK
189287-M91	G-297-B	MASY	1901919	GP-66 ¹⁰	KHDF	195	GG-17	AMP	19797	G-293	ROO
1894685-M1	G-238	MASY	19025	GA-16 ¹¹²	ERO	195	GG-17	BGA	198	GG-76	AMP
1896000M91	G-870	LAND	19025	GAK-16 ³⁴	ERO	195-121	GA-42	DITC	198	GP-14	DEL
1896000-M91	G-870	MASY	1905004	GP-3766	ALLI	1951890-M1	G-296	MASY	19803	G-293	ROO
1896074-M91	G-296	MASY	1907694	GP-2071W	IVEC	1951890-M1	G-296-B	MASY	198492	GA-33 ¹¹²	FORD
1896074-M91	G-296-B	MASY	1907714	G-31	CHRY	19519	G-295	ROO	198492	GA-33 ¹¹²	NEWH
1896096	G-296	MASY	1909117	GA-459	FIAT	19519550056	GG-214	STER	19856	G-293	ROO
1896096	G-296-B	MASY	1909124	G-1121F	FIAT	19519550081	GG-214	STER	1-986-452-00	GP-38	BOG
1896096-M1	G-296	MASY	1909136	GA-360	FIAT	1953CT7	G-1175 ¹⁰⁸	COM	1-986-452-000	GP-38	BOG
1896096-M1	G-296-B	MASY	1909141	GAK-216	FGR	1954	G-566	NAP	1-986-452-004	GP-38	BOG
1896096-M91	G-296	MASY	190935H1	G-1173 ¹⁰⁸	IHCO	195-427	GA-33 ¹¹²	CHMA	1-986-452-006	GP-462	BOG
1896096-M91	G-296-B	MASY	19114110	GA-348	GMCX	195-427	GA-33 ¹¹²	DITC	1-986-452-004	GP-38	BOG
1896149	G-870	MASY	191407	GA-218	PEGA	195-635	GAK-16	DITC	1-987-429-002	GP-1	BOG
1896149-M91	G-871	MASY	191439	GA-26 ¹¹²	HYST	195-654	GAK-16	DITC	1-987-429-003	GAD-3	BOG
1896247M91	G-296	MASY	191443-H1	G-1175	IHCO	19567	G-750	VERS	1-987-429-005	GAD-3	BOG
1896247M91	G-296-B	MASY	1914634	GA-7142	PARM	195-671	GA-33 ¹¹²	DITC	1-987-429-009	GA-4303	BOG
1896287-M91	G-297	MASY	1916123	GG-150	PARM	195-682	GA-33 ¹¹²	CHMA	1-987-429-018	GA-2740	BOG
1896287-M91	G-297-B	MASY	19185485	G-911	GMCX	195-682	GA-33 ¹¹²	DITC	1-987-429-022	GAD-3	BOG
1896432-M91	G-297	MASY	191-9784	GP-761H	CATP	195690	GAK-1532	DITC	1-987-429-028	GA-3490	BOG
1896432-M91	G-297-B	MASY	192	GG-20	AMP	195-703	GAK-625	DITC	1-987-429-031	GA-3490	BOG
1897103	GA-604	PARM	192	GG-20	BGA	195-709	GAK-625	CHMA	1-987-429-039	GA-230	BOG
1897151-M1	GA-18	MASY	192	GA-192	FACE	195-709	GAK-625	DITC	1-987-429-051	GAD-15	BOG
1-89962-295-3	GA-398	ISUZ	192326	GAK-16	MUIR	195735	GAK-403	CHMA	1-987-429-117	GAD-30	BOG
18A	GP-1	AUTV	19250	GA-71	MIOF	195-735	GAK-403	DITC	1-987-429-120	GA-471	BOG
18A	GA-403	BOG	19251	GAK-200	MIOF	195-807	GP-1122	DITC	1-987-429-121	GA-78	BOG

Para números Gonher con Superíndice vea página 651
For Gonher with Superscript numbers see page 651

Numero	Gonher	Fabricante	Numero	Gonher	Fabricante	Numero	Gonher	Fabricante	Numero	Gonher	Fabricante
Number	Gonher	Manufacturer	Number	Gonher	Manufacturer	Number	Gonher	Manufacturer	Number	Gonher	Manufacturer
1-987-429-132	GA-4303	BOG	1F12-9155-AD	GG-307	FORD	1N8164	GA-357	CATP	1W7399	G-191	CATP
1-987-429-135	GA-195	BOG	1F12-9155-CA	GG-307	FORD	1N8165	GA-356	CATP	1W7919	GA-9334 ¹⁰⁴	CATP
1-987-429-141	GAD-3	BOG	1F70-23-603	GA-158	MZDA	105-64-040601	G-296	ALFA	1W8161	GA-483 ¹⁰⁴	CATP
1-987-429-302	GA-78	BOG	1G8878	GP-76H	CATP	105-64-040601	G-296-B	ALFA	1W8633	GP-110	CATP
1-987-430-003	GA-360	BOG	1H0 819 638 A	GAC-10 ²⁸	AUDI	1P2299	GP-110	CATP	1W8845	GP-57	CATP
1-987-430-005	GA-106 ⁴⁶	BOG	1H0 819 638 A	GAC-8	AUDI	1P2781	GA-1286 ¹⁰⁸	CATP	1X 43 9155 A	GG-106	JAGU
1-987-430-005	GA-326 ⁷¹	BOG	1H0 819 638 A	GAC-10 ²⁸	PORS	1P2781	GA-9334 ¹⁰⁴	CATP	1X 43 9155 AA	GG-106	JAGU
1-987-430-006	GAK-16	BOG	1H0 819 638 A	GAC-8	PORS	1P6450	GA-7360	CATP	1X11972	GP-50	ALCH
1-987-430-006	GA-229	BOG	1H0 819 638 A	GAC-10 ²⁸	VOLK	1P6450	GA-7716 ¹⁰⁴	CATP	1X23100	G-31	CCO
1-987-430-009	GA-33 ¹¹²	BOG	1H0 819 638 A	GAC-8	VOLK	1P7330	GA-482 ¹⁰⁸	CATP	1X23102	G-1123	CCO
1-987-430-011	GA-206	BOG	1H0 819 644	GAC-10 ²⁸	AUDI	1P7330	GA-483 ¹⁰⁴	CATP	1X23103	G-1121	CCO
1-987-430-016	GA-49	BOG	1H0 819 644	GAC-8	AUDI	1P7360	GA-7360	CATP	1X23107	GAK-403	CCO
1-987-430-018	GAK-403	BOG	1H0 819 644	GAC-10 ²⁸	PORS	1P7360	GA-7360	NEL	1X23109	G-225	CCO
1-987-430-026	GAK-20	BOG	1H0 819 644	GAC-8	PORS	1P7716	GA-7716	CATP	1X23110	GP-54	CCO
1-987-430-030	GA-436	BOG	1H0 819 644	GAC-10 ²⁸	VOLK	1P7716	GA-7716	NEL	1X23111	G-834	CCO
1-987-430-062	GA-6127	BOG	1H0 819 644	GAC-8	VOLK	1P7748	GA-7360	CATP	1X23112	G-330	CCO
1-987-430-064	GA-361	BOG	1H0 819 644 B	GAC-10 ²⁸	AUDI	1P7958	GA-1286 ¹⁰⁸	CATP	1X23117	GP-36	CCO
1-987-430-064	GA-6129	BOG	1H0 819 644 B	GAC-8	AUDI	1P7958	GA-9334 ¹⁰⁴	CATP	1X23118	GP-26	CCO
1-987-430-076	GA-636	BOG	1H0 819 644 B	GAC-10 ²⁸	PORS	1P8482	GA-482	CATP	1X23120	G-296	CCO
1-987-430-077	GA-467	BOG	1H0 819 644 B	GAC-8	PORS	1P8482	GA-482	NEL	1X23120	G-296-B	CCO
1-987-452-028	GA-3490	BOG	1H0 819 644 B	GAC-10 ²⁸	VOLK	1P8483	GA-483	CATP	1X23122	GP-81	CCO
198780	GA-6127	ALCH	1H0 819 644 B	GAC-8	VOLK	1P8483	GA-483	NEL	1X23125	GP-66	CCO
198780	GA-6129	ALCH	1H0 819 644A	GAC-10 ²⁸	AUDI	1PS2548	GA-5648	CHIC	1X23126	G-11816	CCO
199	GG-45	AMP	1H0 819 644A	GAC-8	AUDI	1PS2690	GAK-20	CHIC			
199	GG-45	BGA	1H0 819 644A	GAC-10 ²⁸	PORS	1PS3547	GP-1	CHIC			
1990244	GA-360	CLRK	1H0 819 644A	GAC-8	PORS	1R0511	GP-110	CATP			
1990248	GA-360	CLRK	1H0 819 644A	GAC-10 ²⁸	VOLK	1R0658	GP-51	CATP			
19903	G-293	ROO	1H0 819 644A	GAC-8	VOLK	1R0659	G-191	CATP			
19905	G-295	ROO	1H0129620	GAVW-121	VAG	1R0711	GP-110	CATP			
1990970	GA-322	PARM	1H0129620	GAVW-121	VOLK	1R0712	GP-749	CATP			
199203	GA-27 ¹¹²	FWDX	1H0201511	GG-251	VAG	1R0713	GP-9586	CATP			
199206	GA-33 ¹¹²	WAUK	1H0201511	GG-251	VOLK	1R0716	GP-52 ¹¹⁰	CATP			
199206	GA-33	WAUK	1H0201511A	GG-251	AUDI	1R0716	GP-691 ⁴⁸	CATP			
1992214	GP-27	CLRK	1H0201511A	GG-251	VOLK	1R0719	G-152	CATP			
1992215	GP-93	CLRK	1H11289	GP-81	DYNM	1R0720	G-222	CATP			
1992216	GP-26	CLRK	1H1230	GP-34	CATP	1R0721	G-238	CATP			
1992217	GP-92	CLRK	1H1230	GP-34	DYNM	1R0724	G-1166	CATP			
1992235	GP-43	CLRK	1H1230	GP-34	WHIT	1R0734	GP-36	CATP			
1992247	GP-43	CLRK	1H1234	GP-34	DYNM	1R0739	GP-51	CATP			
1992248	GP-53	CLRK	1H1234	GP-34	WHIT	1R0740	GP-110	CATP			
1992594	GG-5 L	VALM	1H1567	GAK-16	WHIT	1R0741	G-222	CATP			
199269	GP-50	WAUK	1H1611	GAK-16	DYNM	1R0749	GP-749	CATP			
199269A	GP-50	WAUK	1H0 819 644	GAC-10 ²⁸	AUDI	1R0750	GP-110	CATP			
1993689	GA-361	CLRK	1H0 819 644	GAC-8	AUDI	1R0751	GP-1109 ²²	CATP			
199395	GP-52 ¹¹⁰	WAUK	1H0 819 644	GAC-10 ²⁸	PORS	1R0751	GP-62 ²⁰	CATP	2.175.107	GP-291	LOMB
199395	GP-691 ⁴⁸	WAUK	1H0 819 644	GAC-8	PORS	1R0759	GP-1109	CATP	2.175.117	GP-291	LOMB
1994	GA-50	CHEK	1H0 819 644	GAC-10 ²⁸	VOLK	1R0762	GP-749	CATP	2.175.136	GP-291	LOMB
199400	GA-27 ¹¹²	FWDX	1H0 819 644	GAC-8	VOLK	1R1712	GP-749	CATP	2/630795A	GP-28 ⁵	JCBM
199421	GAK-625	WAUK	1J0 129 620A	GAVW-621	VOLK	1R1740	GP-110	CATP	2/630795A	GP-430 ⁸	JCBM
199434	GAK-1532	WAUK	1J0 819 644	GAC-10 ²⁸	AUDI	1R1807	GP-51	CATP	2/910970	GP-178	JCBM
1996	GP-1	DEL	1J0 819 644	GAC-8	AUDI	1R1808	GP-52 ¹¹⁰	CATP	20	GG-20	FACE
199750	GA-27 ¹¹²	FWDX	1J0 819 644	GAC-10 ²⁸	PORS	1R1808	GP-691 ⁴⁸	CATP	20	G-31	REF
19994	GAK-16	MILL	1J0 819 644	GAC-8	PORS	1R2005	GA-106 ⁴⁶	CATP	20	GA-70	WIX
19A346	GA-27 ¹¹²	LINK	1J0 819 644	GAC-10 ²⁸	VOLK	1R2005	GA-326 ⁷¹	CATP	200	G-200	FACE
19A347	GA-26	LINK	1J0 819 644	GAC-8	VOLK	1R2005	GA-106 ⁴⁶	FARM	20000318	GP-26	GASO
19A451	GA-27 ¹¹²	LINK	1J0 819 644A	GAC-10 ²⁸	AUDI	1R2005	GA-326 ⁷¹	FARM	20-000318	GAK-20	WHIT
19R4	G-1173 ¹⁰⁸	COM	1J0 819 644A	GAC-8	AUDI	1R2006	GA-206	CATP	20-000615	GA-361	WHIT
19R6	G-1174 ¹⁰⁸	COM	1J0 819 644A	GAC-10 ²⁸	PORS	1R2006	GA-206	FARM	200006803	G-295	OLIV
19R8	G-1175 ¹⁰⁸	COM	1J0 819 644A	GAC-8	PORS	1R2006	GA-206	FARM	20-0006803	G-295	WHIT
19X4-2TV	G-1173 ¹⁰⁸	COM	1J0 819 644A	GAC-10 ²⁸	VOLK	1R3535109263	GA-6129	INGR	20-0008703	GA-360 ¹⁰⁴	WHIT
19X4-2V	G-1173 ¹⁰⁸	COM	1J0 819 644A	GAC-8	VOLK	1R7402	GA-360	CATP	20-0008703	GA-361 ¹⁰⁸	WHIT
19X64-1V	G-1174 ¹⁰⁸	COM	1J0126620	GAVW-621	VOLK	1S1286	GA-1286	CATP	2002	GP-1	GLOB
19X6-4YV	G-1174 ¹⁰⁸	COM	1J0126620	GAVW-621	VOLK	1S1287	GA-1287	CATP	20003	GAK-20	ERO
19X8-2V	G-1176	COM	1J0129620	GAVW-621	VOLK	1S1479	GA-1287 ¹⁰⁸	CATP	20005	G-6	BAKR
19X8TV	G-1175 ¹⁰⁸	COM	1J0129620	GAVW-621	VOLK	1S1479	GA-9045 ¹⁰⁴	CATP	20005	GAK-403	ERO
1A3479	GP-110	CATP	1K0 129 620P	GAVW-621	VOLK	1S2373	GA-1287 ¹⁰⁸	CATP	20006	GAK-16	ERO
1A36	GA-27 ¹¹²	CRAN	1K0 129 620	GAVW-618	AUDI	1S2373	GA-9045 ¹⁰⁴	CATP	20006	GP-13	GLOB
1A80638	GA-106 ⁴⁷	FARM	1K0 129 620	GAVW-618	PORS	1S4762	GA-1286 ¹⁰⁸	CATP	20007	GA-33 ¹¹²	ERO
1A80638	GA-206 ¹⁰⁸	FARM	1K0 129 620	GAVW-618	VOLK	1S4762	GA-9334 ¹⁰⁴	CATP	20007	GA-33	ERO
1A80638	GA-326 ⁷²	FARM	1K0 129 620B	GAVW-618	AUDI	1S4763	GA-1286 ¹⁰⁸	CATP	20007	GP-23	GLOB
1A9021	GP-66	CRSS	1K0 129 620B	GAVW-618	PORS	1S4763	GA-9334 ¹⁰⁴	CATP	20007507	GAK-403	BRAU
1A902110	GP-66	CRSS	1K0 129 620B	GAVW-618	PORS	1S479-2	GA-9045	YELC	20007507	GAK-403	FIAT
1A9023	GP-66	CRSS	1K0 129 620B	GAVW-618	VOLK	1S6811	G-1166	CATP	200086	G-31	TCLD
1A9160	GP-66	KINB	1K0129620D	GAVW-619	VOLK	1S71 9155 BA	GG-915	FORD	20-0086	G-31	CARR
1A9161	GP-66	KINB	1K0129620E	GAVW-619	VOLK	1S71-9601-AA	GA-196	FORD	20009	G-31	BROK
1A9162	GP-66	MELR	1K0129620G	GAVW-619	VOLK	1S7G-6714-DA	GP-58	FORD	20009	G-33	GLOB
1B6402	G-31	FEDL	1K0129620G	GAVW-619	VOLK	1S7G-6744-AC	G-70	FORD	20009	G-31	MACK
1B7105	G-31	FEDL	1K5351	G-1173 ¹⁰⁸	OLIV	1S7Z-6714-DA	GP-58	FORD	2000A	G-1143	FARB
1B7716	GA-7716	CATP	1K5351	G-1173 ¹⁰⁸	WHIT	1S7Z-6731-DA	GP-58 ⁹	FORD	2000A	G-1143	SHEP
1C32-9601-AA	GA-780	FORD	1L0-129-601C	GAVW-212	SEAT	1W0217	GA-1285 ¹⁰⁸	CATP	2000E-6228	GA-33	FORD
1C7105	G-31	FEDL	1L0-129-607M	GAVW-212	SEAT	1W0217	GA-8047 ¹⁰⁴	CATP	2000E-9601-A	GAK-20	FORD
1C7195	G-31	FEDL	1L0-129-620	GAVW-212	VOLK	1W0392	GA-1008	CATP	20010	G-33	BROK
1D6	GA-37	OSHK	1L0-129-620A	GAVW-212	VOLK	1W2638	GP-9586	CATP	20010	G-33	BROK
1DX06	GA-37	OSHK	1L0129620E	GAVW-619	VOLK	1W2660	GP-52 ¹¹⁰	CATP	20010	G-33	MACK
1DX158	GA-27 ¹¹²	OSHK	1L0129620E	GAVW-619	VOLK	1W2660	GP-691 ⁴⁸	CATP	20012	GA-27	ERO
1DX178	GA-251	OSHK	1L22-9601-AA	GA-395	FORD	1W3300	GP-51	CATP	2001301	G-1121	EICH
1DX28	GA-26	OSHK	1L5353	G-1173 ¹⁰⁸	OLIV	1W3635	GA-482 ¹⁰⁸	CATP	2001301	G-1121	MASY
1DX43	GA-27 ¹¹²	OSHK	1L5357	G-1173 ¹⁰⁸	WHIT	1W3635	GA-483 ¹⁰⁴	CATP	20014	G-295	ROO
1DX83	GA-6129	OSHK	1L8644	G-1175 ¹⁰⁸	CATP	1W3894	GA-9045 ¹⁰⁴	CATP	20014446	GP-81	LUF
1DX88	GA-6129	OSHK	1M9150	G-152	CATP	1W392	GA-1008	CATP	20-016-00	G-31	UFI
1E10182	GAK-403	FARB	1M9156	G-152	CATP	1W4114	GA-483 ¹⁰⁴	CATP	2001746	G-870	ASTN
1E10183	GAK-20	FARB	1M9156M	G-152	REF	1W4845	GP-57	CATP	20018	G-295	ROO
1E2377	GP-34	CATP	1N3224	GP-9586	CATP	1W5518	GP-1013Q	CATP	200208	G-1175 ¹⁰⁸	KENW
1EK1197-2	GP-50	ALCH	1N3964	GA-482 ¹⁰⁸	CATP	1W7000	G-238	CATP	20-02-245	GA-410	ASKA
1ELE01	G-296	FRIG	1N3964	GA-483 ¹⁰⁴	CATP	1W7339	G-191	CATP	2002566	GP-642	THER
1ELE01	G-296-B	FRIG	1N3965	GA-482 ¹⁰⁸	CATP	1W7364	GA-8047 ¹⁰⁴	CATP	2002596	GP-642	THER
1ELE01	G-296-B										

Referencia Cruzada por Numero de Parte

Cross Reference by Part Number



Numero	Gonher	Fabricante	Numero	Gonher	Fabricante	Numero	Gonher	Fabricante	Numero	Gonher	Fabricante
Number	Gonher	Manufacturer	Number	Gonher	Manufacturer	Number	Gonher	Manufacturer	Number	Gonher	Manufacturer
2003	GP-51	CRO	2010SM	2010TM-OR ²	RAR	202150	GP-81 ³⁵	NAPI	2039875	G-33	YALE
20030	GP-3429	GLOB	2010SM-OR	2010PM-OR ²	RAR	202150	GP-9 ³⁸	NAPI	204	G-200	CRM
200333-C92	GA-221R ¹⁰⁴	IHCO	2010SM-OR	2010TM-OR ²	RAR	2021736	G-1173 ¹⁰⁸	EATN	204	GA-55	PROT
200333-C92	GA-723R ¹⁰⁸	IHCO	2010TM	2010TM-OR	RAR	2021736	G-1173 ¹⁰⁸	YALE	2040	GP-1	AMP
200336	G-31	HYST	2010TM-OR	2010TM-OR	GONH	2021737	G-1174 ¹⁰⁸	EATN	2040	GP-46	AUTO
2003377	G-813	MASY	2011	GP-1	AMP	2021737	G-1174 ¹⁰⁸	YALE	2040	GP-171	CRO
20036	GAD-3	MIOF	2011	GP-28 ⁹	CRO	2021739	G-1173 ¹⁰⁸	EATN	204002	GAK-16	IHCO
20037	GAD-1	MIOF	2011	GP-430 ⁹	CRO	2021739	G-1173 ¹⁰⁸	YALE	204002-H1	GA-16	IHCO
20037	G-295	ROO	2011	GA-71	NAP	2-0217705	GAK-403	JCBM	204002-H1	GAK-16	IHCO
2004	GP-44	AMP	201104	GP-408	CRUS	2021P	G-1166	WIX	2040PM	GS-2034	RAR
2004	GP-44	BGA	20113111	GG-48	VICK	2022	GP-3816	CRO	2040PM-OR	GS-2034	RAR
20040934	GA-154	GMCX	201-13111	GG-48	LSTR	2022289-C1	GA-723R	IHCO	2040SM	GS-2034	RAR
200443	GA-106 ⁴⁶	BELL	201-13112	GG-48	LSTR	2022412	G-1143	EATN	2040SM-30	GS-2034	RAR
200443	GA-326 ⁷¹	BELL	201-13116	GG-48	LSTR	2022412	G-1143	YALE	2040SM-OR	GS-2034	RAR
200444	GA-206	BELL	201-13117	GG-48	LSTR	2022585	G-31	HERC	2040TM	GS-2034	RAR
2004-57	GA-357	DRIL	201-13118	GG-48	LSTR	202262	G-750	FWDX	2040TM-OR	GS-2034	RAR
2004-58	GA-356	DRIL	201133112	GG-48	KOHL	202270	G-1143	FWDX	20411815	GA-624R	VOLV
200482	G-33	FWDX	20113692	GP-1105	CARR	2022746	GA-442	PARM	2042	GP-54 ¹¹	CRO
20049	GA-325	MIOF	20113692	GP-1105	TCLD	2023	GP-57	CRO	2042	GP-66 ¹⁰	CRO
2005	GP-53	AMP	20113693	GP-62	CARR	20230	GP-9586	GLOB	2042046	G-1176	EATN
2005	GP-28 ⁸	CRO	20113693	GP-62	TCLD	202319	GAK-16	MILL	204205	GP-77	OREN
2005	GP-430 ⁸	CRO	20113712	GP-69	CARR	2023300	GA-11	CLI	204214	G-33	FWDX
2005	GAK-403	ERO	20113746	GP-67	CARR	2023300	GA-11	CLIN	2043	GP-81	CRO
20050	GP-50	GLOB	20113854	GP-1108	CARR	202354-826	GA-403	AIM	2044	GP-66	CRO
20050	GAK-20	MIOF	20113855	GP-1107	CARR	2024	GP-46	CRO	2044	GA-730	NAP
20051	GA-33 ¹²	MIOF	20113871	GP-88	CARR	2025	GP-462	CRO	20442	GA-356 ¹⁰⁴	URIG
20052	GAK-403	MIOF	20115	G-295	ROO	20251	GP-31	GLOB	20442	GA-357 ¹⁰⁸	URIG
20054	GAK-16	MIOF	20115703	GP-67	TCLD	202536-826	GA-403	AIM	20442-1	GA-356 ¹⁰⁴	URIG
200541	GA-21	AIM	20115704	GP-1108	CARR	2026	GP-43	CRO	20442-1	GA-357 ¹⁰⁸	URIG
200541-07	GA-21	AIM	20115705	GP-1107	CARR	2026131-M92	GA-18	MASY	204436H1	GAK-16	HOUG
20055	GA-360	MIOF	20115978	GA-2804 T	CARR	202627-826	GA-21	AIM	204439	GAK-16	IHCO
20057	GA-18	MIOF	2012	GP-3569	MPA	2026P	G-297-B	WIX	204439-H1	GAK-16	IHCO
2005895-C1	GA-221R	IHCO	20123692	GP-1105	CARR	2027	GP-40	CRO	204495	GP-81	SAAB
2006	GP-42	AMP	20123692	GP-1105	TCLD	202792	G-33	FWDX	2045	GP-3429	AMP
2006	GP-42	BGA	20123693	GP-62	TCLD	2027P	G-296	WIX	2045	GP-3429	AUTO
2006	GAK-16	ERO	20123746	GP-67	CARR	2027P	G-296-B	WIX	2045	GP-3429	BGA
20064	GA-436	MIOF	20123746	GP-67	TCLD	2028	GP-50	AMP	2045	GP-34	CRO
20064	G-834	PALM	20123855	GP-1107	CARR	2028	GP-50	BGA	2045	GA-9045	NAP
2006H	GP-58 ¹⁵	BOG	20123855	GP-1107	TCLD	2028006	GP-36	CCO	204538	GA-106 ⁴⁶	CUMM
2007	GP-46	AMP	20123871	GP-88	CARR	2028020	GA-106 ⁴⁶	CCO	204538	GA-326 ⁷¹	CUMM
2007	GP-46	BGA	20123871	GP-88	TCLD	2028020	GA-326 ⁷¹	CCO	20458769	GP-2108W	VOLV
20076	GP-51	GLOB	20125702	GP-88	CARR	2028021	GA-206	CCO	2046	GP-44	AMP
200789	G-1173 ¹⁰⁸	HYST	20125702	GP-88	TCLD	2028024	G-191	CCO	2046	GP-44	BGA
200790	G-1176	CONT	20125703	GP-67	CARR	2028025	GP-110	CCO	2046	GP-54 ⁹⁰	CRO
2008185	GA-5648	GARD	20125703	GP-67	TCLD	202893	GPP-11	CUMM	2046	GA-1287	NAP
20086700	GAK-1532	VERM	20126020	G-816	LSTR	202893	GPP-14	CUMM	204629	GA-360 ¹⁰⁴	CUMM
200867004	GAK-1532	VERM	201274	GA-27	DEMA	2029	GP-1	CRO	204629	GA-361 ¹⁰⁸	CUMM
20087	G-331	GLOB	2013	GP-390 ⁹³	AMP	2029211	GA-373	GMCX	204631	GA-360	CUMM
20088	G-238	GLOB	2013	GP-390 ⁹³	BGA	202951	GA-37	HYST	204632	GA-361	CUMM
2008947	GA-26	GARD	2013	GA-415	NAP	20299	GA-11	GRAV	204635	GA-6129	CUMM
2009	GP-171 ¹⁶	AMP	20134	GP-3766	GLOB	2029911	GA-373	GMCX	204636	GA-6127	CUMM
2009	GP-171 ¹⁶	BGA	2013P	G-11816	WIX	203	GP-3	CRM	204637	GA-106 ⁴⁷	CUMM
2009286	GA-361	LBHR	2014558	GA-377	GMCX	203	GA-50	PROT	204637	GA-206 ¹⁰⁸	CUMM
20095	GP-53	GLOB	201508	GP-66	TIMB	2030	GP-54	AMP	204637	GA-326 ⁷¹	CUMM
2009540	GA-37	GMCX	20152	G-295	ROO	20-300480	GA-33	WHIT	204638	GA-106 ⁴⁶	CUMM
20096	GP-53	GLOB	201-55370	GP-58	LSTR	20-3004805	GA-33	WHIT	204638	GA-326 ⁷¹	CUMM
20-0973329	GP-2071W	WHIT	201-55373	GP-58	LSTR	20-300482	GAK-16	WHIT	204639	GA-206	CUMM
20097332-9	GP-2071W	VOLV	2016	GA-434	NAP	20-3004926	GA-33	WHIT	204644	GA-6127 ¹⁰⁸	CUMM
200B	G-1143	FARB	2016171	GA-514	PARM	2030P	G-33	PETI	204644	GA-6129 ¹⁰⁴	CUMM
200B	G-1143	SHEP	2016336	G-33	EATN	2030P	G-296	WIX	204645	GA-6129	CUMM
200E	GP-26	CIM	2017142	GA-90	GMCX	2030P	G-296-B	WIX	204646	GA-6127	CUMM
200E-6228	GA-33	FORD	2017144	GA-90	GMCX	2031	GP-40	CRO	2046544	GA-135	GMCX
200E-9601-A	GAK-20	FORD	201-729	GP-66	MIFP	2031381	GA-373	GMCX	2046546	GA-135	GMCX
201	GP-1	CRM	2018/40	GA-44	SAVA	20319	GAK-16	MILL	204664	GA-6127	CUMM
201	GA-59	PROT	2018498	GP-34	CCO	2032	G-331	AMP	2046909	GAK-20	EATN
2010	GP-53	AMP	20189	G-152	GLOB	2032	G-331	BGA	2047	GP-81	CRO
2010	GP-3569	MPA	2019	GP-3985	AMP	2033	GP-67	AMP	2047	GA-8047	NAP
201001	GP-53	KNUD	2019/40	GA-44	FIAT	2033	GP-67	BGA	2047874	GAK-403	EATN
201002	GPP-14	KNUD	2019/40	GP-11	SAVA	2033002	GP-11	GMCX	2047864G01	GA-33	THER
20101	GP-66	PFAC	201940A	GA-44	PUR	2033026	GA-378	GMCX	2048	GP-38	CRO
2010122	GA-356	GARD	2019681	GA-100	GMCX	2033350	GAK-403	HARR	2048	GA-1285	NAP
20102	GP-66	PFAC	2019740	GA-44	FIAT	203335CS	G-236	HERC	2049	GP-310	CRO
201021C1	GP-66	CASE	201B	G-1143	SHEP	20-3335-CS	G-236	WHIT	2049	GP-3569	CRO
201021-C1	GP-66	IHCO	201X	GP-1	CRM	203339	GA-4365	VOLV	2049	GA-429	NAP
201-026	GP-66	MIFP	202	GA-70	AMP	203350	GAK-403	HARR	205	GP-5	CRM
2010260	GA-360	GARD	202	GA-70	BGA	2034	GP-88	AMP	205	GA-192	PROT
2010262	GA-106 ⁴⁶	GARD	202	GP-20	CRM	2034	GP-81	CRO	2050	GP-3531 EXP	AMP
2010262	GA-326 ⁷¹	GARD	202	GA-57	PROT	203418	GAK-16	IHCO	2050	GP-3531 EXP	BGA
2010274	GA-6129	GARD	2020	GP-53	AMP	203418H	GAK-16	HOUG	2050-1K1470	GP-1	KOMA
2010501	GA-5648	GARD	2020	GA-70	NAP	203418-H	GAK-16	IHCO	20505	GAK-403	ERO
2010505	GA-26	GARD	202-0030	GP-34	MIFP	203418-H1	GAK-16	IHCO	2051	GP-3980	AMP
2010507	GA-356	GARD	2020064	GG-5 L	CHRY	2034940	GA-135	GMCX	2051	GP-3980	AMP
2010508	GA-360	GARD	2020067	GG-5 L	CHRY	2034941	GA-135	GMCX	2052	GP-28 ⁶	BGA
2010509	GA-106 ⁴⁶	GARD	20201	GP-66	PFAC	2035	GP-54	AMP	2052	GP-430 ⁸	AMP
2010509	GA-326 ⁷¹	GARD	20202	GP-34	PFAC	2035	GP-81	CRO	2052	GP-77	CRO
2010510	GA-6129	GARD	202-0600	GP-34	MIFP	2036	GP-3980	AUTO	2052546	GAK-20	EATN
20106	GAK-16	ERO	202088	GA-26	CUMM	2036	GP-53	CRO	2052546	GAK-20	YALE
2010697	GA-206	GARD	2020933	GG-5 L	CHRY	2036	GA-3445	NAP	2053	GP-40	AMP
2010698	GA-6127	GARD	2020MP	GA-70	NAP	2037035-6	GA-33	ALCH	2053	GP-40	BGA
2010699	GA-361	GARD	2020PM	GS-2033	RAR	2038	GP-77	CRO	2053101	GA-373	GMCX
2010700	GA-357	GARD	2020PM-OR	GS-2033	RAR	2038573	GA-378	GMCX	2054	GA-77	NAP
2010760	GA-372	GMCX	2020SM	GS-203							

Numero	Gonher	Fabricante	Numero	Gonher	Fabricante	Numero	Gonher	Fabricante	Numero	Gonher	Fabricante
Number	Gonher	Manufacturer	Number	Gonher	Manufacturer	Number	Gonher	Manufacturer	Number	Gonher	Manufacturer
2055	GP-58 ²	BGA	2070424	GA-26	EATN	20882320	GA-624R	VOLV	21043	G-836	TCLD
2055	GA-80	NAP	2071	GP-462	CRO	2088MP	GA-192	NAP	2-1043	G-836	CARR
205526	G-6	FWDX	20-7100980	G-296	WHIT	208964	GP-66	ZETT	21045	GP-3429	NAPS
2056480000	GP-1107	LUF	20-7100980	G-296-B	WHIT	209	GP-3816	CRM	21-048-00	G-1121F	UPI
20567	GA-106 ⁴⁶	COLT	20717	GA-33	HOMR	209	GA-54	PROT	2105	GA-604	GREE
20567	GA-206	COLT	207194	GAK-625	FMC	209026	GA-360	CCO	21-050-00	G-1121F	UPI
20567	GA-326 ⁷¹	COLT	2072	GA-349	NAP	209027	GA-361	CCO	21-051-00	G-1123F	UPI
2057	GP-310	AMP	2072636	GAK-16	ALCH	2090647	G-31	GMCX	21-053-00	G-870	UPI
2057	GP-310	BGA	2073	GP-455	CRO	209-07-008-7	GP-171	STEY	21060	GP-205	NAPS
2057	GP-28 ⁶	CRO	2073	GA-75	NAP	2090765	GA-376	GMCX	21-060-00	G-1123F	UPI
2057	GP-430 ⁸	CRO	20-7300207	GP-34	WHIT	209-07-87	GP-171	STEY	21061	GP-13	NAPS
2057	GA-74	NAP	20-7300768	GA-33	WHIT	2091	G-750	LUF	21061	GP-13	SEI
205736-H1	G-31	IHCO	20-7300769	GAK-16	WHIT	2091	GA-56	NAP	21-061-00	G-1121F	UPI
205739H1	G-31	IHCO	2074	GP-9	CRO	2091B09H	GA-33	THER	21-062-00	G-1123F	UPI
2059451	GA-378	GMCX	20750	G-750	GLOB	2091B09H06	GA-33	THER	21068	GP-81 ³¹	NAPS
206	GP-13	CRM	2077	GP-166	AMP	2092142	GAD-118	PARM	21068	GP-9 ⁵⁸	NAPS
206	GA-3523	PROT	2077	GP-166	BGA	20927	GA-361	CCO	21069	GP-3	NAPS
20606	GA-49	HODR	2077	GP-157	CRO	2093	GP-3600	CRO	2107	GP-1	NAPS
20608940	GP-36	DEMA	2077	GA-3300	NAP	2093	GA-322	GREE	21085	GP-81	CRO
20609140	GP-1122	DEMA	20775001	GP-58	VERM	2093	GA-90	NAP	21085MP	GP-81	NAPS
2061	GP-3985	AMP	2078	GP-66	AMP	20932	GP-66	VERS	21088	GP-28 ⁶	NAPS
2061	GP-13	AUTO	2078	GP-66	BGA	2095	G-500	CHP	21088	GP-430 ⁸	NAPS
2061	GA-78	NAP	207833	G-613	EATN	2095	GP-462	CRO	211	G-1173 ⁹⁸	DEL
2062	GP-10	CRO	207838	GP-178	KOEK	2095	G-500	LUF	2110	GP-58	CRO
2062660	GP-20	CHRY	207839	GP-1122	KOEK	2095	GA-55	NAP	2110	GP-1122	SULL
2062660	GP-20	MOP	207840	GP-118	KOEK	20960	GAK-20	BWMN	21100	GAK-20	COLT
2062661	GP-50	CHRY	207861	GA-5648	FWDX	20960	GP-1011Q	CUMM	21100	GAK-20	QUIN
2062661	GP-50	MOP	207861	GA-5648	RAYG	209604	GP-2071W	CUMM	211032	GPP-18	DYPA
2062662	G-200	CHRY	2078833	G-613	YALE	209605	GP-1011Q	CUMM	211033	GP-43	DYPA
2062662	G-200	MOP	2079	GP-2951	CRO	209606	GP-2071W	CUMM	211037	GP-1011Q	DYPA
2063	GP-3985	CRO	207965	GAK-1532	WAUK	2096525	GA-240	PARM	2112620	GA-240	VOLK
20633	G-31	BAUD	208	GP-81 ³¹	CRM	209-6906	GP-34	CATP	2115351	GP-81	PORS
2063585	GA-109	GMGX	208	GP-9 ⁵⁸	CRM	2097035	GA-33	ALCH	2115351	GP-81	PORS
2063586	GA-109	GMGX	20801-01021	G-870	TCM	2097035	GA-33	FIAT	211-153-51	GP-9	VOLK
2063587	GP-1101	GMGX	2-08010-104-1	GP-3682	ISUZ	209720	G-870	SAVA	21-115-351A	GP-81	VOLK
2063991	GP-1	CHRY	20801-01041	GP-3682	NISS	2097301	G-870	SAVA	211-153-51A	GP-171	PORS
2064	GP-3600	AMP	20801-01041	GP-3682	TCM	2097690	GP-28	ALCH	2115561B	G-112	VOLK
2064	GP-3600	BGA	20801-01261	GP-36	TCM	2097690-8	GP-28	ALCH	2115562A	G-112	VOLK
206409	GA-106 ⁴⁶	KOEK	20801-01281	GP-149	TCM	2098	GA-59	NAP	21-115-562B	G-112	VOLK
206409	GA-326 ⁷¹	KOEK	20801-02181	GP-149	TCM	209891	GA-21	CUMM	2116351A	GP-81	VOLK
20644	GP-20	HOME	20801-03021	GAD-3	TCM	209892	GA-21	CUMM	2112	GP-149	CRO
206464	GAK-403	CASE	20801-03081	GAK-20	TCM	2098MP	GA-59	NAP	2112	GA-105	NAP
206468	GAK-20	CASE	2080103091	GAK-403	TOYK	2099	GA-325	NAP	2112	G-31	SHEP
2065	GA-85	NAP	20801-03091	GAK-403	TCM	2099490	G-296	ALCH	21129620	GAVV-4	AUDI
2066	G-139	AMP	2080103111	GA-360	TOYK	2099490	G-296-B	ALCH	21129620	GAVV-4	VAG
2066	G-139	BGA	20801-03131	GA-33	TCM	20999	G-566	GLOB	21129620	GAVV-4	VOLK
2067	GA-303	NAP	20801-03161	GA-360	TCM	20C	G-31	REF	211-296-20	GAVV-4	PORS
20670	G-191	GLOB	20801-03221	GAK-16	TCM	20M-01R-2211	GP-171	KOMA	21129620D	GAVV-4	VAG
2067018	GA-56	CHRY	2080205	G-813	ALCH	20M-603-1230	GP-68	KOMA	21129620D	GAVV-4	VOLK
2067018	GA-56	MOP	2080205-4	G-813	ALCH	20P2690	GA-6129	CHIC	21-129-620D	GAVV-4	VOLK
206723	GA-5648	FWDX	20803	GA-206	COLT	20X97	GA-251	BARB	21129629	GAVV-4	VOLK
2067259	G-870	CHRY	20803	GA-206	QUIN	21	GG-5 L	HOLY	2113	GP-9586	CRO
2067261	G-871	CHRY	20804	GA-106 ⁴⁶	COLT	21	GP-42	WIX	2113	G-31	FARB
2067272	GP-3600	ALCH	20804	GA-326 ⁷¹	COLT	210	GP-81	CRM	2113	GA-86	NAP
2067660	G-330	CHRY	20804	GA-106 ⁴⁶	QUIN	210	G-871	CRO	2113	G-31	SHEP
2067660	G-330	MOP	20804	GA-326 ⁷¹	QUIN	210	G-1166	DEL	2113	G-31	UNIV
2068	GP-9586	AMP	2080483	GP-3600	ALCH	210	GA-3647	PROT	211384	GP-432	MANO
2068	GP-81 ³¹	AUTO	2080764	G-222	EATN	2100	GP-156	CRO	21142	GA-27	COLT
2068	GP-9 ⁵⁸	AUTO	2080764	G-222	YALE	2-100073	GP-31	JCBM	2115371	GP-34	GARD
2068	GP-9586	BGA	2081098	GA-360	EATN	21000872	GP-58	SATU	211589	GA-436	SAAB
2068	GA-86	NAP	2081098	GA-361	EATN	21000938	GA-604	GMGX	2115939	GP-34	GARD
2068B74	GA-33	THER	2081099	GA-106 ⁴⁶	EATN	21000938	GA-604	SATU	2116	GA-85	NAP
2069	GP-1122	AMP	2081099	GA-206	EATN	210034	GP-761H	BELL	2116	GA-218	THEO
2069	GP-3	AUTO	2081099	GA-326 ⁷¹	EATN	21005	GP-34	TERR	2116110	GP-34	GARD
2069	GP-1122	BGA	208203A	GP-171	WAUK	2101	GP-212	CRO	2116128	GP-66	GARD
2069	GP-178	CRO	208226	GA-26	WAUK	2101	GA-432	GREE	21166	G-295	ROO
2069	GA-3300	NAP	208227	GAK-625	WAUK	2101	GA-57	NAP	2116MP	GA-85	NAP
206911-C91	GA-26	IHCO	2082398	GA-6127 ¹⁰⁸	EATN	21010260	GA-360	GARD	2117	G-159	AMP
20691681	GAK-16	GARW	2082398	GA-6129 ¹⁰⁴	EATN	2101-1012-005	GP-81	LADA	2117	G-159	BGA
207	GP-3600	CRM	2083	GP-77	AMP	2101-1109-100-01	GA-230	LADA	2117	GP-156	CRO
2070	GP-46	AMP	2083	GP-77	BGA	21012	G-836	CANC	2118	GA-20	NAP
20700	GA-360	HOMR	2083	GA-50	NAP	21018801	G-49	SATU	211811	GA-436	SAAB
207000318	GAK-20	OLIV	2083768	GA-361	ALCH	21018826	G-45	GMGX	2119	GA-360	NAP
207000318	GAK-20	WHIT	2083771	GA-360	ALCH	21018826	G-45	SATU	212	GP-24 ²⁵	CRM
207000615	GA-361	MINN	2083771	GA-360	FIAT	2101MP	GA-57	NAP	212	GP-462 ²⁴	ERM
207000615	GA-361	OLIV	208378	GP-26	FMC	2102	GA-55	NAP	212	GA-26	CRO
20-7000615	GA-361	WHIT	20839	G-33	AVEL	2102530	GAK-403	DUTZ	212	GA-27	ERO
20-7002168	GAK-403	WHIT	2084258	GG-5 L	CHRY	21026	G-836	TCLD	212	GG-1	HOLY
20-7002171	GAK-16	AGCO	208433	GAK-403	CASE	2-1026	G-836	CARR	212	GG-4	HOLY
20-7002171	GAK-16	WHIT	208436	GAK-16	CASE	21029	G-1174	EUCL	212	GA-3588	PROT
20-7002178	GAK-403	AGCO	2084467	GG-5 L	CHRY	21029	G-1174	GMGX	212	GA-55	UNN
20-7002178	GAK-403	WHIT	2084467	GG-5 L	MOP	2103	GP-3766	AMP	2120	GP-390	CRO
20-7002181	GAK-16	AGCO	20850539	GA-357	CASE	2103	GP-3766	BGA	2120064	GG-3	CHRY
20-7002181	GAK-16	WHIT	20850539	GA-357	POCL	2103	GP-51	CRO	2120064	GG-5 L	CHRY
20-700318	GAK-20	WHIT	20854675700	G-1121	RENA	2103	GA-3523	NAP	2120064	GG-3	MOP
20701	GAK-403	HOMR	20855589600	G-296	RENA	21030	GAK-20	COLT	2120064	GG-5 L	MOP
20-7010002	GP-1013Q	WHIT	20855589600	G-296-B	RENA	2103129	GA-33	ALCH	212013	GPP-14	CUMM
20-7015001	GP-1011Q	WHIT	2086	GP-36	CRO	21034	GP-3682	NAPS	2120158	GP-66	JLGI
207015003	GP-2071W	WHIT	2087029	GAK-20	FMC	2103566	G-871	LANC	2120216	GA-71	CHRY
20-7015004	GP-1011Q	WHIT	2087029	GAK-20	JONB	21036	GP-3980	NAPS	2120216	GA-71	TALB
20-7015005	GP-1011Q	WHIT	20870465700	G-1121	RENA	21036MP	GP-3980	NAPS	2121	GP-68	CRO
207015007	GP-1013Q	VOLV	208728	GP-50	HERC	2104	G-750	AMP	2121779	GG-5 L	CHRY
20-70											

Referencia Cruzada por Numero de Parte

Cross Reference by Part Number



Numero	Gonher	Fabricante	Numero	Gonher	Fabricante	Numero	Gonher	Fabricante	Numero	Gonher	Fabricante
Number	Gonher	Manufacturer	Number	Gonher	Manufacturer	Number	Gonher	Manufacturer	Number	Gonher	Manufacturer
2122-1		G-750 LUF	21356		GP-149 NAPS	215780		GP-166 DAVS	21886		GA-106 ⁶⁶ ATHY
2122-6		G-750 IHCO	2136		GA-4303 NAP	215787		GP-166 CASE	21886		GA-326 ⁷¹ ATHY
2122-6		G-750 LUF	2-136		GA-55 AUTV	215787		GP-166 DAVS	218889-H1		GA-27 IHCO
2123		GP-149 CRO	2-136		GA-55 PARM	2159		GP-291 CRO	218889-H2		GA-27 IHCO
21235		GP-28 ⁸ WEST	21361		GP-3682 NAPS	2159003		GA-27 VERM	2-189PL		GA-50 AUTV
21235		GP-430 ⁸ WEST	21365		GP-91 NAPS	215K		GP-38 ASAH	2-189PL		GA-50 PARM
21236		G-296 ROO	21367		G-297 COLT	216		GA-56 AMP	219		GP-28 ⁸ CRM
21236		G-296-B ROO	21367		G-297-B COLT	216		GA-56 BGA	219		GP-430 ⁸ CRM
212374		GPP-18 DYPA	21368		G-296 COLT	216		GP-3429 CRM	2190		GA-448 NAP
212396		GP-178 DYPA	21368		G-296-B COLT	2160		GA-230 NAP	21915-95000		GP-2071W NISS
2124		GP-50 ²⁰ BGA	21368		G-296 QUIN	216080199		GAK-20 GROV	21915-99003		GP-1011Q NISS
2124		GA-322 GREE	21368		G-296-B QUIN	2-160PL		GA-70 AUTV	21915-990032		GP-1011Q NISS
2124		GA-27 NAP	21372		GP-68 NAPS	2-160PL		GA-70 PARM	2191P101234		GAK-20 MACK
212431		GP-54 ¹¹ DYPA	21372MP		GP-68 NAPS	216139-R91		G-333 IHCO	2191P101237		GA-1285 MACK
212431		GP-66 ¹⁰ DYPA	21374		GP-58 NAPS	216139-R92		G-333 IHCO	2191P101240		GA-27 MACK
2125		GP-3980 CRO	21380		GP-3985 NAPS	216140-R91		G-333 IHCO	2191P101243		GA-26 MACK
2125		GA-514 GREE	21380		GP-91 ⁷⁸ SER	216140-R92		G-333 IHCO	2191P116918		GA-378 MACK
2125		GA-26 NAP	21381		GP-91 ⁷⁸ NAPS	216150-R92		G-333 IHCO	2191P117332		GA-26 MACK
2125548		G-236 CHRY	21381		GP-91 ⁷⁸ SER	2161582		GP-1122 DUTZ	2191P117797		GA-229 MACK
21255F		GA-27 CRO	2138240		G-1121 SULL	2161582		GP-1122 KHDF	2191P1240		GA-27 MACK
21255F		GA-27 OSHK	2138240		G-1121 ZETT	2162		GP-149 CRO	2191P1243		GA-26 MACK
21258		GP-20 NAPS	21382409		G-1121 ZETO	2162		G-500 LUF	2192		GP-43 BGA
2126		GAK-403 NAP	21382409		G-1121 ZETT	21622		G-1173 ¹⁰⁸ CUMM	2-192		GA-192 PARM
2126LUB		G-750 LUF	213860		G-33 BROK	216227		G-1173 ¹⁰⁸ CUMM	21925		GA-12 TECU
2128		G-1173 ¹⁰⁸ COM	2139		GP-9 CRO	21626		GP-3985 NAPS	2-192PL		GA-192 AUTV
2128		GA-356 NAP	21390		GP-42 NAPS	2163		GP-149 CRO	2194		GP-54 ¹¹ AMP
2128548		G-236 CHRY	21390		GP-42 SER	21638		G-296 ROO	2194		GP-66 ¹⁰ AMP
212880		G-31 BENX	21392		GP-3531 EXP NAPS	21638		G-296-B ROO	2195		GP-35 BGA
212880		G-31 BROK	21392		GP-3531 EXP SER	2164		GP-91 CRO	219517		GA-405 SAAB
2129		GP-171 CRO	21394		GP-157 NAPS	2164750		GA-5648 DUTZ	2195196470		GA-405 SAAB
2129023		G-236 CHRY	213E-9601-AB		GAD-3 FORD	2164750		GA-5648 KHDF	219640		GA-230 PUR
2129023		G-236 MOP	214		GP-46 CRM	2165031		GA-49 DUTZ	2196907		G-200 CHRY
2129023		G-236 WHIT	214		GG-6 HOLY	2165031		GA-49 KHDF	2196908		GP-50 CHRY
212E2550		G-31 AMLA	214		GA-3681 PROT	2165034		GA-49 ABG	2196908		GP-50 MOP
213		GP-310 CRM	2140		GA-3424 NAP	2165034		GA-49 DUTZ	2196909		GP-5 CHRY
213		GG-5 L HOLY	21401091		GA-6880 KENW	2165034		GA-49 FUCH	2196909		GP-9 MOP
2130		GP-54 CRO	2141		G-500 LUF	2165034		GA-49 KHDF	219814701		GA-880R RANS
2-130142		GP-3600 JCBM	2141		GA-3425 NAP	2165034		GA-49 KRAM	2198450		GP-66 ZETT
213020		G-1163 ¹⁰⁸ SAVA	21415W		G-31 DIAM	2165043		GA-49 ABG	21984506		GP-66 ZETT
21307		GP-81 NAPS	214178		GAK-16 WAYN	2165054		GA-360 MAGI	21PS269		GA-27 CHIC
21307		GP-81 SER	2142		GP-149 CRO	2165056		GA-405 DUTZ	21T5-18658-A		G-31 FORD
21308		G-801 FORD	2142		G-750 LUF	2165056		GA-405 FIAT	21T5-18658-B		G-31 FORD
2131		GP-22 CRO	2142		GAK-403 NAP	2165056		GA-405 KHDF	21U6-011330		GP-3937 KOMA
21315		GP-128 NAPS	21427684		GP-34 KOEH	2165059		GA-405 DUTZ	21W		GA-405 SULL
2131510		G-1121 ZETT	2143		GP-58 AMP	2165059		GA-405 FIAT	21X115464		GAK-403 JOND
21315108		G-1121F ZETT	2143		G-750 LUF	2165059		GA-405 IVEC	21X11983C		GAK-403 JOND
213184		GA-26 CUMM	2143003		GA-33 VERM	2165059		GA-405 KHDF	21X11984A		GAK-403 JOND
213188		GA-7 FORD	2143138		G-200 WHIT	216612598		GP-31 CCO	21X11987A		GAK-403 JOND
213188		GA-7 NEWH	2144		GP-38 AMP	216763		G-31 WHIT	21X12939		GAK-16 JOND
2132		GA-357 NAP	2144		GP-38 BGA	2168		GA-2193 NAP	21X12939A		GAK-16 COCT
21321701		GP-77 ZETT	21446675-M91		GP-31 MASY	2169939		GA-322 PARM	21X12939A		GAK-16 JOND
213227		G-31 BENX	2145		GP-3985 AMP	217		G-1173 ¹⁰⁸ CRO	21X25035A		GAK-16 JOND
213227		G-31 BROK	2145		GP-3985 BGA	2170		GAVW-2 NAP	22		GG-19 FACE
213282-R91		G-333 IHCO	2145		GA-386 GREE	21710837		GAK-403 OLIV	22		GG-20 HOLY
2-13298		G-750 TERA	21450		G-295 GOL	21710837		GAK-403 WHIT	22		GG-19 LONF
2133		G-169 ⁹⁹ MACK	21452		GP-310 NAPS	217-11-45		GP-34 HOLL	22		GP-46 WIX
2133		GA-277 NAP	2146007		GAK-16 VERM	21712		GP-14 GOL	220		GP-40 CRM
21334		GP-149 ⁶⁹ NAPS	214672		G-31 BENX	217307		GP-66 CASE	220		GA-85 PROT
21334		GP-91 NAPS	2-146PL		GA-71 AUTV	217307		GP-66 DAVS	22001		GA-27 COLT
21334MP		GP-149 ⁶⁹ NAPS	2-146PL		GA-71 PARM	2174340		GP-1122 ZETT	22001		GA-27 QUIN
21334MP		GP-91 NAPS	214731M		G-333 REF	217443		GA-356 ¹⁰⁴ RAYG	220010054		GA-376 MINN
2133558		GP-1122 ATCO	214731-R91		G-333 IHCO	217443		GA-357 ¹⁰⁸ RAYG	220010055		GA-376 MINN
2133558		GP-1122 DUTZ	2-148		GA-80 PARM	217490		GA-33 FORD	220010095		GA-376 MINN
2133558		GP-1122 FIAT	214A1-02601B		GA-16 ¹² TCM	217490		GA-33 NEWH	22-0010167		GA-378 WHIT
2133558		GP-1122 KHDF	214A1-02601B		GAK-16 ³⁴ TCM	217493		GA-135 MCCU	220010185		GA-376 MINN
213383-R91		G-333 IHCO	215		GP-44 CRM	2175		GP-43 BGA	220010240		GA-376 MINN
213388R91		G-333 IHCO	215		GA-2719B PROT	2175.131		GP-461 LOMB	220010240		GA-376 WHIT
2133943		GP-1122 ATCO	2150001		GAK-403 VERM	217517		GA-405 SAAB	22-0015041		GA-1095 WHIT
2133943		GP-1122 DUTZ	2150007		GAK-403 VERM	217617		GA-357 RAYG	220026		G-31 ALCH
2133943		GP-1122 FIAT	2150109811		GAK-16 TOYK	21766		GAK-16 EXCL	220026-6		G-31 ALCH
2133943		GP-1122 KHDF	21502		GA-6127 ¹⁰⁸ URIG	217670		GP-1122 OREN	220026-9		G-31 ALCH
2133WD107		G-169 ⁹⁹ MACK	21502		GA-6129 ¹⁰⁴ URIG	2177074		G-1123 LANC	220047		GP-54 ¹¹ BELL
21342		GP-28 ⁸ NAPS	215086		GA-5648 RAYG	2177974		GA-165 PARM	220047		GP-66 ¹⁰ BELL
21342		GP-430 ⁸ NAPS	2151		GP-91 CRO	218		GP-3980 CRM	220048		GP-1122 BELL
21342		GP-28 ⁸ SER	21515		GP-1 NAPS	218		GG-5 L HOLY	220048		GA-732R ERO
21342		GP-430 ⁸ SER	21515MP		GP-1 NAPS	218		GA-78 UNN	220050001		GA-376 MINN
213428		G-750 CUMM	21516		GP-3600 NAPS	2181		GP-3985 AMP	22-0050002		GA-2984 WHIT
213428		G-750 MACK	21516		GP-3600 SER	2181		GA-183 NAP	22-0050008		GA-372 WHIT
213462		GG-5 L EATN	21516MP		GP-3600 NAPS	2182		GP-3985 AMP	220051		GA-413R ERO
213462		GP-124 YALE	21521		GP-171 NAP	2182		GP-3985 BGA	220051		GA-413R WHIT
213464		GPP-1122 VOLV	21521		GP-171 NAPS	2183		GP-14 BGA	22-0053201		GA-1095 WHIT
213464-5		GPP-1122 VOLV	21522		GP-3675 NAPS	2184		GP-3531 EXP BGA	22-0054401		GA-493 ¹⁰⁸ WHIT
21347		GP-24 ²⁶ NAPS	2153		GA-381 GREE	218420035		GP-462 VERM	22-0055002		GA-493 ¹⁰⁸ WHIT
21347		GP-462 ⁹⁴ NAPS	2153003		GAK-20 VERM	21844001		GP-1 MBNZ	220055039		GA-1095 VOLV
21347		GP-24 ²⁶ SER	215410SV		G-1123 SAVA	21847725		G-143 MBNZ	22-0055039		GA-1095 WHIT
21347		GP-462 ⁹⁴ SER	215502		G-333 AUSW	2-184PL		GA-77 AUTV	22-0055064		GA-3551 ⁵⁵ WHIT
21348		GP-2951 NAPS	215502		G-33 CLRK	2-184PL		GA-77 PARM	22-0055064		GA-3551 XT ⁶⁴ WHIT
21348		GP-58 NAPS	21551		GP-3675 PARM	2185		GP-53 AMP	22005-5094		GA-885 VOLV
21348MP		GP-2951 NAPS	2156		GP-54 ⁹⁰ AMP	218532		GA-27 IHCO	220067		GA-768R ERO
21348MP		GP-58 NAPS	215630		GAK-1532 NEWH	218532-H1		GA-27 IHCO	2200676		GAK-20 EATN
2135		GP-46 AMP	215678-R92		G-333 IHCO	218577-A1		G-296 IHCO	220077		GP-761H BELL
2135		GP-46 BGA	215678R-93		G-333 IHCO	218577-A1		G-296-B IHCO	220086		GS-2033 BELL
2135		GP-3000 CRO	2157		GP-57 AMP	2188		GP-57 BGA	22-0096		GAK-20 ROI
213527		G-500 CONT	2157		GP-57 BGA	2188566		GA-5466 PARM	22-0099		GA-33 ROI
213527		G-500 CUMM	215777-R91		G-1173 ¹⁰⁸ IHCO	21886		GA-106 ⁶⁶ ASTR	22-0105		GAK-16 ROI
213529		G-500 BENX	215780		GP-166 CASE	21886		GA-326 ⁷¹ ASTR	22011		GA-71 NAPS

REFERENCIA CRUZADA

Numero	Gonher	Fabricante	Numero	Gonher	Fabricante	Numero	Gonher	Fabricante	Numero	Gonher	Fabricante
Number	Gonher	Manufacturer	Number	Gonher	Manufacturer	Number	Gonher	Manufacturer	Number	Gonher	Manufacturer
220132	GA-563	BELL	221176	GG-20	BROK	222-4570	GA-3300	GOY	2246334	GG-1	IPS
22020	GA-70	NAPS	221176	GG-20	MACK	222-4571	GA-86	GOY	2246334	GG-4	IPS
22021703	GAK-16	BLAW	22118	G-33	CANC	222-4572	GA-192	GOY	224636	GA-357	CASE
2202783	GG-20	CHRY	221184	GA-37	RENA	222-4573	GA-85	GOY	224636	GA-357	DROT
2202783	GG-20	MOP	22122	G-296	ROO	222-4574	GA-86	GOY	224637	GA-356	DROT
2202786	G-236	CHRY	22122	G-296-B	ROO	222-4575	GA-3425	GOY	224785	GA-200	DAF
2202787	G-236	CHRY	221292	GA-31	BROK	222-4577	GA-54	GOY	224785	GA-218	DAF
2203	GA-1203	NAP	221320	GC-1133	CUMM	222-4578	GA-3523	GOY	224785	GA-200	VOLV
22-038	G-33	STEI	22133	GA-277	NAPS	222-4579	GAD-3	GOY	224785	GA-218	VOLV
22039	GA-54	NAPS	221347	GA-27	CASE	222-4580	GAVW-2	GOY	22487	GA-348	NAPS
22039	GA-54	SER	221347	GA-27	DROT	222-4581	GA-277	GOY	2249621	GG-1	IPS
220425	GP-171 ¹⁶	LANC	22-13-470	GG-5 L	MZDA	222-4582	GA-735 ¹²⁴	GOY	2249621	GG-4	IPS
22044	GA-730	NAPS	22-13-470A	GG-5 L	MZDA	222-4583	GA-3445	GOY	225	GA-86	PROT
22054	GA-77	NAPS	22-13-470B	GG-5 L	MZDA	222-4584	GA-271	GOY	225	GPP-14	RAR
22055	GA-80	NAPS	22136	GA-4303	NAPS	222-4585	GA-3588	GOY	2250	G-750	LUF
22055	GA-80	SER	221383	G-1123F	BELL	222-4586	GA-3424	GOY	2250	GA-37	NAP
2205517	GP-1	CHRY	221384	G-1121F	BELL	222-4588	GA-3647	GOY	2250077-643	GG-3	SULL
22057	GA-74	NAPS	22140	GA-3424	NAPS	222-4590	GA-3490	GOY	2250118495	GPP-425	SULL
22057	GA-74	SER	22140	GA-3424	SER	222-4592	GA-101	GOY	2250153904-KIT	GPP-425	SULL
2206020	GA-106 ⁴⁶	SHIN	221409	GAK-1532	NEWH	222-4594	GA-74	GOY	2252020	GAK-403	BELL
2206020	GA-326 ⁷¹	SHIN	22141	GA-3425	NAPS	222-4595	GA-89	GOY	2252	GA-37	NAP
22060200	GA-106 ⁴⁶	SHIN	221550	G-33	CLRK	222-4597	GA-2719B	GOY	2252	GA-4365	TEHO
22060200	GA-326 ⁷¹	SHIN	2216260	GA-436	DUTZ	222-4602	GA-3566	GOY	2252506	GA-135	GMCX
22060210	GA-206	SHIN	2216260	GA-436	KHDF	222-4603	GA-274	GOY	2252525	GA-209	NAP
2206376	GA-71	CHRY	2216260	GA-436	ZETT	222-4650	GG-5 L	GOY	2254	GA-210	NAP
2206376	GA-71	MOP	22162607	GA-436	ZETT	222-4652	GG-7	GOY	2254347	GP-31	PERK
22067	GA-303	NAPS	22170	GAVW-2	NAPS	222-4653	GG-123	GOY	2258	GP-20	AUTO
22073	GA-75	NAPS	22170	GAVW-2	SER	222-4654	GG-19	GOY	2258	GA-563	NAP
22077	GA-3300	NAPS	221767	G-31	GMCCX	222-4655	GG-16	GOY	2258	GAVW-2	GREY
2208	GA-106 ⁴⁶	NAP	22177737	GP-3001	INGR	222-4656	GG-17	GOY	225D	GP-310	CRM
2208	GA-326 ⁷¹	NAP	2218	GA-390	NAP	222-4659	GG-8 ¹⁰³	GOY	225D	GP-3569	CRM
22083	GA-50	NAPS	221A	GA-39	GREY	222-4659	GG-8 L ⁸⁰	GOY	225K	GP-10	ASAH
22088	GA-192	NAPS	222	GP-3531	EXP	222-4660	GG-87	GOY	226	GP-58	CRM
2209	GA-206	NAP	222	GA-303	PROT	2227	GP-1107	JAT	226	G-1166	DEL
220918	GP-53	BELL	22201640	GAK-403	KOBL	2227241021	GP-462	VERM	226	GA-3424	PROT
22095	GA-55	NAPS	22202-390	GA-33	MITTS	22273	GAK-16	COLT	226021-11120	GAK-16	FURU
22096	GAK-20	LETR	22202-392	GA-33	MITTS	22274	GAK-403	COLT	2-26021-111-20	GAK-16	ISUZ
22-096	GAK-20	LROI	22202420	GAK-16	KOBL	2228802	GG-1	IPS	22604	GP-54 ¹¹	HANO
22097	GAK-403	LETR	2220425	GP-171 ¹⁶	LANC	2228802	GG-4	IPS	22604	GP-66 ¹⁰	HANO
22-097	GAK-403	LROI	22-2099	GA-33	LROI	223	GP-3600	CRM	2261	G-750	LUF
22098	GA-59	NAPS	222-13-478	GG-5 L	MZDA	223	GA-80	PROT	2261014	GAK-20	JONB
22099	GA-33	LETR	222-14-300	GP-42	MZDA	2230	G-25	CRO	2261017	GAK-20	FMC
22-099	GA-33	LROI	2221767	G-31	GMCCX	2230994	GG-19	IPS	2261017	GAK-20	JONB
220K	GP-1	ASAH	22218	GA-390	NAPS	2232	G-466	CRO	22612473	GP-81	OLIV
221	GP-42	CRM	2222	GAK-16	NAP	2233193	G-31	GMCCX	22612473	GP-81	WHIT
221	GA-75	PROT	222260	GAK-403	IHCO	2233219	G-31	GMCCX	2262770	GG-261	IPS
22101	GA-57	NAPS	222260-H1	GAK-403	IHCO	2233220	G-1143	GMCCX	2263501	GG-261	IPS
22103	GA-3523	NAPS	222401	GA-26	CASE	22333	GA-139	NAPS	22-642473	GP-81	WHIT
22104	G-33	ALCH	222421A1	GA-853R	CASE	2234	GAK-20	NAP	22-6424730	GP-81	WHIT
221041	G-33	ALCH	222-4501	GP-1	GOY	22344	GAK-403	COLT	2266	G-500	CATP
22104628	GA-106 ⁴⁶	PHHR	222-4502	GP-5	GOY	22344	GAK-403	QUIN	226-6551	GP-3000	ACD
22104628	GA-326 ⁷¹	PHHR	222-4503	G-200	GOY	2234421	G-750	GMCCX	226-6552	GP-53	CATP
22104637	GP-1010Q	PHHR	222-4504	GP-20	GOY	2234422	G-750	GMCCX	226-6555	GPP-14	CATP
221046A53	G-566	PHHR	222-4505	GP-3	GOY	2234424	G-750	GMCCX	226-6557	GP-55	CATP
221046Z14	GP-1122	PHHR	222-4506	GP-81 ³¹	GOY	22345	GAK-16	COLT	226-6558	GP-26	CATP
221046Z19	GP-77	PHHR	222-4506	GP-9 ⁵⁸	GOY	22345	GAK-16	QUIN	226-6561	GPP-11	CATP
221046Z20	G-31	PHHR	222-4507	GP-38	GOY	223478	GP-34	DYPA	226-6562	GP-27	CATP
221046Z21	GP-54 ¹¹	PHHR	222-4508	GP-310	GOY	22349	GA-2740	NAPS	226-6563	GP-85 ³²	CATP
221046Z21	GP-66 ¹⁰	PHHR	222-4509	GP-28 ⁸	GOY	22349	GA-2740	SER	226-6564	G-3202 ¹⁰	CATP
221046Z25	GP-54 ¹¹	PHHR	222-4509	GP-430 ⁸	GOY	22349	GA-2740	SLIN	226-6565	GP-2071W	CATP
221046Z25	GP-66 ¹⁰	PHHR	222-4510	GP-46	GOY	2235	GP-9	SULL	226-6566	GP-1013Q	CATP
221046Z26	GP-54 ¹¹	PHHR	222-4511	GP-44	GOY	2235826	G-1143	GMCCX	226-6567	GP-1011Q	CATP
221046Z26	GP-66 ¹⁰	PHHR	222-4512	GP-3429	GOY	2235978	GA-135	GMCCX	22665803	GP-1	ZETT
221046Z32	GP-66	PHHR	222-4513	GP-13	GOY	2235979	GA-135	GMCCX	22665803	GP-310	ZETT
221046Z37	GP-2071W	PHHR	222-4514	GP-46	GOY	2236054	G-834	CHRY	226751	G-1121	HODR
221046Z38	GA-106 ⁴⁶	PHHR	222-4515	GP-28	GOY	2236054	G-834	MASY	22676970	GA-367	GMCCX
221046Z38	GA-326 ⁷¹	PHHR	222-4516	GP-3980	GOY	2236054	G-834	MOP	22676970	GA-367	SATU
221046Z39	GA-206	PHHR	222-4517	GP-42	GOY	2236054	G-834	PERK	22680	G-1175 ⁹⁸	EUCL
221046Z42	G-143	PHHR	222-4518	GP-3531	EXP	2236295	G-296	CHRY	22685727	G-49	SATU
221046Z46	GP-54 ¹¹	PHHR	222-4519	GP-40	GOY	2236295	G-296-B	CHRY	226Y2473	GP-81	OLIV
221046Z46	GP-66 ¹⁰	PHHR	222-4520	GP-3600	GOY	2236295	G-296	MOP	226Y2473	GP-81	WHIT
221046Z47	GP-1122	PHHR	222-4521	GP-1	GOY	2236295	G-296-B	MOP	227	G-296	DEL
221046Z66	GP-54 ¹¹	PHHR	222-4521	GP-3569	GOY	2236295	G-296	PERK	227	G-296-B	DEL
221046Z66	GP-66 ¹⁰	PHHR	222-4522	GP-58	GOY	2236295	G-296-B	PERK	227	GA-3300	PROT
221046Z67	GP-1122	PHHR	222-4524	GP-171	GOY	2236318	GA-135	GMCCX	227040	G-1174	ALCH
221046Z69	G-1123	PHHR	222-4525	GP-24 ²⁶	GOY	2236323	G-834	CHRY	227040-7	G-1174	ALCH
221046Z70	GP-77	PHHR	222-4525	GP-462 ²⁴	GOY	22385	GA-224	NAPS	2271170	GG-94	IPS
221046Z71	GP-36	PHHR	222-4526	GP-3531	EXP	223960-R92	G-333	IHCO	22714000	GP-1	RENA
221046Z76	G-163	PHHR	222-4527	GP-81	GOY	224	GA-37	AMP	22719	GA-2719B	PARM
221046Z96	G-1121F	PHHR	222-4550	GA-100	GOY	224	GA-37	BGA	2271979	GA-853R	OREN
221106	GAK-20	CASE	222-4551	GA-113	GOY	224	GP-58	CRM	22740	GA-2740	PARM
221106	GAK-20	DROT	222-4553	GA-78	GOY	224	GA-74	PROT	227456	GA-56 ⁹⁰	NEWH
22113	GA-86	NAPS	222-4554	GA-55	GOY	2240348	GA-436	DUTZ	227457	GA-361 ⁹⁸	NEWH
22113	GA-86	SER	222-4555	GA-71	GOY	2240348	GA-436	KHDF	227457	GA-56 ⁹¹	NEWH
221137	GA-37	BROK	222-4556	GA-70	GOY	2240546	GG-20	CHRY	2275188	GG-261	IPS
221137	GA-37	MACK	222-4557	GA-56	GOY	2240546	GG-20	MOP	2276	GA-33	NAP
22114	G-1173 ¹⁰⁸	CANC	222-4558	GA-77	GOY	2240855	GG-94	IPS	227671	GA-361	FORD
221140	GA-37	BROK	222-4559	GA-50	GOY	224-11-134	GP-34	HOLL	227671	GA-361	NEWH
221140	GA-37	MACK	222-4560	GA-303	GOY	2242622	GA-384	PARM	2278506	GP-66	ZETT
221144	GA-37	BROK	222-4561	GA-730	GOY	224285007	GA-880R	VERM	2279	GA-215	NAP
221144	GA-37	CONT	222-4562	GA-85	GOY	2243412	GG-94	IPS	227A	GA-7	GREY
221144	GA-37	CUMM	222-4563	GA-325	GOY	2244062	G-31	GMCCX	228	GA-77	PROT
221144	GA-37	MACK	222-4564	GA-59	GOY	2244699	G-31	GMCCX	2285	GA-2146	NAP
221145	GA-37	MACK	222-4565	GA-57	GOY	224-512-1701	GAK-403	KOMA	22852800	GP-1122	RENA
22116	GA-85	NAPS	222-4567	GA-75	GOY	2245544	GA-384	PARM	22-860	G-238	LROI
22117	G-119	CANC	222-4568	GAD-1	GOY	2245826	G-1143	GMCCX	22860400	GA-405	RENA

Referencia Cruzada por Numero de Parte

Cross Reference by Part Number



Numero	Gonher	Fabricante	Numero	Gonher	Fabricante	Numero	Gonher	Fabricante	Numero	Gonher	Fabricante
Number	Gonher	Manufacturer	Number	Gonher	Manufacturer	Number	Gonher	Manufacturer	Number	Gonher	Manufacturer
229	GA-735 ²⁴	PROT	23-102-03	GP-1	UFI	23300	GA-3300	AUTV	2330688	GA-86	CANT
22905	GAD-1 ⁸⁷	NAPS	23-106-01	GP-54 ¹¹	UFI	23300	GA-3300	PARM	23-3069-6	GA-382	CANT
22905	GAD-1 ⁸⁷	SER	23-106-01	GP-66 ¹⁰	UFI	23-300-00	GP-9	UFI	2330776	GA-3300	CANT
22906	GAD-3	NAPS	23-110-00	GP-36	UFI	23300-09020	GG-220	TOYO	233078	G-750	GMXC
2291	GA-42	NAP	23-110-02	GP-36	UFI	23300-11090	GG-185	TOYO	23-3078-4	GA-142	CANT
22912	GA-3490	NAPS	23110800	G-296	RENA	23300-11150	GG-164	TOYO	2330822	GA-3814	CANT
22912	GA-3490	SER	23110800	G-296-B	RENA	23300-13020	GG-185	TOYO	2330856	GA-180	CANT
2293248	G-162H ⁹⁹	DAF	23-112-00	GP-14	UFI	23300-15010	GG-204	TOYO	2330898	GA-153	CANT
229348	G-162H ⁹⁹	DAF	23-113-00	GP-68	UFI	23300-15020	GG-220	TOYO	2330928	GA-5056	CANT
229348	G-162H	LEYL	23116	GA-7	KOHL	23300-16050	GG-185	TOYO	2330936	GA-90	CANT
22936	GP-2071W	VERS	2311778	GA-33	CLRK	23300-16240	GG-185	TOYO	2330986	GA-59	CANT
2295	GA-VW-622	NAP	231178	G-11816	FORD	23300-19045	GG-185	TOYO	2330994	GA-325	CANT
229651	GP-171	HODR	231179	G-870	FORD	23300-19085	GG-185	TOYO	2331	G-1173 ⁹⁸	COM
229651	GP-81	HODR	23-121-00	GP-38	UFI	23300-19145	GG-220	TOYO	2331026	GA-4303	CANT
229-6554	GP-57	CATP	23-122-00	GP-38	UFI	23300-19225	GG-185	TOYO	2331034	GA-735 ²⁴	CANT
22991	GA-113	NAPS	23-123-00	GP-1	UFI	23300-19235	GG-185	TOYO	2331042	GA-2740	CANT
22995	GA-100	NAPS	23-124-00	GP-81	UFI	23300-19265	GG-185	TOYO	2331076	GA-VW-4	CANT
229K	GP-54 ¹¹	ASAH	23-128-00	GP-81	UFI	23300-19295	GG-220	TOYO	23-3109-2	GA-3566	CANT
229K	GP-66 ¹⁰	ASAH	23-129-02	GP-38	UFI	23300-19375	GG-185	TOYO	23311	GG-66	NAPS
22L2251	GP-1122	LEYL	231308	G-871	FORD	23300-19385	GG-164	TOYO	2331122	GA-4365	CANT
22L2252	G-31	LEYL	231309	G-11816	FORD	23300-19425	GG-185	TOYO	23-3113-0	GA-140	CANT
22X25035A	GAK-16	COCT	231310	G-871	FORD	23300-20020	GG-185	TOYO	2331236	GA-230	CANT
22X25035A	GAK-16	JOND	231311	G-11816	FORD	23300-24020	GG-76	TOYO	2331244	GAD-15	CANT
22X25039A	GAK-16	JOND	23-132-00	GP-22	UFI	2330024050	GG-199	TOYO	2331321	G-6	HYST
23	GAK-20	ERO	23-137-00	GP-3985	UFI	23300-25020	GG-76	DTSU	233134-12	G-6	HYST
23	GG-5 L	HOLY	23-138-00	GP-3600	UFI	23300-25020	GG-76	TOYO	233134-A	G-6	HYST
23	GP-3600	WIX	23-139-00	GP-3985	UFI	23300-26060	GG-203	DTSU	23-3144-6	GA-322	CANT
23.102.00	GP-171 ¹⁶	UFI	23-144-00	GP-51	UFI	23300-26060	GG-203	TOYO	23-3150-0	GA-386	CANT
23.130.00	GP-28 ⁸	UFI	231495	GP-36	HAMM	23300-29045	GG-185	TOYO	23-3152-6	GA-432	CANT
23.130.00	GP-430 ⁸	UFI	23-152-00	GP-54	UFI	2330032	GA-71	CANT	2331606	GA-253	CANT
23.130.01	GP-28 ⁸	UFI	2315300	GP-9	WOOG	23300-34100	GG-203	TOYO	2331622	GA-174	CANT
23.130.01	GP-430 ⁸	UFI	23-153-00	GP-171	UFI	23300-36020	GG-76	TOYO	23-3166-4	GA-514	CANT
23.151.00	GP-462	UFI	23-155-00	GP-46	UFI	23300-38010	GG-208	TOYO	2331698	GA-3425	CANT
23.186.01	GP-28 ⁸	UFI	23-156-02	GP-310	UFI	2330040	GA-70	CANT	2331882	GA-3588	CANT
23.186.01	GP-430 ⁸	UFI	23-159-00	GP-42	UFI	23300-41030	GG-202	NISS	23319	GG-79	NAPS
23.187.00	GP-3980	UFI	23-165-00	GP-40	UFI	23300-41031	GG-202	NISS	2331912	GA-VW-2	CANT
23.197.00	GP-455	UFI	23-166-00	GP-81	UFI	23300-50020	GG-187	TOYO	23-3192-0	GA-3445	CANT
23.252.00	GP-462	UFI	23-171	GP-81	UFI	2330050025	GG-187	TOYO	2331938	GA-3490	CANT
23.254.00	GP-455	UFI	23-174-00	GP-46	UFI	23300-50040	GG-187	TOYO	2331996	GA-271	CANT
23.472.00	GP-112	UFI	23175	GA-39	KOHL	23300-50050	GG-187	TOYO	2332028	GA-57	CANT
230	GA-3814	PROT	23-175-00	GP-3816	UFI	23300-62010	GG-187	TOYO	23-3215-8	GA-604	CANT
23001	GG-1	NAPS	23-177-00	GP-40	UFI	23300-62020	GG-187	TOYO	23323	GG-61	NAPS
23001	GG-4	NAPS	23-180-00	GP-68	UFI	23300-62030	GG-187	TOYO	233239	G-1123	VOLV
23002	GG-124	NAPS	2318021	GA-27	CLRK	23300-65010	GG-187	TOYO	23324	GG-65	NAPS
23003	GG-5 L	NAPS	23180-73	GA-27	PETI	23300-74020	GG-220	TOYO	233277	G-33	CLRK
2-301217	GP-3600	JCBM	23-181-00	GP-1	UFI	23300-74040	GG-185	TOYO	2333	GA-139	NAP
230-12-3693	GP-62	CARR	23-182-00	GP-3531	EXP	23300-74050	GG-185	TOYO	2334	GP-91	AUTO
23022	GG-94	NAPS	2318400	GP-91	UFI	23300-74080	GG-185	TOYO	2334	GA-9334	NAP
23023	GG-63	NAPS	231847	GA-12	JOND	23300-74210	GG-164	TOYO	23-3405-6	GG-220	CANT
2-303	GA-303	AUTV	231847	GA-12	KOHL	23300-74260	GG-164	TOYO	23-3411-0	GG-65	CANT
2-303	GA-303	PARM	231847	GA-12	MASY	23300-79025	GG-185	TOYO	23-3417-8	GG-256	CANT
23030-13020	GG-185	TOYO	231847	GA-12	WHEL	23300-79105	GG-220	TOYO	23-3428-2	GG-150	CANT
23030-31031	GG-76	DTSU	23-185-00	GP-171	UFI	23300-79175	GG-185	TOYO	23-3429-0	GG-115	CANT
23030-41030	GG-202	TOYO	23-186-00	GP-3600	UFI	23300-79185	GG-185	TOYO	23-3431-2	GG-142	CANT
23030-62010	GG-187	TOYO	23-188-00	GP-3816	UFI	23300-79235	GG-185	TOYO	23-3434-6	GG-151	CANT
23030-74020	GG-185	TOYO	23-191-00	GP-3985	UFI	23300-79285	GG-227	TOYO	23-3462-8	GG-177	CANT
23030-79025	GG-185	TOYO	231996	GA-360	DROT	23300-79305	GG-185	TOYO	23-3463-6	GG-146	CANT
23030-87603	GG-5 L	DTSU	232	GA-5056	PROT	23300-79405	GG-227	TOYO	23-3470-8	GG-213	CANT
23032	GG-5 L	NAPS	23204	GG-208	NAPS	23300-79425	GG-164	TOYO	2335	GA-1286	NAP
230320	GP-50	SAVA	232241	GP-1	ALCH	23300-79495	GG-164	TOYO	23-3534-8	GG-194	CANT
230362	GG-5 L	GMXC	23-23-00	GP-171	TORO	23300-79545	GG-185	TOYO	23-3552-4	GG-188	CANT
230-370	GP-149 ⁹⁹	MZDA	2323108	G-871	FIAT	2330082	GA-230	CANT	233574	G-1121	VOLV
230-370	GP-91	MZDA	2-324	GA-85	AUTV	23300-87310-00	GG-185	DTSU	233628	G-296	VOLV
23042062	GP-3766	ALLI	2-324	GA-85	PARM	23300-87724	GG-185	DTSU	233628	G-296-B	VOLV
23042062	GP-3766 ⁰⁰	GMXC	23-240-00	GP-3682	UFI	23300-87724-000	GG-185	DTSU	23373	GA-VW-2	PARM
23044	GG-6	NAPS	23-241-00	GP-1	UFI	23300-87729-000	GG-185	DTSU	2338	GAK-403	NAP
23046	GG-19	NAPS	232421	GP-1	ALCH	23300-87731-000	GG-185	DTSU	2338478	G-1123	VOLV
23048	GG-7	NAPS	23-2421	G-1175	PBLT	2330112	GAD-1	CANT	233897	G-1123	VOLV
2-305	GA-730	AUTV	232421-1	GP-1	ALCH	2330154	GA-277	CANT	2338978	G-1123	VOLV
2-305	GA-730	PARM	23-2436	G-750	PBLT	23-3020-0	GA-390	CANT	233898	G-1121	VOLV
23051	GA-116	NAPS	2-325	GA-325	AUTV	2330226	GA-3681	CANT	233898-6	G-1121	VOLV
23052	GG-17	NAPS	2-325	GA-325	PARM	2330234	GA-89	CANT	2339-5	G-1174 ⁹⁸	COM
23054	GG-8 ⁰³	NAPS	23-251-00	GP-156	UFI	2330242	GA-78	CANT	233988	G-1121	VOLV
23054	GG-8 ¹⁸⁰	NAPS	2325391	G-750	GMXC	2330276	GA-3647	CANT	234	GAD-3	PROT
230578	GP-1	ALCH	23-257-00	GP-22	UFI	23-303-00	GP-9	UFI	2-340	GA-86	PARM
2307	GP-81	AUTO	232578	GP-1	ALCH	2330314	GA-56	CANT	23401-1190	GP-1101	HINO
230-74-28	GAK-403	BLKW	232578-4	GP-1	ALCH	2330348	GA-4828	CANT	23401-1200	GP-1101	HINO
23081	GG-87	NAPS	23-258-00	GP-149	UFI	23-3036-4	GA-390	CANT	23401-1220	GP-1101	HINO
23081	GG-87	SER	2-326	GA-59	AUTV	2330372	GA-74	CANT	23401-1240	GP-1101	HINO
230840	GA-11	JACO	2-326	GA-59	PARM	23303-78309-000	GPP-111	DTSU	23401-1241	GP-1101	HINO
230840	GA-11	JOND	23-260-00	GP-149	UFI	23303-78309-000	GPP-524	DTSU	23401-1241A	GP-1101	HINO
230840	GA-11	KOHL	23262	G-294	ROO	23303-79025	GG-185	TOYO	23401-1242	GP-1101	HINO
230840	GA-11	MASY	232639-R91	GP-1101	IHCO	2330380	GA-54	CANT	23401-1280	GP-1101	HINO
230840	GA-11	WHEL	23-265-00	GP-149	UFI	23303-87308	GPP-111	DTSU	23401-1281	GP-1101	HINO
230840	GA-11	WHIT	23-266-00	GP-156	UFI	23303-87308	GPP-524	DTSU	23401-1282	GP-1101	HINO
230848	GA-11	JACO	2-327	GA-57	AUTV	23303-87308-00	GPP-111	DTSU	23401-1283	GP-1101	HINO
23087	GG-196	NAPS	2-327	GA-57	PARM	23303-87308-00	GPP-524	DTSU	23401-1371A	GP-1101	HINO
23087	GG-196										

Numero	Gonher	Fabricante	Numero	Gonher	Fabricante	Numero	Gonher	Fabricante	Numero	Gonher	Fabricante				
Number	Gonher	Manufacturer	Number	Gonher	Manufacturer	Number	Gonher	Manufacturer	Number	Gonher	Manufacturer				
23401-1441	PF831 ⁴¹	HINO	2-352	GAD-1	PARM	2-381	GA-74	PARM	24-08001	GP-156	ALAS
23401-1441	S 3225 P ⁴²	HINO	23521528	G-128	DETR	23814	GA-3814	PARM	24094	GA-240	WIX
23401-1441A	GPP-1287 ³⁹	HINO	23521528	G-128	GMCX	238-173	GP-462	MZDA	24096	GP-26	WIX
23401-1441A	PF831 ⁴¹	HINO	23523	GA-3523	AUTV	238373	G-31	LEYL	24097	GP-27	WIX
23401-1441A	S 3225 P ⁴²	HINO	23523	GA-3523	PARM	2384	GA-278R	NAP	24097	GP-93	WIX
2340700	G-31	GMCX	2352341	GA-106 ⁴⁶	DUTZ	2384102071	GAK-16	TOYK	24099	GP-27	WIX
23409	GA-892	BERN	2352341	GA-326 ⁷¹	DUTZ	2385	GA-224	NAP	24099	GP-93	WIX
2341	GA-479	NAP	2352341	GA-106 ⁴⁶	KHDF	238513	G-1123	VOLV	241	G-119	DEL
23411	GA-277	PARM	2352341	GA-326 ⁷¹	KHDF	23881	GA-33 ¹¹²	AMCO	241	GA-730	PROT
2341200	GP-52 ¹⁰	UFI	2352343	GA-206	DUTZ	23881	GA-33	AMHO	2410	GP-1	MPA
2341200	GP-691 ⁴⁸	UFI	2352343	GA-206	KHDF	23881A	GA-33 ¹¹²	ASTR	24112	GP-2126V	WIX
23414	GAK-625	BERN	23524251	GP-193	DETR	23881A	GA-33	ATHY	24113	GP-2127W	WIX
2341402	GAK-403	JONB	23527033	GP-193	DETR	238840	GA-11	KOHL	24114	GP-2108W	WIX
2342	GP-28 ⁸	AUTO	2-353	GAD-3	PARM	2389	GA-248	NAP	24120900	GP-77	RENA
2342	GP-430 ⁸	AUTO	235301	G-1121F	DAF	2390	GP-42	AUTO	24133	G-33	WIX
23424	GA-3424	PARM	235301	G-1121	LEYL	23901	GA-3901	PARM	24149	GAK-625	CHAM
23425	GA-3425	PARM	23530407	GP-43	DETR	23902	GA-3901	PARM	24-15101-7	GP-310	MAN
234330	G-870	HYST	23530573	GP-193	DETR	23916	GA-3916	PARM	24151018	GP-1	SAVI
234448-R91	G-6	IHCO	23530652	GGP-25	DETR	2392	GP-3531 EXP	AUTO	24151119	G-1123	RENA
234486	GP-54 ¹¹	HAMM	23530707	GP-27	DETR	23924	GA-153	PARM	24151119	G-1123F	RENA
234486	GP-66 ¹⁰	HAMM	23537	GA-54	AUTV	2393448	GAK-1532	CLRK	24152004	G-1121F	RENA
2344865018	GP-54 ¹¹	HAMM	23537	GA-54	PARM	2394	GP-157	AUTO	24152005	G-1121	RENA
2344865018	GP-66 ¹⁰	HAMM	2353816	GA-33	CLRK	2394166	GP-761H	CLRK	24152006	G-834	RENA
2345353	GA-20	CLRK	23549	GA-89	PARM	23-9470	GP-66	TORO	24-16101-7	GP-1	MAN
2345755018	GP-1122	HAMM	23558	GG-79	NAPS	239513	GA-33	ALCH	24164103	GP-54 ¹¹	RENA
234581	GA-589	QUIN	23559	GG-160	NAPS	239513	GA-33	FIAT	24164103	GP-66 ¹⁰	RENA
23458-1	GA-589	COLT	23559	GA-271	PARM	239513	GA-33	FTA	241671	GP-1122	VOLV
234591	GA-588	QUIN	23579	GG-266	NAPS	239516	GA-33	ALCH	241672	GP-1122	VOLV
23459-1	GA-588	COLT	235849	G-33	HYST	239518	GA-33	ALCH	241672-5	GP-1122	VOLV
23463	GG-264	NAPS	235849-06	G-33	HYST	239518	GA-33	FIAT	24197	GP-1012Q	WIX
2347	GP-462 ⁹⁴	AUTO	23588	GA-3588	AUTV	239518-4	GA-33	ALCH	241A	GAK-20	GREY
23477	GG-137	NAPS	23588	GA-3588	PARM	23965	GA-26	MURY	241AF	GAK-20	GREY
234774	GP-5	ALCH	2359	GA-6	NAP	239661-8	GA-31	WHIT	242	G-870	DEL
234774-6	GP-5	ALCH	235918	GA-33	ALCH	23-9740	GP-66	TORO	242	GA-71	PROT
2348	GP-2951 ⁶²	AUTO	23595	GG-986	NAPS	23982F	GA-26	OSHK	24206	GP-2071W	WIX
2348	GP-58	AUTO	23597	GA-735 ¹²⁴	PARM	239930	GP-5	ALCH	2422	GA-6129	NAP
23481	GG-46	NAPS	235A	GA-33	GREY	239930	GP-5	FIAT	2423	GA-6127	NAP
23483	GG-3728	NAPS	235AF	GA-33	GREY	239930-1	GP-5	ALCH	2424	GP-3816	PALM
23484	GG-581	NAPS	235K	GP-156	ASAH	239930-8	GP-5	ALCH	242490504	GA-416	SAME
234849	G-33	HYST	236	GA-3566	PROT	239A	GA-360	GREY	242490702	GA-892	SAME
23486	GG-79	NAPS	23600-11100	GP-40	HYUN	23F	G-11816	CHAM	242490704	GA-892	SAME
23486	GA-31	URIG	23609	G-1174	CANC	23FF15	G-1143 ¹⁰⁸	OSHK	242490801	GAK-216	SAME
2349	GA-2740	NAP	2361	GP-3682	AUTO	24	GA-113	FACE	242490802	GA-416	SAME
23490	GA-3490	PARM	23637	GA-3637	PARM	24	GG-5 L	HOLY	242491101	GA-98 ¹¹²	SAME
234900	GP-1	ALCH	2364	GA-2184	NAP	24	GP-44	WIX	242491102	GA-98 ¹¹²	SAME
234900-8	GP-1	ALCH	23647	GA-3647	PARM	240	GA-70	PROT	242491201	GA-98 ¹¹²	SAME
234930	G-500	HYST	23660	GA-277	PARM	240-00389	GA-106 ⁴⁶	KALB	242491706	GAK-216	SAME
235	GA-77	AMP	236628	G-296	VOLV	240-00389	GA-326 ⁷¹	KALB	242492901	GAK-458	SAME
235	GA-77	BGA	236628	G-296-B	VOLV	240-00504	GA-405	KALB	242493601	GA-360	SAME
235	GA-274	PROT	236628-4	G-296	VOLV	24006	GGP-25	WIX	242495001	GAK-216	FIAT
23500828	G-294	GMCX	236628-4	G-296-B	VOLV	24006MP	GGP-25	WIX	242495001	GAK-216	LAMB
23501	GA-3501	PARM	23681	GA-3681	PARM	24009	GP-92	WIX	242495001	GAK-216	SAME
23501-1010	GP-1101	HINO	236840	GA-11	JACO	24009J16F2	GAK-16	KOBL	242495002	GA-416	LAMB
23502	GG-185	NAPS	236840	GA-11	KOHL	2401	GA-5648	ERO	242495002	GA-416	SAME
23505F	GA-106 ⁴⁶	OSHK	236GB114	G-31	MACK	24-01002	GP-754	ALAS	24262	G-294	ROO
23505F	GA-326 ⁷¹	OSHK	236GB117	G-31	MACK	24010185	GP-43	GMCX	243	GA-4303	PROT
23507189	GP-1013Q	GMCX	236GB16	G-1163 ¹⁰⁸	MACK	24010185	GP-53	GMCX	243004	GP-1122	VOLV
23507545	GP-2071W	GMCX	236GB217	G-31	MACK	24010829013	G-870	BMW	243004-9	GP-1122	VOLV
23508425	GP-1011Q	GMCX	236GB223	G-31	MACK	24011	GP-92	WIX	243009	GA-135	BENX
23508426	GP-1013Q	GMCX	236GB233	G-31	MACK	240-15890	G-870	LSTR	243009	GA-135	BROK
2351	GA-475	NAP	236GB241	G-31	MACK	24020	GP-2071W	WIX	243009	GA-135	CUMM
2-351	GA-75	AUTV	236GB27	G-750	MACK	24-02001	GP-58	ALAS	243009	GA-135	FORD
2-351	GA-75	PARM	236GB321P	G-500	MACK	24022	GP-2071W	WIX	243009	GP-1122	VOLV
235116	GA-7	BOLN	236GB35	G-750	MACK	24-02202	GP-38	ALAS	243009	GA-135	WHIT
235116	GA-7	FORD	236GB35A	G-750	MACK	24023	GP-2071W	WIX	24303	GA-4303	PARM
235116	GA-7	JACO	236GB36	G-500	MACK	2402368	GA-73	CHRY	24-304-00	GP-1122	UFI
235116	GA-7	KOHL	237	GA-90	AMP	24025	GP-1011Q	WIX	24-307-00	GP-1122	UFI
235116	GA-7	MASY	237	GA-90	BGA	24027	GP-92	WIX	24309	GAD-15	PARM
235116	GA-7	SPRI	237	GA-3637	PROT	2402704	GA-71	CHRY	24-310-00	GP-1101	UFI
235116	GA-7	WHEL	237	GP-36	SULL	24029	GA-26	MURY	24-313-00	GP-110	UFI
23-5116	GP-1	TORO	237000	GP-1	ALCH	24029	GGP-125	WIX	24-314-00	GP-1122	UFI
23512317	S 3202 ⁴⁰	GMCX	2370000-5	GP-1	ALCH	24030	GP-2071W	WIX	243152	G-813	OREN
23514049	G-128	DETR	237000-5	GP-1	ALCH	2403060	GAK-20	TAYL	243153	GA-33	OREN
23514049	G-128	GMCX	2371	GA-44	NAP	24-03100	GP-81	ALAS	243156	G-836	OREN
23516189	GPP-11	GMCX	23717	GA-274	PARM	2403700	GAK-403	TAYL	243157	G-296	OREN
23518480	GP-193	DETR	2372	GP-68	AUTO	240439H-1	GAK-16	IHCO	243157	G-296-B	OREN
23518480	GP-193	GMCX	2372	GA-11	NAP	24-04801	GP-53	ALAS	243162	GAK-16	ALCH
23518481	GP-26	DETR	2373	GA-7	NAP	2405	GG-19	PAR	243162	GAK-16	FIAT
23518482	GP-27	DETR	237373	GG-1	LEYL	2405002	GG-1	KOHL	243163	GAK-16	ALCH
23518524	GP-43	DETR	237395	GA-18	ALCH	2405002	GG-4	KOHL	243163	GAK-16	FIAT
23518525	GP-43	DETR	237395	GA-18	ALCH	24-05401	GP-1	ALAS	243163-2	GAK-16	ALCH
23518525	GP-43	GMCX	237395-9	GA-18	ALCH	240611049	GP-54 ¹¹	DAF	243163-3	GAK-16	ALCH
23518526	GP-93	DETR	2374	GP-58	AUTO	240611049	GP-66 ¹⁰	DAF	243163-4	GAK-16	ALCH
23518526	GP-93	GMCX	2374	GA-12	NAP	2406411	GG-20	MOP	243190601	G-296	LAMB
23518527	GP-92	DETR	237473	G-31</									

Referencia Cruzada por Numero de Parte

Cross Reference by Part Number



Numero	Gonher	Fabricante	Numero	Gonher	Fabricante	Numero	Gonher	Fabricante	Numero	Gonher	Fabricante
Number	Gonher	Manufacturer	Number	Gonher	Manufacturer	Number	Gonher	Manufacturer	Number	Gonher	Manufacturer
243195304	G-1121	SAME	24508572	GA-6479 ⁹⁰	GMCX	2474-6003	GA-360	DAEW	249999022	GP-1	PREM
243214	GG-5 L	VOLV	2451005	GPP-418	ALAS	2474-6017	G-296	DAEW	249999023	GP-66	PREM
2432-30	G-330	POCL	24-51510-17	GP-310	MAN	2474-6017	G-296-B	DAEW	249999026	GP-38	PREM
24-323-00	GP-1122	UFI	2451857	GP-13	CHRY	2474-6018	GP-31	DAEW	249999027	GP-3600	PREM
2432-32	GP-36	POCL	2451857	GP-13	MOP	2474-6025	GA-361	DAEW	249999028	GP-149	PREM
24325	GA-4325	PARM	2451859	GP-3	CHRY	2474-9026	G-1123	DAEW	249999029	GAD-30	PREM
2432-50	GP-36	POCL	2451859	GP-3	MOP	2474-9037	GP-43	DAEW	249999030	GP-462	PREM
2432-52	GP-36	POCL	2451R1243B	GA-361	KOBL	2474-9038	GA-361	DAEW	249999038	GP-91	PREM
24-329-00	GP-1122	UFI	2451U1243B	GA-361	KOBL	2474966	GA-135	GMCX	249999040	GP-3	PREM
243333	GA-8047	CUMM	2451U1253	GAK-403	KOBL	2474990	GA-135	GMCX	249K	GP-3682	ASAH
2434	GP-1013Q	LETR	2451U1662	G-1123	KOBL	24751	G-750	WIX	25	GAK-403	ERO
24347	GP-26	WIX	2451U221-3	GA-33	KOBL	24755	GP-50	WIX	25	GP-20	FACE
24348	GP-26	WIX	2451U3031	GP-3985	KOBL	2476	GA-286	NAP	25	GG-19	HOLY
2435000	GPP-1122	UFI	2452	GP-3569	APRO	2477025	GA-135	GMCX	25	GP-3429	WIX
24-350-02	GP-1122	UFI	2452	GP-310	AUTO	24770301	GG-189	MBNZ	25 052 00	G-25	UFI
24351	GP-1101	CHAM	245301	G-1123	LEYL	24770401	GG-189	MBNZ	250	GP-26	CIM
24-351-00	GPP-14	UFI	245301	G-1123F	LEYL	24770601	GG-189	MBNZ	250	G-870	CRO
24-351-01	GPP-1122	UFI	2453346	GA-77	CHRY	24770701	GG-189	MBNZ	250	GG-19	DEL
24355	GP-53	CHAM	2453348	GA-55	CHRY	24770801	GG-189	MBNZ	250	GG-87	PAR
24-355-00	GP-1122	UFI	2453350	GA-50	CHRY	24771	GAC-9	WIX	250	GA-89	PROT
24-355-01	GP-1122	UFI	2453351	GA-80	CHRY	24771301	GG-189	MBNZ	250030	G-1173 ¹⁰⁸	KOHL
24-356-00	GP-1122	UFI	2453498	GG-6	GMCX	24771701	GG-189	MBNZ	250096416	GA-360	GMCX
24-357-00	GP-1122	UFI	24-54808	G-277	ALAS	24771801	GG-189	MBNZ	25010013	GP-38	GMCX
24-357-01	GP-1122	UFI	2455	GA-968R	NAP	24771901	GG-189	MBNZ	25010042	GP-53	GMCX
24-358-00	GP-1122	UFI	24550	G-500	WIX	24772001	GG-189	MBNZ	25010043	GP-53	GMCX
24-360-00	G-296	UFI	2455102	GA-105	CHRY	24772601	GG-431	CHRY	25010065	GP-69	GMCX
24-360-00	G-296-B	UFI	24551192	GA-229	RENA	24772701	GG-251	MBNZ	25010066	GP-67	GMCX
24-360-01	G-296	UFI	2455358	G-500	GMCX	24772801	GG-251	MBNZ	25010068	GP-1108	GMCX
24-360-01	G-296-B	UFI	24554	G-500	WIX	24773001	GG-420	CHRY	25010071	GP-1107	GMCX
24-360-02	G-296	UFI	2455808	GG-1	CHRY	24773901	GG-411	CHRY	25010073	GP-67	GMCX
24-360-02	G-296-B	UFI	2455808	GG-4	CHRY	247772701	GG-251	MBNZ	25010100	GP-46	GMCX
24-361-00	G-297-B	UFI	24560060	GP-54 ¹¹	RENA	2477901	GA-27	GMCX	25010130	GP-31	GMCX
243612	GAK-16	ALCH	24560060	GP-66 ¹⁰	RENA	2477961	GA-27	GMCX	25010185	GP-43	GMCX
24-372-00	GP-1122	UFI	24564057	GP-54 ¹¹	RENA	24782	GAC-13	WIX	25010185	GP-53	GMCX
243K	GP-38	ASAH	24564057	GP-66 ¹⁰	RENA	2478K12	G-169	DIAM	25010191	GP-43	GMCX
244	GA-71	AMP	24564058	GP-54 ¹¹	RENA	2478K1-2	G-169	WHIT	25010191	GP-53	GMCX
244	GA-71	BGA	24564058	GP-66 ¹⁰	RENA	2479	GA-286	NAP	25010200	GP-83	GMCX
244	G-1163 ¹⁰⁸	DEL	24564060	GP-54 ¹¹	RENA	2479036	GA-135	GMCX	25010246	GP-46	GMCX
244	GA-271	PROT	24564060	GP-66 ¹⁰	RENA	248	GA-140	PROT	25010251	GP-44	GMCX
2440	GA-879	NAP	24568011	G-191	BMW	24807	G-24	GULD	25010256	GP-93	GMCX
244191401	GP-81	SAME	24568011	G-191	RENA	24808	GAC-7	WIX	25010257	GP-93	GMCX
2-4419-150-1	GP-310	SAME	24568658	G-191	RENA	2480970	GA-135	GMCX	25010276	GP-3429	GMCX
244192602	GP-34	SAME	2456-H2	GA-27	WHIT	2480971	GA-135	GMCX	25010277	GP-3985	GMCX
244241-R91	GA-39	IHCO	2-457-010-001	G-1121	ROB	2480972	GA-135	GMCX	25010324	GP-3429	GMCX
244241-R92	GA-39	IHCO	2457456	GA-135	GMCX	2480973	GA-135	GMCX	25010325	GP-44	GMCX
244242-R91	GA-90	IHCO	2457476	GA-135	GMCX	2480974	GA-135	GMCX	25010333	GP-53	GMCX
24428	GP-2015W	WIX	24577608	GA-3916	GMCX	2480975	GA-135	GMCX	25010367	GP-92	GMCX
24429	GP-2022W	WIX	2458256	G-236	CHRY	248143	G-1121	KOHL	25010417	G-191	GMCX
24430	GP-2015W	WIX	24586011	G-191	RENA	24817	GAC-6	WIX	25010419	G-238	GMCX
24431	GP-2022W	WIX	2458807	GP-1	CHRY	24822	GAC-10 ²⁸	WIX	25010421	G-191	GMCX
244340	G-870	LEYL	2458957	GP-1	CHRY	24822	GAC-8	WIX	25010441	GP-171 ¹⁶	GMCX
244427-M1	GP-1	MASY	2459985	GP-5	CHRY	24828	GA-4828	PARM	25010449	GP-53	GMCX
244458-R91	GP-1101	IHCO	245A	GAK-16	GREY	24830	GA-180	PARM	25010450	GP-53	GMCX
244458-R92	GP-1101	IHCO	245AF	GAK-16	GREY	248399	GP-66	ALCH	25010471	G-200	GMCX
244523-R91	G-566	IHCO	246	GA-78	PROT	248399-8	GP-66	ALCH	25010495	GP-53	GMCX
244570	GA-361	ALCH	2460427	GA-135	GMCX	2484	GA-395	NAP	25010495	GP-53	PERL
244570	GA-361	FIAT	2460U196-4	GA-206	KOBL	2485	GA-626	NAP	25010543	GP-171 ¹⁶	GMCX
244575-R91	G-1123	IHCO	2461	GA-2130	NAP	24864	GAC-2	WIX	25010580	G-750	GMCX
24458-R92	GP-1101	IHCO	246109	GA-27	HYST	2486580100	GP-157	FUJI	25010584	G-333	GMCX
24460713	G-49	GMCX	246110	GAK-20	HYST	2486580100	GP-157	ROBN	25010588	G-331	GMCX
244622	GAK-20	ALCH	2461759	GA-50	GMCX	24865-80100	GP-157	SUBA	25010633	GP-44	GMCX
244622	GAK-20	FIAT	2463552	GG-20	CHRY	24866064	G-1123F	RENA	25010634	GP-44	GMCX
2446R150D8S1	GA-33	KOBL	2463552	GG-20	MOP	24866064	G-1121	SAVI	25010638	GP-10	GMCX
2446R27755	GAK-625	KOBL	2463980	GA-71	CHRY	24866092	G-1123	RENA	25010639	GP-10	GMCX
2446U122S2	GA-206	KOBL	2463980	GA-71	MOP	24867468	G-834	RENA	25010731	GP-23	GMCX
2446U122S3	GA-106 ⁶⁶	KOBL	2463981	GA-70	CHRY	24867468	G-834	SAVI	25010754	GP-23	GMCX
2446U122S3	GA-326 ⁷¹	KOBL	2463981	GA-70	MOP	2487	GA-348	NAP	25010761	G-500	GMCX
2446U128S2	GA-360	KOBL	2463983	GA-71	CHRY	24876	GAC-1	WIX	25010766	GP-46	GMCX
2446U141S2	GP-166	KOBL	2463983	GA-71	MOP	248795	GA-360 ¹⁰⁸	NEWH	25010775	GP-26	GMCX
2446U144S2	GA-361	KOBL	2463984	GA-70	CHRY	248795	GA-361 ¹⁰⁸	NEWH	25010776	GP-26	GMCX
2446U144S3	GA-360	KOBL	2463984	GA-70	MOP	2488	GA-348	NAP	25010776	GP-26	KOBL
2446U177S2	GA-6127	KOBL	2463986	GA-71	TALB	24882	GAK-16	ALCH	25010777	GP-27	GMCX
2446U177S3	GA-6129	KOBL	24650040	GP-54 ¹¹	DEMA	24882	GAK-16	ALCH	25010778	GP-27	GMCX
2446U185S2	GA-206	KOBL	24650040	GP-66 ¹⁰	DEMA	248882	GAK-16	FIAT	25010778	GP-27	KOBL
2446U185S3	GA-106 ⁶⁶	KOBL	2465703	GG-3	CHRY	24-897	GP-9586	ACD	25010779	GP-26	GMCX
2446U185S3	GA-326 ⁷¹	KOBL	2465703	GG-5 L	CHRY	248K	GP-171	ASAH	25010780	GP-26	GMCX
2446U196S2	GAK-16	KOBL	2465703	GG-3	MOP	2491	GA-107	NAP	25010785	GP-83	GMCX
2446U205S2	GA-360	KOBL	2465703	GG-5 L	MOP	24920	G-1176	ALCH	25010786	GP-78	GMCX
2446U212S2	GA-6127	KOBL	2465704	GG-5 L	CHRY	249-23-603	GA-349	MZDA	25010792	GP-46	GMCX
2446U212S3	GA-6129	KOBL	2467368	GA-135	GMCX	249-23-603	GAD-3	MZDA	25010793	GP-26	GMCX
2446U215S5	GP-3682	KOBL	246918	GA-33	MASY	2493	GA-251	NAP	25010794	GP-27	GMCX
2446Z126D3	GA-106 ⁶⁶	KOBL	246918-M1	GA-33	MASY	24939	GA-139	PARM	25010811	GP-55	GMCX
2446Z126D3	GA-360	KOBL	246918-M91	GA-33	MASY	24954	G-566	WIX	25010812	GP-55	GMCX
2446Z126D4	GA-326 ⁷¹	KOBL	246918-M92	GA-33	MASY	2495698	GA-135	GMCX	25010849	GP-42	GMCX
2446Z126D5	GA-6129	KOBL	2469981	GA-70	CHRY	2495698	GA-35	GMCX	25010850	GP-42	GMCX
2446Z147S3	GA-360	KOBL	247	GA-7	AMP	2495994	G-750	GMCX	25010854	GP-43	GMCX
2446Z147S4	GA-361	KOBL	247	GA-7	BGA	2498427	GA-230	FORD	25010855	GP-43	GMCX
244728	GAK-20	ALCH	247	G-871	CRO	249987A1	GA-966R	CASE	25010856	GP-43	GMCX
244728	GAK-20	FIAT	247139	GP-1122	DAF	249988A					

Numero	Gonher	Fabricante	Numero	Gonher	Fabricante	Numero	Gonher	Fabricante	Numero	Gonher	Fabricante
Number	Gonher	Manufacturer	Number	Gonher	Manufacturer	Number	Gonher	Manufacturer	Number	Gonher	Manufacturer
25010907	GP-3980	GMCX	25011693	GPP-11	GMCX	2503	GA-98 ¹¹²	NAP	25055302	GG-47	GMCX
25010908	GP-3980	GMCX	25011694	GPP-11	GMCX	2503405	GA-6479 ⁹⁰	PARM	25055339	GG-202	GMCX
25010914	GP-46	GMCX	25011704	GP-58	GMCX	2503770	GA-348	PARM	25055341	GG-76	GMCX
25010919	GP-390 ⁹³	GMCX	25011710	GS-2033	GMCX	2504	GA-109	ERO	25055360	GG-5 L	GMCX
25010920	GP-390 ⁹³	GMCX	25011759	GP-3766	GMCX	25040007	GAVW-22	GMCX	25055364	GG-255	GMCX
25010921	GP-2022W	GMCX	25011761	GP-155	GMCX	25040109	GA-3490	GMCX	25055372	GG-213	GMCX
25010922	GP-2022W	GMCX	25011765	G-294	GMCX	25040318	GA-3445	GMCX	25055419	GG-79	GMCX
25010924	GP-85 ⁹²	GMCX	25011791	GP-1011Q	GMCX	25040429	GA-373	GMCX	25055420	GG-189	GMCX
25010944	GP-92	GMCX	25011792	GP-2071W	GMCX	25040529	GA-373	GMCX	25055425	GG-261	GMCX
25010957	GP-93	GMCX	25011863	GP-85 ⁹²	GMCX	25040556	GA-154	GMCX	25055426	GG-246	GMCX
25010959	GP-93	GMCX	25011910	S 3202 ⁴⁰	GMCX	25040873	GA-107	GMCX	25055427	GG-226	GMCX
25010966	GP-166	GMCX	25011911	S 3202 ⁴⁰	GMCX	25040881	GA-3647	GMCX	25055428	GG-246	GMCX
25010967	GP-166	GMCX	25011912	GPP-19	GMCX	25040929	GA-3588	GMCX	25055428	GG-408	GMCX
25010968	GP-85	GMCX	25011932	GP-51	GMCX	25040934	GA-154	GMCX	25055429	GG-246	GMCX
25010969	GP-85	GMCX	25011954	GP-35	GMCX	25041032	GAVW-2	GMCX	25055480	GG-46	GMCX
25010971	GP-53	GMCX	25011995	GP-390	GMCX	25041080	GA-210	GMCX	25055481	GG-3728	GMCX
25011008	GP-92	GMCX	25011997	GP-178	GMCX	25041138	GA-75	GMCX	25055508	GG-264	GMCX
25011009	GP-92	GMCX	25011999	GPP-1122	GMCX	25041171	GAVW-2	GMCX	25055509	GG-67	GMCX
25011010	GP-92	GMCX	25012001	GP-18	GMCX	25041176	GA-2740	GMCX	25055533	GG-76	GMCX
25011011	GP-92	GMCX	25012003	GP-1122	GMCX	25041177	GA-2740	GMCX	25055660	GG-208	GMCX
25011011	GP-92	KOBL	25012325	GP-36	GMCX	25041181	GA-56	GMCX	25055673	GG-203	GMCX
25011026	GP-85 ⁹²	GMCX	25012377	GP-14	GMCX	25041211	GA-826	GMCX	250558360	GG-5 L	GMCX
25011026	GP-85 ⁹²	KOBL	25012406	GP-77	GMCX	25041213	GA-827	GMCX	25055856	GG-185	GMCX
25011099	GP-9586	GMCX	25012408	GP-51	GMCX	25041229	GAD-3	GMCX	25055857	GG-185	GMCX
25011106	GP-43	GMCX	25012424	GP-66	GMCX	25041231	GA-4365	GMCX	25055865	GG-185	GMCX
25011107	GP-43	GMCX	25012425	GP-36	GMCX	25041245	GA-230	GMCX	25056	GA-5056	PARM
25011111	GP-43	GMCX	25012435	G-133	GMCX	25041283	GA-209	GMCX	2505-66	GA-892	POCL
25011122	GP-9586	GMCX	25012435	G-989	GMCX	25041531	GA-734 ⁸¹	GMCX	25058	GA-273	PARM
25011124	GP-36	GMCX	25012480	GP-166 ¹⁰⁰	GMCX	25041531	GA-735 ¹²⁴	GMCX	2505-99	GAK-625	POCL
25011130	GP-1	GMCX	25012488	GP-34	GMCX	25041532	GA-734 ⁸¹	GMCX	25062209	GA-2110	GMCX
25011131	GP-1	GMCX	25012532	GP-34	GMCX	25041532	GA-735 ¹²⁴	GMCX	25062261	GA-2156	GMCX
25011140	GP-1122	GMCX	25012534	GP-34	GMCX	25041541	GA-3681	GMCX	250657	G-870	MASY
25011159	GP-9586	GMCX	25012539	GP-54	GMCX	25041542	GA-3681	GMCX	250657	G-870	PERK
25011160	GP-36	GMCX	25012551	G-191	GMCX	25041593	GA-271	GMCX	250657	G-870	PETT
25011162	GP-14	GMCX	25012564	GP-36	GMCX	25041598	GA-271	GMCX	250-657	G-870	LSTR
25011163	GP-66	GMCX	25012566	GP-149	GMCX	25041646	GA-390	GMCX	250667	G-870	PETT
25011164	GP-1101	GMCX	25012634	GP-88	GMCX	25041707	GA-109	GMCX	250696	G-296	LNCR
25011165	GP-9586	GMCX	25012636	GP-36	GMCX	25041708	GA-109	GMCX	250696	G-296-B	LNCR
25011167	GP-1101	GMCX	25012637	GP-3000	GMCX	25041980	GA-493 ¹⁰⁸	GMCX	250699	GA-33	ALCH
25011168	GP-66	GMCX	25012645	GP-66	GMCX	25042001	GA-3566	GMCX	250699	GA-33	FIAT
25011169	GP-50	GMCX	25012652	GP-28	GMCX	25042131	GA-140	GMCX	2507392	G-765	PARM
25011170	GP-1101 ¹⁴	GMCX	25012679	GP-43	GMCX	25042135	GAP-379	GMCX	250779	G-834	LNCR
25011183	GP-34	GMCX	25012681	GP-62	GMCX	25042562	GA-392	GMCX	250825	G-750	CUMM
25011184	GP-34	GMCX	25012757	GP-3980 ⁸⁴	GMCX	25042585	GAK-625	GMCX	250826	G-500	CUMM
25011185	GP-50	GMCX	25012757	GP-48 ¹¹⁷	GMCX	25043119	GA-153	GMCX	2508301	GA-880R	KOHL
25011187	GP-57	GMCX	25012760	GP-3980	GMCX	25043194	GAD-3	GMCX	2508301S	GA-880R	KOHL
25011188	GP-57	GMCX	25012789	GP-36	GMCX	25043246	GA-3915	GMCX	2509	GA-509 ¹⁴	NAP
25011193	G-33	GMCX	25012824	GA-230	GMCX	25043253	GA-3637	GMCX	25092	GAK-403	MILL
25011194	G-33	GMCX	25012893	GP-2071W	GMCX	25043254	GA-3637	GMCX	2509216	GAD-15	GMCX
25011197	G-297	GMCX	25012895	GP-1011Q	GMCX	25043276	GA-230	GMCX	25095201	GA-2194	GMCX
25011197	G-297-B	GMCX	25012897	GP-1012Q	GMCX	25043317	GA-3647	GMCX	25095205	GA-2194	GMCX
25011198	G-297	GMCX	25012931	G-33	GMCX	25043504	GA-253	GMCX	25095333	GA-3916	GMCX
25011198	G-297-B	GMCX	25013032	GP-40	GMCX	25043550	GA-4828	GMCX	25096099	GA-277	GMCX
25011214	GP-1122	GMCX	25013075	GP-171	GMCX	25043552	GA-730	GMCX	25096103	GA-77	GMCX
25011229	GP-66	GMCX	25013192	GP-53	DETR	25043568	GA-274	GMCX	25096113	GA-108	GMCX
25011230	GP-66	GMCX	25013192	GP-53	GMCX	25043585	GA-89	GMCX	25096123	GPP-19	GMCX
25011233	GP-92	GMCX	25013192	GP-53	TERE	25043609	GA-642	GMCX	25096137	GA-694	GMCX
25011243	GP-3569	GMCX	25013194	G-33	GMCX	25043775	GAD-15	GMCX	25096141	GA-467	GMCX
25011285	GP-92	GMCX	25013195	G-566	GMCX	25043779	GA-563	GMCX	25096143	GA-422	GMCX
25011292	GP-22	GMCX	25013261	GP-27	GMCX	250440556	GA-154	GMCX	25096166	GA-29	GMCX
25011293	GP-22	GMCX	25013273	GP-93	GMCX	250441591	GA-271	GMCX	25096184	GA-608	GMCX
25011296	GP-3531 EXP	GMCX	25013454	GP-13	GMCX	2505	GA-18	NAP	25096212	G-333	GMCX
25011302	GP-36	GMCX	25013931	G-33	GMCX	25-050-01	GP-58	KOHL	25096214	GA-4325	GMCX
25011312	GS-2034	GMCX	25013977	GP-205	GMCX	25050385	GA-3588	GMCX	25096238	GA-405	GMCX
25011354	GP-462	GMCX	25014120	GP-359	GMCX	2505052	GG-47	GMCX	25096248	GA-49	GMCX
25011395	GP-46	GMCX	25014120	GP-43	GMCX	2505-21	GP-54 ¹¹	POCL	25096399	GA-101	GMCX
25011398	GP-53	GMCX	25014155	GP-3985	GMCX	2505-21	GP-66 ¹⁰	POCL	25096414	GA-361	GMCX
25011401	GP-52 ¹⁰⁰	GMCX	25014214	GP-53	DETR	25052220	GAD-15	GMCX	25096432	GAP-381	GMCX
25011401	GP-691 ⁴⁸	GMCX	25014233	GP-46	GMCX	250522-C91	GA-27	IHCO	25096442	GA-349	GMCX
25011404	GP-50 ³⁰	GMCX	25014274	GP-26	GMCX	25052320	GAD-15	GMCX	25096450	GA-376	GMCX
25011416	GP-69	GMCX	25014342	GP-27	GMCX	25055001	GG-240	GMCX	25096463	GA-165	GMCX
25011422	GP-92	GMCX	25014371	GP-92	GMCX	25055032	GG-5 L	GMCX	25096829	GA-153	GMCX
25011423	GP-93	GMCX	25014377	GP-3675	GMCX	25055046	GG-46	GMCX	25096895	GA-180	GMCX
25011424	GP-55 ¹⁰⁴	GMCX	25014422	GP-91	GMCX	25055052	GG-46	GMCX	25096932	GA-6479	GMCX
25011425	GP-85 ⁹²	GMCX	25014426	GPP-14	GMCX	25055065	GG-242	GMCX	25096933	GA-7007	GMCX
25011441	GP-3985	GMCX	25014476	GP-1122	GMCX	25055066	GG-242	GMCX	25097004	GA-3814	GMCX
25011443	2010PM-OR ⁷	GMCX	25014478	GP-1 ⁹	GMCX	25055074	GG-240	GMCX	25097057	GA-5056	GMCX
25011443	2010TM-OR ⁷	GMCX	25014504	GP-193	GMCX	25055075	GG-3728	GMCX	25097105	GA-6128	GMCX
25011444	2010PM-OR ⁷	GMCX	25014505	GP-193	GMCX	25055083	GG-3728	GMCX	25097119	GA-251	GMCX
25011444	2010TM-OR ²	GMCX	25014507	GP-193	GMCX	25055115	GG-196	GMCX	25097183	GAD-30	GMCX
25011445	GP-78	GMCX	25014520	GP-68	GMCX	25055117	GG-87	GMCX	25097184	GAD-30	GMCX
25011446	GP-78	GMCX	25014564	GP-156	GMCX	25055121	GG-246	GMCX	25097254	GA-70	GMCX
25011447	GP-1108	GMCX	25014568	GP-149	GMCX	25055128	GG-46	GMCX	25097340	GA-180	GMCX
25011469	G-153	GMCX	25014734	GP-88	GMCX	250551289	GG-46	GMCX	250979	G-834	LNCR
25011493	GPP-11	GMCX	25014748	GP-3675	GMCX	25055129	GG-46	DAEW	25097917	GA-7017	GMCX
25011520	GP-58	GMCX	25014776	GP-52 ¹¹⁰	GMCX	25055129	GG-46	GMCX	25097919	GA-7017	GMCX
25011574	GP-462	GMCX	25014776	GP-691 ⁴⁸	GMCX	25055140	GG-240	GMCX	25098463	GA-165	GMCX
25011613	GP-77	GMCX	25014777	GP-52 ¹¹⁰	GMCX	25055157	GG-94	GMCX	25098522	GA-195	GMCX
25011615	GP-54 ⁹⁰	GMCX	25014777	GP-691 ⁴⁸	GMCX	25055188	GG-204	GMCX	25098632	GA-153	GMCX
25011621	GP-166	GMCX	25014818	GP-3816	GMCX	25055223	GG-1	GMCX	25098766	GA-3588 ¹¹³	GMCX
25011623	GP-38	GMCX	25014831	GP-205	GMCX	25055223	GG-4	GMCX	25098845	GA-3916	GMCX
25011625	GP-50	GMCX	2501800	G-25	UFI	250552388	GG-42	GMCX	25099096	GA-70	GMCX
25011627	GP-50	GMCX	25026209	GP-3985	GMCX	25055280	GG-188	GMCX	25099116	GA-195	GMCX
25011689	GPP-11	GMCX	25026659	GAK-403	BOUR	25055288	GG-42	GMCX	25099136	GA-275	GMCX
25011690	GPP-11	GMCX	25026660	GAK-16	BOUR	250552-C91	GA-27	IHCO	25099149	GA-164	GMCX
25011691	GPP-11	GMCX	2502-99	GAK-625							

Referencia Cruzada por Numero de Parte

Cross Reference by Part Number



Numero	Gonher	Fabricante	Numero	Gonher	Fabricante	Numero	Gonher	Fabricante	Numero	Gonher	Fabricante
Number	Gonher	Manufacturer	Number	Gonher	Manufacturer	Number	Gonher	Manufacturer	Number	Gonher	Manufacturer
25099249	GA-142	GMCX	250D42	GA-589	UNI	25161878	GP-462	GMCX	25177076	GA-2114	GMCX
25099253	GA-3501	GMCX	250D42S	GA-589	UAC	25161879	GP-462	GMCX	25177078	GA-128	GMCX
25099343	GA-139	GMCX	250D42S	GA-589	UNI	25161880	GP-157	GMCX	251771377	GP-3980	GMCX
25099409	GA-139	GMCX	250D43	GA-826	UAC	25161977	GA-279	GMCX	25177176	GA-398	GMCX
25099411	GA-276	GMCX	250D43	GA-826	UNI	25162296	GP-3000	GMCX	25177203	GA-389	GMCX
25099419	GA-382	GMCX	250DX246	GA-425	UAC	25162816	GP-3600	GMCX	25177242	GG-1872	GMCX
25099421	GAVW-120	GMCX	250DX246	GA-425	UNI	25164444	GG-106	OPEL	25177526	GA-7	GMCX
25099547	GA-6619 ¹	GMCX	250DX250	GA-360	UAC	25165072	GG-7018 ³⁸	GMCX	25177528	GPP-19	GMCX
25099547	GA-6620 ²	GMCX	250DX250	GA-360	UNI	25165072	GG-7019 ³⁷	GMCX	25177541	GA-6	GMCX
25099549	GA-6690	GMCX	250DX250A	GA-360	UAC	25165072	GG-7020 ¹⁴⁴	GMCX	25177917	G-765	GMCX
250997105	GA-6128	GMCX	250DX250A	GA-360	UNI	25165074	GP-1101	GMCX	25177933	GP-562	GMCX
250A13	GA-105	UAC	250DX251	GA-361	UAC	25165075	S 3202 ⁴⁰	GMCX	2517A	GP-81	DEAR
250A13B	GA-105	UAC	250DX251	GA-361	UNI	25166009	G-296	GMCX	2517A	GP-81	INTM
250A13B	GA-105	UNI	250DX251A	GA-361	UAC	25166009	G-296-B	GMCX	2518	GAK-1532	NAP
250A152	GA-3300	UAC	250DX251A	GA-361	UNI	25166243	GA-604	GMCX	25194900	GAK-16	TALB
250A22	GA-800	UAC	250DX38A	GAK-20	UAC	25166937	GG-61	GMCX	251A	GA-106 ⁴⁶	GREY
250A25	GA-192	UAC	250DX38A	GAK-20	UNI	25166957	GA-7142	GMCX	251A	GA-326 ⁷¹	GREY
250A25W	GA-90	UAC	250E	GP-26	CIM	25166958	GA-217	GMCX	252	GAK-16	ERO
250A25W	GA-90	UNI	2510908	GP-3980	GMCX	25166959	GA-322	GMCX	252	GA-3588	PROT
250A35	GA-90	UNI	2510998	GA-361	NEWH	25166960	GA-381	GMCX	25-200096-8	GAK-16	WHIT
250A35CRB	GA-90	UAC	25113810	GP-1	ALCH	25166963	GAVW-121	GMCX	252050	G-296	ALCH
250A35CRB	GA-90	UNI	251178	GP-1	ALCH	25166964	GAVW-620	GMCX	252050	G-296-B	ALCH
250A35W	GA-90	UAC	251201511	GG-124	HEN	25166965	GA-175	GMCX	2521	GP-171	AUTO
250A35W	GA-90	UNI	251201511A	GG-251	VAG	25167021	GA-132	GMCX	252193	G-1143	CUMM
250A35WB	GA-90	UAC	251201511A	GG-251	VOLK	25167331	GA-141	GMCX	2522	GAK-625	NAP
250A35WB	GA-90	UNI	251201511H	GG-251	VAG	25167334	GA-300	GMCX	252281	G-750	CUMM
250A35WR	GA-90	UAC	251201511H	GG-251	VOLK	25168081	GA-673R	GMCX	2524	GA-168	NAP
250A35WR	GA-90	UNI	251201511S	GG-246	VOLK	25168082	GA-732R	GMCX	252427	GG-48	PETT
250A43	GA-85	UAC	25121074	GG-64	GMCX	25168594	GG-266	GMCX	252-427	GG-48	LSTR
250A44	GA-85	UAC	25121082	GG-64	GMCX	25170512	GA-165 ¹¹³	GMCX	2525254	GG-5 L	CHRY
250A44	GA-85	UNI	25121113	GG-5 L	GMCX	25171109	GG-46	GMCX	2525254	GG-5 L	MOP
250A45	GA-730	UAC	25121129	GG-64	GMCX	25171377	GP-3980	GMCX	25257	G-31	ALCH
250A46	GA-59	UAC	25121141	GG-260	GMCX	25171792	GG-46	GMCX	25257-1	G-31	ALCH
250A47	GA-57	UAC	25121150	GG-260	GMCX	25171946	GP-91	GMCX	25265	G-1175	ALCH
250A47	GA-57	UNI	25121160	GG-260	GMCX	25171950	G-963	GMCX	25265-1	G-1175	ALCH
250A51	GA-303	UAC	25121293	GG-66	GMCX	2517277	G-834	MUIR	2527-1	GP-31	ALCH
250A65	GA-55	UAC	25121353	GG-106	GMCX	25175285	GA-442	GMCX	252792	GA-206	HYST
250B14	GA-12	UNI	25121449	GG-66	GMCX	25175291	GAD-129	GMCX	252811	GP-1101	CUMM
250B26B	GA-42	UNI	25121466	GG-581	GMCX	25175304	GAD-118	GMCX	25282	G-1123	VOLV
250B32B	GA-42	UNI	25121468	GG-177 ⁴³	GMCX	25175321	GA-6690	GMCX	2528680	GA-616	CLRK
250B8B	GA-7	UAC	25121468	GG-581 ¹¹⁶	GMCX	25175326	GA-240	GMCX	2528681	GA-398	CLRK
250B8B	GA-7	UNI	25121472	GG-580	GMCX	25175332	GA-5466	GMCX	2528681	GA-398	VOLV
250B165	GA-680	UAC	25121585	GG-146	GMCX	251755	GP-31	HYST	25289	G-1123	VOLV
250B165	GA-680	UNI	25121587	GG-151	GMCX	251755-12	GP-31	HYST	252916	G-566	CUMM
250C118	GA-18	UAC	25121593	GG-181	GMCX	25175534	GG-187	GMCX	253	GA-253	PROT
250C118	GA-18	UNI	25121598	GG-220	GMCX	25175535	GG-185	GMCX	2530053	GP-81	TCLD
250C118S	GA-18	UAC	25121600	GG-63	GMCX	25175538	GG-185	GMCX	25-30053	GP-81	CARR
250C118S	GA-18	UNI	25121602	GG-185	GMCX	25175541	GG-79	GMCX	253053	GAK-403	IONB
250C135B	GA-70	UAC	25121603	GG-181	GMCX	25175542	GG-76	GMCX	25-30940-0	GP-28 ⁸	CARR
250C135B	GA-70	UNI	25121604	GG-190	GMCX	25175543	GG-214	GMCX	25-30940-0	GP-430 ⁸	CARR
250C147	GA-588	UAC	25121606	GG-215	GMCX	25175545	GG-208	GMCX	2531	G-6	DEAR
250C147	GA-588	UNI	25121656	GG-256	GMCX	25175546	GG-217	GMCX	2531	G-6	EATN
250C147S	GA-588	UAC	25121666	GG-177	GMCX	25175551	GG-115	GMCX	2531	G-6	INTM
250C147S	GA-588	UNI	25121673	GG-46	GMCX	25175552	GG-148	GMCX	25311966	GA-1616	GMCX
250C151	GA-403	UAC	25121674	GG-208	GMCX	25175553	GG-185	GMCX	25311968	GA-384	GMCX
250C151	GA-403	UNI	25121675	GG-208	GMCX	25175557	GG-137	GMCX	25311969	GA-172	GMCX
250C23	GA-71	UAC	25121677	GG-65	GMCX	25175559	GG-67	GMCX	25311970	GA-244	GMCX
250C38	GA-55	UAC	25121778	GG-255	GMCX	25175560	GG-185	GMCX	25311972	GA-476	GMCX
250C5	GA-18	UNI	25121792	GG-46	GMCX	25175561	GG-30	GMCX	25311974	GA-1615	GMCX
250C50	GA-18	UNI	25121875	GG-580	GMCX	25175563	GG-72	GMCX	25312133	GA-348	GMCX
250C50S	GA-18	UAC	25121915	GG-46	GMCX	25175567	GG-67	GMCX	25312506	GP-9586	GMCX
250C50S	GA-18	UNI	25121935	GG-66	GMCX	25175568	GG-65	GMCX	25313348	GA-348	GMCX
250C5B	GA-18	UAC	25121942	GG-66	GMCX	25175570	GG-7018 ³⁸	GMCX	25313349	GA-348	GMCX
250C5B	GA-18	UNI	25121970	GG-256	GMCX	25175570	GG-7019 ³⁷	GMCX	25313359	GG-106	GMCX
250C5S	GA-18	UAC	25121974	GG-5 L	GMCX	25175570	GG-7020 ¹⁴⁴	GMCX	25313728	GP-171	GMCX
250C5S	GA-18	UNI	2512644	GP-1013Q	CLRK	25175592	GA-186	GMCX	25313731	G-112	GMCX
250C65	GA-18	UNI	251381-0	GP-1	ALCH	25175740	GG-268	GMCX	25313733	GP-43	GMCX
250C65S	GA-18	UAC	251397	G-296	ALCH	25176272	GG-203	GMCX	25313734	GP-77	GMCX
250C65S	GA-18	UNI	251397	G-296-B	ALCH	25176273	GG-208	GMCX	25313735	GP-642	GMCX
250CX470	GA-107	UAC	251397	G-296	FIAT	25176275	GG-184	GMCX	25313738	GP-36	GMCX
250CX470	GA-107	UNI	251397	G-296-B	FIAT	25176276	GG-214	GMCX	25313739	GP-9 ¹⁰⁰	GMCX
250CX578	GA-426	UAC	251397-5	G-296	ALCH	25176278	GG-215	GMCX	25313740	GP-761H	GMCX
250CX578	GA-426	UNI	251397-5	G-296-B	ALCH	25176280	GG-185	GMCX	25313743	GP-3600	GMCX
250D23	GA-826	UAC	251397-6	G-296	ALCH	25176281	GG-196	GMCX	25313749	GP-69	GMCX
250D23	GA-826	UNI	251397-6	G-296-B	ALCH	25176284	GG-79	GMCX	25313753	GPP-1000	GMCX
250D23S	GA-826	UAC	251399	GA-7	KOHL	25176288	GG-215	GMCX	25313757	GP-96	GMCX
250D23S	GA-826	UNI	2514	GP-1	INTM	25176290	GG-203	GMCX	25313787	GA-221R	GMCX
250D24	GA-827	UAC	251452	GA-49	HODR	25176291	GG-136	GMCX	25313795	GA-217	GMCX
250D24	GA-827	UNI	25147106	GA-276	GMCX	25176297	GG-232	GMCX	25313797	GA-130	GMCX
250D24S	GA-827	UAC	25147112	GA-386	GMCX	25176301	GG-255	GMCX	25313803	GG-114	GMCX
250D24S	GA-827	UNI	25147120	GA-133	GMCX	25176320	GG-76	GMCX	25313804	GG-351	GMCX
250D29	GA-229	UAC	25147122	GAD-294	GMCX	25176324	GG-160	GMCX	25313805	GG-185	GMCX
250D29	GA-229	UNI	25147124	GAD-117	GMCX	25176331	GG-164	GMCX	25313806	GG-185	GMCX
250D29S	GA-229	UNI	25147124	GAD-17	GMCX	25176732	GG-185	GMCX	25313809	GG-185	GMCX
250D30S	GA-826	UAC	25147142	GA-300	GMCX	25176735	GG-92	GMCX	25313811	GG-164	GMCX
250D34	GA-827	UAC	2514965018	GP-171	HAMM	25176752	GG-7018 ³⁸	GMCX	25313817	GG-1872	GMCX
250D34	GA-827	UNI	2515	GP-1	AUTO	25176752	GG-7019 ³⁷	GMCX	25313883	GA-329	GMCX
250D34S	GA-827	UAC	251503800	GP-462	TCLD	25176752	GG-7020 ¹⁴⁴	GMCX	25319686	GG-581	GMCX
250D34S	GA-827	UNI	25-15038-00</								

Numero	Gonher	Fabricante	Numero	Gonher	Fabricante	Numero	Gonher	Fabricante	Numero	Gonher	Fabricante
Number	Gonher	Manufacturer	Number	Gonher	Manufacturer	Number	Gonher	Manufacturer	Number	Gonher	Manufacturer
25324052	GP-408	WHOR	256839	G-500	CUMM	26040	GA-3588	NAPS	26300-21010	GP-91	HYUN
253243	GP-14	CUMM	2568753	GPP-1000	CATP	26040	GA-3588	SER	26300-21010	GP-40	MITS
2532744	GP-1	CHRY	256943	G-750	CUMM	26042	GA-4325	NAPS	26300-21A00	GP-91	HYUN
2532744	GP-1	MOP	257014	GA-39	CUMM	26046	GA-3681	NAPS	26300-2Y500	GP-91	KIA
2532756	GP-1	CHRY	257045	GAK-403	HART	26046	GA-3681	SER	26300-35004	GP-91	HYUN
253290	GA-9045	CUMM	257046	GAK-20	HART	26048	GA-3637	NAPS	26300-35054	GP-91	HYUN
253322	GA-5648	CUMM	257047	GAK-403	HART	26051	GA-217	NAPS	26300-35056	GP-149	HYUN
25332443	GA-348	GMCX	257048	GAK-20	HART	260630	G-836	SAVA	26300-35500	GP-6811	HYUN
253333	GA-8047	CUMM	257427	GG-48	PETT	26064	GA-386	NAPS	26300-35500	GP-91	HYUN
253341	GA-1008	CUMM	257-427	GG-48	LSTR	26077	GA-3901	NAPS	26300-35501	GP-6811	HYUN
253376	G-33	MUIR	25750701	GAVW-212	GMCX	2608	GA-405	NAP	2630035502	GP-6811	KIA
25-34602-00	GP-490	CARR	257528	G-566	CUMM	26080	GA-141	NAPS	26300-35A00	GP-91	HYUN
25351142	GA-1545	GMCX	257563	G-296	PEGA	26081	GG-20	ECH	26300-42040	GP-112	HYUN
2535206	GP-149	CARR	257563	G-296-B	PEGA	26082	GG-5 L	ECH	26302	GA-164	NAPS
253565	GA-1287	CUMM	257597	GA-33	ALCH	26082	GA-166	NAPS	26303	GA-514	NAPS
25361000	GP-1107	TRS	257597	GA-33	FIAT	26084	GA-3814	NAPS	2631	GAK-216	NAP
25361300	GP-462	TRS	257865	G-750	MUIR	26090	GG-19	ECH	2632	GA-416	NAP
2536186	GP-1	CHRY	257878	GA-39	MUIR	26093	GA-275	NAPS	26334	GA-129	PARM
253621	G-33	CUMM	257886	G-750	CUMM	26095	GAD-118	NAPS	263434	GA-426	ALCH
253652	GAK-20	ALCH	25789	G-31	CORB	26097	GA-133	NAPS	263435	GA-425	ALCH
253653	GAK-20	ALCH	25796	GA-33	ALCH	260A	GA-18	GREY	26344	G-31	CLTA
2536786	GP-1	CHRY	25811	GP-1101	CUMM	260-HS10	GP-92	CIM	26344	G-31	OLIV
2537	GP-43 ⁹⁰	LETR	2581933	GA-168	PARM	261	G-222	DEL	26344	G-31	WHIT
2537	GP-53 ⁴⁶	LETR	258237	GP-13	HYST	261	GA-277	PROT	26349	GA-127	NAPS
253723	GAK-16	LNCR	258237-12	GP-13	HYST	261	GA-3490	UNN	26358	GA-384	NAPS
2538	GP-57	LETR	258264	GP-1013Q	CUMM	26108	GA-604	NAPS	26362	GA-362	PARM
2539	GP-55	LETR	258482-M91	GAK-1532	MASY	2611	GA-372	NAP	26366	GA-174	PARM
2540	GA-2160	TEHO	258522	GA-892	MASY	26111	GA-4365	NAPS	264	GS-2033	DEL
25-400-00	G-238	UFI	258522-M91	GA-892	MASY	2611238011	GAK-16	TOYK	264	GA-2740	PROT
25-402-00	G-813	UFI	258646	GA-33	KOHL	26116	GAD-15	NAPS	264	GA-362	UNN
25-402-01	G-813	UFI	2586638C1	G-638	IHCO	26117	GA-165	NAPS	26404	G-31	CLTA
25-406-00	G-225	UFI	25881	GP-2071W	VERS	26119	GA-471	NAPS	26404	G-31	OLIV
25-407-00	G-871	UFI	259025	GP-3600	HYST	26120	GA-271	NAPS	26404	G-31	WHIT
25-408-00	G-870	UFI	259025-12	GP-3600	HYST	26120	GA-271	SER	26406	GA-130	NAPS
25-409-00	G-870	UFI	259044	G-296	OLIV	26126	GA-273	NAPS	26418	GA-1615	NAPS
2542	GA-360	NAP	259044	G-296-B	OLIV	26-127-177B	GG-262	VOLK	26425	GA-132	NAPS
25-420-00	G-6	UFI	259044	G-296	WHIT	2613	GA-373	NAP	26440	GA-673R	NAPS
25-421-00	G-836	UFI	259044	G-296-B	WHIT	26132	GA-274	NAPS	26443	GA-163	NAPS
25-423-01	G-143	UFI	25914300	GP-42	HOND	26133837	GAVW-2	VOLK	26450153	G-834	PERK
2542700	GA-230	UFI	25914300	GP-42	VOLK	26133837A	GAVW-2	VAG	2647	GA-679	NAP
2543	GA-361	NAP	259-14-300	GP-42	MZDA	26133837A	GAVW-2	VOLK	2647018	G-333	CHRY
25-431-00	G-191	UFI	259-23-603	GA-349	MZDA	26133837B	GAVW-2	VAG	2647019	GP-1	CHRY
25-435-00	G-1143	UFI	259-23-603	GAD-3	MZDA	26133837B	GAVW-2	VOLK	2647019	GP-1	MOP
25445	GAK-16	MACO	259453	GP-2071W	CUMM	26134	GA-5056	NAPS	2647020	GP-58	CHRY
25446	GAK-403	MACO	259642	GP-171 ¹⁶	FLXI	26139	GA-3916	NAPS	2647021	GP-50	CHRY
25447	GAK-20	MACO	259793	GA-759 ¹⁰⁸	ALCH	26144	GA-392	NAPS	26472	GA-8606	NAPS
25-447-00	G-33	UFI	259793	GA-759 ¹⁰⁸	FIAT	26146	GA-180	NAPS	264739	GA-826	ALCH
25-447-01	G-33	UFI	259A	GA-405	GREY	26148	GA-2106	NAPS	264740	GA-827	ALCH
254521	GA-33	FORD	25C1202702	GAK-403	LEYL	2615038	GAK-16	YOBW	2647666	G-33	CHRY
25-455-00	G-834	UFI	25G1202702	GAK-403	LEYL	2615038	GAK-16	YORK	2647872	GP-58	CHRY
25-455-01	G-834	UFI	25GAS	GA-105	UNI	26153	GA-6479	NAPS	26479	GA-6479	PARM
25-455-02	G-834	UFI	25MF214P2	GP-1011Q	MACK	26156902AO	GP-157	ROBI	2648	GA-680	NAP
25-463-00	G-222	UFI	25MF314	GP-2015W	MACK	26157	GA-78	NAPS	265	GA-44	AMP
25-467-00	G-330	UFI	25MF314A	GP-2015W	MACK	26158	GA-382	NAPS	265	GA-44	BGA
2547746	GP-5	ALCH	25MF314B	GP-2015W	MACK	26162	GA-6690	NAPS	2650017	G-296	CHAB
255	GA-153	PROT	25MF314B	GP-2015W	MAXI	26165	GAD-1	NAPS	2650017	G-296-B	MASY
255027	G-169 ⁹⁹	GALN	25MF418	GP-2022W	MACK	26165902AO	GP-157	ROBI	2650017	G-296	MASY
25-505-00	G-163	UFI	25MF418	GP-2022W	MAXI	26174	GA-174	NAPS	2650017	G-296-B	MASY
2550873	GA-27	CHRY	25MF422	GP-2022W	MACK	2618	GA-229	NAP	2650017	G-296	PERK
2550873	GA-27	MOP	25MF428	GP-2022W	MAXI	26180	GA-253	NAPS	2650017	G-296-B	PERK
2550873	GA-27	TALB	25MF428	GP-2015W	MACK	26186	GA-142	NAPS	2650090	G-871	MASY
25-520-00	G-833	UFI	25MF428A	GP-2015W	MACK	261F	G-1173 ¹⁰⁸	APOL	2650097	G-297-B	PERK
2552007	GA-27	CHRY	25MF429	GP-2022W	MACK	261F	G-1173 ¹⁰⁸	BWS	2650124	GP-20	CHRY
2552007	GA-27	MOP	25MF429A	GP-2022W	MACK	261F	G-1173 ¹⁰⁸	CAM2	2650396	GP-58	CHRY
2552624	GA-26	CHRY	25MF430	GP-2022W	MACK	261F	G-1173 ¹⁰⁸	CHP	2650423	G-834	MASY
2552624	GA-26	MOP	25MF435	GP-2015W	MACK	261F	G-1173 ¹⁰⁸	LUF	2650589	GP-13	CHRY
2553629	GA-26	CHRY	25MF435A	GP-2015W	MACK	262	GA-50	BGA	2650597	GP-13	CHRY
2553629	GA-26	MOP	25MF435B	GP-2015W	MACK	262	GAVW-2	PROT	26507	G-31	OLIV
25-545-00	G-133	UFI	25MF436	GP-2022W	MACK	262013	GA-21	CUMM	26507	G-31	WHIT
25-545-00	G-989	UFI	25MF436A	GP-2022W	MACK	26205	GAK-403	MANI	265088	G-297-B	PERK
2554600	GA-26	CHRY	25MF436B	GP-2022W	MACK	26205	GAK-403	MANO	2651	GA-108	NAP
2554600	GA-26	MOP	25PS269	GA-6129	CHIC	26206	GP-1011Q	VERS	26510093	GAK-16	MASY
25-548-00	G-963	UFI	25PS269	GAK-20	CHIC	26213	GA-300	NAPS	26510093	GAK-16	PERK
25-551-00	G-163	UFI	26	GG-7	HOLY	2621321	GA-21	DINA	26510093	GAK-403	MASY
2555929	GP-1	CHRY	26	GP-28 ⁸	WIX	26220	GA-89	NAPS	26510105	GAK-403	PERK
2555929	GP-1	MOP	26	GP-430 ⁸	WIX	262280	GAK-403	HYST	26510124	GAK-16	MASY
25568011	G-191	RENA	260	G-1175	DEL	26234	GA-153	NAPS	26510125	GAK-20	MASY
255963	GA-39	CUMM	26001	GG-6	SRS	26236	GA-4828	NAPS	26510125	GAK-20	PERK
256269	GP-1	HERC	26002	GG-7	SRS	26244	GA-195	NAPS	26510126	GAK-16	MASY
256274	GP-50	HERC	26003	GG-19	SRS	26246	GA-7017	NAPS	26510126	GAK-16	PERK
256274	GP-50	WHIT	26004	GG-123	SRS	26253	GA-158	NAPS	26510143	GA-33 ¹¹²	MASY
256274B	GP-50	WHIT	26005	GA-100	SRS	26259	G-296	CHAB	26510143	GA-33 ¹¹²	PERK
256345	G-750	CUMM	26007	GA-3566	SLIN	26259	G-296-B	CHAB	26510148	GAK-403	MASY
2563552	GG-20	CHRY	26010042	GP-53	GMCX	2626	GP-3985	AUTO	265-10148	GAK-403	PERK
256476	G-1143 ⁹⁰	CUMM	26013	GA-735 ¹²⁴	NAPS	26264	GA-362	NAPS	26510-148	GAK-403	NISS
256540	GA-230	PUR	26013	GA-735 ¹²⁴	SER	26271	GG-5 L	SRS	26510154	GA-360	MASY
256559	G-1143 ⁹⁰	CUMM	26016	GA-140	SLIN	26273	GA-5466	NAPS	26510154	GA-360	PERK
256640	GA-230	SAVA	26017	GA-322	NAPS	26281	GG-20	SRS	26510154	GA-360	POWP
256787	GAK-625	ALCH	2601863	GA-405	ATWE	26282	GG-5 L	SRS	26510-154	GA-360	NISS
256834	G-1143	CUMM	26024	GA-2719B	NAPS	26289	GA-175	NAPS	26510192	GA-33 ¹¹²	MASY
256835	G-1143	CUMM	26025	GAVW-4	NAPS	262F	G-1175	BWS	26510192	GA-33 ¹¹²	PERK
256838	G-750	CUMM	26026	GA-381	NAPS	262F	G-1175	CHP	26510211	GAK-403	MASY
256838	G-750	LBHR	26027	GAD-294	NAPS	262F1	G-1174	CHP	26510211	GAK-403	PERK
256838	G-750	LEDR	26028	GA-7344	NAPS	263	GA-174	PROT	26510216	GAK-16	MASY
			26035	GA-279	NAPS	26300-02500	GP-91	KIA	26510216	GAK-16	PERK
			26036	GA-3647	NAPS	26300-11100	GP-40	HYUN	26510230	GAK-361	PERK

Referencia Cruzada por Numero de Parte

Cross Reference by Part Number



Numero	Gonher	Fabricante	Numero	Gonher	Fabricante	Numero	Gonher	Fabricante	Numero	Gonher	Fabricante
Number	Gonher	Manufacturer	Number	Gonher	Manufacturer	Number	Gonher	Manufacturer	Number	Gonher	Manufacturer
26510235		GAK-625 PERK	2654408		GP-3600 MASY	2661017		GAK-20 JONB	27		GG-6 HOLY
26510236		GA-18 MASY	2654408		GP-3600 PERK	26617-87011		GP-761H TCM	27		GP-1 WIX
26510236		GA-18 PERK	2654408		GP-3600 POWP	266221		GAK-1532 NEWH	27		GA-2160 UFI
26510236		GA-18 POWP	2654412		GP-432 ¹ PERK	26-623-00		G-1163 ¹⁰⁸ UFI	27		71.00.00 GA-44 UFI
26510238		GA-106 ⁴⁶ MASY	2654412		GP-9 ⁹ PERK	26-626-00		G-870 UFI	27		77.00.00 GA-44 UFI
26510238		GA-326 ⁷¹ MASY	2654435		GA-360 ATWE	26-627-00		GG-48 UFI	27		79.56.00 GA-2122 UFI
26510238		GA-106 ⁴⁶ PERK	2654446		GA-361 ATWE	266286		GP-81 VOLV	270		GA-5648 AMP
26510238		GA-326 ⁷¹ PERK	2655		GA-426 NAP	26-629-00		G-1174 ¹⁰⁸ UFI	270		GA-5648 BGA
26510238		GA-106 ⁴⁶ POWP	26550001		GP-1012Q PERK	2663		G-500 LUF	270		GP-110 DEL
26510238		GA-326 ⁷¹ POWP	26550153		G-834 PERK	26-633-00		G-1175 UFI	270		GA-3901 PROT
26510289		GA-106 ⁴⁶ PERK	26555		GA-275 PARM	26-639-00		G-1173 ¹⁰⁸ UFI	27		7-000142 GPP-14 WHIT
26510289		GA-326 ⁷¹ PERK	26556611		G-296 PERK	2-664		GA-78 PARM	2700028		GAK-20 HYMA
26510342		GA-853R MASY	26556611		G-296-B PERK	26-640-00		G-1163 ¹⁰⁸ UFI	2700-028		GAK-20 HYDR
26510342		GA-853R PERK	26560017		G-296 BRAU	266526		G-297 HERC	27-000615		GA-361 WHIT
2651143		GA-33 ¹² MASY	26560017		G-296-B BRAU	266526		G-297-B HERC	2700072		G-296 HYMA
265118		GPP-1122 PERK	26560017		G-296 EICH	266526		G-297 WHIT	2700072		G-296-B HYMA
26513		G-296 MANO	26560017		G-296-B EICH	266526		G-297-B WHIT	2700-072		G-296 HYDR
26513		G-296-B MANO	26560017		G-296 HANO	266536		G-297 HERC	2700-072		G-296-B HYDR
2651382		GA-71 MOP	26560017		G-296-B HANO	266536		G-297-B HERC	2700080		G-613 HYMA
265189		G-33 VME	26560017		G-834 LEYL	266536		G-297 WHIT	27-00142		GPP-14 WHIT
2653		GA-106 ⁴⁶ NAP	26560017		G-296 MASY	266536		G-297-B WHIT	2700180		G-613 HYMA
26530142		GPP-419 PERK	26560017		G-296-B MASY	266536AS		G-297 HERC	2700-180		G-613 HYDR
2654		GA-425 NAP	26560017		G-296 PERK	266536AS		G-297-B HERC	2700192		GP-31 HYMA
26540005		G-871 PERK	26560017		G-296-B PERK	266536AS		G-297 WHIT	2700216		G-297-B HYMA
26540017		G-296 MASY	2656007		G-871 MASY	266536AS		G-297-B WHIT	2700217		G-870 HYMA
26540017		G-296-B MASY	2656007		G-871 PERK	266537		G-296 HERC	2700217		G-870 HYVA
26540017		G-296 PERK	26560076		G-833 PERK	266537		G-296-B HERC	2700-217		G-870 HYDR
26540017		G-296-B PERK	2-6560076		G-833 JCBM	266537		G-296 WHIT	2700218		GP-1 HYMA
26540053		G-871 PERK	26560077		G-870 MASY	266537		G-296-B WHIT	2700-218		GP-1 HYDR
26540055		G-871 MASY	26560077		G-870 PERK	266537AS		G-296 HERC	2700228		GA-33 ¹² HYMA
26540055		G-801 PERK	26560-077		G-870 NISS	266537AS		G-296-B HERC	2700-228		GA-33 ¹² HYDR
26540055		G-870 PERK	26560090		G-871 BRAU	266537-AS		G-296 WHIT	27-003-00		GA-1008 UFI
26540055		G-871 PERK	26560090		G-871 MASY	266537-AS		G-296-B WHIT	27-006-00		GA-9334 UFI
26540077		G-871 MASY	26560090		G-870 PERK	266547AS		G-296 HERC	27-007-00		GA-467 UFI
26540077		G-871 PERK	26560110		G-296 MASY	266547AS		G-296-B HERC	27-008-00		GA-483 UFI
26540095		G-834 PERK	26560110		G-296-B MASY	26-658-00		G-1123 UFI	27-009245		GP-1108 WHIT
26540110		G-834 MASY	26560110		G-296 PERK	26664		GA-166 PARM	2700E-6731-A		G-613 FORD
26540110		G-834 PERK	26560110		G-296-B PERK	2666800		GP-1122 DUTZ	2701		GA-482 ERO
26540111		G-834 MASY	26560137		GP-78 PERK	2666800		GP-1122 KHDF	27-013005		GP-1101 WHIT
26540111		G-834 PERK	26560139		GPP-423 PERK	266787		GAK-625 ALCH	2701E-6731		G-836 FORD
26540132		G-813 LEYL	26560141		GPP-423 PERK	266787		GAK-625 FIAT	2701E-6731-A		G-836 FORD
26540132		G-813 LIN	26560143		GPP-419 MASY	2667870-1		GAK-625 ALCH	2701E-6731-A2		G-836 FORD
26540132		G-813 MASY	26560143		GPP-419 PERK	266787-1		GAK-625 ALCH	2701E-9150-A		G-296 FORD
26540132		G-813 PERK	26560144		GP-425 PERK	26716001		GP-1 VERM	2701E-9150-A		G-296-B FORD
26540132		G-813 POWP	26560145		GPP-425 MASY	26718001		GG-20 VERM	2701E-9150-B		G-296 FORD
26540148		GAK-403 MASY	26560145		GP-425 PERK	267518		G-33 ¹⁰⁰ VOLV	2701E-9150-B		G-296-B FORD
26540148		GAK-403 PERK	26560602		G-297-B HANO	267518-9		G-33 VOLV	2701E-9176-B		G-296 FORD
26540153		G-834 BRAU	26560602		G-297-B MASY	267560		GG-48 PETT	2701E-9176-B		G-296-B FORD
26540153		G-834 DECH	26560602		G-297-B PERK	267-560		GG-48 LSTR	2701E-9K600		GAK-403 FORD
26540153		G-834 GULD	26560607		G-297-B PERK	2676		GA-679 NAP	2701EK600		GA-33 ¹² COLS
26540153		G-834 MASY	26560608		GPP-1122 PERK	2677		GA-680 NAP	27-023-00		GA-5648 UFI
26540153		G-834 PERK	26560919		GPP-419 MASY	2678		GA-891 NAP	27-024-00		GA-6127 UFI
26540153		G-834 POWP	26560919		GPP-419 PERK	26789		GP-93 KOEH	27-029-00		GA-1284 UFI
26540154		G-836 BRAU	26560920		GP-425 PERK	2679		GA-892 NAP	2702E-6731-A		G-834 FORD
26540154		G-836 MASY	26561117		G-296 MASY	26790		GP-92 KOEH	27-033-00		GA-7716 UFI
26540154		G-836 PERK	26561117		G-296-B MASY	268		GA-192 AMP	27-034-00		GA-7360 UFI
26540154		G-836 POWP	26561117		G-296 PERK	268		GA-192 BGA	2703E-6731		G-834 FORD
26540218		G-870 MASY	26561117		G-296-B PERK	268		G-566 DEL	2703E-6731-A		G-834 FORD
26540218		G-870 PERK	26561118		GPP-1122 PERK	268		GA-3490 PROT	27-041-00		GA-482 UFI
26540218		G-870 POWP	26562002		GP-78 PERK	2680		GA-483 NAP	27-044-00		GA-588 UFI
26540238		GP-152 PERK	26566017		G-296 GULD	26803		GA-356 ¹⁰⁴ MURY	2704E-9150		G-296 FORD
26540253		G-834 MASY	26566017		G-296-B GULD	26803		GA-357 ¹⁰⁸ MURY	2704E-9150		G-296-B FORD
26540253		G-834 PERK	2656611		G-296 PERK	2681		GA-482 NAP	2705		GA-7360 ERO
26540-253		G-834 NISS	2656611		G-296-B PERK	26814		GA-356 MURY	270-5419		GA-33 ¹² LSTR
2654063		G-813 MASY	2656613		G-296 MASY	26815		GA-27 RIKL	2705420		GAK-16 HAWK
2654111		G-834 MASY	2656613		G-296-B MASY	2682		GA-329 NAP	270-5420		LSTR LSTR
2654111		G-834 PERK	2656613		G-296 PERK	26828		GA-133 PARM	2705421		GAK-403 HAWK
2654153		G-834 PERK	2656613		G-296-B PERK	2683		GA-239 NAP	270-5421		GAK-403 LSTR
2654154		G-870 MASY	2656621		G-296 BAUT	2683001		GP-66 VERM	2705568		GAK-20 HAWK
2654154		G-871 PERK	2656621		G-296-B BAUT	26838060		GP-66 MORB	270-5568		GAK-20 LSTR
2654156		G-813 MASY	2656621		G-296 DECH	26838071		GP-66 MORB	2705583		GA-360 HAWK
26541-56		G-813 NISS	2656621		G-296-B DECH	26838077		GP-34 MORB	2705583		GA-360 LSTR
2654167		G-833 PERK	2656621		G-296 IHCO	26838085		GP-34 MORB	2706-0649-01		GA-7 TRAN
2654172		G-833 PERK	2656621		G-296-B IHCO	26838667		GP-761H MORB	2706-0660-01		GP-1101 TRAN
2654186		GP-3600 MASY	2656621		G-296 MASY	26850		GAD-294 PARM	2706-0660-26		GP-51 TRAN
2654186		GP-3600 PERK	2656621		G-296-B MASY	2685724		GA-26 AMLA	2707008		GAK-403 HYMA
2654193		G-834 PERK	2656621		G-296 PERK	2687		G-33 WORT	2707-008		GAK-403 HYDR
2654342		GP-1 MASY	2656621		G-296-B PERK	268724		GA-26 AMLA	27-070278		GA-27 WHIT
2654342		GP-1 PERK	2656621		G-296 RENA	269		GP-110 ⁹⁰ DEL	27-070278		GP-110 HYDR
2654343		GP-9 MASY	2656621		G-296-B RENA	269		GP-1105 ⁶⁷ DEL	2707057		G-500 HYMA
2654343		GP-1 PERK	26566602		G-297-B MASY	2691		GA-885 NAP	27-07057		G-500 HYDR
2654344		G-836 PERK	26566602		G-297-B PERK	269212		GG-1 NEWH	2707084		GP-81 HYMA
2654347		GP-31 MASY	26566602		G-297-B POWP	269212		GG-4 NEWH	2707-084		GP-81 HYDR
2654347		GP-31 PERK	2658616		G-836 PERK	26947		GAK-16 HAHN	2707096		GA-416 HYMA
2654401		GP-31 PERK	26586-16		G-836 NISS	2696621		G-225 FIAT	2-707198		GP-27 WHIT
2654403		GP-1 ⁹ MASY	2659000		G-236 CHRY	2696621		G-225 IVEC	27073505		GG-6 WHIT
2654403		GP-432 ¹ MASY	2659000		G-236 MOP	269685		GA-27 IHCO	2-7073723		GP-2071W WHIT
2654403		GP-1 ⁹ PERK	26-602-02		G-1173 ¹⁰⁸ UFI	269685-C9		GA-27 IHCO	27-073723		GP-1010Q WHIT
2654403		GP-432 ¹ PERK	26-604-00		G-1123 UFI	269685-C91		GA-27 IHCO	2-7073724		GP-1010Q WHIT
2654403		GP-432 POWP	26-606-00		G-1173 ¹⁰⁸ UFI	269695-C91		GA-27 IHCO	27-073724		GP-1011Q WHIT
2654406		GP-3600 EICH									

Numero	Gonher	Fabricante	Numero	Gonher	Fabricante	Numero	Gonher	Fabricante	Numero	Gonher	Fabricante
Number	Gonher	Manufacturer	Number	Gonher	Manufacturer	Number	Gonher	Manufacturer	Number	Gonher	Manufacturer
2-7074039	GP-2071W	WHIT	2721788	GP-691 ⁴⁸	CATP	27764	GA-172	PARM	28-020	GA-326 ²¹	STEI
27-074039	GP-1010Q	WHIT	2724E-6714-B	GP-1	FORD	27-764-00	GA-18	UFI	28-021	GA-206	STEI
27-074164	GA-360	WHIT	2724E-6714-C	GP-1	FORD	27-769-00	GAD-1	UFI	28023001	GP-50	VERM
27-074252	GA-106 ⁹⁶	WHIT	2725	GA-490	NAP	27774	GA-1616	PARM	28-024	G-191	STEI
27-074252	GA-326 ⁷¹	WHIT	27-26107	GG-5 L	WHIT	277930	G-871	SAME	28-025	GP-110	STEI
27-074452	GA-26	WHIT	27288	G-294	ROO	27-793-00	GA-360	UFI	28-028	GP-750	STEI
27-074454	GA-27	WHIT	2728951R91	G-1175	IHCO	27-794-00	GA-361	UFI	28-029	GA-6129	STEI
27-074457	GA-31	WHIT	272895-R91	G-1175	IHCO	27-799-00	GA-2740	UFI	28-030	GA-6127	STEI
27-074458	GA-360	WHIT	2729	GA-414R	NAP	278	GP-66	DEL	28-031	GP-2071W	STEI
2-7074467	GA-885	WHIT	273	GA-11	AMP	278	GA-6479	PROT	28-034	G-566	STEI
27-074819	GA-26	WHIT	273	GA-11	BGA	278062-R91	G-1163 ¹⁰⁸	IHCO	28-035	GPP-14	STEI
27-075128	GA-6129	WHIT	273	GPP-18	DEL	27-820-00	GA-9045	UFI	28-036	GP-51	STEI
27-075224	GA-26	WHIT	273	GA-275	PROT	278-2175-35	GP-1122	LOMB	28037001	GG-5 L	VERM
27-075719	GA-6880	WHIT	2731	GA-4999	NAP	27-838-00	GA-436	UFI	278038	GA-673R	PARM
27-075970	GP-1011Q	WHIT	27344	GA-7344	PARM	27845	GA-300	PARM	28040048	G-1121F	TERB
27-076194	GA-26	WHIT	2735	GA-2184	TEHO	278500	GA-135	BENX	28043	GP-1011Q	AGCH
27-076198	GP-27	WHIT	273572-M91	GAK-625	MASY	278500	GA-135	WHIT	2806	GA-426	ERO
27-076199	GP-26	WHIT	2735E-6714-B	GP-3600	FORD	27851	GP-43	CHAM	280611	G-750	WHIT
27-076750	G-750	WHIT	2735E-9601-A	GA-77	FORD	27852	GP-92	CHAM	2806201	GP-1	CHRY
27-077318	GA-378	WHIT	27365	GA-217	PARM	27853	GP-93	CHAM	2806201	GP-1	MOP
27077520	GP-1010Q	AUTC	273716	GP-34	FRM	27-860-00	GA-7	UFI	280745-R92	GAK-16	IHCO
2-7077520	GP-2071W	WHIT	274	GPP-19	DEL	27863	GA-165	PARM	28086	GA-8606	PARM
2-7077521	GP-1010Q	WHIT	274	GAD-15	PROT	278674	GA-26	DEMA	2809	GA-701 ¹⁰⁴	NAP
27-077522	GP-2015W	WHIT	27414	GA-141	PARM	27872	GP-57	CHAM	281	GA-139	PROT
27-077554	GA-229	WHIT	27417	GA-198	PARM	27872	GA-164	PARM	2810	GA-702 ¹⁰⁸	NAP
2-7087462	GA-231	WHIT	27432	GA-132	PARM	27-873-00	GA-3490	UFI	28-1000	GP-1011Q	STEI
27-088230	GP-1	WHIT	2743290	GP-310	CLRK	27877	GA-3901	PARM	2811	GP-3985	MPA
27-088234	GP-1	WHIT	27438	GA-442	PARM	27-878-00	GAK-403	UFI	2811070	GA-33 ¹¹²	AVEL
2-7088627	GA-885	WHIT	274F	G-1174	CHP	27-879-00	GAK-625	UFI	28111070	GA-33 ¹¹²	AVEL
27-088752	GA-31	WHIT	274F1	G-1174	CHP	27-887-00	GA-49	UFI	28113-02510	GA-281	CHRY
2709	GAD-1	FACE	2750	GP-2015W	LEDR	27891-000AA	GAC-4	NISS	28113-02510	GA-281	HYUN
27-0900	GA-31	WHIT	2750940104	GA-2198 ⁷⁹	MBNZ	27891-000AA	GAC-4	NISS	28113-02750	GA-302	HYUN
27-090093	GA-31	WHIT	2750940104	GA-438 ²¹	MBNZ	27-893-00	GA-106 ⁹⁶	UFI	28113-1G000	GA-363	HYUN
2709024	GAK-20	HYMA	2750940204	GA-2198 ⁷⁹	MBNZ	27-893-00	GA-326 ⁷¹	UFI	28113-1G000	GA-363	KIA
2709-024	GAK-20	HYDR	2750940204	GA-438 ²¹	MBNZ	27-894-00	GA-206	UFI	28113-21000	GA-3490	HYUN
2709024	GA-360	HYMA	2752	GP-2071W	LEDR	278F	G-1175	CHP	28113-21330	GA-3490	MIITS
27-090278	GA-27	WHIT	275-2604	GP-52 ¹¹⁰	CATP	279	GG-48	CRO	28113-21340	GA-78	HYUN
2-7090917	GP-1010Q	WHIT	275-2604	GP-691 ⁴⁸	CATP	279	GA-195	PROT	28113-22051	GA-476	HYUN
27-090917	GP-1011Q	WHIT	2754362M	GP-66	MANO	27-902-00	GAK-20	UFI	2811322600	GA-216	HYUN
27-092218	GP-3	WHIT	2754362-M1	GP-66	MASY	279026	GAK-403	WHIL	28113-2G000	GA-149	KIA
2709-26	GA-360	HYDR	2757	GA-826	NAP	27-906-00	GA-405	UFI	28113-32000	GA-4325	HYUN
27-096-00	GAD-3	UFI	27577	GP-57	GLOB	2791	G-500	LUF	28113-32510	GA-362	HYUN
270F	G-1175	CHP	2758	GA-827	NAP	279108	GAK-16	NEWH	28113-37010	GA-491	KIA
271	G-613	DEL	2759	GA-109	NAP	279180	GAK-16	NEWH	28113-37101	GA-491	HYUN
27-10005	GA-26	WHIT	275P	G-123	WIX	27-920-00	GAK-16	UFI	28113-37101	GA-491	KIA
27-100059	GA-26	WHIT	276	G-1122	DEL	27-922-00	GA-8047	UFI	28113-4F000	GA-110	HYUN
27-101209	GA-6129	WHIT	276	G-338	DEL	27-924-00	GA-33 ¹¹²	UFI	28115351	GP-28 ⁶	VAG
27-101701	GA-26	WHIT	2760	G-500	LUF	279261	GP-27	KOHL	28115351	GP-430 ⁸	VAG
2710837	GA-16	COCT	27611	G-294	ROO	279294-C91	G-169 ⁹⁹	IHCO	28115351	GP-28 ⁸	VOLK
2710837	GA-16	MINN	276-2175-046	GP-1122	LOMB	279294-C92	G-169 ⁹⁹	IHCO	28115351	GP-430 ⁸	VOLK
2710837	GA-16	OLIV	276-2175-14	G-1121	LOMB	2793	G-750	LUF	28115561	GP-28 ⁶	VOLK
27-10837	GA-16	WHIT	276-2175-36	GP-3600	LOMB	2793	GA-224	NAP	28115561	GP-430 ⁸	VOLK
2710E-9K600	GAK-403	FORD	276-2175-42	G-296	LOMB	27-931-00	GAK-216	UFI	28-115-561E	GP-1	VOLK
2711006-M91	GA-360 ¹⁰⁴	MASY	276-2175-42	G-296-B	LOMB	27-934-00	GA-18	UFI	28121	GA-398	CHAM
2711006-M91	GA-361 ¹⁰⁸	MASY	276-2175-46	GP-1122	LOMB	27-936-00	GA-98 ¹¹²	UFI	28127	GA-392	PARM
27110617	G-236	WHEL	27628	GAD-118	PARM	27-944-00	GA-229	UFI	281286	G-31	HERC
27-110617	G-236	WHIT	2763	G-750	LUF	27-945-00	GA-6129	UFI	281286	G-31	WHIT
27-111480	GA-27	WHIT	27640	GA-240	PARM	27-946-00	GA-3425	UFI	28133-23001	GA-217	HYUN
271160243	GP-1122	CCO	276513	GA-3600	NEWH	27-965-00	GAK-458	UFI	281370	GP-66	JACO
27-118239	GP-1013Q	WHIT	276514	GP-3816	NEWH	2797	GA-491	NAP	28-1370	GP-66	TORO
27-122218	GA-26	WHIT	276515	GA-892	NEWH	27-970-00	GA-892	UFI	2813P	GAK-403	PETI
271333843	GA-277	VAG	276516	GP-36	NEWH	27-971-00	GA-589	UFI	2814	GP-3985	MPA
271333843	GA-277	VOLK	27669	GA-3445	AIR	27-978-00	GA-416	UFI	28142	GA-130	PARM
27-133-843	GA-277	VOLK	27675	GA-2740	AIR	27-984-00	GA-1285	UFI	28145-4110	GAD-3	SUBA
2714	GA-135	NAP	276766	GA-106 ⁴⁶	FORD	27-985-00	GA-1286	UFI	28148	G-277	ROO
271415-06	G-238	HYST	276766	GA-326 ⁷¹	FORD	27-986-00	GA-1287	UFI	28155351	GP-28	VOLK
271437	G-750	ALCH	276766	GA-106 ⁴⁶	NEWH	27-991-00	GA-356	UFI	28162	GP-166	KLAV
27151001	GA-6	VERM	276766	GA-326 ⁷¹	NEWH	27-996-00	GA-357	UFI	281666-C91	GAK-20	IHCO
271519	GA-105	KOHL	276767	GA-206	FORD	279991R91	G-335	IHCO	28177-32520	GA-362	HYUN
27-156-00	GA-78	UFI	276767	GA-206	NEWH	279994M	G-335	REF	28177-32520	GA-362	MIITS
2715877	GAK-403	COCT	27695	GP-53	AGCH	279994R91	G-335	CASE	282	GP-69	DEL
2715877	GAK-403	OLIV	277	GP-66	DEL	279994R91	G-335	CLEV	282	G-6	EATN
27-15877	GAK-403	WHIT	277	GA-4828	PROT	279994R91	G-335	ELGN	28221	GA-279	PARM
2715E-6731-A	G-834	FORD	27-701-00	GA-71	UFI	279994R91	G-335	HOUG	28243	GA-158	PARM
2715G-6731-A	G-834	FORD	27701008326	GP-171	RENA	279994R91	G-335	PALM	2824613	GA-33 ¹¹²	CLRK
2716	GA-39	NAP	27703E-631-A	G-834	FORD	279994-R91	G-335	IHCO	2825	GP-38	FACE
2716017	G-236	CHRY	277040	G-1174	ALCH	279994-R91	G-335	QUIC	2826	GA-328	NAP
2716017	G-236	COCT	277050	G-1174	ALCH	279GB210	GA-135	MACK	282K99	G-31	EATN
2716017	G-236	MOP	277050-8	G-1174	ALCH	27DDP15838	GA-37	FWDX	282K99	G-31	YALE
27-16017	G-236	WHIT	27-7110	GA-33 ¹¹²	TORO	27E5521	G-871	FENW	283	GPP-18	DEL
27161001	GP-92	VERM	27-719-00	GA-230	UFI	27H1135	G-870	LEYL	283	GA-322	PROT
27162001	GP-93	VERM	27-719-01	GA-230	UFI	27H4586	GAK-403	LEYL	283-0217-5045	GP-1122	LOMB
27-164-00	GA-3490	UFI	277233	GP-3600	BOLN	27H7943	GAK-403	LEYL	2830348	GPP-1122	CUMM
27-170-00	GA-139	UFI	277233	GP-3600	KOHL	27H7944	GAK-403	LEYL	283119	GP-1122	NEWH
27-171-00	GA-362	UFI	277233	GP-3600	TENN	27H8294	GAK-16	LEYL	2837	GA-29	NAP
27-189-00	GA-467	UFI	27730	GA-175	PARM	280	GA-390	PROT	284203	GA-37	PETT
2719	GA-2719B	FACE	27-731-00	GA-200	UFI	2-800395	GP-3985	JCBM	284210	GP-1101	SAVA
271F	G-1176	CHP	27-731-00	GA-218	UFI						

Referencia Cruzada por Numero de Parte

Cross Reference by Part Number



Numero	Gonher	Fabricante	Numero	Gonher	Fabricante	Numero	Gonher	Fabricante	Numero	Gonher	Fabricante
Number	Gonher	Manufacturer	Number	Gonher	Manufacturer	Number	Gonher	Manufacturer	Number	Gonher	Manufacturer
28473		GA-163 PARM	2900-0026		GA-467 ATCO	2921026		G-836 TCLD	297		GP-66 DEL
284834		GG-261 VOLV	2900-0206		GA-467 ATCO	29-21026		G-836 CARR	297		GG-7 ECH
2849		GP-245 FACE	2900-0206-00		GP-467 ATCO	29214176		G-750 MORB	297		GP-9 PMC
2849		GP-462 ⁹⁴ FACE	2900-0338		GP-54 ¹¹ ATCO	29214180		GP-57 MORB	2971		GA-539R NAP
284A		GA-49 GREY	2900-0338		GP-66 ¹⁰ ATCO	29214193		GPP-14 MORB	2976		GA-31 NAP
285		GA-381 PROT	2900-0517-00		G-1123F ATCO	292196		GP-462 PARM	2977		GPP-19 NAP
2850		GP-310 FACE	2900-0553		GP-77 ATCO	292311820		GP-58 ¹⁵ UFI	297865		GP-171 ¹⁶ HYST
2851		GA-29 NAP	2900-0553-00		GP-77 ATCO	2924		GA-361 NAP	297865-12		GP-171 ¹⁶ HYST
285168-R1		GA-7 IHCO	2900-0687-00		GPP-1122 ATCO	29245330		GP-52 ¹⁰ MORB	2979653-M1		GP-66 MASY
285233		G-813 HYST	2900252		GA-7 HARL	29245330		GP-691 ⁴⁸ MORB	298		GA-9334 AMP
2853		GA-375 NAP	29002-52A		GA-7 HARL	2926		GA-403 NAP	298		GA-9334 BGA
2854		GP-66 VERS	29002-57		GA-7 HARL	292737		GA-33 ¹¹² HERC	298		GG-6 ECH
2859		GAVW-616 NAP	29002-58		GA-7 HARL	29294		GAK-403 HAHN	298		GA-382 PROB
286		GA-217 PROT	2900-5122-00		GP-1011Q ATCO	292975H2		G-1175 DIAM	298		GA-382 PROT
2862344		GP-1122 MASY	290-0518-00		G-1123 ATCO	292975N2		G-1175 DIAM	2980		GA-7716 HANE
2862344M1		GP-1122 HANO	2900-5346-00		GA-106 ⁴⁶ ATCO	292A		GA-6129 GREY	29800133		GP-1 NAP
2862344-M1		GP-1122 MASY	2900-5346-00		GA-326 ⁷¹ ATCO	293		G-566 DEL	29800136		G-296 HEDE
2862361		GP-1122 MASY	2900-5347-00		GAK-16 ATCO	293		GA-471 PROT	29800136		G-296-B HEDE
2862361-M1		GP-1122 MASY	2900-5351-00		GP-36 ATCO	2931095		G-3754 DUTZ	2981		GA-7360 NAP
2862362		GP-1122 MASY	2900-5352-00		G-277 ATCO	29321211		GA-6127 MORB	2981113		GA-853R ATWE
2862362M1		GP-1122 HANO	2900-5354-00		GP-1011Q ATCO	29321212		GA-6129 MORB	29819153		GP-34 REXN
2862362-M1		GP-1122 MASY	2900-6488-00		GA-33 ¹¹² ATCO	29321255		GA-563 MORB	298226-C91		GA-27 IHCO
2863		GP-3985 FACE	2900776		GP-461 VOLV	29353002		GP-81 ³¹ DUTZ	29823153		GP-34 REXN
2863093		GAK-16 MASY	2901		GA-375 ERO	29353002		GP-9 ⁹⁸ DUTZ	2984		GA-2984 NAP
2863093M1		GAK-16 HANO	29010		G-222 GLOB	29359A		GP-761H TYLR	29851449		GA-27 REXN
2863093-M1		GAK-16 MASY	2901501		GP-54 ¹¹ FIAT	294		GA-8047 AMP	298670		GP-53 CUMM
2863317		GA-730 CHRY	2901501		GP-66 ¹⁰ FIAT	294		GA-8047 BGA	298751		G-750 CUMM
2863317		GA-730 MOP	2902		GA-1203 ERO	294		GA-180 PROT	298754		G-750 CUMM
2863349		GA-730 CHRY	290283DS		G-33 HERC	2940-00-580-6283		G-33 NSN	2988-52		GP-28 ⁹ UNIV
2863349		GA-730 MOP	290283-DS		G-33 WHIT	2940-01-174-1347		GP-28 ⁹ NSN	2988-52		GP-430 ⁸ UNIV
2863365M1		G-1121 HANO	2903		GA-29 ERO	2940-01-174-1347		GP-430 ⁸ NSN	299		G-122 DEL
2865		GP-42 FACE	290305A		G-33 HERC	2940-01-194-9730		GP-3980 NSN	299		G-338 DEL
2865		GA-5648 NAP	290305-AB		G-33 WHIT	2940-01-435-2603		GP-462 NSN	299		GG-123 ECH
286622		G-31 KOHL	290305B		G-33 HERC	2940-01-447-1786		GPP-1122 NSN	299		GA-6690 PROT
286623		G-1175 KOHL	290306		G-33 HERC	2941		GA-493 ¹⁰⁸ NAP	299		GAVW-2 UNN
2866477		GP-3816 OPEL	290306		G-33 WHIT	2-94456-641-0		GP-149 ISUZ	29901711		GA-26 CONF
2866477		GP-81 ³¹ OPEL	290309-C91		GA-135 IHCO	29461		GP-43 AGCH	2990297		GAK-403 EATN
2866477		GP-9 ⁵⁸ OPEL	290312CS		G-6 HERC	29461		GP-53 AGCH	2990297		GAK-403 YALE
286760C		GP-50 HERC	29036-56		GA-7 HARL	29462		GP-26 AGCH	2990304		GA-5648 EATN
286760-C		GP-50 WHIT	290383		G-33 HERC	29463		GP-27 AGCH	2990304		GA-5648 YALE
2868365-M1		G-1121 MASY	290383		G-33 WHIT	29493		GP-1122 OK	299080		GP-2071W CUMM
2868366M1		G-1121 HANO	290403		GP-1101 WOOD	294AX		GA-6 GREY	299082		GP-1011Q CUMM
2868366-M1		G-1121 MASY	2905		GAD-1 ⁸⁷ NAP	295		GA-1285 AMP	299084		GP-2071W CUMM
2868508M1		GP-50 HANO	2906		GA-356 ERO	295		GA-1285 BGA	299086		GP-1011Q CUMM
2868508-M1		GP-50 MASY	2906		GAD-3 NAP	295		GP-31 DEL	2991		GA-113 NAP
2868515-M1		GAK-20 MASY	2-90654-600-0		GP-359 ISUZ	2950026		GP-166 EATN	2991015C1		GA-299 IHCO
286A		GA-27 GREY	2-90654-800-0		GP-359 ISUZ	2950026		GP-166 YALE	299103		G-1175 CUMM
286AF		GA-27 GREY	290732		GAK-1532 HYST	2950090		GAK-20 EATN	2991202		GAK-20 EATN
287		GA-18 AMP	2908		GA-75 NAP	2950090		GAK-20 YALE	2991202		GAK-20 YALE
287		GA-18 BGA	290969AS		G-33 HERC	295011008		G-1123 TCLD	2991764		GA-360 EATN
287		GP-38 DEL	290969-AS		G-33 WHIT	29-50110-08		G-1123 CARR	2991764		GA-360 YALE
287		GA-386 PROB	290A		GA-5648 GREY	29-50110-09		G-1123 CARR	299202		GP-55 CUMM
287		GA-386 PROT	291		GA-27 AMP	29-50110-09		G-1123F CARR	2992216		GA-106 ⁴⁶ EATN
2870094-M1		G-31 MASY	291		GA-27 BGA	29501109		G-1123 TCLD	2992216		GA-326 ⁷¹ EATN
2871492-M1		G-296 MASY	291		GA-113 PROT	29501109		G-1123F TCLD	2992216		GA-106 ⁴⁶ YALE
2871492-M1		G-296-B MASY	2910-00-307-5999		GA-357 NSN	295012001		G-31 TCLD	2992216		GA-326 ⁷¹ YALE
2871513-M1		GP-1122 MASY	2910-00-477-8175		GG-6 NSN	29-50120-01		G-31 CARR	2992241		GP-548 IVEC
2871513M2		GP-1122 HANO	2910-00-533-1429		GG-1 NSN	2950185		GAK-403 EATN	2992242		GP-737 IVEC
2871513-M2		GP-1122 MASY	2910-00-533-1429		GG-4 NSN	2950185		GAK-403 YALE	299253		GA-37 CUMM
2871722M1		GP-54 HANO	2910-01-051-2341		GP-749 NSN	29504356		GA-405 DEMA	29926714		GA-44 CONF
2871722-M1		GP-54 ¹¹ MASY	2910-01-411-0980		G-1143 ³⁰ NSN	29504526		GA-467 DEMA	299289		GA-5648 CUMM
2871722-M1		GP-66 ¹⁰ MASY	2910-01-424-7315		GP-1109 ²⁷ NSN	2951		GP-2951 ¹²⁰ MPA	29930		GP-5 ALCH
2871722-M2		GP-54 ¹¹ MASY	2910-01-424-7315		GP-62 ²⁰ NSN	2951		GP-58 MPA	299346		GA-26 ¹² CUMM
2871722-M2		GP-66 ¹⁰ MASY	2-910140		GP-178 JCBM	29510922		GP-3766 ALLI	299350		GAK-20 CUMM
28719-20M1		GAK-20 NISS	2-910150		GP-18 JCBM	2951382		GA-71 CHRY	299351		GA-27 CUMM
2871920-M1		GAK-20 MASY	2-910155		GP-1122 JCBM	2951957		GP-1 CHRY	299353		GA-24 CUMM
2871928M1		GAK-403 HANO	2-910550		GP-3000 JCBM	2951957		GP-1 MOP	299364		GA-135 CUMM
2872920		GAK-20 MASY	2-910551		GP-1012Q JCBM	29561		GP-28 ⁹ GENI	299364		GA-35 CUMM
2872920M1		GAK-20 HANO	2912		GA-3490 NAP	29561		GP-430 ⁹ GENI	299365		GA-35 CUMM
2872920-M1		GAK-20 MASY	291295		G-6 HERC	29561		GP-149 JLGI	2993-81		GP-3816 UNIV
2872988M1		GA-5648 HANO	2914074		G-296 FORD	29571		GPP-418 ROO	2994		GA-101 NAP
2872988-M1		GA-5648 MASY	2914074		G-296-B FORD	29573		GPP-419 ROO	299418		GA-360 CUMM
2874154		GA-360 MASY	2914107-M1		G-1123F MASY	295PS2690		GA-6129 CHIC	2995		GA-100 NAP
2874154M1		GA-360 HANO	2914220-M1		G-1123 MASY	295PS2690		GA-6129 CONP	2995-84		GP-81 ²¹ NAP
2874154-M1		GA-360 MASY	2914220-M1		G-1123F MASY	296		GA-1008 AMP	2995-84		GP-9 ⁸ UNIV
2874165-M1		GA-436 MASY	2914530		GAK-403 BROY	296		GA-1008 BGA	299634		GP-169 CUMM
2874186M1		GA-361 HANO	2914533		GA-206 BROY	296		G-296 CAV	299670		GP-53 CUMM
2874186-M1		GA-361 MASY	2914534		GA-106 ⁴⁶ BROY	296		G-296-B CAV	2998553		GP-54 ¹¹ MASY
28755		GA-348 PARM	2914534		GA-326 ⁷¹ BROY	296		GA-2106 PROT	2998553		GP-66 ¹⁰ MASY
2876465		GP-81 OPEL	2914-6039-00		GA-616 ATCO	296		GAVW-2 UNN	2998553M1		GP-54 ¹¹ HANO
2879154M1		GA-360 HANO	2914-8002		GG-3 ATCO	2961		GA-378 NAP	2998553M1		GP-66 ¹⁰ HANO
2879154-M1		GA-360 MASY	2914-8070-00		GPP-1291 ³⁹ ATCO	296186		GA-11 BRIG	2998553-M1		GP-54 ¹¹ MASY
287999		GP-3985 VOLV	2914-8070-00		PF831 ⁴¹ ATCO	296188		GA-11 BRIG	2998553-M1		GP-66 ¹⁰ MASY
288		GP-54 DEL	2914-8070-00		R 90 P ⁴² ATCO	296-18-8		GA-11 BBR	2999089		G-1174 EATN
288		GA-166 PROT	2914-8071		GPP-1291 ³⁹ ATCO	2966		GA-229 NAP	2999976-M1		GP-36 MASY
28815		GA-71 TENN	2914-8071		PF831 ⁴¹ ATCO	2966251		G-162H DUTZ	298-18697		G-31 FORD
2888		GA-2803T NAP	2914-8071		R 90 T ⁴² ATCO	2966251		G-162H KHDF	2988294		GAK-16 LEYL
2889829-M91		G-162H ⁹⁹ MASY	2914-8071		GPP-1291 ³⁹ ATCO	2966261		G-162H DUTZ	280611		G-750 ALCH
2889829-M91		G-225 MASY	2914-8071-00		PF831 ⁴¹ ATCO	2966261		G-225 FIAT	2		

Numero	Gonher	Fabricante	Numero	Gonher	Fabricante	Numero	Gonher	Fabricante	Numero	Gonher	Fabricante
Number	Gonher	Manufacturer	Number	Gonher	Manufacturer	Number	Gonher	Manufacturer	Number	Gonher	Manufacturer
2D0129620A	GA-5876	AUDI	2N1U 9601 BD	GA-179	FORD	3 7399	GG-99	PARM	30-01090-00	GP-1224	CARR
2D0129620A	GA-5876	PORS	2N1U-9601-CB	GA-288R	FORD	3 7416	GG-84	PARM	30-01090-01	GP-458	CARR
2D0129620A	GA-5876	VOLK		GP-1	LEMN	30	GP-3	FACE	30-01090-04	GP-1224	CARR
2D0129620B	GA-475	VOLK	2-NIV-9601-BD	GA-288R	FORD	30.050.00	GA-2146	UPI	30-0109005	GP-1224	CARR
2D0129620D	GA-475	VOLK	2P0611	G-750	AUTC	30.186.00	GA-2184	UPI	30-01099	GPP-1287 ³⁹	CARR
2D0201051	GG-431	VAG	2P0611	G-750	WHIT	30.332.00	GA-27161	UPI	30-01099	PFF831 ⁴¹	CARR
2D952446	G-1121	RUGG	2P0661	G-750	AUSW	30.738.033	GP-28 ⁶	MOND	30-01099	R 60 P ⁴²	CARR
2DO-129-620	GA-475	VOLK	2P0661	G-750	CLRK	30.738.033	GP-430 ⁸	MOND	30-01099-00	GPP-1287 ³⁹	CARR
2F800G	G-1166	KRA	2P1482	GA-7360 ¹⁰⁸	CATP	30.738.125	GP-28 ⁶	MOND	30-01099-00	PFF831 ⁴¹	CARR
2F800H	G-1166	KRA	2P1482	GA-7716 ¹⁰⁴	CATP	30.738.125	GP-430 ⁸	MOND	30-01099-00	R 60 P ⁴²	CARR
2H1560	G-222	CATP	2P3224	GA-1285 ¹⁰⁸	CATP	300	GA-55	AMP	300136922	GA-360	FIAT
2H16	G-870	LEVL	2P3224	GA-8047 ¹⁰⁴	CATP	300	GA-55	BGA	30015	GA-390	IPD
2H1927	G-870	AUST	2P3576	GP-152	CATP	300	GGP-25	CIM	3001690	GA-37	CUMM
2H1927	G-870	LEVL	2P4004	GP-51	CATP	300	GP-81	FORD	3001825	GC-1133	CUMM
2H4123	GP-77	DUTZ	2P4005	GP-52 ¹¹⁰	CATP	300	GGP-25	FUEL	3001825	GS-1133	CUMM
2H4316	G-870	LEVL	2P4005	GP-69 ¹⁴⁸	CATP	300	GGP-25	GASO	3001893	GA-563	CUMM
2H4340	G-870	AUST	2P5080	GA-1286 ¹⁰⁸	CATP	300	GA-277	UNN	3002	GG-124	NAP
2H4340	G-870	LEVL	2P5080	GA-9334 ¹⁰⁴	CATP	3000030200	GPP-18	TCLD	30020673	GG-206	GMCX
2H4346	G-870	AUST	2P8863	GA-9334 ¹⁰⁴	CATP	30-000302-00	GPP-18	CARR	300207	GA-26	IHCO
2H4346	G-870	LEVL	2R0 115 403	GP-737	VOLK	3000043	GP-50	HYST	300207-C91	GA-26	IHCO
2J1360	G-222	CATP	2R3129	GA-1203	CATP	3000043-12	GP-50	HYST	3002211	GA-109	CUMM
2J1550	G-222	CATP	2R6008	GA-29	CATP	3000046	GP-1	HYST	300224	GA-106	HEIN
2J1560	G-222	CATP	2R7797	GA-375	CATP	3000046-12	GP-1	HYST	3002261	GP-10	DUTZ
2J1660	G-222	CATP	2RD 129 620	GA-8150	VOLK	3000058	GP-9	HYST	3002377-12	GP-66	UNSR
2J6135	G-222	CATP	2S0129620	GA-864R	VOLK	3000058-12	GP-9	HYST	30025009	GA-244	GMCX
2KYU6	GA-2804 T	GGER	2S0648	GA-5648	CATP	3000059	GP-171	HYST	3003	GG-5 L	NAP
2KY66	GA-518R	GGER	2S1284	GA-1284	CATP	3000059-12	GP-171	HYST	30030-76801	GAK-20	MITZ
2KZ8	GP-1224	GGER	2S1284	GA-1284	NEL	3000065-12	GP-462	UNSR	3003078801	GAK-20	KOBL
2KZ85	G-278	GGER	2S1285	GA-1285	CATP	3000066-12	GP-36	UNSR	30030-83100	GA-361	MITZ
2KZG6	GA-493 ¹⁰⁸	GGER	2S1285	GA-1285	NEL	3000086	G-31	TCLD	30033-076801	GAK-20	MITZ
2L2Z-9155-AB	GG-308	FORD	2S1286	GA-1286	CATP	30-00086	G-31	CARR	3003477	GP-171	DEMA
2L2Z-9601-AC	GA-158	FORD	2S1286	GA-1286	NEL	3000087	G-296	HYST	3003477	GP-81	DEMA
2LAA8	GA-600R	GGER	2S1287	GA-1287	CATP	3000087	G-296-B	HYST	300359	GP-761H	POWB
2LB0611	G-191	ALCH	2S1287	GA-1287	NEL	3000087	G-31	TCLD	30045	GA-362	IPD
2LB0611	G-191	AUTC	2S1288	GA-1008 ¹⁰⁴	CATP	30-00087	G-31	CARR	30053	GA-3588	IPD
2LB0611	G-191	WHIT	2S1288	GA-1284 ¹⁰⁸	CATP	3000087-12	G-296	HYST	3005806	G-1123	RENA
2M3243	G-152	CATP	2S1289	GA-1285 ¹⁰⁸	CATP	3000087-12	G-296-B	HYST	3006174	GP-761H	HYST
2M3243	G-330	CATP	2S1289	GA-8047 ¹⁰⁴	CATP	30-00092	G-1143	CARR	30065	GAK-16	HYST
2M3943	G-152	CATP	2S1636	GA-1008 ¹⁰⁴	CATP	3000127	GA-218	VOLV	300651-09	GAK-16	HYST
2M5522	GA-5648	CATP	2S1636	GA-1284 ¹⁰⁸	CATP	3000231	GP-1	HYST	3006800	GA-2174	UPI
2M6377	GA-5648	CATP	2S1677	G-152	CATP	3000231-12	GP-1	HYST	3007	GG-3	NAP
2M6446	GA-5648	CATP	2S3087	GA-1285 ¹⁰⁸	CATP	3000243-12	GP-40	UNSR	3008	GG-246	NAP
2M7491	GA-5648	CATP	2S3087	GA-8047 ¹⁰⁴	CATP	3000249	GP-3600	HYST	3009	GG-240	BGA
2M7941	GA-5648	CATP	2S5640	GA-5648	CATP	3000249-12	GP-3600	HYST	3009	GP-458	NAP
2M8708	GA-5648	CATP	2S5648	GA-5648	CATP	3000301	GA-106	CUMM	30095	GA-4303	IPD
2M9140	G-238	CATP	2S5652	GA-5648	CATP	30-00301	GPP-18	CARR	30098	GP-43	AGCH
2M9156	G-152	CATP	2S5698	GA-5648	CATP	30-00301-00	GPP-18	CARR	300A	GA-37	GREY
2MD02134	GA-378	MACK	2S61-9601-CA	GA-284	FORD	30-00302	GP-110	CARR	300HS	GGP-25	FUEL
2MD1108	GA-27	MACK	2S648	GA-5648	CATP	30-00302-00	GP-110	CARR	300-HS	GP-92	CIM
2MD19314	GA-26	MACK	2S6610	GA-5648	CATP	30-00303	GP-69	CARR	300-HS10	GP-92	CIM
2MD19327	GA-26	MACK	2U2Z-9601-AA	GA-780	FORD	30-00303-00	GP-54	CARR	300-HS30	GP-92	CIM
2MD196	GA-27	CUMM	2UG0611	G-31	AUTC	30-00303-00P12	GP-10	CARR	300M	GP-92	CIM
2MD196	GA-27	MACK	2UG0611	G-31	WHIT	30-00304	GP-50 ³⁰	CARR	301	GA-50	CRM
2MD198	GA-26	MACK	2UU01335	G-31	AUTC	300030400	GP-50 ³⁰	TCLD	301	GG-152	CRO
2MD198-2	GA-26	MACK	2UU01335	G-31	WHIT	30-00304-00	GP-50 ³⁰	CARR	301	GG-5 L	PROT
2MD2134A	GA-378	MACK	2UU0611	G-31	AUTC	30003053	G-33	BOMG	30105	GP-3766	PFAC
2MD2134AP8	GA-378	MACK	2UU0611	G-31	WHIT	3000307	GA-6129	CUMM	30106	GA-139	IPD
2MD2143P2	GA-378	MACK	2UU0746	G-31	AUTC	3000323	GP-31	TCLD	3011	GA-71	AUTO
2MD2147	GA-229	MACK	2UU0746	G-31	WHIT	30-00323	GP-31	CARR	3011	GG-116	NAP
2MD2151	GA-229	MACK	2UUA0611	G-31	AUTC	30-00323-00	GP-31	CARR	30115561	GP-28 ⁶	VOLK
2MD2152	GA-378	MACK	2UUA0611	G-31	WHIT	3000328	GAK-20	HYST	30115561	GP-430 ⁸	VOLK
2MD2153	GA-378	MACK	2VC 129 619	GA-8150	VOLK	3000336	GA-105	HYST	30115561C	GP-28 ⁶	VAG
2MD2159	GA-229	MACK	2W2134	GP-749	CATP	30-00381-00P12	GP-1108	CARR	30115561C	GP-430 ⁸	VAG
2MD29337	GA-378	MACK	2W3236	G-297-B	CATP	30-00426-20	GA-880R	CARR	30115561C	GP-28 ⁶	VOLK
2MD29349	GA-378	MACK	2W3785	GA-9334	CATP	30-00426-24	GA-880R	CARR	30115561C	GP-430 ⁸	VOLK
2MD29350	GA-229	MACK	2W4234	G-1143 ³⁰	CATP	30-00426-27	GA-880R	CARR	30115561D	GP-28 ⁶	VAG
2MD3116	GA-106 ⁶	MACK	2W9Z-6A642-EA	GP-457	FORD	30-00430-22	GA-888R	CARR	30115561D	GP-430 ⁸	VAG
2MD3116	GA-326 ⁷¹	MACK	2XWF2	GP-24	GGER	30-00430-23	GA-888R	CARR	30115561D	GP-28 ⁶	VOLK
2MD3129	GA-229	MACK	2Y8096	GP-51	CATP	30-00450-00	GP-31	CARR	30115561D	GP-430 ⁸	VOLK
2MD3130	GA-378	MACK	2Y8097	GP-52 ¹¹⁰	CATP	300-05	GGP-25	CIM	30-115-561T	GP-428	VOLK
2MD3138	GA-229	MACK	2Y8097	GA-161 ⁴⁸	CATP	3000526	GAK-16	HYST	30-1165	GP-20	CAR
2MD3141	GA-378	MACK	2Y8670	GP-110	CATP	3000537	GP-58	UNSR	3012	GG-46	AMP
2MD3141P	GA-378	MACK	2ZJ0611	G-31	AUTC	3000537-12	GP-58	UNSR	3012	GG-46	BGA
2MD3156	GA-229	MACK	2ZJ0611	G-31	WHIT	3000539-12	GP-3682	UNSR	3012	GG-5 L	NAP
2MD3156P1	GA-229	MACK	2ZJ0807	G-31	AUTC	3000539-12	GP-37	UNSR	30-121U	GG-20	CAR
2MD3156P2	GA-229	MACK	2ZJ0807	G-31	WHIT	3000540	GAD-30	HYST	301283	GA-360	HUBR
2MD3156P3	GA-493 ¹⁰⁸	MACK				3000540-1	GAD-30	HYST	3013206	GA-6129	CUMM
2MD3161P3	GA-493 ¹⁰⁸	MACK				3000-6	G-31	MIC	3013207	GA-6127	CUMM
2MD3165	GA-378	MACK				30-0086	G-31	CARR	3013208	GA-106	CUMM
2MD3178	GA-229	MACK				3000870	GP-31	HYST	3013209	GA-206	CUMM
2MD3179	GA-229	MACK				3000870-12	GP-31	HYST	3013210	GA-206	CUMM
2MD3229	GA-229	MACK				30009	GA-2194	IPD	3013212	GA-563	CUMM
2MD390	GA-27	MACK				3001	GG-1	NAP	30136	GAVV-2	IPD
2MD39323	GA-6880	MACK				3001	GG-4	NAP	301360	GA-27	HUBR
2MD396	GA-27	MACK				30010	GA-2110	IPD	301369	GA-27	HUBR
2MD4121	GA-378	MACK				300-10	GGP-25	CIM	3014	GG-246	BGA
2MD4122	GA-229	MACK				30-01077-00	GA-2804 T	CARR	301405-9	GP-66	HYST
2MD443	GA-26	MACK				30-01077-01	GA-2803T	CARR	30-141	GG-20	CAR
2MD445	GA-27	MACK				30-01079	GPP-1287 ³⁹	CARR	30-141A	GG-20	CAR
2MD445AP2	GAK-403	MACK				30-01079	PFF831 ⁴¹	CARR	3014654	GP-43	CUMM
2MD455AP2	GAK-403	MACK				30-01079	R 60 P ⁴²	CARR	30150	GAVV-4	IPD
2MD471	GA-6129	MACK				30-01079-00	GPP-1287 ³⁹	CARR	30154	GA-382	IPD
2MD473P1	GA-378	MACK				30-01079-00	PFF831 ⁴¹	CARR	30-159	GG-7	CAR
2MD477	GA-378	MACK				30-01079-00	R 60 P ⁴²	CARR	30-160	GG-6	CAR
2MD482	GA-378	MACK				30-01079-01	GP-458	CARR	30176001	G-870	MBNZ
2MDA19318	GA-27	MACK				30-01090	GP-1224	CARR	30-1760-01	G-870	LEVL

Números Nuevos

3

Referencia Cruzada por Numero de Parte

Cross Reference by Part Number



Numero	Gonher	Fabricante	Numero	Gonher	Fabricante	Numero	Gonher	Fabricante	Numero	Gonher	Fabricante
Number	Gonher	Manufacturer	Number	Gonher	Manufacturer	Number	Gonher	Manufacturer	Number	Gonher	Manufacturer
3018713	GA-49	DUTZ	3030	GG-196	BGA	3042-003	GA-230	CEWF	3051MP	GG-16	NAP
3019042	GA-376	CUMM	3030	GG-1	NAP	3042-006	GA-50	CEWF	3052	GG-17	NAP
30-194	GG-16	CAR	3030	GG-4	NAP	304219-R92	G-870	IHCO	305-23-603	GA-2740	MZDA
30-194A	GG-16	CAR	30302	GP-310	EICH	30422	GPP-419	ROO	3052535	G-297	RENA
30-195	GG-17	CAR	303048581	GAK-403	ALCH	30422	GPP-421	ROO	3052535	G-297-B	RENA
3015D19	G-128	MACK	303048581	GAK-403	FIAT	3042383-R91	G-870	IHCO	3052MP	GG-17	NAP
3015D19A	G-128	MACK	3030499	GP-9	GMCX	3042412R93	G-870	CASE	3053	GG-45	NAP
3015D19B	G-128	MACK	30-3073157	GP-1108	WHIT	3042412-R93	G-870	IHCO	3053290	GA-360	ALCH
302	GA-85	CRM	30-3073165	GP-78	WHIT	3042419R92	G-870	CASE	3053290	GA-361	ALCH
302	GAD-1	PROT	3031	GG-1	NAP	3042419-R92	G-870	IHCO	3054	GA-77	AUTO
302	GA-4303	UNN	3031	GG-4	NAP	3042419-R93	G-870	IHCO	3054	GG-8 ¹⁰³	NAP
3020	GA-70	AUTO	3031-002	GA-2194	CEWF	3042912	G-222	ALCH	3054	GG-8 L ⁸⁰	NAP
30201	G-1121F	PERK	3031-005	GA-3300	CEWF	3042912	G-222	FIAT	305426	GA-106 ⁶⁶	WAUK
302012251	GA-360	MINN	3031-006	GA-3300	CEWF	3042912-0	G-222	ALCH	305426	GA-326 ⁷¹	WAUK
302012251	GA-360	OLIV	30-3110605	G-296	WHIT	3042912-7	G-222	ALCH	305427	GA-206	WAUK
30-2012251	GA-360	WHIT	30-3110605	G-296-B	WHIT	3042922	GA-360	ALCH	30545	G-871	CASE
302012324	GA-361	OLIV	30-3119475	GP-36	WHIT	3042922	GA-360	FIAT	30545	G-870	DAVI
30-2012324	GA-361	WHIT	303122-R91	G-33	IHCO	3042922-4	GA-360	ALCH	3054750-R91	G-6	IHCO
30208	GAK-20	ENUM	3031500	GAVW-617	UFI	3042994	GA-360	ALCH	3055	GA-80	AUTO
3021	GG-202	NAP	303156	GAK-6129	URIG	3043203R91	G-870	CASE	3055134-R91	GP-9	IHCO
3021026	G-836	TCLD	3031563R1	GAK-403	YUMB	3043203-R91	G-870	IHCO	3055228	GP-58	IHCO
30-21026	G-836	CARR	3031563-R1	GAK-403	IHCO	304326	GA-5648	DATT	3055228-R91	GP-81	IHCO
30211	G-871	NISS	3031563-R91	GAK-403	IHCO	30-4326	GA-5648	KENW	3055229	GP-171	IHCO
30211	G-871	PERK	30-3167844	GP-31	WHIT	3043283	G-870	IHCO	3055229-R91	GP-9	IHCO
30212	G-836	JOND	3032	GG-5 L	NAP	3043283-R91	G-870	IHCO	3055230-R1	GP-10	IHCO
30212	G-836	LANZ	3032750	GP-1122	IHCO	3043283R92	G-870	CASE	3055230-R91	GP-10	IHCO
30212	G-836	MASY	3032750-R1	GP-1122	IHCO	3043283-R92	G-870	IHCO	3055270R91	GP-54 ¹¹	CASE
30212	G-836	NISS	3032MP	GG-5 L	NAP	304330	GA-106 ⁶⁶	WAUK	3055270R91	GP-66 ¹⁰	CASE
30212	G-836	PERK	3033	GG-5 L	NAP	304330	GA-206	WAUK	3055270-R91	GP-54 ¹¹	IHCO
3021200	G-836	GMCX	3033-002	GA-303	CEWF	304330	GA-326 ⁷¹	WAUK	3055270-R91	GP-66 ¹⁰	IHCO
302121	G-836	MASY	3033-004	GA-3300	CEWF	3043645-R91	G-296	IHCO	3055272-R91	G-1123	IHCO
302121	G-836	PERK	3033MP	GG-5 L	NAP	3043645-R91	G-296-B	IHCO	3055324R91	G-1121F	SEDN
30215	GA-2110	IPD	30342	G-871	PERK	304383-R92	G-870	IHCO	3055650	G-1123	IHCO
3021642	GA-109	CUMM	30-3436861	GP-43	AGCO	3044	GA-730	AUTO	3055650-R91	G-1123	IHCO
3021643	GA-109	CUMM	30-3436861	GP-43	WHIT	3044	GG-6	NAP	3055650-R91	G-1123F	IHCO
3021644	GA-2984	CUMM	30-3437574	GP-1122	WHIT	304405-R91	G-296	IHCO	3055765	GP-81	IHCO
3021645	GA-2984	CUMM	30-3437582	GPP-18	WHIT	304405-R91	G-296-B	IHCO	3055765-R91	GP-81	IHCO
3021658	GP-57	CUMM	303438430	GP-1011Q	AGON	3044106-R91	G-296	IHCO	3055766-R91	GP-54 ¹¹	IHCO
30217	G-871	PERK	30-3455696	GP-178	WHIT	3044106-R91	G-296-B	IHCO	3055766-R91	GP-66 ¹⁰	IHCO
3022	GG-196	BGA	30347	G-871	PERK	3044162	GAK-20	ADAM	3055768-R91	GP-81	IHCO
3022	GG-94	NAP	30-3483576	G-335	WHIT	3044162	GAK-20	ALCH	3056768-R91	GP-81	IHCO
30220	GP-91	WEST	30-3483584	GP-14	WHIT	3044162	GAK-20	FIAT	3056982	G-1121	IHCO
30221	GPP-419	ROO	30-3483592	GP-34	WHIT	3044162	GAK-20	LETR	3056982-R1	G-1121	IHCO
3022104	G-33 ¹⁰⁰	ALCH	30-3483606	GP-3600	WHIT	3044230-12	GP-38	UNSR	3057	GA-74	AUTO
3022104-1	G-33 ¹⁰⁰	ALCH	30-3483614	GP-35	WHIT	3044299-4	GA-360	ALCH	3057-004	GAVW-2	CEWF
3022107241	GA-509 ¹⁴	BLUE	30-3483622	GP-36	WHIT	3044506	G-296	IHCO	3057-007	GA-56	CEWF
3022209	GA-2984	CUMM	30-3483630	G-331	WHIT	3044506	G-296-B	IHCO	3057-008	GA-4365	CEWF
3022211	GA-109	CUMM	30-3485161	G-139	WHIT	3044506-R91	G-296	CASE	3059-13-1021	GA-33	KOMA
3022-21-3470A	GG-5 L	KOMA	30-3497518	GP-78	WHIT	3044506-R91	G-296-B	CASE	3059134-R91	GP-1	IHCO
3022214	GA-109	CUMM	30-3497534	G-122	AGCO	3044506-R91	G-296	IHCO	3059244	G-1123	IHCO
30226	GPP-425	ROO	30-3497534	G-338	AGCO	3044506-R91	G-296-B	IHCO	3059245	G-1123	IHCO
3023	GG-47	AMP	30-3497542	G-122	AGCO	3044506-R92	G-296	IHCO	3059245-R91	G-1123	IHCO
3023	GG-47	BGA	30-3497542	G-338	AGCO	3044506-R92	G-296-B	IHCO	3059245-R92	G-1123	IHCO
3023	GG-63	NAP	30-3497542	G-122	WHIT	3044506-R93	G-296	CASE	3059246R91	GP-54	IHCO
30233	GPP-419	ROO	30-3497542	G-338	WHIT	3044506-R93	G-296-B	CASE	3059246-R91	GP-10	IHCO
30233	GP-40	WEST	30-3497569	GP-1101	WHIT	3044506-R93	G-296	IHCO	3059247R91	GP-54 ¹¹	CASE
3024	GG-76	NAP	30-3497577	G-870	WHIT	3044506-R93	G-296-B	IHCO	3059247R91	GP-66 ¹⁰	CASE
30241	G-813	GULD	30-3498387	GP-110	WHIT	3044506-R94	G-296	IHCO	3059247R91	GP-54 ¹¹	IHCO
30241	G-813	MASY	30-3498409	GP-9586	AGCO	3044506-R94	G-296-B	IHCO	3059247R91	GP-66 ¹⁰	IHCO
30241	G-813	NISS	30-3498409	GP-9586	WHIT	3044713	GAK-403	ALCH	305P	G-836	WIX
30241	G-813	PERK	3035	G-750	LUF	3044713	GAK-403	FIAT	306	GA-77	CRM
30242	G-11816	PERK	30-3506517	GP-3000	WHIT	304505	GA-37	DATT	306	GP-3816	CRO
3025	GG-1	NAP	30-3506819	GP-761H	AGCO	30-4505	GA-37	KENW	306	GG-87	PROT
3025	GG-4	NAP	3035558-R1	GAK-16	IHCO	304558	GA-27	AMHO	306013	GAK-403	WAUK
3025265	G-1175	ALCH	3035753	GP-1	UNSR	3045583	GAK-20	ALCH	3061	G-1173	NAP
30257	GA-360	ASTR	3036	G-750	LUF	3045583	GAK-20	FIAT	3062	G-1175	NAP
30257	GA-360	ATHY	3037-002	GAVW-2	CEWF	3046	GG-19	NAP	3062-002	GA-4325	CEWF
30257	GA-360	CATP	3038732	GA-26	FIAT	3046858	GAK-403	ALCH	3062-006	GA-78	CEWF
302574-R91	G-33	IHCO	3038733-1	GA-26	ALCH	3046858	GAK-403	FIAT	3062788	G-296	IHCO
3026	GG-8	BGA	3039	GA-54	AUTO	3046858-1	GAK-403	ALCH	3062788	G-296-B	IHCO
3026	GG-5 L	NAP	3039-003	GA-277	CEWF	3046MP	GG-19	NAP	3062788R91	G-296	IHCO
3026-000	GA-200	CEWF	3039-004	GAVW-4	CEWF	30472161	GP-1	INGR	3062788R91	G-296-B	IHCO
3026-000	GA-218	CEWF	3039-005	GAVW-2	CEWF	304766-C91	GA-26	IHCO	3063-000	GAD-1 ⁷	CEWF
3026-001	GA-71	CEWF	3039-006	GAVW-2	CEWF	304766C92	GA-26 ¹¹²	CASE	3063-001	GAD-3	CEWF
3026-003	GA-230	CEWF	3039297-12	G-296	UNSR	304766-C92	GA-26	IHCO	3063-003	GA-4303	CEWF
30261	GAD-1 ⁸⁷	IPD	3039297-12	G-296-B	UNSR	3048	GG-48	COO	3063-004	GA-75	CEWF
30262	GA-142	IPD	3039972-R1	GA-6127	IHCO	3048	GG-7	NAP	30630-07310	GA-33	MIT
30262	G-813	MASY	303E1500	G-1143	AMLA	3048581	GAK-403	ALCH	3063-011	GAD-3	CEWF
30262	G-813	PERK	303E630	G-1143	AMLA	3048581	GAK-403	FIAT	3063-013	GAD-15	CEWF
30267	G-834	PERK	303M	G-169	REF	305	GA-9045	AMP	3063-014	GAD-30	CEWF
3027	GG-42	BGA	304	GA-1287	AMP	305	GA-9045	BGA	3063-016	GA-4303	CEWF
302742	GP-462	NANN	304	GA-1287	BGA	305	GA-55	CRM	30630-56800	GA-33	MIT
3028	GG-5 L	BGA	304	GA-56	CRM	305	GA-730	FACE	306353-R91	G-1163	IHCO
3028-000	GA-7	CEWF	304	GP-54 ¹¹	CRO	305	GA-142	PROT	30640-50300	GP-36	MIT
3029	GG-3728	BGA	304	GP-66 ¹⁰	CRO	3050	GG-123	NAP	3066	GG-76	NAP
3029244-R91	G-1123	IHCO	304	GG-19	PROT	3050258	GA-360	ALCH	3066498	GA-33	IHCO
3029244-R91	G-1123F	IHCO	30401-37580	GP-91	KUBO	3050258	GA-360	FIAT	3066498-R1	GA-33	IHCO
3029245	G-1123	IHCO	304101-R91	G-1163	CASE	3050258-5	GA-360	ALCH	3066498-R91	GA-33	IHCO
3029245	G-1123F	IHCO	304101-R91	G-1163	IHCO	3050258-7	GA-360	ALCH	3066498-R92	GA-33	IHCO
3											

Numero	Gonher	Fabricante	Numero	Gonher	Fabricante	Numero	Gonher	Fabricante	Numero	Gonher	Fabricante
Number	Gonher	Manufacturer	Number	Gonher	Manufacturer	Number	Gonher	Manufacturer	Number	Gonher	Manufacturer
3068-002	GA-2740	CEWF	30-781-958	GAK-20	MOND	309443	GA-436	SAAB	3104894-6	G-33	ALCH
3068-007	GA-2740	CEWF	30-781-974	GA-436	MOND	309443001	GA-436	SAAB	31049845	G-33	ALCH
306836	GA-2740	PARM	30-781-975	GA-405	MOND	30945004	GA-467	MBNZ	3105	G-159	WHIT
3068655R91	G-870	CASE	30-781-978	GA-360	MOND	30-946-00	GAVW-120	UFI	31-05264	G-159	WHIT
3068655-R91	G-870	IHCO	30-781-987	GA-106 ⁴⁶	MOND	30947504	GA-475	MBNZ	31-05264-A	G-159	WHIT
3068931-R91	G-33	IHCO	30-781-987	GA-326 ⁷¹	MOND	30948204	GA-5876	MBNZ	31-05264-A7	G-159	WHIT
3069-000	GAD-1	CEWF	30-781-989	GA-467	MOND	30948304	GA-5876	MBNZ	31060166	GG-87	KUSS
306907-C91	GA-27	IHCO	30-781-994	GA-467	MOND	3094830467	GA-5876	MBNZ	31060438	GG-46	KUSS
306908-C91	GA-26	IHCO	3078220	G-31	ZETT	3095	GA-55	AUTO	31060482	GG-242	KUSS
306910-C9	GA-27	IHCO	30782201	G-31	ZETT	3095	GG-5 L	NAP	31063	GAVW-2	IPD
306910-C91	GA-27	IHCO	30-784-354	G-1123F	MOND	309594-C91	GA-5648	IHCO	3107	GP-1101	NAP
306911-C9	GA-27	IHCO	30-784-359	G-1121F	MOND	309594-R91	GA-5648	IHCO	31072	GA-277	IPD
306911-C91	GA-26	IHCO	30-784-604	G-162H	MOND	309653	GG-5 L	HYST	31-07365	GA-31	WHIT
306912-C91	GA-26	IHCO	30-784-675	GP-1122	MOND	3097	GG-47	NAP	31-07365-H	GA-31	WHIT
3069205	G-296	IHCO	30-784-678	G-297	MOND	30-973-00	GAD-15	UFI	3107365H2	GA-31	DIAM
3069205	G-296-B	IHCO	30-784-678	G-297-B	MOND	3097MP	GG-47	NAP	3107365H2	GA-31	DIGT
3069205-R1	G-296	IHCO	30-784-735	G-163	MOND	3098	GA-59	AUTO	3107365H2	GA-31	REOT
3069205-R1	G-296-B	IHCO	30-784-736	G-163	MOND	30980-70020	GAK-403	KAWA	31-07365-H2	GA-31	WHIT
3069205-R91	G-296	IHCO	30-784-739	G-143	MOND	30980-70050	GA-398	KAWA	31-07368	GA-360	WHIT
3069205-R91	G-296-B	IHCO	30-784-740	G-143	MOND	30981-70080	GP-761H	KAWA	31-07368-H	GA-360	WHIT
306975	G-296	IHCO	30-784-749	G-143	MOND	3098170200	GP-761H	KAWA	3107368H2	GA-360	DIAM
306975-R1	G-296-B	IHCO	30-786-158	G-1121F	MOND	3098170340	GP-761H	FURU	3107368H2	GA-360	DIGT
306975-R1	G-296	IHCO	30-786-325	G-1121	MOND	30981-70340	GP-761H	KAWA	3107368-H2	GA-360	REOT
306975-R1	G-296-B	IHCO	30-786-326	G-1123	MOND	30981-70370	GA-398	KAWA	31-07368-H2	GA-360	WHIT
306975-R91	G-296	IHCO	30-789-051	GP-1122	MOND	30981-70410	GA-853R	KAWA	3108-000	GP-81 ²¹	CEWF
306975-R91	G-296-B	IHCO	30-789-092	GP-1122	MOND	309825	GP-81	FORD	3108-000	GP-9 ³⁸	CEWF
307	GA-70	CRM	30-789-105	GP-1122	MOND	30-986-00	GA-4303	UFI	3108-002	GP-81 ²¹	CEWF
307	GP-3600	CRO	30-789-106	GP-1122	MOND	3099	GG-268	NAP	3108-002	GP-9 ³⁸	CEWF
307	GG-196	PROT	30-789-154	GP-1122	MOND	30-991-00	GA-2114	UFI	310813	GA-106	SAAB
30-704-058	GG-1	MOND	30-789-159	GPP-1122	MOND	309944	GP-54	DEMA	310814	GA-206	SAAB
30-704-058	GG-4	MOND	30-789-900	G-296	MOND	309954-C91	GA-5648	IHCO	310816	GA-6129	SAAB
30-704-160	GG-5 L	MOND	30-789-900	G-296-B	MOND	30-996-00	GAVW-121	UFI	310817	GA-6127	SAAB
307090	GAK-20	WHIL	3079	GG-42	NAP	30A	GA-436	BOG	31-08839	GA-21	WHIT
3071	G-1176	NAP	307963-05	G-813	LEYL	30A40-00100	GP-149	MIT	3109	GP-1101	NAP
3071235-R91	G-33	IHCO	307976	GAK-403	WHIL	30A40-00100A	GP-149	MIT	31099	G-296	LAND
3072251M1	GA-6127	HANO	308	GP-31	CRO	30A40-00102	GP-149	MIT	31099	G-296-B	LAND
3072254M1	GA-6129	HANO	308	GG-20	PROT	30A40-00103	GP-149	MIT	31099	G-296	LANI
3072700198	G-834	MBNZ	3080	G-1163	NAP	30RFS105	G-169	SUND	31099	G-296-B	LANI
30729	GPP-419	ROO	30804	GA-11	LAUS	31.501.00	GG-5 L	UFI	31099	G-296	LEYL
3073	GA-75	AUTO	30804	GA-11	TECU	31.503.00	GG-226	UFI	31099	G-296-B	LEYL
3073	G-1174	NAP	30-806-00	GA-50	UFI	31.510.00	GG-5 L	UFI	3109MP	GP-1101	NAP
30-738-018	GP-22	MOND	3081	GG-87	NAP	31.517.00	GG-142	UFI	311	GA-78	CRM
30-738-026	GP-3816	MOND	30-816-00	GA-303	UFI	31.551.00	GG-114	UFI	311	GP-81	CRO
30-738-029	GP-81 ³¹	MOND	30-817-00	GAVW-2	UFI	31.580.00	GG-164	UFI	311	GG-6	PARM
30-738-029	GP-9 ³⁸	MOND	30-818-00	GAVW-2	UFI	31.589.00	GG-260	UFI	311-00-190-02-0	GA-49	STEY
30-738-033	GP-28	MOND	3081MP	GG-87	NAP	31.592.00	GG-164	UFI	311-00-190-70-1	GA-49	STEY
30-738-048	GP-3816	MOND	3082	GG-8	NAP	31.611.00	GG-255	UFI	3110452-R1	G-870	IHCO
30-738-050	GP-3816	MOND	30822	GA-106 ⁴⁶	ENUM	31.636.00	GG-148	UFI	3110452R91	G-870	CASE
30-738-078	GP-46	MOND	30822	GG-115	UFI	31.642.00	GG-115	UFI	31-10720	G-200	WHIT
30-738-150	GP-40	MOND	30822	GA-326 ⁷¹	ENUM	31.649.00	GG-136	UFI	311099-R91	G-1163	IHCO
30-738-162	GP-81 ³¹	MOND	3082654	G-871	RENA	31.671.00	GG-217	UFI	3111946	GP-55	FIAT
30-738-162	GP-9 ³⁸	MOND	3082657	G-297	RENA	310	GA-71	CRM	3112	G-1123	NAP
30-738-207	GP-171	MOND	3082657	G-297-B	RENA	310	GP-3985	CRO	3112	G-1123F	NAP
30-738-221	GP-81	MOND	3082658	G-834	RENA	310	GP-44	DEL	3113	GA-86	AUTO
30-738-225	GP-3985	MOND	3082659	G-871	CITR	3100	GG-6	PAR	3113	G-1173	NAP
3074-004	GAD-1 ⁸⁷	CEWF	3082659	G-871	RENA	31-001-00	GG-1	UFI	31130-01312	GAK-20	MIT
3074-005	GA-2719B	CEWF	3082667	G-836	RENA	31-001-00	GG-4	UFI	31130-02300	GAK-20	MIT
3074-014	GA-180	CEWF	3082669	G-813	RENA	3100127	GA-200	DAF	31130-16400	GA-360	MIT
3074-021	GA-139	CEWF	3082671	GP-38	RENA	3100127	GA-218	DAF	31133	GP-53	VERS
307567-C91	GA-26	IHCO	3083	GA-50	AUTO	31001274	GA-200	VOLV	3114-001	GP-1	CEWF
307567-C92	GA-26 ¹²	IHCO	30830-11200	GAK-403	MIT	31001274	GA-218	VOLV	3114-002	GP-5	CEWF
307567-K92	GA-26 ¹²	IHCO	30830-19200	GAK-16	MIT	31-00213	G-870	FRIG	3114-003	GP-1	CEWF
30-758-001	GP-54	MOND	30-833-00	GA-2194	UFI	31-00214	G-1176	FRIG	31147	GA-2740	IPD
30-758-002	GP-54	MOND	30-835-00	GAVW-4	UFI	31-00308	G-1173	FRIG	3115	GP-110	NAP
30-758-004	GP-31	MOND	3084	GG-203	NAP	31-005-00	GG-76	UFI	31152	G-24	LBHR
30-758-010	GP-31	MOND	30-841-00	GAVW-2	UFI	310054	G-31	SHEP	3115559-R91	GA-459	IHCO
30-758-012	GP-310	MOND	30-848-00	GA-2194	UFI	31006	GP-1101	COLT	31-1558043	GAK-20	WHIT
30-758-061	GP-310	MOND	3084963	GP-91	POLA	31-006-00	GG-203	UFI	31-1558093	GAK-20	WHIT
30-758-066	GP-36	MOND	3085	GG-203	NAP	310063	G-1173	SHEP	3116	GA-85	AUTO
30-758-067	GP-54 ¹¹	MOND	308504-C91	GA-26	IHCO	3101	GA-57	AUTO	3116	GP-55	NAP
30-758-067	GP-66 ¹⁰	MOND	30-851-00	GA-277	UFI	31-01112	GA-27	WHIT	3116-000	G-870	CEWF
30-758-070	GP-81	MOND	30-857-00	GAVW-2	UFI	3101112H	GA-27	DIGT	311647	GP-66	CASE
30-758-071	GP-10	MOND	30-860-00	GA-4365	UFI	3101112H2	GA-27	DIAM	311647	GP-66	DAVS
30-758-077	GP-51	MOND	30-864-00	GAVW-2	UFI	3101112H2	GA-27	REOT	311654	GP-66	DAVS
30-758-880	GP-40	MOND	30-864-02	GAVW-2	UFI	31-0112-H	GA-27	WHIT	3116609-R91	GP-36	IHCO
30-758-881	GP-3531	EXP	3087	GG-196	NAP	310123	G-1173	FARB	3116609-R92	GP-36	IHCO
30-758-887	GP-3682	MOND	30-87	GG-123	CAR	310123	G-1173	SHEP	31-16833	GAK-625	WHIT
30-758-887	GP-37	MOND	30-870-00	GAVW-2	UFI	310130	G-1173	SHEP	31-1683380	GAK-625	WHIT
30-758-893	GP-171	MOND	30-873-00	GAVW-4	UFI	31017541	GG-19	KUSS	3117	G-1176	NAP
30-758-898	GP-1	MOND	3088	GA-192	AUTO	3101871	GPP-10075	CUMM	3117-001	G-870	CEWF
3077	GA-3300	AUTO	3089	GG-188	NAP	31-01874	G-169	WHIT	3118	G-750	LUF
30-780-025	GA-349	MOND	3089BP	GG-188	NAP	3102-001	G-870	CEWF	3118	GP-26	NAP
30-780-035	GA-303	MOND	309	GA-78	AMP	310274	G-1143	FARB	3118119-R1	GP-1	IHCO
30-780-053	GA-50	MOND	309	GA-78	BGA	310274	G-1143	SHEP	3118119-R91	GP-9	IHCO
30-780-057	GA-277	MOND	309	GP-3429	DEL	310284	G-31	FARB	311811-R91	GP-9	IHCO
30-780-073	GA-3300	MOND	309112	GP-9	HYST	310284	G-31	SHEP	3118MP	GP-26	NAP
30-780-075	GAVW-2	MOND	30-914-00	GA-2110	UFI	31028723	GP-3985	VOLV	312	GA-80	CRM
30-780-076	GAVW-2	MOND	30-914-02	GA-2110	UFI	3103	GA-3523	AUTO	312	GA-192	DEL
30-780-078	GAVW-4	MOND	30-925-00	GAVW-4	UFI	3103	GG-137	NAP	312	GA-7017	PROT
30-780-085	GA-4365	MOND	3093	GG-240	NAP	3-10309	GP-54	CAP	3120	GP-27	NAP
30-780-109	GAVW-2	MOND	30940601	GP-28 ⁸	MBNZ	310310	G-31	SHEP	3-12021-111-0	GAK-403	ISUZ
30-780-842	GA-2740	MOND	30940601	GP-430 ⁹	MBNZ	31-03535	GA-5648	WHIT	312021-11110	GAK-403	FURU
30-781-932	GA-49	MOND	30941504	GA-467	DAIM	310393	G-1173	PUR	3-12021-111-10	GAK-403	ISUZ
30-781-933	GAK-16	MOND	30941504	GA-467	MBNZ	310402	G-6	SHEP	3120MP	GP-27	NAP
30-781-940	GAK-403	MOND	309439	G-1121	SAAB	3104894	G-33	ALCH	3121	GP-92	NAP
30-781-947	GA-206	MOND	30-944-00	GAVW-622	UFI	3104894-5	G-33	ALCH	3121MP	GP-92	NAP

Referencia Cruzada por Numero de Parte

Cross Reference by Part Number



Numero	Gonher	Fabricante	Numero	Gonher	Fabricante	Numero	Gonher	Fabricante	Numero	Gonher	Fabricante
Number	Gonher	Manufacturer	Number	Gonher	Manufacturer	Number	Gonher	Manufacturer	Number	Gonher	Manufacturer
3122		GP-93 NAP	31327-R9		GP-10 IHCO	31504-00		GG-246 UFI	31669-00		GG-185 UFI
3122MP		GP-93 NAP	3132887		GPP-11 VOLV	31505-00		GG-189 UFI	3166MP		G-296 NAP
3123-000		GP-46 CEWF	3133		GA-277 AUTO	3150-6		G-31 MIC	3166MP		G-296-B NAP
3123-003		GP-46 CEWF	3133		GC-1133 NAP	31506-00		GG-246 UFI	3167		G-1121 NAP
3123-004		GP-3985 CEWF	3133-001		GP-3682 CEWF	31507-00		GG-246 UFI	3167-000		GP-3531 EXP CEWF
31230-06102		GA-26 MITS	3133-001		GP-37 CEWF	31518		GPP-424 ROO	3167-002		GP-42 CEWF
31230-06120		GA-26 MITS	3133241-R1		GAK-16 IHCO	31523-00		GG-185 UFI	3167-004		GP-462 CEWF
31230-12700		GA-106 ⁴⁶ MITS	3133858-1		G-296 UNSR	31526-00		GG-185 UFI	316701		G-31 DIAM
31230-12700		GA-326 ⁷¹ MITS	3133858-1		G-296-B UNSR	31527-00		GG-185 UFI	31-6701		G-750 WHIT
31230-60600		GA-27 MITS	3133858-12		G-296 UNSR	31528-00		GG-94 UFI	316702		G-500 WHIT
31230-60601		GA-27 MITS	3133858-12		G-296-B UNSR	31529-00		GG-63 UFI	31-6702		G-500 DIAM
31230-80500		GA-206 MITS	3134		GS-1133 NAP	3153		GG-189 NAP	31-6707		G-500 WHIT
31230-84800		GA-106 ⁴⁶ MITS	3134		G-870 NIPP	31530-00		GG-137 UFI	316741-C91		GA-5648 IHCO
31230-84800		GA-326 ⁷¹ MITS	3134-000		G-162H CEWF	3153230		GP-1 AMCO	3167847		GP-5 AMCO
3123567		G-296 FENW	3134055		GPP-1122 VOLV	3153230		GP-1 CHRY	3168-000		GP-24 ²⁶ CEWF
3123567		G-296-B FENW	313429		GA-360 WHIL	31539-00		GG-190 UFI	3168-000		GP-462 ²⁴ CEWF
3124		GP-1122 NAP	3134477-R92		G-296 IHCO	3154354		GP-50 AMCO	3168-002		GP-3985 ⁸³ CEWF
3124011-R1		GAK-458 IHCO	3134477-R92		G-296-B IHCO	3154354		GP-50 CHRY	3168-004		GP-149 ⁸⁹ CEWF
3124011-R2		GAK-458 IHCO	3135		GG-246 NAP	3154362		GP-50 AMCO	3168-004		GP-91 ⁷⁸ CEWF
3124012-R1		GA-459 IHCO	3135948-12		GP-3600 UNSR	3154364		GP-50 AMCO	3169-000		GP-3985 ⁸³ CEWF
3124014-R1		GA-33 IHCO	3136		GA-4303 AUTO	3154364		GP-50 CHRY	316960-C91		GA-26 IHCO
3124027		GP-149 HYST	3136		G-294 NAP	31546-00		GG-185 UFI	316972-C91		GA-27 IHCO
3124027-12		GP-149 UNSR	3136046-R91		GP-36 IHCO	31550-00		GP-91 ⁷⁸ CEWF	317		GAK-20 AMP
3124338-R1		GAK-403 IHCO	3136046-R92		G-870 IHCO	3155-001		GP-81 CEWF	317		GAK-20 BGA
3124339-R1		GAK-20 IHCO	3136046-R93		GP-36 IHCO	315530		GA-8 PART	317		GA-192 CRM
3124456		G-296 RENA	3136187-R91		GP-1122 IHCO	31554-00		GG-185 UFI	3170		GAVW-2 AUTO
3124456		G-296-B RENA	3136406R91		GP-54 ¹¹ CASE	31556-00		GG-187 UFI	31701010		GP-2071W BOMG
31-2461793		GA-106 ⁴⁷ WHIT	3136406R91		GP-66 ¹⁰ CASE	31559-00		GG-185 UFI	31701051		GP-2071W BOMG
31-2461793		GA-206 ⁰⁸ WHIT	3136406-R91		GP-54 ¹¹ IHCO	3156		GG-246 NAP	31701053		GP-1011Q BOMG
31-2461793		GA-326 ⁷² WHIT	3136406-R91		GP-66 ¹⁰ IHCO	3156		GG-408 NAP	31701054		GP-43 BOMG
3124910-12		GP-3 UNSR	3136458-R1		GP-81 IHCO	31564-00		GG-46 UFI	31701061		GPP-10 ³⁰ BOMG
3125		GP-92 NAP	3136459-R91		GP-81 ³¹ IHCO	31565-00		GG-146 UFI	31701061		GPP-11 ³⁹ BOMG
31250		GA-100 CAC	3136459-R91		GP-9 ⁵⁸ IHCO	31567-00		GG-67 UFI	31701062		GPP-103 ⁴⁰ BOMG
3125077		GAK-16 HYST	3136459-R93		GP-9 IHCO	31571-00		GG-246 UFI	31701062		GPP-11 ³⁹ BOMG
3125199-R1		GAK-16 IHCO	3136460R91		GP-54 ¹¹ CASE	31572		GPP-425 ROO	31701105		GP-1101 BOMG
3125199-R2		GAK-16 IHCO	3136460R91		GP-66 ¹⁰ CASE	31572-00		GG-246 UFI	31701500		G-500 BOMG
3125199-R2		GAK-16 KOMA	3136460-R91		GP-10 IHCO	3157847		GP-5 AMCO	31701613		G-613 BOMG
31254		GA-113 CAC	313658		GP-1 TOWM	3157847		GP-5 CHRY	31701613		G-613 KOEH
31255		GA-113 CAC	31-3658		GP-1 CATP	3157877		GP-13 AMCO	31701670		GP-53 BOMG
3126-000		GP-22 CEWF	313707-R91		GA-5648 IHCO	31584-00		GG-251 UFI	31701734		GP-43 BOMG
3126-001		GP-91 ⁷⁸ CEWF	313709-R91		GA-5648 IHCO	3158648		GAK-16 EATN	31725-L1000		GP-58 NISS
312732230		GAK-20 OLIV	3138-000		G-870 CEWF	3158658		GA-33 EATN	31725-L1000B		GP-58 NISS
31-2732230		GAK-20 WHIT	3138-001		GP-1 CEWF	31587-00		GG-3728 UFI	31732		GPP-418 ROO
31-275007		GAK-625 WHIT	313827R91		G-335 IHCO	3159		G-1123 ¹⁰⁸ NAP	31733		GPP-419 ROO
31-2752257		GP-31 AGCO	31385		GPP-419 ROO	31591-00		GG-581 UFI	31734		GPP-419 ROO
31-2752257		GP-31 WHIT	31387		GPP-421 ROO	31594-00		GG-246 UFI	31734		GP-421 ROO
31-2755007		GAK-625 AGCO	3139-003		GP-28 ⁹ CEWF	316		GAK-16 AMP	317342		G-169 GMCX
31-2755007		GAK-625 WHIT	3139-003		GP-430 ⁸ CEWF	316		GAK-16 BGA	31737		GPP-426 ROO
31-2770467		GP-1 WHIT	3139-004		GP-310 CEWF	316		G-31 CRO	31738		GPP-424 ROO
31-2772597		GA-106 ⁴⁶ WHIT	3139010		G-33 RENA	3160		GG-232 NAP	3174-001		GP-3682 CEWF
31-2772597		GA-326 ⁷¹ WHIT	3139-011		GP-28 ⁹ CEWF	3160-000		GP-3985 CEWF	3174-001		GP-37 CEWF
31-2772607		GA-206 AGCO	3139-011		GP-430 ⁸ CEWF	31605-00		GG-185 UFI	3174-002		GP-81 ³¹ CEWF
31-2772607		GA-206 WHIT	31391		GPP-425 ROO	316071		G-750 EUCL	3174-002		GP-9 ⁸ CEWF
3127-81-9031		GA-6127 KOMA	313964-R91		GA-18 IHCO	316072		G-500 WHIT	3174-003		GP-58 CEWF
31-2795397		GP-1122 AGCO	3139661		G-1175 RENA	31608-00		GG-185 UFI	3174-004		GP-81 ³¹ CEWF
31-2795397		GP-1122 WHIT	313A		GAK-216 GREY	31609-00		GG-185 UFI	3174-004		GP-9 ⁸ CEWF
3128		GPP-111 NAP	313AF		GAK-216 GREY	3161		GG-251 NAP	3174-007		GP-1 CEWF
3128		GPP-524 NAP	314		GP-462 CRO	3161267		GP-5 AMCO	31756		G-278 STDY
3128-81-7042		GA-6127 KOMA	314		GA-78 DEL	3161267		GP-5 CHRY	3177601		GP-5 AMCO
3128-81-7042		GA-6128 KOMA	3140		GA-3424 AUTO	31614-00		GG-215 UFI	3177601		GP-5 CHRY
3129		GG-209 NAP	3140		GPP-612 NAP	31615-00		GG-215 UFI	3177754		GP-317H VOLV
313		GA-56 BGA	3141		GA-3425 AUTO	31616		GPP-419 ROO	3177757		GP-5 AMCO
313		GP-20 CRO	314120		G-1121 SAME	31616-00		GG-181 UFI	31780104		GP-57 BOMG
313		GG-123 PARM	314120		G-1121F SAME	31617		GPP-424 ROO	31780104		GP-57 KOEH
313		GA-362 PROT	314130		G-1121 SAME	31619-00		GG-181 UFI	31780204		GP-390 BOMG
31300		GPP-425 ROO	31415W		G-500 MINN	3162		GG-215 NAP	31780205		GP-1122 BOMG
3130-000		GP-3816 CEWF	3141914		GP-310 RENA	3162-000		GP-91 ⁷⁸ CEWF	31780206		GPP-18 BOMG
3130-001		GP-171 CEWF	3142		G-296 NAP	31621-00		GG-160 UFI	317885		GP-761H CUMM
3130-002		GP-28 ⁹ CEWF	3142		G-296-B NAP	31623-00		GG-30 UFI	3179		GG-251 NAP
3130-002		GP-430 ⁸ CEWF	31422-72		GG-5 L MITTS	31624-00		GG-47 UFI	318		GA-26 AMP
31302		GPP-423 ROO	3142456		G-834 RENA	31625-00		GG-268 UFI	318		GA-26 BGA
3130920-R91		GAK-403 IHCO	3142456		G-834 SOPA	31627-00		GG-1872 UFI	318		GA-75 CRM
3131-001		GP-58 CEWF	314361		GP-1 TOWM	3163		G-297 NAP	3180187		GC-1133 IHCO
3131-002		G-834 CEWF	31-4361		GP-1 CATP	3163		G-297-B NAP	3180193		GS-1133 IHCO
3131-004		GP-28 ⁹ CEWF	3144		G-1143 NAP	3163-001		GP-3682 CEWF	3180836		G-33 RENA
3131-004		GP-430 ⁸ CEWF	3144477-R91		G-296 IHCO	3163-001		GP-37 CEWF	3181		G-1166 NAP
3131411		GAVW-4 HYST	3144477-R91		G-296-B IHCO	3163-002		GP-171 CEWF	3181366		GP-5 AMCO
3131750		GP-57 VOLV	3144477-R92		G-296 IHCO	3163-003		GP-171 CEWF	3181366		GP-5 CHRY
3131751		GP-2071W VOLV	3144477-R92		G-296-B IHCO	3163-004		GP-38 CEWF	3181366		GP-5 JEEP
3132		G-750 LUF	314531072		GA-33 SHIB	3163-005		G-870 CEWF	3181366B		GP-5 AMCO
3132015		G-1123 IHCO	3146927-R1		GA-49 IHCO	31633-00		GG-232 UFI	3181366-B		GP-5 JEEP
3132015-R92		G-1123 CASE	3146927-R91		GA-49 IHCO	316372-C9		GA-27 IHCO	3181367		GP-5 JEEP
3132015-R92		G-1123 IHCO	3147441		GP-28 ⁹ IHCO	316372-C91		GA-27 IHCO	3181367-B		GP-5 JEEP
3132023R92		GP-171 IHCO	3147441		GP-430 ⁸ IHCO	31639-00		GG-98 UFI	318150-C91		G-750 IHCO
3132123-R91		GP-10 IHCO	3147441R91		GP-28 ⁹ CASE	31648		GPP-426 ROO	3182442		GAK-20 AVEL
3132183-R91		GP-171 IHCO	3147441R91		GP-430 ⁸ CASE	31648-00		GG-185 UFI	3183		GG-290 NAP
3132275-R1		GPP-1122 IHCO	3147441-R91		GP-28 ⁹ IHCO	31649		GPP-425 ROO	3184		GPP-1283 ³⁹ NAP
3132275-R91		GP-1122 IHCO	3147441-R91		GP-430 ⁸ IHCO	3165818		GP-50 AMCO	3184		PFF831 ⁴¹ NAP
3132428-R1		GPP-1122 IHCO	3147441-R92		GP-28 ⁹ IHCO	3166		G-296 NAP	3184		R 60 P ⁴² NAP
3132428-R2		G									

Numero	Gonher	Fabricante	Numero	Gonher	Fabricante	Numero	Gonher	Fabricante	Numero	Gonher	Fabricante
Number	Gonher	Manufacturer	Number	Gonher	Manufacturer	Number	Gonher	Manufacturer	Number	Gonher	Manufacturer
31870		GPP-418 ROO	3201438		G-1123 CLRK	32-22		GAK-1532 ERO	324-14-300		GP-91 MZDA
31872		GPP-419 ROO	32020		GA-70 NAPS	32223001		G-871 CITR	3242		GPP-103 ⁴⁰ NAP
31873		GPP-419 ROO	32029		GA-33 EXCL	322230010		G-871 CITR	3242		GPP-11 ³⁹ NAP
31875		GPP-419 ROO	3203		GG-76 NAP	3222897		GP-20 AMCO	324-23-802		GP-149 ⁹ MZDA
31876		GPP-419 ROO	3204		GG-208 NAP	3222899		GP-20 AMCO	324-23-802		GP-91 MZDA
3188		G-1166 NAP	3208		2010PM-OR ⁷ NAP	3222899		GP-20 CHRY	3242397		GP-44 AMCO
3188793		GP-5 AMCO	3208		2010TM-OR ⁷ NAP	3223		GG-220 NAP	3242397		GP-44 CHRY
3188793		GP-5 CHRY	3208320		GP-5 AMCO	32-23170		GA-416 JCBM	3243		GG-101 NAP
318880		G-1121 SAME	3208320		GP-5 CHRY	3223251		GAK-403 RENA	324335		G-6 EATN
318880		GP-1101 SAME	3209		GS-2034 NAP	322405		G-1121 DAIM	324335		G-6 YALE
318887-C92		G-1123 IHCO	320AR		GA-516R KS	322405		G-1121 MBNZ	3244		GP-1101 NAP
3189		G-1166 NAP	321		GA-4365 PROT	32243		GPP-426 ROO	3244142		G-1175 GMCX
319		GAK-403 AMP	3210		GS-2033 NAP	3224385		G-31 HERC	324617A1		GP-9000 CASE
319		GAK-403 BGA	3210185-R1		GA-360 IHCO	32243-85		G-31 WHIT	324618A1		GP-2126Q CASE
319		GP-36 CRO	3210209		G-297 VOLV	32243CS		G-31 HERC	324692		GP-462 HYST
3190		GG-177 NAP	3210209		G-297-B VOLV	32243-CS		G-31 WHIT	324957001		GPP-1291 ³⁹ FREI
3190562		GA-77 AMCO	32102097		G-297 VOLV	3225897		GP-20 AMCO	324957001		S 3226 P ⁴⁰ FREI
3190562		GA-77 CHRY	32102097		G-297-B VOLV	3225897		GP-20 CHRY	3249665		G-1175 GMCX
3190563		GA-77 AMCO	321091		G-834 NEWH	3226315		GAK-20 JOY	324A		GA-11 GREY
3190563		GA-77 CHRY	3211		GPP-14 NAP	3227		GG-7018 ³⁸ NAP	325		GA-325 FACE
3190564		GA-77 AMCO	3212		GS-2033 NAP	3227		GG-7019 ³⁷ NAP	325		GA-141 PROT
3190564		GA-77 CHRY	32-1202501		GA-361 JCBM	3227		GG-7020 ¹⁴ NAP	3250		G-750 LUF
31910-11000		GG-196 HYUN	3212882		GG-5 AMCO	3227778		GAK-403 JOY	3250334		GP-28 ⁶ AMCO
31910-11100		GG-196 HYUN	3212882		GG-5 L CHRY	3228		GG-351 NAP	3250334		GP-430 ⁸ AMCO
31910-21000		GG-196 HYUN	321320		GS-1133 CUMM	3-22A		GG-19 PARM	32511		G-834 MASY
31910-21000		GG-196 MITS	3213711		G-871 CLRK	323		GA-105 CRM	32511		G-834 NISS
31910-21100		GG-196 HYUN	3214		GG-194 NAP	323		GA-300 PROT	32511		G-834 PERK
31910-21100		GG-196 MITS	3214300100		GAK-20 HOKU	32-300518		G-33 JCBM	32512		G-836 PERK
31910-21200		GG-196 HYUN	3214300300		GA-33 HOKU	3230272		GA-360 CUMM	32516		G-169 GARI
31910-28300		GG-185 HYUN	3214300400		GAK-16 HOKU	3230273		GA-361 CUMM	3252002		GA-49 MASY
31910-33601		G-277 HYUN	3214300500		GA-26 HOKU	32306		GPP-420 ROO	32527		GP-813 AMCO
31911-02100		GG-169 CHRY	3214300700		GA-27 HOKU	3231		GPP-1287 ³⁹ NAP	32527		G-813 FERG
31911-02100		GG-169 HYUN	3214300800		GAK-403 HOKU	3231		PPF831 ⁴¹ NAP	32527		G-813 KAIS
31911-05000		GG-369 HYUN	3214301200		GAK-16 HOKU	3231		R 60 P ⁴² NAP	32527		G-813 LAND
31911-22000		GG-114 HYUN	3214302700		GA-360 HOKU	32311		GPP-426 ROO	32527		G-813 MASY
31911-25000		GG-182 HYUN	3214303400		GA-6129 HOKU	323142		G-1175 GMCX	32527		G-813 NISS
31911-33301		GG-223 HYUN	3214303500		GA-27 HOKU	32317		GAK-403 OK	32527		G-813 PERK
31911-34000		GG-187 HYUN	3214303600		GA-106 ⁴⁶ HOKU	32317		GAK-403 OREN	32527		G-813 WILY
3192		GPP-1122 NAP	3214303600		GA-326 ⁷¹ HOKU	3232		GPP-547 ³⁹ NAP	3253		GG-5 L NAP
31925		GA-12 LAUS	3214304100		GA-360 HOKU	3232		PPF831 ⁴¹ NAP	3255-000		GG-246 CEWF
31925		GA-12 TECU	32143-04100		GA-360 MITS	3232		R 60 P ⁴² NAP	32562-20300D		GP-110 MITS
319255-P01		GAK-16 HAGI	3214305300		GA-206 HOKU	3232126		GP-28 ⁶ AMCO	3257		GG-239 NAP
31928		GP-171 ARIE	32143-05300		GA-206 MITS	3232126		GP-430 ⁸ AMCO	3257-003		GG-226 CEWF
31928		G-813 PERK	32143065		G-296 CITR	32327		G-11816 PERK	32578		G-836 CHRY
319290P01		GAK-16 HAGI	32143065		G-296-B CITR	323274-C9		GA-27 IHCO	32578		G-836 DECH
319292P0		GAK-16 HAGI	321430650		G-296 CITR	323274-C91		GA-27 IHCO	32578		G-836 JOND
3193		GG-580 NAP	321430650		G-296-B CITR	323275		GA-27 IHCO	32578		G-836 MASY
3193898		GG-19 AMCO	3214306500		GA-361 HOKU	323275-C91		GA-27 IHCO	32578		G-836 NISS
3193898		GG-19 CHRY	32143-06500		GA-361 MITS	323276		GA-27 IHCO	32578		G-836 PERK
3194		G-11816 NAP	3214313		G-834 CLRK	323276-C91		GA-27 IHCO	325827-R91		G-335 IHCO
3195		GP-1122 NAP	3214797R1		GP-31 CASE	323277		GA-26 IHCO	32591		G-813 MASY
3196		G-297 NAP	32148P		GG-194 NAP	323277-C91		GA-26 IHCO	32591		G-813 PERK
3196		G-297-B NAP	3215		G-500 LUF	323278		GA-26 IHCO	32599		G-834 BAUT
31962-04010		GPP-18 NISS	32150-40840-71		GP-81 TOYO	323278-C91		GA-26 IHCO	32599		G-834 CHRY
3196332		GP-20 AMCO	3215877		GP-20 AMCO	3234-001		G-1121 CEWF	32599		G-834 DECH
3196333		GP-5 AMCO	3215877		GP-20 CHRY	3234-002		G-1121 CEWF	32599		G-834 LEYL
3196333		GP-5 CHRY	3216		GP-85 NAP	3234-006		GG-3 CEWF	32599		G-834 MASY
3196841		GP-5 AMCO	3216-1655-00		GP-5 ¹⁰ ATCO	3234142		G-1173 GMCX	32599		G-834 MOTA
3196841		GP-5 CHRY	3216-1655-00		GP-691 ⁴⁸ ATCO	3235398M1		GA-206 HANO	32599		G-834 NISS
319700-PO		GA-33 HAGI	3216-2456-00		GA-6129 ATCO	3236		GG-187 NAP	32599		G-834 PERK
319709-P01		GA-33 HAGI	3216-2614-00		GA-361 ATCO	3237		GP-1107 NAP	32599		G-834 YALE
31973-44001		GPP-111 HYUN	3216-3286-00		GA-106 ⁴⁶ ATCO	3238-000		GG-246 CEWF	326		GA-730 AMP
31973-44001		GPP-524 HYUN	3216-3286-00		GA-326 ⁷¹ ATCO	323827R91		G-335 CASE	326		GA-730 BGA
31973-44100		GPP-111 HYUN	3216-3287-00		GA-206 ATCO	323827R91		G-335 HOUG	326		G-1173 CRO
31973-44100		GPP-524 HYUN	3216-7081-02		GA-206 ATCO	323827-R91		G-335 IHCO	326		GA-59 FACE
31976-43670		GG-237 HYUN	3216-9214-0		GP-54 ¹¹ ATCO	323827-R91		G-335 KOMA	326		GA-164 PROT
3198112		GP-5 AMCO	3216-9214-0		GP-66 ¹⁰ ATCO	323828R91		G-335 CASE	32-600117		GP-68 JCBM
3198615		GG-5 AMCO	3216-9214-01		GP-77 ATCO	323828-R91		G-335 IHCO	32-60017		GP-68 JCBM
3198615		GG-5 L CHRY	3217-000		GG-5 L CEWF	323838-C91		G-1143 IHCO	326065		GP-1122 SAAB
3199		GG-64 NAP	32170979		GA-12 INGR	323842R91		G-333 IHCO	326143		G-6 EATN
319926-R1		G-33 IHCO	32179		GPP-423 ROO	3239		GP-1101 NAP	32614300		G-6 YALE
319926-R91		G-33 IHCO	3218		GA-390 AUTO	3239-001		GG-246 CEWF	3262-000		GG-196 CEWF
31-999-00		GG-185 UFI	3218		GP-84 NAP	3239-003		GPP-1122 CEWF	3262-002		GPP-111 CEWF
31X10894A		GA-33 JOND	3218793-R91		GPP-1122 IHCO	3239-005		GG-226 CEWF	3262-002		GPP-524 CEWF
31X11513A		GAK-20 JOND	3218794R91		GPP-1122 CASE	3239-006		GPP-1122 CEWF	32-62159		GA-27 KENW
31X11546A		GAK-20 JOND	3218794-R91		GP-1122 IHCO	324		G-1176 CRO	32-62172		GA-26 KENW
32		GG-5 L PARM	3219		GP-83 NAP	324		GA-85 FACE	3262290000		GP-3682 NISS
32/909200		GP-761H JCBM	322		G-1173 CRO	32-400052		G-297 JCBM	32622-900002		GP-3682 NISS
32/910700A		GP-9 JCBM	322		GAVW-4 PROT	32-400052		G-297-B JCBM	32622-900002		GP-37 NISS
32/915700		GA-853R ¹⁰⁴ JCBM	32-200102		GAK-16 JCBM	32-400502		G-297 JCBM	32622-90002		GP-3682 NISS
32/915701		GA-853R JCBM	32200-35753		G-1173 KUBO	32-400502		G-297-B JCBM	32622-90002		GP-37 NISS
320		GA-33 AMP	32200-35791		G-1173 KUBO	32-400701		G-296 JCBM	32622-9002		GP-3682 NISS
320		G-870 ASAH	32200-35793		G-1173 KUBO	32-400701		G-296-B JCBM	32622-9002		GP-37 NISS
320		GAK-403 JCBM	32-200406		GAK-403 JCBM	32-401102		G-296 JCBM	32623-12620-71		GP-58 TOYO
320		GA-349 CRM	32-201033		GA-33 JCBM	32-401102		G-296-B JCBM	32623-20570-71		GP-81 TOYO
320		GPP-14 DAVC	32-201074		GAK-16 JCBM	32-401701		G-296 JCBM	3263-000		GG-5 L CEWF
320		GG-20 PARM	32-201601		GA-361 JCBM	32-401701		G-296-B JCBM	3263-002		GG-45 CEWF
320		GA-165 PROT	32-201602		GA-360 JCBM	3240511		GP-3429 AMCO	3263-003		GG-196 CEWF
3200		GG-7 PAR	32-20217705		GAK-403 JCBM	3240511		GP-3429 CHRY	3263-004		GG-5 L CEWF
32006		GA-7 TECU	32-202501		GA-361 JCBM	32411120717		G-162H BMW	3263-009		GG-76 CEWF
32007		G-3752 HEN	32-203702		GAK-216 JCBM	3241389		GP-46 AMCO	3263-011		GG-5 L CEWF

Referencia Cruzada por Numero de Parte

Cross Reference by Part Number



Numero	Gonher	Fabricante	Numero	Gonher	Fabricante	Numero	Gonher	Fabricante	Numero	Gonher	Fabricante
Number	Gonher	Manufacturer	Number	Gonher	Manufacturer	Number	Gonher	Manufacturer	Number	Gonher	Manufacturer
32650		GPP-421 ROO	3294		GG-220 NAP	33068		GG-4 WIX	3315843		GPP-11 CUMM
3267		GG-208 CEWF	3295		GG-150 NAP	33071		G-1176 WIX	3315844		GP-1101 CUMM
3267-012		GG-580 NAP	3296		GG-1872 NAP	33073		G-1174 WIX	3315846		GP-1101 CUMM
326701-2620		GP-215 CEWF	3296MP		GG-1872 NAP	330780		GA-39 TOWM	3315847		GPP-14 CUMM
32670-12620-71		GP-58 ⁸ DENS	32974		GG-185 PARM	33-0780		GA-39 CATP	33159		G-1123 ¹⁰⁸ WIX
3267-013		GP-58 ⁸ TOYO	3298		GG-115 NAP	3307885		GP-53 CUMM	3316		GG-99 NAP
326771-4		GG-181 CEWF	32C40-00100		GP-91 MITS	33079		GG-42 WIX	33160		GG-232 WIX
3268-000		GG-1176 ALCH	33		G-33 FACE	3308		GG-136 NAP	33161		GG-251 WIX
3268-001		GG-5 L CEWF	330		GA-325 CRM	33080		G-1163 WIX	33162		G-297 WIX
3269-000		GG-5 L CEWF	330		GA-1616 PROT	33081		GG-87 WIX	33162		G-297-B WIX
3269-001		GG-196 CEWF	3300		GP-91 BOG	33081MP		GG-87 WIX	33162		GG-215 WIX
3269-003		GG-196 CEWF	3300		GA-3300 FACE	33082		GG-8 WIX	331623-C91		GA-77 IHCO
327		GPP-111 CEWF	3300		GG-92 NAP	33084		GG-203 WIX	3316462		GP-1011Q CUMM
327		GPP-524 CEWF	3300		GP-91 ROB	33085		GG-203 WIX	33166		G-296 WIX
327		GA-85 AMP	33000076		GG-79 AMCO	3308638		GPP-11 CUMM	33166		G-296-B WIX
327		GA-85 BGA	33000076		GG-79 CHRY	33087		GG-196 WIX	33166MP		G-296 WIX
327		GA-57 FACE	33000076		GG-79 MOP	33089		GG-188 WIX	33166MP		G-296-B WIX
3271		GA-432 PROT	330004047		G-152 CONV	33093		GG-240 WIX	33167		G-1121 WIX
32716		GG-20 NAP	33001		GG-1 WIX	33095		GG-5 L WIX	33167		G-1121F WIX
32716		GP-3 MEAD	33001		GG-4 WIX	3309604		G-1175 ¹⁰⁸ GMCX	33168		GPP-420 ROO
32716		GP-3 MERC	33002		GG-124 WIX	3309637		GP-57 CUMM	3316874		GP-1011Q CUMM
32716		GP-408 MERC	33002		GG-3 WIX	33097		GG-47 WIX	33169		GPP-425 ROO
32717		GP-13 MERC	33003		GG-5 L WIX	33097MP		GG-47 WIX	3317		GG-203 BGA
32717MP		GG-20 NAP	33003007		GG-243 CHRY	33099		GG-268 WIX	3317		GG-214 NAP
3272-000		GG-203 CEWF	33003915		GP-26 FLG	3309950		GP-390 ⁹³ CUMM	33179		GG-251 WIX
3272-002		GG-203 CEWF	33003915		GP-92 FLG	331		GA-50 AMP	3318		GG-203 AMP
327-23-802		GP-91 MZDA	33003925		GP-27 FLG	331		GA-50 BGA	3318		GG-72 NAP
3274-010		GG-45 CEWF	33003925		GP-93 FLG	331		GA-604 PROT	33180		G-1166 WIX
3274-011		GG-202 CEWF	33004195		GP-3985 AMCO	3310		GP-91 BOG	33181		G-1166 WIX
3274-021		GG-202 CEWF	33004195		GP-3985 CHRY	3310		GG-255 NAP	3318157		GP-2071W CUMM
3274-026		GG-208 CEWF	33004195		GP-3985 MOP	3310169		GP-53 CUMM	3318201		GP-1010Q CUMM
3274-029		GG-208 CEWF	33007		GG-3 WIX	3310216		GPP-11 CUMM	3318279		GA-33 CUMM
3274-032		GG-185 CEWF	33-0071420		GA-33 AGCO	33103		GG-137 WIX	33183		GG-290 WIX
3274-034		GG-185 CEWF	33008		GG-246 WIX	3310442		GP-43 CUMM	3318319		GP-1013Q CUMM
327458		G-31 HALL	33-0083836		GP-58 AGCO	3310445		GP-53 CUMM	33184		GPP-1287 ⁹⁹ WIX
3274635		G-1175 GMCX	33-0083836		GP-58 WHIT	33107		GP-1101 WIX	33184		PPF831 ⁴¹ WIX
327468		G-31 HALL	3300901		GP-110 CUMM	33109		GP-11 ⁷⁶ WIX	33184		R 60 P ⁴² WIX
327470		G-31 ACFB	33009225		GP-43 CUMM	33109		GP-1101 ⁴⁵ WIX	33187		G-1166 WIX
327470		G-31 HALL	33009225		GP-53 CUMM	3311		GG-66 NAP	33188		G-1166 WIX
327490-R91		GG-185 IHCO	33009225		GP-43 FLG	331104		GA-90 GMCX	3318853		GP-3000 CUMM
327491-R91		GG-185 IHCO	33009225		GP-53 FLG	33112		G-1123 ¹⁰⁸ WIX	33189		G-1166 WIX
3275		GG-204 NAP	33009235		GP-43 FLG	33112		G-1123F ¹⁰⁸ WIX	3319		GG-187 NAP
3277		GG-226 NAP	33009235		GP-53 FLG	33115		GP-110 WIX	33190		GG-177 WIX
3279		GG-261 NAP	3301		GG-84 NAP	33-1156T1		GP-43 STEI	33192		GPP-1122 WIX
328		GA-730 CRM	33-01		GA-589 ERO	33-1157T1		GP-1122 STEI	33193		GG-580 WIX
328		GA-673R PROT	33010		G-152 WIX	33-1158T1		GP-18 STEI	33194		G-11816 WIX
3280		G-500 LUF	3301060		G-33 CUMM	33116		GP-55 WIX	33195		GP-1122 WIX
3280-000		GG-5 L CEWF	3301061		G-33 CUMM	33117		G-1176 WIX	33196		G-297 WIX
3280185-M91		GP-28 MASY	33011		GG-116 WIX	331172		GA-90 GMCX	33196		G-297-B WIX
32808		GPP-423 ROO	33012		GG-5 L WIX	33118		GP-26 WIX	33199		GG-64 WIX
3280V5040		GP-3 ROCK	33013405		GP-43 FLG	33118MP		GP-26 WIX	331K		GP-3985 ASAH
3280V5040		GP-3 TIMK	33-0143863		G-870 WHIT	3312		GP-462 ⁶⁶ BOG	331P		GP-171 WIX
3280V8394		GP-81 ³¹ ROCK	3302		GG-7018 ³⁸ NAP	3312		GP-91 ³¹ BOG	332		GA-59 AMP
3280V8394		GP-98 ⁸ ROCK	3302		GG-7019 ³⁷ NAP	33120		GP-27 WIX	332		GA-59 BGA
3281019-M1		GP-490 MASY	3302		GG-7020 ¹⁴ NAP	33120MP		GP-27 WIX	332		GA-3300 CRM
328-11500		GP-68 LSTR	3302026		GP-53 CUMM	33121		GP-92 WIX	332		GA-325 UNN
3281672		G-1175 GMCX	33020585		GP-43 FLG	33121MP		GP-92 WIX	3320		GP-40 BOG
328181		GAK-403 WAGR	33020585		GP-53 FLG	33122		GP-93 WIX	3320		GG-67 NAP
3282		GG-214 NAP	33021		GG-202 WIX	33122MP		GP-93 WIX	332001		GAVW-2 KENG
3283		GG-214 NAP	33022		GG-94 WIX	33124		GP-1122 WIX	332002		GA-277 KENG
3284		GG-146 NAP	33022MP		GG-94 WIX	33125		GP-92 WIX	332003		GAVW-4 KENG
3284080		GP-34 GILC	33023		GG-63 WIX	33128		GPP-111 WIX	332006		GA-271 KENG
3286503		GPP-112 CUMM	33024		GG-76 WIX	33128		GPP-524 WIX	332007		GA-277 KENG
3287		GG-185 NAP	33025		GG-209 WIX	33129		GG-209 WIX	33201		GG-213 WIX
328-72260		GP-54 LSTR	33025		GG-4 WIX	3313279		GP-53 CUMM	332010		GA-4303 KENG
328760		GAK-403 WAGR	33026		GG-5 L WIX	3313280		GP-53 CUMM	33-2025		GA-382 KENG
3287990		GP-3985 VOLV	33030		GG-1 WIX	3313281		GP-43 CUMM	33203		GG-76 WIX
32879900		GP-40 VOLV	33030		GG-4 WIX	3313282		GP-53 CUMM	33204		GG-208 WIX
3287999		GP-385 VOLV	33031		GG-1 WIX	3313283		GP-57 CUMM	33-2047		GA-381 KENG
3288		GG-185 NAP	33031		GG-4 WIX	3313287		GP-53 CUMM	33-2049		GA-432 KENG
3289		G-750 LUF	33032		GG-5 L WIX	3313289		GP-57 CUMM	33-2050-1		GA-7017 KENG
328A6		G-31 REOT	3303242		GP-57 CUMM	33133		GC-1133 WIX	33-2051		GA-7017 KENG
328-A6		G-31 WHIT	33032MP		GG-5 L WIX	3313306		GP-55 CUMM	33-2052		GA-322 KENG
329		GA-303 AMP	33033		GG-5 L WIX	33134		GS-1133 WIX	33-2055		GA-604 KENG
329		GA-303 BGA	33033MP		GG-5 L WIX	33135		GG-246 WIX	33-2060		GAD-315 KENG
329		G-1174 CRO	33041735		GP-57 FLG	33135		GG-408 WIX	33-2061		GA-382 KENG
329		GA-1615 PROT	3304232		GP-57 CUMM	33136		G-294 WIX	33-2071		GA-514 KENG
329		GA-57 UNN	33044		GG-6 WIX	3314		GG-256 NAP	33208		2010PM-OR ⁷ WIX
32900		GPP-423 ROO	33046		GG-19 WIX	33140		GPP-612 WIX	33208		2010TM-OR ² WIX
32-905501		GP-761H JCBM	33046MP		GG-19 WIX	33142		G-296 WIX	33209		GS-2034 WIX
329060		GP-1 TOWM	33048		GG-7 WIX	33142		G-296-B WIX	33-2092		GAVW-10 KENG
32-9060		GP-1 CATP	33050		GG-123 WIX	33144		G-1143 WIX	3320K		GP-40 ASAH
329081		G-1173 GMCX	33051		GG-16 WIX	3314581		GP-2071W CUMM	3321		2010PM-OR ⁷ WIX
3290851		G-1173 GMCX	33051MP		GG-16 WIX	3314K		GP-3985 ASAH	3321		2010TM-OR ² AMP
3291		GG-246 NAP	33052		GG-17 WIX	33150		GG-206 WIX	3321		2010PM-OR ⁷ BGA
32-910601		GP-761H JCBM	33052MP		GG-17 WIX	3315114		GP-1012Q CUMM	3321		2010TM-OR ² BGA
32-912001		GPP-1122 JCBM	33053		GG-45 WIX	3315115		GP-1011Q CUMM	3321		GG-67 WIX
32-915500		GP-36 JCBM	3305366		GP-2071W CUMM	3315116		GP-2071W CUMM	33210		GS-2033 NAP
32916		GPP-419 ROO	3305367		GP-2071W CUMM	3315187		GA-360 CUMM	33211		GPP-14 WIX
3291672		G-1175 GMCX	3305369		GP-1010Q CUMM	33153		GG-189 WIX	33-2119		GA-2146 KENG
32917		GPP-419 ROO	33054		GG-8 ¹⁰³ WIX	33153		GG-189 WIX	33212		GS-2033 WIX
32918		GPP-425 ROO	33054		GG-8 L ⁸⁰ WIX	331535		GP-34 DEL	33-2120		GA-384 KENG
32919		GPP-425 ROO	3306		GP-10 FACE	331535B		GP-34 DEL	33214		GG-194 WIX
32921000		GPP-425 JCBM	33061		GG-1173 WIX	33156		GG-246 WIX	33-2145		GA-322 KENG
32925413		GP-3937 JCBM	33066		GG-76 WIX						

Numero	Gonher	Fabricante	Numero	Gonher	Fabricante	Numero	Gonher	Fabricante	Numero	Gonher	Fabricante
Number	Gonher	Manufacturer	Number	Gonher	Manufacturer	Number	Gonher	Manufacturer	Number	Gonher	Manufacturer
33-2153	GA-258	KENG	33283	GG-214	WIX	333660	GA-105	TOWM	33499	GG-8 L ⁸⁰	PARM
33216	GP-85	WIX	33284	GG-146	WIX	33-3660	GA-105	CATP	335	GAD-30	CRM
33216MP	GP-85	WIX	33-2848	GA-397	KENG	33367	GP-1105	WIX	335	GP-58	FACE
33-2172	GA-285	KENG	33-2849	GA-292	KENG	33368	GP-62	WIX	335	GA-158	PROT
33218	GP-84	WIX	33285	GG-184	WIX	33369	G-293	WIX	33500	GG-151	WIX
33-2182	GA-216	KENG	33-2859	GA-2198 ⁷⁹	KENG	3336MP	GP-1107	NAP	33500	GG-227	WIX
33-2183	GA-2179	KENG	33-2859	GA-438 ⁸¹	KENG	33370	G-295	WIX	33500	GG-232	WIX
33-2184	GA-2104	KENG	33-2863	GA-391	KENG	33371	G-270	WIX	33501	GG-203	WIX
33-2184	GA-2164	KENG	33-2865	GAVW-619	KENG	333719-R91	G-33	IHCO	33502	GG-185	WIX
33218MP	GP-84	WIX	33287	GG-185	WIX	33372	GPP-1122	WIX	33504	GP-1105	WIX
33219	GP-83	WIX	33288	GG-185	WIX	33373	GP-1122	WIX	3350-6	G-31	MIC
33-2190	GA-2130	KENG	33-2890	GA-2135	KENG	33374	GP-749	WIX	33508	GG-189	WIX
33-2192	GA-194	KENG	3329	GG-148	NAP	33375	G-270	WIX	33511	G-1173	WIX
33-2193	GA-2109	KENG	33291	GG-246	WIX	33377	GP-1109 ⁸²	WIX	33512	G-1175	WIX
33219MP	GP-83	WIX	3329289	GPP-1000	CUMM	33377	GP-62 ⁸⁰	WIX	33512	G-1176	WIX
3322	GP-408	BOG	33293	GG-30	WIX	33379	GP-1232	WIX	33517	G-178	WIX
3322	GG-247	NAP	33294	GG-220	WIX	3338	GP-78	NAP	33518	G-862	WIX
33221	GG-217	WIX	33295	GG-150	WIX	33380	GPP-19	WIX	3352	GP-110	NAP
332211	GA-364	KENG	33296	GG-1872	WIX	33381	GPP-18	WIX	33521	GG-102	WIX
33-2213	GA-334	KENG	33296MP	GG-1872	WIX	33383	GP-1101 ⁸⁴	WIX	33522	GPP-11	WIX
33-2215	GA-4319	KENG	33298G6319	GG-115	WIX	33384	GP-56	WIX	33527	GP-1109	WIX
33223	GG-220	WELA	332A	GA-589	GREY	33384MP	GP-56	WIX	33528	GP-110	WIX
33223	GG-220	WIX	332K	GP-3985	ASAH	33388	GG-16	PARM	335285	GA-37	VOLV
33-2254	GA-241	KENG	333	GA-325	AMP	33389	GG-17	PARM	3352MP	GP-110	NAP
33-2256	GA-2161	KENG	333	GA-325	BGA	3339	GP-155	BGA	3353	GPP-18	NAP
33-2265	GA-2146	KENG	3330	GP-1105	BOG	3339	GP-1105	NAP	33531	GPP-418	WIX
33227	GG-7018 ³⁸	WIX	3330	GG-190	NAP	33391	GAK-625	DERR	33532	GPP-419	WIX
33227	GG-7019 ³⁷	WIX	33300	GG-92	WIX	33391	GAK-625	DUTZ	33533	GPP-424	WIX
33227	GG-7020 ¹⁴	WIX	33301	GG-84	WIX	33393	GAK-625	FIAT	33534	GPP-419	WIX
33228	GG-351	WIX	33302	GG-7018 ³⁸	WIX	333A	GA-588	GREY	33535	GPP-425	WIX
33-2288	GA-249	KENG	33302	GG-7019 ³⁷	WIX	334	GAD-1	CRM	33536	GPP-426	WIX
3323	GG-61	NAP	33302	GG-7020 ¹⁴	WIX	334	GA-7344	PROT	33537	GPP-419	WIX
3323	GP-149	ROB	33308	GG-136	WIX	3340	GP-110	NAP	33540	G-1175	WIX
33231	GPP-1287 ³⁹	WIX	3331	GP-46	BOG	33400	GPP-19	WIX	33543	G-278	WIX
33231	PFF831 ⁴¹	WIX	3331	GG-181	NAP	33401	G-1143 ⁸⁰	WIX	33544	G-276	WIX
33231	R 60 P ⁴²	WIX	33310	GG-255	WIX	33403	GP-78	WIX	33545	G-277	WIX
33232	GPP-547 ³⁹	WIX	3331096	GPP-10075	CUMM	33404	GP-1224	WIX	33546	GPP-419	WIX
33232	PFF831 ⁴¹	WIX	33311	GG-66	WIX	33405	GPP-11	WIX	33547	GPP-425	WIX
33232	R 60 P ⁴²	WIX	33311MP	GG-66	WIX	33405MP	GPP-11	WIX	33548	GPP-420	WIX
3323251	GAK-403	RENA	33314	GG-256	WIX	33406	GPP-1000	WIX	33549	GPP-426	WIX
33-2337	GA-646	KENG	33316	GG-99	WIX	33407	GPP-11	WIX	335494	GA-33	CLRK
33-2-34	GA-360	SEDN	33317	GG-214	WIX	3341	GP-1108	NAP	335498	GA-33	CLRK
33235	GG-182	WIX	33318	GG-72	WIX	33411	GPP-1287 ³⁹	WIX	33553	GG-164	WIX
33236	GG-187	WIX	33319	GG-187	WIX	33411	PFF831 ⁴¹	WIX	33554	GG-164	WIX
33-2360	GA-265	KENG	33319NH	GPP-425	ROO	33411	R 60 P ⁴²	WIX	33555	GG-234	WIX
33237	GP-1107	WIX	3332	GP-44	BOG	33412	GPP-1291 ³⁹	WIX	33556	GG-215	WIX
33-2374	GA-1530	KENG	3332	GP-44	ROB	33412	S 3226 P ⁴⁰	WIX	33559	GG-160	WIX
33-2375	GAD-116	KENG	33320	GG-67	WIX	33415	GPP-11	WIX	3355903	GPP-103 ⁴⁰	CUMM
33-2377	GA-341	KENG	33321	GG-67	WIX	33418	S 3202 ⁴⁰	WIX	3355903	GPP-11 ³⁹	CUMM
33-2385	GA-4317	KENG	33322	GG-247	WIX	3341MP	GP-1108	NAP	3356	GP-110	NAP
33239	GP-1107	WIX	33323	GG-61	WIX	3342	GPP-11	NAP	33561	GG-164	WIX
3324	GG-65	NAP	33324	GG-65	WIX	33421	GPP-14	WIX	33566	GG-246	WIX
33-2402	GA-193	KENG	33324MP	GG-65	WIX	33422	GPP-10035	WIX	33568	GG-196	WIX
33-2403	GA-171	KENG	33325	GG-249	WIX	33422	GPP-10225	WIX	33569	GG-146	WIX
33242	GPP-103 ⁴⁰	WIX	33328	GG-142	WIX	33423	GPP-10075	WIX	3357	GPP-18	NAP
33242	GPP-11 ³⁹	WIX	33329	GG-148	WIX	33424	GG-308	WIX	3357461	GP-81	KHDF
33243	GG-101	WIX	3333	GA-139	AUTO	33425	GG-1872	WIX	33-5747	G-119	CATP
33243BS	G-31	HERC	3333	GG-185	NAP	33431	GPP-11	WIX	33576	GG-265	WIX
33243-BS	G-31	WHIT	33330	GG-190	WIX	33432	S 3202 ⁴⁰	WIX	33577	GG-267	WIX
33244	GP-1122	WIX	33331	GG-181	WIX	33433	GPP-11	WIX	33579	GG-266	WIX
33244	GPP-14	WIX	33333	GG-185	WIX	33434	GPP-14	WIX	3358	GP-1122	NAP
332441	GP-1122	SAAB	33334	GPP-1000	WIX	33439	GPP-11	WIX	33585	GS-1261	WIX
3325	G-500	LUF	33335	GG-7018 ³⁸	WIX	3344	GP-1122	AMP	33585MP	GS-1261	WIX
3325	GG-249	NAP	33335	GG-7019 ³⁷	WIX	3344	GP-1122	BGA	33586	GPP-423	WIX
33251	G-1175	WIX	33335	GG-7020 ¹⁴	WIX	33441	GPP-11	WIX	3358MP	GP-1122	NAP
3325106	GAK-625	CHAM	33336	GP-1107	WIX	33442	S 3202 ⁴⁰	WIX	3359	GG-45	FACE
3325291	GA-206	CUMM	33336	GP-1109	WIX	33443	GPP-11	WIX	3359	GG-45	LONF
3325292	GA-106 ⁴⁶	CUMM	33336MP	GP-1107	WIX	33444	GPP-14	WIX	33594	GG-251	WIX
3325292	GA-326 ⁷¹	CUMM	33338	GP-78	WIX	3344-H2	GA-26	WHIT	33595	GG-986	WIX
33253	GG-5 L	WIX	33339	GP-1105	WIX	33451	G-128	WIX	33595MP	GG-986	WIX
33257	GG-239	WIX	3334	GP-92	BGA	33452	GPP-11	WIX	33596	GG-87	PARM
3326	G-750	LUF	3334	GPP-1000	NAP	33454	GG-39	WIX	33597	GG-206	WIX
33-2613	GA-386	KENG	33340	GP-110	WIX	3346	GG-95	NAP	33599	G-1047	WIX
332623-C1	GA-77	IHCO	33341	GG-1108	WIX	33460	GG-181	WIX	335A	GA-42	GREY
332623-C91	GA-77	IHCO	33341MP	GP-1108	WIX	33461	GG-114	WIX	335	GP-3816	WIX
3326416-R1	GA-49	IHCO	33342	GG-264	WIX	33463	GG-264	WIX	336	GA-100	CRM
33-2649	GAVW-212	KENG	33346	GG-95	WIX	3347	GG-104	NAP	336	G-1175 ¹⁰⁸	CRO
33265	GG-260	WIX	33347	GG-104	WIX	33472	GPP-1122	WIX	336	GA-5466	PROT
33267	GG-580	WIX	33348	GG-48	WIX	33472MP	GPP-1122	WIX	33604	GPP-10035	WIX
33-2673	GA-2173	KENG	333494	GA-33	CLRK	33477	GG-137	WIX	33604XE	GPP-10035	WIX
33-2677	GA-2184	KENG	3335	GG-7018 ³⁸	NAP	33477MP	GG-137	WIX	3361	GP-1122	NAP
3327	G-750	LUF	3335	GG-7019 ³⁷	NAP	33479	GG-208	WIX	33611	GPP-547 ³⁹	WIX
33-2703	GA-1919	KENG	3335	GG-7020 ¹⁴	NAP	3348	GG-48	NAP	33611	PFF831 ⁴¹	WIX
33271	GG-20	WIX	33352	GP-110	WIX	33481	GG-46	WIX	33611	R 60 P ⁴²	WIX
33271MP	GG-20	WIX	33352MP	GP-110	WIX	33481MP	GG-46	WIX	3362	GP-110	NAP
33-2733	GA-2193	KENG	33353	GG-242	WIX	33482	GG-242	WIX	33621	GPP-11	WIX
33273923	GA-26	JAEG	33356	GP-110	WIX	33483	GG-3728	WIX	33626	GP-1109	WIX
33275	GG-204	WIX	33357	GPP-18	WIX	33484	GG-581	WIX	33630	GPP-1287 ³⁹	WIX
33277	GG-226	WIX	33358	GP-1122	WALM	33486	GG-79	WIX	33630	PFF831 ⁴¹	WIX
33-2779	GA-2141	KENG	33358	GP-1122	WIX	33486MP	GG-79	WIX	33630	S 3225 P ⁴²	WIX
33-2781	GA-2123	KENG	33358MP	GP-1122	WIX	33487	GG-256	WIX	33632	GPP-425	WIX
33-2787	GA-234	KENG	33359	GG-45	PARM	3349	GA-2740	APRO	33633	GPP-423	WIX
33279	GG-261	WIX	33359	GP-110	WIX	3349	GA-2740	AUTO	33634	G-1046	WIX
3328	GG-142	NAP	3336	GP-1107	NAP	33491	GG-185	WIX	33636	GPP-424	WIX
33282	GG-214	WIX	33361	GP-1122	WIX	33494	GG-232	WIX	33637	GPP-425	WIX
33-2827	GA-314	KENG	33362	GP-110	WIX	33499	GG-8 ¹⁰³	PARM	33638	GPP-421	WIX

Referencia Cruzada por Numero de Parte

Cross Reference by Part Number



Numero	Gonher	Fabricante	Numero	Gonher	Fabricante	Numero	Gonher	Fabricante	Numero	Gonher	Fabricante
Number	Gonher	Manufacturer	Number	Gonher	Manufacturer	Number	Gonher	Manufacturer	Number	Gonher	Manufacturer
33639	GG-185	WIX	3388	GG-16	FACE	3421	GP-28 ⁵	ROB	346396	GA-326 ⁷¹	WAGR
33640	GP-749	WIX	3388	GG-16	LONF	3421	GP-430 ⁸	ROB	346397	GA-206	WAGR
33641	GG-79	PARM	33880	GPP-420	ROO	3422	GP-3600	BOG	346398	GA-106 ⁶⁶	WAGR
33641	G-1166	WIX	33888	GG-355	WIX	3422	GPP-10225	NAP	346398	GA-326 ⁷¹	WAGR
33642	G-1166	WIX	3389	GG-17	FACE	3423	GPP-10075	NAP	346399	GA-206	WAGR
33643	GG-420	WIX	3389	GG-17	LONF	3423	GP-3675	ROB	34654	GP-1011Q	CHAM
33648	GPP-423	WIX	33899	G-1047	WIX	342449	GP-35	CATP	34661000	GAK-16	HERC
33651	GA-5648	COLT	339	GA-86	CRM	342449	GP-34	TOWM	346610C	GAK-16	HERC
33651	GA-5648	ERF	339	GP-171 ¹⁶	CRO	34-2449	GP-34	CATP	346610CS	GAK-16	HERC
33651	G-128	WIX	339	GA-348	PROT	3425	GG-1872	NAP	346610DS	GAK-16	HERC
33654	GP-548	WIX	33918	GG-187 ¹⁵	WIX	342K	GP-42	ASAH	3467	GG-240	PAR
33659	GG-97	WIX	33932-0100	GAK-625	HINO	343	GP-1101	DEL	347	GA-192	BGA
33664	GA-360	COLT	33957	GG-307	WIX	3430	GP-3980	BOG	347	GA-86	CRM
33664	GA-360	ERF	33963	GPP-425	ROO	3430	GP-3980	ROB	347	GP-34	DEL
3366456	GA-8047	DUTZ	33971	GG-19	GENI	3431	GPP-11	NAP	347	GA-429	FACE
3366456	GA-8047	KHDF	340	GA-98 ¹²	AMP	343144	GP-1122	SAAB	347	GA-806	PROT
336662	GAK-20	IHCO	340	GA-98 ¹²	BGA	3432	S 3202 ⁴⁰	NAP	347028	GA-5648	MANI
336662-R91	GAK-20	IHCO	340	GA-113	CRM	3433	GPP-11	NAP	3472	GPP-1122	NAP
33668	GPP-419	WIX	340	GP-1101	DEL	3434	GPP-14	NAP	3472MP	GPP-1122	NAP
3367	GP-1105	NAP	340	GA-86	FACE	343445	GP-193	KOHL	34740-00100	GP-54	MIT
33674	GP-1101	NAP	3400	GP-3000	BOG	34345	G-296	COLT	34740-00200	GP-69	MIT
33674	GP-749	WIX	3400	GP-3682	BOG	34345	G-296-B	COLT	3476	GG-240	PAR
3368	GP-62	NAP	3400	GP-37	BOG	3435171-M1	GP-490	MASY	3477	GG-137	NAP
33686	GG-151	WIX	3400	GPP-19	NAP	3438718-M1	GAK-16	MASY	3477	GG-226	PAR
33690	GP-96	WIX	340001	G-33	WOOD	3438731-M91	G-296	MASY	34774	GG-208	PARM
33691	GP-1101	WIX	340-00-320	GA-360	KALB	3438731-M91	G-296-B	MASY	3477601	GP-5	AMCO
33697	GP-1109	WIX	340-00-330	GA-206	KALB	3438856M2	GP-3682	MASY	34777	GG-98	PARM
336A	GAD-30	GREY	340-003-30	GA-206	KASB	3439	GPP-11	NAP	34778	GP-1	VERS
337	GA-113	CRM	340-00-594	GAK-20	KALB	344	GA-57	AMP	3479	GG-208	NAP
337	GA-384	PROT	3401	G-1143 ³⁰	NAP	344	GA-57	BGA	347P	GP-462	WIX
3370	G-295	NAP	3401	GP-3985	ROB	344	GA-3300	CRM	348	GA-3424	CRM
33704	GG-986	WIX	3401261	GAK-403	CHRY	344	GP-46	CRO	348	GA-224	PROT
33708	G-1176	WIX	3401-303	GP-34	HYDR	344	GPP-14	DEL	348	GA-59	UNN
33709	G-1176	WIX	3401-307	GP-34	HYDR	344	GA-392	PROT	3481	GG-46	NAP
3371	G-270	NAP	3401368	GAK-403	CHRY	34402111130	GA-106 ⁶⁶	FURU	3481	GG-46	PAR
33713	GG-246	PARM	3401544	GP-3001	CUMM	34402111130	GA-326 ⁷¹	FURU	3481MP	GG-46	NAP
3371378-R1	GAK-625	IHCO	340175-R91	G-33	IHCO	3440927005	G-1121	MBNZ	3482	GG-242	NAP
3371420-R1	G-143	IHCO	340202	G-33	WOOD	3441	GA-277	FACE	3482	GG-242	PAR
33715	G-1176	WIX	3402356	GP-13	GMCX	3441	GPP-11	NAP	3483	GG-3728	NAP
33717	GP-26	WIX	3403	GP-78	NAP	3-441	GG-7	PARM	3483	GG-3728	PAR
3371843-R21	G-1121F	KOMA	340386	GAK-20	WAGR	3441241	GA-303	FORD	3484	GG-581	NAP
3371843R91	G-1121F	CASE	3404	GP-1224	NAP	3441800109	G-926	MBNZ	3486	GG-79	NAP
3371843-R91	G-1121F	IHCO	3405	GPP-11	NAP	3441840025	G-926	MBNZ	3487	GG-256	NAP
3372	GPP-1122	NAP	3405418-M1	G-296	MASY	3442	S 3202 ⁴⁰	NAP	348P	GG-81	WIX
33727	GG-46	PARM	3405418-M1	G-296-B	MASY	3443	GPP-11	NAP	349	GA-349	FACE
33728	GG-3728	PARM	3405419-M1	G-297	MASY	34430-21300	GAK-16	MIT	3490	GA-3490	FACE
3373	GAVW-2	FACE	3405419-M1	G-297-B	MASY	34430-21301	GAK-16	MIT	3491	GG-185	NAP
3373	GP-1122	NAP	3405419-M91	G-297	MASY	3444	GPP-14	NAP	349197C1	GP-1143	IHCO
33734	GG-265 ³⁶	WIX	3405419-M91	G-297-B	MASY	34440-22100	GP-36	MIT	34926-1040	GP-9586	HINO
33735	GG-307	WIX	3405MP	GPP-11	NAP	3444700092	G-1121F	MBNZ	34926-1041	GP-9586	HINO
33737	GG-299	WIX	3406	GPP-1000	NAP	3444777215	G-1121	DAIM	3493878	GA-33	CLRK
3373806-R1	GP-77	IHCO	3406809	GP-9001	CUMM	3444777215	G-1121	MBNZ	3493-H2	GA-26	WHIT
3374	GP-749	NAP	3406810	GP-9000	CUMM	3445	GA-3445	FACE	349619	G-162H	VOLV
33744	GG-246	PARM	340681000	GP-9000	CUMM	3445868090	G-926	MBNZ	3496191	G-162H	VOLV
33747	GG-246	PARM	3406889	GPP-1003S	CUMM	344622	GAK-20	ALCH	3496197	G-162H	VOLV
3375	G-270	NAP	3406889	GPP-1003S	CUMM	3448661	GP-3	GMCX	3499	GG-8 ¹⁰³	FACE
3375263-R1	GA-361	DRES	3407	GPP-11	NAP	3448661	GP-3	OPEL	3499	GG-8 L ⁸⁰	FACE
3375263-R1	GA-361	IHCO	3408-305	GP-54	HYDR	3448991	GP-310	GMCX	3499	GG-8 ¹⁰³	LONF
3375264-R1	GA-360	DRES	34091	GP-836	MASY	3448992	GP-310	GMCX	3499	GG-8 L ⁸⁰	LONF
3375264-R1	GA-360	IHCO	34091	G-836	PERK	344P	GP-3600	WIX	3499445-C91	G-750	IHCO
3375404	GP-55	CUMM	340A	GA-372	GREY	345	GA-12	AMP	349945	G-750	IHCO
33756	GPP-423	WIX	340P	GP-38	WIX	345	GA-12	BGA	349945-C91	G-750	IHCO
33759	GPP-420	WIX	341	GPP-14	DEL	345	GA-3425	CRM	349P	GP-42	WIX
33769	GG-42	PARM	341	GA-279	PROT	345	GP-83	DEL	34A5532	GP-1	MINN
3377	GP-1109 ²²	NAP	3410	GP-68	BOG	345	GA-175	PROT	34A5532	GP-1	WHIT
3377	GP-62 ²⁰	NAP	34102-111120	GA-361	MIT	3451	G-128	NAP	3480-231930	GA-33	KOMA
33774	R120P	WIX	341021-11120	GA-361	FURU	3452	G-750	LUF	35	G-31	LEDR
33-7778	G-813	CATP	34102-111140	GA-360	MIT	3452	GPP-11	NAP	35	G-31	LEE
337854	G-296	TOWM	341021-11140	GA-360	FURU	3453003	G-1174 ¹⁰⁸	VERM	350	GAD-118	PROT
337854	G-296-B	TOWM	3411	GPP-1287 ³⁹	NAP	3454	GG-39	NAP	350	GPP-1122	SOFM
33-7854	G-296	CATP	3411	PFF831 ⁴¹	NAP	3455013	GAK-20	CLRK	3500	GP-1	ROB
33-7854	G-296-B	CATP	3411	R 60 P ⁴²	NAP	3455014	GAK-20	CLRK	35002512	GP-1122	INGR
33793	GS-2033	WIX	34115561A	GP-28 ⁵	VAG	3455192	G-33	CLRK	35005561	GP-28 ⁶	VOLK
33795	2010TM-OR	WIX	34115561A	GP-430 ⁸	VAG	3455837	GAK-20	ALCH	35005561	GP-430 ⁸	VOLK
33796	2010PM-OR ⁷	WIX	34115561A	GP-28 ⁵	VOLK	3455867290	G-133	MBNZ	3501	GG-203	NAP
33796	2010TM-OR ²	WIX	34115561A	GP-430 ⁸	VOLK	3455867290	G-989	MBNZ	3501238	GA-27	WAGR
338	GAK-16	AMP	3412	GPP-1291 ³⁹	NAP	3456-H2	GA-27	WHIT	350176	G-296	WALK
338	GAK-16	BGA	3412	S 3226 P ⁴⁰	NAP	3456-H21	GA-27	WHIT	350176	G-296-B	WALK
338	GAVW-2	CRM	34133837	GAVW-2	VAG	3456-H290	GA-27	WHIT	3502	GG-185	NAP
338	GA-130	PROT	34133837	GAVW-2	VOLK	3456H2900	GA-27	DIAM	35034	G-33	CASE
3380	GPP-19	NAP	34140-70100	GP-149	MIT	3456H2900	GA-27	REOT	35034	G-33	CESS
3-3802A	GG-47	PARM	34143	GG-196	PARM	346	GA-85	CRM	350347-R91	GA-33	IHCO
33804315	G-1143 ³⁰	CUMM	3415	GPP-11	NAP	346	GP-84	DEL	350383	GA-360	WALK
3381	GPP-18	NAP	341544	GP-3001	PERK	346	GP-58	FACE	350383	GA-361	WALK
33811	GP-155	WIX	341546	GAK-16	HYST	346	GA-163	PROT	3504	GP-1105	NAP
33812	GPP-1291 ³⁹	WIX	3415561A	GP-28	VOLK	3460	GG-181	NAP	350433	GP-1122	WALK
33812	S 3226 P ⁴⁰	WIX	34167	GG-202	PARM	3460094	G-834	HYMA	350436	GA-361	WALK
33819	GS-557	WIX	34178	GPP-425	ROO	3460094	G-834	HYVA	350437	GA-360	WALK
338194	GA-90	GMCX	3418	S 3202 ⁴⁰	NAP	3460-094	G-834	HYDR	350467	G-296	WALK
338195	GA-90	GMCX	341841701	GP-88	MBNZ	3461	GG-114	NAP	350467	G-296-B	WALK
33829	GG-251	PARM	34191	GG-203	PARM	3461267	GP-5	AMCO	35054	G-33	CASE
3383	GP-1101 ⁵⁴	NAP	34194	GG-94	PARM	346246	G-6	HERC	3508	GG-189	NAP
3384	GP-56	NAP	342	GP-38	DEL	346246					

Numero	Gonher	Fabricante	Numero	Gonher	Fabricante	Numero	Gonher	Fabricante	Numero	Gonher	Fabricante
Number	Gonher	Manufacturer	Number	Gonher	Manufacturer	Number	Gonher	Manufacturer	Number	Gonher	Manufacturer
351.....	GA-75	FACE	35290568.....	G-1175	INGR	3551800109.....	G-133	MBNZ	35-866340K01.....	GP-408	MERC
35102706.....	GA-127	PROT	35290600.....	GP-27	INGR	3551800109.....	G-989	MBNZ	3587702C1.....	GA-770R	IHCO
35107309.....	GA-356	INGR	35290618.....	GP-26	INGR	3551814-C1.....	GA-4862R	IHCO	358793.....	GA-361	WAGR
35108950.....	GAK-403	INGR	35290626.....	G-33	INGR	3551815-C1.....	GA-4863	IHCO	359.....	GP-3980	CRO
35109099.....	GAK-20	INGR	35290634.....	G-566	INGR	3553.....	GG-164	NAP	35902279.....	GAK-20	INGR
35109156.....	GA-106 ⁶⁶	INGR	35290642.....	G-119	INGR	3554.....	GG-164	NAP	35902295.....	GAK-403	INGR
35109156.....	GA-326 ⁷¹	INGR	35291970.....	GAK-1532	INGR	35545-001.....	GA-853R	MATB	35902444.....	GA-106 ⁶⁷	INGR
35109206.....	GA-206	INGR	35292358.....	GP-36	INGR	355451.....	GA-853R	MATB	35902444.....	GA-206 ⁶⁸	INGR
35109262.....	GA-6127	INGR	35292366.....	GP-1122	INGR	3554700192.....	G-1123	MBNZ	35902444.....	GA-326 ⁷²	INGR
35109263.....	GA-6127 ⁰⁸	INGR	35298108.....	GA-563	INGR	3555.....	GG-234	NAP	35902451.....	GA-6127 ⁰⁸	INGR
35109271.....	GA-6129 ⁰⁴	INGR	353.....	GP-81 ³¹	CRO	3556.....	GG-215	NAP	35902451.....	GA-6129 ⁰⁴	INGR
3511.....	G-1173	NAP	353.....	GP-9 ⁵⁸	CRO	355607-C1.....	GA-106 ⁶⁶	IHCO	35911858.....	GA-27	INGR
35113100.....	G-803	LETR	353.....	GP-78	DEL	355607-C1.....	GA-326 ⁷¹	IHCO	359251C1.....	GP-1107	CASE
35115561.....	GP-28 ⁶	VAG	353.....	GAD-3	FACE	35575.....	G-31	PALM	359251-C1.....	GP-1107	IHCO
35115561.....	GP-430 ⁸	VAG	35303692.....	GP-1	INGR	3559.....	GG-160	NAP	3594.....	GG-251	NAP
35115561.....	GP-3816	VAG	35308030.....	GP-14	INGR	35595.....	GG-986	WEST	3595.....	GG-986	NAP
35115591.....	GP-3816	VOLK	35308048.....	G-295	INGR	356.....	GA-271	CRM	3596.....	GG-87	LONF
3512.....	GP-22	FACE	35308063.....	GP-27	INGR	3560734-C1.....	GA-682R	IHCO	3597.....	GG-206	NAP
3512.....	GA-4958	MPA	3531.....	GP-3531 EXP	FACE	3561.....	GG-164	NAP	359771.....	GP-157	KOHL
3512.....	G-1175	NAP	3531.....	GPP-418	NAP	35614.....	GPP-419	ROO	359828.....	GA-467	GOTT
35121216.....	GA-357	INGR	3531003.....	G-1121	VMEN	356181-C9.....	GA-27	IHCO	3599.....	GA-1047	NAP
35121245.....	GA-356	INGR	3531022.....	GP-1122	VMEN	356181-C91.....	GA-27	IHCO	359A.....	GA-55	GREY
35121425.....	GA-356	INGR	35310556.....	GP-51	INGR	35622-90002.....	GP-3682	NISS	35A12422.....	GAK-16	WHIT
35121516.....	GA-357	INGR	35312396.....	GP-2071W	INGR	35622-90002.....	GP-37	NISS	35-A2550-17.....	GP-1122	MAN
351-29760.....	G-296	LSTR	353192.....	GP-149	PARM	35-626.....	GAK-403	ERIC	35A4420.....	GA-105	MINN
351-29760.....	G-296-B	LSTR	3532.....	GPP-419	NAP	3563021.....	GA-467	RENA	35A4420.....	GA-105	WHIT
35133843.....	GAVW-2	VAG	35326230.....	GAK-625	INGR	3563513.....	GA-436	RENA	35A5533.....	GP-1	MINN
35133843.....	GAVW-2	VOLK	3532799C1.....	GA-799R	IHCO	3563525.....	G-133	RENA	35A5533.....	GP-1	WHIT
3514.....	GA-2740	MPA	3532800C1.....	GA-798R	IHCO	3563525.....	G-989	RENA	35A8197.....	GA-33	MINN
3515328-M91.....	GP-761H	MASY	3533.....	GPP-424	NAP	3563577.....	GA-49	RENA	35A8197.....	GA-33	WHIT
3515328-M92.....	GP-761H	MASY	35330007.....	GP-66	ALTE	3563591.....	GP-1	RENA	35A8260.....	GA-33	MINN
3516.....	GA-3425	MPA	35330687.....	GP-54 ¹⁰	INGR	3563602.....	G-834	RENA	35A8260.....	GA-33	WHIT
3517.....	GA-390	MPA	35330687.....	GP-66 ¹⁰	INGR	3563603.....	GP-31	RENA	35P1601.....	GA-33	MINN
3517.....	G-178	NAP	35330901.....	GP-53	INGR	3563608.....	GA-405	RENA	35P1601.....	GA-33	WHIT
35-176.....	GA-33	ERIC	35330919.....	GP-92	INGR	3564024.....	GA-33	RENA	35P2787.....	GA-44	WHIT
35-178.....	GA-33	ERIC	35336163.....	GP-28 ⁶	INGR	3564035.....	GAK-403	RENA	35P2787.....	GA-44	MINN
3518.....	G-862	NAP	35336163.....	GP-430 ⁸	INGR	3564040.....	GAK-16	RENA	35P32.....	G-6	MINN
3519.....	GA-390	MPA	35-3387.....	GP-66	TORO	3564042.....	GAK-16	RENA	35P32.....	G-6	WHIT
3519485.....	GP-54	MERC	3534.....	GPP-419	NAP	3564047.....	GAK-20	RENA	36 129 620.....	GAVW-623	VOLK
351P.....	GP-58 ¹⁵	WIX	3535.....	GPP-425	NAP	3564049.....	GA-27	RENA	36 129 620D.....	GAVW-623	VOLK
352.....	GP-1108	DEL	35351092.....	GA-6129	INGR	3564085.....	GA-356	RENA	3602788.....	G-296	IHCO
352.....	GAD-1	FACE	35355395.....	GA-251	INGR	3564086.....	GA-357	RENA	3602788.....	G-296-B	IHCO
352.....	GP-3985	PMC	353557.....	GP-91	PARM	3564103.....	GP-54 ¹¹	RENA	36-031200.....	GP-1	WHIT
3520400-C1.....	GA-682R	IHCO	35357243.....	GP-53	INGR	3564103.....	GP-66 ¹⁰	RENA	3604.....	GPP-10035	NAP
3520401C1.....	GA-683R ⁰⁸	IHCO	35357250.....	GP-57	INGR	3564110.....	GA-229	RENA	3604XE.....	GPP-10035	NAP
3521.....	GG-102	NAP	35357268.....	GP-11	INGR	3564113.....	GA-27	RENA	3606283.....	GA-6127	JOY
35211.....	G-834	PERK	35357276.....	GP-1011Q	INGR	3564115.....	GA-361	RENA	3606283-20.....	GA-6127	JOY
35212.....	G-836	BUNG	3536.....	GPP-426	NAP	3564116.....	GA-27	RENA	3606283-29.....	GA-251	JOY
35212.....	G-836	MASY	35366301.....	GP-77	INGR	3564117.....	GA-360	RENA	3606797.....	GAK-403	JOY
35212.....	G-836	NISS	35366681.....	GP-1	INGR	3564118.....	GA-106	RENA	3608012-5.....	GP-3600	VOLV
35212.....	G-836	PERK	35366699.....	GG-5 L	INGR	3564118.....	GA-326 ⁷¹	RENA	360956.....	GA-360	WAGR
3522.....	GPP-11	NAP	3537.....	GPP-419	NAP	3564119.....	GA-206	RENA	360D.....	GAVW-2	CRM
3522-H2.....	GA-27	WHIT	35374651.....	GP-390	INGR	3564120.....	GA-106	RENA	361.....	GA-277	CRM
3522-H21.....	GA-27	WHIT	35374669.....	GP-18	INGR	3564120.....	GA-326 ⁷¹	RENA	3611.....	GPP-547 ³⁹	NAP
3522-H22.....	GA-27	WHIT	35374677.....	GP-1122	INGR	3564128.....	GA-360	RENA	3611.....	PF831 ⁴¹	NAP
352-31720.....	G-870	LSTR	35375914.....	GP-2071W	INGR	3564129.....	GA-357	RENA	3611.....	R 60 P ⁴²	NAP
35243.....	GP-761H	THOM	35378546.....	GP-3000	INGR	3564137.....	GA-6129	RENA	3612.....	GP-1	AMP
3524700092.....	G-1121F	HANO	35380781.....	GA-398	INGR	3564138.....	GA-206	RENA	3612.....	GP-1	BGA
3524700092.....	G-1121F	MBNZ	35-385.....	GAK-16	ERIC	3566.....	GA-3566	FACE	3612.....	GA-3566	MPA
352470092.....	G-1121F	HANO	35-386.....	GAK-16	ERIC	3566.....	GG-246	NAP	3612.....	GP-1	VALU
35249.....	G-836	MASY	35387489.....	GP-178	INGR	35676.....	G-813	MASY	3614353.....	GA-429	CHRY
35249.....	G-836	PERK	3539.....	GA-4828	MPA	35676.....	G-813	PERK	3614353.....	GA-429	MOP
35254.....	GA-33	TENN	353923.....	GP-91	PARM	35677.....	G-813	MASY	3618544.....	GP-1	BENA
35265.....	G-834	MASY	354.....	GA-3523	CRM	35677.....	G-813	PERK	3618686.....	G-834	BENA
35265.....	G-834	PERK	354.....	GA-730	UNN	3568.....	GG-196	NAP	362.....	GP-1101	DEL
35269.....	G-836	MASY	3540.....	G-1175	NAP	3569.....	GG-146	NAP	3620612.....	G-33	RENA
35269.....	G-836	PERK	3540051-M1.....	GA-853R	MASY	357.....	GA-735 ¹²⁴	CRM	3621.....	GPP-11	NAP
3527.....	GP-1109	NAP	3540106.....	GP-1	FENW	357.....	GP-81	CRO	3621009-M1.....	G-297	MASY
35272.....	G-836	MASY	3540117-C1.....	GA-682R	IHCO	357.....	GP-14	DEL	3621009-M1.....	G-297-B	MASY
35272.....	G-836	PERK	35404.....	G-801	PERK	357.....	GA-303	UNN	362100V5.....	GAK-16	VERS
35277078.....	GA-229	IHCO	3541.....	GA-271	MPA	3571013.....	G-870	RENA	362100V51.....	GAK-16	VERS
35277078.....	GA-229	INGR	3542.....	GA-3445	MPA	357427-C92.....	GA-78	IHCO	362103V1.....	GAK-16	VERS
3528.....	GP-110	NAP	3543.....	G-278	NAP	357433.....	G-295	WAUK	362103V11.....	GAK-16	VERS
35288.....	G-813	MASY	3544.....	G-276	NAP	3575.....	GA-271	FACE	362114V1.....	GAK-403	VERS
35288.....	G-813	NISS	3545.....	G-277	NAP	3575.....	G-31	PALM	362114V11.....	GAK-403	VERS
35288.....	G-813	PERK	3546.....	GPP-419	NAP	3576.....	GG-265	NAP	3621200.....	G-836	BEDF
35288331.....	GA-357	INGR	3547.....	GPP-425	NAP	3576059.....	GP-26	CLRK	3621281-M1.....	GP-761H	MASY
35288349.....	GA-356	INGR	3548.....	GPP-420	NAP	3576061.....	GP-27	CLRK	3621286-M1.....	G-870	MASY
352888.....	GA-6127	WAGR	3549.....	GPP-426	NAP	35-767.....	GA-33	ERIC	3621292-M1.....	GP-9	MASY
35289.....	G-813	MASY	3549232.....	GP-1	CHRY	3576P165354.....	GP-761H	FORD	3621800110.....	G-163	DAIM
35289.....	G-813	NISS	35496.....	GA-206	CASE	3577.....	GG-267	NAP	36-2331.....	GP-26	COP
35289081.....	G-813	PERK	3549957.....	GP-81 ³¹	CHRY	3579.....	GG-266	NAP	3626.....	GP-1109	NAP
35289099.....	GP-1101	INGR	3549957.....	GP-9 ⁵⁸	CHRY	358.....	GA-3647	CRM	362760.....	GA-357	WAGR
35289107.....	G-500	INGR	3549957.....	GP-81 ³¹	MOP	358.....	G-296	CRO	362972.....	GP-1122	ATCO
35290.....	G-870	BRAU	3549957.....	GP-9 ⁵⁸	MOP	358.....	G-296-B	CRO	362972.....	GP-1122	ATWE
35290.....	G-870	MASY	355.....	GA-85	UNN	3580.....	GA-274	FACE	363.....	GP-455	CRO
35290.....	G-870	NISS	35-508.....	GA-33	ERIC	358003C1.....	GA-80	CASE	363.....	GP-78	DEL
35290.....	G-870	PERK	3551347.....	G-834	CLRK	358003-C1.....	GA-77	IHCO	3630.....	GPP-1287 ³⁹	NAP
35290535.....											

Referencia Cruzada por Numero de Parte

Cross Reference by Part Number



Numero	Gonher	Fabricante	Numero	Gonher	Fabricante	Numero	Gonher	Fabricante	Numero	Gonher	Fabricante
Number	Gonher	Manufacturer	Number	Gonher	Manufacturer	Number	Gonher	Manufacturer	Number	Gonher	Manufacturer
363031	GP-36	KHDF	36918	GP-91	WEST	377059	GA-892	FORD	3819-76-3251	GA-361	KOMA
3632	GPP-425	NAP	369256	GP-9	MASY	377059	GA-892	NEWH	3819-76-3261	GA-360	KOMA
36320455760	GP-3682	TADA	3694160	G-31	GMCX	377-129-620	GA-892	VOLK	382	GP-66	DEL
36320455760	GP-37	TADA	3694840	G-31	GMCX	377-133-511A	GA-892	VOLK	382248-R91	G-122	IHCO
363282	GA-6127	WAGR	369499-C93	GA-78	IHCO	3774	R120P	NAP	382248-R91	G-338	IHCO
36343	GG-190	PARM	369500-C1	GA-78	IHCO	3778897	GP-66	CLRK	3825133-6	GP-1122	VOLV
36348	GG-580	PARM	3697	GP-1109	NAP	3779685	GP-36	CLRK	38252	GA-71	MON
3636	GPP-424	NAP	3698	G-750	LUF	3780299-M1	GPP-425	MASY	382520	GA-71	MONW
3636608	GP-3816	SEAT	3700733592	GP-66	FIAT	3780931M1	GPP-425	AGCO	3825970	GP-3000	CUMM
36367057	G-296	GENC	37019	GG-7018 ³⁸	PARM	378396	GP-1011Q	SAAB	3827069-0	GP-46	VOLV
36367057	G-296-B	GENC	37019	GG-7019 ³⁷	PARM	378579	G-31	STUD	38272629	GA-376	CHRY
363691	G-33	CLRK	37019	GG-7020 ¹⁴	PARM	3793	GS-2033	NAP	3829	GP-3	AMP
3637	GPP-425	NAP	370-23-802	GP-149 ⁶⁹	MZDA	379411	GAK-16	HYST	3829	GP-3	BGA
3638	GPP-419	NAP	370-23-802	GP-91 ⁷⁸	MZDA	3795	2010TM-OR	NAP	3829	GP-3	VALU
3638	GPP-421	NAP	370-23-803	GP-462	MZDA	3796	2010PM-OR ⁷	NAP	383	GA-71	DEL
3638291-M1	GPP-1122	MASY	370-25-802	GP-91	MZDA	3796	2010TM-OR ⁷	NAP	383	GP-1122	SULL
364	GP-1105	DEL	3704	GG-986	NAP	37A0635	GP-3	FMC	383	GA-230	UNN
3640	GP-749	NAP	3704178-M1	GP-58	MASY	37A0635	GP-3	LINK	3831110	GA-135	GMCX
364302C91	GA-3501	CASE	370508	GP-1	NAPI	37H1581	G-296	LEYL	3831132	GPP-11	CUMM
36436	GG-208	PARM	3706	GG-5 L	PAR	37H1581	G-296-B	LEYL	3831236	GP-54 ¹¹	VOLV
364464	GP-1	TOWM	370-64-000	GP-1	ALFA	37H1881	G-296	LEYL	3831236	GP-66 ¹⁰	VOLV
36-4464	GP-1	CATP	370-64-0000	GP-1	ALFA	37H1881	G-296-B	LEYL	383260-R91	GAK-403	IHCO
364624	GP-1122	SAAB	3708	G-1176	NAP	37H2924	GA-360	LEYL	38327	G-1121	KALB
36476	GG-220	PARM	37092	GG-30	PARM	37H4649	G-834	LEYL	3833199S	GP-26	FLG
3648	GPP-423	NAP	371	GA-27	AMP	37H4694	G-834	LEYL	3833199S	GP-92	FLG
364F	G-1166	CHP	371	GA-27	BGA	37H4920	GA-18	LEYL	3833200S	GP-27	FLG
364F	G-1166	LUF	371	GP-28 ⁹	CRO	37H576	G-296	LEYL	3833200S	GP-93	FLG
365	GP-62	DEL	371	GP-430 ⁹	CRO	37H576	G-296-B	LEYL	38-37	GA-27	MURY
36500075	GAK-16	MILL	371	GP-69	DEL	37H6214	G-296	LEYL	383728	GAK-16	IHCO
3651	G-128	NAP	371	GA-113	ESSE	37H6214	G-296-B	LEYL	383728-R91	GAK-16	IHCO
3653146	G-31	GMCX	3710	GA-140	MPA	37H6241	G-296	LEYL	3838011	GP-3985	CHRY
36534659	GPP-418	INGR	37115561	GP-28	VOLK	37H6241	G-296-B	LEYL	383812-R93	GAK-16	IHCO
3654	GP-548	NAP	37115561A	GP-28 ⁹	VAG	37H7937	G-297	LEYL	383883-R91	GA-5648	IHCO
3654344	G-836	MASY	37115561A	GP-430 ⁹	VAG	37H7937	G-297-B	LEYL	383964-R91	GA-18	IHCO
3654344	G-836	PERK	37115561A	GP-28 ⁹	VOLK	37J4694	G-834	LEYL	38414H9452	G-296	LEYL
36553	GG-185	PARM	37115561A	GP-430 ⁹	VOLK	37Z0-20-F201	GP-3682	KOMA	38414H9452	G-296-B	LEYL
36563	GG-61	PARM	37115561B	GP-28	VAG	37Z0-20-F201	GP-37	KOMA	38417H9452	G-296	LEYL
36563	GP-58 ¹⁵	TECU	37115561B	GP-28 ⁹	VOLK	37Z0-20-F201L	GP-3682	KOMA	38417H9452	G-296-B	LEYL
36566	GG-65	PARM	37115561B	GP-430 ⁹	VOLK	37Z0-20-F201L	GP-37	KOMA	3843447	GPP-14	CUMM
36567	GG-67	PARM	37-115-561E	GP-28	VOLK	37Z0-20-F301	GP-81	KOMA	3843750	GPP-1000	CUMM
365727	GA-436	SAAB	37118270	GA-360	INGR	37Z0-2A-F135	GAD-3	KOMA	3843760	GPP-1122	CUMM
366	GP-58	CRO	371291	GP-1122	ATWE	37Z0-2A-F331	GA-3637	KOMA	3845	G-750	CHP
366-06227	GA-8	LSTR	3713186	GG-124	VOLV	37Z0-2A-F931	GA-33	KOMA	3845	G-750	LUF
3660940004	GA-209	MBNZ	371682	GP-3600	TOWM	37Z0-2A-F931L	GA-33	KOMA	38451	GA-403	STOL
3661	GP-5	AMP	372	GP-69	DEL	37Z0-20-F102	G-870	KOMA	3847	GP-81 ²¹	AMP
3661	GP-5	BGA	372	GA-113	ESSE	37Z020F104	GP-3985	KOMA	3847	GP-9 ⁸⁸	AMP
3661	GP-5	VALU	372	GA-3300	UNN	37Z020F105	GP-3985	HEDE	3847	GP-81 ²¹	BGA
36613	GG-580	PARM	37242	G-31	MERC	37Z020F201	GP-3682	HEDE	3847	GP-9 ⁸⁸	BGA
366380-C91	GA-27	IHCO	37244W	GP-3980	BWS	37Z0-20-F201L	GP-3682	KOMA	3847	GP-81 ²¹	NAP
366381-R91	GA-26	IHCO	37253	GP-91	BWS	37Z0-20-F201L	GP-37	KOMA	3847	GP-9 ⁸⁸	NAP
366391-C91	GA-26 ¹²	IHCO	37254W	GP-81	BWS	380	GA-70	DEL	384712-R93	GAK-16	IHCO
3664	GP-3985	FACE	372572-C91	GA-27	IHCO	3800028F7	GP-66	MARI	38473	GA-24	STOL
366-6227	GA-8	LSTR	3727848	G-1121	CLRK	3800066Y8	GP-34	MARI	384812	GAK-16	IHCO
366700A1	GP-3001	CASE	373	GP-51	DEL	380-0077	GP-34	MIFP	384812R91	GA-16 ¹²²	CASE
36673542300	GP-149	ISEK	373	GP-23	FACE	3800084Y8	GP-34	MARI	384812R91	GAK-16 ¹⁴	CASE
366792-C91	GA-5648	IHCO	3730	G-750	LUF	3800394	GPP-1003S	CUMM	384812-R91	GAK-16	IHCO
3668	GPP-419	NAP	37315	GG-66	PARM	3800394	GPP-1022S	CUMM	384812R92	GA-16 ¹²²	CASE
36680	GG-187	PARM	37333	GG-581	PARM	380070	GP-34	FLUI	384812R92	GAK-16 ¹⁴	CASE
366822	GP-2071W	VOLV	3734	GG-265 ³⁸	NAP	380087	G-128	DAVC	384812-R92	GAK-16	IHCO
36-6E104-02	G-31	MAN	3734468	GP-3600	CLRK	380088	G-1173	DEMA	384812R93	GA-16 ¹²²	CASE
367	GP-3816	CRO	3734666	GA-49	CLRK	380347-R91	GA-33	IHCO	384812R93	GAK-16 ¹⁴	CASE
36706083	GA-229	INGR	3735	GG-307	NAP	380348-R91	GAK-16	IHCO	384812-R93	GAK-16	IHCO
3674	GP-110	NAP	3736833	GP-28 ⁹	CLRK	380348-R93	GAD-1	MASY	384843-C1	GP-20	IHCO
3679734	GP-1101	CLRK	3736833	GP-430 ⁹	CLRK	380744-R91	GAK-16	IHCO	384843-C2	GP-20	IHCO
368	GP-40	CRO	374 094 70 04	GA-8150	MBNZ	380745-R92	GAK-16	IHCO	384854-C91	GA-78	IHCO
3680433	GP-2126Q	CUMM	3740	GA-100	ESSE	380745R94	GA-16 ¹²²	IHCO	384912-R93	GAK-16	IHCO
3680434	GP-2127W	CUMM	3744811	GP-40	CHRY	380745R94	GAK-16 ¹⁴	IHCO	3850	GP-310	FACE
36844	GP-178	CHAM	375273	GAK-625	FORD	38087-2100	GP-91	SUBA	3850	GP-3569	FACE
36844	GP-178	CUMM	375273	GAK-625	NEWH	38087-21000	GP-91	KUBO	3850	G-750	LUF
36844	GP-178	VOLV	37540-02100D	GP-57	MEN	3808-90-3211	GAK-20	KOMA	385154	GA-50	NAPI
36845	GP-1122	CHAM	37540-02100D	GP-57	MITTS	380-95-516-3	G-1121	STEY	385163-R1	GA-11	IHCO
36845	GP-1122	VOLV	37540-02100E	GP-57	MEN	380-95-516-4	G-1121	STEY	385163-R2	GA-11	IHCO
36846	GPP-18	CHAM	375588	GP-3980	HYST	381	GA-74	FACE	385163-R91	GA-11	IHCO
36846	GPP-18	VOLV	3756	GP-20	AMP	381007	GA-371	KENG	385163-R92	GA-11	IHCO
36847	GP-43	CHAM	3756	GP-20	BGA	3811	GP-155	NAP	385168-R1	GA-7	IHCO
36849	GPP-11	CHAM	3756	GPP-423	NAP	3812	GPP-1291 ³⁹	NAP	385168-R2	GA-7	IHCO
3685741	GP-81 ³¹	CHRY	3756	GP-20	VALU	3812	S 3226 P ⁴⁰	NAP	3853247	GA-50	GMCX
3685741	GP-9 ⁵⁸	CHRY	3759	GPP-420	NAP	381343	GA-33	IHCO	3856	GP-40	FACE
3685741	GP-81 ³¹	MOP	3759764	GG-123	GMCX	381343-R91	GA-33	IHCO	385683R91	G-122	CASE
3685741	GP-9 ⁵⁸	MOP	376	GP-36	CRO	3814	GP-13	AMP	385683R91	G-338	CASE
36867786	GA-251	INGR	3760927201	GPP-1060	MBNZ	3814	GP-13	BGA	385683-R91	G-122	IHCO
36868156	GP-1010Q	INGR	3760927208	GPP-1060	MBNZ	3814	GP-13	VALU	385683-R91	G-338	IHCO
3686H2	GA-27	WHIT	376364R91	G-870	CASE	38-15	GAK-20	MURY	3856-H2	GA-26	WHIT
36870038	GP-35	INGR	376364-R91	G-870	IHCO	3816-25-6261	GP-1101	KOMA	3857	GA-26	WHIT
36876423	GAK-1532	INGR	376774	GAK-403	ATWE	3816-25-6271	GP-1108	KOMA	385951	GP-1122	HYST
36881696	GP-754	INGR	3769001	GA-70	CHRY	3816-27-9341	GA-329	KOMA	386120R91	G-122	CASE
369	GA-3300	AMP	3769001	GA-70	CHRY	3816-27-9351	GA-239	KOMA	386120R91	G-338	CASE
369	GA-3300	BGA	3769002	GA-730	CHRY	3816-75-6171	GP-69	KOMA	386120-R91	G-122	IHCO
369	GP-3531 EXP	CRO	3769006	GA-730	CHRY	38-17	GA-27	MURY	386120-R91	G-338	IHCO
369	G-297	DEL	3769010	GA-71	CHRY	38-18					

Numero	Gonher	Fabricante	Numero	Gonher	Fabricante	Numero	Gonher	Fabricante	Numero	Gonher	Fabricante
Number	Gonher	Manufacturer	Number	Gonher	Manufacturer	Number	Gonher	Manufacturer	Number	Gonher	Manufacturer
38634		GA-6127	3900920001		GP-110	39203		GP-5	39293WB		GA-75
387		GP-10	390221		GAK-403	39203		GP-20	39295WB		GA-3490
3870		GP-28 ⁸	3902837		GA-192	39204		GP-13	39298WB		GAVW-2
387054		GG-430 ⁸	3903202		GPP-1122	39204		GP-3	393		GA-410
387054		GG-8 ⁸⁰	3903224		GP-390	39205		GP-3	393		GA-75
3870548		GG-8 ⁸⁰	3903224		GP-390	39205		GP-3	39306		GP-81
3870548		GG-8 ⁸⁰	3903264		GP-178	39206		G-200	3930942		GPP-18
387263		GAK-403	3903264		GP-178	39207		GP-20	3931062		GPP-1122
387263-R91		GAK-403	3903410		GPP-18	39208		GP-46	3932217		GP-178
3872920-M1		GAK-20	3903410		GP-18	39208		GP-46	3933642ZF		GP-52 ¹¹⁰
387311-R91		GAK-403	3903410		GPP-18	39208		GP-46	3933642ZF		GP-69 ¹⁸
38735-73		G-339H	3903640		GP-1122	39209		GAK-403	3934429		GP-390
387357-C9		GA-26	3903964		GP-178	39211WB		GP-38	3935274		GP-18
387357-C91		GA-26	3904376		GA-827	39213WB		GP-42	3936634		GA-230
387363-C91		GA-5648	3904604		GA-90	39215		GP-3531 EXP	3937061		G-296
3874-23-603		GA-2740	3904610		GAK-403	39224		GP-171	3937061		G-296-B
387493		GP-54 ¹¹	3905		GAD-1 ⁸⁷	39225		GP-3682	3937144		GP-3937
387493		GP-66 ¹⁰	39050		GG-76	39225		GP-37	3937145		GP-178
3875827		GP-81	390560-R91		G-122	39226		GP-91 ²⁸	3937146		GP-178
3876100		G-31	390560-R91		G-338	39228		GP-310	3937147		GP-178
3876-100		G-31	3906		GAD-3	39230		GP-3429	3937211		GP-178
387620		GAK-16	3906		GG-5 L	39234		GP-3600	3937695		GP-178
387620		GAK-16	3906320		GA-50	39237WB		GP-310	3937736		GP-3937
387868-R91		GP-10	390650-R91		G-122	39241		GA-4303	3937743		GP-178
3879782		GG-8 ⁸⁰	390650-R91		G-338	39242		GP-3980	3938626		GP-81
3879782		GG-8 ⁸⁰	3907091		GAK-625	39246		GP-462	39389		GG-6
3879782		GG-8 ⁸⁰	3907091		GAK-625	39249		GP-157	3938-H2		GA-106 ⁶
387981-R91		GAK-16	39-083		GP-66	39250		GA-3523	3938-H2		GA-326 ¹
387981-R92		GA-16 ¹²	3908615		GP-178	39251		GA-80	393957		GA-42
387981-R92		GA-16 ³⁴	3908615		SAMS	39251		GA-80	394		GP-26
388025-R91		GAK-403	3908616		GP-390	39251A		G-6	394018		GA-6
388025-R91		GAK-403	3908616		GP-390	39251A		G-6	394018		GA-6
388025-R91		GAK-403	3908616		GP-390	39251A		G-6	394018		GA-6
388086-R91		GAK-16	390930		GA-42	3925274		GPP-18	394018S		GA-6
388086R92		GA-16 ¹²	3909817		GA-106 ⁴⁷	3925274		GA-71	394018S		GA-6
388086R92		GAK-16 ³⁴	3909817		GA-206 ¹⁰⁸	39253		GA-50	394100-R91		GP-58
38-81		GA-360	3909817		GA-326 ⁷²	39253		GA-50	3942365		GP-3937
388126-R1		GA-33	3909821		GA-106 ⁴⁷	39253WB		GA-50	3942470		GS-1261
388126-R9		GA-33	3909821		GA-206 ¹⁰⁸	39254		GA-77	39440		GA-3647
388126-R91		GA-33	3909821		GA-326 ⁷²	39254		GA-77	39441		GA-3588
388126-R92		GA-33	391		G-295	39255		GP-156	39442		GA-735 ¹²⁴
38-82		GA-360	391		GAD-1	39255		GA-78	39443		GA-271
388227		GP-1	3911018		GA-360	39256		GA-70	39446489		GP-36
388227-R1		GP-1	3911018		GA-361	39256		GA-70	39447WB		GA-4828
388227-R91		GP-1	39113600		GA-44	39256		GA-70	39448		GA-3681
38823		GA-2194	3912		GA-3490	39258		GA-303	39450		GA-274
3882945		G-870	3912104		GP-1232	39258		GA-303	39452		GA-153
38-83		GA-361	39129620A		GAVW-2	39258		GA-303	3945213		GS-1261
3885063		G-870	39129620A		GAVW-2	39259		GA-75	39453		GA-3916
3885315		G-296	39-129-620A		GAVW-4	39259		GA-75	3945411		GP-2108W
3885315		G-296-B	391-296-20A		GAVW-2	39259		GA-75	39455		GA-273
3885315B		G-296	3912-H21		GA-360	39260		GA-56	3945577		GP-28
3885315B		G-296-B	3912-H22		GA-360	3926045		GA-50	3945577		GP-430 ⁸
388625-R91		GAK-403	3912-H29-0		GA-360	3926051		GA-192	39461		GA-277
38884-28		GP-196	3912-H29-01		GA-360	39261		GA-3300	3946285		GA-642
3889310		GP-53	3912-H90		GA-360	39261		GA-3300	39463		GA-5056
3889311		GP-57	39134		GA-106 ⁴⁷	39261		GA-3300	39464		GA-2740
3889716		GP-1000	39134		GA-326 ⁷²	39262		GA-57	39465		GA-74
389		GG-48	39136650		GP-761H	39262		GA-57	39466		GA-3814
3890-200		G-31	3913764		GA-398	39262		GA-57	394667		G-31
3890-200		G-31	3913H21		GA-360	39263		GA-59	39466A		GA-106 ⁴⁷
3890300		G-1173 ¹⁰⁸	3913H22		GA-360	39263		GA-59	39466A		GA-206 ¹⁰⁸
3890-300		G-1173 ¹⁰⁸	3913H22901		GA-360	39263		GA-59	39466A		GA-326 ⁷²
3890301		G-1173 ¹⁰⁸	3913H2-901		GA-360	39264		GA-730	39469WB		GA-89
3890-301		G-1173 ¹⁰⁸	3914051		GA-192	39264		GA-730	39471		GA-253
3890450		GG-6	3914074		G-296	392642		GA-6	39474		GA-4325
3890-450		GG-6	3914074		G-296-B	39264WB		GA-730	39475		GA-174
3890550		GG-6	3914395		GP-178	39265WB		GP-178	3947813		GP-178
3890-550		GG-6	39144712		GA-106 ⁴⁷	39266		GA-85	39478WB		GA-471
3890-575		G-33	39144712		GA-326 ⁷²	39266		GA-85	39480WB		GA-3637
3890-575		G-33	3914-H2-1		GA-31	39266WB		GA-195	39481		GA-6479
3890708		GP-178	3914-H2-2		GA-31	39267		GA-55	39485WB		GA-80
3890709		GP-390	3914H2901		GA-31	39267		GA-55	39487WB		GA-2194
38924		GAK-403	3914-H29-01		GA-31	39267WB		GA-55	39488		GAD-15
389259-C9		GA-27	391506		GA-106 ⁴⁷	39268		GA-192	39489WB		GAVW-4
389259-C91		GA-27	391506		GA-206 ¹⁰⁸	39269		GA-325	39491WB		GA-4365
389263		GAK-403	391506		GA-326 ⁷²	39269		GA-325	3949561		GP-178
389263-R91		GAK-403	39-160		GG-6	39269WB		GA-325	39496WB		GA-180
389263-R92		GAK-403	3916604		GP-77	39270WB		GA-6690	39497WB		GA-139
389290		GA-33	3916770		GP-66	39271		GA-349	395		GP-27
389290-R91		GA-33	3917626		G-297	39273		GAD-3	39502WB		GA-390
389291		GA-33	3917626		G-297-B	39273		GAD-3	39503WB		GA-3501
389291-R91		GA-33	3917626		G-297	39273		GAD-3	39504		GA-362
38930-37714		GP-171	3917626		G-297-B	39274		GAD-1	39505WB		GA-6619 ¹
389363R91		GA-403	3917694		GP-9	39274		GAD-1	39505WB		GA-6620 ⁵
3894		G-500	3917696		GP-9	39277		GA-3300	39507WB		GA-142
389567		GA-33	3917924		2010PM-OR	39277		GA-3300	39510WB		GA-7017
389567-R91		GA-33	3919562		GP-3000 ¹³	39278		GA-86	395188		GAD-3
3897992		GP-81	3919764		GP-77	39278		GA-86	395191		GA-4303
389845-C91		GA-27	392		GP-23	39282WB		GA-85	395283-C9		GA-26
3899		G-1047	392		GAD-3	39283WB		GA-86	395283-C91		GA-26
38991386		GA-77	39201		GP-1	39284WB		GA-3424	3954809		GP-2071W
3899811		G-296	39201		GP-1	39285WB		GA-3425	3954891		GPP-10035
3899811		G-296-B	39202		GP-9 ⁵⁸	39287		GA-54	3954904		GPP-10035
3900		GP-390	39202		GP-81 ³¹	39288		GA-2719B	395540		GAK-16

Referencia Cruzada por Numero de Parte

Cross Reference by Part Number



Numero	Gonher	Fabricante	Numero	Gonher	Fabricante	Numero	Gonher	Fabricante	Numero	Gonher	Fabricante
Number	Gonher	Manufacturer	Number	Gonher	Manufacturer	Number	Gonher	Manufacturer	Number	Gonher	Manufacturer
395540-R91GAK-16	IHCO	3A11532GA-37	FMC	310052GA-24	CATP	310750GP-1101	CATP
395540-R92GAK-16	IHCO	3A11535GP-1101	FMC	310082GA-892	CATP	310751GP-27	CATP
39556WBGP-171 ¹⁶	AUTE	3A11535GP-1101	LINK	310085GA-98 ¹¹²	CATP	310752GP-749	CATP
39557WBGP-3766	AUTE	3A11537G-500	FMC	310088GA-357	CATP	310753GP-1101	CATP
39564WBGP-22	AUTE	3A11537G-500	LINK	310101GA-31	CATP	310754GP-55	CATP
39566WBGP-36	AUTE	3A11538G-613	FMC	310102GA-27	CATP	310755GP-93	CATP
39569WBGP-44	AUTE	3A11538G-613	LINK	310125GA-6127	CATP	310756GP-110	CATP
3957GG-307	NAP	3A11539GP-53	FMC	310126GA-206	CATP	310757GP-84	CATP
39570WBGP-23	AUTE	3A11542GP-57	FMC	310127GA-361	CATP	310758GP-85	CATP
39574GP-68	AUTE	3A11542GP-57	LINK	310130GA-5648	CATP	310759GA-27	CATP
3957554GA-192	GMCX	3A11544GP-43	FMC	310157GA-33	CATP	310760GA-26	CATP
3957719GP-1010Q	FORD	3A11544GP-43	LINK	310158GAK-16	CATP	310761GA-6129	CATP
395789-R2GP-171	IHCO	3A11549G-1173	FMC	310159GAK-20	CATP	310765GA-229	CATP
395789-R91GP-81	IHCO	3A11549G-1173	JONB	310161GA-24	CATP	310766GA-378	CATP
395789-R92GP-81	IHCO	3A11549G-1173	LINK	310162GA-27	CATP	310767GA-6880	CATP
39579WBGP-91	AUTE	3A11550G-1143	FMC	310174GA-360	CATP	310773GA-107	CATP
3958076GP-54	FORD	3A11550G-1143	JONB	310179GA-398	CATP	310774GA-493 ¹⁰⁸	CATP
3958076GP-54	NEWH	3A11550G-1143	LINK	310206GAK-458	CATP	310777GA-109	CATP
3958768GP-1122	NEWH	3A11554GP-110	FMC	310207GA-459	CATP	310782GA-209	CATP
39-5-941GAK-20	SEDN	3A11554GP-110	JONB	310223GA-372	CATP	310787GA-360	CATP
3959612GP-1109	CUMM	3A11554GP-110	LINK	310225GA-357	CATP	310788GA-24	CATP
396GA-6129	AMP	3A11555GP-51	FMC	310228GAK-216	CATP	310789GA-24	CATP
396GA-6129	BGA	3A11555GP-51	JONB	310229GAK-216	CATP	310792GA-356	CATP
396GP-81 ³¹	DEL	3A11555GP-51	LINK	310233GA-403	CATP	310795GA-563	CATP
396GP-9 ⁵⁸	DEL	3A11556GP-66	FMC	310239GA-416	CATP	310796GA-251	CATP
3961258GP-1122	NEWH	3A11556GP-66	JONB	310241GA-373	CATP	310798GAK-20	CATP
3963906GP-171	NEWH	3A11556GP-66	LINK	310244GA-891	CATP	310799GA-106 ⁶⁶	CATP
3968615GG-5 L	AMCO	3A11646GP-53	FMC	310254GA-239	CATP	310799GA-326 ⁷¹	CATP
397GP-34	DEL	3A11646GP-53	JONB	310260GA-329	CATP	310803GA-33	CATP
397032GP-310	TENN	3A11646GP-53	LINK	310262GA-891	CATP	310804GAK-16	CATP
397079GA-33	PETT	3A11652GP-13	FMC	310269GAK-16	CATP	310806GAK-403	CATP
397-079GA-33	LSTR	3A11652GP-13	JONB	310285GA-759	CATP	310814GAK-1532	CATP
397173-R91GAK-16	IHCO	3A11652GP-13	LINK	310286GA-239	CATP	310815GAK-625	CATP
397193GAK-16	IHCO	3A11653GP-36	JONB	310297GA-425	CATP	310842GA-1095	CATP
397193-R91GAK-16	IHCO	3A11653GP-36	LINK	310303GA-679	CATP	310848GA-9045	CATP
3971-H2-1GA-31	WHIT	3A15895GP-1011Q	LINK	310305GA-18	CATP	310849GA-8047	CATP
3971-H22GA-31	WHIT	3A4571GA-26	CRAN	310309GA-426	CATP	310850GA-9334	CATP
397323GP-1122	SAMB	3A4968GA-27	CRAN	310316GA-373	CATP	310851GA-1008	CATP
3973252GA-90	GMCX	3A7733G-33	JONB	310324GA-329	CATP	310854GA-375	CATP
39732523GA-90	GMCX	3A7733G-33	LINK	310328GA-210	CATP	310859GA-7716	CATP
3973253GA-90	GMCX	3C0183GA-18	CATP	310329GA-108	CATP	310860GA-483	CATP
3973287GA-90	GMCX	3C0183EGA-18	CATP	310342GA-372	CATP	310872GA-509 ¹⁴	CATP
39-7-341GAK-403	SEDN	3C183GA-18	CATP	310344GA-389	CATP	310875GA-403	CATP
39741GP-1101	DRIL	3C183EGA-18	CATP	310345GA-680	CATP	310879GA-405	CATP
3974113GP-91	CLRK	3C183EGA-18	TOWM	310349GA-371	CATP	310883GA-422	CATP
3974113-BGP-91	CLRK	3C3U-9601-BCGA-4999	FORD	310372GA-6129	CATP	310887GA-589	CATP
3974896GP-81 ³¹	CLRK	3C3Z-6731-AAG-3752	FORD	310373GA-106 ⁶⁶	CATP	310889GA-588	CATP
3974896GP-9 ⁵⁸	CLRK	3C3Z-9601-BAGA-4999	FORD	310373GA-326 ⁷¹	CATP	310890GA-27	CATP
3974896BGP-81 ³¹	CLRK	3C3Z-9N184-AAG-1047	FORD	310374GA-6128	CATP	310891GA-26	CATP
3974896BGP-9 ⁵⁸	CLRK	3C3Z-9N184-CAG-1047	FORD	310387GA-372	CATP	310892GA-6129	CATP
397-512G-297	LSTR	3CM1-1715GA-33	MITTS	310392GAK-1532	CATP	310896GA-229	CATP
397-512G-297-B	LSTR	3ECO-11-1730GAK-16	KOMA	310394GAK-16	CATP	310897GA-378	CATP
3978040GP-548	CUMM	3ECO-11-1730LGAK-16	KOMA	310396GAK-403	CATP	310903GA-209	CATP
397868-R1GP-10	IHCO	3ED6-64-1130GP-9586	KOMA	310397GA-33	CATP	310904GA-107	CATP
397868-R91GP-10	IHCO	3F5874-1GGP-25	SACO	310399GAP-381	CATP	310907GA-109	CATP
3979547GA-90	GMCX	3FV1344000GP-91	YAMH	310404GA-694	CATP	310911GA-209	CATP
3979575GA-90	GMCX	3H0950GA-106 ⁶⁶	FMC	310415GA-3551 ²⁵	CATP	310915GA-360	CATP
39795756GA-90	GMCX	3H0950GA-326 ⁷¹	FMC	310415GA-3551 XT ²⁴	CATP	310916GA-24	CATP
3979576GA-90	GMCX	3H0950GA-106 ⁶⁶	JONB	310425GA-1285	CATP	310920GA-356	CATP
3979645GA-90	GMCX	3H0950GA-326 ⁷¹	JONB	310426GA-1286	CATP	310924GA-251	CATP
398080-R1GP-10	IHCO	3H0950GA-106 ⁶⁶	LINK	310427GA-1287	CATP	310926GAK-20	CATP
398080-R2GP-10	IHCO	3H0950GA-326 ⁷¹	LINK	310428GA-1284	CATP	310927GA-106 ⁶⁶	CATP
398080-R2GP-10	KOMA	3H1283G-870	AUST	310432GA-7360	CATP	310927GA-326 ⁷¹	CATP
3981923GP-1	CLRK	3H1283G-870	LEYL	310433GA-482	CATP	310929GA-33	CATP
3982984GA-90	GMCX	3H1287G-870	LEYL	310443GA-616	CATP	310930GAK-16	CATP
3986170GP-77	FORD	3H1288G-870	AUST	310548GP-761H	CATP	310932GAK-403	CATP
39867GPP-19	CASE	3H1288G-870	LEYL	310549GP-761H	CATP	310937GAK-1532	CATP
39868GPP-18	CASE	3H1363G-33	FMC	310550GP-761H	CATP	310938GAK-625	CATP
398706GP-761H	HOUG	3H1363G-33	JONB	310551GP-761H	CATP	310947GA-1095	CATP
398845-C91GA-27	IHCO	3H1363G-33	LINK	310553GP-761H	CATP	310949GA-376	CATP
398865GP-761H	HYST	3H1749GP-57	FMC	310554GP-761H	CATP	310958GA-251	CATP
399GP-53	DEL	3H1749GP-57	JONB	310566GP-761H	CATP	310969GA-377	CATP
3991GA-113	AUTO	3H1749GP-57	LINK	310567GP-761H	CATP	310970GAK-16	CATP
39911615GP-761H	INGR	3H2135GP-58	LEYL	310568GP-761H	CATP	310980GA-77	CATP
3995GA-100	AUTO	3H2139GP-58	LEYL	310589G-152	CATP	310982GA-50	CATP
3999976GP-54	FORD	3H217GAK-20	FMC	310591G-222	CATP	310983GA-80	CATP
3AGA-360	BOG	3H217GAK-20	JONB	310592G-153	CATP	310984GA-192	CATP
3A10314G-159	FMC	3H217GAK-20	LINK	310609GP-761H	CATP	310985GA-78	CATP
3A10503G-1175	FMC	3H-217GAK-20	FORD	310610GP-761H	CATP	310986GA-90	CATP
3A10503G-1175	LINK	3H218GA-24	FMC	310611GP-761H	CATP	310987GA-59	CATP
3A10511GP-1101	FMC	3H218GA-24	JONB	310612GP-761H	CATP	310988GA-57	CATP
3A10511GP-1101	LINK	3H218GA-24	LINK	310642G-339H	CATP	310989GA-85	CATP
3A10512G-566	FMC	3H-218GA-24	FORD	310702GP-864H	CATP	310990GA-303	CATP
3A10512G-566	LINK	3H219GA-27	FMC	310704GP-34	CATP	310991GA-3300	CATP
3A10513G-750	FMC	3H219GA-27	JONB	310712G-33	CATP	310993GA-75	CATP
3A10522GP-2071W	FMC	3H219GA-27	LINK	310713G-33	CATP	310994GA-3501	CATP
3A10771GP-26	FMC	3H-219GA-27	FORD	310718G-238	CATP	310998GA-3501	CATP
3A10771GP-26	LINK	3H220GA-26	FMC	310719G-191	CATP	310999GA-89	CATP
3A10772GP-27	FMC	3H220GA-26	JONB	310720G-566	CATP	311000GA-3424	CATP
3A10772GP-27	LINK	3H220GA-26	LINK	310721GP-9586	CATP	311001GA-3425	CATP
3A11007GP-92	FMC	3H-220GA-26	FORD	310722GP-36	CATP	311002GA-3523	CATP
3A11007GP-92	LINK	3H4340G-870	LEYL	310730GP-51	CATP	311004GAD-1	CATP
3A11008GP-93	FMC	3H950GA-106 ⁶⁶	LINK	310731GP-52 ¹¹⁰	CATP	311005GAD-3	CATP
3A11008GP-93	LINK	3H950GA-326 ⁷¹	LINK	310731GP-691 ⁴⁸	CATP	311006GA-74	CATP
3A11009GP-53	FMC	310026GA-2804 T	CATP	310737GP-53	CATP	311007GA-3490	CATP
3A11009GP-53	LINK	310038GAP-379	CATP	310740GP-43	CATP	311008GA-54	CATP

REFERENCIA CRUZADA

Referencia Cruzada por Numero de Parte

Cross Reference by Part Number



Numero	Gonher	Fabricante	Numero	Gonher	Fabricante	Numero	Gonher	Fabricante	Numero	Gonher	Fabricante
Number	Gonher	Manufacturer	Number	Gonher	Manufacturer	Number	Gonher	Manufacturer	Number	Gonher	Manufacturer
4007200		G-1166 HATZ	4025923		GAK-20 ALCH	4041540		GG-8 L ⁸⁰ MOP	40593		GP-93 GLOB
4007300		G-1166 HATZ	4025933		GAK-20 ALCH	4041959		GP-14 EUCL	4059343		G-750 ALCH
4007348		GP-50 FIAT	4025933		GAK-20 FIAT	4042		GA-4325 AUTO	4059343		G-750 FIAT
400751062		GA-360 FLOM	4026		GA-381 AUTO	404203		GAK-16 HOBT	4059343-6		G-750 ALCH
40078800		G-296 HATZ	4026		GP-2071W NAP	404295		GAK-403 EATN	4059373		G-500 ALCH
40078800		G-296-B HATZ	4026075		GP-50 ALCH	404295		GAK-403 TIMB	40595		GAK-403 SULL
4007K		G-1123F CRO	4026075		GP-50 FERI	404295		GAK-403 YALE	40596		GP-55 GLOB
4008		G-750 LUF	4026075		GP-50 FIAT	4044270		GAK-20 TAYL	40596		GAK-403 SULL
40089401		GG-124 HATZ	4026486		GP-3985 CHRY	4044300		GAK-403 TAYL	4059818		GA-361 HITA
4009		G-750 LUF	402652A1		GP-761H CASE	4044356		GAK-625 TAYL	4059976		G-33 EUCL
4009		GP-92 NAP	4026860		GA-230 FIAT	4044418		GA-398 TAYL	406		GG-20 CRM
4009078		GAK-403 ALCH	4026941		GPP-18 TAYL	4044447		GA-251 TAYL	40600169		G-1123F GMEI
4009F		2010PM-OR ⁷ GREY	4026942		GP-178 TAYL	4044471		GP-761H TAYL	406-00-169		G-112 KALB
4009F		2010TM-OR ² GREY	4027		GP-92 NAP	4046		GA-3681 AUTO	406-00-169		G-1123F KALB
401		GG-19 CRM	402700		G-566 CUMM	404-6101		GP-36 LETR	406-00-261		GA-206 KALB
401		G-6 CRO	402719		G-31 WHIT	4047601		GA-356 ¹⁰⁴ LETR	406-00-493		GP-36 KALB
40101		GP-34 PFAC	40285		G-33 SULL	4047601		GA-357 ¹⁰⁸ LETR	406-00-494		GP-31 KALB
40102		GP-34 PFAC	4029		GGP-125 NAP	4048147		GA-3637 ALCH	40-60-05		GG-48 SLAN
4010217840		G-1121F TALB	4029084		GP-2071W FIAT	4049224		GG-8 ¹⁰³ CHRY	4060050		G-296 ALCH
4010276340		G-1166 TALB	4029089		GP-2071W ALCH	4049224		GG-8 L ⁸⁰ CHRY	4060050		G-296-B ALCH
4010476		GP-1101 CUMM	4029089-2		GP-1010Q ALCH	4049224		GG-8 ¹⁰³ MOP	40600504		G-296 FIAT
4010651		GPP-10075 CUMM	4029099		GP-2071W ALCH	4049224		GG-8 L ⁸⁰ MOP	40600504		G-296-B FIAT
4010F		GS-2034 GREY	4029120		GP-2071W ALCH	404925		GAK-403 TIMB	4060050-4		G-296 ALCH
4011		GP-92 NAP	402969675		GG-5 L LOSE	4049357		GP-69 CRSS	4060050-4		G-296-B ALCH
4011024630		G-1123F TALB	402P20H		G-33 CASE	405		GA-206 AMP	40-60-37		GP-110 SLAN
401102630		G-1123F TALB	403		GA-360 AMP	405		GA-206 BGA	40-60-38		G-296 SLAN
4011080430		G-1121F TALB	403		GA-360 BGA	405		GG-6 CRM	40-60-38		G-296-B SLAN
40111834		GP-81 CASE	403		GG-5 L CRM	405067		GA-37 CUMM	40-60-41		GP-112 SLAN
401151022		GAK-625 FLOM	403		G-871 CRO	4050740		GP-54 ¹¹ ZETT	40-60-42		G-297-B SLAN
4011800009		G-163 DAIM	403		GA-56 DEL	4050740		GP-66 ¹⁰ ZETT	406-07-004-9		G-834 STEY
4011800009		G-163 MBNZ	4030		GP-2071W NAP	40507408		GP-54 ¹¹ ZETT	406-07-18		GP-1 STEY
4011840025		G-163 DAIM	403103		G-1173 TIMB	40507408		GP-66 ¹⁰ ZETT	406113		GP-54 ZETT
4011840025		G-163 MBNZ	403104		G-1174 TIMB	4051		GA-217 AUTO	4061130		GP-54 ZETT
4011F		GPP-125 GREY	403108		G-119 TIMB	405118-R91		GAK-16 IHCO	406130-R1		GA-891 IHCO
40120300		GP-1122 HATZ	4031-102		G-112 CAV	4051490		G-1173 ALCH	406130R91		GA-892 IHCO
4012356		GA-356 GMCX	4031215		GA-357 GMCX	4051490-0		G-1173 ALCH	4062072		GA-44 FIAT
4012357		GA-357 EUCL	4031216		GA-356 GMCX	40514904		G-1173 ALCH	4062434		GA-27 ALCH
4012357		GA-357 GMCX	4031840025		G-143 DAIM	4051925		GA-16 ¹¹² FIAT	4062494		GA-27 TIMB
40125-00010		GP-385 MITS	4031840025		G-143 MBNZ	4051925		GAK-16 ⁹⁴ FIAT	4063224		GA-106 ⁹ ALCH
4013		GA-357 AUTO	403-2		G-871 CRO	4052172		G-1175 AMHO	4063224		GA-326 ⁷¹ ALCH
401362		GA-26 HOBT	403217		GA-33 HUBR	4052172		G-1175 BLDW	4063262		GP-178 CUMM
4013F		GS-2033 GREY	403-3		G-871 CRO	4052572		GP-1 ALCH	40633-96		GP-3985 MITS
4014155-8		G-33 VOLV	4033156710		GP-1122 RENA	4052677		GA-37 ALCH	4064		GA-386 AUTO
40143		G-1173 PHHR	4033158110		G-1122 RENA	4053800		GP-1122 HAMM	40660		GAK-16 ALCH
40150-30370		GP-81 ³¹ TOYO	40340W		GP-54 ¹¹ BAUD	4053800		GP-1122 SULL	406761		G-1173 TIMB
40150-30370		GP-9 ⁵⁸ TOYO	40340W		GP-66 ¹⁰ BAUD	4053800		GP-1122 ZETT	4068		GP-43 NAP
40150-30370-71		GP-81 TOYO	403507-R91		GA-5648 IHCO	405416136		GP-310 CASE	4068		GP-53 NAP
40151		G-1173 PHHR	4035540		GA-357 LETR	4054551		GPP-14 EUCL	4068480		GP-77 ZETT
4016		GA-140 APRO	4035540		GA-357 WABC	4054554		G-750 EUCL	40684806		GP-77 ZETT
401644		GA-360 HUBR	403554000		GA-357 LETR	4054555		GP-2071W EUCL	4068894		GA-230 FIAT
4017		GA-322 AUTO	4035541		GA-356 LETR	4054556		GP-55 EUCL	4069		GP-1 LUF
4017640		GA-356 ¹⁰⁴ LETR	4035541		GA-356 WABC	4054557		GP-1011Q EUCL	40695		GP-66 HYDS
4017640		GA-357 ⁰⁸ LETR	403554100		GA-356 LETR	405484		GP-81 TIMB	407		GG-7 CRM
4018390-R91		G-122 IHCO	4035556		GP-390 ⁹³ ALCH	405501-C1		GG-20 IHCO	407		G-152 DEL
4018390-R91		G-338 IHCO	4035556		GP-390 ⁹³ FIAT	4055020005		GG-251 RENA	407-00-147		G-1121 KALB
401839R91		G-122 CASE	4035556-2		GP-390 ⁹³ ALCH	4055036001		GG-189 RENA	407-00-148		G-1123F KALB
401839R91		G-338 CASE	4036		GA-3647 AUTO	4055040		GA-27 HITA	407-00-313		GP-1122 KALB
401839-R91		G-122 IHCO	4036432		G-270 ALCH	4055345		GS-1133 ALCH	40-70-04		G-225 SLAN
401839-R91		G-338 IHCO	4036711		GP-78 ALCH	4055345-1		GS-1133 DEMA	407-00-433		G-31 KALB
401947		GP-81 TIMB	4036791		GP-51 ALCH	4055533		G-1174 ALCH	407018		G-31 WHIT
402		GA-361 AMP	403755		G-33 TIMB	405556		G-1174 ALCH	40-70-25		GP-68 SLAN
402		GA-361 BGA	403836		GAK-20 EATN	4055563		G-1174 ALCH	407026		G-31 WHIT
402		GG-5 L CRM	403836		GAK-20 TIMB	4055563-3		G-1174 ALCH	40-70-42		G-297-B SLAN
402		G-191 CRO	403836		GA-26 ¹¹² YALE	4055563-9		G-1174 ALCH	407061-R91		GAK-16 IHCO
4020		GP-2071W NAP	403936		GAK-20 TIMB	4055916		G-1173 ALCH	407-08-007-4		GGP-1122 STEY
40200114		GP-9 SKOD	4039371		GA-90 CHRY	4055916-4		G-1173 ALCH	407-08-007-6		GGP-1122 STEY
40201		GP-34 PFAC	4039371		GA-90 MOP	4055920		G-1175 ALCH	407-08-011-6		GP-1122 STEY
40202		GP-34 PFAC	4039440-7		GPP-1000 ALCH	4055920-3		G-1175 ALCH	407-08-013-1		G-1121 STEY
40210		GP-1 INGR	403997		GAK-403 HOBT	4056350		GP-110 ZETT	407-08-013-2		G-1121 STEY
4021442		GP-1101 ALCH	403F		G-296 GREY	40563502		GP-110 ZETT	407-08-116		G-1121 STEY
4021443		GAK-403 ADAM	403F		G-296-B GREY	4056630		GAK-20 ALCH	4070874		GP-1122 LEYL
4021443		GAK-403 FIAT	404		GA-106 ⁶⁶ AMP	4056630		GAK-20 FIAT	407-08-74		GP-1122 STEY
4021443		GAK-403 LETR	404		GA-326 ⁷¹ AMP	4056630-1		GAK-20 ALCH	4071		GP-2071W NAP
4021443-5		GAK-403 ALCH	404		GA-106 ⁶⁶ BGA	4056632-1		G-1175 ALCH	4071965		GG-8 ¹⁰³ CHRY
4021800009		G-143 DAIM	404		GA-326 ⁷¹ BGA	4056633		G-1173 ALCH	4071965		GG-8 L ⁸⁰ CHRY
4021800009		G-143 MBNZ	404		GG-123 CRM	4056633-1		G-1173 ALCH	4071965		GG-8 ¹⁰³ MOP
4022		GP-2071W NAP	404		G-870 CRO	405712		GP-36 ZETT	4071965		GG-8 L ⁸⁰ MOP
402219101		GP-77 LOSE	404		G-335 DEL	4057120		GP-54 ¹¹ SULL	4071MP		GP-2071W NAP
402219303		GP-66 LOSE	404		GP-38 PMC	4057120		GP-66 ¹⁰ SULL	4072		GP-1011Q NAP
402255-C1		GPP-14 IHCO	4040		GA-3588 AUTO	40571203		GP-36 ZETT	407296		GAK-403 LNCR
4023		GP-2071W NAP	4040		GP-26 NAP	40580		GP-26 GLOB	4073		GP-1011Q NAP
40231-52300		GA-360 KUBO	40400		G-33 SULL	40581		GP-27 GLOB	4073MP		GP-1011Q NAP
4023548		GP-390 ⁹³ ALCH	4040478		G-1173 ALCH	40588		GP-78 GLOB	4074		GP-1013Q NAP
40235483		GP-390 ⁹³ FIAT	4040478-3		G-1173 ALCH	405-905-601		GG-246 ROB	4076282		GP-57 CLRK
4023548-3		GP-390 ⁹³ ALCH	404082		G-296 TIMB	405916-R1		GAK-16 IHCO	40766705		GP-77 HAMM
4024		GA-2719B AUTO	404082		G-296-B TIMB	40592		GP-92 ¹⁰⁴ GLOB	4077		GA-3901 AUTO
4024223		G-293 ALCH	404083		G-871 TIMB	4059252		GAK-403 ALCH	4077001		GP-1 WAUK
4024232		G-295 ALCH	40412306		GP-57 VOLV	4059252		GAK-403 FIAT	4077629		GP-50 FIAT
4024232		G-295 FIAT	4041252		GA-78 CHRY	4059252-6		GAK-403 ALCH	40779		G-1173 PHHR
40242323		G-295 FIAT	4041252		GA-78 MOP	4059263		G-750 ALCH	40781		GP-92 ¹⁰⁴ GLOB
4024232-3		G-295 ALCH	4041330-6		GP-57 VOLV	4059263		G-750 FIAT	40782		GP-1122 GLOB
402441		G-813 TIMB	404154		GG-8 ¹⁰³ CHRY	4059263-5		G-750 ALCH	407839		GAK-20 TIMB
4024-7900		GA-206 KUBO	404154		GG-8 L ⁸⁰ CHRY	4059292		GAK-403 ALCH	40786		GP-55 GLOB
40248-47410		GA-6129 KUBO	4041540		GG-8 ¹⁰³ CHRY	4059292		GAK-403 FIAT	408107		GP-92 ¹⁰⁴ SULL
40251-56400		GA-33 KUBO	4041540		GG-8 L ⁸⁰ CHRY	40592922		GAK-403 FIAT	408193		GA-206 SULL
40251-56500		GA-361 KUBO	4041540		GG-8 ¹⁰³ MOP	4059292-2		GAK-403 ALCH	4082		GA-166 AUTO

REFERENCIA CRUZADA

Numero	Gonher	Fabricante	Numero	Gonher	Fabricante	Numero	Gonher	Fabricante	Numero	Gonher	Fabricante	
Number	Gonher	Manufacturer	Number	Gonher	Manufacturer	Number	Gonher	Manufacturer	Number	Gonher	Manufacturer	
40823		G-1166	GLOB	41-0266	GP-81	BEK	41-0758	GP-156	BEK	4113	GP-2127W	NAP
408242		GP-34	SULL	41028	G-1121	CARO	41-0758	GP-157	BEK	4-1130	GP-1	IPS
40-82-42-S		GP-34	SLAN	41-0282	G-162H	BEK	41-0759	GP-157	BEK	41130009A	GA-892	VMEN
4083040016		G-834	RENA	4-1029	GP-462	IPS	41-0760	GP-40	BEK	4113009	GA-892	MVM
4083490		GP-50	FIAT	41-0324	GP-81	BEK	41-0764	G-871	BEK	4113009	GA-892	VMEN
4084		GA-3814	AUTO	41-0332	GP-171 ¹⁶	BEK	41-0765	GP-58	BEK	41130705A	GA-106 ¹⁶	VMEN
4084196		GPP-11	VOLV	41-0340	GP-36	REK	41-0766	GP-58	BEK	41130705A	GA-326 ⁷¹	VMEN
4084262		GP-55	EUCL	41-0365	GP-1	BEK	41-0767	GP-157	BEK	4-1131	GP-91	IPS
4084262		GP-55	VME	4103735	GG-915	MTR	41-0768	GP-91	BEK	4-1133	GP-462	IPS
4084262		GP-55	VOLV	4-1038	GP-310	IPS	41-0769	GP-149	BEK	4113539	GP-81	ALCH
4085787		GA-186 ¹⁶	HITA	41-0399	GP-870	BEK	4-1077	GP-40	IPS	4113559	GP-81	ALCH
4085787		GA-326 ⁷¹	HITA	4-1040	GP-46	IPS	41-0772	GP-28	BEK	4-1137	GP-91	IPS
4085788		GA-206	HITA	41-0407	GP-42	BEK	41-0774	GP-58	BEK	4113705	GA-106 ¹⁶	VMEN
4085912		GP-14	HITA	41042	G-296	CARO	41-0776	GP-1	BEK	4113705	GA-326 ⁷¹	VMEN
40859121		GPP-11	HITA	41042	G-296-B	CARO	41-0777	GP-28 ⁶	BEK	4114	GP-2108W	NAP
4085913		GP-53	HITA	41-0423	GP-1	BEK	41-0777	GP-430 ⁸	BEK	41150006A	G-871	VMEN
4085914		G-750	HITA	410449	GP-46	BEK	4107775	GP-50	FIAT	41150030A	GP-68	MVM
408695		G-31	VOLV	4-1045	GP-22	IPS	41-0778	GP-149 ¹⁰	BEK	41150030A	GP-68	VMEN
40876		GP-84	GLOB	4-1046	GP-22	IPS	41-0778	GP-91 ¹⁴	BEK	41150057A	GP-54 ¹¹	VMEN
40877		GP-83	GLOB	4-1047	GP-1	IPS	41-0779	GP-28	BEK	41150057A	GP-66 ¹⁰	VMEN
408925		GPP-14	TIMB	4-1048	GP-5	IPS	4-1078	GP-310	IPS	41150059A	GP-36	VMEN
408928		G-613	TIMB	41052	G-1121	CARO	41-0780	GP-157	BEK	4115006	G-871	VMEN
408929		G-500	TIMB	4-1052	GP-870	IPS	41-0784	GP-40	BEK	41150068A	GP-1	VMEN
408F		G-1121F	GREY	4105404	GP-58	CHRY	41-0787	G-963	BEK	4115030	GP-68	VMEN
409		GG-16	CRM	4105409	GP-58	CHRY	41-0788	GP-171	BEK	4115031	GP-406	MVM
409		GA-50	DEL	4105409	GP-58	MOP	41-0788	GP-81	BEK	4-115-031	GP-406	VMEN
4090		G-500	LUF	41-0548	GP-3531	EXP	41-0789	GP-149	BEK	4115057	GP-54 ¹¹	VMEN
4090408		GA-360	HITA	41-0555	GP-42	BEK	4-1079	GP-38	IPS	4115057	GP-66 ¹⁰	VMEN
4090409		GA-361	HITA	4-1056	GP-58	IPS	41-0792	GP-28	BEK	4115059	GP-36	VMEN
409-07-36		GP-310	STEY	41-0563	GP-1	BEK	41-0795	GP-58	BEK	4115063	GP-3816	VMEN
4093		GA-275	AUTO	41-0571	GP-40	BEK	41-0796	GP-46	BEK	4115064	GP-28 ⁶	MVM
4094		GA-240	NAP	41-0589	GP-462	BEK	41-0797	GP-149	BEK	4115064	GP-430 ⁸	MVM
409409		GP-390	WALD	4-1059	GP-81	IPS	4-1080	G-870	IPS	4115064	GP-28 ⁶	VMEN
4-094-16-04		GA-2179	CHRY	41-0597	GP-28	BEK	41-0804	G-984	BEK	4115064	GP-430 ⁸	VMEN
4-094-16-04		GA-2179	MBNZ	41-06	GA-389	ERO	41-0817	G-70	BEK	4115065	GP-1	MVM
40942604		GA-475	MBNZ	4106001	GG-8 ¹⁰³	CHRY	41-0820	GP-42	BEK	4115065	GP-1	VMEN
40957		GPP-14	GLOB	4106001	GG-8 L ⁸⁰	CHRY	4-1083	GP-91	IPS	4115066	GP-31	VMEN
4096		GP-26	NAP	4106001	GG-8 ¹⁰³	MOP	4108311	GA-33	HYMA	411519-C91	GA-27	IHCO
4097		GA-133	AUTO	4106001	GG-8 L ⁸⁰	MOP	4108-311	GA-33	HYDR	41152001A	GP-58 ¹⁵	DUCA
4097		GP-27	NAP	41-0605	GP-81	BEK	4-1084	GP-46	IPS	411554001	GP-81	SAME
4097		GP-93	NAP	41-0613	GP-171	BEK	41-0847	GP-3985	BEK	41179	GA-3424	VALU
40979		GP-1108	GLOB	41-0639	GP-149 ¹⁰	BEK	4-1086	GP-40	IPS	41180	GA-86	VALU
4098		GP-92 ¹⁰⁴	NAP	41-0639	GP-40	BEK	41-0865	GP-157	BEK	41182	GA-85	VALU
40983		GA-50	PER	41-0639	GP-91 ¹⁴	BEK	4-1087	GP-3600	IPS	4119	GA-471	AUTO
4099		GP-27	NAP	41-0647	GP-310	BEK	4-1088	GP-24 ²⁶	IPS	4119015	GP-1	ALCH
4099		GP-93	NAP	41-0670	GP-157	BEK	4-1088	GP-462 ²⁴	IPS	4119015	GP-171 ¹⁶	FIAT
40990		G-296	SULL	41-0670	GP-58	BEK	4-1090	GP-42	IPS	4119217	G-1123F	CLRK
40990		G-296-B	SULL	41-0688	GP-3531	EXP	4-1091	GP-3531	EXP	4119277	G-871	ALCH
40990		G-297-B	SULL	4-1069	GP-81 ³¹	IPS	4-1093	GP-310	IPS	4119668	GA-230	FIAT
40992		G-297-B	SULL	4-1069	GP-9 ³⁸	IPS	4-1093	GP-3569	IPS	4119775	GP-36	CLRK
40993		G-296	SULL	41-0696	GP-81	BEK	41-0954	G-871	BEK	412	GA-71	AUTP
40993		G-296-B	SULL	41-0697	GP-22	BEK	4-1096	GP-28 ⁶	IPS	4120	GA-271	AUTO
4099601		GP-1011Q	VOLV	41-0698	GP-28	BEK	4-1096	GP-430 ⁸	IPS	412013	G-1121F	DONT
40A134		GA-33	MINN	41-0699	GP-28	BEK	4-1097	GP-310	IPS	412015406	G-1121	EATN
40A134		GA-33	WHIT	41-0699	GP-3682	BEK	4-1098	GP-28 ⁶	IPS	4120154-06	G-1121	YALE
40HE		G-870	BOG	4-1070	GP-1	IPS	4-1098	GP-430 ⁸	IPS	4120154-6	G-1121	YALE
41 63 853		GG-261	SAAB	41-0703	GP-171	BEK	4-1099	GP-171	IPS	412019	G-1123F	DONT
410		GA-50	AUTP	41-0704	GP-38	BEK	411	GA-77	AUTP	412108	G-1123F	DONT
410		GG-17	CRM	41-0706	GP-149 ¹⁰	BEK	411005	G-33	DONT	412110	GP-1121	DONT
4100		G-750	LUF	41-0706	GP-91 ¹⁴	BEK	411008	G-871	DONT	41211831	GP-81	HOND
410000207		G-133	MBNZ	41-0707	GP-3985	BEK	411009	G-133	DONT	412120	G-1121	DONT
410000207		G-989	MBNZ	41-0708	GP-28 ⁶	BEK	411009	G-989	DONT	4121-2153	GA-70	DTSU
4-1001		G-871	IPS	41-0708	GP-430 ⁸	BEK	4-1101	GP-38	IPS	4121392	GP-1	ALCH
41-0019		GP-1	BEK	41-0709	GP-3816	BEK	41102	G-133	SULL	4121392	GP-1	FIAT
4-1002		GP-81	IPS	4-1071	GP-38	IPS	41102	G-989	SULL	412157	GA-106 ¹⁶	WORT
4-1003		GP-28 ⁶	IPS	41-0710	GP-3985	BEK	411020	G-813	DONT	412157	GA-326 ⁷¹	WORT
4-1003		GP-430 ⁸	IPS	41-0711	GP-3985	BEK	411023	G-225	DONT	412158	GA-206	WORT
41-0043		G-870	BEK	41-0712	GP-28	BEK	4110239	G-162H	VOLV	4121609	GP-1122	CLRK
41004346		GA-5648	LEYL	41-0714	GP-28 ⁶	BEK	4-1103	GP-3985	IPS	4121609	GP-1122	MELR
41-0068		G-871	BEK	41-0714	GP-430 ⁸	BEK	411039	G-834	DONT	4121609B	GP-1122	CLRK
41007148		GA-360	LEYL	41-0718	GP-1	BEK	4-1104	GP-3985	IPS	4121609B	GP-1122	MELR
41007448		GA-360	LEYL	41-0718	GP-3569	BEK	411042	G-834	DONT	41218000	GP-58	FIAT
4-1008		GP-81	IPS	41-0719	GP-3985	BEK	411058	G-834	DONT	412194	GP-53	MANI
4100806		GA-360	HITA	41-0720	GP-462	BEK	411063	G-225	DONT	412195	GP-27	MANI
41008819		GA-106 ¹⁶	LEYL	41-0722	GP-28	BEK	4-1107	GP-3985	IPS	412196	GP-26	MANI
41008819		GA-326 ⁷¹	LEYL	41-0726	GP-38	BEK	411079	GA-360	WORT	412203	GA-230	FIAT
41009		G-870	IPS	4-1073	GP-171	IPS	4-1108	GP-3985	IPS	4122937	GAK-403	HITA
4-1010		G-870	IPS	41-0730	GP-1	BEK	411080	GA-361	WORT	412-3627	GP-43	LETR
4-1012		G-225	IPS	41-0731	GP-3682	BEK	411083	G-871	DONT	412-3628	GP-57	LETR
4-1013		GP-58	IPS	41-0735	GP-28	BEK	411089	G-143	DONT	412-3629	GP-55	LETR
4101-300		GAK-16	HYDR	41-0736	GP-3985	BEK	4-1109	GP-3985	IPS	412-3630	GP-1013Q	LETR
4101-303		GAK-16	HYDR	41-0737	GP-1	BEK	411090	G-163	DONT	41239	GA-33	LETR
41-0134		GP-81 ³¹	BEK	41-0738	GP-40	BEK	4111378	GP-1122	CLRK	41243	GA-54	VALU
41-0134		GP-9 ³⁸	BEK	41-0739	GP-3985	BEK	4112	GP-2126Q	NAP	4125030018	G-1123	RENA
41015		GA-3300	VALU	41-0743	GP-81	BEK	4-1120	GP-171	IPS	4126	GA-273	AUTO
4-1015		GP-42	IPS	41-0744	GP-81	BEK	411-22-07413559	GP-81	ALFA	4126434	GP-58	FIAT
4-1016		GP-3985	IPS	41-0749	GP-462	BEK	4112209	GP-81	FIAT	4126435	GP-81	FIAT
4-1017		G-834	IPS	41-0750	GP-157	BEK	411227	GP-26	TIMB	4127340	GP-2071W	HITA
41017301		GA-206	LEYL	41-0750	GP-57	BEK	411228	GP-92 ¹⁰⁴	TIMB	413	GA-78	AUTP
41017302		GA-106 ¹⁶	LEYL	41-0751	GP-58	BEK	411229	GP-27	TIMB	413	GP-3682	PMC
41017302		GA-326 ⁷¹	LEYL	41-0752	GP-3985	BEK	411230	GP-93	TIMB	413012	GA-71	DONT
41-0191		G-834	BEK	41-0753	GP-91	BEK	4-1124	GP-310	IPS	413021	GA-71	DONT
41020		GP-68	CARO	41-0754	GP-149 ¹⁰	BEK	411273	GP-43	HYDX	413037	GA-230	DONT
41022		GP-1122	CARO	41-0754	GP-91 ³⁴	BEK	411273	GP-53	TIMB	413042	GA-405	DONT
41-0233		GP-3816	BEK	41-0755	GP-462	BEK	411274	GP-43	TIMB	413047	GAD-3	DONT
4-1026		G-871	IPS	41-0756	GP-81	BEK	41128	GA-18	CONV	413063	GA-71	DONT

Referencia Cruzada por Numero de Parte

Cross Reference by Part Number



Numero	Gonher	Fabricante	Numero	Gonher	Fabricante	Numero	Gonher	Fabricante	Numero	Gonher	Fabricante
Number	Gonher	Manufacturer	Number	Gonher	Manufacturer	Number	Gonher	Manufacturer	Number	Gonher	Manufacturer
413073	GA-200	DONT	41735724	GA-360	LEVY	41-8159	GP-1	BEK	42020MP	GA-70	WIX
413073	GA-218	DONT	4173888	GA-361	HITA	41-8161	GP-28 ⁵	BEK	420-2127	GA-33	OWTN
413097U	GAK-403	DONT	4174	GA-174	AUTO	41-8161	GP-430 ⁸	BEK	4202887	GP-81	FIAT
413099U	GAK-16	DONT	4175	GG-19	VALU	41-8164	GP-2951	BEK	420-2891	GAK-16	OWTN
4131113	GG-6	CHRY	4175913	GP-57	HITA	41-8165	GP-91	BEK	420-28917	GAK-16	OWTN
4131113	GG-6	MOP	41759131	GP-57	HITA	41-8168	GP-145	BEK	42-0299	GA-16	BEK
41313	GA-735 ¹²⁴	VALU	4175914	GP-43	HITA	41-8175	GP-457	BEK	420-31259	GG-5 L	OWTN
413130-0	G-1175 ⁰⁸	ALCH	4175915	GP-1101	HITA	41-8176	GP-91	BEK	42-0323	GA-277	BEK
4131313	GG-6	CHRY	4176	GG-7	VALU	41-8181	GP-91	BEK	420-32381	GA-16	OWTN
4132	GA-274	AUTO	4176610	GP-81	FIAT	41-8190	G-912	BEK	420-32385	GAK-16	OWTN
4133	GG-3	NAP	4178830	GP-69	HITA	418432	GP-81	INTM	42033500	GP-91	SUBA
413341	GA-6129	WORT	4179	GA-153	AUTO	418432	GP-81	VOLV	42033-5400	GP-149	SUBA
413342	GA-6127	WORT	417917-C91	GG-5	IHCO	418432-1	GP-81	VOLV	42033-5410	GP-149	SUBA
4134	GA-5056	AUTO	4179923	GA-77	CHRY	4184342	GP-81	VOLV	42033-5500	GP-91	SUBA
4134196	GAK-20	FAUN	4179923	GA-77	MOP	41850	G-1176	PHHR	42033-7100	GP-3682	SUBA
4134217	GP-54 ¹¹	FAUN	418	GP-166	DITC	4185533	GG-5 L	CHRY	42033-7110	GP-3682	NISS
4134217	GP-66 ¹⁰	FAUN	4180	GA-253	AUTO	4185536	GG-5 L	CHRY	42033-7110	GP-3682	SUBA
4134377	GP-77	EATN	41-8004	G-834	BEK	4186	GA-142	AUTO	420-34257	GAK-1532	OWTN
4134377	GP-77	FAUN	41-8012	GP-81	BEK	4186165	GP-3985	CHRY	42-0349	GA-2740	BEK
4134389	GA-360	FAUN	41-8020	GP-42	BEK	4186209	GG-5 L	CHRY	4203564	GA-26	KOEK
4134403	GA-405	FAUN	41-8038	GP-1	BEK	4186267	GP-40	CHRY	4203568	GAK-403	KOEK
4134419	GA-467	FAUN	41-8038	GP-81	BEK	4186267	GP-40	MOP	4203569	GA-26	KOEK
4134427	GA-49	FAUN	41-8039	GP-1	BEK	41-8681	GP-46	BEK	4203581	GAK-403	KOEK
4134471	GP-66	FAUN	41-8041	GP-36	BEK	41-8684	GP-46	BEK	4203586	GAK-20	KOEK
4134475	GP-1122	FAUN	41-8043	G-834	BEK	41-8707	GP-149 ⁹⁹	BEK	42036	GA-3445	WIX
4134772	GP-1122	FAUN	41-8044	GP-3531 EXP	BEK	41-8707	GP-40	BEK	420-36075	GA-880R	MMAN
4134784	GP-54 ¹¹	FAUN	41-8046	GP-38	BEK	41-8707	GP-91 ⁹⁸	BEK	420-36075	GA-880R	OWTN
4134784	GP-66 ¹⁰	FAUN	41-8047	GP-3985	BEK	41-8715	GP-24 ⁹⁵	BEK	42-0380	GA-39	BEK
4134896	GP-53	FAUN	41-8050	GP-28 ⁸	BEK	41-8715	GP-462 ⁹⁴	BEK	4203815	GA-27	KOEK
4134897	GP-1011Q	FAUN	41-8050	GP-430 ⁸	BEK	418719	GP-81	VOLV	4203837	GA-26	KOEK
41350	G-1175	PHHR	41-8052	GP-157	BEK	41-8723	GP-28	BEK	4203838	GA-27	KOEK
4135559	GP-81 ³¹	FIAT	41-8052	GP-58	BEK	41-8723	GP-3682	BEK	42039	GA-54	WIX
4135559	GP-9 ⁵⁸	FIAT	41-8054	GP-3985	BEK	41-8731	GP-28	BEK	4204048	GP-57	HITA
4135600	GP-81 ³¹	FIAT	41-8055	GP-91	BEK	41-8731	GP-81	BEK	42040481	GP-57	HITA
4135600	GP-9 ⁵⁸	FIAT	41-8056	GP-3985	BEK	41-8749	GP-171	BEK	42-0406	GA-200	BEK
4135600-0	GP-81 ³¹	ALCH	4180565	GA-230	FIAT	41-8749	GP-81	BEK	42-0406	GA-218	BEK
4135600-0	GP-9 ⁵⁸	ALCH	41-8058	GP-3569	BEK	41-8756	GP-171	BEK	42044	GA-730	WIX
4137784	GP-68	MTR	41-8058	GP-3600	BEK	41-8764	GP-28	BEK	42045	GP-22	IPS
4138076	GA-403	HITA	41-8059	GP-2951	BEK	41-8772	GP-28 ⁸	BEK	42045	GP-3429	VALU
4139	GA-3916	AUTO	41-8059	GP-58	BEK	41-8772	GP-430 ⁸	BEK	42045	GA-9045	WIX
4139-7111-1	G-31	STEY	41-8060	GP-22	BEK	41-8798	GP-3816	BEK	42046	GA-1287	WIX
414	GA-106 ⁴⁶	AMP	41-8061	GP-40	BEK	41-8806	GP-22	BEK	42047	GA-8047	WIX
414	GA-326 ⁷¹	AMP	41-8062	GP-462	BEK	41-8814	GP-81	BEK	42-0471	GAD-1 ⁸⁷	BEK
414	GA-106 ⁴⁶	BGA	41-8063	GP-46	BEK	41-8822	GP-157	BEK	42048	GA-1285	WIX
414	GA-326 ⁷¹	BGA	41-8064	GP-462	BEK	41-8830	G-871	BEK	42049	GA-429	WIX
414	G-870	CRO	41-8065	GP-156	BEK	41-8855	GP-50	BEK	42051	GP-3980	VALU
414	GP-28 ⁸⁴	DEL	41-8066	GP-157	BEK	41-8889	GP-81	BEK	42052	GA-2179	WIX
414	GP-3000 ⁹⁴	DEL	41-8068	G-871	BEK	41-8921	G-870	BEK	42054	GA-77	SECU
414	GP-430 ⁸⁵	DEL	41-8070	GP-22	BEK	41-89485	GP-22	BEK	42054	GA-77	WIX
414001	GA-2194	DONT	41-8072	GP-212	BEK	41-8954	G-871	BEK	420542	G-296	TIMB
414003	GA-3588	DONT	41-8073	GP-91	BEK	41-8970	GP-81	BEK	420542	G-296-B	TIMB
4140067	GG-1	BOMB	41-8074	GP-91	BEK	41-8988	GP-3816	BEK	42055	GA-80	WIX
4140067	GG-4	BOMB	41-8075	GP-149	BEK	41-8996	GP-3600	BEK	42057	GA-74	WIX
414007	GA-479	DONT	41-8076	GP-149	BEK	41-8996	GP-81	BEK	42-0596	GA-71	BEK
414008	GA-479	DONT	41-8077	GP-58	BEK	419	G-871	CRO	4206	GP-2071W	NAP
414020	GA-319	PERK	41-8078	GP-157	BEK	4190-21-1230	GA-398	KOMA	42-0604	GA-2740	BEK
41415	G-836	VOLV	41-8079	GP-157	BEK	4191413	GPP-14	FAUN	42060891	GP-43	HITA
4143271	G-1174	HITA	41-8080	GP-40	BEK	4192169	GAK-403	FAUN	42061	GA-78	WIX
414383	G-1121	VOLV	41-8081	GP-2951	BEK	4192631	GPP-14	HITA	42-0620	GA-303	BEK
414572	GP-178	TIMB	41-8082	GP-28 ⁸	BEK	4193038	G-816	LSTR	4206272	GA-563	HITA
414574	GP-390	TIMB	41-8082	GP-430 ⁸	BEK	4193265	G-870	MASY	4206273	GA-357	HITA
4146	GA-180	AUTO	41-8086	GP-3985	BEK	4193265	G-870	PERK	42064	GP-3600	VALU
4146050	GA-230	FIAT	41-8092	GP-3985	BEK	4193265	G-870	PETT	42-0646	GA-2719B	BEK
4146898	GA-106 ⁴⁶	HITA	41-8093	GP-28	BEK	419-3265	G-870	LSTR	42-0646	GA-3300	BEK
4146898	GA-326 ⁷¹	HITA	41-8095	GP-3600	BEK	4194770	G-33	FAUN	42065	GA-85	WIX
4148	GA-2106	AUTO	41-8096	GP-81	BEK	419572-C1	GP-1011Q	IHCO	42067	GA-303	WIX
415	GA-6127	AMP	41-8097	GP-58	BEK	419668	GA-230	FIAT	42068	GA-86	WIX
415	GA-6127	BGA	41-8098	GP-81	BEK	4197	GP-1012Q	NAP	4206888V01	GP-1122	VAND
415	GP-871	CRO	41-8100	GP-171	BEK	4197896	GP-53	FAUN	420688V01	GP-54 ¹¹	VAND
415027-C91	GA-356 ¹⁰⁴	IHCO	41-8102	GP-156	BEK	4197897	GP-1011Q	FAUN	420688V01	GP-66 ¹⁰	VAND
415027-C91	GA-357 ¹⁰⁸	IHCO	41-8103	G-963	BEK	4198280	G-750	FAUN	42069	GP-81 ³¹	IPS
415039	GAK-625	TIMB	4181058	GP-81	ALCH	419858A1	GPP-10075	CASE	42069	GP-9 ⁵⁸	IPS
4151	GG-5 L	VALU	4181058	GP-81	FIAT	41X10894A	GA-33	JOND	42069	GA-3300	WIX
4152-31090	G-912	TOYO	41-8107	GP-91	BEK	41X10896A	GAK-16	COCT	42070	GA-73	WIX
4152-37010	G-911	TOYO	41-8111	G-871	BEK	41X10896A	GAK-16	JOND	42-0711	GA-56	BEK
41524-1060	GP-91	NISS	41-8114	GP-81	BEK	42	G-31	DEL	42072	GG-208	SUBA
4152-YZZA1	G-912	TOYO	41-8117	G-225	BEK	42-0018	GA-3300	BEK	42072	GA-349	WIX
4152-YZZA6	G-911	TOYO	41-8119	GP-46	BEK	42003	GP-28 ⁸	IPS	42-0729	GA-2194	BEK
4153	GA-6479	AUTO	41-8121	GP-3816	BEK	42003	GP-430 ⁸	IPS	42072-KA020	GP-76	SUBA
415361C91	GA-376	IHCO	41-8134	GP-1	BEK	420051C1	GA-376	IHCO	42073	GP-81 ³¹	IPS
415415	G-836	VOLV	41-8135	GP-149	BEK	42007	GP-46	VALU	42073	GP-9 ⁵⁸	IPS
4155	GG-20	VALU	41-8136	GP-91	BEK	42008	GP-81	IPS	42073	GA-75	WIX
4155098	G-31	CLRK	41-8139	GP-310	BEK	42011	GA-71	WIX	42073MP	GA-75	WIX
4157	GA-78	AUTO	41-8139	GP-3569	BEK	4201103	GA-70	CHRY	42074972	GP-1122	FIAT
4158	GA-382	AUTO	41-8140	GP-28 ⁸	BEK	4201103	GA-70	MOP	42074972	GP-1122	IVEC
4160703	GP-81	IVEC	41-8140	GP-430 ⁸	BEK	42013	GP-58	IPS	42077	GA-3300	WIX
4162	GA-6690	AUTO	41-8141	GP-1	BEK	42013	GA-415	WIX	42-0778	GA-349	BEK
416256	GP-35	TIMB	41-8143	GP-28 ⁸	BEK	4201-300	GAK-16	HYDR	42-0778	GAD-3	BEK
4163736	GA-398	HITA	41-8143	GP-430 ⁸	BEK	42015789	GA-405	FIAT	42078	GP-1	IPS
4163738	GA-398	HITA	41-8147	GP-28<							

Numero	Gonher	Fabricante	Numero	Gonher	Fabricante	Numero	Gonher	Fabricante	Numero	Gonher	Fabricante
Number	Gonher	Manufacturer	Number	Gonher	Manufacturer	Number	Gonher	Manufacturer	Number	Gonher	Manufacturer
42-0828	GA-349	BEK	42-1420	GA-271	BEK	42-2001	GAVW-120	BEK	42384	GA-278R	WIX
42-0828	GA-75	BEK	42-1429	GA-139	BEK	42-2002	GAVW-120	BEK	423841	GAK-625	ATWE
42083	GA-50	WIX	42143	GP-58	VALU	42-2009	GA-172	BEK	42385	GA-224	WIX
42-0855	GA-70	BEK	42-1433	GA-390	BEK	42-2015	GAC-6	BEK	423870-C1	GP-1010Q	IHCO
42088	GA-192	WIX	42-1434	GA-2110	BEK	42203	GA-1203	WIX	42389	GA-248	WIX
42088MP	GA-192	WIX	42-1435	GA-471	BEK	42208	GA-106 ⁶⁶	WIX	4238H2	GA-106 ⁶⁶	WHIT
42091	GP-3531	EXP IPS	42-1436	GA-216	BEK	42208	GA-326 ⁷¹	WIX	4238H2	GA-326 ⁷¹	WHIT
42091	GA-56	WIX	42-1438	GA-3588	BEK	42209	GA-206	WIX	423911	GA-360	FODN
4209-106	GG-6	HYDR	42-1440	GA-277	BEK	4220900051	G-1123	HANO	42-3-911	GA-360	SEDN
4209-146	GP-3600	HYDR	42-1442	GA-735 ¹²⁴	BEK	4220900051	G-1123	MBNZ	424	G-870	CRO
42-0919	GAD-1 ⁸⁷	BEK	42-1445	GA-195	BEK	4220920005	G-1123	DAIM	424	GP-50	DEL
42092	GP-58	IPS	42-1448	GA-142	BEK	4220920005	G-1123	MBNZ	4240049	GG-8 L	CHRY
42-0927	GAD-1 ⁸⁷	BEK	42-1451	GAD-3	BEK	42213	GA-2104	WIX	4240170	GG-5 L	CHRY
42093	GP-1	IPS	42145-4110	GAD-3	SUBA	42213	GA-2164	WIX	4241042	GA-277	CHRY
42093	GA-90	WIX	42145-5600	GAD-3	SUBA	42218	GA-390	WIX	42412	GA-305	WIX
4209314	GP-81	FIAT	42145-7000	GA-140	SUBA	42218000210	G-143	DAIM	42421	GA-491	WIX
4209394	GP-81	FIAT	42145-7100	GA-4303	SUBA	42222	GA-16	WIX	42422	GA-6129	WIX
42-0943	GA-2719B	BEK	42-1459	GAVW-120	BEK	42222	GAK-16	WIX	42423	GA-6127	WIX
42-0943	GA-3300	BEK	42-1461	GAD-30	BEK	42224	GAK-20	SULL	424305-50060	GP-749	YNMR
42095	GA-55	WIX	42-1466	GA-382	BEK	4222406	GP-171	FIAT	4243301	GP-81	ALCH
42098	GA-59	WIX	42-1469	GA-139	BEK	4222H2	GA-229	WHIT	4244	GA-195	AUTO
42098MP	GA-59	WIX	42-1470	GA-362	BEK	42234	GA-20	WIX	4244	GAD-3	FACE
42099	GP-9	IPS	42-1472	GAD-30	BEK	42234	GAK-20	WIX	4244	GA-71	VALU
42099	GA-325	WIX	42-1473	GA-2106	BEK	42237	GA-24 ¹¹²	WIX	42440	GA-879	WIX
42101	GA-57	WIX	42-1474	GA-2106	BEK	4224194	GP-81	FIAT	4244607	GA-361	HITA
42101MP	GA-57	WIX	42-1482	GA-2156	BEK	42242	G-31	TRAB	4245	GA-80	VALU
42102	GA-55	WIX	42-1484	GA-166	BEK	4224701M1	GPP-423	AGCO	42455	GA-968R	WIX
42103	GA-3523	WIX	42-1488	GA-6690	BEK	4224H290	GA-229	WHIT	424580	GAK-625	ATWE
42-1-03	GA-33	BLKW	42-1489	GA-6619 ⁹	BEK	4224H2900	GA-229	REOT	4246	GA-7017	AUTO
42-1032	GA-3490	BEK	42-1489	GA-6620 ⁹	BEK	42250	GA-37	WIX	42461	GA-2130	WIX
42-1040	GA-4325	BEK	42-1490	GAD-29	BEK	42252	GA-37	WIX	42462	GA-2175	WIX
42-1040	GAD-1 ⁸⁷	BEK	42-1492	GAD-117	BEK	42253	GA-209	WIX	42472	GAVW-621	WIX
42105	GA-57	WIX	42-1492	GAD-17	BEK	42254	GA-210	WIX	42474	GAVW-621	WIX
42110	GA-105	WIX	42-1493	GA-386	BEK	422547-C1	G-31	IHCO	42476	GA-286	WIX
42-1107	GA-4365	BEK	42-1494	GA-133	BEK	42258	GA-563	WIX	42479	GA-286	WIX
42112	GA-105	WIX	42-1495	GA-273	BEK	42263	GAK-20	SULL	424837-R91	G-335	IHCO
42113	GA-86	WIX	42-1503	GAD-129	BEK	422668	GA-106 ⁶⁶	SULL	42484	GA-395	WIX
42-1156	GA-349	BEK	42-1508	GAD-294	BEK	422668	GA-326 ⁷¹	SULL	42484724	GA-360	DUTZ
42116	GA-85	WIX	42-1513	GA-3647	BEK	42268	GA-106 ⁶⁶	SULL	42484724	GA-360	FIAT
42-1164	GA-2740	BEK	42-1514	GAVW-120	BEK	42268	GA-326 ⁷¹	SULL	42484724	GA-360	IVEC
42-1164	GA-3490	BEK	42-1519	GA-7142	BEK	422681	GA-106 ⁶⁶	SULL	42484724	GA-360	KHDF
42116MP	GA-85	WIX	42-1522	GA-7344	BEK	422681	GA-326 ⁷¹	SULL	42484726	GA-360	IVEC
42118	GA-20	WIX	42-1523	GA-322	BEK	4227087	GA-271	CHRY	42485	GAVW-626	WIX
42118	GAK-20	WIX	42-1524	GA-381	BEK	4227087	GA-271	MOP	42486	GA-348	WIX
42-1180	GA-3445	BEK	42-1-53	GAK-403	BLKW	422714-C91	GA-6880	IHCO	42487	GA-348	WIX
42119	GA-360	WIX	42-1-531	GAK-403	BLKW	422714-C92	GA-6880	IHCO	42488	GA-348	WIX
42-1206	GA-50	BEK	42-1533	GA-2184	BEK	42276	GA-33	WIX	42488361	GA-467	DUTZ
4212109	GP-81	FIAT	42-1536	GA-2114	BEK	42277	GA-377	WIX	42488361	GA-467	IVEC
42124	GA-27	WIX	42-1537	GA-5466	BEK	42279	GA-215	WIX	42488361	GA-467	KHDF
42-1248	GA-2740	BEK	42-1538	GA-198	BEK	4228326	GP-81	ALCH	42491	GA-107	WIX
42125	GA-26	WIX	42-1540	GA-166	BEK	4228326	GP-81	FIAT	42493	GA-251	WIX
42-1255	GA-2740	BEK	42-1541	GA-198	BEK	42285	GA-2146	WIX	424F	G-1123	GREY
42126	GAK-403	WIX	42-1549	GA-432	BEK	42286	GA-89	WIX	425	GP-3985	DEL
42-1263	GA-2740	BEK	42-1550	GAD-118	BEK	4228688	GP-3000	HITA	42503	GA-98 ¹¹²	WIX
42128	GA-356	WIX	42-1551	GA-2195	BEK	42291	GA-42	WIX	42505	GA-18	WIX
42-1297	GA-3566	BEK	42-1554	GA-514	BEK	42295	GAVW-622	WIX	42509	GA-509 ¹⁴	WIX
42-1297	GAD-1 ⁸⁷	BEK	42-1558	GAVW-622	BEK	422994	GP-51	VOLV	42511	GG-5 L	SULL
42-1305	GA-140	BEK	42-1559	GAVW-121	BEK	423	GP-14	DEL	4251-1834	GP-91	DTSU
42-1313	GAVW-4	BEK	42-1560	GA-5466	BEK	42300000	GPP-14	YNMR	4251799	GP-152	WIX
42132	GA-357	WIX	42-1564	GA-605	BEK	423119-C1	G-1173	IHCO	42518	GAK-1532	WIX
42-1321	GA-349	BEK	42-1567	GA-434	BEK	423135	GP-54	VOLV	42522	GAK-625	WIX
42133	GA-277	WIX	42-1570	GA-476	BEK	423135-3	GP-54	VOLV	4252248	G-3754	DUTZ
42-1339	GA-3490	BEK	42-1572	GA-595	BEK	423217C1	GA-357	CASE	42524	GA-168	WIX
42-1347	GA-2740	BEK	42-1577	GA-244	BEK	423217-C1	GA-357	IHCO	4252427	GG-48	PETT
42-1348	GA-3566	BEK	42-1579	GA-2146	BEK	423218C1	GA-356	IHCO	425-2427	GG-48	LSTR
42-1351	GAVW-4	BEK	42-1580	GA-384	BEK	42329	GA-477	WIX	42525	GA-2195	WIX
42-1353	GA-2740	BEK	42-1581	GA-172	BEK	4232H2	GA-6880	WHIT	42530-37	GP-40	MIT
42-1354	GAVW-2	BEK	42-1581	GA-384	BEK	42333	GA-139	WIX	425-32250	GP-3600	OWTN
42-1355	GAVW-2	BEK	42-1586	GA-607	BEK	42334	GA-9334	WIX	425-32300	GP-81	OWTN
42-1356	GAVW-4	BEK	42-1588	GA-1616	BEK	42335	GA-1286	WIX	425-32331	G-296	OWTN
4213582	GA-271	CHRY	42-1589	GA-163	BEK	4233784	GP-81	FIAT	425-32331	G-296-B	OWTN
4213582	GA-271	MOP	42-1590	GA-170	BEK	42338	GAK-403	WIX	425-32606	G-871	OWTN
4213583	GA-277	CHRY	42-1595	GAVW-621	BEK	4234	GA-153	AUTO	425-32607	G-296	OWTN
4213583	GA-277	MOP	42-1599	GA-165	BEK	42341	GA-479	WIX	425-32607	G-296-B	OWTN
42136	GA-4303	WIX	42160	GA-230	WIX	42349	GA-2740	WIX	425-32693	GP-3600	OWTN
42-1364	GAD-15	BEK	42-1601	GA-286	BEK	4235	GA-77	VALU	425-33600	GP-91	OWTN
42-1365	GAVW-2	BEK	42-1609	GA-286	BEK	42351	GA-475	WIX	425-33721	GP-81 ³¹	OWTN
42-1367	GAD-1	BEK	42-1610	GA-183	BEK	42356	GA-3588	WIX	425-33721	GP-9 ⁸⁸	OWTN
42-1-37	GA-33	BLKW	42-1612	GA-158	BEK	42359	GA-6	WIX	425-34584	GP-3985	OWTN
42-1371	GA-180	BEK	42-1619	GA-3901	BEK	4236	GA-4828	AUTO	42534635	GP-462	OUTB
42-1-371	GA-33 ¹¹²	BLKW	42-1647	GA-263	BEK	423-6030	GA-2118	SAAB	4254048	GP-3985	HITA
42-1378	GA-2719B	BEK	42-1648	GA-264	BEK	42364	GA-2184	WIX	42542	GA-360	WIX
42-1380	GA-230	BEK	42-1658	GA-479	BEK	4236942	GP-81	ALCH	42543	GA-361	WIX
42-1383	GA-4325	BEK	42-1668	GAVW-616	BEK	4236942	GP-81	FIAT	425438-R1	G-500	IHCO
42-1384	GA-3490	BEK	42-1671	GA-380	BEK	4236942	GP-81	IVEC	425438-R91	G-500	IHCO
42-1385	GA-2740	BEK	42168	GA-2193	WIX	42370	GA-210	WIX	42546	GA-679	WIX
42-1390	GA-4325	BEK	42170	GAVW-2	WIX	42371	GA-44	WIX	42547	GA-680	WIX
42-1393	GA-3490	BEK	4217497	GP-69	HITA	42372	GA-11	WIX	42564	GA-194	WIX
42-1399	GA-4958	BEK	42174971	GP-69	HITA	42373	GA-7	WIX	42572	GA-433	WIX
42140	GA-3424	WIX	42181	GA-183	WIX	42374	GA-12	WIX	42595	GAP-379	WIX
42-1405	GA-230	BEK	42188	GA-184	WIX	42375	GA-7	WIX	426	GP-462	DEL
42-1407	GA-4303	BEK	421899	GA-356	CUMM	4237663	GA-106 ⁶⁶	HITA	42606	G-1173	ALCH
42141	GA-3425	WIX	42190	GA-448	WIX	4237663	GA-326 ⁷¹	HITA	42606-4	G-1173	ALCH
42-1414	GA-78	BEK	421F	G-1174	GREY	42377	GA-6128	WIX	42608	GA-405	WIX
42-1417	GA-4303	BEK	4220	GA-89	AUTO	42378	GA-1008	WIX	4261	GP-28 ⁶	ALL
42142	GAK-403	WIX	42200	GA-219	WIX	42379	GA-1284	WIX	4261	GP-430 ⁸	ALL

Referencia Cruzada por Numero de Parte

Cross Reference by Part Number



Numero	Gonher	Fabricante	Numero	Gonher	Fabricante	Numero	Gonher	Fabricante	Numero	Gonher	Fabricante
Number	Gonher	Manufacturer	Number	Gonher	Manufacturer	Number	Gonher	Manufacturer	Number	Gonher	Manufacturer
42610	GA-377	WIX	42-8227	GAD-1	BEK	43-0512	GG-203	BEK	43-0899	GG-251	BEK
42611	GA-372	WIX	42826	GA-328	WIX	43-0520	GG-203	BEK	4309	GA-78	VALU
42612	GA-596	WIX	42-8268	GAVW-2	BEK	4305289	G-1173	LETR	43-0901	GG-185	BEK
42613	GA-373	WIX	42827	GAVW-212	WIX	4305289	G-1173	WABC	43-0902	GG-232	BEK
4261739	G-296	IVEC	42-8276	GAVW-2	BEK	43-0546	GG-5 L	BEK	43-0904	GG-214	BEK
4261739	G-296-B	IVEC	4-2828-001	GP-26	CMI	43-0553	GG-246	BEK	43-0906	GG-39	BEK
42618	GA-229	WIX	4-2828-002	GP-27	CMI	43-0561	GG-246	BEK	43-0909	GG-46	BEK
42631	GAK-216	WIX	4-2828-003	GP-53	CMI	43-0587	GG-226	BEK	43-0910	GG-246	BEK
42632	GA-416	WIX	42831	GA-324	WIX	43-0595	GG-189	BEK	43-0914	GG-142	BEK
42633	GA-287	WIX	42-8318	GA-303	BEK	43-0611	GG-1	BEK	43-0915	GG-148	BEK
4264	GA-362	AUTO	42-8326	GA-3425	BEK	43-0611	GG-4	BEK	43-0918	GG-185	BEK
42641	G-1175	PHHR	42-8334	GA-3490	BEK	4306113	GA-271	CHRY	43-0920	GG-187	BEK
42647	GA-679	WIX	42-8335	GA-271	BEK	4306113	GA-271	MOP	43-0922	GG-181	BEK
42648	GA-680	WIX	42-8340	GA-2740	BEK	43-0629	GG-1	BEK	43-0925	GG-185	BEK
42651	GA-108	WIX	42837	GA-29	WIX	43-0629	GG-4	BEK	43-0926	GG-220	BEK
42653	GAK-216	WIX	42843	GA-289	WIX	4306393	GA-70	CHRY	43-0927	GG-5 L	BEK
42654	GA-425	WIX	42844	GA-383	WIX	43-0652	GG-3	BEK	43-0928	GG-190	BEK
42655	GA-426	WIX	42851	GA-29	WIX	43-0660	GG-246	BEK	43-0929	GG-243	BEK
42661	GA-6880	WIX	42853	GA-375	WIX	43-0678	GG-246	BEK	43-0930	GG-67	BEK
42667	GA-106 ⁴⁶	SULL	4285802	GP-3985	GILC	43-0686	GG-5 L	BEK	43-0934	GG-98	BEK
42667	GA-326 ⁷¹	SULL	4285816	GPP-111	GILC	43-0694	GG-251	BEK	43-0937	GG-115	BEK
42668	GA-106 ⁴⁶	SULL	4285816	GPP-524	GILC	43-0702	GG-246	BEK	43-0940	GG-146	BEK
42668	GA-326 ⁷¹	SULL	42859	GAVW-616	WIX	43-0736	G-296	BEK	43-0943	GG-79 ⁹⁰	BEK
426681	GA-106 ⁴⁶	SULL	42865	GA-5648	WIX	43-0736	G-296-B	BEK	43-0946	GG-184	BEK
426681	GA-326 ⁷¹	SULL	428680C1	GA-6880	CASE	4307426	G-191	RENA	43-0947	GG-185	BEK
4-267	G-750	ACD	428680-C1	GA-6880	IHCO	43-0751	GG-76	BEK	43-0948	GG-137	BEK
4-267	G-750	WHIT	42885	GA-597	WIX	43-0769	GG-5 L	BEK	43-0954	GG-214	BEK
42676	GA-679	WIX	42888	GA-2803T	WIX	43-0785	GG-1	BEK	43-0956	GG-260	BEK
42677	GA-680	WHIT	429	GP-24 ²⁶	DEL	43-0785	GG-4	BEK	43-0960	GG-150	BEK
42677	GA-680	WIX	429	GP-462 ²⁴	DEL	43-0786	GG-203	BEK	43-0964	GG-185	BEK
42678	GA-891	WIX	42900	GAVW-22	WIX	4307868	GA-129	CHRY	43-0965	GG-185	BEK
42679	GA-892	WIX	42-9030	GP-91	TORO	4307873	GPP-111	CLRK	43-0968	GG-185	BEK
4268	GA-192	VALU	42905	GAD-1 ⁸⁷	WIX	4307873	GPP-524	CLRK	43-0970	GG-185	BEK
42680	G-1175	EUCL	42906	GAD-3	WIX	43-0788	GG-45	BEK	43-0972	GG-232	BEK
42680	G-1175	GMCX	42908	GA-75	WIX	43-0789	GPP-1122	BEK	43-0979	GG-187	BEK
42680	GA-483	WIX	42912	GA-3490	WIX	43-0790	GPP-1122	BEK	43-0981	GG-247	BEK
42681	GA-482	WIX	42916	GA-21	WIX	43-0793	GG-1	BEK	43-0982	GG-136	BEK
42682	GA-329	WIX	42924	GA-361	WIX	43-0793	GG-4	BEK	43-0984	GG-255	BEK
42683	GA-239	WIX	42926	GA-403	WIX	43-0794	GG-246	BEK	43-0985	GG-268	BEK
42686	GA-31	WIX	4292737	GA-33	NEWI	43-0796	GPP-1122	BEK	43-0987	GG-220	BEK
4268981	GA-276	CHRY	42941	GA-493 ¹⁰⁸	WIX	43-0798	GG-246	BEK	43-0989	GG-1872	BEK
4268981	GA-276	MOP	4294128	GP-317H	HITA	43-0799	GG-251	BEK	43-0993	GG-185	BEK
42691	GA-885	WIX	4294577	GP-1011Q	HITA	43-0801	GG-194	BEK	43-0995	GG-160	BEK
42697	GA-3501	WIX	4294838	GP-91	HITA	43-0802	GG-6	BEK	43-0996	GG-164	BEK
427	GA-357	AMP	4294841	GP-149	HITA	43-0804	GG-5 L	BEK	43-0999	GG-185	BEK
427	GA-357	BGA	42960	GA-376	WIX	43-0805	GG-251	BEK	431	GA-75	AUTP
427	GP-3816	DEL	42961	GA-378	WIX	43-0807	GG-76	BEK	431	GP-31	DEL
427083	G-750	MANI	42966	GA-229	WIX	43-0808	GG-196	BEK	431 133 511D	GG-408	AUDI
427084	G-750	MANI	4296675	GP-51	HITA	43-0811	GG-208	BEK	431 133 511D	GG-408	PORS
42714	GA-135	WIX	42971	GA-539R	WIX	43-0812	GG-208	BEK	431 133 511D	GG-408	VOLK
42714	GA-35	WIX	42972	GA-2124	WIX	43-0813	GG-5 L	BEK	43-1000	GG-94	BEK
42716	GA-39	GRAD	42976	GA-31	WIX	43-0814	GPP-111	BEK	43-1002GF8004	GG-114	BEK
42716	GA-39	WIX	42980	GA-7716	WIX	43-0814	GPP-524	BEK	43-1003	GG-187	BEK
4-2720-2	GA-357	CMI	42981	GA-7360	WIX	43-0816	GG-213	BEK	43-1004	GG-185	BEK
427207-C1	GP-54	IHCO	42984	GA-2984	WIX	43-0817	GG-246	BEK	43-1006	GG-164	BEK
427207-C2	GP-54	IHCO	42990	GA-33	TCI	43-0817	GG-408	BEK	43-1007	GG-185	BEK
427207-C2	GP-54	KOMA	42991	GA-113	WIX	43-0819	GG-261	BEK	43-1009	GG-146	BEK
427207-C3	GP-54	IHCO	42994	GA-101	WIX	43-0821	GG-204	BEK	431010	GP-1	DONT
42725	GA-490	WIX	42995	GA-100	WIX	43-0821	GG-220	BEK	4310104	GP-46	DONT
42729	GA-414R	WIX	4299582	GPP-1287 ³⁹	BLUE	43-0823	GG-76	BEK	43-1011	GG-185	BEK
42731	GA-4999	WIX	4299582	PFF831 ⁴¹	BLUE	43-0825	GG-208	BEK	4310117	GP-28 ⁶	DONT
42736	GA-26 ¹¹²	ERO	4299582	S 3225 P ⁴²	BLUE	43-0828	GPP-111	BEK	4310117	GP-430 ⁸	DONT
4273810	GP-58	CHRY	42996401	GP-1012Q	HITA	43-0828	GPP-524	BEK	4310127	GP-40	DONT
4273810	GP-58	MOP	42999	GA-113	WIX	43-0831	GG-94	BEK	4310129	GP-38	DONT
42-740BS	G-31	HERC	429F	GG-48	GREY	43-0832	GG-196	BEK	4310130	GP-3682	DONT
4274474	GG-124	FIAT	43	GP-81	FACE	43-0833	GPP-111	BEK	4310130	GP-37	DONT
427471A1	GA-853R	CASE	43	GP-9	FACE	43-0833	GPP-524	BEK	4310139	GP-54	DONT
42750	GA-249	WIX	430	GA-70	AUTP	43-0834	GG-246	BEK	431014	GP-81 ¹¹	DONT
42757	GA-826	WIX	4300	GA-55	VALU	4308344	G-133	RENA	431014	GP-9 ⁸	DONT
42758	GA-827	WIX	43-0025	GG-5 L	BEK	4308344	G-989	RENA	4310140	GP-54	DONT
42759	GA-109	WIX	43-0058	G-296	BEK	43-0835	GG-94	BEK	43-1015	GG-164	BEK
42767	GA-26 ¹¹²	ERO	43-0058	G-296-B	BEK	43-0836	GG-185	BEK	431017	GP-81	DONT
427713-C1	GP-2071W	IHCO	43-0066	GG-196	BEK	43-0840	GG-63	BEK	431021	G-33	ALCH
427717-C1	GP-1011Q	IHCO	43-0074	G-1121	BEK	43-0843	GG-185	BEK	431021-6	G-33	ALCH
4278774	GA-405	DEMA	43-0090	GA-129	BEK	43-0848	GG-226	BEK	43-1025	GG-102	BEK
4278859	GP-1	HITA	43010500	GAVW-2	TALB	43-0850	GG-196	BEK	43-1032	GG-266	BEK
42793	GA-224	WIX	43-0108	GG-1	BEK	43-0853	GG-63	BEK	43-1034	GG-986	BEK
42796	GA-33	WALD	43-0108	GG-4	BEK	43-0854	GG-79	BEK	431035	GP-54 ¹¹	DONT
42797	GA-149	WIX	4301181	GP-53	PUR	43-0857	GG-76	BEK	431035	GP-66 ¹⁰	DONT
42797	GA-491	WIX	43-0124	GG-5 L	BEK	43-0860	GG-203	BEK	43-1035	GG-187	BEK
42798	GA-27	GEHL	430-135	GG-189	MCAB	43-0864	GG-189	BEK	431040	GP-81	DONT
4279897	GG-67	CHRY	430143	GP-1	VOLV	43-0865	GG-208	BEK	431056G	GP-28 ⁶	DONT
4279898	GG-67	CHRY	4301438	GP-81	VOLV	43-0871	GG-63	BEK	4310566	GP-430 ⁸	DONT
4279987	GG-264	CHRY	43-0157	GG-196	BEK	43-0872	GG-8	BEK	431060	GP-54	DONT
4279987	GG-264	MOP	43-0165	GG-94	BEK	43-0873	GG-5 L	BEK	431062	GP-36	DONT
4279995	GG-264	CHRY	43-0173	GG-196	BEK	43-0874	GG-8 ¹⁰³	BEK	431066	GP-3816	DONT
428	GP-1101 ⁵⁴	DEL	43-0272	GG-76	BEK	43-0874	GG-8 L ⁸⁰	BEK	431078	GP-3816	DONT
42809	GA-701 ¹⁰⁴	WIX	43-0397	GG-45	BEK	43-0875	GG-47	BEK	431084	GP-81	DONT
428098-C1	GA-2984	IHCO	43-0405	GG-76	BEK	43-0878	GG-215	BEK	431087	GP-1	DONT
42810	GA-702 ¹⁰⁸	WIX	43-0413	GG-202	BEK	43-0881	GG-185	BEK	431092	GP-54 ²⁰	DONT
42-8110	GA-230	BEK	43-0454	GG-48	BEK	43-0887</					

Numero	Gonher	Fabricante	Numero	Gonher	Fabricante	Numero	Gonher	Fabricante	Numero	Gonher	Fabricante
Number	Gonher	Manufacturer	Number	Gonher	Manufacturer	Number	Gonher	Manufacturer	Number	Gonher	Manufacturer
431133511A	GG-246	VOLK	4347021	G-33	ALCH	4371021	G-33	DIAM	440043410	G-296-B	EATN
431133511B	GG-246	VOLK	4347437	GP-27	CHRY	43-71021	G-33	KENW	4400434-10	G-296	YALE
431133511D	GG-246	VAG	4347786	G-1174	ALCH	4371021-4	G-33	ALCH	4400434-10	G-296-B	YALE
43-123	G-31	LROI	4347786-2	G-1174	ALCH	4371021-9	G-33	ALCH	440044576	G-870	EATN
43-1231	G-31	LROI	4347787	G-1174	ALCH	4371137	G-33	ALCH	4400445-76	G-870	YALE
43-124	G-31	LROI	4347787-2	G-1174	ALCH	4371137-3	G-33	ALCH	4400519-73	GA-33	YALE
43129	G-1173	ALCH	4347787-2	G-1174	ALCH	4371165	G-1176	ALCH	4400540-69	GP-3600	YALE
43129-6	G-1173	ALCH	4347788	G-1174	ALCH	4371165-0	G-1176	ALCH	440054593	GA-49	EATN
4313207	GA-230	FIAT	4347788	G-1174	AUSW	4371449	G-1176	ALCH	4400545-93	GA-49	YALE
4314814-9	G-1173	ALCH	4347788-2	G-1174	ALCH	4371499	G-1176	ALCH	440054600	GP-3600	EATN
431716	GPP-19	ALCH	4347912	G-1173	ALCH	4371499	G-1175	LETR	44006-010	GA-33	NISS
43-187	G-31	LROI	4347912-9	G-1173	ALCH	4371574	GA-230	FIAT	4402070	GA-50	FIAT
43-187-1	G-31	LROI	4348	GP-26	NAP	4371581	GP-81	ALCH	4402614	GA-4319	OPEL
431892	GPP-426	TIMB	4348148	G-1173	ALCH	4371581	GP-81	FIAT	4-40453-002-0	GA-33	ISUZ
4319256	GA-459	DUTZ	4348148-5	G-1173	ALCH	4371582	GP-81	ALCH	4405	G-500	LUF
4319256	GA-459	KHDF	4348149	G-1173	ALCH	4371582	GP-81	FIAT	4405150	GAVVW-2	NAPI
4319257	GAK-458	DUTZ	4348149	G-1173	BUCY	4371582	GP-81	HESS	4405151	GA-277	NAPI
432104	GP-110	DONT	4348149-5	G-1173	OSGO	4371582	GP-81	HEST	4405504	GP-81	VALM
432107	GP-1122	DONT	4348149-5	G-1173	ALCH	4372517	G-6	ALCH	4405600	GP-31	DEMA
432116	G-296	DONT	4348149-8	G-1173	ALCH	4372517-4	G-6	ALCH	4406095	GA-50	LUF
432116	G-296-B	DONT	434871R1	G-1176	IHCO	4372517-5	G-6	ALCH	4407	GA-750	FIAT
432121	GP-1122	DONT	434871-R91	G-1174	IHCO	4372574	GA-230	FIAT	440-8341	GA-2158	OPEL
432128	GP-1122	DONT	43-491-1	GA-26	LROI	4377149	G-1175	ALCH	44-094-16-04	GA-2179	CHRY
432132	GP-1122	DONT	4349146	G-1173	ALCH	4377880	GPP-1000	HITA	44-094-16-04	GA-2179	MBNZ
432135	GP-54	VOLV	4349146-4	G-1173	ALCH	43778801	GPP-1000	HITA	441-201-511B	GG-408	AUDI
4321716	GPP-19	ALCH	43493	GA-33	INGR	4377882	G-1174	ALCH	441-201-511B	GG-408	PORS
4321716-5	GP-1101	ALCH	43-493	GA-33	LROI	43-8002	GG-45	BEK	441-201-511B	GG-408	VOLK
432223	GP-66	HYST	43-4931	GA-33	LROI	43-8010	GG-19	BEK	441-201-511C	GG-408	AUDI
4322636	GA-49	CLRK	43493-1	GA-33	INGR	438-14	GP-310	MURY	441-201-511C	GG-408	PORS
4322701	GP-57	ALCH	43494	GAK-16	INGR	438-15	GP-1122	MURY	441093-C1	GA-6129	IHCO
4324010	GA-272	CLRK	43-494	GAK-16	LROI	4381608	GP-81	FIAT	441094-C1	GA-6127	IHCO
4324170R91	G-1174	IHCO	43-4941	GAK-16	LROI	4382018	GP-81	FIAT	4411064	G-834	HATR
432417-R91	G-1174	IHCO	43494-1	GAK-16	INGR	4382101	GP-81	FIAT	4411578	GA-230	FIAT
432419-R91	G-1175	IHCO	435	GP-390 ⁹³	DEL	4384509	GG-124	FIAT	441201511B	GG-246	VAG
43247	G-31	SHEP	4352269	G-1174	ALCH	438713-R91	GA-27	IHCO	441201511B	GG-246	VOLK
43248	G-1173	SHEP	4352368	G-1174	ALCH	43-884-1	GA-106 ⁶⁶	LROI	441-201-511-C	GG-408	VAG
4325601	GG-1	FIAT	4352368-8	G-1174	ALCH	43-884-1	GA-326 ³¹	LROI	441-201-511-C	GG-408	VOLK
4325601	GG-4	FIAT	43-530	GA-27	LROI	438851	2010PM-OR ⁷	GMCX	441365C1	GP-2071W	IHCO
4326	GA-730	VALU	4353268	G-1174	ALCH	438851	2010TM-OR ²	GMCX	441365C2	GP-2071W	IHCO
43262100	GA-405	DEMA	4353268	G-1174	LETR	438888	G-1175	ALCH	4415540	GP-81	LAMB
43262700	GA-467	DEMA	4353268-8	G-1174	ALCH	438888-1	G-1175	ALCH	4415540	GP-81	SAME
43-269	G-31	LROI	4353269	G-1174	ALCH	438888-8	G-1175	ALCH	4415540	GP-81	ZETO
43-2704	G-191	KENW	4353269-8	G-1174	ALCH	4389026	GAK-16	ADAM	44-1554-0	GP-81	HUR
43274	G-191	AUTC	4353688	G-1174	ALCH	4389026	GAK-16	ALCH	441554001	GP-81	SAME
43-274	G-191	LROI	43-547	GA-360	LROI	4389026	GAK-16	FIAT	4415670	GP-81	SAME
43277	G-238	WAUK	4355	GP-54 ¹¹	BEK	4389026	GAK-16	LETR	441567001	GP-81	LAMB
43-277	G-238	WAUK	4355	GP-66 ¹⁰	SULL	4389026-6	GAK-16	ALCH	441567001	GP-81	SAME
43-277-A	G-238	LROI	4355	GP-66 ¹⁰	SULL	439	GA-349	AMP	4416403	GA-4319	OPEL
4329	GA-303	VALU	4355	GP-66 ¹⁰	SULL	439	GA-349	BGA	441700A1	GP-9000	CASE
43299200	GP-54 ¹¹	DEMA	43-550	GA-27	LROI	439	GP-1	CRO	441701A1	GPP-10075	CASE
43299200	GP-66 ¹⁰	DEMA	4355556	GP-390 ⁹³	ALCH	4390593-4	G-750	ALCH	441702A1	GP-2126Q	CASE
432K	GP-40	ASAH	43-561	GA-27	LROI	439216	G-6	DIAM	441703A1	GP-3001	CASE
433	GA-56	AUTP	43-562	GA-26	LROI	439216	G-6	REOT	441703A1	GP-3001	NEWH
4330-01-120-5989	GP-66	NSN	4356500	GP-81	ALCH	439216	G-6	WHIT	4417559	GP-81 ²¹	CHRY
4330-01-291-1819	GP-66	NSN	4356575	GP-81	ALCH	4393504	GP-1011Q	ALCH	4417559	GP-9 ⁹⁸	CHRY
4330-01-319-7504	GP-761H	NSN	43-575	GA-27	LROI	4393504-8	GP-1011Q	ALCH	4417559	GP-81 ²¹	MOP
4330-01-363-9818	S 3202 ¹⁰	NSN	43-582-1	GP-34	LROI	4393505	GP-2071W	ALCH	4417559	GP-9 ⁹⁸	MOP
43300-13-89-0458	2010PM-OR	NSN	43-593	GA-26	LROI	4394407	GPP-1000	ALCH	4417560	GP-81 ²¹	CHRY
43300-13-89-2610	GP-58 ¹⁵	NSN	43594	GP-157	GRAV	4394407-3	GPP-1000	ALCH	4417560	GP-9 ⁹⁸	CHRY
4331	GA-50	VALU	43-594	GA-27	LROI	4394463	GP-81	FIAT	4417560	GP-81 ²¹	MOP
4331923	GA-879	HITA	436	GP-34	MTM	43944630	GP-81	FIAT	4417560	GP-9 ⁹⁸	MOP
4332	GA-59	VALU	4361	GAK-458	BEK	439505-R91	GA-27	IHCO	4417561	GP-81 ²¹	CHRY
433271	GA-24	FODN	436233	G-1175 ¹⁰⁸	ALCH	4395889	G-33	ALCH	4417561	GP-9 ⁹⁸	CHRY
43-3-271	GA-24	SEDN	436233-2	G-1175 ¹⁰⁸	ALCH	4395889-1	G-33	ALCH	4417561	GP-81 ²¹	MOP
4333	GP-28 ⁶	ALL	4362633	G-1175 ¹⁰⁸	ALCH	4396645	GP-53	ALCH	4417561	GP-9 ⁹⁸	MOP
4333	GP-430 ⁸	ALL	4362633-2	G-1175 ¹⁰⁸	ALCH	4396645	GP-53	ALCH	4417562	GP-81 ²¹	CHRY
4333	GA-325	VALU	4362639	G-1175 ¹⁰⁸	ALCH	4396645-6	GP-53	ALCH	4417562	GP-9 ⁹⁸	CHRY
43333	GAK-16	SULL	4362639-2	G-1175 ¹⁰⁸	ALCH	439703-R91	GA-27	IHCO	4417562	GP-81 ²¹	MOP
43334	GAK-16	SULL	43-628	GA-27	LROI	439704-R91	GA-27	IHCO	4417562	GP-9 ⁹⁸	CHRY
4335348	G-33	ALCH	4363009	GA-230	FIAT	4397165	GP-81	FIAT	4418090	GG-65	MOP
4335348-5	G-33	ALCH	4363010	GP-81	ALCH	43971650	GP-81	FIAT	4418090	GG-65	CHRY
43353488	G-33	ALCH	4363010	GP-81	FIAT	4398149	G-1173	ALCH	4418276	GG-61	MOP
4337568	GA-105	ALCH	4363484	GP-81	FIAT	43BA17	G-750	MACK	441840025	G-31	MBNZ
4339076	G-1173	ALCH	43-635	GA-33	LROI	43E	G-1143	CHP	4418521	GG-245	CHRY
4339076-1	G-1173	ALCH	43-635-1	GA-33	LROI	43F	G-1143	CHP	4418560	GG-61	CHRY
434	GA-303	AUTP	43-639	GAK-20	LROI	43SB27	G-750	MACK	4418625	GG-61	CHRY
434	GP-52 ¹⁰	DEL	43-640	GA-27	LROI	43SB30	G-500	MACK	4418625	GG-61	MOP
434	GP-691 ⁴⁸	DEL	43-644	GP-10	LROI	43SB32	G-31	MACK	4418772	GG-72	CHRY
434061	GP-1122	VOLV	4364559	G-1173	ALCH	43SB34	G-6	MACK	4418788	GG-65	CHRY
434119-C1	G-1173 ¹⁰⁸	IHCO	4364559-8	G-1173	ALCH	43SB35	G-500	MACK	4418788	GG-65	MOP
43422	GAK-403	LROI	43-658	GAK-16	LROI	43SB40	G-169	MACK	441887	GP-1122	ATCO
4342800	GA-277	CHRY	4367714	G-1176	ALCH	43SB41	G-6	MACK	441887	GP-1122	DUTZ
4342800	GA-277	MOP	4367714-9	G-1176	ALCH	43SB43	G-6	MACK	441898	GP-1122	ATWE
4342801	GA-271	CHRY	4367868	G-1175	ALCH	43SB47	G-750	MACK	441923	GP-1122	ATCO
4342801	GA-271	MOP	4367868-4	G-1175	ALCH	43SBA27	G-750	MACK	441923	GP-1122	ATWE
434365-C2	GA-2984	IHCO	4369289	G-31	ALCH	43SBA30	G-500	MACK	4419493	GAVVW-2	FIAT
43-437	GA-200	LROI	4369289-0	G-31	ALCH	44	GP-44	FACE	4419970	GP-22	MOP
4344	GA-57	VALU	436936	GP-58	FORD	44	GA-730	WIX	44199700	GP-22	CHRY
43-442	GA-5648	LROI	4369988	G-33	ALCH	440002266	GP-3816	EATN	442004	GP-54 ¹¹	ATCO
43-442-1	GA-5648	LROI	440024726	G-33	ALCH	440024726	GAK-16	EATN	442004	GP-66 ¹⁰	ATCO
43-458-1	GAK-20	LROI	440024726	G-33	ALCH	440024726	GAK-16	EATN	442004	GP-54 ¹¹	ATWE
43465	GAK-403	WAYN	437	GP-42	DEL	4400247-6	GAK-16	YALE	442004	GP-66 ¹⁰	ATWE
43-465	GP-1	LROI	437050-C91	GA-6880	IHCO	440031106	G-296	EATN	4425274	GP-52 ¹⁰	DEMA
4347	GP-26	NAP	4371021	G-33	ALCH	440031106	G-296-B	EATN	4425274	GP-691 ⁴⁸	DEMA
			4371021	G-33	BROW	4400422-81	G-871	YALE	44268	G-1175	EUCL
			4371021	G-33	CASE	440043410	G-296	EATN	4428	GP-2015W	NAP

Referencia Cruzada por Numero de Parte

Cross Reference by Part Number



Numero	Gonher	Fabricante	Numero	Gonher	Fabricante	Numero	Gonher	Fabricante	Numero	Gonher	Fabricante
Number	Gonher	Manufacturer	Number	Gonher	Manufacturer	Number	Gonher	Manufacturer	Number	Gonher	Manufacturer
4429	GP-2022W	NAP	4495950	GG-95	CHRY	450-905-091	GG-246	BOG	451-103-024	GP-28 ⁶	BOG
4429107	GP-1232	CHRY	4497132	GA-105	ALCH	450-905-095	GG-251	BOG	451-103-024	GP-430 ⁸	BOG
4429395	GP-178	CHRY	45	GP-3429	FACE	450-905-096-065	GG-5 L	BOG	451-103-025	GP-81	BOG
4429395	GP-178	MOP	45	GG-189	REF	450-905-098	GG-189	BOG	451-103-026	GP-3816	BOG
4429615	GP-178	CHRY	45 115 466	G-466	AUDI	450-905-099	GG-251	BOG	451-103-028	GP-171	BOG
4429615	GP-178	MOP	45 115 466	G-466	PORS	450-905-099-065	GG-251	BOG	451-103-029	GP-81 ³¹	BOG
443	GA-31	AMP	45 115 466	G-466	VOLK	450-905-103	GG-189	BOG	451-103-029	GP-9 ⁵⁸	BOG
443	GA-31	BGA	450	GA-59	AUTP	450905104	GG-408	BOG	451-103-030	GP-46	BOG
4430	GP-2015W	NAP	450 902 161	GG-291	BOG	450-905-104	GG-246	BOG	451-103-032	GP-37	BOG
4430501	G-870	NAPI	45011-019	GP-1	TOYO	450-905-130	GG-189	BOG	451-103-033	GP-28 ⁶	BOG
4431	GP-2022W	NAP	45014	GA-2719B	IPS	450-905-133	GG-246	BOG	451-103-033	GP-430 ⁸	BOG
443133511	GG-246	VOLK	45-02	GA-1287	ERO	450-905-142	GG-189	BOG	451-103-033-310	GP-28 ⁶	BOG
4434791	GP-58	FIAT	450-203-010	GP-31	BOG	450-905-143	GG-226	BOG	451-103-033-310	GP-430 ⁸	BOG
4434825	GP-81	FIAT	450209	GA-6129	WOOD	450905145	GG-261	BOG	451-103-038	GP-171	BOG
4434857	GAVW-2	FIAT	450210	GA-6127	WOOD	450-905-147	GG-246	BOG	451-103-040	GP-81 ³¹	BOG
4434867	GAVW-2	FIAT	45022	GA-230	IPS	450905164	GG-408	BOG	451-103-040	GP-9 ⁵⁸	BOG
4434951	GA-50	FIAT	45024	GP-20	SRS	450-905-164	GG-246	BOG	451-103-041	GP-22	BOG
4434958	GA-3637	FIAT	4502696	GP-46	SAAB	450-905-177	GG-189	BOG	451-103-041-850	GP-22	BOG
4435144	GG-5 L	FIAT	4503973	G-31	ALCH	450-905-198	GG-189	BOG	451-103-043	GP-3816	BOG
444	GP-46	DEL	4503973-5	G-31	ALCH	450-905-200	GG-246	BOG	451-103-044	GP-81 ³¹	BOG
44416	GP-92 ¹⁰⁴	SULL	45042	GA-2740	IPS	450-905-201	GG-251	BOG	451-103-044	GP-9 ⁵⁸	BOG
44419	GP-761H	CHAM	45043	GAD-3	IPS	450-905-203	GG-189	BOG	451-103-045	GP-46	BOG
4442559	GG-251	FIAT	4505	GG-5 L	PAR	450-905-206	GG-251	BOG	451-103-045-850	GP-46	BOG
444-25-59	GG-251	ALFA	450504	GAK-403	OREN	4-509-052-145	GG-246	ROB	451-103-046	GP-28 ⁶	BOG
4443064	GG-61	CHRY	4505-04	GAK-403	POCL	450-905-231	GG-246	BOG	451-103-046	GP-430 ⁸	BOG
4443452	GG-67	CHRY	4505289	G-1173	ALCH	4505289	GG-251	BOG	451-103-049	GP-3816	BOG
4443453	GG-67	CHRY	4505289	G-1173	AUSW	450-905-264	GG-251	BOG	451-103-050	GP-3816	BOG
4443454	GG-67	CHRY	4505289	G-1173	DIAM	450-905-275	GG-251	BOG	451-103-051	GP-28 ⁶	BOG
4443455	GG-67	CHRY	4505289-2	G-1173	ALCH	450-905-318	GG-102	BOG	451-103-051	GP-430 ⁸	BOG
4443461	GG-61	CHRY	4505989	G-1173	ALCH	450905401	GG-408	BOG	451-103-052	GP-3600	BOG
4443461	GG-61	MOP	4505989-2	G-1173	ALCH	450-905-401	GG-246	BOG	451-103-057	GP-81	BOG
4443462	GG-61	CHRY	45060	G-33	PHHR	450-905-401	GG-246	ROB	451-103-062	GP-171	BOG
4443463	GG-65	CHRY	450613	GA-356	WOOD	450-905-403	GG-246	BOG	451-103-062	GP-81	BOG
4445152	GAVW-2	NAPI	450617	GA-357	WOOD	450-905-403	GG-246	ROB	451-103-068	GP-46	BOG
4445153	GAVW-2	NAPI	45064	GA-71	IPS	450-905-405	GG-189	BOG	451-103-068-850	GP-46	BOG
444898	GP-1122	ATCO	45064	GP-171 ¹⁶	SRS	450905601	GG-261	BOG	451-103-069	GP-28 ⁶	BOG
444898	GP-1122	ATWE	4506491	G-1173	ALCH	450-905-603	GG-189	BOG	451-103-069	GP-430 ⁸	BOG
4449040	GP-81	FIAT	4506491-0	G-1173	ALCH	450-905-604	GG-189	BOG	451-103-074	GP-28	BOG
4449040	GP-81	SEAT	45065-2071	GP-157	KAWA	450-905-916	GG-160	BOG	451-103-074	GP-3600	BOG
445	GP-46	DEL	45068	GA-230	IPS	45092	GAD-1	IPS	451-103-079	GP-46	BOG
4450502	GP-81	NAPI	4506839	GP-1	FIAT	45093	GAD-1	IPS	451-103-084	GP-3816	BOG
4450503	GP-81	NAPI	4507143	GC-1133	ALCH	45096	GA-2719B	IPS	451-103-086	GP-28 ⁶	BOG
4455153	GA-230	NAPI	4507143-4	GC-1133	ALCH	45099	GAVW-2	IPS	451-103-086	GP-430 ⁸	BOG
4459	GG-16	ALL	45074	GP-81 ³¹	SRS	451	G-1163 ¹⁰⁸	AMP	451-103-089	GP-40	BOG
446	GA-892	BGA	45074	GP-9 ⁵⁸	SRS	451	GA-85	AUTP	451-103-091	GP-28 ⁶	BOG
446	GP-20	DEL	45080-51011	GA-26	CEDR	451	G-1163 ¹⁰⁸	BOG	451-103-091	GP-430 ⁸	BOG
44-63001-040	G-152	MAN	45081	GA-100	SRS	451	GP-66	DEL	451-103-095	GP-58	BOG
4465121	GP-1122	SEAT	45082	GA-113	SRS	451-001-001	GP-22	BOG	451-103-096	GP-3816	BOG
4465154	GA-303	NAPI	450820001	GP-1122	KRAM	451-001-002	GP-22	BOG	451-103-097	GP-46	BOG
4465177	GP-119	NAPI	450820401	GP-1122	KRAM	451-001-002-850	GP-22	BOG	451-103-099	GP-40	BOG
446638-C91	GA-3501	IHCO	4508334	GP-457	LAND	451-001-053	GP-22	BOG	451-103-101	GP-3600	BOG
446661	GA-3501	IHCO	45084	GAVW-2	IPS	451-001-053-850	GP-22	BOG	451-103-101-850	GP-3600	BOG
446661C1	GA-3501	CASE	45084	GP-3	SRS	451-001-150	GP-81 ³¹	BOG	451-103-110	GP-3600	BOG
446661C1	GA-3501	IHCO	45085	GAVW-2	IPS	451-001-150	GP-9 ⁵⁸	BOG	451-103-122	GP-81	BOG
446661C2	GA-3501	CASE	45086	GA-101	SRS	451-001-181	GP-40	BOG	451-103-126	GP-81	BOG
446661C2	GA-3501	CASE	450879-C1	GA-229	IHCO	451011	GA-100	BGA	451-103-127	GP-3816	BOG
44667	GP-36	OREN	4509010	GAK-20	HITA	45-1014	GA-113	BGA	451-103-132	GP-46	BOG
446910C1	GA-3501	CASE	450-901-001	GG-5 L	BOG	451018	GA-101	BGA	451-103-133	GP-22	BOG
446910C1	GA-3501	IHCO	450-901-053	GG-5 L	BOG	451027	GA-176	BGA	451-103-134	GP-28 ⁶	BOG
44693	GP-3600	EXCL	450-901-060	GG-3	ROB	45103	GA-303	IPS	451-103-134	GP-430 ⁸	BOG
447	GP-3980	DEL	450-903-003	GG-5 L	BOG	45104	GAVW-4	IPS	451-103-136	GP-81 ³¹	BOG
447014-C1	GA-378	IHCO	450-904-003	GG-3	BOG	45106	GAVW-4	IPS	451-103-136	GP-9 ⁵⁸	BOG
447048-M1	GP-1	MASY	450-904-058	GG-1	BOG	45108	GA-277	IPS	451-103-140	GP-46	BOG
4470500	GP-42	NAPI	450-904-058	GG-4	BOG	45-10954-174	GA-361	MAN	451-103-141	GP-22	BOG
447133511	GG-246	VAG	450-904-059	GG-1	BOG	45-10954-174	GAVW-2	MAN	451-103-142	GP-81	BOG
447133511	GG-246	VOLK	450-904-059	GG-4	BOG	451-102-001	GP-58	BOG	451-103-147	GP-40	BOG
44773	GP-66	SULL	450-904-060	GG-3	BOG	451-102-002	GP-81	BOG	451-103-148	GP-40	BOG
44791	GP-66	WAYN	450-904-060	GG-3	ROB	451-102-056	GP-3816	BOG	451-103-162	GP-40	BOG
448	G-870	CRO	450-904-060-850	GG-3	BOG	451-102-901	GP-3816	BOG	451-103-164	GP-40	BOG
448231	GA-303	FORD	450-904-061	GG-5 L	BOG	451-103-001	GP-81	BOG	451-103-166	GP-81 ³¹	BOG
448283	G-750	WHIT	450-905-002	GG-5 L	BOG	451-103-002	GP-81	BOG	451-103-166	GP-9 ⁵⁸	BOG
4486002	GA-853R	HITA	450-905-004	GG-189	BOG	451-103-003	GP-81	BOG	451-103-167	GP-81 ³¹	BOG
448898	GP-1122	ATCO	450-905-006	GG-246	BOG	451-103-004	GP-58	BOG	451-103-167	GP-9 ⁵⁸	BOG
448898	GP-1122	ATWE	450905009	GG-408	BOG	451-103-005	GP-58	BOG	451-103-170	GP-81	BOG
449	G-613	CRO	450-905-009	GG-246	BOG	451-103-006	GP-81	BOG	451-103-171	GP-81	BOG
4490295	G-297-B	ALCH	450-905-010	GG-246	BOG	451-103-007	GP-1	BOG	451-103-174	GP-40	BOG
4490295	G-297-B	ARCT	450-905-021	GG-246	BOG	451-103-008	GP-81	BOG	451-103-195	GP-171	BOG
4490296	G-296	ALCH	450-905-021	GG-246	ROB	451-103-009	GP-28 ⁶	BOG	451-103-205	GP-28	BOG
4490296	G-296-B	ALCH	450-905-024	GG-226	BOG	451-103-009	GP-430 ⁸	BOG	451-103-219	GP-171	BOG
449-0296	G-296	ARCT	450-905-025	GG-246	BOG	451-103-011	GP-81 ³¹	BOG	451-103-225	GP-28 ⁶	BOG
449-0296	G-296-B	ARCT	450-905-025	GG-246	ROB	451-103-011	GP-9 ⁵⁸	BOG	451-103-225	GP-430 ⁸	BOG
44924	GP-3816	GENI	450-905-027	GG-246	BOG	451-103-011-310	GP-81	BOG	451-103-228	GP-28 ⁶	BOG
4494477	GP-3985	CHRY	450-905-030	GG-251	BOG	451-103-012	GP-81	BOG	451-103-228	GP-430 ⁸	BOG
4495662	GG-7018 ³⁸	CHRY	450-905-031	GG-251	BOG	451-103-013	GP-28 ^{6</}				

Numero	Gonher	Fabricante	Numero	Gonher	Fabricante	Numero	Gonher	Fabricante	Numero	Gonher	Fabricante
Number	Gonher	Manufacturer	Number	Gonher	Manufacturer	Number	Gonher	Manufacturer	Number	Gonher	Manufacturer
451-104-002	GP-13	BOG	45151	GG-16	SRS	4525704	GA-326 ²¹	CLRK	4538573	G-33	FIAT
451-104-002	GP-205	BOG	45151311	GA-26	BUCY	45261	GA-56	SRS	45389	GA-4365	SRS
451-104-004	GP-36	BOG	45152	GG-17	SRS	45-262	GA-356	STEI	45391	GA-273	SRS
451-104-005	GP-14	BOG	45153	GG-45	SRS	45263	GA-50	SRS	45392	GA-274	SRS
451-104-005-850	GP-14	BOG	45154	GA-3300	IPS	45-263	GA-357	STEI	454	GA-3300	AUTP
451-104-063	GP-1	BOG	45154	GG-1	SRS	45265	GA-55	SRS	454	G-139	CRO
451-104-064	GP-205	BOG	45154	GG-4	SRS	45266	G-500	WHIT	45401	GA-59	SRS
451-104-064	GP-3	BOG	45155	GA-3490	IPS	45268	GA-303	SRS	45402	GA-55	SRS
451-104-065	GP-310	BOG	45156	GAD-3	IPS	45270	GA-3445	SRS	45403	GA-85	SRS
451-104-066	GP-36 ³⁰	BOG	45156	GG-1	SRS	45272	GA-349	SRS	45404	GA-50	SRS
451-104-066	GP-66	BOG	45156	GG-4	SRS	45273	GA-325	SRS	45405	GP-57	SRS
451-104-469	G-33	BOG	45157	GG-8 ¹⁰³	SRS	45274	GA-86	SRS	45406	GA-71	SRS
451-105-001	GP-54	BOG	45157	GG-8 L ⁸⁰	SRS	45275	GA-3300	SRS	45408	GA-70	SRS
451-105-067	GP-54 ¹¹	BOG	45161	GG-6	SRS	45276	GA-86	SRS	45409	GAK-403	CARO
451-105-067	GP-66 ¹⁰	BOG	45162	GG-19	SRS	45277	GA-192	SRS	45409	GA-75	SRS
451-105-182	GP-54 ¹¹	BOG	45163	GG-123	SRS	45278	GA-3424	SRS	45411	GA-303	SRS
451-105-182	GP-66 ¹⁰	BOG	45164	GG-5 L	SRS	45279	GA-3523	SRS	45415	GA-735 ¹²⁴	SRS
451-105-188	GP-54	BOG	45165	GA-100	SRS	4528873	G-33	FIAT	45416136	GP-432	CASE
451-105-188	GP-66	BOG	45166	GA-113	SRS	4529190	GP-171 ¹⁶	CHRY	45418795	GA-436	NEWH
45113	GAD-1	IPS	45167	GA-113	SRS	4529806	GP-171 ¹⁶	CHRY	45-41972	GA-27	WHIT
45114	GAD-1	IPS	45168000	GP-50	FERI	4529989	GP-20	FIAT	45440786	GA-436	NEWH
451140001	GP-36	KRAM	45169	GG-7	SRS	453	GA-57	AUTP	45441	GA-71	SRS
45115561A	GP-1	VOLK	45170	GP-1	SRS	453	G-1123	CRO	45-45245	GA-360	WHIT
45115561B	GP-1	VOLK	45170000	GP-1	ASTN	453	GP-66	DEL	45-45249	GA-31	WHIT
45115561C	GP-1	VOLK	45170000	GP-1	MORE	45302	GA-59	SRS	4546679	GG-95	CHRY
45116	GAVW-2	IPS	451-70-000	GP-1	ALFA	45303	GP-1	SRS	45470	GA-59	SRS
4511629	GP-1	ALCH	451-70-0000	GP-1	ALFA	45304	GA-730	SRS	45471	GA-55	SRS
4511629-0	GP-1	ALCH	45171	GP-1	SRS	4530468	GA-33	FIAT	45472	GA-85	SRS
4511629-2	GP-1	ALCH	45172	GP-20	SRS	453050	GA-106 ⁹⁶	INSL	45473	GA-50	SRS
45117	GAD-3	IPS	45173	GAD-30	IPS	453050	GA-206	INSL	45474	GA-356	ASTR
45-11754-166	GAVW-4	MAN	45173	GP-3	SRS	453050	GA-326 ²¹	INSL	45474	GA-356	ATHY
451-202-001	GP-50	BOG	45174	GAD-15	IPS	453053	GA-27	INSL	45474	GA-57	SRS
451-202-002	GP-50	BOG	45174	G-200	SRS	453054	GA-26	INSL	45475	GA-71	SRS
451-202-055	GP-37	BOG	45175	GP-38 ¹²²	SRS	45306	GA-85	SRS	45477	GA-70	SRS
451-202-055	GP-50	BOG	45176	GAVW-2	IPS	4530702	GP-36	FIAT	45478	GA-75	SRS
451-203-001	GP-31	BOG	45176	GP-81 ³¹	SRS	45307022	GP-36	FIAT	45479	GA-303	SRS
451-203-001-850	GP-31	BOG	45176	GP-9 ⁵⁸	SRS	4530702-2	GP-36	ALCH	45480	GA-3300	SRS
451-203-002	GP-54	BOG	45177	GP-46	SRS	453100012A	G-1123	VMEN	45481	GA-730	SRS
451-203-003	GP-22	BOG	45178	GP-3429	SRS	45310001A	G-1121F	VMEN	45481348	G-225	FIAT
451-203-005	GP-1	BOG	45179	GP-3985	SRS	45310002A	G-1121	VMEN	45482	GA-77	SRS
45120-3005	GP-1	NISS	45180	GP-3980	SRS	4531001	G-1121F	MVM	45-4855	G-750	WHIT
451-203-006	GP-81	BOG	45181	GG-87	SRS	4531001	G-1121	VMEN	4549712	GG-67	CHRY
451-203-008	GP-1	BOG	45182	GP-20	SRS	4531002	G-1121	MVM	455	G-1173 ¹⁰⁸	AMP
451-203-009	GP-1	BOG	45184	GP-81 ³¹	SRS	4531002	G-1121	VMEN	455	GA-86	AUTP
451-203-009-850	GP-1	BOG	45184	GP-9 ⁵⁸	SRS	45310040A	GP-1122	VMEN	455	G-1173	BGA
451-203-010	GP-31	BOG	45185	GA-4325	IPS	45310041A	GP-1122	VMEN	455	G-1143	DEL
451-203-010-850	GP-31	BOG	45185	GP-24	SRS	45310054	G-296	VMEN	45-5088	G-500	WHIT
451-203-011	GP-81	BOG	45187	GP-28 ⁸	SRS	45310054	G-296-B	VMEN	45-51925	GA-27	WHIT
451-203-012	GP-310	BOG	45187	GP-430 ⁸	SRS	45310054A	G-296	VMEN	45-5266	G-500	WHIT
451-203-058	GP-81	BOG	45188	GP-310	SRS	45310054A	G-296-B	VMEN	4554	G-500	NAP
451-203-059	GP-171 ¹⁹	BOG	45189	GP-434	SRS	45310059A	G-297-B	VMEN	4554038	GG-247	CHRY
451-203-061	GP-310	BOG	45190	GP-40	SRS	45310063A	GP-1122	VMEN	4554040	GG-84	CHRY
451-203-081	GP-20	BOG	451-905-601	GG-246	BOG	45310071A	GPP-1122	VMEN	4554040	GG-84	MOP
451-203-081	GP-5	BOG	45191	GP-1	SRS	4531012	G-1123	VMEN	4556	GGP-25	GRAD
451-203-087	GP-1	BOG	45192	GP-20	SRS	4531012	G-1123F	VMEN	455F	G-1121	GREY
451-203-087	GP-31	BOG	45193	GP-3	SRS	4531013	GP-1101	MVM	456	GA-730	AUTP
451-203-088	GP-310	BOG	45194	GA-4303	IPS	4531013	GP-1101	VMEN	45-60399	GAK-20	KENW
451-203-108	GP-3985	BOG	45194	GP-81 ³¹	SRS	4531022	GP-1122	VMEN	4561986	G-296	FIAT
451-203-152	GP-171	BOG	45194	GP-9 ⁵⁸	SRS	4531040	GP-1122	VMEN	4561986	G-296-B	FIAT
451-203-153	GP-1	BOG	45195	GA-2740	IPS	4531041	GP-1122	VMEN	4561986	G-296	IVEC
451-203-154	GP-81	BOG	45195	GP-24 ²⁶	SRS	4531048	G-1121F	MVM	4561986	G-296-B	IVEC
451-203-177	GP-81	BOG	45195	GP-462 ²⁴	SRS	4531048	G-1121	VMEN	45-64285	GA-31	WHIT
451-203-178	GP-81	BOG	45196	GP-42	SRS	4531054	G-296	MVM	45674	GP-2071W	CHAM
451-203-194	GP-1	BOG	45197	GP-28 ⁸	SRS	4531054	G-296-B	MVM	45690-00115	GAK-403	CEDR
451-203-199	GP-9	BOG	45197	GP-430 ⁸	SRS	4531054	G-296	VMEN	45690-001-1502	GAK-403	IOWA
451-203-201	GP-9	BOG	45199	GA-230	IPS	4531054	G-296-B	VMEN	45690-001-152	GAK-403	IOWA
451-203-218	GP-36	BOG	45199	GP-46	SRS	4531059	G-297-B	VMEN	457	G-1174	AMP
451-203-220	GP-54	BOG	452	GA-55	AUTP	4531063	GPP-1122	VMEN	457	G-1174	BGA
451-203-224	GP-54	BOG	452	GP-3985	PMC	45311	GA-85	SRS	457	G-1121	CRO
451-203-226	GP-54	BOG	45200	GP-3600	SRS	45313	GA-54	SRS	457-2491	GA-2147	SAAB
451-203-228	GP-178	BOG	45201	GP-3429	SRS	45316	GA-735 ¹²⁴	SRS	45728	G-1173 ¹⁰⁸	EMCO
451-203-229	GP-390	BOG	45203	GA-180	IPS	45317	GA-271	SRS	4573031	GA-141	CHRY
45122	GAD-3	IPS	45203	GP-3980	SRS	45318	GA-2740	SRS	4573624	GA-132	CHRY
4512207	GP-50	ALCH	45204	GAD-1	IPS	45320	GA-74	SRS	45740-70111	GA-1008	MIT
4512207-3	GP-50	ALCH	45204	GP-3531 EXP	SRS	45321	GA-3588	SRS	45740-70111E	GA-1008	MIT
4512207-4	GP-50	ALCH	45-204	GA-356	STEI	45322	GA-4828	SRS	45740-70210	GA-9334	MIT
45123	GA-50	IPS	45205	GP-66	FILP	45328	GA-75	SRS	45740-70510	GA-8047	MIT
45126	GA-75	IPS	45205	GA-200	IPS	45333	GA-3490	SRS	457-429-808	GAD-1 ⁸⁷	BOG
45127	GA-4303	IPS	45205	GP-66	MACD	45337	GAVW-2	SRS	4574312-6	G-1123	VOLV
45128	GA-3490	IPS	45205	GP-58	SRS	45342	GAD-1	SRS	457431326	GP-1122	SAAB
451-300-003	GP-55	BOG	45206	GP-58	SRS	45343	GAD-3	SRS	45748	G-1173 ¹⁰⁸	EMCO
451-301-001	GP-54 ¹¹	BOG	4521002	S 3202 ⁴⁰	TAMR	45345	GA-3425	SRS	45748	G-1173 ¹⁰⁸	EUCL
451-301-001	GP-66 ¹⁰	BOG	45221	GA-78	IPS	45346	GA-71	SRS	458	GP-1122	DEL
451-301-156	GP-54	BOG	45226	GA-3490	SRS	45347	GA-3647	SRS	458	GPP-1122	DEL
451-302-001	GP-1101	BOG	45229	GAVW-2	SRS	45349	GA-3681	SRS	4-581135-3	GA-106 ⁶	UNID
451-302-054	GP-1101	BOG	45230	GA-4303	IPS	45351	GA-70	SRS	4-581135-3	GA-326 ²¹	UNID
451-302-182	GP-31	BOG	45-232	GA-356	STEI	45356	GA-78	SRS	4-581576-3	GA-6129	UNID
45134	GA-56	IPS	45233	GA-139	IPS	45357	GA-75	SRS	4-581577-4	GAK-403	UNID
45140	GA-3490	IPS	4523873	GP-171 ¹⁶	FIAT	453570	GA-3637	SRS	4-581641-2	GA-206	UNID
451-403-001	GP-77	BOG	452418-C1	GP-3	IHCO	45373	GA-77	SRS	4-582229-8	GA-6127	UNID
451-403-077	GP-51	BOG	452-45-000	G-871	ALFA	45376	GA-80	SRS	45833	GA-2740	SRS
45141	GAD-3	IPS	45252	GA-356	CASE	45380	GA-277	SRS	45844	GA-3566	FIAT
45142	GA-3425	IPS	45-252	GA-356	STEI	45381	GA-4303	SRS	4587711	G-33	SRS
45143	GA-39	IPS	45-25251	GA-356	STEI	45-38142	GA-26	WHIT	458F	G-297-B	GREY
45147	GA-2740	IPS	45-253	GA-357	STEI	45384000	GP-171 ¹⁶	FERI	459	G-1176	AMP
4515089	GA-27	HITA	4525704	GA-106 ⁶	CLRK	45-38454-114	GA-781	MAN	459	G-1175 ¹⁰⁸	BGA

Referencia Cruzada por Numero de Parte

Cross Reference by Part Number



Numero	Gonher	Fabricante	Numero	Gonher	Fabricante	Numero	Gonher	Fabricante	Numero	Gonher	Fabricante
Number	Gonher	Manufacturer	Number	Gonher	Manufacturer	Number	Gonher	Manufacturer	Number	Gonher	Manufacturer
459.....	GP-1122	DEL	4612227.....	G-296-B	IVEC	46244.....	GA-195	WIX	46429.....	GA-768R	WIX
459.....	GPP-1122	DEL	46123.....	GAWV-2	WIX	46246.....	GA-7017	WIX	46429000.....	GA-361	DRON
4590074.....	G-33	FIAT	461249-C1.....	GA-360	IHCO	462516C2.....	GP-1010Q	IHCO	46433.....	GA-197R	WIX
4591100.....	GA-8606	CHRY	46126.....	GA-273	WIX	46253.....	GA-158	WIX	46438.....	GA-880R	WIX
4591100AB.....	GA-8606	CHRY	46126MP.....	GA-273	WIX	46255.....	GA-3501	WIX	46440.....	GA-673R	WIX
4591100AC.....	GA-8606	CHRY	4613117.....	G-31	ALCH	46-2634.....	GA-27	KENW	46441.....	GA-732R	WIX
4591110AB.....	GA-8606	CHRY	4613117.....	G-31	FIAT	46264.....	GA-362	WIX	46441236.....	GG-106	FIAT
45928.....	GA-357	ASTR	4613117-0.....	G-31	ALCH	46-2660.....	GA-26	KENW	46443.....	GA-163	WIX
45928.....	GA-357	ATHY	46132.....	GA-274	WIX	46267.....	GAD-29	WIX	46444.....	GA-170	WIX
4596890.....	G-33	FIAT	46133.....	GA-277	WIX	46272.....	GA-240	WIX	46462.....	GA-304	WIX
4596890.....	G-33	HEST	46133843.....	GA-277	VOLK	46273.....	GA-5466	WIX	4646509.....	GA-90	GMXC
4596890.....	G-33	IVEC	46134.....	GA-5056	WIX	46279.....	GAD-30	WIX	46466.....	GAK-458	WIX
4596891.....	G-33	ALCH	46134MP.....	GA-5056	WIX	462816-C1.....	GP-2071W	IHCO	46467.....	GA-459	WIX
4596891.....	G-33	FIAT	46135.....	GA-2194	WIX	462816-C2.....	GP-2071W	IHCO	46470.....	GA-712R	WIX
45C.....	G-31	REF	46139.....	GA-3916	WIX	46284.....	GAD-30	WIX	46472.....	GA-8606	WIX
45LC.....	G-31	REF	46139MP.....	GA-3916	WIX	46288.....	GA-198	WIX	46473.....	GA-145	WIX
46 474 249.....	GG-106	LANC	46140220.....	GAK-403	BUCY	46289.....	GA-175	WIX	46474.....	GA-499R	WIX
46000.....	GA-416	BONS	46140230.....	GAK-403	BUCY	46293.....	GA-240	WIX	46474.....	GA-8047	WIX
46001.....	GA-135	WIX	46140232.....	GAK-20	BUCY	46298.....	GA-2179	WIX	46484.....	GA-472	WIX
46003.....	GAK-216	BONS	46140238.....	GA-27	BUCY	46298.....	GA-2198 ²⁹	WIX	4649.....	GP-81	VALU
46006.....	GA-198	WIX	46140239.....	GA-27	BUCY	46298.....	GA-438 ³¹	WIX	4650285.....	GA-360	FIAT
46007.....	GA-3566	WIX	46140240.....	GA-26	BUCY	46302.....	GA-164	WIX	4650285.....	GA-360	IVEC
46011.....	GAD-3	WIX	46140243.....	GA-26	BUCY	46303.....	GA-514	WIX	46503.....	GA-3916	WIX
46012.....	GA-3300	WIX	46140304.....	GA-27	BUCY	4630787.....	GP-171	ALCH	46505.....	GA-329	WIX
46013.....	GA-735 ¹²⁴	WIX	46140305.....	GA-6880	BUCY	46308.....	GA-605	WIX	4651986.....	G-296	IVEC
46016.....	GA-190	WIX	46140311.....	GA-26	BUCY	4631-0074.....	GA-33	VAPR	4651986.....	G-296-B	IVEC
46017.....	GA-322	WIX	46144.....	GA-392	WIX	4631071020.....	GA-436	SAUR	46523087.....	GG-106	FIAT
46024.....	GA-2719B	WIX	46146.....	GA-180	WIX	4631072010.....	GA-436	SAUR	465249-C1.....	GA-360	IHCO
46025.....	GAWV-4	WIX	46148.....	GA-2106	WIX	4631072040.....	GA-405	SAUR	46527.....	GA-781	WIX
46026.....	GA-381	WIX	4614877.....	GP-178	EATN	4631281100.....	GP-54 ¹¹	SAUR	46528.....	GA-782	WIX
46027.....	GAD-294	WIX	4614878.....	GP-18	EATN	4631281100.....	GP-66 ¹⁰	SAUR	46530.....	GA-589	WIX
46028.....	GA-7344	WIX	4614879.....	GP-1122	EATN	4631281110.....	GP-66	SAUR	46531.....	GA-588	WIX
46032.....	GA-57	WIX	46149231.....	GAK-20	BUCY	46320.....	GA-2114	WIX	46538.....	GA-459	WIX
46035.....	GA-279	WIX	46150.....	GA-129	WIX	46321.....	GA-2195	WIX	465501C1.....	GG-20	IHCO
46036.....	GA-3647	WIX	46151311.....	GA-26 ¹¹²	BUCY	46322.....	GA-293	WIX	46553.....	GA-529	WIX
46036MP.....	GA-3647	WIX	46151723.....	GA-26	BUCY	46323.....	GA-7007	WIX	46556.....	GA-682R	WIX
46040.....	GA-3588	WIX	46151726.....	GA-27	BUCY	46325.....	GA-119	WIX	465583.....	G-1173	ALCH
46040MP.....	GA-3588	WIX	46151727.....	GA-26	BUCY	46327.....	GAWV-121	WIX	465583-6.....	G-1173	ALCH
46041.....	GA-390	WIX	46151728.....	GAK-403	BUCY	46339.....	GA-128	WIX	46562.....	GA-853R	WIX
46042.....	GA-4325	WIX	46151729.....	GAK-403	BUCY	46349.....	GA-127	WIX	46567.....	GAK-1532	WIX
460420.....	GA-90	GMXC	46153.....	GA-6479	WIX	46350.....	GA-642	WIX	465680-C91.....	GP-26	IHCO
46043.....	GA-139	WIX	46155.....	GAK-403	DAVY	463505.....	GA-4365	VOLV	46573.....	GA-413R	WIX
460430.....	GA-90	GMXC	46157.....	GA-78	WIX	463505-8.....	GA-4365	VOLV	46580.....	GAP-381	WIX
46044.....	GAD-117	WIX	46158.....	GA-382	WIX	46358.....	GA-384	WIX	46594.....	GAK-16	OREN
46044.....	GAD-17	WIX	4616.....	GP-1122	SULL	46359.....	GA-1008	WIX	46600198.....	GP-295 ¹²	YUGO
46045.....	GA-154	WIX	46160.....	GA-3523	WIX	46360.....	GA-33	WIX	46600198.....	GP-58 ⁸⁴	YUGO
46046.....	GA-3681	WIX	46162.....	GA-6690	WIX	463640.....	GA-4365	VOLV	46602.....	GP-3600	GRAV
46048.....	GA-3637	WIX	46162800.....	GA-357	BUCY	4636401.....	G-33	FIAT	4660204.....	G-162H	DAIM
46049.....	GA-429	WIX	46163260.....	GA-6880	BUCY	4636686.....	GG-7018 ³⁸	CHRY	4660204.....	G-162H	MBNZ
46051.....	GA-217	WIX	46163280.....	GA-6880	BUCY	4636686.....	GG-7019 ³⁷	CHRY	4660393.....	GAK-20	FIAT
46053.....	GAD-129	WIX	46163294.....	GA-27	BUCY	4636686.....	GG-7020 ¹¹⁴	CHRY	46604004.....	G-225	MBNZ
46054.....	GA-56	WIX	46163302.....	GA-356	BUCY	4636686.....	GG-7018 ³⁸	MOP	4660455.....	GAK-20	FIAT
46057.....	GA-7142	WIX	46163350.....	GAK-20	BUCY	4636686.....	GG-7019 ³⁷	MOP	4660604.....	G-162H	DAIM
46061.....	GA-230	WIX	46163360.....	GAK-20	BUCY	4636686.....	GG-7020 ¹¹⁴	MOP	4660604.....	G-162H	MBNZ
46064.....	GA-386	WIX	46165.....	GAD-1	WIX	4636687.....	GG-7018 ³⁸	CHRY	46-609001.....	G-833	JCBM
46065.....	GA-59	WIX	46166.....	GA-89	WIX	4636687.....	GG-7019 ³⁷	CHRY	4661.....	GP-28 ⁶	ALL
46066.....	GA-3681	WIX	46167.....	GA-85	WIX	4636687.....	GG-7020 ¹¹⁴	CHRY	4661.....	GP-430 ⁸	ALL
46067.....	GA-192	WIX	46170.....	GA-276	WIX	4636687.....	GG-7018 ³⁸	MOP	4661.....	GP-5	VOLV
46068.....	GA-71	WIX	46174.....	GA-174	WIX	4636687.....	GG-7019 ³⁷	MOP	466176.....	G-31	VOLV
46069.....	GA-70	WIX	46174MP.....	GA-174	WIX	4636687.....	GG-7020 ¹¹⁴	MOP	4662.....	G-750	LUF
46072.....	GA-80 ¹¹³	WIX	46179.....	GA-153	WIX	4637101.....	GG-72	CHRY	46620004.....	GP-58	YUGO
46077.....	GA-3901	WIX	46180.....	GA-253	WIX	4637714.....	G-1175	ALCH	46620892.....	GG-5 L	YUGO
46080.....	GA-141	WIX	46186.....	GA-142	WIX	46383.....	GA-2118	WIX	46621482.....	GP-3600	YUGO
46081.....	GA-301	WIX	4618907.....	GP-390	YALE	4638387.....	GG-7018 ³⁸	CHRY	466268011.....	GG-251	YUGO
46082.....	GA-166	WIX	46190.....	GA-6619 ¹	WIX	4638387.....	GG-7019 ³⁷	CHRY	46626811.....	GG-251	YUGO
46084.....	GA-3814	WIX	46190.....	GA-6620 ²	WIX	4638387.....	GG-7020 ¹¹⁴	CHRY	46627520.....	GA-2194	YUGO
46084MP.....	GA-3814	WIX	46195.....	GA-244	WIX	4638387.....	GG-7018 ³⁸	MOP	466-27520.....	GA-2194	ZAST
46085.....	GA-3647	WIX	462.....	G-1173	AMP	4638387.....	GG-7019 ³⁷	MOP	46628.....	GA-683R	WIX
46086.....	GA-70	WIX	462.....	G-1173	BGA	4638387.....	GG-7020 ¹¹⁴	MOP	46641.....	GA-8	WIX
46089.....	GA-4958	WIX	462.....	GPP-1000	DEL	4638390.....	GG-7018 ³⁸	CHRY	46646.....	GA-364	WIX
46093.....	GA-275	WIX	46200.....	GA-3501	WIX	4638390.....	GG-7019 ³⁷	CHRY	46648.....	GA-780	WIX
46095.....	GAD-118	WIX	46204.....	GA-422	WIX	4638390.....	GG-7020 ¹¹⁴	CHRY	46659.....	GA-1616	WIX
46097.....	GA-133	WIX	46209.....	GP-761H	ADVA	46388.....	GA-172	WIX	466634.....	GP-51	VOLV
46098.....	GA-432	WIX	46213.....	GA-300	WIX	463883C92.....	GA-376	IHCO	4666343.....	GP-51	VLEN
461.....	GP-11	DEL	46215.....	GA-607	WIX	46389.....	GAK-16	WIX	466634-3.....	GP-51	VOLV
46104.....	GA-476	WIX	4621540.....	G-296	FIAT	46390.....	GAWV-620	WIX	46664.....	GA-930R	WIX
46105.....	GA-595	WIX	4621540.....	G-296-B	FIAT	46394.....	GAK-16	WIX	46665.....	GA-890R	WIX
4610575.....	GA-106 ⁴⁶	EATN	4621540.....	G-296	IVEC	4639-4028.....	GA-33 ¹¹²	VAPR	46673.....	GA-264	WIX
4610575.....	GA-326 ⁷¹	EATN	4621540.....	G-296-B	IVEC	46397.....	GA-16	WIX	4667339.....	GP-88	ALCH
46108.....	GA-604	WIX	4621739.....	G-296	FIAT	46397.....	GAK-16	WIX	46674.....	GA-216	WIX
4611.....	GP-1	VALU	4621739.....	G-296-B	FIAT	46402.....	GA-2804 T	WIX	46675.....	GA-1095	WIX
46111.....	GA-4365	WIX	4621739.....	G-296	PERK	46403932.....	GG-106	FIAT	46677.....	GA-183R	WIX
4611120.....	GP-1	IHCO	4621739.....	G-296-B	PERK	46403933.....	GG-106	FIAT	4667755.....	GP-88	ALCH
46116.....	GAD-15	WIX	4621740.....	G-296	ALCH	46405.....	GA-2804 T	WIX	46690.....	GA-826	WIX
4611641.....	GP-110	PUR	4621740.....	G-296-B	ALCH	46406.....	GA-130	WIX	46691.....	GG-1	GRAV
46117.....	GA-165	WIX	4621740.....	G-296	FIAT	46415.....	GA-49	WIX	46691.....	GG-4	GRAV
461177.....	GA-56	VOLV	4621740.....	G-296-B	FIAT	46416.....	GA-1616	WIX	4669550.....	G-296	FIAT
46117MP.....	GA-165	WIX	462174								

Numero	Gonher	Fabricante	Numero	Gonher	Fabricante	Numero	Gonher	Fabricante	Numero	Gonher	Fabricante
Number	Gonher	Manufacturer	Number	Gonher	Manufacturer	Number	Gonher	Manufacturer	Number	Gonher	Manufacturer
467.....	GA-75	UNN	470186-C91H.....	GA-107	IHCO	4751198V01.....	GP-54 ¹⁵	VAND	4785921.....	GA-6127	VOLV
46701.....	GP-10	SULL	4705.....	GG-5 L	PAR	4751198V01.....	GP-66 ¹⁰	VAND	4785922.....	GA-6129	VOLV
4671001.....	GP-1122	DUTZ	4708302.....	GA-7	KOHL	475190.....	GA-360	VOLV	4785971.....	GP-54	VOLV
4671001.....	GP-1122	KHDF	4708317.....	GG-249	CHRY	475191.....	GA-361	VOLV	4785974.....	GP-54	VOLV
467113.....	GA-398	WIX	4708317.....	GG-249	MOP	47529.....	GP-81	SULL	4785974-9.....	GP-54	VOLV
46723.....	GA-398	WIX	470963.....	GA-37	FWDX	4755.....	GP-50	NAP	478765.....	GP-2071W	FAUN
46726.....	GA-376	WIX	4710052.....	GA-563	TAMR	4755401.....	G-1121	MBNZ	478735.....	GP-51	VOLV
46728.....	GA-780	WIX	47114.....	G-870	JOY	4756.....	GP-20	VALU	478736.....	GP-51	VOLV
46738.....	GA-616	WIX	47128196.....	GP-171	CASE	475643.....	GP-81	MANO	4787410.....	GP-9	FIAT
46741.....	GA-467	WIX	47132343.....	GA-853R	NEWH	4761277.....	GP-178	CHRY	4787410.....	GP-9	IVEC
46744.....	GA-968	WIX	47132345.....	GA-853R	CASE	47628.....	G-750	EUCL	478743-C1.....	GA-107	IHCO
46745.....	GA-221R	WIX	4713715.....	GA-70	CHRY	4764693.....	GP-1122	FIAT	4787502.....	GP-1013Q	FAUN
46746.....	GA-600R	WIX	4713715.....	GA-70	MOP	4764693.....	GP-1122	IVEC	4787923.....	GP-66	VOLV
46756.....	GA-251	WIX	471392.....	GP-57	VOLV	4764725.....	GP-1122	IVEC	4787923-4.....	GP-66	VOLV
46761.....	GA-697R	WIX	4713921.....	GP-57	VME	476473-C1.....	GA-107	IHCO	4788715.....	G-33	FAUN
46772.....	GA-435R	WIX	471392-1.....	GP-57	VOLV	47652CS.....	G-31	DIVC	4789026.....	GAK-16	ALCH
46774.....	GA-758	WIX	471869.....	GP-1122	DEMA	47652CS.....	G-31	HERC	4789026-6.....	GAK-16	ALCH
46775.....	GA-759 ⁰⁸	WIX	4719150.....	GP-81	IVEC	476741-C1.....	GA-209	IHCO	4789056.....	G-33	ALCH
46782.....	GA-967R	WIX	47195.....	GP-3682	GRAV	476743-C1.....	GA-107	IHCO	4789056.....	G-33	FIAT
46799.....	GA-2198 ⁷⁹	WIX	4720364.....	GP-28 ⁸	CHRY	476.....	GPP-425	GREY	4789521.....	GA-6127	VOLV
46799.....	GA-438 ³¹	WIX	4720364.....	GP-430 ⁸	CHRY	477.....	GG-76	AMP	4789522.....	GA-6129	VOLV
46804.....	GA-1617	WIX	472088-C91.....	GA-2984	IHCO	477.....	G-31	CRO	478974-C1.....	GA-109	IHCO
4680444.....	G-296	IVEC	472098-C1.....	GA-2984	IHCO	477.....	GA-361	DEL	479.....	GA-429	UNN
4680444.....	G-296-B	IVEC	47220-12012.....	GA-360	MITTS	4770815.....	G-1121	DAIM	4791113.....	GP-9	FIAT
4681776.....	GP-2071W	ALCH	47220-12020.....	GA-361	MITTS	4770815.....	G-1121	MBNZ	479461-C91.....	GA-109	IHCO
4682003.....	GG-7018 ³⁸	CHRY	47220-12810.....	GA-360	MITTS	4770980.....	G-1121	MBNZ	4795601.....	GPP-1122	FIAT
4682003.....	GG-7019 ³⁷	CHRY	47220-12820.....	GA-361	MITTS	4771.....	GAC-9	NAP	4795772.....	GP-1122	EATN
4682003.....	GG-7020 ¹⁴	CHRY	47220-21800.....	GA-27	MITTS	4771015.....	G-1121	DAIM	4795772.....	GP-1122	FAUN
4682003.....	GG-7018 ³⁸	MOP	47220-22810.....	GA-206	MITTS	4771015.....	G-1121	MBNZ	4795772.....	GP-1122	YALE
4682003.....	GG-7019 ³⁷	MOP	47220-22820.....	GA-106 ⁶⁶	MITTS	47712.....	GAK-16	WALD	4795837.....	GP-54 ¹¹	EATN
4682003.....	GG-7020 ¹⁴	MOP	47220-22820.....	GA-326 ⁷¹	MITTS	4771475.....	GA-4365	VOLV	4795837.....	GP-66 ¹⁰	EATN
4682004.....	GG-7018 ³⁸	CHRY	47220-24800.....	GA-106 ⁶⁶	MITTS	47714758.....	GA-4365	VOLV	4795837.....	GP-54 ¹¹	FAUN
4682004.....	GG-7019 ³⁷	CHRY	47220-24800.....	GA-326 ⁷¹	MITTS	4771869.....	GP-1122	DEMA	4795837.....	GP-66 ¹⁰	FAUN
4682004.....	GG-7020 ¹⁴	CHRY	47220-24800E.....	GA-106 ⁶⁶	MITTS	47720.....	GAK-16	WALD	4796458.....	GP-9	FIAT
4682004.....	GG-7018 ³⁸	MOP	47220-24800E.....	GA-326 ⁷¹	MITTS	47722-012810.....	GA-360	MITTS	4797777.....	GA-301	CHRY
4682004.....	GG-7019 ³⁷	MOP	47220-30800.....	GA-26	MITTS	4773511.....	G-1123	MBNZ	4797777AB.....	GA-301	CHRY
4682004.....	GG-7020 ¹⁴	MOP	47220-30801.....	GA-26	MITTS	4773515.....	G-1123	MBNZ	4797777AC.....	GA-301	CHRY
4682370.....	GG-267	CHRY	47220-31800.....	GA-6129	MITTS	4773515.....	G-1123F	MBNZ	4799425.....	GP-9	FIAT
4682569.....	GG-265	CHRY	47220-32111.....	GA-6129	MITTS	4773580.....	G-1121	MBNZ	4799645.....	GP-53	FAUN
46826.....	GP-54 ¹¹	OREN	47220-32112.....	GA-6127	MITTS	47737.....	GP-1122	OREN	479.....	G-1121F	GREY
46826.....	GP-66 ¹⁰	OREN	47220-32800.....	GA-6127	MITTS	4773815.....	G-1121	DIAM	47A1902.....	GAK-625	FMC
4682923.....	GG-65	CHRY	47220-32801.....	GA-6127	MITTS	4773815.....	G-1121	MBNZ	47A1902.....	GAK-625	JONB
46831.....	GA-138	WIX	47220-33400.....	GA-398	MITTS	4773815.....	G-1121F	MBNZ	47A1902.....	GAK-625	LINK
46832.....	GA-269	WIX	47220-35800.....	GA-6129	MITTS	4773815.....	G-1121	VOLV	47A1988.....	G-200	JONB
46834.....	GA-263	WIX	472306.....	GAK-16	DEMA	4774015.....	G-1123	ASTR	47A1988.....	G-200	LINK
46840.....	GA-389	WIX	47240CS.....	G-31	HERC	4774015.....	G-1123	DAIM	48.....	G-6	LEDR
46842.....	GA-518R	WIX	472508S.....	G-31	HERC	4774015.....	G-1123	MBNZ	48.....	G-6	LEE
46843.....	GA-539R	WIX	4728406.....	GA-240	CHRY	4774215.....	G-1121	DIAM	48.....	G-6	OHFC
46860.....	GA-371	WIX	4728406.....	GA-240	MOP	4774215.....	G-1121	MBNZ	480.....	G-870	CRO
46863.....	GA-534R	WIX	473037.....	G-296	MANO	4774215.....	G-1121	VOLV	48001.....	GG-5 L	IPS
46868.....	GA-608	WIX	473037.....	G-296-B	MANO	4774515.....	G-1123	AHLM	48002.....	GG-1	IPS
46870.....	GA-799R	WIX	47310029.....	G-1174	WITT	4774515.....	G-1123	HANO	48002.....	GG-4	IPS
46871.....	GA-798R	WIX	47312183.....	G-31	WITT	4774515.....	G-1123	MBNZ	48002-10.....	GG-1	IPS
46873.....	GA-606	WIX	47312216.....	G-1175	WITT	4774515.....	G-1123F	MBNZ	48002-10.....	GG-4	IPS
46876.....	GA-694	WIX	47312288.....	G-31	WITT	4774615.....	G-1121	MBNZ	48004.....	GG-5 L	IPS
46879.....	GA-510	WIX	47313080.....	G-1143	WITT	4774701.....	G-1121	MBNZ	48005.....	G-1121	IPS
46883.....	GA-3551 ⁵⁵	WIX	47313081.....	G-1143	WITT	4774701.....	G-1123	MBNZ	48007.....	G-1121	IPS
46883.....	GA-3551 XT ⁶⁴	WIX	47313082.....	G-33	WITT	4774715.....	G-1121	DIAM	48008.....	GG-19	IPS
46888.....	GA-370	WIX	47313083.....	G-33	WITT	4774715.....	G-1121	MBNZ	48009.....	G-1121	IPS
46902.....	GA-367	WIX	47313643.....	G-1173	WITT	4775401.....	G-1121	MBNZ	4801749.....	G-870	ASTN
46915.....	GA-646	WIX	47313644.....	G-1174	WITT	4775401.....	G-1123	MBNZ	4801749.....	G-870	GMCX
46916.....	GA-1546	WIX	47313884.....	G-6	WITT	4775415.....	G-1121	DIAM	48028.....	GG-45	IPS
469164-C91.....	GG-20	IHCO	47313885.....	G-6	WITT	4775415.....	G-1121	MBNZ	48029.....	GG-76	IPS
46922.....	GA-770R	WIX	47315768.....	G-31	PETI	4775415.....	G-1121F	MBNZ	48033.....	GG-202	IPS
46932.....	GA-633R	WIX	47315768.....	G-31	WITT	477556.....	GP-556	VOLV	48035.....	GG-94	IPS
46935.....	GA-1542	WIX	47315769.....	G-31	WITT	4775715.....	G-1121	DIAM	48035000.....	GP-54 ¹¹	FINI
46939.....	GA-241	WIX	47317382.....	G-1173	WITT	4775715.....	G-1121	MBNZ	48035000.....	GP-66 ¹⁰	FINI
469441-C1.....	GP-26	IHCO	47317384.....	G-1174	WITT	4775901.....	G-1121	MBNZ	48037.....	GG-5 L	IPS
469442-C1.....	GP-27	IHCO	47317428.....	G-1174	WITT	4775901.....	G-1123	MBNZ	48038.....	GG-45	IPS
46949.....	GP-3	SULL	47317430.....	G-1175	WITT	4776415.....	G-1121	DIAM	48039.....	GG-196	IPS
4695049.....	GG-104	CHRY	4733112.....	GP-84	FIAT	4776415.....	G-1121	MBNZ	48041.....	GG-5 L	IPS
46956.....	GA-251	SULL	4733112.....	GP-84	IVEC	4776514.....	G-1121	MBNZ	48042.....	GG-94	IPS
46968.....	GA-251	SULL	4733112.....	GP-84	MAGI	4776580.....	G-1121	MBNZ	48045.....	GG-5 L	IPS
46976.....	GA-176	WIX	4734562.....	GP-2071W	ALCH	4776815.....	G-1121	DIAM	4804651.....	GP-171 ¹⁶	VME
46977.....	GA-186	WIX	4734562.....	GP-1011Q	IVEC	4776815.....	G-1121	MBNZ	4804651.....	GP-171 ¹⁶	VOLV
4698-1590.....	GA-372	GRAD	4735.....	GG-8 ¹⁰³	PAR	4776815.....	G-1121F	MBNZ	48046510.....	GP-171 ¹⁶	VOLV
46983.....	GA-723R	WIX	4735.....	GG-8 L ⁸⁰	PAR	4776915.....	G-1121	DIAM	48049.....	G-296	IPS
469954.....	GP-54	VOLV	47352.....	GP-81 ³¹	TENN	4776915.....	G-1121	MBNZ	48049.....	G-296-B	IPS
4699542.....	GP-54	VOLV	47352.....	GP-9 ⁵⁸	TENN	4777001.....	G-1121	MBNZ	48052.....	GG-246	IPS
462112.....	GA-37	PHHR	47352B.....	G-31	HERC	4777257.....	G-33	FIAT	48053.....	GG-5 L	IPS
462141.....	GA-27	PHHR	473663C1.....	GP-171 ¹⁶	CASE	4777258.....	G-33	FIAT	48054.....	GG-203	IPS
462142.....	GAK-20	PHHR	473728.....	GPP-18	MANO	4777315.....	G-1123	MBNZ	48055.....	GG-203	IPS
462186.....	GA-27	PHHR	473729.....	GP-1122	MANO	4777901.....	G-1123	MBNZ	48058.....	GPP-1122	IPS
46236.....	G-33	PHHR	473730.....	GP-390	MANO	4778838.....	GP-28 ⁸	CHRY	4806002-69.....	G-836	YALE
47.....	GP-46	FACE	47-4-261.....	GA-106 ⁶⁶	SEDN	4778838.....	GP-430 ⁸	CHRY	48068.....	G-1173	ALCH
470.....	GP-50	CRO	47-4-261.....	GA-326 ⁷¹	SEDN	4778901.....	G-1121	MBNZ	48068.....	G-1173	FIAT
4700192.....	G-										

Referencia Cruzada por Numero de Parte

Cross Reference by Part Number



Numero	Gonher	Fabricante	Numero	Gonher	Fabricante	Numero	Gonher	Fabricante	Numero	Gonher	Fabricante
Number	Gonher	Manufacturer	Number	Gonher	Manufacturer	Number	Gonher	Manufacturer	Number	Gonher	Manufacturer
4809118AD	GG-265 ³⁶	CHRY	48-6286	G-500	WHIT	4910008	G-836	DONT	497	GPP-14	BGA
48092	GA-26	DAVY	4864307	GG-111	CHRY	4910124	G-191	DONT	497	GA-9045	DEL
480-A4-707-48	G-162H	STEY	4864442	GA-240	CHRY	4910141	G-238	DONT	4975415	G-1121	MBNZ
481	G-834	CRO	4864442AB	GA-240	CHRY	49103	GAK-625	SULL	49-7616	G-750	WHIT
48100	GG-246	IPS	4865/0	GG-245	PAR	4910328	GP-3600	ALCH	49779	GA-770R	WIX
48100161	G-834	COUA	4866	GP-66	SULL	4910328-6	GP-3600	ALCH	498	G-1121	AMP
48100163	G-834	RENA	486610	GP-54 ¹¹	SULL	49104	GA-265	WIX	498	G-1121	BGA
48100163	G-296	RENA	486610	GP-66 ¹⁰	SULL	491056	GP-58	BRIG	498	GA-1287	DEL
48100163	G-296-B	RENA	48682-3570	G-296	GREY	4910810	GP-1	ALCH	4980649	GA-405	DUTZ
48100250	G-1121	RENA	48682-3570	G-296-B	GREY	4911021	G-500	DONT	4980649	GA-405	FIAT
48100251	G-1121	RENA	487	G-1174	AMP	49114	GA-1572	WIX	4980649	GA-405	IVEC
48118	GG-94	IPS	487	G-1174	BGA	4912	GA-75	VALU	4980649	GA-405	KHDF
481209261	GG-1	VOLK	487	G-813	CRO	49122	GAVW-618	WIX	49809	GP-54	OREN
481209261	GG-4	VOLK	4874153	GA-132	CHRY	49126	GA-624R	WIX	49843	GAVW-617	WIX
48127	GA-33	TENN	4876	GG-67	PAR	49133843	GA-277	AUDI	4984919	GP-310	GMCX
4814	GP-13	VALU	488	GP-1101	AMP	49133843	GA-277	WIX	49883	GA-437	VAG
48146	GG-208	IPS	4881174	GA-356	VME	49133843	GA-277	VOLK	498F	GPP-419	GREY
48149	GG-185	IPS	4881174	GA-356	VOLV	49135	GAK-20	KELG	499	GS-1133	AMP
48193	GA-206	SULL	48811749	GA-356	VME	49136	GA-1571	WIX	499	GS-1133	BGA
481F	GPP-419	GREY	4881174-9	GA-356	VOLV	4914339	GA-18	ALCH	499	GA-9334	DEL
482051	G-871	VOLV	4881175	GA-357	VOLV	4914339-9	GA-18	ALCH	499074	GP-52 ¹¹⁰	DEMA
4820510	G-871	VOLV	48811756	GA-357	VME	49145	GA-1540	WIX	499074	GP-69 ¹⁸	DEMA
4822	GAC-10 ²⁸	NAP	4881175-6	GA-357	VOLV	4915151	G-331	DONT	4-99129-200	GP-36	CMI
4822	GAC-8	NAP	4881749	GA-356	VOLV	4915223	GP-166	ALCH	4991358	GA-105	ALCH
482247139	GP-1122	DAF	4882141	GA-132	CHRY	4915246	G-191	DONT	499140	GAK-403	CYMA
482644C1	GA-210	CASE	4882141AB	GA-132	CHRY	4915347	GP-66	KALM	4-99143-718	GP-1011Q	DIPA
482644-C1	GA-210	IHCO	4884899AB	GP-68	CHRY	49172	GA-320	WIX	499144274	GP-52 ¹¹⁰	LOSE
482645-C1	GA-108	IHCO	4884899AB	GP-68	MOP	491810	G-162H	DAF	499144274	GP-69 ¹⁸	LOSE
482646-C91	GA-107	IHCO	4884900AB	GP-406	CHRY	49186	GAVW-625	WIX	499190	GAK-16	DYPA
482646-C91	GA-108	IHCO	4884900AB	GP-406	MOP	49192	GA-489	WIX	499193	G-296	WAWK
482647-C91	GA-209	IHCO	4885955AA	GAC-2	CHRY	492	G-222	CRO	499193	G-296-B	WAWK
482647-C91	GA-210	IHCO	48861	G-33	GALN	4920158	GP-40	ALCH	499306	GAK-625	DYPA
482664-C1	GA-210	IHCO	489	GG-48	CRO	4-92164-004	GP-51	CMI	499309	GA-33	DYPA
4829	GP-3	VALU	4891097AA	GA-278R	CHRY	49223	GA-464	WIX	499310	G-119	DYPA
482949	GAK-403	DEMA	4891176AA	GA-258	CHRY	49225	GAD-116	WIX	499313	GAK-20	DYPA
482958	GAK-20	DEMA	4891176AA	GA-258	MOP	49-2500	GP-36	TORO	4993158	GA-105	ALCH
482F	GPP-425	GREY	4891691AA	GA-492	CHRY	492646	GA-26	WAWK	4993158-3	GA-105	ALCH
483316-C1	GA-372	IHCO	4891694AA	GA-489	CHRY	49268	GP-1011Q	ASTR	49933	GA-143	WIX
483407	G-31	FWDX	4891916AA	GA-248	CHRY	492919-C1	GA-209	IHCO	499387	GA-398	DYPA
483GB215	G-1163	MACK	4891926AA	GA-248	CHRY	492921-C91	GA-109	IHCO	4996245	GAK-16	ALCH
483GB218	GP-84	MACK	4892	GA-26	DAVY	492932	GP-58 ¹⁵	BRIG	4996245	GAK-16	FIAT
483GB218A	GP-84	MACK	4892339AA	GP-406	MOP	492932	GP-58 ¹⁵	JACO	4996245-1	GAK-16	ALCH
483GB218B	GP-84	MACK	48933003509	GP-3985	AMCO	492952	GAK-16	WAWK	4996253	GA-33 ¹¹²	ALCH
483GB218B	GP-84	MAXI	48959	GP-66	GEHL	493	GA-26	DEL	4996253	GA-33 ¹¹²	FIAT
483GB218C	GP-84	MACK	4897833	GP-548	CUMM	49301	GAK-625	SULL	4996253-0	GA-33 ¹¹²	ALCH
483GB219	GP-83	MACK	4897898	GP-737	CUMM	4930108	GA-27	DONT	4997568-8	GA-105	ALCH
483GB219A	GP-83	MACK	4899-14-300	GP-42	MZDA	493016	GAK-625	WAWK	4997958	GP-166	ALCH
483GB219A	GP-83	MAXI	48A9311	G-31	FWDX	493017	GAK-1532	WAWK	4997958-9	GP-166	ALCH
483GB219B	GP-83	MACK	48A-C43P	G-1143	FWDX	4930309	GA-467	DONT	4998842	G-6	ALCH
483GB431	GP-85	MACK	48G171	G-870	AUST	4930367	GA-18	DONT	4998842-0	G-6	ALCH
483GB431	GP-85	MAXI	48G171	G-870	AUSW	4930384	GA-361	DONT	49988421	G-6	ALCH
483GB440	GP-85	MACK	48G171	G-870	LEYL	4930432	GAK-216	DONT	499950338	GP-36	LOSE
483GB441	GP-84	MACK	48H171	G-870	LEYL	4930436	GA-106 ⁴⁸	DONT	499950338	GP-36	LOSE
483GB444	GP-83	MACK	49	G-330	LEDR	4930436	GA-326 ¹	DONT	499950339	GP-54 ¹¹	LOSE
483GB446	GP-85	MACK	49	G-330	LEE	4930439	GA-206	DONT	499950339	GP-66 ¹⁰	LOSE
484	GP-81	CRO	49	G-330	OHFC	4930440	GA-416	DONT	499950341	GP-1122	LOSE
484074-0	GP-1	VOLV	49	GA-70	UNN	4930445	GAK-20	DONT	4A	GA-405	BOG
484074-0	GP-1	VOLV	490	G-238	CRO	4930497	GA-360	DONT	4A0339	G-152	CATP
4841879	GA-33	ALCH	49000	GA-1529	WIX	4930509	GA-6127	DONT	4A339	G-152	CATP
4841879	GA-33	FIAT	4900154	GAK-20	ALCH	4930511	GAK-625	DONT	4C2Z-9601-AA	GA-4999	FORD
4842288	GAK-16	ALCH	4900154	GAK-20	FIAT	4930512	GA-49	DONT	4C3Z-9601-AA	GA-4999	FORD
48441	GG-20	MEAD	490025	GA-78	FACE	4930646	GA-33 ¹¹²	DONT	4D15-5A-5523	G-191	KOMA
48441	GG-20	MERC	490160	GGP-1122	DAF	493217	GP-166	RACN	4D2954	G-222	CATP
48458	G-296	ALBN	49019-1055	GA-116	KAWA	493217	GP-166	REXN	4E1526	GA-5648	HUBR
48458	G-296-B	ALBN	490196	GP-178	DAF	493218	GP-166	RACN	4E15267	GA-5648	HUBR
48458	G-296	MEAD	49020	GAVW-619	WIX	493218	GP-166	REXN	4E15464	GA-5648	HUBR
48458	G-296-B	MEAD	490257	GA-26	SICA	493309	GP-66	RACN	4E30246	G-33	HUBR
48458	G-296	MERC	49-0257	GA-26	KENW	493309	GP-66	REXN	4F1005F	GA-27	NKK
48458	G-296-B	MERC	49026	GAK-16	DAVY	49380000	GA-230	FIAT	4F1006F	GAK-20	NKK
4847	GP-81 ³¹	VALU	49040	GA-193	WIX	4939	GA-6129	LETR	4F6064	G-222	CATP
4847	GP-98 ⁵⁸	VALU	49041	GA-171	WIX	493F	G-296	GREY	4H1005F	GA-27	NKK
48-4855	G-750	WHIT	49051	GA-8	WIX	493F	G-296-B	GREY	4H2Z-6731-AA	GP-457	FORD
484874	GP-1	VOLV	49057	GA-1530	WIX	494	GP-1122	CAV	4H8860	G-1166	CATP
484947	GP-3766	FACE	49058	GA-341	WIX	494133	GP-1	DAF	4ID111	GP-3985	NKK
48495	GP-81 ³¹	MERC	49062	GA-488	WIX	4-94145-823	GP-56	CMI	4J0806	G-222	CATP
48495	GP-98 ⁵⁸	MERC	49063	GA-269	WIX	494251	G-296	DAF	4J4195	G-152	CATP
485	G-500	CRO	49065	GA-340	WIX	494251	G-296-B	DAF	4J6064	G-222	CATP
48540	GA-27	DAVY	49065-2001	GP-58	KAWA	494251	G-296	LEYL	4J6068	G-222	CATP
4855	GG-264	PAR	49065-2057	GP-58	KAWA	494251	G-296-B	LEYL	4J6164	G-222	CATP
4855745	GP-171 ¹⁶	ALCH	49065-2062	GP-58	KAWA	49445	G-870	MANO	4J806	G-222	CATP
4856649	GA-240	CHRY	49065-2071	GP-157	KAWA	4950103	GAK-403	FIAT	4L3Z-9601-BA	GA-1617	FORD
485F	GG-48	GREY	49065-2078	GP-157	KAWA	4-95190-485	G-238	CMI	4L4718	GA-375	CATP
485GB3116P1	G-500	MACK	49067	GA-492	WIX	4954	G-566	NAP	4L4719	GA-1203	CATP
485GB3116P5	G-500	MACK	49069	GA-363	WIX	49551	GP-166	CASE	4L4720	GA-1203	CATP
485GB3160	G-169	MACK	4907485	GP-2126Q	CUMM	49551	GP-166	DAVS	4L4721	GA-375	CATP
485GB3191	GP-51	MACK	4907733	GAK-403	ALCH	4956902	GAK-403	FIAT	4L9851	GA-29	CATP
485GB3191A	GP-51	MACK	4907794	GA-33	ALCH	495F	G-1163	GREY	4L9851	GA-29	NEL
485GB3191B	GP-51	MACK	4907794	GA-33	FIAT	496	GPP-1122	CAV	4L9853	GA-375	CATP
485GB3191C	GP-51	MACK	4907794-3	GA-33	ALCH	496	GP-81 ³¹	DEL	4L9853	GA-375	NEL
485GB3232	GP-51	MACK	4907795	GAK-16	ALCH	496	GP-9 ³⁸	DEL	4L9892	GA-29	CATP
485GB3236	GP-51	MACK	49087	GAK-458	WIX	496209	GP-761H	ADVA	4M0383	GA-8047	CATP
485GB5138	GP										

Numero	Gonher	Fabricante	Numero	Gonher	Fabricante	Numero	Gonher	Fabricante	Numero	Gonher	Fabricante
Number	Gonher	Manufacturer	Number	Gonher	Manufacturer	Number	Gonher	Manufacturer	Number	Gonher	Manufacturer
4M505	GG-5 L	NKK	50001494	GAK-20	SCHM	5001004323	GP-53	RENA	5006951	GP-430 ⁸	FORD
4M8047	GA-8047	CATP	5000157104	G-834	RENA	5001004324	GP-2071W	RENA	5007	GP-18	CRO
4M8048	GA-1285	CATP	5000161	GP-50	FORD	5001156	GP-22	FORD	5007124	GP-28 ⁶	FORD
4M9045	GA-9045	NEL	5000184	GP-28 ⁸	FORD	5001116	G-33	COLS	5007124	GP-430 ⁸	FORD
4M9334	GA-9334	CATP	5000184	GP-430 ⁸	FORD	5001217	GA-200	FORD	5007125	GP-46	FORD
4M9334	GA-9334	NEL	5000185	GP-81 ³¹	FORD	5001217	GA-218	FORD	5007145	GA-49	FORD
4M9335	GA-1286	CATP	5000185	GP-9 ⁵⁸	FORD	5001248	GP-81 ³¹	FORD	5007146	GA-49	FORD
4M9339	GA-1286	CATP	5000188	GP-3	FORD	5001248	GP-9 ⁵⁸	FORD	5007165	GP-455	FORD
4M9378	GA-1008	CATP	5000215	GA-50	FORD	50013320	GA-516R	KS	5007365	GP-28 ⁶	FORD
4M9378	GA-1008	NEL	5000241677	G-1121	RENA	5001823228	GP-1011Q	RENA	5007365	GP-430 ⁸	FORD
4M9379	GA-1284	CATP	5000242504	GA-405	RENA	5001829572	GA-436	RENA	5007366	GP-28 ⁶	FORD
4M9387	GA-1008	CATP	5000242510	G-163	RENA	5002230	GP-81 ³¹	FORD	5007366	GP-430 ⁸	FORD
4N0015	GAP-381	CATP	5000243097	G-296	RENA	5002230	GP-9 ⁵⁸	FORD	5007367	GP-50	FORD
4N15	GAP-381	CATP	5000243097	G-296-B	RENA	5002456	GP-50	FORD	5007385	GP-81	FORD
4N4812	GA-1286	CATP	5000243098	G-143	RENA	5002463	GA-200	FORD	5007413	GA-3490	FORD
4N4812	GA-9334	CATP	5000261	GAD-1	FORD	5002463	GA-218	FORD	5008	G-122	CHP
4N5823	GP-749	CATP	5000262	GAD-3	FORD	5002530	GP-3816	FORD	5008	G-338	CHP
4N6274	GA-7360	CATP	5000275939	G-834	RENA	5002535	GP-38	FORD	5008	GP-92	CRO
4N6274	GA-7716	CATP	5000279	GA-356	GARD	500275939	G-834	RENA	5008304-0004	GAK-625	MAN
4N6275	GA-7360	CATP	5000480	GP-3816	FORD	5002798	GP-81	FORD	50-08304-0005	GA-106 ⁴⁶	MAN
4N6275	GA-7716	CATP	5000513	GP-1	FORD	5003	GP-1122	CRO	50-08304-0005	GA-326 ⁷¹	MAN
4N9164	GA-357	CATP	5000531	G-813	FORD	5003138	G-834	FORD	500831	G-813	FORD
4NC102	GP-1	NKK	5000541768	GP-83	RENA	5003243	GAVW-2	FORD	5008652	GP-28 ⁶	FORD
4NC505	GG-1	NKK	5000541976	GA-373	RENA	5003329	GP-3816	FORD	5008652	GP-430 ⁸	FORD
4NC505	GG-4	NKK	5000592852	GP-1011Q	RENA	5003331	GP-3816	FORD	5008677	GP-81 ³¹	FORD
4ND103	GP-38	NKK	5000670699	GP-51	RENA	5003370	GA-853R	JACO	5008677	GP-9 ⁵⁸	FORD
4NJ101	GP-10	NKK	5000670700	GP-51	RENA	5003455	GP-91	FORD	5008679	GA-2122	FORD
4PS253	GAK-403	CHIC	5000670701	GP-51	RENA	5003456	GP-462	FORD	5008717	GA-349	FORD
4PS2530	GAK-403	CHIC	5000674	G-225	FORD	5003460	GP-28 ⁶	FORD	5008720	GP-3816	FORD
4PS2530	GAK-403	CONP	5000675	G-225	FORD	5003460	GP-430 ⁸	FORD	5008721	GP-3816	FORD
4PS254	GA-5648	CHIC	5000676	G-225	FORD	5003461	GP-28 ⁶	FORD	5008722	GP-3816	FORD
4PS2548	GA-5648	CHIC	5000682146	GP-51	RENA	5003461	GP-430 ⁸	FORD	5008725	GA-303	FORD
4PS2690	GA-27	CHIC	5000682148	GP-57	RENA	5003607	GA-7	FORD	5008816061	GP-9586	RENA
4PS915	G-33	CHIC	5000686525	GP-1	RENA	5003691	GP-761H ⁵⁵	JACO	5008874	G-1121	FORD
4R2298	GA-1286	CATP	5000686589	GP-1122	RENA	5003914	GP-3816	FORD	5008876	GP-1122	FORD
4R2299	GA-9334	CATP	5000686590	GP-1122	RENA	5003929	GP-3816	FORD	5009	GP-93	CRO
4S1029	GAD-1	NKK	5000693	GA-357	GARD	5003930	GP-3816	FORD	5009063	GA-277	FORD
4S108	GP-3985	NKK	5000694	GA-356	GARD	5003931	GP-81	FORD	5009088	GP-3816	FORD
4S5368	G-1166	CATP	5000695	GA-356	GARD	5003967	GP-3816	FORD	5009230	G-871	FORD
4S8833	GA-287	CATP	5000717	GA-8	FORD	5003968	GP-3816	FORD	5009285	GP-46	FORD
4T3131	GP-38	NKK	5000717	GA-8	GARD	5004388	GP-462	FORD	5009421	GP-22	FORD
4T6788	GP-34	CATP	5000786107	GP-54 ⁴¹	RENA	50044776	GP-31	FORD	5009781	GAD-3	FORD
4T6915	GP-166	CATP	5000786107	GP-66 ¹⁰	RENA	500462	GP-1	NEWH	500B	G-500	LUF
4TC1005	GAD-1 ⁸⁷	NKK	5000790570	GP-1122	RENA	500464	G-5000	FORD	500C	G-500	LUF
4TP1005	GAD-1 ⁸⁷	NKK	500079078	GP-54 ⁴¹	RENA	500464	G-5000	NEWH	500C	G-500	REF
4TP112	GP-38	NKK	500079078	GP-66 ¹⁰	RENA	5004747	GP-28	FORD	500LF7	G-500	OSHK
4W0086	GA-482	CATP	5000790787	GP-54 ⁴¹	RENA	5004772	GA-360	FORD	501	GG-5 L	PROT
4W4840	G-191	CATP	5000790787	GP-66 ¹⁰	RENA	5004780	GP-1122	FORD	5010038	GP-40	FORD
4W4926	G-191	CATP	5000790822	GP-54 ⁴¹	RENA	5004783	G-1121	FORD	5010080	GP-66	TYMC
4W6000	GP-52 ¹⁰	CATP	5000790822	GP-66 ¹⁰	RENA	5004784	G-1121	FORD	5010-1	G-834	TEHO
4W6000	GP-691 ⁴⁸	CATP	5000790823	GP-54 ⁴¹	RENA	5004837	GG-5 L	FORD	5-01017	GA-27	WARD
4W9079	GA-9334	CATP	5000790823	GP-66 ¹⁰	RENA	5004838	G-1123	FORD	5010295	GAVW-2	FORD
			5000806317	GA-467	RENA	5004873	G-1121	FORD	50103065	GA-33 ¹²	FURU
			5000806336	GP-1122	RENA	5004880	GA-303	FORD	50103-065	GA-33 ¹²	ISUZ
			5000806377	GA-467	RENA	5004926	GP-3816	FORD	5010462	GP-1122	FORD
			5000807081	G-200	RENA	5004928	GP-28 ⁶	FORD	5-01049	GA-26	WARD
			5000807551	G-296	RENA	5004928	GP-430 ⁸	FORD	5010518	G-296	FORD
			5000807551	G-296-B	RENA	5004929	GP-28 ⁶	FORD	5010518	G-296-B	FORD
			5000807751	G-296	RENA	5004929	GP-430 ⁸	FORD	5010664	GP-54 ⁴¹	FORD
			5000807751	G-296-B	RENA	5005	GPP-1122	CRO	5010664	GP-66 ¹⁰	FORD
			5000808716	GP-53	RENA	5005	G-870	TEHO	5010665	GP-171	FORD
			5000808717	GP-1101	RENA	50050	GG-5 L	SERC	501072	GAK-403	JOY
			5000808718	GP-55	RENA	5005079	GP-462	FORD	501072-0030	GAK-403	JOY
			5000808719	GP-1011Q	RENA	5005080	GP-462	FORD	5010910	GA-49	FORD
			5000808720	GP-1013Q	RENA	5005099	GAVW-2	FORD	5010912	GG-5 L	FORD
			5000808721	GP-2071W	RENA	5005156	GAVW-4	FORD	5010913	GP-3980	FORD
			5000808722	GP-1013Q	RENA	50052	GG-5 L	SERV	5010917	GG-246	FORD
			5000812484	GP-57	RENA	5005532	GA-4365	FORD	5010962	GP-9	FORD
			5000814227	GP-1122	RENA	5005571	GP-3980	FORD	5010964	GP-42	FORD
			5000814407	G-162H	RENA	5005572	GP-3816	FORD	5010965	GP-3531 EXP	FORD
			5000816071	GP-9	RENA	50056	G-31	PHHR	501117030A	G-1120	BLAR
			5000819339	GA-360	RENA	5005629	GP-42	FORD	5011193	G-33	GMXC
			5000819340	GA-106 ⁴⁶	RENA	5005804	GP-3980	FORD	5011267	GP-1122	FORD
			5000819340	GA-326 ⁷¹	RENA	5005823	GAVW-2	FORD	5011270	G-1123F	FORD
			5000819343	GA-6129	RENA	5005828	GAD-3	FORD	5011271	G-1121F	FORD
			5000820895	G-162H	RENA	5005863	G-1121	FORD	5011278	G-1163	FORD
			5000822870	GP-1013Q	RENA	5006	GPP-1122	CRO	5011279	G-1173 ¹⁰⁸	FORD
			5000822872	GP-53	RENA	5006027	GAD-1	FORD	5011306	G-297-B	FORD
			5000823838	GP-2022W	RENA	5006136	G-296	RENA	5011310	GA-33 ¹²	FORD
			5000831	G-813	FORD	5006136	G-296-B	RENA	5011312	GAK-16	FORD
			5000836	G-871	FORD	5006163	G-871	CITR	5011315	GAK-403	FORD
			5000838	G-834	FORD	5006163	G-296	RENA	5011319	GAK-625	FORD
			5000842	G-238	FORD	5006163	G-296-B	RENA	5011322	GAK-20	FORD
			5000849	G-191	FORD	5006224	GA-277	FORD	5011328	GA-436	FORD
			5000856	GP-54	FORD	5006227	GP-3985	FORD	5011329	GA-405	FORD
			5000858	GP-54	FORD	5006225	G-296	FORD	5011332	GA-27	FORD
			5000859	GP-54 ⁴¹	FORD	5006225	G-296-B	FORD	5011337	GA-106	FORD
			5000859	GP-66 ¹⁰	FORD	5006225	G-296	NEWH	5011337	GA-326 ⁷¹	FORD
			5000861	GP-36	FORD	5006225	G-296-B	NEWH	5011338	GA-467	FORD
			5000872	G-33	FORD	5006580	GP-81	FORD	5011417	GP-51	FORD
			5000890	G-31	FORD	500660	GG-20	NEWH	5011419	GP-77	FORD
			5000906336	GP-1122	RENA	5006946	G-1121	FORD	5011424	GP-9	FORD
			5000919	GA-880R	JACO	5006949	GA-71	FORD	5011425	G-225	FORD
			5000931	G-33	LBHR	5006950	GA-200	FORD	5011426	G-143	FORD
			5001001646	G-296	RENA	5006950	GA-218	FORD	5011427	G-163	FORD
			5001001646	G-296-B	RENA	5006951	GP-28 ⁶	FORD	5011431	G-31	FORD

5

Referencia Cruzada por Numero de Parte

Cross Reference by Part Number



Numero	Gonher	Fabricante	Numero	Gonher	Fabricante	Numero	Gonher	Fabricante	Numero	Gonher	Fabricante
Number	Gonher	Manufacturer	Number	Gonher	Manufacturer	Number	Gonher	Manufacturer	Number	Gonher	Manufacturer
5011435		G-833 FORD	5025071		GAD-15 FORD	50513118		GA-27 INGR	5101-06009		GAK-20 FURU
5011438		G-834 FORD	5025091		GP-9 FORD	5052		GG-17 AUTO	51011		GP-46 MTRV
5011443		G-330 FORD	5025102		GPP-111 FORD	5052-6		GP-1122 POCL	51015		GP-1 WIX
5011472		G-33 FORD	5025102		GPP-524 FORD	5052600		GP-3600 NEWH	51016		GP-1 WIX
5011477		GP-46 FORD	50251500		GP-1122 HATZ	505315530		GA-8 PART	510185		G-296 PEGA
5011488		G-1121F FORD	50251500		GP-1122 WISC	505511		GP-1 NEWH	510185		G-296-B PEGA
5011490		GP-1122 FORD	502520		GP-34 AGON	505530		G-1173 ¹⁰⁸ FWDX	51020		GP-81 KMA
5011502		GP-51 FORD	5026		GA-56 CHEK	50554500		GA-27 INGR	51020		GP-81 MTRV
5011545		GA-33 ¹¹² FORD	502684		GAK-16 OTIS	5056768		GAK-403 EATN	51021		G-31 WIX
5011546		GAK-16 FORD	5027		GPP-11 CRO	5056768		GAK-403 YALE	5102236		GAK-458 FIAT
5011548		GAK-403 FORD	50270100		GG-3 HATZ	50-56768		GAK-403 WHIT	5102240		GA-459 FIAT
5011553		GAK-20 FORD	5027147		GAVW-121 FORD	505694		GAK-403 CASE	51027		GP-3531 EXP KMA
5011559		GA-436 FORD	50279397		GA-27 INGR	505776		G-296 NEWH	51027		GP-3531 EXP MTRV
5011560		GA-405 FORD	5028		GPP-111 CRO	505776		G-296-B NEWH	5102905AA		G-180 CHRY
5011561		GA-27 FORD	5028		GPP-524 CRO	5057957		GP-81 ROOT	5102905AA		G-918 CHRY
50-115871		GP-57 STEI	502826		GA-106 ⁴⁶ HITA	5057957		GP-81 TALB	5102905AB		G-180 CHRY
5011788		GP-40 FORD	502826		GA-326 ⁷¹ HITA	505847		GAK-20 CASE	5102905AB		G-918 CHRY
5011836AA		GA-183R CHRY	502827		GA-206 HITA	5058570		G-613 CHRY	51031		GP-40 MTRV
5011880		GA-200 FORD	5029035-01		GP-66 YALE	505887		GA-27 CASE	510-31-300000		GP-81 ALFA
5011880		GA-218 FORD	5029459		G-296 FORD	5058925		GA-8 MOTA	51034		GP-3600 WIX
5011882		GAK-403 FORD	5029459		G-296-B FORD	5058925		GA-8 ROOT	510354AAA		GA-475 CHRY
5011889		G-143 FORD	502957		GP-166 NEWI	5058925		GA-8 TALB	510354AAA		GA-475 MOP
5011991		GP-40 FORD	5029703AA		GA-488 CHRY	5059665-78		GP-9 YALE	5103554AB		GA-475 CHRY
5012		GP-78 CRO	503		GP-14 BGA	506		G-11816 AMP	5103555AA		GA-5876 CHRY
501203016		GP-66 ZF	503		G-834 CRO	506		G-11816 BGA	5103577AA		GPP-612 CHRY
5012037		GP-22 FORD	503		GG-19 PROT	506		GG-16 PROT	51036		GP-3980 WIX
5012176		GA-2122 FORD	5030		GPP-1122 CRO	506090		GA-360 CLRK	51036MP		GP-3980 WIX
5012316		G-31 FORD	50302800		GP-58 ¹⁵ HATZ	50616390		GA-356 INGR	51037		GP-46 WIX
5012321		GP-78 FORD	5031031		G-834 CHRY	50616408		GA-357 INGR	51040		CHRY
5012551		GP-3682 FORD	5031031		G-834 MOTA	50616879		GP-27 INGR	51040MP		GP-46 WIX
5012556		GP-28 ⁸ FORD	5031031		G-834 ROOT	506337		GA-436 DAF	51041		GP-44 WIX
5012556		GP-430 ⁸ FORD	5031031		G-834 TALB	506577		G-870 LEYL	51042		GP-44 WIX
5012561		GA-2194 FORD	50311022003		G-6 BMW	506645		GAK-403 MASY	51045		GP-3429 WIX
5012574		GA-400 FORD	50311022014		G-6 BMW	506645-M91		GAK-403 MASY	51046		GP-3 WIX
5012575		GP-3682 FORD	50317000		GG-3 HATZ	50666		G-31 HYST	51047		GA-206 ENDU
5012580		GP-310 FORD	5032		GG-5 L AUTO	5066645-M91		GAK-403 MASY	51049		GP-157 KMA
5012585		GAD-3 FORD	503202		GP-81 ³¹ NEWH	506973401		GAK-403 EATN	51049		GP-157 MTRV
5012651		GP-28 ⁸ FORD	503202		GP-9 ⁵⁸ NEWH	5069734-01		GAK-403 YALE	51049		GP-5 WIX
5012651		GP-430 ⁸ FORD	50332		GA-55 COMA	5069734-03		GAK-20 YALE	5105		GA-106 ⁹⁷ STEI
5013090		G-6 EATN	50332		GA-55 HYVA	50698		GAK-20 DAVY	5105		GA-206 ¹⁰⁸ STEI
5013090		G-6 YALE	50332		GA-55 MATT	507		GA-106 ⁶⁶ MAXI	5105		GA-326 ⁷² STEI
5013135		GA-230 FORD	5035		GP-1122 CRO	507		GA-326 ⁷¹ MAXI	51050		GP-50 WIX
5013149		GP-22 FORD	503634-C91		GA-372 IHCO	507		GG-17 PROT	51051		GP-50 WIX
5013192		GP-53 GMCX	5037615AA		GA-289 CHRY	507107		GP-3600 NEWH	51052		GP-50 WIX
5013319		GP-3816 FORD	5037615AA		GA-289 MOP	507221		GA-356 ¹⁰⁴ CASE	51053		GP-66 WIX
5013388		GA-400 FORD	50382		GA-26 KELG	507221		GA-357 ¹⁰⁸ CASE	51054		GP-81 MTRV
5014056		GP-81 FORD	503836		GA-27 CLRK	507221		GA-356 ¹⁰⁴ DROT	51055		GP-5 WIX
501488		GA-361 HITA	503883		G-296 TALB	507221		GA-357 ¹⁰⁸ DROT	51-05501-0002		GP-54 ¹¹ MAN
5-0149		GA-26 WARD	503883		G-296-B TALB	50739		DAVY	51-05501-0002		GP-66 ¹⁰ MAN
5015		GPP-111 CRO	503883		G-296 CHRY	507407		GP-68 NEWH	51-05501-0003		GP-54 ¹¹ MAN
5015		GPP-524 CRO	5038883		G-296-B CHRY	50748078		GAK-625 INGR	51-05501-0003		GP-66 ¹⁰ MAN
501547		GP-81 ³¹ NEWH	5038883		G-296 FORD	5076408		GAK-403 EATN	51-05501-002		GP-54 ¹¹ MAN
501547		GP-9 ⁵⁸ NEWH	5038883		G-296-B FORD	5076408		GAK-403 YALE	51-05501-002		GP-66 ¹⁰ MAN
5015581AA		GS-1261 CHRY	5038883		G-296 RENA	508		GG-8 ¹⁰³ PROT	51-05504-0048		G-163 MAN
5015581AB		GS-1261 CHRY	5038883		G-296-B RENA	508		GG-8 L ⁸⁰ PROT	51-05504-0049		G-163 MAN
5015610AA		GA-448 CHRY	5038883		G-296 TALB	5080244AA		G-180 CHRY	51-05504-0068		G-163 MAN
50159600		G-1121 HATZ	5038883		G-296-B TALB	5081		GG-87 AUTO	51-05504-0084		G-163 MAN
50159600		G-1121 WISC	5039546		G-813 CHRY	508129		GP-81 NEWH	51-05504-0085		G-163 MAN
5016547AA		GP-178 CHRY	5039546		GP-813 ROOT	5083285AA		GP-178 CHRY	51-05504-0086		G-163 MAN
5016547AB		GP-178 CHRY	5039546		G-813 TALB	5083285AA		GP-178 MOP	51-05504-0091		G-163 MAN
5016547AC		GP-178 CHRY	503P		GG-19 GREY	5087		GG-196 AUTO	51055040096		G-3754 MAN
5016646AA		GA-70 CHRY	504		G-296 AMP	508E6731		G-836 COMA	51056604		GP-1122 INGR
5016960		GP-1 FORD	504		G-296-B AMP	508E6731		G-836 FAHR	51056612		GP-54 ¹¹ INGR
5017-853		GA-2110 FORD	504		G-296 BGA	508E6731		G-836 HOLM	51056612		GP-66 ¹⁰ INGR
5018034		GPP-1122 FORD	504		G-296-B BGA	508E-6731		G-836 FORD	51060		GP-205 WIX
5018035		GG-251 FORD	504		GP-3985 PMC	508E-6731-A		G-836 FORD	51060MP		GP-205 WIX
5018351		GP-9 FORD	504		GG-7 PROT	508E-6731-A1		G-836 FORD	51061		GP-13 WIX
5018353		GP-3682 FORD	5040251		GAK-403 EATN	509		G-1143 AMP	5106133		GP-36 LBHR
5018356		GP-81 FORD	5040251		GAK-403 EATN	509		G-1143 BGA	5106169		GP-1122 LBHR
5018777AA		GA-477 CHRY	504033400		GP-548 IVEC	509		GG-87 PROT	5106173		G-24 LBHR
5018777AB		GA-477 CHRY	5040646		G-871 CHRY	509020		GP-1 HOBT	510617308		G-24 LBHR
5019002AA		GA-289 CHRY	50408400		GP-58 ¹⁵ HATZ	509021		GP-50 HOBT	5106181		GA-405 LBHR
5019002AA		GA-289 MOP	5041315		GP-81 HUMB	509025		G-31 HOBT	510618108		GA-405 LBHR
5019415		GA-49 FORD	5041315		GP-81 ROOT	509081801		GA-18 EATN	5106191		GA-467 LBHR
502		GP-38 PMC	5042		GP-96 CRO	5093092AA		GP-178 CHRY	510619108		GA-467 LBHR
502		GG-6 PROT	504226		G-871 MASY	509581801		GA-18 EATN	51061IMP		GP-13 WIX
5020-120		GP-455 FORD	504239		G-296 MASY	5095818-01		GA-18 YALE	51063		GP-13 WIX
5020289		G-296 FORD	504239		G-296-B MASY	509666		GA-5648 CLRK	5106368		GA-360 LBHR
5020289		G-296-B FORD	5042621		GP-1 CHRY	50-9666		GA-5648 KENW	51064		GP-149 ⁷⁵ WIX
5020403		GP-1122 FORD	5042621		GP-9 MOTA	509812		GP-34 FRM	51064		GP-91 WIX
5020405		GG-246 FORD	5042621		GP-1 ROOT	5098424-AA		GA-2161 CHRY	51065		GP-58 ¹⁵ WIX
5020868		GAVW-2 FORD	5042621		GP-1 TALB	509928		GP-50 NEWH	51068		GP-81 ³¹ WIX
50211022004		G-871 BMW	50430024		G-33 INGR	50995034		GP-761H INGR	51068		GP-9 ⁵⁸ WIX
50222		G-31 WAUK	50439868		GA-356 ¹⁰⁴ INGR	50SL45DP5		GP-761H EPE	51068MP		GP-81 ³¹ WIX
5022-741		GA-2156 FORD	50439868		GA-357 ¹⁰⁸ INGR	50SL45P10		GP-761H EPE	51068MP		GP-9 ⁵⁸ WIX
5022742		GA-471 FORD	5044		GG-6 AUTO	50SL56DP5		GP-761H EPE	51069		GP-3 WIX
5022749		GAVW-120 FORD	5046		GG-19 AUTO	50SL80DP5		GP-761H EPE	51069664		GAK-1532 INGR
5022796		GP-38 FORD	5048		GG-7 AUTO	51		GP-20 DEL	51069MP		GP-3 WIX
5022798		GP-462 FORD	504848		GA-49 ZETT	51		GP-3980 FACE	51076		G-236 WIX
5022955		GP-68 FORD	5048480		GA-49 ZETT	510		GG-47 PROT	51077		G-236 WIX
50230680		GP-34 REXN	50484-80		GA-49 SULL	51-00142		GA-11 FRIG	51083		GP-6811 WIX
5023923		GPP-1122 FORD	50484800		GA-49 ZETT	51-00153		G-870 FRIG	51084		GP-81

Numero	Gonher	Fabricante	Numero	Gonher	Fabricante	Numero	Gonher	Fabricante	Numero	Gonher	Fabricante
Number	Gonher	Manufacturer	Number	Gonher	Manufacturer	Number	Gonher	Manufacturer	Number	Gonher	Manufacturer
51088	GP-28 ⁸	WIX	512594000	G-1123	HANO	513642	GA-27	MACX	51516MP	GP-3600	WIX
51088	GP-430 ⁸	WIX	51261	GP-36	WIX	51365	GP-91	WIX	515179801	G-813	EATN
51099	G-834	WIX	51268	GP-9586	WIX	51366	GP-58	WIX	51521	GP-81	WIX
510999-C9	GA-26	IHCO	51268MP	GP-9586	WIX	51367	GP-3682	WIX	51521	GP-9	WIX
510999-C91	GA-26	IHCO	51270	G-330	WIX	51372	GP-68	WIX	51522	GP-3675	WIX
510M	G-566	REF	51271	G-330	WIX	51372MP	GP-68	WIX	51522MP	GP-3675	WIX
511	G-1175	BGA	51272	G-5000	WIX	51374	GP-58 ¹²²	WIX	51523	GP-3985	WIX
511	G-1173 ⁰⁸	CRO	51275	GP-54	WIX	51377	GP-57	WIX	51525	GP-1	WIX
511	GG-61	PROT	51278133	GA-360	INGR	51378	GP-212	WIX	515304-C91	GA-6880	IHCO
51110	GP-50	WIX	51279	G-5000	WIX	51380	GP-40	WIX	51541300	GP-1	EATN
5112-1410-6	G-33	ATCO	51281	GP-171	MOXY	51381	GP-91 ⁷⁸	WIX	51541300	GP-1	YALE
5112-1461-06	G-33	ATCO	51283	GP-36	WIX	51386	GP-3985	WIX	51545	GP-171 ¹⁶	WIX
51-12503-0004	GP-1122	MAN	51288	GP-3816	WIX	5138834	GA-135	GMCX	51550	G-500	WIX
51-12503-0005	GP-1122	MAN	5128918	GAK-20	EATN	5138835	GA-135	GMCX	51551	GP-66	WIX
51-12503-0009	GP-1122	MAN	5128918	GAK-20	YALE	51390	GP-42	WIX	51551MP	GP-66	WIX
51-12503-0010	GP-1122	MAN	5128919	GAK-20	EATN	51391	GP-490	WIX	51552	GP-66	WIX
51-12503-0012	GP-1122	MAN	51296986	GA-106 ⁶⁶	INGR	51392	GP-3531	EXP	51553	GP-66	WIX
51-12503-0031	GP-1122	MAN	51296986	GA-326 ⁷¹	INGR	51393	GP-28 ⁶	WIX	51554	G-500	WIX
51129	G-34	WIX	51298	GP-66	WIX	51393	GP-430 ⁸	WIX	51555	G-500	WIX
51130	G-33	WIX	513	GGP-25	AMP	51394	GP-157	WIX	515601	GA-33 ¹²²	TENN
51133	G-33	WIX	513	GGP-25	BGA	51395	GP-157	WIX	515601-1	GA-33 ¹²²	TENN
51133MP	G-33	WIX	513	GP-38	PMC	51396	GP-156	WIX	51561	GA-33 ¹²²	TENN
51138	G-119	WIX	513	GG-264	PROT	5139639	GA-26	GMCX	51568	GP-462	WIX
51141	G-200	WIX	51302	G-870	WIX	514	GA-7	DEL	51581	GP-14	WIX
51143	G-200	WIX	51305	G-836	WIX	514	GG-46	PROT	5158658	GA-33 ¹²²	EATN
511440	GP-166	NEWH	51312	GP-81	WIX	5140184	GA-27	GMCX	5158658	GA-33 ¹²²	YALE
51145	G-971	WIX	5131371	GAK-20	GMCX	514-032	GA-7	ONAN	515865800	GA-33 ¹²²	EATN
51147	G-331	WIX	5131379	GAK-20	GMCX	514052	GA-37	FWDX	5158658-00	GA-33 ¹²²	YALE
51151	G-335	WIX	51314	G-162H	WIX	514-082	GA-7	ONAN	51592	GP-68	WIX
51156	G-333	WIX	51314	G-225	WIX	51409	GP-5	WIX	51596	GP-66	WIX
51157	G-871	WIX	51315	GP-128	WIX	51414	GP-57	WIX	515998	GA-18	EATN
51158	GP-54 ⁵¹	WIX	51316	GP-81	WIX	5141403	G-296	LEYL	515998	GA-18	YALE
51160	G-963	WIX	51317	GP-37	WIX	5141403	G-296-B	LEYL	515998-00	GA-18	YALE
51161	G-191	WIX	513173000	G-1123	HANO	5141521	GAK-403	GMCX	516	G-1163	CRO
51162	G-333	WIX	513173000	G-1123	MASY	5141522	GAK-16	GMCX	516	GG-66	PROT
51163	G-152	WIX	51317-3000	G-1123	NISS	5-14210-175-0	GA-33 ¹²²	ISUZ	51601	GP-171	WIX
51168	G-238	WIX	51318	GP-28	WIX	5-14215-000	GAD-1 ⁸⁷	ISUZ	51602	GP-390	WIX
51176	G-33	WIX	51319	GP-81	WIX	5-14215-003	GAD-1	ISUZ	51602MP	GP-390	WIX
51178	G-222	WIX	51320	GP-50	WIX	5-14215-003-0	GAD-1	ISUZ	51604	GP-178	WIX
51183	G-801	WIX	5-13200-066-0	GG-5 L	ISUZ	5-14215-004-0	GAD-3	ISUZ	5160428-52	G-296	YALE
51183	G-871	WIX	5-13200-066-1	GG-5 L	ISUZ	5-14215-011-0	GAK-16	ISUZ	5160428-52	G-296-B	YALE
51184	G-816	WIX	5-13200-093-0	GG-5 L	ISUZ	5-14215-014-0	GA-33 ¹²²	ISUZ	51607	GP-178	WIX
51186	G-984	WIX	5-13200-231-0	G-870	ISUZ	5-14215-017-0	GAD-30	ISUZ	51607MP	GP-178	WIX
51188	G-813	WIX	51321	GP-38	WIX	5-14215-017-1	GAD-30	ISUZ	51609	GP-36	WIX
51189	GP-81	WIX	5-13211-018-0	GP-3985	ISUZ	5-14215-030	GAD-1	ISUZ	51613	G-613	WIX
51190	GP-3980	WIX	5-13211-018-1	GP-3985	ISUZ	5-14215-183-0	GA-403	ISUZ	51618	GP-20	WIX
51191	GP-3569	WIX	51322667	GA-106 ⁶⁶	INGR	514222	G-500	AGCH	516180	GG-5 L	AGCH
51193	G-871	WIX	51322667	GA-326 ⁷¹	INGR	51426	G-33	WIX	51619	GP-166 ⁶⁵	WIX
51195	G-153	WIX	51324	GP-3985 ⁶⁹	WIX	51431	GP-9	WIX	51619	GP-3937 ¹¹	WIX
51196	GP-66	WIX	5-13240-017-0	GP-3682	ISUZ	5143474	GAK-20	GMCX	51621	GP-166	WIX
511967-C91	GA-6127 ⁰⁸	IHCO	5-13240-018-0	GP-462	ISUZ	5143477	GAK-20	GMCX	51622	GP-171 ¹⁶	WIX
511967-C91	GA-6129 ⁰⁴	IHCO	5-13240-041-0	GP-3682	ISUZ	5143477	GAK-20	JOND	51624	GP-9	WIX
51197	G-222	WIX	5-13240-093-0	GP-38	ISUZ	51442	G-191	WIX	51625	GP-58	WIX
511K	GP-149	ASAH	5133	GP-1011Q	LUF	51447	GP-761H	WIX	51626	GP-3985	WIX
512	G-225	CRO	51334	GP-91 ⁷⁸	WIX	51448	GP-761H	WIX	51628	GP-54	WIX
512	GA-37	DEL	51334MP	GP-149 ⁶⁹	WIX	51449	GP-761H	WIX	51637	G-159	WIX
512	GG-65	PROT	51334MP	GP-91 ⁷⁸	WIX	51450	GP-761H	WIX	516372	GA-371	JEFF
5120454	GAK-20	EATN	51335	GP-22	WIX	51451	GP-761H	WIX	51649	GP-43	WIX
5120454	GAK-20	YALE	51338	GP-462	WIX	51452	GP-310	WIX	51660	GP-556	WIX
51206	GP-36	WIX	51340	GP-46	WIX	51452	GP-3569	WIX	51663	GP-166	WIX
5120700509	GP-28 ⁸	VAG	51342	GP-28 ⁸	WIX	51452MP	GP-310	WIX	51664	GP-166	WIX
5120700509	GP-430 ⁸	VAG	51342	GP-430 ⁸	WIX	51452MP	GP-3569	WIX	51669	GP-53	WIX
5120700509	GP-28 ⁸	VOLK	51344	GP-462	WIX	51453	GP-66	WIX	51670	GP-53	WIX
5120700509	GP-430 ⁸	VOLK	51345	GP-3682	WIX	51456	GP-761H	WIX	51671	GP-53	WIX
512-07-005-09	GP-28 ⁸	NSU	51346	GP-28	WIX	51459	GP-31	WIX	516716	GAK-403	NEWH
512-07-005-09	GP-430 ⁸	NSU	51347	GP-24 ²⁶	WIX	51460	GP-3600	WIX	51673	GP-359	WIX
512-086-094	G-31	KASB	51347	GP-24 ²⁶	WIX	51461	GP-54	WIX	51681	GP-57	WIX
51212	G-112	WIX	51347	GP-462 ²⁴	WIX	51462	GP-66	WIX	516920	G-296	LEYL
51213	G-975	WIX	51348	GP-2951 ⁶²	WIX	51475	G-6	WIX	516920	G-296-B	LEYL
51214	GP-3600	WIX	51348	GP-58	WIX	5148023	GP-26	GMCX	517	G-335	CRO
512147	G-296	LEYL	51348MP	GP-2951 ⁶²	WIX	5148171	GP-27	GMCX	517	GG-581	PROT
512147	G-296-B	LEYL	51348MP	GP-58	WIX	51482	GP-761H	WIX	51701	GP-31	WIX
51215	GP-58	WIX	51349	GP-51	WIX	51483	GP-761H	WIX	51704	GP-50 ⁰	WIX
51-22	GA-425	ERO	5134988	GP-66	EATN	51485	GP-761H	WIX	5170778-02	GAK-1532	YALE
512222	GAK-16	BENF	5134988	GP-171 ¹⁶	YALE	51486	GP-761H	WIX	51712	GP-166	WIX
51223	G-954	WIX	513498800	GP-171 ¹⁶	YALE	51487	G-169	WIX	51722	GP-52 ¹⁰	WIX
51226	G-180	WIX	513498801	GP-171 ¹⁶	EATN	51491	GP-761H	WIX	51722	GP-691 ⁸	WIX
51226	G-918	WIX	5134988-01	GP-171 ¹⁶	YALE	51494	GP-761H	WIX	51727	G-926	WIX
51228	GP-457	WIX	5134988-02	GP-171 ¹⁶	YALE	51495	GP-761H	WIX	517-3166	GA-2147	SAAB
5123	GA-50	CHEK	5134988-03	GP-171 ¹⁶	YALE	51496	GP-761H	WIX	51734	GP-562	WIX
51231	GP-36	WIX	5134988-06	GP-66	YALE	51498	GP-761H	WIX	51734MP	GP-562	WIX
5123656	GA-49	STIL	51349881	GP-171 ¹⁶	YALE	515	GA-39	DEL	51740	GP-864H	WIX
51239	G-31	WIX	51349882	GP-171 ¹⁶	YALE	515	GG-1872	PROT	51741	GP-3000 ¹³	WIX
51240	GP-166	WIX	51349883	GP-171 ¹⁶	YALE	51500	GP-31	WIX	51742	GP-3766	WIX
51242	G-139	WIX	5134RX	G-31	YALE	5150064	GG-5 L	CHRY	51742MP	GP-3766	WIX
51243	GP-14	WIX	51354	G-871	WIX	515027	GP-1	DEMA	51746	GP-34	WIX
51243MP	GP-14	WIX	5135447AA	GA-2161	MOP	51503	G-31	WIX	51747	GP-88	WIX
51253	G-122	WIX	51355	GP-171	WIX	51512	GP-38	WIX	51748	GP-3000	WIX
51253	G-338	WIX	51356	GP-149	WIX	5151274	GAK-625	DEMA	51748MP	GP-3000	WIX
512542100	G-31	HANO	51357	GP-91	WIX	5151338-51	G-296				

Referencia Cruzada por Numero de Parte

Cross Reference by Part Number



Numero	Gonher	Fabricante	Numero	Gonher	Fabricante	Numero	Gonher	Fabricante	Numero	Gonher	Fabricante
Number	Gonher	Manufacturer	Number	Gonher	Manufacturer	Number	Gonher	Manufacturer	Number	Gonher	Manufacturer
51752		G-750 WIX	51848		GP-691 ⁴⁸ WIX	52005		GP-20 MTRV	5221272		GP-1 CHRY
51753		G-750 WIX	518566		GAK-403 JOY	52005131		GG-99 CHRY	5221273		GP-1 TALB
51754		GP-54 WIX	51867		G-339H WIX	52005131		GG-99 MOP	5221313		GP-1 CHRY
51754MP		GP-54 WIX	51869		GP-53 WIX	52009		GP-81 ³¹ KMA	52222		GAK-16 BENF
51756		GP-34 WIX	51870		GP-53 WIX	52009		GP-9 ³⁸ KMA	5223103A		GP-1 CITR
51758		GP-34 WIX	5189933AA		GA-143 CHRY	52009		GP-81 ³¹ MTRV	5224165		GG-5 L ASTN
51759		GP-34 WIX	519		GP-83 AMP	52009		GP-9 ³⁸ MTRV	52248879		GP-85 ³² INGR
51762		GP-3600 WIX	519		GP-83 BGA	52010		GP-3429 KMA	52248887		GP-1011Q INGR
51763		GP-69 WIX	519		GG-63 PROT	52010		GP-3429 MTRV	52248895		GP-9586 INGR
51764		GP-3600 WIX	519000-243		GAK-20 JOY	5-20106-004		GA-360 ISUZ	52252061		GA-563 INGR
51768		GP-36 WIX	51900217		GA-26 JONB	5201-06004		GA-360 FURU	5225254		GG-3 STIL
51769		GP-10 WIX	519002-17		GA-26 JOY	5-20106-013		GA-361 ISUZ	52253275		G-159 INGR
51769		GP-69 WIX	519002-29		GAK-20 JOY	5201-06013		GA-361 FURU	52261336		GP-53 INGR
51771		GP-1 WIX	519002-33		GAK-20 JOY	52012		GP-3980 MTRV	52261369		GP-26 INGR
517711		G-296 LEYL	519002-35		GAK-403 JOY	52014		GP-3600 KMA	522764		G-1123 PEGA
517711		G-296-B LEYL	519002-38		GAK-20 JOY	52014		GP-3600 MTRV	522P		G-225 GREY
517711		G-296 ROVE	5192800		G-1173 ¹⁰⁸ GMCX	52018646		GG-72 CHRY	523		GP-110 AMP
517711		G-296-B ROVE	5192802		G-1175 ¹⁰⁸ GMCX	52019023		GG-249 CHRY	523		GG-160 PROT
51772		GP-54 ¹¹ WIX	5192803		G-1175 ¹⁰⁸ GMCX	52019023		GG-249 MOP	52302		GA-100 SERV
51772		GP-66 ¹⁰ WIX	5192808		G-1175 ¹⁰⁸ GMCX	52020016		GG-249 CHRY	52304		GA-101 SERV
51773		GP-31 WIX	5192852		G-1174 ¹⁰⁸ GMCX	52020016		GG-249 MOP	5231996		GA-360 CASE
51773MP		GP-31 WIX	5192853		G-1174 ¹⁰⁸ GMCX	52026		GP-28 ⁵ MTRV	52339U		G-1121 BORG
51774		GP-54 ⁹⁰ WIX	5192854		G-1174 ¹⁰⁸ ADAM	52026		GP-430 ⁸ MTRV	523611		G-33 CLRK
51775		GP-1 WIX	5192854		G-1174 ¹⁰⁸ AUSW	52032		GP-3682 KMA	52377		GA-27 WAYN
51776		GP-77 WIX	5192854		G-1174 ¹⁰⁸ BARB	52032		GP-3682 MTRV	52382		G-169 GALN
51777		GP-77 WIX	5192854		G-1174 ¹⁰⁸ BAYC	5203217		GP-28 ⁵ CHRY	524		GP-1108 AMP
51783		G-122 WIX	5192854		G-1174 ¹⁰⁸ BLAW	5203217		GP-430 ⁸ CHRY	524		GP-1108 BGA
51783		G-338 WIX	5192854		G-1174 ¹⁰⁸ DETR	5203217		GP-28 ⁵ MOP	524		G-871 CRO
51784		GP-69 WIX	5192854		G-1174 ¹⁰⁸ EMCO	5203217		GP-430 ⁸ MOP	524		GG-187 PROT
51784MP		GP-69 WIX	5192854		G-1174 ¹⁰⁸ FLXI	52048		GP-171 KMA	5240668		GA-3445 CHRY
51785		GP-58 WIX	5192854		G-1174 ¹⁰⁸ FWDX	52048		GP-171 MTRV	524071		GP-2071W WIX
5178782		G-1173 ¹⁰⁸ GMCX	5192854		G-1174 ¹⁰⁸ GMCX	52050		GG-123 SERV	524073		GP-1011Q WIX
51788		GP-51 WIX	5192854		G-1174 ¹⁰⁸ OLIV	520-5002		GP-58 KOHL	524117		GA-31 BROK
51789		GP-69 WIX	5192854		G-1174 ¹⁰⁸ PRIE	520509		GP-66 RAYM	5241522		GAK-16 GMCX
5178980		G-1173 ¹⁰⁸ GMCX	5192855		G-1175 ¹⁰⁸ BARB	52050901		GP-66 REYN	524164		G-1121 OREN
5178982		G-1173 ¹⁰⁸ BAYC	5192855		G-1175 ¹⁰⁸ FLXI	520512		GP-166 RAYM	5241840301		GP-152 ³⁰ DETR
5178982		G-1173 ¹⁰⁸ BLAW	5192855		G-1175 ¹⁰⁸ FWDX	52052		GG-6 SERV	524428		GP-2015W WIX
5178982		G-1173 ¹⁰⁸ BUCY	5192855		G-1175 ¹⁰⁸ GARD	52054		GG-7 SERV	524429		GP-2022W WIX
5178982		G-1173 ¹⁰⁸ COCT	5192855		G-1175 ¹⁰⁸ GMCX	5205401300		GP-54 ¹¹ HANO	524610-12620		GAK-403 YNMR
5178982		G-1173 ¹⁰⁸ EMCO	5192855		G-1175 ¹⁰⁸ LORA	5205401300		GP-66 ¹⁰ HANO	524894		G-750 DIAM
5178982		G-1173 ¹⁰⁸ GMCX	51933		GAK-1532 VERS	52056		GG-16 SERV	52-4894		G-750 WHIT
5178982		G-1173 ¹⁰⁸ LORA	519421-10		GP-26 JOY	52058		GG-17 SERV	525		GP-1107 AMP
5178982		G-1173 ¹⁰⁸ OLIV	519421-11		GP-27 JOY	52059		GG-76 SERV	525		GP-1107 BGA
5178982		G-1173 ¹⁰⁸ PRIE	519421-12		GG-5 L JOY	52061		GG-203 SERV	525		GG-94 PROT
51789MP		GP-69 WIX	519421-13		GP-56 JOY	520-610		GP-66 RAYM	52549D		GA-27 OSHK
51791		GP-51 WIX	519421-14		G-1175 JOY	52062		GG-20 SERV	525571-M91		GA-360 MASY
5179109		G-1173 ¹⁰⁸ GMCX	519421-3		G-295 JOY	52063		GG-240 SERV	525571-M91		GA-361 MASY
51791MP		GP-51 WIX	519421-4		G-1173 JOY	52066		GG-46 SERV	525611-M1		GA-360 MASY
51792		GP-52 ¹⁰ WIX	519421-5		GP-110 JOY	52066B		GG-46 SERV	525611-M91		GA-360 MASY
51792		GP-69 ¹⁴⁸ WIX	519421-8		G-1174 ¹⁰⁸ JOY	52067		G-1173 ¹⁰⁸ OLIV	525612-M1		GA-361 MASY
51792MP		GP-52 ¹⁰ WIX	5194548-00		GP-81 ³¹ YALE	52067		GG-3728 SERV	525612-M91		GA-361 MASY
51792MP		GP-69 ¹⁴⁸ WIX	5194548-00		GP-9 ⁵⁸ YALE	52067		G-1173 ¹⁰⁸ WHIT	52561-M1		GAK-16 MASY
51792XE		GP-52 ¹⁰ WIX	51954		G-566 WIX	52071		GG-580 SERV	525661		GA-31 BROK
51792XE		GP-69 ¹⁴⁸ WIX	51954MP		G-566 WIX	52072		GG-64 SERC	5256612-M91		GA-361 MASY
51794		GP-23 WIX	51955		G-566 WIX	52073		GG-66 SERC	525665		GA-106 ⁶ BLOU
51794MP		GP-23 WIX	519573		G-33 CLRK	52073		GG-66 SERC	525665		GA-326 ¹ BLOU
51796		GP-390 ⁹³ WIX	5196878		GC-1133 GMCX	52074		GG-256 SERV	52582		GP-66 TENN
51797		GP-10 WIX	5196879		GS-1133 GMCX	52074		GG-580 SERV	526		GG-79 PROT
51797		GP-66 WIX	51970		GP-43 ⁵⁰ WIX	52075		GG-581 SERV	526023		GA-33 ¹² AMHO
51797MP		GP-10 WIX	51970		GP-53 ⁴⁶ WIX	52076		GG-177 SERV	526249		GP-3600 LEYL
51799		GP-152 WIX	51970MP		GP-43 ⁵⁰ WIX	52077		G-294 SERV	526312		GA-31 DIAM
51799MP		GP-152 WIX	51970MP		GP-53 ⁴⁶ WIX	520831		G-31 STER	526314		GA-360 DIAM
518		GP-84 AMP	51970XD		GP-53 WIX	520831		G-31 STUD	5266844		GP-53 GMCX
518		GP-84 BGA	51970XE		GP-53 WIX	520837		GA-360 MACO	5266845		GP-57 GMCX
518		GA-80 DEL	51971		G-1173 ¹⁰⁸ OLIV	520943		GA-892 MACO	5266846		GP-1101 GMCX
518		GG-208 PROT	51971		G-1173 ¹⁰⁸ WHIT	520985		G-31 STUD	52672		GAK-16 CASE
51800		GP-77 WIX	51971		GP-193 WIX	521		G-834 CRO	52672		GAK-16 DROT
51801		GP-52 ¹⁰ WIX	51971MP		GP-193 WIX	521		GG-1 PROT	526K		GP-91 ASAH
51801		GP-69 ¹⁴⁸ WIX	51971XD		GP-193 WIX	521		GG-4 PROT	527		GG-184 PROT
51802		GP-67 WIX	5197828		GAK-20 GMCX	52100283AC		GG-283 CHRY	5271		GG-20 AUTO
51803		GP-54 WIX	5197828		GAK-20 TERE	52100283AD		GG-283 CHRY	52731		GP-13 MEAD
51806		GP-1 WIX	5197854		G-1174 ¹⁰⁸ GMCX	52100-402-AE		GG-97 CHRY	52731		GP-13 MERC
51807		GP-10 WIX	5198838		G-1175 GMCX	521190		G-1123 WORT	52731B		GP-13 MERC
51807		GP-54 WIX	5198856		GA-27 GMCX	521192		G-1163 ¹⁰⁸ WORT	52739001		GP-1 VERM
51807		GP-66 WIX	5198867		GAK-403 DETR	521248-M91		GG-19 MASY	527563		G-296 PEGA
51808		GP-88 WIX	5198867		GAK-403 GMCX	521248-M92		GG-19 MASY	527563		G-296-B PEGA
51809		GP-642 WIX	5198871		GAK-16 GMCX	521347		G-31 WORT	527631-10		GP-10 JOY
51811		GP-53 WIX	5198872		GAK-16 GARW	521347		G-31 YALE	527631-12		GP-52 ¹⁰ JOY
5181127		G-31 GMCX	5198872		GAK-16 GMCX	521347		G-31 YELC	527631-12		GP-691 ⁴⁸ JOY
5181127		G-31 IHCO	5198982		G-1174 ¹⁰⁸ GMCX	5214626		GG-5 L CHRY	527631-2		GP-14 JOY
5181127		G-31 WORT	5199835		G-1175 GMCX	5214626		GG-5 L MOP	527631-3		G-33 JOY
51813		GP-53 WIX	5199838		G-1175 GMCX	5214692		GG-8 L CHRY	527631-4		GP-51 JOY
51817		GP-761H WIX	5199839		G-1175 ¹⁰⁸ GMCX	5214692		GG-8 L MOP	527631-6		GP-36 JOY
51818		GP-54 WIX	519K		GP-462 ASAH	52146958		GA-563 INGR	527631-9		G-33 JOY
51819		GP-761H WIX	51M		G-5000 GREY	521500		GP-54 ¹¹ MACO	52770S		GP-1 TENN
51820		GP-54 ¹¹ WIX	51PS3072		GP-66 CALI	521500		GP-66 ¹⁰ MACO	5278-097AB		GG-195 CHRY
51820		GP-66 ¹⁰ WIX	51PS3072		GP-66 CHIC	521542		GAK-625 MACO	528		GG-30 PROT
5182041		G-1174 ¹⁰⁸ GMCX	51T-18697		G-31 FORD	521926		G-31 STUD	5281090		GP-81 MOP
51824		GP-35 WIX	51T-67275-A		G-31 FORD	521950-12510		GAK-16 YNMR	5281090		GP-81 MOP
51829		GP-66 WIX	52		GP-13 DEL	521K		GP-36 ASAH	528250-R1		GP-10 IHCO
518											

Numero	Gonher	Fabricante	Numero	Gonher	Fabricante	Numero	Gonher	Fabricante	Numero	Gonher	Fabricante
Number	Gonher	Manufacturer	Number	Gonher	Manufacturer	Number	Gonher	Manufacturer	Number	Gonher	Manufacturer
528493R2		G-338 CASE	533512		G-1176 WIX	54070		G-178 SERV	545245		GA-360 DIAM
528493-R2		G-122 IHCO	533537		GPP-419 WIX	54073		GG-986 SERC	54-5248		GA-27 WHIT
528493-R2		G-338 IHCO	533604XE		GPP-1003S WIX	54074		G-862 SERV	545249		GA-31 DIAM
528493R3		G-122 CASE	533621		GPP-11 WIX	540F		G-1175 ¹⁰⁸ CHP	54-5249		GA-31 WHIT
528493R3		G-338 CASE	533630		GPP-1287 ³⁹ WIX	540X		G-1175 ¹⁰⁸ EUCL	545251C1		GP-53 CASE
528493-R3		G-122 IHCO	533630		PPFF831 ⁴¹ WIX	541		GPP-1000 AMP	545251-C1		GP-53 IHCO
528493-R3		G-338 IHCO	533630		S 3225 P ⁴² WIX	541		GP-50 CRO	5457752S		GP-1 CITR
528493-R92		G-338 IHCO	533640		GP-749 WIX	5410502		GP-58 ¹⁵ BRIG	54599		GP-34 WAYN
528507-R91		G-122 IHCO	533690		GP-96 WIX	5410502		GP-58 WACK	546027		GAD-294 WIX
528507-R91		G-338 IHCO	53371090		GA-31 DIAM	54111		GP-3 MERC	546043		GA-139 WIX
528507-R92		G-122 IHCO	53371090		GA-31 REOT	54111B1		GP-3 MERC	546064		GA-386 WIX
528507-R92		G-338 IHCO	534		G-1123 AMP	5411254300		GP-1122 SCHA	546077		GA-3901 WIX
529		GP-1101 AMP	534		G-1121 BGA	5411316400		GP-36 SCHA	546093		GA-275 WIX
529		GP-81 CRO	534		G-1174 ¹⁰⁸ CRO	5411316410		GP-1122 DRES	546097		GA-133 WIX
529		GG-137 PROT	534		GG-986 PROT	5411-31-6410		GP-1122 KOMA	546118		GA-216 WIX
529-1		GP-58 CRO	5342		G-31 FRM	54113164-10		GP-1122 SCHA	546119		GA-471 WIX
5291940		GA-26 CLRK	534349-R91		GA-891 ¹⁰⁴ IHCO	541403		G-834 LEYL	546135		GA-2194 WIX
5293047		G-335 CLRK	534349-R91		GA-892 ¹⁰⁸ IHCO	541403		G-834 ROVE	546144		GA-392 WIX
52937		G-31 PUR	534564		GA-378 BROK	54141		GA-33 ¹¹² TENN	546148		GA-2106 WIX
529821-R1		GA-360 IHCO	535		G-1143 AMP	54141-1		GA-33 ¹¹² TENN	546150		GA-129 WIX
529821-R2		GA-360 IHCO	535		G-1143 BGA	541414		GA-33 ¹¹² TENN	546153		GA-6479 WIX
529851-R1		GA-891 IHCO	535		G-33 CRO	54141M		GA-33 ¹¹² TENN	546158		GA-382 WIX
529851-R2		GA-891 IHCO	535003		G-870 LEYL	541913		GP-53 BLOU	546162		GA-6690 WIX
529852-R1		GA-892 IHCO	53501080		GA-27 BARH	54-1972		GA-27 WHIT	546170		GA-276 WIX
529852-R2		GA-892 IHCO	53501110		GAK-1532 BARH	54-1978		GA-27 WHIT	546174		GA-174 WIX
529852-R3		GA-892 IHCO	53501137		GP-27 BARH	542		GP-26 AMP	546180		GA-253 WIX
529852-R4		GA-892 IHCO	53501138		GP-92 BARH	542		GP-26 BGA	546186		GA-142 WIX
529852-R4		GA-892 KOMA	53501140		GPP-18 BARH	542		GP-3 CRO	546195		GA-244 WIX
529852-R5		GA-892 IHCO	53501156		GAK-20 BARH	542072		GA-349 WIX	546215		GA-607 WIX
529892-R2		GA-892 IHCO	53501157		GA-26 BARH	542091		GA-56 WIX	546244		GA-195 WIX
530		GG-79 PROT	53501257		GA-106 ⁴⁶ BARH	542093		GA-90 WIX	546246		GA-7017 WIX
53001		GP-1 MTRV	53501257		GA-326 ⁷¹ BARH	542099		GA-325 WIX	546255		GA-3501 WIX
53002184		GAUV-2 AMCO	53501258		GA-206 BARH	542113		GA-86 WIX	546279		GAD-30 WIX
53002184		GAUV-2 CHRY	53-57109		GA-31 WHIT	542118		GAK-20 WIX	546284		GAD-30 WIX
53002184		GAUV-2 MOP	5-3571090		GA-31 DIAM	542132		GA-357 WIX	546394		GAK-16 WIX
53004383		GA-3901 AMCO	53-57113		GA-27 WHIT	542136		GA-4303 WIX	546402		GA-2804 T WIX
53004383		GA-3901 CHRY	53-5740		GA-27 WHIT	542142		GAK-403 WIX	546425		GA-132 WIX
53004383		GA-3901 MOP	53-5763		GA-5648 WHIT	542203		GA-1203 WIX	546438		GA-880R WIX
53006317		GAUV-2 CHRY	536		GP-50 CRO	542218		GA-390 WIX	546466		GAK-458 WIX
53007386		GA-300 CHRY	53629029		GP-28 ⁸ VERM	542252		GA-37 WIX	546467		GA-459 WIX
53007386AB		GA-300 CHRY	53629029		GP-430 ⁰ VERM	542263		GP-35 BLOU	546527		GA-781 WIX
53015		GP-13 KMA	53630005		GAK-16 VERM	542276		GA-33 ¹¹² CASE	546528		GA-782 ¹⁰⁸ WIX
53015		GP-13 MTRV	537		GP-5 CRO	542285		GA-2146 WIX	546530		GA-589 WIX
53020311		GP-81 CHRY	537335-R1		GA-416 IHCO	542338		GAK-403 WIX	546531		GA-588 WIX
530270-R1		GA-361 IHCO	537335-R2		GA-416 IHCO	5424		GG-123 ALL	546538		GA-459 WIX
530270-R2		GA-361 IHCO	537335-R3		GA-416 IHCO	542455		GA-968R WIX	546562		GA-853R WIX
53032404AA		GA-490 CHRY	537336-R2		GA-416 IHCO	542479		GA-286 WIX	546641		GA-8 WIX
53032527AA		GA-249 CHRY	537355-R2		GA-416 IHCO	542509		GA-509 ¹⁴ WIX	546664		GA-930R WIX
53032527AB		GA-249 CHRY	537984		GP-14 BLOU	542518		GAK-1532 WIX	546665		GA-890R WIX
53032700AA		GA-488 CHRY	537985		G-295 BLOU	542542		GA-360 WIX	546675		GA-1095 WIX
53032700AB		GA-488 CHRY	537986		GAK-403 BLOU	542543		GA-361 WIX	546723		GA-398 WIX
53038		GP-310 KMA	538		GP-1101 AMP	542608		GA-405 WIX	546726		GA-376 WIX
53038		GP-310 MTRV	53-8142		GA-26 WHIT	542613		GA-373 WIX	546741		GA-467 WIX
53040025		GA-2198 ⁷⁹ CHRY	538654R91		G-122 CASE	542618		GA-229 WIX	546744		GA-966R WIX
53040025		GA-438 ³¹ CHRY	538654R91		G-338 CASE	542632		GA-416 WIX	546745		GA-221R WIX
53055-2		GP-50 TENN	538654-R91		G-122 IHCO	542648		GA-680 WIX	546746		GA-600R WIX
530751-R1		GA-360 ¹⁰⁴ IHCO	538654-R91		G-338 IHCO	542651		GA-108 WIX	546756		GA-251 WIX
530751-R1		GA-361 ¹⁰⁸ IHCO	53-8691-H2		GA-27 WHIT	542653		GAK-216 WIX	546772		GA-435R WIX
530776-C1		GA-119 IHCO	538836-R1		GP-50 IHCO	542654		GA-425 WIX	546775		GA-759 WIX
530778-C1		GA-119 IHCO	539		GP-1101 AMP	542655		GA-426 WIX	546782		GA-967R WIX
530824-R1		GP-66 IHCO	539		GP-14 CRO	542677		GA-680 WIX	546840		GA-389 WIX
530824-R2		GP-66 IHCO	5390504		GAK-16 ALCH	542679		GA-892 WIX	546842		GA-518R WIX
531		G-295 AMP	5391112011		GAK-403 TOYK	542888		GA-2803T WIX	546843		GA-539R WIX
531		G-295 BGA	53915520		GP-81 LAMB	542916		GA-21 WIX	546860		GA-371 WIX
531005		GP-54 ¹¹ BUSH	53921		GA-680 WIX	5429192		GG-1 CITR	546863		GA-534R WIX
531005		GP-66 ¹⁰ BUSH	539536		GA-892 SAMB	5429192		GG-4 CITR	546868		GA-608 WIX
53110		GA-33 ¹¹² WHIT	539821		GAK-20 CLRK	542957		GP-9 ³⁸ FORD	546870		GA-799R WIX
531546-R1		GG-20 IHCO	53-9821		GAK-20 KENW	542957		GP-22 FRF	546876		GA-694 WIX
531546-R91		GG-20 IHCO	539851R1		GA-891 IHCO	542971		GA-539R WIX	546922		GA-770R WIX
5315520		GP-81 SAME	539851R2		GA-891 IHCO	543		GP-27 AMP	546983		GA-723R WIX
532		GP-1 CRO	539934		GP-3600 OREN	543		GP-27 BGA	547		GP-58 CRO
532-28-1		GG-5 L ALFA	53MW		GP-1011Q GREY	543		GP-3 CRO	5470530		GG-5 L CITR
532859		GA-6129 BLOU	54		GP-3 DEL	54300		GA-113 SERC	5470709		G-296 B CITR
533		G-296 CRO	54		GA-113 FACE	54307		GA-176 SERV	5470709D		G-296 CITR
533		G-296-B CRO	54		GP-117 WIX	54313		GA-186 SERV	5470709D		G-296 CITR
533		GG-266 PROT	540		GP-1105 AMP	543298-0006		GAK-625 JOY	5470709D		G-296-B CITR
5330901		GP-53 INGR	540		GP-1105 BGA	543298-6		GAK-625 JOY	547159-R2		GA-357 IHCO
5330919		GP-92 INGR	54-0110		GP-66 TORO	543543		GG-16 PARM	54770		GP-66 TERE
533109		GP-1101 WIX	540125		GA-11 NEWH	543908		GG-17 PARM	548		GP-78 AMP
533118		GP-26 WIX	540153		G-834 GULD	54392001		GP-27 VERM	548		GP-78 BGA
533120		GP-27 WIX	540-20-800-18-01		G-1123 STEY	544		G-1173 ¹⁰⁸ BGA	548		GP-50 CRO
533216		GP-85 WIX	540-20-800-18-02		G-1123F STEY	544		G-296 CRO	548052		GA-7 SIMC
533218		GP-84 WIX	540-20-800-01		G-1123 STEY	544		G-296-B CRO	5481874		GG-1 CITR
533219		GP-83 WIX	540-20-800-02		G-1123F STEY	54429		GP-3000 CHAM	5481874		GG-4 CITR
533242		GPP-103 ⁴⁰ WIX	54050		GG-19 SERV	5443		GG-20 ALL	548257		G-1121 DAF
533242		GPP-11 ³⁹ WIX	54060		GG-87 SERV	544379		GP-761H SAUR	548436-R1		GA-12 IHCO
533289-R91		G-122 IHCO	54061		GG-30 SERV	544379		GP-761H SUND	54900862		GG-1 RENA
533289-R91		G-338 IHCO	54062		GG-47 SERV	5446		GG-5 L ALL	54900862		GG-4 RENA
533336		GP-78 WIX	5406243		GP-1 CITR	54461-R91		G-1175 ¹⁰⁸ IHCO	549126		GA-624R WIX
533341		GP-1108 WIX	54064		GG-42 SERV	5447		GG-1 ALL	549593		GA-33 ¹¹² JACO
533352		GG-1108 WIX	54066		GG-1872 SERC	5447		GG-4 ALL	549597		GP-66 JACO
533367		GP-1105 WIX	54066		GG-1872 SERV	54477104		GP-171 INGR	549633		GAK-16 JACO
533384		GP-56 WIX	54068		GP-155 SERV	54477104		GP-171 VOLV	549633		GP-1010Q GREY
533404		GP-1224 WIX	54069		GG-92 SERV	5448		GG-5 L ALL	55		GA-80 WIX
533442		S 3202 ⁴⁰ WIX	540699		GA-27 CLRK	545		G-1174 ¹⁰⁸ BGA	550		GPP-18 AMP
533512		G-1173 ¹⁰⁸ WIX	54-0699		GA-27 KENW	545		GP-1 CRO	550		GPP-18 BGA

Referencia Cruzada por Numero de Parte

Cross Reference by Part Number



Numero	Gonher	Fabricante	Numero	Gonher	Fabricante	Numero	Gonher	Fabricante	Numero	Gonher	Fabricante
Number	Gonher	Manufacturer	Number	Gonher	Manufacturer	Number	Gonher	Manufacturer	Number	Gonher	Manufacturer
55000574	GP-28 ⁸	DEL	551808	GP-88	WIX	5572425	G-31	CLRK	557404	GP-761H	WIX
55000574	GP-430 ⁸	DEL	551817	GP-761H	WIX	5572425	G-31	ELGN	5574201	G-236	GMCX
55000574	GP-28	DEMA	551819	GP-761H	WIX	5572425	G-31	FITZ	5574208	G-1173 ¹⁰⁸	GMCX
5500174	GP-1122	DEMA	551820	GP-54 ¹¹	WIX	5572425	G-31	FWDX	5574210	G-1163 ¹⁰⁸	GMCX
5500460	GAK-403	READ	551820	GP-66 ¹⁰	WIX	5572425	G-31	GMCX	5574213	G-31	GMCX
5500531	GAK-403	READ	551824	GP-35	WIX	5572425	G-31	GRAY	5574279	G-200	GMCX
5500560	GAK-403	READ	55-1925	GA-27	WHIT	5572425	G-31	KOBL	5574382	GP-1	GMCX
5500574	GP-28 ⁸	DEL	551954	G-566	WIX	5572425	G-31	OLIV	5574406	G-200	GMCX
5500574	GP-430 ⁸	DEL	551970	GP-53	WIX	5572425	G-31	QUIC	5574406	G-200	OWEN
5500574	GP-28	DEMA	552	G-31	CRO	5572425	G-31	READ	5574459	GP-1	GMCX
5500611	GA-33 ¹¹²	READ	552006	G-613	CUMM	5572428	G-31	GMCX	55-74486	G-33	KENW
55-00699	GA-27	KENW	5521	GG-1	ALL	5572428	G-31	LINK	5574506	G-1175 ¹⁰⁸	GMCX
55007385	GP-9	FORD	5521	GG-4	ALL	5572435	G-31	GMCX	5574508	G-1175 ¹⁰⁸	GMCX
5500874	GP-54 ¹¹	DEMA	5522	GG-19	ALL	557245	G-31	INGR	5574508	G-1175 ¹⁰⁸	KOBL
5500874	GP-66 ¹⁰	DEMA	5522	G-25	TEHO	5572472	G-31	GMCX	55-74508	G-1175 ¹⁰⁸	KENW
55010	GP-66	RAND	55222	GAK-16	BENF	5572503	G-31	GMCX	55745-08	G-1175 ¹⁰⁸	NISS
55014	GA-33 ¹¹²	GEHL	552352602	GP-1122	RICI	5572508	G-139	GMCX	5574515	G-1175 ¹⁰⁸	GMCX
55017	GA-33 ¹¹²	GEHL	552352603	GP-36	RICI	5572600	G-33	GMCX	5574515	G-1175 ¹⁰⁸	LORA
5502029	GP-54 ¹¹	LBHR	552352604	GP-54 ¹¹	RICI	5572827	G-6	GMCX	5574533	G-1175 ¹⁰⁸	GMCX
5502029	GP-66 ¹⁰	LBHR	552352604	GP-66 ¹⁰	RICI	5572941	G-31	GMCX	5574540	G-200	CRIS
5502029	GP-54 ¹¹	LEYL	552442365	G-33	RICI	5572942	G-33	GMCX	5574540	G-200	GMCX
5502029	GP-66 ¹⁰	LEYL	552442388	G-1174	RICI	5573	GA-101	ALL	5574540	G-200	MERC
5502096	GP-54 ¹¹	LBHR	5525	GG-19	ALL	5573012	G-33	GMCX	5574540	G-200	OWEN
5502096	GP-66 ¹⁰	LBHR	552652307	GAK-16	RICI	5573013	G-33	GMCX	5574558	G-1175 ¹⁰⁸	GMCX
5502096	GP-54 ¹¹	LEYL	552652350	G-871	RICI	5573014	G-33	ADAM	5574589	G-238	GMCX
5502096	GP-66 ¹⁰	LEYL	552652370	G-296	RICI	5573014	G-33	ALCH	55746	G-1176	ALCH
5502259	G-1123 ¹⁰⁸	LBHR	552652370	G-296-B	RICI	5573014	G-33	ALLI	55746-2	G-1176	ALCH
5502259	G-1123F ¹⁰⁸	LBHR	552682302	G-1121	RICI	5573014	G-33	AUSW	5574639	GP-50	GMCX
5502263	G-1123 ¹⁰⁸	LBHR	5527655810	GA-33 ¹¹²	SCHA	5573014	G-33	BARB	5574641	GP-50	GMCX
5502263	G-1123F ¹⁰⁸	LBHR	5527-65-5814	GP-166	KOMA	5573014	G-33	BAUR	5574653	G-331	GMCX
5502266	G-31	LBHR	5527662013	GP-462	SCHA	5573014	G-33	BAYC	5574797	G-1166	GMCX
5502268	G-1123 ¹⁰⁸	LBHR	5527-95-5814	GP-166	KOMA	5573014	G-33	BEDF	5574808	G-1143	GMCX
5502268	G-1123F ¹⁰⁸	LBHR	553	G-330	CRO	5573014	G-33	BLAW	5574809	G-1175 ¹⁰⁸	GMCX
5502278	G-33	LBHR	5535	GG-47	ALL	5573014	G-33	COCT	5574905	G-119	GMCX
5502454	G-330	LBHR	553503	GAK-20	DIAM	5573014	G-33	CRUS	5574937	G-1174 ¹⁰⁸	GMCX
5502455	GP-36	LBHR	553643	G-31	WAUK	5573014	G-33	CURT	5574961	G-1174 ¹⁰⁸	AUSW
5502896	GP-1122	LBHR	5539	GG-1	FACE	5573014	G-33	DETR	5574961	G-1174 ¹⁰⁸	BARB
550416	GAK-403	READ	5539	GG-4	FACE	5573014	G-33	EMCO	5574961	G-1174 ¹⁰⁸	BLAW
55-0485	G-238	CATP	5541	GG-5 L	ALL	5573014	G-33	FLXI	5574961	G-1174 ¹⁰⁸	CLRK
55054	GG-5 L	REVL	554329	GP-1	LEYL	5573014	G-33	FWDX	5574961	G-1174 ¹⁰⁸	DETR
55-0699	GA-27	KENW	554497	GA-31	DIAM	5573014	G-33	GMCX	5574961	G-1174 ¹⁰⁸	EUCL
55070208	G-1123F	LBHR	554498	GA-360	DIAM	5573014	G-33	HOUG	5574961	G-1174 ¹⁰⁸	GMCX
5507547	GP-54 ¹¹	LBHR	5548	GG-6	ALL	5573014	G-33	INGR	5574961	G-1174 ¹⁰⁸	KOEH
5507547	GP-66 ¹⁰	LBHR	5549	GG-16	ALL	5573014	G-33	KENW	5574961	G-1174 ¹⁰⁸	PHHR
5507701	G-1121F	LBHR	555	GP-56	AMP	5573014	G-33	KOBL	5574962	G-1174 ¹⁰⁸	BLAW
5507741	GA-49	LBHR	555	GP-56	BGA	5573014	G-33	KOEH	5574962	G-1174 ¹⁰⁸	GMCX
5507991	GA-106 ⁴⁶	LBHR	55525-2	G-1176	ALCH	5573014	G-33	OLIV	5574971	G-33	GMCX
5507991	GA-326 ⁷¹	LBHR	555329	GP-1	LEYL	5573014	G-33	PHHR	5574978	G-119	EUCL
5507994	GA-563	LBHR	55-5484	G-191	CATP	5573052	GP-13	CHEK	5574978	G-119	GMCX
550799408	GA-563	LBHR	5559-65-2510	GP-52 ¹⁰	KOMA	5573062	G-1175 ¹⁰⁸	CLRK	557498	G-33	ALLI
55087	GG-196	AUTO	5559-65-2510	GP-691 ⁴⁸	KOMA	5573102	G-33 ¹⁰⁰	EUCL	5575104	GP-5	GMCX
5508916	GA-6129	LBHR	556012185	GAK-625	RICI	5573102	G-33	GMCX	5575115	G-1174 ¹⁰⁸	GMCX
5508917	GA-6127	LBHR	556012188	GAK-16	RICI	557321	G-1173 ¹⁰⁸	EATN	5575134	G-33	GMCX
5510	GP-34	TUXC	556012192	GAK-20	RICI	5573244	G-1175 ¹⁰⁸	GMCX	5575152	GP-5	GMCX
5510026AA	GA-510	CHRY	556012194	GAK-403	RICI	5573261	G-1173 ¹⁰⁸	ADAM	5575173	G-1174 ¹⁰⁸	GMCX
55102	GG-123	ACC	556012197	GA-33 ¹¹²	RICI	5573261	G-1173 ¹⁰⁸	AUSW	5575176	G-33	GMCX
55110	GG-6	ACC	556019120	G-870	RICI	5573261	G-1173 ¹⁰⁸	BLAW	5575198	GP-5	GMCX
551143	G-200	WIX	556019301	G-296	RICI	5573261	G-1173 ¹⁰⁸	EMCO	5575208	G-33	GMCX
551157	G-801	WIX	556019301	G-296-B	RICI	5573261	G-1173	FWDX	5575224	G-33	GMCX
551157	G-871	WIX	556019309	G-33	RICI	5573261	G-1173 ¹⁰⁸	GMCX	5575246	G-200	GMCX
55117	GG-7	ACC	556019313	G-871	RICI	5573262	G-1175 ¹⁰⁸	AUSW	5575296	G-1173 ¹⁰⁸	GMCX
55122	GG-5 L	ACC	556019319	G-31	RICI	5573262	G-1175 ¹⁰⁸	BARB	5575412	G-31	GMCX
551228	GP-457	WIX	556019328	G-834	RICI	5573262	G-1173 ¹⁰⁸	FWDX	5575428	G-330	GMCX
55123	GG-19	ACC	55608	GAK-403	WALD	5573262	G-1175 ¹⁰⁸	GMCX	5575568	G-1174 ¹⁰⁸	GMCX
55-12503-015	GS-2034	MAN	55-6122	GA-27	WHIT	5573262	G-1175 ¹⁰⁸	LORA	5575823	G-5000	GMCX
55126	GA-100	ACC	556418	GP-761H	JACO	5573263	G-1173 ¹⁰⁸	ADAM	5575840	GP-1	GMCX
551261	GP-36	WIX	5568656314	GP-1	DRES	5573263	G-1173 ¹⁰⁸	BLAW	5575995	G-33	GMCX
551268	GP-9586	WIX	5568656314	GP-1	FURU	5573263	G-1173 ¹⁰⁸	EMCO	5576023	G-333	GMCX
55129	GA-113	ACC	5568656322	GP-3600	DRES	5573263	G-1173 ¹⁰⁸	GMCX	5576025	G-333	GMCX
55129620A	GAVW-2	VOLK	5568656322	GP-3600	FURU	5573264	G-1175 ¹⁰⁸	BARB	5576028	G-6	GMCX
55129620A	GAVW-10	VOLK	5568656325	GAK-403	SCHA	5573264	G-1175 ¹⁰⁸	GMCX	5576049	G-330	GMCX
55130	GA-113	ACC	557	GP-55	AMP	5573265	G-1173 ¹⁰⁸	GMCX	5576054	G-200	GMCX
551338	GP-462	WIX	557	GP-55	BGA	5573266	G-1176	GMCX	5576057	G-191	GMCX
55135	GG-123	ACC	557	G-236	CRO	5573268	G-1173 ¹⁰⁸	GMCX	5576067	G-33	GMCX
55136	GG-6	ACC	5570092	G-31	GMCX	5573353	G-31	GMCX	5576073	G-238	GMCX
551362	GP-81	WIX	557009297	G-31	GMCX	5573433	G-750	GMCX	5576141	G-31	GMCX
55137	GG-7	ACC	5570097	G-31	GMCX	5573446	G-1174 ¹⁰⁸	GMCX	5576147	G-500	GMCX
551374	GP-58	WIX	55-700-97	G-31	DEMP	5573482	G-1174 ¹⁰⁸	ADAM	5576148	G-750	GMCX
55138	GG-16	ACC	5570141	G-31	GMCX	5573482	G-1174 ¹⁰⁸	BLAW	5576199	G-33	GMCX
55139	GG-17	ACC	5570141-43	G-31	GMCX	5573482	G-1174 ¹⁰⁸	GMCX	5576200	G-33	ALCH
551394	GP-157	WIX	5570143	G-31	GMCX	5573490	G-1173 ¹⁰⁸	GMCX	5576200	G-33	ALLI
551396	GP-156	WIX	5570676	G-31	GMCX	5573493	G-1176	GMCX	5576200	G-33	EUCL
5514	GA-303	MPA	557085	GP-3816	WIX	5573597	G-191	GMCX	5576200	G-33	GMCX
5515104	GP-5	GMCX	5571256	G-1173	GMCX	5573614	G-1176	GMCX	5576301	G-335	GMCX
551522	GP-3675	WIX	5571343	G-31	GMCX	5573615	G-1173 ¹⁰⁸	GMCX	5576711	G-33	CLRK
551580	GAK-20	JAEG	5571343	G-31	LINK	557363	G-1173 ¹⁰⁸	EATN	5576797	G-31	GMCX
551607	GP-178	WIX	5571503	G-31	GMCX	5573712	G-1173	GMCX	5576873	GP-1101	

Numero	Gonher	Fabricante	Numero	Gonher	Fabricante	Numero	Gonher	Fabricante	Numero	Gonher	Fabricante				
Number	Gonher	Manufacturer	Number	Gonher	Manufacturer	Number	Gonher	Manufacturer	Number	Gonher	Manufacturer				
5577281		GP-81	GMCX	56115561		GP-28 ⁸	VOLK	5651536		GG-7	GMCX	57092		GP-6811	WIX
55772827		G-330	GMCX	56115561		GP-430 ⁸	VOLK	5651557		GG-7	GMCX	57099		GP-408	WIX
55772827		G-6	GMCX	56115561A		GP-28 ⁸	VAG	5651558		GG-7	GMCX	5710621		GP-3816	BOMG
5577306		G-1174 ¹⁰⁸	GMCX	56115561A		GP-430 ⁸	VAG	5651563		GG-7	GMCX	5710632		GP-28 ⁸	BOMG
5577317		GP-5	GMCX	56115561A		GP-28 ⁸	VOLK	5651584		GG-19	GMCX	5710632		GP-430 ⁸	BOMG
5577317		GP-81	LEYL	56115561A		GP-430 ⁸	VOLK	5651673		GG-1	GMCX	5710633		GP-77	BOMG
5577410		GP-5	GMCX	56115561AB		GP-28	VOLK	5651673		GG-4	GMCX	5710634		GP-54 ¹¹	BOMG
5577569		GP-1101	GMCX	56115561B		GP-28 ⁸	VAG	5651676		GG-1	GMCX	5710634		GP-66 ¹⁰	BOMG
5577588		GP-3	GMCX	56115561B		GP-430 ⁸	VAG	5651676		GG-4	GMCX	5710634		GP-54	KOEK
557759		GP-462	JACO	56115561B		GP-28 ⁸	VOLK	5651677		GG-1	GMCX	5710639		GP-36	BOMG
5577618		GP-81	GMCX	56115561B		GP-430 ⁸	VOLK	5651677		GG-4	GMCX	5710639		GP-36	KOEK
5577945		G-1175 ¹⁰⁸	GMCX	561-155-61B		GP-28 ⁸	PORS	5651682		GG-1	GMCX	5710640		GP-54 ¹¹	BOMG
5577966		G-225	GMCX	561-155-61B		GP-430 ⁸	PORS	5651682		GG-4	GMCX	5710640		GP-66 ¹⁰	BOMG
5577974		G-1175	GMCX	56115561C		GP-28 ⁸	VOLK	5651689		GG-123	GMCX	5710640		GP-54	KOEK
5577981		GP-5	GMCX	56115561C		GP-430 ⁸	VOLK	5651736		GS-2033	GMCX	5711401		GP-28 ⁶	BOMG
5577981		GP-5	JEEP	56115561G		GP-28 ⁸	AUDI	5651764		GG-1	GMCX	5711401		GP-430 ⁸	BOMG
5578014		G-33	GMCX	56115561G		GP-430 ⁸	AUDI	5651764		GG-4	GMCX	57115561		GP-28 ⁶	VAG
5578035		GP-13	GMCX	56115561G		GP-28 ⁸	GULD	5651765		GG-1	GMCX	57115561		GP-430 ⁸	VAG
5578052		GP-13	CHEK	56115561G		GP-430 ⁸	GULD	5651765		GG-4	GMCX	57115561		GP-28 ⁸	VOLK
5578052		GP-13	GMCX	56115561G		GP-28 ⁸	SEAT	56517657		GG-1	GMCX	57115561		GP-430 ⁸	VOLK
5578052		GP-13	MOP	56115561G		GP-430 ⁸	SEAT	56517657		GG-4	GMCX	5711729		GP-1122	BOMG
5578072		GP-13	CHRY	56115561G		GP-28 ⁸	VAG	56517657		GS-2033	GMCX	5711729		GP-1122	KOEK
5578072		GP-13	MOP	56115561G		GP-430 ⁸	VAG	5651775		GG-45	GMCX	5711730		GP-1122	BOMG
5578077		GP-3	GMCX	56115561G		GP-28 ⁸	VOLK	5651776		GG-20	GMCX	5711730		GP-1122	KOEK
5578085		GP-3	GMCX	56115561G		GP-430 ⁸	VOLK	5651780		GG-19	GMCX	5711731		G-1123 ¹⁰⁸	BOMG
5578108		GP-3	GMCX	561-155-61G		GP-28 ⁸	PORS	5651781		GG-19	GMCX	5711731		G-1123 ^{F108}	BOMG
5578135		GP-13	GMCX	561-155-61G		GP-430 ⁸	PORS	5651785		GG-16	GMCX	5711731		G-1123	KOEK
5578188		G-1173	GMCX	561207		G-6	BMW	5651786		GG-17	GMCX	5711732		GP-1122	BOMG
5578262		G-1175 ¹⁰⁸	GMCX	561208		G-6	BMW	5651788		GG-19	GMCX	57124		GP-57	FORD
5578352		GP-13	GMCX	562		GP-1101 ⁵⁴	AMP	5651802		GG-16	GMCX	57124		GP-57	VERS
5578640		G-6	GMCX	562		GP-1101 ⁵⁴	BGA	5651803		GG-17	GMCX	5712600		GP-28 ⁶	BOMG
5578650		G-139	GMCX	563		GS-2033	AMP	5651804		GG-6	GMCX	5712600		GP-430 ⁸	BOMG
5578688		G-834	GMCX	563		GS-2033	BGA	5651809		GG-16	GMCX	57131		G-162H	WIX
5578842		G-1174 ¹⁰⁸	GMCX	563942		GAK-20	CLRK	5651810		GG-17	GMCX	57134		GP-67	WIX
5578843		G-1175 ¹⁰⁸	GMCX	564		GP-85	AMP	5651828		GG-5 L	GMCX	5715388		GP-205	AMG
5578911		G-834	GMCX	564		GP-85	BGA	5651866		GP-1101 ⁵⁴	GMCX	57-16546-13000		GAD-30	LPM
5579164		GP-81 ³¹	GMCX	564		G-1143	CRO	5651879		GG-20	GMCX	57165763		GP-3000	INGR
5579164		GP-9 ⁵⁸	GMCX	5640780		GG-5 L	JEEP	5651886		GP-1101 ⁵⁴	GMCX	57172		GP-452	WIX
5579266		G-335	GMCX	56-4285		GA-31	WHIT	5651920		GG-6	GMCX	57181		GP-58 ⁹	WIX
5579574		GG-48	GMCX	5643186		GA-50	AMCO	5651921		GG-7	GMCX	57182		GP-3937	WIX
5579680		GP-205	AMG	5643186		GA-50	JEEP	5651922		GG-16	GMCX	57187		G-313	WIX
5579770		G-152	GMCX	56450117		GA-56	MASY	5651923		GG-17	GMCX	572		GPP-1122	AMP
558000301		GP-54 ¹¹	BOGE	5645017		GA-56	GMCX	5651924		GG-123	GMCX	57203		G-70	WIX
558000301		GP-66 ¹⁰	BOGE	56457		GP-171	HVYA	5651944		GG-240	GMCX	5720631		GG-1	GMCX
55849		GP-462	TENN	5645790		GA-90	GMCX	56-540153		G-834	JCBM	5720631		GG-4	GMCX
559-00-071-00-20		GA-436	STEY	5646040		GA-90	GMCX	565763		GA-5648	MINN	5720632		GG-5 L	GMCX
559-00-100-03-45		G-31	STEY	5646042		GA-90	GMCX	5658136		GA-50	GMCX	57207		GP-291	WIX
55900433		G-870	LEYL	5646209		GA-90	GMCX	5659		GA-100	ALL	5721376		GG-1	GMCX
55925		G-1176	ALCH	5646509		GA-90	GMCX	5659797		GA-50	GMCX	5721376		GG-4	GMCX
55925-1		G-1176	ALCH	5646510		GA-90	GMCX	566		G-222	AMP	5721377		GG-5 L	GMCX
5597XE		G-222	WIX	5647255		GA-77	GMCX	566		G-222	BGA	57214		G-3827	WIX
55P2690		GAK-20	CHIC	5647414		GA-50	GMCX	566		G-296	CRO	57215		G-3754	WIX
55P269		GAK-20	CHIC	5648		GG-7	ALL	566		G-296-B	CRO	57216		GP-42	HOND
55P269		GAK-20	CONP	5648003		GA-90	GMCX	5661		GA-113	ALL	5721		GP-455	WIX
55P2690		GAK-20	CHIC	5648036		GA-50	GMCX	56-6121		GA-27	WHIT	57243		GP-754	WIX
55P2690		GAK-20	CONP	5648065		GA-44	GMCX	56-6122		GA-27	WHIT	5724690		GA-77	GARW
5600531		GP-13	FORD	5648076		GA-44	GMCX	5662		GA-113	ALL	5724690		GA-77	GMCX
5601056		GP-77	LBHR	5648079		GA-37	GMCX	566682		G-1173	ALCH	57247		GP-761H	WIX
56014		GA-33 ¹¹²	GEHL	5648136		GA-50	AMCO	566682		G-1173 ¹⁰⁸	FIAT	572498-C1		GP-57	IHCO
5601514		GP-1122	LBHR	5648136		GA-50	GMCX	56696654000		GP-91	ISEK	57252		GP-66	WIX
5602073		G-143	LBHR	5648136		GA-50	JEEP	567		GC-1133	AMP	5725461		GA-192	GMCX
5602112		G-1121	LBHR	5648139		GA-50	CHRY	567		G-200	CRO	5725847		G-33	GMCX
560217553		GPP-1122	LOMB	5648139		GA-50	GMCX	5678		G-1175 ¹⁰⁸	WAUK	57269771		GA-26	INGR
5602719		GP-2071W	LBHR	5648152		GA-105	GMCX	568		GP-50	CRO	5727381		GP-81	BOMG
5602720		GP-53	LBHR	5648671		GA-71	GMCX	568440		GP-54	CLAA	5727894		GG-124	BOMG
5604365		GP-57	LBHR	5648679		GA-39	GMCX	56845		GP-3600	TENN	5728385		GA-50	GARW
56050		GG-8 ¹⁰³	SERC	5649		GG-17	ALL	569		GP-1122	AMP	5728385		GA-50	GMCX
56050		GG-8 ¹⁰⁰	SERC	5649690		GA-80	GMCX	56903743		GA-106 ⁶⁵	INGR	5729641		GA-50	GMCX
56050		GG-8 ¹⁰³	SERV	5649797		GA-50	CHEK	56903743		GA-326 ⁷¹	INGR	573		GP-1101	AMP
56050		GG-8 ¹⁰⁰	SERV	5649797		GA-50	GMCX	56928757		GP-27	INGR	573		GP-3816	CRO
56052		GG-5 L	SERV	5650030		GG-20	GMCX	56928765		GP-26	INGR	573		GA-44	DEL
56053		GG-264	SERV	5650170		GG-1	GMCX	56952		G-813	HYST	5730100		GA-853R	BOMG
56058		GG-67	SERV	5650179		GG-4	GMCX	56985963		GP-57	INGR	5730101		GAK-403	BOMG
56059		GG-61	SERV	5650556		GG-5 L	GMCX	56985971		GP-1013Q	INGR	5730101		GAK-403	KOEK
56060		GG-65	SERV	5650658		GG-20	GMCX	57021		G-72	WIX	5730102		GAK-20	BOMG
56061		GG-67	SERV	5650718		GG-5 L	GMCX	57027		GP-36	WIX	5730102		GAK-20	KOEK
56062		GG-7018 ³⁸	SERC	5650743		GG-5 L	GMCX	57028		GP-166 ⁶⁵	WIX	5730103		GA-27	BOMG
56062		GG-7019 ³⁷	SERC	5650780		GG-5 L	GMCX	57028		GP-3937 ³¹	WIX	5730103		GA-27	KOEK
56062		GG-7020 ¹⁴	SERC	5650906		GG-7	GMCX	57033		G-45	WIX	5730104		GAK-403	BOMG
56062		GG-7018 ³⁸	SERV	5650931		GG-20	GMCX	57035		GP-58 ¹⁵	WIX	5730104		GAK-403	KOEK
56062		GG-7019 ³⁷	SERV	5650960		GG-20	GMCX	570350		GA-27	CLRK	5730105		GA-361	BOMG
56062		GG-7020 ¹⁴	SERV	5650961		GG-20	GMCX	57037		GP-737	WIX	5730105		GA-361	KOEK
56063		GG-84	SERC	5650961		GG-20	GMCX	57038		G-180	WIX	5730108		GA-26	BOMG
56063		GG-84	SERV	5651090		GG-5 L	GMCX	57038		G-910	WIX	5730108		GA-26	KOEK
56064		GG-72	SERV	5651100		GGP-25	GMCX	57038		G-918	WIX	5730109		GA-27	BOMG
56066		GG-67	SERV	5651251		GG-20	GMCX	57046		GP-461	WIX	5730109		GA-27	KOEK
56067		GG-95	SERV	5651290		GG-5 L	GMCX	57047		G-912	WIX	5730114		GA-360	BOMG
56070		GG-265	SERV	5651369		GG-6	GMCX								

Referencia Cruzada por Numero de Parte

Cross Reference by Part Number



Numero	Gonher	Fabricante	Numero	Gonher	Fabricante	Numero	Gonher	Fabricante	Numero	Gonher	Fabricante
Number	Gonher	Manufacturer	Number	Gonher	Manufacturer	Number	Gonher	Manufacturer	Number	Gonher	Manufacturer
5730120	GA-206	BOMG	5766164	GA-56	GMCX	5883	GA-33 ¹¹²	EXCL	59154856	GP-754	INGR
5730121	GA-251	BOMG	5767091	GP-5	GMCX	58883	GA-33	EXCL	59156	GG-114	SERC
57302	GP-457	WIX	576975	GA-892	OREN	5894520700	G-1123F	HANO	591567	GP-34	NEWH
573082	GP-166	VICK	576977	GA-892	OREN	589-452-0700	G-1123F	KASB	59158	GG-136	SERC
573083	GP-166	VICK	577064	GG-48	LEYL	589-452-0800	G-1123	KASB	59159	GG-164	SERC
573138-C91	GA-694	IHCO	5772439	GG-5 L	GMCX	590	GP-26	BGA	59160	GG-164	SERC
57314	G-3752	WIX	5773274	GP-66	DEMA	590000-C1	GS-2033	CLEF	591689	GP-66	FORD
57314MP	G-3752	WIX	57745	GP-9000	WIX	590000-C2	GA-251	IHCO	591689	GP-66	NEWH
5733222	G-200	GMCX	57745XD	GP-9000	WIX	59026	GA-251	IHCO	592	GP-1101	CRO
573465-C91	GA-422	IHCO	57746	GP-9001	WIX	59026	G-133	WIX	592000131	G-870	CONV
573640-C1	GA-389	IHCO	57746XD	GP-9001	WIX	59026	G-989	WIX	5922	GA-49	SULL
57368-C1	GA-694	IHCO	57748	GP-9000	WIX	59026500	GP-66	INGR	59226	GP-2951	WIX
573AIR	GA-44	DEL	5775698	GP-5	GMCX	59035	GP-9	WIX	59247	GP-36	WIX
574	G-297	AMP	57766	G-296	MASY	59055	GG-226	SERC	59248	GP-36	WIX
574	G-297-B	AMP	57766	G-296-B	MASY	59056	GG-45	SERV	592602	GP-1	ALCH
574	GA-11	DEL	578	G-238	CRO	59056	G-833	WIX	592602	GP-1	ALCH
574	GA-74	UNN	57810	GP-43	WIX	59060	GG-203	SERV	5926021	GP-310	FIAT
574002	G-870	BRAU	5784640	GP-761H	CLAA	59061	GG-255	SERC	592765	GP-1	ALCH
574002	G-870	MASY	57899	GP-68	WIX	59062	GG-203	SERV	592765	GP-1	FIAT
574002	G-870	PERK	579	G-1173 ¹⁰⁸	CRO	59063	GG-204	SERV	592821-R1	GA-360	IHCO
574002	G-870	RENA	579873-M1	GA-33 ¹¹²	MASY	59065	GG-185	SERV	593	GA-21	DEL
5740096	GP-91	BOMG	57MD25	GA-229	MACK	59069	GG-267	SERV	593302	G-296	OREN
57401	GP-3766	WIX	57MD25P2	GA-493 ¹⁰⁸	MACK	59070	GG-196	SERV	593302	G-296-B	OREN
57404	GP-761H	WIX	57MD26	GA-229	MACK	59070B	GG-196	SERV	593394	GP-3600	OREN
574082	G-162H	PUR	57MD27	GA-373	MACK	59071	GG-63	SERC	59341560	GAK-16	INGR
574107	GA-871	APL	57MD29307	GA-6880	MACK	59071	GG-98	SERC	59387373	GA-27	INGR
574108	G-31	APL	57MD29503	GA-372	MACK	59074	GG-94	SERC	594240-C1	GA-371	IHCO
574110	G-870	APL	57MD310	GA-229	MACK	59074	GG-94	SERV	59428995	GAK-16	INGR
574110	G-870	PUR	57MD311	GA-378	MACK	59080	GG-196	SERV	59436	G-870	LEYL
574111	GG-20	APL	57MD314	GA-885	MACK	59089	GG-208	SERV	59436	G-871	STAN
574112	G-813	APL	57MD33	GA-378	MACK	59096	GG-208	SERV	59438820	GP-1	INGR
574112	G-813	PUR	57MD33	GA-378	MACK	59097	G-31	WIX	59445171	GA-398	INGR
57412	GP-166 ⁶⁵	WIX	57MD35	GA-6880	MACK	59098	G-143	WIX	5945/1F	GG-84	PAR
57412	GP-3937 ¹¹	WIX	57P54670	GA-357	CHIC	59099	G-163	WIX	594686-R91	GA-33 ¹¹²	IHCO
574124	G-836	APL	580	G-1173 ¹⁰⁸	CRO	59066007D	G-1174 ¹⁰⁸	DAGN	594734	G-297-B	CITR
574127	G-31	APL	580007144	GP-171 ¹⁶	YALE	591	GP-27	BGA	59480673	GP-66	INGR
574127	G-31	PUR	5800139-77	GP-3980	YALE	591	GP-81	CRO	59489583	GP-28 ⁶	INGR
574129	G-1121	APL	58042	GA-229	WHIT	59100	GP-54	WIX	59489583	GP-430 ⁸	INGR
574130	G-33	APL	58051	GG-79	SERC	59105	GG-298	WIX	59490664	GP-66	INGR
574132	G-1173 ¹⁰⁸	APL	58052	GG-99	SERV	59110	GG-181	SERC	59500249	GA-27	INGR
574133	G-1123	APL	581	G-1173 ¹⁰⁸	CRO	59110	GG-181	SERV	59501519	GP-171 ¹⁶	HEDE
574139	G-1121	APL	58120	GA-33 ¹¹²	TENN	59111	GG-215	SERV	59507368	G-33	INGR
574148	G-834	APL	58122	GP-58	TENN	59113	GG-215	SERV	59507376	GP-27	INGR
574148	G-834	PUR	58125	GG-214	FORD	59115	GG-214	SERC	59507384	GP-26	INGR
574153	G-191	APL	58125	GP-43	VERS	59115	GG-213	SERV	595075568	G-33	INGR
574157	G-870	PUR	58133843	GAVW-622	AUDI	5911542	G-296	BROY	59507568	G-33	INGR
574159	G-1143	APL	58133843	GAVW-622	VAG	5911542	G-296-B	BROY	59510	G-871	MNH
574184	GP-1	APL	58133843	GAVW-622	VOLK	59115561	GP-28 ⁶	VOLK	59512483	GP-27	INGR
574184	GP-1	PUR	58133843M	GAVW-622	AUDI	59115561	GP-430 ⁸	VOLK	5951661	GPP-1122	FIAT
574186	GP-5	PUR	58133843M	GAVW-622	VOLK	59115561A	GP-28 ⁶	VAG	5951661	GP-1122	LANC
574187	GP-81	APL	581473	GP-1	PEGA	59115561A	GP-430 ⁸	VAG	59517	G-870	MNH
574196	GP-13	APL	58194234	G-750	INGR	59115561A	GP-28 ⁶	VOLK	59517X	G-870	MNH
574198	G-5000	APL	58194747	GP-2071W	INGR	59115561A	GP-430 ⁸	VOLK	59518621	GP-26	INGR
574225	G-119	APL	5821212	GP-66	BOMG	59115561B	GP-28 ⁶	VAG	5951865	GP-171	FIAT
574239	G-139	APL	5821213	GP-66	BOMG	59115561B	GP-430 ⁸	VAG	59518910	GAK-403	INGR
574249	G-152	LOCK	5821214	GG-5 L	BOMG	59115561B	GP-28 ⁶	VOLK	5952	GG-45	ALL
574257	G-500	APL	5821220	GP-66	BOMG	59115561B	GP-430 ⁸	VOLK	5953	GP-58	ALL
574258	G-750	APL	5821220	GP-54	KOEK	59115561C	GP-28 ⁶	VAG	59534669	GP-110	INGR
574264	G-200	APL	5821305	GA-49	BOMG	59115561C	GP-430 ⁸	VAG	5954	GG-45	ALL
574271	G-238	APL	582551	G-1174 ¹⁰⁸	PUR	59115561C	GP-28 ⁶	VOLK	5955	GG-76	ALL
574281	G-331	APL	5825543	GA-879	GARD	59115561C	GP-430 ⁸	VOLK	5955	GG-76	FACE
574284	G-333	APL	58268	G-1143	PUR	59115661A	GP-28 ⁶	VAG	5955068	G-24	HIAB
574319	G-870	APL	58269	G-1143	PUR	59115661A	GP-430 ⁸	VAG	59567255	GAK-1532	INGR
574368	GP-1101	APL	583	GS-2034	AMP	59115661A	GP-28 ⁶	VOLK	59568055	GP-1122	INGR
574390	G-1163	APL	583	GS-2034	BGA	59115661A	GP-430 ⁸	VOLK	5957	GG-1	ALL
574402	G-1173	APL	583125	GAK-625	OREN	59117	GG-181	SERV	5957	GG-4	ALL
574403	G-1174 ¹⁰⁸	APL	583135	GAK-625	OREN	59117	GG-181	SERV	59572842	GP-34	INGR
574409	G-1173	APL	583456	GAK-20	OREN	59118	GG-190	SERC	5958	GG-196	ALL
574415	G-1123	APL	5836010	G-296	BRAU	59118	GG-190	SERV	59587916	GP-34	INGR
574439	GA-80	APL	5836010	G-296-B	BRAU	59120	GG-184	SERV	59594846	GAK-20	INGR
574451	GA-70	APL	5836016	G-296	BRAU	59121	GG-137	SERV	596	GP-92	AMP
574473	GA-77	APL	5836016	G-296-B	BRAU	59121	GG-137	SERV	596	GP-92	BGA
574474	GA-90	APL	58396-47601	GP-36	NISS	59123	GG-142	SERC	596	G-5000	CRO
574476	GA-90	APL	58396-47601B	GP-36	NISS	59123	GG-142	SERV	596	GA-1284	DEL
57448	GA-33 ¹¹²	EXCL	58396-91H10	GP-66	NISS	59125	GG-220	SERV	5960	GG-203	ALL
57455	GA-33 ¹¹²	EXCL	584576	GA-405	PEGA	59126	GG-187	SERV	5962400	GP-1122	FIAT
574844C1	GA-389	CASE	584786	GA-3501	PARM	59127	GG-185	SERV	5965	GP-92	DUTN
574844-C1	GA-389	IHCO	58485	G-1174 ¹⁰⁸	PUR	59128	GG-251	SERV	59651232	GP-93	INGR
575	G-1123	AMP	586	GG-48	AMP	59129	GG-260	SERC	59651257	GP-43	INGR
575	GA-271	UNN	586	GG-48	BGA	59-129-620	GA-2740	VOLK	59651265	GP-53	INGR
57500	GP-3001	WIX	5-86202-208-0	GG-160	ISUZ	59130	GG-150	SERC	596528101	G-870	RICI
5750527	G-330	FORD	5-86202-255-0	GA-514	ISUZ	59130	GG-150	SERV	59666917	GA-27	INGR
5751032	G-6	FORD	5-86202-002-0	GG-160	ISUZ	59130	GP-166	WIX	59681151	GP-92	INGR
57512931	GP-3766	INGR	5865	GAD-1	ALL	59131	GG-115	SERC	59686261	GP-93	INGR
575129311	GP-3766	INGR	5-87310-337-0	GP-3985	ISUZ	59131	GG-115	SERV	597	GP-93	AMP
57521	GP-359	WIX	58736	GG-5 L	FORD	59131	GP-166 ⁶⁵	WIX	597	GP-93	BGA
575942	GP-34	VICK	58736	GG-124	NEWH	59131	GP-3937 ¹¹	WIX	597	GA-1008	DEL
575943	GP-34	VICK	587374	GP-66	DEMA	59136	GG-160	SERV	59700-26112	GA-853R	KUBO
576	G-297-B	AMP	587425-C1	GA-372	IHCO	59137	GG-268	SERV	597033071	GAK-625	RICI
576	G-297-B	BGA	587426C1	GA-377	IHCO	59141	GG-146	SERC	597173	GP-380 ⁴⁴	PARM
576	GP-3816	CRO	58755	GP-14	SAMB	59141	GG-146	SERV	597173	GP-48 ¹¹⁷	PARM
57604	GP-52 ¹⁰	WIX	587568								

Numero	Gonher	Fabricante	Numero	Gonher	Fabricante	Numero	Gonher	Fabricante	Numero	Gonher	Fabricante
Number	Gonher	Manufacturer	Number	Gonher	Manufacturer	Number	Gonher	Manufacturer	Number	Gonher	Manufacturer
59769117	GP-1122	INGR	5PS2530	GAK-403	CHIC	600-185-4110	GA-966R	KOMA	601110290	GP-91	SAMS
59778431	GP-1122	INGR	5PS2530	GAK-403	CONP	600-185-4120	GA-967R	KOMA	6012	GA-3300	NAP
59792	G-33	ALCH	5PS269	GA-26	CHIC	600-211-1210	G-238	KOMA	60129620	GA-49	VAG
59792-6	G-33	ALCH	5PS878	G-33	CHIC	600-211-1230	GP-53	KOMA	60129620	GA-49	VOLK
59796	G-33	ALCH	5PS878	G-33	CONP	600-211-1231	GP-53	KOMA	6013	GA-73 ¹²⁴	NAP
598	GA-1285	DEL	5R0381	GA-1286	CATP	600-211-1290	GP-53	KOMA	601-35390	GG-48	LSTR
598031C91	GA-376	IHCO	5R0381	GA-9334	CATP	600-211-1291	GP-53	KOMA	6015	GAP-381	AQUP
59803361	GAK-403	INGR	5R381	GA-1286	CATP	600-211-1340	GP-9001	KOMA	6016	GP-110	AQUP
59805572	GA-563	INGR	5R381	GA-9334	CATP	600-211-2110	GP-58 ⁹	KOMA	6016	GA-140	NAP
5981936	GP-1122	FIAT	5S0484	G-191	CATP	600-211-5213	GP-36	KOMA	60165	GA-360	GENC
5983298	G-296	FIAT	5S0485	G-238	CATP	600-211-5214	GP-36	KOMA	6017	GP-749	AQUP
5983298	G-296-B	FIAT	5S484	G-191	CATP	600-211-5240	GP-36	KOMA	6017	GA-322	NAP
598380	GP-1122	DYPA	5S485	G-238	CATP	600-211-5241	GP-36	KOMA	601748	GAK-16	MILL
598380	GP-1122	OREN	5S5144	G-1166	CATP	600-211-5242	GP-36	KOMA	60187-6	GP-166	CESS
5983900	GP-9	FIAT	5S5484	G-191	CATP	600-211-6140	GP-36	KOMA	6019	GPP-11	AQUP
5983958	G-296	FIAT	5S5652	GA-5648	CATP	600-211-6140L	GP-36	KOMA	6019329	G-566	FORD
5983958	G-296-B	FIAT	5S8382	GA-1008 ¹⁰⁴	CATP	600-211-6230	GP-36	KOMA	601980	G-296	AVEL
5984018	G-297-B	FIAT	5S8382	GA-1284 ¹⁰⁸	CATP	60021-16230	GP-36	KUBO	601980	G-296-B	AVEL
5984019	G-297-B	FIAT	5S9004	GA-1008 ¹⁰⁴	CATP	600-212-1510	GP-57	KOMA	601980	G-296	CHRY
5984020700	G-1123	HANO	5S9004	GA-1284 ¹⁰⁸	CATP	600-212-1511	GP-57	KOMA	601980	G-296-B	LEYL
5984093	GG-5 L	FIAT	5W3407	GP-77	CATP	600-24-228	G-1176	CLRK	601980	G-296	LEYL
598-450-0800	G-1123	AUWA	5W5887	GP-36	CATP	600-24-229	G-1175	CLRK	601980	G-296-B	LEYL
598-450-0888	G-1123	AUWA	5W5887N	GP-36	CATP	600-24-229	G-1176	CLRK	601980	G-296	MOTA
5984500900	G-1123	HANO	5W6017	GP-54 ¹¹	CATP	600287	GP-3600	GEHL	601980	G-296-B	MOTA
5984520600	G-1123	HANO	5W6017	GP-66 ¹⁰	CATP	6002A15350	G-870	COMA	601984	G-296	LEYL
5984520700	G-1123 ¹⁰⁸	HANO	5W6081	G-296	CATP	600-311-3310	G-296	CATP	601984	G-296-B	LEYL
5984520700	G-1123F ¹⁰⁸	HANO	5W6081	G-296-B	CATP	600-311-3510	GP-55	KOMA	6019967	GPP-14	FORD
5984521500	G-1121	HANO	Números Nuevos			600-311-7110	GP-55	KOMA	601P	G-836	GREY
5984529700	G-1123F ¹⁰⁸	HANO				600-311-7111	GP-55	KOMA	601T15	GAK-20	VERS
5984529700	G-1123 ¹⁰⁸	HENS				600-311-7130	GP-55	KOMA	601T152	GAK-20	VERS
5985420100	G-31	HANO				600-311-7131	GP-55	KOMA	602	G-31	AMP
59860841	GAK-403	INGR				600-311-7132	GP-55	KOMA	602	G-31	BGA
598698-C1	G-159	IHCO				600-311-7632	GP-55	KOMA	602	GP-1	DEL
598730-R1	GAK-16	IHCO				600-311-8281	G-277	KOMA	602	GA-271	UNN
598730-R91	GAK-16	IHCO				600-311-8282	G-277	KOMA	6020	GP-26	AQUP
59873539	GP-864H	INGR				600-311-8283	GPP-14	KOMA	6021	GP-27	AQUP
59877779	GP-761H	INGR				600-311-8290	G-277	KOMA	602329	GP-20	ROVE
59897	G-1176	ALCH				600-311-8291	G-277	KOMA	6023900	G-296	CLAA
59897-0	G-1176	ALCH				600-311-8292	G-277	KOMA	6023900	G-296-B	CLAA
598971	G-1176	ALCH				600-311-8293	GPP-14	KOMA	6024	GA-2719B	NAP
59897-9	G-1176	ALCH				600-311-9120	G-277	KOMA	602-41760	GA-33 ¹¹²	LSTR
599	GPP-14	AMP				600-311-9121	G-277	KOMA	602424	G-870	LEYL
599	GA-8047	DEL				600-319-3510	GP-55	KOMA	602450	GA-33 ¹¹²	READ
5990	GP-81	WHEL				600-320-0110	G-191	KOMA	602451	GA-33 ¹¹²	READ
59901104	GA-416	AGRI	6	GP-54 ¹¹	KAES	600377	G-750	AGCH	6025	GAVV-4	NAP
59905104	GA-892	AGRI	6	GP-66 ¹⁰	KAES	600393	GPP-14	AGCH	602561	GAK-16	READ
59905104	GA-892	FIAT	6	GP-310	WIX	6004	GP-3980	AQUP	6026	GP-9586	AQUP
59941	GA-5648	GALN	600	GA-1286	DEL	600-411-1010	GP-2071W	KOMA	6026	GA-381	NAP
599912	G-33	OREN	600 411 1141	GP-11	KOMA	600-411-1020	GP-2071W	KOMA	602639	GP-20	LEYL
59993451	GAK-16	INGR	600009	GAK-20	GEHL	600-411-1030	GP-1013Q	KOMA	602639	GP-20	ROVE
59LK-5714-A	GP-1	FORD	60002	GA-18	ERO	600-411-1040	GP-1011Q	KOMA	6027	GAD-294	NAP
59W-18660	GP-1	FORD	600022	GAK-20	GEHL	600-411-1140	GP-1011Q	KOMA	6028	GA-7344	NAP
5A	GA-106 ⁴⁶	BOG	600094	G-31	OLIV	600-411-1150	GP-1011Q	KOMA	6029109	GP-28 ⁶	FORD
5A	GA-326 ⁷¹	BOG	60-0094	G-31	WHIT	600-411-1151	GP-1011Q	KOMA	6029109	GP-430 ⁸	FORD
5A517	GA-106 ⁴⁶	GARD	600094A	G-31	MINN	600-411-1160	GP-1013Q	KOMA	602T120	GA-39	VERS
5A517	GA-326 ⁷¹	GARD	600094FS	G-31	MINN	600-411-1161	GP-1013Q	KOMA	602T121	GA-613	VERS
5A518	GA-6129	GARD	6001	GA-135	NAP	600-411-1170	GP-1013Q	KOMA	602T126	G-6	VERS
5A519	GA-360	GARD	6001000383	GA-277	RENA	600-411-1171	GP-1013Q	KOMA	602T141	G-6	VERS
5A6717	GP-110	CATP	600136AA	GP-50	COCT	600-411-1190	GP-2071W	KOMA	603	G-31	AMP
5B351	GA-5648	GARD	600136AA	GP-50	OLIV	600-411-1191	GP-2071W	KOMA	603	G-31	BGA
5B440	GA-26	GARD	60-0136-AA	GP-50	WHIT	600-411-1320	GP-2071W	KOMA	603	G-870	CRO
5B469	GA-356	GARD	600136F	GP-50	OLIV	600-411-1420	GP-1013Q	KOMA	603	GP-3600	DEL
5B472	GA-26	GARD	60-0136-F	GP-50	WHIT	600-411-1571	GP-2071W	KOMA	603007	G-296	AVEL
5B5982	G-333	CATP	600-181-1560	GA-6127	KOMA	6005	GP-13	AQUP	603007	G-296-B	AVEL
5C32-9601-AA	GA-1571	FORD	600-181-3800	GA-106 ⁴⁷	KOMA	6005000735	GP-36	RENA	6031840125	GP-81	HANO
5F5P51833	G-33	CONP	600-181-3800	GA-206 ¹⁰⁸	KOMA	6005000788	GP-1122	RENA	6032	GA-57	NAP
5GH1344000	GP-91	YAMH	600-181-3800	GA-326 ⁷¹	KOMA	6005000894	G-296	RENA	6035	GA-279	NAP
5H5174	G-222	CATP	600-181-4200	GA-6129	KOMA	6005000894	G-296-B	RENA	603503	G-613	AGCH
5H6886	G-238	CATP	600-181-4211	GA-206	KOMA	6005000895	G-297-B	RENA	6036	GA-3647	NAP
5J6174	G-222	CATP	600-181-4212	GA-206	KOMA	6005007409	G-296	RENA	60361	G-33	PUR
5J9174	G-222	CATP	6-00181-423-0	GA-206	ISUZ	6005007409	G-296-B	RENA	60362	G-6	PUR
5L008	GA-106 ⁴⁶	GARD	600-181-4230	GA-206	KOMA	6005007410	G-297-B	RENA	60369	G-31	CLRK
5L008	GA-326 ⁷¹	GARD	600-181-4300	GA-106 ⁴⁶	KOMA	6005011111	GA-853R	RENA	60369	G-31	WAUK
5L1203	GA-1203	CATP	600-181-4300	GA-326 ⁷¹	KOMA	6005012109	GP-14	RENA	603-69A	G-31	ONAN
5L1203	GA-1203	NEL	600-181-4311	GA-106 ⁴⁶	KOMA	6005012113	GPP-418	RENA	6036MP	GA-3647	NAP
5L2772	G-1166	CATP	600-181-4311	GA-326 ⁷¹	KOMA	6005019553	GP-66	RENA	603729AS	G-1143	OLIV
5L7534	G-1166	CATP	6-00181-433-0	GA-106 ⁴⁶	KOMA	6005021346	GP-754	RENA	60-3729-AS	G-1143	WHIT
5L7564	G-1166	CATP	6-00181-433-0	GA-326 ⁷¹	KOMA	6005021347	GP-754	RENA	60378	GAK-20	DAVY
5L7687	GA-29	CATP	600-181-4400	GA-6128	KOMA	6006	GP-3	AQUP	60-3846T2	GAVV-2	STEI
5L8	GA-106 ⁴⁶	GARD	600-181-4500	GA-6128	KOMA	6006	GPP-425	CRO	60389	G-31	CLRK
5L8	GA-326 ⁷¹	GARD	6-00181-460-0	GA-106 ⁴⁶	ISUZ	60066	GP-66	AUSW	60389	G-31	WAUK
5L8363	G-238	CATP	6-00181-460-0	GA-326 ⁷¹	ISUZ	60066	GP-66	CLRK	603962	GAK-16	WAYN
5L8364	G-238	CATP	600-181-4600	GA-106 ⁴⁶	KOMA	6007	GP-1	AQUP	603P	G-296	GREY
5L8403	GA-1203	CATP	600-181-4600	GA-326 ⁷¹	KOMA	6007	GPP-419	CRO	603P	G-296-B	GREY
5M0473	G-1166	CATP	600-181-5480	GA-6128	KOMA	6007	GA-3566	NAP	604 094 0004	GA-2195	CHRY
5M0476	G-1166	CATP	600-181-6050	GA-361	KOMA	600709	GP-2071W	AGCH	604 094 0004	GA-2195	MBNZ
5M0953	G-1166	CATP	600-181-6211	GA-206	KOMA	600717	G-566	AGCH	604 094 01 04	GA-2195	CHRY
5M0957	GA-1285 ¹⁰⁸	CATP	600-181-6560	GA-361	KOMA	600776	G-500	AGCH	604 094 01 04	GA-2195	MBNZ
5M0957	GA-8047 ¹⁰⁴	CATP	600-181-7300	GAK-16	KOMA	6009	GP-1	AQUP	604 094 03 04	GA-2195	CHRY

Referencia Cruzada por Numero de Parte

Cross Reference by Part Number



Numero	Gonher	Fabricante	Numero	Gonher	Fabricante	Numero	Gonher	Fabricante	Numero	Gonher	Fabricante
Number	Gonher	Manufacturer	Number	Gonher	Manufacturer	Number	Gonher	Manufacturer	Number	Gonher	Manufacturer
604 094 10 04	GA-2106	CHRY	607402	GA-33 ¹²	WAYN	6110-70-6201	G-1123	KOMA	6128-81-7221	GA-6127	KOMA
604 094 10 04	GA-2106	MBNZ	607488	G-31	LEYL	6110-70-6201	G-1123F	KOMA	6128-81-7320	GA-6128	KOMA
604 094 1304	GA-2195	MBNZ	6077	GA-3901	NAP	6110-71-8600	G-1143	KOMA	6128-81-7330	GA-6128	KOMA
6040	GA-3588	NAP	608	GP-14	CRO	6111	GA-4365	NAP	613	GP-50	AMP
6040MP	GA-3588	NAP	6080	GA-141	NAP	61115561	GP-31	VOLK	613	GP-50	BGA
6041	GA-390	NAP	608-00-0970000	GG-251	ALFA	61-12	GA-357	ERO	613	GA-86	UNN
6041176	GP-3816	FORD	6081	GA-301	NAP	6112-13-8640	GA-39	KOMA	61-30	GA-679	ERO
6042	GA-4325	NAP	60811822	GG-106	ALFA	6112420	GP-28 ⁵	FORD	6130-13-6750	G-750	KOMA
604208	GP-53	AGCH	60811904	GG-106	ALFA	6112420	GP-430 ⁸	FORD	6130357	G-296	FORD
60424	G-870	LEYL	60812738	GG-106	ALFA	61127175	G-296	VOLK	6130357	G-296-B	FORD
60426	G-870	STAN	6081921	GA-360	DENN	61127175	G-296-B	VOLK	6130358	G-296	FORD
60427	G-870	FERG	6082	GA-166	NAP	61142392	GP-1122	FIAT	6130358	G-296-B	FORD
60427	G-870	KRAM	60834	GA-55	GENC	61142392	GP-1122	IVEC	6130864	GP-57	FORD
60427	G-870	LEYL	6084	GA-3814	NAP	61142397	GP-1122	FIAT	61315	GP-128	PARM
60427	G-870	MASY	6084MP	GA-3814	NAP	61144392	GP-1122	FIAT	6132	GA-274	NAP
60427	G-870	STAM	6085	GA-3647	NAP	6-11450-510-0	G-191	ISUZ	6-132	G-33	ACDS
60427	G-870	STAN	608527	GA-3566	PARM	6114-50-5100	G-191	KOMA	6133	GA-277	NAP
6043	GA-139	NAP	6086	GA-70	NAP	6115020890	GP-166	JSWS	61334	GP-91	PARM
604334	GA-33 ¹²	WAYN	6089	GA-4958	NAP	6115020970	GP-1	JSWS	6134	GA-5056	NAP
6044	GAD-117	NAP	6089378	GA-360	FORD	61150-20970	GP-3569	JSWS	61342	GP-28	PARM
6044	GAD-17	NAP	608990	GP-178	AGCH	61155614	GP-28 ⁵	GULD	61342	GP-28 ⁶	RKHL
60441	GA-33 ¹²	LACR	608P	G-566	GREY	61155614	GP-430 ⁸	GULD	61342	GP-430 ⁸	RKHL
60442	GAK-403	LACR	608T118	GPP-14	VERS	6116	GAD-15	NAP	6134-61-8110	GP-1011Q	KOMA
60-4452T2	GA-3271	STEI	608T119	GG-20	VERS	6117	GA-165	NAP	6134MP	GA-5056	NAP
6045	GA-154	NAP	608T119V11A	GG-20	VERS	6117MP	GA-165	NAP	6135	GA-2194	NAP
6046	GAK-403	LACR	608T137	GPP-14	VERS	6118	GA-216	NAP	6135130	GP-1122	FORD
6046	GA-3681	NAP	609	G-871	AMP	61-18	GA-563	ERO	61356	GP-149	PARM
60472	G-870	MASY	609	G-871	BGA	6119	GA-471	NAP	61361	GP-3682	PARM
60472	G-870	PERK	609161	GP-1	AGCH	611909	GA-135	GMCK	61361	GP-3682	RKHL
6048	GA-3637	NAP	6093	GA-275	NAP	61198552	G-296	VAG	61365	GP-91	PARM
6049	GA-429	NAP	609374	GA-361	AGCH	61198552	G-296-B	VAG	61365	GP-91	RKHL
604948	GA-206	GETM	609375	GA-360	AGCH	61198552	G-296	VOLK	61372	GP-68	PARM
604950	GA-106 ⁴⁶	GETM	609421	GA-360	DROT	61198552	G-296-B	VOLK	61372	GP-68	RKHL
604950	GA-326 ⁷¹	GETM	609431	GP-864H	AGCH	612	GP-1	AMP	613797-C91	G-33	IHCO
6050140	GA-880R	PELJ	6095	GAD-118	NAP	612	GP-1	BGA	613798-C91	G-33	IHCO
60506968	GG-408	ALFA	609592	GP-3569	PARM	612	GA-85	UNN	61381	GP-40	PARM
605-06-968	GG-246	ALFA	6097	GA-133	NAP	6120	GA-271	NAP	6139	GA-3916	NAP
605-07-208	GPP-1122	ALFA	6098	GA-432	NAP	6120-50-5101	G-191	KOMA	61392	GP-3531 EXP	PARM
6051	GA-217	NAP	609934	GP-761H	AGCH	6120-50-5102	G-191	KOMA	61392	GP-3531 EXP	RKHL
60514-AS	GP-50	WHIT	60-999-620	GA-49	VOLK	6120-50-5103	G-191	KOMA	61394	GP-157	PARM
605-21-128	GP-81	ALFA	60F	G-1121	CHP	6120-81-7412	GA-6127	KOMA	61394	GP-157	RKHL
605-23-4320000	GG-251	ALFA	61	GA-78	WIX	6120920001	GPP-612	MBNZ	61396	GP-156	PARM
605264	GA-33 ¹²	WAYN	610-00-070-00-5	GP-54 ¹¹	STEY	6120MP	GA-271	NAP	6139MP	GA-3916	NAP
6053	GAD-129	NAP	610-00-070-00-5	GP-66 ¹⁰	STEY	61212	G-112	PARM	6139PS1734	GAK-20	CANP
6054	GA-56 ⁹⁰	NAP	6100-266	GP-1	HYDR	6123	GAVW-2	NAP	613P	G-162H	GREY
6054100002	G-1121	MWM	6100448	GP-1	ROOT	6124136	GP-1122	FORD	614	GP-81 ³¹	CRO
60541140003	G-1123	MWM	6100448	GP-1	TALB	61258	GP-20	PARM	614	GP-9 ⁵⁸	CRO
60541180002	GP-310	MWM	610-07-05	GP-54 ¹¹	STEY	61258	GP-20	RKHL	614-08-073-9	G-1123	STEY
60541180003	GP-310	MURY	610-07-05	GP-66 ¹⁰	STEY	6125-81-7031	GA-106 ⁶⁷	KOMA	614-08-074-0	G-1123F	STEY
60541180003	G-238	MWM	61029	GA-271	KMA	6125-81-7031	GA-206 ¹⁰⁸	KOMA	614-09-073-9	G-1123	STEY
60554	G-834	LACR	61029	GA-271	MTRV	6125-81-7031	GA-326 ⁷²	KOMA	6144	GA-392	NAP
605602	GP-34	HAGI	610309-C91	G-1163	IHCO	6125-81-7032	GA-106 ⁶⁷	KOMA	6146	GA-180	NAP
605624	GA-33 ¹²	WAYN	6103124	GAK-403	DENN	6125-81-7032	GA-206 ¹⁰⁸	KOMA	6147498	G-1175 ¹⁰⁸	GMCK
6057	GA-7142	NAP	6103279	GG-246	FORD	6125-81-7032	GA-326 ⁷²	KOMA	6148	GA-2106	NAP
605-74-554	GP-58	ALFA	61036	GP-3980	PARM	61259013	GP-1013Q	FIAT	6149716	G-296	FORD
605757AS	G-1173 ¹⁰⁸	OLIV	61036	GP-3980 ⁴⁴	RKHL	61259040	GP-57	FIAT	6149716	G-296-B	FORD
605757-AS	G-1173	WHIT	6104	GA-476	NAP	6126	GA-273	NAP	6149717	G-296	FORD
605757FS	G-1173 ¹⁰⁸	OLIV	61040	GP-46	PARM	6126-62-91	GG-251	ALFA	6149717	G-296-B	FORD
605757FS	G-1173 ¹⁰⁸	WHIT	61040	GP-46	RKHL	6126MP	GA-273	NAP	615	G-5000	AMP
605814AS	GP-50	OLIV	61042	GP-44	PARM	6127-51-5040	G-238	KOMA	615	G-5000	BGA
605814-AS	GP-50	WHIT	61042	GP-44	RKHL	6127-81-4711	GA-6127	KOMA	615	GP-171	CRO
605814ASA	GP-50	OLIV	61045	GP-3429	PARM	6127-81-4712	GA-6127	KOMA	6150	GA-129	NAP
605814-ASA	GP-50	WHIT	61045	GP-3429	RKHL	6127-81-7031	GA-6127 ¹⁰⁸	KOMA	6150-080-04-3	GP-1122	STEY
605814FS	GP-50	OLIV	6105	GA-595	NAP	6127-81-7031	GA-6129 ¹⁰⁴	KOMA	61511	GP-66	GEHL
605814-FS	GP-50	WHIT	61-05	GA-483	ERO	6127-81-7032	GA-6127 ¹⁰⁸	KOMA	61515	GP-1	PARM
6058519	GG-246	FORD	61053	GAVW-2	KMA	6127-81-7032	GA-6129 ¹⁰⁴	KOMA	61515	GP-1	RKHL
60608-00800	GA-106 ⁴⁶	MIT	61053	GAVW-2	MTRV	6127-81-7033	GA-6127 ¹⁰⁸	KOMA	61516	GP-3600	PARM
60608-00800	GA-326 ⁷¹	MIT	61060	GP-205	PARM	6127-81-7033	GA-6129 ¹⁰⁴	KOMA	61516	GP-3600	RKHL
6061641	GAK-217	FORD	61061	GP-13	RKHL	6127-81-7040	GA-6127	KOMA	61521	GP-171	PARM
606168	GG-124	LEYL	61064	GP-91	PARM	6127-81-7310	GA-6129	KOMA	61521	GP-171	RKHL
606204	GG-48	LEYL	6106753	GP-1122	FORD	6127-81-7311	GA-6129	KOMA	61522	GP-3675	PARM
6063473	GAK-403	DENN	61068	GP-81 ³¹	PARM	6127-81-7320	GA-6129	KOMA	6153	GA-6479	NAP
6064	GA-386	NAP	61068	GP-9 ⁵⁸	PARM	6127-81-7411	GA-6127	KOMA	615447C1	G-333	IHCO
6064881	GA-3425	FORD	61068	GP-81 ³¹	RKHL	6127-81-7412	GA-6127	KOMA	61559	GP-55	VERS
6065	GA-59	NAP	61068	GP-9 ⁵⁸	RKHL	6127-81-7413	GA-6127	KOMA	6157	GA-78	NAP
606-511	G-1143	KALB	6106841	GP-54 ¹¹	FORD	6127-81-7421	GA-6127	KOMA	6158	GA-382	NAP
6066	GA-3681	NAP	6106841	GP-66 ¹⁰	FORD	6127-81-9031	GA-6127	KOMA	61584009	GP-36	FIAT
6066094	GP-3816	FORD	61069	GP-3	PARM	612797C91	G-333	IHCO	6160	GP-31	CRO
6066095	GP-3816	FORD	61069	GP-3	RKHL	6128-51-5091	G-238	KOMA	6160	GA-3523	NAP
6066096	GP-3816	FORD	6108	GA-604	NAP	6128-81-4400	GA-6128	KOMA	6160448	GP-1	CHRY
6066755	G-335	ELGN	61085	GP-81	PARM	6128-81-7040	GA-6127 ¹⁰⁸	KOMA	6160448	GP-99	MOTA
6067	GA-192	NAP	61088	GP-28 ⁵	PARM	6128-81-7040	GA-6128 ¹⁰⁴	KOMA	6160448	GP-1	TALB
6067917	G-119	ELGN	61088	GP-430 ⁵	PARM	6128-81-7041	GA-6127	KOMA	61607	GP-178	PARM
6068	GA-71	NAP	610932-C91	G-1163 ¹⁰⁸	IHCO	6128-81-7042	GA-6127 ¹⁰⁸	KOMA	61607	GA-8047	GLOB
6069	GA-70	NAP	610P	G-813	GREY	6128-81-7042	GA-6128 ¹⁰⁴	KOMA	6161789	G-296	FORD
607	G-750	CRO	611	AMP	AMP	6128-81-7050	GA-6127 ¹⁰⁸	KOMA	6161789	G-296-B	FORD
607	GP-56	DEL	611	GP-1	BGA	6128-81-7050	GA-6128 ¹⁰⁴	KOMA	61618093200	GA-44	PARM
607071	GP-57	AGCH	611	GP-3682	PMC	6128-81-7051	GA-6127 ¹⁰⁸	KOMA	6162	GA-6690	NAP
6070-81	GA-90	JSCB	611 180 00 09</								

Numero	Gonher	Fabricante	Numero	Gonher	Fabricante	Numero	Gonher	Fabricante	Numero	Gonher	Fabricante
Number	Gonher	Manufacturer	Number	Gonher	Manufacturer	Number	Gonher	Manufacturer	Number	Gonher	Manufacturer
616520	GA-33 ¹²	FIAT	620003-5	GA-5648	ALCH	621321	GA-21	CUMM	62725	GA-490	PARM
6165401	GG-408	S500	620004	GA-5648	ALCH	62133	GA-277	RKHL	6273	GA-566	NAP
61654541	GA-360	FORD	620005	GA-5648	ALCH	62136	GA-4303	PARM	6275	GA-33 ¹²	THOM
61654541	GA-360	IVEC	62000AB	GP-166	CASE	62136	GA-4303	RKHL	6275368	G-296	FIAT
6166040	GG-220	S500	62002	GA-85	GLOB	62140	GA-3424	RKHL	6275368	G-296-B	FIAT
6166512	GA-75	FORD	62003817	GA-357	BUCY	62141	GA-3425	PARM	62784	GA-33 ¹²	GENC
61669	GA-9045	GLOB	62003818	GA-356	BUCY	62141	GA-3425	RKHL	6279	GAD-30	NAP
6167	GA-85	NAP	6-2004-0	GP-1122	KAES	6215	GA-607	NAP	627934-C1	GA-329	CASE
61670	GA-1287	GLOB	6200-466	GP-1	HYDR	62170	GAVW-2	PARM	627934-C1	GA-329	IHCO
61671160	GP-54 ¹¹	FIAT	62006	GA-57	GLOB	62170	GAVW-2	RKHL	627934-C1	GA-329	KOMA
61671160	GP-66 ¹⁰	FIAT	62006	GA-273	KMA	621740	G-296	FIAT	627935-C1	GA-239	IHCO
61671160	GP-54 ¹¹	IVEC	62006	GA-273	MTRV	621740	G-296-B	FIAT	627935-C1	GA-239	KOMA
61671160	GP-66 ¹⁰	IVEC	6200-626	GP-3985	HYDR	62185	G-871	CASE	628	G-870	AMP
61671600	GP-54 ¹¹	ALCH	62008	GA-59	GLOB	62185	G-870	DAVI	628	G-870	BGA
61671600	GP-66 ¹⁰	ALCH	6200AF	GP-166	CESS	621P	G-833	GREY	62800	G-871	MNH
61671600	GP-54 ¹¹	FIAT	62011	GA-71	RKHL	622	G-34	CRO	6284	GAD-30	NAP
61671600	GP-66 ¹⁰	FIAT	6201200	G-566	LBHR	6220	GA-89	NAP	628616	GA-140	PARM
616720	GA-33 ¹²	FORD	62020	GA-70	PARM	62200A	GP-166	CESS	6288	GA-198	NAP
61673585	GP-54 ¹¹	ALCH	62020	GA-70	RKHL	62200A14	GP-166	CESS	6289	GA-175	NAP
61673585	GP-66 ¹⁰	ALCH	620215	GA-1285	CLRK	62200AF	GP-166	CESS	628P	G-31	GREY
61673585	GA-326 ⁷¹	FIAT	6203126	GP-68	FORD	62200B	GP-166	CESS	628P1	G-31	GREY
61673585	GP-66 ¹⁰	FIAT	62039	GA-54	PARM	62200D	GP-166	CESS	628P2	G-31	GREY
61673585	GP-54 ¹¹	IVEC	62039	GA-54	RKHL	62200G2	GP-166	CESS	62906	GAD-3	PARM
61673585	GP-66 ¹⁰	IVEC	6204	GA-422	NAP	6221	GA-2110	NAP	62906	GAD-3	RKHL
61674455	GP-1222	FIAT	62044	GA-730	RKHL	62218	GA-390	PARM	62907	GAD-1	PARM
61675	GA-1286	GLOB	62047	G-31	OLIV	62218	GA-390	RKHL	62912	GA-3490	RKHL
61676	GA-26	GLOB	62047	G-31	WHIT	6226097	GA-361	FIAT	6293	GA-240	NAP
61683	GA-18	GLOB	62054	GA-77	PARM	623	GP-81	CRO	629329-C91	GA-329	IHCO
61690	GA-33 ¹²	GLOB	62054	GA-77	RKHL	6230	GA-200	NAP	629330-C91	GA-239	IHCO
6169998	GA-106 ⁴⁶	FORD	62055	GA-80	PARM	6230	GA-218	NAP	6298	GA-2198 ⁷¹	NAP
6169998	GA-326 ⁷¹	FORD	62055	GA-80	RKHL	62300024	GA-27	BUCY	6298	GA-438 ⁷¹	NAP
617	G-330	AMP	62057	GA-74	PARM	623000296	GA-26	BUCY	629821-R1	GA-360	IHCO
617	GP-52 ¹⁰	DEL	62057	GA-74	RKHL	62300685	GA-6127	BUCY	629P	GG-48	GREY
617	GP-691 ⁴⁸	DEL	62059	G-871	STAN	62300686	GA-6129	BUCY	62BP109	GG-123	HOLY
6170	GA-276	NAP	620601	G-1121	MASY	623050-4	GAK-16	ALCH	62BP126A	GG-5 L	HOLY
61734	GA-303	PARM	62067	GA-303	PARM	62312	GA-229	GLOB	62BP127A	GG-5 L	HOLY
6174	GA-174	NAP	62067	GA-303	RKHL	62317	GA-378	GLOB	62BP150	GG-6	HOLY
61740	G-870	ARMS	620717	GA-5648	ALCH	62331463	GA-357	VOLV	62R124A	GG-20	HOLY
61742	GP-3766	PARM	620717	GA-5648	FIAT	62333	GA-139	PARM	630	GP-9586	DEL
6174AMP	GA-174	NAP	620717-4	GA-5648	ALCH	62333	GA-139	RKHL	63002	GA-50	KMA
6179	GA-153	NAP	620717-9	GA-5648	ALCH	6234	GA-153	NAP	63002	GA-50	MTRV
618	GP-66	AMP	62073	GA-75	PARM	62349	GA-2740	PARM	63003	GA-77	KMA
618	GP-66	BGA	62073	GA-75	RKHL	62349	GA-2740	RKHL	63003	GA-77	MTRV
618	GP-92	DEL	62077	GA-3300	PARM	62350-63	GG-5 L	HARL	6302	GA-164	NAP
6180	GA-253	NAP	62077	GA-3300	RKHL	62357	GA-6880	GLOB	63023	GA-192	KMA
6180-51-5130	GP-1	KOMA	620-820-367	GAC-3	SEAT	62358	GA-7716	GLOB	63023	GA-192	MTRV
61812	G-500	ALCH	620-820-367	GAC-3	VOLK	62359	GA-7360	GLOB	630257	G-1121	MASY
61814	G-500	ALCH	620-820-367B	GAC-3	SEAT	6236	GA-4828	NAP	630270-R2	GA-361	IHCO
61814	G-500	FIAT	620-820-367B	GAC-3	VOLK	62384	GA-483	GLOB	6303	GA-514	NAP
61814-2	G-500	ALCH	62083	GA-4303	KMA	62384	GA-278R	PARM	63070	GA-3647	KMA
61817	G-500	ALCH	62083	GA-50	PARM	62385	GA-482	GLOB	63070	GA-3647	MTRV
61817	G-500	FIAT	62083	GA-50	RKHL	62385	GA-224	PARM	63071	GA-274	KMA
61817-9	G-500	ALCH	62087	GA-277	KMA	62389	GA-248	PARM	63071	GA-274	MTRV
61818	G-500	ALCH	62087	GA-277	MTRV	624	GP-14	AMP	630710	GA-1008	CLRK
61819	G-500	ALCH	62088	GA-5056	KMA	624	GP-38	CRO	6308	GA-605	NAP
61846	GA-6129	GLOB	62088	GA-5056	MTRV	6240	GAVW-120	NAP	63085	GA-3814	KMA
6184813	GA-12	GMCX	62088	GA-192	PARM	6241405	GA-563	VOLV	63085	GA-3814	MTRV
6186	GA-142	NAP	62088	GA-192	RKHL	62429	GA-2984	GLOB	63099	GA-390	KMA
61880	GA-6127	GLOB	62093	GA-3901	KMA	6243135	GA-1203	GMCX	6300	G-1174 ⁴⁹⁸	WIN
61894	GA-356	GLOB	62093	GA-3901	MTRV	6244	GA-195	NAP	630P	G-871	GREY
618FPS1734	GA-106 ⁴⁶	CONP	62094	GA-174	KMA	6246	GA-7017	NAP	63103	GA-382	KMA
618FPS1734	GA-326 ⁷¹	CRO	62095	GA-55	PARM	62476	GA-286	PARM	63116700	GP-77	RENA
619	GP-54	CRO	62095	GA-55	RKHL	62478	GA-6128	GLOB	631198	G-31	TOWM
619	GP-93	DEL	62096	G-162H	PUR	62484	GA-395	PARM	631201530	GA-405	VANH
6190	GA-6619 ¹	NAP	62098	GA-59	PARM	62488	GA-348	PARM	631226	G-834	MASY
6190	GA-6620 ¹	NAP	62098	GA-59	RKHL	624A0299	GA-27	KOEHL	631227	G-1121	MASY
61901	GP-3816	KAES	62099	GA-325	PARM	625	G-871	AMP	631P	G-24	GREY
61905	GA-357	GLOB	621	GP-26	DEL	625	G-871	BGA	6320	GA-2114	NAP
6190627-M1	GA-853R	MASY	62101	GP-500	ALCH	625	GP-85	DEL	6321	GA-2195	NAP
61908-00100	GA-206	MITTS	62101	GP-500	FIAT	625	GP-34	NOEQ	632114112	G-162H	VANH
6-1918-0	GP-54 ¹¹	KAES	62101	GAD-15	KMA	62500	GA-372	GLOB	63219001	GP-1	VERM
6-1918-0	GP-66 ¹⁰	KAES	62101	GA-57	PARM	62524	GA-168	PARM	632207450	GP-1013Q	VANH
6195	GA-244	NAP	62101	GA-57	RKHL	6253	GA-158	NAP	6323	GA-7007	NAP
61979	GP-52 ¹⁰	KAES	62101-2	G-500	ALCH	6255	GA-3501	NAP	632315	G-1176	TOWM
61979	GP-691 ⁴⁸	KAES	62101232	GA-879	NORT	62554	GAP-381	GLOB	63234	GP-310	MANO
61981	GP-54	KAIS	62102	G-500	ALCH	625625-C1	GP-1101	IHCO	6325	GA-119	NAP
6-1981-0	GP-54	KAIS	62103	GA-3523	PARM	625626-C1	GP-1105	IHCO	6327	GAVW-121	NAP
6-1981-00	GP-54 ¹¹	KAES	62103	GA-3523	RKHL	625627-C1	GP-1108	IHCO	6327468	G-31	HALL
6-1981-00	GP-66 ¹⁰	KAES	62105	GA-362	KMA	625627-C1	GP-1108	KOMA	6327470	G-31	HALL
6-1981-0-A1	GP-54	KAIS	62107	GA-180	KMA	626	G-566	CRO	6327470B	G-31	HALL
6-1989-0	GA-405	KAES	62109	GA-195	KMA	6260152271	G-1123	HANO	63280600	GP-1122	RENA
6-1993-0	GA-436	KAES	62112	GA-386	KMA	62608-00200	GA-106 ⁴⁶	MITTS	63317111001	GP-28 ⁶	TOKY
6-1995-0	GA-467	KAES	621128	GA-8047	CLRK	62608-00200	GA-326 ⁷¹	MITTS	63317111001	GP-430 ⁸	TOKY
619P	G-613	GREY	62113	GA-86	PARM	626181	GA-106 ⁴⁶	ALCH	63324	G-65	RKHL
61F	G-1123	CHP	62113	GA-86	RKHL	626181	GA-326 ⁷¹	ALCH	6339	GA-128	NAP
61FPS1734	GAK-403	CONP	6211489-7	GP-54 ¹¹	VOLV	626-23-821	G-834	MZDA	633P	G-163	GREY
62	GA-18	ERO	6211489-7	GP-66 ¹⁰	VOLV	62631	GA-371	GLOB	634	G-33	CRO
620	G-813	AMP	6211585	G-296	VOLV	6264	GA-362	NAP	6340398	GP-81	GOL
620	G-813	BGA	6211585	G-296-B	VOLV	6-266	G-500	ACD	6345280306	GA-864R	MBNZ
620	G-297-B	CRO	62115852	G-296	VOLV	6267	G-750	AC	63459	GP-34	GEHL
620	GP-34	DEL	62115852	G-296-B	VOLV	6267	GAD-29	NAP	6349	GA-127	NAP
6200	GA-3501	NAP	62116	GA-422	GLOB	6-267	G-750	ACD	635	G-162H	AMP
620003	GA-5648	ALCH									

Referencia Cruzada por Numero de Parte

Cross Reference by Part Number



Numero	Gonher	Fabricante	Numero	Gonher	Fabricante	Numero	Gonher	Fabricante	Numero	Gonher	Fabricante
Number	Gonher	Manufacturer	Number	Gonher	Manufacturer	Number	Gonher	Manufacturer	Number	Gonher	Manufacturer
635P		G-191 GREY	64079		GA-3588 MTRV	6426987		G-1174 ¹⁰⁸ LEDR	6438085		G-1163 GMCX
6360		GA-33 ¹¹² NAP	64084		GA-4325 KMA	6426988		G-33 LBHR	6438121		GP-171 ¹⁶ GMCX
6361613		G-750 LBHR	64084		GA-4325 MTRV	6427114		GP-43 LBHR	6438122		GP-66 GMCX
636-23-802		G-834 MZDA	640934		GA-192 GMCX	6427275		G-33 GMCX	6438148		GP-13 GMCX
63623-820A		G-834 NISS	641		GA-3425 FACE	6429		GA-768R NAP	6438162		GP-81 ²¹ GMCX
636-23-821		G-834 MZDA	641		GA-3425 UNN	643		G-870 CRO	6438162		GP-9 ⁸⁸ GMCX
636372		G-31 GERL	64100		GA-3490 KMA	6431690		GA-405 CLAA	6438209		G-33 GMCX
636372		G-31 TOWM	64100		GA-3490 MTRV	64320-47211		GAK-16 MITS	6438261		GP-3 GMCX
63-6372		G-31 CATP	641123		GP-28 ⁸ CECC	64323-90636		GP-81 MITS	6438384		GP-13 DETR
636843		GP-34 FORD	641123		GP-430 ⁸ CECC	6432PER17		GP-81 MACK	6438384		GP-13 GMCX
636843		GP-34 NEWH	6415		GA-49 NAP	6433		GA-197R NAP	6438401		G-238 GMCX
636844		GP-66 NEWH	6415541		GP-66 CLRK	643422		GA-56 GMCX	6438403		G-191 GMCX
63691		G-33 CLRK	6416		GA-1616 NAP	6435035		G-5000 GMCX	6438409		G-238 GMCX
637		GP-1 CRO	6417		GA-442 NAP	6435036		G-5000 GMCX	6438415		G-225 GMCX
6371122		GP-36 PEGA	6418		GA-1615 NAP	6435087		G-813 GMCX	6438419		G-152 GMCX
6371716		G-296 BEDF	6419		GA-1614 NAP	6435089		G-870 GMCX	6438432		G-331 GMCX
6371716		G-296-B BEDF	6419301		GA-105 GMCX	6435091		G-11816 GMCX	6438452		G-1173 GMCX
6371716		G-296 GMCX	6419309		GA-105 GMCX	6435092		G-871 GMCX	6438454		G-1173 GMCX
6371716		G-296-B GMCX	6419362		GA-192 GMCX	6435093		G-871 GMCX	6438455		G-1175 GMCX
63781-72R		GP-58 HARL	6419857		GA-50 GMCX	6435094		G-870 GMCX	6438457		G-1174 GMCX
63785		GA-33 ¹¹² EATN	6419892		GA-192 GMCX	6435095		G-870 GMCX	6438468		G-1175 GMCX
637899		G-1176 TOWM	642		GP-3600 CRO	6435102		G-870 GMCX	6438469		G-1175 GMCX
637957		G-500 ALCH	642		GA-2984 DEL	6435103		G-836 GMCX	6438470		G-1174 GMCX
637957-1		G-500 ALCH	64201-0020		GG-5 L SUBA	6435145		G-871 GMCX	6438490		G-236 GMCX
637957-2		G-500 ALCH	64201-00201		GG-5 L SUBA	6435460		GP-50 GMCX	6438511		G-191 GMCX
63796-77		GP-58 HARL	642010200		GG-199 SUBA	6435477		G-1123 GMCX	6438513		GP-10 GMCX
638		G-836 AMP	6420408		GA-5648 GMCX	6435674		G-200 GMCX	6438561		G-335 GMCX
638		G-836 BGA	6420490		GA-56 GMCX	6435675		GP-1 GMCX	6438567		G-834 GMCX
63805-80		GP-58 HARL	6420491		GA-56 GMCX	6435677		GP-5 GMCX	6438590		G-33 GMCX
63805-80A		GP-58 HARL	6420680		GA-56 GMCX	6435678		GP-5 GMCX	6438680		G-870 GMCX
63806-83		GP-58 HARL	6420690		GA-56 CHEK	6435679		GP-13 GMCX	6438686		G-870 GMCX
6381290		GP-3600 HARL	6420690		GA-56 GMCX	6435736		GP-50 GMCX	6438690		G-870 GMCX
638274		GAK-403 ALCH	6420696		GA-56 GMCX	6435917		G-1143 GMCX	6438694		GP-11 GMCX
638274		GAK-403 FIAT	6420901		GA-56 GMCX	6436058		G-1143 GMCX	6438696		GP-1101 GMCX
6383		GA-2118 NAP	6420903		GA-56 GMCX	6436089		GP-5 AMCO	6438698		GP-110 GMCX
6388		GA-172 NAP	6420904		GA-56 GMCX	6436089		GP-5 CRIS	6438700		GP-1105 GMCX
638P		G-238 GREY	6420934		GA-192 GMCX	6436089		GP-5 JEEP	6438704		GP-1108 GMCX
639		G-834 AMP	6421446		GA-55 GMCX	6436145		G-33 GMCX	6438811		G-613 GMCX
639		G-834 BGA	6421538		GA-8047 GMCX	6436205		G-222 GMCX	6438812		G-613 GMCX
639		G-1175 ¹⁰⁸ CRO	6421539		GA-9045 GMCX	6436232		GP-66 GMCX	6438813		G-169 GMCX
6390		GAUV-620 NAP	6421540		GA-9334 GMCX	6436241		GPP-11 GMCX	6438814		G-169 GMCX
639005-0		GAK-16 ALCH	6421541		GA-1008 GMCX	6436290		G-566 GMCX	6438835		GP-26 ⁶ GMCX
639050		GAK-16 ALCH	6421671		GA-78 GMCX	6436319		GP-20 GMCX	6438835		GP-92 ⁴⁵ GMCX
639050		GAK-16 FIAT	6421746		GA-55 GMCX	6436383		GP-14 GMCX	6438836		GP-27 ⁶ GMCX
639050-4		GAK-16 ALCH	6421824		GA-7 GMCX	6436567		G-1174 GMCX	6438836		GP-93 ⁴⁵ GMCX
6390504-4		GAK-16 ALCH	6422135		GA-1203 GMCX	6436572		GP-11 ⁷⁶ GMCX	6438837		GP-26 GMCX
639050-7		GAK-16 ALCH	6422139		GA-375 GMCX	6436572		GP-1101 ⁴⁵ GMCX	6438838		GP-27 GMCX
6390550		GAK-16 FIAT	6422260		GA-56 ²⁰ GMCX	6436573		GPP-14 GMCX	6438839		GP-26 BEDF
639055-0		GAK-16 ALCH	6422680		GA-56 ⁵⁰ GMCX	6436608		GPP-14 GMCX	6438839		GP-26 DETR
639213		G-1176 ALCH	6422727		GA-56 GMCX	6436749		GP-1 GMCX	6438839		GP-26 GMCX
639213-2		G-1176 ALCH	6422866		GA-50 GMCX	6436848		G-1173 GMCX	6438839		GP-26 PHHR
639214		G-1173 ¹⁰⁸ ALCH	6422880		GA-56 GMCX	6437008		G-331 GMCX	6438839		GP-26 TERE
639214-1		G-1173 ¹⁰⁸ ALCH	6422887		GA-56 GMCX	6437034		GP-20 AMCO	6438840		GP-27 GMCX
6394		GAK-16 NAP	6423057		GA-27 GMCX	6437034		GP-20 JEEP	6438840		GP-27 PHHR
63953-AS		G-296 WHIT	6423106		GA-11 GMCX	6437055		GP-3 GMCX	6438842		G-333 GMCX
63953-AS		G-296-B WHIT	6423107		GA-11 GMCX	6437228		GP-66 GMCX	6438866		GP-171 ¹⁶ GMCX
639959-7		GAK-16 ALCH	6423108		GA-7 GMCX	6437275		G-33 GMCX	6438883		G-333 GMCX
639P		G-222 GREY	6423122		GA-7 GMCX	6437325		G-870 GMCX	6438919		GP-2071W GMCX
640		GP-31 CRO	6423125		GA-29 GMCX	6437326		G-871 GMCX	6439031		GP-23 GMCX
640		GA-3424 FACE	6423135		GA-1203 GMCX	6437358		GP-1101 GMCX	6439034		GP-23 GMCX
640		GA-3224 UNN	6423137		GA-1286 GMCX	6437359		GPP-14 GMCX	6439109		GP-171 GMCX
6400373		GAUV-2 VOLV	6423138		GA-1284 GMCX	6437375		G-871 GMCX	6439131		GP-34 GMCX
6400379		GAUV-2 VOLV	6423139		GA-375 GMCX	6437401		GP-20 GMCX	6439132		GP-34 GMCX
64004		GA-3637 KMA	6423148		GP-13 GMCX	6437411		GP-50 GMCX	6439133		GPP-18 GMCX
64004		GA-3637 MTRV	6423383		GA-11 GMCX	6437412		GP-3 GMCX	6439134		GPP-18 GMCX
64008		GA-70 KMA	6423398		GA-11 GMCX	6437417		GP-3 GMCX	6439142		GP-81 ²¹ GMCX
64008		GA-70 MTRV	6423516		GA-50 GMCX	6437419		GP-81 GMCX	6439142		GP-9 ⁸⁸ GMCX
64009		GA-74 KMA	6423726		GA-56 GMCX	6437461		GP-20 GMCX	6439143		GP-81 ²¹ GMCX
64009		GA-74 MTRV	6423731		GA-56 GMCX	6437462		GP-20 AMCO	6439143		GP-9 ⁸⁸ GMCX
640105		GP-28 ⁸ CECC	6423921		GA-55 GMCX	6437462		GP-20 GMCX	6439163		GP-78 GMCX
640105		GP-430 ⁸ CECC	6423926		GA-56 GMCX	6437462		GP-20 JEEP	6439164		GP-1107 GMCX
640130		GP-28 ⁸ CECC	6423927		GA-56 GMCX	6437465		GP-20 GMCX	6439245		GP-26 GMCX
640130		GP-430 ⁸ CECC	6424140		GA-55 GMCX	6437494		GP-66 GMCX	6439246		GP-27 GMCX
640130		GP-28 ⁸ MARK	6424407		GAK-20 GMCX	6437553		G-750 GMCX	6439296		GP-2015W GMCX
640130		GP-430 ⁸ MARK	6424409		GA-1285 GMCX	6437562		G-34 GMCX	6439297		GP-2015W GMCX
640150		GP-54 ¹¹ MARK	6424410		GA-1287 GMCX	6437709		G-34 GMCX	6439298		GPP-1000 GMCX
640150		GP-66 ¹⁰ MARK	6424421		GA-55 GMCX	6437789		G-6 GMCX	6439299		GPP-1000 GMCX
64017		GA-303 KMA	6424423		GA-50 GMCX	6437797		G-6 GMCX	6439302		G-295 GMCX
6402		GA-2804 T NAP	6424423		GA-50 GMCX	6437802		G-1163 GMCX	6439303		G-295 GMCX
64020		GA-75 KMA	6424613		GA-55 GMCX	6437834		GP-83 GMCX	6439304		GP-1122 GMCX
64020		GA-75 MTRV	6424677		GA-9045 GMCX	6437836		GP-84 GMCX	6439304		GPP-1122 GMCX
64027		GA-3523 KMA	6424688		GA-33 ¹¹² GMCX	6437852		GP-14 GMCX	6439305		GP-1122 GMCX
6405		GA-2804 T NAP	6424689		GA-26 GMCX	6437946		GP-13 GMCX	6439305		GPP-1122 GMCX
640509		GP-28 ⁸ CECC	6424690		GAK-403 GMCX	6437949		G-139 GMCX	6439306		GP-1122 GMCX
640509		GP-430 ⁸ CECC	6424691		GAK-16 GMCX	6437955		GP-13 GMCX	6439307		GP-1122 GMCX
640509		GP-28 ⁸ MACO	6424692		GA-18 GMCX	6437968		GP-14 GMCX	6439308		GP-78 GMCX
640509		GP-430 ⁸ MACO	6424834		GA-55 GARW	6437982		GP-38 GMCX	6439309		GP-78 GMCX
6406		GA-130 NAP	6424834		GA-55 GMCX	6437983		GP-38 GMCX	6439314		GP-1105 GMCX
6406012D		G-31 HALL	6424864		GA-56 GMCX	6437985		G-122 GMCX	6439315		GP-1105 GMCX
640608		GP-54 ¹¹ CECC	6425		GA-132 NAP	6437985		G-338 GMCX	6439316		GP-62 GMCX
640608		GP-66 ¹⁰ CECC	64250-10020		GG-124 SUBA	6437989		G-122 GMCX	6439317		GP-62 GMCX
6406102D		G-31 HALL	6425723		GA-360 LBHR	6437989		G-338 GMCX	6439348		G-122 GMCX
640660		GAK-16 ALCH	6425724								

Numero	Gonher	Fabricante	Numero	Gonher	Fabricante	Numero	Gonher	Fabricante	Numero	Gonher	Fabricante
Number	Gonher	Manufacturer	Number	Gonher	Manufacturer	Number	Gonher	Manufacturer	Number	Gonher	Manufacturer
6439355	GP-462	GMCX	6484653	GA-303	GMCX	6487958	GA-59	GMCX	651386	GA-135	GMCX
6439392	GP-51	GMCX	6484662	GA-50	GMCX	6488087	GA-192	GMCX	651387	GA-135	GMCX
6439393	GP-51	GMCX	6484800	GA-100	GMCX	6488088	GA-192	GMCX	651388	GA-135	GMCX
6439400	G-33	EUCL	6484815	GA-12	GMCX	6488306	GAK-20	GMCX	6515541	GP-66	CLRK
6439400	G-33	GMCX	6484866	GA-57	GMCX	6488356	GA-378	GMCX	6515541	GP-66	MELR
6439461	GP-69	GMCX	6484867	GA-57	GMCX	6488360	GA-7360	GMCX	6516394	GAK-16	READ
6439462	GP-69	GMCX	6484868	GA-57	GMCX	6488362	GA-7716	GMCX	6516722	GP-66	CLRK
6439517	GP-24 ²⁶	GMCX	6484883	GA-70	GMCX	6489643	GA-6129	GMCX	6518192	GA-33 ¹¹²	CLRK
6439517	GP-462 ⁹⁴	GMCX	6484963	GA-57	GMCX	6489	G-1173	GREY	6518241	GA-7	CLRK
6439518	GP-24 ²⁶	GMCX	6484966	GA-100	GMCX	649	GP-81	AMP	6518241	GA-7	MELR
6439518	GP-462 ⁹⁴	GMCX	6485108	GA-57	GMCX	649	GP-81	BGA	6519239	GP-34	MELR
6439531	GP-36	GMCX	6485236	GA-50	GMCX	649	GP-91	PMC	652	GP-28 ⁶	CRO
6439534	GC-1133	GMCX	6485254	GA-50	GMCX	649003	GP-46	GMCX	652	GP-430 ⁸	CRO
6439535	GC-1133	GMCX	6485257	GA-50	GMCX	649003	GP-46	OPEL	65234	GAK-403	GENC
6439536	GS-1133	GMCX	6485381	GA-57	GMCX	64-9229E	GP-1	CATP	6527	GA-781	NAP
6439537	GS-1133	GMCX	6485382	GA-57	GMCX	6493692	GP-2071W	GMCX	6528	GA-782	NAP
643955	GP-36	GMCX	6485383	GA-57	GMCX	649911	G-1123F	DEMA	653	GP-46	CRO
6439617	G-222	GMCX	6485496	GA-135	GMCX	65.12503-5016	GPP-11	DAEW	6530	GA-589	NAP
6439618	GPP-14	GMCX	6485652	GA-57	GMCX	650	GP-50	AMP	6531	GA-588	NAP
6439620	GP-84	GMCX	6485786	GA-135	GMCX	650	GP-50	BGA	65345	G-295	VERS
6439657	GP-52 ¹⁰	GMCX	6485791	GA-192	GMCX	650	GP-28 ⁵	CRO	6536	GP-34	CRIS
6439657	GP-691 ⁴⁸	GMCX	6485816	GA-3300	GMCX	650	GP-430 ⁸	CRO	653785	GA-33 ¹¹²	EATN
6439658	GP-52 ¹⁰	GMCX	6485817	GA-3300	GMCX	6500416	GAK-403	READ	653785	GA-33	YALE
6439658	GP-691 ⁴⁸	GMCX	6485832	GA-100	GMCX	6500460	GAK-403	READ	6537850	GA-33 ¹¹²	YALE
6439675	GP-110	GMCX	6485886	GA-50	GMCX	6500667	GAK-20	CUMM	653785-0	GA-33 ¹¹²	EATN
6439676	GP-110	GMCX	6485891	GA-50	GMCX	6500668	GAK-20	CUMM	6538	GA-459	NAP
6439678	GP-10	GMCX	6485898	GA-50	GMCX	650078	GAK-20	CUMM	653-83-855	GP-1122	DUCA
6439681	GP-31	GMCX	6485908	GA-100	GMCX	65010	GA-85	KMA	653-83-895	G-296	DUCA
6439682	GP-31	GMCX	6485944	GA-57	GMCX	65010	GA-85	MTRV	653-83-895	G-296-B	DUCA
6439692	GP-2071W	GMCX	6485946	GA-100	GMCX	65010-65011	GP-38	NISS	6540085	G-162H	FLI
6439694	GP-1011Q	GMCX	6485983	GA-100	GMCX	65012	GA-59	KMA	6541193	GP-66	CLRK
64396946	GP-1010Q	GMCX	6485984	GA-100	GMCX	65012	GA-59	MTRV	6544578	GA-33 ¹¹²	CLRK
6439696	GP-1013Q	GMCX	6486	GA-33 ¹¹²	COMA	65012-65014	GP-38	NISS	6546-00QAB	GA-391	NISS
6439698	GP-1011Q	GMCX	6486	GA-33 ¹¹²	HYVA	650138	GG-5 L	ALMN	6546	G-750	GREY
6439700	GP-1013Q	GMCX	6486234	GA-192	GMCX	650152	GA-360	CUMM	65507	G-296	CHAB
6439759	G-750	GMCX	6486236	GA-57	GMCX	650156	GAK-403	GRAD	65507	G-296-B	CHAB
6439766	GP-2071W	GMCX	6486264	GA-192	GMCX	650156	GAK-403	WARN	6552	G-813	CANC
6439792	GP-26	GMCX	6486700	GA-100	GMCX	6501613	GP-81	KHDF	6552507	GP-34	CLRK
6439857	GP-44	GMCX	6486753	GA-56 ⁵⁰	GMCX	65019	GA-57	KMA	6552507	GP-34	MELR
6439900	GP-46	GMCX	6486785	GA-90	GMCX	65019	GA-57	MTRV	6553	GA-529	NAP
6439901	GP-46	GMCX	6486862	GAD-1	GMCX	6502115	G-1123	KALB	6555779	GP-38	CLRK
6439910	GP-46	GMCX	6486863	GAD-3	GMCX	650-21-18	GP-66	KALB	6555779	GP-38	MELR
6439913	GP-46	GMCX	6486874	GA-21	GMCX	6503	GA-3916	NAP	655815	G-1121	MASY
6439929	GP-46	GMCX	6486894	GA-192	GMCX	650352	GP-3816	GMCX	65583	G-1173 ¹⁰⁸	ALCH
6439977	G-634	GMCX	6486913	GA-21	GMCX	650352	GP-3816	OPEL	65583	G-1173	BLDW
6440	GA-73R	NAP	6486924	GAD-1	GMCX	650354	GP-81 ³¹	GMCX	65583	G-1173 ¹⁰⁸	LETR
64406	GA-130	PARM	6486925	GAD-3	GMCX	650354	GP-9 ³⁸	OPEL	65583	G-1173	LUW
6441	GA-732R	NAP	6486931	GA-360	GMCX	650355	GP-13	GMCX	65583	G-1173 ¹⁰⁸	WABC
644-14-300	GP-42	MZDA	6486933	GA-21	GMCX	650355	G-200	OPEL	65583-6	G-1173	ALCH
6443	GA-163	NAP	6486940	GA-31	GMCX	650362	GP-310	GMCX	65586	G-1173	ALCH
6444	GA-170	NAP	6486943	GA-6129	GMCX	650364	GP-3816	GMCX	65587	G-1173 ¹⁰⁸	ALCH
644700123	G-31	RENA	6486946	GA-287	GMCX	650365	GP-3816	GMCX	65587-2	G-1173	ALCH
6447-AZ	GAC-5	PEUG	6487014	GA-356	GMCX	650373	GP-3816	GMCX	65587-8	G-1173	ALCH
645 400 56 239	GA-905R	MBNZ	6487015	GA-356	GMCX	650375	GP-3	OPEL	65588	G-1173	ALCH
645 862 56 100	GA-904R	MBNZ	6487036	GA-106	GMCX	650381	GP-46	GMCX	65590	G-1173 ¹⁰⁸	ALCH
64511629	GP-1	ALCH	6487036	GA-326 ⁷¹	GMCX	650381	GP-46	OPEL	65590-2	G-1173	ALCH
645200	GA-33 ¹¹²	CUST	6487037	GA-106	GMCX	650382	GP-3980	GMCX	65590-9	G-1173	ALCH
645200-02	GA-33 ¹¹²	CUST	6487037	GA-326 ⁷¹	GMCX	650400	GP-3816	GMCX	65592	G-1173	ALCH
64540056239	GA-904R ¹⁰⁴	MBNZ	6487043	GA-6127	GMCX	650401	GP-46	GMCX	6559458	GP-54	CLRK
645450-05	GA-33 ¹¹²	GMCX	6487044	GA-6127	GMCX	650401	GP-46	OPEL	65596	G-1173 ¹⁰⁸	ALCH
645450-06	GAK-403	GMCX	6487051	GA-86	GMCX	6505	GA-329	NAP	65596-3	G-1173	ALCH
645881	GP-1	INGR	6487058	GA-86	GMCX	65-05510-5002	GP-3985	DAEW	65596-9	G-1173	ALCH
6459302	G-295	GMCX	6487130	GA-349	GMCX	65055105007	GP-43	DAEW	655972	GA-135	GMCX
6459892	GA-192	GMCX	6487131	GA-349	GMCX	65-05510-50128	GP-53	DAEW	655972	GA-360	CONP
6462	GA-304	NAP	6487136	GA-206	GMCX	6505511	GA-360	DENN	6559	G-1121	GREY
646450	GP-1011Q	PEGA	6487159	GA-21	GMCX	6505731	GA-360	DENN	656	GP-333	CRO
6466	GAK-458	NAP	6487233	GA-50	GMCX	650577	GA-106 ⁴⁶	CUMM	656135	G-1121	MASY
6467	GA-459	NAP	6487235	GA-192	GMCX	650577	GA-326 ⁷¹	CUMM	6562	GA-853R	NAP
6470	GA-712R	NAP	6487282	GA-50	GMCX	650-615	G-1121	PORS	656501	GP-1122	CLAA
647013	G-500	TOWM	6487314	GA-57	GMCX	650653	GP-3600	OPEL	6565010	GP-1122	CLAA
6472	GA-8606	NAP	6487318	GA-192	GMCX	650717	GA-5648	ALCH	656501-00	GP-1122	MASY
6473	GA-145	NAP	6487320	GA-192	GMCX	650865	GP-3682	PARM	6567	GAK-1532	NAP
6474	GA-499R	NAP	6487322	GA-57	GMCX	650930	GA-106 ⁴⁶	CRUS	6568340	GP-3816	CLAA
647728	GG-5 L	JEEP	648734	GA-106 ⁴⁶	ALCH	650930	GA-326 ⁷¹	CRUS	6569	G-33	GREY
648235	GA-59	GMCX	648734	GA-326 ⁷¹	ALCH	650930	GA-106 ⁴⁶	CUMM	657	G-331	CRO
6483509	GA-57	GMCX	648734	GA-106 ⁴⁶	FIAT	650930	GA-326 ⁷¹	CUMM	6573	GA-413R	NAP
6483572	GA-192	GMCX	648734	GA-326 ⁷¹	FIAT	650930	GA-106 ⁴⁶	GARD	657368	GP-66	ALCH
6483644	GA-325	GMCX	6487358	GA-357	GMCX	650930	GA-326 ⁷¹	GARD	65756	G-1173 ¹⁰⁸	EATN
6483645	GA-57	GMCX	64874368	GA-361	GMCX	6509306	GA-106 ⁴⁶	CUMM	65756	G-1173	YALE
6483697	GA-50	GMCX	6487468	GA-361	GMCX	6509306	GA-326 ⁷¹	CUMM	6575656	G-1173 ¹⁰⁸	EATN
6483700	GA-192	GMCX	6487520	GA-75	GMCX	65106	GP-310	IPS	6575656	G-1173	YALE
6483723	GA-192	GMCX	6487536	GA-59	GMCX	6511393	GG-1	CLRK	657906	GA-6129	GMCX
6483724	GA-192	GMCX	6487561	GA-50	GMCX	6511393	GG-4	CLRK	657957	GA-6129	GMCX
6483808	GA-57	GMCX	6487574	GA-192	GMCX	6511550	G-295	CLRK	658	GP-1122	CRO
6483819	GA-192	GMCX	6487575	GA-192	GMCX	6511730	GP-14	CLRK	6580	GP-381	NAP
6483864	GA-192	GMCX	6487576	GA-192	GMCX	6511766	GP-1	CLRK	658126	GA-566	ALCH
6484	GA-472	NAP	6487580	GA-192	GMCX	6511766	GP-1	MELR	658126-8	G-566	ALCH
6484026	GA-192	GMCX	6487583	GA-59	GMCX	6511793	GP-28 ⁵	CLRK	658128	G-1143	ALCH
6484035	GA-100	GMCX	6487599	GA-50	GMCX	6511793	GP-430 ⁸	CLRK	658128-4	G-1143	ALCH
6484164	GA-100	GMCX	6487668	GA-50	GMCX	6512143	GP-3600	CLRK	6581568	G-566	ALCH
6484235	GA-59	GMCX	64878	G-1175 ¹⁰⁸	ALCH	6512491	GP-3600	CLRK	658451	GA-106 ⁴⁶	ALCH
6484445	GA-56	GMCX	64878	G-1175 ¹⁰⁸	LAPL	65-12503-5003	G-1121	DAEW	658451	GA-326 ⁷¹	ALCH
6484495	GA-192	GMCX	6487800	GA-429	GMCX	65-12503-5004	G-1123	DAEW	658451-1	GA-106 ⁴⁶	ALCH
6484600	GA-85	GMCX	6487801	GA-429	GMCX	65132400261	GP-91	ISEK	658451-1	GA-326 ⁷¹	ALCH
6484602	GA-730	GMCX	6487927	GA-74	GMCX	6513601	GP-58	CLRK	658P	G-297-B	GREY
6484645	GA-57	GMCX	6487956	GA-376	GMCX	651384	GA-135	GMCX	659	GP-58 ¹⁵	CRO

Referencia Cruzada por Numero de Parte

Cross Reference by Part Number



Numero	Gonher	Fabricante	Numero	Gonher	Fabricante	Numero	Gonher	Fabricante	Numero	Gonher	Fabricante
Number	Gonher	Manufacturer	Number	Gonher	Manufacturer	Number	Gonher	Manufacturer	Number	Gonher	Manufacturer
659095	GA-360 ⁰⁴	ALCH	66093	GA-275	RKHL	662477	GA-206	FIAT	665459	GAK-403	TOWM
659095	GA-361 ⁰⁸	ALCH	66095	GAD-118	PARM	662477-3	GA-206	ALCH	66-5459	GAK-403	CATP
659095-0	GA-360	ALCH	66097	GA-133	PARM	662477-9	GA-206	ALCH	665501	GP-1122	CLAA
659095-4	GA-360 ⁰⁴	ALCH	66097	GA-133	RKHL	66253	GA-158	PARM	6655010	GP-1122	CLAA
659095-4	GA-361 ⁰⁸	ALCH	66098	GA-432	RKHL	66255	GA-3501	PARM	665573	GA-413R	PARM
659378	GA-6129	ALCH	661	GP-5	AMP	662607	GA-360	ALCH	6657350	G-813	PUR
659386	GA-6127 ⁰⁸	ALCH	661	GP-5	BGA	662607-1	GA-360	ALCH	6657463	G-813	PUR
659386	GA-6129 ⁰⁴	ALCH	661	GP-3816	CRO	662609	GA-361	ALCH	665859-7	G-33	ALCH
659387	GA-6129	ALCH	661049	GP-54	DAF	662609	GA-361	FIAT	6659	GA-1616	NAP
659387	GA-6129	FIAT	66105	GA-595	PARM	6626097	GA-361	FIAT	6659135	G-1163	IHCO
659387-5	GA-6129	ALCH	6610-51-5050	G-750	KOMA	662609-7	GA-361	ALCH	665934	GP-66	TOWM
659389	GAK-16	ALCH	6610-51-5100	G-566	KOMA	662609-9	GA-361	ALCH	66-5934	GP-66	CATP
659533	GA-106 ⁴⁶	ALCH	6610-51-5300	G-750	KOMA	662618	GA-106 ⁴⁷	ALCH	6660728	GP-66	CLRK
659533	GA-326 ⁷¹	ALCH	6610-53-5120	G-191	KOMA	662618	GA-206 ¹⁰⁸	ALCH	6661011	GP-461	MELR
659533	GA-106 ⁴⁶	FIAT	6610-61-8600	G-1143	KOMA	662618	GA-326 ⁷²	ALCH	666196	GA-18	ALCH
659533	GA-326 ⁷¹	FIAT	6610-70-8063	G-1143	KOMA	662618-8	GA-106 ⁴⁷	ALCH	6662	GG-3	CRO
659533-3	GA-106 ⁴⁶	ALCH	66108	GA-604	PARM	662618-8	GA-206 ¹⁰⁸	ALCH	6663000	G-1175 ¹⁰⁸	PUR
659533-4	GA-106 ⁴⁶	ALCH	66108	GA-604	RKHL	662618-8	GA-326 ⁷²	ALCH	6663084	G-1173 ¹⁰⁸	PUR
659533-4	GA-326 ⁷¹	ALCH	661135	G-225	BMW	66264	GA-362	PARM	6663085	G-1175 ¹⁰⁸	PUR
659533-7	GA-106 ⁴⁶	ALCH	66116	GAD-15	PARM	66264	GA-362	RKHL	6663116	G-1173 ¹⁰⁸	PUR
659533-7	GA-326 ⁷¹	ALCH	66116	GAD-15	RKHL	66273	GA-5466	PARM	6663172	GP-50	TOWM
659574	G-1121	DEMA	661160	G-225	BMW	662791	GAK-20	TOWM	666-3172	GP-50	CATP
6598361	GAK-16	CLRK	66117	GA-165	PARM	66-2791	GAK-20	CATP	6664	GA-930R	NAP
6598482	GAK-16	CHRY	66119	GA-471	RKHL	6628	GA-683R	NAP	666421	G-222	ALCH
6598491	GA-33 ¹¹²	CLRK	66120	GA-271	PARM	66288	GA-198	PARM	6664213	G-222	FIAT
6598492	GAK-16	CLRK	66120	GA-271	RKHL	66289	GA-175	PARM	666421-3	G-222	ALCH
6598898	GA-892	CLRK	6612069	G-813	BOLI	66293	GA-240	PARM	6664793	G-152	PUR
6598898	GA-892	MELR	6612069	G-813	VOLV	663	G-119	AMP	6665	GG-45	CRO
6598903	GP-761H	CLRK	6612098	G-225	VOLV	663	G-119	BGA	6665	GA-890R	NAP
6598903	GP-761H	MELR	6612-13-8640	GA-39	KOMA	66302	GA-164	BGA	6665379	GP-50	PUR
6599543	GP-761H	CLRK	661258	GP-31	VOLV	66303	GA-514	PARM	6665603	GP-3816	MELR
6599587	GP-50	CLRK	6612598	GP-31	VOLV	66303	GA-514	RKHL	6665688	G-238	PUR
655	GAK-16	ASAH	66126	GA-273	PARM	6630939	GAK-1532	CLRK	666589	GP-9	DEMA
660	G-200	BGA	66126	GA-273	RKHL	6630939	GAK-1532	MELR	66659	GA-1616	PARM
660	GP-36	CRO	661302	GP-2071W	SAAB	6631-54-5050	G-750	KOMA	6665943	GP-81	PUR
660	GA-230	FACE	66132	GA-274	PARM	6631705	GP-761H	CLRK	6665972	GP-1	PUR
66007	GA-3566	RKHL	66132	GA-274	RKHL	66-3172	GP-50	CATP	6665973	GP-50	PUR
66013	GA-55	KMA	66133	GA-277	PARM	66318	GA-217	PARM	6665974	GP-5	PUR
66013	GA-55	MTRV	66134	GA-5056	PARM	66327	GAVW-121	PARM	6665976	GP-3	PUR
66013	GA-735 ¹²⁴	RKHL	66134	GA-5056	RKHL	6632745	GP-40	CLRK	6665979	GP-3816	PUR
66016	GA-140	RKHL	6613665	G-296	VOLV	6632745	GP-40	MELR	6665980	GP-58	PUR
66017	GA-322	PARM	6613665	G-296-B	VOLV	663384	GAK-403	TOWM	6665981	GP-66	PUR
66017	GA-322	RKHL	6613665	G-296	VOLV	66-3384	GAK-403	CATP	6665982	GP-1101	PUR
660213-6021	GP-3682	KOMA	6613665	G-296-B	VOLV	6634505	GP-66	MELR	6665983	GP-14	PUR
6602136060	GP-3682	KUBO	66139	GA-3916	PARM	66349	GA-127	PARM	6665984	GP-31	PUR
66021-36061	GP-3682	KUBO	66139	GA-3916	RKHL	66358	GA-384	PARM	6665985	GP-50	PUR
66026	GA-381	PARM	66144	GA-392	PARM	66361-37950	GP-9586	KUBO	6666	GG-203	CRO
66026	GA-381	RKHL	66146	GA-180	RKHL	6637488	G-834	VME	6666052	G-6	PUR
66027	GAD-294	PARM	66148	GA-2106	PARM	6637488	G-834	VOLV	6666055	G-1163	PUR
66028	GA-7344	PARM	66148	GA-2106	RKHL	66374885	G-834	VME	6666108	G-6	PUR
660289	GA-405	VOLV	66150	G-1173	PUR	66374885	G-834	VOLV	6666499	GGP-25	PUR
660296	GP-28 ⁸	WAYN	66152	GA-129	PARM	663776	G-31	STUD	6667	GG-76	CRO
660296	GP-430 ⁸	WAYN	66153	GA-6479	PARM	66388	GA-172	PARM	6667028	GP-14	PUR
66030	GA-360	ALCH	66153	GA-6479	RKHL	66390	GAVW-620	PARM	66673	GA-264	PARM
6603091	G-1123	VOLV	66153-1	GA-6479 ⁹⁰	PARM	664	GP-42	CRO	6667352	GPP-1122	CLRK
66035	GA-279	PARM	66158	GA-382	PARM	664 180 0009	G-180	MBNZ	6667352	GPP-1122	MELR
66036	GA-360	ALCH	66158	GA-382	RKHL	664000	G-222	ALCH	6668819	GP-761H	MELR
66036	GA-325	PARM	66162	GA-6690	PARM	6640289	GA-405	VOLV	6669547	GA-880R	CLRK
66036	GA-325	RKHL	66162	GA-6690	RKHL	6640708	GA-33 ¹¹²	CLRK	6669547	GA-880R	MELR
660360	GA-360	ALCH	66174	GA-174	PARM	6641	GA-8	NAP	6670	GG-39	CRO
660360	GA-360	FIAT	66174	GA-174	RKHL	66416	GA-1616	PARM	6670255	GP-84	PUR
660360-1	GA-360	ALCH	6617506	G-33	VOLV	66417	GA-442	PARM	667031	G-31	STUD
660360-9	GA-360	ALCH	6617506-8	G-33	VOLV	66418	GA-1615	PARM	6670727	GP-20	PUR
66040	GA-3588	PARM	6617509	G-33	VOLV	664214	G-222	ALCH	667097	G-31	STUD
66040	GA-3588	RKHL	66179	GA-153	PARM	66425	GA-132	PARM	6670996	GPP-419	MELR
66042	GA-4325	PARM	66180	GA-253	PARM	66440	GA-673R	PARM	6671	GG-204	CRO
66042	GA-4325	RKHL	66180	GA-253	RKHL	6644015	GP-3985	CLRK	6671057	GP-91	MELR
66046	GA-3681	PARM	6618093200	GP-44	PORS	6644210	GP-3985	CLRK	6671-50-5300	G-500	KOMA
66046	GA-3681	RKHL	66186	GA-142	PARM	66443	GA-163	PARM	6671-51-5000	G-500	KOMA
66048	GA-3637	PARM	66186	GA-142	RKHL	66444	GA-170	PARM	6671-51-5300	G-500	KOMA
66048	GA-3637	RKHL	661874	GA-405	DEMA	664482	GA-853R	SAMB	6671649	GPP-425	MELR
6604948	G-1123	BOLI	66195	GA-244	PARM	6645119	GA-360	VOLV	6671856	GP-83	PUR
6604948	G-1123F	BOLI	662	GP-462	CRO	66451196	GA-360	VOLV	6672467	GA-880R	CLRK
6604948	G-1123	VOLV	6620140	GA-33 ¹¹²	CLRK	664577	GAK-16	EATN	6672467	GA-880R	MELR
66051	GA-217	PARM	6620-21-7510	GA-39	KOMA	664577	GAK-16	YALE	66728001	GP-14	VERM
66051	GA-217	RKHL	6620-21-7550	GA-39	KOMA	664577-00	GAK-16	YALE	66729001	G-295	VERM
66057	GA-7142	PARM	66-2047	GA-381	S&B	664578	GA-33 ¹¹²	EATN	6673	GG-63	CRO
660576	GP-81	CLAA	66-2049	GA-432	S&B	664578	GA-33	YALE	6673	GA-264	NAP
6605860	G-1121	BOLI	66-2052	GA-322	S&B	66-4578	GA-33 ¹¹²	WHIT	667359	GG-46	PARM
6605860	G-1121	VOLV	66-2055	GA-604	S&B	664578-00	GA-33 ¹¹²	YALE	6674293	G-1174 ¹⁰⁸	NAP
66058603	G-1121	VOLV	662111	G-31	STUD	664579	GAK-16	EATN	6675	GA-1095	PUR
66064	GA-386	PARM	662112	G-31	STUD	664579	GAK-16	YALE	6675008	GP-13	PUR
66064	GA-386	RKHL	66-2120	GA-384	S&B	66458555	GP-3600	VME	667543	GAK-20	TOWM
6607485	G-870	BOLI	66213	GA-300	PARM	6646494	GA-33 ¹¹²	CLRK	66-7543	GAK-20	CATP
6607485	G-870	VOLV	66215	GA-607	PARM	6646494	GA-33 ¹¹²	MELR	6675517	GP-81 ³¹	MELR
6607576	G-1123	VOLV	6621505	GAK-403	VOLV	66472	GA-8606	PARM	6675517	GP-9 ⁵⁸	MELR
66077	GA-3901	PARM	66220	GA-89	PARM	6647773	GPP-1122	CLRK	6675580	GP-1101	PUR
66077	GA-3901	RKHL	66220	GA-89	RKHL	6647773	GPP-1122	MELR	6675582	GP-110	PUR
66080	GA-141	PARM	66236	GA-4828	RKHL	6648	GA-780	NAP	6675584	GP-1105	PUR
66080	GA-141	RKHL	6624214	G-222	FIAT	6648201	G-24	VOLV	6675588	GP-1108	PUR
66081	GA-301	PARM	662421-4	G-222	ALCH	6648845	G-296	VOLV	6675911	GA-18	PUR
66082	GA-166	RKHL	66244	GA-195	PARM	6648845	G-296-B	VOLV	6675998	GA-27	PUR
66084	GA-3814	PARM	66244	GA-195	RKHL	66488453	G-296	VOLV	6676011	GA-26	PUR
66084	GA-3814	RKHL	66246	GA-7017	PARM	66488453	G-296-B	VOLV	6676017	GA-375	PUR
66089	GA-4958	RKHL	66246	GA-7017	RKHL	6653336	GP-166	MELR	6676050	GA-6129	PUR
66093	GA-275	PARM	662477	GA-206	ALCH	6654328	GP-3682	CLRK	66-7694	GG-20	CATP

REFERENCIA CRUZADA

Numero	Gonher	Fabricante	Numero	Gonher	Fabricante	Numero	Gonher	Fabricante	Numero	Gonher	Fabricante
Number	Gonher	Manufacturer	Number	Gonher	Manufacturer	Number	Gonher	Manufacturer	Number	Gonher	Manufacturer
6677	GA-183R	NAP	6710-61-8131	GP-1011Q	KOMA	6750558-336	GP-54 ¹¹	MAN	68115561A	GP-310	VAG
6677360	GP-54	PUR	671160	GP-54 ¹¹	FIAT	67-50558-336	GP-66 ¹⁰	MAN	68-115-561C	GP-1	VOLK
6678200	GA-360	PUR	671160	GP-66 ¹⁰	FIAT	67-50558-426	GP-54	MAN	68127177	GPP-1122	GULD
6678201	GA-106 ⁹⁶	PUR	6711730	GP-1122	BOMG	6750559016	GP-54 ¹¹	MNH	68127177	GPP-1122	LIN
6678201	GA-326 ⁷¹	PUR	6712619	GA-482	PUR	6750559016	GP-66 ¹⁰	MNH	68127177	GPP-1122	VAG
6678233	GP-171	MELR	67129	G-1163	PUR	67512-42820-71	GP-761H	TOYO	68127177	GP-1122	VOLK
668	GP-3	AMP	6713	GA-398	NAP	67521-41930-71	GP-761H	TOYO	68127177	GPP-1122	VOLK
668	GP-3	BGA	6713617	GA-210	PUR	6754189	GP-43	PUR	68127177B	GPP-1122	VAG
6680518	GP-1107	PUR	6713680	GA-373	PUR	67547-C1	GAK-16	IHCO	68127177B	GPP-1122	VOLK
6681	GG-150	CRO	6713714	GA-493 ¹⁰⁸	PUR	6756	GA-251	NAP	68127401	GPP-1122	VOLK
6681138	GP-66	PUR	6714	GG-185	CRO	675616-C91	GP-69	FURU	68129620A	GAVW-2	VOLK
66829	GAK-403	GALN	671490	GP-54 ¹¹	DAF	675616-C91	GP-69	IHCO	6813-16-2130	GP-317H	KUBO
668373	GAK-403	TOWM	671490	GP-66 ¹⁰	DAF	675616-C91	GP-69	KOMA	6813162132	GP-317H	KUBO
66-8373	GAK-403	CATP	67149850	GP-58 ¹⁵	DUCA	675617-C91	GP-69	IHCO	68147	GP-50	CATP
6684-71-8600	GP-1101	KOMA	6715	GG-227	CRO	675627-C1	GP-1108	IHCO	68147	GP-50	TOWM
6685	GG-151	CRO	6718	GG-151	NIPP	67581001	GP-761H	VERM	681546	GP-2071W	ALCH
6685817	GPP-1000	PUR	6718312	GP-57	PUR	675911	GA-106	GMCX	681609	GAVW-2	VOLV
6685-81-9910	GP-14	KOMA	6719831	GP-1122	PUR	675911	GA-326 ⁷¹	GMCX	681955	GP-2071W	GMCX
668610050	GP-54 ¹¹	LOSE	672	GP-91	CRO	676	GA-826	DEL	681956	GP-2071W	GMCX
668610050	GP-66 ¹⁰	LOSE	672	GA-3425	DEL	6761	GA-697R	NAP	682059AS	G-296	OLIV
66867-00212	GA-27	MITS	672019C2	GA-31	IHCO	676228	G-834	TOWM	682059AS	G-296-B	OLIV
6686884	G-222	FIAT	672019C91	GA-31	IHCO	67-6228	G-834	CATP	68-2059-AS	G-296	WHIT
6687	GG-208	CRO	6721532	GP-376	PUR	676288	G-834	TOWM	68-2059-AS	G-296-B	WHIT
668703506	GP-1122	LOSE	6723	GA-398	NAP	67634001	GP-43	VERM	682609	GA-361	ALCH
6688	GG-142	CRO	6726	GA-376	NAP	67685-C92	GA-826 ¹⁰⁴	IHCO	682994	GAK-20	TOWM
6689	GG-251	CRO	672603C1	GP-78	CASE	67685-C92	GA-827 ¹⁰⁸	IHCO	68-2994	GAK-20	CATP
668989	GG-20	CLRK	672603-C1	GP-78	IHCO	676944	G-871	TOWM	683	GP-171	CRO
669	G-33	AMP	672603C2	GP-78	CASE	67-6944	G-871	CATP	683070	GA-135	GMCX
669	G-33	BGA	672603-C2	GP-78	FURU	676987	G-296	TOWM	683073	GA-135	GMCX
669	GA-85	DEL	672603-C2	GP-78	IHCO	676987	G-296-B	TOWM	6832	GA-269	NAP
6690	GG-5 L	CRO	672603-C2	GP-78	KOMA	67-6987	G-296	CATP	683238-C91	GA-891 ¹⁰⁴	IHCO
6690	GA-826	NAP	672603C3	GP-78	CASE	67-6987	G-296-B	CATP	683238-C91	GA-892 ¹⁰⁸	IHCO
6691	GG-261	CRO	672603-C3	GP-78	IHCO	67-6987E	G-296	CATP	6834	GA-263	NAP
6691230	GP-23	PUR	672702	GA-135	GMCX	67-6987E	G-296-B	CATP	683557	G-169	GMCX
6691327	GP-2015W	PUR	672791	GA-6129	GMCX	67-6987T	G-296	CATP	684	G-191	AMP
6692713	GG-1143	PUR	6728	GA-780	NAP	67-6987T	G-296-B	CATP	684	G-191	BGA
6693	GG-196	CRO	67305	G-11816	CASE	677	GA-827	DEL	6840	GA-389	NAP
6693756	GA-6880	PUR	6731638	GGP-25	PUR	6772	GA-435R	NAP	6840066171	GA-489	MOP
6693835	GP-1011Q	PUR	6731-C	G-236	FORD	677251	G-335	TOWM	684163	GAK-403	TOWM
6693954	GP-81	PUR	6731-F	G-200	FORD	6774452	GAVW-2	VOLV	68-4163	GAK-403	CATP
6694030	GP-51	PUR	6731-G	GP-20	FORD	6775	GA-759 ¹⁰⁸	NAP	6842	GA-518R	NAP
6694036	GPP-14	PUR	6731-G	GP-5	FORD	677509-R91	GAK-16	IHCO	684206-C1	GP-52 ¹¹⁰	IHCO
6694042	GP-31	PUR	6732	G-128	WEBB	677509-R92	GA-16 ¹¹²	IHCO	684206-C1	GP-69 ¹⁴⁸	IHCO
6694048	GP-1101	PUR	6732 71 6112	GP-1122	KOMA	677509-R92	GAK-16 ⁹⁴	IHCO	684206-C2	GP-52 ¹¹⁰	FURU
6695	GG-208	CRO	673217	GAK-20	TOWM	677709-C91	GP-10	IHCO	684206-C2	GP-69 ¹⁴⁸	FURU
6695318	GP-10	PUR	67-3217	GAK-20	CATP	678021	GP-50	RENA	684206-C2	GP-52 ¹¹⁰	IHCO
6696257	GP-38	GMCX	6732-51-5140	GP-390	KOMA	67802100	GP-50	RENA	684206-C2	GP-69 ¹⁴⁸	IHCO
6696776	GP-3816	GMCX	6732-71-6110	GP-1122	KOMA	678029	GP-50	RENA	684206-C2	GP-52 ¹¹⁰	KOMA
6698	GG-189	CRO	6732-71-6111	GP-1122	KOMA	678071	GP-46	PUR	684206-C2	GP-69 ¹⁴⁸	KOMA
6699	GG-246	CRO	6732-71-6120	GGP-18	KOMA	678078	GP-81 ³¹	PUR	6843	GA-539R	NAP
66U12155	GA-33 ¹¹²	TCLD	6732-71-6310	GPP-1122	KOMA	678078	GP-9 ⁹⁸	PUR	684374	GA-106 ⁹⁶	ALCH
66U1-2155	GA-33 ¹¹²	CARR	6733-51-5140	GP-390	KOMA	678109	GP-46	PUR	684374	GA-326 ⁷¹	ALCH
66U1-2911	G-1123	CARR	6733-71-9110	GPP-1122	KOMA	6782	GA-967R	NAP	684733	GA-360	ALCH
66U1-2911	G-1123F	CARR	67342400177	GA-6129	FLXI	678356	G-31	STUD	684733	GA-360	FIAT
66U1-2921	G-31	CARR	6735-51-5140	GP-178	KOMA	679248	GA-6129	GMCX	684733-9	GA-360	ALCH
66U1-5262-1	GA-33 ¹¹²	CARR	6735-51-5142	GP-178	KOMA	679348	GA-6129	GMCX	684734	GA-106 ⁹⁶	ALCH
67	GA-303	WIX	673569	GG-261	PARM	679436-C91	GA-106 ⁹⁶	IHCO	684734	GA-326 ⁷¹	ALCH
670	GA-86	DEL	673588	GP-54 ¹¹	FIAT	679436-C91	GA-326 ⁷¹	IHCO	684-734	GA-326 ⁷¹	ALCH
67000014	GA-357	RAYG	673588	GP-66 ¹⁰	FIAT	679482	GA-6129	GMCX	684-734	GA-106 ⁹⁶	FIAT
67000015	GA-356	RAYG	6736	GAK-20	JACK	679487	GA-6129	GMCX	684-734	GA-326 ⁷¹	FIAT
67000024	GA-106 ⁹⁶	RAYG	6736-51-5140	GP-178	KOMA	679658	GAVW-2	VOLV	6857	GP-51	ACD
67000024	GA-326 ⁷¹	RAYG	6736-51-5141	GP-178	KOMA	67974-C1	GA-826	IHCO	685974	GA-135	GMCX
67000037	GA-33 ¹¹²	RAYG	6738	GA-616	NAP	67974-C2	GA-826	IHCO	686	G-236	AMP
67000042	GAK-20	RAYG	67-40358-366	GP-3600	MAN	67974-C3	GA-826	IHCO	686	G-236	BGA
67000043	GA-106 ⁹⁶	RAYG	6741	GA-467	NAP	67974-C4	GA-826	IHCO	6860	GA-371	NAP
67000043	GA-326 ⁷¹	RAYG	6742-01-4120	GP-3000	KOMA	67975-C1	GA-827	IHCO	686185	G-750	GMCX
67000044	GA-356	RAYG	6742-01-4540	GP-3001	KOMA	67975-C2	GA-827	IHCO	6863	GA-534R	NAP
67000049	GA-6129	RAYG	674293C1	GP-1107	CASE	68 115 561	GP-3569	AUDI	6868	GA-608	NAP
67000050	GA-6127	RAYG	674293C1	GP-1107	HOUG	68 115 561	GP-3569	PORS	686911	GAK-403	TOWM
67000055	GAK-403	RAYG	674293-C1	GP-1107	FURU	68 115 561	GP-3569	VOLK	68-6911	GAK-403	CATP
67000059	GAK-403	RAYG	674293-C1	GP-1107	IHCO	68 115 561B	GP-3569	AUDI	687	GP-1122	CRO
67000081	GA-357	RAYG	674293-C1	GP-1107	KOMA	68 115 561B	GP-3569	PORS	687	GA-356	DEL
670139-C1	GP-1011Q	IHCO	674293-C91	GP-78	IHCO	68 115 561B	GP-3569	VOLK	6870	GA-799R	NAP
6701654	GA-16 ¹¹²	PUR	67-4330	GP-149	TORO	68 115 561E	GP-3569	AUDI	6871	GA-798R	NAP
6701654	GAK-16 ³⁴	PUR	674351A	GP-1	CHRY	68 115 561E	GP-3569	PORS	6876	GA-694	NAP
6701901	GP-67	PUR	674351A	GP-1	OLIV	68 115 561E	GP-3569	VOLK	687743	GAK-20	TOWM
6701903	GP-69	PUR	67-4351-A	GP-1	WHIT	680	G-139	AMP	68-7743	GAK-20	CATP
6701905	GP-88	PUR	6744	GA-966R	NAP	680	G-139	BGA	687744	GAK-403	TOWM
6703	GG-246	CRO	674416	GA-106 ⁹⁶	GMCX	68001914AA	GS-1261	CHRY	68-7744	GAK-403	CATP
6703	GG-408	CRO	674416	GA-326 ⁷¹	GMCX	68001914AB	GS-1261	CHRY	687746	GAK-403	TOWM
67033	G-45	PARM	674433-C91	GA-239 ¹⁰⁸	IHCO	6801	G-295	CRO	68-7746	GAK-403	CATP
6704	GG-226	CRO	674433-C91	GA-329 ¹⁰⁴	IHCO	68-016-093	GP-54	ZETO	687747	GAK-20	TOWM
6706142	GP-2022W	PUR	674-4A	G-236	ONAN	6804	GA-1617	NAP	68-7747	GAK-20	CATP
67090	G-765	PARM	6745	GA-221R	NAP	680587C2	GA-6129	IHCO	6879	GA-510	NAP
67099	GP-408	PARM	6746	GA-600R	NAP	681	GP-54	SULL	688	G-238	AMP
671	GA-3424	DEL	674751A	GP-1	MIINN	681	GP-66	SULL	688	G-238	BGA
671	GA-2740	SLIN	674805	GA-135	GMCX	6810-51-5130	GP-1	KOMA	6880866	GP-26	GMCX
671	GA-2740	UNN	674953	GAK-16	ALCH	6810-71-6110	GPP-1122	KOMA	6883	GA-3551 ⁹⁵	NAP

Referencia Cruzada por Numero de Parte

Cross Reference by Part Number



Numero	Gonher	Fabricante	Numero	Gonher	Fabricante	Numero	Gonher	Fabricante	Numero	Gonher	Fabricante
Number	Gonher	Manufacturer	Number	Gonher	Manufacturer	Number	Gonher	Manufacturer	Number	Gonher	Manufacturer
6895003		GP-3 VOLV	6952298		G-500 EATN	6K0-129-620B		GA-285 AUDI	70000-14648		GP-36 KUBO
68999		GA-377 GMCX	6952298		G-500 YALE	6K0-129-620B		GA-285 SEAT	70000-14649		GP-38 KUBO
68MF-6731-BAA		G-613 FORD	695299		G-1143 CUMM	6K0-129-620B		GA-285 VAG	70000-14650		GP-40 KUBO
68PS4670		GA-356 CHIC	6953030		GA-6129 EATN	6K0-129-620B		GA-285 VOLK	70000-14651		GP-42 KUBO
68PS4670		GA-356 CONP	6953030		GA-6129 YALE	6L22-9601-A		GA-395 FORD	70000-14653		GP-1 KUBO
69 115 561		GP-3569 AUDI	6953031		GA-6127 EATN	6L22-9601-AA		GA-1540 FORD	70000-14654		GP-3600 KUBO
69 115 561		GP-3569 PORS	6953031		GA-6127 YALE	6L4714		GAP-379 CATP	70000-14655		GAK-16 KUBO
69 115 561		GP-3569 VOLK	6953104		GA-360 EATN	6L6873		GAP-379 CATP	70000-14656		GA-33 ¹² KUBO
690		G-225 CRO	6953104		GA-360 YALE	6L7440		GP-110 CATP	70000-14659		GG-5 L KUBO
690056		GA-135 GMCX	6953105		GA-361 EATN	6L7543		GAK-20 CATP	70000-14660		G-11816 KUBO
6900947004		GA-5876 MBNZ	6953105		GA-361 YALE	6LS1114		GP-54 ¹¹ GENE	70000-14663		G-295 KUBO
690124-C1		GP-1011Q IHCO	6953106		GA-206 EATN	6LS1114		GP-66 ¹⁰ GENE	70000-14669		GP-13 KUBO
690139-C1		GP-1011Q IHCO	6953106		GA-206 YALE	6M3217		GAK-20 CATP	70000-14670		GP-3429 KUBO
690140-C1		GP-1011Q IHCO	6953107		GA-106 ⁶ EATN	6N0201511A		GG-5 L VAG	70000-14671		GP-3980 KUBO
690171-C1		GP-2071W IHCO	6953107		GA-326 ⁷¹ EATN	6N0347		GA-482 ¹⁰⁸ CATP	70000-14672		GP-3600 KUBO
6902		GA-367 NAP	6953107		GA-106 ⁶ YALE	6N0347		GA-483 ¹⁰⁴ CATP	70000-14673		GP-58 KUBO
690260		GP-36 DAF	6953107		GA-326 ⁷¹ YALE	6N1681		GA-482 ¹⁰⁸ CATP	70000-14674		GA-59 KUBO
690348		GP-171 ¹⁶ ALCH	6953369		G-750 EATN	6N1681		GA-483 ¹⁰⁴ CATP	70000-14675		GA-75 KUBO
690348		GP-171 ¹⁶ ALLI	6955207		G-33 EATN	6N2731		GA-7360 ¹⁰⁸ CATP	70000-14677		GA-70 KUBO
690348		GP-171 ¹⁶ GMCX	6955207		G-33 YALE	6N2731		GA-7716 ¹⁰⁴ CATP	70000-14678		GA-192 KUBO
6908352		GP-367 PUR	6955303		G-33 EATN	6N2732		GA-7360 ¹⁰⁸ CATP	70000-14680		GA-303 KUBO
691		GP-3816 CRO	6955303		G-33 YALE	6N2732		GA-7716 ¹⁰⁴ CATP	70000-14681		GA-50 KUBO
69100108		GA-106 ⁴⁶ HAWK	6960003		GA-251 EATN	6N3784		GP-110 CATP	70000-14682		GA-77 KUBO
69100108		GA-326 ⁷¹ HAWK	6960003		GA-251 YALE	6N6071		GA-356 CATP	70000-14683		GA-3647 KUBO
691-00108		GA-106 ⁴⁶ LSTR	6960390		GP-57 YALE	6N6072		GA-357 CATP	70000-14684		GA-80 KUBO
691-00108		GA-326 ⁷¹ LSTR	6962224		GA-360 WERK	6N7302		GA-482 ¹⁰⁸ CATP	70000-14685		GA-89 KUBO
691030		GAK-625 PEGA	6962225		GA-361 WERK	6N7302		GA-483 ¹⁰⁴ CATP	70000-14686		GA-3300 KUBO
69115561		GP-310 VAG	69-6987E		G-296 CATP	6N7617		G-293 CATP	70000-14688		GA-85 KUBO
69115561		GP-310 VOLK	69-6987E		G-296-B CATP	6N7847		GA-1286 ¹⁰⁸ CATP	70000-14689		GP-1 KUBO
69129620		GAUVW-2 AUDI	696P		G-238 GREY	6N7847		GA-9334 ¹⁰⁴ CATP	70000-14690		GP-3 KUBO
69129620		GAUVW-2 VAG	697		G-162H CRO	6N8262		GA-1286 ¹⁰⁸ CATP	70000-14691		GP-46 KUBO
69129620		GAUVW-2 VOLK	6976		GA-176 NAP	6N8262		GA-9334 ¹⁰⁴ CATP	70000-14692		GP-81 ³¹ KUBO
69149-C1		GP-34 IHCO	6977		GA-186 NAP	6N0201211		GG-5 L VOLK	70000-14692		GP-9 ⁸ KUBO
69149-C1		GP-34 KOMA	698089		GA-405 PEGA	6P41B		G-566 PUR	70000-14693		GP-20 KUBO
6915		GA-646 NAP	6982		G-31 WAUX	6PS2690		GAK-403 CHIC	70000-15241		GP-149 KUBO
6916		GA-1546 NAP	698789		GA-26 FWDX	6Q0 129 620		GAUVW-624 VOLK	70000-16674		GA-59 KUBO
691681		GP-166 FORD	699		G-297-B CAV	6Q0 129 662 0		GAUVW-624 VOLK	70000-16675		GA-75 KUBO
691681		GP-166 NEWH	699		G-1121 CRO	6Q0-129-620B		GAUVW-624 VOLK	70000-16676		GA-57 KUBO
691726		GA-49 DAF	699143		G-750 GMCX	6Q0201511		GG-355 SEAT	70000-16677		GA-70 KUBO
691726		GA-49 LEYL	69948		G-1176 ALCH	6Q0820367		GAC-3 SEAT	70000-16678		GA-192 KUBO
691M-6714-A		GP-28 ⁸ FORD	69948		G-1175 ¹⁰⁸ BLDW	6Q0820367		GAC-3 VOLK	70000-16679		GA-55 KUBO
691M-6714-A		GP-430 ⁸ FORD	699487		G-1175 ¹⁰⁸ ALCH	6V3690		GP-36 CATP	70000-16681		GA-50 KUBO
691M-6714-A-A		GP-360 FORD	6994670		GA-357 CHIC	6V5875		GP-9586 CATP	70000-16682		GA-77 KUBO
692		GA-331 AMP	69954670		GA-357 CONP	6X0 201 511		GG-106 AUDI	70000-16683		GA-3647 KUBO
692		G-331 BGA	6A		GAK-16 BOG	6X0 201 511		GG-106 SEAT	70000-16684		GA-80 KUBO
6920340		GA-6129 VOLV	6A115561		GP-28 ⁸ VOLK	6X0 201 511		GG-106 SKOD	70000-16685		GA-89 KUBO
6922		GA-770R NAP	6A115561B		GP-430 ⁸ VOLK	6X0 201 511		GG-106 VOLK	70000-16686		GA-3300 KUBO
692306		GP-57 DEMA	6A115561B		GP-28 ⁸ VOLK	6X0 201 511 B		GG-106 AUDI	70000-16687		GA-3523 KUBO
692336		GP-1011Q DEMA	6A115561B		GP-430 ⁸ VOLK	6X0 201 511 B		GG-106 SEAT	70000-16688		GA-85 KUBO
692338		GP-2071W DEMA	6A32157		G-1174 ¹⁰⁸ INGR	6X0 201 511 B		GG-106 SKOD	70000-16689		GA-303 KUBO
6928490		GP-77 PUR	6A4604		GA-49 CATP	6X0 201 511 B		GG-106 VOLK	70000-32050		GP-91 KUBO
6930670		GP-54 ⁹⁰ PUR	6A4604V		GA-49 CATP	6X0-201-511B		GG-106 VOLK	70000-32090		GP-1 KUBO
6931950		GP-171 ¹⁶ PUR	6A4604V		GA-49 TOWM				70000-32091		GP-1 KUBO
6934765		GP-50 PUR	6C 1196 01 BC		GA-27161 FORD				70000-32431		GP-3600 KUBO
6934769		GA-105 PUR	6C133843		GA-2124 VOLK				70000-37500		G-296 KUBO
6934938		GP-31 PUR	6CH0330		GA-29 WHIT				70000-37500		G-296-B KUBO
6934965		GP-23 PUR	6D300U		GP-3000 KRA				7001		GA-9334 ERO
6935		GA-1542 NAP	6DBA0330		GA-5648 WHIT				7001-01		GP-92 CIM
6935058		G-1175 PUR	6E52-9601-AE		GA-1572 FORD				70016		GA-6129 GMCX
6935115		GA-12 PUR	6E52-9601-EA		GA-1572 FORD				70017		GA-6129 GMCX
6935189		G-1173 PUR	6F 133 843A		GAUVW-617 AUDI				7002		GA-9045 ERO
6935221		GP-1101 ⁵⁴ PUR	6F 133 843A		GAUVW-617 PORS				700-02		GP-26 CIM
6935244		G-236 PUR	6F 133 843A		GAUVW-617 VAG				700-03		GP-26 CIM
693747		GA-357 DEMA	6F 133 843A		GAUVW-617 VOLK				70030		G-613 WHIT
6938155		GP-178 PUR	6F701162		GA-319 PERK				7000-32-431		GP-28 ⁶ KOMA
693853		G-6 CLRK	6F80117		GA-360 CONP				7000-32-431		GP-430 ⁸ KOMA
6939		GA-241 NAP	6F80119		GAK-403 CONP				70003-2431		GP-28 ⁶ KUBO
693P		G-296 GREY	6FAA0330		GA-27 AUTC				70003-2431		GP-430 ⁸ KUBO
693P		G-296-B GREY	6FAA0330		GA-27 WHIT				70038		G-613 WHIT
694		G-333 BGA	6FAB0330		GA-27 AUTC				7004		GA-8047 ERO
694		GP-3682 CRO	6FAB0330		GA-27 WHIT				7005		GA-7716 ERO
6940		GP-57 ACD	6FC0330		GAK-20 AUTC				70052371		GP-11 FIAT
6940571		GP-171 ¹⁶ PUR	6FC0330		GAK-20 WHIT				70052371		GP-11 HEST
694218		GA-467 DAF	6FH0330		GAK-20 AUTC				700712		GP-1122 LBHR
694229		GP-1 TOWM	6FH0330		GAK-20 WHIT				700713		GP-1122 LBHR
69-4229		GP-1 CATP	6FP2330		GA-26 AUTC				700713		GP-1122 LBHR
69-4229E		GP-1 CATP	6FP2330		GA-26 WHIT				7-00094		GA-105 WARD
694450		GA-5648 DAF	6FPS1734		GAK-20 CONP				700-10		GGP-25 CIM
6947176		GA-879 GMCX	6FS2330		GA-26 AUTC				70-010005		GP-1108 WHIT
695		G-335 AMP	6FS2330		GA-26 WHIT				7001087		GP-77 LBHR
695		G-335 BGA	6GAB0330		GA-27 WHIT				700-11		GGP-25 CIM
695		GA-18 DEL	6GT0330		GA-31 AUTC				70011955		G-500 FIAT
6950090		GAK-20 EATN	6GT0330		GA-31 WHIT				70012		GP-66 CIM
6950090		GAK-20 YALE	6H5931		G-1166 CATP				7001222		G-1123 LBHR
69-50090		GAK-20 WHIT	6H5932		G-1166 CATP				7001222		G-1123F LBHR
6950185		GAK-403 EATN	6H9936		G-238 CATP				7001224		G-31 LBHR
6950185		GAK-403 YALE	6H9937		G-238 CATP				7001261		GP-1122 LBHR
69-50185		GAK-403 WHIT	6H9999		G-222 CATP				70013		GP-92 CIM
695018500		GAK-403 EATN	6H9999		G-238 CATP				700131301		GA-33 ¹² CASE
6950639		GA-29 MINN	6H9999M		G-238 REF				700131301		GA-33 CASE
6951125		G-566 EATN	6I2499		GA-499R CATP				70000-14640		GP-50 KUBO
6951125		G-566 YALE	6I4783		GP-1109 ²² CATP				70000-14641		GP-50 KUBO
6951127		G-1175									

Numero	Gonher	Fabricante	Numero	Gonher	Fabricante	Numero	Gonher	Fabricante	Numero	Gonher	Fabricante
Number	Gonher	Manufacturer	Number	Gonher	Manufacturer	Number	Gonher	Manufacturer	Number	Gonher	Manufacturer
7002304	G-1121	LBHR	70108N	GA-98 ¹¹²	NLSN	702322-C91	GA-326 ⁷¹	IHCO	7031	GAD-118	SERC
7002305	G-1121	LBHR	701096-C91	G-1163 ¹⁰⁸	IHCO	702323-C1	GA-206	IHCO	7031	GAD-118	SERV
7-00242	GA-26	WARD	70110141	GAK-403	ALCH	702323-C91	GA-206	IHCO	703101	GP-13	CHEK
70024920	G-1175 ¹⁰⁸	FIAT	7011192	G-870	MOTA	70232421	GP-310	FIAT	703103	GP-3	WHIT
70025257	G-31	FIAT	70115561	GP-3600	VOLK	70232578	GP-310	FIAT	703112	GAK-403	WHIT
70025265	G-1175	FIAT	70-115-561	GP-28	VOLK	70234774	GP-5	FIAT	70315-N	GA-891	NLSN
70025725	G-31	FIAT	701159	GA-50	CHEK	70234900	GP-1	FIAT	7031-6	G-1123	CAV
70025725	G-31	IVEC	701162	GA-56	CHEK	70235N	GA-680	NLSN	7031-6	G-1123F	CAV
700266	GP-66	AGCH	701177	GA-5648	CUMM	70237000	GP-1	FIAT	70324N	GA-679	NLSN
7002914	G-163	LBHR	70126517	GP-1101	FIAT	7023700-0	GP-1	ALCH	70325N	GA-680	NLSN
7002915	G-143	LBHR	70132578	GP-1	FIAT	70237395	GA-18	FIAT	7033	G-45	NAP
7003751	GA-405	OREN	70132N	GA-509 ¹⁴	NLSN	70237N	GA-106 ⁴⁶	NLSN	7033	GA-141	SERV
7003804655	GA-33 ¹¹²	BLUE	70134	GP-66	VESC	70237N	GA-326 ⁷¹	NLSN	7033616	GP-166	FIAT
7004209	GP-66	LBHR	7013404	GG-123	GMCCX	70238N	GA-6127	NLSN	7033616	GP-166	HEST
70042606	G-1173 ¹⁰⁸	FIAT	701350-C1	GP-1101	IHCO	70239513	GA-33 ¹¹²	ALCH	703420-C91	GP-1108	IHCO
70043129	G-1173 ¹⁰⁸	FIAT	701350-C1	GP-1101	KOMA	70239513	GA-33 ¹¹²	FIAT	70346N	GA-18	NLSN
70048068	G-1173 ¹⁰⁸	FIAT	70135N	GA-885	NLSN	70239518	GA-33 ¹¹²	FIAT	7035	GP-58 ¹⁵	NAP
7005658	GP-36	LBHR	70138637	GP-1101	FIAT	7023951-8	GA-33 ¹¹²	ALCH	70351N	GA-6128	NLSN
70059792	G-33	FIAT	70140N	GA-376	NLSN	70239930	GP-5	ALCH	70356N	GA-6129	NLSN
70059897	G-1176	FIAT	70141N	GA-109	NLSN	70239930	GP-5	FIAT	70367N	GA-892	NLSN
70059N	GA-6127	NLSN	70142A	GA-209	NLSN	70243162	GAK-16	FIAT	7037	GP-737	NAP
70061814	G-500	FIAT	70142N	GA-209	NLSN	70243163	GAK-16	FIAT	70381N	GA-239	NLSN
70061817	G-500	FIAT	70143N	GA-107	NLSN	7024316-3	GAK-16	ALCH	70383N	GA-329	NLSN
70061818	G-500	FIAT	7015	GP-2015W	DEL	70244570	GA-361	ALCH	70391N	GA-372	NLSN
70062101	G-500	FIAT	7016	GP-1011Q	DEL	70244570	GA-361	FIAT	70395	G-871	MASY
70062A	GA-18	NLSN	701619	GA-378	GMCCX	70244622	GAK-20	FIAT	70395	G-871	PERK
70062N	GA-18	NLSN	70167N	GA-425	NLSN	7024462-2	GAK-20	ALCH	70395	G-871	STAN
70063L	GA-106 ⁴⁶	NLSN	70168N	GA-426	NLSN	70244728	GAK-20	FIAT	70398N	GA-229	NLSN
70063L	GA-326 ⁷¹	NLSN	70172N	GA-563	NLSN	7024472-8	GAK-20	ALCH	70399L	GA-26	NLSN
70063N	GA-106 ⁴⁶	NLSN	70175N	GA-891	NLSN	70244N	GA-7360	NLSN	70399N	GA-26	NLSN
70063N	GA-326 ⁷¹	NLSN	70182N	GA-372	NLSN	702455	GA-106 ⁴⁶	AGCH	70400N	GA-879	NLSN
700-64	GP-92	CIM	70184756	GA-5648	FIAT	702455	GA-326 ⁷¹	AGCH	70402N	GA-371	NLSN
700640000	GP-92	CIM	70185162	GA-5648	FIAT	70245N	GA-482	NLSN	704036791	GP-51	FIAT
70065583	G-1173 ¹⁰⁸	FIAT	70185691	G-33	FIAT	702463	GA-206	AGCH	70410-R91	G-31	IHCO
70065587	G-1173 ¹⁰⁸	FIAT	701856915	G-33	FIAT	70248399	GP-66	FIAT	70411-R1	G-31	HYST
70065590	G-1173 ¹⁰⁸	FIAT	70185N	GA-6880	NLSN	702483998	GP-66	FIAT	70411-R91	G-31	IHCO
70065596	G-1173 ¹⁰⁸	FIAT	70186162	GA-5648	FIAT	70248882	GAK-16	FIAT	70413130	G-1176	FIAT
70067N	GA-361	NLSN	70186N	GA-378	NLSN	7024888-2	GAK-16	ALCH	70413N	GA-9334	NLSN
70069948	G-1176	FIAT	70188056	G-33	FIAT	70249N	GA-1284	NLSN	70414N	GA-7716	NLSN
7006S	G-870	WIX	701880566	G-33	FIAT	70250699	GA-33 ¹¹²	ALCH	70415N	GA-1285	NLSN
700701211	GA-356	FIAT	7019-113	G-1121	CAV	70250699	GA-33 ¹¹²	FIAT	70417L	GA-27	NLSN
700701220	GA-357	FIAT	7019-122	G-1123	CAV	70251397	G-296	AGCO	70417N	GA-27	NLSN
700702595	GPP-14	HEST	7019-122	G-1123F	CAV	70251397	G-296-B	AGCO	704202	G-296	COLS
700702595	GPP-14	HEST	7019-124A	G-1121	CAV	70251397	G-296	ALCH	704202	G-296-B	COLS
700702596	G-750	FIAT	7019-221	G-1121	CAV	70251397	G-296-B	ALCH	70422N	GA-31	NLSN
700702596	G-750	HEST	7019222	G-296	CAV	70251397	G-296	FIAT	70431021	G-33	FIAT
700703331	GP-53	FIAT	7019222	G-296-B	CAV	70251397	G-296-B	FIAT	704314	GA-229	GMCCX
700703331	GP-53	HEST	70192N	GA-373	NLSN	70251397-9	G-296	AGCO	70432C91	G-122	CASE
700703332	GP-57	FIAT	70194N	GAK-216	NLSN	70251397-9	G-296-B	AGCO	70432C91	G-338	CASE
700703332	GP-57	HEST	70196N	GAK-403	NLSN	70251397-9	G-296	ALCH	70432-C91	G-122	IHCO
700708235	GAK-216	HEST	70197121	G-33	FIAT	70251397-9	G-296-B	ALCH	70432-C91	G-338	IHCO
700708236	GA-416	HEST	70197569	GA-6129	FIAT	70251397-9	G-296	FIAT	70436233	G-1175 ¹⁰⁸	FIAT
70070L	GA-360	NLSN	70197588	GA-6127	FIAT	70251397-9	G-296-B	FIAT	704391	GA-378	GMCCX
70070N	GA-360	NLSN	7019758-8	GA-6127	ALCH	70251N	GA-1286	NLSN	70440158	GA-892	FIAT
70071-AB	G-31	CASE	70197822	GA-6129	FIAT	70252050	G-296	FIAT	7046	GP-461	NAP
700721779	GAK-16	FIAT	70198780	GA-6129	FIAT	70252050	G-296-B	FIAT	704614	GG-251	PARM
70072636	GAK-16	FIAT	70199N	GA-105	NLSN	7025282	G-1121	VOLV	70463222	GP-53	FIAT
70072L	GA-356	NLSN	702	GG-5 L	CRO	70252N	GA-1287	NLSN	70465583	G-1173 ¹⁰⁸	FIAT
70072N	GA-356	NLSN	702016	GA-229	GMCCX	70254N	GA-1008	NLSN	7047	G-912	NAP
70073N	GA-357	NLSN	70202	GP-3766	CIM	70256395	GAK-625	FIAT	70475N	GAK-1532	FIAT
70076N	GA-493 ¹⁰⁸	NLSN	70206N	GA-33 ¹¹²	NLSN	70257597	GA-33 ¹¹²	FIAT	7048399	GP-66	FIAT
70079325	G-33	FIAT	70206Z	GA-33 ¹¹²	NLSN	702582	G-1121	VOLV	704890	G-750	GMCCX
70079352	G-33	FIAT	7021	G-72	NAP	70258N	GA-9045	NLSN	704944	G-33	WHIT
70079C	GAK-16	NLSN	702142-C1	GP-110	IHCO	70259793	GA-759 ¹⁰⁸	FIAT	704944	G-33	NEWI
70079G	GAK-16	NLSN	702143-C1	GP-1105	IHCO	70261N	GA-8047	NLSN	7049445	G-33	WHIT
70079N	GAK-16	NLSN	702167	G-31	BOLI	70263434	GA-426	FIAT	704945	G-33	NEWI
70079Z	GAK-16	NLSN	702167	G-31	BRIG	70263435	GA-425	FIAT	704945	G-33	WHIT
70081733	G-33	FIAT	702167	G-31	VOLV	7026343-5	GA-425	ALCH	7049490	GA-6127	GMCCX
70082441	G-500	FIAT	7022	GP-2022W	DEL	70264739	GA-826	FIAT	704953	GAK-403	AVAI
70082442	G-500	FIAT	70220022	G-31	FIAT	7026473-9	GA-826	ALCH	704953	GAK-403	AVCO
70082449	G-500	FIAT	70220026	G-31	ALCH	70264740	GA-827	FIAT	704953	GAK-403	HERC
70082508	G-500	FIAT	70220026	G-31	FIAT	7026474-0	GA-827	ALCH	704953	GAK-403	NEWI
70082N	GA-37	NLSN	7-02203	GA-12	PRIL	7026593	GAK-625	FIAT	705	GP-1	BGA
7008443	GA-563	LBHR	7-02204	GA-7	PRIL	70266787	GAK-625	FIAT	705068	GAK-20	NEWI
70085N	GA-5648	NLSN	7-02246	GA-44	PRIL	7026678-7	GAK-625	ALCH	705085	GA-210	AGCH
7008775	GPP-1122	LBHR	70224785	GA-200	VOLV	7026687	GAK-625	FIAT	705086	GA-209	GMCCX
7008776	GPP-1122	LBHR	70224785	GA-218	VOLV	70267075	GAK-625	FIAT	70517N	GA-416	NLSN
70090828	G-33	FIAT	702250-C1	GP-1101	IHCO	70269N	GA-206	NLSN	7052417	GP-81 ³¹	LNCR
70091540	G-500	ALCH	702251-C1	GP-1108	IHCO	7027	GP-36	NAP	7052417	GP-9 ⁹⁸	LNCR
70091540	G-500	FIAT	702253-C1	GP-110	IHCO	70271437	G-750	ALCH	7052420	GP-81 ³¹	LNCR
70091L	GA-251	NLSN	702253-C2	GP-110	KOMA	70274N	GA-356	NLSN	7052420	GP-9 ⁹⁸	LNCR
70091N	GA-251	NLSN	702254-C1	GPP-14	IHCO	702762Y	GP-53	PERL	70529N	GA-1203	NLSN
7009285	GA-360	LBHR	702255-C1	GPP-14	IHCO	70276N	GA-375	NLSN	70533N	GA-679	NLSN
70093B	GA-3501	NLSN	702255-C1	GP-114	KOMA	70277050	G-1174	FIAT	705346	GAK-403	CUMM
70093N	GA-3501	NLSN	702256	GP-1101	IHCO	7028	GP-166 ⁶⁵	NAP	705347	GAK-20	CUMM
7009621	GAWV-2	LBHR	702256-C1	GPP-1000	IHCO	7028	GP-3937 ¹¹	NAP	705-47	GP-34	CIM
700988	GA-229	GMCCX	70226C	GA-33 ¹¹²	NLSN	70293L	GAK-1532	NLSN	705-48	GP-66	CIM
700K	GG-1	CRO	70227040	G-1174 ¹⁰⁸	FIAT	70293N	GAK-1532	NLSN	70566682	G-1173 ¹⁰⁸	FIAT
700K	GG-4	CRO	7023	GP-2071W	DEL	70299A	GAK-20	NLSN	705730-R91	G-870	IHCO
701	G-152	AMP	70230578	GP-1	FIAT	70299L	GAK-20	NLSN	705735-R91	G-871	IHCO
701	G-152	BGA	702319-C91	GA-106 ⁴⁶	IHCO	70299N	GAK-20	NLSN	705747R91	G-870	CASE
701	GG-5 L	CRO	702319-C91	GA-326 ⁷¹	IHCO	702K	GG-5 L	CRO	705747-R91	G-870	IHCO
7010	GP-2071W	DEL	70231N	GA-2984	NLSN	703	GG-1	CRO	705763	GA-90	GMCCX
70101N	GA-361	NLSN	702322-C1	GA-106 ⁴⁶	IHCO	703	GG-4	CRO	70581N	GA-239	NLSN
7010578	GA-206	LBHR	702322-C1	GA-326 ⁷¹	IHCO	70302A	GAK-625	NLSN	70585	GP-310	IPS
701069	GP-13	CHEK	702322-C91	GA-106 ⁴⁶	IHCO	70302N	GAK-625	NLSN	70586N	GA-210	NLSN

Referencia Cruzada por Numero de Parte

Cross Reference by Part Number



Numero	Gonher	Fabricante	Numero	Gonher	Fabricante	Numero	Gonher	Fabricante	Numero	Gonher	Fabricante
Number	Gonher	Manufacturer	Number	Gonher	Manufacturer	Number	Gonher	Manufacturer	Number	Gonher	Manufacturer
70592765		GP-1 FIAT	7073		GP-406 NAP	710-10-703-32		GP-36 STEY	71450		GAK-20 GALN
705977	GA-378	GMCX	7073083		GA-360 GMCX	710195	GP-1010Q	AGCH	71455185		GPP-11 FIAT
706	GP-14	AMP	70-73723		GP-1011Q WHIT	71023	GG-246	BOG	71455205		GP-57 FIAT
706	GP-14	BGA	70-73724		GP-1011Q WHIT	71028	GG-251	BOG	71465205		G-834 WIX
7060	GP-406	NAP	70-74037		GP-2071W WHIT	71028	GG-251	ROB	71490		GAK-20 GALN
706049	GAK-20	AGCO	70-74038		GP-1011Q WHIT	71030	GG-408	BOG	71497005		GP-3000 FIAT
706049	GAK-20	AVAI	707419		GP-9586 AGCH	71031	GG-226	ROB	7149838		G-834 VAUX
706049	GAK-20	AVCO	70746N		GA-459 NLSN	710319	GP-3600	GMCX	7149839		G-834 BEDF
706049	GAK-20	NEWI	70759951		G-238 FIAT	71035	GG-246	BOG	7149839		G-834 GMCX
706049	GAK-20	WHIT	707706		GA-27 CUMM	71035	GG-408	BOG	71502		GG-185 ROB
706075	GA-37	NLSN	707721517		GA-6129 FIAT	71036	GG-408	BOG	71504		GG-184 ROB
706125	GA-459	NLSN	707721525		GA-6127 FIAT	71038	GG-189	BOG	71506		GG-190 ROB
70615N	GA-892	NLSN	7078		G-180 NAP	71039	GG-261	BOG	71508		GG-181 ROB
70620717	GA-5648	FIAT	7078		G-918 NAP	71047	GG-189	BOG	71509		GG-94 BOG
7062071-7	GA-5648	ALCH	707804		GA-209 AGCH	71048	GG-246	BOG	71509		GG-94 ROB
7063182-8	G-1175 ¹⁰⁸	ALCH	707825060		GAK-625	7105000	G-834	TRCA	71511		GG-220 BOG
70637957	G-500	FIAT	707858		G-870 MASY	71052	GG-408	BOG	71512		GG-142 BOG
70638274	GAK-403	ALCH	707858-M91		G-870 MASY	71052	GP-66	ELGN	71512		GG-142 BOG
70638274	GAK-403	FIAT	707858R1		G-870 IHCO	71056	GG-408	BOG	71513		GG-220 BOG
70639050	GAK-16	ALCH	707858R91		G-870 CASE	71064	GG-46	BOG	71514		GG-187 BOG
70639050	GAK-16	FIAT	707858-R91		G-870 IHCO	71064	GG-46	ROB	71516		GG-215 BOG
70639213	G-1176	FIAT	70793N		GA-360 NLSN	7110408	G-871	BEDF	71521		GG-185 ROB
70639214	G-1173 ¹⁰⁸	FIAT	7079710		G-295 ELGN	7110408	G-871	GMCX	71523		GG-146 BOG
7064	G-911	NAP	7079711		GP-14 ELGN	711048	GPP-11	AGCH	71523		GG-146 BOG
70640660	GAK-16	FIAT	708041782		GA-106 ⁴⁶ FIAT	711049	GP-3000	AGCH	71530		GG-214 ROB
70640N	GA-351 ⁵⁵	NLSN	708041782		GA-326 ⁷¹ FIAT	7111-096	G-296	CAV	71533		GG-214 ROB
70640N	GA-3551 XT ⁶⁴	NLSN	70804N		GA-329 NLSN	7111-096	G-296-B	CAV	71534		GG-79 ROB
706425	GA-360	CUMM	70806N		GA-357 NLSN	71111796	G-296	PERK	71537		GG-260 ROB
706453	G-836	COLS	7082		G-49 NAP	71111796	G-296-B	PERK	71538		GG-181 BOG
70648734	GA-106 ⁴⁶	ALCH	708476		GP-34 AGCH	7111296	G-296	EXCL	71539		GG-137 BOG
70648734	GA-326 ⁷¹	ALCH	7085		GP-3816 NAP	7111296	G-296-B	EXCL	71539		GG-137 ROB
70648734	GA-106 ⁴⁶	FIAT	70852N		GA-616 NLSN	7111-296	G-296	CAV	71540		GG-150 BOG
70648734	GA-326 ⁷¹	FIAT	70860410		GA-111 FIAT	7111-296	G-296-B	CAV	71540		GG-150 ROB
706546	GA-135	GMCX	70867471		G-1173 ¹⁰⁸ FIAT	7111-396	GP-78	CAV	71541		GG-185 ROB
70658126	G-566	FIAT	708721029		GA-206 FIAT	7111-500	G-296	CAV	71542		GG-47 BOG
70658128	G-1143	ALCH	708722126		GA-360 FIAT	7111-500	G-296-B	CAV	71542		GG-47 ROB
70658128	G-1143	FIAT	708722126		GA-360 HEST	7111-596	GG-298	CAV	71549		GG-185 ROB
70658451	GA-106 ⁴⁶	FIAT	708722134		GA-361 FIAT	7111-699	G-297-B	CAV	71551		GG-148 BOG
70658451	GA-326 ⁷¹	FIAT	708722134		GA-361 HEST	7111-796	G-297	CAV	71551		GG-148 ROB
70659095	GA-360	FIAT	70873N		GA-39 NLSN	7111-796	G-297-B	CAV	71552		GG-185 BOG
70659386	GA-6129	ALCH	708748		GA-106 ⁴⁶ CUMM	71134825	GP-171	FIAT	71552		GG-185 ROB
70659386	GA-6129	FIAT	708748		GA-326 ⁷¹ CUMM	71134975	GP-166	FIAT	71558		GG-185 ROB
70659387	GA-6129	ALCH	70877269		GA-44 FIAT	71140887	GAK-403	FIAT	71559		GG-142 ROB
70659387	GA-6129	FIAT	7088752-H		GA-31 WHIT	71140888	GAK-16	FIAT	71560		GG-151 BOG
70659389	GAK-16	FIAT	7088752-H2		GA-31 WHIT	71140889	GA-33 ¹¹²	FIAT	71563		GG-227 BOG
70659397	GA-6129	ALCH	70895N		GA-119 NLSN	71143747	GAK-16	FIAT	715711-R91		GHCO
70659397	GA-6129	FIAT	7090		G-765 NAP	71146873	GP-3	FIAT	715712		G-1121 ICHCO
70659397	GA-6129	FIAT	70905		GA-467 CLAA	71167807	GAK-16	FIAT	715712-R91		G-1121 ICHCO
70659533	GA-106 ⁴⁶	ALCH	709050		GA-467 CLAA	71167808	GAK-16	ALCH	71572		GG-232 BOG
70659533	GA-326 ⁷¹	ALCH	70-90917		GP-1011Q WHIT	71167808	GAK-16	FIAT	71575		GG-115 BOG
70659533	GA-106 ⁴⁶	FIAT	7092		GP-6811 NAP	71167808	GAK-16	IVEC	71575		GG-115 ROB
70659533	GA-326 ⁷¹	FIAT	7095		GP-761H NAP	71174421	GP-54 ⁴¹	GMCX	71581		GG-146 BOG
70660360	GA-360	ALCH	70954N		GA-880R NLSN	71174421	GP-66 ¹⁰	GMCX	71581		GG-146 ROB
70660360	GA-360	FIAT	70956N		GA-853R NLSN	71183469	GP-66	FIAT	71584		GG-215 BOG
706603609	GA-360	FIAT	709666		GP-34 AGCH	711922	GP-36	IHCO	71585		GG-151 BOG
70662447	GA-206	FIAT	70969052		G-871 FIAT	711922604	GP-54 ⁴¹	HANO	71591		GG-185 ROB
7066247-1	GA-206	ALCH	70970269		G-1173 ¹⁰⁸ FIAT	711922604	GP-66 ¹⁰	HANO	71593		GG-217 ROB
70662477	GA-206	FIAT	70986N		GA-966R NLSN	711-922-604	GP-54 ⁴¹	AUWA	71597		GG-185 ROB
70662477	GA-206	ALCH	7099		GP-408 NAP	711-922-604	GP-66 ¹⁰	AUWA	71599		GG-185 BOG
70662607	GA-360	FIAT	709924318		G-296 FIAT	711-922-604	GP-54 ⁴¹	KASB	715F-6714-AA3A		G-836 FORD
70662609	GA-361	ALCH	709924318		G-296-B FIAT	711-922-604	GP-66 ¹⁰	KASB	715F-6731-AA		G-836 FORD
70662609	GA-361	FIAT	709935		GP-1122 AGCH	71192-2604	GP-54 ⁴¹	NISS	715F-6731-BA1A		G-834 FORD
70662618	GA-106 ⁴⁷	FIAT	709936		GPP-18 AGCH	71192-2604	GP-66 ¹⁰	NISS	715F-6731-BA1A		G-834 FORD
70662618	GA-206 ¹⁰⁸	FIAT	709937		GP-43 AGCH	711922853	GP-36	HANO	715F-9150-AAA		GP-1122 FORD
70662618	GA-326 ⁷¹	FIAT	709938		GP-1011Q AGCH	711-922-853	GP-36	KASB	715F-9150-ABA		GP-1122 FORD
70664000	G-222	ALCH	709939		GP-2071W AGCH	71192561	GP-46	ALCH	715HF-6731-AA		G-836 FORD
70664000	G-222	FIAT	70G		GG-124 GREY	71192561	GP-46	FIAT	71600		GG-260 ROB
7066421	G-238	ALCH	70HM-6714-AA		GP-81 ³¹ FORD	711983614	GP-1122	HANO	71601		GG-214 ROB
7066421	G-222	FIAT	70HM-6714-AA		GP-9 ⁵⁸ FORD	711988614	GP-1122	HANO	71606		GG-185 ROB
7066442-1	G-222	ALCH	70M		G-836 REF	711T106	G-500	VERS	71614		GG-1872 BOG
70674953	GAK-16	FIAT	71		GA-9334 ERO	712-01-190-02-1	GA-49	STEY	71614		GG-1872 ROB
70678241	G-1173	ALCH	71 115 466		G-466 AUDI	71206239	G-296	ALCH	71616		GG-185 ROB
70681546	GP-1010Q	FIAT	71 115 466		G-466 PORS	71206239	G-296-B	ALCH	71622		GG-150 ROB
70684733	GA-360	FIAT	71 115 466		G-466 VOLK	712-11-900-21	GA-49	STEY	71623		GG-136 BOG
70684733	GA-360	VOLV	71 115 562		G-466 AUDI	71220N	GA-360	NLSN	71623		GG-136 ROB
7068473-3	GA-360	ALCH	71 115 562		G-466 PORS	712284	GG-1872	PARM	71626		GG-185 ROB
70684734	GA-106 ⁴⁶	FIAT	71 115 562		G-466 VOLK	712420	GA-467	CLAA	71627		GG-185 ROB
70684734	GA-326 ⁷¹	FIAT	71 115 562A		G-466 AUDI	712628	G-1121	IHCO	71628		GG-185 ROB
7068473-4	GA-106 ⁴⁶	ALCH	71 115 562A		G-466 PORS	712628-R91	G-1121	IHCO	71629		GG-185 ROB
7068473-4	GA-326 ⁷¹	ALCH	71 115 562A		G-466 VOLK	712629-R91	G-1121	IHCO	71630		GG-79 ROB
70697135	GP-2071W	FIAT	71 115 562B		G-466 AUDI	713	GA-735 ¹²⁴	FACE	71633		GG-234 BOG
70697633	GPP-14	FIAT	71 115 562B		G-466 PORS	713	GA-735 ¹²⁴	UNN	71636		GG-150 BOG
7069763-3	GPP-14	ALCH	71 115 562B		G-466 VOLK	71309	GA-33 ¹¹²	MILL	71644		GG-164 BOG
70697634	GP-53	ALCH	71000010		G-119 RAYG	7131	G-162H	NAP	71650954		GP-9 ALCH
70697634	GP-53	FIAT	71000011		G-1173 RAYG	71321111	GP-66	AGCO	71650954		GP-81 FIAT
70697635	GP-1011Q	ALCH	7100092		G-870 MOTA	71329308	GP-34	ALCH	716806-R91		G-1121F ICHCO
70697635	GP-1011Q	FIAT	71004421		GAK-403 FIAT	7133574	G-1121	VOLV	716976		GP-35 AGCH
70698281	GP-1011Q	FIAT	71004652		GAK-403 ALCH	7134	GP-67	NAP	7171		G-31 SCHM
7071052	GP-66	ELGN	71004652		GAK-403 FIAT	71354828	GP-1	FIAT	71736100		GG-106 ALFA

Numero	Gonher	Fabricante	Numero	Gonher	Fabricante	Numero	Gonher	Fabricante	Numero	Gonher	Fabricante				
Number	Gonher	Manufacturer	Number	Gonher	Manufacturer	Number	Gonher	Manufacturer	Number	Gonher	Manufacturer				
7176502		G-1123	CAV	72104		GP-81 ³¹	ROB	72214		G-984	ROB	73008		GG-20	CENE
7176601		GPP-1122	LUC	72104		GP-9 ⁵⁸	ROB	72215		G-49	ROB	73008		GG-20	DEL
7176901		G-296	CAV	7211141150		GP-28 ⁸	FIAT	72217092		GP-81 ³¹	AGCO	73013		GG-6	CENE
7176901		G-296-B	CAV	7211141150		GP-430 ⁸	FIAT	72217092		GP-9 ⁵⁸	AGCO	73013		GG-6	DEL
7176901		G-296	LUC	7211141150		GP-28 ⁸	MNH	72217092-5		GP-81 ³¹	AGCO	73014		GG-7	CENE
7176901		G-296-B	LUC	7211141150		GP-430 ⁸	MNH	72217092-5		GP-9 ⁵⁸	AGCO	73014		GG-7	DEL
7176902		G-297-B	CAV	7211141300		GP-54 ¹¹	FIAT	72219		GP-455	ROB	73015		GG-5 L	DEL
717858-R91		G-1121	IHCO	7211141300		GP-66 ¹⁰	FIAT	72221450		GP-54 ¹¹	INGR	73017		GG-19	CENE
71789056		GA-33 ¹¹²	FIAT	7211170		GP-1122	LBHR	72221450		GP-66 ¹⁰	INGR	73017		GG-19	DEL
71799		GG-48	WIX	7211178		GAK-403	LBHR	722256		GAK-16	ALCH	73018		GG-123	CENE
718023		GA-360	OREN	7211197		GAK-16	LBHR	722256		GAK-16	FIAT	73018		GG-123	DEL
718024		GA-361	OREN	7211197		GAK-16	LEVY	722360-M91		GAK-403	MASY	730190101		GAK-216	AGRI
718078		GA-135	GMCX	7211230		GP-1122	LBHR	72257868		G-297-B	AGCO	7301916		GP-9	FIAT
7181		GP-58 ⁸	NAP	72114		GP-20	BOG	72257916		GP-1	AGCO	7301939		GP-9	IVEC
7181P		G-833	WIX	72114		GP-20	ROB	722630-M91		GAK-20	MASY	7302		GP-457	NAP
7182		GP-3937	NAP	72115		GP-3	BOG	722K		GP-157	ASAH	7302020		GA-405	TRCA
718325		GA-356	OREN	72115		GP-3	ROB	72319		G-1173 ¹⁰⁸	CASE	7302060		GA-436	TRCA
718326		GA-357	OREN	72116		GP-36	BOG	7232		G-31	CASE	7302121		GAK-403	KOEH
718456		GA-6880	GMCX	72116		GP-36	ROB	72321		G-31	CASE	7302200		GA-360	TRCA
718481		G-750	GMCX	72116008		GP-58	FIAT	7232329		G-1123 ¹⁰⁸	VOLV	7302210		GA-361	TRCA
718500		GA-135	GMCX	7211853-3		GP-3600	ALCH	7232329		G-1123 ¹⁰⁸	VOLV	73022104		G-33	FIAT
718638		GA-206	OREN	72118856		GP-490	AGCO	7233574		G-1121	BOLI	7302240		GA-106 ⁶⁶	TRCA
7188		GG-181	HAS	72118856		GP-490	FIAT	7233574		G-1121	VOLV	7302240		GA-326 ²¹	TRCA
7188		GG-181	HOND	72119		GP-42	BOG	723360-M91		GAK-403	IHCO	7302250		GA-206	TRCA
719		GA-4365	CRO	72119		GP-42	ROB	723360-M91		GAK-403	MASY	73025265		G-1175 ¹⁰⁸	FIAT
71901		GG-45	BOG	72120		GP-28 ⁸	ROB	7233897		G-1123 ¹⁰⁸	VOLV	7302565		G-1175	FIAT
71901688		G-1173	FIAT	72120		GP-430 ⁸	ROB	7233897		G-1123 ¹⁰⁸	VOLV	73026		GA-49	FUCH
71901929		G-296	FIAT	72121		G-834	BOG	7236628		G-296	BOLI	7302830		GA-6129	TRCA
71901929		G-296-B	FIAT	72121		G-834	ROB	7236628		G-296-B	BOLI	730290101		G-296	AGRI
71902		GG-76	BOG	72122420		GP-3600	FIAT	7236628		G-296	VOLV	730290101		G-296-B	AGRI
71904		GG-202	BOG	721237		GA-360	AGCH	7236628		G-296-B	VOLV	73029050		G-297-B	AGRI
71909		GG-45	BOG	721237023A		GA-360	AGCH	72370000		GP-1	ALCH	73033		GP-54 ¹¹	FUCH
71909100		G-296	FIAT	72125		GP-3531	EXP	723721		GP-3937	AGCH	73033		GP-66 ¹⁰	FUCH
71909100		G-296-B	FIAT	72125		GP-3531	EXP	7237395		GA-18	ALCH	730341		GP-31	NEWH
71909112		G-1173	FIAT	72129		GP-22	BOG	7237395		GA-18	FIAT	730390201		GP-68	AGRI
71909116		GAK-458	FIAT	72129		GP-22	ROB	7238513		G-1123 ¹⁰⁸	VOLV	73039724		G-33	ALCH
71909128		GAK-216	FIAT	72130		GP-58	BOG	7238513		G-1123 ¹⁰⁸	VOLV	7304000037		GAK-16	GROV
71909129		GA-416	FIAT	72130		GP-58	ROB	723K		GP-157	ASAH	73041000		GA-106 ⁶⁶	GROV
71909136		GA-360	FIAT	721305		G-613	CUMM	7241		GP-455	NAP	73041000		GA-326 ²¹	GROV
71909140		GA-416	FIAT	72131		GP-3429	BOG	7243		GP-754	NAP	7304100001		GA-106 ⁶⁶	GROV
71909141		GAK-216	FIAT	72132		GP-46	BOG	7243004		GP-1122	VOLV	7304100001		GA-326 ²¹	GROV
71911		GG-196	BOG	72132		GP-46	ROB	72430044		GP-1122	VOLV	7304100019		GA-106 ⁶⁶	GROV
71916		GG-196	BOG	721322		GA-21	CUMM	7243004-9		GP-1122	VOLV	7304100019		GA-326 ²¹	GROV
71918		GG-203	BOG	72133		GP-3682	BOG	724401		G-31	GMEI	7304100024		GA-27	GROV
71922		GG-188	BOG	72133		GP-3682	ROB	724-401		G-31	KALB	73042912		G-222	FIAT
71924		GG-208	BOG	72137		GP-3816	BOG	7247		GP-761H	NAP	73042922		GA-360	ALCH
71930		GG-204	BOG	7214		G-3827	NAP	725		GP-81	AMP	73042922		GA-360	FIAT
71930213		GP-9	FIAT	721415		GP-194	PARM	725		GP-81	BGA	73044162		GAK-20	ALCH
71961003		GP-171	IVEC	72142		GP-40	BOG	725		GAVW-2	CRO	73044162		GAK-20	FIAT
71999		GG-5 L	BOG	72142		GP-40	ROB	72501530		GP-1122	AGCO	73044713		GAK-403	FIAT
71G		GG-124	GREY	72143		GP-3600	BOG	72501531		GPP-18	AGCO	730449		GP-166	LONG
71M		G-1163 ¹⁰⁸	REF	72143		GP-3600	ROB	72501532		GP-178	AGCO	73045583		GAK-20	ALCH
72		GA-9045	ERO	72144		GP-3980	BOG	72501533		GP-3000	AGCO	73045583		GAK-20	FIAT
72		GA-214	GMCX	72144		GP-3980	ROB	72509505		GP-1012Q	AGCO	73046858		GAK-403	ALCH
72		GA-349	WIX	72150		GP-28 ⁸	ROB	72513286		GP-3000 ¹³	AGCO	73046858		GAK-403	FIAT
7201600		G-1121	TRCA	72150		GP-430 ⁸	ROB	7252		GP-66	NAP	73048581		GAK-403	ALCH
7201620		G-1123	TRCA	72151		GP-462	ROB	72532042		GP-66	FIAT	73048581		GAK-403	ALCH
7201640		G-1121F	TRCA	721569-M91		GAK-16	MASY	725324-M91		GAK-16	MASY	73048658		GAK-403	FIAT
720189		GA-360	AGCH	72161		GP-58	BOG	725387		G-870	ALCH	73050258		GA-360	ALCH
72019740		GA-44	FIAT	72161316		GP-81	AGCO	72-571		G-169	TWIN	73050258		GA-360	FIAT
720257		GAK-403	AGCH	72161316		GP-81	FIAT	725859-M91		GP-66	MASY	7305062		GA-360	KOEH
720258		GAK-20	AGCH	72163		GP-28 ⁸	ROB	72-591-52		G-169	TWIN	730509		GA-436	RIET
7203		G-70	NAP	72163		GP-430 ⁸	ROB	72636		GAK-16	ALCH	73052006		GP-66	IOWA
720300		GP-36	AGCH	72166		GP-157	ROB	72642051021		GP-1101	KRUP	73053290		GA-360	FIAT
720309		GP-10	AGCH	72167		GP-156	ROB	72642-05102-1		GP-1101	KUBO	7305346		GP-57	KOEH
720369		GP-110	AGCH	72168		GP-91	ROB	72674028		GP-28 ⁸	CHRY	7305500		GA-106 ⁶⁶	TRCA
72037395		GA-18	FIAT	72170		GP-212	BOG	72674028		GP-430 ⁸	CHRY	7305500		GA-326 ²¹	TRCA
72037395		GA-18	IVEC	72171		GP-28 ⁸	ROB	727		GP-50	AMP	730755		G-296	NEWH
7206110		GP-78	TRCA	72171		GP-430 ⁸	ROB	727		GP-50	BGA	730755		G-296-B	NEWH
72066436		GA-7	FIAT	72174		GP-1	BOG	727-23-802A		G-834	MZDA	730755		G-296	NEWI
72072636		GAK-16	FIAT	72174		GP-3569	BOG	727-23-820		G-834	MZDA	730755		G-296-B	NEWI
72080205		G-813	FIAT	72174		GP-310	ROB	727-23-820A		G-834	MZDA	730760		GA-826	AGCO
72080483		GA-361	ALCH	72176		GP-156	BOG	727-23-821A		G-834	MZDA	730760		GA-826	NEWI
72080483		GA-361	FIAT	72177		GP-2951	BOG	7272820301		GA-39	KRUP	730760		GA-826	WHIT
72083768		GA-361	FIAT	721779		GAK-16	ALCH	7274622101		G-750	KRUP	730761		GA-827	NEWI
72083768		GA-361	ALCH	721779		GAK-16	FIAT	72776		GP-171	IPS	730761		GA-827	WHIT
72083771		GA-360	ALCH	721779		GAK-16	FTA	728		GP-31	AMP	7309077		GP-3985	KOEH
72083771		GA-360	FIAT	721779		GAK-16	HEST	728		GP-31	BGA	731		GA-1203	DEL
7209396-3		GP-31	ALCH	72178		GP-2951	BOG	7284417		GG-1	SAAB	73-1000		GS-2033	RAR
72097035		GA-33 ¹¹²	AGCO	72179		GP-149	ROB	7284417		GG-4	SAAB	73-1000EE		GS-2033	RAR
72097035		GA-33 ¹¹²	FIAT	72180		GP-91	ROB	728720		GG-264	PARM	73-1000-SERIES		GS-2033	RAR
72097035-5		GA-33 ¹¹²	ALCH	72182		GP-91	ROB	729		GP-1	AMP	73-100EE		GS-2033	RAR
72097371		GA-33 ¹¹²	ALCH	72183		GP-452	BOG	729		GAVW-4	CRO	73101		GG-5 L	CENE
72097690		GP-28	FIAT	72190		GP-46	BOG	729206		G-1143	LETR	73101		GG-5 L	DEL
7209769-01		GP-3600	ALCH	72190		GP-46	ROB	729206		G-1143	WABC	73-1020EO		GS-2033	RAR
72099164		GAK-216	FIAT	72191		GP-31	BOG	72-951		G-169	TWIN	73103		GG-5 L	DEL
721		GA-2194	CRO	72192		G-963	ROB	729865		GP-3675	SAAB	73104894		G-33	FIAT
72101		GP-81	BOG	721K		GP-58	ASAH	72M		G-834	REF	731094		GP-310	VOLV

Referencia Cruzada por Numero de Parte

Cross Reference by Part Number



Numero	Gonher	Fabricante	Numero	Gonher	Fabricante	Numero	Gonher	Fabricante	Numero	Gonher	Fabricante
Number	Gonher	Manufacturer	Number	Gonher	Manufacturer	Number	Gonher	Manufacturer	Number	Gonher	Manufacturer
73140	GG-4	CENE	73323	GA-6127 ¹⁰⁸	FELD	73437	GA-273	ROB	7381646	GPP-425	LBHR
73140	GG-1	DEL	73323	GA-6129 ¹⁰⁴	FELD	73438	GA-381	BOG	7381816	GPP-103 ⁴⁰	LBHR
73140	GG-4	DEL	73324	GA-195	ROB	73438	GA-381	ROB	7381816	GPP-11 ³⁹	LBHR
73144499	GP-761H	FIAT	73326	GA-382	BOG	73439	GA-7344	BOG	7381877	GPP-421	LBHR
73144663	GPP-11	FIAT	73326	GA-382	ROB	73439	GA-7344	ROB	73840	G-200	CASE
73145	GG-94	LEYL	73329	GA-362	BOG	73440	GA-166	ROB	73873	GA-5648	GALN
7314AMP	G-3752	NAP	73329	GA-362	ROB	73441	GAD-118	ROB	73893	GA-5648	GALN
73153	G-1121	KALB	73330	GG-5 L	DEL	73442	GA-432	BOG	739051	GAK-403	JAEG
731607	GP-390 ⁹³	NEWI	73332	GA-180	ROB	73443	GA-198	BOG	7391047	G-33	FAUN
731607	GP-390 ⁹³	WHIT	73333	GA-139	ROB	73453	GA-514	BOG	739472	GA-18	LEYL
73175965	GPP-1122	FIAT	73336	GG-8 ¹⁰³	DEL	73454	GA-434	BOG	739472	GA-18	LONG
73176	GG-251	LUC	73336	GG-8 L ⁸⁰	DEL	73458	GA-2184	BOG	739473	GA-18	LONG
73177276	GP-390	FIAT	73337	GG-16	CENE	73460	GA-2195	BOG	739540	GP-1	LONG
73177276	GP-390	NEWH	73337	GG-16	DEL	73463	GA-5466	ROB	7395819	GP-36	FAUN
73180	GG-45	CENE	73338	GG-17	CENE	73467	GA-384	BOG	73982	GG-1	DEL
73180	GG-45	DEL	73338	GG-17	DEL	7347100135	GA-360	GROV	73982	GG-4	DEL
73181	GG-1	DEL	73341	GA-2110	BOG	73472	GA-479	BOG	73MF-8A424-BAA	GP-1011Q	FORD
73181	GG-4	DEL	73341	GA-2110	ROB	73473	GA-2130	BOG	74	G-31	DEL
732	GA-135	DEL	73351	GA-2110	BOG	73475	GG-87	CENE	74	GA-8047	ERO
73201	GAD-1	BOG	73352	GA-120	ROB	73475	GG-87	DEL	74	GA-86	UNN
73201	GG-251	LUC	733592	GP-66	FIAT	73476	GA-244	ROB	74001	GG-3	BOG
73201	GAD-1	ROB	73366	GA-386	BOG	73480	G-200	LETR	74001	GG-3	ROB
73202	GAD-3	BOG	73366	GA-386	ROB	73483	GA-621	BOG	74002528	GA-44	FIAT
73202	GAD-3	ROB	73372	GA-7142	BOG	73488	GA-491	BOG	74006995	GPP-14	FIAT
73203	GA-277	BOG	73372	GA-7142	ROB	73496	GA-2193	BOG	74007348	GP-50	FIAT
73203	GA-277	ROB	73374	GA-2106	ROB	7349619	G-225	VOLV	74009078	GAK-403	ALCH
73204	GA-3425	ROB	73375	GA-133	ROB	73498	GA-2118	BOG	74009078	GAK-403	FIAT
73205	GA-620 ²⁰	ROB	73376	GA-6619 ¹	ROB	735	GA-54	FACE	7401	GP-3766	NAP
73206	GA-230	BOG	73376	GA-6620 ²⁰	ROB	735	GA-54	UNN	74010	GPP-1122	BOG
73206	GA-230	ROB	73378	GAD-117	ROB	73502069	GA-397	FIAT	740104AS	G-1173 ¹⁰⁸	COCT
73212	GA-2719B	ROB	73378	GAD-117	ROB	73504	GA-2175	BOG	740104AS	G-1173 ¹⁰⁸	OLIV
73213	GA-3300	BOG	73379	GAD-294	BOG	73507	GA-2106	BOG	740104-AS	G-1173 ¹⁰⁸	WHIT
73213	GA-3300	ROB	73380	GAD-129	BOG	735724	GA-360	LEYL	740104GS	G-1173	WHIT
73216	GA-70	BOG	73385	GA-142	BOG	736	GA-7	CRO	7401316	GAK-625	LBHR
73216	GA-70	ROB	73386	GA-6690	ROB	736	GA-31	DEL	74014	G-296	BOG
73218	GA-70	BOG	73388	GA-3523	FACE	736	GA-3523	UNN	74014	G-296-B	BOG
73218	GA-70	ROB	73390	GA-139	ROB	736	GA-3523	UNN	74014	G-296-B	BOG
73219	G-1173 ¹⁰⁸	CASE	73391	GA-139	ROB	7360	GP-1011Q	DEL	74016	G-1121	BOG
73226	GA-50	ROB	73391	GAD-30	BOG	7360149	GAK-625	LBHR	7402000	GP-1101	LBHR
73231	GA-4365	BOG	73393	GA-142	BOG	7360197	GAK-16	LBHR	7402019	GP-1013Q	LBHR
73231	GA-4365	ROB	73393	GA-142	ROB	73605	G-1173 ¹⁰⁸	ALCH	7402022	GP-1101	LBHR
73233	GA-2740	BOG	73394	GA-166	BOG	73605	G-1173	LAPL	7402111	G-1143 ⁹⁰	LBHR
73233	GA-2740	ROB	73395	GAD-3	BOG	7361	GP-1011Q	DEL	74021443	GAK-403	FIAT
73234	GA-4303	BOG	73401	GA-55	ROB	7361354	GA-357	LBHR	74023548	GP-390 ⁹³	FIAT
73234	GA-4303	ROB	73402	GA-71	BOG	7361355	GA-356	LBHR	740235483	GP-390 ⁹³	FIAT
73236	GA-75	BOG	73402	GA-71	ROB	7361501	GP-2071W	LBHR	74024232	G-295	FIAT
73236	GA-75	ROB	73403	GA-70	BOG	7361503	GPP-14	LBHR	74025923	GAK-20	FIAT
73240	GA-75	BOG	73403	GA-70	ROB	7361613	G-750	LBHR	74025933	GAK-20	FIAT
73240	GA-75	ROB	73404	GA-77	BOG	7362686	GA-106 ⁹⁵	LBHR	74026075	GP-50	FIAT
73240	GA-77	BOG	73404	GA-77	ROB	7362686	GA-326 ⁷¹	LBHR	7402855	G-1123	LBHR
73241	GA-3490	BOG	73405	GA-50	BOG	7362687	GA-206	LBHR	74029089	GP-2071W	FIAT
73241	GA-3490	ROB	73405	GA-50	ROB	7363165	GP-53	LBHR	74029120	GP-2071W	FIAT
73241	GG-45	DEL	73406	GA-192	BOG	7363259	GP-66	LBHR	740332	G-834	COLS
73241	GA-3490	ROB	73406	GA-192	ROB	7363465	GP-53	LBHR	74035556	GP-390 ⁹³	FIAT
73242	GG-76	CENE	73407	GA-730	BOG	7363710	G-1143 ⁹⁰	LBHR	74036711	GP-78	FIAT
73242	GG-76	DEL	73407	GA-730	ROB	7364	G-31	PETI	74036791	GP-51	FIAT
73243	GA-140	BOG	73408	GA-85	BOG	7364111	GPP-11	LBHR	7404	GP-761H	NAP
73244	GA-3566	BOG	73408	GA-85	ROB	7364115	GA-6129	LBHR	74040478	G-1173 ¹⁰⁸	FIAT
73246	GA-59	BOG	73409	GA-59	BOG	7364116	GA-6127	LBHR	74051490	G-1173 ¹⁰⁸	FIAT
73246	GA-59	ROB	73409	GA-59	ROB	7364117	GP-1011Q	LBHR	74052172	G-1176	FIAT
73252	GG-1	CENE	73410	GA-57	BOG	7364434	GPP-11	LBHR	74055345	GS-1133	FIAT
73252	GG-4	CENE	73410	GA-57	ROB	736474	GP-34	VICK	74055533	G-1174 ¹⁰⁸	FIAT
73252	GG-4	DEL	73411	GA-75	BOG	7364869	GA-563	LBHR	74055563	G-1174 ¹⁰⁸	FIAT
73252	GG-4	DEL	73411	GA-75	ROB	73660	GP-1122	FUCH	74055916	G-1173 ¹⁰⁸	FIAT
73258	GA-200	BOG	73412	GA-74	BOG	73663	GP-1122	FUCH	74055920	G-1176	FIAT
73258	GA-200	ROB	73412	GA-74	ROB	736662	GP-34	VICK	74056630	GAK-20	FIAT
73258	GA-218	ROB	73413	GA-3425	BOG	736693	GP-34	VICK	74056632	G-1176	FIAT
73259	GA-30	BOG	73413	GA-3425	ROB	7367045	GP-2071W	LBHR	74057143	GC-1133	FIAT
73259	GA-30	ROB	73414	GA-735 ¹²⁴	BOG	736715	GP-166	VICK	74057728	G-1143	FIAT
73267	GA-230	BOG	73414	GA-735 ¹²⁴	ROB	7367183	GA-405	LBHR	74059263	G-750	FIAT
73267	GA-230	ROB	73415	GA-54	BOG	736820	GP-34	VICK	74059292	GAK-403	FIAT
73267714	G-1176	FIAT	73415	GA-54	ROB	736886	GP-166	VICK	74059343	G-750	FIAT
73270	GA-56	BOG	73416	GA-3523	BOG	736910020	GP-9	SAMS	7405934-3	G-750	ALCH
73270	GA-56	ROB	73416	GA-3523	ROB	7369715	GP-53	LBHR	74059373	G-500	FIAT
73277	GA-2194	ROB	73417	GA-89	BOG	737	GA-6129	DEL	74060050	G-296	FIAT
73281	GA-4958	BOG	73417	GA-89	ROB	7371716	G-296	BEDF	74060050	G-296-B	FIAT
73288	GA-4325	BOG	73418	GA-3588	BOG	7371716	G-296-B	BEDF	74062072	GA-44	FIAT
73288	GA-4325	ROB	73418	GA-3588	ROB	7371716	G-296	GMCCX	74062390	GA-360	AGCO
73295	GA-78	ROB	73419	GA-3647	BOG	7371716	G-296-B	GMCCX	740711	G-836	COLS
73296	GAD-3	BOG	73419	GA-3647	ROB	7371716	G-296	LACR	741	GA-85	CRO
73296	GAD-3	ROB	73420	GA-3300	BOG	7371716	G-296-B	LACR	74115561	GP-310	VOLK
73299	GA-322	BOG	73420	GA-3300	ROB	7373	GP-1011Q	DEL	74115561	GP-310	VOLK
73299	GA-322	ROB	73421	GA-274	BOG	737337	GP-34	VICK	741195	GP-14	COLS
7330	GP-1011Q	DEL	73421	GA-274	ROB	737574	GP-390 ⁹³	NEWI	7412	GP-166 ⁹⁵	NAP
73302	GA-4365	ROB	73422	GA-4828	ROB	737816	GP-34	VICK	7412	GP-393 ⁷¹	NAP
73305	GAD-15	ROB	73423	GA-303	BOG	737994	GP-166	VICK	74121392	GP-1	FIAT
7331	GP-1011Q	DEL	73423	GA-303	ROB	737A1	G-31	BAKR	74127435A	GP-1122	VAG
73311	GA-3588	BOG	73424	GA-3424	BOG	737AA1	G-1173 ¹⁰⁸	BAKR	74-129-620	GA-626	VOLK
73311	GA-3588	ROB	73424	GA-3424	ROB	737AD1	GP-66	BAKR	74135559	GP-81	FIAT
73312	GA-390	BOG	73425	GA-86	ROB	737AD2	GP-66	BAKR	741615	GA-2740	NLSN
73312	GA-390	ROB	73426	GA-271	BOG	737G1	GA-44	BAKR	74170601	GP-1	FIAT
73313	GA-471	BOG	73426	GA-271	ROB	737R1	GP-50	BAKR	7417534	GP	

Numero	Gonher	Fabricante	Numero	Gonher	Fabricante	Numero	Gonher	Fabricante	Numero	Gonher	Fabricante
Number	Gonher	Manufacturer	Number	Gonher	Manufacturer	Number	Gonher	Manufacturer	Number	Gonher	Manufacturer
7420-23000	GG-188	SUBA	74-54259	GA-55	WESA	74-6017-3	GA-86	WESA	749F-8A469-BAA	GP-1013Q	FORD
74202-3010	GG-203	SUBA	74-54267	GA-71	WESA	74-6018-1	GA-303	WESA	749F-9176-AAA	GP-14	FORD
74202-3020	GG-202	SUBA	74-5427-5	GA-70	WESA	74-6026-4	GAD-1	WESA	74HM6714CA	GP-81	FORD
74204-2076	GG-208	SUBA	74-54283	GA-77	WESA	74-6027-2	GAD-3	WESA	75	GA-7716	ERO
7420-70020	GG-213	SUBA	74-54291	GA-50	WESA	74-60280	GAD-1 ⁸⁷	WESA	750	G-750	DEL
7420-70021	GG-213	SUBA	74-54309	GA-303	WESA	74-6030-6	GA-3490	WESA	750	G-750	LUF
7420-72020	GG-213	SUBA	74-54317	GA-730	WESA	74-6031-4	GAVW-2	WESA	750	G-750	REF
7420-72021	GG-213	SUBA	74-54325	GA-85	WESA	74-6032-2	GA-277	WESA	7500	GP-3001	NAP
74207-2170	GG-203	SUBA	74-54333	GA-59	WESA	74-6033-0	GA-27198	WESA	7500SAL202F2	GP-34	PFAC
74221405	GP-81	FIAT	74-54341	GA-57	WESA	74-6034-8	GA-75	WESA	750131007	GP-66	ZF
7422680	GA-56	GMCX	74-54374	GA-75	WESA	7461	G-31	CASE	750131063	GP-66	ZF
74228326	GP-81	FIAT	74-54382	GA-3300	WESA	74613117	G-31	FIAT	75013N	GA-33 ¹¹²	NLSN
7423135	GP-54	BOLI	7454408	GA-80	WESA	7461AB	G-31	CASE	750181	GA-26	OREN
7423135	GP-54	VOLV	74-54416	GA-78	WESA	74621540	G-296	FIAT	750-2C	G-750	LUF
7423195	GP-54	VOLV	74-54689	GA-74	WESA	74621540	G-296-B	FIAT	750-3C	G-750	LUF
74236942	GP-81	FIAT	74-55314	GA-50	WESA	74621739	G-296	FIAT	75060642	GA-360	CHRY
74243301	GP-81	FIAT	74-55579	GA-392	WESA	74621739	G-296-B	FIAT	75060642	GA-360	TALB
742-895-5143	GA-230	AUWA	74-55751	GA-74	WESA	74621740	G-296	FIAT	75061045	GA-360	TALB
743	GA-589	DEL	7458	GG-5 L	ALL	74621740	G-296-B	FIAT	75061409	GP-9	MOTA
74321716	GPP-19	FIAT	74-5801-1	GP-1	WESA	746222	GAK-403	FAUN	75061411	GP-1	CHRY
74322701	GP-57	ALCH	74-5802-9	GP-46	WESA	746233	GAK-20	FAUN	75061411	GP-9	MOTA
74322701	GP-57	FIAT	74-5803-7	GP-81 ³¹	WESA	746293	G-1123F	FAUN	75061411	GP-1	TALB
74326239	G-1175 ¹⁰⁸	FIAT	74-5803-7	GP-9 ⁵⁸	WESA	746305	GA-26	FAUN	75065049	GP-9	MASY
74335348	G-33	FIAT	74-5805-2	GP-20	WESA	74636401	G-33	FIAT	75065049	GP-1	TALB
74337568	GA-105	FIAT	74-5809-4	GP-13	WESA	74637714	G-1175 ¹⁰⁸	FIAT	75065398	G-31	CHRY
74339076	G-1173 ¹⁰⁸	FIAT	74-58128	GP-3	WESA	746385	GA-436	FAUN	75065703	GP-3600	RENA
74347021	G-33	FIAT	74587711	G-33	FIAT	746389	GA-467	FAUN	75066000	G-297-B	TALB
74347786	G-1174 ¹⁰⁸	FIAT	74-58805	GP-310	WESA	746395	GA-356	FAUN	75-09-4-30	G-954	BMW
74347787	G-1174 ¹⁰⁸	FIAT	74-5880-5	GP-3569	WESA	74651047	G-31	IVEC	7507	G-750	LUF
74347788	G-1174 ¹⁰⁸	FIAT	74-5881-3	GP-3531 EXP	WESA	74651986	G-296	FIAT	750C	G-750	LUF
74347912	G-1173 ¹⁰⁸	FIAT	74-5882-1	GP-3600	WESA	74651986	G-296-B	FIAT	750C	G-750	REF
74348148	G-1173 ¹⁰⁸	FIAT	74-58839	GP-28 ⁹	WESA	746760	GP-66	FAUN	750LF5	G-750	OSHK
74348148	G-1173 ¹⁰⁸	IVEC	74-58839	GP-430 ⁹	WESA	746773	GP-66	FAUN	750M1C	G-750	LUF
74348149	G-1173 ¹⁰⁸	FIAT	74-58896	GP-3985	WESA	74680444	G-296	FIAT	7505	GP-57	HARV
74348149	G-1173 ¹⁰⁸	IVEC	74-5891-2	GP-2951 ⁶²	WESA	74680444	G-296-B	FIAT	751	GA-891	DEL
74349146	G-1173 ¹⁰⁸	ALCH	74-5891-2	GP-58	WESA	74681776	GP-2071W	FIAT	75-1000	GS-2033	RAR
74349146	G-1173 ¹⁰⁸	FIAT	74-58920	GP-81 ³¹	WESA	746-870	GP-57	FAUN	75-1000FE	GS-2033	RAR
74353268	G-1174 ¹⁰⁸	FIAT	74-58920	GP-9 ⁵⁸	WESA	746911	GA-436	FAUN	75-1000-SERIES	GS-2033	RAR
74353269	G-1174 ¹⁰⁸	FIAT	74590074	G-33	FIAT	746916	GA-106 ⁹⁰	FAUN	751050-C91	GA-27	IHCO
74356500	GP-81	FIAT	74-5903-5	GP-24	WESA	746916	GA-326 ⁷¹	FAUN	75-115-561	GP-1	VOLK
74356575	GP-81	FIAT	74-59043	GP-5	WESA	746920	GP-1122	FAUN	7511800	GPP-1122	LSTR
74-3570	GP-34	TORO	74-5908-4	G-200	WESA	746920	GPP-1122	YALE	751-18100	GPP-1122	LSTR
74-3610	GP-34	TORO	74-5910-0	GP-13	WESA	746928	GA-467	FAUN	75127	GP-50	NEWH
74362633	G-1175 ¹⁰⁸	FIAT	74-5913-4	GP-28 ⁹	WESA	747-075	GAK-625	FAUN	75-1310	GP-761H	TORO
74362639	G-1175 ¹⁰⁸	FIAT	74-5913-4	GP-430 ⁹	WESA	747082	GA-563	FAUN	75131055	GP-66 ⁹⁰	ZRO
74363010	GP-81	FIAT	74-5917-5	GP-81 ³¹	WESA	747284	GP-36	DYPA	7514	GP-66	CRO
74364559	G-1173 ¹⁰⁸	FIAT	74-5917-5	GP-9 ⁵⁸	WESA	747289	GP-36	DYPA	751-74	GA-230	KALB
74367714	G-1176	FIAT	74-5930-8	GP-81	WESA	7473	GP-2071W	DEL	752047	GP-110	DYPA
74367868	G-1175 ¹⁰⁸	FIAT	74-5931-6	GP-42	WESA	747305	G-1121	DYPA	75208272	GP-1122	FIAT
74369289	G-31	FIAT	74-59324	GP-1	WESA	74733112	GP-84	FIAT	75208274	GP-118	FIAT
74369988	G-33	FIAT	74-5943-1	GP-81	WESA	74734562	GP-2071W	FIAT	75208314	GP-43	FIAT
7437000091	GP-26	GROV	74-5951-4	GA-55	WESA	747384	GP-1122	DYPA	75208896	GP-1011Q	FIAT
74371001	GA-360	GROV	74-5953-0	GA-3424	WESA	747476	GP-54 ¹¹	DYPA	752091	GP-9586	DYPA
7437100135	GA-360	GROV	74-5954-8	GA-59	WESA	747476	GP-66 ⁹⁰	DYPA	7521	GP-359	NAP
74371021	G-33	ALCH	74-5955-5	GA-325	WESA	747487	GP-1122	DYPA	75221405	GP-81	FIAT
74371021	G-33	FIAT	74-5956-3	GA-735 ¹²⁴	WESA	7475	GP-2015W	DEL	75221481	GP-81 ³¹	CHRY
74371137	G-33	FIAT	74-5958-9	GA-277	WESA	7475191	GA-361	VOLV	75221481	GP-9 ⁵⁸	CHRY
74371165	G-1176	FIAT	74-59597	GA-59	WESA	74751918	GA-361	VOLV	752489-C91	GAK-20	IHCO
74371449	G-1176	FIAT	74-59605	GA-75	WESA	747760	GP-1122	DYPA	752490-C91	GAK-20	IHCO
74371499	G-1176	FIAT	74-5961-3	GA-4303	WESA	74787410	GP-9	FIAT	7525	GP-19	ALL
74371582	GP-81	FIAT	74-5964-7	GA-192	WESA	74789026	GAK-16	FIAT	752518S	G-31	HERC
74377149	G-1175 ¹⁰⁸	FIAT	74-5968-8	GA-54	WESA	748	GA-59	CRO	75251-BS	G-31	WHIT
74387043	GS-1133	FIAT	74596890	G-33	FIAT	74830	GP-761H	GEHL	75285999	GP-3000	FIAT
74388888	G-1175	FIAT	74596891	G-33	FIAT	74841879	GA-33 ¹¹²	FIAT	753	GA-3425	CRO
74389026	GAK-16	ALCH	74-59704	GA-71	WESA	74842288	GAK-16	FIAT	753	GA-89	FACE
74389026	GAK-16	FIAT	74-59712	GA-57	WESA	748620	GP-3816	DYPA	753	GA-89	UNN
74390593	G-750	FIAT	74-5972-0	GA-271	WESA	748749	GP-91	PARM	75318C1	GP-28 ⁶	CASE
7439059-3	G-750	ALCH	74-5973-8	GA-3814	WESA	74877711	G-33	FIAT	75318C1	GP-430 ⁸	CASE
74393504	GP-1011Q	FIAT	74-59753	GA-730	WESA	749	GA-55	CRO	75318-C1	GP-28 ⁹	IHCO
74393505	GP-2071W	FIAT	74-5977-9	GA-3523	WESA	749	GA-4303	FACE	75318-C1	GP-430 ⁸	IHCO
74394407	GPP-1000	ALCH	74-5978-7	GA-153	WESA	74900600	GP-50	ALCH	753486	GA-405	NEWH
74394407	GPP-1000	FIAT	74-5979-5	GA-3588	WESA	74907794	GA-33 ¹¹²	ALCH	753F-6731-AA	G-836	FORD
74395889	G-33	FIAT	74-5981-1	GA-89	WESA	74907795	GA-33 ¹¹²	FIAT	753F-6731-AA1A	G-836	FORD
7439588-9	G-33	ALCH	74-59829	GA-57	WESA	74910328	GAK-16	FIAT	753F-6731-BA1A	G-834	FORD
74396645	GP-53	FIAT	74-59837	GA-85	WESA	74910810	GP-1	ALCH	754	GA-27198	CRO
74396656	GP-53	FIAT	74-5984-5	GA-3647	WESA	74910810	GP-1	FIAT	75403A	GA-20	BRAY
74398149	G-1173 ¹⁰⁸	FIAT	74-5985-2	GA-3681	WESA	74920158	GP-490	AGCO	75403A	GAK-20	MATB
74406	G-1123	VOLV	74-5986-0	GA-274	WESA	7492158	GP-40	ALCH	754145-C91	G-169	IHCO
74442559	GG-215	FIAT	74-59878	GA-77	WESA	74942265	GP-3682	ALCH	75435	G-500	GALN
74490296	G-296	FIAT	74-5989-4	GA-253	WESA	74980649	GA-405	FIAT	754495	GAK-403	NEWH
74490296	G-296-B	FIAT	74-5990-2	GA-56	WESA	74991358	GA-105	FIAT	75495	GAK-403	NEWH
745	GA-588	DEL	74-59936	GA-3300	WESA	74996245	GAK-16	ALCH	755	GA-27198	CRO
74503973	G-31	FIAT	74-5998-5	GA-70	WESA	74996245	GAK-16	ALCH	755F-6714-AA	G-836	FORD
74505289	G-1173 ¹⁰⁸	FIAT	746	GA-3490	CRO	74996253	GA-33 ¹¹²	ALCH	755F-6714-AAA	G-836	FORD
74505989	G-1173 ¹⁰⁸	FIAT	746	GA-12	DEL	74996253	GA-33 ¹¹²	ALCH	756	GP-20	AMP
74506491	G-1173 ¹⁰⁸	FIAT	74-60041	GA-80	WESA	74997568	GA-105	FIAT	756	GP-20	BGA
74506839	GP-1	FIAT	74-60058	GA							

Referencia Cruzada por Numero de Parte

Cross Reference by Part Number



Numero	Gonher	Fabricante	Numero	Gonher	Fabricante	Numero	Gonher	Fabricante	Numero	Gonher	Fabricante
Number	Gonher	Manufacturer	Number	Gonher	Manufacturer	Number	Gonher	Manufacturer	Number	Gonher	Manufacturer
7571569.....	GP-9	FIAT	763-314-1101.....	G-1123	KASB	7700629215.....	GP-58 ⁵⁵	RENA	771457-C9.....	GA-27	IHCO
757295-C91.....	GA-27	IHCO	76331411107.....	GA-230	ZF	7700676302.....	GP-3985	RENA	771457-C91.....	GA-27	IHCO
757343-C91.....	GA-26	IHCO	76335.....	GAK-16	TENN	77006800167.....	GG-251	RENA	7721517.....	GA-6129	FIAT
7577020000.....	GAK-16	CLM	7634.....	G-31	AMLA	7700680167.....	GG-251	AMCO	7721525.....	GA-6127	FIAT
7577021000.....	GAK-403	CLM	763553.....	GP-1101	OREN	7700680167.....	GG-251	RENA	7722336.....	G-33	FIAT
757836-R91.....	G-296	IHCO	763554.....	GP-1013Q	OREN	7700688711.....	GPP-1122	RENA	7722374.....	GP-36	FIAT
757836-R91.....	G-296-B	IHCO	764455.....	G-31	MASY	7700695804.....	GP-3985	RENA	7722935.....	GP-27	FIAT
757996-C91.....	GA-27	IHCO	764455-M91.....	G-31	MASY	7700700092.....	GPP-1122	RENA	7722943.....	GP-26	FIAT
758.....	GA-277	CRO	764457.....	G-31	MASY	7700705521.....	GA-200	RENA	7723935.....	GP-26	HEST
758245.....	GP-178	PARM	764457M31.....	G-31	MASY	7700705521.....	GA-218	RENA	7723943.....	GP-26	HEST
758262-C91.....	GA-27	IHCO	764457-M91.....	G-31	MASY	7700711477.....	GA-230	RENA	7723992.....	GG-1	CASE
7584031.....	G-25	HFFE	764621-M91.....	G-1173 ¹⁰⁸	MASY	7700720978.....	GP-3985	RENA	7723992.....	GG-4	CASE
7584058.....	G-25	HFFE	76491.....	G-750	GALN	7700727478.....	GP-40	RENA	7724008.....	GP-81 ¹¹	FIAT
758465-C91.....	GA-26	IHCO	7650075.....	GP-54 ¹¹	GUAS	7700730077.....	GP-40	AMCO	7724008.....	GP-9 ⁸	FIAT
758495-C91.....	GA-26	IHCO	7650075.....	GP-66 ¹⁰	GUAS	7700730077.....	GP-3985	RENA	77250.....	G-31	ELGN
75-900.....	GS-2034	RAR	7650143.....	GP-52 ¹¹⁰	GUAS	7700734825.....	GP-40	RENA	77281.....	GP-1	GRAY
75-900FE.....	GS-2034	RAR	7650143.....	GP-691 ⁴⁸	GUAS	7700734937.....	GP-40	RENA	773.....	GA-3588	FACE
75-900-SERIES.....	GS-2034	RAR	765051.....	G-296	IHCO	7700741993.....	GG-251	RENA	773.....	GA-3588	UNN
75921440.....	GP-3816	CITR	765051.....	G-296-B	IHCO	7700742386.....	GG-251	RENA	77301939.....	GP-9	FIAT
7594031901.....	GA-230	KRUP	765051-C91.....	G-296	IHCO	7700873583.....	GP-291	RENA	77-3492.....	GP-66	CATP
759706.....	GP-3980 ¹⁴	PARM	765051-C91.....	G-296-B	IHCO	7700957336.....	GA-2121	RENA	7738-3201.....	GP-178	GRAD
759706.....	GP-48 ¹⁷	PARM	765051-R91.....	G-296	IHCO	7701.....	GP-2071W	CRO	7738-3303.....	GPP-1122	GRAD
759951.....	G-238	FIAT	765051-R91.....	G-296-B	IHCO	7701001494.....	GA-200	RENA	77-3900.....	GP-92	CATP
75C294.....	G-6	HEIL	765449.....	GP-28 ⁸	OREN	7701001494.....	GA-218	RENA	773906234.....	GA-230	HANO
75C425-1.....	GP-34	HEIL	765449.....	GP-430 ⁸	OREN	7701001499.....	GA-200	RENA	773906234.....	GA-230	MASY
75C94.....	G-6	HEIL	76547883.....	GP-149	HITA	7701001499.....	GA-218	RENA	773966.....	GAK-403	RAGY
75TM-9601-AA.....	GAVW-2	FORD	76547923.....	GPP-111	FIAT	7701002280.....	GP-310	RENA	77-3973.....	G-119	CATP
76.....	G-236	LEDR	76547923.....	GPP-524	FIAT	7701005514.....	GA-200	RENA	77430122.....	GAK-403	FIAT
760093-C91.....	GA-26	IHCO	765638.....	GP-2071W	OREN	7701005514.....	GA-218	RENA	7745.....	GP-9000	NAP
760131.....	G-163	DEMA	76567342.....	GP-317H	HITA	7701010100.....	G-296	RENA	77-4592.....	GA-106 ⁶	CATP
760142.....	G-143	DEMA	76570088.....	GA-6128	FIAT	7701010100.....	G-296-B	RENA	77-4592.....	GA-326 ⁷¹	CATP
76031370.....	GA-106 ⁴⁶	WARN	76575245.....	GP-110	FIAT	7701015820.....	GP-1122	RENA	7746.....	GP-9001	NAP
76031370.....	GA-326 ⁷¹	WARN	76590430.....	GA-6127	FIAT	7701016133.....	G-834	RENA	7746XD.....	GP-9001	NAP
7603-1370.....	GA-106 ⁴⁶	GRAD	765925-M91.....	G-1176	MASY	7701016181.....	G-296	RENA	7748.....	GP-9000	NAP
7603-1370.....	GA-326 ⁷¹	GRAD	765951.....	G-296	IHCO	7701016181.....	G-296-B	RENA	775.....	GA-679	DEL
760386.....	G-1123	DEMA	765951.....	G-296-B	IHCO	7701017322.....	GP-1122	RENA	775F-9150-AA.....	G-296	FORD
760387.....	G-1123F	DEMA	765951-C91.....	G-296	IHCO	7701020783.....	GP-81	RENA	775F-9150-AA.....	G-296-B	FORD
760392-C91.....	GA-27	IHCO	765951-C91.....	G-296-B	IHCO	7701021327.....	GA-71	RENA	776.....	GA-12	CRO
76040367.....	GP-761H	HITA	765951-R91.....	G-296	IHCO	7701023168.....	GP-171	RENA	776.....	GA-680	DEL
76040385.....	GA-206	FIAT	765951-R91.....	G-296-B	IHCO	7701025064.....	GA-49	RENA	77-6258.....	GA-206	CATP
7604100130.....	GAK-403	ARMA	7659533.....	GA-106 ⁴⁶	ALCH	7701028181.....	G-297-B	RENA	77659533.....	GA-106 ⁶	FIAT
760424.....	G-143	DEMA	7659533.....	GA-326 ⁷¹	ALCH	7701028406.....	GP-3600	RENA	77659533.....	GA-326 ⁷¹	FIAT
76042658.....	GP-761H	FIAT	7659533.....	GA-106 ⁴⁶	FIAT	7701029280.....	GP-1	RENA	77662477.....	GA-206	FIAT
760590.....	G-1121	DEMA	7659533.....	GA-326 ⁷¹	FIAT	7701030546.....	GPP-1122	RENA	77674.....	GA-135	GMXC
760737-C91.....	GA-27	IHCO	766120-C91.....	GA-26	IHCO	7701033713.....	GA-2121	RENA	776-773.....	GP-66 ⁹⁰	FAUN
76074218.....	GP-761H	FIAT	766122C91.....	GA-106	IHCO	7701033837.....	GP-22	RENA	777.....	G-750	AMUP
7609.....	G-143	NAP	76624214.....	G-222	FIAT	7701035650.....	GP-9	RENA	777.....	G-750	BGA
76102380.....	G-1143	FIAT	7662477.....	GA-206	ALCH	7701035984.....	GA-2121	RENA	777.....	GA-425	DEL
76102382.....	GP-1013Q	FIAT	7662477.....	GA-206	FIAT	7-701-040-285.....	GA-2182	RENA	77722126.....	GA-360	FIAT
76106535.....	GP-2071W	FIAT	7662609.....	GA-361	ALCH	7-701-042-841.....	GA-2173	RENA	77-7261.....	GP-110	CATP
76107722.....	GPP-14	FIAT	7662609.....	GA-361	FIAT	7701-045724.....	GA-2158	RENA	778.....	G-500	AMUP
76107812.....	GP-1013Q	FIAT	76626097.....	GA-361	ALCH	7701052082.....	GA-391	RENA	778.....	G-500	BGA
76107829.....	GPP-18	FIAT	76626097.....	GA-361	FIAT	7701-0793.....	GP-14	ZETO	778.....	GA-426	DEL
76108379.....	GA-39	WARN	766422-C91.....	GA-106 ⁴⁶	IHCO	77011365661.....	GP-81	AMCO	77-8190.....	GP-9586	CATP
7610-8379.....	GA-39	GRAD	766422-C91.....	GA-326 ⁷¹	IHCO	7701265435.....	GP-22	RENA	778-23-802.....	GP-42	MZDA
76109223.....	GA-106 ⁴⁶	BDGR	766442-C91.....	GA-106 ⁴⁶	IHCO	770130546.....	GPP-1122	RENA	7782-38-020.....	GP-42	MZDA
76109223.....	GA-326 ⁷¹	BDGR	766442-C91.....	GA-326 ⁷¹	IHCO	7701348023.....	GP-22	RENA	77825060.....	GAK-625	FIAT
7610-9223.....	GA-106 ⁴⁶	GRAD	76648.....	G-1123	VOLV	7701348025.....	GA-71	RENA	779.....	GAVW-2	CRO
7610-9223.....	GA-326 ⁷¹	GRAD	76648.....	G-1123F	VOLV	7701348028.....	GP-22	RENA	779-400.....	GG-123	GUP
7611-3482.....	GP-27	GRAD	76649.....	G-1123	VOLV	7701348108.....	GP-22	RENA	779-401.....	GG-1	GUP
7611-3483.....	GP-26	GRAD	76649.....	G-1123F	VOLV	7701348110.....	GP-81	RENA	779-401.....	GG-4	GUP
7611-3484.....	G-33	GRAD	7664-90.....	GP-66	PEUG	7701348115.....	GA-200	AMCO	779-402.....	GG-1	GUP
76115651.....	GP-310	VOLK	7665025430.....	GP-91	KUBO	7701348115.....	GA-218	AMCO	779-402.....	GG-4	GUP
761370.....	GA-106 ⁴⁶	GRAD	76653.....	G-1121	VOLV	7701348115.....	GA-200	RENA	779-404.....	GG-20	GUP
761370.....	GA-326 ⁷¹	GRAD	767338-C91.....	G-750	IHCO	7701348115.....	GA-218	RENA	779-409.....	GG-45	GUP
76141573.....	GA-563	DEMA	767520-C91.....	GA-26	IHCO	77013-48175.....	GA-219	RENA	779-410.....	GG-6	GUP
761533.....	GP-3985	PARM	76816099.....	GAVW-2	VOLV	7701348440.....	GP-22	RENA	779-411.....	GG-7	GUP
7616296.....	GP-1122	LBHR	769136C91.....	GA-106 ⁴⁶	IHCO	7701349332.....	GG-1	RENA	779-412.....	GG-19	GUP
7616297.....	GP-28 ⁸	LBHR	769136C91.....	GA-326 ⁷¹	IHCO	7701349332.....	GG-4	RENA	779-414.....	GG-16	GUP
7616297.....	GP-430 ⁸	LBHR	769432-C91.....	GA-106 ⁴⁶	IHCO	7701349452.....	GP-3985	RENA	779-415.....	GG-17	GUP
76190709.....	GPP-14	FIAT	769432-C91.....	GA-326 ⁷¹	IHCO	7701349725.....	GP-40	RENA	779-417.....	GG-76	GUP
76191167.....	GPP-14	FIAT	769436-C91.....	GA-106 ⁴⁶	IHCO	7701349779.....	GP-81	RENA	779-418.....	GG-45	GUP
76191168.....	GP-53	FIAT	769436-C91.....	GA-326 ⁷¹	IHCO	7701349942.....	GP-40	RENA	779-419.....	GG-203	GUP
76192087.....	GP-178	FIAT	76951R91.....	G-296	IHCO	7701349952.....	GP-40	RENA	779-421.....	GG-8 ¹⁰³	GUP
76192146.....	GP-390	FIAT	76951R91.....	G-296-B	IHCO	7701365435.....	GP-22	RENA	779-421.....	GG-8 L ⁸⁰	GUP
76192222.....	GP-2071W	FIAT	7698.....	GA-679	CANC	7701365436.....	GP-22	RENA	779-422.....	GG-1	GUP
7619404.....	GA-853R	LBHR	76986.....	GAK-20	GALN	7701365661.....	GP-81	RENA	779-422.....	GG-4	GUP
761943-C91.....	GA-26	IHCO	76GB-9155-AB.....	GG-246	FORD	770138440.....	GP-22	RENA	779426.....	GG-196	GUP
761970.....	G-33	FIAT	77.....	GA-3300	UNN	7701456922.....	GPP-418	RENA	779-427.....	GG-196	GUP
761F-9601-AA.....	GAK-16	FORD	77.....	GA-3300	WIX	7701480025.....	GA-71	RENA	77943.....	G-169	PENN
7620.....	GP-178	NAP	77 01 047 285.....	GA-4319	RENA	7702.....	GP-1011Q	CRO	779435.....	GG-240	GUP
7620XE.....	GP-178	NAP	77 01 476 258.....	GA-4319	RENA	7702184008.....	GA-231	RENA	779437.....	GG-46	GUP
7621057.....	GP-3816	LBHR	7700040.....	GP-66	FORD	770538151.....	GP-22	RENA	779-438.....	GG-242	SRN
76242051021.....	GP-1101	KRUP	7700042054.....	GA-405	RENA						

Numero	Gonher	Fabricante	Numero	Gonher	Fabricante	Numero	Gonher	Fabricante	Numero	Gonher	Fabricante
Number	Gonher	Manufacturer	Number	Gonher	Manufacturer	Number	Gonher	Manufacturer	Number	Gonher	Manufacturer
777F-9601-M	GA-3425	FORD	79008170	GA-3647	ALCH	7961073	G-870	GMXC	7988016	GA-218	GMXC
77U305EC5	GA-33 ¹¹²	BARB	79008171	GA-277	ALCH	7961094	G-813	FORD	7988077	GA-8	GMXC
780	GAUV-2	CRO	79009138	GA-3637	ALCH	7961094	G-813	GMXC	7988149	G-296	BEDF
78009532	GAK-16	FIAT	79009164	GA-827	ALCH	7961094	G-813	PERK	7988149	G-296-B	BEDF
78011014	GAK-403	ALCH	79009174	GA-3523	ALCH	7961096	G-813	PERK	79909154	G-1173 ¹⁰⁸	FIAT
78011014	GAK-403	FIAT	79009176	GA-893	ALCH	7961106	GG-48	GMXC	79918114	G-296	FIAT
78011414	GAK-403	FIAT	79010563	G-33	FIAT	7961121	GG-48	GMXC	79918114	G-296-B	FIAT
78041782	GA-106 ⁴⁶	FIAT	79011014	GAK-403	FIAT	7961301	G-836	GMXC	79918184	G-296	FIAT
78041782	GA-326 ⁷¹	FIAT	7902000299	G-296	INDE	7961367	GP-58	GMXC	79918184	G-296-B	FIAT
780878941	GP-81	CUSH	7902000299	G-296-B	INDE	7961394	G-836	BEDF	79921320	GA-360	FIAT
7810	GP-43	NAP	79022025	GAK-216	FIAT	7961394	G-836	GMXC	79923130	GA-360	FIAT
78115561B	GP-1	VOLK	79022026	GA-416	FIAT	7961399	G-836	GMXC	79924318	G-296	FIAT
78115561D	GP-171	VOLK	79032093	G-33	FIAT	7961399	G-836	KOHL	79924318	G-296-B	FIAT
78115561J	GP-171	VOLK	79043778	GA-360	FIAT	7961447	G-834	BEDF	79933225	GAK-458	FIAT
78115561K	GP-28 ⁸	VOLK	79043779	GA-361	FIAT	7961447	G-834	GMXC	79933226	GA-459	FIAT
78115561K	GP-430 ⁸	VOLK	79043780	GA-106 ⁴⁶	FIAT	7961447	G-834	LACR	79933276	GA-106 ⁴⁶	FIAT
7825060	GAK-625	FIAT	79043780	GA-326 ⁷¹	FIAT	7961447	G-834	LEYL	79933276	GA-326 ⁷¹	FIAT
7825516	GP-81	ALCH	79043781	GA-206	ALCH	7961477	G-834	BEDF	79935594	GAK-625	FIAT
7825516	GA-37	HEST	79043781	GA-206	FIAT	7961477	G-834	GMXC	79936891	GPP-1122	FIAT
782672-R91	GA-37	IHCO	79049790	GA-892	ALCH	796293	G-1123F	FAUN	7995000510	GP-36	GULD
78271662	G-1163	FIAT	79049790	GA-892	FIAT	796293	G-1123	TROJ	79955749	GA-416	FIAT
78280	G-33	GALN	7905354-2	G-836	VOLV	7964291	G-833	GMXC	79955976	GAK-216	FIAT
78288	G-1123	VOLV	79055273	G-296	VOLV	796460-R91	G-296	IHCO	79957615	GAK-16	FIAT
78300099	GP-1013Q	FIAT	79055273	G-296-B	VOLV	796460-R91	G-296-B	IHCO	79957810	GA-416	FIAT
78300224	GP-1013Q	FIAT	79064101	GAK-20	VOLV	7965049	GP-3816	GMXC	79957811	GAK-216	FIAT
783733	GP-66	NEWH	79068	G-613	GALN	7965051	GP-3816	GMXC	79957889	GA-360	FIAT
784	GA-6880	DEL	79075882	GPP-1122	FIAT	7965051	GP-3816	VAUX	7998954	GAK-20	GMXC
784373R91	GP-10	IHCO	79078234	GP-171	VOLV	7965190	G-296	GMXC	7998964	GA-106 ⁴⁶	GMXC
784592	GP-81	BOLI	79080	GP-11	VERS	7965190	G-296-B	GMXC	7998964	GA-326 ⁷¹	GMXC
784592	GP-81	VOLV	79081327	GAK-216	FIAT	7965457	G-1121	GMXC	7998966	GAK-403	GMXC
785	GA-892	DEL	79081328	GA-416	FIAT	7965458	G-1121	GMXC	7998968	GAK-16	GMXC
785	GA-3647	FACE	79-1000	GS-2033	RAR	7965460	G-1121	GMXC	7998970	GA-33 ¹¹²	GMXC
785	GA-3647	UNN	79-1000FE	GS-2033	RAR	7965799	GP-58	GMXC	7998979	GA-403	GMXC
78511654	GP-171	FIAT	79-1000-SERIES	GS-2033	RAR	796951-R91	G-296	IHCO	7998991	GA-6129	GMXC
785150	GAK-403	CLAA	7910031728	GP-46	CITR	796951-R91	G-296-B	IHCO	79AX-6714-JA	GP-3980	FORD
78520-30200-71	GP-171 ¹⁶	TOYO	79111	GP-50	EXCL	796AIR	GA-403	DEL	79HF-9601-BA	GAK-216	FORD
785261	GA-880R	HLER	79128732	GP-1122	VOLV	797	GA-892	DEL	79K315055	GA-33 ¹¹²	FMC
785896R91	G-335	CASE	79159323	GP-54	VOLV	79703001	GP-66	VERM	79K315055	GA-33 ¹¹²	IONB
785896-R91	G-335	IHCO	79178732	GP-1122	VOLV	7971447	G-834	GMXC	79K315055	GA-33 ¹¹²	LINK
785F-6714-AA1A	GP-68	FORD	79199808	GA-39	VOLV	7971783	GP-54 ¹¹	LNCR	7A5351	G-1176	OLIV
785F-6714-AA2A	GP-68	FORD	79199816	G-566	VOLV	7971783	GP-66 ¹⁰	LNCR	7A5351	G-1176	WHIT
785F-6714-AA3A	GP-68	FORD	79199824	G-750	VOLV	797180	GA-135	GMXC	7A5351-B	G-1173 ¹⁰⁸	WHIT
78641-C1	GP-58	IHCO	79199865	G-1143	VOLV	797181	GA-135	GMXC	7A5351C	G-1173	OLIV
7866485040	GA-33 ¹¹²	TOYK	792	GAD-1	CRO	7973058	G-296	GMXC	7A5351-C	G-1173	WHIT
78721029	GA-206	FIAT	79200549	GA-356	VOLV	7973058	G-296-B	GMXC	7A5507	G-31	OLIV
78722126	GA-360	FIAT	79200556	GA-357	VOLV	7973235	GP-3816	GMXC	7A5507	G-31	WHIT
7874	GAK-16	JACK	79211272	G-33	VOLV	7973235	GP-3816	VAUX	7A5507A	G-31	OLIV
78747	G-296	LEYL	792240	GAK-16	CLRK	7973429	GP-3816	GMXC	7A5507A	G-31	WHIT
78747	G-296-B	LEYL	792340	GAK-16	CLRK	7973429	GP-3816	VAUX	7A5507B	G-31	OLIV
78754	GAK-16	CASE	79250015	GP-53	VOLV	7973745	G-871	GMXC	7A5841	G-1173	OLIV
78754	GAK-16	DROT	79250023	GPP-14	VOLV	79756	GP-31	GEHL	7A5841A	G-1173 ¹⁰⁸	OLIV
7880000230	G-159	GROV	79250031	GP-2071W	VOLV	7976051	GP-81 ³¹	OPEL	7A5841-A	G-1173 ¹⁰⁸	WHIT
78809472	G-173	FIAT	7926	GP-171	SULL	7976051	GP-9 ⁹⁸	OPEL	780 129 620	GA-248	VOLK
78813556	G-1133	FIAT	7926	GP-81	SULL	79800039	GPP-425	HEDE	7B1559	G-6	AMLA
78814510	G-6	FIAT	79286795	GP-1013Q	VOLV	79840-R91	G-834	IHCO	7C3638	GP-110	CATP
78825228	G-1163	FIAT	79293140	GA-439	FIAT	7984225	GP-58	GMXC	7C3Z-9601-A	GA-437	FORD
78827662	G-1163	FIAT	79320	GAK-16	CLRK	7984256	GP-3816	BEDF	7C4228	GP-57	CATP
78-8422	GA-405	OREN	79325	G-33	ALCH	7984256	GP-3816	GMXC	7C4428	GA-8047	CATP
7884256	GP-3816	GMXC	7934578192	GAK-20	CLM	7984260	G-162H	GMXC	7C6376	GA-8047	CATP
7884256	GP-3816	VAUX	79352	G-33	ALCH	7984260	G-225	GMXC	7C8301	GA-27	CATP
78849	GP-1	GEHL	79360	G-33	GALN	7984262	G-870	GMXC	7C8301	GA-27	PROM
78850	G-296	GEHL	79360	G-33	KOMA	7984267	G-834	BEDF	7C8302	GA-6129	CATP
78850	G-296-B	GEHL	79384772	GA-106 ⁴⁶	VOLV	7984267	G-834	GMXC	7C8302	GA-6129	PROM
78881	G-296	LEYL	79384772	GA-326 ⁷¹	VOLV	7984283	G-813	GMXC	7C8303	GA-229	CATP
78881	G-296-B	LEYL	79384780	GA-206	VOLV	7984288	G-296	GMXC	7C8303	GA-229	PROM
78891	G-296	LEYL	79400	G-871	LEYL	7984288	G-296-B	GMXC	7C8304	GA-378	CATP
78891	G-296-B	LEYL	794007	GA-27 ¹¹²	FAUN	7984291	G-833	GMXC	7C8304	GA-378	PROM
78934	GAK-16	GEHL	794367	G-31	FAUN	7984292	GP-1	GMXC	7C8305	GA-6880	CATP
7894989	GP-42	GMXC	79446	GP-761H	VERS	7984298	G-1121	GMXC	7C8305	GA-6880	PROM
789508-C91	GA-378	IHCO	79460	G-871	LEYL	7984299	G-1121	GMXC	7C8307	GA-209	CATP
7897321	GP-58	VOLV	794693	G-1123	EATN	7984314	GG-48	GMXC	7C8307	GA-209	PROM
78981	G-296	ALCH	794693	G-1123	TROJ	7984342	G-870	GMXC	7C8309	GA-376	CATP
78981	G-296-B	ALCH	795	GG-87	FACE	7984346	G-870	GMXC	7C8309	GA-376	PROM
78981	G-296	LEYL	795097	GP-1	BOLI	7984351	GP-3682	GMXC	7C8310	GA-26	CATP
78981	G-296-B	LEYL	795097	GP-10	VOLV	7984373	G-836	BEDF	7C8310	GA-26	PROM
789F-6144-AA	GP-53	FORD	7950975	GP-1	VOLV	7984374	G-836	GMXC	7C8313	GA-493 ¹⁰⁸	CATP
789F-6714-AA	GP-53	FORD	7951298	G-1121F	GMXC	7984463	G-834	GMXC	7C8313	GA-493 ¹⁰⁸	PROM
78GB9150AA	G-297	FORD	795837-R92	G-834	IHCO	7984473	GP-54	GMXC	7C8320	GA-371	CATP
78GB-9150-AA	G-297-B	FORD	795840	G-834	IHCO	7984550	GP-58 ¹⁵	GMXC	7C8320	GA-371	PROM
78GB-9155-AB	GG-246	FORD	795840R91	G-834	CASE	7984655	GP-310	GMXC	7C8324	GA-107	CATP
78HM-6714-AA	GP-81 ³¹	FORD	795840-R91	G-834	IHCO	7984716	GP-3600	GMXC	7C8324	GA-107	PROM
78HM-6714-AA	GP-9 ⁵⁸	FORD	796	GP-38	AMP	7984781	G-297-B	BEDF	7C8328	GA-3551 ¹⁵	CATP
78SF-6714-AA3A	GP-68	FORD	796	G-297-B	CAV	7984781	G-297-B	GMXC	7C8328	GA-3551 XT ⁶⁴	CATP
790	GA-75	FACE	796	GA-403	DEL	7984836	GP-3600	GMXC	7C8331	GA-109	CATP
79008147	GA-9334	ALCH	796051	G-296	IHCO	7984844	GP-3600	GMXC	7C8331	GA-109	PROM
79008151	GA-826	ALCH	796051	G-296-B	IHCO	7984864	GP-54 ¹¹	GMXC	7C8334	GA-1095	CATP
79008154	GA-403	ALCH	796051-R91	G-296	IHCO	7984864	GP-66 ¹⁰	GMXC	7C8334	GA-1095	PROM
79008160	GA-240	ALCH	796051-R91	G-296-B	IHCO	7984867	GP-1122	GMXC	7C8337	GA-3501	CATP
79008161	GA-303	ALCH	79								

Referencia Cruzada por Numero de Parte

Cross Reference by Part Number



Numero	Gonher	Fabricante	Numero	Gonher	Fabricante	Numero	Gonher	Fabricante	Numero	Gonher	Fabricante
Number	Gonher	Manufacturer	Number	Gonher	Manufacturer	Number	Gonher	Manufacturer	Number	Gonher	Manufacturer
7E6013	GP-1011Q	CATP				803	G-750	AMP	81-05504-0019	G-31	MAN
7E6014	GP-2071W	CATP				803	G-750	BGA	81-05504-0023	G-834	MAN
7E9763	GP-1101	CATP				803	GA-44	CRO	81-05504-0029	G-31	MAN
7H0129620A	GAVW-627	VOLK				803	GA-77	DEL	81-05504-0031	G-143	MAN
7H0833	G-1166	CATP				8030103	GP-1	KOEHL	81-05504-0038	G-163	MAN
7H16	G-870	LEYL				8030104	G-296	KOEHL	81-05504-0039	G-143	MAN
7H1927	G-870	AUST				8030104	G-296-B	KOEHL	81-05504-0040	G-163	MAN
7H1927	G-870	LEYL				803201511C	GG-1	VOLK	81-05504-0041	G-143	MAN
7H2041	G-871	LEYL				803201511C	GG-4	VOLK	81-05504-0048	G-750	MAN
7H833	G-1166	CATP				8032064	GA-853R	IVEC	81-05504-0049	G-750	MAN
7HA5351	G-1173 ⁰⁸	OLIV				8035098	GA-853R	OQJP	81-05504-6008	G-31	MAN
7HA5351	G-1173	WHIT				8037	GA-6619 ⁵	CRO	8106	GP-310	SER
7HA5351B	G-1174 ⁰⁸	OLIV				8037	GA-6620 ⁵	CRO	8106	GP-3569	SER
7HA5351-B	G-1174 ⁰⁸	WHIT				804	G-500	AMP	8107	GP-46	SER
7HA5351C	G-1173 ⁰⁸	OLIV				804	G-500	BGA	810817	GP-77	ATWE
7HA5351-C	G-1173 ⁰⁸	WHIT				804	GA-90	DEL	81-08205-0005	GA-405	MAN
7HCS351C	G-1173	OLIV				8041642	GA-853R	IVEC	81-08205-005	GA-405	MAN
7HCS351-C	G-1173 ⁰⁸	WHIT				8041782	GA-106 ⁶⁶	FIAT	81-08304-0016	G-834	MAN
7H0129620A	GAVW-627	VOLK				8041782	GA-326 ⁷¹	FIAT	81-08304-0032	GA-436	MAN
7J0670	G-153	CATP				8041782	GA-106 ⁶⁶	HEST	81-08304-0038	GA-467	MAN
7J670	G-153	CATP				8041782	GA-326 ⁷¹	HEST	81-08304-0040	GA-405	MAN
7K 129 620	GAVW-625	AUDI				805	GA-7	CRO	81-08304-0041	GA-405	MAN
7K 129 620	GAVW-625	PORS				8057-000	GP-66	GRES	81-08304-0043	GA-467	MAN
7K-129-620	GAVW-625	VOLK				8057-001	GP-66	GRES	81-08304-0044	GA-467	MAN
7L0 129 620	GAVW-616	AUDI				8058	GA-5876	CRO	81-08304-0048	GA-405	MAN
7L0 129 620	GAVW-616	PORS				80591689	GP-66	NEWH	81-08304-0050	GA-206	MAN
7L0 129 620A	GAVW-616	AUDI				8060266	GP-3985 ⁶⁹	AMCO	81-08304-0051	GA-106 ⁶⁶	MAN
7L0 129 620A	GAVW-616	PORS				80640-0022	GP-310	NIPP	81-08304-0051	GA-326 ⁷¹	MAN
7L0 129 620A	GAVW-616	VOLK				80640-0030	GP-42	NIPP	81-08304-0057	GA-405	MAN
7L0-129-620	GAVW-616	VOLK				80640-0040	GP-24 ²⁶	DENS	81-08304-0058	GA-6127	MAN
7L5628	GA-1203	CATP				80640-0040	GP-24 ²⁶	NIPP	81-08304-0059	GA-6129	MAN
7M1045	GA-5648	CATP				80640-0040	GP-462 ²⁴	NIPP	81-08304-0060	GA-405	MAN
7M2045	GA-5648	CATP				80640-0110	GP-40	NIPP	81-08304-0062	GA-360	MAN
7M2645	GA-5648	CATP				80640-0120	GP-3531 EXP	NIPP	81-08304-0063	GA-361	MAN
7M2654	GA-5648	CATP				80640-0130	GP-171	NIPP	81089774	GA-106 ⁶⁶	GMCX
7M3800	G-191	BARB				8064271	S 3202 ⁴⁰	VOLV	8109110	GA-361	GMCX
7M3800	G-191	CATP				8-06438-235-0	GA-59	ISUZ	81096417	GA-6127	GMCX
7M4862	GA-1287 ⁰⁸	CATP				8-06438-384-0	GP-13	ISUZ	8105	GP-27	GREY
7M4862	GA-9045 ⁰⁴	CATP				80650-0011	GAD-1	NIPP	8110	GP-44	SER
7M5264	G-152	CATP				80650-0041	GAD-3	NIPP	811133511	GG-246	VAG
7M5979	GA-5648	CATP				80650-0160	GA-2740	NIPP	811133511	GG-246	VOLK
7M7176	G-191	CATP				80650-0260	GA-3490	NIPP	811133511A	GG-226	VAG
7M8700	GA-5648	CATP				80650-0310	GA-3490	NIPP	811133511A	GG-226	VOLK
7M8708	GA-5648	CATP				80650-0320	GA-2740	NIPP	811133511B	GG-246	VOLK
7M8903	GA-5648	CATP				80650-0330	GA-4303	NIPP	811133511D	GG-226	VAG
7M9045	GA-9045	CATP				80650-0340	GAD-15	NIPP	811133511D	GG-226	VOLK
7M9045	GA-9045	NEL				80650-0350	GA-4325	NIPP	81-12050-30021	G-1123	MAN
7M9046	GA-1287	CATP				8066-000	GP-66	GRES	81-12503-0001	G-1121	MAN
7N0688	GA-482 ⁰⁸	CATP				8066-001	GP-66	GRES	81-12503-0013	G-1121	MAN
7N1308	GA-482	CATP				8070	GAVW-622	CRO	81-12503-0015	G-1121	MAN
7N2320	GA-7360 ⁰⁸	CATP				807180	GP-81	VOLV	81125030016	G-1121	RENA
7N2320	GA-7716 ⁰⁴	CATP				8076195	GA-435R	VOLV	81-12503-0016	G-1121	MAN
7N4048	GA-482 ⁰⁸	CATP				8075	GP-78	GREY	81125030018	G-1123F	KRAU
7N4048	GA-483 ⁰⁴	CATP				808 568	GG-106	OPEL	81125030018	G-1123F	NANN
7N5483	GA-1286 ⁰⁸	CATP				8081	GA-475	CRO	81125030018	G-1123F	RENA
7N5483	GA-9334 ⁰⁴	CATP				8084	GA-410	CRO	8112503-0018	G-1123F	SAVI
7S1220	GP-110	CATP				8086	GA-180	CRO	81-12503-0018	G-1123F	MAN
7S1224	GA-1287 ⁰⁸	CATP				80861361	GP-1012Q	NEWH	8112503-0019	G-1121	SAVI
7S1224	GA-9045 ⁰⁴	CATP				8087	GA-6690	CRO	81-12503-0019	G-1121	MAN
7S1778	GA-1287 ⁰⁸	CATP				809	GA-85	DEL	81-12503-0020	G-1121	MAN
7S1778	GA-9045 ⁰⁴	CATP				8094	GA-166	CRO	81125030021	G-1123	MAN
7S2513	GA-1285 ⁰⁸	CATP				80949600	G-236	EATN	81-12503-0023	G-1121	MAN
7S2513	GA-8047 ⁰⁴	CATP				809496-00	G-236	YALE	81-12503-0028	G-1121	MAN
7S5474	GA-1286 ⁰⁸	CATP				80963	G-335	GALN	81-12503-0035	GP-1122	MAN
7S5474	GA-9334 ⁰⁴	CATP				8097	GA-5466	CRO	81-12503-0036	G-1121	MAN
7S8699	G-152	CATP				8098	GAK-16	CRO	81-12503-0037	G-1121	MAN
7S8701	G-222	CATP				8099	GA-198	CRO	81-12503-0038	G-296	MAN
7S9896	G-191	CATP				809S	GP-26	GREY	81-12503-0038	G-296-B	MAN
7T42-9601-A	GA-1542	FORD				80MA010P	GP-66	HYC	81-12503-0040	G-1121	MAN
7W2326	GP-31	CATP				80MF-6731-AA	GP-43	FORD	81-12503-0041	G-1121	MAN
7W2327	GP-1	CATP				8100	GA-7142	CRO	81-12503-0042	G-1123	MAN
7W2328	GP-3600	CATP				81-00000-0239	G-163	MAN	81-12503-0042	G-1123F	MAN
7W3920	GA-1008	CATP				81-00000-0244	G-1121	MAN	81-12503-0043	G-1121	MAN
7W5313	GA-483	CATP				81-00000-0246	G-1123	MAN	81-12503-0050	G-1121F	MAN
7W5316	GA-9045	CATP				8100778	GA-33 ¹¹²	FENW	81-12503-0051	G-1121	MAN
7W5317	GA-9334	CATP				8100779	GAK-16	FENW	81-12503-0052	G-1123	MAN
7W5317E	GA-9334	CATP				8101	GP-1	SER	81-12503-0054	G-1123	MAN
7W5389	GA-8047	CATP				8101108	GAK-403	FENW	81-12503-0054	G-1123F	MAN
7W5389E	GA-8047	CATP				8101278	GP-3600	FENW	81-12503-0075	GPP-1122	MAN
7W5495	GA-7716	CATP				81014125	GP-46	FENW	8114800100	GA-33 ¹¹²	TOSH
7W6221	GP-1	CATP				8101700	G-834	ASTN	8115	GP-81	DIVC
7W7421	GA-6880	CATP				8102	GP-3	SER	8115	G-200	SER
7W7422	GA-378	CATP				81024947	GAK-16	GMCX	8115561	GP-310	GULD
7W7424	GA-229	CATP				81025569	GAK-403	GMCX	81190493	G-871	FIAT
7W7426	GA-372	CATP				8103	GP-20	SER	81190839	G-871	FIAT
7W7510	GA-7360	CATP				8104	GP-81 ³¹	SER	812	GP-81	BGA
7W7510	GA-7716	CATP				8104	GP-9 ³⁸	SER	812	GPP-19	CRO
						8104048	G-834	LIN	812	GA-730	DEL
						8104087	GP-28 ⁹	FENW	8120	GP-3980	SER
						8104087	GP-430 ⁸	FENW	812073	G-238	MASY
						8104266	GP-54 ¹¹	FENW	8121269	GA-70	AMCO
						8104266	GP-66 ¹⁰	FENW	8121675	GA-192	AMCO
						8104270	GP-36	FENW	8121677	GA-192	AMCO
						8105	GP-3429	SER	8121678	GA-57	AMCO
						81-05504-0008	G-31	MAN	8121678	GA-57	CHRY
						81-05504-0016	G-834	MAN	812322	GA-27	AMHO

REFERENCIA CRUZADA

Numero	Gonher	Fabricante	Numero	Gonher	Fabricante	Numero	Gonher	Fabricante	Numero	Gonher	Fabricante
Number	Gonher	Manufacturer	Number	Gonher	Manufacturer	Number	Gonher	Manufacturer	Number	Gonher	Manufacturer
8123679	GP-1122	FIAT	818511	GP-14	VOLV	82449	G-500	ALCH	830098	G-33	NLSN
8123679	GP-1122	IVEC	8185118	GP-20	VOLV	82449	G-500	FIAT	830152-11	G-6	UNIT
81-25030-021	G-1123	MAN	818512	GG-5 L	OPEL	82449-0	G-500	ALCH	830166	G-200	NLSN
8127168	GP-28 ⁸	AMCO	818541	GG-5 L	GMCX	82449-9	G-500	ALCH	83016C	G-200	NLSN
8127168	GP-430 ⁸	AMCO	81863799	GP-761H	NEWH	8244H	GP-462	BOG	8304	GG-19	SER
8127168	GP-28 ⁸	CHRY	818663799	GP-761H	NEWH	824510	G-330	VALM	83041	GA-171	CAMP
8127168	GP-430 ⁸	CHRY	81866927	GA-589	NEWH	8248012	GAK-16	FORD	83041	GA-171	CRQ
8129975	GPP-1061	VOLV	81878046	GP-54	NEWH	8245	G-295	GREY	83047A	GA-70	NLSN
8125	GP-1108	GREY	81879134	GP-54	NEWH	825	GA-75	DEL	83054	GA-486	CRQ
813	GA-59	DEL	818828	GP-38	TVH	8-25010-633-0	GP-44	ISUZ	83057	GA-1530	CRQ
813	GP-3682	PMC	818868	GP-9	MACH	8-25010-792-0	GP-46	ISUZ	83058	GA-341	CRQ
8130	GP-20	CRIS	818K	GP-3531	EXP ASAH	8-25014-377-0	GP-3675	ISUZ	83063	GA-269	CRQ
8130	GP-58	SER	819	G-200	AMP	8-25014-693-0	GP-46	ISUZ	83063A	GA-56	NLSN
813-14-300	GP-149	MZDA	819	G-200	BGA	8-25036-141-0	GA-414R	ISUZ	83065	GA-340	CRQ
8132313	GP-46	AMCO	81902-001	GP-761H	VERM	8-25040-929-0	GA-3588	ISUZ	83067	GA-492	CRQ
8132313	GP-46	CHRY	819266-R93	GP-310	IHCO	8-25055-052-0	GG-46	ISUZ	83069	GA-363	CRQ
813-23-802	GP-462	MZDA	8193841	GP-96	VOLV	8-25055-129-0	GG-46	ISUZ	83070A	GA-77	NLSN
813-23-802A	GP-462	MZDA	819F-8A469-AA	GP-2071W	FORD	8-25055-364-0	GG-255	ISUZ	83076A	GA-71	NLSN
813-23-802B	GP-462	MZDA	81D21	GA-27	MACK	82507	GAK-20	GALN	83078A	GA-80	NLSN
8132734	GG-16	AMCO	81DB-9601-BA	GA-360	FORD	82508	G-500	ALCH	8308	GG-6	SER
8132734	GG-16	CHRY	81F703025	GA-33 ¹¹²	FMC	82508	G-500	BLDW	83080A	GA-50	NLSN
81-33118-0003	GP-310	MAN	81F703025	GA-33 ¹¹²	JONB	82508	G-500	FIAT	83085A	GA-192	NLSN
8133481	GG-16	AMCO	81F703025	GA-33 ¹¹²	LINK	82508-9	G-500	ALCH	83086A	GA-78	NLSN
8133965	GP-44	AMCO	81F703025	GA-33 ¹¹²	FORD	82509	G-500	ALCH	830870M1	G-31	MASY
813561	G-296	GMCX	81F703047	GA-24 ³⁴	FMC	8-25098-463-0	GA-165	ISUZ	83088	GA-4862R	CRQ
813561	G-296-B	GMCX	81F703047	GA-24 ³⁴	JONB	8-25121-150-0	GG-260	ISUZ	83089	GA-4863	CRQ
813561	G-296	OPEL	81F703047	GA-24 ³⁴	LINK	8-25121-160-0	GG-260	ISUZ	830902	G-870	MASY
813561	G-296-B	OPEL	81-F703047	GA-24 ³⁴	FORD	8-25121-778-0	GG-255	ISUZ	830902-M91	G-870	FERG
813562	G-296	GMCX	81SD14	GA-37	MACK	8-25160-561-0	GP-205	ISUZ	830902-M91	G-870	MASY
813562	G-296-B	GMCX	81SD17A	GA-37	CUMM	8-25168-594-0	GG-266	ISUZ	831	GP-10 ⁶⁷	AMP
813562	G-296	OPEL	81SD21	GAK-20	MACK	8-25170-512-0	GA-165 ¹¹³	ISUZ	831	GP-54 ¹¹	AMP
813562	G-296-B	OPEL	81SD25	GA-24 ³⁴	MACK	8-25171-377-0	GP-3980	ISUZ	831	GP-69 ⁹	AMP
813564	GP-1122	OPEL	81SD29	GA-26	MACK	8256032	GA-33 ¹¹²	FORD	831	GP-10	BGA
813565	GPP-1122	OPEL	81SM-6714-A2A	GP-58	FORD	825619	GG-5 L	CUSH	8310	GG-16	SER
813566	GPP-1122	GMCX	81SM-6714-A3A	GP-3816	FORD	825664	G-871	MASY	831038	GP-36	ATWE
81-3904	G-750	WHIT	81SM-6714-A4A	GP-3816	FORD	825664-M1	G-871	FERG	83104	GA-265	CRQ
813923	GA-360	TOWM	82 00 457 286	GA-4319	RENA	825664-M1	G-871	MASY	83-105	GAK-16	INTR
81-3923	GA-360	CATP	820	G-6	AMP	825664-M91	G-871	MASY	83109E	G-1175 ⁹⁸	NLSN
813957	GA-361	TOWM	820	G-6	BGA	8257912	GAK-16	FORD	83111A	G-1173 ⁹⁸	NLSN
81-3957	GA-361	CATP	82003166	GP-761H	NEWH	8257914	GA-33 ¹¹²	FORD	83114	GA-1572	CRQ
8135	GP-78	GREY	8200464	GA-410	HFFE	825807	G-871	MASY	831-199-9136	G-143	KASB
814	GP-13	AMP	8201	GA-59	SER	825807-M1	G-871	MASY	831-199-9137	G-163	KASB
814	GP-13	BGA	8202	GA-57	SER	825807-M2	G-871	MASY	8312	GG-17	SER
814	GA-57	DEL	820-23-800	GP-462	MZDA	825F-9150-A2A	G-296	FORD	831-206-2050	GP-43	KASB
81410	GAK-16	GALN	8203	GA-50	SER	825F-9150-A2A	G-296-B	FORD	831-206-2050-0	GP-43	KASB
81456001	GP-13	VERM	820314	GP-157	BRIG	826	G-613	AMP	831-206-2080-0	GP-1011Q	KASB
81-4648	GAK-403	CATP	8204	GA-55	SER	826	G-613	BGA	831-208-8007-0	G-3754	KASB
81-47301-6005	G-162H	MAN	8205	GA-192	SER	826	GA-3681	FACE	831-208-8015-0	G-1046	KASB
8-15015-509-0	GG-209	ISUZ	8206	GA-3523	SER	826	GA-3681	UNN	83122	GAVVW-618	CRQ
8-15036-141-0	GA-414R	ISUZ	8207	G-834	NIPP	826137	G-870	MASY	83126	GA-624R	CRQ
81507003000	GAK-216	TOSH	8205	GP-1122	GREY	826137-M1	G-870	MASY	83136	GA-1571	CRQ
815127	GA-5648	VOLV	821	GA-86	DEL	826137-M91	G-870	FERG	831-400-0048	GP-54 ¹¹	KASB
8-15202-408-0	GA-415	ISUZ	8210	GG-124	SAAB	826137-M91	G-870	MASY	831-400-0048	GP-66 ¹⁰	KASB
815287-11081	GA-33 ¹¹²	KUBO	82115	GP-3816	WACK	826147-M91	G-870	MASY	83145	GA-1540	CRQ
8152AB	G-1163 ¹⁰⁸	BAKR	82-12503-0038	G-296	MAN	826317-M91	G-870	MASY	83148A	G-238	NLSN
81544003000	GAK-16	TOSH	82-12503-0038	G-296-B	MAN	82693	GP-171	TENN	83148B	G-238	NLSN
81557001	G-296	VERM	82145-4100	GAD-3	SUBA	8265	GPP-1122	GREY	83155A	GA-7	NLSN
81557001	G-296-B	VERM	82145-4110	GAD-3	SUBA	827200	G-500	DIAM	83172	GA-320	CRQ
815606-11081	GAK-16	KUBO	82145-7000	GA-140	SUBA	82-7200	G-500	WHIT	8317-23-603	GAD-3	MZDA
815958	G-31	ATWE	82181001	GP-1	VERM	8273006	GAK-403	KOEH	83175	GA-149	CRQ
8159975	GPP-1061	VOLV	8215	GA-20	GREY	8273007	GAK-20	KOEH	831842	GG-5 L	SAAB
8159975	GPP-1291 ³⁹	VOLV	8220	GA-85	SER	8277662	G-1163 ¹⁰⁸	FIAT	83186	GAVVW-625	CRQ
8159975	PFF831 ⁴¹	VOLV	8220044	GAK-16	FORD	82784	G-1121	SAMB	831-900-0048	GP-54 ¹¹	KASB
8159975	R 90 P ⁴²	VOLV	82205905	GAC-2	CHRY	828	G-122	AMP	831-900-0048	GP-66 ¹⁰	KASB
81599755	GPP-1291 ³⁹	VOLV	8221	GA-75	SER	828	G-338	AMP	831-900-0049	GP-1122	KASB
81599755	PFF831 ⁴¹	VOLV	82214	GP-3600	BGA	828	G-122	BGA	831-900-0103	G-1121	KASB
81599755	R 90 P ⁴²	VOLV	8222	GA-303	SER	828	G-338	BGA	8319000104	G-1121	KHDF
8155	GP-1122	GREY	8224	GA-3300	SER	8283485	GA-106 ⁹⁵	COLS	831-90-00100	G-1121	DUTZ
816	GA-325	DEL	822-500-0030	G-162H	KASB	8283485	GA-326 ⁹¹	COLS	831-900-0104	G-1121	KASB
81612679	GP-54 ¹¹	TAMR	822-500-030	G-162H	KASB	8283693	GAK-20	COLS	831-900-0110	G-163	KASB
81612679	GP-66 ¹⁰	TAMR	82289	G-1143	GALN	82871513	GP-1122	GMCX	831-900-048	GP-54 ¹¹	KASB
816K	GP-42	ASAH	8225	GP-55	GREY	82872988	GA-5648	GMCX	831-900-048	GP-66 ¹⁰	KASB
817	GA-303	DEL	823	GA-349	DEL	829	GP-3	AMP	831-900-049	GP-1122	KASB
8172-23-603	GA-2740	MZDA	8230	GA-77	SER	829	GP-3	BGA	831-904-2017	GAK-20	KASB
8173-23-603	GA-2740	MZDA	82342881	GP-81	LANC	8290	GA-100	SER	831-905-0042	GP-1122	KASB
8173-23-608	GA-2740	MZDA	82345728	GA-230	FIAT	829390	GP-46	VOLV	831-908-6094	GA-436	KASB
8173-23-802	GP-462	MZDA	82345730	GA-230	FIAT	8294	GA-113	SER	831-909-5116	GA-467	KASB
8173-26-603	GA-2740	MZDA	82360558	GP-81	LANC	829528C1	GP-66	CASE	831-909-8117	GA-436	KASB
81733	G-33	ALCH	824	G-222	AMP	82973-72	GG-20	HYST	83192	GA-489	CRQ
81733-2	G-33	ALCH	824	G-222	BGA	82981152	GA-853R	NEWH	832	GP-66	AMP
817695	G-1121	VOLV	824	GA-39	CRO	829913	GP-1122	VOLV	832	GP-66	BGA
8176950	G-1121	VOLV	8240	GA-70	SER	8299132	GP-1122	VOLV	832	GA-680	DEL
8175	GP-62	GREY	82403555	GG-246	FIAT	829993	GP-1122	VOLV	83200004	GA-71	MOP
818 506	GG-106	OPEL	8241	GA-730	SER	82DB-9155-BA	GP-1122	FORD	83200007	GA-730	MOP
818 508	GG-106	OPEL	8242	GA-71	SER	82DF-6714-AA	GP-54 ¹¹	FORD	8320047	GP-761H	KOEH
818 509	GG-106	OPEL	82434499	GG-246	FIAT	82DF-6714-AA	GP-66 ¹⁰	FORD	8320047	GP-761H	TRAK
818 510	GG-106	OPEL	82440	G-500	ALCH	82DF-9155-BA	GP-1122	FORD	8320103	GP-66	KOEH
818 514	GG-106	OPEL	82441	G-500	ALCH	82GB-9155-AA	GG-246	FORD	8320238	G-295	KOEH
818 568	GG-106										

Referencia Cruzada por Numero de Parte

Cross Reference by Part Number



Numero	Gonher	Fabricante	Numero	Gonher	Fabricante	Numero	Gonher	Fabricante	Numero	Gonher	Fabricante
Number	Gonher	Manufacturer	Number	Gonher	Manufacturer	Number	Gonher	Manufacturer	Number	Gonher	Manufacturer
832046	GA-106 ⁴⁶	AMHO	83509A	GA-303	NLSN	83937061	G-296	NEWH	84456S	GA-77	NLSN
832046	GA-326 ⁷¹	AMHO	8351075	GA-106 ⁴⁶	COLS	83937061	G-296-B	NEWH	8446-0005-01	GA-7	TRAN
832047	GA-206	AMHO	8351075	GA-326 ⁷¹	COLS	83968079	GP-54 ⁹⁰	NEWH	8448-0301-01	G-296	TRAN
83213A	G-169	NLSN	835331343	GP-1122	VALM	83991510	GP-54	FORD	8448-0301-01	G-296-B	TRAN
83213D	G-169	NLSN	835440	GP-3	VOLV	83DB-9155-AA	GPP-11	FORD	8448-0466-01	GP-31	TRAN
8322497	GA-360	FIAT	8354409	GP-3	VOLV	83SB14	GA-37	MACK	84481S	GA-105	NLSN
8322497	GA-360	IVEC	835440-9	GP-408	VOLV	83SB15	G-1175 ¹⁰⁸	MACK	84489S	GA-50	NLSN
8322498	GA-361	FIAT	83547A	G-11	NLSN	83SB19	G-1143	MACK	8449-0027-01	GP-81	TRAN
83225	GAD-116	CRQ	835506	G-1173 ¹⁰⁸	MASY	83SD15	G-1175 ¹⁰⁸	MACK	8449-0296-01	G-296	TRAN
83-225	GP-6811	INTR	835506-M91	G-1173 ¹⁰⁸	MASY	840	GA-429	DEL	8449-0296-01	G-296-B	TRAN
8322872	GAK-403	FIAT	835507	G-871	MASY	84021	G-72	CRQ	84490S	GA-56	NLSN
8322972	GAK-403	FIAT	835507-M91	G-870	MASY	84027	GP-36	CRQ	84492S	GA-71	NLSN
8322986	GA-467	FIAT	835514	G-33	MASY	84028	GP-166 ⁶⁵	CRQ	84493S	GA-70	NLSN
8322986	GA-360	IVEC	835514-M91	G-33	MASY	84028	GP-3937 ¹¹	CRQ	84495S	GA-21	NLSN
8322988	GA-405	FIAT	835562	G-871	MASY	84031880	GP-761H	NEWH	84499S	GA-80	NLSN
8322988	GA-405	IVEC	835562-M91	G-870	MASY	84033	G-45	CRQ	84500	GP-3001	CRQ
8322989	GA-405	FIAT	835567-M91	G-871	MASY	8403339	GAK-20	YALE	84521	GP-359	CRQ
8322989	GA-405	IVEC	835568	G-813	CLRK	84035	GP-58 ¹⁵	CRQ	84521S	GA-44	NLSN
83239A	G-191	NLSN	835568-M91	G-813	MASY	84036676	GA-853R	NEWH	84525S	GA-78	NLSN
83239B	G-191	NLSN	835568-M92	G-813	MASY	84037	GP-737	CRQ	84528S	GA-90	NLSN
83239D	G-191	NLSN	835597-M91	G-871	MASY	8403756	GA-24 ³⁴	EATN	84529S	GA-325	NLSN
83239E	G-191	NLSN	835622	GA-234	OPEL	8403756	GA-24 ³⁴	YALE	84530S	GA-57	NLSN
83239F	G-191	NLSN	835631	GA-397	OPEL	8403836	GAK-20	EATN	84531S	GA-730	NLSN
8324025	GPP-1122	TRAK	83568A	GA-3300	NLSN	8403836	GAK-20	YALE	84532S	GA-85	NLSN
832498S	G-1173 ¹⁰⁸	HERC	835786-M91	G-200	MASY	84040113000	GA-436	BECK	84537S	GA-3300	NLSN
83254CS	G-31	HERC	835787	G-1174 ¹⁰⁸	MASY	8404295	GAK-403	EATN	84538S	GA-303	NLSN
83261A	GA-55	NLSN	835787-M91	G-1174 ¹⁰⁸	MASY	8404295	GAK-403	YALE	84545N	GA-100	NLSN
83-299	GP-462	INTR	83589A	GA-75	NLSN	84046	GP-461	CRQ	84547N	GA-59	NLSN
833	GA-679	DEL	835944	G-296	MASY	84047	G-912	CRQ	84551N	GA-39	NLSN
83-310	GP-310	INTR	835944	G-296-B	MASY	84060	GP-406	CRQ	84552N	GA-192	NLSN
83317CS	G-31	HERC	835984-M91	G-236	MASY	8406294	GA-27	TIMB	84554N	GA-21	NLSN
833-2	G-1173 ¹⁰⁸	CLEA	835994	G-296	MASY	8406294000	GA-27	TIMB	84557N	GA-55	NLSN
833438	GP-157	CUSH	835994	G-296-B	MASY	84064	G-911	CRQ	84578S	GA-349	NLSN
8-335064	G-31	TWIN	835994-M91	G-296	MASY	84073	GP-406	CRQ	84591S	GA-2719B	NLSN
833544	G-296	LEYL	835994-M91	G-296-B	MASY	84074777	GP-761H	NEWH	84595S	GA-75	NLSN
833544	G-296-B	LEYL	835994-M92	G-296	MASY	84078	G-180	CRQ	846	GP-3600	AMP
83361A	GA-59	NLSN	835994-M92	G-296-B	MASY	84078	G-918	CRQ	846	GP-3600	BGA
83370A	GA-7	NLSN	835995	G-871	MASY	8407839	GAK-20	EATN	84604	GP-52 ¹⁰	CRQ
83370N	GA-7	NLSN	835995-M91	G-871	MASY	8407839	GAK-20	YALE	84604	GP-691 ⁴⁸	CRQ
8339731	GG-246	SAAB	835995-M92	G-871	MASY	840783900	GAK-20	TIMB	846-08-01-60	GP-54 ¹¹	DUTZ
83398A	GA-85	NLSN	835995-M93	G-871	MASY	84082	G-49	CRQ	846-08-01-60	GP-66 ¹⁰	DUTZ
83399A	GA-730	NLSN	836	GP-3600	AMP	8408295	GAK-403	YALE	846-08-01-61	GP-1122	DUTZ
834	GP-34	AMP	836	GP-3600	BGA	84085	GP-3816	CRQ	84609	G-143	CRQ
834	GP-34	BGA	836	GA-360	DEL	840870	G-31	MASY	846095227	GP-53	BOMG
834	GA-229	DEL	836007789	G-1121	VALM	840870-M1	G-31	MASY	84615S	GA-29	NLSN
834 581	GA-134	OPEL	836007790	G-1121	VALM	840870-M91	G-31	MASY	84618S	GA-403	NLSN
834 583	GA-134	OPEL	836007806	G-871	IHCO	8409	GA-607	CRQ	84620	GP-178	CRQ
83-417	GP-58	INTR	836007806	G-871	VALM	84090	G-765	CRQ	84620XE	GP-178	CRQ
834230	GA-57	OPEL	83600A	GAD-3	NLSN	84092	GP-6811	CRQ	84639S	GA-482	NLSN
834232	GAVW-2	OPEL	836015106	G-296	VALM	84095	GP-761H	CRQ	84645S	GA-357	NLSN
834257	GA-50	GMCX	836015106	G-296-B	VALM	84099	GP-408	CRQ	84664S	GA-86	NLSN
834262	GAVW-2	GMCX	83602A	GAD-1	NLSN	840AIR	GA-429	DEL	84684S	GA-357	NLSN
834262	GAVW-2	OPEL	83605A	GA-7	NLSN	8411228	GP-92	TIMB	84690S	GA-429	NLSN
834270	GA-50	GMCX	836064	GP-1	MASY	8411230	GP-93	TIMB	84695S	GA-680	NLSN
834275	GAVW-2	GMCX	836120822	GP-36	VALM	8411274	GP-43	TIMB	847	GP-81 ³¹	AMP
834275	GAVW-2	OPEL	8361-22208	GP-36	VALM	841162	GG-20	VOLV	847	GP-9 ⁵⁸	AMP
834286	GAVW-622	OPEL	836218-M91	G-296	MASY	841162-1	GG-20	VOLV	847	GA-230	CRO
834289	GAD-15	OPEL	836218-M91	G-296-B	MASY	84131	G-162H	CRQ	847	GA-376	DEL
83431A	GA-57	NLSN	83628A	GA-86	NLSN	8413330	GP-1122	TIMB	84700S	GA-436	NLSN
83432A	GA-325	NLSN	83646A	GA-349	NLSN	8413331	GPP-18	TIMB	84709S	GA-107	NLSN
834337	GP-58 ¹⁵	VOLV	83653N	GA-7	NLSN	84134	GP-67	CRQ	84711S	GA-108	NLSN
8343378	GP-58	VOLV	83653R	GA-12	NLSN	8414572	GP-178	TIMB	84718S	GA-608	NLSN
834581	GA-134	GMCX	83656A	GA-44	NLSN	84148A	G-159	NLSN	84732S	GA-3424	NLSN
834629	GA-106 ⁴⁶	AMHO	83656N	GA-44	NLSN	841750	GP-3980	VOLV	84733S	GA-3425	NLSN
834629	GA-326 ⁷¹	AMHO	836866577	GPP-423	SISU	8417503	GP-3980	VOLV	84739S	GA-3523	NLSN
834635	GA-206	AMHO	836980	G-834	MASY	84181	GP-58 ⁹	CRQ	84745	GP-9000	CRQ
834639	GA-6129	AMHO	836980-M91	G-834	MASY	84182	GP-3937	CRQ	84746	GP-9001	CRQ
834644	GA-6127	AMHO	837	GP-36	AMP	842	GA-74	DEL	84746XD	GP-9001	CRQ
83472N	GA-12	NLSN	837	GP-36	BGA	84203	G-70	CRQ	847471	G-1173 ¹⁰⁸	FIAT
834801	GA-50	GMCX	83715	GP-3600	GEHL	84214	G-3827	CRQ	847471	G-1173 ¹⁰⁸	IVEC
834801	GA-50	OPEL	837-23-672	GA-70	MZDA	8423132	GP-26	EMD	84748	GP-9000	CRQ
834804	GAVW-2	GMCX	837595-M91	G-813	MASY	8423132	GP-26	ERF	84749S	GA-425	NLSN
834804	GAVW-2	OPEL	837609	GG-5 L	SAAB	8423132	GP-26	GMCX	84750S	GA-426	NLSN
834930	GP-81 ³¹	SAAB	83779	GA-770R	CRQ	842351200	GA-398	TIMB	84751S	GA-588	NLSN
834930	GP-98 ⁵⁸	SAAB	837928	GG-94	PARM	84241	GP-455	CRQ	84752S	GA-589	NLSN
834940	GP-81	SAAB	838	GP-754	AMP	84243	GP-754	CRQ	84758S	GAD-1	NLSN
8349409	GP-81	SAAB	838	GP-333	BGA	84247	GP-761H	CRQ	84759S	GA-12	NLSN
835	GP-22	AMP	83804E	G-159	NLSN	84252	GP-66	CRQ	84770S	GA-680	NLSN
835	GP-22	BGA	83843	GAVW-617	CRQ	8428088	GP-761H	TIMB	8477192	GP-1011Q	OREN
835	GA-106 ⁴⁶	DEL	838475	GG-1	VOLV	842808800	GP-761H	TIMB	84771S	GA-679	NLSN
835	GA-326 ⁷¹	DEL	838475	GG-4	VOLV	84302	GP-457	CRQ	84774S	GAD-3	NLSN
835 624	GA-334	OPEL	83858N	GA-135	NLSN	84314	G-3752	CRQ	84776S	GA-11	NLSN
83500079	GA-230	CHRY	838593	GP-1122	VOLV	84314MP	G-3752	CRQ	84780S	GA-113	NLSN
83500079	GA-230	MOP	838593	GPP-1122	VOLV	84360N	GA-135	NLSN	84781S	GA-74	NLSN
83500999	GA-303	CHRY	838593-2	GP-1122	VOLV	84365A	G-169	NLSN	84793S	GA-827	NLSN
83500999	GA-303	MOP	83883	GAK-16	CRQ	84370	GAK-16	GALN	84-8012	G-191	WHIT
83501080	GP-22	CHRY	83893N	GAP-381	NLSN	84371	GAK-20	DRES	84810	GP-43	CRQ
83501080	GP-22	MOP	8390135	GP-2071W	VOLV	84371	GAK-20	GALN	8481-01-189	GA-853R	KOMA
83501900	GP-40	CHRY	83912256	GP-166 ¹⁰⁰	NEWH	844	GP-3600 ¹⁰²	AMP	84814S	GA-3490	NLSN
83501900	GP-91 ⁷⁸	MOP	83913766	GA-616	NEWH	844	GP-38 ¹²²	AMP	84815S	GA-113	NLSN
83501902	G-294	CHRY	839-14-300	GP-40	MZDA						

Numero	Gonher	Fabricante	Numero	Gonher	Fabricante	Numero	Gonher	Fabricante	Numero	Gonher	Fabricante
Number	Gonher	Manufacturer	Number	Gonher	Manufacturer	Number	Gonher	Manufacturer	Number	Gonher	Manufacturer
848555	GA-735 ²⁴	NLSN	85088	GP-28 ⁸	CRQ	85298	GP-66	CRQ	85451	GP-761H	CRQ
848565	GA-3490	NLSN	85088	GP-430 ⁹	CRQ	85302	G-870	CRQ	85452	GP-310	CRQ
848575	GA-271	NLSN	85098A	GP-36	NLSN	85305	G-836	CRQ	85452	GP-3569	CRQ
848585	GA-VW-2	NLSN	85099	G-834	CRQ	85307	GP-81	CRQ	85452MP	GP-310	CRQ
848605	GA-140	NLSN	85105	GP-5	GMCX	85307	GP-9	CRQ	85453	GP-66	CRQ
848615	GA-2740	NLSN	85105	GP-5	GRAY	85312	GP-81	CRQ	85455	GP-761H	CRQ
848623-R1	GA-361	IHCO	85110	GP-50	CRQ	85312	GP-9	CRQ	85456	GP-761H	CRQ
848625	GA-75	NLSN	85116A	GP-3	NLSN	85313	G-162H	CRQ	854568	GG-20	GMCX
848635	GA-3588	NLSN	85117E	GP-20	NLSN	85314	G-162H	CRQ	854569	GG-20	GMCX
848665	GA-3647	NLSN	85118E	GP-1	NLSN	85315	GP-128	CRQ	854569	GG-20	INTM
848705	GA-436	NLSN	85119E	GP-5	NLSN	85319	GP-81	CRQ	854569	GG-20	PHHR
848785	GA-467	NLSN	85120G	GP-1	NLSN	85319	GP-9	CRQ	85457	GP-761H	CRQ
848924	GAK-216	ATWE	85121E	GP-3	NLSN	85319	GAK-403	LOCK	854582	GG-5 L	GMCX
848935	GAD-30	NLSN	85124B	GP-81 ³¹	NLSN	85320	GP-50	CRQ	854583	GG-5 L	GMCX
848975	GA-135	NLSN	85124B	GP-9 ⁵⁸	NLSN	85324	GP-3985 ⁶⁹	CRQ	8545896	G-296	RENA
8485	GG-255	GREY	85129	G-34	CRQ	85325	GAK-403	LOCK	8545896	G-296-B	RENA
849035	GA-376	NLSN	85129A	GP-81	NLSN	85328	GA-33 ¹¹²	LOCK	854589600	G-296	RENA
849045	GA-372	NLSN	85130	G-33	CRQ	85329	GA-33 ¹¹²	LOCK	854589600	G-296-B	RENA
849055	GA-416	NLSN	85133	G-33	CRQ	85334	GP-149 ⁶⁹	CRQ	85459	GP-31	CRQ
849115	GAK-216	NLSN	85133MP	G-33	CRQ	85334	GP-91 ⁷⁸	CRQ	85460	GP-3600	CRQ
849125	GA-694	NLSN	85136	G-33	CRQ	85334MP	GP-149 ⁶⁹	CRQ	854600	GG-5 L	GMCX
849135	GA-826	NLSN	85138	G-119	CRQ	85334MP	GP-91 ⁷⁸	CRQ	854606	GG-20	GMCX
849175	GA-416	NLSN	85143	G-200	CRQ	85335	GP-22	CRQ	85461	GP-54	CRQ
849185	GA-8	NLSN	85145	GP-971	CRQ	85338	GP-462	CRQ	85461	G-566	GALN
849415	GA-422	NLSN	85147	G-331	CRQ	85340	GP-46	CRQ	854619	GG-5 L	GMCX
849485	GA-642	NLSN	85151	G-335	CRQ	85342	GP-28 ⁹	CRQ	85462	GP-66	CRQ
849515	GA-3681	NLSN	85156	G-333	CRQ	85342	GP-430 ⁸	CRQ	854670900	G-1121	RENA
849565	GA-1095	NLSN	85157	G-871	CRQ	85344	GP-462	CRQ	8547031	GP-50	RENA
849615	GA-230	NLSN	85158	GP-54	CRQ	85345	GP-3682	CRQ	854703100	GP-50	RENA
8499135552	G-225	RENA	85160	G-963	CRQ	85345	GP-37	CRQ	8547327	GP-81 ³¹	RENA
849925	GA-405	NLSN	85161	GP-191	CRQ	85346	GP-28	CRQ	8547327	GP-9 ⁵⁸	RENA
849973-M91	G-870	MASY	85163	G-152	CRQ	85347	GP-24 ⁸⁶	CRQ	85475	G-6	CRQ
849975	GA-49	NLSN	85167	G-152	CRQ	85347	GP-462 ³⁴	CRQ	8548060	G-1121F	RENA
850	GP-110	AMP	85168	G-238	CRQ	85348	GP-2951 ¹²⁰	CRQ	8548060	G-1121F	RENA
850	GP-110	BGA	85176	G-33	CRQ	85348	GP-58	CRQ	854806000	G-1121F	RENA
8500002	GP-9	HYST	85176	GP-2015W	GLOB	85348MP	GP-2951 ¹²⁰	CRQ	8548060000	G-1121F	RENA
85004	G-6	CRQ	85177	GP-2022W	GLOB	85348MP	GP-58	CRQ	8548078	GP-50	RENA
8500411	GP-3	NACC	85183	G-871	CRQ	85349	GP-51	CRQ	8548079	GP-81 ³¹	RENA
85006A	GP-50	NLSN	85186	G-984	CRQ	853521066	GA-26	BUFF	8548079	GP-9 ⁵⁸	RENA
85011A	GP-1101	NLSN	85188	G-813	CRQ	853521066	GA-26	KOEI	854807999	GP-50	RENA
85021	G-31	CRQ	85189	GP-81	CRQ	853521067	GA-26	BUCY	854809061	GA-71	RENA
8503214	G-31	FIAT	85189	GP-9	CRQ	853521067	GA-26	BUFF	85482	GP-761H	CRQ
85034	GP-3600	CRQ	851890	G-296	MASY	853521067	GA-26	KOEI	85483	GP-761H	CRQ
85036	GP-3980	CRQ	851890	G-296-B	MASY	853521072	GA-33 ¹¹²	BUFF	8548386	G-834	RENA
85036MP	GP-3980	CRQ	851890-M1	G-296	MASY	853521072	GA-33 ¹¹²	KOEI	85485	GP-761H	CRQ
85037	GP-46	CRQ	851890-M1	G-296-B	MASY	853521073	GA-33 ¹¹²	BUCY	85486	GP-761H	CRQ
8504	GG-1	PAR	851890-M91	G-296	MASY	853521073	GA-33 ¹¹²	BUFF	8548620	GP-50	RENA
8504	GG-4	PAR	851890-M91	G-296-B	MASY	853521073	GA-33 ¹¹²	GENE	854862000	GP-50	RENA
85040	GP-46	CRQ	85190	GP-3980	CRQ	853521073	GA-33 ¹¹²	KOEI	85487	G-169	CRQ
85040MP	GP-46	CRQ	85191	GP-310	CRQ	853521139	GAK-20	KOEI	8548759	G-1121	RENA
85042	GP-44	CRQ	85191	GP-3569	CRQ	853521144	GAK-20	KOEI	8548759000	G-1121	RENA
85042A	GP-1101	NLSN	85193	G-870	CRQ	853521198	GAK-403	KOEI	8548979	GP-81 ³¹	RENA
85044A	GP-81	NLSN	85195	G-153	CRQ	8535301235	GP-761H	KOEI	8548979	GP-9 ⁵⁸	RENA
85045	GP-3429	CRQ	85196	GP-66	CRQ	853531220	GP-761H	JOY	854897999	GP-81 ³¹	RENA
85046	GP-3	CRQ	85197	G-222	CRQ	853531235	GP-761H	KOEI	854897999	GP-81	RENA
85049	GP-5	CRQ	851SA226	GA-24 ³⁴	CLRK	853531244	GP-761H	KOEI	854897999	GP-9 ⁵⁸	RENA
85050	GP-50	CRQ	851SA2269	GA-24 ³⁴	BLDW	85354	G-870	CRQ	8549061	GA-71	RENA
85051	GP-50	CRQ	851SA227	GA-27	CLRK	85356	GP-149	CRQ	854906100	GA-71	RENA
85052	GP-50	CRQ	851SA2271	GA-27	BLDW	85357	GP-91	CRQ	854906199	GA-71	RENA
8505-29	GA-6127	POCL	852	GP-52 ¹¹⁰	AMP	85358	GP-91	CRQ	854907999	GP-50	RENA
85053	GP-66	CRQ	852	GP-691 ⁴⁸	AMP	85361	GP-3682	CRQ	85491	GP-761H	CRQ
850550	GA-357	CASE	85206	GP-36	CRQ	85362	GP-81	CRQ	85492	GP-761H	CRQ
8505-50	GA-357	POCL	85212	G-112	CRQ	85362	GP-9	CRQ	854924	GG-20	GMCX
8505-61	GA-360	POCL	85213	G-975	CRQ	85364	GP-3816	CRQ	854925	GG-20	GMCX
850562	GA-360	CASE	85214	GP-3600	CRQ	85365	GP-91	CRQ	85494	GP-761H	CRQ
8505-62	GA-361	POCL	85215	GP-58	CRQ	85366	GP-58	CRQ	85495	GP-761H	CRQ
8505-89	GP-77	POCL	85217	GAK-16	LOCK	85367	GP-3682	CRQ	85496	GP-761H	CRQ
8506	GA-27161	CRO	85223	G-954	CRQ	85369	GP-81	CRQ	85498	GP-761H	CRQ
85060	GP-205	CRQ	85224	GP-452	CRQ	85369	GP-9	CRQ	855	GP-36	AMP
85060A	GP-31	NLSN	852251-M91	G-813	MASY	85372	GP-68	CRQ	855	GP-36	BGA
85060MP	GP-205	CRQ	85226	G-180	CRQ	85372MP	GP-68	CRQ	855	GA-29	DEL
85061	GP-13	CRQ	85228	GP-457	CRQ	85374	GP-58 ¹²²	CRQ	85500	G-31	CRQ
85061MP	GP-13	CRQ	85239	G-31	CRQ	85377	GP-57	CRQ	855017P0780	GAK-625	INGR
85063	GP-13	CRQ	85240	GP-166	CRQ	85378	GP-212	CRQ	85503	G-31	CRQ
85064	GP-149	CRQ	85242	G-139	CRQ	85381	GP-91	CRQ	85512	GP-38	CRQ
85064	GP-91	CRQ	85243	GP-14	CRQ	85386	GP-3985	CRQ	85515	GP-1	CRQ
85065	GP-58 ¹⁵	CRQ	85243MP	GP-14	CRQ	85390	GP-42	CRQ	85516	GP-3600	CRQ
85068	GP-81 ³¹	CRQ	85253	G-122	CRQ	85391	GP-490	CRQ	85516MP	GP-3600	CRQ
85068	GP-9 ⁵⁸	CRQ	85253	G-338	CRQ	85392	GP-3531 EXP	CRQ	85521	GP-171	CRQ
85068MP	GP-81 ³¹	CRQ	85254A	GPP-1122	NLSN	85393	GP-28 ⁹	CRQ	85522	GP-3675	CRQ
85068MP	GP-9 ⁵⁸	CRQ	85258	GP-20	CRQ	85393	GP-430 ⁸	CRQ	85522MP	GP-3675	CRQ
85069	GP-3	CRQ	85259	GP-66	CRQ	85394	GP-157	CRQ	85525	GP-1	CRQ
85069MP	GP-3	CRQ	85259N	GPP-1122	NLSN	85395	GP-157	CRQ	85545	GP-171 ¹⁶	CRQ
8507-1443	GA-39	GRAD	85261	GP-166	CATP	85396	GP-156	CRQ	85550	G-500	CRQ
85076	G-236	CRQ	85261	GP-36	CRQ	85400727	GA-853R	INGR	85551	GP-66	CRQ
85077	G-236	CRQ	85261	GP-166	TOWM	85400976	GPP-420	INGR	8555101	GA-71	RENA
8508111	G-1123	BUSS	85268	GP-9586	CRQ	85414	GP-57	CRQ	855510100	GA-71	RENA
8508111	G-1123	FIAT	85268MP	GP-9586	CRQ	854152006	G-834	RENA	85551MP	GP-66	CRQ
85083	GP-6811	CRQ	85270	G-330	CRQ	8541840005	G-1143	CRQ	85552	GP-66	CRQ
85084	GP-81	CRQ	85271	G-330	CRQ	85426	G-33	CRQ	85553	GP-66	CRQ
85084	GP-9	CRQ	85275	GP-54	CRQ	85431	GP-9	CRQ	85554	G-500	CRQ
85085	GP-81	CRQ	85279	G-5000	CRQ	85442	G-191	CRQ	85555	G-500	CRQ
85085	GP-9	CRQ	85283	GP-36	CRQ	85447	GP-761H	CRQ	85558910	GP-22	RENA
85085MP	GP-81	CRQ	85288	GP-3816	CRQ	85448	GP-761H	CRQ	85558910	GP-81	RENA
85085MP	GP-9	CRQ	852931	GP-28 ⁸	ATWE	85449	GP-761H	CRQ	8555896	G-296	RENA
85087	GP-68	CRQ	852931	GP-430 ⁸	ATWE	85450	GP-761H	CRQ	8555896	G-296-B	RENA

Referencia Cruzada por Numero de Parte

Cross Reference by Part Number



Numero	Gonher	Fabricante	Numero	Gonher	Fabricante	Numero	Gonher	Fabricante	Numero	Gonher	Fabricante
Number	Gonher	Manufacturer	Number	Gonher	Manufacturer	Number	Gonher	Manufacturer	Number	Gonher	Manufacturer
855589600	G-296	RENA	85776	GP-77	CRQ	85971MP	GP-193	CRQ	86122	GP-93	CRQ
855589600	G-296-B	RENA	85777	GP-57	CRQ	85971XD	GP-193	CRQ	86122MP	GP-93	CRQ
855590600	G-296	RENA	85779	GAK-403	FIAT	859777	G-200	REOT	86123	GP-92	CRQ
855590600	G-296-B	RENA	85783	G-122	CRQ	85-9777	G-200	WHIT	86124	GP-1122	CRQ
85568	GP-462	CRQ	85783	G-338	CRQ	8595	GG-255	GREY	86125	GP-92	CRQ
85581	GP-14	CRQ	85784	GP-52 ¹⁰⁰	CRQ	86	G-6	DEL	86128	GPP-111	CRQ
85582-151	G-870	ISUZ	85784	GP-691 ⁴⁸	CRQ	86	GA-56	UNN	86128	GPP-524	CRQ
85582-151-000	G-870	HOND	85784MP	GP-69	CRQ	860	G-834	AMP	86129	GG-209	CRQ
85582-153	G-870	ISUZ	85785	GP-58	CRQ	860	G-834	BGA	86133	GG-1133	CRQ
85582-153-000	G-870	HOND	85789	GP-69	CRQ	860	GA-71	CRO	86134	GS-1133	CRQ
8558238	GP-22	RENA	85789MP	GP-69	CRQ	8600082	GPP-1122	VOLV	86136	GP-294	CRQ
8558238	GP-81 ³¹	RENA	85791	GP-51	CRQ	86001	GG-1	CRQ	861361	GP-1012Q	NEUWH
8558238	GP-9 ⁵⁸	RENA	85791MP	GP-51	CRQ	86001	GG-4	CRQ	861362	GP-2071W	FORD
8558910	GP-81	RENA	85791XE	GP-51	CRQ	86002	GG-124	CRQ	86140	GPP-612	CRQ
8558910	GP-9	RENA	85792	GP-52 ¹¹⁰	CRQ	86003	GG-5	L	86142	GP-296	CRQ
855891099	GP-22	RENA	85792	GP-691 ⁴⁸	CRQ	860030890	GP-22	RENA	86142	G-296-B	CRQ
85592	GP-68	CRQ	85792MP	GP-52 ¹¹⁰	CRQ	860038900	GA-218	RENA	86144	G-1143	CRQ
8559611	GP-22	RENA	85792MP	GP-691 ⁴⁸	CRQ	86007	GG-3	CRQ	86153	GG-189	CRQ
855961100	GP-22	RENA	85792XD	GP-52 ¹¹⁰	CRQ	86008	GG-246	CRQ	86156	GG-246	CRQ
856	GP-28 ⁶	AMP	85792XD	GP-691 ⁴⁸	CRQ	860-08-50177	GP-36	KALB	86156	GG-408	CRQ
856	GP-430 ⁸	AMP	85792XE	GP-52 ¹¹⁰	CRQ	86009	GP-458	CRQ	86159	G-1123 ¹⁰⁸	CRQ
856	GP-28 ⁶	BGA	85792XE	GP-691 ⁴⁸	CRQ	86011	GG-116	CRQ	86159	G-1123F ¹⁰⁸	CRQ
856	GP-430 ⁸	BGA	85794	GP-23	CRQ	86012	GG-5	L	86160	GG-232	CRQ
856	GA-3814	UNN	85794MP	GP-23	CRQ	86016C	G-238	NLSN	86161	GG-251	CRQ
85601	GP-171	CRQ	85796	GP-390 ⁹³	CRQ	86021	GG-202	CRQ	86162	GG-215	CRQ
85602	GP-390	CRQ	85797	GP-10	CRQ	86022	GG-94	CRQ	86163	G-297	CRQ
85602MP	GP-390	CRQ	85797MP	GP-10	CRQ	86023	GG-63	CRQ	86163	G-297-B	CRQ
85604	GP-178	CRQ	85799	GP-152	CRQ	86024	GG-76	CRQ	86166	G-296	CRQ
85607	GP-178	CRQ	85799MP	GP-152	CRQ	86025	GG-1	CRQ	86166	G-296-B	CRQ
85607MP	GP-178	CRQ	8575	GPP-1287 ³⁹	GREY	86025	GG-4	CRQ	86166MP	G-296	CRQ
85609	GP-36	CRQ	8575	PFF831 ⁴¹	GREY	86030	GG-1	CRQ	86166MP	G-296-B	CRQ
85612	GP-14	CRQ	8575	R 60 P ⁴²	GREY	86030	GG-4	CRQ	86167	G-1121	CRQ
85613	G-613	CRQ	858	GP-24 ²⁶	AMP	86031	GG-1	CRQ	86179	GG-251	CRQ
85618	GP-20	CRQ	858	GP-462 ²⁴	AMP	86031	GG-4	CRQ	86180	G-1166	CRQ
85619	GP-166 ⁶⁵	CRQ	858	GP-24 ²⁶	BGA	86032MP	GG-5	L	86181	G-1166	CRQ
85619	GP-3937 ¹¹	CRQ	858	GP-462 ²⁴	BGA	86033	GG-5	L	86182A	G-31	NLSN
8562	GP-26	MULP	858	GAD-1	DEL	86033MP	GG-5	L	86183	GG-290	CRQ
85620	GP-166	CRQ	85800	GP-77	CRQ	860365-C9	GA-26	IHCO	86184	GPP-1287 ³⁹	CRQ
85621	GP-166	CRQ	85801	GP-52 ¹¹⁰	CRQ	860365-C91	GA-26	IHCO	86184	PFF831 ⁴¹	CRQ
85622	GP-171 ¹⁶	CRQ	85801	GP-691 ⁴⁸	CRQ	860410	GA-11	ALCH	86184	R 60 P ⁴²	CRQ
85624	GP-81	CRQ	85802	GP-67	CRQ	860410-0	GA-11	ALCH	86186	G-11816	CRQ
85625	GP-58	CRQ	85803	GP-54	CRQ	86044	GG-6	CRQ	86187	G-1166	CRQ
85626	GP-3985	CRQ	85806	GP-1	CRQ	86046	GG-19	CRQ	86188	G-1166	CRQ
85628	GP-54	CRQ	85807	GP-54	CRQ	86046MP	GG-19	CRQ	86189	G-1166	CRQ
85637	G-159	CRQ	85808	GP-88	CRQ	86048	GG-7	CRQ	86190	GG-177	CRQ
85642	GP-51	CRQ	85809	GP-642	CRQ	86050	GG-123	CRQ	86-1909	G-6	WHIT
85644309	GA-71	CTOL	85810	GP-43	CRQ	86051	GG-16	CRQ	86192	GPP-1122	CRQ
85649	GP-43	CRQ	85811	GP-53	CRQ	86051MP	GG-16	CRQ	86193	GG-580	CRQ
85660	GP-556	CRQ	85812	GG-17	CRQ	86052	GG-17	CRQ	86194	G-11816	CRQ
85663	GP-166	CRQ	85813	GP-53	CRQ	86052MP	GG-17	CRQ	86195	GP-1122	CRQ
85669	GP-53	CRQ	85817	GP-761H	CRQ	86053	GG-45	CRQ	86196	G-296	CRQ
85669XD	GP-53	CRQ	85818	GP-54	CRQ	86054	GG-8 ¹⁰³	CRQ	86196	G-296-B	CRQ
85671	GP-53	CRQ	85819	GP-761H	CRQ	86054	GG-8 L ⁸⁰	CRQ	8619828	GAK-216	LNCR
85673	GP-359	CRQ	85820	GP-54 ¹¹	CRQ	8606006	GP-1122	HYDO	8619844	GA-416	LNCR
85-6773	GA-37	WHIT	85820	GP-66 ¹⁰	CRQ	8606007	GPP-18	HYDO	86199	GG-64	CRQ
85681	GP-57	CRQ	858201	G-296	VOLV	86061	G-1173 ¹⁰⁸	CRQ	862	GA-3300	DEL
857	GAD-3	DEL	858201	G-296-B	VOLV	86062	G-1175 ¹⁰⁸	CRQ	86201	GG-213	CRQ
85704	GP-50 ²⁰	CRQ	85824	GP-35	CRQ	86066	GG-76	CRQ	8620132	GAK-16	LNCR
85712	GP-166 ¹⁰⁰	CRQ	85829	GP-66	CRQ	86068	GG-1	CRQ	8620140	GA-106 ⁴⁹	LNCR
85-7213	G-500	WHIT	85830	G-335	GALN	86068	GG-4	CRQ	8620140	GA-326 ¹¹	LNCR
85-7214	G-750	WHIT	85832	G-1163 ¹⁰⁸	GALN	86071	G-1176	CRQ	8620159	GA-33 ¹¹²	LNCR
85722	GP-52 ¹¹⁰	CRQ	85838	G-49	CRQ	86073	G-1174 ¹⁰⁸	CRQ	8620167	GAK-216	LNCR
85722	GP-691 ⁴⁸	CRQ	8584532	GA-360	COLS	86074	G-1174	CRQ	8620175	GA-416	LNCR
85734	GP-562	CRQ	85848	GP-52 ¹¹⁰	CRQ	86079	GG-42	CRQ	8620191	GAK-403	LNCR
85734MP	GP-562	CRQ	85848	GP-691 ⁴⁸	CRQ	86080	G-1163 ¹⁰⁸	CRQ	86203	GG-76	CRQ
85740	GP-864H	CRQ	8585	G-500	WHIT	86081	GG-87	CRQ	86204	GG-208	CRQ
85741	GP-3000 ¹³	CRQ	85-8500	G-500	WHIT	86081MP	GG-87	CRQ	86208	2010PM-OR ⁷	CRQ
85742	GP-3766	CRQ	85867	G-339H	CRQ	86082	GG-8	L	86208	2010TM-OR ²	CRQ
85742MP	GP-3766	CRQ	85870	GP-53	CRQ	86084	GG-203	CRQ	86209	GS-2034	CRQ
85746	GP-34	CRQ	8587271	G-834	LNCR	86085	GG-203	CRQ	86210	GS-2033	CRQ
85747	GP-88	CRQ	85873	GG-196	CRQ	86087	GG-196	CRQ	86211	GPP-14	CRQ
85748	GP-3000	CRQ	858750	G-750	AUTC	86089	GG-188	CRQ	86212	GS-2033	CRQ
85748MP	GP-3000	CRQ	858750	G-750	DIAM	86093	GG-240	CRQ	86214	GG-194	CRQ
85748XD	GP-3001	CRQ	858750	G-750	REOT	86097	GG-47	CRQ	86216	GG-85	CRQ
85749	GP-57	CRQ	8-58750	G-750	WHIT	86097MP	GG-47	CRQ	86216MP	GP-85	CRQ
85749MP	GP-57	CRQ	859	GG-268	AMP	86099	GG-268	CRQ	86218	GP-84	CRQ
85750	G-750	CRQ	859	GP-23	BGA	86103	GG-137	CRQ	86218MP	GP-84	CRQ
85751	G-750	CRQ	859	GA-100	DEL	86107	GPP-14	CRQ	86219	GP-83	CRQ
85752	G-750	CRQ	859086	GP-761H	NEUWH	86109	GP-1101	CRQ	86219MP	GP-83	CRQ
85753	G-750	CRQ	859129620	GAWV-120	VAG	86109MP	GP-1101	CRQ	86221	GG-217	CRQ
85754	GP-54	CRQ	859129620	GAWV-120	VOLK	8611127	GP-53	HYDO	86223	GG-220	CRQ
85754MP	GP-54	CRQ	859336	GP-1101	AUTC	86112	G-1123 ¹⁰⁸	CRQ	86227	GG-7018 ³⁸	CRQ
85756	GP-34	CRQ	859336	GP-1101	DIAM	86112	G-1123F ¹⁰⁸	CRQ	86227	GG-7019 ³⁷	CRQ
85758	GP-34	CRQ	859336	GP-1101	REOT	86113	G-1173 ¹⁰⁸	CRQ	86227	GG-7020 ¹⁴⁴	CRQ
85759	GP-34	CRQ	85-9336	GP-1101	WHIT	86115	GP-110	CRQ	86228	GG-351	CRQ
85762	GP-3000	CRQ	859337	GA-39	AUTC	86116	GP-55	CRQ	86231	GPP-1287 ³⁹	CRQ
8576344	GA-24 ³⁴	COLS	859337	GA-39	DIAM	86117	G-1176	CRQ	86231	PFF831 ⁴¹	CRQ
85764	GP-3600	CRQ	859337	GA-39	REOT	86117F	G-1174 ¹⁰⁸	CRQ	86231	R 60 P ⁴²	CRQ
85768	GP-36	CRQ	8-59337	GA-39	WARD	86118	GP-26	CRQ	86232	GPP-547 ³⁹	CRQ
85769	GP-69	CRQ	85-9337	GA-39	WHIT	86118MP	GP-26	CRQ	86232	PFF831 ⁴¹	CRQ
85772	GP-54 ¹¹	CRQ	85-9337A	GA-39	WHIT	86120	GP-27	CRQ	86232	R 60 P ⁴²	CRQ
85772	GP-66 ¹⁰ </										

Numero	Gonher	Fabricante	Numero	Gonher	Fabricante	Numero	Gonher	Fabricante	Numero	Gonher	Fabricante
Number	Gonher	Manufacturer	Number	Gonher	Manufacturer	Number	Gonher	Manufacturer	Number	Gonher	Manufacturer
86243	GG-101	CRQ	86401	G-1143 ³⁰	CRQ	86553	GG-164	CRQ	86796	2010TM-OR ²	CRQ
86244	GPP-14	CRQ	86403	GP-78	CRQ	86554	GG-164	CRQ	868	GA-2719B	DEL
86251	G-1176	CRQ	86404	GP-1224	CRQ	86555	GG-234	CRQ	868014	G-296	PERK
86253	GG-5 L	CRQ	86405	GPP-11	CRQ	86555246	GPP-1122	NEWH	868014	G-296-B	PERK
86257	GG-239	CRQ	86405MP	GPP-11	CRQ	86555826	GA-853R	NEWH	86811	GP-155	CRQ
86265	GG-260	CRQ	86406	GG-1000	CRQ	86556	GG-215	CRQ	86812	GPP-1291 ³⁹	CRQ
86267	GG-580	CRQ	86407	GPP-11	CRQ	865571	GPP-1122	HYST	86812	S 3226 P ⁴⁰	CRQ
86271	GG-20	CRQ	86411	GPP-1287 ³⁹	CRQ	86558	GG-79	CRQ	86819	GS-557	CRQ
86271MP	GG-20	CRQ	86411	PFF831 ⁴¹	CRQ	86559	GG-160	CRQ	868446-C9	GAK-20	IHCO
8627334	GG-68	LNCR	86411	R 60 P ⁴²	CRQ	86559431	GA-853R ¹⁰⁴	NEWH	868446-C91	GAK-20	IHCO
86275	GG-204	CRQ	86412	GPP-1291 ³⁹	CRQ	86561	GG-164	CRQ	86848	GG-65	CRQ
86277	GG-226	CRQ	86412	S 3226 P ⁴⁰	CRQ	86566	GG-246	CRQ	86878	GG-164	CRQ
86279	GG-261	CRQ	86415	GPP-11	CRQ	86568	GG-196	CRQ	86881304	GA-372	PETI
86282	GG-214	CRQ	86418	S 3202 ⁴⁰	CRQ	86569	GG-146	CRQ	86882	GG-206	CRQ
86283	GG-214	CRQ	86421	GPP-14	CRQ	865701	G-6	MINN	86899	G-1047	CRQ
86284	GG-146	CRQ	86422	GPP-1022S	CRQ	86576	GG-265	CRQ	8685	GP-1109 ²²	GREY
86285	GG-184	CRQ	86423	GPP-1007S	CRQ	86577	GG-267	CRQ	8685	GP-62 ²⁰	GREY
86286	GG-79	CRQ	86424	GG-308	CRQ	86579	GG-266	CRQ	869065	GA-360	ATWE
86287	GG-185	CRQ	86425	GG-1872	CRQ	86585	GS-1261	CRQ	8690940	GA-467	MTU
86288	GG-185	CRQ	8642570	G-313	VOLV	86586	GPP-423	CRQ	8690940020	GA-467	DAIM
86291	GG-246	CRQ	86431	GPP-11	CRQ	86594	GG-251	CRQ	8690940020	GA-467	MBNZ
86293	GG-30	CRQ	86432	S 3202 ⁴⁰	CRQ	86595	GG-986	CRQ	8690940020	GA-467	MTU
86294	GG-220	CRQ	86433	GPP-11	CRQ	86596	GG-7020	CRQ	86909400203	GA-467	MBNZ
86295	GG-150	CRQ	86434	GG-206	CRQ	86597	GG-206	CRQ	8690940390	GA-6129	MTU
86296	GG-1872	CRQ	864353	G-1173 ¹⁰⁸	CLRK	86597475	GP-761H	NEWH	86918	GG-187	CRQ
86296MP	GG-1872	CRQ	86439	GPP-11	CRQ	86599	G-1047	CRQ	8692305	G-313	VOLV
86298	GG-115	CRQ	86441	GPP-11	CRQ	866	GP-3816	AMP	86957	GG-307	CRQ
863	GP-171 ¹⁶	AMP	86442	S 3202 ⁴⁰	CRQ	866	GP-3816	BGA	869668	G-31	CLRK
86300	GG-92	CRQ	86443	GPP-11	CRQ	866019-C91	GAK-403	IHCO	869688	G-31	CLRK
86301	GG-84	CRQ	86444	GPP-14	CRQ	86604	GPP-1003S	CRQ	8698-1590	GA-372	GRAD
86-3010	GP-66	TORO	86451	G-128	CRQ	86604XE	GPP-1003S	CRQ	86909080	GP-3000 ¹³	NEWH
86302	GG-7018 ³⁸	CRQ	86452	GPP-11	CRQ	86611	GPP-547 ³⁹	CRQ	87	G-191	DEL
86302	GG-7019 ³⁷	CRQ	86454	GG-39	CRQ	86611	PFF831 ⁴¹	CRQ	8700068	GP-761H	SUND
86302	GG-7020 ¹⁴	CRQ	86-4543	G-236	WHIT	86611	R 60 P ⁴²	CRQ	870017560	GP-1122	RENA
86308	GG-136	CRQ	86455	GG-214	CRQ	866155	G-834	DIA	8700958	GAK-403	RENA
86310	GG-255	CRQ	86460	GG-181	CRQ	866155	G-296	PERK	870095800	GAK-403	RENA
86311	GG-66	CRQ	86461	GG-114	CRQ	866155	G-296-B	PERK	87011	GA-71	CRQ
86314	GG-256	CRQ	86463	GG-264	CRQ	866155	G-834	REOT	8701155447	GP-54 ⁴¹	KHDF
86316	GG-243	CRQ	86472	GPP-1122	CRQ	86-6155	G-834	WHIT	8701155447	GP-66 ⁴⁰	KHDF
86317	GG-214	CRQ	864720	G-31	CLRK	866165	G-834	MASY	870-11-55-447	GP-54 ⁴¹	DUTZ
86318	GG-72	CRQ	86472MP	GPP-1122	CRQ	866165	G-834	PERK	870-11-55-447	GP-66 ⁴⁰	DUTZ
86319	GG-187	CRQ	86477	GG-137	CRQ	86621	GPP-11	CRQ	8701175600	GP-1122	RENA
86320	GG-67	CRQ	86479	GG-208	CRQ	866-23-802	GP-462	MZDA	87013	GA-415	CRQ
86321	GG-67	CRQ	86481	GP-46	CRQ	866-23-803	GP-462	MZDA	87016	GA-434	CRQ
86322	GG-247	CRQ	86481MP	GG-46	CRQ	86626	GP-1109 ²⁶	CRQ	8701759	G-1121	RENA
86323	GG-61	CRQ	86482	GG-242	CRQ	86630	GPP-1287 ³⁹	CRQ	8701759	G-1121F	RENA
86324	GG-65	CRQ	86483	GG-3728	CRQ	86630	PFF831 ⁴¹	CRQ	870175900	G-1121F	RENA
86325	GG-249	CRQ	86484	GG-581	CRQ	86630	S 3225 P ⁴²	CRQ	8701760	G-1121	RENA
86327	G-1173 ¹⁰⁸	GALN	86486	GG-79	CRQ	86632	GPP-425	CRQ	8701760	G-1121	SAVI
86328	GG-142	CRQ	86487	GG-256	CRQ	86632018	GP-34	NEWH	870176000	G-1121	RENA
86329	GG-148	CRQ	86491	GG-185	CRQ	866340K18	GP-408	MERC	8701760000	G-1121	RENA
86329	G-119	GALN	865	GP-3816	AMP	866340Q02	GP-408	MERC	870199A	GA-240	NLSN
86330	GG-190	CRQ	8650	G-6	HYST	86636	GPP-424	CRQ	870199E	GA-240	NLSN
86331	GG-181	CRQ	86500	GG-223	CRQ	86637	GPP-425	CRQ	87020	GA-70	CRQ
86333	GG-185	CRQ	86501	GG-203	CRQ	86638	GPP-419	CRQ	87020MP	GA-70	CRQ
86334	GPP-1000	CRQ	86502	GG-185	CRQ	86638	GPP-421	CRQ	87027972	GP-34	CASE
86335	GG-7018 ³⁸	CRQ	86504	GP-1105	CRQ	86640	GP-749	CRQ	87027972	GP-34	IHCO
86335	GG-7019 ³⁷	CRQ	86504140	GPP-1122	NEWH	86641	G-1166	CRQ	87027973	GP-34	NEWH
86335	GG-7020 ¹⁴	CRQ	86504784	GA-271	CASE	86642	G-1166	CRQ	87036	GA-3445	CRQ
86336	GP-1107	CRQ	86504784	GA-271	NEWH	866455	G-834	MINN	87036044	GPP-1122	NEWH
86336MP	GP-1107	CRQ	86508	GG-189	CRQ	86648	GPP-423	CRQ	87039	GA-54	CRQ
86338	GP-78	CRQ	86509128	GA-405	FORD	86651	G-128	CRQ	87039679	GPP-1122	CASE
86339	GP-1105	CRQ	86511	G-1173 ¹⁰⁸	CRQ	866520	GAK-20	MINN	87039679	GPP-1122	NEWH
86340	GP-110	CRQ	86512	G-1175 ¹⁰⁸	CRQ	86654	GP-548	CRQ	87044	GA-730	CRQ
86341	GP-1108	CRQ	86512355	GA-459	NEWH	86668	GPP-419	CRQ	87045	GA-9045	CRQ
86341MP	GP-1108	CRQ	86517	G-178	CRQ	86674	GP-749	CRQ	87046	GA-1287	CRQ
86-3444	GG-20	WHIT	86518	G-862	CRQ	86690	GP-96	CRQ	8704657	G-1121	RENA
86346	GG-95	CRQ	86519866	GA-880R	NEWH	86691	GP-1101	CRQ	870465700	G-1121	RENA
86347	GG-104	CRQ	86521	GP-102	CRQ	86697	GP-1109	CRQ	87047	GA-8047	CRQ
86348	GG-48	CRQ	86522	GPP-11	CRQ	867	GP-42	AMP	87048	GA-1285	CRQ
86352	GP-110	CRQ	86527	GP-1109 ²⁶	CRQ	867	GP-42	BGA	87049	GA-429	CRQ
86352MP	GP-110	CRQ	86528	GP-110	CRQ	867	GAD-1	DEL	87054	GA-77	CRQ
86353	GPP-18	CRQ	86531	GPP-418	CRQ	867014	G-834	MASY	87055	GA-80	CRQ
86356	GP-110	CRQ	86532	GPP-419	CRQ	867014	G-296	PERK	87057	GA-74	CRQ
86357	GPP-18	CRQ	86533	GPP-424	CRQ	867014	G-296-B	PERK	87061	GA-78	CRQ
86358	GP-1122	CRQ	86534	GPP-419	CRQ	867014	G-296	REOT	87065	GA-85	CRQ
86358MP	GP-1122	CRQ	86535	GPP-425	CRQ	867014	G-296-B	REOT	87067	GA-303	CRQ
86361	GP-1122	CRQ	86536	GPP-426	CRQ	86-7014	G-296	WHIT	87068	GA-86	CRQ
86362	GP-110	CRQ	86537	GPP-419	CRQ	86-7014	G-296-B	WHIT	87072	GA-349	CRQ
86367	GP-1105	CRQ	86540	G-1175 ¹⁰⁸	CRQ	86704	GG-986	CRQ	870726A	GA-799R	NLSN
86368	GP-62	CRQ	86542664	GP-34	NEWH	86708	G-1175	CRQ	870728N	GA-798R	NLSN
86370	G-295	CRQ	86543	G-278	CRQ	86709	G-1175	CRQ	87073	GA-75	CRQ
86372	GPP-1122	CRQ	86544	G-276	CRQ	8-671-000-496	GP-455	RENA	87073MP	GA-75	CRQ
86373	GP-1122	CRQ	86545	G-277	CRQ	8-671-004-329	GP-461	RENA	87077	GA-3300	CRQ
86374	GP-749	CRQ	86546	GPP-419	CRQ	86715	G-1175	CRQ	870807A	G-638	FLG
86375	G-270	CRQ	86546603	GP-66	NEWH	86717	GP-26	CRQ	87083	GA-50	CRQ
86377	GP-1109 ²²	CRQ	86546614	GP-171 ¹⁹	NEWH	86734	GG-265 ³⁶	CRQ	87087	GA-77	CRQ
86377	GP-62 ²⁰	CRQ	86546615	GP-77	NEWH	86735	GG-307	CRQ	87088	GA-192	CRQ
86380	GPP-19	CRQ	86546616	GP-54 ³⁰	NEWH	867471	G-1173 ¹⁰⁸	FIAT	87088MP	GA-192	CRQ
86381	GPP-18	CRQ	86546618	GP-81	NEWH	86756	GPP-423	CRQ	87091	GA-56	CRQ
86383	GP-1101 ¹⁴	CRQ	86546620	G-870	NEWH	86759	GPP-420	CRQ	87093	GA-90	CRQ
86384	GP-56	CRQ	86546624	GP-66	NEWH	86774	R120P	CRQ	87095	GA-55	CRQ
86384MP	GP-56	CRQ	86547	GPP-425	CRQ	86774	R120P	DAF	87096	GA-3523	CRQ
8639028	GAK-1532	LNCR	86548	GP-420	CRQ	86793	GS-2033	CRQ	870971	G-296	MASY
8635	GPP-1122	GREY	86549	GPP-426	CRQ	86795	2010TM-OR	CRQ	870971	G-296-B	MASY
86400	GPP-19	CRQ	86549700	GA-880R	NEWH	86796	2010PM-OR ⁷	CRQ	87098	GA-59	CRQ

Referencia Cruzada por Numero de Parte

Cross Reference by Part Number



Numero	Gonher	Fabricante	Numero	Gonher	Fabricante	Numero	Gonher	Fabricante	Numero	Gonher	Fabricante
Number	Gonher	Manufacturer	Number	Gonher	Manufacturer	Number	Gonher	Manufacturer	Number	Gonher	Manufacturer
87098MP	GA-59	CRQ	87384	GA-278R	CRQ	87691	GA-885	CRQ	88002	GA-135	CRQ
87099	GA-325	CRQ	87385	GA-224	CRQ	8769674	GP-1013Q	COLS	880043	G-31	CLRK
870-X-9601-RA	GA-2110	FORD	87389	GA-248	CRQ	87697	GA-3501	CRQ	880045	G-1173 ¹⁰⁸	CLRK
871	GA-378	DEL	87409203	GP-58 ^R	CASE	87714	GA-135	CRQ	880047	G-6	CLRK
87101	GA-57	CRQ	87415600	GP-58 ^R	CASE	87714	GA-35	CRQ	880049	G-31	CLRK
87101MP	GA-57	CRQ	87418364	GA-853R	CASE	87716	GA-39	CRQ	88007	GA-3566	CRQ
87102	GA-55	CRQ	87418364	GA-853R	NEWH	87725	GA-490	CRQ	88011	GAD-3	CRQ
87103	GA-3523	CRQ	87422	GA-6129	CRQ	8772571	G-297-B	COLS	88012	GA-3300	CRQ
87105	GA-57	CRQ	87423	GA-6127	CRQ	8772583	G-833	COLS	88013	GA-735 ¹²⁴	CRQ
8710541	GP-1013Q	FLXI	87438248	GA-853R	CASE	877269	GA-44	FIAT	88016	GA-140	CRQ
871077	G-6	CLRK	87440	GA-879	CRQ	87729	GA-414R	CRQ	88017	GA-322	CRQ
87112	GA-105	CRQ	87442705	GA-853R ¹⁰⁴	NEWH	87731	GA-4999	CRQ	88020D	G-31	NLSN
87113	GA-86	CRQ	87-4487	GA-377	WHIT	877380-C91	G-33	IHCO	88021A	G-33	NLSN
87116	GA-85	CRQ	87455	GA-968R	CRQ	87750	GA-249	CRQ	88024	GA-2719B	CRQ
87116MP	GA-85	CRQ	87461	GA-2130	CRQ	87757	GA-826	CRQ	88024A	G-834	NLSN
87118	GA-20	CRQ	87462	GA-2175	CRQ	87758	GA-827	CRQ	88025	GA-VW-4	NLSN
87118	GAK-20	CRQ	87472	GA-VW-621	CRQ	87759	GA-109	CRQ	88026	GA-381	CRQ
87119	GA-360	CRQ	87476	GA-286	CRQ	87760	GA-27 ¹¹²	IHCO	88027	GAD-294	CRQ
87124	GA-27	CRQ	87479	GA-286	CRQ	877600-C9	GA-27	IHCO	880271M1	GA-18	NISS
87125	GA-26	CRQ	87484	GA-395	CRQ	877600-C91	GA-27	IHCO	880271-M1	GA-18	MASY
87126	GA-403	CRQ	87485	GA-VW-626	CRQ	877744-C91	GA-27	IHCO	88027A	G-200	NLSN
87126	GAK-403	CRQ	87487	GA-348	CRQ	87793	GA-224	CRQ	88028	GA-7344	CRQ
87128	GA-356	CRQ	87488	GA-348	CRQ	8779663	GP-53	COLS	880307-C9	GAK-403	IHCO
87132	GA-357	CRQ	87491	GA-107	CRQ	8779663	GP-53	LBHR	880307C91	GAK-403	HOUG
87133	GA-277	CRQ	87493	GA-251	CRQ	87797	GA-491	CRQ	88032	GA-57	CRQ
87136	GA-403	CRQ	87503	GA-98 ¹¹²	CRQ	878	G-33	AMP	880334	GP-81	SAAB
8714	G-6	BAKR	87505	GA-18	CRQ	87800068	GP-81	NEWH	8803348	GP-81	SAAB
87140	GA-3424	CRQ	87509	GA-509 ¹⁴	CRQ	87800083	GP-310	FIAT	88035	GA-279	CRQ
87141	GA-325	CRQ	8750996	GP-34	HYDO	87800083	GP-1	NEWH	88036	GA-3647	CRQ
87142	GA-403	CRQ	875102	G-296	NANN	87800220	GPP-1122	NEWH	88036MP	GA-3647	CRQ
87142	GAK-403	CRQ	875102	G-296-B	NANN	87801285	GPP-423	NEWH	88040	GA-3588	CRQ
87160	GA-230	CRQ	87518	GAK-1532	CRQ	87801341	GPP-425	NEWH	88040MP	GA-3588	CRQ
87168	GA-2193	CRQ	87522	GAK-625	CRQ	87802728	GPP-423	NEWH	88041	GA-390	CRQ
87170	GA-VW-2	CRQ	87524	GA-168	CRQ	87802921	GPP-423	CASE	88042	GA-4325	CRQ
87181	GA-183	CRQ	87525	GA-2195	CRQ	87803194	GPP-1122	CASE	88042A	GP-1	NLSN
87188	GA-184	CRQ	8752811	GA-360	COLS	87803200	GP-548	CASE	88043	GA-139	CRQ
87190	GA-448	CRQ	8753934	GP-2071W	COLS	87803260	GP-737	NEWH	88044	GAD-117	CRQ
872	GP-69	AMP	8753936	G-566	COLS	87803261	GP-737	CASE	88044	GAD-17	CRQ
872	GP-69	BGA	8754056	G-750	COLS	87803264	GPP-1122	NEWH	88045	GA-154	CRQ
87203	GA-1203	CRQ	8754115	G-566	COLS	87809	GA-701 ¹⁰⁴	CRQ	88046	GA-3681	CRQ
87208	GA-106 ⁶⁶	CRQ	8754116	GA-39	COLS	87810	GA-702 ¹⁰⁸	CRQ	88048	GA-3637	CRQ
87208	GA-326 ⁷¹	CRQ	8754194	G-500	COLS	87810-022	G-750	ISUZ	8804872	G-1173 ¹⁰⁸	FIAT
87209	GA-206	CRQ	8754195	GPP-14	COLS	8-78107-910	GG-5 L	ISUZ	8804872	G-1173 ¹⁰⁸	IVEC
8721029	GA-206	FIAT	8754199	GPP-14	COLS	87826	GA-328	CRQ	88049	GA-429	CRQ
8721029	GA-206	HEST	87542	GA-360	CRQ	87837	GA-29	CRQ	88050A	G-6	NLSN
87218	GA-390	CRQ	8754228	GA-27	COLS	87840509	GPP-1122	NEWH	88051	GA-217	CRQ
8722126	GA-360	FIAT	8754231	GA-106 ⁶⁶	COLS	87840590	GPP-423	NEWH	88053	GAD-129	CRQ
8722126	GA-360	HEST	8754231	GA-326 ⁷¹	COLS	87840591	GPP-425	NEWH	88053A	G-5000	NLSN
8722134	GA-361	FIAT	87543	GA-361	CRQ	87843	GA-289	CRQ	88054	GA-56 ⁹⁰	CRQ
8722134	GA-361	HEST	875492156	G-1121	RENA	87844	GA-383	CRQ	88-05501-6002	GP-310	MAN
87222	GA-16	CRQ	8755185	G-296	COLS	87845	GA-8	CRQ	88056	GA-3588	CRQ
87222	GAK-16	CRQ	8755185	G-296-B	COLS	878471	GA-37	AUTC	88057	GA-7142	CRQ
87234	GA-20	CRQ	8755935	GP-9	LNCR	878472	GA-37	AUTC	88060C	G-750	NLSN
87234	GAK-20	CRQ	875598	GA-240	NLSN	87-8472	GA-37	WHIT	88061	GA-230	CRQ
87237	GA-24	CRQ	87559D	GA-240	NLSN	87851	GA-29	CRQ	88061710	GP-50	BUSS
8724	GP-66	THOM	87559J	GA-240	NLSN	87853	GA-375	CRQ	88064	GA-386	CRQ
87250	GA-37	CRQ	87564	GA-194	CRQ	87859	GA-VW-616	CRQ	88065	GA-59	CRQ
87252	GA-37	CRQ	8757435	GP-2071W	COLS	87860	GAK-1532	GEHL	88066	GA-3681	CRQ
87253	GA-209	CRQ	8758313	GP-1011Q	COLS	87865	GA-5648	CRQ	88067	GA-192	CRQ
87254	GA-210	CRQ	8758907	G-33	COLS	87888	GA-2803T	CRQ	88068	GA-71	CRQ
87258	GA-563	CRQ	8759112	G-1143	COLS	878945-C91	GA-27	IHCO	88069	GA-70	CRQ
87276	GA-33 ¹¹²	CRQ	87595	GAP-379	CRQ	878945C92	GA-27	HOUG	88072	GA-80 ¹¹³	CRQ
87279	GA-215	CRQ	87608	GA-405	CRQ	878945-C92	GA-27	IHCO	88072-100	GP-149	SUBA
8728391	G-834	COLS	87610	GA-377	CRQ	8785	GP-110	GREY	88074-100	GP-38	SUBA
87285	GA-2146	CRQ	87611	GA-372	CRQ	87905	GAD-1 ⁸⁷	CRQ	88074110	GP-38	SUBA
87290	GA-1285	CRQ	87613	GA-373	CRQ	87906	GAD-3	CRQ	88077	GA-3901	CRQ
87291	GA-42	CRQ	87618	GA-229	CRQ	87908	GA-75	CRQ	88080	GA-141	CRQ
87295	GA-VW-622	CRQ	87631	GAK-216	CRQ	87912	GA-3490	CRQ	88081	GA-301	CRQ
8729984	GA-360	COLS	87632	GA-416	CRQ	87916	GA-21	CRQ	88082	GA-166	CRQ
873	GP-51	AMP	87633	GA-287	CRQ	87924	GA-361	CRQ	88084	GA-3814	CRQ
873	GP-51	BGA	87647	GA-679	CRQ	87926	GA-403	CRQ	88084MP	GA-3814	CRQ
87300179	GA-880R	CASE	87648	GA-680	CRQ	87941	GA-493 ¹⁰⁸	CRQ	88085	GA-3647	CRQ
87300179	GA-880R	IHCO	8764949	G-1175 ¹⁰⁸	CHRY	87960	GA-376	CRQ	88086	GA-70	CRQ
87327N	GA-398	NLSN	87651	GA-108	CRQ	87961	GA-378	CRQ	88087-4100	GP-38	SUBA
87329	GA-477	CRQ	87653	GAK-216	CRQ	87966	GA-229	CRQ	880874110	GP-3682	NISS
87333	GA-139	CRQ	87654	GA-425	CRQ	87970	GA-21	CRQ	88087-4110	GP-38	SUBA
87334	GA-9334	CRQ	87655	GA-426	CRQ	87971	GA-539R	CRQ	88089	GA-4958	CRQ
87335	GA-1286	CRQ	8765665	G-613	COLS	87976	GA-31	CRQ	88093	GA-275	CRQ
87338	GA-403	CRQ	8765666	G-500	COLS	87977	GPP-19	CRQ	8809472	G-1173 ¹⁰⁸	FIAT
87338	GAK-403	CRQ	87661	GA-6880	CRQ	87980	GA-7716	CRQ	88095	GAD-118	CRQ
87338N	GA-3588	NLSN	8766599	GP-1101	COLS	87981	GA-7360	CRQ	8809614	G-1143	FIAT
87341	GA-479	CRQ	8766600	G-296	COLS	87984	GA-2984	CRQ	88097	GA-133	CRQ
87349	GA-2740	CRQ	8766600	G-296-B	COLS	87991	GA-113	CRQ	8809707	G-31	FIAT
87351	GA-475	CRQ	8767113	GP-1122	COLS	87994	GA-101	CRQ	88098	GA-432	CRQ
87359	GA-6	CRQ	8767435	GP-2071W	COLS	87995	GA-100	CRQ	88099	GAP-379	CRQ
87364	GA-2184	CRQ	87676	GA-679	CRQ	87999	GA-113	CRQ	881	GA-483	DEL
87371	GA-44	CRQ	8767632	G-33	COLS	87DB-9601-AA	GA-106 ⁶⁶	FORD	88104	GA-476	CRQ
87372	GA-11	CRQ	87677	GA-680	CRQ	87DB-9601-AA	GA-326 ⁷¹	FORD	88105	GA-595	CRQ
87373	GA-7	CRQ	87678	GA-891	CRQ	88	G-34	DEL	88108	GA-604	CRQ
873737-C91	GA-360	IHCO	87679	GA-892	CRQ	88	GA-436	ERO	88109D	G-1175 ¹⁰⁸	NLSN
87374	GA-12	CRQ	87680	GA-483	CRQ	88	GA-192	WIX	88111	GA-4365	CRQ
87375	GA-7	CRQ	87681	GA-482	CRQ	880	GA-230	CRQ</			

Numero	Gonher	Fabricante	Numero	Gonher	Fabricante	Numero	Gonher	Fabricante	Numero	Gonher	Fabricante
Number	Gonher	Manufacturer	Number	Gonher	Manufacturer	Number	Gonher	Manufacturer	Number	Gonher	Manufacturer
88120	GA-271	CRQ	88302	GA-164	CRQ	88628	GA-683R	CRQ	88-9760	G-750	WHIT
88120MP	GA-271	CRQ	88303	GA-514	CRQ	88641	GA-8	CRQ	88977	GA-186	CRQ
88123	GAVW-2	CRQ	88308	GA-605	CRQ	88646	GA-364	CRQ	88983	GA-723R	CRQ
88126	GA-273	CRQ	883162	GP-3980	VOLV	88648	GA-780	CRQ	88983068	GG-209	GMCX
88126MP	GA-273	CRQ	88320	GA-2114	CRQ	886524	GAK-16	CLRK	88984215	GP-44	GMCX
8812739	GP-50	FIAT	88321	GA-2195	CRQ	886525	GAK-16	BRAY	885Y-9155AA	GG-29	FORD
88127-A	G-296	HYST	88322	GA-293	CRQ	886525	GAK-16	CLRK	88TY-9155AA	GG-25	FORD
88127-A	G-296-B	HYST	88323	GA-7007	CRQ	886526	GAK-403	BRAY	88X20X117	G-330	DUTZ
881304-M91	GP-1	MASY	88325	GA-119	CRQ	886526	GAK-403	MATB	88X20X117H4119	G-330	DUTZ
88132	GA-274	CRQ	88327	GAVW-121	CRQ	88659	GA-1616	CRQ	89	G-6	DEL
88133	GA-277	CRQ	88332A	G-1176	CRQ	88664	GA-930R	CRQ	890	GA-8	CRO
88134	GA-5056	CRQ	88339	GA-128	CRQ	88665	GA-890R	CRQ	89001	GGP-25	CRO
88134MP	GA-5056	CRQ	88349	GA-127	CRQ	88673	GA-264	CRQ	89001	GP-26	CRO
88135	GA-2194	CRQ	88350	GA-642	CRQ	88675	GA-1095	CRQ	89001	GP-92	CRO
8813556	G-33	FIAT	88357A	G-335	NLSN	88677	GA-183R	CRQ	890-01-56162	GA-27	KALB
8813556	G-33	IVEC	88358	GA-384	CRQ	88690	GA-826	CRQ	890-01-56163	GA-26	KALB
88139	GA-3916	CRQ	88360	GA-33 ¹¹²	CRQ	88699	GA-258	CRQ	89001934	GA-234	GMCX
88139MP	GA-3916	CRQ	883786-M91	G-296	MASY	887	GA-113	DEL	89001935	GA-334	GMCX
88144	GA-392	CRQ	883786-M91	G-296-B	MASY	88713	GA-398	CRQ	89006	GGP-25	CRQ
881446-M91	GP-31	MASY	88383	GA-2118	CRQ	88723	GA-398	CRQ	89006MP	GGP-25	CRQ
8814510	G-6	BUSS	88383A	G-333	NLSN	88726	GA-376	CRQ	89009	GP-92	CRQ
8814510	G-6	FIAT	88388	GA-172	CRQ	88728	GA-780	CRQ	89011	GP-92	CRQ
88146	GA-180	CRQ	88389	GA-16	CRQ	8873271	GA-27	GMCX	89017342	GP-3675	GMCX
88148	GA-2106	CRQ	88389	GAK-16	CRQ	88738	GA-616	CRQ	89017524	GP-406	ACD
88150	GA-129	CRQ	88390	GAVW-620	CRQ	88740-00594	GAK-20	KALB	89017524	GP-406	GMCX
8815228	G-1163 ¹⁰⁸	FIAT	88394	GA-16	CRQ	88741	GA-467	CRQ	89020	GP-2071W	CRQ
88152A	G-191	NLSN	88394	GAK-16	CRQ	8874282	GG-6	GMCX	89022	GP-2071W	CRQ
88152B	G-191	NLSN	8835	GPP-1291 ³⁹	GREY	88744	GA-966R	CRQ	89023	GP-2071W	CRQ
88152C	G-191	NLSN	8835	PPF831 ⁴¹	GREY	88745	GA-221R	CRQ	89025	GP-1011Q	CRQ
88152D	G-191	NLSN	8835	R 90 ^{P42}	GREY	88746	GA-600R	CRQ	89026	GP-2071W	CRQ
88152E	G-191	NLSN	884014	G-813	HYST	8875051	GA-135	GMCX	89027	GP-92	CRQ
88153	GA-6479	CRQ	88402	GA-2804 T	CRQ	8875052	GA-135	GMCX	89028761	GG-62	ACD
88154A	G-238	NLSN	884044-C9	GA-26	IHCO	8875053	GA-135	GMCX	89028762	GG-7018 ⁸⁸	ACD
88157	GA-78	CRQ	884044-C91	GA-26	IHCO	88756	GA-251	CRQ	89028762	GG-7019 ⁸⁷	ACD
88158	GA-382	CRQ	88405	GA-2804 T	CRQ	88761	GA-697R	CRQ	89028762	GG-7020 ¹⁴⁴	ACD
88160	GA-3523	CRQ	88406	GA-130	CRQ	88772	GA-435R	CRQ	89028762	GG-7018 ⁸⁸	GMCX
88162	GA-6690	CRQ	88415	GA-49	CRQ	88774	GA-758	CRQ	89028762	GG-7019 ⁸⁷	GMCX
88162	GAK-403	HYST	88416	GA-1616	CRQ	88775	GA-759 ¹⁰⁸	CRQ	89028762	GG-7020 ¹⁴⁴	ACD
88165	GAD-1	CRQ	88417	GA-442	CRQ	8877632	GA-56	GMCX	89028764	GG-7018 ⁸⁸	GMCX
88167	GA-85	CRQ	88418	GA-16	CRQ	88782	GA-967R	CRQ	89028764	GG-7019 ⁸⁷	ACD
88170	GA-276	CRQ	88418	GA-1615	CRQ	888	G-236	AMP	89028764	GG-243	GMCX
88174	GA-174	CRQ	88419	GA-1614	CRQ	888	G-236	BGA	89028764	GG-7018 ⁸⁸	GMCX
88174MP	GA-174	CRQ	88425	GA-132	CRQ	888	GA-113	DEL	89028764	GG-7019 ⁸⁷	GMCX
88179	GA-153	CRQ	88429	GA-768R	CRQ	88804	GA-1617	CRQ	89028764	GG-7020 ¹⁴⁴	GMCX
88180	GA-253	CRQ	88433	GA-197R	CRQ	8881271	GA-27	GMCX	89028766	GG-243	GMCX
88186	GA-142	CRQ	88438	GA-880R	CRQ	8881280	GA-26	GMCX	89028771	GG-30	ACD
88187A	G-1173 ¹⁰⁸	NLSN	88440	GA-673R	CRQ	8881281	GA-6129	GMCX	89028771	GG-30	GMCX
88190	GA-6619 ¹	CRQ	88441	GA-732R	CRQ	8881284	GA-6880	GMCX	89028774	GG-47	ACD
88190	GA-6620 ¹	CRQ	8-84428-931-0	GP-3985	ISUZ	8881290	GA-493 ¹⁰⁸	GMCX	89028774	GG-47	GMCX
88192A	G-1173 ¹⁰⁸	NLSN	88443	GA-163	CRQ	8881293	GA-109	GMCX	89028775	GG-1872	ACD
88192P	G-1173	NLSN	88444	GA-170	CRQ	8881296	GA-209	GMCX	89028775	GG-1872	GMCX
88193B	G-1175 ¹⁰⁸	NLSN	88462	GA-304	CRQ	8881299	GA-376	GMCX	89028776	GG-63	ACD
88195	GA-244	CRQ	884658-C9	GAK-20	IHCO	8881300	GA-371	GMCX	89028779	GG-137	ACD
88196A	G-1175 ¹⁰⁸	NLSN	884658-C91	GAK-20	IHCO	88832	GA-269	CRQ	89028781	GG-251	ACD
88200	GA-3501	CRQ	88466	GAK-458	CRQ	88833	GP-1122	VERS	89028781	GG-251	GMCX
88200A	G-1174 ¹⁰⁸	NLSN	88467	GA-459	CRQ	88834	GA-263	CRQ	89028785	GG-64	ACD
88204	GA-422	CRQ	88470	GA-712R	CRQ	88834	GPP-18	VERS	89028785	GG-64	GMCX
88213	GA-300	CRQ	88472	GA-8606	CRQ	88835	GP-390	VERS	89028786	GG-46	ACD
88215	GA-607	CRQ	88473	GA-145	CRQ	88840	GA-389	CRQ	89028787	GG-3728	ACD
88220	GA-89	CRQ	88474	GA-499R	CRQ	88842	GA-518R	CRQ	89028788	GG-66	ACD
88221	GA-2110	CRQ	88484	GA-472	CRQ	88843	GA-539R	CRQ	89028789	GG-266	ACD
88230	GA-200	CRQ	88487	GAK-458	CRQ	88860	GA-371	CRQ	89028789	GG-266	GMCX
88230	GA-218	CRQ	8845	GP-1107	WOOO	88863	GA-534R	CRQ	89028790	GG-581	GMCX
88234	GA-153	CRQ	88503	GA-3916	CRQ	88868	GA-608	CRQ	89028791	GP-57	ACD
88236	GA-4828	CRQ	88505	GA-329	CRQ	88870	GA-799R	CRQ	89028792	G-297	ACD
88240	GAVW-120	CRQ	88511-166	G-870	ISUZ	88871	GA-798R	CRQ	89028792	G-297-B	ACD
88244	GA-195	CRQ	88512-151-000	G-870	HOND	88876	GA-694	CRQ	89029	GGP-125	CRQ
88246	GA-7017	CRQ	88513107	G-870	KOMA	88879	GA-510	CRQ	8903	GP-9	COO
8825164	GP-81	KOEH	88513-107	G-870	ISUZ	88883	GA-3551 ²⁵	CRQ	89030	GP-2071W	CRQ
8825183	G-296	KOEH	88513-263	GP-81	TCM	88883	GA-3551 XT ⁶⁴	CRQ	890321-H1	GAK-20	KOMA
8825183	G-296-B	KOEH	885249	GP-66	CUSH	88886-67	GP-36	POCL	89037212	GP-6811	ACD
8825228	G-1163 ¹⁰⁸	FIAT	88527	GA-781	CRQ	88886-77	G-330	POCL	89037213	GP-91	ACD
8825228	G-1163 ¹⁰⁸	IVEC	88528	GA-782 ¹⁰⁸	CRQ	88888	GA-380	CRQ	89037217	GAVW-621	ACD
88253	GA-158	CRQ	885299	GP-91	CUSH	88888-40	GP-36	POCL	89037218	GA-289	ACD
8825380	G-296	KOEH	88530	GA-589	CRQ	888936	GA-27	AUTC	89040	GP-2015W	CRQ
8825380	G-296-B	KOEH	88531	GA-588	CRQ	888936	GAK-403	CLRK	89060467	GP-408	GMCX
88255	GA-3501	CRQ	88537	GAK-458	CRQ	88-8936	GA-27	WHIT	89060468	GP-205	GMCX
88-2633	GA-135	WHIT	88538	GA-459	CRQ	8-88983-068-0	GG-209	ISUZ	89060499	GP-408	GMCX
88264	GA-362	CRQ	88553	GA-529	CRQ	8-88984-215-0	GP-44	ISUZ	89067	GP-43	CRQ
88266A	GP-13	NLSN	88556	GA-682R	CRQ	88902	GA-367	CRQ	89067	GP-53	CRQ
88267	GAD-29	CRQ	88562	GA-853R	CRQ	889088	GA-33 ¹¹²	CLRK	89068	GP-43	CRQ
88269	G-333	CATP	88567	GAK-1532	CRQ	889097	GA-33 ¹¹²	CLRK	89068	GP-53	CRQ
88272	GA-240	CRQ	885709-C9	GAK-403	IHCO	889098	GA-33 ¹¹²	CLRK	89071	GP-2071W	CRQ
88273	GA-5466	CRQ	885709-C91	GAK-403	IHCO	88913	G-1175 ¹⁰⁸	GALN	89071MP	GP-2071W	CRQ
88275A	G-119	NLSN	88573	GA-413R	CRQ	88915	GA-646	CRQ	89072	GP-1011Q	CRQ
8827662	G-1163 ¹⁰⁸	FIAT	885767-C91	GAK-20	IHCO	88915422	GA-197R	GMCX	89073	GP-1011Q	CRQ
8827662	G-1163 ¹⁰⁸	IVEC	88580	GAP-381	CRQ	88916	GA-1546	CRQ	89073MP	GP-1011Q	CRQ
88279	GAD-30	CRQ	886017	GAK-20	IHCO	88922	GA-770R	CRQ	89074	GP-1013Q	CRQ
88280A	G-31	NLSN	886017-C91	GAK-20	IHCO	88925275	GP-3675	GMCX	89094	GA-240	CRQ
88284	GAD-30	CRQ	886017-C92	GAK-20	IHCO	88935	GA-1542	CRQ	89096	GP-26	CRQ
88288	GA-198	CRQ	886019	GAK-403	IHCO	88939	GA-241	CRQ	89097	GP-27	CRQ
88289	GA-175	CRQ	886019-C91	GAK-403	IHCO	88969107	GA-263	GMCX	89097	GP-93	CRQ
88293	GA-240	CRQ	88-6026	GA-21	WHIT	88969580	GP-156	GMCX	890971	G-296	MASY
88298	GA-2198 ⁷⁹	CRQ	886091-C91	GAK-403	IHCO	88971573	GP-157	GMCX	890971	G-296-B	MASY
88298	GA-438 ³¹	CRQ	88626A	GAK-403	BRAY	88-9750	G-750	WHIT	89098	GP-92	CRQ
883	G-871	AMP	88626A	GAK-403	MATB	88976	GA-176	CRQ	89099	GP-27	CRQ

Referencia Cruzada por Numero de Parte

Cross Reference by Part Number



Numero	Gonher	Fabricante	Numero	Gonher	Fabricante	Numero	Gonher	Fabricante	Numero	Gonher	Fabricante
Number	Gonher	Manufacturer	Number	Gonher	Manufacturer	Number	Gonher	Manufacturer	Number	Gonher	Manufacturer
89099	GP-93	CRQ	8933004195	GP-3985	AMCO	894977	G-871	MASY	8990499	GP-1	CHRY
891	GA-7360	DEL	8933004195	GP-3985	CHRY	894977-M91	G-871	MASY	8990499	GP-1	HUBR
89110001	GP-58	VERM	89347	GP-26	CRQ	894998	G-200	CLRK	8990508	GP-50	AMCO
89112	GP-2126Q	CRQ	89348	GP-26	CRQ	895	GA-303	CRO	8990508	GP-50	CHRY
89112	GP-55	VERS	893500079	GA-230	RENA	8-9516-0	GP-1122	KAES	8990508	GP-50	HUBR
891129R91	GA-24 ¹²	IHCO	8935978	GA-106 ⁴⁶	COLS	8-9516-0A	GP-1122	KAES	8990688	GP-5	AMCO
89113	GP-2127W	CRQ	8935978	GA-326 ⁷¹	COLS	8953002184	GAVW-2	AMCO	8990688	GP-5	CHRY
89114	GP-2108W	CRQ	894	GA-77	CRO	8953002184	GAVW-2	CHRY	8990808	GP-50	AMCO
89133	G-33	CRQ	89-407-110	G-6	AJAW	8953002656	GP-3985	RENA	8990837	GP-5	AMCO
8-91421-517-20	GAD-3	ISUZ	8-94101-021-0	GP-149	ISUZ	8953004383	GA-3901	AMCO	8990837	GP-5	CHRY
8914-23-603	GAD-3	MZDA	8-94107-744-0	GG-203	ISUZ	8953004383	GA-3901	CHRY	8990837	GP-5	AMCO
8914-236-039A	GAD-3	MZDA	8-94114-881-0	GAD-1	ISUZ	895390	GP-28 ⁵	KAES	8990873	GP-5	CHRY
891528	GAK-403	DYPA	8-94122-612-0	GAD-15	ISUZ	895390	GP-430 ⁸	KAES	8991012	GA-105	AMCO
891733	GP-1101	CUMM	8-94125-784-0	GG-63	ISUZ	895414-R91	G-834	IHCO	8991012	GA-105	CHRY
891733	GPP-14	CUMM	8-94132-678	GAD-15	ISUZ	89550	G-500	CRQ	8991072	GP-5	AMCO
891733	GP-1101	DIAM	8-94132-678-0	GAD-15	ISUZ	89554	G-500	CRQ	8991072	GP-5	AMCO
891733	GPP-14	DIAM	8-94135-747-1	GP-149	ISUZ	896	GP-10	AMP	8991072	GP-5	CHRY
891733	GP-1101	REOT	8-94148-661-0	GP-42	ISUZ	896	GP-10	BGA	8991386	GA-77	AMCO
891733	GPP-14	REOT	8-94149-418-0	GP-91	ISUZ	896056	GA-18	CLRK	8991386	GA-77	CHRY
89-1733	GP-1101	WHIT	8-94151-614-3	GAD-15	ISUZ	8962148	GAK-403	COLS	8991800	G-200	AMCO
89-1733	GP-1101	WHIT	8-94167-399-0	GP-3985	ISUZ	8966281	GA-50	OPEL	8991802	GP-13	AMCO
8917333	GP-1101	DIAM	8-94169-778-0	GP-1 ⁹	ISUZ	896639	G-31	CLRK	8991803	GP-5	AMCO
891833-M91	G-813	MASY	8-94169-778-1	GP-1 ⁹	ISUZ	89664K	G-122	NLSN	8992430	GG-19	AMCO
8919500	G-296	FIAT	8-94169-778-2	GP-1 ⁹	ISUZ	89664K	G-338	NLSN	8992430	GG-19	CHRY
8919500	G-296-B	FIAT	8-94201-942-0	GP-3985	ISUZ	896698	G-236	CLRK	8992638	GG-5	AMCO
89197	GP-1012Q	CRQ	8-94201-942-2	GP-3985	ISUZ	89-6702	GA-135	WHIT	8992638	GA-70	AMCO
892	GP-81	AMP	8-94201-942-3	GP-3985	ISUZ	89-6891	GAK-20	WHIT	8992661	GA-70	CHRY
892	GP-81	BGA	8-94202-736-0	GG-1	ISUZ	8-97035-303-0	GA-198	ISUZ	8992873	GA-78	AMCO
892	GA-7716	DEL	8-94202-736-0	GG-4	ISUZ	8970415	GA-106 ⁴⁶	COLS	8992873	GA-78	CHRY
892	GA-140	UCAL	8-94203-536-0	GAD-1 ⁸⁷	ISUZ	8970415	GA-326 ⁷¹	COLS	8993146	GP-20	AMCO
89201808201	GP-28 ⁸	VAG	8-94203-536-1	GAD-1	ISUZ	8-97046-464-1	GP-359	ISUZ	8993146	GP-20	CHRY
89201808201	GP-430 ⁸	VAG	8-94206-007-0	GAD-1	ISUZ	8-97049-282-0	GP-359	ISUZ	8993146	GP-20	GMX
89201808201	GP-28 ⁸	VOLK	8-94206-038-0	GAD-1	ISUZ	8970622940	GA-633R	ISUZ	899322H2	GA-26	AUTC
89201808201	GP-430 ⁸	VOLK	8-94207-533-0	GG-94	ISUZ	8-97065-676-0	GA-139	HOND	89-9322	GA-26	WHIT
89201808900	GP-28 ⁸	VAG	8-94207-910-1	GG-196	ISUZ	8-97065-676-0	GA-139	ISUZ	899322H2	GAK-20	DIAM
89201808900	GP-430 ⁸	VAG	8-94217-272	GP-3985	ISUZ	8-97096-777-0	GP-359	ISUZ	899322H2	GA-26	DIGT
89201808900	GP-28 ⁸	VOLK	8-94217-272-0	GP-3985	ISUZ	8-97111-423-0	GA-198	ISUZ	899322H2	GAK-20	REOT
89201808900	GP-430 ⁸	VOLK	8-94217-272-1	GP-3985	ISUZ	8-97136470-0	GP-359	ISUZ	89-9322-H2	GAK-20	WHIT
89206	GP-2071W	CRQ	8-94217-272-2	GP-3985	ISUZ	8-97140-666-0	GP-149	ISUZ	8994204	GA-879	GMX
8-92080-380	GAD-1	ISUZ	8-94220-833-2	GP-3985	ISUZ	8-97148-270-0	GP-359	ISUZ	8994210	GA-98 ¹²²	GMX
892107	G-834	MASY	8-94235-020	GP-40	ISUZ	8-97148-280-0	GP-359	ISUZ	8994216	GA-403	GMX
892107-M91	G-834	MASY	8-94239-493-0	GG-47	ISUZ	8-97182-282-0	GP-310	ISUZ	8994222	GA-6880	GMX
892161	G-566	DIAM	8-94243-270-0	GP-3985	ISUZ	897229	G-31	FIAT	8994232	GA-885	GMX
892161	G-566	REOT	8-94243-270-1	GP-38	ISUZ	897321	GP-81	VOLV	8994238	GA-229	GMX
892161	G-566	WAUK	8-94243-502-0	GP-40	ISUZ	8973286	GA-360	COLS	8994465	GA-3300	GMX
89-2161	G-566	WHIT	8-94243-502-1	GP-91 ⁷⁸	ISUZ	89750	GP-57	CRQ	8994486	GA-135	GMX
892163	G-566	REOT	8-94250-176-1	GG-196	ISUZ	8975053	GA-360	COLS	8994494	GAK-1532	GMX
89-2163	G-566	WHIT	894268-H1	GAK-20	IHCO	89751	G-500	CRQ	8994506	GA-482	GMX
892168	GP-1101	WAUK	89428	GP-2015W	CRQ	89751	G-750	CRQ	8994508	GA-483	GMX
89-2168	GP-1101	WHIT	89429	GP-2022W	CRQ	89755	GP-50	CRQ	8994510	GA-679	GMX
8922-02001	GP-157	TOYO	89430	GP-2015W	CRQ	89-7602	GA-135	WHIT	8994512	GA-680	GMX
89220-2001	GP-156	TOYO	89431	GP-2022W	CRQ	89771	GAC-9	CRQ	8994514	GA-426	GMX
8922-02002	GP-156	TOYO	8-94314-263-2	GP-149	ISUZ	89782	GAC-13	CRQ	8994528	GA-239	GMX
8922-02002	GP-157	TOYO	8-94338-181-0	GP-359	ISUZ	8978561	GG-246	SAAB	8994530	GA-329	GMX
89220-2004	GP-58	TOYO	8-94338-181-1	GP-359	ISUZ	8-98018-858-0	G-3753	ISUZ	8994568	GA-425	GMX
89220-2005	GP-157	TOYO	894360419	GPP-111	GMX	8-98037-011-0	G-179	ISUZ	8994587	GA-416	GMX
89220-2010	GP-58	TOYO	894360419	GPP-524	GMX	8-98037-481-0	GPP-111	ISUZ	8994589	GAK-216	GMX
89220-2011	GP-58	TOYO	8-94368-727-0	GP-149	ISUZ	8-98037-481-0	GPP-524	ISUZ	8994607	GA-679	GMX
892489-M91	G-834	MASY	894369299	GPP-111	GMX	89808	GAC-7	CRQ	8994609	GA-680	GMX
89254CS	G-31	HERC	894369299	GPP-524	GMX	89818	G-159	KOMA	8994613	GA-509 ⁴¹	GMX
89-254-CS	G-31	WHIT	8-94376-353-0	GA-6690	ISUZ	89821387	GP-761H	NEWH	8994625	GA-31	GMX
89-2575	GP-14	WHIT	8-94411-084-01	GP-91	ISUZ	89822	GAC-10 ²⁸	CRQ	8994635	GA-892	GMX
892575-A	GP-14	WHIT	8-94412-815-0	GP-462	ISUZ	89822	GAC-8	CRQ	8994641	GA-827	GMX
89-2633	GA-135	WHIT	8-94414-778	GP-1	ISUZ	8983500079	GA-230	AMCO	8994696	GA-5648	GMX
8927985	G-1163 ⁰⁸	HERC	8-94428-310	GP-3985	ISUZ	8983500079	GA-230	CHRY	8994702	GA-26	GMX
892861	G-566	DIAM	8-94428-931-0	GP-3985	ISUZ	8983500079	GA-230	RENA	8994710	GAK-20	GMX
89-2861	G-566	WHIT	8-94430-411-0	GP-149	ISUZ	8983500890	GG-17	AMCO	8994712	GA-27	GMX
892868	GP-1101	REOT	8-94430-411-1	GP-149	ISUZ	8983500890	GG-17	CHRY	8994726	GA-31	GMX
89-2868	GP-1101	WHIT	8-94430-411-2	GP-149	ISUZ	8983500999	GA-303	AMCO	8994728	GAK-403	GMX
89-2971	G-31	WHIT	8-94430-983-0	GP-3985	ISUZ	8983500999	GA-303	CHRY	8994732	GA-360	GMX
89-2972	G-31	WHIT	8-94443-256-0	GP-3985	ISUZ	8983501000	GP-22	RENA	8994740	GA-106 ⁴⁶	GMX
892972H2	G-33	DIAM	8-94445-272-0	GP-3682	ISUZ	8983501022	GG-17	AMCO	8994746	GA-326 ⁷¹	GMX
89-2973	G-1174 ⁰⁸	WHIT	8-94445-656-0	GA-139	ISUZ	8983501022	GG-17	CHRY	8994746	GA-33 ¹²²	GMX
89-2974	G-1173 ⁰⁸	WHIT	8-94455-838-0	GAD-15	ISUZ	8983501080	GP-22	AMCO	8994747	GA-33 ¹²²	GMX
89-2975	G-1175 ⁰⁸	WHIT	8-94456-741-0	GP-149	ISUZ	8983501080	GP-22	RENA	8994750	GAK-16	GMX
892985	G-1163 ⁰⁸	OLIV	8-94456-741-1	GP-149	ISUZ	8983501900	GP-40	AMCO	8994751	GAK-16	GMX
893 133 511	GG-261	AUDI	8-94456-741-11	GP-149	ISUZ	8983501900	GP-40	CHRY	8994764	GA-361	GMX
893 133 511	GG-261	PORS	8-94456-741-2	GP-149	ISUZ	8983501900	GP-40	RENA	8994770	GA-206	GMX
893 133 511	GG-261	VAG	8-94459-700-0	GP-462	ISUZ	8983501901	GP-3985	AMCO	8994874	GA-50	GMX
893 133 511	GG-261	VOLK	8-94463-715-0	GP-58	ISUZ	8983501902	G-294	AMCO	8994929	GA-42	GMX
893001	GG-3	DAF	8-94463-715-1	GP-58	ISUZ	8983692	GAVW-2	GMX	8994961	GA-18	GMX
89310700	GA-853R	INGR	8-94465-656-0	GA-139	HOND	8983692	GAVW-2	OPEL	8994985	GA-892	FITZ
89314	GG-87	GEHL	8-94465-656-0	GA-139	ISUZ	89842392	GP-761H	NEWH	8994985	GA-892	GMX
8931529	GP-54 ¹¹	COLS	8-94465-656-2	GA-139	ISUZ	8985117	GP-54 ¹¹	COLS	8994987	GA-891	GMX
8931529	GP-66 ¹⁰	COLS	8-94483-850-0	GPP-111							

Referencia Cruzada por Numero de Parte

Cross Reference by Part Number



Numero	Gonher	Fabricante	Numero	Gonher	Fabricante	Numero	Gonher	Fabricante	Numero	Gonher	Fabricante
Number	Gonher	Manufacturer	Number	Gonher	Manufacturer	Number	Gonher	Manufacturer	Number	Gonher	Manufacturer
903942	GP-66 ¹⁰	DYPA	9059574	GAK-403	GMCC	91008551	GA-326 ⁷¹	GMCC	914	GA-90	AMP
9039986	GA-27	EUCL	9059909	GP-53	GMCC	910207	GP-81	CLRK	914	GA-77	CRO
9039987	GA-26	EUCL	9059910	GP-27	GMCC	91021394	GA-6129	GMCC	91401	GP-3766	BGA
90395	GP-462	GREY	9059911	GP-26	GMCC	91027	GP-36	BGA	91404	GP-761H	BGA
904	GA-21	AMP	905P	G-801	WIX	91028	GP-166 ⁶⁵	BGA	9141	GA-4325	CRO
9041	GA-171	NAP	906	GA-3490	DEL	91028	GP-3937 ¹¹	BGA	91412	GP-166 ⁶⁵	BGA
90411732	GA-134	GMCC	9060900051	G-1046	MBNZ	9103	GAD-15	CRO	91412	GP-3937 ¹¹	BGA
90411732	GA-134	VAUX	9060920105	G-1046	MBNZ	910311-R91	G-31	IHCO	9-14151-144-1	GA-26	ISUZ
90412779	GA-134	GMCC	9060920205	G-1046	MBNZ	91033	G-45	BGA	9-14215-046-1	GA-106 ⁶⁶	ISUZ
90412779	GA-134	VAUX	9060920305	G-1046	MBNZ	9103614-00	GP-81	YALE	9-14215-046-1E	GA-326 ⁷¹	ISUZ
9041800009	G-3827	MBNZ	9060920505	G-1046	MBNZ	9104	GA-265	NAP	9-14215-046-1E	GA-106 ⁶⁶	ISUZ
9041800210	G-3827	MBNZ	9061800009	G-3754	MBNZ	91042	GP-44	NNSE	9-14215-046-1E	GA-326 ⁷¹	ISUZ
904200091	G-1121	RENA	90615	GP-291	GREY	910535	GP-1	CLRK	9-14215-113-50	GAK-403	ISUZ
904200093	G-1121	RENA	9062	GA-271	CRO	910535	GP-1	SAMS	9-14215-129-0	GA-27	ISUZ
904200176	G-1121	RENA	906200186	GP-22	RENA	91066585	GP-3980	GMCC	9-14215-132-0	GAK-20	ISUZ
904200177	G-1121	RENA	906202028	GP-1	NANN	91075322	GA-360	GMCC	9-14215-132-1	GAK-20	ISUZ
904-2175-040	GP-3816	LOMB	9063	GA-269	NAP	91082	G-49	BGA	91421-51321	GAK-20	TCM
9042680	G-1175 ⁰⁸	EUCL	9064	GA-3425	CRO	91090	G-765	BGA	9-14215-134-0	GA-27	ISUZ
9042680	G-1175 ⁰⁸	GMCC	9065	GA-340	NAP	91092	GP-6811	BGA	9-14215-134-1	GA-27	ISUZ
90442434	GP-3980	GMCC	90-6602T1	GP-761H	STEI	91095	GP-761H	BGA	9-14215-134-2	GA-27	ISUZ
9044268	G-1175 ⁰⁸	EUCL	90665	GP-3980	GREY	91099	GP-408	BGA	9-14215-135-0	GAK-403	ISUZ
9045	GAVW-2	CRO	9067	GA-492	NAP	910S	GP-9	GREY	9-14215-135-1	GAK-403	ISUZ
9045087	G-1173 ⁰⁸	EUCL	9067798	GA-135	EUCL	911	GA-206	ERO	9-14215-137-0	GAD-30	ISUZ
9045087	G-1173 ⁰⁸	GMCC	9068614M91	G-813	MASY	91104516	GA-24	BUCY	9-14215-137-1	GAD-30	ISUZ
9045087	G-1173 ⁰⁸	TERE	9069	GA-363	NAP	9110614	GA-4319	GMCC	9-14215-140-1	GA-24	ISUZ
9045748	G-1173 ⁰⁸	EUCL	906930	GA-471	PARM	9111	GA-78	CRO	9-14215-140-2	GA-24	ISUZ
9045748	G-1173 ⁰⁸	GMCC	9065	GP-38	GREY	91110775400	GP-36	VAG	9-14215-144-1	GA-26	ISUZ
9045748	G-1173 ⁰⁸	TERE	90705	GP-406	GREY	911-107-754-00	GP-36	PORS	9-14215-144-2	GA-26 ¹²	ISUZ
90465	GP-171	GREY	907101T1	GP-3000	CASE	911-107-764-00	GP-36	PORS	9-14215-152-1	GAK-16	ISUZ
9047628	G-750	EUCL	90735	GP-28 ⁸	GREY	91131	G-162H	BGA	9142151720	GAD-1	GMCC
9047881	GP-171 ¹⁶	YALE	90735	GP-430 ⁸	GREY	9113293	G-750	EUCL	9-14215-172-0	GAD-1	GMCC
9047881-00	GP-1	YALE	9074	GAD-30	CRO	9114	GA-1572	NAP	9-142151-830	GAK-403	ISUZ
90486296	GA-134	GMCC	90749136	GPP-14	INGR	91151707	GP-149	GMCC	9-14215-193-1	GA-24	ISUZ
9049448	GA-357	GMCC	90749193	GA-206	INGR	91155714	GA-234	GMCC	9-14215-193-2	GA-24	ISUZ
9049488	GA-357	EUCL	9076331	G-836	LNCR	91155714	GA-234	OPEL	9-14215-196-0	GAK-403	ISUZ
9049488	GA-357	GMCC	9079	GP-1	COLT	91159955	GA-2158	GMCC	9-14215-604-0	GAD-3	ISUZ
9049488	GA-357	TERE	9079	GA-4958	CRO	9117	GA-4303	CRO	9142-15-6040	GAD-3	KOMA
9049490	GA-6127	EUCL	9075	GP-43	GREY	91171836	GG-146	GMCC	91422-06530	GA-33	TCM
9049490	GA-6127	GMCC	908	GA-55	DEL	91173772	GP-156	GMCC	9144445	GP-58	SAAB
9049490	GA-6127	TERE	908	GA-5056	UNN	91174457	GA-244	GMCC	914453	GA-361	HITA
9045	GP-3816	GREY	9080	GAD-3	CRO	9117557	GA-234	GMCC	9145	GA-1540	NAP
905	GA-153	UNN	90-80116-1188	G-31	MAN	9117557	GA-234	OPEL	914602	GA-27	INSL
905	GAD-1 ⁸⁷	WIX	90801195131	G-191	BUSS	91176161	GP-156	GMCC	91461-00500	GA-33	MIT
90509318	GA-145	GMCC	90-80119-5131	G-191	MAN	91176162	GP-2951	GMCC	914611	GA-26	INSL
9051578	GA-360	GMCC	9081	GAD-3	CRO	91181	GP-58 ⁹	BGA	914612	GA-27	BDGR
90517711	G-296	LEYL	90825	G-33	ALCH	91182	GP-3937	BGA	914613	GA-24	INSL
90517711	G-296-B	LEYL	90828	G-33	ALCH	911901107	GP-171 ¹⁶	PORS	914632	GA-251	BDGR
9052	GA-356	CRO	90828	G-33	BLDW	911901107	GP-1	VOLK	914632	GA-251	INSL
9052907	GA-251	GMCC	90828-5	G-33	ALCH	91195	G-153	BGA	91470530	GG-5 L	CITR
90525	GP-58 ⁹	GREY	90852	G-1121	SCHL	911AP	G-870	WIX	914F-6714-A	GP-68	FORD
90531003	GA-234	GMCC	9088	GA-4862R	NAP	911P	G-870	WIX	914F-6714-AA	GP-68	FORD
90531003	GA-234	OPEL	9089	GA-4863	NAP	911S	GP-3682	GREY	915	GA-429	AMP
9053259	GA-563	GMCC	908946M4	GA-18	EICH	912	GA-75	AMP	915	GA-429	BGA
9053388	GA-361	GMCC	908946-M4	GA-18	MASY	912	GA-75	BGA	91500	GP-3001	BGA
90535000	G-191	COM	908948M4	GA-18	EICH	9120038	GAK-403	BDGR	9150999180	GG-246	TALB
90535001	G-238	COM	908996-M91	GA-18	MASY	9120126	GP-52 ¹¹⁰	SVIK	91-511A	GP-81	VOLK
90536362	G-45	GMCC	908HE	G-834	BOG	9120126	GP-691 ⁴⁸	SVIK	915213	GP-66	OREN
90537280	G-49	GMCC	909	GA-273	UNN	912153	GAK-403	GRIM	915319	G-296	CASE
90535	GP-50	GREY	90915-03001	GP-157	NIPP	912153A	GAK-403	GROV	915319	G-296-B	CASE
90542540	GG-246	GMCC	90915-03001	GP-156	TOYO	912153-A	GAK-403	GRIM	915319	G-296	DAVI
905480	G-225	DAF	90915-03001	GP-157	TOYO	9122	GAVW-618	NAP	915319	G-296-B	DAVI
9055171	GA-2194	FORD	90915-03002	GP-58	NIPP	91220-00500	GP-40	MIT	91535807	GG-251	CITR
905575	GP-53	CLRK	90915-03002	GP-58	TOYO	91243	GP-754	BGA	91540	G-500	ALCH
9056189	GA-853R	ABAC	90915-03004	GP-157	NIPP	9126	GA-624R	NAP	91540	G-500	BLDW
9056238	GP-28 ⁸	ABAC	90915-03004	GP-156	TOYO	91261-00700	GA-33	MIT	91540-5	G-500	ALCH
9056238	GP-430 ⁸	ABAC	90915-03004	GP-157	TOYO	91261-007000	GA-33	MIT	91540-6	G-500	ALCH
9057	GA-1530	NAP	90915-03005	GP-2951 ⁶²	NIPP	91261-05700	GAK-16	MIT	915613	GA-24	INSL
9058	GA-341	NAP	90915-03005	GP-58	NIPP	91261-10110	GA-33	MIT	9157891	G-750	EUCL
90585	GP-52 ¹⁰	GREY	90915-10001	GP-157	TOYO	9128	GP-81	FIAT	9157897	G-750	EUCL
90585	GP-691 ⁴⁸	GREY	90915-10002	GP-156	TOYO	912878	GAK-20	GRIM	915P	GP-870	WIX
90585-1	GP-52 ¹⁰	GREY	90915-10003	GP-157	TOYO	912879A	GAK-20	GRIM	915S	GP-3816	GREY
90585-1	GP-691 ⁴⁸	GREY	90915-10004	GP-156	TOYO	912879A	GAK-20	GROV	91605196	GP-1122	INGR
9059500	GA-27	GMCC	90915-20001	GP-58	TOYO	9129	GA-216	CRO	91605204	GP-36	INGR
9059501	GA-26	GMCC	90915-20002	GP-58	TOYO	9129	GP-81	FIAT	91609	GP-143	BGA
9059502	GA-6129	GMCC	90915-20003	GP-58	TOYO	912916N	GAK-20	GRIM	91610775400	GP-36	VAG
9059506	GA-360	GMCC	90915-20004	GP-58	TOYO	9129747	GA-289	GMCC	916-107-754-00	GP-36	PORS
9059507	GA-24	GMCC	90915-20005	GP-58	TOYO	91301150	GP-53	INGR	91619882	G-834	INGR
9059511	GA-356	GMCC	90915-2002	GP-58	TOYO	9131141	GAK-16	FORD	91619999	G-566	INGR
9059514	GA-563	GMCC	90915-YZA1	GP-156	TOYO	91314	G-3752	BGA	91634337	GA-6127	INGR
9059515	GA-251	GMCC	90915-YZA2	GP-157	TOYO	9-13200-093-0	GG-5 L	ISUZ	91634405	GA-6129	INGR
9059517	GAK-20	GMCC	90915-YZB5	GP-3682	TOYO	91320022500	GG-580	GMCC	91634402	G-296	INGR
9059518	GA-106 ⁴⁶	GMCC	90915-YZB9	GP-58	TOYO	9-13200-250	GG-5 L	ISUZ	91634402	G-296-B	INGR
9059518	GA-326 ⁷¹	GMCC	90915-YZD1	GP-58	TOYO	9-13200-250-0	GG-5 L	ISUZ	91634733	G-801	INGR
9059550	GA-27	GMCC	90915-YZD1	GP-58	TOYO	9-13240-036-0	G-870	ISUZ	91636407	G-613	INGR
9059551	GA-26	GMCC	9091S	GP-28 ⁸	GREY	9132-40-0361	G-870	KOMA	91670679	G-1143	INGR
9059552	GA-6129	GMCC	9091S	GP-430 ⁸	GREY	9-13240-088-0	GP-38	ISUZ	91671230	G-836	INGR
9059556	GA-360	GMCC	909213	GP-40	CLRK	9-13240-093	GP-38	ISUZ	91671743	GP-1101	INGR
9059557	GA-24	GMCC	9094</								

Numero	Gonher	Fabricante	Numero	Gonher	Fabricante	Numero	Gonher	Fabricante	Numero	Gonher	Fabricante
Number	Gonher	Manufacturer	Number	Gonher	Manufacturer	Number	Gonher	Manufacturer	Number	Gonher	Manufacturer
9165	GP-46	GREY	92029517	G-834	SAVA	9211-8678	GP-66 ¹⁰	INGR	9223197	GAK-20	GMCX
9172	GA-320	NAP	92031717	G-238	SAVA	9212	GA-362	CRO	9223197	GAK-20	TERE
917336	GP-166 ⁰⁵	TOWM	92034	GP-3600	BGA	92120351	GP-3600	INGR	92239	G-31	BGA
917336	GP-3937 ¹¹	TOWM	92035948	GA-467	INGR	92120385	G-296	INGR	92242	G-139	AMP
91-7336	GP-166 ⁰⁵	CATP	92036	GP-3980	AMP	92120385	G-296-B	INGR	92242	G-139	BGA
91-7336	GP-3937 ¹¹	CATP	92036	GP-3980	BGA	92128859	GP-1	INGR	92243	GP-14	BGA
91745	GP-9000	BGA	92036219	GP-52 ¹⁰	INGR	92129	G-34	BGA	92248	GP-9586	BGA
91746	GP-9001	BGA	92036219	GP-691 ⁴⁸	INGR	92133	G-33	BGA	92249	GP-66	AMP
91746XD	GP-9001	BGA	92036MP	GP-3980	BGA	92133MP	G-33	BGA	9225	GAD-116	NAP
91748	GP-9000	BGA	92037	GP-46	BGA	92136	G-33	BGA	92253	G-122	AMP
9177267	GA-397	GMXC	92039	GP-3816	VMAC	92138	G-119	BGA	92253	GP-338	AMP
9177267	GA-397	OPEL	9204	GA-390	CRO	92143	G-200	BGA	92253	G-122	BGA
9177267	GA-397	VAUX	92040	GP-46	BGA	92145	G-971	BGA	92253	G-338	BGA
91780486	G-500	INGR	92040111	GA-8047	SAVA	92147	G-331	BGA	92258	GP-20	AMP
91780510	GP-2071W	INGR	92040117	GA-8047	SAVA	92147353	GAK-1532	INGR	92258	GP-20	BGA
91780742	G-750	INGR	92040MP	GP-46	BGA	92147453	GAK-1532	INGR	92259	GP-66	BGA
91786129	GP-26	INGR	92042	GP-44	AMP	921505	G-1121	DAIM	92260207	GAK-20	INGR
91786137	GP-27	INGR	92042	GP-44	BGA	921505	G-1121	MBNZ	922604	GP-54	HANO
91784946	GA-27	GENE	92044117	G-1173 ⁰⁸	SAVA	9215055	G-1121	DAIM	922604	GP-66 ¹⁰	HANO
91810	GP-43	BGA	92045	GP-3429	BGA	92150817	G-238	SAVA	922604	GP-54 ¹¹	MASY
9182552	G-296	VOLK	92046	GP-3	BGA	92151	G-335	AMP	922604	GP-66 ¹⁰	MASY
9182552	G-296-B	VOLK	92048925	GP-53	INGR	92151	G-335	BGA	92261	GP-36	BGA
918266-R91	GP-1	IHCO	92048933	GP-57	INGR	92151317	G-1163	SAVA	922614	GA-200	SAVA
918266-R92	GP-1	IHCO	92049	GP-5	AMP	92152917	G-33	SAVA	922614	GA-218	SAVA
918266-R93	GP-1	IHCO	92049	GP-5	BGA	92154317	G-613	SAVA	92261417	GA-200	SAVA
918266-R93	GP-1	KOMA	9205	GA-382	CRO	92154517	G-870	SAVA	92261417	GA-218	SAVA
918267-R91	GP-1	IHCO	92050	GP-50	BGA	92155417	GP-1	SAVA	92266451	GAK-403	INGR
9184	GA-2156	CRO	92050617	G-1163	SAVA	92155617	GP-81	SAVA	92266485	GA-24	INGR
9186	GAVW-625	NAP	92051	GP-50	BGA	92156	G-333	BGA	92266519	GA-360	INGR
91860-01600	GAK-403	MITTS	92052	GP-50	BGA	921565	G-297	SAVA	92268	GP-9586	BGA
918648	GP-149	CLRK	92052517	G-1163	SAVA	921565	G-297-B	SAVA	922705	G-1121	DAIM
918P	G-870	WIX	92053	GP-66	BGA	92156717	G-122	SAVA	922705	G-1121	MBNZ
9192	GAVW-2	CRO	920531	G-1174	SAVA	92156717	G-338	SAVA	92271	G-330	BGA
9192	GA-489	NAP	92053117	G-1174	SAVA	92157	G-871	BGA	922725	G-1121F	MBNZ
9194	GA-2110	CRO	92055530	GA-467	INGR	92158	GP-54	BGA	92273705	GA-106 ⁶	INGR
9194405	GA-334	GMXC	9206	GA-386	CRO	92160	G-963	BGA	92273705	GA-326 ¹¹	INGR
9194405	GA-334	OPEL	92060	GP-205	BGA	921603	G-834	SAVA	92275	GP-54	BGA
9194746	G-49	GMXC	92061	GP-13	BGA	92160317	G-834	SAVA	922783	GP-1122	HANO
919782-R91	GP-1	IHCO	92064	GP-91	BGA	92161	G-191	BGA	922783	GP-1122	MASY
9195	GP-3816	GREY	92065	GP-58 ¹⁵	BGA	92163	G-152	BGA	922783	GP-1122	MBNZ
91G	GG-5 L	GREY	92067517	G-191	SAVA	921655	G-33	SAVA	92279	GP-5000	BGA
92	GA-349	UNN	92068	GP-9 ⁵⁸	AMP	92165517	G-33	SAVA	92283	GP-36	BGA
92	GA-325	WIX	92068	GP-81 ²¹	BGA	921656	G-801	SAVA	922840C91	GAK-403	HOUG
92000717	G-1173 ⁰⁸	SAVA	92069	GP-3	BGA	92165617	G-801	SAVA	922853	GP-36	HANO
92000817	G-1173 ⁰⁸	SAVA	92070	GG-251	NAFI	92168	G-238	BGA	92286417	GA-39	SAVA
920019	G-191	SAVA	92071182	GP-77	INGR	9216910001	GP-51	KALM	92288	GP-3816	BGA
92001917	G-191	SAVA	92076	G-236	BGA	92176	G-33	BGA	92289011	GAK-16	SAVA
92003917	G-870	SAVA	920788	GP-761H	ALMN	9217925	GAK-20	EUCL	92289017	GAK-16	SAVA
92004	G-6	BGA	92084	GP-81	BGA	9217925	GAK-20	GMXC	92289111	GAK-403	SAVA
920040	G-870	SAVA	92085	GP-81	BGA	9217942	GA-24	EUCL	92289117	GAK-403	SAVA
92004017	G-870	SAVA	92085MP	GP-81	BGA	9217942	GA-24	GMXC	92289211	GAK-20	SAVA
92005317	G-870	SAVA	92086017	G-200	SAVA	92183	G-871	BGA	92289217	GAK-20	SAVA
92005417	G-870	SAVA	92087	GP-68	BGA	92186	G-984	BGA	9229	GG-1	FIAT
920055	G-801	SAVA	92087217	GG-48	SAVA	9218617	GA-27	EUCL	9229	GG-4	FIAT
92005517	G-801	SAVA	92088	GP-28 ⁸	BGA	9218617	GA-27	GMXC	92290111	GA-9334	SAVA
920063	G-1123	SAVA	92088	GP-430 ⁸	BGA	92188	G-813	BGA	92290117	GA-9334	SAVA
92006317	G-1123	SAVA	92090817	G-834	SAVA	92189	GP-81	BGA	92290211	GA-5648	SAVA
92006717	G-1123	SAVA	92091317	G-750	SAVA	92190	GP-3980	AMP	92290217	GA-5648	SAVA
920073	G-33	SAVA	92092188	G-836	INGR	92190	GP-3569	BGA	922903	GA-206	SAVA
92007317	G-33	SAVA	92092204	G-834	INGR	92190	GP-3980	BGA	92290311	GA-206	SAVA
92007517	G-33	SAVA	92092212	GP-43	INGR	921905	G-1121	DAIM	92290317	GA-206	SAVA
92007617	G-33	SAVA	920922123	GP-43	INGR	921905	G-1121	MBNZ	92290411	GA-6129	SAVA
92007717	G-33	SAVA	92092220	G-33	INGR	921905	G-1121F	MBNZ	92290417	GA-6129	SAVA
92007817	G-33	SAVA	92092279	G-1174	INGR	92191	GP-310	BGA	92290517	GA-3300	SAVA
920088	G-1121	SAVA	92092287	G-1175	INGR	92191	GP-3569	BGA	922906	GA-106 ⁶	SAVA
92008817	G-1121	SAVA	92095317	GG-20	SAVA	92192817	G-143	SAVA	922906	GA-326 ¹¹	SAVA
92009017	G-1121	SAVA	92095417	G-500	SAVA	92193	G-801	BGA	92290611	GA-106 ⁶	SAVA
920102	G-238	SAVA	92095617	G-119	SAVA	92195	G-153	BGA	92290611	GA-326 ¹¹	SAVA
92010217	G-238	SAVA	9209591	G-139	SAVA	92196	GP-66	AMP	92290617	GA-106 ⁶	SAVA
92011217	G-1175 ⁰⁸	SAVA	92096017	G-152	SAVA	92196	GP-66	BGA	92290617	GA-326 ¹¹	SAVA
920113	G-1173 ⁰⁸	SAVA	92096217	G-566	SAVA	92197	G-222	BGA	92290911	GA-37	SAVA
92011317	G-1173 ⁰⁸	SAVA	92096517	G-236	SAVA	92198017	G-133	SAVA	92291117	GA-77	SAVA
92013	GG-251	NAFI	92096717	G-331	SAVA	92198017	G-989	SAVA	92291217	GA-70	SAVA
920140	G-6	SAVA	9209690005	GAK-403	KALM	921999	GP-66	PARK	92291317	GA-78	SAVA
92014017	G-6	SAVA	92096917	G-333	SAVA	9215	GP-50	GREY	92291417	GA-55	SAVA
92014117	G-870	SAVA	92097017	G-335	SAVA	92200211	GA-44	SAVA	92291617	GA-71	SAVA
920178	G-222	SAVA	92099	G-834	AMP	92200217	GA-44	SAVA	92291717	GA-730	SAVA
92017817	G-222	SAVA	92099	G-834	BGA	922024-C91	GA-416 ⁰⁸	IHCO	92291917	GA-50	SAVA
920181	G-813	SAVA	92099617	G-1174 ⁰⁸	SAVA	922024-C91	GAK-216 ⁰⁸	IHCO	92292017	GA-59	SAVA
92018117	G-813	SAVA	92099717	GC-1133	SAVA	922054	G-296	KALM	9229213	GA-6127 ⁰⁸	EUCL
9201936	GP-1101	EUCL	92099817	GC-1133	SAVA	922054	G-296-B	KALM	9229213	GA-6129 ⁰⁴	EUCL
9202	GA-390	CRO	920A2001	GA-6127 ⁰⁸	EMCO	9220540001	G-296	KALM	9229213	GA-6127 ⁰⁸	GMXC
9202	GA-390	DEFS	920A2001	GA-6129 ⁰⁴	EMCO	9220540001	G-296-B	KALM	9229213	GA-6129 ⁰⁴	GMXC
92020017	G-1143	SAVA	9205	GP-38	GREY	92206	GP-36	BGA	92292217	GA-303	SAVA
920203	GP-1	IHCO	9210	GA-471	CRO	92212	G-112	BGA	92292317	GA-80	SAVA
920203-C1	GP-1	IHCO	9210	GA-471	CRO	92215	GP-58	BGA	92292417	GA-75	SAVA
92021	G-31	BGA	92100981	GPP-1122	INGR	92220917	GA-71	SAVA	92292507	G-870	INGR
920236	G-836	SAVA	9211040001	GP-1	KALM	922228	GA-230	SAVA	92292517	GA-86	SAVA
92023617	G-836	SAVA	921144764	GPP-1287 ³⁹	BOMB	92222817	GA-230	SAVA	92292617	GA-3300	SAVA
9202382	GA-334	GMXC	921144764	PFF831 ⁴¹	BOMB	92223	G-954	BGA	92292663	G-870	INGR
92027217	G-5000	SAVA	921144764	R 60 P ⁴²	BOMB	92228	GP-457	BGA	92292717	GA-74	SAVA
92028211	GA-1285	SAVA	921169	GP-34	PARK	9223	GA-464	NAP	92293217	GAD-3	SAVA
92028217	GA-1285	SAVA	921183023	GP-761H	BOMB	922305	G-1121	DAIM	9229417	GA-33	SAVA
920285	G-330	SAVA	92118660	GP-28 ⁸	INGR	922305	G-1121	MBNZ	92294311	GA-27	SAVA
92028517	G-330	SAVA	92118660	GP-430 ⁸	INGR	9223130	GA-360	FIAT	92294317	GA-27	SAVA
920295	G-834	SAVA	9211-8678	GP-54 ¹¹	INGR	9223197	GAK-20	EUCL	92294411	GA-33	SAVA

Referencia Cruzada por Numero de Parte

Cross Reference by Part Number



Numero	Gonher	Fabricante	Numero	Gonher	Fabricante	Numero	Gonher	Fabricante	Numero	Gonher	Fabricante
Number	Gonher	Manufacturer	Number	Gonher	Manufacturer	Number	Gonher	Manufacturer	Number	Gonher	Manufacturer
922950	GA-360	SAVA	92348	GP-58	BGA	92475	G-6	BGA	926163	GP-34	PARK
92295011	GA-360	SAVA	92348MP	GP-2951 ⁶²	BGA	92477330	G-870	INGR	926169	GP-34	PARK
92295017	GA-360	SAVA	92348MP	GP-58	BGA	924779-C1	GAK-216	IHCO	926169B	GP-34	PARK
92295111	GA-361	SAVA	92351217	GA-VW-2	SAVA	924779-C2	GAK-216	IHCO	926170	GP-36	PARK
92295117	GA-361	SAVA	923530	GA-VW-2	SAVA	92482	GP-761H	AMP	92618	GP-20	BGA
92296417	GA-100	SAVA	92353017	GA-VW-2	SAVA	92482	GP-761H	BGA	92619	GP-166 ⁶⁵	BGA
92296617	GA-113	SAVA	92354117	GA-3425	SAVA	92483	GP-761H	AMP	92619	GP-3937 ¹¹	BGA
92297317	GA-11	SAVA	92354217	GA-2194	SAVA	92483	GP-761H	BGA	92621	GP-166	BGA
922977	GP-66	DYPA	923551	GA-71	SAVA	92485	GP-761H	AMP	92622	GP-171 ¹⁶	AMP
92298	GP-66	BGA	92355117	GA-71	SAVA	92485	GP-761H	BGA	92622	GP-171 ¹⁶	BGA
923	GA-7716	AMP	92356	GP-149	BGA	92486	GP-761H	BGA	92624	GP-9	BGA
923	GA-7716	BGA	92357	GP-91	BGA	92487	G-169	BGA	92626	GP-3985	AMP
9230	GG-5 L	FIAT	92358	GP-91	BGA	9249021	GA-357	EUCL	92626	GP-3985	BGA
92302	G-870	AMP	92361	GP-3682	AMP	9249021	GA-356 ¹⁰⁴	GMCX	92628	GP-54	BGA
92302	G-870	BGA	92361	GP-3682	BGA	9249021	GA-357 ¹⁰⁸	GMCX	92637	G-159	BGA
92302111	GA-1008	SAVA	92361	GP-37	BGA	9249091	GA-356 ¹⁰⁴	GMCX	926388	GP-34	VICK
92302117	GA-1008	SAVA	92362	GP-81	BGA	9249091	GA-357 ¹⁰⁸	GMCX	92642	GP-51	BGA
923026	GA-8047	SAVA	92363	GP-750	BGA	92491	GP-761H	BGA	92649	GP-43	BGA
92302611	GA-8047	SAVA	92364	GP-38	BGA	92494	GP-761H	AMP	926541	GP-34	PARK
92302617	GA-8047	SAVA	92365	GP-91	BGA	92494	GP-761H	BGA	926556	GP-66	DYPA
92302911	GA-18	SAVA	92366	GP-58	BGA	92495	GP-761H	AMP	92658095	GP-51	INGR
92302917	GA-18	SAVA	92367	GP-3682	AMP	92495	GP-761H	BGA	92669	GP-53	BGA
92303211	GA-9045	SAVA	92367	GP-3682	BGA	92496	GP-761H	BGA	92669XD	GP-53	BGA
92303217	GA-9045	SAVA	92367	GP-37	BGA	92498	GP-761H	BGA	9267	GA-VW-120	CRO
92303311	GA-1287	SAVA	92367017	GA-6127	SAVA	924K	GAK-403	CRO	92671	GP-53	BGA
92303317	GA-1287	SAVA	92367317	GA-229	SAVA	9245	GP-36	GREY	92673	GP-359	BGA
92303411	GA-1284	SAVA	92368317	GA-436	SAVA	925	GA-37	CRO	926783-C1	GA-106 ⁶⁶	IHCO
92303417	GA-1284	SAVA	92368917	GA-892	SAVA	92500	G-31	BGA	926783-C1	GA-326 ⁷¹	IHCO
92303511	GA-1286	SAVA	92369617	GA-416	SAVA	925023	GP-66	JACO	926784-C1	GA-206	IHCO
92303517	GA-1286	SAVA	92370117	GAK-625	SAVA	925023	GP-66	PARK	926901	G-1121	MBNZ
923036	GA-1285	SAVA	92370417	GA-6129	SAVA	925023B	GP-66	PARK	926901	G-1121F	MBNZ
92303611	GA-1285	SAVA	92371117	GA-467	SAVA	92503	G-31	BGA	926926	GP-66	PARK
92303617	GA-1285	SAVA	92371217	GA-78	SAVA	9250787	G-296	TECF	926971	GP-34	PARK
92303717	GA-375	SAVA	92371417	GA-3490	SAVA	9250787	G-296-B	TECF	927	GAD-3	CRO
92304811	GA-24	SAVA	92371517	GA-3490	SAVA	9250883	G-1121	TECF	92702617	GA-8047	SAVA
92304817	GA-24	SAVA	92372	GP-68	BGA	9250889	G-31	CHRY	92704	GP-50 ⁵⁰	AMP
92304911	GA-26	SAVA	92372717	GA-2740	SAVA	9250979	G-834	LNCR	92704	GP-50 ⁵⁰	BGA
92304917	GA-26	SAVA	92372MP	GP-68	BGA	9251	GA-139	CRO	92722	GP-52 ¹⁰	BGA
92305	G-836	BGA	92374	GP-58	BGA	925102-R91	GA-27	IHCO	92722	GP-691 ⁴⁸	BGA
92305411	GAK-16	SAVA	92375117	GA-277	SAVA	92512	GP-38	AMP	92727	G-926	AMP
92307	GP-81	BGA	92377217	GAD-3	SAVA	92512	GP-38	BGA	92727	G-926	BGA
92309417	GA-85	SAVA	92378	GP-212	BGA	92515	GP-1	AMP	92734	GP-562	BGA
92309517	GA-135	SAVA	92380	GP-3985	AMP	92515	GP-1	BGA	92740	GP-864H	BGA
92311311	GA-98 ¹¹²	SAVA	92381	GP-91 ⁷⁸	AMP	9251517	G-834	LNCR	92740950	GP-54 ¹¹	INGR
92311317	GA-98 ¹¹²	SAVA	92381	GP-91 ⁷⁸	BGA	92515MP	GP-1	BGA	92740950	GP-66 ¹⁰	INGR
92312	GP-81	BGA	92384017	GA-2110	SAVA	92516	GP-3600	BGA	92741	GP-3000 ¹³	AMP
92313211	GA-356	SAVA	92385417	GA-VW-120	SAVA	92516MP	GP-3600	BGA	92741	GP-3000 ¹³	BGA
92313217	GA-356	SAVA	92386	GP-3985	AMP	92521	GP-171	BGA	92742	GA-589	AVEL
92313311	GA-357	SAVA	92386	GP-3985	BGA	92522	GP-3675	BGA	92742	GP-3766	BGA
92313317	GA-357	SAVA	92390	GP-42	BGA	925229	GP-171	IHCO	92743	GA-588	AVEL
92313611	GA-31	SAVA	92391	GP-28 ⁸	AMP	92525	GP-1	BGA	92744523	GP-110	INGR
92314	G-162H	BGA	92391	GP-430 ⁸	AMP	9253723	GAK-16	LNCR	92746	GP-34	BGA
92315	GP-128	BGA	92391	GP-490	BGA	925405	G-1121F	MBNZ	92748	GP-3000	BGA
92316-041-2001	GP-38	FUJI	92392	GP-3531 EXP	BGA	925418	GP-50	AMCO	92748XD	GP-3001	BGA
92318017	GAD-1	SAVA	92393	GP-28 ⁸	BGA	925418	GP-50	CHRY	92749	GP-57	BGA
92319	GP-81	BGA	92393	GP-430 ⁸	BGA	925418	GP-50	JEEP	92750	GP-750	AMP
9232186	GA-6127 ¹⁰⁸	GMCX	92394	GP-157	BGA	925418	GP-50	KAIS	92750	G-750	BGA
9232186	GA-6129 ¹⁰⁴	GMCX	92395	GP-157	BGA	925418	GP-50	WILY	92751	G-750	AMP
92324	GP-3985 ⁶³	BGA	92396	GP-156	BGA	92545	GP-171 ¹⁶	BGA	92751	G-750	BGA
9232508	GA-6129	EUCL	92398-05120-00	GP-3682	KUBO	92551	GP-66	AMP	92752	G-750	AMP
92325417	GA-57	SAVA	92398-05120-00	GP-37	KUBO	92551	GP-66	BGA	92752	G-750	BGA
92331117	GA-VW-2	SAVA	923P	G-566	WIX	925516	GP-66	PARK	92753	G-750	BGA
923315	GA-VW-4	SAVA	924	GA-403	CRO	925516B	GP-66	PARK	92754	GP-54	AMP
92331517	GA-VW-4	SAVA	924039-R91	GA-6129	IHCO	92551MP	GP-66	BGA	92754	GP-54	BGA
923322	GA-277	SAVA	92408117	GG-6	SAVA	92552	GP-66	AMP	92756	GP-34	BGA
92332217	GA-277	SAVA	92408217	GG-7	SAVA	92552	GP-66	BGA	92758	GP-34	BGA
92334	GP-149 ⁶⁹	BGA	92408317	GG-123	SAVA	92553	GP-66	AMP	92759	GP-34	BGA
92334	GP-91 ⁷⁸	BGA	92408417	G-1143	SAVA	92553	GP-66	BGA	92762	GP-3600	BGA
92334MP	GP-149 ⁶⁹	BGA	9241	G-500	CRO	92554	G-500	BGA	92764	GP-3600	BGA
92334MP	GP-91 ⁷⁸	BGA	924141	G-31	SAVA	9256640	GA-356 ¹⁰⁴	GMCX	92768	GP-36	AMP
92335	GP-22	BGA	92426	G-33	BGA	9256640	GA-357 ¹⁰⁸	GMCX	92768	GP-36	BGA
92337817	GAD-1	SAVA	92431	GP-9	BGA	925676	GP-36	DYPA	92769	GP-69	BGA
92338	GP-462	BGA	92442	G-191	BGA	925678	GP-3816	DYPA	9277	GA-VW-121	CRO
92338517	GA-2194	SAVA	92447	GP-761H	BGA	92568	GP-462	BGA	92771	GP-310	BGA
92340	GP-46	BGA	92448	GP-761H	AMP	9257695	G-870	LNCR	92772	GP-54 ¹¹	AMP
923404	GA-405	SAVA	92448	GP-761H	BGA	925809	G-31	CHRY	92772	GP-66 ¹⁰	AMP
92340417	GA-405	SAVA	92449	GP-761H	BGA	92-5809	G-31	WHIT	92772	GP-54 ¹¹	BGA
923412	GA-49	SAVA	92450	GP-761H	AMP	92581	GP-14	BGA	92772	GP-66 ¹⁰	BGA
92341217	GA-49	SAVA	92450	GP-761H	BGA	92592	GP-68	BGA	92773	GP-31	BGA
923416	GA-467	SAVA	92451	GP-761H	BGA	925947	GP-66	PARK	927736	GP-34	PARK
92341617	GA-467	SAVA	92451	GP-761H	CASE	925H2R	G-1173 ¹⁰⁸	REOT	92774	GP-54 ⁹⁰	AMP
92342	GP-28 ⁸	AMP	92452	GP-310	AMP	925H2R	G-1173 ¹⁰⁸	WHIT	92774	GP-54 ⁹⁰	BGA
92342	GP-430 ⁸	AMP	92452	GP-310	BGA	9255	GP-50	GREY	92775	GP-1	BGA
92342	GP-28 ⁸	BGA	92452	GP-3569	BGA	92601	GP-171	BGA	92776	GP-77	BGA
92342	GP-430 ⁸	BGA	92455	GP-761H	BGA	926016	G-31	UNIT	92777	GP-77	BGA
9234215	G-1121	LEYL	92456	GP-761H	BGA	92602	GP-390	AMP	927787	GP-1	AMCO
92344	GP-462	BGA	92457	GP-761H	AMP	92602	GP-390	BGA	927787	GP-1	CHRY
92345617	GAK-16	SAVA	92457	GP-761H	BGA	9260261	GA-33	LNCR	927787	GP-1	JEEP
92346	GP-3682	AMP	92459	GP-31	BGA	92602MP	GP-390	BGA	927787	GP-1	KAIS
92346	GP-28	BGA	92460	GP-3600	BGA	92604	GP-178	AMP	927787	GP-1	WILY
92347	GP-462	AMP	92461	GP-54	BGA	92604	GP-178	BGA	92783	G-122	AMP
92347	GP-24 ²⁶	BGA	924625-C1	GA-357	IHCO	926042					

Numero	Gonher	Fabricante	Numero	Gonher	Fabricante	Numero	Gonher	Fabricante	Numero	Gonher	Fabricante
Number	Gonher	Manufacturer	Number	Gonher	Manufacturer	Number	Gonher	Manufacturer	Number	Gonher	Manufacturer
92788	GP-51	BGA	92818817	GP-81 ³¹	SAVA	930046	G-813	BRAU	93110770100	GP-28 ⁶	VAG
92789	GP-69	BGA	92818817	GP-9 ⁵⁸	SAVA	930049	G-870	MASY	93110770100	GP-430 ⁸	VAG
92791	GP-51	BGA	92819	GP-761H	BGA	930049-M91	G-870	MASY	93110770100	GP-28 ⁶	VOLK
9279108	GAK-16	FORD	92819017	GP-14	SAVA	93-009-904	G-1121F	ZETO	93110770100	GP-430 ⁸	VOLK
9279180	GAK-16	FORD	92819117	GP-1101	SAVA	93-009-905	G-1121	ZETO	931-107-701-00	GP-28 ⁶	PORS
92791XE	GP-51	BGA	92819517	GP-1107	SAVA	93010776400	GP-36	VAG	931-107-701-00	GP-430 ⁸	PORS
92792	GP-52 ¹⁰	AMP	9282	GA-2160	CRO	930-107-764-00	GP-36	PORS	93112	GA-105	BGA
92792	GP-691 ⁴⁸	AMP	92820	GP-54 ¹¹	AMP	93011	GA-71	AMP	93113	GA-86	AMP
92792	GP-52 ¹⁰	BGA	92820	GP-66 ¹⁰	AMP	93011	GA-71	BGA	93113	GA-86	BGA
92792	GP-691 ⁴⁸	BGA	92820	GP-54 ¹¹	BGA	930-110-196-00	GG-246	PORS	93116	GA-85	AMP
92792XD	GP-52 ¹⁰	BGA	92820	GP-66 ¹⁰	BGA	93011019601	GG-246	PORS	93116	GA-85	BGA
92792XD	GP-691 ⁴⁸	BGA	92820217	GP-11	SAVA	9301361	GA-29	CASE	93116MP	GA-85	BGA
92792XE	GP-52 ¹⁰	BGA	92820317	GP-11	SAVA	93016	GA-434	BGA	93118	GAK-20	BGA
92792XE	GP-691 ⁴⁸	BGA	92820417	GP-11	SAVA	9302	GP-27	CRO	93119	GA-360	BGA
92793025	GA-853R	INGR	92820517	GPP-18	SAVA	93020	GA-70	AMP	9312	GG-137	NAFI
92793223	GP-28 ⁸	INGR	92821017	GP-66	SAVA	93020	GA-70	BGA	93121342	GG-19	SAVA
92793223	GP-430 ⁸	INGR	92821117	GP-66	SAVA	9303	GP-26	CRO	93123142	GG-5 L	SAVA
92794	GP-23	BGA	92821517	GP-171	SAVA	93036	GA-3445	BGA	93124	GA-27	BGA
92795	GP-390 ⁹³	AMP	928216	GP-54	SAVA	93039	GA-54	AMP	93125	GA-26 ¹¹²	AMP
92796	GP-390 ⁹³	AMP	92821717	G-870	SAVA	93039	GA-54	BGA	93125	GA-26	BGA
92796	GP-390 ⁹³	AMP	92821917	GP-58	SAVA	9304	GP-10	CRO	9312596	GA-12	PUR
92797	GP-10	BGA	92822117	GP-81 ³¹	SAVA	9304100001	GA-106 ⁴⁶	GROV	93126	GAK-403	BGA
92799	GP-152	BGA	92822117	GP-9 ⁵⁸	SAVA	9304100001	GA-326 ⁷¹	GROV	93128	GA-356	BGA
92799MP	GP-152	BGA	92822217	GP-3985	SAVA	9304100003	GA-6129	GROV	93132	GA-357	AMP
927A-6731	G-813	FORD	92822617	GP-42	SAVA	9304100009	GA-24	GROV	93132	GA-357	ATWE
9275	GP-28 ⁸	GREY	928228	GP-28 ⁸	SAVA	9304100023	GA-6129	GROV	93132	GA-357	BGA
9275	GP-430 ⁸	GREY	928228	GP-430 ⁸	SAVA	9304-100023	GA-6129	GRAV	93133	GA-277	BGA
92800	GP-77	BGA	92822817	GP-28 ⁸	SAVA	9304100026	GA-27	GROV	93136	GA-4303	BGA
928001	G-296	SAVA	92822817	GP-430 ⁸	SAVA	9304100035	GA-360	GROV	93140	GA-3424	AMP
928001	G-296-B	SAVA	92823217	GP-1	SAVA	9304100052	GA-6880	GROV	93140	GA-3424	BGA
92800117	G-296	SAVA	92823917	GP-1	SAVA	9304100056	GAK-16	GROV	93141	GA-3425	AMP
92800117	G-296-B	SAVA	92824	GP-35	BGA	9304-100056	GAK-16	GRAV	93141	GA-3425	BGA
92800317	GP-11	SAVA	92824017	GP-1	SAVA	9304100063	GA-376	GROV	93142	GAK-403	BGA
92800517	GP-1122	SAVA	92828217	GP-1	SAVA	9304100068	GA-361	GROV	93152007	GAVW-4	GMCX
928008	GP-81	SAVA	92829	GP-66	BGA	9304100074	GA-206	GROV	93152111	GAVW-2	GMCX
92800817	GP-81	SAVA	928301	GP-1122	DAIM	9304100077	GAK-1532	GROV	93152307	GA-3425	GMCX
9280124	G-296	FIAT	928301	GP-1122	MBNZ	930410009	GA-24	GROV	93152308	GA-2194	GMCX
9280124	G-296-B	FIAT	92832717	GPP-1122	SAVA	9304100123	GA-6129	GROV	93152341	GA-3490	GMCX
928014	GP-14	SAVA	92838	G-49	BGA	9304100168	GA-853R	GROV	93152731	GA-3425	GMCX
92801417	GP-14	SAVA	92840117	GP-40	SAVA	9304100561	GAK-16	GROV	93152736	GA-2122	GMCX
92801517	GP-1	SAVA	92841117	GP-9	SAVA	93044	GA-730	AMP	93152974	GAVW-2	GMCX
92802	GP-67	BGA	92841617	GP-9	SAVA	93044	GA-730	BGA	93156092	GP-40	GMCX
92802017	GP-36	SAVA	92843217	GP-46	SAVA	93045	GA-9045	BGA	93156093	GP-40	GMCX
92802217	GP-81	SAVA	92844417	GP-9	SAVA	93046	GA-1287	BGA	93156108	G-870	GMCX
92802417	GP-81 ³¹	SAVA	92846817	GPP-1122	SAVA	93047	GA-8047	BGA	93156201	GP-3531 EXP	GMCX
92802417	GP-9 ⁵⁸	SAVA	92848	GP-52 ¹⁰	AMP	93048	GA-1285	BGA	93156245	GP-46	GMCX
92803	GP-54	BGA	92848	GP-691 ⁴⁸	AMP	93049	GA-429	AMP	93156288	GPP-1122	GMCX
92803917	GP-1122	SAVA	92848	GP-52 ¹⁰	BGA	93049	GA-429	BGA	93156288	GPP-1122	OPEL
928040	GP-54 ¹¹	SAVA	92848	GP-691 ⁴⁸	BGA	9304M	GG-94	NAFI	93156290	GP-40	GMCX
928040	GP-66 ¹⁰	SAVA	92848217	GPP-1122	SAVA	93054	GA-77	AMP	93156291	GP-68	GMCX
92804017	GP-54 ¹¹	SAVA	92850917	GP-1122	SAVA	93054	GA-77	BGA	93156298	GP-46	GMCX
92804017	GP-66 ¹⁰	SAVA	92851517	GP-77	SAVA	93055	GA-80	AMP	93156299	GP-3816	GMCX
92804100	GP-1	SAVA	92852317	GP-3531 EXP	SAVA	93055	GA-80	BGA	93156300	GP-46	GMCX
92804117	GP-1	SAVA	92855617	GP-1122	SAVA	93057	GA-74	AMP	93156303	GP-3600	GMCX
92804917	GP-1101	SAVA	92867	G-339H	BGA	93057	GA-74	BGA	93156310	GP-46	GMCX
928055	GP-50	AMCO	92870	GP-53	BGA	9305874	GA-11	PUR	93156321	GP-40	GMCX
928055	GP-50	CHRY	92873	GP-53	BGA	930589	GP-54 ¹⁰	CECC	93156322	GP-3600	GMCX
928055	GP-50	JEEP	928767	GP-864H	PARK	930589	GP-66 ¹¹	CECC	93156363	GP-310	GMCX
928055	GP-50	WHIT	92878990	GG-3	INGR	9306	G-1163	CRO	93156538	GP-40	GMCX
92805917	GP-3816	SAVA	9290	GA-195	CRO	93061	GA-78	AMP	93156613	GP-28 ⁶	GMCX
92806	GP-1	BGA	92900117	GP-2071W	SAVA	93061	GA-78	BGA	93156613	GP-430 ⁸	GMCX
92807	GP-54	BGA	929096	GP-34	PARK	93061	GG-164	NAFI	93156634	GPP-111	GMCX
928071	GP-50	SAVA	929096B	GP-34	PARK	93065	GG-164	NAFI	93156634	GPP-524	GMCX
92807117	GP-50	SAVA	9291	GA-386	CRO	93067	GA-303	AMP	93156663	GP-3682	GMCX
92807917	GP-50	SAVA	9292493	GAVW-2	GMCX	93067	GA-303	BGA	93156665	GP-91	GMCX
92808	GP-88	BGA	9292493	GAVW-2	OPEL	930697	GP-54 ¹⁰	CECC	93156666	GP-462	GMCX
92809	GP-642	BGA	9293140	GA-49	FIAT	930697	GP-66 ¹¹	CECC	93156668	GP-3682	GMCX
92810	GP-43	BGA	9293140	GA-49	IVEC	93072	GA-349	BGA	93156668	GP-37	GMCX
92811	GP-53	AMP	9295	GA-2174	CRO	93073	GA-75	AMP	93156669	GP-171	GMCX
92811	GP-53	BGA	92954	G-566	BGA	93073	GA-75	BGA	93156769	GP-3985	GMCX
92811100	GP-10	SAVA	92966	GA-90	FORD	93073MP	GA-75	BGA	93156856	GP-46	GMCX
92811117	GP-54 ¹¹	SAVA	92970	GP-53	AMP	93077	GA-3300	AMP	93156863	GP-455	GMCX
92811117	GP-66 ¹⁰	SAVA	92970	GP-53	BGA	93077	GA-3300	BGA	93156943	GPP-111	GMCX
92811517	GP-36	SAVA	92970XD	GP-53	BGA	93083	GA-50	AMP	93156943	GPP-524	GMCX
92812717	GP-22	SAVA	92970XD	GP-53	CRQ	93083	GA-50	BGA	9316	GPP-19	CRO
92813	GP-53	BGA	92970XE	GP-53	BGA	93088	GA-192	AMP	93160	GA-230	BGA
928130	GP-46	SAVA	92970XE	GP-53	CRQ	93088	GA-192	BGA	9317	GPP-18	CRO
92813017	GP-46	SAVA	92971	GP-193	BGA	93088MP	GA-192	BGA	93170	GAVW-2	BGA
92813117	GP-22	SAVA	92971MP	GP-193	BGA	9308934	GA-5648	PUR	93172461	GA-397	GMCX
92814217	GP-462	SAVA	92971XD	GP-193	BGA	9309	GP-51	CRO	93172461	GA-397	OPEL
928144	GP-3	SAVA	929A6	G-31	RENA	93093	GA-90	AMP	93172461	GA-397	VAUX
92814417	GP-3	SAVA	929P	G-801	WIX	93093	GA-90	BGA	93172462	GA-397	OPEL
92815217	GP-38	SAVA	925B-9155-AB	GG-82	FORD	9309481	GA-7	PUR	93172462	GA-397	VAUX
92815917	GP-110	SAVA	93 18 6310	G-765	SAAB	93095	GA-55	AMP	93172463	GA-397	OPEL
92817	GP-761H	BGA	93 28 519	GG-408	SAAB	93095	GA-55	BGA	93172463	GA-397	VAUX
92817517	GP-5	SAVA	93 33 790	GG-261	SAAB	9309576	GP-81	SAAB	93172464	GA-397	OPEL
92817817	GP-34	SAVA	930 110 139 00	GG-408	AUDI	93098	GA-59	AMP	93172464	GA-397	VAUX
92817917	GP-20	SAVA	930 110 139 00	GG-408	PORS	93098	GA-59	BGA	931726	GP-66	TENN
92818	GP-54 ¹¹	AMP	930 110 139 00	GG-408	VOLK	93098MP	GA-59	BGA	9317268	GP-66	TENN
92818	GP-66 ¹⁰	AMP	93-000-990	G-1121F	ZETO	93099	GA-325	BGA	93175493	G-49	GMCX
92818	GP-54	BGA	93001	G-57	AMP	9310	G-1121F	CRO	93177663	GA-397	VAUX
928180	GP-51	SAVA	93001	GA-57	BGA	93101-05013	GAK-403	FURU	9318	GP-66	CRO
92818117	GP-3600	SAVA	930023	G-870	RENA	93101MP	GA-57	BGA	93181	GA-183	BGA
92818417	GP-14	SAVA	930026	G-870	RENA	93102	GA-55	BGA	93184334	G-49	GMCX
92818517	GP-10	SAVA	930028	G-870	MASY	93103	GA-3523	AMP	93187335	GA-4319	GMCX
92818717	GP-10	SAVA	930028	G-870	RENA	93103	GA-3523	BGA	93188	GA-184	BGA

Referencia Cruzada por Numero de Parte

Cross Reference by Part Number



Numero	Gonher	Fabricante	Numero	Gonher	Fabricante	Numero	Gonher	Fabricante	Numero	Gonher	Fabricante
Number	Gonher	Manufacturer	Number	Gonher	Manufacturer	Number	Gonher	Manufacturer	Number	Gonher	Manufacturer
93190		GA-448 BGA	93493		GA-251 BGA	93837		GA-29 BGA	94036		GA-3647 BGA
931-905-8609-4		GA-405 KASB	935		GA-378 AMP	93853		GA-375 BGA	94036MP		GA-3647 BGA
9315		GP-3600 GREY	935		GA-378 BGA	93865		GA-5648 BGA	94040		GA-3588 AMP
9320		G-1176 WIN	9350		GP-53 CRO	93-8717		GA-403 CATP	94040		GA-3588 BGA
93204117		GG-246 SAVA	93503		GA-98 ¹¹² AMP	93888		GA-2803T BGA	940404		G-225 MBNZ
932054		GP-171 PARK	93503		GA-98 ¹¹² BGA	9389009		G-1121 GULD	94040MP		GA-3588 BGA
93208		GA-106 ⁴⁶ BGA	93505		GA-18 BGA	93891769		GPP-1122 GMCX	94041		GA-390 BGA
93208		GA-326 ⁷¹ BGA	9350576		GP-462 TECF	93891826		GAVW-2 GMCX	94042		GA-4325 BGA
93209		GA-206 BGA	9350599		GP-38 TECF	93892081		GP-3682 GMCX	94043		GA-139 BGA
93210417		GG-251 SAVA	9350605		GP-3816 TECF	93892086		GA-230 GMCX	94044		GAD-117 BGA
93210517		GG-246 SAVA	9350606		GP-28 ⁵ TECF	93892090		GP-28 ⁵ GMCX	94044		GAD-17 BGA
93210617		GG-226 SAVA	9350606		GP-430 ⁸ TECF	93892090		GP-430 ⁸ GMCX	94045		GA-154 BGA
93218		GA-390 BGA	9350614		GP-58 ¹⁵ TECF	93892092		GA-2194 GMCX	94046		GA-3681 AMP
932200		GP-34 FALK	9350618		GP-3600 TECF	93905		GAD-1 ²⁷ GMCX	94046		GA-3681 BGA
93220010		GP-66 FALK	9350618		GP-3682 TECF	93906		GAD-3 AMP	94048		GA-3637 BGA
93220010		GP-66 SUND	9350618		GP-57 TECF	93906		GAD-3 BGA	94049		GA-429 BGA
93222		GAK-16 BGA	9350621		GP-46 TECF	93908		GA-74 BGA	94051		GA-217 BGA
932237		GP-34 FALK	9350622		GP-81 TECF	93912		GA-3490 AMP	94051143		GAD-30 GMCX
9323		G-31 CRO	9350634		GP-46 TECF	93912		GA-3490 BGA	94053		GAD-129 BGA
93234		GAK-20 BGA	9350651		GP-81 TECF	9391461		GA-106 ⁴⁶ GMCX	94054		GA-56 BGA
93237		GA-24 BGA	93509		GA-509 ¹⁴ AMP	9391461		GA-326 ⁷¹ GMCX	94057		GA-7142 BGA
9324		G-143 CRO	93509		GA-509 ¹⁴ BGA	93916		GA-21 BGA	94061		GA-230 BGA
9325		GP-54 ¹¹ CRO	93516538		GP-40 CITR	93924		GA-361 BGA	94064		GA-386 BGA
9325		GP-66 ¹⁰ CRO	93518		GAK-1532 BGA	93926		GA-403 BGA	94065		GA-59 BGA
93250		GA-37 BGA	93522		GAK-625 BGA	9393784		GAK-403 EUCL	94066		GA-3681 BGA
93252		GA-37 BGA	93524		GA-168 BGA	9393784		GAK-403 GMCX	94067		GA-192 BGA
93253		GA-209 BGA	93542		GA-360 BGA	93941		GA-493 ¹⁰⁸ AMP	940677		G-31 CLRK
93254		GA-210 BGA	93543		GA-361 BGA	93941		GA-493 ¹⁰⁸ BGA	94068		GA-71 BGA
93258		GA-563 AMP	9355714		G-834 TECF	9394161		GA-106 ⁴⁶ EUCL	94069		GA-70 BGA
93258		GA-563 BGA	9355928		G-225 TECF	9394161		GA-326 ⁷¹ EUCL	94072		GA-80 ¹¹³ BGA
9326		G-143 CRO	9357		GP-69 CRO	9394161		GA-106 ⁴⁶ GMCX	9407296		GAK-403 LNCR
9327		G-163 CRO	9355		GP-36 GREY	9394161		GA-326 ⁷¹ GMCX	940768		G-296 CARR
9327074		GP-3766 PUR	936		GA-80 CRO	9395941		GAK-20 SEDN	940768		G-296-B CARR
9327084		GP-864H PUR	936		GA-174 UNN	93960		GA-376 BGA	94077		GA-3901 BGA
93276		GA-33 BGA	9360		GP-1108 CRO	93961		GA-378 BGA	94080		GA-141 BGA
93285		GA-2146 BGA	93608		GA-405 BGA	9396292		GA-356 GMCX	94081		GA-301 BGA
9328519		GG-246 SAAB	9361		GP-51 CRO	9396293		GA-357 GMCX	94082		GA-166 BGA
9329		GP-54 CRO	93611		GA-372 BGA	9396294		GA-6129 GMCX	94084		GA-3814 BGA
93291		GA-42 BGA	93613		GA-373 AMP	9396295		GA-6127 GMCX	94084MP		GA-3814 BGA
93295		GAVW-622 BGA	93613		GA-373 BGA	9396394		GA-6129 GMCX	94085		GA-3647 BGA
9330		GP-69 CRO	93618		GA-229 BGA	93966		GA-229 BGA	94086		GA-70 BGA
9331		GP-1105 CRO	9362		GP-1 CRO	93971		GA-539R BGA	94089		GA-4958 BGA
933160-02190		GP-171 ¹⁶ YNMR	93631		GAK-216 BGA	93976		GA-31 BGA	940906		G-613 CLRK
9332		GP-62 CRO	93632		GA-416 BGA	93980		GA-7716 BGA	94093		GA-275 BGA
93329		GA-477 BGA	936406		GP-1 AMCO	93981		GA-7360 BGA	94095		GAD-118 BGA
93333		GA-139 BGA	936406		GP-1 CHRY	93984		GA-2984 BGA	94095		G-1175 ¹⁰⁸ CLRK
93334		GA-9334 BGA	936406		GP-1 JEEP	9398482		GA-106 ⁴⁶ EUCL	94097		GA-133 BGA
93335		GA-1286 BGA	936406		GP-1 KAIS	9398482		GA-326 ⁷¹ EUCL	94098		GA-432 BGA
93338		GAK-403 BGA	936407		GP-50 AMCO	9398483		GA-206 EUCL	94099		GAP-379 BGA
9334		GP-52 ¹⁰ CRO	936407		GP-50 CHRY	93991		GA-113 AMP	9410031728		GP-46 CITR
9334		GP-691 ⁴⁸ CRO	936407		GP-50 JEEP	93991		GA-113 BGA	94104		GA-476 BGA
93341		GA-479 BGA	936407-B		GP-50 JEEP	93994		GA-101 BGA	94105		GA-595 BGA
933430		GP-761H PARK	93648		GA-680 BGA	93995		GA-100 AMP	941071		GG-5 L AMCO
933431		GP-761H PARK	93651		GA-108 BGA	93995		GG-5 L JEEP	941071		GG-5 L JEEP
93349		GA-2740 BGA	93653		GAK-216 BGA	93999		GA-113 AMP	94107744		GG-203 GMCX
93359		GA-6 BGA	93654		GA-425 BGA	93999		GA-113 BGA	94108		GA-604 BGA
93364		GA-2184 BGA	93655		GA-426 BGA	94001		GA-135 AMP	941089		GA-27 CLRK
933688		GA-360 CLRK	9366		GG-298 CRO	94001		GA-135 BGA	941107		GP-34 VICK
933689		GA-361 CLRK	93661		GA-6880 AMP	940034		G-31 CLRK	941111		GA-4365 BGA
9337		GP-56 CRO	93661		GA-6880 BGA	940035		G-31 CLRK	94116		GAD-15 BGA
93371		GA-44 AMP	93676		GA-679 BGA	94007		GA-3566 BGA	94117		GA-165 BGA
93371		GA-44 BGA	93677		GA-680 BGA	940095		G-1176 CLRK	941172		GP-490 CARR
93372		GA-11 BGA	93678		GA-891 BGA	940107		G-152 CLRK	941172P12		GP-490 CARR
93373		GA-7 BGA	93679		GA-892 BGA	94011		GAD-3 BGA	9411732		GA-134 GMCX
93374		GA-12 BGA	93680		GA-483 BGA	9401109438		GP-46 FIAT	94117MP		GA-165 BGA
93375		GA-7 BGA	93681		GA-482 BGA	94012		GA-3300 BGA	94118		GA-216 BGA
93377		GA-6128 BGA	93682		GA-329 BGA	94013		GA-735 ¹²⁴ AMP	94119		GA-471 BGA
93378		GA-1008 BGA	93683		GA-239 BGA	94013		GA-735 ¹²⁴ BGA	941190		GP-34 VICK
93379		GA-1284 BGA	9369053		GA-357 EUCL	94016		GA-140 BGA	941191		GP-34 VICK
9338		GP-68 CRO	93691		GA-885 BGA	94017		GA-322 BGA	94120		GA-271 AMP
93384		GA-278R BGA	93697		GA-3501 AMP	940184		G-152 CLRK	94120		GA-271 BGA
93385		GA-224 BGA	93697		GA-3501 BGA	940185		G-152 CLRK	94123		GAVW-2 BGA
93389		GA-248 BGA	9365		GP-54 ¹¹ GREY	9401906138		G-296 CITR	94126		GA-273 BGA
9339		GP-78 CRO	9365		GP-66 ¹⁰ GREY	9401906138		G-296-B CITR	94132		GA-274 BGA
9335		GP-91 GREY	9370902		GA-356 ¹⁰⁴ GMCX	94020398		GG-5 L GMCX	94132241		GPP-111 GMCX
93-407-505		GP-36 ZETO	9370902		GA-357 ¹⁰⁸ GMCX	94020402		GP-38 GMCX	94132241		GPP-524 GMCX
9341		GP-1011Q CRO	93714		GA-135 AMP	94020442		GAD-1 GMCX	94132-678		GAD-15 ISUZ
9342		GP-2071W CRO	93714		GA-135 BGA	940221		G-1176 CLRK	94133		GA-277 BGA
93422		GA-6129 BGA	93716		GA-39 BGA	94023895		GG-5 L GMCX	94134		GA-5056 BGA
93423		GA-6127 BGA	93725		GA-490 BGA	94023-904		GAD-1 ISUZ	94134MP		GA-5056 BGA
93428149		GA-134 ACD	93729		GA-414R BGA	94023905		GAD-1 GMCX	94135		GA-2194 BGA
93429345		GG-64 GMCX	9373		GP-50 CRO	94024		GA-2719B AMP	94136		GA-4365 AMP
93429346		GG-46 ACD	93-7520		GP-166 CATP	94024		GA-2719B BGA	94139		GA-3916 BGA
93-4295		GP-91 TORO	937521		GP-166 CATP	94024002		GAD-1 GMCX	941392		G-297 CARR
93431991		GP-81 ³¹ ACD	93-7521X		GP-166 CATP	9402442		GAD-1 GMCX	941392		G-297-B CARR
93431991		GP-9 ⁵⁸ ACD	93757		GA-826 BGA	94025		GAVW-4 BGA	941392		G-297 TALB
93440		GA-879 BGA	93758		GA-827 BGA	94026		GA-381 BGA	941392		G-297-B TALB
93455		GA-968R BGA	93759		GA-109 BGA	94026388		GPP-111 GMCX	941392		G-297 TCLD
9347100135		GA-360 GROV	9377816		GA-206 EUCL	94026388		GPP-524 GMCX	941392		G-297-B TCLD
93472		GAVW-621 BGA	9377816		GA-206 GMCX	94027		GAD-294 BGA	94139MP		GA-3916 BGA
93476		GA-286 BGA	9377816		GA-206 TERE	940271		G-31 CLRK	9414100288		GP-1 GROV
93479		GA-286 BGA	93793		GA-224 BGA	940272		G-1176 CLRK	9414100362		GP-110 GROV
93484		GA-395 BGA	93793025		GA-853R INGR	94028		GA-7344 BGA	9414100363		GP-52 ¹⁰ GROV
93487		GA-348 BGA	938143		GP-1 AMCO	94028863		GP-3985 GMCX	9414100363		GP-691 ⁴⁸ GROV
93488		GA-348 BGA	938143		GP-1 CHRY	94032		GA-57 BGA	9414100364		GP-56 GROV
93491		GA-107 BGA	938143		GP-1 JEEP	94035		GA-279 BGA	9414100481		GP-1101 GROV

REFERENCIA CRUZADA

Para números Gonher con Superíndice vea página 651
For Gonher with Superscript numbers see page 651

Visite nuestro sitio en internet www.grupogonher.com
Visit our web site www.grupogonher.com

Numero	Gonher	Fabricante	Numero	Gonher	Fabricante	Numero	Gonher	Fabricante	Numero	Gonher	Fabricante
Number	Gonher	Manufacturer	Number	Gonher	Manufacturer	Number	Gonher	Manufacturer	Number	Gonher	Manufacturer
9414100482	GP-53	GROV	94264	GA-362	BGA	944700033	G-834	RENA	94553	GA-529	BGA
9414100529	GP-54 ¹¹	GROV	94267	GAD-29	BGA	944700123	G-31	BERL	945539	GP-462	TCLD
9414100529	GP-66 ¹⁰	GROV	94-2690	GG-1	TORO	944700123	G-31	RENA	94-5539	GP-462	CARR
9414100547	GP-51	GROV	94-2690	GG-4	TORO	944700126	G-31	RENA	94556	GA-682R	BGA
9414100572	GP-27	GROV	94272	GA-240	BGA	94472	GA-8606	BGA	94558	G-33	CLRK
9414100607	GP-53	GROV	94273	GA-5466	BGA	94474	GA-499R	BGA	945580	G-33	CLRK
9414100619	GP-93	GROV	94278-6	GA-6127	ERF	944809	GA-27	CLRK	9456000220	GP-3985	TALB
9414100620	GP-92	GROV	94279	GAD-30	BGA	944809	GA-27	KENW	9456000927	GP-40	FIAT
9414100734	GP-13	GROV	94279-2	GA-6129	ERF	94481	GG-46	NAFI	945618	G-750	CLRK
9414100788	GP-390	GROV	94284	GAD-30	BGA	94484	GA-472	BGA	9456183480	GP-461	FIAT
9414100789	PPP-18	GROV	94288	GA-198	BGA	94487	GAK-458	BGA	945619	GP-1101	CLRK
9414100789	GP-1122	MANI	94289	GA-175	BGA	944954	GAK-20	CLRK	94562	GA-853R	BGA
9414100790	GP-1122	GROV	94293	GA-240	BGA	944954	GAK-20	KENW	9456203480	GP-461	FIAT
9414100813	GP-178	GROV	94298	GA-2198 ⁷⁰	BGA	9445	GP-58 ¹⁵	GREY	9456203580	GP-461	FIAT
94144	GA-392	BGA	94298	GA-438 ³¹	BGA	945	GA-303	CRO	945622	GA-39	CLRK
94146	GA-180	BGA	94302	GA-164	BGA	945005	G-1173 ¹⁰⁸	CASE	945623	G-1173	CLRK
94148	GA-2106	BGA	9430204	GA-200	TECF	94503	GA-3916	BGA	945624	GP-548	DYPA
9414941	GP-149 ⁶⁹	GMCX	9430204	GA-218	TECF	94505	GA-329	BGA	945628	G-33	CLRK
9414941	GP-91 ⁷⁸	GMCX	94303	GA-514	BGA	945059	GA-24	CLRK	94563	GG-260	NAFI
94149418	GP-91	GMCX	9430405	GA-71	TECF	945059	GA-24	KENW	94567	GAK-1532	BGA
94150	GA-129	BGA	943066	G-33	CLRK	9-450-732-000	GP-81	BOG	9-457-200-190	G-191	BOG
94153	GA-8	AMP	94308	GA-605	BGA	9-450-732-001	GP-81	BOG	9-457-200-400	G-870	BOG
94153	GA-6479	BGA	94320	GA-2114	BGA	9-450-732-005	GP-81	BOG	9-457-200-780	G-33	BOG
94157	GA-78	BGA	94323	GA-7007	BGA	9-450-732-006	GP-22	BOG	9-457-202-360	G-836	BOG
94158	GA-382	BGA	943235102	G-870	RENA	9-450-732-008	GP-1	BOG	9-457-202-850	G-330	BOG
94160	GA-323	AMP	943249	G-33 ¹⁰⁰	CLRK	9-450-732-009	GP-81	BOG	9-457-208-080	G-834	BOG
94160	GA-3523	BGA	94325	GA-119	BGA	9-450-732-010	GP-3816	BOG	9-457-209-080	G-834	BOG
94162	GA-6690	BGA	94327	GAVW-121	BGA	9-450-732-011	GP-46	BOG	9-457-216-030	G-834	BOG
94163	GA-483	BGA	94338181	GP-359	GMCX	9-450-732-012	GP-36	BOG	9-457-216-040	G-834	BOG
94165	GAD-1	BGA	94349	GA-127	BGA	9-450-732-013	GP-54 ¹¹	BOG	9-457-216-560	G-801	BOG
94166	GA-89	AMP	94350	GA-642	BGA	9-450-732-013	GP-66 ¹⁰	BOG	9-457-222-090	GA-71	BOG
94166	GA-89	BGA	94358	GA-384	BGA	9-450-732-019	GP-81	BOG	9-457-226-140	GA-200	BOG
94167	GA-85	BGA	94360	GA-33	BGA	9450868	GAD-1	TECF	9-457-226-140	GA-218	BOG
94167398	GPP-111	GMCX	94369299	GPP-111	GMCX	9450878	GAD-3	TECF	9-457-228-240	GA-50	BOG
94167398	GPP-524	GMCX	94369299	GPP-524	GMCX	9450964	GA-230	TECF	9-457-228-310	GA-303	BOG
94169778	GP-1 ¹	GMCX	943700133	G-834	RENA	9450990	GA-24	TECF	9-457-229-320	GAD-3	BOG
94170	GA-276	BGA	9437100063	G-33	GROV	9450992	GAK-16	TECF	9-457-233-110	GAVW-2	BOG
941700033	G-834	RENA	94371001	GA-360	GROV	9450993	GA-24	TECF	9-457-233-150	GAVW-4	BOG
941709013	G-296	RENA	9437100135	GA-360	GROV	9450994	GAK-403	TECF	9-457-233-220	GA-277	BOG
941709013	G-296-B	RENA	9437100136	GA-361	GROV	9450995	GA-33	TECF	9-457-233-830	GAVW-2	BOG
94174	GA-174	BGA	9437100139	G-33	GROV	9450996	GAK-20	TECF	9-457-234-790	GA-230	BOG
94174MP	GA-174	BGA	9437100235	G-1143 ⁹⁰	GROV	9-451-080-065	GP-1122	BOG	9-457-235-530	GAVW-2	BOG
94179	GA-153	BGA	9437100309	GAK-625	GROV	9451080077	G-1121	MBNZ	9-457-280-140	GP-14	BOG
94180	GA-253	BGA	943766	G-750	CLRK	9451103610	GP-1	ACD	9-457-280-400	GP-54 ¹¹	BOG
941809	GA-27	CLRK	94388	GA-172	BGA	9451103F8U	GP-1	ACD	9-457-280-400	GP-66 ¹⁰	BOG
94186	GA-142	BGA	94389	GAK-16	BGA	9-451-160-003	GA-360	BOG	9-457-281-270	GP-22	BOG
94188	GA-27	CASE	94390	GAVW-620	BGA	9-451-160-004	GA-405	BOG	9-457-281-800	GP-67	BOG
94188	GA-27	DROT	94394	GAK-16	BGA	9-451-160-005	GA-106 ⁶⁶	BOG	9-457-282-160	GP-54	BOG
94190	GA-6619 ¹	BGA	943949	G-33	CLRK	9-451-160-005	GA-326 ⁷¹	BOG	9-457-282-170	GP-81	BOG
94190	GA-6620 ⁶	BGA	943989	G-33	CLRK	9-451-160-006	GAK-16	BOG	9-457-282-180	GP-171	BOG
94195	GA-244	BGA	9435	GP-42	GREY	9-451-160-007	GA-229	BOG	9-457-282-280	GP-28 ⁶	BOG
94201942	GP-3985	GMCX	944	GA-360	CRO	9-451-160-009	GA-33	BOG	9-457-282-280	GP-430 ⁸	BOG
94201942	GP-3985	OPEL	94402	GA-2804 T	AMP	9-451-160-011	GA-206	BOG	9-457-282-440	GP-462	BOG
94201-942	GP-3985	ISUZ	94402	GA-2804 T	BGA	9-451-160-016	GA-49	BOG	9-457-283-080	GP-3600	BOG
94203-536	GAD-1	ISUZ	94405	GA-2804 T	AMP	9-451-160-018	GAK-403	BOG	94573	GA-413R	BGA
94203618	GAD-1	GMCX	94405	GA-2804 T	BGA	9-451-160-026	GAK-20	BOG	94573	GA-413R	BOG
94204	GA-422	BGA	94406	GA-130	BGA	9-451-160-028	GA-24	BOG	94578	GG-66	NAFI
94206-003	GAD-1	ISUZ	94412815	GP-462	GMCX	9-451-160-030	GA-436	BOG	94580	GAP-381	BGA
94206007	GAD-1	GMCX	94415	GA-49	BGA	9-451-160-062	GA-6127	BOG	9458048280	GP-3985	TALB
94206007	GAD-1	OPEL	944159	G-750	CLRK	9-451-730-701	GA-230	BOG	945867	GA-6129	CLRK
94206-007	GAD-1	ISUZ	94416	GA-1616	BGA	9-451-730-703	GA-303	BOG	945910	G-119	CLRK
94206-007G	GAD-1	ISUZ	94417	GA-442	BGA	9-451-730-714	GAVW-2	BOG	945912	G-1143	CLRK
94213	GA-300	BGA	94418	GA-1615	BGA	9-451-732-600	G-33	BOG	945913	G-566	CLRK
94213709	GAD-1	GMCX	94419	GA-1614	BGA	9-451-732-601	G-801	BOG	945927	G-33	CLRK
94215	GA-607	BGA	94425	GA-132	BGA	9-451-732-603	G-225	BOG	945928	GP-1	CLRK
94215-007	GAD-1	ISUZ	94428931	GP-3985	GMCX	9-451-733-000	G-296	BOG	9455	GP-3980	GREY
94217272	GP-3985	GMCX	94429	GA-768R	BGA	9-451-733-001	G-296-B	BOG	946008	G-119	CLRK
94219638	GAD-1	GMCX	94433	GA-197R	BGA	9-451-733-001	G-1163	BOG	946010	G-1143	CLRK
94220	GA-89	AMP	944345	GP-5	AMCO	9-451-733-010	GG-1	BOG	946011	G-566	CLRK
94220	GA-89	BGA	944345	GP-5	CHRY	9-451-733-010	GG-4	BOG	94-6081	GA-206	CATP
94221	GA-2110	BGA	944345	GP-5	JEEP	9-451-733-012	GG-1	BOG	946096	G-613	CLRK
94230	GA-200	BGA	94438	GA-880R	BGA	9-451-733-012	GG-4	BOG	946108	G-191	CLRK
94230	GA-218	BGA	944398	GA-5648	CLRK	9-451-733-300	G-1173 ¹⁰⁸	BOG	946161	GP-1	CLRK
94234	GA-153	BGA	94440	GA-673R	BGA	945197	GP-53	OREN	94628	GA-683R	AMP
94236	GA-4828	BGA	944404	GA-106 ⁶⁶	CLRK	94527	GA-781	BGA	94628	GA-683R	BGA
94240	GAVW-120	BGA	944404	GA-326 ⁷¹	CLRK	94528	GA-782 ¹⁰⁸	BGA	94632619	GP-46	GMCX
94243-270	GP-3985	ISUZ	944408	G-1173	CLRK	94530	GA-589	BGA	9463381080	GA-2156	FIAT
94244	GA-195	BGA	94441	GA-732R	BGA	94531	GA-588	BGA	94-6352	GA-361	CATP
94244455	GPP-111	GMCX	94443	G-750	BGA	945350	G-750	CLRK	94-6353	GA-360	CATP
94244455	GPP-524	GMCX	94444	GA-170	BGA	945352	GP-1101	CLRK	9463704780	G-141	PEUG
94244456	GPP-111	GMCX	94445272	GP-3682	GMCX	945354	GA-39	CLRK	94641	GA-8	BGA
94244456	GPP-524	GMCX	94445272	GP-37	GMCX	94537	GAK-458	BGA	94648	GA-780	BGA
94246	GA-7017	BGA	944472	G-1143	CLRK	94538	GA-459	BGA	94659	GA-1616	BGA
9424870	GPP-111	GMCX	944474	G-750	CLRK	945443	G-1173 ¹⁰⁸	CLRK	94664	GA-930R	BGA
9424870	GPP-524	GMCX	944475	G-1176	CLRK	945445	G-1175 ¹⁰⁸	CLRK	94665	GA-890R	BGA
9424LF637	G-159	MACK	94455838	GAD-15	GMCX	9454647	GA-305	VOLV	94673	GA-264	BGA
94250176	GG-196	GMCX	94455838	GAD-15	OPEL	9454647-0	GA-305	VOLV	94675	GA-1095	AMP
94253	GA-158	BGA	94456741	GP-91	GMCX	9-455-160-246	G-296	BOG	94675	GA-1095	BGA
942534-C1	GA-891	IHCO	94459700	GP-462	GMCX	9-455-160-246	G-296-B	BOG	94677	GA-183R	BGA
94255	GA-3501	AMP	94462	GA-304	BGA	9-455-160-251	G-1121	BOG	9468447	GA-106 ⁶⁶	CLRK
94255	GA-3501	BGA	94463561	GAD-30	GMCX	9-455-160-317	GP-1122	BOG	9468447	GA-326 ⁷¹	CLRK
94-2621	GP-761H	TORO	94463715	GP-58	GMCX	9-455-160-327	G-1163	BOG	946857	GA-6129	CLRK
942625-C1	GA-357	IHCO	94466	GAK-458	BGA	9-455-160-328	G-297	BOG	946897	GA-106 ⁶⁶	CLRK
942625-C1	GA-357	KOMA	94467	GA-459	BGA	9-455-160-328	G-297-B	BOG	946897	GA-326 ⁷¹	CLRK
942626-C1	GA-356	IHCO	94470	GA-712R	BGA	9-455-160-329	G-1121F	BOG	94690	GA-826	BGA
942626-C1	GA-356	KOMA	9447000033	G-834	RENA	9-455-160-352	GP-1122	BOG	94699	GA-258	BGA

Referencia Cruzada por Numero de Parte

Cross Reference by Part Number



Numero	Gonher	Fabricante	Numero	Gonher	Fabricante	Numero	Gonher	Fabricante	Numero	Gonher	Fabricante
Number	Gonher	Manufacturer	Number	Gonher	Manufacturer	Number	Gonher	Manufacturer	Number	Gonher	Manufacturer
947.....	GA-74	AMP	950196.....	G-870	RENA	95135.....	GG-246	BGA	95242.....	GPP-11 ³⁹	BGA
947.....	GA-74	BGA	95021.....	GG-202	BGA	95136.....	G-294	AMP	95243.....	GG-101	BGA
94713.....	GA-398	BGA	95021.....	GP-50	CHEK	95136.....	G-294	BGA	95244.....	GPP-14	BGA
94-7207.....	GP-3985	CATP	95022.....	GG-94	BGA	95138.....	GG-298	BGA	95253.....	GG-5 L	BGA
94723.....	GA-398	BGA	95023.....	GG-63	BGA	9514.....	GA-356	CRO	95257.....	GG-239	BGA
94726.....	GA-376	BGA	95024.....	GG-76	BGA	95140.....	GPP-612	BGA	95265.....	GG-260	BGA
94728.....	GA-780	BGA	9503.....	GA-6129	CRO	95142.....	G-296	BGA	95267.....	GG-580	BGA
947293.....	G-750	CLRK	95030.....	GG-1	BGA	95142.....	G-296-B	BGA	95271.....	GG-20	BGA
94738.....	GA-616	BGA	95030.....	GG-4	BGA	95144.....	G-1143	BGA	95271IMP.....	GG-20	BGA
94741.....	GA-467	BGA	95031.....	GG-1	AMP	951475.....	G-31	CLRK	95275.....	GG-204	BGA
9474261.....	GA-106 ⁴⁶	SEDN	95031.....	GG-4	BGA	951475.....	G-31	WAUK	95277.....	GG-226	BGA
9474261.....	GA-326 ⁷¹	SEDN	95032.....	GG-5 L	BGA	95151.....	GG-189	BGA	95279.....	GG-261	BGA
94744.....	GA-966R	AMP	95032IMP.....	GG-5 L	BGA	95153.....	GG-189	BGA	95282.....	GG-214	BGA
94744.....	GA-966R	BGA	95033.....	GG-5 L	AMP	95156.....	GG-246	BGA	95283.....	GG-214	BGA
94745.....	GA-221R	BGA	95033.....	GG-5 L	BGA	95156.....	GG-408	BGA	95284.....	GG-146	BGA
94746.....	GA-600R	AMP	95033IMP.....	GG-5 L	BGA	95160.....	GG-232	BGA	95287.....	GG-185	BGA
94746.....	GA-600R	BGA	95044.....	GG-6	AMP	95161.....	GG-251	BGA	95288.....	GG-185	BGA
94756.....	GA-251	BGA	95044.....	GG-6	BGA	95162.....	GG-215	BGA	95291.....	GG-246	BGA
94761.....	GA-697R	BGA	95046.....	GG-19	AMP	95163.....	G-297	BGA	95293.....	GG-30	BGA
94772.....	GA-435R	BGA	95046.....	GG-19	BGA	95163.....	G-297-B	BGA	95294.....	GG-220	BGA
947728.....	GG-5 L	JEEP	95046IMP.....	GG-19	AMP	95166.....	G-296	BGA	95295.....	GG-150	BGA
94775.....	GA-759	BGA	95046IMP.....	GG-19	BGA	95166.....	G-296-B	BGA	95296.....	GG-1872	BGA
94782.....	GA-967R	BGA	95048.....	GG-7	AMP	95166IMP.....	G-296	BGA	95296IMP.....	GG-1872	BGA
9-4794-1.....	GP-149	SAME	95048.....	GG-7	BGA	95166IMP.....	G-296-B	BGA	95298.....	GG-115	BGA
947944.....	G-33	CLRK	95050.....	GG-123	AMP	95167.....	G-1121	BGA	953.....	GA-7	BGA
9479-7406.....	GP-46	DAEW	95050.....	GG-123	BGA	9516K.....	GAK-458	CRO	953.....	GP-52 ¹¹⁰	SULL
948.....	GA-50	CRO	95051.....	GG-16	AMP	951745.....	G-31	QUIC	953.....	GP-69 ¹⁸	SULL
94804.....	GA-1617	BGA	95051.....	GG-16	BGA	951745.....	G-31	STER	95300.....	GA-49	CRO
94834.....	GA-263	BGA	95051IMP.....	GG-16	AMP	951745.....	G-31	WAUK	95300.....	GG-92	BGA
94840.....	GA-389	AMP	95051IMP.....	GG-16	BGA	95179.....	GG-251	BGA	95301.....	GG-84	BGA
94840.....	GA-389	BGA	95052.....	GG-17	AMP	95181.....	G-1166	BGA	95302.....	GG-7018 ³⁸	BGA
94840078.....	GP-58	GMCX	95052.....	GG-17	BGA	95183.....	GG-290	BGA	95302.....	GG-7019 ³⁷	BGA
94840272.....	GA-3566	GMCX	95053.....	GG-45	BGA	95184.....	GPP-1287 ³⁹	BGA	95302.....	GG-7020 ¹⁴⁴	BGA
94840281.....	GG-203	GMCX	95054.....	GG-8 ¹⁰³	AMP	95184.....	PFF831 ⁴¹	BGA	95308.....	GG-136	BGA
94842.....	GA-518R	BGA	95054.....	GG-8 L ⁸⁰	AMP	95184.....	R 60 P ⁴²	BGA	95310.....	GG-255	BGA
9484246.....	GP-156	GMCX	95054.....	GG-8	BGA	95187.....	G-1166	BGA	95311.....	GG-66	BGA
94843.....	GA-539R	BGA	95054.....	GG-8 L	BGA	95188.....	G-1166	BGA	95314.....	GG-256	BGA
94844782.....	GG-220	GMCX	95061.....	G-1173	BGA	95189.....	G-1166	BGA	95316.....	GG-243	BGA
94845246.....	GP-156	GMCX	95061IMP.....	GG-16	BGA	95190.....	GG-177	BGA	95317.....	GG-214	BGA
94847351.....	GP-157	GMCX	95062.....	G-1175 ¹⁰⁸	BGA	95192.....	GPP-1122	AMP	95318.....	GG-72	BGA
94847597.....	GG-220	GMCX	95066.....	GG-76	BGA	95192.....	GPP-1122	BGA	95319.....	GG-187	BGA
94848478.....	GP-156	GMCX	95068.....	GG-1	BGA	95193.....	GG-580	BGA	95320.....	GG-67	BGA
948516.....	GA-192	AMCO	95068.....	GG-4	BGA	95194.....	G-11816	BGA	95321.....	GG-67	BGA
948516.....	GA-192	CHRY	95071.....	G-1176	BGA	95195.....	GP-1122	BGA	95322.....	GG-247	BGA
948516.....	GA-192	JEEP	95073.....	G-1174	BGA	95196.....	G-297	BGA	95323.....	GG-61	BGA
94851858.....	GP-156	GMCX	95079.....	GG-42	BGA	95196.....	G-297-B	BGA	95324.....	GG-65	BGA
94851874.....	GP-157	GMCX	95080.....	G-1163	BGA	95199.....	GG-64	BGA	95325.....	GG-249	BGA
94853522.....	GA-5466	GMCX	95080147.....	GA-200	ASTN	95199.....	GP-455	GREY	95328.....	GG-142	BGA
94853643.....	GP-157	GMCX	95080147.....	GA-218	ASTN	95201.....	GG-213	BGA	95329.....	GG-148	BGA
94856888.....	GA-5466	GMCX	95081.....	GG-87	BGA	95203.....	GG-76	BGA	95330.....	GG-190	BGA
94858995.....	GP-157	GMCX	95081IMP.....	GG-87	BGA	95204.....	GG-208	BGA	95331.....	GG-181	BGA
94860.....	GA-371	BGA	95082.....	GG-8	BGA	95208.....	2010PM-OR ⁷	AMP	95333.....	GG-185	BGA
94863.....	GA-534R	BGA	95084.....	GG-203	BGA	95208.....	2010TM-OR ²	AMP	95334.....	GPP-1000	BGA
94868.....	GA-608	AMP	95085.....	GG-203	BGA	95208.....	2010PM-OR ⁷	AMP	95335.....	GG-7018 ³⁸	BGA
94868.....	GA-608	BGA	95087.....	GG-196	BGA	95208.....	2010TM-OR ²	BGA	95335.....	GG-7019 ³⁷	BGA
948686.....	G-6	CLRK	95089.....	GG-203	BGA	95209.....	GS-2034	AMP	95335.....	GG-7020 ¹⁴⁴	BGA
94870.....	GA-799R	BGA	95093.....	GG-240	BGA	95209.....	GS-2034	BGA	95336.....	GP-78	AMP
94871.....	GA-798R	BGA	95095.....	GG-5 L	BGA	95210.....	GS-2033	AMP	95336.....	GP-1107	BGA
94876.....	GA-694	BGA	950964.....	G-31	WAUK	95210.....	GS-2033	BGA	95336IMP.....	GP-78	AMP
94879.....	GA-510	BGA	95097.....	GG-47	AMP	95211.....	GG-144	BGA	95338.....	GP-78	AMP
94883.....	GA-3551 ⁵⁵	BGA	95097.....	GG-47	BGA	95212.....	GS-2033	BGA	95338.....	GP-78	BGA
94883.....	GA-3551 XT ⁶⁴	BGA	95099.....	GG-268	BGA	95214.....	GG-194	BGA	95339.....	GP-1105	BGA
94888.....	GA-380	BGA	9-51010-600-9.....	GAK-20	ISUZ	95216.....	GP-85	AMP	95340.....	GP-110	BGA
949.....	GA-86	AMP	95101-06009.....	GAK-20	FURU	95216.....	GP-85	BGA	95341.....	GP-1108	AMP
949.....	GA-86	BGA	95101-06009.....	GAK-20	HAMA	95216IMP.....	GP-85	AMP	95341.....	GP-1108	BGA
94902.....	GA-367	BGA	95103.....	GG-137	BGA	95218.....	GG-19	BGA	95341IMP.....	GP-1108	BGA
949095.....	GPP-14	CLRK	95107.....	GP-1101	BGA	95218.....	G-801	DAIM	95342.....	GP-11	BGA
949096.....	G-613	CLRK	95108.....	GP-1101	BGA	95218.....	G-801	LEYL	95346.....	GG-95	BGA
949097.....	GP-2071W	CLRK	95109.....	GP-1101	BGA	95218.....	G-801	MBNZ	95347.....	GG-104	BGA
949098.....	G-500	CLRK	95109IMP.....	GP-1101	BGA	95218IMP.....	GP-84	BGA	95348.....	GG-48	BGA
949145.....	G-750	CLRK	95112.....	G-1123 ¹⁰⁸	BGA	95219.....	GP-83	BGA	95352.....	GP-110	BGA
94932-128.....	GP-54 ¹¹	NISS	95113.....	G-1173	BGA	95219IMP.....	GP-83	BGA	95352IMP.....	GP-110	BGA
94932-128.....	GP-66 ¹⁰	NISS	95115.....	GP-110	BGA	9522.....	GA-405	CRO	95353.....	GPP-18	BGA
949363.....	GA-6127	CLRK	95116.....	GP-55	BGA	95221.....	GG-217	BGA	95356.....	GP-110	AMP
949418.....	GP-2071W	CLRK	95117.....	G-1176	BGA	952218.....	G-31	WAUK	95356.....	GP-110	BGA
94976.....	GA-176	BGA	95118.....	GP-26	BGA	95223.....	GG-220	BGA	95357.....	GPP-18	AMP
94977.....	GA-186	BGA	95118IMP.....	GP-26	BGA	95227.....	GG-7018 ³⁸	BGA	95357.....	GPP-18	BGA
949838.....	GP-26	CLRK	95120.....	GP-27	AMP	95227.....	GG-7019 ³⁷	BGA	95358.....	GP-1122	BGA
949839.....	GP-27	CLRK	95120.....	GP-27	BGA	95227.....	GG-7020 ¹⁴⁴	BGA	95361.....	GP-1122	BGA
9495.....	GP-14	GREY	95120IMP.....	GP-27	BGA	95228.....	GG-351	BGA	95362.....	GP-110	BGA
95.....	G-236	DEL	95121.....	GP-92	BGA	9523.....	GA-436	CRO	95367.....	GP-1105	BGA
95.....	GA-361	ERO	95121IMP.....	GP-92	BGA	95231.....	GPP-1287 ³⁹	AMP	95368.....	GP-62	BGA
95.....	GA-55	WIX	95122.....	GP-93	BGA	95231.....	PFF831 ⁴¹	AMP	95369.....	G-293	BGA
95001.....	GG-1	BGA	95122IMP.....	GP-93	BGA	95231.....	R 60 P ⁴²	AMP	95370.....	G-295	BGA
95001.....	GG-4	BGA	95124.....	GP-1122	BGA	95231.....	GPP-1287 ³⁹	BGA	95371.....	G-270	AMP
9500196.....	G-870	MASY	95125.....	GP-92	BGA	95231.....	PFF831 ⁴¹	BGA	95371.....	G-270	BGA
95002.....	GG-124	BGA	95128.....	GPP-111	AMP	95231.....	R 60 P ⁴²	BGA	95372.....	GPP-1122	BGA
95003.....	GG-5 L	BGA	95128.....	GPP-524	AMP	95232.....	GPP-547 ³⁹	BGA	95373.....	GP-1122	BGA
95007.....	GG-3	BGA	95128.....	GPP-111	BGA	95232.....	PFF831 ⁴¹	BGA	95374.....	GP-749	AMP
95008.....	GG-246	BGA	95128.....	GPP-524	BGA	95232.....	R 60 P ⁴²	BGA	95374.....	GP-749	BGA
95009.....	GP-458	BGA	95129.....	GG-209	BGA	95237.....	GP-1107	AMP	95375.....	G-270	BGA
95010.....	G-152	BGA	9513.....	GA-5648	CRO	95237.....	GP-1107	BGA	95377.....	GP-1109 ²²	AMP
95011.....											

Numero	Gonher	Fabricante	Numero	Gonher	Fabricante	Numero	Gonher	Fabricante	Numero	Gonher	Fabricante
Number	Gonher	Manufacturer	Number	Gonher	Manufacturer	Number	Gonher	Manufacturer	Number	Gonher	Manufacturer
95381	GPP-18	AMP	95537	GPP-419	BGA	959757-C1	GP-310	IHCO
95381	GPP-18	BGA	95540	G-1176	BGA	9597K	GAK-216	CRO
95383	GP-1101 ⁵⁴	AMP	95543	G-278	AMP	9598	GA-416	CRO
95383	GP-1101 ⁵⁴	BGA	95543	G-278	BGA	95PS269	GA-27	CONP
95384	GP-56	BGA	95544	G-276	BGA	95PS-269	GA-27 ¹¹²	CHIC
95384MP	GP-56	BGA	95545	G-277	BGA	95PS2690	GA-27	CHIC
953989	G-33	CLRK	95546	GPP-419	BGA	95PS2690	GA-27	CONP
9535	GP-51	GREY	95547	GPP-425	BGA	96 536 696	GA-324	GMCX
954	GAD-1	AMP	95548	GPP-420	BGA	96 536 697	GA-324	GMCX
954	GAD-1	BGA	95549	GPP-426	BGA	960	GP-28 ⁶	TFIL
954	GA-18	CRO	95551283	G-296	CITR	960	GP-430 ⁸	TFIL
95400	GPP-19	BGA	95551283	G-296-B	CITR	96002933	GP-40	CITR
95401	G-1143 ⁹⁰	AMP	95553	GG-164	BGA	960044	GP-2071W	CLRK
95401	G-1143 ⁹⁰	BGA	95554	GG-164	BGA	96006	GGP-25	BGA
95403	GP-78	BGA	95555	GG-234	BGA	96006MP	GGP-25	BGA
95404	GP-1224	BGA	95556	GG-215	BGA	96009	GP-92	BGA
95405	GPP-11	BGA	95556	GG-215	CRQ	96010991	GA-2156	CITR
95405MP	GPP-11	BGA	95559	GG-160	BGA	96011	GP-92	BGA
95406	GPP-1000	BGA	9556000220	GP-40	TALB	96019991800	GA-2156	CITR
95407	GPP-11	BGA	95561	GG-164	BGA	96020	GP-2071W	BGA
95411	GPP-1287 ³⁹	BGA	95566	GG-246	BGA	960216	G-1143 ⁹⁰	OREN
95411	PFF831 ⁴¹	BGA	95568	GG-196	BGA	96022	GP-2071W	BGA
95411	R 60 P ⁴²	BGA	95569	GG-146	BGA	96023	GP-2071W	BGA
95412	GPP-1291	BGA	95575783	G-296	CITR	960243	GA-106 ⁹⁶	CLRK
95415	GPP-11	BGA	95575783	G-296-B	CITR	960243	GA-326 ⁷¹	CLRK
95418	S 3202 ⁴⁰	BGA	95575783	G-296	TALB	96025	GP-1011Q	BGA
95422	GPP-1022S	BGA	95575783	G-296-B	TALB	96026	GP-2071W	BGA
95423	GPP-1007S	BGA	95576	GG-265	BGA	96027	GP-92	BGA
95431	GPP-11	BGA	95576	GG-267	BGA	96029	GGP-125	BGA
95432	S 3202 ⁴⁰	BGA	95577	GG-267	BGA	96030	GP-2071W	BGA
95433	GPP-11	BGA	95579	GG-266	BGA	96033	GP-92	AMP
95434	GPP-14	BGA	95580482	GP-40	CITR	96040	GP-2015W	BGA
95439	GPP-11	BGA	9558048280	GP-40	CITR	96042	GP-2022W	AMP
95441	GPP-103 ⁴⁰	AMP	9558048280	GP-40	TALB	96051792	GG-76	EUCL
95441	GPP-11 ³⁹	AMP	95580483	GP-40	CITR	96051792	GG-76	GMCX
95441	GPP-11	BGA	95583693	G-297	CITR	96055471	GA-142	GMCX
95442	S 3202 ⁴⁰	BGA	95583693	G-297-B	CITR	96057994	GA-166	GMCX
95443	GPP-11	BGA	95585	GS-1261	BGA	96058022	GG-151	GMCX
95444	GP-14	BGA	95594	GG-251	BGA	96058042	GP-2951	GMCX
95451	G-128	BGA	95595	GG-986	BGA	96060114	GG-146	GMCX
95452	GPP-11	BGA	95599	GG-1047	BGA	96064225	GG-146	GMCX
95454	GG-39	BGA	9555	GP-3816	GREY	96064348	GA-166	GMCX
9545622	GP-3985	CITR	9560	GA-98 ¹¹²	CRO	960689	G-296	MASY
95460	GG-181	BGA	95604	GPP-1003S	BGA	960689	G-296-B	MASY
95461	GG-114	BGA	95608917	G-296	CITR	960698	GP-31	CLRK
95463	GG-264	BGA	95608917	G-296-B	CITR	96071	GP-2071W	BGA
95470530	GG-5 L	CITR	9560K	GA-98 ¹¹²	CRO	96071MP	GP-2071W	BGA
95472	GPP-1122	BGA	95611	GPP-547 ³⁹	BGA	96072	GP-1011Q	BGA
95472MP	GPP-1122	BGA	95611	PFF831 ⁴¹	BGA	96073	GP-1011Q	BGA
95477	GG-137	BGA	95611	R 60 P ⁴²	BGA	96073MP	GP-1011Q	BGA
95479	GG-208	BGA	95612	GA-759	VERS	96074	GP-1013Q	BGA
95481	GG-46	AMP	95618786	GA-2156	CITR	960775	G-750	CLRK
95481	GG-46	BGA	95621	GP-11	BGA	960911	G-296	CASE
95481MP	GG-46	BGA	95626	GPP-1109	BGA	960911	G-296-B	CASE
95482	GG-242	BGA	95630	GPP-1287 ³⁹	BGA	960911	G-296	DAVI
95483	GG-3728	BGA	95630	PFF831 ⁴¹	BGA	960911	G-296-B	DAVI
95484	GG-581	BGA	95630	S 3225 P ⁴²	BGA	960978	GP-2071W	CLRK
95486	GG-79	BGA	95632	GPP-425	BGA	9609K	GAK-1532	CRO
95487	GG-256	BGA	95636	GGP-424	BGA	9605	GP-53	GREY
95487	GG-580	BGA	95638	GPP-419	BGA	961000	GAK-625	CLRK
95491	GG-185	BGA	95638	GPP-421	BGA	9610-1619	GP-69	ATCO
95495621	GP-40	CITR	95638747	GP-40	CITR	961028	GP-1011Q	CLRK
95495622	GP-40	CITR	95640	GP-749	BGA	961048	G-297	CLRK
955 110 131 00	GAVW-616	AUDI	95651	G-128	BGA	961048	G-297-B	CLRK
955 110 131 00	GAVW-616	PORS	95658-433	GA-2160	CITR	96112	GP-2126Q	BGA
955 110 131 00	GAVW-616	VOLK	95659-354	GA-2160	CITR	96113	GP-2127W	BGA
95500	GG-223	BGA	956594	GA-49	DEMA	96114	GP-2108W	BGA
95501	GG-203	BGA	9566	GA-7716	CRO	961172	GP-53	CLRK
95502	GG-185	BGA	9567	GA-375	CRO	961172	GP-53	CUMM
95503693	G-297	CITR	95674	GP-749	BGA	9611973	GG-124	NEWH
95503693	G-297-B	CITR	9569	GA-482	CRO	9613	GA-892	CRO
95504	GP-1105	BGA	95690	GP-96	AMP	96131549	GG-5 L	CITR
95508	GG-189	BGA	95690	GP-96	BGA	96133	G-33	BGA
95511	G-1173	BGA	9565	GP-54	GREY	9613322	GP-14	FORD
95512	G-1175	BGA	95708	G-1176	BGA	9613323	GP-50	FORD
95512	G-1176	BGA	95734	GG-265 ³⁶	BGA	9613324	GP-1	FORD
9551241	G-1123	KAMP	95735	GG-307	BGA	9613325	GPP-19	FORD
95517	G-178	BGA	9574	GA-6127	CRO	9613326	GPP-18	FORD
95518	G-862	BGA	9575	GA-357	CRO	9613327	GP-310	FORD
9552	GA-9334	CRO	95759	GPP-420	BGA	9613328	G-335	FORD
95521	GG-102	BGA	9576-P163428	GP-761H	FORD	9613329	G-331	FORD
95522	GPP-11	BGA	9579	GA-1284	CRO	9613330	GP-1	FORD
95527	GP-109	BGA	957E-6731	G-813	FORD	9613334	G-139	FORD
95528	GP-110	BGA	957E-6731-A	G-813	FORD	9613336	GPP-18	FORD
9553	GA-8047	CRO	958	GAK-16	CRO	9613337	GP-3600	FORD
95531	GPP-418	AMP	9580	GA-1286	CRO	9613339	GP-78	FORD
95531	GPP-418	BGA	9581	GA-589	CRO	9613340	GP-35	FORD
95532	GPP-419	AMP	95811	GP-155	BGA	9613342	GP-390 ⁹³	FORD
95532	GPP-419	BGA	95814	G-870	PETT	9613344	GP-1122	KENW
95533	GPP-424	BGA	958-14	G-870	LSTR	961419	GP-55	CLRK
95534	GPP-419	AMP	9582	GA-588	CRO	96144-871	GA-2173	CITR
95534	GPP-419	BGA	9586	GA-1285	CRO	961605	GA-251	CLRK
95534486	GG-1	CITR	9588	GA-1008	CRO	961657	GP-55	CLRK
95534486	GG-4	CITR	9589K	GA-27	CRO	9617	GP-171	NANN
95535	GPP-425	BGA	958K	GAK-16	CRO	961711	GP-53	CLRK
95536	GPP-426	BGA	95-9336	GP-1101	WHIT	96197	GP-1012Q	BGA

Referencia Cruzada por Numero de Parte

Cross Reference by Part Number



Numero	Gonher	Fabricante	Numero	Gonher	Fabricante	Numero	Gonher	Fabricante	Numero	Gonher	Fabricante
Number	Gonher	Manufacturer	Number	Gonher	Manufacturer	Number	Gonher	Manufacturer	Number	Gonher	Manufacturer
9707-6483	GP-28 ⁸	ATCO	9721-0338	GP-66 ¹⁰	ATCO	980917-M91	G-801	MASY	9843662	GP-2071W	FORD
9707-6483	GP-430 ⁸	ATCO	9721-0338-00	GP-54 ¹¹	ATCO	9809615	GAK-625	NEWH	984479-M91	G-813	MASY
9707-6483-00	GP-28 ⁸	ATCO	9721-0338-00	GP-66 ¹⁰	ATCO	980985-R91	G-750	IHCO	984636	G-33	HYST
9707-6483-00	GP-430 ⁸	ATCO	972214	GA-44	TOWM	981	GA-98 ¹¹²	AMP	985233	G-813	HYST
970875102	G-296	NANN	97-2214	GA-44	CATP	981	GA-98 ¹¹²	BGA	9853	GAK-16	MANI
970875102	G-296-B	NANN	972690	GP-81	PROM	98100M1	G-162H	KNE	9853	GAK-16	MANO
9709-0000-103	GP-28 ⁸	ATCO	9726K	GA-26	CRO	98100M1	G-225	KNE	9-85582-125-0	G-870	ISUZ
9709-0000-103	GP-430 ⁸	ATCO	9728	GA-467	CRO	98100M1	G-225	PUR	9-85582-151-0	G-870	ISUZ
9709-0001-00	GP-110	ATCO	97295	GG-146	NAFI	9819500	G-296	FIAT	9855-82-1510	G-870	KOMA
9709-0001-02	G-238	ATCO	9725	GP-40	GREY	9819500	G-296-B	FIAT	98559-21510	G-870	TCM
9709-0001-03	GP-28 ⁸	ATCO	97310	GAK-403	HYST	9815	GP-28 ⁸	GREY	98561	G-836	HYST
9709-0001-03	GP-430 ⁸	ATCO	973118-M1	G-813	MASY	9815	GP-430 ⁸	GREY	985651	G-834	HYST
9709-0005-20	GP-1122	ATCO	97335	GA-27	GALN	982	GAK-403	AMP	985651-06	G-834	HYST
9709-0005-50	G-296	ATCO	97340400207	GP-1	FLXI	982	GAK-403	BGA	985934-001	G-1173 ¹⁰⁸	PHHR
9709-0005-50	G-296-B	ATCO	97342400152	GA-6880	FLXI	9821387	GP-761H	NEWH	9855	GP-3985	GREY
9709-0007-35	GP-54	ATCO	97342400159	GA-26	FLXI	98262135	GP-3816	COMA	98-6029	GA-21	WHIT
9709-0010-00	G-836	ATCO	97342400174	GA-376	FLXI	98262136	GP-3816	COMA	986-450-001	GG-45	BOG
9709-0010-01	GP-26	ATCO	97342400177	GA-6129	FLXI	98262220	GP-54	COMA	986-450-001	GG-45	BOG
9709-0010-02	GP-27	ATCO	97342400182	GP-57	FLXI	98262225	GP-54 ¹¹	COMA	986-450-002	GG-76	BOG
9709-0011	GP-36	ATCO	97342400184	GP-1101	FLXI	9826225	GP-66 ¹⁰	COMA	986-450-004	GG-202	BOG
9709-0011-00	GP-36	ATCO	97342400187	GAK-16	FLXI	982625006	GA-6129	COMA	986-450-009	GG-45	BOG
9709-0012	GP-54 ¹¹	ATCO	97342400188	G-33	FLXI	982625026	GA-6129	COMA	986-450-010	GG-94	BOG
9709-0012	GP-66 ¹⁰	ATCO	97342400189	G-1175	FLXI	9826283	GP-54 ¹¹	COMA	986-450-012	GG-5 L	BOG
9709-0012-00	GP-54	ATCO	97342400192	GA-376	FLXI	9826283	GP-66 ¹⁰	COMA	986-450-015	GG-45	BOG
9709-0014	GP-1122	ATCO	97342400201	GA-229	FLXI	9826688	GP-864H	NEWH	986-450-016	GG-196	BOG
9709-0016	GP-1122	ATCO	97342400206	GA-1095	FLXI	982671-R91	GA-37	IHCO	986-450-018	GG-203	BOG
9709-0021	G-33	ATCO	97342400207	GP-1	FLXI	982672-R91	GA-37	IHCO	986-450-022	GG-203	BOG
9709-0021-00	G-33	ATCO	97342400209	GAK-1532	FLXI	982673-R91	GA-37	IHCO	986-450-101	GG-98	BOG
9709-0023-00	G-834	ATCO	9736-5671-00	GP-77	ATCO	982678-R91	GA-37	IHCO	986-450-103	GG-185	BOG
9709-0024-00	GP-77	ATCO	97372	GG-20	HYST	983	GA-71	CRO	986-450-104	GG-184	BOG
9709-0029-00	G-1123	ATCO	9738	GA-7360	CRO	9830006	GA-49	GULD	986-450-111	GG-185	BOG
9709-0034-00	G-31	ATCO	974	GA-3916	UNN	9830006	GA-49	KRAM	986-450-119	GG-46	BOG
9709-0071-00	G-1174	ATCO	974535-M1	G-813	MASY	9830520	G-296	LIN	986-450-135	GG-986	BOG
9709-0075-00	G-1175	ATCO	9745	GP-3531	EXP	9830520	G-296-B	LIN	986-450-999	GG-5 L	BOG
97095	GG-146	NAFI	975	GAD-15	UNN	9830600	GP-1	GULD	986-452-000	GP-38	BOG
97096777	GP-359	GMCX	97520500163	GP-2071W	FLXI	9830600	GP-1	LIN	986-452-001	GP-1	BOG
9705	GP-3682	GREY	9752050-0164	GP-27	FLXI	9830606	GP-81	GULD	986-452-002	GP-1	BOG
9705	GP-58	GREY	9752050-0165	GP-26	FLXI	9830606	GP-171	LIN	986-452-003	GP-81	BOG
971	GAD-1	BGA	9752050-0167	GP-57	FLXI	9830607	GP-1	GULD	986-452-003	GP-9	BOG
971	GA-274	UNN	9752050-0175	G-169	FLXI	9830607	GP-310	LIN	986-452-005	GP-1	BOG
9710-0098-01	G-31	ATCO	9752050-0176	GP-53	FLXI	9830610	GP-54	GULD	986-452-005	GP-81	BOG
9710-0110-01	G-1123	ATCO	9752050-0178	GA-376	FLXI	9830610	GP-66 ¹⁰	GULD	986-452-006	GP-462	BOG
9710-0376	G-191	ATCO	9752050-0183	GP-1	FLXI	9830610	GP-54 ¹¹	LIN	986-452-007	GP-149 ⁸⁹	BOG
9710-0377	GP-110	ATCO	97520500197	GA-229	FLXI	9830610	GP-66 ¹⁰	LIN	986-452-007	GP-91 ⁷⁸	BOG
9710-0378	G-238	ATCO	97520500220	GP-171 ¹⁶	FLXI	9830615	GP-66	GULD	986-452-008	GP-3985	BOG
9710-0405	GP-36	ATCO	97520500234	GP-9586	FLXI	9830615	GP-66	LIN	986-452-009	GP-42	BOG
9710-0406	GP-1122	ATCO	97520500248	GA-26	FLXI	9830617	GP-66	GULD	986-452-015	GP-3531	EXP
9710-0633-01	G-1175	ATCO	975205227	G-750	FLXI	9830622	GP-77	GULD	986-452-016	GP-40	BOG
9710-0633-02	G-33	ATCO	975205228	G-750	FLXI	9830622	GP-77	LIN	986-452-017	GP-157	BOG
9710-1776	GP-114	ATCO	975205233	GP-3766	FLXI	9830624	GP-36	GULD	986-452-017	GP-58	BOG
9710-1777	G-566	ATCO	97540900167	GA-26	FLXI	9830625	GP-28 ⁸	GULD	986-452-020	GP-40	BOG
9710-1778	G-750	ATCO	9758	GA-425	CRO	9830625	GP-430 ⁸	GULD	986-452-021	GP-38	BOG
9710-1779	G-1143	ATCO	9759	GA-426	CRO	9830625	GP-28 ⁸	LIN	986-452-023	GP-3682	BOG
9710-1788	GP-2071W	ATCO	9759112	G-1143	COLS	9830625	GP-430 ⁸	LIN	986-452-023	GP-37	BOG
9710-1893	GP-1122	ATCO	9755	GP-46	GREY	9830626	GP-128	LIN	986-452-024	GP-171	BOG
9710-1894	GP-1122	ATCO	976	GA-33	AMP	9830626	GP-28 ⁸	LIN	986-452-026	GP-3531	EXP
9711-0024	G-1123	ATCO	976	GA-33	BGA	9830626	GP-430 ⁸	LIN	986-452-028	GP-157	BOG
9711-0127	G-33	ATCO	97611005	GAK-1532	VERM	9830627	GP-36	LIN	986-452-036	GP-149	BOG
9711-0130	G-1175	ATCO	976325-C1	GA-361	KOMA	9831606	GP-1123	GULD	986-452-041	GP-40	BOG
971215	GP-171 ¹⁶	TOWM	976326-C1	GA-360	IHCO	9831615	GP-1122	GULD	986-452-044	GP-58	BOG
97-1217	GA-33	CATP	976326-C1	GA-360	KOMA	9831615	GPP-1122	GULD	986-452-061	GP-91	BOG
971238001	GP-36	HANO	977	GAK-16	AMP	9831617	GPP-1122	GULD	986-452-900	GP-38	BOG
971238001	GP-36	MASY	977	GP-31	FACE	9831622	GP-1122	GULD	986-452-903	GP-81	BOG
971238001	GP-36	MBNZ	97710	GP-761H	VOLV	9831622	GP-1122	LIN	986-452-904	GP-38	BOG
971251	GP-3682	TOWM	97719921	GP-359	GMCX	9831625	GPP-1122	LIN	986-452-905	GP-171	BOG
9712-5401-02	GP-1122	ATCO	9779	GA-779	NAP	9832045	GA-106 ⁶⁷	CLEV	986-452-908	GP-40	BOG
9712-5401-03	GP-36	ATCO	9779663	GP-53	COLS	9832045	GA-206 ¹⁰⁸	CLEV	986-452-909	GP-42	BOG
9712-5401-04	GP-54	ATCO	9775	GP-455	GREY	9832045	GA-326 ⁷²	CLEV	986-452-916	GP-40	BOG
9712-5401-203	GP-36	ATCO	978	GAK-16	AMP	9832046	GA-106 ⁶⁷	CLEV	986-452-917	GP-157	BOG
9712-5401-204	GP-54 ¹¹	ATCO	978	GAK-16	BGA	9832046	GA-326 ⁷¹	CLEV	986-452-928	GP-157	BOG
9712-5401-204	GP-66 ¹⁰	ATCO	9783	GA-853R	CRO	9832047	GA-206	CLEV	986-452-929	GP-3682	BOG
9712-5402	G-31	ATCO	9790-1147	G-31	ATCO	9832047	GA-206	TORI	986-452-929	GP-37	BOG
9712-5404-04	GP-54 ¹¹	ATCO	9790-1480	G-1123	ATCO	9832825	GA-7	FORD	986-452-930	GP-171	BOG
9712-5404-04	GP-66 ¹⁰	ATCO	9790-1543	GP-36	ATCO	983561	G-836	HYST	9865	GA-33	MANO
971292	G-6	PROM	9794770007	GPP-1060	MBNZ	983614	GP-1122	AUWA	986614-M91	G-870	MASY
971293	GAK-16	TOWM	9794770015	GPP-1060	MBNZ	983614	GP-1122	HANO	986674-M91	G-813	MASY
97-1357	G-296	CATP	9795	GP-3816	GREY	983-614-109	GP-1122	KASB	986B03003	GA-864R	BOG
97-1357	G-296-B	CATP	97U305EC5	GA-33	BARB	983-614-1098	GP-1122	KASB	987	GAK-20	AMP
97136470	GP-359	GMCX	97W39EC5	GAK-16	BARB	983883	G-296	GMCX	987	GAK-20	BGA
97140	GA-360	GALN	98	GA-59	WIX	983883	G-296-B	GMCX	987-452-904	GP-38	BOG
97140	GA-361	GALN	9800633	GP-761H	NEWH	983883	G-296	HYST	987-452-909	GP-42	BOG
97148270	GP-359	GMCX	98024725	GP-54 ¹¹	MENG	983883	G-296-B	HYST	9875053	GA-360	COLS
971739-171	GP-26	FLXI	98024725	GP-66 ¹⁰	MENG	983884	G-296	GMCX	98771	GP-34	ROCK
971739-172	GP-27	FLXI	98025	G-152	ALCH	983884	G-296-B	GMCX	9-879-993-000	G-1123	BOG
9717392	G-1175	FLXI	98025-0	G-152	ALCH	9839008	GP-9				

Numero	Gonher	Fabricante	Numero	Gonher	Fabricante	Numero	Gonher	Fabricante	Numero	Gonher	Fabricante
Number	Gonher	Manufacturer	Number	Gonher	Manufacturer	Number	Gonher	Manufacturer	Number	Gonher	Manufacturer
9884	GG-94	NAFI	991154	G-169	CLRK	995390	GP-22	CLRK	9A	GA-33	BOG
9-88511-166-0	G-870	ISUZ	991203410	GPP-18	SAMS	9955749	GA-416	FIAT	9C3-107	GAK-403	MTOR
9885-11-1660	G-870	KOMA	991203410	GPP-18	VOLV	9955749	GA-416	IVEC	9C3-110	GAK-403	MTOR
9-88512-151-0	G-870	ISUZ	991203640	GP-1122	SAMS	9955976	GAK-216	FIAT	9F642	GA-361	CATP
9-88513-107-0	G-870	ISUZ	991203640	GP-1122	VOLV	9955976	GAK-216	IVEC	9F6426	G-191	CATP
9-88513-107-1	G-870	ISUZ	991218853	GP-1300	SAMS	9957615	GAK-16	FIAT	9F6427	G-191	CATP
9885779	GA-403	MAGI	991218853	GP-3000	VOLV	9957615	GAK-16	IVEC	9F6428	G-191	CATP
988580	GAK-625	DEMA	991245700	GA-360	SAMS	9957810	GA-416	FIAT	9F6430	G-191	CATP
9-88580-105-0	G-870	ISUZ	991245800	GA-361	SAMS	9957810	GA-416	IVEC	9F6700	G-191	BARB
9-88582-125-0	G-870	ISUZ	991290710	GP-178	DAEW	9957811	GAK-216	FIAT	9F6700	G-191	BAYC
988596	GA-405	DEMA	991290710	GP-178	SAMS	9957811	GAK-216	IVEC	9F6700	G-191	CATP
9886	GG-1872	NAFI	991290710	GP-178	VOLV	9957888	GA-361	FIAT	9F6700	G-191	CLEV
988618	G-33	DEMA	991312	GA-405	ERF	9957888	GA-360	FIAT	9F6742	G-191	CATP
988637	GA-356	DEMA	9914-23-603	GA-405	MZDA	9957889	GA-360	IVEC	9G6420	G-191	CATP
988638	GA-357	DEMA	9914553	G-225	FIAT	99-5800	GA-398	CATP	9H1252	G-1166	CATP
988670	GA-24	DEMA	9915545	GA-26	FIAT	99-6140	GA-24	WHIT	9H4537	G-1166	CATP
988673	GA-467	DEMA	991718	GP-50	AMCO	99-6140-A	GA-24	WHIT	9H4565	G-1166	CATP
988692	G-750	DEMA	991718	GP-50	CHRY	9961941	G-24	HIAB	9H4729	G-1166	CATP
988694	GP-110	DEMA	991718	GP-50	JEEP	996204-R1	G-750	IHCO	9H8792	G-1166	CATP
988695	GA-5648	DEMA	9917419	GA-24	FIAT	996204-R91	G-750	IHCO	9L0699	GA-9334	CATP
988702	GPP-14	DEMA	9917419	GA-24	IVEC	996900	GP-20	AMCO	9L1695	GA-375	CATP
988732	GP-1101	DEMA	9917881	GA-24	ALCH	996900	GP-20	CHRY	9L2169	GA-135	CATP
988738	GA-436	DEMA	9917881	GA-24	FIAT	996900	GP-20	JEEP	9L2169	GA-35	CATP
988768	G-143	DEMA	9917881	GA-24	IVEC	9965	GP-3985	GREY	9L25	G-1166	CATP
988972	GAK-403	HITA	9918114	G-296	FIAT	997121-R1	G-750	IHCO	9L699	GA-9334	CATP
989	G-75	CRO	9918114	G-296-B	FIAT	997121R9	G-750	IHCO	9L9054	GP-36	CATP
98927	GA-106 ⁹⁷	GALN	9918114	G-296	IVEC	99737	GA-360	GALN	9L9200	GP-36	CATP
98927	GA-206 ⁰⁸	GALN	9918114	G-296-B	IVEC	99737	GA-360	KOMA	9M1827	GA-1286	CATP
98927	GA-326 ⁷²	GALN	9918144	G-296	FIAT	99739	GA-361	GALN	9M1827	GA-9334	CATP
98-9763	GA-880R	TORO	9918144	G-296-B	FIAT	99739	GA-361	KOMA	9M1828	GA-1008	CATP
9-89980-105-0	G-870	ISUZ	9918144	G-296	IVEC	9974131	GA-5648	GMCX	9M1828	GA-1284	CATP
99	G-200	DEL	9918144	G-296-B	IVEC	9974136	GA-49	GMCX	9M1829	GA-1008	CATP
99	GA-325	WIX	9918184	G-296	FIAT	9974143	GA-405	GMCX	9M1829	GA-1284	CATP
99000061	G-834	VERS	9918184	G-296-B	FIAT	9974186	GA-49	GMCX	9M1884	GA-1285	CATP
99000062	G-296	VERS	9918184	G-296	IVEC	9974283	GA-303	GMCX	9M1884	GA-8047	CATP
99000062	G-296-B	VERS	9918184	G-296-B	IVEC	9974287	GAD-3	GMCX	9M1885	GA-1008	CATP
99000063	G-296	VERS	9921320	GA-360	FIAT	9974318	GA-3300	GMCX	9M1885	GA-1284	CATP
99000063	G-296-B	VERS	9921320	GA-360	IVEC	9974336	GAVW-2	GMCX	9M4798	GA-1287	CATP
990-00-190-13-7	GA-405	STEY	9921419	GAK-403	FIAT	9974337	GA-2740	GMCX	9M4798	GA-9045	CATP
99008150	GA-113	ALCH	9921419	GAK-403	IVEC	9974341	GAD-1	GMCX	9M5511	GA-1287	CATP
990-12-190-03-7	GA-405	STEY	992221	GP-171 ¹⁵	CLRK	9974348	G-296	GMCX	9M5511	GA-9045	CATP
990-12-190-13-7	GA-405	STEY	9923130	GA-360	ALCH	9974348	G-296-B	GMCX	9M6377	GA-5648	CATP
990-12-190-70-5	GA-405	STEY	9923130	GA-360	FIAT	997438-R91	G-500	IHCO	9M6379	GA-5648	CATP
990-14-190-03-3	GA-467	STEY	9923130	GA-360	IVEC	9974649	GAK-625	GMCX	9M9377	GA-5648	CATP
990325	G-801	HYST	9924138	G-296	FIAT	9974668	GA-8047	GMCX	9M9641	G-1166	CATP
990359	GP-3	AMCO	9924138	G-296-B	FIAT	9974697	GA-71	GMCX	9M9740	G-152	CATP
990359	GP-3	CHRY	9924318	G-296	ALCH	9974726	GA-49	GMCX	9N1000	GP-36	CATP
990359	GP-3	JEEP	9924318	G-296-B	ALCH	9974791	GA-4365	GMCX	9N3366	GP-1011Q	CATP
990436	GP-50	CLRK	9924318	G-296	FIAT	9974793	GA-277	GMCX	9N3367	GP-1011Q	CATP
990504	GA-49	DEMA	9924318	G-296-B	FIAT	9975216	GP-1122	GMCX	9N3368	GP-2071W	CATP
9905154	G-1173 ⁰⁸	FIAT	9924318	G-296	IVEC	9975233	GP-28 ⁵	GMCX	9N3717	GP-2071W	CATP
99053	GG-148	NAFI	9924318	G-296-B	IVEC	9975233	GP-430 ⁸	GMCX	9N3718	GP-1011Q	CATP
990539	GP-91	PARM	9930006	GA-49	KRAM	9975267	GP-310	GMCX	9N3719	GP-2071W	CATP
99054	GG-142	NAFI	9930038	G-834	NISS	9975334	GP-46	GMCX	9N5570	GP-9586	CATP
990656	G-31	DEMA	9930450	G-1123	FIAT	9975348	G-296	GMCX	9N5680	GP-36	CATP
99068	GG-115	NAFI	9930450	G-1123	IVEC	9975348	G-296-B	GMCX	9N5690	GP-36	CATP
990759	GA-77	AMCO	9932594	GAK-625	FIAT	9975363	GP-46	GMCX	9N6123	GP-1011Q	CATP
990759	GA-77	CHRY	9932594	GAK-625	IVEC	9975449	GP-455	GMCX	9N9589	GP-9586	CATP
990759	GA-77	JEEP	9933	GA-143	NAP	997591	GP-66	CLRK	9R334	GA-6880	MOSK
99079	GG-114	NAFI	9933149	G-191	FIAT	998	G-33	DEL	9R3-34	GA-6880	MTOR
9908154	G-1173 ⁰⁸	FIAT	9933225	GAK-458	FIAT	998054-C91	GA-209	IHCO	9R3-5	GA-6880	MTOR
99087	GG-136	NAFI	9933226	GA-459	FIAT	998055-C91	GA-209	IHCO	9S0664	GA-1286	CATP
9909154	G-1173 ⁰⁸	FIAT	9933226	GA-459	IVEC	9980AB	G-1174	CASE	9S0664	GA-9334	CATP
990936	GP-50	CLRK	9933276	GA-106 ⁴⁵	FIAT	9983764	GA-405	FIAT	9S1128	GA-1286	CATP
990936	GP-50	TALB	9933276	GA-326 ⁷¹	FIAT	9983764	GA-405	IVEC	9S1128	GA-9334	CATP
990937	GP-1	CHRY	9933276	GA-106 ⁴⁵	IVEC	998429-R91	GG-20	IHCO	9S664	GA-1286	CATP
990937	GP-1	CLRK	9933276	GA-326 ⁷¹	IVEC	998430-R91	G-1174	IHCO	9S664	GA-9334	CATP
9909999	G-1143	FIAT	9933276	GA-106 ⁴⁵	VANH	998431-R91	G-1173	IHCO	9S9970	GA-9334	CATP
9905	GP-3816	GREY	9933276	GA-326 ⁷¹	VANH	998434-R91	G-5000	IHCO	9T5664	GP-34	CATP
991	GA-24	AMP	9933644	GA-24	KOEH	998438-R91	GP-13	IHCO	9T5916	GP-761H	CATP
991	GA-24	BGA	993445-C1	GP-2071W	IHCO	998439-R91	GP-1	IHCO	9T8578	GP-864H	CATP
991	GAVW-2	CRO	9935594	GAK-625	FIAT	998440-R91	GP-84	IHCO	9W6427	G-152	CATP
99100026	GP-40	ALCH	993608	GA-360	CLRK	998441-R91	GP-83	IHCO	9W6428	G-222	CATP
99100059	GA-49	ALCH	993609	GA-361	CLRK	998443-R91	GP-1101	IHCO	9Y1022	GP-1011Q	CATP
99100083	GP-1122	ALCH	993668	GA-360	CLRK	998443-R91	GPP-14	IHCO	9Y3820	GA-403	CATP
99100208	GP-54 ¹¹	ALCH	993669	GA-360	CLRK	998447-R91	G-6	IHCO	9Y3820	GA-403	PROM
99100208	GP-66 ¹⁰	ALCH	993688	GA-360	CLRK	998451-R91	G-191	IHCO	9Y3839	GA-33	CATP
99100208	GP-54 ¹¹	FIAT	993689	GA-361	CLRK	998456-R91	G-139	IHCO	9Y3839	GA-33	PROM
99100208	GP-66 ¹⁰	FIAT	9936891	GP-1122	FIAT	998457-R91	GP-14	IHCO	9Y4202	GP-1101	CATP
99100216	GP-1	ALCH	993862-C1	GP-462	CASE	998458-R91	GA-39	IHCO	9Y4202	GP-1101	PROM
99100224	G-870	ALCH	993862-C1	GP-462	IHCO	99853	GA-11	HYST	9Y4400	GG-5 L	CATP
99100224	G-870	FIAT	9939229	G-297	FIAT	9985779	GA-403	FIAT	9Y4400	GG-5 L	CATP
99100240	GP-28 ⁸	ALCH	9939229	G-297-B	FIAT	9985779	GA-403	IVEC	9Y4401	GP-1101	PROM
99100240	GP-430 ⁸	ALCH	994	GA-26	AMP	9985779	GA-403	MAGI	9Y4401	GP-1101	PROM
99100240	GP-28 ⁸	FIAT	994	GA-26	BGA	9985780	GA-403	IVEC	9Y4402	GP-1101	CATP
99100240	GP-430 ⁸	FIAT	9-94156-455	GP-3985	ISUZ	99876	GP-110	GALN	9Y4403	GPP-14	CATP
99100562	GP-51	ALCH	9-94236-909-0	GG-5 L	ISUZ	999102	GA-77	AMCO	9Y4403	GPP-14	CATP
99103	GA-70	AMCO	9942863	GA-5648	KHDF	999102	GA-77	CHRY	9Y4404	GP-55	CATP
99104	G-1121	CLAA	99447	GA-6127 ⁰⁸	GALN	999102	GA-77	JEEP	9Y4404	GP-55	PROM
991040	G-1121	CLAA	9944								

Referencia Cruzada por Numero de Parte

Cross Reference by Part Number



Numero	Gonher	Fabricante	Numero	Gonher	Fabricante	Numero	Gonher	Fabricante	Numero	Gonher	Fabricante	
Number	Gonher	Manufacturer	Number	Gonher	Manufacturer	Number	Gonher	Manufacturer	Number	Gonher	Manufacturer	
9Y4408		GP-85	PROM	9Y4466	G-750	CATP	9Y6804	GA-206	CATP	A0116-007	GA-4828	IAPC
9Y4409		G-1174	CATP	9Y4466	G-750	PROM	9Y6804	GA-206	PROM	A0116-009	GA-362	IAPC
9Y4409		G-1174	PROM	9Y4467	G-750	CATP	9Y6805	GA-361	CATP	A0117-002	GA-2740	IAPC
9Y4410		G-1175	CATP	9Y4468	GP-57	CATP	9Y6808	GA-398	CATP	A0120-006	GA-75	IAPC
9Y4410		G-1175	PROM	9Y4468	GP-57	PROM	9Y6817	GAK-216	CATP	A0120-015	GA-4303	IAPC
9Y4413		GP-1122	CATP	9Y4469	GP-3766	CATP	9Y6817	GAK-216	PROM	A0120-016	GA-3588	IAPC
9Y4415		GP-155	CATP	9Y4469	GP-3766	PROM	9Y6820	GA-403	CATP	A0120-022	GAD-15	IAPC
9Y4415		GP-155	PROM	9Y4470	GP-23	CATP	9Y6820	GA-403	PROM	A0120-025	GAD-30	IAPC
9Y4417		GP-26	CATP	9Y4470	GP-23	PROM	9Y6821	GA-416	CATP	A0120-027	GA-4303	IAPC
9Y4417		GP-26	PROM	9Y4471	GP-23	CATP	9Y6821	GA-416	PROM	A0122-013	GA-50	IAPC
9Y4418		GP-27	CATP	9Y4472	GP-53	CATP	9Y6826	GA-18	CATP	A-0126-011	GA-4958	IAPC
9Y4418		GP-27	PROM	9Y4473	GP-53	CATP	9Y6826	GA-18	PROM	A-0126-013	GA-390	IAPC
9Y4419		GP-93	CATP	9Y4474	GP-36	CATP	9Y6827	GA-6129	CATP	A0138-018	GA-471	IAPC
9Y4419		GP-93	PROM	9Y4474	GP-36	PROM	9Y6828	GA-106 ⁴⁶	CATP	A0150-001	GA-200	IAPC
9Y4420		GP-92	CATP	9Y4475	GP-34	CATP	9Y6828	GA-326 ⁷¹	CATP	A0150-001	GA-218	IAPC
9Y4420		GP-92	PROM	9Y4475	GP-34	PROM	9Y6829	GA-6128	CATP	A0150-005	GA-230	IAPC
9Y4421		GP-1122	CATP	9Y4476	GP-69	CATP	9Y6829	GA-6128	PROM	A-0158-001	GA-140	IAPC
9Y4421		GP-1122	PROM	9Y4477	GP-88	CATP	9Y6834	GA-24	CATP	A0158-003	GAD-3	IAPC
9Y4423		G-295	CATP	9Y4477	GP-88	PROM	9Y6834	GA-24	PROM	A0161-004	GAD-1 ⁹⁷	IAPC
9Y4423		G-295	PROM	9Y4479	GP-1	CATP	9Y6836	GA-563	CATP	A0161-005	GA-2719B	IAPC
9Y4424		GP-1101	CATP	9Y4479	GP-1	PROM	9Y6836	GA-563	PROM	A0161-011	GA-180	IAPC
9Y4424		GP-1101	PROM	9Y4480	GP-3600	CATP	9Y6837	GA-251	CATP	A-0161-022	GA-3566	IAPC
9Y4425		GP-78	CATP	9Y4480	GP-3600	PROM	9Y6838	GAK-20	CATP	A0165-003	GAVV-2	IAPC
9Y4425		GP-78	PROM	9Y4481	G-333	CATP	9Y6838	GAK-20	PROM	A0166-002	GA-56	IAPC
9Y4426		G-1173	CATP	9Y4481	G-333	PROM	9Y6839	GA-33	CATP	A0166-008	GA-4365	IAPC
9Y4426		G-1173	PROM	9Y4482	GP-69	CATP	9Y6839	GA-33	PROM	A0171-011	GA-3425	IAPC
9Y4427		GP-1105	CATP	9Y4483	GP-10	CATP	9Y6840	GAK-16	CATP	A0180-001	GA-277	IAPC
9Y4427		GP-1105	PROM	9Y4483	GP-10	PROM	9Y6840	GAK-16	PROM	A0180-005	GAVV-4	IAPC
9Y4428		GP-1107	CATP	9Y4484	GP-10	CATP	9Y6841	GAK-403	CATP	A0180-011	GAVV-2	IAPC
9Y4428		GP-1107	PROM	9Y4484	GP-10	PROM	9Y6841	GAK-403	PROM	A0190-002	GA-2740	IAPC
9Y4429		GP-78	CATP	9Y4485	GP-67	CATP	9Y6842	GAK-1532	CATP	A0190-004	GA-3490	IAPC
9Y4429		GP-78	PROM	9Y4485	GP-67	PROM	9Y6842	GAK-1532	PROM	A0190-005	GAD-3	IAPC
9Y4430		G-296	CATP	9Y4486	G-31	CATP	9Y7662	GA-879	CATP	A0190-006	GAD-1	IAPC
9Y4430		G-296	PROM	9Y4486	G-31	PROM	9Y7805	GA-361	CATP	A0195-001	GA-230	IAPC
9Y4431		GPP-11	CATP	9Y4487	GP-81	CATP	9Y7808	GA-360	CATP	A02004	GA-589	HDA
9Y4431		GPP-11	PROM	9Y4488	GP-1	CATP	9Y7808	GA-360	PROM	A02005	GA-425	HDA
9Y4432		GPP-11	CATP	9Y4488	GP-1	PROM	9Y7811	GA-106 ⁴⁶	CATP	A02007	GA-679	HDA
9Y4432		GPP-11	PROM	9Y4489	GP-69	CATP	9Y7811	GA-326 ⁷¹	CATP	A0204	GA-218	TECF
9Y4435		GP-62	CATP	9Y4490	GP-69	CATP	9Y7811	GA-106 ⁴⁶	PROM	A0206-002	GP-3816	IAPC
9Y4435		GP-62	PROM	9Y4491	GP-40	CATP	9Y7811	GA-326 ⁷¹	PROM	A0210-004	GP-28 ⁶	IAPC
9Y4436		GG-5 L	CATP	9Y4492	GP-3816	CATP	9Y7814	GAK-625	CATP	A0210-004	GP-430 ⁸	IAPC
9Y4436		GG-5 L	PROM	9Y4493	GP-58	CATP	9Y7814	GAK-625	PROM	A0211-002	GP-81 ³¹	IAPC
9Y4437		GG-19	CATP	9Y4494	GP-24 ²⁶	PROM	Números Nuevos					
9Y4437		GG-19	PROM	9Y4494	GP-462 ²⁴	PROM	A0211-003			A0211-003	GP-2951 ⁹²	IAPC
9Y4438		GG-6	CATP	9Y4495	GP-81	CATP	A0211-003			A0211-003	GP-58	IAPC
9Y4438		GG-6	PROM	9Y4495	GP-81	PROM	A0220-004			A0220-004	GP-171	IAPC
9Y4439		GP-1101	CATP	9Y4496	GP-66	CATP	A0220-005			A0220-005	GP-3682	IAPC
9Y4439		GP-1101	PROM	9Y4496	GP-66	PROM	A0226-001			A0226-001	GP-42	IAPC
9Y4440		GG-17	CATP	9Y4497	G-31	CATP	A0226-005			A0226-005	GP-3531 EXP	IAPC
9Y4440		GG-17	PROM	9Y4498	G-335	CATP	A0226-006			A0226-006	GP-462	IAPC
9Y4441		GPP-18	CATP	9Y4498	G-335	PROM	A0227-001			A0227-001	GP-3985 ⁹³	IAPC
9Y4441		GPP-18	PROM	9Y4501	GP-5	CATP	A0229-002			A0229-002	G-871	IAPC
9Y4442		GP-92	CATP	9Y4501	GP-5	PROM	A0238-006			A0238-006	GP-91	IAPC
9Y4442		GP-92	PROM	9Y4502	GP-20	CATP	A0248-001			A0248-001	GP-46	IAPC
9Y4443		GG-87	CATP	9Y4502	GP-20	PROM	A0248-002			A0248-002	GP-46	IAPC
9Y4443		GG-87	PROM	9Y4503	GP-38	CATP	A0249-002			A0249-002	GP-171	IAPC
9Y4444		GG-1	CATP	9Y4503	GP-38	PROM	A0249-003			A0249-003	GP-36	IAPC
9Y4444		GG-1	PROM	9Y4504	GP-10	CATP	A0250-002			A0250-002	GP-22	IAPC
9Y4445		G-293	CATP	9Y4506	GP-81 ³¹	CATP	A0250-003			A0250-003	GP-81	IAPC
9Y4445		G-293	PROM	9Y4506	GP-9 ⁵⁸	CATP	A0250-004			A0250-004	GP-22	IAPC
9Y4446		GS-2033	CATP	9Y4507	GP-24 ²⁶	PROM	A0261-001			A0261-001	GP-81 ³¹	IAPC
9Y4446		GS-2033	PROM	9Y4507	GP-462 ²⁴	PROM	A0261-001			A0261-001	GP-9 ⁵⁸	IAPC
9Y4447		G-294	PROM	9Y4509	GP-390 ⁹³	CATP	A0261-005			A0261-005	GP-1	IAPC
9Y4448		GP-66	CATP	9Y4510	GP-28 ⁸	PROM	A0265-002			A0265-002	GP-28 ⁸	IAPC
9Y4448		GP-66	PROM	9Y4510	GP-430 ⁸	PROM	A0265-002			A0265-002	GP-430 ⁸	IAPC
9Y4449		GP-1	CATP	9Y4511	G-139	CATP	A0265-007			A0265-007	GP-28 ⁶	IAPC
9Y4449		GP-1	PROM	9Y4511	G-139	PROM	A0265-007			A0265-007	GP-430 ⁸	IAPC
9Y4450		GP-14	CATP	9Y4512	GP-40	CATP	A0270-006			A0270-006	GP-310	IAPC
9Y4450		GP-14	PROM	9Y4512	GP-40	PROM	A0271-003			A0271-003	G-834	IAPC
9Y4451		GP-3	CATP	9Y4513	GP-1122	CATP	A-0280-001			A-0280-001	GP-3569	IAPC
9Y4451		GP-3	PROM	9Y4513	GP-1122	PROM	A0280-006			A0280-006	GP-310	IAPC
9Y4452		GP-13	CATP	9Y4515	G-33	CATP	A-0280-006			A-0280-006	GP-3569	IAPC
9Y4452		GP-13	PROM	9Y4515	G-33	PROM	A0290-007			A0290-007	GP-3985	IAPC
9Y4453		GP-3429	CATP	9Y4516	GP-1122	CATP	A03004			A03004	GA-588	HDA
9Y4453		GP-3429	PROM	9Y4516	GP-1122	PROM	A03005			A03005	GA-426	HDA
9Y4454		GP-46	CATP	9Y4517	G-331	CATP	A03006			A03006	GA-680	HDA
9Y4454		GP-46	PROM	9Y4517	G-331	PROM	A0001801709			A0001801709	GA-3754	MBNZ
9Y4455		GP-3980	CATP	9Y4518	GP-66	PROM	A0015			A0015	GAP-381	HDA
9Y4455		GP-3980	PROM	9Y4520	G-191	CATP	A0022			A0022	GAK-625	HDA
9Y4456		G-33	CATP	9Y4521	G-153	CATP	A0030947504			A0030947504	GA-475	MBNZ
9Y4456		G-33	PROM	9Y4521	G-153	PROM	A0030948304			A0030948304	GA-5876	MBNZ
9Y4457		G-119	CATP	9Y4524	GP-57	CATP	A003094830467			A003094830467	GA-5876	MBNZ
9Y4457		G-119	PROM	9Y4524	GP-57	PROM	A0036			A0036	GP-38	NISS
9Y4458		GP-31	CATP	9Y4525	GP-1011Q	CATP	A0040942604			A0040942604	GA-475	MBNZ
9Y4458		GP-31	PROM	9Y4525	GP-1011Q	PROM	A0083			A0083	GA-357	HDA
9Y4459		GP-3600	CATP	9Y4527	GP-2022W	CATP	A0110-006			A0110-006	GA-3300	IAPC
9Y4459		GP-3600	PROM	9Y4527	GP-2022W	PROM	A0110-013			A0110-013	GA-2194	IAPC
9Y4460		G-169	CATP	9Y4529	GP-1010Q	CATP	A0110-014			A0110-014	GA-2110	IAPC
9Y4460		G-169	PROM	9Y4529	GP-1010Q	PROM	A-0111-001			A-0111-001	GA-3445	IAPC
9Y4461		G-500	CATP	9Y4530	GP-2015W	CATP	A0111-002			A0111-002	GA-271	IAPC
9Y4462		G-566	CATP	9Y4530	GP-2015W	PROM	A0111-003			A0111-003	GA-271	IAPC
9Y4462		G-566	PROM	9Y4531	GP-1011Q	CATP	A0113-001			A0113-001	GA-3300	IAPC
9Y4463		G-159	CATP	9Y4531	GP-1011Q	PROM	A0114			A0114	GAK-16	HDA
9Y4464		GP-53	CATP	9Y4532	GP-1011Q	CATP	A0115			A0115	GA-360	HDA
9Y4465		GP-53	CATP	9Y6803	GA-6127	CATP	A0116-004			A0116-004	GA-4325	IAPC
9Y4465		GP-43	PROM	9Y6803	GA-6127	PROM	A0116-006			A0116-006	GA-78	IAPC

REFERENCIA CRUZADA

Para números Gonher con Superíndice vea página 651
For Gonher with Superscript numbers see page 651

Numero	Gonher	Fabricante	Numero	Gonher	Fabricante	Numero	Gonher	Fabricante	Numero	Gonher	Fabricante
Number	Gonher	Manufacturer	Number	Gonher	Manufacturer	Number	Gonher	Manufacturer	Number	Gonher	Manufacturer
A0361-028	GG-208	IAPC	A1081C	GA-376	ACD	A1179	GA-6690	ASAH	A-13	GA-604	ATL
A0361-030	GG-185	IAPC	A1089C	GA-277	ACD	A117C	GA-77	ACD	A130	G-24	HFIL
A0361-035	GG-204	IAPC	A-109	GA-4325	ATL	A1180	GA-2195	DEUS	A1300C	GA-673R	ACD
A0361-036	GG-185	IAPC	A1092C	GA-422	ACD	A1183C	GA-70	ACD	A1301C	GA-732R	ACD
A0361-044	GG-185	IAPC	A1096C	GA-6479	ACD	A118455	G-1175	COBE	A1302C	GA-165 ¹¹³	ACD
A-0361-046	GG-220	IAPC	A1097C	GA-7007	ACD	A118455	G-1175	COO	A1304	GA-27	SAKU
A0365-007	GG-251	IAPC	A1098C	GA-153	ACD	A1193C	GA-195	ACD	A-1307	GA-398	SAKU
A0371-001	GG-246	IAPC	A11	GP-44	AUW	A119420	G-1175	COO	A1307C	GA-442	ACD
A0371-005	GPP-1122	IAPC	A11	GG-6	FLAG	A1195C	GA-275	ACD	A1308	GA-482	HDA
A-0371-006	GG-408	IAPC	A11	GP-13	PAMO	A12	GP-3429	AUW	A-130C	GA-105	ACD
A0371-009	GG-246	IAPC	A-11	GA-142	ATL	A12	GA-730	SUN	A131	GA-3425	PRET
A0371-010	GG-251	IAPC	A110	GAD-3	MIGH	A-12	GA-322	ATL	A-131	GA-195	ATL
A0380-002	GG-246	IAPC	A-110	GA-2194	ATL	A-120	GA-4365	ATL	A1311C	GA-432	ACD
A0380-004	GG-246	IAPC	A1103	GA-54	DEUS	A1201C	GA-362	ACD	A1317	GA-389	HDA
A0380-005	GG-226	IAPC	A1103C	GA-70	ACD	A1203	GA-1203	HDA	A1319	GA-680	HDA
A0390-001	GG-45	IAPC	A11042	GPP-19	PUR	A1203C	GA-142	ACD	A13192	GA-271	ECOL
A0390-002	GG-196	IAPC	A1105	GAVW-121	DEUS	A1204	GAD-294	SERV	A13192	GA-271	PUR
A-0390-004	GG-213	IAPC	A1106C	GA-89	ACD	A1205C	GA-3501	ACD	A-132	GA-139	ATL
A0390-005	GG-208	IAPC	A1107	GA-378	DEUS	A1206	GA-230	SAKU	A13212	GA-135	PUR
A0426	GA-109	HDA	A1109C	GA-180	ACD	A1208C	GA-164	ACD	A1322	GAK-16	HDA
A049F	GAD-3	ASAH	A111	GP-46	PAMO	A121	GA-442	DEUS	A1323C	GAD-118	ACD
A04H4123	GP-3816	DUTZ	A111	GA-71	RYCO	A-121	GA-180	ATL	A13281	GA-891 ¹⁰⁴	ELGN
A04H4123	GP-3816	KHDF	A-111	GA-253	ATL	A12102	G-33	WHIT	A13281	GA-892 ¹⁰⁸	ELGN
A051F	GAD-3	ASAH	A1110	GA-27198	SAKU	A1211	GP-55	DEUS	A1329C	GA-198	ACD
A052524	GA-33 ¹¹²	DON	A-1110-1	GA-3300	SAKU	A1212	GA-3501	DEUS	A133C	GA-50	ACD
A052526	GA-33 ¹¹²	DON	A1113C	GA-3814	ACD	A1212C	GA-139	ACD	A133	GA-78	FLAG
A0591	GAK-625	HDA	A11149	GAVW-2	ECOL	A1212C	GA-139	HDA	A133	GA-78	GOY
A065007	GAK-16	DON	A11149	GAVW-2	PUR	A1213	GA-57	DEUS	A133	GA-55	GUD
A065015	GAK-16	DON	A1115C	GA-5056	ACD	A1214	GA-3300	DEUS	A133	GA-78	KND
A0653039	GP-91	LONG	A1118C	GA-6128	ACD	A-1215	GAD-3	SAKU	A133	GA-55	RYCO
A0724	GA-6880	HDA	A112	094 0304	MBNZ	A1216	GA-240	DEUS	A133	GA-78	VALV
A0735	GA-27	UNN	A112	180 0009	G-180	A-122	GA-3501	ATL	A133	GA-356	WIX
A0760	GAK-216	HDA	A112	184 0025	G-180	A1220	GA-56	DEUS	A-133	GA-78	FACE
A0761	GAK-216	HDA	A112	184 0225	G-180	A1220C	GA-139	ACD	A1331	GAD-294	DEUS
A0766	GA-403	HDA	A112	184 0325	G-180	A1221	GA-59	DEUS	A1332	GA-85	DEUS
A0776	GA-416	HDA	A112	184 0425	G-180	A1221C	GA-276	ACD	A1333	GA-86	DEUS
A080022	GAK-403	DON	A1120	GA-75	DEUS	A1222	GA-429	DEUS	A13338	GA-42	PUR
A080031	GAK-403	DON	A1121	GA-2740	DEUS	A1222	GAK-16	HDA	A1336	GA-239	HDA
A08505-28	GA-6129	DON	A1123	GAK-195	SAKU	A1226	GPP-1122	PAMO	A1336C	GA-6690	ACD
A0-85497-5700	G-296	MAN	A1124	GA-303	DEUS	A1226C	GAVW-120	ACD	A134	GP-3766	PAMO
A0-85497-5700	G-296-B	MAN	A1125C	GA-251	ACD	A-123	GA-230	ATL	A1340	GAK-16	HDA
A-0876	GA-885	HDA	A1127	GA-75	DEUS	A1230	GA-230	DEUS	A1341C	GA-240	ACD
A09199	GA-206	HDA	A113	GA-75	MIGH	A1231C	GA-6619 ¹	ACD	A1346	GAK-216	HDA
A092018	GA-372	DON	A113	GA-75	PRET	A1231C	GA-6620 ²	ACD	A1347C	GA-5466	ACD
A092019	GA-373	DON	A1131C	GA-273	ACD	A1232C	GA-6690	ACD	A1348	GA-329	HDA
A092037	GA-372	DON	A1132C	GAD-30	ACD	A1234	GAK-20	HDA	A134C	GA-71	ACD
A0959	GA-373	HDA	A1135C	GA-7017	ACD	A124	GA-3300	MIGH	A135	GA-75	VALV
A1	GP-1	AUW	A1138C	GA-166	ACD	A1240	GA-27	HDA	A-135	GA-3637	ATL
A1	GP-1	PAMO	A1139	GA-6690	SAKU	A1243	GA-26	HDA	A1351	GA-361	HDA
A1	GA-50	SUN	A-114	GA-277	ATL	A1246	GAK-403	HDA	A1351-1	GA-361	HDA
A10	GP-46	AUW	A1143C	GA-129	ACD	A1246C	GAD-294	ACD	A1351C	GA-215	ACD
A10	GA-3300	CSP	A1144C	GA-471	ACD	A1248C	GA-276	ACD	A1352	GA-206	HDA
A10	GA-71	SUN	A1145	GA-322	SAKU	A125	GA-50	RYCO	A1353	GA-891	HDA
A-100	GA-3814	ATL	A1146	GP-3531 EXP	SAKU	A125	GA-50	RYCO	A1358C	GA-2184	ACD
A100017	GAK-20	DON	A1146C	GA-174	ACD	A-125	GA-471	ATL	A135C	GA-77	ACD
A10008	GA-135	PUR	A1147	GA-139	SAKU	A1251C	GA-386	ACD	A136	GA-55	FLAG
A10008	GA-35	PUR	A-1148	GA-5466	SAKU	A1255C	GA-133	ACD	A136	GA-55	GOY
A10031	GA-39	PUR	A1148C	GA-216	ACD	A1256C	GAD-294	ACD	A136	GA-57	GUD
A10037	GA-44	PUR	A1149	GA-198	SAKU	A1257C	GAD-117	ACD	A136	GA-57	RYCO
A1003C	GA-467	ACD	A1149C	GA-2106	ACD	A1257C	GAD-17	ACD	A137785	GAK-20	CASE
A1005	GA-4325	SAKU	A114C	GA-390	ACD	A1267C	GA-300	ACD	A137901	GAK-16	CASE
A10060	GA-11	PUR	A115	GA-175	DEUS	A1268C	GA-371	ACD	A138	GA-49	WIX
A10079	GA-12	PUR	A-115	GA-3681	ATL	A127	GA-6129	WIX	A139	GAD-3	RYCO
A101	GP-36	CHAM	A1150	GA-3566	DEUS	A-127	GA-6479	ATL	A-139	GA-382	ATL
A1010	GAVW-2	SAKU	A1150C	GAD-30	ACD	A1270	GA-730	DEUS	A139086	GAK-16	CASE
A1011C	GPP-19	ACD	A1151C	GA-390	ACD	A1271	GP-10	DEUS	A1399	GA-6127	HDA
A10122	GAVW-2	PUR	A1152	GA-74	DEUS	A1272C	GA-604	ACD	A14	GP-46	AUW
A1014	GAK-16	SAKU	A1154	GA-3424	DEUS	A1272CK	GA-604	ACD	A-14	GA-165	ATL
A1015	GA-78	SAKU	A1155	GA-3425	DEUS	A1275	GA-33	HDA	A140	GA-6128	DEUS
A1016	GA-362	SAKU	A1156	GA-4958	DEUS	A1279C	GA-279	ACD	A-140	GA-6619 ¹	ATL
A-1016-1	GA-362	SAKU	A11569	GAK-403	ELGN	A128	GA-129	DEUS	A-140	GA-6620 ⁵	ATL
A-102	GA-78	ATL	A1157	GA-6619 ¹	DEUS	A-128	GA-362	ATL	A1400	GA-55	DEUS
A1023	GA-3490	SAKU	A1157	GA-6620 ⁵	DEUS	A1280C	GA-300	ACD	A1401	GAK-16	HDA
A102A6	GA-26	CRAN	A115C	GA-90	ACD	A1282	GAK-625	HDA	A1402	GP-149	PAMO
A103	G-31	ALCA	A116	GP-53	PAMO	A1282C	GA-7142	ACD	A1406	GAK-16	HDA
A103	GAD-1	MIGH	A116	GA-405	WIX	A1283	GA-891	HDA	A1408	GA-166	SAKU
A-103	GA-174	ATL	A-116	GA-275	ATL	A1283C	GA-7344	ACD	A140C	GA-37	ACD
A1030C	GA-405	ACD	A1160C	GA-2110	ACD	A1284C	GA-217	ACD	A-141	GA-2110	ATL
A1034C	GA-49	ACD	A1163C	GA-165	ACD	A1285	GA-1285	HDA	A141041	GA-33	CASE
A1044	GA-605	SAKU	A1164	GAK-16	ASAH	A1285C	GA-141	ACD	A1411	GA-142	SAKU
A1046	GA-7344	SAKU	A1164C	GA-195	ACD	A1286	GA-1286	HDA	A1411C	GAVW-622	ACD
A1047	GA-607	SAKU	A1165	GA-166	DEUS	A1286C	GA-322	ACD	A1413C	GA-605	ACD
A1047C	GA-694	ACD	A1166C	GA-3901	ACD	A1286CK	GA-322	ACD	A141491	GG-1	CHRY
A105	GAD-3	RYCO	A1167	GA-605	DEUS	A1287	GA-1287	HDA	A141491	GG-4	CHRY
A1052C	GA-4325	ACD	A1169C	GA-197R	ACD	A1287C	GA-381	ACD	A141494	GG-45	CHRY
A-1053	GA-7142	SAKU	A1169CF	GA-197R	ACD	A1289C	GA-514	ACD	A1414C	GA-2114	ACD
A-1057	GA-141	SAKU	A116C	GP-53	PAMO	A129	GA-3424	MIGH	A1415C	GA-2195	ACD
A-106	GA-140	ATL	A117	GAVW-2	WIX	A129	GP-53	PRET	A1416	GA-244	SAKU
A1063C	GA-361	ACD	A1170	GA-139	ASAH	A1290C	GAVW-121	ACD	A1416C	GP-83 ¹⁰⁴	ACD
A1064C	GA-360	ACD	A1170C	GA-3588 ¹¹³	ACD	A1291C	GAVW-620	ACD	A1417C	GA-127	ACD
A-107	GA-71	WIX	A1172C	GA-3916	ACD	A1292C	GA-175	ACD	A1419C	GA-434	ACD
A1072C	GAP-381	ACD	A1173	GA-195	ASAH	A1295C	GA-386	ACD	A-142	GA-2106	ATL
A1077C	GA-349	ACD	A-1174	GA-286	SAKU	A1298C	GA-132	ACD	A142C	GA-44	ACD
A108	GA-673R	DEUS	A1174C	GA-166	ACD	A13	GP-28 ⁹	AUW	A-143	GA-139	ATL
A108	GP-52 ¹⁰	VIC	A1175C	GA-3551 ²⁵	ACD	A13	GP-430 ⁸	AUW	A1430C	GAK-16	ACD
A108	GP-691 ⁴⁸	VIC	A1175C	GA-3551 XT ⁵⁴	ACD	A13	GA-80	SUN	A143382	GP-34	CASE

Referencia Cruzada por Numero de Parte

Cross Reference by Part Number



Numero	Gonher	Fabricante	Numero	Gonher	Fabricante	Numero	Gonher	Fabricante	Numero	Gonher	Fabricante
Number	Gonher	Manufacturer	Number	Gonher	Manufacturer	Number	Gonher	Manufacturer	Number	Gonher	Manufacturer
A14347	GA-153	ECOL	A15363	GA-364	GRP	A1641	GA-1614	VALV	A187	GA-392	DUTZ
A14347	GA-153	PUR	A15363	GA-364	MOB	A1643	GA-130	VALV	A187	GA-90	GOY
A14349	GAVW-2	EVGR	A15363	GA-364	PUR	A165	GA-180	ASAH	A187	GA-90	KND
A14349	GAVW-2	MIGH	A15363	GA-364	SHE	A165	GAVW-4	DEUS	A187	GA-90	MIGH
A14349	GAVW-2	PUR	A1537C	GA-221R	ACD	A166	GA-7142	DEUS	A187	GAVW-2	TNC
A14414	GA-398	ACD	A-154	GA-1614	ATL	A-167	GA-384	ATL	A187	GA-90	VALV
A14417	GA-29	CASE	A154367	GA-1095	HDA	A1679	GA-479	MIGH	A-187	GA-90	FACE
A146	GA-71	FLAG	A154451A	G-31	WAUK	A1682	GA-433	MIGH	A189	GA-50	FLAG
A146	GA-71	GOY	A154575	GA-389	HDA	A1683	GA-224	MIGH	A189	GA-50	GOY
A146	GA-71	VALV	A1546C	GA-1614	ACD	A1688	GA-168	MIGH	A189348	GAK-1532	CASE
A146	GA-206	WIX	A1547C	GA-130	ACD	A1695	GA-395	MIGH	A189C	GA-5648	ACD
A14622	GAVW-619	PUR	A1548C	GA-301	ACD	A1696	GA-224	MIGH	A189CL	GA-5648	ACD
A14650	GA-604	ECOL	A1549C	GA-595	ACD	A1697	GA-277	PRET	A19	GA-100	FLAG
A14650	GA-604	EVGR	A-155	GA-130	ATL	A169C	GA-50	ACD	A-19	GA-381	ATL
A14650	GA-604	JFL	A1558C	GA-2118	ACD	A169CW	GA-50	ACD	A190	GA-90	DEUS
A14650	GA-604	PEP	A155A	GA-139	VIC	A16CW	GA-50	ACD	A190600	GP-3985	CASE
A14650	GA-604	PUR	A-156	GA-158	ATL	A-17	GA-77	ATL	A191	GA-192	DEUS
A14652	GA-276	EVGR	A15622	GAVW-619	PUR	A-170	GA-410	VIC	A1917	GAVW-2	SAKU
A14652	GA-276	MIGH	A15669	GAD-116	PUR	A17001	GP-2071W	HDA	A192	GA-192	FLAG
A14652	GA-276	PUR	A15679	GAVW-10	PUR	A17002	GP-1013Q	HDA	A192	GA-192	GOY
A14656	GA-7017	ECOL	A157	GA-18	WIX	A17003	GP-2071W	HDA	A192	GA-192	MIGH
A14656	GA-7017	JFL	A15703	GA-1530	PUR	A17004	GP-1012Q	HDA	A19215R	GA-608	HDA
A14656	GA-7017	PUR	A1576C	GA-329	ACD	A1701	GA-2740	SAKU	A-1923	GA-77	SAKU
A146696	GP-1	CASE	A-158	GA-5466	ATL	A1701-1	GA-2740	SAKU	A-1927	GA-158	SAKU
A146696P	GP-1	CASE	A1588C	GA-499R	ACD	A1702	GAD-3	SAKU	A-1928	GA-217	SAKU
A1468C	GA-389	ACD	A159	GA-361	WIX	A1703	GA-277	SAKU	A-1929	GA-275	SAKU
A147	GA-2174	TNC	A-159	GA-348	ATL	A171	GAD-3	DEUS	A-193	GA-278R	ATL
A-147	GAVW-120	ATL	A15903	GA-29	CASE	A1715	GA-133	SAKU	A-1930	GA-174	SAKU
A147020	GA-329	CASE	A15H4123	GP-54 ²¹	AHLM	A-1715-1	GA-133	SAKU	A-1931	GA-273	SAKU
A148	GA-80	FLAG	A15H4123	GP-66 ¹⁰	AHLM	A1719	GA-471	SAKU	A-1932	GA-274	SAKU
A148	GA-80	FSN	A15H4123	GP-54 ²¹	ATCO	A172	GA-2106	DEUS	A-1938	GA-175	SAKU
A148	GA-80	GOY	A15H4123	GP-66 ¹⁰	ATCO	A-172	GA-479	ATL	A-1939	GA-1616	SAKU
A148	GA-59	GUD	A15H4123	GP-54 ²¹	DUTZ	A-1726	GA-2106	SAKU	A194	GA-139	DEUS
A148	GA-59	RYCO	A15H4123	GP-66 ¹⁰	DUTZ	A-1728	GA-216	SAKU	A194C	GA-192	ACD
A-148	GA-673R	ATL	A15H4123	GP-54 ²¹	KHDF	A173	GAD-3	DEUS	A19578	G-1174 ¹⁰⁸	CASE
A-148	GAD-294	ATL	A15H4123	GP-66 ¹⁰	KHDF	A173200	GAK-1532	CASE	A196	GA-71	PFX
A-148	GA-80	FACE	A15H4123	GP-54 ²¹	KRAM	A173290	GAK-1532	CASE	A-196	GA-442	ATL
A14HH4123	GP-36	DUTZ	A15H4123	GP-66 ¹⁰	KRAM	A-1734	GA-595	SAKU	A197	GA-200	PFX
A15	GP-3980	AUW	A16	GP-3600	AUW	A174	G-500	APCO	A197	GA-218	PFX
A-15	GA-300	ATL	A16	GA-2740	PRET	A-174	GA-168	ATL	A-197	GA-217	ATL
A-150	GA-1615	ATL	A16	GA-78	SUN	A-1744	GA-158	MIGH	A199	GA-139	DEUS
A15001	GP-10	HDA	A-16	GA-141	ATL	A175	G-750	APCO	A-199	GA-607	ATL
A15002	GP-36	HDA	A160	GP-1101	FLAG	A175	GA-2193	DEUS	A19E-3W	GP-50	MWGC
A15003	GP-51	HDA	A160	GP-1101	GOY	A-175	GA-248	ATL	A1H4123	GP-36	DUTZ
A15004	GP-53	HDA	A-160	GA-780	ATL	A176	GA-50	DEUS	A1H4123	GP-36	AHLM
A15005	GP-52 ¹⁰	HDA	A16001	GP-1101	HDA	A176	GA-56	FLAG	A1H4123	GP-36	ATCO
A15005	GP-691 ⁴⁸	HDA	A16002	GP-84	HDA	A176	GA-56	KND	A1H4123	GP-36	DUTZ
A15006	GP-57	HDA	A16003	GP-83	HDA	A176	GA-56	MIGH	A1H4123	GP-36	FAHR
A150061	GA-106 ⁹⁶	HDA	A16005	GP-110	HDA	A176	GA-56	VALV	A1H4123	GP-36	KHDF
A15007	GP-3000	HDA	A16006	GP-1101	HDA	A-176	GA-56	FACE	A1H4123	GP-36	KRAM
A15008	GP-81	HDA	A16007	GA-105	HDA	A176C	GA-105	ACD	A1H4412	GP-36	DUTZ
A15009	GP-57	HDA	A16008	GP-27	HDA	A177	GAD-3	DEUS	A-1P2299	GP-110	PAMO
A1500C	GA-6	ACD	A16009	GP-26	HDA	A-177	GA-224	ATL	A1R0751	GP-1109 ²²	PAMO
A1501	GAD-1	SAKU	A1600C	GA-197R	ACD	A-177	GA-410	UJAP	A1R0751	GP-62 ²⁰	PAMO
A15010	GP-9586	HDA	A16010	GP-56	HDA	A178	GA-77	DEUS	A1R0751	GP-62 ²²	PAMO
A15012	GP-36	HDA	A16011	GP-85	HDA	A178CW	GA-192	ACD	A2	GP-5	AUW
A15013	G-33	HDA	A16012	GP-78	HDA	A179	GAVW-4	DEUS	A2	GA-85	SUN
A15014	G-33	HDA	A16013	GP-1108	HDA	A17943	GA-2174	PUR	A20	GP-9	PAMO
A15016	G-238	HDA	A16015	G-1174 ¹⁰⁸	HDA	A18	GP-91 ²⁸	AUW	A20	GA-349	SUN
A15017	G-191	HDA	A16017	G-1175 ¹⁰⁸	HDA	A18	GP-3816	PAMO	A200	G-200	ALY
A15018	G-613	HDA	A16019	G-1166	HDA	A-18	GA-217	ATL	A200	GA-467	PFX
A15020	G-750	HDA	A16020	G-296	HDA	A-180	GA-6479 ⁹⁰	ATL	A-200	GA-244	ATL
A15021	GP-53	HDA	A16020	G-296-B	HDA	A18001	G-153	HDA	A2001	GA-77	SAKU
A1506C	GA-7	ACD	A16021	GPP-11	HDA	A18002	G-152	HDA	A2002	GA-44	FIL
A1507	GAD-15	SAKU	A16022	GS-2033	HDA	A18003	G-222	HDA	A20021	GA-105	PUR
A1507C	GA-145	ACD	A16023	GS-2034	HDA	A1801	GAD-3	SAKU	A20058	GA-105	EVGR
A1509C	GA-158	ACD	A1604	GA-3490	SAKU	A1801-1	GAD-3	SAKU	A20058	GA-105	MIGH
A150F	GP-85	PAMO	A1604C	GA-158	ACD	A1807	GAD-1	SAKU	A20058	GA-105	PUR
A1511C	GA-384	ACD	A1605	GA-2740	SAKU	A-181	GA-395	ATL	A20070	GA-4303	ECOL
A1512	GA-139	SAKU	A1605C	GA-518R	ACD	A1811	GA-4303	SAKU	A20070	GA-4303	PUR
A151281	GPP-18 ⁰⁴	CASE	A1608C	GAD-3	ACD	A1812	GAD-30	SAKU	A-201	GAVW-621	ATL
A151281	GPP-19 ⁰⁸	CASE	A-1609	GA-390	SAKU	A1818	GAD-15	SAKU	A2011C	GA-5466	ACD
A151281-KIT	GPP-18 ⁰⁴	CASE	A161	GA-195	VIC	A181V	GP-52 ¹¹⁰	ASAH	A2014	GA-414R	MIGH
A151281-KIT	GPP-19 ⁰⁸	CASE	A-161	GAVW-620	ATL	A181V	GP-691 ⁴⁸	ASAH	A2014C	GA-414R	ACD
A1512C	GA-172	ACD	A1610C	GA-8606	ACD	A182	GP-52 ¹¹⁰	ASAH	A-202	GA-301	ATL
A1513C	GA-244	ACD	A1611C	GA-163	ACD	A182	GP-691 ⁴⁸	ASAH	A2025	GAVW-2	HARM
A1514C	GA-2198 ⁷⁹	ACD	A1612C	GA-170	ACD	A182	GA-3814	DEUS	A-203	GA-286	ATL
A1514C	GA-438 ³¹	ACD	A1613	GA-381	SAKU	A-182	GA-780	ATL	A2036C	GA-263	ACD
A15157	GA-2184	GRP	A1614C	GA-6479 ⁹⁰	ACD	A1820	GA-75	SAKU	A2038C	GA-479	ACD
A15157	GA-2184	MIGH	A1615	GA-6128	VALV	A1823	GAD-1	SAKU	A2039C	GA-224	ACD
A15157	GA-2184	MOB	A1615C	GA-3916	ACD	A1829	GA-26	SAKU	A2040C	GA-168	ACD
A15157	GA-2184	PUR	A1616	GA-382	SAKU	A183	GA-264	ATL	A2044C	GA-607	ACD
A15157	GA-2184	SHE	A1616C	GA-244	ACD	A183	GA-390	DEUS	A2046C	GAVW-621	ACD
A1515C	GA-476	ACD	A1617	GA-442	VALV	A1833	GAD-117	SAKU	A2047C	GA-286	ACD
A1517C	GA-1615	ACD	A1617C	GA-164	ACD	A1833	GAD-17	SAKU	A2048C	GA-278R	ACD
A1518	GA-348	MIGH	A1618	GA-386	SAKU	A1835	GA-6619 ¹	SAKU	A2051C	GA-183	ACD
A1518C	GA-348	ACD	A1619C	GA-244	ACD	A1835	GA-6620 ⁵	SAKU	A2052C	GA-491	ACD
A151931	GP-2071W	CASE	A162	GA-275	DEUS	A184	GA-490	ATL	A2054C	GA-183R	ACD
A1519C	GA-348	ACD	A-162	GA-240	ATL	A184	GA-142	DEUS	A2055C	GA-248	ACD
A-152	GA-1616	ATL	A1621	GA-172	SAKU	A184	GA-77	FLAG	A2057C	GA-472	ACD
A152819	GP-1011Q	CASE	A1621C	GA-413R	ACD	A184	GA-77	GOY	A2058C	GA-780	ACD
A15283	GA-782 ⁰⁸	PUR	A1623	GAVW-212	MIGH	A184774	GP-78	CASE	A206	GA-8	GUD
A152C	GA-80	ACD	A-1624	GA-415	MIGH	A184775	GP-69	CASE	A206	GA-8	RYCO
A-153	GA-279	ATL	A1624C	GA-415	ACD	A184776	GPP-1000	CASE	A206	GAD-1	VIC
A153551	GA-3551 ⁵⁵	HDA	A1625	GA-384	SAKU	A1851	GAD-118	SAKU	A206A	GAD-1	VIC
A153551	GA-3551 XT ⁶⁴	HDA	A-1632	GA-163	SAKU	A187	GA-392	DEUS	A-207A	GA-413R	ATL

Numero	Gonher	Fabricante	Numero	Gonher	Fabricante	Numero	Gonher	Fabricante	Numero	Gonher	Fabricante
Number	Gonher	Manufacturer	Number	Gonher	Manufacturer	Number	Gonher	Manufacturer	Number	Gonher	Manufacturer
A2078	GA-3425	HARM	A23087	GA-2194	EVGR	A24339	GA-3915	ECOL	A249	GA-3490	TNC
A207C	GA-8047	ACD	A23087	GA-2194	MIGH	A24339	GA-3915	PUR	A249	GA-4303	VIC
A-208	GA-477	ATL	A23087	GA-2194	PUR	A24342	GA-253	ECOL	A2492	GAK-403	HDA
A208C	GA-9045	ACD	A2311	GA-27	FIL	A24342	GA-253	PUR	A2493	GA-251	REF
A2091	GA-70	FIL	A2318	GA-71	FIL	A24343	GA-5056	ECOL	A2498	GA-98 ¹¹²	FIL
A2093	GA-197R	HAS	A23180-1	GA-5648	PETI	A24343	GA-5056	PUR	A-25	GA-3901	ATL
A209C	GA-9334	ACD	A23180-14	GAK-403	PETI	A24357	GA-216	EVGR	A25042	GA-442	EVGR
A-210	GA-414R	ATL	A23180-23	GAK-403	PETI	A24357	GA-216	MIGH	A25042	GA-442	MIGH
A2100	GA-371	HDA	A23180-29	GAK-403	PETI	A24357	GA-216	PUR	A25042	GA-442	PUR
A2102	GPP-19	FIL	A23180-30	GA-27	PETI	A24372	GA-3901	ECOL	A25043	GAVW-620	EVGR
A2104	GA-180	SERV	A23180-39	GA-27	PETI	A24372	GA-3901	PUR	A25043	GAVW-620	MIGH
A21059	GA-11	CLRK	A23180-40	GA-27	PETI	A24375	GA-362	ECOL	A25043	GAVW-620	PUR
A210C	GA-1008	ACD	A23180-52	GAK-16	PETI	A24375	GA-362	PUR	A25048	GA-132	EVGR
A211	GAVW-121	PFX	A2319	GA-18	FIL	A24378	GA-174	ECOL	A25048	GA-132	FSN
A-211	GA-263	ATL	A232	GA-70	DEUS	A24378	GA-174	PUR	A25048	GA-132	MIGH
A-211	GA-5466	ATL	A232028	GP-3980	DAEW	A24409	GAVW-120	EVGR	A25048	GA-132	PUR
A2112	GA-37	FIL	A232-1	GAK-403	AMHO	A24409	GAVW-120	MIGH	A25049	GA-595	EVGR
A21133	G-1173 ⁰⁸	CASE	A2327	GA-135	FIL	A24409	GAVW-120	PEP	A25049	GA-595	MIGH
A212CW	GA-55	ACD	A2330	GA-5648	FIL	A24409	GAVW-120	PUR	A25049	GA-595	PUR
A212CX	GA-55	ACD	A2331	GA-37	FIL	A24468	GA-195	ECOL	A25076	GA-476	EVGR
A213	GAD-1	VIC	A2336	GA-9334	FIL	A24468	GA-195	PUR	A25076	GA-476	MIGH
A214	GA-2114	PFX	A2338	GA-1286	FIL	A24471	GA-471	ECOL	A25076	GA-476	PUR
A21475	G-6	CASE	A234	GA-3588	DEUS	A24471	GA-471	EVGR	A25077	GA-434	GRP
A215	GA-3637	DEUS	A23436	GA-4365	EVGR	A24471	GA-471	FSN	A25077	GA-434	MIGH
A215	GAD-3	TOKO	A23436	GA-4365	MIGH	A24471	GA-471	PUR	A25077	GA-434	MOB
A215	GAD-3	TOKY	A23436	GA-4365	PUR	A245	GA-300	DEUS	A25077	GA-434	PUR
A215	GAD-3	VIC	A23465	GA-277	ECOL	A2452	GA-49	FIL	A25077	GA-434	SHE
A2155	G-6	YALE	A23465	GA-277	PUR	A2455	GP-28 ⁶	FIL	A25089	GA-301	EVGR
A21575	G-6	CASE	A235	GA-3681	DEUS	A2455	GP-430 ⁶	FIL	A25089	GA-301	MIGH
A216	GA-3523	DEUS	A235	GA-4365	TNC	A2459	GA-44	FIL	A25089	GA-301	PUR
A216	GA-2740	GUD	A23538	GA-140	ECOL	A24616	GAD-30	PUR	A2510	GA-33 ¹¹²	HDA
A216	GA-2740	RYCO	A23538	GA-140	GRP	A2464	GA-892	FIL	A2513AL	GAK-625	FIL
A2168	GA-71	FIL	A23538	GA-140	JFL	A24645	GA-6690	ECOL	A25148	GA-384	EVGR
A218	GA-78	ACD	A23538	GA-140	MOB	A24645	GA-6690	PUR	A25148	GA-384	GRP
A218	G-34	ALY	A23538	GA-140	PUR	A24648	GA-133	ECOL	A25148	GA-384	MIGH
A218045	GAK-20	PETI	A23538	GA-140	SHE	A24648	GA-133	PUR	A25148	GA-384	PUR
A21875	G-6	CASE	A2354	GA-59	FIL	A24675	GAD-117	EVGR	A2517	GAK-20	HDA
A218C	GA-78	ACD	A2356	GA-6129	FIL	A24675	GAD-17	EVGR	A251C	GA-7	ACD
A22	GPP-19	GUD	A2359	GA-106 ⁶⁰	FIL	A24675	GAD-117	MIGH	A252	GA-362	VALV
A22	GPP-19	RYCO	A2359	GA-326 ⁷¹	FIL	A24675	GAD-17	MIGH	A25210	GA-2118	GRP
A22	GA-113	SUN	A23592	GA-273	ECOL	A24675	GAD-117	PUR	A25210	GA-2118	MIGH
A-22	GA-164	ATL	A23592	GA-273	PUR	A24675	GAD-17	PUR	A25210	GA-2118	MOB
A220	GA-303	GUD	A235C	GA-11	ACD	A24680	GA-386	ECOL	A25210	GA-2118	PUR
A220	GA-303	RYCO	A236	G-236	ALY	A24680	GA-386	JFL	A25210	GA-2118	SHE
A2200	GA-71	FIL	A236	GA-18	GUD	A24680	GA-386	PUR	A2523	GA-2719B	FIL
A2202	GA-230	SAKU	A236	GA-18	RYCO	A24690	GA-322	ECOL	A2524	GA-71	SAKU
A2203	GA-50	SAKU	A236	GA-78	TNC	A24690	GA-322	JFL	A25243	GA-6	PUR
A2205	GA-33	SAKU	A2362	GAD-1	FIL	A24690	GA-322	PUR	A25248	GA-163	EVGR
A2209	GA-230	FIL	A2369	GA-360	FIL	A246C	GA-108	ACD	A25248	GA-163	MIGH
A-2210	GA-360	SAKU	A236C	GA-11	ACD	A2470	G-33	FULR	A25248	GA-163	PUR
A221-1	GA-33	AMHO	A237	GA-85	GUD	A2471	G-33	FULR	A25249	GA-170	EVGR
A22140	GA-37	CASE	A2371	GAD-3	FIL	A24712	GA-217	ECOL	A25249	GA-170	MIGH
A2217	GA-1008	FIL	A238	GA-7	GUD	A24712	GA-217	MIGH	A25249	GA-170	PUR
A2218	GA-1284	FIL	A238	GA-7	RYCO	A24712	GA-217	PEP	A2526	GA-71	SAKU
A221C	GA-27	ACD	A23A	GP-110	PAMO	A24712	GA-217	PUR	A2529	GA-27	HDA
A221CL	GA-27	ACD	A23L/39	GP-1108	PAMO	A24720	GA-7344	EVGR	A25301	GA-479	MOB
A222	GA-2194	TNC	A24	GA-113	FLAG	A24720	GA-7344	FSN	A25301	GA-479	PUR
A2221	GA-8047	FIL	A24	GA-113	SUN	A24720	GA-7344	MIGH	A25301	GA-479	SHE
A2222	GA-1285	FIL	A24	GAD-3	TNC	A24720	GA-7344	PUR	A25306	GA-278R	PUR
A2226	GA-39	FIL	A-24	GA-192	ATL	A24722	GA-5466	FSN	A25324	GA-168	PUR
A223	GP-2951	PAMO	A240	GA-2719B	GUD	A24722	GA-5466	PEP	A25352	GA-183	PUR
A2233	GA-9045	FIL	A240	GA-4303	TOKO	A24722	GA-5466	PUR	A2536	GAK-20	FIL
A2234	GA-1287	FIL	A240	GA-4303	TOKY	A24731	GA-165	ECOL	A25372	GA-258	GRP
A2236	GA-90	FIL	A240	GA-4303	VIC	A24731	GA-165	MIGH	A25372	GA-258	MOB
A223C	GA-56 ⁹⁰	ACD	A2405	GA-105	FIL	A24731	GA-165 ¹¹³	PUR	A25372	GA-258	GRP
A2248	GAK-403	FIL	A2407	GA-206	FIL	A248	GA-3490	TNC	A25373	GA-491	GRP
A2248AL	GAK-403	FIL	A240X	GA-2719B	RYCO	A2480	GA-436	FIL	A25373	GA-491	MOB
A226	GA-200	GUD	A241	GA-2110	TNC	A24807	GAD-129	EVGR	A25373	GA-491	PUR
A226	GA-218	GUD	A2411	GA-360	FIL	A24807	GAD-129	MIGH	A25373	GA-491	SHE
A226	GA-200	RYCO	A-2411	GA-5056	SAKU	A24807	GAD-129	PUR	A25398	GA-293	GRP
A226	GA-218	RYCO	A-2411-1	GA-5056	SAKU	A24819	GA-141	ECOL	A25398	GA-293	MOB
A226	GAD-30	TOKO	A-2412	GAVW-4	SAKU	A24819	GA-141	EVGR	A25398	GA-293	PUR
A226	GAD-30	TOKY	A-2414	GA-4365	SAKU	A24819	GA-141	MIGH	A25405	GA-183R	GRP
A22637	GAK-20	IHC0	A242	GA-3425	TNC	A24819	GA-141	PUR	A25405	GA-183R	MOB
A2269V	GA-4303	ASAH	A242	GA-27	TOKY	A24831	GAD-118	EVGR	A25405	GA-183R	PUR
A227	GA-277	TNC	A2424	GA-6127	FIL	A24831	GAD-118	FSN	A25418	GA-395	PUR
A2271V	GA-75	ASAH	A2426	GA-361	FIL	A24831	GAD-118	MIGH	A25446	GA-780	PUR
A227C	GA-50	ACD	A24278	GA-15	ECOL	A24831	GAD-118	PUR	A25456	GA-184	GRP
A2289	GA-33	FIL	A24278	GAD-15	MIGH	A24832	GA-432	ECOL	A25456	GA-184	MOB
A2289AL	GA-33	FIL	A24278	GAD-15	PUR	A24832	GA-432	JFL	A25456	GA-184	PUR
A2295AL	GAK-16	FIL	A24282	GAD-30	EVGR	A24832	GA-432	PUR	A25456	GA-184	SHE
A2296	GAK-20	FIL	A24282	GAD-30	MIGH	A24850	GAD-29	PUR	A25458	GA-2164	PUR
A2296AL	GAK-20	FIL	A24282	GAD-30	PUR	A24858	GA-127	EVGR	A25463	GA-263	GRP
A229C	GAK-403	ACD	A2429	GA-2984	HDA	A24858	GA-127	FSN	A25463	GA-263	MOB
A22H4123	GP-77	DUTZ	A24295	GA-200	EVGR	A24858	GA-127	MIGH	A25463	GA-263	PUR
A22H4123	GP-77	KHDF	A24295	GA-218	EVGR	A24858	GA-127	PUR	A25463	GA-263	SHE
A23	GP-110	PAMO	A24295	GA-200	MIGH	A24859	GA-128	EVGR	A25485	GA-780	PUR
A23	GA-86	SUN	A24295	GA-218	MIGH	A24859	GA-128	MIGH	A254C	GA-29	ACD
A2305	GA-70	SAKU	A24295	GA-200	PUR	A24859	GA-128	PUR	A25503	GA-138	MOB
A2307	GA-200	FIL	A24295	GA-218	PUR	A24873	GA-514	EVGR	A25503	GA-138	PUR
A2307	GA-218	FIL	A24299	GA-180	ECOL	A24873	GA-514	FSN	A25503	GA-138	SHE
A23080	GA-3445	GRP	A24299	GA-180	PUR	A24873	GA-514	GRP	A25507	GA-269	MOB
A23080	GA-3445	MIGH	A243	GAD-15	TOKO	A24873	GA-514	MIGH	A25507	GA-269	PUR
A23080	GA-3445	MOB	A243	GAD-15	TOKY	A24873	GA-514	PUR	A2552	GA-7360	FIL
A23080	GA-3445	PUR	A243	GAD-15	VIC	A24880	GA-164	MIGH	A25525	GA-597	PUR
A23080	GA-3445	SHE	A243004	GP-1122	PAMO	A24880	GA-164	PUR			

Referencia Cruzada por Numero de Parte

Cross Reference by Part Number



Numero	Gonher	Fabricante	Numero	Gonher	Fabricante	Numero	Gonher	Fabricante	Numero	Gonher	Fabricante
Number	Gonher	Manufacturer	Number	Gonher	Manufacturer	Number	Gonher	Manufacturer	Number	Gonher	Manufacturer
A25558	GA-241	PUR	A289	GA-6620	VALV	A32297	GP-66	CASE	A345	GA-4303	WESF
A25582	GA-1572	PUR	A289V	GAD-15	ASAH	A323	GP-91	PAMO	A34545	GAK-403	CASE
A25585	GA-269	PUR	A2904	GA-3647	SAKU	A324	GA-85	FLAG	A346	GA-4303	GUD
A25588	GA-324	PUR	A2906	GAVW-2	SAKU	A324	GA-85	GOY	A346	GA-4303	RYCO
A25596	GAVW-625	PUR	A290C	GA-1285	ACD	A324	GA-3490	TOKO	A346	GA-4303	WESF
A25634	GA-492	PUR	A-2916	GA-604	SAKU	A324	GA-3490	TOKY	A34613	GA-142	ECOL
A25635	GA-489	PUR	A291V	GAD-1	ASAH	A324	GA-3490	VIC	A34613	GA-142	JFL
A25647	GA-363	PUR	A2932C	GA-184	ACD	A3245	GA-269	MIGH	A34613	GA-142	PUR
A25651	GA-383	PUR	A2934C	GA-194	ACD	A325	GA-325	FACE	A34616	GAD-30	EVGR
A25653	GA-340	PUR	A2936C	GA-216	ACD	A325	GA-325	FLAG	A34616	GAD-30	MIGH
A25655	GA-265	PUR	A293R	G-139	JOND	A325	GA-325	GOY	A34616	GAD-30	PUR
A25680	GA-196	PUR	A293V	GAD-1	ASAH	A325	GA-78	GUD	A34625	GA-2106	EVGR
A25699	GA-1542	PUR	A2941C	GA-477	ACD	A325	GA-2194	TNC	A34625	GA-2106	MIGH
A2569C	GA-475	ACD	A2943C	GA-490	ACD	A326	GA-59	FLAG	A34625	GA-2106	PUR
A256C	GA-608	ACD	A2945	GA-1545	MIGH	A326	GA-59	GOY	A34629	GA-139	EVGR
A25710	GA-263	PUR	A29503	GA-134	PUR	A326	GA-4325	VIC	A34629	GA-139	MIGH
A25714	GA-2159	PUR	A2955C	GA-1617	ACD	A327	GA-57	FLAG	A34629	GA-139	PUR
A258	GA-471	DEUS	A2957C	GA-395	ACD	A327	GA-57	GOY	A3463	GA-230	MIGH
A26	GP-14	PAMO	A296	GA-3490	GUD	A327	GAVW-622	TNC	A3463	GA-230	MINL
A26	GA-303	SUN	A296	GA-3490	RYCO	A328C	GA-3501	ACD	A3463	GA-230	VALV
A26	GAD-1	TNC	A296V	GAD-3	ASAH	A329C	GA-57	ACD	A-3463	GA-230	FACE
A-26	GA-514	ATL	A297C	GA-33112	ACD	A33	G-33	ALY	A347	GA-429	FLAG
A-2604	GAVW-620	SAKU	A298C	GA-26	ACD	A33	GA-230	GUD	A347	GA-429	KND
A2605	GA-2110	SAKU	A298CL	GA-26	ACD	A33	GP-20	PAMO	A347	GA-429	MIGH
A26067	GA-1614	EVGR	A2990C	GA-879	ACD	A33	GA-85	SUN	A-347	GA-429	FACE
A26067	GA-1614	GRP	A2991C	GA-4999	ACD	A-33	GA-7142	ATL	A34711	GA-328	PUR
A26067	GA-1614	MIGH	A299C	GAK-403	ACD	A330	G-330	ALY	A34715	GA-7142	EVGR
A26067	GA-1614	PUR	A299CL	GAK-403	ACD	A330	GA-4325	GUD	A34715	GA-7142	MIGH
A26097	G-1173 ⁰⁸	CATP	A2H4123	GP-77	DUTZ	A3300	GA-3300	FLAG	A34715	GA-7142	PEP
A26097	G-1173 ⁰⁸	TOWM	A3	GA-75	SUN	A3300	GA-3300	GOY	A34715	GA-7142	PUR
A261	GA-78	DEUS	A30	GP-84	PAMO	A331	GA-78	TOKO	A3472	GA-274	PRET
A262	GA-3490	DEUS	A30	GA-3300	SUN	A33193	GA-735 ¹²⁴	ECOL	A34721	GA-198	EVGR
A263	GA-4325	DEUS	A-3001	GA-2194	SAKU	A33193	GA-734 ⁸¹	PUR	A34721	GA-198	MIGH
A264	GA-78	DEUS	A30017	GAD-3	EVGR	A33193	GA-735 ¹²⁴	PUR	A34721	GA-198	PUR
A264C	GA-1203	ACD	A30017	GAD-3	MIGH	A332	GA-325	VALV	A3474	GA-3681	PRET
A266	GAD-1 ⁸⁷	DEUS	A30017	GAD-3	PUR	A332C	GA-325	ACD	A34799	GA-381	ECOL
A266C	GA-1286	ACD	A30023	GA-230	EVGR	A333	G-333	ALY	A34799	GA-381	EVGR
A266V	GAD-30	ASAH	A30023	GA-230	MIGH	A33380	GA-3647	ECOL	A34799	GA-381	MIGH
A267C	GA-1284	ACD	A30023	GA-230	PUR	A33380	GA-3647	PUR	A34799	GA-381	PUR
A268C	GA-375	ACD	A30045	GA-77	ECOL	A33382	GA-390	GRP	A34838	GA-2179	PUR
A27	GA-325	SUN	A30045	GA-77	PUR	A33382	GA-390	MIGH	A34838	GA-2198 ⁷⁹	PUR
A2709	GAD-1 ⁸⁷	FACE	A30050	GA-90	EVGR	A33382	GA-390	MOB	A34838	GA-438 ³¹	PUR
A2709	GAD-1 ⁸⁷	FLAG	A30050	GA-90	MIGH	A33382	GA-390	PUR	A34850	GAD-29	EVGR
A2709	GAD-1 ⁸⁷	GOY	A30050	GA-90	PUR	A33382	GA-390	SHE	A34850	GAD-29	PUR
A2709	GAD-1 ⁸⁷	KND	A30052	GA-71	MIGH	A333C	GA-192	ACD	A34852	GA-392	EVGR
A2709	GAD-1 ⁸⁷	MIGH	A30052	GA-71	PUR	A334	GA-2110	TNC	A34852	GA-392	MIGH
A2719	GA-2719B	FLAG	A30057	GA-80	PUR	A33466	GA-4828	ECOL	A34852	GA-392	PUR
A2719	GA-2719B	GOY	A30059	GA-50	ECOL	A33466	GA-4828	PUR	A34868	GA-646	PUR
A2719	GA-2719B	MIGH	A30059	GA-50	PUR	A33472	GA-274	ECOL	A34877	GA-175	MIGH
A-2719	GA-3300	FACE	A-3006	GA-2114	SAKU	A33472	GA-274	PUR	A34877	GA-175	PUR
A2719B	GA-2719B	MIGH	A30067	GA-192	ECOL	A33487	GP-1	CASE	A34878	GA-1615	EVGR
A2740	GA-2740	FLAG	A30067	GA-192	PUR	A3345	GAK-16	VIC	A34878	GA-1615	FSN
A2740	GA-2740	MIGH	A30110	GA-349 ⁵⁸	PUR	A33590	GA-3916	ECOL	A34878	GA-1615	MIGH
A274A	GA-360	ASAH	A30110	GA-3916	PUR	A33590	GA-3916	PUR	A34878	GA-1615	PUR
A274B	GA-361	ASAH	A301C	GA-20	ACD	A33591	GA-3814	ECOL	A34879	GA-1616	MIGH
A274C	GA-55	ACD	A301CL	GAK-20	ACD	A33591	GA-3814	PUR	A34879	GA-1616	PUR
A275	GA-166	DEUS	A302	GAD-3	RYCO	A3361B	GA-398	ASAH	A348C	GA-59	ACD
A27698	GA-2175	GRP	A302C	GA-16 ¹¹²	ACD	A3367	GA-139	ASAH	A349	GA-349	KND
A27698	GA-2175	MOB	A302C	GAK-16 ³⁴	ACD	A3371	GA-3647	MINL	A349	GA-349	MIGH
A27698	GA-2175	PUR	A302CL	GAK-16	ACD	A3373	GAVW-2	FLAG	A349	GA-349	MINL
A27698	GA-2175	SHE	A303	GA-303	FLAG	A3373	GAVW-2	GOY	A-349	GAD-3	FACE
A-2769S	GA-27	NIPP	A303	GA-303	GOY	A3373	GAVW-2	MIGH	A3490	GA-3490	FACE
A277	GA-85	RYCO	A303C	GA-18	ACD	A3380	GA-3647	PUR	A3490	GA-3490	FLAG
A2780	GA-1540	MIGH	A305	GA-730	FLAG	A3384	GA-89	PRET	A3490	GA-3490	GOY
A2782	GA-1571	MIGH	A305	GA-730	GOY	A339	GP-178	PAMO	A3490	GA-3490	KND
A2785	GA-1572	MIGH	A305	GA-730	VALV	A33C	GP-9	ACD	A3490	GA-3490	MIGH
A279	GA-7344	DEUS	A3086C	GA-348	ACD	A34	GA-86	SUN	A3497	GA-3425	FLAG
A279C	GA-55	ACD	A308C	GA-29	ACD	A340	GA-86	FLAG	A3497	GA-3425	MIGH
A28	GA-113	SUN	A3090C	GA-646	ACD	A340	GA-86	GOY	A34995	GAVW-121	EVGR
A280	GAVW-2	GUD	A3093	GAK-20	HDA	A3424	GA-3424	FLAG	A34995	GAVW-121	MIGH
A280	GAVW-2	RYCO	A31	G-31	ALY	A3425	GA-3425	FLAG	A34995	GAVW-121	PUR
A28008	G-31	CASE	A31	GA-70	GUD	A3425	GA-3425	MIGH	A34C	G-871	ACD
A2801	GA-362	SAKU	A31	GA-56	MIGH	A3427	GA-239	HDA	A35	GA-192	SUN
A2802	GA-476	SAKU	A31	GP-83	PAMO	A34320	GA-219	PUR	A-35	GA-730	ATL
A-2807	GA-217	SAKU	A31	GAD-1	SUN	A34333	GA-392	PUR	A3501	GA-3501	FLAG
A281	GA-106 ⁴⁶	ASAH	A-31	GA-55	ATL	A34356	GA-390	ECOL	A3501	GA-3501	KND
A281	GA-326 ⁷¹	ASAH	A3102	GA-7142	SERC	A34356	GA-390	JFL	A3501	GA-3501	MIGH
A281B	GA-206	ASAH	A31153	GAVW-4	EVGR	A34356	GA-390	PUR	A3501	GA-3501	MINL
A281V	GA-106 ⁴⁶	ASAH	A31153	GAVW-4	MIGH	A34356	GA-390	SHE	A3501	GA-595	SERC
A281V	GA-326 ⁷¹	ASAH	A31153	GAVW-4	PUR	A34361	GA-139	ECOL	A3501	GA-595	SERV
A282	GAVW-2	RYCO	A312	GA-90	GUD	A34361	GA-139	PUR	A3501	GA-3501	VALV
A282V	GAK-403	ASAH	A312	GA-90	RYCO	A344	GA-362	TOKO	A-3501	GA-3501	FACE
A283	GA-164	DEUS	A31222	G-1174	CASE	A344	GA-362	VIC	A3501HD	GA-3501	MIGH
A283C	GA-230	ACD	A3138	GA-54	PRET	A3441	GA-277	FLAG	A35050	GA-605	EVGR
A284	GA-132	DEUS	A3149	GA-6129	HDA	A3441	GA-277	GOY	A35050	GA-605	MIGH
A28471	G-31	TOWM	A3149	GA-3523	PRET	A3441	GA-277	MIGH	A35050	GA-605	PUR
A2848C	GA-304	ACD	A3152	GA-6129	HDA	A34445	GAK-403	CASE	A351	GA-75	FLAG
A284C	GA-29	ACD	A3192	GA-271	PRET	A3445	GA-3445	GOY	A351	GA-75	GOY
A-2870	GA-217	SAKU	A3193	GA-735 ¹²⁴	PRET	A-3445	GA-3445	FLAG	A35106	GA-2193	GRP
A28741	G-31	CATP	A3195	GA-3588	PRET	A34479	GA-6479	ECOL	A35106	GA-2193	MIGH
A288	GA-7007	DEUS	A3201	GA-381	SERC	A34479	GA-6479	PUR	A35106	GA-2193	MOB
A2883	GA-437	MIGH	A3202	GA-7344	SERV	A34487	GA-382	ECOL	A35106	GA-2193	PUR
A2884	GA-1542	MIGH	A3205	GA-198	SERV	A34487	GA-382	JFL	A35106	GA-2193	SHE
A28895	GA-27	INGR	A32083	GA-29	PUR	A34487	GA-382	PUR	A35150	GA-172	EVGR
A288C	GA-1287	ACD	A321	GAVW-120	TNC	A345	GA-4303	GUD	A35150	GA-172	MIGH
A289	GA-6619 ¹	VALV	A3216	GA-138	MIGH	A345	GA-4303	RYCO	A35150	GA-172	PUR

REFERENCIA CRUZADA

Para números Gonher con Superíndice vea página 651
For Gonher with Superscript numbers see page 651

Numero	Gonher	Fabricante	Numero	Gonher	Fabricante	Numero	Gonher	Fabricante	Numero	Gonher	Fabricante
Number	Gonher	Manufacturer	Number	Gonher	Manufacturer	Number	Gonher	Manufacturer	Number	Gonher	Manufacturer
A35155	GA-130	EVGR	A3566	GA-3566	GOY	A3814	GA-3814	MINL	A4086	GAK-403	CASE
A35155	GA-130	MIGH	A3566	GA-3566	MIGH	A3814	GA-3814	PRET	A408C	GA-360	ACD
A35155	GA-130	PUR	A-3566	GA-3566	FLAG	A-3814	GA-3814	FACE	A408CL	GA-360	ACD
A35192	GA-158	EVGR	A35670	GA-143	PUR	A3827	GA-360	HDA	A41076	GAVW-22	PUR
A35192	GA-158	MIGH	A35671	GA-149	PUR	A387	GAVW-2	TNC	A410C	GA-21	ACD
A35192	GA-158	PUR	A35672	GA-248	PUR	A389	GA-2174	PFX	A411	GA-2114	TNC
A352	GAD-1 ⁸⁷	FACE	A35678	GA-334	PUR	A3896	GAVW-619	MIGH	A41174	GAK-16	CASE
A352	GAD-1 ⁸⁷	FLAG	A35700	GA-1546	PUR	A39	GA-54	SUN	A415	GA-142	VALV
A352	GAD-1 ⁸⁷	GOY	A35708	GA-291	PUR	A-39	GA-325	ATL	A416C	GA-31	ACD
A35219	GA-244	EVGR	A35712	GAVW-624	PUR	A3901	GA-3901	FLAG	A416CL	GA-31	ACD
A35219	GA-244	MIGH	A3575	GA-271	GOY	A3902	GA-253	FLAG	A41725	GA-34	CASE
A35219	GA-244	PUR	A357C	GA-303	ACD	A3904	GA-289	MIGH	A41745	GPP-18	CASE
A35227	GA-279	EVGR	A3580	GA-274	GOY	A3915	GA-3915	FLAG	A4183	GA-6880	HDA
A35227	GA-279	MIGH	A3580	GA-274	MIGH	A3916	GA-3916	FLAG	A42	GA-277	SUN
A35227	GA-279	PUR	A3588	GA-3588	FLAG	A3916	GA-3916	MIGH	A-42	GAD-3	ACD
A3523	GA-3523	FLAG	A3588	GA-3588	MIGH	A391C	GAD-1	ACD	A42019	GA-33 ¹¹²	ATL
A3523	GA-3523	MIGH	A358S	GA-27	VIC	A3924	GA-153	FLAG	A42029	GA-18	PUR
A35244	GA-607	EVGR	A359	GAD-1	GUD	A3924	GA-153	MIGH	A42030	GA-16	PUR
A35244	GA-607	MIGH	A359	GA-139	VALV	A392C	GAD-3	ACD	A42030	GAK-16	PUR
A35244	GA-607	PUR	A3590	GA-490	MIGH	A39346	GAK-16	CASE	A42039	GA-98 ¹¹²	PUR
A3524700092	G-1121F	MBNZ	A3592	GA-273	GOY	A3936	GAVW-618	MIGH	A42039K	GA-98	PUR
A35252	GA-2146	MIGH	A3592	GA-273	PRET	A394C	GA-6129	ACD	A42041	GA-1284	PUR
A35252	GA-2146	PUR	A3595	GA-263	MIGH	A3956	GA-249	MIGH	A42062	GA-20	PUR
A35258	GA-304	GRP	A3597	GA-735 ¹²⁴	FLAG	A396	GA-277	TNC	A42062	GAK-20	PUR
A35258	GA-304	MOB	A3597	GA-735 ¹²⁴	MIGH	A3966	GA-646	MIGH	A42073	GA-24 ¹¹²	PUR
A35258	GA-304	PUR	A36	GA-3490	MICF	A39867	GPP-19	CASE	A420C	GA-287	ACD
A35258	GA-304	SHE	A36	GA-3424	SUN	A39868	GPP-18	CASE	A42117	GA-287	PUR
A35265	GA-8606	EVGR	A-36	GA-59	ATL	A3997	GA-1546	MIGH	A42274	GAK-16	CASE
A35265	GA-8606	MIGH	A360	GAD-15	WESF	A4	GA-70	MIGH	A42278	GAK-403	CASE
A35265	GA-8606	PUR	A3603	GP-291	PAMO	A4	GP-50	PAMO	A422C	GA-21	ACD
A35267	GAVW-621	EVGR	A3621	GA-140	GOY	A4	GA-70	PRET	A42318	GA-429	EVGR
A35267	GAVW-621	MIGH	A3621	GA-140	MIGH	A4	GA-56	SUN	A42318	GA-429	PUR
A35267	GAVW-621	PUR	A-3621	GA-140	FLAG	A-4	GA-70	ATL	A4244	GAD-3	FACE
A35272	GA-472	EVGR	A36308	GA-171	PUR	A-4	GP-81	AUW	A4244	GAD-3	FLAG
A35272	GA-472	GRP	A36309	GA-193	PUR	A40	GA-3523	SUN	A4244	GAD-3	GOY
A35272	GA-472	MIGH	A3637	GA-3637	FLAG	A40	GA-230	WIX	A4244	GAD-3	MINL
A35272	GA-472	MOB	A3637	GA-3637	KND	A-40	GA-303	ATL	A425C	GA-356	ACD
A35272	GA-472	PUR	A3637	GA-3637	MIGH	A40003	GA-75	EVGR	A4278	GAD-15	GOY
A35290	GA-1616	EVGR	A3637	GA-3637	MINL	A40003	GA-75	PUR	A4278	GAD-15	PRET
A35290	GA-1616	PUR	A3637	GA-3637	VALV	A40004	GA-70	ECOL	A42896	GA-416	PUR
A35291	GA-780	EVGR	A-3637	GA-3637	FACE	A40004	GA-70	PUR	A428C	GA-106 ⁶⁶	ACD
A35291	GA-780	PUR	A3642	GA-101	FLAG	A40012	GA-7	PUR	A428C	GA-326 ⁷¹	ACD
A352S	GAK-20	VIC	A3647	GA-3647	FLAG	A40015	GA-3490	ECOL	A42978	GA-239	PUR
A353	GAD-3	FLAG	A3647	GA-3647	MIGH	A40015	GA-3490	PUR	A4299	GA-180	MIGH
A353	GAD-3	GOY	A365	GA-616	VIC	A40016	GA-2740	ECOL	A-4299	GA-180	FACE
A35305	GA-286	PUR	A365C	GA-12	ACD	A40016	GA-2740	JFL	A43	GPP-18	PAMO
A35322	GA-433	GRP	A366	GA-106 ⁶⁶	VIC	A40016	GA-2740	MOB	A43	GAVW-2	SUN
A35322	GA-433	MOB	A366	GA-326 ⁷¹	VIC	A40016	GA-2740	PUR	A4303	GA-4303	FLAG
A35322	GA-433	PUR	A3660	GA-277	MIGH	A40016	GA-2740	SHE	A4303	GA-4303	MIGH
A35322	GA-433	SHE	A367	GAVW-121	TNC	A40068	GA-78	EVGR	A4303S	GAK-16	PUR
A35323	GA-224	PUR	A367	GA-206	VIC	A40068	GA-78	PUR	A43066	GAK-403	CASE
A35330	GA-6479	PUR	A3681	GA-3681	FLAG	A4007	GA-486	MIGH	A4309	GAD-15	FLAG
A3537	GA-54	FLAG	A3681	GA-3681	MIGH	A4009	GA-410	ATEC	A430C	GA-6127	ACD
A3537	GA-54	MIGH	A368C	GA-57	ACD	A40090	GA-303	ECOL	A43-123	G-31	LROI
A35396	GA-248	PUR	A37	GA-2740	MICF	A40090	GA-303	PUR	A43-124	G-31	LROI
A35397	GA-194	PUR	A37	GA-3425	SUN	A400C	GA-56 ⁹⁰	ACD	A43138	GA-54	ECOL
A35406	GA-2106	GRP	A37	GA-71	WIX	A40103	GAD-1	PUR	A43138	GA-54	PUR
A35406	GA-2106	MOB	A-37	GA-57	ATL	A4011	GA-492	MIGH	A43149	GA-3523	ECOL
A35406	GA-2106	PUR	A370	GAVW-4	TNC	A40113	GA-75	ECOL	A43149	GA-3523	PUR
A35414	GA-2106	SHE	A3702	GAD-1	MICF	A40113	GA-75	PUR	A43-187-1	G-31	LROI
A35414	GA-477	GRP	A37035	GAVW-4	PUR	A4012	GA-349	DEUS	A431892	GPP-426	TIMB
A35414	GA-477	MOB	A3706	GAD-1	MICF	A40120	GA-74	ECOL	A43195	GA-3588	ECOL
A35414	GA-477	PUR	A3717	GA-274	FLAG	A40120	GA-74	PUR	A43195	GA-3588	PUR
A35414	GA-477	SHE	A3717	GA-274	MIGH	A40124	GA-2719B ¹²²	ECOL	A43197	GA-154	EVGR
A35420	GA-216	PUR	A37189	GP-1	CASE	A40124	GA-3300 ⁹⁸	ECOL	A43197	GA-154	MIGH
A35424	GA-2104	PUR	A371C	GA-135	ACD	A40124	GA-2719B ¹²²	PUR	A43197	GA-154	PUR
A35431	GA-367	PUR	A372	GP-3600	PAMO	A40124	GA-3300 ⁹⁸	PUR	A432	GA-2740	VIC
A35432	GA-264	PUR	A37237	GA-2195	MIGH	A40129	GA-3424	PUR	A4325	GA-4325	FACE
A35433	GA-4149	PUR	A372C	GA-3300	ACD	A40131	GA-3425	ECOL	A4325	GA-4325	FLAG
A35440	GA-305	PUR	A37327	GA-2195	MIGH	A40131	GA-3425	PUR	A4325	GA-4325	GOY
A35442	GA-2114	PUR	A37327	GA-2195	MOB	A4015	GA-105	DEUS	A4325	GA-4325	KND
A35462	GA-490	PUR	A37327	GA-2195	PUR	A4017	GA-163	SERV	A4325	GA-4325	MIGH
A35470	GA-2195	GRP	A37327	GA-2195	SHE	A402	GA-230	TNC	A4325	GA-4325	MINL
A35470	GA-2195	MOB	A3740947204	GA-3096R	MBNZ	A4020	GA-230	DEUS	A4325	GA-4325	VALV
A35470	GA-2195	PUR	A3740947401	GA-3095R	MBNZ	A4022	GA-149	MIGH	A4326	GA-78	GOY
A35470	GA-2195	SHE	A376	GAD-30	VALV	A4026	GA-143	MIGH	A4326	GA-78	MIGH
A35489	GA-158	PUR	A3760927201 KZ	GPP-1060	MBNZ	A4027606	GPP-1122	AWD	A-4326	GA-78	FACE
A3549	GA-89	FLAG	A3760927208 KZ	GPP-1060	MBNZ	A4029	GA-1529	MIGH	A43-260	G-31	LROI
A3549	GA-89	MIGH	A3765	GA-425	HDA	A4030	GA-1530	MIGH	A43-269	G-31	LROI
A354C	GA-730	ACD	A3779	GAK-20	PUR	A4039	GA-31	WHIT	A4327	GA-4958	MIGH
A35528	GA-1617	PUR	A37859	GAVW-626	GRP	A404	GAD-3	TOKO	A43-27	G-191	LROI
A35534	GA-606	PUR	A37859	GAVW-626	MOB	A404	GAD-3	TOKY	A43-277	G-238	LROI
A35546	GAVW-616	PUR	A37859	GAVW-626	PUR	A404	GAD-3	VIC	A4333	GA-392	MIGH
A35553	GA-249	PUR	A37859	GAVW-626	SHE	A4043	GP-91	PAMO	A43357	GA-3637	EVGR
A35556	GA-415	PUR	A378VS	GAK-16	ASAH	A4044	GP-3985 ⁹⁸	PAMO	A43357	GA-3637	PUR
A35560	GA-289	PUR	A37975	GAK-403	CASE	A4044	GP-40 ¹⁷	PAMO	A4339	GA-3915	MIGH
A35578	GA-380	PUR	A381	GA-74	FLAG	A4046	GA-398	HDA	A43398	GA-3566	ECOL
A355834	GP-58	JOY	A381	GA-74	GOY	A406	GA-2740	VIC	A43398	GA-3566	JFL
A3559	GA-271	FLAG	A381	GA-74	MIGH	A4063	GA-154	DEUS	A43398	GA-3566	PUR
A3559	GA-271	MIGH	A381	GA-74	PRET	A4069	GA-361	HDA	A43398	GA-3566	SHE
A35591	GA-1545	PUR	A381	GA-471	TNC	A406V	GA-2740	VIC	A433C	GA-86	ACD
A355C	GA-85	ACD	A-381	GA-74	FACE	A4070	GA-360	HDA	A4342	GA-253	FACE
A35626	GAVW-618	PUR	A3814	GA-3814	FLAG	A4076	GA-434	DEUS	A4342	GA-253	GOY
A35633	GA-1540	PUR	A3814	GA-3814	GOY	A408	GP-152	PAMO	A4342	GA-253	MIGH
A35642	GA-437	PUR	A3814	GA-3814	KND	A40866	GAK-403	CASE	A4343	GA-5056	GOY
A35649	GA-464	PUR	A3814	GA-3814	MIGH	A40871	GAK-403	CASE	A4343	GA-5056	PRET

Referencia Cruzada por Numero de Parte

Cross Reference by Part Number



Numero	Gonher	Fabricante	Numero	Gonher	Fabricante	Numero	Gonher	Fabricante	Numero	Gonher	Fabricante
Number	Gonher	Manufacturer	Number	Gonher	Manufacturer	Number	Gonher	Manufacturer	Number	Gonher	Manufacturer
A43463	GA-230	EVGR	A45047	GA-240	PUR	A-48	GA-432	ATL	A-5205	GA-880R	SAKU
A43463	GA-230	MIGH	A45047HD	GA-240	MIGH	A48006	GAK-20	CASE	A52052	GA-1285	PUR
A43463	GA-230	PUR	A45090	GA-673R	EVGR	A48006	GAK-20	DAVY	A52053	GA-1286	PUR
A43467	GA-4325	ECOL	A45090	GA-673R	FSN	A48065	GA-5648	PUR	A5208-H8903	GP-3682	NISS
A43467	GA-4325	PUR	A45090	GA-673R	MIGH	A48092	GA-26	DAVY	A52094	GA-27	PUR
A43474	GA-3681	ECOL	A45090	GA-673R	PUR	A48141	GAK-403	CASE	A52103	GA-375	PUR
A43474	GA-3681	PUR	A45091	GA-732R	EVGR	A48141	GAK-403	DAVY	A52108	GA-375	PUR
A434C	GA-349	ACD	A45091	GA-732R	MIGH	A482	GA-206	TNC	A52215	GA-31	PUR
A43510	GA-642	PUR	A45091	GA-732R	PUR	A4828	GA-4828	FLAG	A52219	GA-403	PUR
A43558	GA-2110	EVGR	A45105	GA-2114	EVGR	A4828	GA-4828	GOY	A52220	GA-360	PUR
A43558	GA-2110	MIGH	A45105	GA-2114	MIGH	A4828	GA-4828	KND	A52266	GA-361	PUR
A43558	GA-2110	PEP	A45105	GA-2114	PUR	A4828	GA-4828	MIGH	A52306	GA-7716	PUR
A43558	GA-2110	PUR	A45143	GA-2804 T	PUR	A4828	GA-4828	PRET	A5255	GA-26	HDA
A4356	GA-390	FACE	A45159	GAK-16	PUR	A-4828	GA-4828	FACE	A527	GA-459	TNC
A4356	GA-390	GOY	A45232	GA-145	GRP	A483	GA-6127	TNC	A528	GA-271	DEUS
A4356	GA-390	MIGH	A45232	GA-145	MIGH	A4830	GA-180	FLAG	A528	GA-1287	TNC
A4361	GA-139	MIGH	A45232	GA-145	MOB	A4830	GA-180	MIGH	A52891	GA-892 ⁹⁷	PUR
A437	GA-471	TOKO	A45232	GA-145	PUR	A48318	GA-27	DAVY	A529	GAK-458	TNC
A437	GA-471	TOKY	A45232	GA-145	SHE	A4832	GA-432	MIGH	A52923	GA-3501	EVGR
A437	GA-471	VIC	A45314	GA-348	PUR	A4837R	GA-18	ACD	A52923	GA-3501	PUR
A4371	GP-3985	PAMO	A454	GA-230	PFX	A485	GAD-3	PFX	A52977	GA-329	PUR
A4372	GA-3901	GOY	A45441	GA-145	GRP	A48534	GAK-20	CASE	A53	GA-89	SUN
A4372	GA-3901	MIGH	A45441	GA-145	MOB	A48534	GAK-20	DAVY	A-53	GA-3424	ATL
A4372	GA-3901	PRET	A45441	GA-145	PUR	A48540	GA-27	DAVY	A530	GA-277	DEUS
A4375	GA-362	GOY	A45441	GA-145	SHE	A4861	GA-251	HDA	A530	GA-9334	TNC
A4375	GA-362	MIGH	A45443	GA-2161	PUR	A487	GA-3490	PFX	A53152	GAK-216	PUR
A4375	GA-362	PRET	A45457	GA-2124	PUR	A488	GA-3490	ASAH	A532	GA-8047	PUR
A-4375	GA-362	FACE	A45488	GA-448	PUR	A488	GAD-3	PFX	A53304	GA-109	PUR
A4378	GA-174	GOY	A45512	GA-488	MOB	A488	GA-229	TNC	A53384	GA-89	ECOL
A4378	GA-174	MIGH	A45512	GA-488	PUR	A489	GA-7142	WESF	A53384	GA-89	PUR
A4378	GA-174	PRET	A45512	GA-488	SHE	A49	GAVW-2	SUN	A534	GAVW-2	DEUS
A4383	GA-471	FLAG	A45535	GA-4999	PUR	A-4901	GA-2146	SAKU	A534	GA-1285	TNC
A44	GA-271	SUN	A45569	GA-1571	PUR	A49026	GAK-16	CASE	A534C	GA-378	ACD
A44	GA-2740	TNC	A45625	GP-34	CASE	A49026	GAK-16	DAVY	A535	GAK-16	PFX
A-44	GA-75	ATL	A45625 KIT	GP-34	CASE	A49329	GAK-403	CASE	A53515	GA-329	PUR
A44068-KIT	GPP-18 ¹⁰⁴	CASE	A45639	GA-633R	PUR	A49329	GAK-403	DAVY	A536	GAK-20	PFX
A44081	GP-54 ¹¹	CASE	A45650	GA-320	PUR	A49378	GA-1008	PUR	A536	GA-1286	TNC
A44081	GP-66 ¹⁰	CASE	A45682	GA-280	PUR	A494C	GA-74	ACD	A536C	GA-7360	ACD
A44326	GA-78	ECOL	A45701	GA-1529	PUR	A495	GA-3490	ASAH	A537	GAVW-2	DEUS
A44326	GA-78	PUR	A45780	GA-341	PUR	A-4958	GA-4958	FLAG	A537C	GA-7716	ACD
A44327	GA-4958	GRP	A45987	G-33	CASE	A496	GA-27	TNC	A538	GAK-403	PFX
A44327	GA-4958	JFL	A45987	G-33	DAVY	A498	GA-361	TNC	A538	GA-9045	TNC
A44327	GA-4958	MOB	A45988	G-1175 ¹⁰⁸	DAVY	A49993	GAK-16	DAVY	A54	GA-3681	SUN
A44327	GA-4958	PUR	A46	GA-735 ¹²⁴	SUN	A499C	GA-376	ACD	A-54	GA-85	ATL
A44327	GA-4958	SHE	A461	GAVW-2	PFX	A49C	GA-70	ACD	A540	GA-33 ¹²²	PFX
A443C	GA-206	ACD	A4613	GA-142	GOY	A5	GP-20	AUW	A540	GA-405	TNC
A443CL	GA-206	ACD	A4613	GA-142	MIGH	A5	GA-44	GUD	A5401	GAK-16	SAKU
A44443	GA-119	PUR	A46158	GP-171	CASE	A5	GA-44	RYCO	A5402	GA-18	SAKU
A44564	GA-105	CASE	A4626	GA-6619 ¹	MIGH	A5	GA-59	SUN	A5408	GA-206	SAKU
A44610	GA-129	EVGR	A4626	GA-6620 ²	MIGH	A-5	GA-7017	ATL	A-5409	GA-376	SAKU
A44610	GA-129	MIGH	A46293	GP-171	CASE	A50	GA-71	CASE	A541	GA-7017	DEUS
A44610	GA-129	PUR	A462C	GA-361	ACD	A50	GA-71	RYCO	A-5413	GA-329	SAKU
A44626	GA-6619 ¹	ECOL	A462CL	GA-361	ACD	A50	GA-74	SUN	A-5414	GA-239	SAKU
A44626	GA-6620 ¹	ECOL	A4632	GA-275	GOY	A-50	GA-275	GOY	A-5415	GA-892	SAKU
A44626	GA-6619 ¹	EVGR	A4632	GA-275	MIGH	A500	GA-2184	DEUS	A542	GA-106 ⁶⁶	PFX
A44626	GA-6620 ¹	EVGR	A4632	GA-275	PRET	A50-00041-045	GP-310	MAN	A542	GA-326 ⁷¹	PFX
A44626	GA-6619 ¹	FSN	A4637	GA-59	GENC	A50031	GA-56	EVGR	A-5423	GA-26	SAKU
A44626	GA-6620 ¹	FSN	A463V	GAK-20	ASAH	A50031	GA-56	MIGH	A-5426	GA-6880	SAKU
A44626	GA-6619 ¹	PUR	A4645	GA-6690	GOY	A50031	GA-56	PUR	A5427	GA-107	SAKU
A44626	GA-6620 ¹	PUR	A4645	GA-6690	MIGH	A-5005	GA-589	SAKU	A5428	GA-109	SAKU
A44632	GA-133	ECOL	A4648	GA-133	MIGH	A50050	GA-37	PUR	A543	GA-360	PFX
A44632	GA-275	PUR	A465	GA-180	RYCO	A-5006	GA-588	SAKU	A543	GA-357	TNC
A44643	GA-166	EVGR	A4650	GA-604	MIGH	A5-00834-0004	GAK-625	MAN	A-5431	GA-209	SAKU
A44643	GA-166	MIGH	A4656	GA-7017	MIGH	A50084	GA-730	PUR	A54314	GA-3501	EVGR
A44643	GA-166	PUR	A4669	GAD-294	MIGH	A50091	GA-59	ECOL	A54314	GA-3501	PUR
A44648	GA-133	PUR	A4672	GG-580	GOY	A50091	GA-59	PUR	A5433	GA-891	SAKU
A44655	GA-7007	EVGR	A467C	GA-75	ACD	A50092	GA-57	ECOL	A-5435	GA-210	SAKU
A44655	GA-7007	MIGH	A468	GA-4325	ASAH	A50092	GA-57	PUR	A544	GA-6129	PFX
A44655	GA-7007	PEP	A4680	GA-386	GOY	A50093	GA-325	ECOL	A5446	GA-422	PUR
A44655	GA-7007	PUR	A4680	GA-386	MIGH	A50093	GA-325	PUR	A5444	GA-33 ¹²²	HDA
A4468	GA-362	ASAH	A4680	GA-386	PRET	A501	GA-467	TNC	A545	GA-356	TNC
A4468	GA-195	GOY	A468C	GA-50	ACD	A5015	GA-277	SAKU	A546	GA-360	TNC
A4468	GA-195	MIGH	A4690	GA-322	MIGH	A5056	GA-5056	MIGH	A54669	GAD-294	PEP
A4468	GA-195	PRET	A46947	GA-357	CASE	A5058	GA-273	MIGH	A54669	GAD-294	PUR
A44688	GA-596	PUR	A47	GA-3647	SUN	A-5069	GA-879	HDA	A547	GA-604	DEUS
A4471	GA-471	MIGH	A-47	GA-3300	ATL	A507C	GA-135	ACD	A54793	GA-768R	PUR
A44727	GA-300	FSN	A47039	GAVW-622	EVGR	A508	GA-2740	PFX	A548	GA-6127	PFX
A44727	GA-300	MIGH	A47039	GAVW-622	MIGH	A50831	GA-85	ECOL	A549	GA-276	DEUS
A44727	GA-300	PEP	A47039	GAVW-622	PUR	A50831	GA-85	PUR	A54999	GA-499R	PUR
A44727	GA-300	PUR	A4712	GA-217	MIGH	A50991	GA-86	ECOL	A55	GA-77	GUD
A4479	GA-6479	GOY	A47145	GA-329	CASE	A50991	GA-86	PUR	A55	GA-77	RYCO
A4479	GA-6479	MIGH	A47146	GA-239	CASE	A509C	GAK-20	ACD	A55	GA-277	SUN
A447C	GA-357	ACD	A4722	GA-5466	MIGH	A50C	GA-73	ACD	A-55	GA-86	ATL
A448	GA-71	TNC	A4731	GA-165	MIGH	A510	GA-360	TNC	A550	GA-206	PFX
A44856	GA-3588 ¹¹³	EVGR	A4747	GA-98 ¹¹²	HDA	A512	GA-3425	PFX	A-5501	GA-7716	SAKU
A44856	GA-3588 ¹¹³	MIGH	A475	GA-78	ASAH	A5140	GA-403	HDA	A-5502	GA-7360	SAKU
A44856	GA-3588 ¹¹³	PUR	A476	GAVW-2	TNC	A5142150140	GA-33 ¹¹²	TAKI	A-5506	GA-375	SAKU
A4487	GA-382	GOY	A477	GAVW-120	TNC	A515	GAVW-4	PFX	A-5507	GA-8047	SAKU
A4487	GA-382	MIGH	A477C	GA-59	ACD	A517	GA-277	PFX	A-5508	GA-1285	SAKU
A449	GA-195	WESF	A478	GA-2110	RYCO	A5191	GA-510	MIGH	A-5509	GA-9334	SAKU
A45	GA-77	MIGH	A4780	GA-33 ¹¹²	TNC	A52	GA-71	MIGH	A550C	GAK-1532	ACD
A45	GA-77	PRET	A47993	GAK-16	DAVY	A52	GAD-1	RYCO	A551	GA-277	DEUS
A45	GA-3490	SUN	A479C	GA-429	ACD	A-52	GA-3425	ATL	A551	GA-361	PFX
A4500	GA-892	HDA	A47C	GA-71	ACD	A520	GA-39	LBF1	A-5510	GA-1286	SAKU
A45047	GA-240	EVGR	A48	GP-54	PAMO	A52040	GAK-403	PUR	A-5511	GA-1008	SAKU
A45047	GA-240	MIGH	A48	GA-274	SUN	A52046	GAK-403	PUR	A-5512	GA-1284	SAKU

REFERENCIA CRUZADA

Numero	Gonher	Fabricante	Numero	Gonher	Fabricante	Numero	Gonher	Fabricante	Numero	Gonher	Fabricante
Number	Gonher	Manufacturer	Number	Gonher	Manufacturer	Number	Gonher	Manufacturer	Number	Gonher	Manufacturer
A-5513	GA-1284	SAKU	A594C	GA-239	ACD	A637	GA-2194	PFX	A669AS	GA-27	ASAH
A-5517	GA-1203	SAKU	A595	GA-229	PFX	A6376	GA-142	FLAG	A67	GP-51	PAMO
A-5520	GA-1287	SAKU	A595C	GA-50	ACD	A6390	GA-18	HDA	A67	GA-192	PRET
A55203	GA-33 ¹²	CASE	A595V	GA-2106	ASAH	A6395	GA-195	FLAG	A67	GA-174	SUN
A-5521	GA-483	SAKU	A596C	GA-329	ACD	A64	GA-3814	SUN	A670	GAK-20	ASAH
A55216	GA-529	PUR	A598	GAK-403	TNC	A-64	GA-735 ^{12A}	ATL	A670C	GA-892	ACD
A5523	GAK-625	SAKU	A5980	GA-488	MIGH	A640	GA-3424	GOY	A673	GAK-20	LBF1
A55282	GA-781	PUR	A5999	GAK-403	CASE	A-640	GA-3424	FACE	A675	GA-128	DEUS
A-5529	GA-482	SAKU	A59998	GA-16	CASE	A6401	GA-426	HDA	A6769	GA-106 ⁴⁶	HDA
A5535	GA-4999	PPRO	A59998	GAK-16	CASE	A-6406B	GA-27	NIPP	A6769	GA-326 ⁷¹	HDA
A55378	GA-240	PUR	A59999	GAK-403	CASE	A641	GA-3425	GOY	A6775	GA-206	HDA
A55380	GA-2130	GRP	A6	G-6	ALY	A641	GA-3425	KND	A68	GA-2740	SUN
A55380	GA-2130	MOB	A6	GP-3	AUW	A-641	GA-3425	FACE	A-68	GA-271	ATL
A55380	GA-2130	PUR	A6	GA-55	SUN	A64453	GP-5	CASE	A6804	GA-467	SAKU
A55380	GA-2130	SHE	A-6	GA-6690	ATL	A645	GA-434	DEUS	A-6806	GA-436	SAKU
A5539	GA-475 ¹³	PPRO	A-60	GA-3566	SUN	A64516	GA-1095	PUR	A-6807	GA-386	FLAG
A5539	GA-5876 ³⁵	PPRO	A600	GA-3445	DEUS	A64699	GA-197R	PUR	A6808	GA-49	SAKU
A55400	GA-413R	PUR	A600	GAK-20	TNC	A646C	GA-18	ACD	A680C	GA-55 ¹³	ACD
A-5541	GA-853R	SAKU	A6005	GA-398	SAKU	A6479	GA-6479	FLAG	A6816	GAVW-2	SAKU
A-5543	GA-9045	SAKU	A6007	GA-3566	S500	A648	GA-133	DEUS	A-6819	GAVW-121	SAKU
A55444	GA-2170	PUR	A60074	GA-55	ECOL	A6492	GAK-403	HDA	A682	GA-26	LBF1
A554C	GA-879	ACD	A60074	GA-55	PUR	A65	GA-153	SUN	A683	GA-361	LBF1
A55521	GA-510	PUR	A6008	GA-361	SAKU	A650	GA-9045	LBF1	A6834	GA-361	HDA
A55539	GA-475	PUR	A600C	GA-680	ACD	A65043	GAK-20	CASE	A684	GA-6129	LBF1
A55539	GA-5876	PUR	A600L221	G-31	CONT	A6505	GA-3916	SAKU	A6840	GA-33 ¹²	HDA
A5556	GA-415	PPRO	A60127	GAK-20	DAVY	A6509	GA-6479	SAKU	A6847	GA-329	HDA
A556	GA-106 ⁴⁶	TNC	A60161	GA-27	DAVY	A651	GA-4303	DEUS	A685	GA-8	HARM
A556	GA-326 ⁷¹	TNC	A602	GA-405	PFX	A651	GA-1287	LBF1	A6-85497-5700	G-296	MAN
A-5566	GA-499R	SAKU	A603	GAVW-2	PFX	A-6510	GA-59	SAKU	A6-85497-5700	G-296-B	MAN
A-5568	GA-499R	SAKU	A6032	GA-403	HDA	A-6511	GA-7017	SAKU	A686	GA-230	HARM
A55683	GA-397	PUR	A60378	GAK-20	JOND	A-6513	GA-164	SAKU	A6869	GA-616	HDA
A-5570	GA-880R ¹⁰⁴	SAKU	A60574	GAK-20	DAVY	A-6514	GA-165	SAKU	A6876C	GA-276	ACD
A55700	GA-413R	PUR	A607	GA-153	DEUS	A65154	GA-930R	PUR	A688	GA-1203	LBF1
A-5572	GA-483 ¹⁰⁴	SAKU	A6074	GA-55	PUR	A-6518	GAVW-622	SAKU	A688	GAVW-2	PFX
A559C	GA-98 ¹²	ACD	A6075	GA-27	TOKY	A652	GA-71	TNC	A688C	GA-892	ACD
A56	GA-80	GUD	A6075	GA-27	VIC	A-6520	GA-673R	SAKU	A689C	GA-891	ACD
A56	GA-5056	SUN	A608	GA-253	DEUS	A-6521	GA-392	SAKU	A69	GA-39	GUD
A-56	GA-3445	ATL	A61	GA-4303	SUN	A-6522	GA-279	SAKU	A69	GP-691	PAMO
A560	GA-49	TNC	A-61	GA-3490	ATL	A-6523	GA-348	SAKU	A69	GA-39	RYCO
A5602V	GA-133	ASAH	A6105	GA-6127	SAKU	A65295	GA-853R	PUR	A69	GA-78	SUN
A-5610	GA-6127	SAKU	A6113	GA-106 ⁴⁶	SAKU	A653	GA-386	DEUS	A690	GA-384	DEUS
A-5613	GA-6127 ¹⁰⁸	SAKU	A6113	GA-326 ⁷¹	SAKU	A653	GA-8047	LBF1	A69045	GA-9045	PUR
A-5613	GA-6128 ¹⁰⁴	SAKU	A6120920001	GPP-612	MBNZ	A65343	GA-930R	PUR	A690X-6731-BA	G-870	FORD
A-5614	GA-6128	SAKU	A613C	GA-21	ACD	A65344	GA-890R	PUR	A690X-6731-EA	G-870	FORD
A-5618	GA-6129	SAKU	A615	GA-378	TNC	A65346	GA-723R	PUR	A690X-6A692-RA	GP-3816	FORD
A5619A	GA-360	MICF	A616C	GA-425	ACD	A65350	GA-712R	PUR	A6918	GA-378	HDA
A5620B	GA-206	MICF	A617C	GA-426	ACD	A65379	GA-2179	CHAM	A69334	GA-9334	PUR
A564	GA-360	VIC	A618	GA-2122	TNC	A65379	GA-2179	MIGH	A6984	GA-416	HDA
A564C	GA-482	ACD	A6187	GA-375	HDA	A65379	GA-2179	PUR	A699	GA-127	DEUS
A565	GA-361	VIC	A619C	GA-416	ACD	A654	GA-595	DEUS	A699	GA-27	LBF1
A565C	GA-483	ACD	A62	GA-4828	SUN	A654	GA-1285	LBF1	A68	GP-1	FORD
A5699	GA-6129	HDA	A-62	GA-2740	ATL	A6545	GAVW-121	ACD	A7	GP-81 ³¹	AUW
A57	GA-80	MIGH	A62034	GA-26	DAVY	A6546C	GAD-30	ACD	A7	GP-9 ⁸	AUW
A57	GA-273	SUN	A62055	GA-1287	PUR	A655	GA-4365	DEUS	A7	GA-70	SUN
A5700	GA-106 ⁴⁶	HDA	A620C	GAK-216	ACD	A655	GA-5648	LBF1	A-7	GA-133	ATL
A5700	GA-326 ⁷¹	HDA	A62104	GA-26	PUR	A6555	GA-275	FLAG	A-700	GA-3647	ATL
A5701	GA-6127	HDA	A62200	GA-206	PUR	A6558	GA-2106	FLAG	A700	GA-2110	DEUS
A-5701	GA-37	SAKU	A62207	GA-357	PUR	A656	GA-195	DEUS	A70014	GAP-379	PUR
A5702	GA-6128	HDA	A62221	GA-106 ⁴⁶	PUR	A656C	GA-679	ACD	A70090	GA-7	CASE
A5705	GA-39	SAKU	A62221	GA-326 ⁷¹	PUR	A657	GA-174	DEUS	A700X-6714-AA	GP-3816	FORD
A5707	GA-27	SAKU	A62275	GA-885	PUR	A6587	GA-360	HDA	A700X-6714-CA	GP-28 ⁶	FORD
A57096	GA-49	PUR	A625	GA-1614	DEUS	A658C	GA-509 ¹⁴	ACD	A700X-6714-CA	GP-430 ⁸	FORD
A571	GAD-3	ASAH	A6255	GA-679	HDA	A659	GA-165	DEUS	A700X-6714-FA	GP-46	FORD
A-5718	GA-563	SAKU	A6257	GAK-403	HDA	A659	GA-1008	LBF1	A700X-6714-GA	GP-171	FORD
A572	GA-2740	ASAH	A6259	GAK-216	HDA	A66	GA-360	WIX	A700X-6714-JA	GP-3816	FORD
A572C	GA-679	ACD	A627C	GA-42	ACD	A-66	GA-3588	ATL	A700X-6714-MA	GP-81	FORD
A572V	GA-2740	ASAH	A62875	GA-7360	PUR	A660	GA-230	KND	A700X-6714-UA	GP-50	FORD
A573C	GA-680	ACD	A62898	GA-482	PUR	A660	GA-230	MIGH	A700X-6731-AF	G-870	FORD
A574	GA-892	TNC	A62899	GA-483	PUR	A660	GA-230	TNC	A700X-6731-AFA	G-870	FORD
A576	GA-98 ¹²	TNC	A62943	GA-426	PUR	A660	GA-230	VALV	A700X-6731-DA	G-834	FORD
A576C	GA-403	ACD	A62945	GA-425	PUR	A-660	GA-230	FACE	A700X-6731-FA	G-870	FORD
A57857	GP-34	CASE	A62958	GA-680	PUR	A6601	GA-132	SAKU	A700X-6731-UA	G-871	FORD
A579C	GA-6880	ACD	A62974	GAK-1532	PUR	A6602	GA-141	SAKU	A700X-6744-DA	G-834	FORD
A58	GAD-3	SUN	A62981	GA-679	PUR	A-6603	GA-271	SAKU	A700X-9601-ABA	GA-200	FORD
A-58	GA-54	ATL	A63	GA-3916	SUN	A-6604	GA-301	SAKU	A700X-9601-ABA	GA-218	FORD
A58047	GA-8047	PUR	A-63	GA-3523	ATL	A-6605	GA-8606	SAKU	A700X-9601-NA	GA-230	FORD
A5838	GA-37	HDA	A63026	GA-891	PUR	A660C	GA-680	ACD	A700X-9601-YA	GA-71	FORD
A584	GA-18	TNC	A63028	GAK-625	PUR	A661	GA-230	TNC	A701	GA-180	DEUS
A5848	GA-2130	MIGH	A6303	GA-405	SAKU	A6619	GA-6619 ¹	FLAG	A7017	GA-7017	FLAG
A584C	GA-885	ACD	A63031	GA-892	PUR	A6619	GA-6620 ⁵	FLAG	A702	GA-216	DEUS
A585	GAK-216	TNC	A-6305	GA-390	FLAG	A662	GAD-15	DEUS	A702C	GAP-379	ACD
A585V	GA-216	ASAH	A63142	GA-827	PUR	A663	GA-273	DEUS	A7033	GA-241	MIGH
A58672	GP-69	CASE	A63143	GA-826	PUR	A663	GA-4958	VALV	A703C	GAK-16	ACD
A587	GA-416	TNC	A63145	GA-2984	PUR	A6632	GA-6129	HDA	A704	GAK-16	LBF1
A58712	GPP-18	CASE	A63228	GA-209	PUR	A664	GAK-403	LBF1	A704C	GA-2740	ACD
A58745	GPP-18	CASE	A63229	GA-210	PUR	A664	GA-78	VALV	A707	GA-140	DEUS
A58758	GP-1	CASE	A632315	G-1176	TOWM	A664 180 0009	G-180	MBNZ	A707	GA-37	HARM
A588V	GA-471	ASAH	A63290	GA-373	PUR	A6641	GA-6127	HDA	A708	GA-3901	DEUS
A59	GA-50	MIGH	A63298	GA-108	PUR	A665	GA-9334	LBF1	A709C	GA-588	ACD
A59	GA-50	PRET	A-6333	GA-382	FLAG	A665	GA-390	VALV	A71	GAD-15	SUN
A-59	GAVW-2	ATL	A63402	GA-589	PUR	A665459	GAK-403	TOWM	A71	GA-44	TNC
A-59	GA-140	SUN	A63403	GA-588	PUR	A665934	GP-66	TOWM	A-71	GA-89	ATL
A590C	GA-229	ACD	A63438	GAP-381	PUR	A665C	GA-31	ACD	A710	GAD-30	DEUS
A592	GAK-16	TNC	A6345280306	GA-864R	MBNZ	A666	GA-1286	LBF1	A710C	GA-589	ACD
A592C	GA-3300	ACD	A6362	GA-362	FLAG	A6660	GA-6127	HDA	A711	GA-106 ⁴⁶	LBF1
A593C	GA-50	ACD	A636372	G-31	TOWM	A6690	GA-6690	FLAG	A711	GA-326 ⁷¹	LBF1

Referencia Cruzada por Numero de Parte

Cross Reference by Part Number



Numero	Gonher	Fabricante	Numero	Gonher	Fabricante	Numero	Gonher	Fabricante	Numero	Gonher	Fabricante
Number	Gonher	Manufacturer	Number	Gonher	Manufacturer	Number	Gonher	Manufacturer	Number	Gonher	Manufacturer
A712	GA-200	DEUS	A74281	GA-398	PUR	A780X-6714-EA	GP-3816	FORD	A804	GA-471	WESF
A712	GA-218	DEUS	A742C	GA-3425	ACD	A780X-6714-GA	GP-28 ⁵	FORD	A8044	GA-372	HDA
A712	GA-375	LBFI	A743	GA-432	DEUS	A780X-6714-GA	GP-430 ⁸	FORD	A8047	GA-376	HDA
A712	GAD-3	TOKO	A743C	GA-3424	ACD	A780X-6714-HA	GP-28	FORD	A8047-1	GA-8047	HDA
A712	GAD-3	TOKO	A7443	GA-6129	HDA	A780X-6714-MA	GP-462	FORD	A805	GA-3915	DEUS
A712	GAD-3	VIC	A74435	GA-3551 ⁵⁵	PUR	A780X-6714-NA	GP-462	FORD	A805	GA-27	PFX
A712C	GA-2984	ACD	A74435	GA-3551 XT ⁶⁴	PUR	A780X-9150-AA	GP-1122	FORD	A806	GA-274	DEUS
A713	GAD-30	DEUS	A744C	GA-89	ACD	A780X-9155-AA	GG-5 L	FORD	A8065	GA-5648	HDA
A713	GA-735 ¹²⁴	GOY	A746	GA-5466	DEUS	A780X-9176-AA	G-1121	FORD	A807	GA-382	DEUS
A717	GAK-625	TNC	A746	GAD-3	HARM	A780X-9176-BA	G-1121	FORD	A810C	GA-826	ACD
A72	GA-362	SUN	A74685	GA-759	PUR	A780X-9176-CA	G-1123F	FORD	A810X-6714-JA	GP-3816	FORD
A-72	GA-2719B	ATL	A74700	GA-682R ¹⁰⁴	PUR	A780X-9176-EA	G-1123	FORD	A810X-6714-KA	GP-3816	FORD
A720	GA-360	HARM	A7475	GAK-403	HDA	A780X-9601-AFA	GA-360	FORD	A810X-6714-LA	GP-3816	FORD
A720	GA-33 ¹¹²	LBFI	A748C	GA-2719B	ACD	A780X-9601-BAA	GA-303	FORD	A810X-9150-CA	GP-1122	FORD
A-7202	GA-378	SAKU	A749	GA-4303	GOY	A780X-9601-BHA	GAVW-2	FORD	A-810-X-9601-CA	GA-2122	FORD
A-7203	GA-229	SAKU	A749	GA-26	LBFI	A780X-9601-CA	GAVW-4	FORD	A810X-9601-JA	GA-277	FORD
A720X-6714-FA	GP-3816	FORD	A749	GA-4303	PRET	A780XX-9601-AFA	GA-360	FORD	A811	GA-459	PFX
A720X-6714-LA	GP-430 ⁸	FORD	A749C	GA-4303	ACD	A781	GAVW-2	PFX	A811C	GA-827	ACD
A720X-6714-SA	GP-3	FORD	A75	GA-6479	SUN	A7813	GA-360	HDA	A813	GA-467	PFX
A720X-9601-FA	GA-71	FORD	A-75	GA-274	ATL	A781C	GA-154	ACD	A813	GA-3490	TOKO
A720X-9601-GA	GAD-1	FORD	A75081	GA-518R	PUR	A784	GAD-129	DEUS	A813	GA-3490	TOKY
A720X-9601-HA	GAD-3	FORD	A75096	GA-221R	PUR	A784C	GA-107	ACD	A813	GA-3490	VIC
A72111	GA-1203	PUR	A75168	GA-966R	PUR	A785	GA-322	DEUS	A813C	GA-3	ACD
A72138	GA-6129	PUR	A751C	GA-277	ACD	A785	GA-3647	GOY	A7813	GA-3490	VIC
A72139	GA-6127	PUR	A75254	GA-539R	PUR	A785C	GA-3647	ACD	A814	GA-362	DEUS
A722	GAD-1	HARM	A75294	GP-69	CASE	A786	GAD-118	DEUS	A814	GA-2740	TOKO
A72201	GA-356	PUR	A752C	GAVW-4	ACD	A787	GA-18	PFX	A814	GA-2740	TOKY
A72207	GA-357	PUR	A753	GA-89	GOY	A787C	GAVW-2	ACD	A814	GA-2740	VIC
A72314	GA-378	PUR	A75314	GA-378	PUR	A788	GA-141	DEUS	A814C	GA-4365	ACD
A725	GA-6127	LBFI	A75345	GA-221R	PUR	A7882	GA-1616	VALV	A814V	GA-2740	VIC
A726C	GA-229	ACD	A753C	GA-89	ACD	A788C	GA-210	ACD	A81519	GA-348	MIGH
A727	GA-472	DEUS	A755C	GAVW-22	ACD	A-79	GA-3916	ATL	A81680	GA-780	MIGH
A72876	GA-376	PUR	A756442	G-1175	COO	A790	GA-514	DEUS	A817C	GA-230	ACD
A72897	GA-229	PUR	A757C	GA-3490	ACD	A790	GA-75	KND	A820X-6714-NA	GP-54 ¹¹	FORD
A72919	GA-829	PUR	A759C	GA-372	ACD	A-790	GA-75	FACE	A820X-6714-NA	GP-66 ¹⁰	FORD
A72C	GA-7	ACD	A75C	GA-37	ACD	A-7907	GA-251	SAKU	A820X-9601-GA	GAD-3	FORD
A73	GA-195	SUN	A76	GA-3901	SUN	A7908	GA-360	SAKU	A820X-9601-LA	GAVW-2	FORD
A-73	GA-80	ATL	A-76	GA-4303	ATL	A790C	GA-75	ACD	A821C	GA-209	ACD
A730	GAD-3	HARM	A760	GA-377	ACD	A790X-6714-BA	GP-3816	FORD	A822	GAD-1	PFX
A730X-6713-AA	G-225	FORD	A-7605	GA-416	SAKU	A790X-6714-CA	GP-3816	FORD	A822	GA-139	WESF
A730X-6714-AA	GP-3816	FORD	A76063	GA-600R	PUR	A790X-6714-FA	GP-42	FORD	A823	GA-180	WESF
A730X-6714-E1A	GP-54	FORD	A-7609	GAK-216	SAKU	A790X-9176-AA	G-1121	FORD	A824	GA-4303	TNC
A730X-6714-E3A	GP-54	FORD	A760X-6714-KA	GP-3816	FORD	A790X-9601-AA	GAVW-4	FORD	A-824	GA-390	FACE
A730X-6714-FA	GP-54 ¹¹	FORD	A760X-6714-RA	GP-81	FORD	A790X-9601-AHA	GAD-1	FORD	A824C	GA-390	ACD
A730X-6714-FA	GP-66 ¹⁰	FORD	A760X-6744-AA	G-834	FORD	A790X-9601-EA	GA-4365	FORD	A826	GA-3681	GOY
A730X-6714-FA	GP-36	FORD	A761	GA-467	TNC	A790X-9601-KA	GAVW-2	FORD	A826	GA-3681	KND
A730X-6731-A1A	GP-36	FORD	A-7616	GA-403	SAKU	A790X-9601-SA	GAD-3	FORD	A-826	GA-3681	FACE
A730X-6731-BA	G-225	FORD	A762	GA-2110	PFX	A-7912	GA-356	SAKU	A826C	GA-3681	ACD
A730X-6731-CA	G-225	FORD	A7626	G-1173	CASE	A-7915	GA-357	SAKU	A826C	GA-7716	LBFI
A730X-6731-J3A	G-33	FORD	A7627	G-1173	CASE	A792	GA-5648	PFX	A827	GA-3490	PFX
A730X-6731-NA	GP-46	FORD	A763	GA-4365	PFX	A793	GA-436	PFX	A828	GA-7360	LBFI
A730X-6731-T1A	G-813	FORD	A7640	GA-210	HDA	A7938	GA-286	MIGH	A828	GA-2719B	TNC
A730X-6731-T3A	G-813	FORD	A7641	GA-108	HDA	A7944	GA-304	MIGH	A82893	GA-6880	PUR
A730X-6731-TA	G-813	FORD	A765	GA-77	HARM	A7946	GA-278R	MIGH	A829	GA-3681	GOY
A730X-6741-E3A	GP-54	FORD	A765C	GA-3445	ACD	A7958	GA-183	MIGH	A829	GA-483	LBFI
A730X-6744-BA	G-834	FORD	A76912	G-1173	STUD	A7959	GA-491	MIGH	A829	GA-2106	WESF
A730X-6744-DA	G-191	FORD	A-77	GA-74	ATL	A796	GA-49	PFX	A83	GA-85	MIGH
A730X-6744-HA	G-143	FORD	A770X-6714-ABA	GP-3816	FORD	A7964	GA-491	MIGH	A-83	GA-4958	ATL
A730X-6744-RA	G-31	FORD	A770X-6714-ACA	GP-3816	FORD	A7975	GA-258	MIGH	A830	GA-482	LBFI
A730X-6744-UA	G-333	FORD	A770X-6714-BA	GP-3816	FORD	A7975C	GA-258	ACD	A830	GAD-30	WESF
A731	GA-8901	DEUS	A770X-6714-DA	GP-3816	FORD	A7981	GA-183R	MIGH	A83057	GA-377	PUR
A73185	GA-251	PUR	A770X-6714-GA	GP-462	FORD	A7984	GA-248	MIGH	A83058	GA-372	PUR
A73240	GA-6128	PUR	A770X-6714-HA	GP-28 ⁵	FORD	A7985	GA-305	MIGH	A8305-9601-DLA	GA-3490	FORD
A73244	GA-107	PUR	A770X-6714-JA	GP-430 ⁸	FORD	A798C	GAVW-2	ACD	A830X-6731-LA	G-33	FORD
A7327	GA-31	HDA	A770X-6714-NA	GP-3816	FORD	A7990	GA-194	MIGH	A830X-6731-RA	G-31	FORD
A73295	GA-229	PUR	A770X-6714-SA	GP-3816	FORD	A7996	GA-413R	MIGH	A830X-9150-EA	G-1173 ¹⁰⁸	FORD
A73498	GA-405	PUR	A770X-9601-AJA	GAVW-4	FORD	A7TN-6731-A	G-31	FORD	A830X-9150-JA	G-297-B	FORD
A735	GA-54	GOY	A770X-9601-AMA	GAVW-2	FORD	A7TW-6731-A	G-31	FORD	A830X-9155-ABA	GP-1122	FORD
A73530	GA-388	PUR	A7716	GA-7716	HDA	A8	G-200	AUW	A830X-9155-SA	GP-1122	FORD
A73530	GA-389	PUR	A773	GA-3588	GOY	A8	GA-77	SUN	A830X-9601-ACA	GAK-625	FORD
A73531	GA-371	PUR	A773C	GA-3588	ACD	A-8	GA-386	ATL	A830X-9601-AFA	GAK-20	FORD
A73536	GA-563	PUR	A774	GA-2194	DEUS	A-80	GA-273	ATL	A830X-9601-AMA	GA-436	FORD
A735C	GA-54	ACD	A77470	GP-1122 ¹⁰⁸	CASE	A800	GA-735 ¹²⁴	DEUS	A830X-9601-ANA	GA-405	FORD
A736	GA-3523	GOY	A77470L	PPP-18 ¹⁰⁴	CASE	A8001	GPP-19	SAKU	A830X-9601-ATA	GA-27	FORD
A7360	GA-7360	HDA	A774702L	GP-1122	SAMS	A800X-6714-AA	GP-3985	FORD	A830X-9601-BDA	GA-106 ⁶	FORD
A736C	GA-3523	ACD	A7747051	PPP-18	SAMS	A800X-6714-FA	GP-28 ⁵	FORD	A830X-9601-BDA	GA-326 ¹	FORD
A737	GA-356	LBFI	A77537	GP-43	CASE	A800X-6714-GA	GP-430 ⁸	FORD	A830X-9601-CDA	GAK-20	FORD
A737C	GAVW-2	ACD	A77544	GP-2071W	CASE	A800X-6714-HA	GP-46	FORD	A830X-9601-CKA	GA-436	FORD
A738	GA-6690	DEUS	A7755	GA-398	HDA	A800X-6714-KA	GP-28 ⁵	FORD	A830X-9601-CLA	GA-405	FORD
A738	GA-357	LBFI	A777	GA-230	ASAH	A800X-6714-LA	GP-430 ⁸	FORD	A830X-9601-CMA	GA-27	FORD
A7383	GA-27	HDA	A777	GA-5056	DEUS	A800X-6714-NA	GP-28 ⁵	FORD	A830X-9601-DFA	GA-200	FORD
A739	GA-6129	TNC	A77750	GA-405	PUR	A800X-6714-RA	GP-430 ⁸	FORD	A830X-9601-DFA	GA-218	FORD
A74	GA-55	MIGH	A778	GAD-3	ASAH	A800X-9601-AA	GA-277	FORD	A830X-9601-DHA	GA-467	FORD
A74	GA-165	SUN	A7784	GA-86	VALV	A800X-9601-AAA	GA-49	FORD	A830X-9601-DLA	GA-3490	FORD
A740X-6714-CA	GP-22	FORD	A778C	GA-373	ACD	A800X-9601-ARA	GA-3490	FORD	A830X-9601-LA	GA-33 ¹¹²	FORD
A740X-9601-ABA	GA-200	FORD	A779	GAVW-120	DEUS	A800X-9601-EA	GA-230	FORD	A830X-9601-NA	GAK-16	FORD
A740X-9601-ABA	GA-218	FORD	A7797	GA-229	HDA	A800X-9601-SA	GA-71	FORD	A830X-9601-TA	GAK-403	FORD
A741	GAD-17	DEUS	A-78	GA-4828	ATL	A800X-9601-TA	GA-200	FORD	A831	GA-85	PRET
A741	GA-17	DEUS	A780X-6714-AA	GP-462	FORD	A800X-9601-TA	GA-218	FORD	A831C	GA-734 ⁸¹	ACD
A742	GA-217	DEUS	A780X-6714-BA	GP-28 ⁵	FORD	A801	GA-2740	FACE	A831C	GA-735 ¹²⁴	ACD
A74280	GA-616	PUR	A780X-6714-CA	GP-430 ⁸	FORD	A801	GA-2740	GOY	A833	GA-382	VIC
						A801C	GA-2740	ACD	A83318	GA-493	

Numero	Gonher	Fabricante	Numero	Gonher	Fabricante	Numero	Gonher	Fabricante	Numero	Gonher	Fabricante
Number	Gonher	Manufacturer	Number	Gonher	Manufacturer	Number	Gonher	Manufacturer	Number	Gonher	Manufacturer
A84	GA-730	MIGH	A905	GA-153	MINL	A987C	GA-77	ACD	AA-1139	GA-3814	INDUCL
A84	GP-23	PAMO	A905	GA-153	PRET	A99	GA-86	MIGH	AA-1141	GA-59	INDUCL
A-84	GA-390	ATL	A-905	GA-153	FACE	A-99	GA-153	ATL	AA-1145	GA-127	INDUCL
A-840-X-9601-BA	GA-2122	FORD	A905C	GA-153	ACD	A998C	GA-56	ACD	AA-1146	GA-89	INDUCL
A843	GAD-15	WESF	A905C	GA-153	CAC	AA-1001	GA-49	INDUCL	AA-1148	GA-392	INDUCL
A84463	GA-372	PUR	A906	G-1173	ALCA	AA-1002	GAVW-121	INDUCL	AA-1149	GA-3915	INDUCL
A845	GA-133	WESF	A9060920305	G-1046	MBNZ	AA-1003	GA-272	INDUCL	AA-1151	GA-3300	INDUCL
A8452	GA-892	HDA	A9065	GA-142	ASAH	AA-1004	GA-78	INDUCL	AA-1152	GA-55	INDUCL
A84530	GA-694	PUR	A909	G-1174 ¹⁰⁸	ALCA	AA-1005	GA-71	INDUCL	AA-1154	GA-89	INDUCL
A84533	GA-493 ¹⁰⁸	PUR	A909	GA-360	WESF	AA-1006	GA-80	INDUCL	AA-1155	GA-57	INDUCL
A84543	GA-377	PUR	A9091	GA-1203	HDA	AA-1007	GA-70	INDUCL	AA-1159	GA-278R	INDUCL
A84545	GA-608	PUR	A9096	GA-780	MIGH	AA-1008	GA-73	INDUCL	AA-1160	GA-732R	INDUCL
A8482	GA-482	HDA	A91	GA-59	MIGH	AA-1009	GA-77	INDUCL	AA-1163	GA-168	INDUCL
A8483	GA-483	HDA	A91	GA-59	PRET	AA-1010	GA-90	INDUCL	AA-1164	GA-348	INDUCL
A85	GA-11	GUD	A91	GAVW-2	TNC	AA-1011	GA-50	INDUCL	AA-1166	GA-1616	INDUCL
A85	GA-106 ⁶⁶	WIX	A912	GAD-3	TOKO	AA-1012	GA-730	INDUCL	AA-1167	GA-904R	INDUCL
A85	GA-326 ⁷¹	WIX	A913	GA-588	PFX	AA-1013	GA-59	INDUCL	AA-1168	GA-780	INDUCL
A-85	GA-349	ATL	A913	GAK-20	WESF	AA-1014	GA-429	INDUCL	AA-1169	GA-224	INDUCL
A851	GA-4828	DEUS	A913C	GA-3647	ACD	AA-1015	GA-75	INDUCL	AA-1172	GA-8606	INDUCL
A851	GA-322	WESF	A9155	GA-356	HDA	AA-1016	GAD-3	INDUCL	AA-1175	GA-905R	INDUCL
A-8512	GA-493 ¹⁰⁸	SAKU	A9159	GA-357	HDA	AA-1018	GA-74	INDUCL	AA-1176	GA-392 ¹¹³	INDUCL
A-8513	GA-880R	SAKU	A916	GA-1287	PFX	AA-1019	GAD-1	INDUCL	AA-1179	GAVW-622	INDUCL
A8523	GA-376	HDA	A917C	GA-392	ACD	AA102	GA-604	RALL	AA-1183	GAVW-626	INDUCL
A85231	GA-534R	PUR	A917C	GA-392	CAC	AA-1022	GAVW-22	INDUCL	AA-1191	GA-197R	INDUCL
A853	GA-6690	WESF	A918C	GA-3915	ACD	AA-1023	GA-27198	INDUCL	AA-1193	GA-768R	INDUCL
A854	GA-71	DEUS	A918C	GA-3915	CAC	AA-1024	GA-21	INDUCL	AA-1194	GA-966R	INDUCL
A855	GA-80	DEUS	A92	GA-57	MIGH	AA-1025	GAD-30	INDUCL	AA-1195	GA-682R	INDUCL
A855	GA-362	TNC	A92	GA-57	PRET	AA-1026	GAVW-2	INDUCL	AA-1196	GA-529	INDUCL
A855C	GA-3566	ACD	A-92	GA-3566	ATL	AA-1027	GAVW-4	INDUCL	AA-1197	GA-224	INDUCL
A856	GA-386	WESF	A920	GA-514	WESF	AA1028	GAVW-10	INDUCL	AA-1199	GA-183R	INDUCL
A8583	GA-372	SAKU	A921	GAD-3	TNC	AA-1029	GA-54	INDUCL	AA-1201	GA-258	INDUCL
A8586	GAK-1532	HDA	A921C	GA-3637	ACD	AA-1030	GA-271	INDUCL	AA-1202	GA-967R	INDUCL
A858C	GA-271	ACD	A922	GA-8047	PFX	AA-1031	GA-200	INDUCL	AA-1203	GA-221R	INDUCL
A859	GA-100	DEL	A922	GA-5466	WESF	AA-1033	GA-3588	INDUCL	AA-1205	GA-413R	INDUCL
A85L	GP-44	HEN	A-9227	GA-1095	SAKU	AA-1034	GA-734 ⁸¹	INDUCL	AA-1206	GA-930R	INDUCL
A86	GA-12	GUD	A923	GP-3682	TNC	AA-1034	GA-735 ¹²⁴	INDUCL	AA-1208	GA-890R	INDUCL
A86	GAD-3	WIX	A924C	GA-2194	ACD	AA-1036	GA-277	INDUCL	AA-1211	GA-853R	INDUCL
A860	GA-200	TNC	A925	GA-253	VALV	AA-1037	GA-274	INDUCL	AA-1212	GA-906R	INDUCL
A860	GA-218	TNC	A925C	GA-253	ACD	AA-1038	GAVW-2	INDUCL	AA-1213	GA-907R	INDUCL
A-8603	GA-517R	SAKU	A925C	GA-253	CAC	AA-1039	GA-3901	INDUCL	AA-1214	GA-334	INDUCL
A862	GA-71	TNC	A926HD	GA-679	COP	AA-1040	GA-253	INDUCL	AA-1215	GA-234	INDUCL
A863	GAK-16	WESF	A929	GA-476	WESF	AA-1041	GA-3916	INDUCL	AA-1219	GA-909R	INDUCL
A863C	GA-109	ACD	A929C	GA-274	ACD	AA-1042	GA-153	INDUCL	AA-1220	GA-908R	INDUCL
A867	GA-7716	PFX	A93	GA-325	MIGH	AA-1044	GA-4303	INDUCL	AA-1221	GA-435R	INDUCL
A867	GAD-15	TNC	A93	GA-325	PRET	AA-1045	GAD-15	INDUCL	AA-1223	GA-170	INDUCL
A868	GA-198	WESF	A930X-9601-BEA	GA-467	FORD	AA-1046	GAD-117	INDUCL	AA-1224	GA-163	INDUCL
A8698	GAK-403	HDA	A931C	GA-730	ACD	AA-1046	GAD-17	INDUCL	AA-1225	GA-683R	INDUCL
A86C	GA-56	ACD	A9334	GA-9334	HDA	AA-1047	GA-4325	INDUCL	AA-1229	GA-799R	INDUCL
A86CW	GA-56	ACD	A9337	GA-209	HDA	AA-1054	GA-5056	INDUCL	AA-1230	GA-798R	INDUCL
A87	GAVW-2	TNC	A933C	GA-642	ACD	AA-1056	GA-273	INDUCL	AA-1232	GA-198	INDUCL
A870	GA-589	PFX	A9340	GA-33 ¹¹²	HDA	AA-1059	GA-174	INDUCL	AA-1235	GA-801R	INDUCL
A872	GA-6690	WESF	A935	GA-595	WESF	AA-1060	GA-6479	INDUCL	AA-1236	GA-802R	INDUCL
A8722	G-31	CASE	A9378	GA-1008	HDA	AA-1062	GA-275	INDUCL	AA-1238	GA-289	INDUCL
A872V	GA-3490	ASAH	A940	GAVW-622	PFX	AA-1063	GA-276	INDUCL	AA-1239	GA-723R	INDUCL
A873	GA-892	PFX	A943	GAD-15	PFX	AA-1064	GAD-294	INDUCL	AA-1240	GA-284	INDUCL
A873V	GA-2740	ASAH	A944	GAVW-120	PFX	AA-1065	GA-6619 ³	INDUCL	AA-1241	GA-196	INDUCL
A8748	GA-33 ¹¹²	HDA	A945	GP-1101	ALCA	AA-1065	GA-6620 ⁵	INDUCL	AA-1242	GA-280	INDUCL
A8777	GA-477	MIGH	A9472	GA-372	HDA	AA-1066	GA-7017	INDUCL	AA-1243	GA-281	INDUCL
A878	GAK-625	PFX	A948	GAK-16	WESF	AA-1067	GA-165	INDUCL	AA-1245	GA-139	INDUCL
A88	GA-230	GUD	A95	GA-27198	TNC	AA-1069	GA-132	INDUCL	AA-1248	GA-291	INDUCL
A88	GA-230	RYCO	A-95	GAVW-4	ATL	AA-1070	GA-300	INDUCL	AA-1250	GA-510	INDUCL
A880C	GAP-379	ACD	A9538	GAK-1532	HDA	AA-1074	GA-217	INDUCL	AA-1261	GA-801R	INDUCL
A88162-A	GAK-403	HYST	A953C	GA-563	ACD	AA-1075	GA-141	INDUCL	AA1280	GAVW-624	INDUCL
A88269	G-333	TOWM	A9544	GA-107	HDA	AA-1076	GA-164	INDUCL	AA1291	GAVW-623	INDUCL
A883	GAK-216	PFX	A9545	GA-209	HDA	AA-1078	GAD-118	INDUCL	AA-1293	GA-209	INDUCL
A884	GA-416	PFX	A9587	GA-509 ³⁴	HDA	AA-1079	GA-175	INDUCL	AA-1294	GA-210	INDUCL
A884	GA-33 ¹¹²	WESF	A96	GP-26	PAMO	AA108	GA-277	RALL	AA133	GA-78	APCO
A886	GA-390	DEUS	A961	GAD-3	WESF	AA-1080	GA-1616	INDUCL	AA-1334	GA-3095R	INDUCL
A886	GAD-117	WESF	A9613	G-1163	COO	AA-1082	GA-1615	INDUCL	AA-1335	GA-3096R	INDUCL
A886	GAD-17	WESF	A963	G-296	ALCA	AA-1083	GA-1615	INDUCL	AA136	GA-55	APCO
A887	GA-198	DEUS	A963	G-296-B	ALCA	AA-1089	GA-3916	INDUCL	AA146	GA-71	APCO
A8876	GA-209	HDA	A97	GP-27	PAMO	AA-1090	GA-158	INDUCL	AA148	GA-80	APCO
A888	GP-1107	PAMO	A-97	GA-5056	ATL	AA-1091	GA-130	INDUCL	AA160	GA-70	APCO
A888	GA-7360	PFX	A9726	GA-31	HDA	AA-1092	GA-301	INDUCL	AA176	GA-56	APCO
A889C	GAK-625	ACD	A972C	GA-2194	ACD	AA-1095	GA-349	INDUCL	AA184	GA-77	APCO
A891V	GA-382	ASAH	A974	GA-3916	GOY	AA-1097	GA-133	INDUCL	AA189	GA-50	APCO
A892C	GA-140	ACD	A974C	GA-3916	ACD	AA-1099	GAVW-120	INDUCL	AA192	GA-192	APCO
A895V	GA-386	ASAH	A974C	GA-3916	CAC	AA-1102	GA-172	INDUCL	AA2092R	G-139	JOND
A8968	GAK-403	HDA	A975C	GAD-15	ACD	AA-1105	GAVW-621	INDUCL	AA2093R	G-139	JOND
A897	GA-381	DEUS	A978C	GA-4828	ACD	AA-1106	GA-218	INDUCL	AA2454A	G-139	JOND
A897	GA-7344	WESF	A9794770007 KZ	GPP-1060	MBNZ	AA-1109	GAVW-212	INDUCL	AA2454R	G-139	JOND
A897C	GAD-3	ACD	A9794770015 KZ	GPP-1060	MBNZ	AA-1110	GA-128	INDUCL	AA245R	G-139	JOND
A898	GA-139	VALV	A98066	G-296	SIMM	AA-1111	GA-1615	INDUCL	AA270A	GP-28 ⁶	AAPA
A899C	GA-230	ACD	A98066	G-296-B	SIMM	AA-1117	GA-215	INDUCL	AA270A	GP-430 ⁸	AAPA
A9	GP-38	AUW	A98066	G-296	THER	AA-1118	GA-11	INDUCL	AA28110	G-139	JOND
A90	GA-303	MIGH	A98066	G-296-B	THER	AA-1119	GA-12	INDUCL	AA2870A	GP-28 ⁶	AAPA
A90	GA-303	PRET	A981	GA-277	WESF	AA-1120	GA-7	INDUCL	AA2870A	GP-430 ⁸	AAPA
A-90	GAD-15	ATL	A98160	G-296	SIMM	AA-1121	GA-279	INDUCL	AA2900	GA-356	FLG
A9010	GA-264	MIGH	A98160	G-296-B	SIMM	AA-1122	GA-192	INDUCL	AA2900	GA-357	FLG
A902	G-1163	ALCA	A98180	G-296	SIMM	AA-1123	GA-673R	INDUCL	AA2901	GA-483	FLG
A902	GA-106 ⁶⁶	WESF	A98180	G-296-B	SIMM	AA-1124	GAVW-4	INDUCL	AA2902	GA-106 ⁶⁶	FLG
A902	GA-326 ⁷¹	WESF	A98181	G-296	SIMM	AA-1129	GA-180	INDUCL	AA2902	GA-206	FLG
A9045	GA-9045	HDA	A98181	G-296-B	SIMM	AA-1130	GA-7344	INDUCL	AA2902	GA-326 ⁷¹	FLG
A905	GA-153	GOY	A98204	G-296	SIMM	AA-1135	GA-195	INDUCL	AA2904	GA-7716	FLG
A905	GA-153	KND	A98204	G-296-B	SIMM	AA-1137	GA-57	INDUCL	AA2906	GA-879	FLG
A905	GA-153	MIGH	A9853	GA-375	HDA	AA-1138	GA-3647	INDUCL	AA2920	GA-6127	FLG

Referencia Cruzada por Numero de Parte

Cross Reference by Part Number



Numero	Gonher	Fabricante	Numero	Gonher	Fabricante	Numero	Gonher	Fabricante	Numero	Gonher	Fabricante
Number	Gonher	Manufacturer	Number	Gonher	Manufacturer	Number	Gonher	Manufacturer	Number	Gonher	Manufacturer
AA2920	GA-6128	FLG	AAF57	GA-80	AWAR	ABP/N10G-AF25667	GA-966R	ALNC	ABU9149	GA-229	LEYL
AA2925	GA-106 ⁴⁶	FLG	AAF59	GA-50	ARC	ABP/N10G-AF888M	GA-885	ALNC	ABU9642	GG-298	LEYL
AA2925	GA-206	FLG	AAF59	GA-50	ARO	ABP/N10G-AF2203	GP-1101	ALNC	ABU9670	GA-106 ⁴⁶	LEYL
AA2925	GA-326 ⁷¹	FLG	AAF59	GA-50	AWAR	ABP/N10G-AF5301	GP-1224	ALNC	ABU9670	GA-326 ⁷¹	LEYL
AA301	GA-78	AUW	AAF67	GA-192	ARC	ABP/N10G-FS19513	S 3202 ⁴⁰	ALNC	AC1025	G-191	PBR
AA302	GA-55	AUW	AAF67	GA-192	AWAR	ABP/N10GFS19593	GPP-1291 ³⁹	ALNC	AC1027	G-871	PBR
AA303	GA-303	APCO	AAF68	GA-78	ARC	ABP/N10GFS19593	S 3226 P ⁴⁰	ALNC	AC1031	G-33	PBR
AA303	GA-71	AUW	AAF68	GA-78	ARO	ABP/N10G-LF782	GP-3980	ALNC	AC1032	G-31	PBR
AA304	GA-80	AUW	AAF68	GA-78	AWAR	ABP/N10G-LF796	GP-44	ALNC	AC1043	G-870	PBR
AA305	GA-730	APCO	AAF735	GA-54	ARC	ABP/N10G-LF9620	GP-193	ALNC	AC1044	G-225	PBR
AA305	GA-70	AUW	AAF735	GA-54	AWAR	ABP/N10G-LF9691A	GP-52 ¹¹⁰	ALNC	AC1048	G-871	PBR
AA306	GA-56	AUW	AAF736	GA-3523	ARC	ABP/N10G-LF9691A	GP-691 ⁴⁸	ALNC	AC1060	G-238	PBR
AA308	GA-77	AUW	AAF736	GA-3523	AWAR	ABP/N10GPF50528	G-3752	ALNC	AC113	G-191	ACD
AA309	GA-50	AUW	AAF74	GA-55	ARC	ABP/N10G-LF2108	GP-2108W	ALNC	AC1138	G-813	PBR
AA310	GA-303	AUW	AAF74	GA-55	AWAR	ABP/N122-S3225P	GPP-1287 ³⁹	ALNC	AC115	GA-59	AUP
AA310893	GA-105	AMCO	AAF83	GA-85	ARC	ABP/N122-S3225P	PFF831 ⁴¹	ALNC	AC116	GA-57	AUP
AA311	GA-730	AUW	AAF83	GA-85	AWAR	ABP/N122-S3225P	S 3225 P ⁴²	ALNC	AC118	GA-730	AUP
AA312	GA-85	AUW	AAF83A	GA-85	ARC	ABP3001560	GA-563	AVEL	AC119	GA-85	AUP
AA313	GA-59	AUW	AAF83A	GA-85	ARO	ABP3001573	GP-53	AVEL	AC120	G-330	ACD
AA314	GA-57	AUW	AAF83A	GA-85	AWAR	ABP3001574	GP-52 ¹¹⁰	AVEL	AC121	GA-303	AUP
AA316	GA-75	AUW	AAF84	GA-730	ARC	ABP3001574	GP-691 ⁴⁸	AVEL	AC122	GA-3300	AUP
AA317	GA-85	AUW	AAF84	GA-730	ARO	ABPAF26163M	GA-624R	ALNC	AC123	GA-80	ACD
AA318	GA-86	AUW	AAF84	GA-730	AWAR	ABP-N10G-AF1731	GA-3501	ALNC	AC1231C	GA-6619 ¹	ACD
AA319	GA-3424	AUW	AAF9	GA-100	ARC	ABP-N10GAF1743M	GA-389	ALNC	AC1231C	GA-6620 ⁵	ACD
AA31953	GA-3588	AWAR	AAF9	GA-100	ARO	ABP-N10GAF1897M	GA-1095	ALNC	AC124	GP-28 ⁶	ACD
AA320	GA-192	AUW	AAF9	GA-100	AWAR	ABP-N10G-AF25215	GA-768R	ALNC	AC124	GP-430 ⁸	ACD
AA321	GA-325	AUW	AAF90	GA-303	ARC	ABP-N10GAF25247	GA-539R	ALNC	AC124	GA-730	AUP
AA322	GA-3523	AUW	AAF90	GA-303	ARO	ABP-N10GAF25248	GA-534R	ALNC	AC125	GA-78	AUP
AA323	GA-54	AUW	AAF90	GA-303	AWAR	ABP-N10G-AF25255	GA-442	ALNC	AC126	GA-325	AUP
AA324	GA-85	APCO	AAF91	GA-59	ARC	ABP-N10G-AF25423	GA-VW-620	ALNC	AC128	GA-31	AUP
AA324	GA-271	AUW	AAF91	GA-59	ARO	ABPN10GAF26163M	GA-624R	ALNC	AC13	GA-56	AUP
AA325	GA-325	APCO	AAF91	GA-59	AWAR	ABP-N10G-AF996M	GA-608	ALNC	AC130	GA-59	AUP
AA325	GA-VW-2	AUW	AAF92	GA-57	ARC	ABP-N10G-AF222	GP-85	ALNC	AC1300	G-836	PBR
AA326	GA-59	APCO	AAF92	GA-57	ARO	ABP-N10G-AF5264	GP-749	ALNC	AC132	GA-349	AUP
AA327	GA-57	APCO	AAF92	GA-57	AWAR	ABP-N10G-AF5320	GP-110	ALNC	AC133	GA-57	AUP
AA327	GA-300	AUW	AAF93	GA-325	ARC	ABP-N10G-FS1201	G-1143 ³⁰	ALNC	AC1346	G-834	PBR
AA328	GA-735 ¹²⁴	AUW	AAF93	GA-325	ARO	ABP-N10G-FS1206	GS-2033	ALNC	AC1354	G-330	PBR
AA338	GA-3300	APCO	AAF93	GA-325	AWAR	ABP-N10GFS19579	GS-1261	ALNC	AC136	GA-100	AUP
AA340	GA-86	APCO	AAF99	GA-86	ARC	ABP-N10G-AF6056	GP-66	ALNC	AC137	GA-85	AUP
AA34006	GA-356 ¹⁰⁴	HEND	AAF99	GA-86	AWAR	ABP-N10G-AF6057	GP-66	ALNC	AC1373	G-5000	PBR
AA34006	GA-357 ¹⁰⁸	HEND	AAF99A	GA-86	ARC	ABP-N10G-AF7936	GP-166 ⁶⁵	ALNC	AC138	GA-59	AUP
AA34008	GA-356	HEND	AAF99A	GA-86	ARO	ABP-N10G-AF7936	GP-3937 ³¹	ALNC	AC141	GAD-1	AUP
AA3506	GP-44	AAPA	AAF99A	GA-86	AWAR	ABP-N10G-LF3443	GP-54	ALNC	AC146	GAD-3	AUP
AA351	GA-75	APCO	AAK426	G-870	LEYL	ABP-N10G-LF3746	GP-642	ALNC	AC147	GA-75	AUP
AA3585M	G-139	REF	AAP103	GAD-1	AWAR	ABP-N10G-LF3827	G-3827	ALNC	AC148	GA-113	AUP
AA3585R	G-139	JOND	AAR82900	GA-356 ¹⁰⁴	FLR	ABP-N10G-LF691	GP-52 ¹¹⁰	ALNC	AC149	GA-113	AUP
AA3586R	G-139	JOND	AAR82900	GA-357 ¹⁰⁸	FLR	ABP-N10G-LF691	GP-691 ⁴⁸	ALNC	AC153	GA-730	AUP
AA360R	G-139	JOND	AAR82901	GA-483 ¹⁰⁴	FLR	ABP-N10G-LF691A	GP-52 ¹¹⁰	ALNC	AC155	G-163	ACD
AA3675	GP-3675	AAPA	AAR82902	GA-106 ⁶⁷	FLR	ABP-N10G-LF691A	GP-691 ⁴⁸	ALNC	AC155	GA-74	AUP
AA3680	G-139	JOND	AAR82902	GA-206 ¹⁰⁸	FLR	ABP-N10G-LF778	GP-50	ALNC	AC156	GA-86	AUP
AA3680R	G-139	JOND	AAR82902	GA-326 ⁷²	FLR	ABP-N10G-LF9009	GP-3001	ALNC	AC157	GA-429	AUP
AA3682	GP-3682	AAPA	AAR82904	GA-7716	FLR	ABPS3225P	GPP-1287 ³⁹	FREI	AC158	GA-50	AUP
AA3980	GP-3980	AAPA	AAR82920	GA-6127	FLR	ABPS3225P	PFF831 ⁴¹	FREI	AC159	GA-3300	AUP
AA6607	GP-991	AAPA	AAR82920	GA-6128	FLR	ABPS3225P	S 3225 P ⁴²	FREI	AC161	GA-2740	AUP
AA7317	GP-149	AAPA	AAR82925	GA-106 ⁴⁶	FLR	ABPS3226FL02	GPP-1291 ³⁹	FREI	AC165	G-162H	ACD
AAF103	GAD-1 ⁸⁷	ARC	AAR82925	GA-206	FLR	ABPS3226FL02	S 3226 P ⁴⁰	FREI	AC165	GA-75	AUP
AAF103	GAD-1 ⁸⁷	AWAR	AAR82925	GA-326 ⁷¹	FLR	ABU4557	GA-6129	LEYL	AC166	GA-86	AUP
AAF113	GA-75	ARC	AAU6273	GA-6129	LEYL	ABU5768	GA-6129	LEYL	AC167	G-143	ACD
AAF113	GA-75	ARO	AAU8435	GP-455	LEYL	ABU6137	GA-360	LEYL	AC178	G-31	STUD
AAF113	GA-75	AWAR	AB19	GA-100	AUW	ABU6138	GA-106 ⁴⁶	LEYL	AC17	GA-71	AUP
AAF122	GA-VW-2	AWAR	AB19	GA-100	FACE	ABU6138	GA-326 ⁷¹	LEYL	AC170	GA-77	AUP
AAF124	GA-3300	ARC	AB24	GA-113	AUW	ABU6151	GA-361	LEYL	AC175	GA-50	AUP
AAF124	GA-3300	ARO	AB3131	GA-101	PUR	ABU7446	GA-6129	LEYL	AC177	GA-3424	AUP
AAF124	GA-3300	AWAR	AB3131M	GA-101	PUR	ABU7446	GA-6129	LEYL	AC178	GA-86	AUP
AAF129	GA-3424	AWAR	AB3160	GA-176	PUR	ABU8050	G-31	LEYL	AC179	GA-85	AUP
AAF131	GA-3425	AWAR	AB3160M	GA-176	PUR	ABU8507	GAK-20	LEYL	AC180	GA-3425	AUP
AAF142	GA-303	ALCA	AB3161	GA-101	PUR	ABU8509	GA-5648	LEYL	AC183	GA-75	AUP
AAF146	GA-325	ALCA	ABH11	GP-5	ALY	ABU8514	GA-6129	LEYL	AC184	GAD-3	AUP
AAF148	GA-55	ALCA	ABH13X	GP-13	ALY	ABU8524	GA-405	LEYL	AC189	G-143	ACD
AAF160	GA-192	ALCA	ABH16	GP-81	ALY	ABU8535	GP-54	LEYL	AC19	GA-77	AUP
AAF1697	GA-277	AWAR	ABH25	GP-20	ALY	ABU8537	GP-54 ⁴¹	LEYL	AC191	GA-3445	AUP
AAF184	GA-3300	ALCA	ABH2825	GP-38	ALY	ABU8537	GP-66 ⁴⁰	LEYL	AC192	GAD-1	AUP
AAF23	GA-55	ALCA	ABH2849	GP-24 ²⁶	ALY	ABU8539	G-31	LEYL	AC196	GA-54	AUP
AAF24	GA-113	ARO	ABH2849	GP-462 ²⁴	ALY	ABU8541	G-834	LEYL	AC197	GA-59	AUP
AAF24	GA-113	AWAR	ABH2850	GP-1	ALY	ABU8542	GP-3600	LEYL	AC198	GA-57	AUP
AAF253	GA-349	ALCA	ABH30	GP-3	ALY	ABU8543	G-833	LEYL	AC2	GA-70	AUP
AAF31	GA-56	ARC	ABH3353	GP-44	ALY	ABU8544	GP-68	LEYL	AC20	G-813	ACD
AAF31	GA-56	ARO	ABH3387	GP-46	ALY	ABU8545	G-33	LEYL	AC200	GA-3523	AUP
AAF31	GA-56	AWAR	ABH43	GP-81 ³¹	ALY	ABU8547	G-834	LEYL	AC203	GA-271	AUP
AAF3192	GA-271	AWAR	ABH43	GP-9 ⁵⁸	ALY	ABU8548	G-163	LEYL	AC204	GA-4828	AUP
AAF3193	GA-735 ¹²⁴	AWAR	ABH50	GP-50	ALY	ABU8550	GP-1122	LEYL	AC205	GA-4325	AUP
AAF3195	GA-3588	ARC	ABH7	GP-81	ALY	ABU8551	GP-27	LEYL	AC207	GA-3588	AUP
AAF3195	GA-3588	AWAR	ABH8A	GP-1	ALY	ABU8551	GP-27	MULP	AC21	GA-55	AUP
AAF3490	GA-3490	ARC	ABH963	GP-28 ⁸⁴	ALY	ABU8555	G-297-B	LEYL	AC210	GA-735 ¹²⁴	AUP
AAF3490	GA-3490	AWAR	ABH963	GP-3600 ⁸⁴	ALY	ABU8556	G-1121	LEYL	AC211	GA-3566	AUP
AAF4	GA-70	ARC	ABH963	GP-38 ⁸⁷	ALY	ABU8557	G-1121	LEYL	AC213	GA-101	AUP
AAF4	GA-70	ARO	ABH963	GP-430 ⁸⁵	ALY	ABU8558	G-296	LEYL	AC214	GA-277	AUP
AAF4	GA-70	AWAR	ABH966	GP-81 ³¹	ALY	ABU8558	G-296-B	LEYL	AC216	GA-113	AUP
AAF45	GA-77	ARC	ABH966	GP-9 ⁵⁸	ALY	ABU8562	GP-26	LEYL	AC217	GA-2719B	AUP
AAF45	GA-77	ARO	ABM1001	GA-VW-622	WOW	ABU8563	G-1123F	LEYL	AC222	GA-3647	AUP
AAF45	GA-77	AWAR	ABM1002	GA-2114	WOW	ABU8564	G-1123	LEYL	AC224	GA-3637	AUP
AAF52	GA-71	ARC	ABM1004	GA-2110	WOW	ABU8783	GP-68	LEYL	AC227	GA-89	AUP

Numero	Gonher	Fabricante	Numero	Gonher	Fabricante	Numero	Gonher	Fabricante	Numero	Gonher	Fabricante
Number	Gonher	Manufacturer	Number	Gonher	Manufacturer	Number	Gonher	Manufacturer	Number	Gonher	Manufacturer
AC235	GA-277	AUP	ACA146	GA-71	ALCA	ADN12102	GP-171	ADL	AF01	GA-59	CSP
AC238	GA-3647	AUP	ACA148	GA-80	ALCA	ADN12103	GP-3682	ADL	AF0199	GA-2160	DPHI
AC24	GA-80	AUP	ACA160	GA-70	ALCA	ADN12106	GP-38	ADL	AF02	GA-75	CSP
AC240	GA-3814	AUP	ACA176	GA-56	ALCA	ADS72101	GP-91	ADL	AF03	GA-57	CSP
AC243	GA-3814	AUP	ACA184	GA-77	ALCA	ADT32102	GP-38	ADL	AF031041-P	GA-135	GFF
AC245	GA-273	AUP	ACA200	GA-55	ALCA	ADT32105	GP-3682	ADL	AF04	GA-192	CSP
AC247	GA-5056	AUP	ACA326	GA-730	ALCA	ADT32229	GA-410	ADL	AF043280	GA-390	GFF
AC2475	G-31	STUD	ACA331	GA-50	ALCA	ADU6196	GA-2122	LEYL	AF0487	GA-410	DPHI
AC248	GA-3916	AUP	ACA332	GA-59	ALCA	ADU7353	GP-455	LEYL	AF0493	GA-2174	DPHI
AC250	GA-253	AUP	ACA344	GA-57	ALCA	ADU7417	GP-455	LEYL	AF05	GA-70	CSP
AC251	GA-4325	AUP	ACA510	GA-98 ¹¹²	QJFA	AE 13165	GA-2160	UNIC	AF050	GA-85	ECOL
AC255	GA-129	AUP	ACB14	GA-100	ALCA	AE 13280	GA-410	UNIC	AF052	GA-303	ECOL
AC257	GA-174	AUP	ACB5	GA-39	ALCA	AE 311	GA-2160	FTRO	AF056214	GA-2740	GFF
AC258	GA-153	AUP	ACD133	G-1163	ACD	AE021285	GA-27	JOND	AF058074-P	GA-12	GFF
AC259	GA-276	AUP	ACD159	G-296	ACD	AE063150	GA-106 ⁶⁶	MIT	AF059103-P	GA-8	GFF
AC260	GA-4828	AUP	ACD159	G-296-B	ACD	AE063150	GA-326 ⁷¹	MIT	AF06	GA-55 ¹¹³	CSP
AC263	GA-VW-2	AUP	ACD173	G-296	ACD	AE063155	GA-206	MIT	AF060201	GAD-1	GFF
AC2678	G-31	STUD	ACD173	G-296-B	ACD	AE10	GP-66	ZING	AF07	GA-303	CSP
AC270	GA-362	AUP	ACD182	G-1123F	ACD	AE10L	GP-66	ZING	AF074	GA-86	ECOL
AC273	GA-300	AUP	ACD185	G-1121	ACD	AE10LP	GP-66	ZING	AF08	GA-50	CSP
AC276	GA-3901	AUP	ACD34	G-871	ACD	AE10P	GP-66	ZING	AF088249-P	GA-59	GFF
AC278	GA-4303	AUP	ACD51	G-296	ACD	AE20574	GAK-20	JOND	AF089208-P	GA-192	GFF
AC281	GA-142	AUP	ACD51	G-296-B	ACD	AE20599	GA-27	JOND	AF09	GA-85	CSP
AC283	GA-133	AUP	ACD519	G-297-B	ACD	AE21285	GA-27	JOND	AF097	GA-75	ECOL
AC284	GA-382	AUP	ACD53	G-1123	ACD	AE21585	GA-27	JOND	AF1	GA-100	GUP
AC287	GA-141	AUP	ACD53	G-1123F	ACD	AE25	GP-66	ZING	AF1	GA-113	SRN
AC296	GA-604	AUP	ACD54	G-1121	ACD	AE27170	GAK-16	JOND	AF10	GA-73	CHP
AC297	GA-386	AUP	ACD55	G-1121	ACD	AE2740	GA-2740	ADGE	AF10	GA-3300	CSP
AC300	GA-7017	AUP	ACD56	G-1121	ACD	AE2756	GA-2174	UNIC	AF10	GAD-30	IAPC
AC3004	G-152	PBR	ACD59	G-296	ACD	AE27766	GA-27	JOND	AF10	GA-101	WELA
AC3006	G-222	PBR	ACD59	G-296-B	ACD	AE28914	GP-1	JOND	AF100	GA-230	IAPC
AC3015	G-335	PBR	ACD60	GG-48	ACD	AE29052	GG-5 L	JOND	AF1002	GAC-9	HAS
AC3017	G-33	PBR	ACG20	GG-20	ALCA	AE30317	GA-416 ¹⁰⁸	JOND	AF1008	GA-29	CHP
AC3026	G-122	PBR	ACH200	G-200	ALCA	AE30317	GAK-216 ¹⁰⁴	JOND	AF101	GA-105	CHP
AC3026	G-338	PBR	ACH236	G-236	ALCA	AE31723	GAK-216	JOND	AF101	GA-105	LUF
AC3035	G-31	PBR	ACH6	G-6	ALCA	AE31724	GA-416	JOND	AF1010	GA-390	DPHI
AC3045	G-566	PBR	ACH838	G-333	ALCA	AE33293	GP-66	JOND	AF1011	GAC-13	HAS
AC3064	G-33	PBR	ACQ70FF	G-836	ROLK	AE3566	GA-3566	ADGE	AF1014	GA-130	HAS
AC3067	G-139	PBR	ACQ72FF	G-834	ROLK	AE6376	GA-142	ADGE	AF1014F	GA-130	FEDE
AC3102	G-331	PBR	ACU1447	G-296	LEYL	AE67007	GA-966R ¹⁰⁴	JOND	AF1016	GA-1614	HAS
AC3117	G-238	PBR	ACU1447	G-296-B	LEYL	AE67007	GA-967R ¹⁰⁸	JOND	AF1016F	GA-1614	FEDE
AC3143	G-191	PBR	ACU3426	GA-106 ⁶⁶	LEYL	AE6807	GA-386	ADGE	AF1019	GA-386	DPHI
AC3177	G-833	PBR	ACU3426	GA-326 ⁷¹	LEYL	AE7094	GA-604	ADGE	AF101K	GA-27	HAS
AC3182	G-331	PBR	ACU8223	GA-467	LEYL	AE7351	GA-322	ADGE	AF102	GA-105	ACE
AC3234	G-163	PBR	AD3000	GP-3000	PAMO	AE7420	GA-514	ADGE	AF102	GA-105	APOL
AC3235	G-238	PBR	AD324	GA-378	PAMO	AE78067	GA-378	HEND	AF102	GA-105	BWS
AC3240	G-133	PBR	AD7041	GP-359	PAMO	AE8040	GA-384	ADGE	AF102	GA-105	CAM2
AC3240	G-989	PBR	AD92104	GP-3985	ADL	AEK2128	GAK-1532	COO	AF102	GA-105	CHP
AC3260-10	G-153	PBR	ADC42303	GPP-111	ADL	AEK2494	GAK-216	COO	AF102	GA-105	GRAN
AC33	G-870	ACD	ADC42303	GPP-524	ADL	AEM2002	GA-483	COO	AF102	GA-105	LUF
AC3300	GP-50	STUD	ADD62306	GPP-111	ADL	AEM2014	GA-563	COO	AF102	GA-105	MASE
AC3311	GP-5	STUD	ADD62306	GPP-524	ADL	AEM2034	GA-329	COO	AF102	GA-105	WARN
AC33A	G-870	ACD	ADG 881	GA-410	GUD	AEM2042	GA-31	COO	AF102030	GA-880R	BRAN
AC33AB	G-870	ACD	ADG342	GAK-403	GUD	AEM2052	GA-251	COO	AF1026	GA-322	DPHI
AC33B	G-870	ACD	ADG343	GAK-20	GUD	AEM2054	GA-425	COO	AF1026F	GA-217	FEDE
AC33C	G-870	ACD	ADG381	GA-18	GUD	AEM2066	GA-679	COO	AF1027	GA-381	DPHI
AC33D	G-870	ACD	ADG494	GA-360	GUD	AEM2070	GA-109	COO	AF1028	GA-514	DPHI
AC34	G-871	ACD	ADG505	GAK-16	GUD	AEM2082	GA-209	COO	AF103	GAD-1	SERV
AC3425	G-6	STUD	ADG518	GA-98 ¹¹²	GUD	AEM2106	GA-376	COO	AF1030	GA-172	HAS
AC34A	G-871	ACD	ADG522	GA-6129	GUD	AEM2120	GA-6128	COO	AF-1030	GA-172	ATL
AC34B	G-871	ACD	ADG523	GA-6127	GUD	AEM2122	GA-467	COO	AF1030F	GA-172	FEDE
AC34C	G-871	ACD	ADG524	GA-106 ⁶⁶	GUD	AEM2126	GA-26	COO	AF1031	GA-277	CAM2
AC34E	G-871	ACD	ADG524	GA-326 ⁷¹	GUD	AEM2142	GA-7	COO	AF1031	GA-277	CHP
AC35A	G-870	ACD	ADG525	GA-206	GUD	AEM2184	GA-18	COO	AF1031	GA-277	GRAN
AC40	GA-192	AUP	ADG533	GA-361	GUD	AEM2198	GA-403	COO	AF1031	GA-384	HAS
AC45	GA-78	AUP	ADG543	GA-33 ¹¹²	GUD	AEM2206	GA-135	COO	AF1031	GA-277	LEE
AC49	GA-90	AUP	ADG546	GA-8047	GUD	AEM2250	GA-105	COO	AF1031	GA-277	LUF
AC4914339	GA-18	TOTL	ADG587	GA-892	GUD	AEM2254	GA-2984	COO	AF1031	GA-277	MASE
AC5	GA-18	HDA	ADG619	GAK-625	GUD	AEM2262	GA-11	COO	AF1031	GA-277	PARP
AC58	GA-44	AUP	ADG626	GA-416	GUD	AEM2264	GA-891	COO	AF1031	GA-277	TRUS
AC61	G-225	ACD	ADG644	GA-1285	GUD	AEM2356	GA-493 ¹⁰⁸	COO	AF1031	GA-277	WARN
AC62	GA-56	AUP	ADG647	GA-1008	GUD	AEM2376	GA-6880	COO	AF-1031	GA-384	ATL
AC63	GA-71	AUP	ADG648	GA-1284	GUD	AEM2388	GA-12	COO	AF1031F	GA-384	FEDE
AC-6460	GAK-403	NIPP	ADG649	GA-9334	GUD	AEM2406	GA-826	COO	AF1032	GA-5056	CAM2
AC65	GA-50	AUP	ADG650	GA-1286	GUD	AEM2486	GA-106 ⁶⁶	COO	AF1032	GA-5056	CHP
AC70	G-836	ACD	ADG651	GA-9045	GUD	AEM2486	GA-326 ⁷¹	COO	AF1032	GA-158	HAS
AC70	GA-70	AUP	ADG652	GA-1287	GUD	AEM2504	GA-6128	COO	AF1032	GA-5056	LUF
AC70FF	G-836	ROLK	ADG657	GA-7716	GUD	AEM2512	GA-18	COO	AF1032A	GA-5056	BWS
AC70V	G-836	ACD	ADG658	GA-7360	GUD	AEM2668	GA-853R	COO	AF1032A	GA-5056	CHP
AC72	G-834	ACD	ADG659	GA-375	GUD	AEM2684	GA-9334	COO	AF1032A	GA-5056	GRAN
AC72A	G-834	ACD	ADG682	GA-589	GUD	AEM2686	GA-8047	COO	AF1032A	GA-5056	LEE
AC72FF	G-834	ROLK	ADG683	GA-588	GUD	AEM2710	GA-517R	COO	AF1032A	GA-5056	LUF
AC73	GA-55	AUP	ADG694	GA-106 ⁶⁶	GUD	AEP2003	GA-482 ¹⁰⁸	COO	AF1032A	GA-5056	MASE
AC74	G-833	ACD	ADG694	GA-326 ⁷¹	GUD	AEP2003	GA-483 ¹⁰⁴	COO	AF1032A	GA-5056	PARP
AC-7472	GAK-20	NIPP	ADG695	GA-98 ¹¹²	GUD	AEP3515	GAP-381	COO	AF1032A	GA-5056	SECU
AC-7472S	GAK-20	NIPP	ADG734	GA-49	GUD	AES2023	GA-482	COO	AF1032A	GA-5056	TRUS
AC7486	GA-106 ⁶⁶	MICF	ADG734A	GA-49	GUD	AES2025	GA-398	COO	AF1032A	GA-5056	WARN
AC7486	GA-326 ⁷¹	MICF	ADG793	GA-356	GUD	AES2035	GA-239	COO	AF1032F	GA-158	FEDE
AC-7486	GA-106 ⁶⁶	NIPP	ADG796	GA-357	GUD	AES2055	GA-426	COO	AF1033	GA-VW-622	HAS
AC-7486	GA-326 ⁷¹	NIPP	ADH22101	GP-91	ADL	AES2067	GA-680	COO	AF1034	GA-607	HAS
AC74W	G-833	ACD	ADH22106	GP-91	ADL	AES2071	GA-119	COO	AF1034F	GA-607	FEDE
AC8020	G-25	PBR	ADH22107	GP-91	ADL	AES2083	GA-210	COO	AF1037	GA-163	HAS
AC82	G-834	ACD	ADH22303	GG-124	ADL	AES2265	GA-892	COO	AF-1037	GA-163	ATL
AC83	G-31	ACD	ADM52101	GP-91	ADL	AES2407	GA-827	COO	AF1037F	GA-163	FEDE
AC91	G-613	ACD	ADM52103	GP-462	ADL	AES2495	GA-416	COO	AF1039	GA-170	HAS
ACA133	GA-78	ALCA	ADN 12114	G-25	ADL	AF004	GA-70	ECOL	AF-1039	GA-170	ATL

Referencia Cruzada por Numero de Parte

Cross Reference by Part Number



Numero	Gonher	Fabricante	Numero	Gonher	Fabricante	Numero	Gonher	Fabricante	Numero	Gonher	Fabricante
Number	Gonher	Manufacturer	Number	Gonher	Manufacturer	Number	Gonher	Manufacturer	Number	Gonher	Manufacturer
AF1039-PL	GA-2194	GFF	AF1096	GA-6479	CHP	AF115	GA-90	APOL	AF1296	GA-1572	HAS
AF104	GA-8047	HAS	AF1096	GA-6479	GRAN	AF115	GA-90	BWS	AF1298	GA-289	HAS
AF1040	GA-279	HAS	AF1096	GA-6479	LEE	AF115	GA-90	CAM2	AF129K	GAK-16	HAS
AF1040F	GA-279	SHE	AF1096	GA-6479	LUF	AF115	GA-90	CHP	AF13	GA-54	CSP
AF1040F	GA-279	FEDE	AF1096	GA-6479	PARP	AF115	GA-90	ECOL	AF130	GA-86	CAC
AF1040-PL	GAVW-622	GFF	AF1096	GA-6479	TRUS	AF115	GA-90	GRAN	AF130	GA-3490	IAPC
AF1041	GA-244	HAS	AF1096	GA-6479	WARN	AF115	GA-90	LUF	AF1300	GA-673R	CHP
AF1041F	GA-244	FEDE	AF1097	GA-7007	CAM2	AF115	GA-90	MASE	AF1300	GA-673R	GRAN
AF1041-PL	GA-50	GFF	AF1097	GA-7007	CHP	AF115	GA-90	MIGH	AF1300	GA-673R	LEE
AF1042	GA-145	HAS	AF1097	GA-7007	GRAN	AF115	GA-90	MINL	AF1300	GA-673R	LUF
AF1043	GA-273	BWS	AF1097	GA-7007	LUF	AF115	GA-90	SECU	AF1300	GA-673R	PARP
AF1043	GA-273	CAM2	AF1097	GA-7007	SECU	AF115	GA-90	WARN	AF1300	GA-673R	SECU
AF1043	GA-273	CHP	AF1097	GA-7007	WARN	AF1153	GAVW-4	PUR	AF1300	GA-673R	TRUS
AF1043	GA-273	ECOL	AF11	GA-101	CENE	AF1153	GAVW-4	SERV	AF1300	GA-673R	WARN
AF1043	GA-273	GRAN	AF11	GA-101	CHP	AF1153	GAVW-4	SPEC	AF1301	GA-732R	CHP
AF1043	GA-273	LEE	AF11	GA-101	CSP	AF116	GA-200	CAM2	AF1301	GA-732R	CIGO
AF1043	GA-273	LUF	AF11	GA-101	GRAN	AF116	GA-218	CAM2	AF1301	GA-732R	GRAN
AF1043	GA-273	MASE	AF11	GA-101	LUF	AF116	GA-200	CHP	AF1301	GA-732R	LUF
AF1043	GA-273	PARP	AF11	GA-101	MIGH	AF116	GA-218	CHP	AF1301	GA-732R	SECU
AF1043	GA-273	TRUS	AF11	GA-101	WARN	AF116	GA-200	GRAN	AF1301	GA-732R	WARN
AF1043	GA-273	WARN	AF110	GAD-3	APOL	AF116	GA-218	GRAN	AF1307	GA-265	HAS
AF1043-PL	GA-2110	GFF	AF110	GAD-3	BWS	AF116	GA-1286	HAS	AF1308	GA-464	HAS
AF1044	GA-8606	HAS	AF110	GAD-3	CHP	AF116	GA-200	LUF	AF130K	GAK-20	HAS
AF-1044	GA-8606	ATL	AF110	GP-44	COO	AF116	GA-218	LUF	AF131	GA-3425	CAC
AF1044F	GA-8606	FEDE	AF110	GA-349	ECOL	AF116	GA-200	MIGH	AF131	GA-3425	PRMT
AF1044-PL	GAVW-2	GFF	AF110	GAD-3	GRAN	AF116	GA-218	MIGH	AF131	GA-3425	SERV
AF1045	GA-472	HAS	AF110	GA-55	HAS	AF116	GA-200	WARN	AF1311	GA-249	HAS
AF1045F	GA-472	FEDE	AF110	GAD-3	LEE	AF116	GA-218	WARN	AF1316	GA-1540	HAS
AF1046	GA-174	BWS	AF110	GAD-3	LUF	AF1161	GA-263	HAS	AF1317	GA-489	HAS
AF1046	GA-174	CHP	AF110	GAD-3	MASE	AF1162	GA-269	HAS	AF1318	GA-143	HAS
AF1046	GA-174	GRAN	AF110	GAD-3	MINL	AF1163	GA-165	CAC	AF131K	GA-26	HAS
AF1046	GA-2106	HAS	AF110	GAD-3	PARP	AF1163	GA-367	HAS	AF132	GA-50	ACE
AF1046	GA-2195	HAS	AF110	GAD-3	PRMT	AF1165	GA-305	HAS	AF132	GA-50	APOL
AF1046	GA-174	LEE	AF110	GAD-3	SERV	AF1167	GAC-10 ²⁸	HAS	AF132	GA-50	BWS
AF1046	GA-174	LUF	AF110	GAD-3	TRUS	AF1167	GAC-8	HAS	AF132	GA-85	CAC
AF1046	GA-174	MASE	AF110	GAD-3	WARN	AF117	GAD-1 ⁸⁷	APOL	AF132	GA-50	CAM2
AF1046	GA-174	PARP	AF1101	GA-258	HAS	AF117	GAD-1 ⁸⁷	CAM2	AF132	GA-50	CHP
AF1046	GA-174	SECU	AF1103	GA-248	HAS	AF117	GAD-1 ⁸⁷	CHP	AF132	GA-50	ECOL
AF1046	GA-174	TRUS	AF-1103	GA-248	ATL	AF117	GA-1287	HAS	AF132	GA-50	GRAN
AF1046	GA-174	WARN	AF1103F	GA-248	FEDE	AF117	GA-142	IAPC	AF132	GA-139	IAPC
AF1047	GA-2740	DPHI	AF1108	GA-183R	HAS	AF117	GAD-1 ⁸⁷	LUF	AF132	GA-50	LEE
AF1047	GAVW-621	HAS	AF1109	GA-413R	HAS	AF117	GAD-1 ⁸⁷	MINL	AF132	GA-50	LUF
AF1048	GA-301	HAS	AF1109F	GA-413R	FEDE	AF117	GAD-1 ⁸⁷	SECU	AF132	GA-50	MASE
AF105	GA-1285	HAS	AF110A	GA-349 ³⁸	PUR	AF118	GA-9045	HAS	AF132	GA-50	MINL
AF1051	GA-2175	HAS	AF110A	GAD-3 ³⁴	PUR	AF1188	GA-145	HAS	AF132	GA-50	PARP
AF1052	GA-348	HAS	AF110F	GA-55	FEDE	AF12	GA-3647	CSP	AF132	GA-50	PRMT
AF1052	GA-348	SHE	AF111	GA-230	APOL	AF120	GA-74	PRMT	AF132	GA-50	SECU
AF1052F	GA-348	FEDE	AF111	GA-230	CAM2	AF120	GA-74	SERV	AF132	GA-50	TRUS
AF1054	GA-2118	HAS	AF111	GAC-2	HAS	AF1203	GA-74	CHP	AF132	GA-50	WARN
AF1057	GAC-1	HAS	AF111	GA-230	GRAN	AF1208	GA-158	HAS	AF1320	GAVW-617	HAS
AF1058	GA-2184	HAS	AF111	GA-230	LUF	AF12-1	G-162H	KNE	AF1321	GAVW-616	HAS
AF106	GA-349	CHP	AF111	GA-230	MAR	AF1210	GA-488	HAS	AF1329	GA-340	HAS
AF106	GA-1008	HAS	AF111	GA-230	MASE	AF1212	GA-2130	HAS	AF132K	GAK-403	HAS
AF106	GA-349	LUF	AF111	GA-230	MIGH	AF1214	GA-380	HAS	AF133	GA-78	ACE
AF106	GA-349	WARN	AF111	GA-230	MINL	AF1216	GA-448	HAS	AF133	GA-78	APOL
AF1060	GA-2195	HAS	AF111	GA-230	SECU	AF1219	GA-1617	HAS	AF133	GA-78	BWS
AF1061	GA-275	BWS	AF111	GA-230	WARN	AF122	GA-78	HAS	AF133	GA-78	CAC
AF1061	GA-275	CHP	AF1111	GAC-7	HAS	AF123	GA-2719B	APOL	AF133	GA-78	CAM2
AF1061	GA-275	GRAN	AF1112	GA-224	HAS	AF123	GA-2719B	BWS	AF133	GA-78	CHP
AF1061	GA-286	HAS	AF1112F	GA-224	FEDE	AF123	GA-2719B	CHP	AF133	GA-78	ECOL
AF1061	GA-275	LEE	AF1113	GA-293	CHAM	AF123	GA-2719B	GRAN	AF133	GA-78	FACE
AF1061	GA-275	LUF	AF1113	GA-293	HAS	AF123	GA-2719B	LEE	AF133	GA-78	GRAN
AF1061	GA-275	PARP	AF112	GA-55	IMPC	AF123	GA-2719B	LUF	AF133	GA-78	LUF
AF1061	GA-275	SECU	AF1121	GA-194	HAS	AF123	GA-2719B	MASE	AF133	GA-78	MASE
AF1061	GA-275	TRUS	AF1125	GA-6479 ³⁰	HAS	AF123	GA-3300	MINL	AF133	GA-78	MIGH
AF1061	GA-275	WARN	AF1127	GA-395	HAS	AF123	GA-2719B	PARP	AF133	GA-78	MINL
AF1063	GA-349 ³⁸	CAM2	AF-1127	GA-395	ATL	AF123	GA-2719B	SECU	AF133	GA-78	SECU
AF1063	GAD-3 ³⁴	CAM2	AF1127F	GA-395	FEDE	AF123	GA-2719B	TRUS	AF133	GA-78	WARN
AF107	GA-1284	HAS	AF1128	GA-477	CHAM	AF123	GA-2719B	WARN	AF133K	GA-33 ¹²	HAS
AF1070	GA-491	HAS	AF1128	GA-477	HAS	AF1233	GA-475	HAS	AF134	GAD-1	ECOL
AF1072	GA-278R	ATL	AF1128F	GA-477	FEDE	AF1234	GA-5876	HAS	AF134	GAD-1	MINL
AF1072	GA-278R	HAS	AF113	GA-75	PRMT	AF124	GA-2719B ¹²²	CAC	AF1344	GA-4365	MTR
AF1072F	GA-278R	FEDE	AF113	GA-75	SERV	AF124	GA-3300 ³⁸	CAC	AF1346K	GA-26	CHP
AF1076	GAVW-22	PUR	AF1130	GA-780	HAS	AF124	GA-2719B ¹²²	PRMT	AF135	GA-75	APOL
AF1078	GA-304	HAS	AF1130F	GA-780	FEDE	AF124	GA-3300 ³⁸	PRMT	AF135	GA-75	BWS
AF1079	GA-479	HAS	AF1133	GA-264	HAS	AF124	GA-2719B ¹²²	SERV	AF135	GA-75	CAM2
AF108	GA-9334	HAS	AF1133	GAVW-2	PUR	AF124	GA-3300 ³⁸	SERV	AF135	GA-75	CHP
AF1080	GA-780	HAS	AF1133F	GA-264	FEDE	AF1240	GA-606	HAS	AF135	GA-75	ECOL
AF1080F	GA-780	FEDE	AF1134	GA-184	GRP	AF1246	GAK-403	CHP	AF135	GA-75	GRAN
AF1081	GA-183	HAS	AF1135	GA-7017	BWS	AF1246	GA-510	HAS	AF135	GA-75	LUF
AF1083	GA-224	HAS	AF1135	GA-7017	CAM2	AF1249	GA-597	HAS	AF135	GA-75	MAR
AF1083F	GA-224	FEDE	AF1135	GA-7017	CHAM	AF1254	GA-269	HAS	AF135	GA-75	MASE
AF1084	GA-168	HAS	AF1135	GA-7017	CHP	AF126	GA-78	IAPC	AF135	GA-75	MINL
AF1084F	GA-168	FEDE	AF1135	GA-7017	GRAN	AF1261	GA-415	HAS	AF135	GA-75	PARP
AF109	GAD-1 ⁸⁷	ACE	AF1135	GA-7017	LUF	AF1261	GA-415	MAHL	AF135	GA-75	SECU
AF109	GAD-1 ⁸⁷	APOL	AF1135	GA-7017	PARP	AF1267	GA-328	HAS	AF135	GA-75	TRUS
AF109	GAD-1 ⁸⁷	CHP	AF1135	GA-7017	SECU	AF1275	GA-33 ¹²	CHP	AF135	GA-75	WARN
AF109	GAD-1 ⁸⁷	LEE	AF1135	GA-7017	TIRP	AF1279	GA-279	CHP	AF1351K	GA-27	CHP
AF109	GAD-1 ⁸⁷	LUF	AF1135	GA-7017	TRUS	AF1279	GA-279	LUF	AF136	GA-55	CAC
AF109	GAD-1 ⁸⁷	MASE	AF1135	GA-7017	WARN	AF1279	GA-279	PARP	AF136	GA-55	FACE
AF109	GAD-1 ⁸⁷	MINL	AF1135F	GA-414R	FEDE	AF1279	GA-279	TRUS	AF136	GA-300	HAS
AF109	GAD-1 ⁸⁷	TRUS	AF1139	GA-490	HAS	AF1279	GA-279	WARN	AF136F	GA-300	FEDE
AF1091	GAVW-626	HAS	AF1139F	GA-490	FEDE	AF129	GA-3424	CAC	AF137	GA-7344	HAS
AF1092	GA-434	HAS	AF1149	GAVW-2	PRMT	AF129	GA-3424	PRMT	AF137	GA-7344	SHE
AF1094	GA-2146	HAS	AF1149	GAVW-2	PUR	AF129	GA-3424	SERV	AF-137	GA-7344	ATL
AF1096	GA-6479	BWS	AF1149	GAVW-2	SERV	AF1291	GA-320	HAS	AF137F	GA-7344	FEDE

REFERENCIA CRUZADA

Para números Gonher con Superíndice vea página 651
For Gonher with Superscript numbers see page 651

Numero	Gonher	Fabricante	Numero	Gonher	Fabricante	Numero	Gonher	Fabricante	Numero	Gonher	Fabricante
Number	Gonher	Manufacturer	Number	Gonher	Manufacturer	Number	Gonher	Manufacturer	Number	Gonher	Manufacturer
AF138	GA-3	CAM2	AF148	GA-80	SECU	AF1641	GA-1614	CAMP	AF178	GA-192	LUF
AF138	GA-3	CHP	AF148	GA-118	SHE	AF1641	GA-1614	CHP	AF178	GA-192	MASE
AF138	GA-3	GRAN	AF148	GA-80	TRUS	AF1641	GA-589	FLG	AF178	GA-192	MINL
AF138	GA-3	LUF	AF148	GA-80	WARN	AF1641	GA-1614	LUF	AF178	GA-192	PARP
AF138	GA-3	MIGH	AF148F	GA-118	FEDE	AF1641	GA-1614	TIRP	AF178	GA-192	TRUS
AF138	GA-3	SECU	AF15	GA-71	CSP	AF1641	GA-1614	WARN	AF178	GA-192	WARN
AF138	GA-3	WARN	AF15	GA-176	GUP	AF1643	GA-130	CHP	AF1780	GA-3588	FLG
AF139	GA-730	HAS	AF15	GA-3490	PRMT	AF1643	GA-130	LUF	AF1785	GA-3647	FLG
AF139CO	GA-730	FEDE	AF15	GA-3490	SER	AF1643	GA-130	WARN	AF1787	GA-154	FLG
AF14	GA-3523	CSP	AF150	GA-432	HAS	AF1647	GA-1203	FLG	AF1789	GA-390	FLG
AF14	GAP-379	PUR	AF1507	GA-145	CAMP	AF1647M	GA-1203	FLG	AF1791	GA-6127	FLG
AF-14	GAP-379	PUMX	AF1507	GA-145	WARN	AF1649	GA-12	FLG	AF1793	GA-436	FLG
AF140	GA-85	HAS	AF1518	GA-348	CHP	AF1651	GA-12	FLG	AF18	GA-86	CSP
AF140	GA-1	IAPC	AF1518	GA-348	CIGO	AF1658	GA-158	CHP	AF180	GA-3566	IAPC
AF140CO	GA-85	FEDE	AF1518	GA-348	LUF	AF1658	GA-158	LUF	AF1802	GA-467	FLG
AF140F	GA-85	FEDE	AF1518	GA-348	MIGH	AF1658	GA-158	PARP	AF1802M	GA-467	FLG
AF141	GA-140	CHAM	AF1518	GA-348	PARP	AF1658	GA-158	TRUS	AF18065	GA-5648	PUR
AF141	GA-140	CHP	AF1518	GA-348	TRUS	AF1658	GA-158	WARN	AF-18065	GA-5648	PUMX
AF141	GA-140	CIGO	AF1519	GA-348	CHP	AF1662	GA-680	FLG	AF1817	GA-371	FLG
AF141	GA-140	GRAN	AF1519	GA-348	LUF	AF1663	GA-679	FLG	AF1817M	GA-371	FLG
AF141	GA-140	LEE	AF1519	GA-348	PARP	AF1666	GA-3	FLG	AF182	GA-30	FLG
AF141	GA-140	LETR	AF1519	GA-348	TRUS	AF1668	GA-11	FLG	AF1822	GA-30	FLG
AF141	GA-140	LUF	AF1519	GA-348	WARN	AF1672	GA-100	FLG	AF1827	GA-135	FLG
AF141	GA-140	MAR	AF153K	GA-98 ¹²	HAS	AF1673	GA-113	FLG	AF1828	GA-251	FLG
AF141	GA-140	MINL	AF157	GA-57	HAS	AF1674	GA-74	FLG	AF1830KM	GA-216	FLG
AF141	GA-140	PARP	AF157CO	GA-57	FEDE	AF1679	GA-479	CHAM	AF1830M	GA-216	FLG
AF141	GA-140	TRUS	AF157F	GA-57	FEDE	AF1679	GA-479	CHP	AF1836	GA-376	FLG
AF141	GA-140	WARN	AF158	GA-12	HAS	AF1679	GA-479	CIGO	AF1836M	GA-376	FLG
AF-141	GA-140	MAST	AF16	GA-113	APOL	AF1679	GA-479	LUF	AF1837	GA-372	FLG
AF1418	GA-360	CHP	AF16	GA-113	CAM2	AF1679	GA-479	WARN	AF1838	GA-377	FLG
AF1418	GA-360	LUF	AF16	GA-113	CENE	AF1682	GA-433	CAMP	AF1839	GA-416	FLG
AF142	GA-3566	CHAM	AF16	GA-113	CHP	AF1682	GA-433	CIGO	AF184	GA-77	ACE
AF142	GA-3566	CHP	AF16	GA-113	CIGO	AF1682	GA-433	LUF	AF184	GA-77	APOL
AF142	GA-3566	GRAN	AF16	GA-730	CSP	AF1682	GA-433	WARN	AF184	GA-77	CAC
AF142	GA-303	HAS	AF16	GA-113	GRAN	AF1683	GA-224	CHP	AF184	GA-77	CHP
AF142	GA-3566	LEE	AF16	GA-113	LUF	AF1683	GA-891	FLG	AF184	GA-77	ECOL
AF142	GA-3566	LETR	AF16	GA-113	MASE	AF1683	GA-224	LUF	AF184	GA-77	FACE
AF142	GA-3566	LUF	AF16	GA-113	PARP	AF1683	GA-224	PARP	AF184	GA-77	GRAN
AF142	GA-3566	MAR	AF16	GA-2740	PRMT	AF1683	GA-224	WARN	AF184	GA-3300	HAS
AF142	GA-3566	MINL	AF16	GA-2740	SERV	AF1688	GA-168	CHP	AF184	GA-77	LEE
AF142	GA-3566	PARP	AF16	GA-113	TRUS	AF1688	GA-168	FSN	AF184	GA-77	LUF
AF142	GA-3566	TRUS	AF16	GA-113	WARN	AF1688	GA-168	LUF	AF184	GA-77	MASE
AF142	GA-3566	WARN	AF16	GA-176	WELA	AF1688	GA-168	PARP	AF184	GA-77	MINL
AF-142	GA-3566	MASE	AF160	GA-70	CAC	AF1688	GA-168	TIRP	AF184	GA-77	PARP
AF142CO	GA-303	FEDE	AF160	GA-70	FACE	AF1688	GA-168	WARN	AF184	GA-77	TRUS
AF142F	GA-303	FEDE	AF160	GA-2740	IAPC	AF169	GA-294	IAPC	AF184	GA-77	WARN
AF144	GA-50	HAS	AF1606K	GA-1532	FLG	AF1690	GA-827	FLG	AF1845K	GA-216	FLG
AF144CO	GA-50	FEDE	AF1606KM	GA-1532	FLG	AF1692	GA-3424	FLG	AF1846	GA-694	FLG
AF144F	GA-50	FEDE	AF161	GAD-29	HAS	AF1695	GA-395	CHP	AF184CO	GA-3300	FEDE
AF145	GA-59	HAS	AF16-1	GA-113	PUR	AF1695	GA-395	FSN	AF184F	GA-3300	FEDE
AF145CO	GA-59	FEDE	AF1612	GA-127	CHP	AF1695	GA-395	LUF	AF185	GA-2719B	IAPC
AF145F	GA-59	FEDE	AF1612	GA-127	GRAN	AF1695	GA-395	PARP	AF1851	GA-416	FLG
AF146	GA-71	ACE	AF1612	GA-127	LUF	AF1695	GA-395	TIRP	AF1852	GA-8	FLG
AF146	GA-71	APOL	AF1612	GA-127	PARP	AF1695	GA-395	WARN	AF1852M	GA-378	CHP
AF146	GA-71	BWS	AF1612	GA-127	SECU	AF1696	GA-224	CHP	AF1853M	GA-229	CHP
AF146	GA-71	CAC	AF1612	GA-127	WARN	AF1696	GA-224	LUF	AF186	GA-3588	IAPC
AF146	GA-71	CAM2	AF1613	GA-128	CHP	AF1696	GA-224	PARP	AF1865	GA-6880	CHP
AF146	GA-71	CHP	AF1613	GA-128	GRAN	AF1696	GA-224	WARN	AF1869	GAP-381	FLG
AF146	GA-71	ECOL	AF1613	GA-128	LUF	AF17	GA-1	CSP	AF187	GA-90	CAC
AF146	GA-71	FACE	AF1613	GA-128	PARP	AF17	GA-362	IAPC	AF1872	GA-376	CHP
AF146	GA-71	FLT	AF1613	GA-128	SECU	AF17	GA-3	PUR	AF1875	GA-7716	CHP
AF146	GA-71	GRAN	AF1613	GA-128	WARN	AF1719	GA-3425	FLG	AF1878	GA-422	FLG
AF146	GA-325	HAS	AF1615	GA-1615	CHP	AF172	GA-55	IMPC	AF1886M	GA-642	FLG
AF146	GA-4958	IAPC	AF1615	GA-1615	GRAN	AF1720	GA-3490	FLG	AF1889	GA-3681	FLG
AF146	GA-71	LEE	AF1615	GA-1615	LEE	AF1731	GA-3501	FLG	AF189	GA-50	CAC
AF146	GA-71	LUF	AF1615	GA-1615	LUF	AF1735K	GA-625	FLG	AF189	GA-50	FACE
AF146	GA-71	MASE	AF1615	GA-1615	PARP	AF1743M	GA-389	FLG	AF189	GA-50	FLT
AF146	GA-71	MIGH	AF1615	GA-1615	SECU	AF1744	GA-158	LUF	AF1897	GA-1095	FLG
AF146	GA-71	MINL	AF1615	GA-1615	TRUS	AF175	GA-75	IAPC	AF1897M	GA-1095	FLG
AF146	GA-71	PARP	AF1615	GA-1615	WARN	AF1750	GA-54	FLG	AF19	GA-55	IMPC
AF146	GA-71	PRMT	AF1616	GA-493 ¹⁰⁸	FLG	AF175210-P	GA-422	GFF	AF19	GA-191	KNE
AF146	GA-71	PROM	AF1617	GA-442	CHP	AF1754	GA-1617	CHP	AF190	GA-39	CHP
AF146	GA-71	SECU	AF1617	GA-3424	FLG	AF1754	GA-1617	LUF	AF1904M	GA-206	FLG
AF146	GA-71	TRUS	AF1617	GA-442	SECU	AF1754	GA-1617	PARP	AF1905	GA-106 ⁴⁶	FLG
AF146	GA-71	WARN	AF1618	GA-620	CHP	AF1758M	GA-373	FLG	AF1905	GA-326 ⁷¹	FLG
AF147	GA-180	IAPC	AF1618	GA-56	CAC	AF176	GA-56	CAC	AF1905M	GA-106 ⁴⁶	FLG
AF1472	GA-6129	CHP	AF1618	GA-3425	FLG	AF176	GA-56 ⁹⁰	FACE	AF1905M	GA-326 ⁷¹	FLG
AF148	GA-80	ACE	AF1618	GA-620	LUF	AF176	GA-56	FLT	AF1906	GA-230	FLG
AF148	GA-80	APOL	AF1618	GA-620	SECU	AF176	GA-4325	IAPC	AF1916	GA-3637	FLG
AF148	GA-118	ATL	AF1618	GA-620	WARN	AF1762	GA-89	FLG	AF192	GA-192	CAC
AF148	GA-80	BWS	AF16-1M	GA-113	PUR	AF1770	GA-3445	FLG	AF192	GA-192	FACE
AF148	GA-80	CAC	AF162	GA-55	IMPC	AF1771	GA-734 ⁸¹	FLG	AF1935M	GA-398	FLG
AF148	GA-80	CAM2	AF1620	GA-57	FLG	AF1771	GA-735 ¹²⁴	FLG	AF1968	GA-3551 ²⁵	FLG
AF148	GA-80	CHP	AF1622	GA-392	CHP	AF1772	GA-3490	FLG	AF1968	GA-3551 ²⁴	FLG
AF148	GA-80	CIGO	AF1622	GA-392	LUF	AF1773	GA-271	FLG	AF1968M	GA-3551 ²⁵	FLG
AF148	GA-80	ECOL	AF1623	GA-212	LUF	AF1774	GA-271	FLG	AF1968M	GA-3551 ²⁴	FLG
AF148	GA-80	FLT	AF1624	GA-415	CHAM	AF1776	GA-140	FLG	AF1983	GA-3501	FLG
AF148	GA-80	GRAN	AF1624	GA-415	CHP	AF1777	GA-2740	FLG	AF19847	GA-33 ¹²	JOND
AF148	GA-118	HAS	AF1624	GA-415	LUF	AF1778	GA-75	FLG	AF2	GA-100	APC
AF148	GA-80	LEE	AF1624	GA-415	PARP	AF178	GA-192	ACE	AF2	GA-113	GUP
AF148	GA-80	LUF	AF1625	GA-192	APOL	AF178	GA-192	APOL	AF2	GA-113	SRN
AF148	GA-80	MASE	AF1627	GA-55	FLG	AF178	GA-192	BWS	AF2	GA-100	WELA
AF148	GA-80	MIGH	AF1632	GA-170	SAKU	AF178	GA-192	CHP	AF20	GA-271	CSP
AF148	GA-80	MINL	AF1638	GA-425	FLG	AF178	GA-192	ECOL	AF20	GA-271	IAPC
AF148	GA-80	PARP	AF1639	GA-426	FLG	AF178	GA-192	GRAN	AF-2006	GA-388	PUMX
AF148	GA-80	PRMT	AF1640	GA-588	FLG	AF178	GA-192	LEE	AF201	GA-1	BOG

Referencia Cruzada por Numero de Parte

Cross Reference by Part Number



Numero	Gonher	Fabricante	Numero	Gonher	Fabricante	Numero	Gonher	Fabricante	Numero	Gonher	Fabricante
Number	Gonher	Manufacturer	Number	Gonher	Manufacturer	Number	Gonher	Manufacturer	Number	Gonher	Manufacturer
AF201	GA-1	ROB	AF212	GA-55	GRAN	AF2275	GA-221R	HAS	AF25090	GA-240	FLG
AF2010	GA-7017	GKIN	AF212	G-163	KNE	AF2276	GA-33 ¹¹²	REF	AF25092	GA-388	FLG
AF20124	GA-2184	DPHI	AF212	GA-55	LEE	AF22760	GA-33 ¹¹²	REF	AF25111	GA-499R	FLG
AF2014	GA-414R	CHP	AF212	GA-55	LUF	AF2277	GA-539R	HAS	AF25111M	GA-499R	FLG
AF2014	GA-414R	LUF	AF212	GA-55	MASE	AF2280	GA-723R	HAS	AF25139	GA-682R	FLG
AF2014	GA-414R	PARP	AF212	GA-55	MINL	AF2283	GA-534R	HAS	AF25139M	GA-682R ¹⁰⁴	FLG
AF2014	GA-414R	TIRP	AF212	GA-55	PARP	AF2288	GA-600R	HAS	AF252	GA-362	BWS
AF2019	GA-33 ¹¹²	PUR	AF212	GAD-1	ROB	AF229	GA-18	CHP	AF252	GA-362	CAM2
AF-2019	GA-33	PUMX	AF212	GA-55	TRUS	AF229	GA-6127	HAS	AF252	GA-362	CHP
AF202	GA-3	BOG	AF212	GA-55	WARN	AF2296	GA-435R	HAS	AF252	GA-362	GRAN
AF202	GA-3	ROB	AF2124	GA-27	REF	AF23	GA-230	PUR	AF252	GA-362	LEE
AF2028	GA-16 ¹¹²	PUR	AF2125	GA-26	REF	AF23	GA-230	SPEC	AF252	GA-362	LUF
AF2028	GAK-16 ³⁴	PUR	AF2126	GAK-403	REF	AF2302	GA-968R	HAS	AF252	GA-362	MASE
AF2028K	GAK-16	PUR	AF2128	GA-356	REF	AF2306	GA-7716	PUR	AF252	GA-362	PARP
AF2029	GA-18	PUR	AF21280	GA-356	REF	AF-2306	GA-7716	PUMX	AF252	GA-362	SECU
AF-2029	GA-18	PUMX	AF213	GA-2719B	BOG	AF231	GA-4365	BOG	AF252	GA-362	TRUS
AF203	GA-277	BOG	AF213	GA-7	BWS	AF231	GA-4365	ROB	AF252	GA-362	WARN
AF203	GA-1203	CHP	AF213	GA-7	CHP	AF2314	GA-378	PUR	AF25215	GA-768R	FLG
AF203	G-143	KNE	AF213	GA-514	HAS	AF-2314	GA-378	PUMX	AF25217	GA-356	FLG
AF203	GA-1203	LUF	AF213	G-163	KNE	AF2318	GA-429	CAC	AF25219	GA-518R	FLG
AF203	GA-277	ROB	AF213	GA-7	LUF	AF2318	GA-429	LEDR	AF25220	GA-197R	FLG
AF2030	GA-1203	LUF	AF213	GA-2719B	ROB	AF2318	GA-429	PUR	AF25223	GA-966R	FLG
AF2030	GAK-16	PUR	AF213	GA-514	SHE	AF2320	GA-229	PUR	AF25247	GA-539R	FLG
AF2030K	GAK-16	PUR	AF2132	GA-26	PUR	AF2327	GA-781	HAS	AF25248	GA-534R	FLG
AF2036	GA-1095	HAS	AF2132	GA-357	REF	AF2328	GA-782	HAS	AF25254	GA-1616	FLG
AF2036	GA-3445	UCAL	AF2138	GA-6129	PUR	AF233	GA-2740	BOG	AF25255	GA-442	FLG
AF2039K	GA-98 ¹¹²	PUR	AF-2138	GA-6128	PUMX	AF233	GA-2740	ROB	AF25256	GA-165	FLG
AF203D	G-143	KNE	AF2139	GA-6127	PUR	AF2332	GA-697R	HAS	AF25257	GAVW-2	FLG
AF2040K	GAK-403	FLOM	AF-2139	GA-6127	PUMX	AF2333	GA-139	UNN	AF25258	GA-673R	FLG
AF2040K	GAK-403	PUR	AF213D	G-163	KNE	AF2334	GAK-458	HAS	AF25259	GA-732R	FLG
AF2041	GA-1284	PUR	AF213F	GA-514	FEDE	AF2334	GA-9334	REF	AF25262	GA-600R	FLG
AF-2041	GA-1284	PUMX	AF214	GA-375	HAS	AF2335	GA-1286	REF	AF25292	GA-853R	FLG
AF2043	GA-29	HAS	AF2140	GA-106 ⁴⁶	PUR	AF2339	GA-403	HAS	AF253	GA-37	FLG
AF2045	GA-9045	REF	AF2140	GA-326 ⁷¹	PUR	AF234	GA-4303	BOG	AF253	GA-349	HAS
AF2046	GA-1287	REF	AF216	GA-361	HAS	AF234	GA-382	CAM2	AF253	GA-694	LUF
AF2047	GA-8047	REF	AF2160	GA-230	UNN	AF234	GA-382	CAMP	AF25300	GA-781	FLG
AF2048	GA-1285	REF	AF2164	GA-135	PUR	AF234	GA-382	CHP	AF25301	GA-782	FLG
AF205	GAVW-4	ROB	AF217	GA-360	HAS	AF234	GA-382	GRAN	AF25304	GA-186	FLG
AF2052	GA-1285	PUR	AF218	GAVW-2	BOG	AF234	GA-382	LUF	AF25306	GA-475	FLG
AF-2052	GA-1285	PUMX	AF218	GA-106 ⁴⁶	HAS	AF234	GA-382	PARP	AF25306-FN	GA-33 ¹¹²	GFF
AF2053	GAD-1	JFL	AF218	GA-326 ⁷¹	HAS	AF234	GA-4303	ROB	AF25314	GA-517R	FLG
AF2053	GA-1286	PUR	AF218	GAVW-2	ROB	AF234	GA-382	SECU	AF25316	GA-392	FLG
AF-2053	GA-1286	PUMX	AF2187	GA-459	HAS	AF234	GA-382	TIRP	AF25319	GA-5876	FLG
AF2055	GA-1287	PUR	AF219	GA-206	HAS	AF234	GA-382	TRUS	AF25338	GA-712R	FLG
AF-2055	GA-1287	PUMX	AF2193	GA-768R	HAS	AF234	GA-382	WARN	AF25345	GA-683R	FLG
AF206	GA-230	BOG	AF2196	GA-529	HAS	AF2346	GA-3588	UNN	AF25352	GA-853R	FLG
AF206	GA-42	BWS	AF2198	GA-499R	HAS	AF234HD	GAK-20	CHP	AF25354	GA-930R	FLG
AF206	GA-42	CHP	AF22	GG-19	APCO	AF235	GAD-30	CAM2	AF25355	GA-930R	FLG
AF206	GA-42	LUF	AF22	GAD-30	CHP	AF235	GAD-30	CHP	AF25359	GA-930R	FLG
AF206	GA-230	ROB	AF22	GA-56	HAS	AF235	GAD-30	GRAN	AF25360	GA-890R	FLG
AF2062	GAK-20	PUR	AF2200	GA-206	PUR	AF235	GAD-30	LUF	AF25380	GA-410	FLG
AF-2062	GA-20	PUMX	AF-2200	GA-206	PUMX	AF235	GAD-30	WARN	AF25395KM	GA-6129	FLG
AF2062K	GAK-20	PUR	AF2201	GA-356	PUR	AF236	GA-75	BOG	AF254	GA-2194	BWS
AF2064	GAK-16	HAS	AF-2201	GA-356	PUMX	AF236	GA-75	ROB	AF254	GA-2194	CAM2
AF2070	GA-21	PUR	AF-2202	GA-16	PUMX	AF237	GA-50	ROB	AF254	GA-2194	CHAM
AF-2070	GA-21	PUMX	AF2203	GA-1203	REF	AF2376	GA-701 ¹⁰⁴	HAS	AF254	GA-2194	CHP
AF2072	GA-349	UNN	AF2207	GA-357	PUR	AF2377	GA-702 ¹⁰⁸	HAS	AF254	GA-2194	CIGO
AF-2073	GA-24	PUMX	AF-2207	GA-357	PUMX	AF2377	GA-6128	REF	AF254	GA-2194	GRAN
AF2081	GA-21	PUR	AF2208	GA-106 ⁴⁶	REF	AF2378	GA-1008	REF	AF254	GA-2194	LUF
AF2082	GA-608	HAS	AF2208	GA-326 ⁷¹	REF	AF2379	GA-1284	REF	AF254	GA-2194	MASE
AF2083	GA-29	PUR	AF2209	GA-206	REF	AF2397	GA-4999	HAS	AF254	GA-2194	MIGH
AF-2083	GA-29	PUMX	AF2213K	GAK-16	PUR	AF24	GA-3424	CSP	AF254	GA-2194	SECU
AF209	GA-164	HAS	AF2215	GA-31	PUR	AF240	GAVW-4	BOG	AF254	GA-2194	WARN
AF2091	GA-56	UNN	AF2216	GA-518R	HAS	AF240	GAK-37	CHP	AF254090-FN	GAK-20	GFF
AF2092	GA-405	HAS	AF2218	GA-390	UCAL	AF240	GA-356	HAS	AF254102	GA-1008	GFF
AF2093	GP-28 ⁸	PUR	AF2218	GA-390	UNN	AF240	GAVW-4	ROB	AF25423	GAVW-620	FLG
AF2093	GP-430 ⁸	PUR	AF2219	GA-403	PUR	AF241	GA-3490	BOG	AF25429	GA-890R	FLG
AF2093	GA-90	UNN	AF-2219	GA-403	PUMX	AF241	GA-179	CHP	AF25430	GA-723R	FLG
AF2094	GA-27	PUR	AF2220	GA-360	PUR	AF241	GA-357	HAS	AF25435	GA-435R	FLG
AF-2094	GA-27	PUMX	AF-2220	GA-360	PUMX	AF241	GA-179	LUF	AF25449	GA-49	FLG
AF2094K	GA-27	PUR	AF2220H	GA-360	PUR	AF241	GA-3490	ROB	AF25456K	GAK-16	FLG
AF209F	GA-164	FEDE	AF2221	GA-106 ⁴⁶	PUR	AF2422	GA-6129	REF	AF2548	GA-448	CHP
AF21	GAD-3	CSP	AF2221	GA-326 ⁷¹	PUR	AF2423	GA-6127	REF	AF2548	GA-448	CIGO
AF21	GA-195	IAPC	AF-2221	GA-206	PUMX	AF244	GA-5466	HAS	AF2548	GA-448	LUF
AF21	G-163	KNE	AF2222	GAK-16	REF	AF244	GA-5466	SHE	AF25492	GA-697R	FLG
AF210	GA-11	BWS	AF223	GA-303	BOG	AF244F	GA-5466	FEDE	AF255	GAD-3	BOG
AF210	GA-11	CHP	AF223	GA-303	ROB	AF246	GAVW-2	BOG	AF255	GAD-3	ROB
AF210	GA-6129	HAS	AF2234	GAK-20	REF	AF246	GAVW-2	ROB	AF25525	GA-518R	FLG
AF210	GA-11	LUF	AF2237	GA-105	HAS	AF248	GA-3300	BOG	AF25531	GA-106 ⁴⁶	FLG
AF-2104	GA-26	PUMX	AF2237	GA-135	PUR	AF248	GA-3300	ROB	AF25531	GA-326 ⁷¹	FLG
AF2104K	GA-26 ¹¹²	PUR	AF2239	GPP-19	HAS	AF2491	GA-107	REF	AF25541	GA-240	FLG
AF2108	GA-2804 T	HAS	AF2241	GA-467	HAS	AF2498	GA-405	PUR	AF25551	GA-880R	FLG
AF2108	GA-375	PUR	AF2242	GA-3501	HAS	AF25	GA-735 ¹²⁴	CSP	AF25557	GA-853R	FLG
AF-2108	GA-375	PUMX	AF-2242	GA-3501	ATL	AF250	GAD-3	BOG	AF25575	GA-880R	FLG
AF211	GA-12	CHP	AF2242F	GA-3501	FEDE	AF250	GA-39	FLG	AF25590	GA-1615	FLG
AF211	GA-12	LUF	AF2243	GA-966R	HAS	AF25013	GAVW-4	FLG	AF25598	GA-968R	FLG
AF2111	GA-1203	PUR	AF2248	GA-930R	HAS	AF25014	GA-129	FLG	AF25599	GA-2146	FLG
AF-2111	GA-1203	PUMX	AF2250	GA-37	REF	AF25017	GA-166	FLG	AF25608	GA-4958	FLG
AF2117	GA-287	PUR	AF2253	GA-209	REF	AF25018	GA-276	FLG	AF25621	GA-472	FLG
AF-2117	GA-287	PUMX	AF2254	GA-210	REF	AF2503	GA-98 ¹¹²	REF	AF25629	GA-780	FLG
AF2119	GA-360	REF	AF2258	GA-563	REF	AF25033	GA-221R	FLG	AF25636	GA-348	FLG
AF212	GA-55	ACE	AF2266	GA-361	PUR	AF25033M	GA-221R	FLG	AF25667	GA-966R	FLG
AF212	GA-55	APOL	AF-2266	GA-360	PUMX	AF25036M	GA-499R	FLG	AF25671	GA-376	FLG
AF212	GA-55	BWS	AF2266H	GA-361	PUR	AF25070K	GAK-16	FLG	AF25682	GA-130	FLG
AF212	GA-55	CHP	AF2270	GA-853R	HAS	AF25075	GA-8150	FLG	AF25		

Numero	Gonher	Fabricante	Numero	Gonher	Fabricante	Numero	Gonher	Fabricante	Numero	Gonher	Fabricante
Number	Gonher	Manufacturer	Number	Gonher	Manufacturer	Number	Gonher	Manufacturer	Number	Gonher	Manufacturer
AF25707	GA-799R	FLG	AF2785	GA-1572	LUF	AF293	GAD-15	SECU	AF300	GA-277	PARP
AF-2571	GAP-381	PUMX	AF279	GA-216	CAM2	AF293	GAD-15	TRUS	AF300	GA-277	SECU
AF25732	GA-798R	FLG	AF279	GA-216	CHAM	AF293	GAD-15	WARN	AF300	GA-277	TRUS
AF25754	GA-164	FLG	AF279	GA-216	CHP	AF2938	GAK-216	PUR	AF300	GA-277	WARN
AF25757	GA-348	FLG	AF279	GA-216	CIGO	AF294	GA-271	BOG	AF300237-PU	GA-375	GFF
AF258	GA-200	BOG	AF279	GA-216	GRAN	AF294	GA-271	ROB	AF3007	GA-39	PUR
AF258	GA-198	HAS	AF279	GA-429	HAS	AF2941	GA-493 ¹⁰⁸	REF	AF30078	GA-39	PUR
AF258	GA-200	ROB	AF279	GA-216	LUF	AF2943	GA-426	PUR	AF300-8	GA-588	PUR
AF258	GA-218	ROB	AF279	GA-216	SECU	AF2945	GA-425	PUR	AF301	GAVW-22	CHP
AF25854	GA-413R	FLG	AF279	GA-216	WARN	AF295	GAVW-4	APOL	AF301	GA-6619 ⁵	IACP
AF25856	GA-904R	FLG	AF28	GA-3490	CSP	AF295	GAVW-4	BWS	AF301	GA-6620 ⁵	IACP
AF25857	GA-905R ¹⁰⁸	FLG	AF280	GA-471	BWS	AF295	GAVW-4	CAM2	AF302	GA-4303	APOL
AF25873	GA-697R	FLG	AF280	GA-471	CAM2	AF295	GAVW-4	CHAM	AF302	GA-4303	BWS
AF25888	GA-888R	FLG	AF280	GA-471	CHP	AF295	GAVW-4	CHP	AF302	GA-4303	CAM2
AF259	GAD-30	ROB	AF280	GA-471	CIGO	AF295	GAVW-4	GRAN	AF302	GA-4303	CHP
AF25962	GA-770R	FLG	AF280	GA-471	GRAN	AF295	GAVW-4	LUF	AF302	GA-4303	ECOL
AF25964	GA-697R	FLG	AF280	GA-471	LUF	AF295	GAVW-4	MASE	AF302	GA-4303	LEE
AF25997	GA-864R	FLG	AF280	GA-471	SECU	AF295	GA-78	ROB	AF302	GA-4303	LUF
AF26	GA-176	BWS	AF280	GA-471	TIRP	AF295	GAVW-4	SECU	AF302	GA-4303	MASE
AF26	GA-176	CENE	AF280	GA-471	WARN	AF295	GAVW-4	WARN	AF302	GA-4303	MINL
AF26	GA-176	CHP	AF280067-FN	GAK-16	GFF	AF2957	GA-679	PUR	AF302	GA-4303	PARP
AF26	GA-2719B	CSP	AF280212	GA-5648	GFF	AF2958	GA-680	PUR	AF302	GA-4303	TRUS
AF26	GA-176	GRAN	AF2821A	GP-58	PUR	AF-2958	GA-680	PUMX	AF302	GA-4303	WARN
AF26	GA-176	LUF	AF283	GAVW-2	FLG	AF296	GAVW-2	APOL	AF3026	GA-891	PUR
AF26	GA-176	PARP	AF285064	GA-49	GFF	AF296	GAVW-2	CAM2	AF-3026	GA-891	PUMX
AF26	GA-176	TRUS	AF2853	GA-375	REF	AF296	GAVW-2	REF	AF3028	GAK-625	PUR
AF26	GA-176	WARN	AF2865	GA-5648	REF	AF296	GAVW-2	GRAN	AF303	GA-303	CAC
AF2608	GA-405	REF	AF2875	GA-7360	PUR	AF296	GAVW-2	LUF	AF303	GA-230	CSP
AF261	GA-3490	APOL	AF-2875	GA-7360	PUMX	AF296	GAVW-2	MASE	AF303	GA-303	FACE
AF261	GA-3490	BWS	AF2876	GA-376	PUR	AF296	GAVW-2	SECU	AF303	GA-303	FLT
AF261	GA-3490	CHP	AF-2876	GA-376	PUMX	AF296	GAVW-2	WARN	AF303	GA-679	HAS
AF261	GA-3490	ECOL	AF288	GA-4325	BOG	AF2960	GA-376	REF	AF3031	GA-892	PUR
AF261	GA-105	FLG	AF288	GA-1203	CAM2	AF2961	GA-2984	PUR	AF303170-FN	GA-27	GFF
AF261	GA-3490	GRAN	AF288	GA-1203	CHP	AF2961	GA-378	REF	AF3035	GAK-16	PUR
AF261	GA-3490	LEE	AF288	GA-4325	ROB	AF29610	GA-378	REF	AF304	GA-730	CHP
AF261	GA-3490	LUF	AF2883	GA-437	CAMP	AF2966	GA-229	REF	AF304	GA-6690	IACP
AF261	GA-3490	MASE	AF2884	GA-1542	CAMP	AF297	GA-4365	APOL	AF3040	GA-426	PUR
AF261	GA-3490	MIGH	AF2889	GA-679	PUR	AF297	GA-4365	BWS	AF3041	GA-425	PUR
AF261	GA-3490	MINL	AF289	GA-6619 ⁵	BWS	AF297	GA-4365	CAM2	AF304119-PU	GA-499R	GFF
AF261	GA-3490	PARP	AF289	GA-6620 ⁵	BWS	AF297	GA-4365	CHP	AF305	GA-730	ACE
AF261	GA-3490	TRUS	AF289	GA-6619 ⁵	CAM2	AF297	GA-4365	CIGO	AF305	GA-730	APOL
AF261	GA-3490	WARN	AF289	GA-6620 ⁵	CAM2	AF297	GA-4365	GRAN	AF305	GA-730	BWS
AF2610	GA-3490	LUF	AF289	GA-6619 ⁵	CHP	AF297	GA-4365	LUF	AF305	GA-730	CAC
AF26103	GA-4862R	FLG	AF289	GA-6620 ⁵	CHP	AF297	GA-4365	MASE	AF305	GA-730	CAM2
AF26106	GA-488	FLG	AF289	GA-6619 ⁵	CIGO	AF297	GA-4365	MIGH	AF305	GA-730	CHP
AF2611	GA-372	REF	AF289	GA-6620 ⁵	CIGO	AF297	GA-4365	SECU	AF305	GA-730	ECOL
AF26110	GA-372	REF	AF289	GA-5648	FLG	AF297	GA-4365	WARN	AF305	GA-730	FACE
AF26111	GA-909R	FLG	AF289	GA-6619 ⁵	GRAN	AF2974	GAK-1532	PUR	AF305	GA-50	FLG
AF26111M	GA-909R	FLG	AF289	GA-6620 ⁵	GRAN	AF2976	GA-31	REF	AF305	GA-730	FLT
AF26114	GA-967R	FLG	AF289	GAD-3	HAS	AF2977	GA-329	PUR	AF305	GA-730	GRAN
AF2613	GA-373	REF	AF289	GA-6619 ⁵	LUF	AF-2977	GA-329	PUMX	AF305	GA-730	LEE
AF26131	GA-1617	FLG	AF289	GA-6620 ⁵	LUF	AF2978	GA-239	PUR	AF305	GA-730	LUF
AF26152	GA-4999	FLG	AF289	GA-6619 ⁵	MIGH	AF-2978	GA-239	PUMX	AF305	GA-730	MASE
AF26153	GA-702 ¹⁰⁸	FLG	AF289	GA-6620 ⁵	MIGH	AF298	GAVW-4	APOL	AF305	GA-730	MIGH
AF26154	GA-701 ¹⁰⁴	FLG	AF289	GA-6619 ⁵	SECU	AF298	GAVW-4	CAM2	AF305	GA-730	MINL
AF26163M	GA-624R	FLG	AF289	GA-6620 ⁵	SECU	AF298	GAVW-4	CHP	AF305	GA-730	PARP
AF26203	GA-780	FLG	AF289	GAD-3	SHE	AF298	GAVW-4	GRAN	AF305	GA-730	PRMT
AF26268	GA-4863	FLG	AF289	GA-6619 ⁵	TIRP	AF298	GAVW-4	LUF	AF305	GA-730	PROM
AF26298	GA-490	FLG	AF289	GA-6620 ⁵	TIRP	AF298	GAVW-4	MASE	AF305	GA-730	SECU
AF2631	GAK-216	REF	AF289	GA-6619 ⁵	WARN	AF298	GAVW-4	SECU	AF305	GA-730	TRUS
AF26313	GA-275	FLG	AF289	GA-6620 ⁵	WARN	AF298	GAVW-4	WARN	AF305	GA-730	WARN
AF26322	GAD-34	FLG	AF2890	GA-680	PUR	AF2980	GA-7716	REF	AF305083-FN	GAK-216	GFF
AF264	GAVW-2	ROB	AF2891	GA-892 ²⁷	PUR	AF2981	GA-679	PUR	AF305092	GA-1285	GFF
AF2651	GA-108	REF	AF-2891	GA-891	PUMX	AF2981	GA-7360	REF	AF305154	GA-329	GFF
AF266	GA-403	HAS	AF2892	GA-891	PUR	AF-2981	GA-679	PUMX	AF3055	GA-89	PUR
AF2661	GA-6880	REF	AF2893	GA-6880	PUR	AF2984	GA-2984	REF	AF3057	GA-377	PUR
AF267	GA-77	FLG	AF2896	GA-416	PUR	AF299	GAVW-2	APOL	AF-3057	GA-377	PUMX
AF267	GA-230	ROB	AF2897	GA-229	PUR	AF299	GAVW-2	BWS	AF3058	GA-372	PUR
AF268	GA-5648	CHP	AF2898	GA-482	PUR	AF299	GAVW-2	CAM2	AF305K	GAK-20	FLG
AF2680	GA-483	REF	AF-2898	GA-482	PUMX	AF299	GAVW-2	CHP	AF306	GA-3445	CAMP
AF2681	GA-482	REF	AF2899	GA-483	PUR	AF299	GAVW-2	ECOL	AF306	GA-3445	CIGO
AF2682	GA-329	REF	AF-2899	GA-483	PUMX	AF299	GAVW-2	GRAN	AF306	GAVW-2	CSP
AF270	GA-56	BOG	AF289CO	GAD-3	FEDE	AF299	GAVW-2	LEE	AF306	GA-56	FLG
AF270	GA-56	ROB	AF289F	GAD-3	FEDE	AF299	GAVW-2	LUF	AF306	GA-3445	GRAN
AF270094-PU	GA-732R	GFF	AF289M	GA-5648	FLG	AF299	GAVW-2	MASE	AF306	GA-6880	HAS
AF2709	GAD-1 ⁸⁷	CAC	AF29	GA-80	CSP	AF299	GAVW-2	MINL	AF306	GA-195	IACP
AF2719	GA-2719B	CAC	AF29	G-191	KNE	AF299	GAVW-2	PARP	AF306	GA-3445	LUF
AF2740	GA-2740	CAC	AF290	GA-105	FLG	AF299	GAVW-2	SECU	AF306	GA-3445	MIGH
AF2740	GA-2740	FLT	AF2906	GA-329	PUR	AF299	GAVW-2	TRUS	AF306	GA-3445	MINL
AF2757	GA-826	REF	AF2908	GA-892	PUR	AF299	GAVW-2	WARN	AF306	GA-3445	PARP
AF2759	GA-109	REF	AF2908	GA-75	UNN	AF3	GA-113 ¹²	APC	AF306	GA-3445	TRUS
AF276	GA-75	HAS	AF291	GA-105	FLG	AF3	GA-113	GUP	AF306	GA-3445	WARN
AF276CO	GA-75	FEDE	AF2923	GA-3501	PRMT	AF3	GA-3588 ¹¹³	HAS	AF-306	GA-3445	MASE
AF276F	GA-75	FEDE	AF2923	GA-3501	PUR	AF3	GA-75	SERV	AF307	GA-2740	APOL
AF277	GA-2194	ROB	AF2923	GA-3501	SERC	AF30	GA-325	CSP	AF307	GA-2740	BWS
AF278	GAD-3	CHP	AF2923	GA-3501	SERV	AF30	GA-37	HAS	AF307	GA-2740	CHP
AF278	GA-90	HAS	AF2923	GA-3501	SPEC	AF300	GA-277	APOL	AF307	GA-2740	CIGO
AF278	GAD-3	LUF	AF2924	GA-361	REF	AF300	GA-277	BWS	AF307	GA-2740	ECOL
AF278	GAD-3	MIGH	AF293	GAD-15	APOL	AF300	GA-277	CAM2	AF307	GA-2740	GRAN
AF278	GAD-3	SECU	AF293	GAD-15	BWS	AF300	GA-277	CHP	AF307	GA-175	HAS
AF278	GAD-3	WARN	AF293	GAD-15	CAM2	AF300	GA-277	ECOL	AF307	GA-2740	LEE
AF2780	GA-1540	CAMP	AF293	GAD-15	CHP	AF300	GA-277	GRAN	AF307	GA-2740	LETR
AF2780	GA-1540	LUF	AF293	GAD-15	GRAN	AF300	GA-277	LEE	AF307	GA-2740	LUF
AF2782	GA-1571	CAMP	AF293	GAD-15	LEE	AF300	GA-277	LUF	AF307	GA-2740	MAR
AF2782	GA-1571	LUF	AF293	GAD-15	LUF	AF300	GA-277	MASE	AF307	GA-2740	MASE
AF2782	GA-1571	SERC	AF293	GAD-15	PARP	AF300	GA-277	MINL	AF307	GA-2740	MINL

Referencia Cruzada por Numero de Parte

Cross Reference by Part Number



Numero	Gonher	Fabricante	Numero	Gonher	Fabricante	Numero	Gonher	Fabricante	Numero	Gonher	Fabricante
Number	Gonher	Manufacturer	Number	Gonher	Manufacturer	Number	Gonher	Manufacturer	Number	Gonher	Manufacturer
AF307	GA-2740	PARP	AF324	GA-80	FLG	AF3373	GAVW-2	FACE	AF351	GA-195	CAM2
AF307	GA-175	SHE	AF324	GA-85	FLT	AF3373	GAVW-2	FLT	AF351	GA-195	CHP
AF307	GA-2740	TRUS	AF3240	GA-128	PUR	AF3380	GA-1286	FLG	AF351	GA-195	CAC
AF307	GA-2740	WARN	AF3244	GA-107	PUR	AF3380	GA-3647	PRET	AF351	GA-195	GRAN
AF-307	GA-175	ATL	AF-3244	GA-107	PUMX	AF3380	GA-3647	PRMT	AF351	GA-195	LUF
AF307F	GA-175	FEDE	AF3245	GAD-30	CAC	AF3380	GA-3647	PUR	AF351	GA-195	PARP
AF308	GA-71	FLG	AF3245	GA-269	CHAM	AF3380	GA-3647	SERV	AF351	GA-195	SECU
AF-3080	GA-3445	PRET	AF3245	GA-269	PARP	AF3384	GA-89	PRET	AF351	GA-195	TRUS
AF3087	GA-2194	PUR	AF324A	GA-85	FACE	AF3384	GA-89	PRMT	AF351	GA-195	WARN
AF3087	GA-2194	SERC	AF325	GA-325	CAC	AF3384	GA-89	PUR	AF3515	GA-329	PUR
AF309	GA-3490	CHP	AF325	GA-325	FACE	AF3384	GA-89	SERV	AF351K	GA-27	FLG
AF309	GA-3490	LUF	AF325	GA-325	FLT	AF339	GA-1286	FLG	AF351KM	GA-27	FLG
AF3094	GA-3490	PUR	AF3254	GA-509 ¹⁴	PUR	AF3398	GA-3566	PRMT	AF352	GAD-1 ⁸⁷	CAC
AF31	GA-56	ACE	AF326	GA-59	CAC	AF3398	GA-3566	SERV	AF352	GAD-1 ⁸⁷	FACE
AF31	GA-56	APOL	AF326	GA-230	CSP	AF3399	GAVW-4	CAC	AF3523	GA-3523	CAC
AF31	GA-56	BWS	AF326	GA-59	FACE	AF34	GA-3681	CSP	AF353	GAD-3	CAC
AF31	GA-56	CAC	AF326	GA-59	FLT	AF340	GAD-1 ⁸⁷	APOL	AF353	GA-3901	CHP
AF31	GA-56	CAM2	AF3267	GA-360	PUR	AF340	GA-86	CAC	AF353	GAD-3	FACE
AF31	GA-56	CHP	AF3268	GA-361	PUR	AF340	GAD-1 ⁸⁷	CAM2	AF353	GA-3901	GRAN
AF31	GA-3425	CSP	AF327	GA-57	CAC	AF340	GA-1287	FLG	AF353	GA-3901	LEE
AF31	GA-175	GRAN	AF327	GA-4828	CSP	AF340	GA-27198	MINL	AF353	GA-3901	LUF
AF31	GA-56	LUF	AF327	GA-57	FACE	AF3402	GA-589	PUR	AF353	GA-3901	SECU
AF31	GA-56	MASE	AF327	GA-57	FLT	AF3403	GA-588	PUR	AF353	GA-3901	TRUS
AF31	GA-56	MIGH	AF3281	G-1121F	PBR	AF340A	GA-86	FACE	AF3530	GA-389	PUR
AF31	GA-56	MINL	AF329	GA-57	ACE	AF341	GA-1284	FLG	AF3531	GA-371	PUR
AF31	GA-56	WARN	AF329	GA-57	APOL	AF342	GA-1284	FLG	AF3534	GAVW-2	PUR
AF3-1	GA-39	PUR	AF329	GA-57	BWS	AF3424	GA-3424	CAC	AF3536	GA-563	PUR
AF3-1	GA-39	REF	AF329	GA-57	CHP	AF3425	GA-3425	CAC	AF3537	GA-54	CAC
AF3-1	GA-39	PUMX	AF329	GA-57	ECOL	AF3425	GA-3425	FLT	AF3538	GA-140	SEFA
AF310	GAVW-4	CSP	AF329	GA-57	GRAN	AF343	GA-1285	FLG	AF3538	GA-140	SERV
AF310	GA-5648	FLG	AF329	GA-322	IAPC	AF343	GA-1203	HAS	AF353K	GA-24 ¹¹²	FLG
AF310	GA-74	HAS	AF329	GA-57	LEE	AF343123	GA-210	GFF	AF353KM	GA-24 ¹¹²	FLG
AF310CO	GA-74	FEDE	AF329	GA-57	LUF	AF3436	GA-4365	PUR	AF3549	GA-89	CAC
AF310F	GA-74	FEDE	AF329	GA-57	MASE	AF3436	GA-4365	SERC	AF355	GA-2110	BWS
AF311	GAVW-22	CHP	AF329	GA-57	MINL	AF3436	GA-4365	SPEC	AF355	GA-2110	CAM2
AF311	GA-70	FLG	AF329	GA-57	PARP	AF3438	GAP-381	PUR	AF355	GA-2110	CHP
AF311	GA-86	HAS	AF329	GA-57	PRMT	AF344	GA-8047	FLG	AF355	GA-2110	CIGO
AF311	GA-2740	LUF	AF329	GA-57	TRUS	AF3441	GA-277	CAC	AF355	GA-2110	GRAN
AF312	GA-192	DEL	AF329	GA-57	WARN	AF3441	GA-277	FACE	AF355	GA-2110	LUF
AF312133-PU	GA-197R	GFF	AF3290	GA-373	PUR	AF3445	GA-3445	CAC	AF355	GA-2110	MIGH
AF3127	GAVW-2	PUR	AF-3290	GA-373	PUMX	AF3445	GA-3445	FLT	AF355	GA-2110	SECU
AF313	GA-2194	CSP	AF329088	GA-361	GFF	AF344M	GA-8047	FLG	AF355	GA-2110	WARN
AF3138	GA-54	FRML	AF3295	GA-229	PUR	AF346	GA-18	FLG	AF3558	GA-2110	PUR
AF3138	GA-54	PRMT	AF-3295	GA-229	PUMX	AF346	GA-26	FLG	AF3558	GA-2110	SERC
AF3138	GA-54	PUR	AF3298	GA-108	PUR	AF346093-PU	GA-853R	GFF	AF3558	GA-2110	SPEC
AF3138	GA-54	SERV	AF33	GA-2740	CSP	AF3463	GA-230	PUR	AF3559	GA-271	CAC
AF314	GA-78	DEL	AF330	GA-381	IAPC	AF3464	GA-77	PUR	AF3566	GA-3566	CAC
AF314	GA-21	FLG	AF330	GA-381	INTE	AF3465	GA-277	PRMT	AF3566	GA-3566	FLT
AF3142	GA-827	PUR	AF3300	GA-3300	CAC	AF3465	GA-277	CAC	AF-3566	GA-3566	PRET
AF3143	GA-826	PUR	AF3300	GA-3300	FACE	AF3465	GA-277	SERV	AF3575	GA-271	FACE
AF3146	GA-465	PUR	AF330120	GA-360	GFF	AF3466	GA-4828	PRMT	AF358	GA-180	BWS
AF3149	GA-3523	PRMT	AF330170-PU	GA-9334	GFF	AF3466	GA-4828	PUR	AF358	GA-180	CAM2
AF3149	GA-3523	PUR	AF330205	GA-7716	GFF	AF3466	GA-4828	SERV	AF358	GA-180	CHP
AF3149	GA-3523	SERV	AF3304	GA-109	PUR	AF3467	GA-4325	ECOL	AF358	GA-180	GRAN
AF3152	GAK-216	PUR	AF-3304	GA-109	PUMX	AF3467	GA-4325	MINL	AF358	GA-180	LEE
AF3153	GA-31	PUR	AF331	GA-29	FLG	AF3467	GA-4325	PRMT	AF358	GA-180	LUF
AF-3153	GA-31	PUMX	AF331117-B	GA-1286	GFF	AF3467	GA-4325	PUR	AF358	GA-180	MASE
AF316	GA-4365	CSP	AF3318	GA-493 ¹⁰⁸	PUR	AF3467	GA-4325	SERV	AF358	GA-180	PARP
AF317	GA-4325	CSP	AF3318	GA-680	PUR	AF3468	GA-2740	PUR	AF358	GA-180	SECU
AF318	GA-230	APOL	AF332	GA-325	ACE	AF346K	GA-26	FLG	AF358	GA-180	TRUS
AF318	GA-230	CAM2	AF332	GA-325	APOL	AF346KM	GA-26	FLG	AF358	GA-180	WARN
AF318	GA-230	CHP	AF332	GA-325	BWS	AF347	GA-429	CAC	AF3588	GA-3588	CAC
AF318	GA-230	GRAN	AF332	GA-325	CAM2	AF3472	GA-274	PRET	AF3588	GA-477	CHAM
AF318	GA-230	LUF	AF332	GA-325	CHP	AF3472	GA-274	PRMT	AF3588	GA-477	CHP
AF318	GA-230	MIGH	AF332	GA-325	ECOL	AF3472	GA-274	PUR	AF3588	GA-477	FSN
AF318	GA-230	SECU	AF332	GA-325	GRAN	AF3472	GA-274	SERV	AF3588	GA-477	LUF
AF318	GA-230	TRUS	AF332	GA-325	LEE	AF3473	GA-730	PUR	AF3588	GA-477	PARP
AF318	GA-230	WARN	AF332	GA-325	LUF	AF3474	GA-3681	PRMT	AF3588	GA-477	TIRP
AF3182	GA-55 ¹¹³	PUR	AF332	GA-325	MASE	AF3474	GA-3681	PUR	AF359	GA-139	BWS
AF3185	GA-251	PUR	AF332	GA-325	MIGH	AF3474	GA-3681	SERV	AF359	GA-139	CAM2
AF3192	GA-271	PRMT	AF332	GA-325	MINL	AF3475	GAD-1	PUR	AF359	GA-139	CHP
AF3192	GA-271	PUR	AF332	GA-325	PARP	AF348	GA-59	ACE	AF359	GA-7716	HAS
AF3192	GA-271	SERV	AF332	GA-325	PRMT	AF348	GA-59	APOL	AF359	GA-139	LEE
AF3193	GA-735 ²¹⁴	PRMT	AF332	GA-325	SECU	AF348	GA-59	BWS	AF359	GA-139	LUF
AF3193	GA-734 ⁸¹	PUR	AF332	GA-325	TRUS	AF348	GA-59	CHP	AF359	GA-139	PARP
AF3193	GA-735 ²¹⁴	PUR	AF332	GA-325	WARN	AF348	GA-59	ECOL	AF359	GA-139	SECU
AF3193	GA-735 ²¹⁴	SERV	AF3326	GA-3300	PUR	AF348	GA-59	GRAN	AF359	GA-139	TRUS
AF3195	GA-3588	PRMT	AF333	GA-375	FLG	AF348	GA-59	LEE	AF359	GA-139	WARN
AF3195	GA-3588	PUR	AF3338	GA-42	PUR	AF348	GA-59	LUF	AF3590	GA-490	CHP
AF3195	GA-3588	SERV	AF334	GA-4958	CHAM	AF348	GA-59	MASE	AF3590	GA-490	FSN
AF3197	GA-154	PUR	AF334	GA-9334	CHP	AF348	GA-59	MINL	AF3590	GA-490	LUF
AF3199	GA-70	PUR	AF3348	GA-251	PUR	AF348	GA-59	PRMT	AF3590	GA-490	PARP
AF32	GA-3588	CSP	AF335	GA-1286	CHP	AF348	GA-59	TRUS	AF3590	GA-3916	PRMT
AF320	GA-135	HAS	AF335	GA-9334	FLG	AF348	GA-59	WARN	AF3590	GA-3916	PUR
AF321	GA-219	LUF	AF335	GA-891	HAS	AF3490	GA-3490	CAC	AF3590	GA-3916	SERV
AF3210	GAD-3	PUR	AF335	GA-432	IAPC	AF3497	GA-75	CAC	AF3590	GA-490	TIRP
AF3212	GA-135	PUR	AF3352	GA-2122	PUR	AF3497	GA-75	FLT	AF3591	GA-3814	PRMT
AF3216	GA-138	PARP	AF3357	GA-3637	PRMT	AF35	GG-20	APCO	AF3591	GA-3814	PUR
AF3228	GA-209	PUR	AF3357	GA-3637	PUR	AF35	GAVW-2	CSP	AF3591	GA-3814	SERV
AF-3228	GA-209	PUMX	AF3357	GA-3637	SERV	AF35	GA-277	IAPC	AF3592	GA-273	MINL
AF3229	GA-210	PUR	AF3358	GA-3637	PUR	AF3501	GA-3501	CAC	AF3592	GA-273	PRMT
AF-3229	GA-210	PUMX	AF335M	GA-9334	FLG	AF350K	GA-20	FLG	AF3592	GA-273	PUR
AF323	GA-229	HAS	AF336	GA-9045	FLG	AF350K	GAK-20	FLG	AF3592	GA-273	SERV
AF3239	GA-77	PUR	AF336M	GA-9045	FLG	AF350KM	GAK-20	FLG	AF3593	GA-2124	LUF
AF324	GA-85	CAC	AF337	GA-1008	FLG	AF351	GA-195	BWS	AF3594	GA-367	CHP
AF324	GAD-15	CSP	AF3373	GAVW-2	CAC	AF351	GA-75	CAC	AF3594	GA-367	LUF

REFERENCIA CRUZADA

Para números Gonher con Superíndice vea página 651
For Gonher with Superscript numbers see page 651

Numero	Gonher	Fabricante	Numero	Gonher	Fabricante	Numero	Gonher	Fabricante	Numero	Gonher	Fabricante
Number	Gonher	Manufacturer	Number	Gonher	Manufacturer	Number	Gonher	Manufacturer	Number	Gonher	Manufacturer
AF3594	GA-367	PARP	AF3933	GAVW-616	CIGO	AF4046	GA-234	CHP	AF4300	GA-300	CSP
AF3595	GA-263	CHAM	AF3933	GAVW-616	LUF	AF4046	GA-234	LUF	AF430115	GA-398	GFF
AF3595	GA-5466	CHAM	AF3933	GAVW-616	MOB	AF4048	GA-248	LUF	AF4303	GA-4303	CAC
AF3595	GA-263	CHP	AF3933	GAVW-616	STP	AF405	GA-239	HAS	AF4309	GAD-15	CAC
AF3595	GA-5466	CHP	AF3936	GAVW-618	CAMP	AF405134	GA-206	GFF	AF431	GA-200	CSP
AF3595	GA-263	LUF	AF3936	GAVW-618	LUF	AF405153	GA-209	GFF	AF431	GA-218	CSP
AF3595	GA-263	PARP	AF394241	GA-1095	GFF	AF406	GA-3637	CSP	AF4313	GA-80 ¹¹³	PUR
AF3597	GA-735 ¹²⁴	CAC	AF395	GA-425	HAS	AF4060	GA-405	FLG	AF4314	GA-3501	PUR
AF36	GA-277	CSP	AF3955	GA-5056	LUF	AF4067	GA-49	FLG	AF4315	GA-3425	PUR
AF360	GA-7360	HAS	AF3956	GA-249	CAMP	AF407106-FN	GAK-625	GFF	AF432	GA-180	CSP
AF3621	GA-140	CAC	AF3956	GA-249	LUF	AF407170-PU	GA-9045	GFF	AF4322	GA-3647	PUR
AF3621	GA-140	FLT	AF3958	GA-606	LUF	AF408	GA-390	CHAM	AF4325	GA-4325	CAC
AF3637	GA-3637	CAC	AF3959	GA-380	CHP	AF408	GA-31	FLG	AF4326	GA-78	CHP
AF363K	GAK-216	HAS	AF3959	GA-380	CIGO	AF408M	GA-31	FLG	AF4326	GA-78	MINL
AF364	GA-135	FLG	AF3959	GA-380	LUF	AF409	GA-429	ACE	AF4326	GA-78	PRMT
AF364	GA-35	FLG	AF396	GA-426	HAS	AF409	GA-429	APOL	AF4326	GA-78	PUR
AF3647	GA-3647	CAC	AF3966	GA-646	CAMP	AF409	GA-429	BWS	AF4326	GA-78	SERV
AF3649	GA-390	CAC	AF3966	GA-646	LUF	AF409	GA-429	CAM2	AF4333	GA-392	MINL
AF3649	GA-390	FLT	AF3974	GA-596	CAMP	AF409	GA-429	CHP	AF4333	GA-392	PUR
AF365	GA-35	FLG	AF3974	GA-596	CIGO	AF409	GA-50	DEL	AF4333	GA-392	SERV
AF365	GA-416	HAS	AF3974	GA-596	FSN	AF409	GA-429	ECOL	AF4333	GA-392	SPEC
AF3681	GA-3681	CAC	AF3974	GA-596	LUF	AF409	GA-429	GRAN	AF4339	GA-3915	CHP
AF37	GA-274	CSP	AF3974	GA-596	PARP	AF409	GA-429	LUF	AF4339	GA-3915	MINL
AF3705	GA-154	CAC	AF398	GA-680	HAS	AF409	GA-429	MASE	AF4339	GA-3915	PRMT
AF3717	GA-274	CAC	AF3981	GA-328	CHAM	AF409	GA-429	MIGH	AF4339	GA-3915	PUR
AF376	GAD-30	BWS	AF3981	GA-328	CHP	AF409	GA-429	MINL	AF4339	GA-3915	SERV
AF376	GAD-30	CAM2	AF3981	GA-328	LUF	AF409	GA-429	SECU	AF4342	GA-253	CHP
AF376	GAD-30	CHP	AF399	GA-325	FLG	AF409	GA-429	TRUS	AF4342	GA-253	MINL
AF376	GAD-30	GRAM	AF3992	GA-383	CHAM	AF409	GA-429	WARN	AF4342	GA-253	PRMT
AF376	GAD-30	GRAN	AF3992	GA-383	LUF	AF409117	GA-1287	GFF	AF4342	GA-253	PUR
AF376	GAD-30	LUF	AF3997	GA-216	CAC	AF409K	GA-403	FLG	AF4342	GA-253	SERV
AF376	GAD-30	MASE	AF3997	GA-1546	CAMP	AF409K	GAK-403	FLG	AF4343	GA-5056	MINL
AF376	GAD-30	SECU	AF3999	GAVW-625	CHAM	AF409KM	GAK-403	FLG	AF4343	GA-5056	PRMT
AF376	GAD-30	WARN	AF3999	GAVW-625	CHP	AF41	GA-77	HAS	AF4343	GA-5056	PUR
AF3784	GA-230	CAC	AF3999	GAVW-625	LUF	AF410	GA-303	FLG	AF4343	GA-5056	SERV
AF3784	GA-230	FLG	AF4	GA-70	ACE	AF411	GA-3300	FLG	AF4347	GA-153	PRMT
AF379	GA-1284	CHP	AF4	GA-113	APC	AF411	GA-595	HAS	AF4347	GA-153	PUR
AF379	GA-1284	LUF	AF4	GA-70	APOL	AF411F	GA-595	FEDE	AF4347	GA-153	SERV
AF38	GA-178	CSP	AF4	GA-70	BWS	AF412	GA-2114	HAS	AF4349	GAVW-2	PUR
AF380	GA-70	DEL	AF4	GA-70	CAC	AF-412	GA-2114	ATL	AF435	GA-2193	HAS
AF380	GA-192	FLG	AF4	GA-70	CHP	AF4128	GAP-379	FLG	AF4356	GA-390	ECOL
AF381	GA-74	CAC	AF4	GA-70	GRAN	AF4139	GA-37	FLG	AF4356	GA-390	MINL
AF381	GA-44	FLG	AF4	GA-113	GUP	AF4148	GAK-625	FLG	AF4356	GA-390	PRMT
AF381	GA-74	PRET	AF4	GA-70	HAS	AF415	GA-142	BWS	AF4356	GA-390	PUR
AF381070-FN	GAK-1532	GFF	AF4	GA-70	LEE	AF415	GA-142	CAM2	AF4356	GA-390	SERC
AF381088	GA-891	GFF	AF4	GA-70	LUF	AF415	GA-142	CAMP	AF4356	GA-390	SERV
AF381132-PA	GAP-381	GFF	AF4	GA-70	MASE	AF415	GA-142	CHP	AF4357	GA-216	PUR
AF3814	GA-3814	CAC	AF4	GA-70	MINL	AF415	GA-142	GRAN	AF4357	GA-216	SERC
AF3814	GA-3814	MINL	AF4	GA-70	PARP	AF415	GA-142	LUF	AF435K	GA-33 ¹²²	FLG
AF3814	GA-3814	PRET	AF4	GA-70	PRMT	AF415	GA-142	MASE	AF435KM	GA-33 ¹²²	FLG
AF382	GA-3490	FLG	AF4	GA-70	SERV	AF415	GA-142	PARP	AF4361	GA-139	ECOL
AF382	GA-3490	LUF	AF4	GA-100	SRN	AF415	GA-142	SECU	AF4361	GA-139	MINL
AF382	GA-3490	MIGH	AF4	GA-70	TRUS	AF415	GA-142	TIRP	AF4361	GA-139	PRMT
AF383	GA-71	DEL	AF4	GA-70	WARN	AF415	GA-142	TRUS	AF4361	GA-139	PUR
AF383	GA-605	HAS	AF40	GAVW-2	IAPC	AF415	GA-142	WARN	AF4361	GA-139	SERV
AF383227-PU	GA-483	GFF	AF400	GA-59	FLG	AF416	GA-476	HAS	AF4361	GA-139	SERC
AF385150-PU	GA-930R	GFF	AF4003	GA-363	LUF	AF4160	GA-6128	FLG	AF4361	GA-139	SPEC
AF386	GAVW-120	BWS	AF4008	GA-340	CHAM	AF4164K	GAK-458	FLG	AF4365	GA-4365	CAC
AF386	GAVW-120	CAM2	AF4008	GA-340	CHP	AF4165	GA-459	FLG	AF4372	GA-3901	MINL
AF386	GAVW-120	CHP	AF4008	GA-340	FSN	AF417	GA-55	DEL	AF4372	GA-3901	PRMT
AF386	GA-21	FLG	AF4008	GA-340	LUF	AF417	GA-1616	HAS	AF4372	GA-3901	PUR
AF386	GAVW-120	GRAN	AF401	GA-57	FLG	AF417F	GA-1616	FEDE	AF4372	GA-3901	SERV
AF386	GA-230	HAS	AF4011	GA-492	CAMP	AF418	GA-360	FLG	AF4375	GA-362	ECOL
AF386	GAVW-120	LUF	AF4011	GA-492	LUF	AF418M	GA-360	FLG	AF4375	GA-362	MINL
AF386	GAVW-120	SECU	AF4012	GA-489	LUF	AF41CO	GA-77	FEDE	AF4375	GA-362	PRMT
AF386	GAVW-120	WARN	AF4015	GA-265	CAMP	AF41F	GA-77	FEDE	AF4375	GA-362	PUR
AF386196	GA-2984	GFF	AF4015	GA-265	LUF	AF42	GA-471	IAPC	AF4375	GA-362	SERV
AF387	GA-2198 ²⁹	HAS	AF4017	GA-464	CHAM	AF420	GA-7	CHP	AF4375	GA-362	SERC
AF387	GA-438 ³¹	HAS	AF4017	GA-464	CHP	AF422179	GA-357	GFF	AF4375	GA-362	SPEC
AF387177	GA-482	GFF	AF4017	GA-464	LUF	AF-4223E	GA-6128	PUMX	AF4378	GA-174	MINL
AF3873	GAVW-2	CAC	AF402	GA-730	FLG	AF423	GA-3916	CSP	AF4378	GA-174	PRMT
AF388	GA-3501	CHP	AF4022	GA-149	CAMP	AF424	GA-3814	CSP	AF4378	GA-174	PUR
AF388	GA-78	FLG	AF4022	GA-149	LUF	AF424	GA-106 ⁶⁶	FLG	AF4378	GA-174	SERV
AF388	GA-3501	LUF	AF4023	GAD-116	LUF	AF424	GA-326 ⁷¹	FLG	AF437K	GA-16	FLG
AF3895	GA-597	CAMP	AF4026	GA-143	CAMP	AF4244	GAD-3	CAC	AF437K	GAK-16	FLG
AF3895	GA-597	CIGO	AF4027	GA-341	CAMP	AF424M	GA-106 ⁶⁶	FLG	AF437KM	GA-16	FLG
AF3895	GA-597	FSN	AF4027	GA-341	LUF	AF424M	GA-326 ⁷¹	FLG	AF437KM	GAK-16	FLG
AF3895	GA-597	LUF	AF4029	GA-1529	CAMP	AF425	GA-273	CSP	AF438	GA-80 ¹¹³	CSP
AF3896	GAVW-619	LUF	AF403	GA-154	CSP	AF4278	GAD-15	ECOL	AF4383	GA-471	CAC
AF39	GA-74	CSP	AF403	GA-56	DEL	AF4278	GAD-15	MINL	AF439	GA-3501	CSP
AF390	GA-55	FLG	AF403	GA-85	FLG	AF4278	GAD-15	PRMT	AF439	GAVW-620	HAS
AF3901	GA-3901	CAC	AF4030	GA-1530	CAMP	AF4278	GAD-15	PUR	AF439F	GAVW-620	FEDE
AF3902	GA-253	CAC	AF4030	GA-1530	LUF	AF4278	GAD-15	SERV	AF44	GA-3566	CHAM
AF3904	GA-289	CHP	AF404	GA-129	BWS	AF4280	GA-616	PUR	AF44	GA-3566	CHP
AF3904	GA-289	LUF	AF404	GA-129	CAM2	AF4281	GA-398	PUR	AF44	GA-2106	IAPC
AF391	GA-132	HAS	AF404	GA-129	CHP	AF4282	GAD-30	PUR	AF440	GA-3425	CSP
AF391	GA-132	SHE	AF404	GA-129	GRAN	AF4282	GAD-30	SPEC	AF4409	GAVW-120	PUR
AF-391	GA-132	ATL	AF404	GA-329	HAS	AF4295	GA-200	PUR	AF4409	GAVW-120	SERV
AF3914	GA-392	CAC	AF404	GA-129	LUF	AF4295	GA-218	PUR	AF4409	GAVW-120	SPEC
AF3915	GA-3915	CAC	AF404	GA-129	MIGH	AF4295	GA-200	SPEC	AF441	GA-3501	HAS
AF3916	GA-3916	CAC	AF404	GA-129	SECU	AF4295	GA-218	SPEC	AF442	GA-3681	CSP
AF391F	GA-132	FEDE	AF404	GA-129	WARN	AF4299	GA-180	ECOL	AF4435	GA-3551 ⁵⁵	PUR
AF392	GA-90	FLG	AF4044	GA-193	LUF	AF4299	GA-180	PRMT	AF4435	GA-3551 XT ⁶⁴	PUR
AF3924	GA-153	CAC	AF4045	GA-171	CAMP	AF4299	GA-180	PUR	AF444	GA-78	CSP
AF393154	GA-108	GFF	AF4045	GA-171	LUF	AF4299	GA-180	SERV	AF444	GA-2984	HAS
AF3933	GAVW-616	CAMP	AF4046	GA-234	CHAM	AF43	GA-216	IAPC	AF444157	GA-6127	GFF

Referencia Cruzada por Numero de Parte

Cross Reference by Part Number



Numero	Gonher	Fabricante	Numero	Gonher	Fabricante	Numero	Gonher	Fabricante	Numero	Gonher	Fabricante
Number	Gonher	Manufacturer	Number	Gonher	Manufacturer	Number	Gonher	Manufacturer	Number	Gonher	Manufacturer
AF445	GA-240	HAS	AF4625	GA-2106	PUR	AF4722	GA-5466	PUR	AF4956	GA-139	FLG
AF-445	GA-240	ATL	AF4625	GA-2106	SERC	AF4722	GA-5466	SERC	AF4957	GA-4365	FLG
AF445F	GA-240	FEDE	AF4625	GA-2106	SPEC	AF4727	GA-300	MINL	AF4958	GA-4958	CAC
AF446	GA-392	CSP	AF4626	GA-6619	ECOL	AF4727	GA-300	PRMT	AF4959	GA-195	FLG
AF4463	GA-372	PUR	AF4626	GA-6620	ECOL	AF4727	GA-300	SERV	AF4960	GA-275	FLG
AF4468	GA-195	ECOL	AF4626	GA-6619	PUR	AF4727	GA-300	SPEC	AF4962	GA-6619 ¹	FLG
AF4468	GA-195	MINL	AF4626	GA-6620 ¹	PUR	AF472M	GA-6129	FLG	AF4962	GA-6620 ⁵	FLG
AF4468	GA-195	PRMT	AF4626	GA-6619 ¹	SERC	AF4731	GA-165	MINL	AF4963	GA-471	FLG
AF4468	GA-195	PUR	AF4626	GA-6620	SERC	AF4731	GA-165	PRMT	AF4965	GA-3901	FLG
AF4468	GA-195	SERC	AF4626	GA-6619 ¹	SERV	AF4731	GA-165	SERC	AF4967	GA-529	FLG
AF4468	GA-195	SPEC	AF4626	GA-6620	SERV	AF4731	GA-165	SERV	AF4969	GA-195	FLG
AF4471	GA-471	PRMT	AF4626	GA-6619 ¹	SPEC	AF4731	GA-165	SPEC	AF497	GA-9045	DEL
AF4471	GA-471	PUR	AF4626	GA-6620 ¹	SPEC	AF4736	GA-403	FLG	AF4975	GA-139	FLG
AF4471	GA-471	SERC	AF4629	GA-139	PUR	AF474	GAK-403	DEL	AF4976	GA-2106	FLG
AF4479	GA-6479	MINL	AF463	GA-127	HAS	AF474	GA-21	HAS	AF4977	GA-6690	FLG
AF4479	GA-6479	PRMT	AF463	GA-127	SHE	AF4747	GA-98 ¹¹²	CHP	AF4979	GAD-29	FLG
AF4479	GA-6479	PUR	AF-463	GA-127	ATL	AF475	GA-826	HAS	AF498	GA-1287	DEL
AF4479	GA-6479	SERV	AF463190	GA-467	GFF	AF4763	GAK-16	FLG	AF498	GAK-1532	HAS
AF4479	GA-6479	SPEC	AF463194	GA-6128	GFF	AF4764	GAK-16	FLG	AF499	GA-9334	DEL
AF4487	GA-382	MINL	AF4632	GA-275	ECOL	AF4765	GA-176	FLG	AF4995	GAVW-121	PRMT
AF4487	GA-382	PRMT	AF4632	GA-275	MINL	AF4766	GA-277	FLG	AF4995	GAVW-121	SERV
AF4487	GA-382	PUR	AF4632	GA-275	PRMT	AF477	GA-361	DEL	AF4ACO	GA-70	FEDE
AF4487	GA-382	SERC	AF4632	GA-275	PUR	AF4799	GA-381	PRMT	AF4F	GA-70	FEDE
AF4487	GA-382	SERV	AF4632	GA-275	SERV	AF4799	GA-381	SERC	AF5	GA-3445	IAPC
AF4487	GA-382	SPEC	AF4633	GA-3501	FLG	AF4799	GA-381	SERV	AF5	GA-37	PUR
AF449	GA-3915	CSP	AF4636	GA-329	FLG	AF48	GA-1285	CHP	AF50	GA-3445	CHAM
AF45	GA-77	CAC	AF463F	GA-127	FEDE	AF48	GA-382	IAPC	AF50	GA-85	CHP
AF45	GA-9045	CHP	AF4643	GA-166	PUR	AF480	GA-33 ¹¹²	DEL	AF50	GAD-15	IAPC
AF45	GA-4303	IAPC	AF4643	GA-166	SERV	AF4800K	GAK-1532	FLG	AF50	GA-85	MASE
AF45	GA-77	PRMT	AF4643	GA-166	SPEC	AF4801	GA-758	FLG	AF50	GA-37	PUR
AF45	GA-77	SERV	AF4645	GA-6690	PRMT	AF4807	GAD-129	SERV	AF50	GA-90	SERV
AF450	GA-253	CSP	AF4645	GA-6690	PUR	AF481	GA-128	HAS	AF-50	GA-37	PUMX
AF4503	GA-467	FLG	AF4645	GA-6690	SERC	AF4814K	GA-27	FLG	AF500	GAVW-2	HAS
AF4504M	GA-6128	FLG	AF4645	GA-6690	SPEC	AF4816	GA-360	FLG	AF500	GA-200	IAPC
AF4505	GA-467	FLG	AF4648	GA-133	MINL	AF4819	GA-141	PRMT	AF500	GA-218	IAPC
AF4506M	GA-6129	FLG	AF4648	GA-133	PRMT	AF4819	GA-141	SERV	AF500	GA-37	PUR
AF451	GA-5056	CSP	AF4648	GA-133	PUR	AF4819	GA-141	SPEC	AF500	GAVW-2	SHE
AF4512	GA-1285	FLG	AF4648	GA-133	SERV	AF481F	GA-128	FEDE	AF50050	GA-37	PUR
AF4513	GA-1286	FLG	AF4650	GA-604	PRMT	AF482	GA-589	HAS	AF500F	GAVW-2	FEDE
AF4514	GA-7360	FLG	AF4650	GA-604	PUR	AF4828	GA-4828	CAC	AF502	GA-2719B	HAS
AF4516	GA-1095	PUR	AF4650	GA-604	SERC	AF4828	GA-759	FLG	AF502	GA-271	IAPC
AF4521	GA-2194	CAC	AF4650	GA-604	SERV	AF4828	GA-4828	MINL	AF502F	GA-2719B	FEDE
AF4524	GA-730	FLG	AF4650	GA-604	SPEC	AF4828	GA-4828	PRET	AF5042	GA-442	PRMT
AF4526	GA-1287	FLG	AF4652	GA-276	PUR	AF483	GA-588	HAS	AF5042	GA-442	SERC
AF4527M	GA-372	FLG	AF4652	GA-276	SERV	AF4830	GA-180	CAC	AF5042	GA-442	SERV
AF4528M	GA-377	FLG	AF4653	GA-180	FLG	AF4831	GAD-118	PRMT	AF5042HD	GA-442	SERC
AF453	GA-153	CSP	AF4655	GA-7007	SERV	AF4831	GAD-118	SERC	AF5043	GAVW-620	SERV
AF4530	GA-694	PUR	AF4656	GA-7017	PRMT	AF4831	GAD-118	SERV	AF5047	GA-240	SERV
AF4533	GA-493 ¹⁰⁸	PUR	AF4656	GA-7017	PUR	AF4831	GAD-118	SPEC	AF5047	GA-240	SERV
AF454	GAVW-2	CSP	AF4656	GA-7017	SERC	AF4832	GA-432	PRMT	AF5048	GA-132	PRMT
AF4543	GA-377	FLG	AF4656	GA-7017	SERV	AF4832	GA-432	SERV	AF5048	GA-132	SERV
AF4545	GA-608	PUR	AF4656	GA-7017	SPEC	AF4838	GA-2198 ⁷⁹	SERC	AF5049	GA-595	PRMT
AF455	GA-56	CSP	AF4669	GAD-294	MINL	AF4838	GA-438 ³¹	SERC	AF5049	GA-595	SERV
AF4557K	GAK-16	FLG	AF4669	GAD-294	PRMT	AF484	GA-1615	HAS	AF5049	GA-595	SERV
AF4561	GA-101	FLG	AF4669	GAD-294	PUR	AF4844KM	GA-33 ¹¹²	FLG	AF5050	GA-605	SERC
AF4568	GA-18	FLG	AF4669	GAD-294	SERV	AF484F	GA-1615	FEDE	AF5056	GA-5056	CAC
AF457	GA-90	CSP	AF4669	GAD-294	SPEC	AF485	GA-2719B	FLG	AF5058	GA-273	CAC
AF457195	GA-6129	GFF	AF4675	GAD-117	PUR	AF4852	GA-392	PRMT	AF507196	GA-251	GFF
AF457240	GA-1203	GFF	AF4675	GAD-17	PUR	AF4852	GA-392	SERV	AF5076	GA-476	SERC
AF457241	GA-376	GFF	AF4675	GAD-117	SERV	AF4856	GA-3566	SERV	AF5077	GA-434	SERV
AF4574	GA-42	FLG	AF4675	GAD-17	SERV	AF4858	GA-127	PRMT	AF5089	GA-301	PRMT
AF4579	GA-119	FLG	AF4680	GA-386	MINL	AF4858	GA-127	SERV	AF5089	GA-301	SERC
AF458	GA-105	CSP	AF4680	GA-386	PRMT	AF4859	GA-128	SERV	AF5090	GA-673R	PRMT
AF458	GA-892	HAS	AF4680	GA-386	PUR	AF4871M	GA-376	FLG	AF5090	GA-673R	SERV
AF458240	GA-356	GFF	AF4680	GA-386	SERC	AF4873	GA-514	PRMT	AF5091	GA-732R	PRMT
AF4588M	GA-377	FLG	AF4680	GA-386	SERV	AF4873	GA-514	SERC	AF5091	GA-732R	SERV
AF459175-PU	GA-221R	GFF	AF4680	GA-386	SPEC	AF4873	GA-514	SERV	AF50A	GA-85	APOL
AF4592	GA-3916	FLG	AF469	GA-349	FLG	AF4877	GA-175	PRMT	AF50A	GA-85	BWS
AF4593	GA-273	FLG	AF469	GA-378	HAS	AF4877	GA-175	SERV	AF50A	GA-85	CHP
AF4595	GAD-3	FLG	AF4690	GA-322	PRMT	AF4878	GA-197R	FLG	AF50A	GA-85	CIGO
AF4596	GA-3566	FLG	AF4690	GA-322	PUR	AF4878	GA-1615	PRMT	AF50A	GA-85	GRAN
AF4597	GA-277	FLG	AF4690	GA-322	SERC	AF4878	GA-1615	SERV	AF50A	GA-85	LEE
AF4598	GA-4303	FLG	AF4690	GA-322	SERV	AF4879	GA-1616	SERV	AF50A	GA-85	LUF
AF46	GA-1287	CHP	AF4690	GA-322	SPEC	AF4880	GA-164	PRMT	AF50A	GA-85	MASE
AF46	GA-429	CSP	AF47	GA-8047	CHP	AF4880	GA-164	SERV	AF50A	GA-85	MINL
AF46	GAD-3	IAPC	AF47	GA-4303	CSP	AF488132	GA-405	GFF	AF50A	GA-85	PARP
AF460	GA-4365	CHP	AF470	GA-349	FLG	AF4888K	GAK-1532	FLG	AF50A	GA-85	PRMT
AF4600	GA-4828	FLG	AF470	GA-885	HAS	AF49	GA-75	CSP	AF50A	GA-85	SECU
AF4601	GA-274	FLG	AF470133-PU	GA-966R	GFF	AF490	GA-361	FLG	AF50A	GA-85	TRUS
AF4602	GA-153	FLG	AF4703	GA-206	FLG	AF4908	GA-682R	FLG	AF50A	GA-85	WARN
AF4604	GA-90	FLG	AF471	GA-6127	FLG	AF490K	GA-361	FLG	AF51	GAD-3	CSP
AF4610	GA-129	PUR	AF4712	GA-3814	FLG	AF490M	GA-361	FLG	AF51	GA-71	HAS
AF4610	GA-129	SERV	AF4712	GA-217	MINL	AF491	GA-75	FLG	AF51	G-133	KNE
AF4610	GA-129	SPEC	AF4712	GA-217	PRMT	AF492	GA-18	FLG	AF51	G-989	KNE
AF4613	GA-142	MINL	AF4712	GA-217	SERV	AF493	GA-26	DEL	AF51	GA-37	PUR
AF4613	GA-142	PRMT	AF4712	GA-217	SPEC	AF4937	GA-18	FLG	AF5105	GA-2114	SERC
AF4613	GA-142	PUR	AF4713	GA-467	FLG	AF4939	GA-139	CAC	AF5106	GA-2193	SERV
AF4613	GA-142	SERC	AF4715	GA-7142	PRMT	AF4941K	GAK-403	FLG	AF511	GA-2194	IAPC
AF4613	GA-142	SERV	AF4715	GA-7142	SERC	AF4944	GA-362	FLG	AF512	GA-37	DEL
AF4613	GA-142	SPEC	AF471M	GA-6127	FLG	AF4947	GA-139	FLG	AF513	GA-673R	HAS
AF4615	GAD-15	FLG	AF472	GA-6129	FLG	AF4949	GA-6479	FLG	AF513F	GA-673R	FEDE
AF4616	GAD-30	PUR	AF4720	GA-7344	PRMT	AF4950	GA-382	FLG	AF514	GA-7	DEL
AF4616	GAD-30	SERV	AF4720	GA-7344	SERV	AF4951	GA-390	FLG	AF514	GAK-625	HAS
AF4619	GA-5056	FLG	AF4721	GA-198	PRMT	AF4952	GA-4325	FLG	AF5148	GA-384	PRMT
AF4624	GA-174	FLG	AF4721	GA-198	SERV	AF4954	GA-386	FLG	AF5148	GA-384	SERC
AF4625	GA-2106	PRMT	AF4722	GA-5466	PRMT	AF4955	GA-253	FLG	AF5148	GA-384	SERV

REFERENCIA CRUZADA

Para números Gonher con Superíndice vea página 651
For Gonher with Superscript numbers see page 651

Numero	Gonher	Fabricante	Numero	Gonher	Fabricante	Numero	Gonher	Fabricante	Numero	Gonher	Fabricante
Number	Gonher	Manufacturer	Number	Gonher	Manufacturer	Number	Gonher	Manufacturer	Number	Gonher	Manufacturer
AF515	GA-39	DEL	AF545	GA-2106	LUF	AF600	GA-1286	DEL	AF6190	GA-6619 ⁵	UNN
AF5150	GA-172	PRMT	AF545	GA-2106	SECU	AF600	GA-4828	GRAN	AF6190	GA-6620 ⁵	UNN
AF5150	GA-172	SERV	AF545	GA-2106	TIRP	AF600	GA-4828	LEE	AF62	GA-390	IAPC
AF5155	GA-130	PRMT	AF545	GA-2106	WARN	AF600	GA-4828	LUF	AF6200	GA-3501	UNN
AF5155	GA-130	SERV	AF5462	GA-490	PRMT	AF600	GA-4828	MASE	AF6213	GA-300	UNN
AF518	GA-80	DEL	AF5462	GA-490	SERC	AF600	GA-4828	PARP	AF62163M	GA-624R	FLG
AF5191	GA-510	CHP	AF5463	GA-263	PRMT	AF600	GA-4828	TRUS	AF6221	GA-2110	UNN
AF5191	GA-510	FSN	AF5463	GA-263	SERC	AF600	GA-4828	WARN	AF6234	GA-153	UNN
AF5191	GA-510	LUF	AF5466	GA-5466	CAC	AF601	GA-735 ¹²⁴	APOL	AF6240	GAVVW-120	UNN
AF5191	GA-510	TIRP	AF5489	GA-158	PRMT	AF601	GA-735 ¹²⁴	BWS	AF6244	GA-195	UNN
AF5192	GA-158	PRMT	AF5489	GA-158	SERC	AF601	GA-734 ⁸¹	CHP	AF6246	GA-7017	UNN
AF5192	GA-158	SERV	AF55	G-871	KNE	AF601	GA-735 ¹²⁴	CHP	AF6255	GA-3501	UNN
AF51D	G-133	KNE	AF5505A	GAK-16	CHP	AF601	GA-735 ¹²⁴	ECOL	AF6273	GA-5466	UNN
AF51D	G-989	KNE	AF5521	GA-510	SERC	AF601	GA-735 ¹²⁴	GRAN	AF6279	GAD-30	UNN
AF52	GA-303	ACE	AF5528	GA-1617	PRMT	AF601	GA-735 ¹²⁴	LEE	AF6284	GAD-30	UNN
AF52	GA-303	APOL	AF5528	GA-1617	SERC	AF601	GA-734 ⁸¹	LUF	AF63	GA-4365	IAPC
AF52	GA-303	BWS	AF554153	GA-229	GFF	AF601	GA-735 ¹²⁴	LUF	AF6303	GA-514	UCAL
AF52	GA-71	CAC	AF5556	GA-415	PRMT	AF601	GA-735 ¹²⁴	MASE	AF6305	GA-390	CAC
AF52	GA-303	CHP	AF5556	GA-415	SERC	AF601	GA-735 ¹²⁴	MINL	AF6305	GA-390	FLT
AF52	GA-303	GRAN	AF5560	GA-289	PRMT	AF601	GA-735 ¹²⁴	PARP	AF-6326E	GA-371	PUMX
AF52	GA-303	HAS	AF557213	GA-378	GFF	AF601	GA-735 ¹²⁴	TRUS	AF6333	GA-382	CAC
AF52	GA-303	LEE	AF5578	GA-380	PRMT	AF601	GA-735 ¹²⁴	WARN	AF6333	GA-382	FLT
AF52	GA-303	LUF	AF5587	GA-476	LUF	AF6011	GAD-3	UNN	AF634	GA-49	HAS
AF52	GA-303	MAR	AF56	G-222	KNE	AF6017	GA-322	UCAL	AF6358	GA-384	UNN
AF52	GA-303	MASE	AF560170	GA-3551 ⁵⁵	GFF	AF602	GA-271	APOL	AF6362	GA-362	CAC
AF52	GA-303	MINL	AF560170	GA-3551 XT ⁵⁴	GFF	AF602	GA-271	BWS	AF6366	GA-174	CAC
AF52	GA-303	PARP	AF57	GA-80	CAC	AF602	GA-271	CHP	AF6376	GA-142	CAC
AF52	GA-303	PRMT	AF57	GA-80	PRMT	AF602	GA-271	ECOL	AF6395	GA-195	CAC
AF52	GA-71	SERV	AF57	GA-80	SERV	AF602	GA-271	GRAN	AF640	GA-3424	APOL
AF52	GA-303	TRUS	AF573	GA-44	DEL	AF602	GA-271	LEE	AF640	GA-3424	BWS
AF52	GA-303	WARN	AF574	GA-74	ACE	AF602	GA-271	LUF	AF640	GA-3424	CAM2
AF5207	GA-217	PRMT	AF574	GA-74	APOL	AF602	GA-271	MASE	AF640	GA-3424	CHP
AF5207	GA-217	SERC	AF574	GA-74	BWS	AF602	GA-271	MINL	AF640	GA-3424	ECOL
AF521	GA-142	CAMP	AF574	GA-74	CHP	AF602	GA-271	PARP	AF640	GA-3424	FACE
AF521	GA-142	CHP	AF574	GA-11	DEL	AF602	GA-271	TRUS	AF640	GA-3424	GRAN
AF521	GA-732R	HAS	AF574	GA-74	ECOL	AF602	GA-271	WARN	AF640	GA-3424	LEE
AF521	GA-142	MASE	AF574	GA-74	GRAN	AF6025	GAVVW-4	UNN	AF640	GA-3424	LUF
AF521	GA-142	SECU	AF574	GA-879	HAS	AF6026	GA-381	UCAL	AF640	GA-3424	MASE
AF5219	GA-244	PRMT	AF574	GA-74	LEE	AF6027	GAD-294	UNN	AF640	GA-3424	MIGH
AF5219	GA-244	SERC	AF574	GA-74	LUF	AF603	GA-6128	HAS	AF640	GA-3424	MINL
AF5219	GA-244	SERV	AF574	GA-74	MASE	AF604	GA-4325	BWS	AF640	GA-3424	PARP
AF5227	GA-279	PRMT	AF574	GA-74	MINL	AF604	GA-4325	CAM2	AF640	GA-3424	SECU
AF5227	GA-279	SERC	AF574	GA-74	PARP	AF604	GA-4325	CHP	AF640	GA-3424	TRUS
AF5227	GA-279	SERV	AF574	GA-74	TRUS	AF604	GA-4325	GRAN	AF640	GA-3424	WARN
AF5244	GA-607	PRMT	AF574	GA-74	WARN	AF604	GA-4325	LEE	AF641	GA-3425	APOL
AF5244	GA-607	SERC	AF578	GA-80	CAC	AF604	GA-4325	LUF	AF641	GA-3425	BWS
AF5248	GA-163	PRMT	AF58	GA-140	CHAM	AF604	GA-4325	MASE	AF641	GA-3425	CHP
AF5248	GA-163	SERV	AF58	GA-140	CHP	AF604	GA-4325	PARP	AF641	GA-3425	ECOL
AF5249	GA-170	SERV	AF580	GA-493 ¹⁰⁸	HAS	AF604	GA-4325	SECU	AF641	GA-3425	FACE
AF5265	GA-8606	PRMT	AF583	GA-372	HAS	AF604	GA-4325	TRUS	AF641	GA-3425	GRAN
AF5265	GA-8606	SERV	AF584	GA-3300	APOL	AF604	GA-4325	WARN	AF641	GA-3425	LUF
AF5267	GAVVW-621	SERV	AF584	GA-3300	BWS	AF6043	GA-139	UNN	AF641	GA-3425	MAR
AF527	GA-827	HAS	AF584	GA-3300	CHP	AF6051	GA-217	UNN	AF641	GA-3425	MASE
AF5272	GA-472	PRMT	AF584	GA-3300	ECOL	AF6061	GA-230	UNN	AF641	GA-3425	MINL
AF5272	GA-472	SERV	AF584	GA-3300	GRAN	AF6067	GA-1614	PRMT	AF641	GA-3425	PARP
AF5291	GA-780	PRMT	AF584	GA-3300	LEE	AF6067	GA-1614	SERC	AF641	GA-3425	PRMT
AF5291	GA-780	SERC	AF584	GA-3300	LUF	AF6067	GA-1614	SERV	AF641	GA-3425	SECU
AF52CO	GA-80	FEDE	AF584	GA-3300	MASE	AF6077	GA-3901	UNN	AF641	GA-3425	TRUS
AF52F	GA-80	FEDE	AF584	GA-3300	PARP	AF608	GA-209	HAS	AF641	GA-3425	WARN
AF5301	GA-479	PRMT	AF584	GA-3300	TRUS	AF609	GA-210	HAS	AF6416	GA-1616	UNN
AF5301	GA-479	SERC	AF584	GA-3300	WARN	AF609264	GA-563	GFF	AF6418	GA-1615	UNN
AF5305	GA-286	PRMT	AF5848	GA-2130	CIGO	AF6093	GA-275	UNN	AF6419	GA-1614	UNN
AF5305	GA-286	SERC	AF5848	GA-2130	WARN	AF6095	GAD-118	UNN	AF642	GA-2984	DEL
AF5306	GA-278R	PRMT	AF5858	GA-2146	CHP	AF6098	GA-432	UCAL	AF6425	GA-132	UNN
AF5306	GA-278R	SERC	AF5858	GA-2146	CIGO	AF610	GA-108	HAS	AF6520	GA-119	HAS
AF5314	GA-348	PRMT	AF5858	GA-2146	LUF	AF6108	GA-604	UCAL	AF6530	GA-589	REF
AF5314	GA-348	SERC	AF5858	GA-2146	MIGH	AF611	GA-3814	BWS	AF6531	GA-588	REF
AF532	GA-483	HAS	AF5858	GA-2146	WARN	AF611	GA-3814	CAM2	AF6545	GAVVW-120	CAC
AF5324	GA-168	PRMT	AF59	GA-100	ACE	AF611	GA-3814	CHP	AF655212	GA-608	GFF
AF5324	GA-168	SERC	AF59	GA-100	APOL	AF611	GA-3814	GRAN	AF6558	GA-2106	CAC
AF5330	GA-6479 ⁹⁰	PRMT	AF59	GA-100	BWS	AF611	GA-3814	LEE	AF658	GA-563	HAS
AF5352	GA-183	SERC	AF59	GA-50	CAC	AF611	GA-3814	LUF	AF660	GA-230	CAC
AF5378	GA-240	PRMT	AF59	GA-100	CENE	AF611	GA-3814	MASE	AF660	GA-230	FLT
AF538	GA-27	DEL	AF59	GA-100	CHP	AF611	GA-3814	PARP	AF660153	GA-493 ¹⁰⁸	GFF
AF5396	GA-248	PRMT	AF59	GA-100	GRAN	AF611	GA-3814	TRUS	AF6619	GA-6619 ⁵	CAC
AF5396	GA-248	SERC	AF59	GA-100	LUF	AF611	GA-3814	WARN	AF6619	GA-6620 ⁵	CAC
AF54	GA-3300	CHP	AF59	GA-100	MASE	AF6111	GA-4365	UNN	AF663	GA-4958	CIGO
AF54	GA-7	HAS	AF59	GA-100	MINL	AF611211	GA-371	GFF	AF663	GA-4958	GRAN
AF5400	GA-413R	PRMT	AF59	GA-100	PARP	AF6117	GA-165	UNN	AF663	GA-4958	LEE
AF5400	GA-413R	SERC	AF59	GA-50	PRMT	AF6118	GA-216	UNN	AF663	GA-4958	LUF
AF5414	GA-477	PRMT	AF59	GA-50	SERV	AF6119	GA-471	UNN	AF663	GA-4958	WARN
AF5414	GA-477	SERC	AF59	GA-100	TRUS	AF612	GA-85	CHP	AF-663	GA-4958	MASE
AF5418	GA-395	PRMT	AF59	GA-100	WARN	AF613	GA-86	CHP	AF664	GA-78	SECU
AF5418	GA-395	SERC	AF593	GA-21	DEL	AF6135	GA-2194	UNN	AF6641	GA-6127	CHP
AF5431	GA-367	SERC	AF594	GA-107	HAS	AF6144	GA-392	UNN	AF665	GA-390	BWS
AF5432	GA-264	PRMT	AF595	GA-50	CHP	AF6148	GA-2106	UNN	AF665	GA-390	CAM2
AF5432	GA-264	SERC	AF595	GA-109	HAS	AF6150	GA-129	UNN	AF665	GA-390	CAMP
AF5433	GA-414R	PRMT	AF596	GA-1284	DEL	AF6153	GA-6479	UNN	AF665	GA-390	CHP
AF5433	GA-414R	SERC	AF597	GA-1008	DEL	AF6158	GA-382	UCAL	AF665	GA-390	GRAN
AF5446	GA-780	PRMT	AF598	GA-1285	DEL	AF6158	GA-382	UNN	AF665	GA-390	LEE
AF5446	GA-780	SERC	AF599	GA-8047	DEL	AF6162	GA-6690	UNN	AF665	GA-390	LUF
AF545	GA-2106	BWS	AF60	GA-140	IAPC	AF6170	GA-276	UNN	AF665	GA-390	MASE
AF545	GA-2106	CAM2	AF600	GA-4828	APOL	AF6180	GA-253	UNN	AF665	GA-390	SECU
AF545	GA-2106	CHP	AF600	GA-4828	BWS	AF6186	GA-142	UCAL	AF665	GA-390	TIRP
AF545	GA-5648	DEL	AF600	GA-4828	CAM2	AF6186	GA-142	UNN	AF665	GA-390	WARN
AF545	GA-2106	GRAN	AF600	GA-4828	CHP	AF619	GA-373	HAS	AF666	GA-251	HAS

Referencia Cruzada por Numero de Parte

Cross Reference by Part Number



Numero	Gonher	Fabricante	Numero	Gonher	Fabricante	Numero	Gonher	Fabricante	Numero	Gonher	Fabricante
Number	Gonher	Manufacturer	Number	Gonher	Manufacturer	Number	Gonher	Manufacturer	Number	Gonher	Manufacturer
AF6664	GA-166	CAC	AF735	GA-54	GRAN	AF7800	GA-166	CHP	AF7837	GA-166	GRAN
AF668	GA-509 ¹⁴	HAS	AF735	GA-54	LEE	AF7800	GA-166	GRAN	AF7837	GA-166	LUF
AF669	GA-85	DEL	AF735	GA-54	LUF	AF7800	GA-166	LUF	AF7837	GA-166	SECU
AF6690	GA-690	CAC	AF735	GA-54	MASE	AF7800	GA-166	SECU	AF7841	GA-6880	DEL
AF67	GA-192	CAC	AF735	GA-54	MINL	AF7800	GA-166	WARN	AF7841	GA-322	BWS
AF67	GA-192	PRMT	AF735	GA-54	PARP	AF781	GA-154	CAM2	AF7841	GA-322	CAM2
AF67	GA-192	SERV	AF735	GA-54	TRUS	AF781	GA-154	CHP	AF7841	GA-322	CAMP
AF670	GA-86	DEL	AF735	GA-54	WARN	AF781	GA-154	GRAN	AF7841	GA-322	CHP
AF671	GA-3424	DEL	AF7351	GA-322	CAC	AF781	GA-154	LUF	AF7841	GA-322	GRAN
AF672	GA-3425	DEL	AF7351	GA-322	FLT	AF781	GA-154	MIGH	AF7841	GA-322	LEE
AF6723	GA-398	REF	AF735C	GA-54	CAC	AF781	GA-154	SECU	AF7841	GA-322	LUF
AF673	GAP-381	HAS	AF736	GA-3523	APOL	AF781	GA-154	WARN	AF7841	GA-322	MASE
AF676	GA-826	DEL	AF736	GA-3523	BWS	AF7816	GA-6690	BWS	AF7841	GA-322	PARP
AF6769	GA-106 ¹⁶	CHP	AF736	GA-3523	CHP	AF7816	GA-6690	CAM2	AF7841	GA-322	TRUS
AF6769	GA-326 ⁷¹	CHP	AF736	GA-31	DEL	AF7816	GA-6690	CHP	AF7841	GA-322	SECU
AF677	GA-827	DEL	AF736	GA-3523	ECOL	AF7816	GA-6690	GRAN	AF7841	GA-322	WARN
AF68	GA-78	CAC	AF736	GA-3523	FACE	AF7816	GA-6690	LEE	AF7842	GA-381	CAMP
AF68	GA-78	SERV	AF736	GA-3523	GRAN	AF7816	GA-6690	PARP	AF7842	GA-381	GRAN
AF6807	GA-386	CAC	AF736	GA-3523	LEE	AF7816	GA-6690	SECU	AF7842	GA-381	LUF
AF6807	GA-386	FLT	AF736	GA-3523	LUF	AF7816	GA-6690	TRUS	AF7842	GA-381	PARP
AF-681	GA-398	DEL	AF736	GA-3523	MASE	AF7816	GA-6690	WARN	AF7842	GA-381	TRUS
AF6820	GA-215	CAC	AF736	GA-3523	MINL	AF7816	GA-6690	WARN	AF7842	GA-381	TRUS
AF6824	GA-2106	CAC	AF736	GA-3523	PARP	AF7821	GA-276	CAM2	AF7842	GA-381	WARN
AF6834	GA-361	CHP	AF736	GA-3523	TRUS	AF7821	GA-276	CHP	AF7842	GA-381	WARN
AF6840	GA-389	REF	AF736	GA-3523	WARN	AF7821	GA-276	GRAN	AF7842	GA-381	WARN
AF6850	GAD-294	CAC	AF7360	GA-7360	CHP	AF7821	GA-276	LUF	AF7842	GA-381	WARN
AF6860	GA-371	REF	AF7365	GA-217	CAC	AF7821	GA-276	MIGH	AF7842	GA-381	WARN
AF687	GA-356	DEL	AF737	GA-6129	DEL	AF7821	GA-276	SECU	AF7842	GA-381	WARN
AF687	GA-759	HAS	AF738	GA-6127	DEL	AF7821	GA-276	WARN	AF7842	GA-381	WARN
AF6876	GA-694	REF	AF74	GA-55	CAC	AF7822	GA-1616	TRUS	AF7842	GA-381	WARN
AF6883	GA-351 ⁵⁵	REF	AF74	GAD-117	CHP	AF7823	GAD-117	CAM2	AF7842	GA-381	WARN
AF6883	GA-351 ⁵⁵	REF	AF74	GA-86	MASE	AF7823	GAD-17	CAM2	AF7842	GA-381	WARN
AF6900	GAD-117	CAC	AF74	GA-55	PRMT	AF7823	GAD-117	CHP	AF7842	GA-381	WARN
AF6900	GAD-117	CAC	AF74	GA-55	SERC	AF7823	GAD-117	CHP	AF7842	GA-381	WARN
AF695	GA-18	DEL	AF74	GA-55	SERV	AF7823	GAD-117	GRAN	AF7842	GA-381	WARN
AF7	GA-4303	PRMT	AF7421	GA-165	CAC	AF7823	GAD-17	GRAN	AF7842	GA-381	WARN
AF70	GA-4303	PUR	AF7426	GA-432	CAC	AF7823	GAD-117	LUF	AF7842	GA-381	WARN
AF70	GA-4303	SERV	AF743	GA-589	DEL	AF7823	GAD-17	LUF	AF7842	GA-381	WARN
AF700	GA-371	HAS	AF7432	GA-132	SERV	AF7823	GAD-117	SECU	AF7842	GA-381	WARN
AF7007	GA-7007	CAC	AF7440	GA-300	CAC	AF7823	GAD-17	SECU	AF7842	GA-381	WARN
AF701	GA-616	HAS	AF745	GA-588	DEL	AF7823	GAD-117	WARN	AF7842	GA-381	WARN
AF7017	GA-7017	CAC	AF746	GA-12	DEL	AF7823	GAD-17	WARN	AF7842	GA-381	WARN
AF7033	GA-241	CAMP	AF746	GA-422	HAS	AF7825	GAD-294	CAM2	AF7842	GA-381	WARN
AF7033	GA-241	CIGO	AF749	GA-4303	PRET	AF7825	GAD-294	CHP	AF7842	GA-381	WARN
AF7033	GA-241	LUF	AF74A	GA-86	APOL	AF7825	GAD-294	GRAN	AF7842	GA-381	WARN
AF7033	GA-241	MOB	AF74A	GA-86	BWS	AF7825	GAD-294	LUF	AF7842	GA-381	WARN
AF7033	GA-241	SERC	AF74A	GA-86	CAM2	AF7825	GAD-294	PARP	AF7842	GA-381	WARN
AF7033	GA-241	STP	AF74A	GA-86	CHP	AF7825	GAD-294	SECU	AF7842	GA-381	WARN
AF7039	GAVV-622	SERV	AF74A	GA-86	GRAN	AF7825	GAD-294	TRUS	AF7842	GA-381	WARN
AF704	GAD-30	HAS	AF74A	GA-86	LEE	AF7825	GAD-294	WARN	AF7842	GA-381	WARN
AF7094	GA-604	CAC	AF74A	GA-86	LUF	AF7826	GA-133	CHP	AF7842	GA-381	WARN
AF7094	GA-604	FLT	AF74A	GA-86	MASE	AF7826	GA-133	GRAN	AF7842	GA-381	WARN
AF712132	GA-372	GFF	AF74A	GA-86	MINL	AF7826	GA-133	LEE	AF7842	GA-381	WARN
AF7142	GA-7142	CAC	AF74A	GA-86	PARP	AF7826	GA-133	LUF	AF7842	GA-381	WARN
AF7174	GA-381	CAC	AF74A	GA-86	SECU	AF7826	GA-133	PARP	AF7842	GA-381	WARN
AF7174	GA-381	FLT	AF74A	GA-86	TRUS	AF7826	GA-133	TRUS	AF7842	GA-381	WARN
AF718	GA-642	HAS	AF74A	GA-86	WARN	AF7826	GA-133	WARN	AF7842	GA-381	WARN
AF72	GA-44	HAS	AF751	GA-891	DEL	AF7828	GA-386	CAM2	AF7842	GA-381	WARN
AF723	GA-398	HAS	AF753	GA-89	APOL	AF7828	GA-386	CAMP	AF7842	GA-381	WARN
AF724	GA-375	DEL	AF753	GA-89	BWS	AF7828	GA-386	CHAM	AF7842	GA-381	WARN
AF724	GA-3501	HAS	AF753	GA-89	CHP	AF7828	GA-386	CHP	AF7842	GA-381	WARN
AF724CO	GA-3501	FEDE	AF753	GA-89	ECOL	AF7828	GA-386	GRAN	AF7842	GA-381	WARN
AF724F	GA-3501	FEDE	AF753	GA-89	GRAN	AF7828	GA-386	LEE	AF7842	GA-381	WARN
AF728	GA-3637	APOL	AF753	GA-89	LEE	AF7828	GA-386	LUF	AF7842	GA-381	WARN
AF728	GA-3637	BWS	AF753	GA-89	LUF	AF7828	GA-386	PARP	AF7842	GA-381	WARN
AF728	GA-3637	CAM2	AF753	GA-89	MASE	AF7828	GA-386	SECU	AF7842	GA-381	WARN
AF728	GA-3637	CHP	AF753	GA-89	MINL	AF7828	GA-386	TRUS	AF7842	GA-381	WARN
AF728	GA-3637	GRAN	AF753	GA-89	PARP	AF7828	GA-386	WARN	AF7842	GA-381	WARN
AF728	GA-3637	LUF	AF753	GA-89	SECU	AF7829	GA-2106	CAM2	AF7842	GA-381	WARN
AF728	GA-3637	MASE	AF753	GA-89	TRUS	AF7829	GA-2106	CHP	AF7842	GA-381	WARN
AF728	GA-3637	MIGH	AF753	GA-89	WARN	AF7829	GA-2106	LUF	AF7842	GA-381	WARN
AF728	GA-3637	PARP	AF7597	GA-164	CAC	AF7829	GA-2106	SECU	AF7842	GA-381	WARN
AF728	GA-3637	TRUS	AF76	GAVV-120	IAPC	AF7831	GAD-129	CHP	AF7842	GA-381	WARN
AF728	GA-3637	WARN	AF763	GA-206	DEL	AF7831	GAD-129	LUF	AF7842	GA-381	WARN
AF73	GA-101	APOL	AF767	GA-42	HAS	AF7831	GAD-129	SECU	AF7842	GA-381	WARN
AF73	GA-101	BWS	AF77	GA-192	HAS	AF7831	GAD-129	WARN	AF7842	GA-381	WARN
AF73	GA-101	CENE	AF770	GA-6	HAS	AF7833	GA-7142	CAM2	AF7842	GA-381	WARN
AF73	GA-101	CHP	AF773	GA-3588	APOL	AF7833	GA-7142	CHP	AF7842	GA-381	WARN
AF73	GA-101	GRAN	AF773	GA-3588	BWS	AF7833	GA-7142	CIGO	AF7842	GA-381	WARN
AF73	GA-386	IAPC	AF773	GA-3588	CHP	AF7833	GA-7142	GRAN	AF7842	GA-381	WARN
AF73	GA-101	LUF	AF773	GA-3588	ECOL	AF7833	GA-7142	LUF	AF7842	GA-381	WARN
AF73	GA-101	MINL	AF773	GA-3588	FACE	AF7833	GA-7142	MASE	AF7842	GA-381	WARN
AF73	GA-101	PARP	AF773	GA-3588	GRAN	AF7833	GA-7142	SECU	AF7842	GA-381	WARN
AF73	GA-101	TRUS	AF773	GA-3588	LEE	AF7833	GA-7142	WARN	AF7842	GA-381	WARN
AF73	GA-101	WARN	AF773	GA-3588	LUF	AF7836	GA-604	CAM2	AF7842	GA-381	WARN
AF731	GA-1203	DEL	AF773	GA-3588	MASE	AF7836	GA-604	CAMP	AF7842	GA-381	WARN
AF732	GA-135	DEL	AF773	GA-3588	MINL	AF7836	GA-604	CHP	AF7842	GA-381	WARN
AF7337	GA-2184	CAC	AF773	GA-3588	TRUS	AF7836	GA-604	GRAN	AF7842	GA-381	WARN
AF734	GA-482	HAS	AF773	GA-3588	WARN	AF7836	GA-604	LEE	AF7842	GA-381	WARN
AF7344	GA-7344	CAC	AF775	GA-679	DEL	AF7836	GA-604	LUF	AF7842	GA-381	WARN
AF7344	GA-7344	FLT	AF776	GA-680	DEL	AF7836	GA-604	PARP	AF7842	GA-381	WARN
AF735	GA-54	APOL	AF777	GA-425	DEL	AF7836	GA-604	SECU	AF7842	GA-381	WARN
AF735	GA-54	BWS	AF778	GA-426	DEL	AF7836	GA-604	TRUS	AF7842	GA-381	WARN
AF735	GA-54	CHP	AF77CO	GA-192	FEDE	AF7836	GA-604	WARN	AF7842	GA-381	WARN
AF735	GA-54	ECOL	AF77F	GA-192	FEDE	AF7837	GA-166	CAM2	AF7842	GA-381	WARN
AF735	GA-54	FACE	AF7800	GA-166	CAM2	AF7837	GA-166	CHP	AF7842	GA-381	WARN

REFERENCIA CRUZADA

Para números Gonher con Superíndice vea página 651
For Gonher with Superscript numbers see page 651

Numero	Gonher	Fabricante	Numero	Gonher	Fabricante	Numero	Gonher	Fabricante	Numero	Gonher	Fabricante
Number	Gonher	Manufacturer	Number	Gonher	Manufacturer	Number	Gonher	Manufacturer	Number	Gonher	Manufacturer
AF7862	GA-141	WARN	AF7885	GA-2114	WARN	AF7958	GA-183	CIGO	AF8188	GA-98 ¹¹²	FLG
AF7863	GA-165	BWS	AF7886	GA-2184	CHAM	AF7958	GA-183	LUF	AF8191	GA-2193	CHAM
AF7863	GA-165	CAM2	AF7886	GA-2184	CIGO	AF7958	GA-183	PARP	AF8191	GA-2193	CIGO
AF7863	GA-165	CHP	AF7886	GA-2184	DEUS	AF7958	GA-183	WARN	AF8191	GA-2193	LUF
AF7863	GA-165	GRAN	AF7886	GA-2184	GRAN	AF7959	GA-491	CAMP	AF8191	GA-2193	WARN
AF7863	GA-165	LEE	AF7886	GA-2184	LUF	AF7959	GA-491	CIGO	AF82	GG-4	APCO
AF7863	GA-165 ¹¹³	LUF	AF7886	GA-2184	MIGH	AF7959	GA-491	WARN	AF82	GG-4	APCO
AF7863	GA-165 ¹¹³	PARP	AF7886	GA-2184	WARN	AF796	GA-403	DEL	AF82	GA-11	HAS
AF7863	GA-165	SECU	AF7888	GA-2195	CHAM	AF7963	GA-145	CIGO	AF820	GA-4303	HAS
AF7863	GA-165	TRUS	AF7888	GA-2195	CIGO	AF7964	GA-364	CHAM	AF820CO	GA-4303	FEDE
AF7863	GA-165	WARN	AF7888	GA-2195	LUF	AF7964	GA-364	CIGO	AF820F	GA-4303	FEDE
AF7864	GA-198	CHP	AF7888	GA-2195	WARN	AF7964	GA-364	LUF	AF820M	GA-206	FLG
AF7864	GA-198	LUF	AF7892	GA-5466	CHP	AF7964	GA-364	PARP	AF821	GA-86	DEL
AF7864	GA-198	PARP	AF7892	GA-5466	GRAN	AF7964	GA-364	WARN	AF8221	GA-279	CAC
AF7864	GA-198	TRUS	AF7892	GA-5466	LUF	AF7971	GA-2195	MIGH	AF823	GA-349	DEL
AF7864	GA-198	WARN	AF7892	GA-5466	PARP	AF7972	GA-2179	LUF	AF824	GA-390	CIGO
AF7872	GA-164	BWS	AF7892	GA-5466	WARN	AF7974	GA-216	LUF	AF824	GA-390	GRAN
AF7872	GA-164	CAM2	AF7893	GA-595	CHP	AF7975	GA-258	CIGO	AF824	GA-390	LUF
AF7872	GA-164	CHP	AF7893	GA-595	CIGO	AF7975	GA-258	LUF	AF824	GA-390	MIGH
AF7872	GA-164	GRAN	AF7893	GA-595	GRAN	AF7975	GA-258	PARP	AF824	GA-390	WARN
AF7872	GA-164	LEE	AF7893	GA-595	LUF	AF7975	GA-258	WARN	AF824	GA-390	MASE
AF7872	GA-164	LUF	AF7893	GA-595	SECU	AF7981	GA-183R	CAMP	AF8243	GA-158	CAC
AF7872	GA-164	PARP	AF7893	GA-595	TIRP	AF7981	GA-183R	CHP	AF825	GA-75	DEL
AF7872	GA-164	SECU	AF7893	GA-595	WARN	AF7981	GA-183R	LUF	AF825	GAVV-4	HAS
AF7872	GA-164	TRUS	AF79	GA-5648	HAS	AF7981	GA-183R	PARP	AF826	GA-3681	APOL
AF7872	GA-164	WARN	AF790	GA-694	HAS	AF7981	GA-183R	WARN	AF826	GA-3681	BWS
AF7874	GA-175	BWS	AF7906	GA-2198 ⁷⁹	CHP	AF7984	GA-248	CHP	AF826	GA-3681	CHP
AF7874	GA-175	CAM2	AF7906	GA-438 ³¹	CHP	AF7984	GA-248	FSN	AF826	GA-3681	ECOL
AF7874	GA-175	CHP	AF7906	GA-2198 ⁷⁹	CIGO	AF7984	GA-248	LUF	AF826	GA-29	FLG
AF7874	GA-175	GRAN	AF7906	GA-438 ³¹	CIGO	AF7984	GA-248	MIGH	AF826	GA-3681	GRAN
AF7874	GA-175	LUF	AF7906	GA-2198 ⁷⁹	LUF	AF7984	GA-248	PARP	AF826	GA-3588	HAS
AF7874	GA-175	SECU	AF7906	GA-438 ³¹	LUF	AF7984	GA-248	TIRP	AF826	GA-3681	LEE
AF7874	GA-175	WARN	AF7906	GA-2198 ⁷⁹	WARN	AF7984	GA-248	WARN	AF826	GA-3681	LUF
AF7874	GA-175	WARN	AF7906	GA-438 ³¹	WARN	AF7985	GA-305	CAMP	AF826	GA-3681	MASE
AF7876	GA-605	CHP	AF7908	GA-384	CAMP	AF7985	GA-305	CIGO	AF826	GA-3681	MINL
AF7876	GA-605	CIGO	AF7908	GA-384	CHP	AF7985	GA-305	MOB	AF826	GA-3681	PARP
AF7876	GA-605	GRAN	AF7908	GA-384	LUF	AF7987	GA-2198 ⁷⁹	LUF	AF826	GA-3681	SECU
AF7876	GA-605	LUF	AF7908	GA-384	PARP	AF7987	GA-438 ³¹	LUF	AF826	GA-3681	TRUS
AF7876	GA-605	SECU	AF7908	GA-384	WARN	AF7989	GA-2146	LUF	AF826	GA-3681	WARN
AF7876	GA-605	WARN	AF7909	GA-476	CHP	AF7990	GA-194	CHAM	AF826F	GA-2118	CIGO
AF7877	GA-3901	BWS	AF7909	GA-476	CIGO	AF7990	GA-194	CHP	AF826F	GA-2118	DEUS
AF7877	GA-3901	CAM2	AF7909	GA-476	LUF	AF7990	GA-194	LUF	AF826F	GA-2118	LUF
AF7877	GA-3901	CHP	AF7909	GA-476	WARN	AF7990	GA-194	WARN	AF826F	GA-2118	WARN
AF7877	GA-3901	GRAN	AF7910	GA-301	CHP	AF7991	GA-293	CHAM	AF826CO	GA-3588	FEDE
AF7877	GA-3901	LEE	AF7910	GA-301	CIGO	AF7991	GA-293	PARP	AF826F	GA-3588	FEDE
AF7877	GA-283	LUF	AF7910	GA-301	LUF	AF7991	GA-293	WARN	AF827	GA-735 ¹²⁴	HAS
AF7877	GA-3901	LUF	AF7910	GA-301	PARP	AF7993	GA-2106	CHAM	AF827F	GA-735 ¹²⁴	FEDE
AF7877	GA-3901	PARP	AF7910	GA-301	TIRP	AF7993	GA-2106	CIGO	AF828	GA-89	HAS
AF7877	GA-3901	SECU	AF7910	GA-301	WARN	AF7993	GA-2106	WARN	AF828CO	GA-89	FEDE
AF7877	GA-3901	TRUS	AF7911	GA-244	CHP	AF7996	GA-413R	CHP	AF828F	GA-89	FEDE
AF7878	GA-240	CHP	AF7911	GA-244	CIGO	AF7996	GA-413R	CIGO	AF829	GA-403	FLG
AF7878	GA-240	GRAN	AF7911	GA-244	LUF	AF7996	GA-413R	LUF	AF83	GA-85	SERV
AF7878	GA-240	LUF	AF7911	GA-244	PARP	AF7996	GA-413R	WARN	AF83-1	GA-85	PRMT
AF7878	GA-240	PARP	AF7911	GA-244	WARN	AF8	GA-135	PUR	AF832	GA-680	DEL
AF7878	GA-240	SECU	AF7913	GA-172	CHP	AF-8	GA-35	PUMX	AF833	GA-679	DEL
AF7878	GA-240	TIRP	AF7913	GA-172	LUF	AF800	GA-3424	HAS	AF833	GA-140	HAS
AF7878	GA-240	WARN	AF7913	GA-172	WARN	AF801	GA-3425	HAS	AF834	GA-229	DEL
AF7879	GA-132	BWS	AF7914	GA-607	CHP	AF801CO	GA-3425	FEDE	AF834	GA-3566	HAS
AF7879	GA-132	CAM2	AF7914	GA-607	CIGO	AF801F	GA-3425	FEDE	AF835	GA-106 ⁹	DEL
AF7879	GA-132	CHP	AF7914	GA-607	LUF	AF802	GA-287	FLG	AF835	GA-326 ¹	DEL
AF7879	GA-132	GRAN	AF7914	GA-607	WARN	AF802	GA-75	HAS	AF836	GA-360	DEL
AF7879	GA-132	LUF	AF7917	GA-8606	TRUS	AF803	GA-77	DEL	AF836	GA-4365	HAS
AF7879	GA-132	PARP	AF7919	GA-163	CHP	AF803	GAD-1	HAS	AF838	GA-3647	HAS
AF7879	GA-132	SECU	AF7919	GA-163	LUF	AF8039	GA-1615	CAC	AF838CO	GA-3647	FEDE
AF7879	GA-132	TRUS	AF7919	GA-163	WARN	AF803CO	GAD-1	FEDE	AF838F	GA-3647	FEDE
AF7879	GA-132	WARN	AF7920	GA-170	CHP	AF803F	GAD-1	FEDE	AF839	GA-154	HAS
AF7880	GA-514	CAM2	AF7920	GA-170	LUF	AF804	GA-90	DEL	AF84	GA-730	CAC
AF7880	GA-514	CAMP	AF7920	GA-170	WARN	AF8047	GA-8047	PUR	AF84	GA-730	PRMT
AF7880	GA-514	CHP	AF7935	GAVV-621	CHP	AF-8047	GA-8047	PUMX	AF84	GA-730	SERV
AF7880	GA-514	GRAN	AF7935	GAVV-621	CIGO	AF805	GA-277	HAS	AF840	GA-429	DEL
AF7880	GA-514	LEE	AF7935	GAVV-621	LUF	AF805CO	GA-277	FEDE	AF840	GA-3637	HAS
AF7880	GA-514	LUF	AF7935	GAVV-621	PARP	AF805F	GA-277	FEDE	AF841	GA-3681	HAS
AF7880	GA-514	PARP	AF7935	GAVV-621	TRUS	AF806	GA-3490	HAS	AF841CO	GA-3681	FEDE
AF7880	GA-514	SECU	AF7935	GAVV-621	WARN	AF8069	GA-244	CAC	AF841F	GA-3681	FEDE
AF7880	GA-514	TRUS	AF7938	GA-286	CHP	AF807	GA-2740	HAS	AF842	GA-74	DEL
AF7880	GA-514	WARN	AF7938	GA-286	LUF	AF807CO	GA-2740	FEDE	AF842	GA-271	HAS
AF7881	GA-434	CAMP	AF7938	GA-286	PARP	AF807F	GA-2740	FEDE	AF842CO	GA-271	FEDE
AF7881	GA-434	CIGO	AF7938	GA-286	TIRP	AF807K	GAK-16	FLG	AF842F	GA-271	FEDE
AF7881	GA-434	GRAN	AF7938	GA-286	WARN	AF809	GA-85	DEL	AF843	GA-7	FLG
AF7881	GA-434	LUF	AF7941	GA-2175	CHAM	AF81	GG-5 L	APCO	AF844	GA-50	DEL
AF7881	GA-434	WARN	AF7941	GA-2175	CIGO	AF81	GA-154	CHP	AF847	GA-376	DEL
AF7882	GA-1616	CHP	AF7941	GA-2175	WARN	AF811	GA-3445	HAS	AF847	GA-274	HAS
AF7882	GA-1616	GRAN	AF7944	GA-304	CAMP	AF813	GA-59	DEL	AF847CO	GA-274	FEDE
AF7882	GA-1616	LEE	AF7944	GA-304	CIGO	AF814	GA-57	DEL	AF847F	GA-274	FEDE
AF7882	GA-1616	LUF	AF7944	GA-304	WARN	AF814	GA-3523	HAS	AF848	GA-200	HAS
AF7882	GA-1616	PARP	AF7946	GA-278R	CHP	AF814CO	GA-3523	FEDE	AF848	GA-218	HAS
AF7882	GA-1616	SECU	AF7946	GA-278R	CIGO	AF814F	GA-3523	FEDE	AF8482	GA-482	CHP
AF7882	GA-1616	WARN	AF7946	GA-278R	FSN	AF815	GA-54	HAS	AF8483	GA-483	CHP
AF7884	GAVV-622	CHP	AF7946	GA-278R	LUF	AF815CO	GA-54	FEDE	AF8494	GA-493 ¹⁰⁸	CHP
AF7884	GAVV-622	GRAN	AF7946	GA-278R	PARP	AF815F	GA-54	FEDE	AF84CO	GA-3637	FEDE
AF7884	GAVV-622	LUF	AF7946	GA-278R	TIRP	AF816	GA-325	DEL	AF851	GA-356	FLG
AF7884	GAVV-622	WARN	AF7946	GA-278R	WARN	AF816	GA-4325	HAS	AF851M	GA-324	SECU
AF7885	GA-2114	CHP	AF7948	GAVV-626	CHAM	AF816CO	GA-4325	FEDE	AF851M	GA-356	FLG
AF7885	GA-2114	CIGO	AF7948	GAVV-626	LUF	AF817	GA-303	DEL	AF852	GA-378	FLG
AF7885	GA-2114	GRAN	AF7948	GAVV-626	WARN	AF818	GA-3300	DEL	AF852M	GA-378	FLG
AF7885	GA-2114	LUF	AF7958	GA-183	CHP	AF818K	GA-98 ¹¹²	FLG	AF853	GA-375	CHP

Referencia Cruzada por Numero de Parte

Cross Reference by Part Number



Numero	Gonher	Fabricante	Numero	Gonher	Fabricante	Numero	Gonher	Fabricante	Numero	Gonher	Fabricante
Number	Gonher	Manufacturer	Number	Gonher	Manufacturer	Number	Gonher	Manufacturer	Number	Gonher	Manufacturer
AF853		GA-229	FLG	AF8936		GA-314	LUF	AF92		GA-349	MINL
AF853M		GA-229	FLG	AF894		GA-139	HAS	AF92		GA-57	PRMT
AF854		GA-390	HAS	AF894F		GA-139	SHE	AF92		GA-57	SERV
AF855		GA-29	DEL	AF894F		GA-139	FEDE	AF92		GA-349	WARN
AF855		GA-4828	HAS	AF8956		GA-479	CAC	AF921		GA-382	HAS
AF855F		GA-4828	FEDE	AF8956		GA-134	LUF	AF921		GA-382	SHE
AF855M		GA-509 ¹⁴	FLG	AF8969		GA-168	CAC	AF921F		GA-382	FEDE
AF857		GA-3	DEL	AF897		GA-174	HAS	AF925		GA-253	BWS
AF858		GA-1	DEL	AF897CO		GA-174	FEDE	AF925		GA-253	CAM2
AF859		GA-140	HAS	AF897F		GA-174	FEDE	AF925		GA-253	CHP
AF86		GA-113	ACE	AF898		GA-139	CAM2	AF925		GA-253	GRAN
AF86		GA-113	APOL	AF898		GA-139	CHP	AF925		GA-195	HAS
AF86		GA-113	CHP	AF899		GA-372	DEL	AF925		GA-253	LEE
AF86		GA-113	CIGO	AF899		GA-3901	HAS	AF925		GA-253	LUF
AF86		GA-113	LUF	AF8997		GA-224	CAC	AF925		GA-253	MASE
AF8606		GA-8606	CAC	AF899CO		GA-3901	FEDE	AF925		GA-253	PARP
AF861		GA-180	HAS	AF899F		GA-3901	FEDE	AF925		GA-253	SECU
AF861		GA-180	SHE	AF9		GA-101	GUP	AF925		GA-195	SHE
AF862		GA-3300	DEL	AF9		GA-100	PUR	AF925		GA-253	TRUS
AF865		GA-6880	FLG	AF90		GA-303	CAC	AF925		GA-253	WARN
AF865		GA-2194	HAS	AF90		GA-59	IAPC	AF925CO		GA-195	FEDE
AF867		GA-1	DEL	AF90		GA-303	PRMT	AF925F		GA-195	FEDE
AF868		GA-2719B	DEL	AF90		GA-303	SERV	AF93		GA-325	CAC
AF868		GA-3501	FLG	AF9010		GA-264	CHP	AF93		GA-325	PRMT
AF868		GA-253	HAS	AF9010		GA-264	CIGO	AF93		GA-325	SERV
AF868CO		GA-253	FEDE	AF9010		GA-264	FSN	AF931		GA-372	FLG
AF868F		GA-253	FEDE	AF9010		GA-264	LUF	AF931		GA-2110	HAS
AF87		GA-113	CHP	AF9010		GA-264	PARP	AF931M		GA-372	FLG
AF87		GA-113	LUF	AF9010		GA-264	TIRP	AF9332		GA-395	CAC
AF87		GA-113	MASE	AF904		GA-329	FLG	AF9334		GA-9334	PUR
AF871		GA-378	DEL	AF9045		GA-9045	PUR	AF-9334		GA-9334	PUMX
AF871		GA-3915	HAS	AF-9045		GA-9045	PUMX	AF9345		GA-414R	CAC
AF871		GA-3915	SHE	AF9046		GA-1287	PUR	AF9378		GA-1008	PUR
AF871CO		GA-3915	FEDE	AF905		GA-153	BWS	AF-9378		GA-1008	PUMX
AF872		GA-376	FLG	AF905		GA-153	CAM2	AF939		GA-142	HAS
AF872M		GA-376	FLG	AF905		GA-153	CHP	AF939		GA-142	SHE
AF873		GA-483	FLG	AF905		GA-239	FLG	AF939CO		GA-142	FEDE
AF873		GA-3916	HAS	AF905		GA-153	GRAN	AF939F		GA-142	FEDE
AF873CO		GA-3916	FEDE	AF905		GA-153	HAS	AF94		GA-7007	HAS
AF873F		GA-3916	FEDE	AF905		GA-153	LEE	AF-94		GA-7007	ATL
AF873M		GA-483	FLG	AF905		GA-153	LUF	AF9401		GA-490	CAC
AF874		GA-482	FLG	AF905		GA-153	MASE	AF942		GA-109	FLG
AF874		GA-3814	HAS	AF905		GA-153	MINL	AF942		GA-30	HAS
AF874CO		GA-3814	FEDE	AF905		GA-153	PARP	AF942M		GA-109	FLG
AF874F		GA-3814	FEDE	AF905		GA-153	PRET	AF943		GA-357	FLG
AF874M		GA-482	FLG	AF905		GA-153	TRUS	AF947		GA-679	FLG
AF875		GA-7716	FLG	AF905		GA-153	WARN	AF9472		GA-372	CHP
AF875		GA-4958	HAS	AF9053		GA-183R	CAC	AF9493		GA-184	CAC
AF8755		GA-348	CAC	AF9054		GA-248	CAC	AF95		GA-3	IAPC
AF875M		GA-7716	FLG	AF905F		GA-153	FEDE	AF950		GA-429	FLG
AF876		GA-7360	FLG	AF906		GA-3490	DEL	AF951		GA-275	HAS
AF8760		GA-183	CAC	AF9072		GA-195	CAC	AF9516		GA-4999	CAC
AF8766		GA-491	CAC	AF909		GA-3425	IAPC	AF951F		GA-275	FEDE
AF877		GA-50	DEL	AF9090		GA-141	CAC	AF953		GA-6479	HAS
AF878		GA-5056	HAS	AF9098		GA-184	LUF	AF953CO		GA-6479	FEDE
AF878CO		GA-5056	FEDE	AF91		GA-59	CAC	AF953F		GA-6479	FEDE
AF878F		GA-5056	FEDE	AF91		GA-59	PRMT	AF954M		GA-377	FLG
AF879		GA-879	FLG	AF91		GA-59	SERV	AF9563		GA-158	CAC
AF879M		GA-879	FLG	AF910		GA-153	HAS	AF958		GA-133	HAS
AF88		GA-113	ACE	AF910F		GA-153	FEDE	AF958		GA-133	SHE
AF88		GA-113	APOL	AF912		GA-78	HAS	AF958F		GA-133	FEDE
AF88		GA-113	CHP	AF912		GA-78	SHE	AF959		GA-129	HAS
AF88		GA-113	CIGO	AF913		GA-50	FLG	AF96		GA-18	HAS
AF88		GA-113	GRAN	AF913		GA-362	HAS	AF961		GA-166	HAS
AF88		GA-113	LUF	AF913		GA-362	SHE	AF962		GA-6128	FLG
AF88		GA-113	MASE	AF913CO		GA-362	FEDE	AF962		GA-2106	HAS
AF88		GA-113	MINL	AF913F		GA-362	FEDE	AF962F		GA-2106	FEDE
AF88		GA-113	PARP	AF914		GA-86	FLG	AF963		GA-680	FLG
AF88		GA-113	TRUS	AF9155		GA-356	CHP	AF964		GA-89	FLG
AF88		GA-113	WARN	AF9159		GA-357	CHP	AF965		GA-6619 ⁵	HAS
AF880		GA-482	DEL	AF917		GA-392	BWS	AF965		GA-6620 ⁵	HAS
AF880		GA-273	HAS	AF917		GA-392	CAM2	AF966		GA-120	HAS
AF880CO		GA-273	FEDE	AF917		GA-392	CHP	AF967		GA-7017	HAS
AF880F		GA-273	FEDE	AF917		GA-392	GRAN	AF967F		GA-7017	FEDE
AF881		GA-483	DEL	AF917		GA-392	LUF	AF968		GA-276	HAS
AF882		GA-115	HAS	AF917		GA-392	SECU	AF9683		GA-380	CAC
AF882F		GA-15	FEDE	AF917		GA-392	WARN	AF97		GA-75	ACE
AF883		GA-357	FLG	AF918		GA-3915	BWS	AF97		GA-75	APOL
AF883M		GA-357	FLG	AF918		GA-3915	CAM2	AF97		GA-75	BWS
AF884		GA-216	HAS	AF918		GA-3915	CHP	AF97		GA-75	CHP
AF885		GA-471	HAS	AF918		GA-3915	GRAN	AF97		GA-75	GRAN
AF886M		GA-209	FLG	AF918		GA-3915	LEE	AF97		GA-75	LEE
AF887		GA-113	DEL	AF918		GA-3915	LUF	AF97		GA-75	LUF
AF888		GA-113	DEL	AF918		GA-3915	MASE	AF97		GA-75	MASE
AF888M		GA-885	FLG	AF918		GA-3915	PARP	AF97		GA-75	MINL
AF890		GA-390	HAS	AF918		GA-3915	SECU	AF97		GA-75	PARP
AF890		GA-390	SHE	AF918		GA-3915	TRUS	AF97		GA-75	TRUS
AF890F		GA-390	FEDE	AF918		GA-3915	WARN	AF97		GA-75	WARN
AF891		GA-7360	DEL	AF92		GA-349	ACE	AF970		GA-436	FLG
AF8913		GA-281	LUF	AF92		GA-349	APOL	AF971		GA-274	BWS
AF8918		GA-286	CAC	AF92		GA-57	CAC	AF971		GA-274	CAM2
AF892		GA-7716	DEL	AF92		GA-349	CAM2	AF971		GA-274	CHP
AF892		GA-392	HAS	AF92		GA-349	CHP	AF971		GA-274	ECOL
AF892		GA-392	SHE	AF92		GA-349	GRAN	AF971		GA-274	LEE
AF-892		GA-392	ATL	AF92		GA-349	LUF	AF971		GA-274	LUF
AF892F		GA-392	FEDE	AF92		GA-349	MASE	AF971		GA-274	MASE

Para números Gonher con Superíndice vea página 651
For Gonher with Superscript numbers see page 651

REFERENCIA CRUZADA

Numero	Gonher	Fabricante	Numero	Gonher	Fabricante	Numero	Gonher	Fabricante	Numero	Gonher	Fabricante
Number	Gonher	Manufacturer	Number	Gonher	Manufacturer	Number	Gonher	Manufacturer	Number	Gonher	Manufacturer
AFG91	GA-59	AUTG	AFL129	G-801	MTR	AFL4	GA-70	LEDR	AFL7823	GAD-17	LEEM
AFG92	GA-57	AUTG	AFL129	GA-3424	OHFC	AFL4	GA-70	LEE	AFL7825	GAD-294	LEEM
AFG93	GA-325	AUTG	AFL-129	GA-3424	POWF	AFL4	GA-70	LEEM	AFL7826	GA-133	LEEM
AFG991	GA-86	AUTG	AFL131	GA-3425	LEE	AFL4	GA-70	OHFC	AFL7828	GA-386	LEEM
AFI6248	GA-616	IRLE	AFL131	GA-3425	LEEM	AFL-4	GA-70	POWF	AFL-7828	GA-386	LEE
AFK103	GAD-1	FDY	AFL131	GA-3425	OHFC	AFL404	GA-129	LEEM	AFL7841	GA-322	LEEM
AFK110	GA-349	FDY	AFL-131	GA-3425	POWF	AFL415	GA-142	LEEM	AFL7845	GA-300	LEEM
AFK113	GA-75	FDY	AFL132	GA-50	LEE	AFL-415	GA-142	LEE	AFL785	GA-3647	LEE
AFK120	GA-7	FDY	AFL132	GA-50	LEEM	AFL45	GA-77	LEDR	AFL785	GA-3647	LEEM
AFK129	GA-3424	FDY	AFL-132	GA-85	POWF	AFL45	GA-77	LEE	AFL7854	GA-217	LEEM
AFK131	GA-3425	FDY	AFL132HP	GA-50	LEE	AFL45	GA-77	LEEM	AFL7862	GA-141	LEEM
AFK31	GA-56	FDY	AFL133	GA-78	LEE	AFL45	GA-77	OHFC	AFL7863	GA-165	LEEM
AFK318	GA-429	FDY	AFL133	G-834	MTR	AFL-45	GA-77	POWF	AFL7872	GA-164	LEEM
AFK37	GA-44	FDY	AFL138	GAD-3	LEE	AFL463	GA-230	LEE	AFL7874	GA-175	LEEM
AFK4	GA-70	FDY	AFL138	GAD-3	LEEM	AFL463	GA-230	LEEM	AFL826	GA-3681	LEE
AFK45	GA-77	FDY	AFL-141	GA-140	LEE	AFL4HP	GA-70	LEE	AFL826	GA-3681	LEEM
AFK474	GAK-403	DEL	AFL15	GA-3490	OHFC	AFL50	GA-90	LEDR	AFL83	GA-85	LEE
AFK47-64	GA-398	FDY	AFL-15	GA-3490	POWF	AFL50	GA-90	LEE	AFL83	GA-85	LEEM
AFK478	GAK-16	DEL	AFL155	GAVW-2	LEE	AFL50	GA-90	OHFC	AFL83	GA-85	OHFC
AFK480	GA-33	DEL	AFL155	GAVW-2	LEEM	AFL-50	GA-90	POWF	AFL-83	GA-85	POWF
AFK493	GA-26	DEL	AFL155FC	GAVW-2	LEE	AFL5033	GP-3985	FORD	AFL831	GA-735 ¹²⁴	LEE
AFK50	GA-90	FDY	AFL160	GA-277	LEE	AFL52	GA-71	LEDR	AFL831	GA-735 ¹²⁴	LEEM
AFK52	GA-71	FDY	AFL160	GA-277	LEEM	AFL52	GA-71	LEE	AFL-831	GA-85	POWF
AFK538	GA-27	DEL	AFL1697	GA-277	OHFC	AFL52	GA-71	LEEM	AFL83HP	GA-85	LEE
AFK545	GA-5648	DEL	AFL-1697	GA-277	POWF	AFL52	GA-71	OHFC	AFL84	GA-730	LEDR
AFK57	GA-80	FDY	AFL178	GA-192	LEE	AFL-52	GA-71	POWF	AFL84	GA-730	LEE
AFK570	GAK-20	DEL	AFL178	GA-192	LEEM	AFL52HP	GA-71	LEE	AFL84	GA-730	LEEM
AFK575	GA-271	FDY	AFL2	GP-5	MTR	AFL545	GA-2106	LEEM	AFL84	GA-730	OHFC
AFK58	GA-105	FDY	AFL-2138	GA-429	POWF	AFL56	GP-462	FORD	AFL-84	GA-730	POWF
AFK59	GA-50	FDY	AFL218	G-5000	MTR	AFL57	GA-80	LEDR	AFL85	GA-85	LEEM
AFK591	GA-24	DEL	AFL234	GA-382	LEEM	AFL57	GA-80	LEE	AFL-855	GA-3566	LEE
AFK657	GA-3490	FDY	AFL-234	GA-382	LEE	AFL57	GA-80	LEEM	AFL875	GA-21	LEE
AFK67	GA-192	FDY	AFL252	GA-362	LEE	AFL57	GA-80	OHFC	AFL898	GA-139	LEEM
AFK68	GA-78	FDY	AFL252	GA-362	LEEM	AFL-57	GA-80	POWF	AFL90	GA-303	LEDR
AFK703	GA-98 ¹¹²	DEL	AFL254	GA-2194	LEE	AFL574	GA-74	LEE	AFL90	GA-303	LEE
AFK710	G-926	FDY	AFL254	GA-2194	LEEM	AFL574	GA-74	LEEM	AFL90	GA-303	LEEM
AFK735	GA-54	FDY	AFL279	GA-55	LEE	AFL575	GA-271	LEE	AFL90	GA-303	OHFC
AFK736	GA-3523	FDY	AFL279	GA-216	LEEM	AFL575	GA-271	LEEM	AFL-90	GA-303	POWF
AFK74	GA-55	FDY	AFL27A	GP-91	MTR	AFL58	GA-105	LEDR	AFL905	GA-153	LEE
AFK773	GA-3588	FDY	AFL280	GA-471	LEEM	AFL58	GA-105	LEE	AFL905	GA-153	LEEM
AFK783	GAK-625	DEL	AFL289	GA-6619 ¹	LEE	AFL58	GA-105	OHFC	AFL91	GA-59	LEDR
AFK83	GA-85	FDY	AFL289	GA-6620 ¹	LEE	AFL59	GA-50	LEDR	AFL91	GA-59	LEE
AFK831	GA-735 ¹²⁴	FDY	AFL289	GA-6619 ¹	LEEM	AFL59	GA-50	LEE	AFL91	GA-59	LEEM
AFK84	GA-730	FDY	AFL289	GA-6620 ¹	LEEM	AFL59	GA-50	OHFC	AFL91	GA-59	OHFC
AFK90	GA-303	FDY	AFL293	GAD-15	LEE	AFL-59	GA-50	POWF	AFL-91	GA-59	POWF
AFK91	GA-59	FDY	AFL293	GAD-15	LEEM	AFL600	GA-4828	LEE	AFL917	GA-392	LEEM
AFK92	GA-57	FDY	AFL295	GA-253	LEE	AFL600	GA-4828	LEEM	AFL918	GA-3915	LEE
AFK93	GA-325	FDY	AFL295	GAVW-4	LEE	AFL604	GA-4325	LEE	AFL918	GA-3915	LEEM
AFK94	GA-3300	FDY	AFL295	GA-253	LEEM	AFL604	GA-4325	LEEM	AFL91HP	GA-59	LEE
AFK99	GA-86	FDY	AFL295	GAVW-4	LEEM	AFL611	GA-3814	LEE	AFL92	GA-57	LEDR
AFL1016	GA-37	LEE	AFL296	GAVW-2	LEE	AFL611	GA-3814	LEEM	AFL92	GA-57	LEE
AFL102	GA-105	LEE	AFL296	GAVW-2	LEEM	AFL657	GA-3490	LEE	AFL92	GA-57	LEEM
AFL103	GAD-1 ⁸⁷	OHFC	AFL297	GA-4365	LEE	AFL657FC	GA-3490	LEE	AFL92	GA-57	OHFC
AFL-103	GAD-1	POWF	AFL297	GA-4365	LEEM	AFL664	GA-78	LEE	AFL-92	GA-57	POWF
AFL1031	GA-277	LEE	AFL298	GAVW-4	LEEM	AFL665	GA-390	LEEM	AFL92HP	GA-57	LEE
AFL1031	GA-277	LEEM	AFL3	GA-71	LEE	AFL-665	GA-390	LEE	AFL93	GA-325	LEDR
AFL1032	GA-5056	LEE	AFL31	GA-56	LEDR	AFL668	GA-230	LEE	AFL93	GA-325	LEE
AFL1032A	GA-5056	LEE	AFL31	GA-56	LEE	AFL668FC	GA-230	LEE	AFL93	GA-325	LEEM
AFL1032A	GA-5056	LEEM	AFL31	GA-56	OHFC	AFL67	GA-192	LEDR	AFL93	GA-325	OHFC
AFL103FC	GAD-1	LEE	AFL-31	GA-56	POWF	AFL67	GA-192	LEE	AFL-93	GA-325	POWF
AFL1043	GA-273	LEE	AFL3138	GA-54	OHFC	AFL67	GA-192	OHFC	AFL94	GA-3300	LEDR
AFL1043	GA-273	LEEM	AFL-3138	GA-54	POWF	AFL-67	GA-192	POWF	AFL94	GA-3300	LEE
AFL1046	GA-174	LEE	AFL3149	GA-3523	OHFC	AFL671	GA-3490	LEE	AFL94	GA-3300	LEEM
AFL1046	GA-174	LEEM	AFL-3149	GA-3523	POWF	AFL671	GA-3490	LEEM	AFL94	GA-3300	OHFC
AFL1061	GA-275	LEE	AFL318	GA-429	LEE	AFL68	GA-78	LEDR	AFL94HP	GA-3300	LEE
AFL1061	GA-275	LEEM	AFL318	GA-429	LEEM	AFL68	GA-78	LEE	AFL971	GA-274	LEE
AFL1096	GA-6479	LEE	AFL3182	GA-55	OHFC	AFL68	GA-78	OHFC	AFL971	GA-274	LEEM
AFL1096	GA-6479	LEEM	AFL-3182	GA-55	POWF	AFL-68	GA-78	POWF	AFL974	GA-3916	LEE
AFL110	GA-349	LEDR	AFL3192	GA-271	OHFC	AFL689	GA-2740	LEE	AFL974	GA-3916	LEEM
AFL110	GA-349	LEE	AFL-3192	GA-271	POWF	AFL689	GA-2740	LEEM	AFL99	GA-86	LEDR
AFL110	GA-349	OHFC	AFL3193	GA-735 ¹²⁴	OHFC	AFL710	GA-75	LEE	AFL99	GA-86	LEE
AFL110FC	GA-349	LEE	AFL-3193	GA-735 ¹²⁴	POWF	AFL710	GA-75	LEEM	AFL99	GA-86	LEEM
AFL113	GA-75	LEDR	AFL3195	GA-3588	OHFC	AFL710FC	GA-75	LEE	AFL99	GA-86	OHFC
AFL113	GA-75	LEE	AFL-3195	GA-3588	POWF	AFL728	GA-3637	LEE	AFL-99	GA-86	POWF
AFL113	GA-75	LEEM	AFL3197	GA-154	OHFC	AFL728	GA-3637	LEEM	AFL991	GA-86	OHFC
AFL113	GA-75	OHFC	AFL3199	GA-70	OHFC	AFL735	GA-54	LEE	AFL-991	GA-86	POWF
AFL-113	GA-75	POWF	AFL-3199	GA-70	POWF	AFL735	GA-54	LEEM	AFN2095	GA-493 ¹⁰⁸	RAR
AFL1135	GA-7017	LEEM	AFL32	GA-55	LEDR	AFL736	GA-3523	LEE	AFP10	GA-73	PUR
AFL113HP	GA-715	LEE	AFL3380	GA-3647	OHFC	AFL736	GA-3523	LEEM	AFP103	GAD-1 ⁸⁷	PRET
AFL1149	GAVW-2	OHFC	AFL-3380	GA-3647	POWF	AFL74	GA-55	LEDR	AFP105	GAD-1	PUR
AFL115	GAD-3	LEE	AFL3384	GA-89	OHFC	AFL74	GA-55	LEE	AFP110	GA-349	FRML
AFL115	GAD-3	LEEM	AFL-3384	GA-89	POWF	AFL74	GA-55	LEEM	AFP110	GA-349	PUR
AFL1150	GA-90	LEEM	AFL351	GA-195	LEE	AFL74	GA-55	OHFC	AFP110E	GAD-3	PUR
AFL115012	GP-3675	ABHN	AFL351	GA-195	LEEM	AFL-74	GA-55	POWF	AFP113	GA-75	PRET
AFL120	GA-74	LEDR	AFL353	GA-3901	LEE	AFL749	GA-4303	LEE	AFP113	GA-75	PUR
AFL120	GA-7	LEE	AFL353	GA-3901	LEEM	AFL749	GA-4303	LEEM	AFP118	GAD-1	PUR
AFL120	GA-74	OHFC	AFL355	GA-2110	LEEM	AFL74HP	GA-55	LEE	AFP12	GA-7	PUR
AFL-120	GA-74	POWF	AFL358	GA-180	LEE	AFL753	GA-75	LEE	AFP-12	GA-12	PUMX
AFL1207	GA-74	LEDR	AFL358	GA-180	LEEM	AFL753	GA-89	LEEM	AFP120	GA-74	FRML
AFL124	GA-3300	LEDR	AFL359	GA-139	LEE	AFL-765	GA-3445	LEE	AFP120	GA-74	PUR
AFL124	GA-27198	LEE	AFL359	GA-139	LEEM	AFL773	GA-3588	LEE	AFP122	GAVW-2	PUR
AFL124	GA-3300	OHFC	AFL36	GP-3985	MTR	AFL773	GA-3588	LEEM	AFP123	GA-50	PUR
AFL-124	GA-3300	POWF	AFL37	GA-44	LEE	AFL7800	GA-166	LEEM	AFP124	GA-3300	FRML
AFL129	GA-3424	LEDR	AFL386	GAVW-120	LEEM	AFL7816	GA-6690	LEEM	AFP124	GA-3300	PRET
AFL129	GA-3424	LEE	AFL388	GA-3501	LEE	AFL7821	GA-276	LEEM	AFP124	GA-3300	PUR
AFL129	GA-3424	LEEM	AFL388	GA-3501	LEEM	AFL7823	GAD-117	LEEM	AFP129	GA-3424	FRML

Referencia Cruzada por Numero de Parte

Cross Reference by Part Number



Numero	Gonher	Fabricante	Numero	Gonher	Fabricante	Numero	Gonher	Fabricante	Numero	Gonher	Fabricante
Number	Gonher	Manufacturer	Number	Gonher	Manufacturer	Number	Gonher	Manufacturer	Number	Gonher	Manufacturer
AFP129	GA-3424	PRET	AFR81690	GA-827	FLR	AFR825423	GAVW-620	FLR	AFR8435K	GA-33	FLR
AFP129	GA-3424	PUR	AFR81719	GA-3425	FLR	AFR825429	GA-890R	FLR	AFR8435KM	GA-33	FLR
AFP130	GA-86	PUR	AFR81720	GA-3490	FLR	AFR825430	GA-723R	FLR	AFR8437K	GAK-16	FLR
AFP131	GA-3425	PRET	AFR81731	GA-3501	FLR	AFR825435	GA-435R	FLR	AFR8437KM	GAK-16	FLR
AFP131	GA-3425	PUR	AFR81735K	GAK-625	FLR	AFR825449	GA-49	FLR	AFR84504M	GA-6128	FLR
AFP132	GA-85	PUR	AFR81743M	GA-389	FLR	AFR825456K	GAK-16	FLR	AFR84506M	GA-6129	FLR
AFP1393	GA-735 ¹²⁴	PRET	AFR81750	GA-54	FLR	AFR825525	GA-518R	FLR	AFR84524	GA-730	FLR
AFP15	GA-3490	PUR	AFR81758M	GA-373	FLR	AFR825531	GA-106 ⁴⁶	FLR	AFR84527M	GA-372	FLR
AFP16	GA-2740	PUR	AFR81762	GA-89	FLR	AFR825531	GA-326 ⁷¹	FLR	AFR84557K	GAK-16	FLR
AFP21	GA-105	PUR	AFR-81770	GA-3445	FLR	AFR825541	GA-240	FLR	AFR84561	GA-101	FLR
AFP24	GA-735 ¹²⁴	PRET	AFR81771	GA-735 ¹²⁴	FLR	AFR825551	GA-880R	FLR	AFR84568	GA-18	FLR
AFP3	GA-75	PUR	AFR81772	GA-3490	FLR	AFR825557	GA-853R	FLR	AFR84574	GA-42	FLR
AFP31	GA-56	FRML	AFR81773	GA-271	FLR	AFR825575	GA-880R	FLR	AFR84579	GA-119	FLR
AFP31	GA-56	PUR	AFR81774	GAVW-2	FLR	AFR825590	GA-1615	FLR	AFR84588M	GA-377	FLR
AFP31	GA-56	SPEC	AFR-81776	GA-140	FLR	AFR825598	GA-968R	FLR	AFR84592	GA-3916	FLR
AFP3138	GA-54	PRET	AFR-81777	GA-2740	FLR	AFR825599	GA-2146	FLR	AFR84595	GAD-3	FLR
AFP3149	GA-3523	PRET	AFR81778	GA-75	FLR	AFR825621	GA-472	FLR	AFR-84596	GA-3566	FLR
AFP3174	GA-3681	PRET	AFR-81778	GA-2740	FLR	AFR825629	GA-780	FLR	AFR84598	GA-277	FLR
AFP3192	GA-271	PRET	AFR81780	GA-3588	FLR	AFR825636	GA-348	FLR	AFR84598	GA-4303	FLR
AFP3195	GA-3588	PRET	AFR81785	GA-3647	FLR	AFR825639	GA-348	FLR	AFR84600	GA-4828	FLR
AFP3592	GA-173	PRET	AFR81787	GA-154	FLR	AFR825667	GA-966R	FLR	AFR84601	GA-2740	FLR
AFP37	GA-44	PUR	AFR81789	GA-390	FLR	AFR825682	GA-130	FLR	AFR84602	GA-153	FLR
AFP4	GA-70	PRET	AFR81791	GA-6127	FLR	AFR825683	GA-1614	FLR	AFR84604	GA-90	FLR
AFP4	GA-70	PUR	AFR81802	GA-467	FLR	AFR825684	GA-158	FLR	AFR84615	GAD-15	FLR
AFP4343	GA-5056	PRET	AFR81817	GA-371	FLR	AFR825707	GA-799R	FLR	AFR84619	GA-5056	FLR
AFP4378	GA-174	PRET	AFR81817M	GA-371	FLR	AFR825732	GA-798R	FLR	AFR84624	GA-174	FLR
AFP45	GA-77	FRML	AFR81822	GAD-30	FLR	AFR825754	GA-164	FLR	AFR84633	GA-3501	FLR
AFP45	GA-77	PRET	AFR81827	GA-135	FLR	AFR825757	GA-348	FLR	AFR84636	GA-329	FLR
AFP45	GA-77	PUR	AFR81828	GA-251	FLR	AFR825854	GA-413R	FLR	AFR84653	GA-180	FLR
AFP-5	GA-101	PUMX	AFR81830KM	GAK-216	FLR	AFR825873	GA-697R	FLR	AFR8469	GA-3490	FLR
AFP50	GA-90	PUR	AFR81830M	GAK-216	FLR	AFR825888	GA-888R	FLR	AFR84703	GA-206	FLR
AFP52	GA-71	FRML	AFR81836M	GA-376	FLR	AFR826131	GA-1617	FLR	AFR8471	GA-6127	FLR
AFP52	GA-71	PRET	AFR81837	GA-372	FLR	AFR826163M	GA-624R	FLR	AFR84712	GA-3814	FLR
AFP52	GA-71	PUR	AFR81839	GA-416	FLR	AFR8267	GA-77	FLR	AFR84713	GA-467	FLR
AFP53	GA-2740	PUR	AFR81845K	GAK-216	FLR	AFR8289	GA-5648	FLR	AFR8471M	GA-6127	FLR
AFP57	GA-80	PRET	AFR81846	GA-694	FLR	AFR8289M	GA-5648	FLR	AFR8472	GA-6129	FLR
AFP57	GA-80	PUR	AFR81847	GA-826	FLR	AFR8291	GA-105	FLR	AFR8472M	GA-6129	FLR
AFP58	GA-105	PUR	AFR81851	GA-416	FLR	AFR8305	GA-50	FLR	AFR84736	GA-403	FLR
AFP59	GA-50	FRML	AFR81852	GA-8	FLR	AFR8306	GA-56	FLR	AFR84763	GAK-16	FLR
AFP59	GA-50	PRET	AFR81869	GAP-381	FLR	AFR8308	GA-71	FLR	AFR84764	GAK-16	FLR
AFP59	GA-50	PUR	AFR81878	GA-422	FLR	AFR8310	GA-5648	FLR	AFR84765	GA-176	FLR
AFP60	GA-11	PUR	AFR-81886M	GA-642	FLR	AFR8311	GA-70	FLR	AFR84766	GA-277	FLR
AFP-60	GA-70	PUMX	AFR81889	GA-3681	FLR	AFR8314	GA-21	FLR	AFR84800K	GAK-1532	FLR
AFP67	GA-192	FRML	AFR81897M	GA-1095	FLR	AFR8324	GA-80	FLR	AFR84814K	GA-27	FLR
AFP67	GA-192	PRET	AFR81904M	GA-206	FLR	AFR8333	GA-375	FLR	AFR84816	GA-360	FLR
AFP67	GA-192	PUR	AFR81905M	GA-106 ⁴⁶	FLR	AFR8335	GA-9334	FLR	AFR84828	GA-759	FLR
AFP68	GA-78	FRML	AFR81905M	GA-326 ⁷¹	FLR	AFR8335M	GA-9334	FLR	AFR84844KM	GA-33	FLR
AFP68	GA-78	PUR	AFR81916	GA-3637	FLR	AFR8336	GA-9045	FLR	AFR8485	GA-2719R	FLR
AFP68	GA-78	SPEC	AFR81935M	GA-398	FLR	AFR8336M	GA-9045	FLR	AFR84871M	GA-376	FLR
AFP69	GA-7	PUR	AFR81968	GA-3551 ⁵⁵	FLR	AFR8337	GA-1008	FLR	AFR84878	GA-197R	FLR
AFP74	GA-55	PRET	AFR81968	GA-3551 ⁵⁵	FLR	AFR8338	GA-1286	FLR	AFR84888K	GAK-1532	FLR
AFP74	GA-55	PUR	AFR81968M	GA-3551 ⁵⁵	FLR	AFR8339	GA-1286	FLR	AFR8490	GA-361	FLR
AFP79	GA-12	PUMX	AFR81968M	GA-3551 ⁵⁵	FLR	AFR8340	GA-1287	FLR	AFR84908	GA-682R	FLR
AFP79	GA-12	PUR	AFR8250	GA-39	FLR	AFR8341	GA-1284	FLR	AFR8490K	GA-361	FLR
AFP831	GA-85	FRML	AFR825013	GAVW-4	FLR	AFR8342	GA-1284	FLR	AFR8490M	GA-361	FLR
AFP831	GA-85	PRET	AFR825014	GA-129	FLR	AFR8343	GA-1285	FLR	AFR8491	GA-75	FLR
AFP83-1	GA-85	PUR	AFR825017	GA-166	FLR	AFR8344	GA-8047	FLR	AFR8492	GA-18	FLR
AFP84	GA-730	FRML	AFR825018	GA-276	FLR	AFR8344M	GA-8047	FLR	AFR84937	GA-18	FLR
AFP84	GA-730	PRET	AFR825033	GA-221R	FLR	AFR8346	GA-26	FLR	AFR84941K	GAK-403	FLR
AFP84	GA-730	PUR	AFR825033M	GA-221R	FLR	AFR8346K	GA-26	FLR	AFR84944	GA-362	FLR
AFP90	GA-303	FRML	AFR825036M	GA-499R	FLR	AFR8346KM	GA-26	FLR	AFR84949	GA-6479	FLR
AFP90	GA-303	PRET	AFR825070K	GAK-16	FLR	AFR8350K	GAK-20	FLR	AFR84950	GA-382	FLR
AFP90	GA-303	PUR	AFR825090	GA-240	FLR	AFR8350KM	GAK-20	FLR	AFR84951	GA-390	FLR
AFP91	GA-59	PRET	AFR825111	GA-499R	FLR	AFR8351K	GA-27	FLR	AFR84952	GA-4325	FLR
AFP91	GA-59	PUR	AFR825111M	GA-499R	FLR	AFR8351KM	GA-27	FLR	AFR84954	GA-386	FLR
AFP92	GA-57	PRET	AFR825139M	GA-682R	FLR	AFR8353	GA-24	FLR	AFR84955	GA-253	FLR
AFP92	GA-57	PUR	AFR825215	GA-768R	FLR	AFR8353K	GA-24	FLR	AFR84956	GA-139	FLR
AFP93	GA-325	FRML	AFR825219	GA-518R	FLR	AFR8353KM	GA-24	FLR	AFR84957	GA-4365	FLR
AFP93	GA-325	PRET	AFR825220	GA-197R	FLR	AFR8353M	GA-24	FLR	AFR84959	GA-195	FLR
AFP93	GA-325	PUR	AFR825223	GA-966R	FLR	AFR8364	GA-135	FLR	AFR84960	GA-275	FLR
AFP99	GA-86	PUR	AFR825247	GA-539R	FLR	AFR8380	GA-192	FLR	AFR84962	GA-6619 ¹	FLR
AFP991	GA-86	FRML	AFR825248	GA-534R	FLR	AFR8381	GA-44	FLR	AFR84962	GA-6620 ⁵	FLR
AFP991	GA-86	PRET	AFR825254	GA-1616	FLR	AFR8386	GA-21	FLR	AFR84963	GA-471	FLR
AFP99-1	GA-86	PUR	AFR825255	GA-442	FLR	AFR8388	GA-78	FLR	AFR84965	GA-3901	FLR
AFR81606K	GAK-1532	FLR	AFR825256	GA-165	FLR	AFR8390	GA-55	FLR	AFR84967	GA-529	FLR
AFR81606KM	GAK-1532	FLR	AFR825257	GAVW-2	FLR	AFR8392	GA-90	FLR	AFR84975	GA-139	FLR
AFR81616	GA-493 ¹⁰⁸	FLR	AFR825258	GA-673R	FLR	AFR8399	GA-325	FLR	AFR84976	GA-2106	FLR
AFR81617	GA-3424	FLR	AFR825259	GA-732R	FLR	AFR8400	GA-59	FLR	AFR84977	GA-6690	FLR
AFR81618	GA-3425	FLR	AFR825262	GA-600R	FLR	AFR8401	GA-57	FLR	AFR84979	GAD-29	FLR
AFR81625	GA-3523	FLR	AFR825292	GA-853R	FLR	AFR8402	GA-730	FLR	AFR8807K	GAK-16	FLR
AFR81627	GA-55	FLR	AFR8253	GA-37	FLR	AFR8403	GA-85	FLR	AFR8818K	GA-98 ¹¹²	FLR
AFR81638	GA-425	FLR	AFR825300	GA-781	FLR	AFR84060	GA-405	FLR	AFR8818KM	GA-98 ¹¹²	FLR
AFR81639	GA-426	FLR	AFR825301	GA-782 ¹⁰⁸	FLR	AFR8409K	GAK-403	FLR	AFR8820M	GA-206	FLR
AFR81640	GA-588	FLR	AFR825304	GA-186	FLR	AFR8409KM	GAK-403	FLR	AFR8826	GA-29	FLR
AFR81641	GA-589	FLR	AFR825306	GA-475	FLR	AFR8410	GA-303	FLR	AFR8829	GA-403	FLR
AFR81649	GAD-1	FLR	AFR825314	GA-517R	FLR	AFR8411	GA-3300	FLR	AFR8843	GA-7	FLR
AFR81651	GA-12	FLR	AFR825316	GA-392	FLR	AFR84139	GA-37	FLR	AFR8851	GA-356	FLR
AFR81662	GA-80	FLR	AFR825319	GA-5876	FLR	AFR84148	GAK-625	FLR	AFR8851M	GA-356	FLR
AFR81663	GA-679	FLR	AFR825338	GA-712R	FLR	AFR84164K	GAK-458	FLR	AFR8852	GA-378	FLR
AFR81666	GAD-3	FLR	AFR825345	GA-683R	FLR	AFR84165	GA-459	FLR	AFR8852M	GA-378	FLR
AFR81668	GA-11	FLR	AFR825352	GA-853R	FLR	AFR8418	GA-360	FLR	AFR8853	GA-229	FLR
AFR81672	GA-100	FLR	AFR825354	GA-930R	FLR	AFR8418M	GA-360	FLR	AFR8853M	GA-229	FLR
AFR81673	GA-113	FLR	AFR825355	GA-930R	FLR	AFR8424	GA-106 ⁴⁶	FLR	AFR8855M	GA-509 ¹⁴	FLR
AFR81674	GA-74	FLR	AFR825359	GA-930R	FLR	AFR8424	GA-326 ⁷¹	FLR	AFR8865	GA-6880	FLR
AFR81683	GA-891	FLR	AFR825360	GA-890R	FLR	AFR8424M	GA-106 ⁴⁶	FLR	AFR8868	GA-3501	FLR
AFR81689	GA-826	FLR	AFR825395KM	GA-6129	FLR	AFR8424M	GA-326 ⁷¹	FLR	AFR8872	GA-376	FLR

REFERENCIA CRUZADA

Para números Gonher con Superíndice vea página 651
For Gonher with Superscript numbers see page 651

Numero	Gonher	Fabricante	Numero	Gonher	Fabricante	Numero	Gonher	Fabricante	Numero	Gonher	Fabricante
Number	Gonher	Manufacturer	Number	Gonher	Manufacturer	Number	Gonher	Manufacturer	Number	Gonher	Manufacturer
AFR8872M	GA-376	FLR	AG156M	GAD-1	COO	AG561	GAVW-4	KNE	AH1172	GA-680 ¹⁰⁸	FLG
AFR8873	GA-483	FLR	AG168	GAVW-2	KNE	AG565	GA-2194	COO	AH1173	GA-679 ¹⁰⁴	FLG
AFR8873M	GA-483	FLR	AG169	GG-6	ALCA	AG574	GAVW-2	COO	AH1173	GA-680 ¹⁰⁸	FLG
AFR8874	GA-482	FLR	AG1698	GA-27161	COO	AG574	GAVW-2	GUD	AH1189	GA-2804 T	FLG
AFR8874M	GA-482	FLR	AG17	GA-303	KNE	AG574	GAVW-2	KNE	AH12	GA-7	HUT
AFR8875	GA-7716	FLR	AG170	GAD-3	KNE	AG574A	GAVW-2	COO	AH128449	GP-761H	JOND
AFR8875M	GA-7716	FLR	AG175	GG-19	ALCA	AG584	GAVW-4	COO	AH-140	GAC-5	PFX
AFR-8879	GA-879	FLR	AG175	GA-71	COO	AG584	GAVW-4	GUD	AH-143	GAC-4	PFX
AFR-8879M	GA-879	FLR	AG175	GA-71	GUD	AG6004	GG-251	PBR	AH148880	GA-221R	JOND
AFR8883	GA-357	FLR	AG176	GG-7	ALCA	AG6010	GG-189	PBR	AH168	GA-230	GIS
AFR8883M	GA-357	FLR	AG178	GA-7	COO	AG609375	GA-360	AGCH	AH19013	GA-2803T	FLG
AFR-8888M	GA-885	FLR	AG179	GA-18	KNE	AG631	GA-8	GUD	AH19053	GA-2803T	FLG
AFR8904	GA-329	FLR	AG181	GA-2194	KNE	AG632	GAD-3	GUD	AH19063	GAK-1532	FLG
AFR8905	GA-239	FLR	AG183	GA-80	COO	AG724	GA-2194	GUD	AH19069	GA-360	FLG
AFR8913	GA-50	FLR	AG183	GA-80	GUD	AG725	GA-277	GUD	AH19070	GA-360 ¹⁰⁴	FLG
AFR8914	GA-86	FLR	AG189	GA-3490	KNE	AG728	GAD-15	GUD	AH19070	GA-361 ¹⁰⁸	FLG
AFR8931M	GA-372	FLR	AG19	GA-303	KNE	AG751	GAD-1	GUD	AH19071	GA-106 ⁶⁶	FLG
AFR8942	GA-109	FLR	AG194	GAVW-2	KNE	AG771	GA-2110	GUD	AH19071	GA-326 ⁷¹	FLG
AFR8942M	GA-109	FLR	AG195	GAVW-2	KNE	AG773	GA-49	KNE	AH19072	GA-106 ⁴⁷	FLG
AFR8943	GA-357	FLR	AG2	GG-5 L	ALCA	AG800	GG-5 L	AUW	AH19072	GA-206 ¹⁰⁸	FLG
AFR8947	GA-679	FLR	AG205	GA-5648	KNE	AG801	GG-19	AUW	AH19072	GA-326 ⁷²	FLG
AFR8950	GA-429	FLR	AG208	GA-6129	KNE	AG802	GG-6	AUW	AH19083	GA-880R	FLG
AFR8962	GA-6128	FLR	AG210	GA-80	COO	AG803	GG-7	AUW	AH19084	GA-880R ¹⁰⁴	FLG
AFR8963	GA-680	FLR	AG217	GA-2740	KNE	AG804	GG-123	AUW	AH19085	GA-880R	FLG
AFR8970	GA-436	FLR	AG219	GA-4365	KNE	AG805	GG-20	AUW	AH19086	GA-880R ¹⁰⁴	FLG
AFR8979	GA-209	FLR	AG219	GA-4365	MAHL	AG806	GG-16	AUW	AH19095	GA-853R	FLG
AFR8979M	GA-209	FLR	AG221	GAD-1	KNE	AG807	GG-17	AUW	AH19096	GA-853R ¹⁰⁴	FLG
AFR8982	GA-107	FLR	AG229	GA-3300	COO	AG808	GG-45	AUW	AH19097	GA-853R	FLG
AFR8982M	GA-107	FLR	AG231	GA-2300	COO	AG81	GAVW-2	KNE	AH-191	GAC-3	PFX
AFR8986	GA-108	FLR	AG238	GA-230	KNE	AG810	GAVW-2	COO	AH19333	GA-770R	FLG
AFR8987	GA-210	FLR	AG255	GAVW-2	KNE	AG82	GAVW-2	KNE	AH19334	GA-770R ¹⁰⁴	FLG
AFR8988	GA-892	FLR	AG258	GA-3425	COO	AG888	GA-2156	COO	AH19582H	GAK-16	JOND
AFR8996M	GA-608	FLR	AG258	GA-3425	GUD	AG889	GA-2110	COO	AH19846	GA-33	JOND
AFT1008	GA-29	PUR	AG261	GA-2122	COO	AG89	GA-405	KNE	AH19847	GA-33	JOND
AFTFP2056	GA-240	RAR	AG265	GA-277	COO	AG896	GAD-30	COO	AH19847H	GA-33	JOND
AFTRD1946	GA-442	RAR	AG265	GA-277	GUD	AG90	GA-467	KNE	AH19851	GAK-16	JOND
AG 1005	GA-2160	GUD	AG275	GA-2110	KNE	AG909	GA-75	COO	AH19852	GA-16	JOND
AG 1061	GA-2160	COO	AG298	GAVW-120	KNE	AG922	GAD-15	COO	AH19852	GAK-16	JOND
AG 1118	GA-410	COO	AG3019	G-1174	PBR	AG925	GA-4365	COO	AH19852H	GAK-16	JOND
AG 1504	GA-2184	COO	AG3021	G-1163	PBR	AG97	GA-77	KNE	AH20487	GAK-403	JOND
AG 1519	GA-2160	COO	AG3032	G-1175	PBR	AG99	GAK-20	KNE	AH20487H	GAK-403	JOND
AG1001	G-1121	PBR	AG3034	G-1143	PBR	AGF111	GG-5 L	AWAR	AH20488	GAK-403	JOND
AG1001-01	G-1121F	PBR	AG3059	G-1173	PBR	AGF11-1	GG-5 L	ARC	AH20488H	GAK-403	JOND
AG100103	G-1121	PBR	AG31	GA-71	KNE	AGF1115	GG-20	ARO	AH20847	GAK-403	JOND
AG100112	G-1121	PBR	AG3104	G-1176	PBR	AGF1115	GG-20	AWAR	AH20847H	GAK-403	JOND
AG1013	G-1123	PBR	AG316	GA-39	COO	AGF111-5	GG-20	ARC	AH21283	GAK-20	JOND
AG102	GA-436	KNE	AG316	GA-39	GUD	AGF119	GG-6	ARC	AH21421	GA-98 ¹¹²	JOND
AG1022	G-1166	PBR	AG3176	GG-48	PBR	AGF119	GG-6	ARO	AH21424	GAK-20	JOND
AG103	GA-71	COO	AG32	GA-50	KNE	AGF119	GG-6	AWAR	AH273	GAK-20	JOND
AG103	GA-71	GUD	AG3207	G-297	PBR	AGF120	GG-7	ARC	AH277	GA-50	GIS
AG104	GA-70	COO	AG3207	G-297-B	PBR	AGF120	GG-7	ARO	AH288	GA-230	GIS
AG104	GA-70	GUD	AG3209	G-295	PBR	AGF120	GG-7	AWAR	AH292	GA-200	GIS
AG1071	GA-139	COO	AG3263	G-296	PBR	AGF131	GG-19	AWAR	AH292	GA-218	GIS
AG108	GA-277	KNE	AG3263	G-296-B	PBR	AGF13-1	GG-19	ARC	AH295	GAD-3	GIS
AG1083	GA-382	COO	AG3281	G-1121F	PBR	AGF21	GG-123	ARC	AH33	GA-44	GIS
AG1084	GA-362	COO	AG328102	G-1121	PBR	AGF21	GG-123	ARO	AH3338	GA-42	TOMI
AG1087	GA-195	COO	AG335	GAD-3	COO	AGF21	GG-123	AWAR	AH34	GA-230	GIS
AG1087	GA-477	GUD	AG335	GAD-1	GUD	AGF3	GG-5 L	ALCA	AH4243	GP-3	JOND
AG110	GA-44	COO	AG340	GA-78	COO	AGF73	GG-5 L	ALCA	AH613	GA-303	GIS
AG110	GA-44	GUD	AG362	GA-55	GUD	AGF9	GG-5 L	ALCA	AH61470	G-33	JOND
AG1100	GA-386	COO	AG380	GA-230	COO	AGI1402	GP-149	ACKL	AH69798	GA-98	JOND
AG1103	GA-2146	COO	AG380	GA-230	GUD	AGI1428	GP-205	ACKL	AH78769	GP-3	JOND
AG1108	GAVW-121	COO	AG381	GA-18	COO	AGI1432	GP-3675	ACKL	AH82432	GP-3	JOND
AG1126	GA-2114	COO	AG381	GA-18	GUD	AGI2	GP-1	ACKL	AHD07	GA-170	WOW
AG113	GAVW-2	KNE	AG391	GA-8	COO	AGI223	GP-58	ACKL	AHD08	GA-172	WOW
AG1163	GAVW-120	COO	AG400	GA-59	GUD	AGI233	GP-81 ³¹	ACKL	AHD1001	GA-514	WOW
AG12	GG-5 L	ALCA	AG402	GA-303	COO	AGI233	GP-9 ³⁸	ACKL	AHD1002	GA-163	WOW
AG1204	GA-2174	COO	AG413	GAD-3	GUD	AGI243	GP-3600	ACKL	AHD364	GA-381	WOW
AG124	GA-230	GUD	AG414	GA-200	COO	AGI329	GP-68	ACKL	AHD365	GA-386	WOW
AG1242	GA-2156	COO	AG414	GA-218	COO	AGI34	GP-81	ACKL	AHD376	GA-172	WOW
AG1261	G-296	PBR	AG414	GA-2114	GUD	AGI355	GP-3980	ACKL	AH1001	GA-206	GIS
AG1261	G-296-B	PBR	AG416	GAVW-2	COO	AGI435	GP-46	ACKL	AH1003	GA-24	GIS
AG1270	GA-5876	COO	AG420	GAD-3	COO	AGI6	GP-13	ACKL	AH1006	GA-360	GIS
AG129	GA-2194	KNE	AG420	GAD-3	GUD	AGM1001	GA-164	WOW	AH1009	GA-405	GIS
AG1296	G-296	PBR	AG420M	GAD-3	COO	AGM1002	GA-6479 ⁹⁰	WOW	AH1014	GA-436	GIS
AG1296	G-296-B	PBR	AG425	GA-77	COO	AH1036201	G-296	VMEN	AH1015	GA-106 ⁶⁶	GIS
AG131	GA-50	GUD	AG430	GAVW-2	COO	AH1036201	G-296-B	VMEN	AH1015	GA-326 ⁷¹	GIS
AG1312	GA-605	COO	AG436	GA-303	COO	AH101801	GP-31	VMEN	AH1016	GA-49	GIS
AG1331	GA-217	COO	AG453	G-75	COO	AH1111RE	G-139	JOND	AH1020	GAK-16	GIS
AG1345	GA-172	COO	AG469	GA-2740	COO	AH1145	GA-588 ¹⁰⁸	FLG	AH1021	GAK-403	GIS
AG137	GA-333	KNE	AG471	GA-730	GUD	AH1145	GA-589 ¹⁰⁴	FLG	AH1026	GA-361	GIS
AG138	GA-56	COO	AG475	GA-85	GUD	AH1146	GA-425 ¹⁰⁴	FLG	AH1039	GAK-20	GIS
AG138	GA-56	GUD	AG482	GA-3490	COO	AH1146	GA-426 ¹⁰⁸	FLG	AH1040	GAK-20	GIS
AG138	GAK-16	KNE	AG484	GA-349	COO	AH1148	GA-679 ¹⁰⁴	FLG	AH1042	GA-1284	GIS
AG139	GAK-403	KNE	AG484	GA-349	GUD	AH1148	GA-680 ¹⁰⁸	FLG	AH1043	GA-1285	GIS
AG1395	GA-475	COO	AG488	GAVW-2	COO	AH114973	GP-761H	JOND	AH1044	GA-1286	GIS
AG140	GAK-20	KNE	AG488	GAVW-2	GUD	AH1157	GA-589	FLG	AH1045	GA-8047	GIS
AG141	GA-8047	KNE	AG51-1	GAVW-2	KNE	AH1158	GA-425	FLG	AH1056	GA-467	GIS
AG147	GA-37	COO	AG524	GA-106 ⁶⁶	GUD	AH1160	GA-679	FLG	AH1068	GA-18	GIS
AG147	GA-37	GUD	AG524	GA-326 ⁷¹	GUD	AH1168	GA-588 ¹⁰⁸	FLG	AH1081	GA-33	GIS
AG149	GA-3425	KNE	AG531	GA-111	GUD	AH1168	GA-589 ¹⁰⁴	FLG	AH1085	GA-27	GIS
AG15	GA-200	KNE	AG532	GA-7	GUD	AH1170	GA-425 ¹⁰⁴	FLG	AH1088	GA-37	GIS
AG15	GA-218	KNE	AG55	GAVW-4	KNE	AH1170	GA-426 ¹⁰⁸	FLG	AH1091	GA-892	GIS
AG15	GA-218	MAHL	AG55-1	GAVW-4	KNE	AH1171	GA-425 ¹⁰⁴	FLG	AH1095	GA-6129	GIS
AG156	GAD-1	COO	AG555	GA-56	COO	AH1171	GA-426 ¹⁰⁸	FLG	AHK426	G-870	LEYL
AG156	GAD-1	GUD	AG556	GA-4303	COO	AH1172	GA-679 ¹⁰⁴	FLG	AHM2094	GP-3600	LEYL

Referencia Cruzada por Numero de Parte

Cross Reference by Part Number



Numero	Gonher	Fabricante	Numero	Gonher	Fabricante	Numero	Gonher	Fabricante	Numero	Gonher	Fabricante
Number	Gonher	Manufacturer	Number	Gonher	Manufacturer	Number	Gonher	Manufacturer	Number	Gonher	Manufacturer
AHM2094	GP-3600	MARS	AI3309-08	GAK-216	PBR	AL3569	GP-3569	ADGE	ALG6045	GG-185	INTE
AHP889	GA-V4W-4	GIS	AI3319	GA-49	PBR	AL3675	GP-3675	ITAL	ALG6046	GG-185	INTE
AHR81145	GA-588 ⁰⁸	FLR	AI3328	GA-436	PBR	AL3976A	GP-178	ITAL	ALG6053	GG-185	INTE
AHR81145	GA-589 ⁰⁴	FLR	AI3330	GA-416	PBR	AL3980	GP-3980	ITAL	ALG-6057	GG-227	INTE
AHR81146	GA-425 ⁰⁴	FLR	AI3336-08	GAK-625	PBR	AL3985	GP-3985	ITAL	ALG6059	GG-185	INTE
AHR81146	GA-426 ⁰⁸	FLR	AI3338	GA-356	PBR	AL42	GP-38	ALFI	ALG6061	GG-185	INTE
AHR81148	GA-679 ⁰⁴	FLR	AI3339	GA-357	PBR	AL42274	GAK-16	CASE	ALG6065	GG-185	INTE
AHR81148	GA-680 ⁰⁸	FLR	AI3341	GA-425	PBR	AL4681	GP-28 ⁸	ITAL	ALG607	GG-8 ¹⁰³	ALFI
AHR81157	GA-589	FLR	AI3342	GAD-30	PBR	AL4681	GP-430 ⁸	ITAL	ALG607	GG-8 L ⁸⁰	ALFI
AHR81158	GA-425	FLR	AI3343	GA-426	PBR	AL56469	GP-66	JOND	ALG607	GG-8 ¹⁰³	INTE
AHR81160	GA-679	FLR	AI3347	GA-7716	PBR	AL6607	GP-91	ITAL	ALG607	GG-8 L ⁸⁰	INTE
AHR81168	GA-588 ⁰⁸	FLR	AI3348	GA-7360	PBR	AL7	GP-5	ALFI	ALG-609	GG-247	INTE
AHR81168	GA-589 ⁰⁴	FLR	AI3354	GA-361	PBR	AL73	GP-462	ALFI	ALG-612	GG-65	INTE
AHR81169	GA-588 ⁰⁸	FLR	AI3358	GA-467	PBR	AL77061	GP-761H	JOND	ALG614	GG-84	INTE
AHR81169	GA-589 ⁰⁴	FLR	AI3377	GA-892	PBR	AL78223	GA-781	JOND	ALG620	GG-45	INTE
AHR81170	GA-425 ⁰⁴	FLR	AI-3653	GA-2160	PBR	AL78224	GA-782	JOND	ALG627	GG-5 L	ALFI
AHR81170	GA-426 ⁰⁸	FLR	AI5005	GA-VW-2	PBR	AL78988	GG-3	JOND	ALG630	GG-203	INTE
AHR81171	GA-425 ⁰⁴	FLR	AI5006	GA-VW-4	PBR	AL8873	GP-408	ADGE	ALG650	GG-202	INTE
AHR81171	GA-426 ⁰⁸	FLR	AI5008	GAD-15	PBR	AL9	GP-81 ³¹	ALFI	ALG-660	GG-188	INTE
AHR81172	GA-679 ⁰⁴	FLR	AI5010	GA-277	PBR	AL9	GP-9 ⁵⁸	ALFI	ALG-670	GG-213	INTE
AHR81172	GA-680 ⁰⁸	FLR	AI5011	GA-4365	PBR	AL9641	G-70	ITAL	ALG675	GG-208	INTE
AHR81173	GA-679 ⁰⁴	FLR	AI5013	GA-VW-2	PBR	ALA-1102	GA-322	INTE	ALG680	GG-204	INTE
AHR81173	GA-680 ⁰⁸	FLR	AI5025	GA-2194	PBR	ALA-1212	GA-596	INTE	ALG7040	GG-215	INTE
AHR81189	GA-2804 T	FLR	AI5033	GA-4303	PBR	ALA-1300	GA-386	INTE	ALG7050	GG-181	INTE
AHR819013	GA-2803T	FLR	AI5183	GA-2174	PBR	ALA-1302	GA-382	INTE	ALG7060	GG-214	INTE
AHR819053	GA-2803T	FLR	AI-5252	GA-2184	PBR	ALA-1304	GA-514	INTE	ALG7062	GG-214	INTE
AHR819063	GAK-1532	FLR	AI-5433	GA-27161	PBR	ALA-1316	GA-269	INTE	ALG7070	GG-190	INTE
AHR819064	GAK-1532	FLR	AI501	GA-198	PBR	ALA-1317	GA-138	INTE	ALG7080	GG-181	INTE
AHR819069	GA-360	FLR	AJ03-13-480	GG-47	MZDA	ALA-1320	GA-340	INTE	ALG-7086	GG-234	INTE
AHR819070	GA-360	FLR	AJ145	GA-180	RALL	ALA-1401	GA-604	INTE	ALG7095	GG-146	INTE
AHR819070	GA-361	FLR	AJ155A	GA-139	RALL	ALA-8260	GA-491	INTE	ALG7200	GG-160	INTE
AHR819071	GA-106 ⁴⁶	FLR	AJ171	GA-6690	RALL	ALA-8263	GA-304	INTE	ALG-7201	GG-206	INTE
AHR819071	GA-326 ⁷¹	FLR	AJ174	GA-322	RALL	ALA-8430	GA-168	INTE	ALG7295	GG-146	INTE
AHR819072	GA-106 ⁴⁷	FLR	AJ177	GA-5466	RALL	ALA-8435	GA-240	INTE	ALG750	GG-208	INTE
AHR819072	GA-206 ⁰⁸	FLR	AJ202	GA-3490	RALL	ALA-8440	GA-477	INTE	ALG751	GG-76	INTE
AHR819072	GA-326 ⁷²	FLR	AJ206A	GAD-1	RALL	ALA-8489	GA-475	INTE	ALG752	GG-203	INTE
AHR819083	GA-880R	FLR	AJ215	GAD-3	RALL	ALG1115	GG-20	ALFI	ALG753	GG-208	INTE
AHR819084	GA-880R ⁰⁴	FLR	AJ217	GA-6619 ¹	RALL	ALG1115	GG-20	INTE	ALG778	GG-19	ALFI
AHR819085	GA-880R	FLR	AJ217	GA-6620 ¹	RALL	ALG14	GG-19	ALFI	ALG795	GG-87	ALFI
AHR819086	GA-880R ⁰⁴	FLR	AJ243	GAD-15	RALL	ALG14	GG-19	INTE	ALG795	GG-87	INTE
AHR819095	GA-853R	FLR	AJ249	GA-4303	RALL	ALG14M	GG-1	ALFI	ALG800	GG-208	INTE
AHR819096	GA-853R ⁰⁴	FLR	AJ299L	GAD-294	RALL	ALG14M	GG-4	ALFI	ALG8001	GG-79	INTE
AHR819097	GA-853R	FLR	AJ3011	GA-607	RALL	ALG14MP	GG-1	ALFI	ALG840	GG-42	INTE
AHR819098	GA-853R ⁰⁴	FLR	AJ346	GA-7142	RALL	ALG14MP	GG-4	ALFI	ALG880	GG-47	ALFI
AHU2880	GP-455	LAND	AJ399M	GA-605	RALL	ALG185	GG-67	INTE	ALG880	GG-47	INTE
AHU2880	GP-455	LEYL	AJ437	GA-471	RALL	ALG-195	GG-99	INTE	ALG882	GG-268	INTE
AHU-2880	GP-455	ROVE	AJ446	GA-2106	RALL	ALG2010	GG-246	INTE	ALG884	GG-94	INTE
AI1038	GA-71	PBR	AJ449	GA-133	RALL	ALG-2010	GG-408	INTE	ALG-887	GG-239	INTE
AI3003	GAP-379	PBR	AJ517A	GA-139	RALL	ALG-2011	GG-261	INTE	ALG-9048	GG-232	INTE
AI3019	G-191	PBR	AJ57-13-240	GP-597	MZDA	ALG2013	GG-251	INTE	ALG9053	GG-148	INTE
AI3026	GA-200	PBR	AJ82897	GA-557	JAGU	ALG2016	GG-226	INTE	ALG9054	GG-142	INTE
AI3026	GA-218	PBR	AJ833G	GA-382	RALL	ALG2017	GG-246	INTE	ALG9055	GG-185	INTE
AI3050	GA-230	PBR	AJ837	GA-386	RALL	ALG2018	GG-246	INTE	ALG9068	GG-115	INTE
AI3079	GAD-3	PBR	AJ843	GA-381	RALL	ALG2026	GG-246	INTE	ALG-9070	GG-151	INTE
AI3088	GA-200	PBR	AJ899J	GA-172	RALL	ALG2051	GPP-1122	INTE	ALG9078	GG-150	INTE
AI3088	GA-218	PBR	AJ899R	GA-163	RALL	ALG2053	GPP-1122	ALFI	ALG9079	GG-114	INTE
AI3098	GAD-1	PBR	AJ899V	GA-384	RALL	ALG296	G-296	ALFI	ALG9083	GG-185	INTE
AI3109	GA-3425	PBR	AJ956	GA-244	RALL	ALG296	G-296-B	ALFI	ALG9087	GG-136	INTE
AI3131	GA-3490	PBR	AJCS122	G-801	AUST	ALG300	GG-45	INTE	ALG-9089	GG-232	INTE
AI3132	GAD-3	PBR	AJCS122	G-801	AUSW	ALG301	GG-196	INTE	ALG-9092	GG-223	INTE
AI3154	GA-303	PBR	AJCS122	G-801	LEYL	ALG302	GG-196	INTE	ALO-8135	G-70	INTE
AI3160	GA-3490	PBR	AJCS122	G-801	LEYL	ALG303	GG-76	INTE	ALO-8147	G-912	INTE
AI3164	GA-2719B	PBR	AJTS122	G-801	LEYL	ALG-306	GG-194	INTE	AM 453	GA-410	FTRO
AI3179	GA-39	PBR	AK0168	GG-1	KAYS	ALG-3061	GG-164	INTE	AM041910	G-566	POWP
AI3184	GA-2740	PBR	AK0168	GG-4	KAYS	ALG-3062	GG-164	INTE	AM041911	G-750	POWP
AI3202	GA-5648	PBR	AK040	G-1121	KAYS	ALG-3065	GG-164	INTE	AM041912	G-33	POWP
AI3203	GA-9334	PBR	AK07-8	GG-3	KAYS	ALG309	GG-63	INTE	AM042901	GP-54 ¹¹	POWP
AI3204	GA-1284	PBR	AK081	GG-45	KAYS	ALG-310	GG-39	INTE	AM042901	GP-66 ⁰	POWP
AI3205	GA-1008	PBR	AK105	GA-VW-2	RALL	ALG38M	GG-5 L	ALFI	AM042903	GP-54	POWP
AI3206	GA-1286	PBR	AK10L	GG-246	KAYS	ALG38MP	GG-5 L	ALFI	AM043903	G-1121	POWP
AI3207	GA-1285	PBR	AK10LV	GG-246	KAYS	ALG4041	GG-123	ALFI	AM043904	G-1123	POWP
AI3208	GA-8047	PBR	AK119	GA-403	WIX	ALG4041	GG-123	INTE	AM043906	GP-1122	POWP
AI3215	GA-1287	PBR	AK11A	GG-246	KAYS	ALG427	GG-6	ALFI	AM043907	G-1121	POWP
AI3216	GA-9045	PBR	AK11B	GG-251	KAYS	ALG427	GG-6	INTE	AM043910	GP-27	MASY
AI3221	GA-360	PBR	AK11BS	GG-246	KAYS	ALG441	GG-7	ALFI	AM043910	GP-27	POWP
AI3234	GAK-16	PBR	AK11KJ	GG-189	KAYS	ALG441	GG-7	INTE	AM043911	GP-26	MASY
AI3234-08	GAK-16	PBR	AK11LA	GG-246	KAYS	ALG4476	GG-240	INTE	AM044901	GA-24	POWP
AI3239	GA-106 ⁴⁶	PBR	AK11LJA	GG-251	KAYS	ALG4481	GG-46	ALFI	AM101001	GP-2951	JOND
AI3239	GA-326 ⁷¹	PBR	AK11LS	GG-246	KAYS	ALG4481	GG-46	INTE	AM101004	G-294	JOND
AI3240	GA-206	PBR	AK11WS	GG-226	KAYS	ALG-4482	GG-242	INTE	AM101054	GP-58	JOND
AI3242	GA-18	PBR	AK120	GA-33	WIX	ALG4483	GG-3728	INTE	AM101126	GG-1	JOND
AI3246	GA-403	PBR	AK204	GA-476	RALL	ALG4516	G-1121	ALFI	AM101126	GG-4	JOND
AI3246-08	GA-403	PBR	AK224	GA-217	RALL	ALG4516	GG-255	INTE	AM101207	GP-58	JOND
AI3247	GA-24	PBR	AKU1033	GP-3600	LEYL	ALG-4562	GG-256	INTE	AM101378	GP-91	JOND
AI3247-08	GA-24	PBR	AL1	GP-1	ALFI	ALG4563	GG-260	INTE	AM105172	GP-157	JOND
AI3259	GA-239	PBR	AL10	GP-46	ALFI	ALG-4580A	GG-256	INTE	AM105555	GP-157	JOND
AI3260	GA-329	PBR	AL118036	GP-761H	JOND	ALG-4611U	GG-177	INTE	AM107423	GP-157	JOND
AI3264	GA-482	PBR	AL17255	GAK-16	JOND	ALG470	GG-16	ALFI	AM107871	GG-1	JOND
AI3265	GA-483	PBR	AL1JA	GP-1	ALFI	ALG471	GG-17	ALFI	AM107871	GG-4	JOND
AI3267	GA-6129	PBR	AL27159	GA-416	JOND	ALG497	GG-196	INTE	AM11139	GA-892	PUR
AI3268	GA-6127	PBR	AL2870A	GP-28 ⁸	ITAL	ALG5021	GG-246	INTE	AM116178	GG-1	JOND
AI3272	GAK-20	PBR	AL2870A	GP-430 ⁸	ITAL	ALG5025	GG-246	INTE	AM116178	GG-4	JOND
AI3272-08	GAK-20	PBR	AL29	GP-13	ALFI	ALG6031	GG-1				

Numero	Gonher	Fabricante	Numero	Gonher	Fabricante	Numero	Gonher	Fabricante	Numero	Gonher	Fabricante
Number	Gonher	Manufacturer	Number	Gonher	Manufacturer	Number	Gonher	Manufacturer	Number	Gonher	Manufacturer
AM125424	GP-58 ¹⁵	JOND	AOF167	GP-3531 EXP	AWAR	AP108	GA-55	GLD	AP280	GA-471	VALV
AM1344	GA-49	HDA	AOF17	GP-81	ARC	AP1080	GP-462	APL	AP28111R	G-139	JOND
AM15-13-200	GA-4325	MZDA	AOF17	GP-81	ARO	AP1080B	GP-462	APL	AP2815	GP-171 ¹⁶	AUTO
AM15-14-302	GP-3985	MZDA	AOF17	GP-81	AWAR	AP1081	GP-1122	APF	AP2817	GP-3531 EXP	AUTO
AM15805	GA-119	HDA	AOF173	GP-3980	ARO	AP1090	GP-58 ¹⁵	APL	AP284	G-833	APF
AM18505	GA-119	HDA	AOF173	GP-3980	AWAR	AP1095	GA-356	COP	AP284	G-833	APL
AM22401	GA-405	HDA	AOF195	GP-3600	AWAR	AP1095	GA-356	GLD	AP284A	G-833	APL
AM24	GA-827	HDA	AOF-257	GP-3569	AWAR	AP10959	GA-357	GLD	AP284A	G-833	APL
AM2400	GA-436	HDA	AOF33	GP-20	ARC	AP1096	GA-6479	VALV	AP2856A	GP-40	AUTO
AM300	GAD-30	HDA	AOF33	GP-20	ARO	AP109726	GA-31	GLD	AP2865	GP-42	AUTO
AM30800	GA-12	JOND	AOF33	GP-20	AWAR	AP109C	GAD-1 ⁸⁷	AUTO	AP28990	GPP-14	JOND
AM30800	GA-12	KOHL	AOF40	GP-13	ARC	AP110C	GAD-3	AUTO	AP29320	G-297-B	JOND
AM31205	GP-81	JOND	AOF40	GP-13	ARO	AP1132FF	G-33	ROLK	AP297	GA-37	APF
AM31400	GA-7	JOND	AOF40	GP-13	AWAR	AP1135	GA-7017	VALV	AP297	GA-37	APL
AM34770	GP-3600	JOND	AOF42	GP-38	ARC	AP1143	GP-50	APL	AP297	GA-4365	VALV
AM35176	GP-3600	JOND	AOF42	GP-38	ARO	AP1153	GAVW-4	MIGH	AP297A	GA-37	APF
AM37025	GP-81	JOND	AOF49	GP-3	ARC	AP-1153	GAVW-4	FACE	AP297A	GA-37	APL
AM38441	GP-171	JOND	AOF49	GP-3	ARO	AP11-6345	GA-891	COP	AP298	GAVW-4	VALV
AM38708	GG-1	JOND	AOF49	GP-3	AWAR	AP11-6918	GA-378	COP	AP299C	GAVW-2	AUTO
AM38708	GG-4	JOND	AOF5	GP-5	ARC	AP11-6918-0	GA-378	COP	AP2A	GP-1	AUTO
AM39687	GP-3600	JOND	AOF5	GP-5	AWAR	AP1172	GP-54	APF	AP30	G-31	APCO
AM43910	GP-27	PERK	AOF50	GP-1	ARC	AP117332	GA-26 ¹¹²	QIFA	AP30	GP-20	AUTO
AM49839	GA-679	HDA	AOF50	GP-1	ARO	AP11-7797	GA-229	COP	AP3003	GAP-379	PBR
AM49840	GA-680	HDA	AOF50	GP-1	AWAR	AP11-8829	GA-891	COP	AP3008	GA-1285	APF
AM725	GA-425	HDA	AOF64	GP-3600	ARC	AP1190	GP-42	APF	AP3008	GA-1285	APL
AM876035	GG-5 L	JOND	AOF64	GP-38	ARC	AP1190	GP-42	APL	AP3008A	GA-1285	APF
AM907	GA-21	HDA	AOF64	GP-28 ⁹	AWAR	AP1192	GP-3531 EXP	APF	AP3008A	GA-1285	APL
AM936	GA-826	HDA	AOF64	GP-430 ⁹	AWAR	AP1192	GP-3531 EXP	APL	AP300C	GA-57	AUTO
AM956	GA-21	HDA	AOF73	GP-24 ²⁶	ARC	AP11-9649	GA-416	COP	AP3011K	GA-26 ¹¹²	AMP
AMA1791	GA-6127	AIM	AOF73	GP-462 ²⁴	ARC	AP12	GA-2740	WIPA	AP3011K	GA-26	APF
AMA4504M	GA-6128	AIM	AOF73	GP-24 ²⁶	AWAR	AP120	GA-7	GLD	AP3015	GA-6127	APF
AMA471	GA-6127	AIM	AOF73	GP-462 ²⁴	AWAR	AP121	G-330	ALCA	AP3015	GA-6127	APL
AMA873M	GA-483	AIM	AOF81	GP-81 ³¹	ARC	AP121	GAVW-2	WIPA	AP3015A	GA-6127	APF
AMA874	GA-482	AIM	AOF81	GP-9 ⁵⁸	ARC	AP122	GA-39	COP	AP3015A	GA-6127	APL
AMD01	GA-2106	WOW	AOF81	GP-81 ³¹	ARO	AP122	GA-39	GLD	AP3027	GA-206	APF
AMD183	GA-595	WOW	AOF81	GP-9 ⁵⁸	ARO	AP1220HD	GA-135	COP	AP3027	GA-206	APL
AMD192	GA-2740	WOW	AOF81	GP-81 ³¹	AWAR	AP123C	GA-2719B	AUTO	AP3027A	GA-206	APF
AMD200	GA-133	WOW	AOF81	GP-9 ⁵⁸	AWAR	AP128407	GA-563	QIFA	AP3027A	GA-206	APL
AMF105D	GP-114	AIM	AP 130/8	GA-2184	FTRO	AP131377	GA-493 ¹⁰⁸	QIFA	AP3028	GA-356	APF
AMF185	GP-110	AIM	AP005	GA-18	TFIL	AP132	GAD-1	WIPA	AP3028	GA-356	APL
AMF202	GP-55	AIM	AP009	GA-135	COP	AP132C	GA-50	AUTO	AP3029A	GA-357	APF
AMF211	GP-56	AIM	AP009	GA-135	GLD	AP134C	GA-71	AUTO	AP3029A	GA-357	APL
AMH6072	G-191	AIM	AP1010	GP-3816	APF	AP140	GAD-3	WIPA	AP3035	GA-229	APF
AMH6083	G-153	AIM	AP101222K	GAK-16	GLD	AP141	G-200	AUTO	AP3035	GA-229	APL
AMH6097	G-152	AIM	AP10-1222K	GAK-16	COP	AP142	GA-349	COP	AP3035A	GA-229	APF
AMH6098	G-222	AIM	AP101234K	GAK-20	GLD	AP142	GA-349	GLD	AP3035A	GA-229	APL
AMK426	G-870	LEYL	AP10-1234K	GAK-20	COP	AP144	GA-75	COP	AP3036	GA-8047	APF
AMK462	G-870	LEYL	AP10-1237	GA-24	COP	AP144	GA-75	GLD	AP3036	GA-8047	APL
AMK9	G-238	AIM	AP101237K	GA-24	GLD	AP144	GA-200	WIPA	AP3036A	GA-8047	APF
AML516	G-566	AIM	AP10-1237K	GA-24	COP	AP144	GA-218	WIPA	AP3036A	GA-8047	APL
AML670	GP-53	AIM	AP101240	GA-27	GLD	AP145	GA-429	COP	AP3041	GA-5648	APF
AML691	GP-52 ¹⁰	AIM	AP101240K	GA-27	GLD	AP146	GA-74	COP	AP3041A	GA-5648	APF
AML691	GP-691 ⁴⁸	AIM	AP10-1240K	GA-27	COP	AP146	GA-71	WIPA	AP3064A	GAD-3	APF
AML750A	G-750	AIM	AP101243K	GA-26	GLD	AP147	GA-86	COP	AP3066	G-331	APF
AML750B	G-750	AIM	AP10-1243K	GA-26	COP	AP147FF	G-119	ROLK	AP3066	G-331	APL
AML777	GP-57	AIM	AP101246K	GAK-403	GLD	AP148	GA-2174	CAMP	AP3066A	G-331	APF
AMO41912	G-33	PERK	AP10-1246K	GAK-403	COP	AP156	GAD-3	WIPA	AP3066A	G-331	APL
AMO43911	GP-26	PERK	AP101275K	GA-33	GLD	AP1612	GA-127	VALV	AP3080	GA-200	APF
AMO43912	G-1174 ¹⁰⁸	PERK	AP10-1275K	GA-33	COP	AP1613	GA-128	VALV	AP3080	GA-218	APF
AMS1001	GA-7142	WOW	AP1020	GP-3600	APF	AP1658	GA-158	VALV	AP3080	GA-200	APL
AMS102	GA-7344	WOW	AP1022	GP-28 ⁹	APF	AP178C	GA-192	AUTO	AP3080	GA-218	APL
AMS254	GA-605	WOW	AP1022	GP-430 ⁹	APF	AP18065K	GA-5648	COP	AP3087	GA-2194	FACE
AMS261	GA-607	WOW	AP1022	GP-28 ⁹	APL	AP187	GA-90	COP	AP3087	GA-2194	MIGH
AMW2051	GP-2071W	AIM	AP1022	GP-430 ⁹	APL	AP187	GA-90	GLD	AP31	G-31	APCO
AMW2054	GP-1013Q	AIM	AP1024	GP-58	APF	AP1871	GA-2174	FTRO	AP31	GA-56	GLD
AMW2056	GP-1013Q	AIM	AP1031	GA-277	FACE	AP2	GP-1	AUTO	AP3104A	GP-58 ¹⁵	APL
AMW2067	GP-1011Q	AIM	AP10-3443K	GAK-16	COP	AP20	GP-81 ³¹	AUTO	AP3112	G-750	APF
AN150200	GA-33	JOND	AP10-3779K	GAK-20	COP	AP20	GP-9 ⁵⁸	AUTO	AP3112	G-750	APL
AN150202	GAK-16	JOND	AP10-3779K	GAK-20	GLD	AP200	G-200	APCO	AP3116	GG-5 L	APF
AN150H	GA-608	VOR	AP10-3951	GAP-379	COP	AP212C	GA-55	AUTO	AP3116	GG-5 L	APL
AN203010	GP-761H	JOND	AP10-3951	GAP-379	GLD	AP219	G-836	APF	AP31264	GC-1133	JOND
AN33232N	GAK-16	JOND	AP-1046	GA-174	FACE	AP219	G-836	APL	AP3145A	GP-81	APF
ANS01	GA-6619 ⁹	WOW	AP105	GA-44	GLD	AP219A	G-836	APF	AP3160	G-1163	APF
ANS01	GA-6620 ⁹	WOW	AP10-5043K	GA-98 ¹¹²	COP	AP219A	G-836	APL	AP3186	G-1143	APF
ANS05	GA-75	WOW	AP10-5043K	GA-98 ¹¹²	GLD	AP22	GA-2740	WIPA	AP3186	G-1143	APL
ANS089	GAD-30	WOW	AP1051	GP-3600	APF	AP221	G-834	APF	AP3189	G-31	APF
ANS1001	GA-384	WOW	AP106	GA-11	COP	AP221	G-834	APL	AP3193	GP-54 ¹¹	APF
ANS1002	GAD-15	WOW	AP106	GA-11	GLD	AP221A1	G-834	APF	AP3193	GP-66 ¹⁰	APF
ANS100A	GA-360	WOW	AP10-6032	GA-403	COP	AP221A1	G-834	APL	AP3193	GP-54 ¹¹	APL
ANS100B	GA-361	WOW	AP10-6032	GA-403	GLD	AP228	GP-81	AUTO	AP3193	GP-66 ¹⁰	APL
ANS102A	GA-106 ⁴⁶	WOW	AP1061	GA-275	VALV	AP234	GA-382	VALV	AP3193A	GP-54 ¹¹	APL
ANS102A	GA-326 ⁷¹	WOW	AP10-6587	GA-360	COP	AP235	GAD-30	VALV	AP3193A	GP-66 ¹⁰	APL
ANS102B	GA-206	WOW	AP10-6587	GA-360	GLD	AP236	G-236	APCO	AP3195	GP-171	APF
ANS118	GAD-3	WOW	AP10-6632	GA-6129	COP	AP25	GP-3	AUTO	AP3196A	GP-171	APL
ANS123	GAD-1	WOW	AP10-6632	GA-6129	GLD	AP250C5S	GA-18	COP	AP3201	GP-1122	APF
AOF1	GP-1	ARC	AP10-6641	GA-6127	COP	AP250C5S	GA-18	GLD	AP3201	GP-1122	APL
AOF1	GP-1	ARO	AP10-6641	GA-6127	GLD	AP254	GA-2194	VALV	AP3202	GP-1122	APF
AOF1	GP-1	AWAR	AP10-6769	GA-106 ⁴⁶	COP	AP26	G-870	APF	AP3202	GP-1122	APL
AOF109	GP-42	AWAR	AP10-6769	GA-326 ⁷¹	COP	AP26	G-870	APL	AP3205	GP-36	APF
AOF111	GP-46	AWAR	AP10-6769	GA-106 ⁴⁶	GLD	AP261C	GA-3490	AUTO	AP3205	GP-36	APL
AOF112	GP-46	AWAR	AP10-6769	GA-326 ⁷¹	GLD	AP26350	G-139	JOND	AP3205A	GP-36	APF
AOF123	GP-3429	AWAR	AP10-6775	GA-206	COP	AP26A3	G-870	APL	AP3205A	GP-36	APL
AOF124	GP-44	AWAR	AP10-6775	GA-206	GLD	AP26A4	G-870	APL	AP3206	GP-54	APF
AOF141	G-200	ARC	AP10-6834	GA-361	GLD	AP27688	G-1175	JOND	AP3206	GP-54	APL
AOF141	G-200	ARO	AP107	GA-12	COP	AP276A	G-				

Referencia Cruzada por Numero de Parte

Cross Reference by Part Number



Numero	Gonher	Fabricante	Numero	Gonher	Fabricante	Numero	Gonher	Fabricante	Numero	Gonher	Fabricante
Number	Gonher	Manufacturer	Number	Gonher	Manufacturer	Number	Gonher	Manufacturer	Number	Gonher	Manufacturer
AP3211A	GP-81	APF	AP3422K	GA-33	APF	AP3738	GP-53	APF	AP561	GP-28 ⁸	AUTO
AP3213	GP-54 ¹¹	APF	AP3422K	GA-33	APL	AP3738	GP-53	APL	AP561	GP-430 ⁸	AUTO
AP3213	GP-66 ¹⁰	APF	AP3424	GP-78	APF	AP374	GA-2194	WIPA	AP565	G-613	APF
AP3213	GP-54 ¹¹	APL	AP3424	GP-78	APL	AP386	GA-113	WIPA	AP565	G-613	APL
AP3213	GP-66 ¹⁰	APL	AP3428	G-143	APF	AP390	GA-113	WIPA	AP565A	G-613	APF
AP3213A	GP-54 ¹¹	APL	AP3429	G-163	APF	AP396	GA-3425	WIPA	AP565A	G-613	APL
AP3213A	GP-66 ¹⁰	APL	AP3436	GA-4365	MIGH	AP4	GA-70	GLD	AP57	GA-80	GLD
AP3216A	GP-36	APF	AP-3436	GA-4365	FACE	AP400	GP-3600	AUTO	AP57	GA-4303	WIPA
AP3216A	GP-36	APL	AP3441	GA-277	FACE	AP4005	GA-37	COP	AP59	GA-50	GLD
AP3219A	GP-91	APF	AP3443	GA-303	APF	AP4005	GA-37	GLD	AP59	GAD-3	WIPA
AP3219A	GP-91	APL	AP3463	GA-3425	APF	AP40051	GA-37	GLD	AP601C	GA-735 ¹²⁴	AUTO
AP3220A	GP-42	APF	AP3463	GA-3425	APL	AP4005-1	GA-37	COP	AP615	G-500	APF
AP3220A	GP-42	APL	AP3466	GA-3490	APF	AP414HD	GA-680	COP	AP615A	G-500	APL
AP3221A	GP-54 ¹¹	APF	AP3466	GA-3490	APL	AP428	G-613	ALCA	AP617	GA-71	APF
AP3221A	GP-66 ¹⁰	APF	AP3476	GA-4365	APF	AP428	GA-37	APF	AP617	GA-71	APL
AP3221A	GP-54 ¹¹	APL	AP3485	G-31	APF	AP428	GA-37	APL	AP622	G-225	APF
AP3221A	GP-66 ¹⁰	APL	AP348C	GA-59	AUTO	AP428A	GA-37	APF	AP629	G-296	APF
AP3223	GP-1122	APF	AP3496	GP-53	APF	AP428A	GA-37	APL	AP629	G-296-B	APF
AP3225A	GP-50	APF	AP3496	GP-53	APL	AP4299	GA-180	FACE	AP629	G-296	APL
AP3225A	GP-50	APL	AP3496A	GP-53	APL	AP4299	GA-180	MIGH	AP629	G-296-B	APL
AP3232	GP-38	APF	AP35	GP-13	AUTO	AP4309	GAD-15	KND	AP629F	G-296	APF
AP3232	GP-66	APL	AP3503	GA-26 ¹¹²	AMP	AP4309	GAD-15	MIGH	AP629F	G-296-B	APF
AP3233A	GP-14	APF	AP3503A	GA-26 ¹¹²	AMP	AP4309	GAD-15	MINL	AP629Y	G-296	APF
AP3233A	GP-14	APL	AP3503A	GA-26	APF	AP4309	GAD-15	VALV	AP629Y	G-296-B	APF
AP3239	GP-1108	APF	AP3504	GA-361	APF	AP-4309	GAD-15	FACE	AP63005A	GP-28 ⁸	APF
AP3241	GP-38	APF	AP3504A	GA-361	APF	AP4339	GA-3915	MIGH	AP63005A	GP-430 ⁸	APF
AP3241	GP-38	APL	AP3504A	GA-361	APL	AP-4339	GA-3915	FACE	AP63006A	GP-38	APF
AP3241A	GP-38	APF	AP3507	GA-206	APF	AP433C	GA-86	AUTO	AP651	GA-18	APL
AP3241A	GP-38	APL	AP3507	GA-206	APL	AP4343	GA-5056	KND	AP651	GA-18	APL
AP3242	GPP-18	APF	AP3507A	GA-206	APF	AP4343	GA-5056	MIGH	AP651A	GA-18	APF
AP3244	GP-78	APL	AP3507A	GA-206	APL	AP4343	GA-5056	MINL	AP651A	GA-18	APL
AP3245	GP-3	APF	AP351	GA-195	VALV	AP-4343	GA-5056	FACE	AP67	GA-192	GLD
AP3248A	GP-462	APL	AP3511	GA-892	APF	AP4349	GAVW-2	FACE	AP6774	GAK-403	TFIL
AP3250	GPP-18	APF	AP3511A	GA-892	APF	AP4349	GAVW-2	MIGH	AP68	GA-78	GLD
AP3251	GPP-19	APF	AP3524	GAK-625	APF	AP4356	GA-390	MIGH	AP688	GA-39	APF
AP3252A	GP-1	APF	AP3524	GAK-625	APL	AP4357	GA-216	FACE	AP689	G-566	APF
AP3254	GP-69	APF	AP3524A	GAK-625	APL	AP4357	GA-216	MIGH	AP689	G-566	APL
AP3254	GP-69	APL	AP3525	GAK-625	APF	AP4361	GA-139	MIGH	AP689A	G-566	APF
AP3255	GP-26	APF	AP353	GA-3901	VALV	AP-4361	GA-139	FACE	AP689A	G-566	APL
AP3256	GP-27	APF	AP3530	GAK-216	APF	AP4365	GA-4365	MIGH	AP700	GA-360	APF
AP3256	GP-27	APL	AP3530	GAK-216	APL	AP4372	GA-3901	FACE	AP700	GA-360	APL
AP3257	G-1174 ¹⁰⁸	APL	AP3531	GA-416	APF	AP4372	GA-3901	MIGH	AP700A	GA-360	APF
AP3276	G-1121	APF	AP3531	GA-416	APL	AP4378	GA-174	FACE	AP700A	GA-360	APL
AP3276	G-1121	APL	AP3532	GAK-458	APF	AP4378	GA-174	MIGH	AP71700	GG-1	APL
AP3277	G-1123	APF	AP3532	GAK-458	APL	AP438	G-152	APL	AP71700	GG-4	APL
AP3277	G-1123	APL	AP3532A	GAK-458	APF	AP4468	GA-195	FACE	AP725HD	GA-425	COP
AP328	G-335	ALCA	AP3532A	GAK-458	APL	AP4468	GA-195	MIGH	AP735C	GA-54	AUTO
AP329	GA-2110	WIPA	AP3533A	GA-459	APF	AP4471	GA-471	FACE	AP7360	GA-7360	TFIL
AP3297	GA-49	APF	AP3533A	GA-459	APL	AP4471	GA-471	MIGH	AP736C	GA-3523	AUTO
AP3297	GA-49	APL	AP3537A	GP-390 ⁹³	APL	AP45	GP-3429	AUTO	AP749	GA-4303	KND
AP3297A	GA-49	APF	AP3539A	GP-1013Q	APF	AP45	GA-77	GLD	AP-749	GA-4303	FACE
AP3297A	GA-49	APL	AP3543	GP-68	APF	AP45800A	GP-81 ³¹	APF	AP75	G-871	APF
AP3299	GA-50	APF	AP3543	GP-68	APL	AP45800A	GP-9 ⁹⁸	APF	AP75A4	G-870	APL
AP329C	GA-57	AUTO	AP354C	GA-730	AUTO	AP45800A	GP-81	APL	AP75A5	G-871	APF
AP33	G-33	APCO	AP355	GA-2110	VALV	AP45805A	GP-50	APF	AP76202A	GP-46	APF
AP330	G-330	APCO	AP3550	GAK-216	APF	AP45805A	GP-50	APL	AP77	GA-7	COP
AP3313	GAVW-2	APF	AP3550	GAK-216	APL	AP460	G-222	APF	AP77	GA-7	GLD
AP3313	GAVW-2	APL	AP3551	GA-416	APF	AP4650	GA-436	TFIL	AP7716	GA-7716	TFIL
AP3316	GAVW-4	APF	AP3551	GA-416	APL	AP46501	GA-405	TFIL	AP77401A	GP-51	APF
AP3316	GAVW-4	APL	AP3553	GP-54 ¹¹	APL	AP467C	GA-75	AUTO	AP77501	GP-52 ¹¹⁰	APF
AP3321	GAD-1	APF	AP3553	GP-66 ¹⁰	APL	AP47	GP-46	AUTO	AP77501	GP-691 ⁴⁸	APF
AP3321	GAD-1	APL	AP3557	GAD-3	APF	AP481	G-33	APF	AP77501	GP-52 ¹¹⁰	APL
AP333	G-333	APCO	AP355C	GA-85	AUTO	AP4934	GA-9334	TFIL	AP77501	GP-691 ⁴⁸	APL
AP3335	GA-436	APF	AP3567	GP-40	APF	AP4935	GA-1286	TFIL	AP77501A	GP-52 ¹¹⁰	APL
AP3341	GAVW-2	APF	AP3569	GP-1	APF	AP4960	GA-589	TFIL	AP77501A	GP-691 ⁴⁸	APL
AP3342	GA-277	APF	AP3578	GPP-1122	APF	AP49839	GA-679	COP	AP7816	GA-6690	VALV
AP3342	GA-277	APL	AP357C	GA-303	AUTO	AP49840	GA-680	COP	AP782	GA-230	APF
AP335	GAVW-2	WIPA	AP358	GA-180	VALV	AP49C	GA-70	AUTO	AP782	GA-230	APL
AP3358	G-834	APF	AP3580	GA-274	KND	AP4L4718	GA-375	VALV	AP7821	GA-276	VALV
AP3358	G-834	APL	AP-3580	GA-274	FACE	AP4L4718	GA-375	GLD	AP7825	GAD-294	VALV
AP3358A	G-834	APF	AP3582	G-133	APF	AP4M8047	GA-8047	COP	AP7826	GA-133	VALV
AP3358A	G-834	APL	AP3582	G-989	APF	AP4M8047	GA-8047	GLD	AP782A	GA-230	APF
AP3372A	G-143	APF	AP3582	G-133	APL	AP4M8048	GA-1285	COP	AP783	G-297-B	APF
AP3394	G-162H	APF	AP3582	G-989	APL	AP4M8048	GA-1285	GLD	AP783	GA-7142	VALV
AP3404	G-1175 ¹⁰⁸	APF	AP3588	GA-27	APF	AP4M9334	GA-9334	COP	AP7836	GA-604	VALV
AP3405	G-1173 ¹⁰⁸	APF	AP3592	GA-273	FACE	AP4M9334	GA-9334	GLD	AP7837	GA-166	VALV
AP3406	G-1121F	APF	AP3592	GA-273	KND	AP4M9335	GA-1286	COP	AP7841	GA-322	VALV
AP3406	G-1121F	APL	AP3592	GA-273	MIGH	AP4M9335	GA-1286	GLD	AP7842	GA-381	VALV
AP3408A	G-191	APF	AP3592	GA-273	MINL	AP4M9378	GA-1008	COP	AP7843	GA-7344	VALV
AP3408A	G-191	APL	AP3608	GA-2194	APF	AP4M9378	GA-1008	GLD	AP7845	GA-300	VALV
AP3409A	G-238	APF	AP3616	G-295	APF	AP4M9379	GA-1284	COP	AP7854	GA-217	VALV
AP3409A	G-238	APL	AP3616	G-295	APL	AP4M9379	GA-1284	GLD	AP7857	GAD-118	VALV
AP3410	G-335	APF	AP3627	GA-589	APF	AP50	GA-37	GLD	AP7858	GA-432	VALV
AP3410	G-335	APL	AP3627	GA-589	APL	AP51	GP-3980	AUTO	AP7859	GA-198	VALV
AP3410A	G-335	APL	AP3628	GA-588	APF	AP52	GA-71	GLD	AP7862	GA-141	VALV
AP3411	GP-14	APF	AP3628	GA-588	APL	AP524	G-870	APF	AP7863	GA-165	VALV
AP3411	GP-14	APL	AP3645	GP-40	APF	AP524	G-870	APL	AP7864	GA-198	VALV
AP3411A	GP-14	APF	AP3656	GAVW-2	APF	AP545	GA-2106	VALV	AP7872	GA-164	VALV
AP3411A	GP-14	APL	AP3664	GA-71	APF	AP547	G-191	APF	AP7878	GA-240	VALV
AP3414	GP-34	APF	AP367	GA-277	WIPA	AP547	G-191	APL	AP7879	GA-132	VALV
AP3414	GP-34	APL	AP368	GAVW-2	WIPA	AP5471A	G-191	APF	AP7880	GA-514	VALV
AP3414A	GP-34	APF	AP36820	GP-34	JOND	AP5471A	G-191	APL	AP7885	GA-2114	VALV
AP3414A	GP-34	APL	AP3683	GP-2015W	APF	AP548	G-238	APF	AP7892	GA-5466	VALV
AP3415	G-1174 ¹⁰⁸	APF	AP36841	GAK-216	JOND	AP548	G-238	APL	AP7893	GA-595	VALV
AP3422	GA-33	APF	AP36862	GP-35	JOND	AP5481A	G-238	APF	AP7908	GA-384	VALV
AP3422	GA-33	APL	AP369	GAVW-4	WIPA	AP5481A	G-238	APL	AP795	GA-106 ⁶⁶	APF

REFERENCIA CRUZADA

Para números Gonher con Superíndice vea página 651
For Gonher with Superscript numbers see page 651

Numero	Gonher	Fabricante	Numero	Gonher	Fabricante	Numero	Gonher	Fabricante	Numero	Gonher	Fabricante
Number	Gonher	Manufacturer	Number	Gonher	Manufacturer	Number	Gonher	Manufacturer	Number	Gonher	Manufacturer
AP795	GA-326 ⁷¹	APF	APF135	GA-75	TARG	APF68	GA-78	HUT	APQ132FF	G-33	ROLK
AP795	GA-106 ⁴⁶	APL	APF136P	GA-4365	TOMI	APF728	GA-3637	TARG	APQ141FF	G-200	ROLK
AP795	GA-326 ⁷¹	APL	APF141	G-200	UNI	APF735	GA-54	TARG	APQ147FF	G-119	ROLK
AP795A	GA-106 ⁴⁶	APF	APF141P	G-200	UNI	APF736	GA-3523	TARG	APQ157HYD	G-33	ROLK
AP795A	GA-326 ⁷¹	APF	APF142	GA-349	COP	APF74	GA-55	HUT	APQ166BP	G-34	ROLK
AP795A	GA-106 ⁴⁶	APL	APF142	GA-3566	TARG	APF74	GA-55	TARG	AQX113760	GAK-403	JOND
AP795A	GA-326 ⁷¹	APL	APF144	GA-75	COP	APF74A	GA-86	TARG	AQX47573	GAK-403	JOND
AP79941	GA-425	JOND	APF145	GA-429	COP	APF74R	GA-55	TOMI	AQX94573	GAK-403	JOND
AP7M9045	GA-9045	COP	APF146	GA-74	COP	APF753	GA-89	TARG	AR 114	GA-2160	CAMP
AP7M9045	GA-9045	GLD	APF146	GA-71	TARG	APF77	GA-7	COP	AR 169	GA-410	CHAM
AP7M9046	GA-1287	COP	APF147	GA-86	COP	APF773	GA-3588	HUT	AR 311	GA-2160	FTRO
AP7M9046	GA-1287	GLD	APF147	G-119	UNI	APF773	GA-3588	TARG	AR00234	G-566	CUMM
AP8047	GA-8047	TFIL	APF148	GA-300	COP	APF7836	GA-604	TARG	AR01058	G-566	CUMM
AP8048	GA-1285	TFIL	APF148	GA-830	TARG	APF783A	G-297-B	APF	AR01872	G-566	CUMM
AP81301	GP-1101	APF	APF153	GAD-3	HUT	APF783A	G-297-B	APL	AR01896	G-566	CUMM
AP81302	GPP-14	APF	APF2318	GA-429	HUT	APF7841	GA-322	TARG	AR07076	G-566	CUMM
AP81400A	GP-54	APF	APF26	GAD-1	COP	APF7842	GA-381	TARG	AR07622	G-566	CUMM
AP8191	GA-2193	VALV	APF261	GA-3490	TARG	APF7854	GA-217	TARG	AR07842	G-566	CUMM
AP83	GA-85	GLD	APF299	GAVW-2	TARG	APF79	GA-12	HUT	AR09465	G-566	CUMM
AP839	GA-405	APF	APF299A1	GG-48	APF	APF79	GA-12	TOMI	AR101278	GP-35	JOND
AP839	GA-106 ⁴⁶	APL	APF299A1	GG-48	APL	APF826	GA-3681	TARG	AR101728	GP-34	JOND
AP839A	GA-405	APF	APF300	GA-277	TARG	APF83	GA-85	COP	AR109	GA-135	AIR
AP839A	GA-405	APL	APF302	GA-4303	TARG	APF83	GA-85	HUT	AR12/18	GP-22	PAMO
AP84	GA-730	GLD	APF307	GA-2740	TARG	APF83	GA-85	TARG	AR1205R	G-331	JOND
AP84102A	GP-3600	APF	APF-3080	GA-3445	HUT	APF84	GA-730	COP	AR122	GA-135	AIR
AP84102A	GP-3600	APL	APF31	GA-56	COP	APF84	GA-730	HUT	AR12990	GP-53	CUMM
AP847	GA-6129	APF	APF31	GA-56	HUT	APF84	GA-730	TARG	AR13242	GP-1013Q	CUMM
AP847	GA-6129	APL	APF3126A	G-1173	APF	APF843	GA-277	HUT	AR13274	GPP-14	CUMM
AP847A	GA-6129	APF	APF3138	GA-54	HUT	APF872A	GG-48	APF	AR1400	G-331	JOND
AP847A	GA-6129	APL	APF3149	GA-3523	HUT	APF872A	GG-48	APL	AR1400R	G-331	JOND
AP849	GAK-20	APF	APF3178A	GG-7	APL	APF90	GA-303	COP	AR1543	GA-891	FCAR
AP849A	GAK-20	APL	APF3186A	G-1143	APL	APF90	GA-303	HUT	AR1580	GA-109	FCAR
AP849K	GAK-20	APF	APF3192	GA-271	HUT	APF90	GA-303	TARG	AR1581	GA-229	FCAR
AP849K	GAK-20	APL	APF3197A	GP-1122	APF	APF905	GA-153	TARG	AR-1596	GA-209	INDUCL
AP8528	GA-49	TFIL	APF3201A	GP-1122	APF	APF91	GA-59	COP	AR-15965Y	GA-210	INDUCL
AP853	GA-27	APF	APF3201A	GP-1122	APL	APF91	GA-59	HUT	AR1599	GA-107	FCAR
AP853	GA-27	APL	APF3231A	GP-1101	APF	APF91	GA-59	TARG	AR17	GP-31	PAMO
AP853K	GA-27	APF	APF3244A	GP-78	APL	APF92	GA-57	COP	AR171	GA-44	GIS
AP853K	GA-27	APL	APF3253A	GPP-1122	APF	APF92	GA-57	HUT	AR178	GA-230	GIS
AP856	GAK-403	APF	APF3255A	GP-26	APF	APF92	GA-57	TARG	AR1A	GP-1	CHP
AP856	GAK-403	APL	APF3256A	GP-27	APF	APF93	GA-325	COP	AR200	GA-230	GIS
AP856K	GAK-403	APCO	APF3256A	GP-27	APL	APF93	GA-325	HUT	AR20072R	G-331	JOND
AP856K	GAK-403	APF	APF3276A	G-1121	APF	APF93	GA-325	TARG	AR20554	G-33	JOND
AP856K	GAK-403	APL	APF3276A	G-1121	APL	APF94	GA-3300	COP	AR21424	GA-98 ¹¹²	JOND
AP857	GAK-16	APF	APF3277A	G-1123	APF	APF94	GA-3300	HUT	AR21627R	GPP-14	JOND
AP857K	GAK-16	APF	APF3277A	G-1123F	APF	APF94	GA-3300	TARG	AR21777R	G-139	JOND
AP872	GG-48	APF	APF3405A	G-1173	APF	APF95	GA-44	HUT	AR229	GA-18	FCAR
AP872	GG-48	APL	APF3406A	G-1121F	APL	APF95	GA-44	TOMI	AR234	GA-1287	FCAR
AP898	GA-139	VALV	APF3407A	G-1123F	APL	APF971	GA-274	TARG	AR239	GA-375	FCAR
AP90	GA-303	GLD	APF3424A	GP-78	APL	APF974	GA-3916	TARG	AR24	GP-20	CHP
AP901	GAK-403	WIPA	APF3472	GA-274	HUT	APF99	GA-86	HUT	AR240	GA-37	FCAR
AP903	GA-33 ¹¹²	WIPA	APF354	GA-89	HUT	APG427	GG-6	AUTO	AR25	GP-3	CHP
AP91	GA-59	GLD	APF37	GA-44	HUT	APG434	GG-19	AUTO	AR2512SY	GA-827	FCAR
AP917	GA-392	VALV	APF37R	GA-44	TOMI	APG441	GG-7	AUTO	AR253	GAK-16	FCAR
AP92	GA-57	GLD	APF4	GA-70	COP	APG470	GG-16	AUTO	AR256	GA-33 ¹¹²	FCAR
AP924K	GAK-458	APF	APF4	GA-70	HUT	APG471	GG-17	AUTO	AR257	GA-26	FCAR
AP924K	GAK-458	APL	APF4	GA-70	TARG	APH10	GP-5	ALCA	AR257	GA-26 ¹¹²	INDUCL
AP93	GA-325	GLD	APF45	GA-77	COP	APH11	GP-5	APCO	AR258	GA-403	FCAR
AP94	GA-3300	GLD	APF45	GA-77	HUT	APH13	GP-13	APCO	AR259	GA-27	FCAR
AP956	GA-21	COP	APF45	GA-77	TARG	APH13X	GP-13	APCO	AR26350	G-139	JOND
AP956	GA-21	GLD	APF50	GA-37	COP	APH14	GP-3	APCO	AR26350R	G-139	JOND
AP96	GA-230	WIPA	APF50	GA-90	HUT	APH25	GP-20	ALCA	AR28072	G-331	JOND
AP974	GA-3916	KND	APF52	GA-71	COP	APH25	GP-20	APCO	AR28072R	G-331	JOND
AP974	GA-3916	MIGH	APF52	GA-71	HUT	APH26	GP-3	ALCA	AR28110R	G-139	JOND
AP974	GA-3916	MINL	APF52	GA-71	TARG	APH30	GP-3	APCO	AR28111R	G-139	JOND
AP-974	GA-3916	FACE	APF55	GA-7	HUT	APH3072A	G-222	APF	AR28271	G-331	JOND
AP9835	GA-467	TFIL	APF55	GA-7	TOMI	APH3072A	G-222	APL	AR28271R	G-331	JOND
APB50	GP-50	ALCA	APF57	GA-80	COP	APH3232A	GP-66	APL	AR29	GP-13	CHP
APB50	GP-50	APCO	APF57	GA-80	HUT	APH43	GP-81 ¹¹²	APCO	AR29	GP-34	PAMO
APB59	GA-100	AUTO	APF57A	GA-74	TARG	APH43	GP-9 ⁹⁸	APCO	AR29174R	G-31	JOND
APB60	GA-113	AUTO	APF57R	GA-80	TOMI	APH4381A	G-152	APF	AR2917AR	G-31	JOND
APC121	GA-360	FAPO	APF58	GA-105	COP	APH440A	G-152	APL	AR29554	G-33	JOND
APC123	GA-18	FAPO	APF58	GA-105	HUT	APH4601A	G-222	APF	AR29554R	G-33	JOND
APC136	GA-436	FAPO	APF5832	GAVW-2	HUT	APH4601A	G-222	APL	AR29583R	G-1175 ¹⁰⁸	JOND
APC155	GA-405	FAPO	APF5833	GAVW-2	HUT	APH8	GP-1	ALCA	AR29586R	G-1174 ¹⁰⁸	JOND
APC163	GA-106 ⁴⁶	FAPO	APF5835	GA-2719B	HUT	APH8	GP-1	APCO	AR29589R	G-31	JOND
APC163	GA-326 ⁷¹	FAPO	APF5883	GA-230	HUT	APH814	GP-3	ALCA	AR30643R	G-33	JOND
APC187	GA-49	FAPO	APF59	GA-50	COP	APH8A	GP-1	APCO	AR30644	GA-20	JOND
APC207	GA-6129	FAPO	APF59	GA-50	HUT	APK174	GA-33 ¹¹²	FAPO	AR30644	GAK-20	JOND
APF103	GAD-1	HUT	APF59	GA-50	TARG	APK260	GAK-403	FAPO	AR30644R	GAK-20	JOND
APF1032A	GA-5056	TARG	APF60	GA-11	HUT	APP3055A	GA-55	APL	AR31267	GPP-14	JOND
APF1043	GA-273	TARG	APF60	GA-11	TOMI	APP3059A	GA-57	APF	AR31267R	GPP-14	JOND
APF1046	GA-174	TARG	APF600	GA-4828	TARG	APP3064A	GAD-3	APF	AR31627R	GPP-14	JOND
APF108	GA-55	COP	APF601	GA-735 ¹²⁴	TARG	APP3080A	GA-200	APF	AR33926R	GPP-14	JOND
APF1096P	GA-8	TOMI	APF602	GA-271	TARG	APP3080A	GA-218	APF	AR35044	GAK-20	JOND
APF110	GA-349	HUT	APF604	GA-4325	TARG	APP3313A	GAVW-2	APF	AR35769R	GAK-20	JOND
APF110	GAD-3	TARG	APF611	GA-3814	TARG	APP3313A	GAVW-2	APL	AR3603	GA-373	FCAR
APF113	GA-75	HUT	APF629A	G-296	APF	APP3316A	GAVW-4	APF	AR-3603	GA-373	INDUCL
APF113	GA-75	TARG	APF629A	G-296-B	APF	APP3316A	GAVW-4	APL	AR36043R	G-33	JOND
APF115	GA-3490	HUT	APF629A	G-296	APL	APP3321A	GAD-1	APF	AR36044	GAK-20	JOND
APF120	GA-74	HUT	APF629A	G-296-B	APL	APP3321A	GAD-1	APL	AR36044R	GAK-20	JOND
APF123	GA-2719B	TARG	APF641	GA-3425	TARG	APP3342A	GA-277	APF	AR36414	GAK-20	JOND
APF129	GA-3424	HUT	APF67	GA-192	COP	APP3466A	GA-3490	APF	AR39534	GA-98 ¹¹²	JOND
APF129	GA-3424	TARG	APF67	GA-192	HUT	APP3466A	GA-3490	APL	AR39798	GA-98 ¹¹²	JOND
APF131	GA-3425	HUT	APF67	GA-192	TARG	APP617A	GA-71	APF	AR-3990	GA-3551 ²⁵	INDUCL
APF132	G-33	UNI	APF68	GA-78	COP	APQ12FF	GP-3	ROLK	AR-3990	GA-3551 XT ²⁴	INDUCL

Referencia Cruzada por Numero de Parte

Cross Reference by Part Number



Numero	Gonher	Fabricante	Numero	Gonher	Fabricante	Numero	Gonher	Fabricante	Numero	Gonher	Fabricante
Number	Gonher	Manufacturer	Number	Gonher	Manufacturer	Number	Gonher	Manufacturer	Number	Gonher	Manufacturer
AR40319	GA-98 ¹¹²	JOND	ARM10-5043	GA-98 ¹¹²	AIR	ARM1580	GA-109	AIR	ARM912	GA-8047	AIR
AR40321	GA-98 ¹¹²	JOND	ARM10-5255	GA-26	AIR	ARM1580S	GA-119	AIR	ARM926	GA-679	AIR
AR411	G-870	JOND	ARM10-6032	GA-403	AIR	ARM15838	GA-37	AIR	ARM936	GA-826	AIR
AR411R	G-870	JOND	ARM10-6587	GA-360	AIR	ARM1596	GA-209	AIR	ARM956	GA-21	AIR
AR43261	GP-34	JOND	ARM10-6632	GA-6129	AIR	ARM1596S	GA-210	AIR	ARM9618	GA-616	AIR
AR43634	GP-34	JOND	ARM10-6641	GA-6127	AIR	ARM1599S	GA-108	AIR	ARM99-0207	GA-49	AIR
AR45	GP-3429	CHP	ARM10-6769	GA-106 ⁴⁶	AIR	ARM1806S	GA-5648	AIR	ARP102	GA-105	AIR
AR45097	GPP-14	JOND	ARM10-6769	GA-326 ⁷¹	AIR	ARM18-1000	GA-27	AIR	ARP1032	GA-5056	AIR
AR45098	GPP-14	JOND	ARM10-6775	GA-206	AIR	ARM18-1001	GA-26	AIR	ARP1042	GPP-19	AIR
AR45943	GA-360 ¹⁰⁴	JOND	ARM10-6834	GA-361	AIR	ARM18-1002	GA-6129	AIR	ARP1046	GA-174	AIR
AR45943	GA-361 ¹⁰⁸	JOND	ARM10-7672	GA-106 ⁴⁶	AIR	ARM18-1006	GA-376	AIR	ARP110	GA-349	MICF
AR46003	GA-360	JOND	ARM10-7672	GA-326 ⁷¹	AIR	ARM18-1007	GA-229	AIR	ARP113	GA-75	MICF
AR46004	GA-361	JOND	ARM10-9155	GA-356	AIR	ARM18-1008	GA-378	AIR	ARP113	GA-75	REX
AR46179	GA-98 ¹¹²	JOND	ARM10-9159	GA-357	AIR	ARM18-1009	GA-6880	AIR	ARP119	GA-7	AIR
AR46180	GA-98 ¹¹²	JOND	ARM10-9726	GA-31	AIR	ARM18-1019	GA-109	AIR	ARP120	GA-74	MICF
AR46181	GA-98 ¹¹²	JOND	ARM11-0022	GAK-625	AIR	ARM18-1028	GA-209	AIR	ARP124	GA-3300	MICF
AR46481	GA-403	JOND	ARM11-0456	GAK-16	AIR	ARM18-1034	GA-360	AIR	ARP129	GA-3424	MICF
AR47	GP-46	CHP	ARM1112	GA-27	AIR	ARM-18-1038	GA-879	AIR	ARP131	GA-3425	MICF
AR47100	GA-360 ¹⁰⁴	JOND	ARM1112K	GA-27	AIR	ARM18-1039	GA-356	AIR	ARP132	GA-50	AIR
AR47100	GA-361 ¹⁰⁸	JOND	ARM1116	GA-9045	AIR	ARM18-1042	GA-563	AIR	ARP133	GA-80	AIR
AR49839	GA-679	JOND	ARM112	GPP-19	AIR	ARM18-1045	GAK-20	AIR	ARP134	GA-78	AIR
AR49840	GA-680	JOND	ARM1126	GA-106 ⁴⁶	AIR	ARM18-1046	GA-106 ⁴⁶	AIR	ARP135	GA-54	MICF
AR50041	G-295	JOND	ARM1126	GA-326 ⁷¹	AIR	ARM18-1046	GA-326 ⁷¹	AIR	ARP1494	GA-200	AIR
AR502	GA-6129	FCAR	ARM112K	GA-27	AIR	ARM18-1050	GA-33 ¹¹²	AIR	ARP1494	GA-218	AIR
AR502SY	GA-6127	FCAR	ARM1143	GAD-30	AIR	ARM18-1052	GAK-16	AIR	ARP15	GA-3490	MICF
AR507	GA-106 ⁴⁶	FCAR	ARM11-4500	GA-892	AIR	ARM18-1054	GAK-403	AIR	ARP16546	GAD-294	AIR
AR507	GA-326 ⁷¹	FCAR	ARM11-4648	GAK-216	AIR	ARM18-1063	GAK-625	AIR	ARP2100	GA-7	AIR
AR51480	G-566	JOND	ARM11-4747	GA-98 ¹¹²	AIR	ARM18-1095	GA-1095	AIR	ARP2103	GAD-3	AIR
AR523	GA-360	FCAR	ARM-11-5069	GA-879	AIR	ARM18-1099	GA-376	AIR	ARP2108	GA-71	AIR
AR536	GA-356	FCAR	ARM-11-6127	GA-885	AIR	ARM18-1102	GA-9045	AIR	ARP2111	GAD-1	AIR
AR5365Y	GA-357	FCAR	ARM11-6345	GA-891	AIR	ARM18-1104	GA-9334	AIR	ARP212	GA-55	AIR
AR5365Y	GA-357	INDUCL	ARM11-6880	GA-6880	AIR	ARM18-1118	GA-7716	AIR	ARP212HD	GA-55 ¹¹³	AIR
AR54	GAK-20	FCAR	ARM11-6918	GA-378	AIR	ARM2178	GA-392	AIR	ARP213	GA-422	AIR
AR54336	GA-425	JOND	ARM11-6918-0	GA-378	AIR	ARM24	GA-827	AIR	ARP2137	GA-44	AIR
AR54337	GA-426	JOND	ARM11-7404	GA-31	AIR	ARM2400	GA-436	AIR	ARP2181	GPP-19	AIR
AR546	GA-426	JOND	ARM11-7797	GA-229	AIR	ARM2401	GA-405	AIR	ARP2196	GA-230	AIR
AR5626RS	GA-864R	RAR	ARM11-8047	GA-376	AIR	ARM2402	GA-436	AIR	ARP2199	GAD-3	AIR
AR58956	GP-14	JOND	ARM11-8155	GA-356	AIR	ARM2499	GA-499R	AIR	ARP223	GA-56 ⁹⁰	AIR
AR-592	GA-376	INDUCL	ARM11-8160	GAK-403	AIR	ARM27-0336	GA-251	AIR	ARP2318	GA-429	MICF
AR60	GA-3424	CHP	ARM11-8829	GA-891	AIR	ARM297	GA-37	AIR	ARP3	GA-71	AIR
AR6016	GA-303	TFIL	ARM11-9374	GA-361	AIR	ARM3	GA-39	AIR	ARP3003	GAD-1	AIR
AR6018	GA-75	TFIL	ARM11-9538	GAK-1532	AIR	ARM300	GAD-30	AIR	ARP3010	GAD-1	AIR
AR60253	G-613	CUMM	ARM11-9587	GA-509 ¹⁴	AIR	ARM3002	GA-467	AIR	ARP31	GA-56	AIR
AR61127	G-566	CUMM	ARM11-9648	GAK-216	AIR	ARM313	GA-426	AIR	ARP31	GA-56	REX
AR61832	G-566	CUMM	ARM11-9649	GA-416	AIR	ARM323	GA-588	AIR	ARP3137	GA-101	MICF
AR61967	GA-679	JOND	ARM11-9726	GA-31	AIR	ARM344	GAK-1532	AIR	ARP3138	GA-54	MICF
AR61968	GA-680	JOND	ARM11-9775	GAK-16	AIR	ARM361	GAK-16	AIR	ARP3149	GA-3523	MICF
AR61988	GA-6127	JOND	ARM12-0215	GA-329	AIR	ARM362	GA-2984	AIR	ARP3195	GA-3588	MICF
AR6320RS	GA-516R	PARK	ARM12-0219	GA-239	AIR	ARM410	GA-33 ¹¹²	AIR	ARP340	GA-86	AIR
AR6325RS	GA-516R	PARK	ARM12-0841	GA-6129	AIR	ARM410K	GA-33 ¹¹²	AIR	ARP342	GA-86	AIR
AR640	GA-3424	CHP	ARM12-0842	GA-106 ⁴⁶	AIR	ARM414	GA-680	AIR	ARP348	GA-59	AIR
AR64104	GA-416 ¹⁰⁸	JOND	ARM12-0842	GA-326 ⁷¹	AIR	ARM492	GA-18	AIR	ARP37	GA-44	AIR
AR64104	GAK-216 ¹⁰⁴	JOND	ARM1211	GA-5648	AIR	ARM49839	GA-679	AIR	ARP388	GA-3501	AIR
AR71365	GA-416 ¹⁰⁸	JOND	ARM1211K	GA-5648	AIR	ARM49840	GA-680	AIR	ARP394	GA-6	AIR
AR71635	GAK-216 ¹⁰⁴	JOND	ARM1214	GA-26	AIR	ARM50	GA-37	AIR	ARP4	GA-70	AIR
AR75601	G-331	JOND	ARM1214K	GA-26	AIR	ARM50-1042	GAK-216	AIR	ARP4	GA-70	MICF
AR75603	G-331	JOND	ARM122	GPP-19	AIR	ARM501K	GAK-16	AIR	ARP4	GA-70	REX
AR75606	G-331	JOND	ARM12-2492	GAK-403	AIR	ARM505K	GAK-1532	AIR	ARP4105	GA-2719B	AIR
AR757601	G-331	JOND	ARM12-2510	GA-33 ¹¹²	AIR	ARM509	GAK-16	AIR	ARP42	GA-77	AIR
AR757603	G-331	JOND	ARM12-2514	GAK-16	AIR	ARM509K	GAK-16	AIR	ARP4206	GAD-1	AIR
AR762	GPP-25	ARC	ARM12-2517	GAK-20	AIR	ARM5-1	GA-37	AIR	ARP45	GA-77	AIR
AR76434	GAK-403	JOND	ARM12-3412	GAP-381	AIR	ARM510	GA-18	AIR	ARP45	GA-77	MICF
AR79679	GA-679	JOND	ARM12-4046	GA-398	AIR	ARM511	GAK-16	AIR	ARP45	GA-77	REX
AR79680	GA-680	JOND	ARM12-4069	GA-361	AIR	ARM511K	GAK-16	AIR	ARP50	GA-85	AIR
AR79941	GA-425	JOND	ARM12-4070	GA-360	AIR	ARM52-7484	GA-197R	AIR	ARP50	GA-90	MICF
AR79942	GA-426	JOND	ARM12-4164	GAK-458	AIR	ARM52-7680	GA-768R	AIR	ARP52	GA-303	AIR
AR81913	GAK-216	JOND	ARM12-4165	GA-459	AIR	ARM52-7683	GA-683R	AIR	ARP52	GA-71	MICF
AR84228	GAK-216	JOND	ARM12-4861	GA-251	AIR	ARM52-9104	GA-529	AIR	ARP52	GA-71	REX
AR86745	G-270	JOND	ARM12-6310	GAK-16	AIR	ARM53-3235	GA-221R	AIR	ARP53	GA-55	AIR
AR86755	G-293	JOND	ARM12-7784	GAK-458	AIR	ARM5978	GA-2804 T	AIR	ARP-554	GA-3445	AIR
AR87112	GP-1011Q	JOND	ARM12-7787	GA-459	AIR	ARM600K	GA-98 ¹¹²	AIR	ARP57	GA-3300	AIR
AR87114	GP-2071W	JOND	ARM12-8407	GA-563	AIR	ARM610K	GA-98 ¹¹²	AIR	ARP57	GA-80	MICF
AR87114	GP-2071W	JOND	ARM12-8494	GA-493 ¹⁰⁸	AIR	ARM611	GAK-403	AIR	ARP57	GA-80	REX
AR88276	GP-1011Q	JOND	ARM12-9472	GA-372	AIR	ARM611K	GAK-403	AIR	ARP574	GA-74	AIR
AR89379	GP-1011Q	JOND	ARM12-9544	GA-107	AIR	ARM612	GA-1284	AIR	ARP58	GA-105	REX
AR89380	GP-2071W	JOND	ARM1308	GA-482	AIR	ARM625	GA-589	AIR	ARP59	GA-50	MICF
AR89381	GP-2071W	JOND	ARM13-0959	GA-373	AIR	ARM712	GA-1285	AIR	ARP59	GA-50	REX
AR9	GP-40	PAMO	ARM1344	GA-49	AIR	ARM713	GA-1286	AIR	ARP603	GA-2740	AIR
AR94510	G-339H	JOND	ARM13-4742	GA-376	AIR	ARM716	GA-1287	AIR	ARP640	GA-3424	AIR
AR94650	GP-1011Q	JOND	ARM13-4743	GA-229	AIR	ARM725	GA-425	AIR	ARP67	GA-192	AIR
AR94651	GP-1011Q	JOND	ARM13-4744	GA-378	AIR	ARM7360	GA-7360	AIR	ARP67	GA-192	MICF
AR94652	GP-1013Q	JOND	ARM13-4745	GA-6880	AIR	ARM7400	GA-2804 T	AIR	ARP67	GA-192	REX
AR95758	GA-758	JOND	ARM13-6847	GA-329	AIR	ARM7716	GA-7716	AIR	ARP671	GA-3490	AIR
AR95759	GA-759	JOND	ARM13-7178	GA-229	AIR	ARM80-2821	GA-6128	AIR	ARP68	GA-78	REX
AR98329	GP-35	JOND	ARM13-8523	GA-376	AIR	ARM80-3915	GA-106 ⁴⁶	AIR	ARP728	GA-3637	AIR
AR98330	GP-57	JOND	ARM14125	GA-375	AIR	ARM80-3915	GA-326 ⁷¹	AIR	ARP735	GA-54	AIR
ARF122	GA-135	AIR	ARM14-1317	GA-389	AIR	ARM810	GAK-20	AIR	ARP736	GA-3523	AIR
ARM1008	GA-29	AIR	ARM14182	GA-1203	AIR	ARM810K	GAK-20	AIR	ARP74	GA-11	AIR
ARM10-1222	GAK-16	AIR	ARM14185	GA-1203	AIR	ARM812	GA-1008	AIR	ARP74	GA-55	MICF
ARM101234	GAK-20	AIR	ARM14-2100	GA-371	AIR	ARM82-2858	GA-880R	AIR	ARP74	GA-55	REX
ARM10-1240	GA-27	AIR	ARM1461	GAK-16	AIR	ARM830	GAK-20	AIR	ARP746	GA-3501	AIR
ARM10-1243	GA-26	AIR	ARM14-8044	GA-372	AIR	ARM830K	GAK-20	AIR	ARP75	GA-7	AIR
ARM10-1246	GAK-403	AIR	ARM-14-8727	GA-642	AIR	ARM8406	GA-240	AIR	ARP753	GA-89	AIR
ARM10-1275	GA-33 ¹¹²	AIR	ARM15-0694	GA-694	AIR	ARM8482	GA-482	AIR	ARP76	GA-12	AIR
ARM10-3443	GAK-16	AIR	ARM15-3551	GA-3551 ¹⁵	AIR	ARM8483	GA-483	AIR	ARP773	GA-3588	AIR
ARM10-3779	GAK-20	AIR	ARM15-3551	GA-3551 XT ⁵⁴	AIR	ARM907	GA-21	AIR	ARP785	GA-3647	AIR

REFERENCIA CRUZADA

Numero	Gonher	Fabricante	Numero	Gonher	Fabricante	Numero	Gonher	Fabricante	Numero	Gonher	Fabricante
Number	Gonher	Manufacturer	Number	Gonher	Manufacturer	Number	Gonher	Manufacturer	Number	Gonher	Manufacturer
ARP826	GA-3681	AIR	AT15088T	G-139	JOND	ATA-240	GA-37	ATSA	ATC-4163	G-297	ATSA
ARP83	GA-85	MICF	AT166136	GA-206	JOND	ATA-2512	GA-826	ATSA	ATC-4163	G-297-B	ATSA
ARP83	GA-85	REX	AT169911	GA-853R ¹⁰⁴	JOND	ATA-2512SY	GA-827	ATSA	ATG-1	GG-1	ATSA
ARP84	GA-730	AIR	AT171853	GA-853R	JOND	ATA-253	GA-16	ATSA	ATG-1	GG-4	ATSA
ARP84	GA-730	MICF	AT1730N	GAK-16	JOND	ATA-253K	GAK-16	ATSA	ATG-11	GG-6	ATSA
ARP84	GA-730	REX	AT17370	GAK-16	JOND	ATA-256	GA-33	ATSA	ATG-12	GG-7	ATSA
ARP85	GA-90	AIR	AT17370R	GAK-16	JOND	ATA-256K	GA-33 ¹¹²	ATSA	ATG-2	GG-3	ATSA
ARP86	GA-429	AIR	AT17370T	GAK-16	JOND	ATA-258K	GAK-403	ATSA	ATG-2	GG-5	ATSA
ARP90	GA-303	MICF	AT17387	G-296	JOND	ATA-259	GA-27	ATSA	ATG-2	GG-5 L	ATSA
ARP90	GA-303	REX	AT17387	G-296-B	JOND	ATA-2662	GAVW-22	ATSA	ATG-20	GG-20	ATSA
ARP91	GA-349	AIR	AT17387	G-296	LANZ	ATA-2663	GA-200	ATSA	ATG-3359	GG-45	ATSA
ARP91	GA-59	MICF	AT17387	G-296-B	LANZ	ATA-305	GA-730	ATSA	ATG-3388	GG-16	ATSA
ARP91	GA-59	REX	AT17387T	G-296	JOND	ATA-3203	GA-21	ATSA	ATG-3389	GG-17	ATSA
ARP92	GA-57	AIR	AT17387T	G-296-B	JOND	ATA-3245	GAD-30	ATSA	ATG-3499	GG-8	ATSA
ARP92	GA-57	MICF	AT17391	GAK-16	JOND	ATA-326	GA-59	ATSA	ATG-3499	GG-8 L	ATSA
ARP92	GA-57	REX	AT17391T	GAK-16	JOND	ATA-327	GA-57	ATSA	ATG-3587	GG-8	ATSA
ARP93	GA-325	AIR	AT178516	GA-966R	JOND	ATA-3280	GA-405	ATSA	ATG-3587	GG-8 L	ATSA
ARP93	GA-325	MICF	AT178517	GA-967R	JOND	ATA-3300	GA-3300	ATSA	ATG-3606	GG-5	ATSA
ARP93	GA-325	REX	AT18426	GAK-403	JOND	ATA-3384	GAVW-2	ATSA	ATG-3606	GG-5 L	ATSA
ARP94	GA-42	AIR	AT18426T	GAK-403	JOND	ATA-3399	GAVW-4	ATSA	ATG-3641	GG-79	ATSA
ARP94	GA-3300	MICF	AT18526	GAK-403	JOND	ATA-3424	GA-3424	ATSA	ATG-3727	GG-46	ATSA
ARP94	GA-3300	REX	AT18649	GAK-16	JOND	ATA-347	GA-429	ATSA	ATG-3728	GG-3728	ATSA
ARP97	GA-75	AIR	AT18649T	GAK-16	JOND	ATA-351	GA-75	ATSA	ATG-3729	GG-25	ATSA
ARP99	GA-86	MICF	AT18650	GAK-16	JOND	ATA-3517	GA-377	ATSA	ATG-3769	GG-42	ATSA
ARS1189	GA-516R	TFIL	AT18650T	GAK-16	JOND	ATA-3518	GA-372	ATSA	ATG-3802A	GG-47	ATSA
ARS6320RS	GA-516R	PARK	AT18675	GA-98 ¹¹²	JOND	ATA-3523	GA-3523	ATSA	ATG-3829	GG-251	ATSA
ARS9839	GA-864R	TFIL	AT18675T	GA-98 ¹¹²	JOND	ATA-353	GAD-3	ATSA	ATG-3850	GG-1872	ATSA
AS-1010	GAK-20	SAKU	AT19044T	GP-14	JOND	ATA-3537	GA-54	ATSA	ATG-3893	GG-62	ATSA
AS-1014	GAK-16	SAKU	AT193883	GP-34	JOND	ATA-3549	GA-89	ATSA	ATG-4194	GG-94	ATSA
AS-1304	GA-27	SAKU	AT19852	GAK-16	JOND	ATA-3551	GA-3551 ²⁵	ATSA	ATG-4777	GG-63	ATSA
AS136	GA-55	SIEG	AT19852H	GAK-16	JOND	ATA-3551	GA-3551 XT ⁶⁴	ATSA	ATG-5237	GG-137	ATSA
AS146PL	GA-71	SIEG	AT19852T	GAK-16	JOND	ATA-3559	GA-271	ATSA	ATG-6	GG-1	ATSA
AS15000-2300	GP-58 ⁸	KOMA	AT203469	GA-697R	JOND	ATA-3588	GA-3588	ATSA	ATG-6	GG-4	ATSA
AS15000-2300L	GP-58 ⁸	KOMA	AT20488	GAK-403	JOND	ATA-3597	GA-734 ⁹¹	ATSA	ATG-6348	GG-41	ATSA
AS160PL	GA-70	SIEG	AT20488H	GAK-403	JOND	ATA-3597	GA-735	ATSA	ATG-64	GG-64	ATSA
AS1825	GAK-16	SAKU	AT20727	GAK-16	JOND	ATA-3603	GA-373	ATSA	ATG-6563	GG-61	ATSA
AS184PL	GA-77	SIEG	AT20728	GAK-16	JOND	ATA-3647	GA-3647	ATSA	ATG-6566	GG-65	ATSA
AS189	GA-50	SIEG	AT20728T	GAK-16	JOND	ATA-3660	GA-277	ATSA	ATG-6567	GG-67	ATSA
AS189PL	GA-50	SIEG	AT21533	GA-98 ¹¹²	JOND	ATA-3705	GA-154	ATSA	ATG-66	GG-32	ATSA
AS19	GA-100	SIEG	AT222722	GA-697R	JOND	ATA-3717	GA-274	ATSA	ATG-6613	GG-580	ATSA
AS192	GA-192	SIEG	AT22892	GAK-16	JOND	ATA-381	GA-74	ATSA	ATG-7018	GG-7018	ATSA
AS1922	GA-192	SIEG	AT22982	GAK-16	JOND	ATA-3814	GA-3814	ATSA	ATG-7092	GG-30	ATSA
AS-2204	GAK-16	SAKU	AT24275	GAK-403	JOND	ATA-3901	GA-3901	ATSA	ATG-7248	GG-72	ATSA
AS-2205	GA-33 ¹¹²	SAKU	AT25981	GAK-403	JOND	ATA-3902	GA-253	ATSA	ATG-7315	GG-66	ATSA
AS24	GA-113	SIEG	AT28724	GA-360	JOND	ATA-3916	GA-3916	ATSA	ATG-7416	GG-84	ATSA
AS303	GA-303	SIEG	AT300487	GA-770R	JONB	ATA-3924	GA-153	ATSA	ATG-7596	GG-92	ATSA
AS305	GA-730	SIEG	AT30644R	GAK-20	JOND	ATA-4010	GA-272	ATSA	ATG-77	GG-29	ATSA
AS324A	GA-85	SIEG	AT308578	GP-1105	JOND	ATA-4309	GAD-15	ATSA	ATG-881	GG-92	ATSA
AS325	GA-325	SIEG	AT314164	GP-761H	JOND	ATA-4325	GA-4325	ATSA	ATG-95	GG-95	ATSA
AS326	GA-59	SIEG	AT31825	GA-33 ¹¹²	JOND	ATA4775	GA-323	ATOX	ATL-1133-C	GC-1133	ATSA
AS327	GA-57	SIEG	AT34670	G-331	JOND	ATA-4828	GA-4828	ATSA	ATL-1133-S	GS-1133	ATSA
AS3300	GA-3300	SIEG	AT38431	GP-66	JOND	ATA-502	GA-6129	ATSA	ATL-1169	G-1176	ATSA
AS340A	GA-86	SIEG	AT41419	GP-26	JOND	ATA-502SY	GA-6127	ATSA	ATL-1173	G-1173	ATSA
AS3425	GA-3425	SIEG	AT41420	GP-27	JOND	ATA-5056	GA-5056	ATSA	ATL-1174	G-1174	ATSA
AS351	GA-75	SIEG	AT44377	GAK-403	JOND	ATA-5058	GA-273	ATSA	ATL-1175	G-1175	ATSA
AS3523	GA-3523	SIEG	AT44631	GA-826	JOND	ATA-507	GA-106 ⁶⁷	ATSA	ATL-11860	G-1121	ATSA
AS3537	GA-54	SIEG	AT44632	GA-827	JOND	ATA-507SY	GA-206 ¹⁰⁸	ATSA	ATL-139	G-139	ATSA
AS3549	GA-89	SIEG	AT44696	GP-34	JOND	ATA-523	GA-360	ATSA	ATL-14	G-5000	ATSA
AS3559	GA-271	SIEG	AT45455	G-331	JOND	ATA-523SY	GA-361	ATSA	ATL-174	G-500	ATSA
AS3566	GA-3566	SIEG	AT509	G-1173 ¹⁰⁸	UNI	ATA-536	GA-356	ATSA	ATL-175	G-750	ATSA
AS3588	GA-3588	SIEG	AT553	G-1174 ¹⁰⁸	UNI	ATA-542	GA-31	ATSA	ATL-191	G-191	ATSA
AS3597	GA-735 ¹²⁴	SIEG	AT58368	GP-34	JOND	ATA-592	GA-376	ATSA	ATL-200	G-200	ATSA
AS3642	GA-101	SIEG	AT650112	GA-6880	HEND	ATA-595	GA-378	ATSA	ATL-211	G-566	ATSA
AS3647	GA-3647	SIEG	AT65088	GA-403	JOND	ATA-596	GA-6880	ATSA	ATL-236	G-236	ATSA
AS3660	GA-277	SIEG	AT65296	GA-403	JOND	ATA-598	GA-7716	ATSA	ATL-2821A	G-613	ATSA
AS4	G-1173 ¹⁰⁸	COM	AT75603	G-331	JOND	ATA-598SY	GA-7360	ATSA	ATL-31	G-31	ATSA
AS5	G-1175	COM	AT81019	GA-398	JOND	ATA-620	GA-49	ATSA	ATL-330	G-330	ATSA
AS5401	GAK-16	SAKU	AT81478	GPP-14	JOND	ATA-6326	GA-371	ATSA	ATL-331	G-331	ATSA
AS-5706	GA-26	SAKU	ATA-1117	GA-217	ATSA	ATA-6366	GA-174	ATSA	ATL-33A	G-33	ATSA
AS5707	GA-27	SAKU	ATA-133	GA-78	ATSA	ATA-6479	GA-6479	ATSA	ATL-6	G-6	ATSA
AS-6905	GAK-1532	SAKU	ATA-1372	GA-134	ATSA	ATA-6491	GA-129	ATSA	ATL-750	G-750	ATSA
AS-7609	GAK-216	SAKU	ATA-146	GA-71	ATSA	ATA-6545	GAVW-120	ATSA	ATL-801	G-871	ATSA
AS8	G-1175 ¹⁰⁸	COM	ATA-148	GA-80	ATSA	ATA-6555	GA-275	ATSA	ATL-813	G-813	ATSA
AS8B5D2V1-4	G-1175 ¹⁰⁸	COM	ATA-1543	GA-891	ATSA	ATA-6576	GA-276	ATSA	ATL-834	G-834	ATSA
ASE646	GG-48	LSTR	ATA-1543SY	GA-892	ATSA	ATA-6591	GA-176	ATSA	ATL-848	G-833	ATSA
ASE64-6	GG-48	PETT	ATA-1548	GA-483	ATSA	ATA-6619	GA-6619 ¹	ATSA	ATL-993	G-801	ATSA
ASF15	GP-3569	AMS	ATA-1580	GA-109	ATSA	ATA-6619	GA-6620 ⁵	ATSA	ATS-11	GP-5	ATSA
ASF54	GP-42	AMS	ATA-1581	GA-229	ATSA	ATA-6850	GAD-294	ATSA	ATS-1118	GP-1108	ATSA
ASF9176	GAK-16	AWSW	ATA-1596	GA-209	ATSA	ATA-6900	GAD-117	ATSA	ATS-1130	G-295	ATSA
ASF9176	GAK-16	CLRK	ATA-1596SY	GA-210	ATSA	ATA-6900	GAD-17	ATSA	ATS-1145	GP-1122	ATSA
ASF9176	GAK-16	LEYL	ATA-1599	GA-107	ATSA	ATA-697	GAD-1	ATSA	ATS-13	GP-13	ATSA
ASK01	GA-244	WOW	ATA-1599SY	GA-108	ATSA	ATA-7007	GA-7007	ATSA	ATS-16	GP-81 ³¹	ATSA
ASK548	GA-166	WOW	ATA-160	GA-70	ATSA	ATA-7414	GA-141	ATSA	ATS-2	GP-68	ATSA
ASK560	GA-142	WOW	ATA-170	GA-73	ATSA	ATA-7421	GA-165	ATSA	ATS-20	GP-14	ATSA
AT100973	GP-864H	JOND	ATA-184	GA-77	ATSA	ATA-7432	GA-132	ATSA	ATS-25	GP-20	ATSA
AT101565	GG-5 L	JOND	ATA-187	GA-90	ATSA	ATA-7440	GA-300	ATSA	ATS-2825	GP-38 ⁹⁷	ATSA
AT1130N	GAK-16	JOND	ATA-189	GA-50	ATSA	ATA-7597	GA-164	ATSA	ATS-2836	GP-10	ATSA
AT1131N	GA-33 ¹¹²	JOND	ATA-192	GA-192	ATSA	ATA-7730	GA-175	ATSA	ATS-2870	GP-28	ATSA
AT1220338	GP-58	JOND	ATA-224	GA-8047	ATSA	ATC-1101	GP-1101	ATSA	ATS-2951	GP-2951	ATSA
AT131683	GA-206	JOND	ATA-226	GA-9334	ATSA	ATC-1104	GP-110	ATSA	ATS-30	GP-3	ATSA
AT131970	GA-106 ⁴⁶	JOND	ATA-229	GA-18	ATSA	ATC-1146	GP-26	ATSA	ATS-3335	GP-52 ¹¹⁰	ATSA
AT131970	GA-326 ⁷¹	JOND	ATA-233	GA-9045	ATSA	ATC-1147	GP-27	ATSA	ATS-3335	GP-691 ⁸	ATSA
AT13387	G-296	JOND	ATA-234	GA-1287	ATSA	ATC-1166	G-1166	ATSA	ATS-3375	GP-53	ATSA
AT13387	G-296-B	JOND	ATA-236	GA-1286	ATSA	ATC-1191	G-296	ATSA	ATS-3380	GP-1109	ATSA
AT135800	GP-864H	JOND	ATA-237	GA-1285	ATSA	ATC-1191	G-296-B	ATSA	ATS-3387	GP-46	ATSA
AT15088	G-139	JOND	ATA-239	GA-375	ATSA	ATC-1191	GG-298	ATSA	ATS-3387A	GP-46	ATSA

Referencia Cruzada por Numero de Parte

Cross Reference by Part Number



Numero	Gonher	Fabricante	Numero	Gonher	Fabricante	Numero	Gonher	Fabricante	Numero	Gonher	Fabricante
Number	Gonher	Manufacturer	Number	Gonher	Manufacturer	Number	Gonher	Manufacturer	Number	Gonher	Manufacturer
ATS-3429	GP-3429	ATSA	AW2016	GP-1013Q	PAMO	AX58828	GAK-20	ALCH	AZC051	GAK-16	COO
ATS-35	GP-22	ATSA	AW2022	GP-1011Q	PAMO	AX58828	GAK-20	FIAT	AZC100	GAK-403	COO
ATS-3506	GP-44	ATSA	AW203	GP-40	KNE	AX61641	GAK-20	ALCH	AZC101	GAK-403	COO
ATS-3522	GPP-1122	ATSA	AW207	GP-91	MAHL	AX64724	GA-33 ¹¹²	ALCH	AZC109	GA-459	COO
ATS-3535	GP-3980 ⁴⁴	ATSA	AW23	GP-54	KNE	AXL135	GP-53	COO	AZC110	GA-98 ¹¹²	COO
ATS-3535	GP-48 ¹¹⁷	ATSA	AW23969	GAK-16	JOND	AY110NS001	G-25	NISS	AZC200	GA-20	COO
ATS-3555	GP-57	ATSA	AW262	GP-46	KNE	AY1943	GAK-20	ELGN	AZC205	GAK-20	COO
ATS-3593	GP-149	ATSA	AW27	GP-1122	KNE	AY20211	GAK-403	ELGN	AZC250	GA-360	COO
ATS-36	GP-36	ATSA	AW283	GP-81	KNE	AY2928	GAK-20	ELGN	AZC251	GA-360	COO
ATS-3600	GP-3600	ATSA	AW29	GP-28	KNE	AZ20625	GAK-625	JOND	AZC254	GA-360	COO
ATS-3612	GP-153	ATSA	AW29/9	GP-28 ⁸	KNE	AZ22878	GP-54 ¹¹	JOND	AZC255	GA-361	COO
ATS-3614	GP-58	ATSA	AW29/9	GP-430 ⁸	KNE	AZ22878	GP-66 ¹⁰	JOND	AZC300	GA-106 ⁶	COO
ATS-3682	GP-3682	ATSA	AW294	GP-28 ⁸	KNE	AZ25868	GAK-625	JOND	AZC300	GA-326 ¹¹	COO
ATS-3757	GP-43	ATSA	AW294	GP-430 ⁸	KNE	AZ39762	GA-206	JOND	AZC301	GA-106 ⁶	COO
ATS-3773	GP-35	ATSA	AW294	GP-28 ⁸	MAHL	AZ45870	GA-206	JOND	AZC301	GA-326 ¹¹	COO
ATS-39	GP-69	ATSA	AW294	GP-430 ⁸	MAHL	AZA052	GA-372	COO	AZC302	GA-27	COO
ATS-3950	GP-40	ATSA	AW298	GP-28 ⁸	KNE	AZA081	GA-39	COO	AZC303	GA-206	COO
ATS-3980	GP-3980 ⁴⁴	ATSA	AW298	GP-430 ⁸	KNE	AZA086	GA-70	COO	AZC350	GA-6127	COO
ATS-42	GP-54	ATSA	AW299C10	GP-28 ⁸	KNE	AZA088	GA-37	COO	AZC351	GA-6129	COO
ATS-43	GP-9 ⁵⁸	ATSA	AW299C10	GP-430 ⁸	KNE	AZA089	GA-18	COO	AZC352	GA-6129	COO
ATS-4386	GP-153	ATSA	AW29C10	GP-28 ⁸	KNE	AZA098	GA-18	COO	AZC353	GA-6129	COO
ATS-47	GP-34	ATSA	AW29C10	GP-430 ⁸	KNE	AZA105	GA-589	COO	AZF001	GP-1101	COO
ATS-49	GP-51	ATSA	AW3	GP-28 ⁸	KNE	AZA106	GA-588	COO	AZF002	G-277	COO
ATS-4967	GP-157	ATSA	AW3	GP-430 ⁸	KNE	AZA128	GA-405	COO	AZF003	GP-1122	COO
ATS-6349	GP-3000	ATSA	AW301340	GA-3490	MITTS	AZA128T	GA-405	COO	AZF004	G-1123F	COO
ATS-6643	GP-77	ATSA	AW319065	GA-71	MITTS	AZA139	GAK-16	COO	AZF007	G-1174 ¹⁰⁸	COO
ATS-7136	GP-88	ATSA	AW32	GP-22	KNE	AZA139T	GAK-16	COO	AZF008	G-1121F	COO
ATS-8	GP-1	ATSA	AW32	GP-58 ¹⁵	MAHL	AZA153	GA-6129	COO	AZF009	G-1123	COO
ATS-927	GP-22	ATSA	AW33	GP-462	KNE	AZA153T	GA-6129	COO	AZF011	G-11816	COO
ATS-966	GP-37	ATSA	AW34	GP-38	KNE	AZA171	GA-436	COO	AZF013	G-1173 ¹⁰⁸	COO
ATS-977	GP-31	ATSA	AW343979	GP-145	MITTS	AZA178	GA-37	COO	AZF014	G-1176	COO
ATSA-3304	GP-1010Q	ATSA	AW35	GP-38	KNE	AZA181	GA-229	COO	AZF015	G-296	COO
ATSA-3614	GP-58	ATSA	AW36	GP-462	KNE	AZA184	GA-8	COO	AZF015	G-296-B	COO
ATSA-3753	GP-1013Q	ATSA	AW36	GP-91	MAHL	AZA18416	GA-8	COO	AZF016	G-1143	COO
ATT08	GA-2719B	WOW	AW3729	GAD-1	MICF	AZA301	GAK-16	COO	AZF025	GG-48	COO
ATT1007	GA-5466	WOW	AW3732	GA-4303	MICF	AZA301T	GAK-16	COO	AZF029	G-297-B	COO
ATTS50	GA-180	WOW	AW38	GP-3	KNE	AZA304	GAK-403	COO	AZF032	G-1163	COO
ATTS65	GA-6690	WOW	AW39	GP-81 ²¹	KNE	AZA304T	GAK-403	COO	AZF037	GP-1108	COO
AU42727	G-1175	JOND	AW39	GP-9 ⁵⁸	KNE	AZA307	GAK-20	COO	AZF051	GP-26	COO
AU42728	G-1175	JOND	AW4	GP-50	KNE	AZA307T	GAK-20	COO	AZF052	GP-27	COO
AU43090	GA-106 ⁵⁷	JOND	AW40	GP-3816	KNE	AZA309	GA-360	COO	AZF053	G-1121	COO
AU43090	GA-206 ⁰⁸	JOND	AW41	GP-14	KNE	AZA309T	GA-360	COO	AZF056	GG-20	COO
AU43090	GA-326 ⁷²	JOND	AW42	GP-36	AUSW	AZA314	GA-106 ⁶⁶	COO	AZF058	G-1121	COO
AU867014	G-296	WHIT	AW42	GP-36	KNE	AZA314	GA-326 ⁷¹	COO	AZF059	G-1174 ¹⁰⁸	COO
AU867014	G-296-B	WHIT	AW46	GP-81 ³¹	KNE	AZA314T	GA-106 ⁶⁶	COO	AZF073	GPP-14	COO
AUU1335	G-31	WHIT	AW46	GP-9 ⁵⁸	KNE	AZA314T	GA-326 ⁷¹	COO	AZF074	GP-1122	COO
AV36	GA-3490	MICF	AW475	GP-2015W	PAMO	AZA316	GA-27	COO	AZF076	GP-110	COO
AV3705	GAD-1	MICF	AW49	GP-3600	KNE	AZA323	GA-6127	COO	AZF086	G-297-B	COO
AV3706	GAD-1	MICF	AW5	GP-36	KNE	AZA323T	GA-6127	COO	AZF089	GP-1122	COO
AV3711	GAD-3	MICF	AW51	GP-31	KNE	AZA324	GA-6129	COO	AZF090	GP-1122	COO
AV-3727	GA-27	NIPP	AW512	GP-36	KNE	AZA324T	GA-6129	COO	AZF091	GP-1122	COO
AV3729	GAD-1	MICF	AW5-2	GP-36	KNE	AZA326	GA-361	COO	AZF094	G-1163	COO
AV3732	GA-4303	MICF	AW56	GP-310	KNE	AZA326T	GA-361	COO	AZF098	GP-1122	COO
AV3738	GAD-15	MICF	AW56	GP-3569	KNE	AZA335	GA-459	COO	AZF100	G-296	COO
AV52	GA-386	MICF	AW59	GP-58	KNE	AZA335T	GA-459	COO	AZF100	G-296-B	COO
AV-5612	GAK-20	NIPP	AW6	GP-81 ³¹	KNE	AZA336	GAK-458	COO	AZF101	G-296	COO
AV79	GAD-3	MICF	AW6	GP-9 ⁵⁸	KNE	AZA337	GA-33 ¹¹²	COO	AZF101	G-296-B	COO
AV8500	GA-133	MICF	AW61	GP-10	KNE	AZA337T	GA-33 ¹¹²	COO	AZF395	GP-78	COO
AV8502	GA-595	MICF	AW62	GP-28 ⁸	KNE	AZA343	GA-206	COO	AZF426	GP-55	COO
AV8511	GA-2106	MICF	AW62	GP-430 ⁸	KNE	AZA343T	GA-206	COO	AZF438	G-295	COO
AV8520	GA-471	MICF	AW62	GP-28 ⁸	MAHL	AZA344	GAK-1532	COO	AZF460	G-1121F	COO
AV8529	GA-2740	MICF	AW62	GP-430 ⁸	MAHL	AZA348	GAK-216	COO	AZF465	G-1123F	COO
AVW1001	GAVW-120	WOW	AW622	GP-3600	KNE	AZA349	GA-416	COO	AZF776	GPP-111	COO
AW1	GP-81 ³¹	KNE	AW63	GP-3600	KNE	AZA349T	GA-416	COO	AZF776	GPP-524	COO
AW1	GP-9 ⁵⁸	KNE	AW64	GP-42	KNE	AZA361	GAK-16	COO	AZF785	GPP-1122	COO
AW10	GP-22	KNE	AW66	GP-1	KNE	AZA364	GA-416	COO	AZF829	GPP-18	COO
AW100	GP-40	KNE	AW67	GP-81	KNE	AZA365	GAK-216	COO	AZF830	GP-1122	COO
AW103	GP-81	KNE	AW67	GP-54 ¹¹	MAHL	AZA366	GAK-625	COO	AZF846	GG-48	COO
AW106	GP-3816	KNE	AW67	GP-66 ¹⁰	MAHL	AZA372	GA-98 ¹¹²	COO	AZH001	G-162H	COO
AW107	GP-66	KNE	AW75	GP-3816	KNE	AZA391	GA-8	COO	AZH004	G-222	COO
AW108	GP-81	KNE	AW76	GP-77	KNE	AZA395	GP-78	COO	AZH006	G-152	COO
AW109	GP-46	KNE	AW78	GP-1	KNE	AZA500	GA-5648	COO	AZH440	GP-166 ¹⁰⁰	COO
AW11	GP-81	KNE	AW8	GP-1101	KNE	AZA508	GA-357	COO	AZL004	G-191	COO
AW117	GP-68	KNE	AW84	GP-1122	KNE	AZA508T	GA-357	COO	AZL006	GP-171	COO
AW118	GP-58	KNE	AW85	GP-3985	KNE	AZA509	GA-356	COO	AZL007	GP-81	COO
AW12	GP-1122	KNE	AW85	GP-3985	MAHL	AZA602	GA-8047	COO	AZL008	GP-31	COO
AW133	GP-3980	MAHL	AW87	GP-3600	KNE	AZA604	GA-1285	COO	AZL009	GP-54	COO
AW136	GP-40	KNE	AW87	GP-3816	MAHL	AZA607	GA-1284	COO	AZL010	G-870	COO
AW138	GP-3816	MAHL	AW9	GP-1101	KNE	AZA608	GA-1008	COO	AZL012	G-813	COO
AW14	GP-58	KNE	AW92	GP-51	KNE	AZA609	GA-9334	COO	AZL014	G-871	COO
AW141	GP-3816	KNE	AW93	GP-58	KNE	AZA610	GA-1286	COO	AZL015	G-162H	COO
AW143	GP-14	KNE	AW94	GP-3531	EXP	AZA611	GA-1287	COO	AZL018	G-836	COO
AW168	GP-38	KNE	AW97	GP-3600	KNE	AZA612	GA-9045	COO	AZL019	G-33	COO
AW169	GP-3682	KNE	AWK115	GP-1122	KNE	AZA613	GA-1203	COO	AZL020	G-834	COO
AW173	GP-40	KNE	AWK115	GPP-1122	KNE	AZA617	GA-7716	COO	AZL022	G-31	COO
AW173	GP-3985	MAHL	AWK12	GP-1122	KNE	AZA618	GA-7360	COO	AZL026	G-31	COO
AW18	GP-81 ³¹	KNE	AWK121	GP-1122	KNE	AZA622	GA-375	COO	AZL027	GP-81 ³¹	COO
AW18	GP-9 ⁵⁸	KNE	AWK126	GPP-1122	KNE	AZA633	GA-49	COO	AZL027	GP-9 ⁵⁸	COO
AW19	GP-31	KNE	AWK149	GP-1122	KNE	AZA815	GA-467	COO	AZL028	GP-1	COO
AW194	GP-28 ⁸	KNE	AWK151	GPP-1122	MAHL	AZB150	GA-5648	COO	AZL029	GP-14	COO
AW194	GP-430 ⁸	KNE	AWK154	GP-1122	KNE	AZB202	GA-356	COO	AZL030	GP-1	COO
AW194	GP-28 ⁸	MAHL	AWK198	GPP-1122	MAHL	AZB203	GA-357	COO	AZL032	GP-54 ¹¹	COO
AW194	GP-430 ⁸	MAHL	AWK27	GP-1122	KNE	AZC001	GA-33 ¹¹²	COO	AZL032	GP-66 ¹⁰	COO
AW20	GP-54	KNE	AWK84	GP-1122	KNE	AZC002	GA-33 ¹¹²	COO	AZL033	G-331	COO
AW2010	GP-1011Q	PAMO	AX58670	GAK-20	ALCH	AZC005	GA-33 ¹¹²	CO			

Numero	Gonher	Fabricante	Numero	Gonher	Fabricante	Numero	Gonher	Fabricante	Numero	Gonher	Fabricante
Number	Gonher	Manufacturer	Number	Gonher	Manufacturer	Number	Gonher	Manufacturer	Number	Gonher	Manufacturer
AZL047	GP-81 ³¹	COO	B13131	GA-101	PUR	B229	GP-171	BLDW	B379	GAVV-4	TEC
AZL049	GP-9 ⁵⁸	COO	B13131M	GA-101	PUR	B233	GP-81 ³¹	BLDW	B39	GP-20	BLDW
AZL050	G-31	COO	B13161	GA-101	EVGR	B233	GP-9 ⁵⁸	BLDW	B392	GAVV-2	TEC
AZL051	G-6	COO	B13161	GA-101	MIGH	B236	GP-54 ⁴¹	BLDW	B3972	G-31	ALCH
AZL052	G-236	COO	B13161	GA-101	PUR	B236	GP-66 ¹⁰	BLDW	B3972	G-31	FIAT
AZL053	G-5000	COO	B13161M	GA-101	PUR	B241	GP-2951 ⁶²	BRAV	B3973	G-31	ALCH
AZL055	GP-36	COO	B132	GP-22	BLDW	B241	GP-58	BRAV	B3973	G-31	FIAT
AZL055A	GP-36	COO	B134	GP-3766	BLDW	B241	GP-3816	CRQR	B4	G-1173 ¹⁰⁸	COM
AZL056	GP-54 ¹¹	COO	B13505-61	GP-57	POCL	B243	GP-3600	BLDW	B40	GP-13	BRAV
AZL056	GP-66 ¹⁰	COO	B1400	GP-91	BLDW	B244	GP-1 ⁹	BLDW	B40	GP-13	CRQR
AZL057	GP-50	COO	B1401	GP-91	BLDW	B245	GP-40	BLDW	B4006	GP-44	CRQR
AZL058	GP-14	COO	B1402	GP-149	BLDW	B245	GAVV-2	TEC	B4007	GP-44	CRQR
AZL060	G-500	COO	B1404	GP-40	BLDW	B245F300	GAK-16	CONT	B4011	GP-3980	BRAV
AZL061	G-238	COO	B1405	GP-58	BLDW	B246	GP-1	BLDW	B4011	GP-3980	CRQR
AZL063	G-235	COO	B1406	GP-156	BLDW	B252	GP-171 ¹⁶	BLDW	B402	G-1121	KNE
AZL070	GP-34	COO	B1407	GP-3682	BLDW	B253	GP-171 ¹⁶	BLDW	B402	G-1121F	MAHL
AZL072	GP-3600	COO	B141	GP-3985	BLDW	B256	GA-360	TEC	B402100M1	G-1121	KNE
AZL073	G-191	COO	B1410	GP-58	BLDW	B257	GP-310	BRAV	B402200M1	G-1121	KNE
AZL075	G-750	COO	B1413	GP-58	BLDW	B257	GP-3569	CRQ	B402C	G-1121	KNE
AZL081	G-222	COO	B1416	GP-128	BLDW	B257	GA-106 ⁶⁶	TEC	B402F	G-1121F	KNE
AZL083	GP-51	COO	B1421	GP-6811	BLDW	B257	GA-326 ⁷¹	TEC	B403	GA-4303	TEC
AZL093	G-834	COO	B1422	GP-212	BLDW	B258	GA-405	TEC	B404C100M1	G-296	KNE
AZL101	G-870	COO	B1424	GP-452	BLDW	B26	G-31	BBR	B404C100M1	G-296-B	KNE
AZL105	G-31	COO	B1425	GP-149	BLDW	B26	G-31	BRGG	B405364	G-1123	HITA
AZL106	G-163	COO	B1428	GP-205	BLDW	B263	GP-88	BLDW	B4-1-2	G-1173 ¹⁰⁸	COM
AZL108	GP-171	COO	B1429	GP-171	BLDW	B27	GP-3	BLDW	B41294	G-1121	CASE
AZL109	GP-1	COO	B143	GP-38 ⁸¹	BLDW	B271	GA-6129	TEC	B414	G-1173 ¹⁰⁸	COM
AZL114	G-163	COO	B1431	GP-145	BLDW	B281	GP-68	BLDW	B4-1-4B12D	G-1173 ¹⁰⁸	COM
AZL124	GP-77	COO	B1432	GP-3675	BLDW	B2821A	GP-58	BRAV	B4-1-4BD	G-1173 ¹⁰⁸	COM
AZL128	GP-52 ¹¹⁰	COO	B1434	GP-171	BLDW	B287	GA-436	TEC	B410-R4	G-1173 ¹⁰⁸	ALCH
AZL128	GP-691 ⁴⁸	COO	B1435	GP-457	BLDW	B291	GA-277	TEC	B421	GP-91	BLDW
AZL129	GP-68	COO	B1438	GP-408	BLDW	B295	GP-38	BLDW	B427F509	GAK-20	CONT
AZL134	GP-68	COO	B1447	GP-455	BLDW	B298	GA-2194	TEC	B43160	GA-176	EVGR
AZL135	GP-53	COO	B149	GA-230	TEC	B299	GP-69	BLDW	B43160	GA-176	PUR
AZL136	G-31	COO	B154	GA-71	TEC	B2A6731A	G-6	AUST	B43160M	GA-176	PUR
AZL334	GP-69	COO	B156	GP-3531 EXP	BLDW	B2A6731A	G-6	DEAR	B43-S	GP-46	BLDW
AZL418	GP-53	COO	B157	GP-54	BLDW	B2A6731A	G-6	GLEN	B44	G-6	BBR
AZL419	GP-57	COO	B158	GAK-16	TEC	B2A6731A	G-6	KENW	B44	G-6	BRGG
AZL432	G-163	COO	B159	GP-2951	BLDW	B2A-6731-B	G-6	FORD	B4443	G-1163 ¹⁰⁸	ENTR
AZL436	G-133	COO	B16	G-750	BBR	B2A-6731-A	G-6	FORD	B4457	GP-3682	BRAV
AZL436	G-989	COO	B16	G-750	BRGG	B27Z-6481-A	GA-105	FORD	B4457	GP-3682	CRQR
AZL456	GP-43	COO	B160	GP-406	BLDW	B30	GP-3429	BLDW	B4458	GP-462	BRAV
AZL474	G-143	COO	B160	GAK-403	TEC	B30011	GA-59	PUR	B4459	GP-149 ⁶⁹	BRAV
AZL799	GP-178	COO	B160071	GA-356 ¹⁰⁴	DON	B304	GA-3490	TEC	B4459	GP-91 ⁷⁸	BRAV
AZW002	GP-2071W	COO	B160071	GA-357 ¹⁰⁸	DON	B309	GP-88 ⁸⁰	BLDW	B4459	GP-91	CRQR
AZW003	GP-1011Q	COO	B161	GP-462	BLDW	B31	G-1176	BBR	B4466	GP-38	CRQR
AZW004	GP-1011Q	COO	B161	GA-113	CAM2	B31	GP-44	BLDW	B4477	GP-156	BRAV
			B161	GA-113	CIGO	B3131	GA-101	CAM2	B4477	GP-58	CRQR
			B161	GA-113	GREA	B3131	GA-101	CIGO	B4484	GP-212	CRQ
			B161	GA-113	GRP	B3131	GA-101	GREA	B44843	GA-186	EVGR
			B161	GA-113	HAVO	B3131	GA-101	GRP	B44843	GA-186	FSN
			B161	GA-113	KND	B3131	GA-101	HAVO	B44843	GA-186	PUR
			B161	GA-113	MOB	B3131	GA-101	KND	B44843M	GA-186	PUR
			B161	GA-113	PEN	B3131	GA-101	MOB	B45	G-31	BBR
			B161	GA-113	PRMT	B3131	GA-101	PEN	B45	G-31	BRGG
			B161	GA-113	QKS	B3131	GA-101	PRMT	B4571C	GP-1122	KNE
			B161	GA-113	SHE	B3131	GA-101	QKS	B457C1	GP-1011Q	KNE
			B161	GA-113	TEX	B3131	GA-101	SHE	B4619	GP-3985	BRAV
			B161-S	GP-462	BLDW	B3131	GA-101	TEX	B4619	GP-3985	CRQR
			B162	GAD-3	TEC	B3160	GA-176	CAM2	B4620	GP-149	BRAV
			B163	GP-81	BLDW	B3160	GA-176	CIGO	B4620	GP-149	CRQR
			B164	GP-50 ⁷⁰	BLDW	B3160	GA-176	GREA	B4622	GP-91	BRAV
			B166	GP-42	BLDW	B3160	GA-176	GRP	B4622	GP-91	CRQR
			B167	GP-10	BLDW	B3160	GA-176	HAVO	B4631	GP-205	BRAV
			B167	GP-54	BLDW	B3160	GA-176	KND	B4651	GP-68	BRAV
			B17	GP-81	BRAV	B3160	GA-176	MOB	B4670	GP-81	BRAV
			B173	GP-3980	BRAV	B3160	GA-176	PEN	B47	G-1143	BBR
			B173-S	GP-40	BLDW	B3160	GA-176	PRMT	B4843	GA-186	CAM2
			B175	GP-212	BLDW	B3160	GA-176	QKS	B4843	GA-186	CIGO
			B178	GP-28 ⁸	BLDW	B3160	GA-176	SHE	B4843	GA-186	GREA
			B178	GP-430 ⁸	BLDW	B3160	GA-176	TEX	B4843	GA-186	GRP
			B179	GP-91	BLDW	B32001	GPP-11	RAR	B4843	GA-186	HAVO
			B18F	G-1121F	MAST	B32002	S 3202 ⁹⁰	RAR	B4843	GA-186	MOB
			B195	GP-46	BLDW	B32003	GPP-11	RAR	B4843	GA-186	PEN
			B195	GP-3600	BRAV	B32004	GPP-14	RAR	B4843	GA-186	PRMT
			B195	GP-3600	CRQR	B329	GP-68	BLDW	B4843	GA-186	QKS
			B197	GP-3600	BLDW	B33	G-191	BBR	B4843	GA-186	SHE
			B197	GA-2122	TEC	B33	GP-157	BLDW	B488	GP-40	BLDW
			B19875-07	GA-21	AIM	B33	GP-20	BRAV	B49	GP-52 ¹¹⁰	BLDW
			B199	GP-24	BLDW	B33	GP-20	CRQR	B49	GP-691 ⁴⁸	BLDW
			B1A	GP-1	BRAV	B331	GAVV-2	TEC	B49	GP-3	BRAV
			B1A	GP-1	CRQR	B3355SCR	GP-50	WIN	B49	GP-3	CRQR
			B2	GP-1	BLDW	B336	GP-81	BLDW	B4916	G-1173 ¹⁰⁸	ALCH
			B20009	G-1175 ¹⁰⁸	COM	B34	GP-81	BLDW	B4916	G-1173 ¹⁰⁸	FIAT
			B20009	GA-100	EVGR	B35	G-1173 ¹⁰⁸	BBR	B495	GP-193	BLDW
			B20009	GA-100	PUR	B35	GP-3980	BLDW	B495-SS	GP-193	BLDW
			B20009M	GA-100	PUR	B35	G-1173 ¹⁰⁸	BRGG	B5	GG-246	TNC
			B20161	GA-113	EVGR	B352	GA-2110	TEC	B50	G-139	BBR
			B20161	GA-113	PUR	B3555SCR	GP-50	WIN	B50	GP-50	BLDW
			B20161M	GA-113	PUR	B3555SCR	GP-50	WIN	B50	GP-139	BRGG
			B201661	GA-113	PUR	B359-14-302	GP-91	MZDA	B5087	GP-2127W	BLDW
			B204	GA-4365	TEC	B35-S	GP-3980	BLDW	B51	G-500	BBR
			B205	GP-43	BLDW	B37	G-1175 ¹⁰⁸	BBR	B51	G-500	BRGG
			B222	GA-4365	TEC	B37	GP-156	BLDW	B519	GP-91	BLDW
			B227	GP-91	BLDW	B37	G-1175 ¹⁰⁸	BRGG	B530	GP-149	BLDW
			B228	GP-3816	BLDW	B373	GP-3682	BRAV	B59	GA-100	PRET

Números Nuevos

B

B002	GG-1	BOG
B002	GG-4	BOG
B0150157510	GP-36	DUTZ
B0150157520	GP-54 ¹¹	DUTZ
B0150157520	GP-66 ¹⁰	DUTZ
B0150157520	GP-54	KHDF
B0150157520	GP-66	KHDF
B032-0033	GA-33 ¹¹²	JCBM
B032-01074	GAK-16	JCBM
B032-10033	GA-33 ¹¹²	JCBM
B1047	GA-176	PRET
B10505-95	GP-1122	POCL
B109	GP-3985	BLDW
B111	GP-46	BRAV
B111	GP-46	CRQR
B113	GP-3682 ⁵³	BLDW
B113	GP-375 ⁴	BLDW
B114	GP-	

Referencia Cruzada por Numero de Parte

Cross Reference by Part Number



Numero	Gonher	Fabricante	Numero	Gonher	Fabricante	Numero	Gonher	Fabricante	Numero	Gonher	Fabricante
Number	Gonher	Manufacturer	Number	Gonher	Manufacturer	Number	Gonher	Manufacturer	Number	Gonher	Manufacturer
B595-13-240	GA-595	MZDA	B7A-6731-A	GP-1	FORD	BA3192	GA-271	BRV	BA4819	GA-141	BRV
B5Z2-9601-A	GA-80	FORD	B7A-6731-B	GP-1	FORD	BA3192	GA-271	CRQR	BA4819	GA-141	CRQR
B6	GP-13	BLDW	B7Q-9601-A	GG-20	FORD	BA3193	GA-735 ¹²⁴	BRV	BA4831	GAD-118	CRQR
B6	G-1174 ¹⁰⁸	COM	B7S-9155-B	GG-20	FORD	BA3193	GA-735 ¹²⁴	CRQR	BA4852	GA-392	CRQR
B608	GP-91	BLDW	B7T-9155-A	GG-20	FORD	BA3195	GA-3588	BRV	BA4873	GA-514	CRQR
B610-14-300	GP-91	MZDA	B7TZ-6731-B	G-834	FORD	BA3195	GA-3588	CRQR	BA4877	GA-175	CRQR
B6-1-4	G-1174 ¹⁰⁸	COM	B8	G-1175 ¹⁰⁸	COM	BA3357	GA-3637	BRV	BA4878	GA-1615	CRQR
B6-1-4B12D	G-1174 ¹⁰⁸	COM	B8071	GA-27	PETI	BA3357	GA-3637	CRQR	BA4879	GA-1616	CRQR
B6-1-4BD	G-1174 ¹⁰⁸	COM	B81	GP-81 ³¹	BRV	BA3380	GA-3647	BRV	BA4880	GA-164	CRQR
B630-14-300	GP-91	MZDA	B81	GP-9 ⁵⁸	BRV	BA3380	GA-3647	CRQR	BA5048	GA-132	CRQR
B630-14-302	GP-91	MZDA	B81	GP-81 ³¹	CRQR	BA3384	GA-89	BRV	BA5090	GA-673R	CRQR
B631-14-302	GP-91	KIA	B81	GP-9 ⁵⁸	CRQR	BA3384	GA-89	CRQR	BA5148	GA-384	CRQR
B64	GP-3600 ²⁷	BRV	B8-1-4B12D	G-1175 ¹⁰⁸	COM	BA3398	GA-3566	CRQ	BA5155	GA-130	CRQR
B64	GP-38 ⁸⁹	BRV	B8-1-4BD	G-1175 ¹⁰⁸	COM	BA3436	GA-4365	CRQ	BA5192	GA-158	CRQR
B6BF-20-490	GG-150	MZDA	B87	GA-113	PRET	BA3465	GA-277	BRV	BA52	GA-71	BRV
B6BF-20-490A	GG-150	MZDA	B88	GA-277	TNC	BA3465	GA-277	CRQR	BA5227	GA-279	CRQR
B6S7-13-240	GA-133	MZDA	B8A-6731-A	GP-1	FORD	BA3466	GA-4828	BRV	BA5248	GA-163	CRQR
B6T-9365-A	GG-20	FORD	B8C-6731-A	G-330	FORD	BA3466	GA-4828	CRQR	BA5314	GA-348	CRQR
B6T-9365-C	GG-20	FORD	B8CM	G-330	REF	BA3467	GA-4325	BRV	BA57	GA-80	BRV
B6Y0-14-300	GP-91	MZDA	B8NN-6714-A	GP-81	DEAR	BA3467	GA-4325	CRQR	BA57	GA-80	CRQR
B6Y0-14-302	GP-91	MZDA	B8NN-6714-A	GP-81	FORD	BA3472	GA-274	BRV	BA59	GA-50	BRV
B6Y1-14-302	GP-91	MZDA	B8Q	G-6	REF	BA3472	GA-274	CRQR	BA59	GA-50	CRQR
B6Y11-43-029A	GP-149	MZDA	B8Q-6731-A	G-6	FORD	BA3474	GA-3681	BRV	BA6591	GA-176	FRM
B6Y1-14-302A	GP-91	MZDA	B8Q-6731-A1	G-6	FORD	BA3474	GA-3681	CRQR	BA6591	GA-176	MILE
B6Y2-14-302	GP-91	MZDA	B8QH	G-5000	REF	BA3538	GA-140	CRQ	BA6591	GA-176	PARM
B6YL-14-302	GP-91	MZDA	B8QH-6714-A	G-5000	FORD	BA3590	GA-3916	BRV	BA6591DP	GA-176	FRM
B7	GP-23	BLDW	B8QH-6731	G-5000	FORD	BA3590	GA-3916	CRQR	BA6591FP	GA-176	FRM
B7	GG-5 L	TNC	B8QH6731A	G-5000	FWDX	BA3591	GA-3814	BRV	BA67	GA-192	BRV
B7001	GP-68	BLDW	B8QH-6731-A	G-5000	FORD	BA3591	GA-3814	CRQR	BA67	GA-192	CRQR
B7005	GP-43	BLDW	B8QH-6731-B	G-5000	FORD	BA3592	GA-273	BRV	BA70	GA-4303	BRV
B7010	GP-3675	BLDW	B9	GP-5	BLDW	BA3592	GA-273	CRQR	BA70	GA-4303	CRQR
B7030	GP-152	BLDW	B9	GA-100	CAM2	BA3642	GA-101	FRM	BA74	GA-55	BRV
B7039	GP-562	BLDW	B9	GA-100	CIGO	BA3642	GA-101	PARM	BA74	GA-55	CRQR
B7047	GP-3885	BLDW	B9	GA-100	GREA	BA3642DP	GA-101	FRM	BA7756	GA-186	FRM
B7052	G-133	BLDW	B9	GA-100	GRP	BA4	GA-70	BRV	BA7756DP	GA-186	FRM
B7052	G-989	BLDW	B9	GA-100	HAVO	BA4278	GAD-15	BRV	BA831	GA-85	BRV
B7109	GG-45	IMPW	B9	GA-100	KND	BA4278	GAD-15	CRQR	BA83-1	GA-85	CRQR
B7114	GG-1	IMPW	B9	GA-100	MOB	BA4299	GA-180	CRQR	BA84	GA-730	BRV
B7114	GG-4	IMPW	B9	GA-100	PEN	BA4326	GA-78	BRV	BA84	GA-730	CRQR
B7115	GG-5 L	IMPW	B9	GA-100	PRMT	BA4339	GA-3915	BRV	BA9	GA-100	BRV
B7117	GP-390	BLDW	B9	GA-100	QKS	BA4339	GA-3915	CRQR	BA90	GA-303	BRV
B7125	GP-754	BLDW	B9	GA-100	SHE	BA4342	GA-253	BRV	BA90	GA-303	CRQR
B7125	GG-76	IMPW	B9	GA-100	TEX	BA4342	GA-253	CRQR	BA91	GA-59	BRV
B7126	GG-45	IMPW	B95	GP-53	BLDW	BA4343	GA-5056	BRV	BA91	GA-59	CRQR
B7135	GG-196	IMPW	B958	GP-66	BLDW	BA4343	GA-5056	CRQR	BA92	GA-57	BRV
B7139	GP-490	BLDW	B95-HPG	GA-153	BRV	BA4347	GA-153	BRV	BA92	GA-57	CRQR
B7149	GG-94	IMPW	B95-SS	GP-53	BLDW	BA4356	GA-390	BRV	BA93	GA-325	BRV
B7151	GG-203	IMPW	B96	GP-53	BLDW	BA4356	GA-390	CRQ	BA991	GA-86	BRV
B7152	GP-171	BLDW	B975	GA-390	BLDW	BA4356	GA-390	CRQR	BA991	GA-86	CRQR
B7156	GG-246	IMPW	B99	GP-52 ¹¹⁰	BLDW	BA4361	GA-139	BRV	BAA129620Z	GAVVW-2	VOLK
B7165	GP-58 ¹⁵	BLDW	B99	GP-691 ⁴⁸	BLDW	BA4361	GA-139	CRQR	BA-DA320933	G-225	PETT
B7167	GP-461	BLDW	B99-HPG	GP-52 ¹¹⁰	BLDW	BA4372	GA-3901	BRV	BAE646	GG-48	LSTR
B7167	GP-461	HAS	B99-HPG	GP-691 ⁴⁸	BLDW	BA4375	GA-362	BRV	BAE646	GG-48	PETT
B7177	GP-3937	BLDW	B99-SS	GP-52 ¹¹⁰	BLDW	BA4375	GA-362	CRQR	BAF11373	GA-75	BOWE
B7225	GP-51	BLDW	B99-SS	GP-691 ⁴⁸	BLDW	BA4378	GA-174	BRV	BAF12057	GA-74	BOWE
B7229	GP-152 ⁹⁰	BLDW	B9AE-6714-A	GP-1	FORD	BA4378	GA-174	CRQR	BAF12373	GA-7	BOWE
B7243	GP-6811	BLDW	B9AE-6714-A2	GP-1	FORD	BA4468	GA-195	BRV	BAF129140	GA-3424	BOWE
B7271	GP-9	BLDW	B9AE-6714-A6	GP-1	FORD	BA4468	GA-195	CRQ	BAF130113	GA-86	BOWE
B7276	GP-291	BLDW	B9AE-6714-B	GP-1	FORD	BA4471	GA-195	BRV	BAF131141	GA-303	BOWE
B7290	GP-58	BLDW	B9AE-6731-A	G-5000	FORD	BA4471	GA-471	CRQR	BAF132116	GA-85	BOWE
B7299	GP-52 ¹¹⁰	BLDW	B9LE-6714-A	GP-1	FORD	BA4479	GA-6479	BRV	BAF3191	GA-56	BOWE
B7299	GP-691 ⁴⁸	BLDW	B9NN-6714-A	GP-81	FORD	BA4479	GA-6479	CRQR	BAF420	GA-70	BOWE
B73	GA-101	PRET	B9TE-6744-A	G-6	FORD	BA4487	GA-382	BRV	BAF4554	GA-77	BOWE
B7311-MPG	GP-31	BLDW	B9TE-9A855-A	G-6	FORD	BA4487	GA-382	CASI	BAF5211	GA-71	BOWE
B7313	GP-462 ⁹⁴	IHCO	BA110A	GAD-3	BRV	BA4487	GA-382	CRQ	BAF5755	GA-80	BOWE
B7313	GP-24 ²⁶	IMPW	BA110A	GAD-3	CRQR	BA4487	GA-382	CRQR	BAF5983	GA-50	BOWE
B7344	GP-81	IMPW	BA113	GA-75	BRV	BA45	GA-77	BRV	BAF60372	GA-11	BOWE
B7348	GP-58	IMPW	BA113	GA-75	CRQR	BA45	GA-77	CRQR	BAF6788	GA-192	BOWE
B7355	GP-28 ⁸	IMPW	BA1149	GAVW-2	BRV	BA4613	GA-142	BRV	BAF6861	GA-78	BOWE
B7355	GP-430 ⁸	IMPW	BA1149	GAVW-2	CRQR	BA4613	GA-142	CRQR	BAF7495	GA-55	BOWE
B7357	GP-42	IMPW	BA120	GA-74	BRV	BA4625	GA-2106	BRV	BAF79374	GA-12	BOWE
B7358	GP-3985	IMPW	BA120	GA-74	CRQR	BA4625	GA-2106	CRQR	BAF8365	GA-85	BOWE
B7366	GP-3531 EXP	IMPW	BA124	GA-3300	BRV	BA4632	GA-275	BRV	BAF8444	GA-730	BOWE
B7396	GP-53	BLDW	BA124	GA-3300	CRQR	BA4645	GA-6690	BRV	BAF9067	GA-303	BOWE
B74	GP-81	BLDW	BA129	GA-3424	BRV	BA4645	GA-6690	CRQ	BAF9198	GA-59	BOWE
B7401	GP-406	BLDW	BA129	GA-3424	CRQR	BA4648	GA-133	BRV	BAF92101	GA-57	BOWE
B74095	GPP-19	VOK	BA131	GA-3425	BRV	BA4648	GA-133	CRQR	BAF9399	GA-325	BOWE
B7419	GP-91	BLDW	BA131	GA-3425	CRQR	BA4650	GA-604	BRV	BAF9968	GA-86	BOWE
B7431	GP-171	BLDW	BA15	GA-3490	CRQR	BA4650	GA-604	CRQR	BAK81-6	G-225	PETT
B7508	GAD-3	IMPW	BA16	GA-113	BRV	BA4656	GA-7017	BRV	BB05	GP-5	BUMP
B7563	GAD-1 ⁸⁷	IMPW	BA19	GA-100	FRM	BA4656	GA-7017	CRQ	BB102	GA-105	ALY
B7577	GP-57	BLDW	BA19	GA-100	MILE	BA4680	GA-386	BRV	BB133	GA-78	ALY
B7580	GAVW-2	IMPW	BA19	GA-100	PARM	BA4680	GA-386	CRQ	BB136	GA-55	ALY
B7587	GA-277	IMPW	BA19DP	GA-100	FRM	BA4680	GA-386	CRQR	BB146	GA-71	ALY
B7589	GA-4303	IMPW	BA19FP	GA-100	FRM	BA4690	GA-322	BRV	BB148	GA-80	ALY
B76	GP-51	BLDW	BA2108	GA-735 ¹²⁴	CRQ	BA4690	GA-322	CRQ	BB160	GA-70	ALY
B7600	GP-51	BLDW	BA24	GA-113	PARM	BA4690	GA-322	CRQR	BB176	GA-56	ALY
B7601	GA-75	IMPW	BA-24	GA-113	FRM	BA4712	GA-217	BRV	BB184	GA-77	ALY
B7609	GA-3490	IMPW	BA24FP	GA-113	FRM	BA4722	GA-5466	CRQR	BB189	GA-50	ALY
B7614	GA-4365	IMPW	BA2923	GA-3501	BRV	BA4727	GA-300	BRV	BB192	GA-192	ALY
B7625	GA-2740	IMPW	BA3131	GA-101	BRV	BA4727	GA-300	CRQR	BB21416	G-31	DIAM
B7685	GP-556	BLDW	BA3138	GA-54	BRV	BA4731	GA-165	BRV	BB2709	GAD-1	ALY
B7700	GP-51	BLDW	BA3138	GA-54	CRQR	BA4731	GA-165	CRQR	BB303	GA-303	ALY
B79	GA-200	TEC	BA3149	GA-3523	BRV	BA4799	GA-381	BRV	BB305	GA-730	ALY
B79	GA-218	TEC	BA3149	GA-3523	CRQR	BA4799	GA-381	CRQ	BB324	GA-85	ALY
B7A-6714-A	GP-1	FORD	BA3160	GA-176	BRV	BA4799	GA-381	CRQR	BB325	GA-325	ALY

REFERENCIA CRUZADA

Numero	Gonher	Fabricante	Numero	Gonher	Fabricante	Numero	Gonher	Fabricante	Numero	Gonher	Fabricante
Number	Gonher	Manufacturer	Number	Gonher	Manufacturer	Number	Gonher	Manufacturer	Number	Gonher	Manufacturer
BB326	GA-59	ALY	BC1113	GP-42	PBR	BF1046	GG-581	BLDW	BF1280	GPP-18	BLDW
BB327	GA-57	ALY	BC1118	GP-10	PBR	BF1049	GG-255	BLDW	BF1281	R120P	BLDW
BB338	GA-3300	ALY	BC1119	GP-23	PBR	BF1052	GG-5 L	BLDW	BF1281	R120P	HAS
BB340	GA-86	ALY	BC1122	GP-34	PBR	BF1053	GG-267	BLDW	BF1282	GPP-14	BLDW
BB349	GA-349	ALY	BC1126	GP-3	PBR	BF1054	GG-104	BLDW	BF1293-SPS	GPP-1003S	BLDW
BB351	GA-75	ALY	BC1131	GP-81 ³¹	PBR	BF1057	GG-7018 ³⁸	BLDW	BF13	GA-113	STAM
BB352	GAD-1	ALY	BC1131	GP-9 ⁵⁸	PBR	BF1057	GG-7019 ³⁷	BLDW	BF13	GA-113	STAN
BB353	GAD-3	ALY	BC1132	GP-3985	PBR	BF1057	GG-7020 ¹⁴	BLDW	BF1322	S 3202 ⁴⁰	BLDW
BB381	GA-74	ALY	BC1137	GP-53	PBR	BF1058	GG-95	BLDW	BF1329	GPP-1291 ³⁹	BLDW
BBA4	GA-70	BUMP	BC1145	GP-40	PBR	BF1059	GG-164	BLDW	BF1329	PFF831 ⁴¹	BLDW
BBA45	GA-77	BUMP	BC1146	GP-3531 EXP	PBR	BF1061	GG-164	BLDW	BF1329	R 90 P ⁴²	BLDW
BBA52	GA-80	BUMP	BC1147	GP-390 ⁹³	PBR	BF11	GA-100	STAN	BF1329-SP	GPP-1291 ³⁹	BLDW
BBA57	GA-80	BUMP	BC1152	GP-28 ⁵	PBR	BF1103	GG-142	BLDW	BF1329-SP	PFF831 ⁴¹	BLDW
BBA68	GA-78	BUMP	BC1152	GP-430 ⁰	PBR	BF1104	GG-63	BLDW	BF1329-SP	R 90 P ⁴²	BLDW
BBA74	GA-55	BUMP	BC1153	GP-3985	PBR	BF1105	GG-94	BLDW	BF1342	S 3202 ⁴⁰	BLDW
BBA831	GA-85	BUMP	BC1154	GP-46	PBR	BF1111	GG-215	BLDW	BF1345	GPP-547 ³⁹	BLDW
BBA84	GA-730	BUMP	BC1156	GP-3682	PBR	BF1117	GG-181	BLDW	BF1345	PFF831 ⁴¹	BLDW
BBA90	GA-303	BUMP	BC1160	GP-1	PBR	BF1118	GG-181	BLDW	BF1345	R 60 P ⁴²	BLDW
BBA91	GA-59	BUMP	BC1162	GP-149	PBR	BF1120	GG-190	BLDW	BF1345-SP	GPP-547 ³⁹	BLDW
BBG119	GG-6	BUMP	BC1163	GP-9586	PBR	BF1121	GG-63	BLDW	BF1345-SP	PFF831 ⁴¹	BLDW
BBG120	GG-7	BUMP	BC1165	GP-44	PBR	BF1123	GG-63	BLDW	BF1345-SP	R 60 P ⁴²	BLDW
BBG131	GG-19	BUMP	BC1166	GP-1	PBR	BF1128	GG-115	BLDW	BF1346	GPP-1291 ³⁹	BLDW
BBG21	GG-123	BUMP	BC1167	GP-36	PBR	BF1131	GG-150	BLDW	BF1346	S 3226 P ⁴⁰	BLDW
BBNN-6714-A	GP-9	FORD	BC1168	GP-166 ¹⁰⁰	PBR	BF1133	GG-148	BLDW	BF1348	GPP-1287 ³⁹	BLDW
BBO100A	GP-1	BUMP	BC1171	GP-36	PBR	BF1138	GG-232	BLDW	BF1348	PFF831 ⁴¹	BLDW
BBO109	GP-42	BUMP	BC1172	GP-171	PBR	BF1139	GG-94	BLDW	BF1348	S 3225 P ⁴²	BLDW
BBO111	GP-46	BUMP	BC1175	GP-455	PBR	BF1140	GG-202	BLDW	BF1348-SP	GPP-1287 ³⁹	BLDW
BBO123	GP-3429	BUMP	BC1178	GP-57	PBR	BF1145	GG-220	BLDW	BF1348-SP	PFF831 ⁴¹	BLDW
BBO124	GP-44	BUMP	BC1184	GP-66	PBR	BF1148	GG-187	BLDW	BF1348-SP	S 3225 P ⁴²	BLDW
BBO1A	GP-1	BUMP	BC1185	GP-67	PBR	BF1152	GG-151	BLDW	BF1349	GPP-1291 ³⁹	BLDW
BBO213	GP-28 ⁸	BUMP	BC1186	GP-88	PBR	BF1156	GG-220	BLDW	BF1349	PFF831 ⁴¹	BLDW
BBO213	GP-430 ⁸	BUMP	BC1187	GP-31	PBR	BF1160	GG-208	BLDW	BF1349	R 90 T ⁴²	BLDW
BBO33	GP-20	BUMP	BC1188	GP-69	PBR	BF1163	GG-137	BLDW	BF1370	GPP-1287	BLDW
BBO3300	GP-20	BUMP	BC1194	GP-66	PBR	BF1165	GG-580	BLDW	BF14	GA-113	STAM
BBO40	GP-13	BUMP	BC1201	GP-38	PBR	BF1166	GG-1872	BLDW	BF14	GA-113	STAN
BBO42	GP-3682	BUMP	BC1202	GP-54	PBR	BF1167	GG-7018 ³⁸	BLDW	BF18	GA-101	STAM
BBO49	GP-3	BUMP	BC1206	GP-9	PBR	BF1167	GG-7019 ³⁷	BLDW	BF19	GA-100	CAC
BBO4900	GP-3	BUMP	BC1238	GP-51	PBR	BF1167	GG-7020 ¹⁴	BLDW	BF193	GP-40	BRAV
BBO81	GP-81 ³¹	BUMP	BC1269	GP-68	PBR	BF1168	GG-7018 ³⁸	BLDW	BF193	GP-3985	CRQ
BBO81	GP-9 ⁵⁸	BUMP	BC1298	GP-291	PBR	BF1168	GG-7019 ³⁷	BLDW	BF193	GP-40	CRQ
BBO8100	GP-81 ³¹	BUMP	BC175T	GP-750	FRM	BF1168	GG-7020 ¹⁴	BLDW	BF193	GP-40	CRQR
BBO8100	GP-9 ⁵⁸	BUMP	BC5	G-31	BBR	BF1169	GG-247	BLDW	BF208-05D02	GP-3985	NISS
BBU2994	GP-1	LEYL	BC5	G-31	BRGG	BF1170	GG-92	BLDW	BF2167	GP-171	BRAV
BBU5555	GP-69	LEYL	BC7	G-31	BBR	BF1171	GG-66	BLDW	BF2167	GP-81	CRQR
BBU5556	GP-1108	LEYL	BC7	G-31	BRGG	BF1172	GG-256	BLDW	BF2167	GP-9	CRQR
BBU5557	GP-78	LEYL	BC7	G-31	BRIG	BF1177	GG-189	BLDW	BF24	GA-113	CAC
BBU5860	GA-372	LEYL	BC8812	G-1143	LETR	BF1179	GG-185	BLDW	BF252	GP-28 ⁶	BRAV
BBU5866	G-162H	LEYL	BC8813	GP-14	LETR	BF1181	GG-84	BLDW	BF252	GP-430 ⁸	BRAV
BBU6367	GA-27	LEYL	BCH200PL	GP-200	FRM	BF1182	GG-249	BLDW	BF252	GP-3600	CRQR
BBU6547	G-143	LEYL	BCH211	G-566	FRM	BF1184	GG-30	BLDW	BF291	GP-3531 EXP	BRAV
BBU6550	GPP-1122	LEYL	BCH33APL	G-33	FRM	BF1185	GG-64	BLDW	BF291	GP-3531 EXP	CRQR
BBU6932	GP-1122	LEYL	BD-103	GP-3000	BLDW	BF1186	GG-260	BLDW	BF303	GA-100	DEUS
BBU8333	GP-57	LEYL	BD1-4BD	G-1173 ¹⁰⁸	COM	BF1188	GG-184	BLDW	BF310-03	G-1123	MNH
BC1001	GP-1	PBR	BD1812	G-1175 ¹⁰⁸	COM	BF119	GP-310	BLDW	BF310-03	G-1123F	MNH
BC1021	GP-50	PBR	BD324	GP-3000 ¹³	BLDW	BF1193	GG-160	BLDW	BF349-01	G-1121	MNH
BC1022	GP-22	PBR	BD7041	GP-359	BLDW	BF1194	GG-268	BLDW	BF3642	GA-101	CAC
BC1028	GP-81	PBR	BD7095	GP-642	BLDW	BF1195	GG-251	BLDW	BF37003	G-1121	MNH
BC1031	GP-1	PBR	BD7153	GP-9000	BLDW	BF1196	GG-114	BLDW	BF37004	G-1121	MNH
BC1035	GP-54 ¹¹	PBR	BD7154	GP-9001	BLDW	BF1199	GG-243	BLDW	BF3733	GP-3682	BRAV
BC1035	GP-66 ¹⁰	PBR	BD7159	GP-359	BLDW	BF1212	GPP-11	BLDW	BF400	GA-101	DEUS
BC1039	GP-14	PBR	BD7166	GP-359	BLDW	BF1214	GPP-11	BLDW	BF4001	GA-113	DEUS
BC1043	GP-31	PBR	BD7169	GP-359	BLDW	BF1220	GPP-14	BLDW	BF403-99013	GP-1101	NISS
BC1048	GP-81	PBR	BD7309	GP-3001	BLDW	BF1221	GPP-1122	BLDW	BF409	GA-113	DEUS
BC1050	GP-171	PBR	BDF1325	G-1121	BOG	BF1223	GPP-1287 ³⁹	BLDW	BF411	GA-101	DEUS
BC1051	GP-81	PBR	BDF4201	G-296	BOG	BF1223	PFF831 ⁴¹	BLDW	BF501	GA-176	DEUS
BC1053	GP-81 ³¹	PBR	BDF4201	G-296-B	BOG	BF1223	R 60 P ⁴²	BLDW	BF5800	GP-26	BLDW
BC1053	GP-9 ⁵⁸	PBR	BDX1812	G-1175 ¹⁰⁸	COM	BF1223-SP	GPP-1287 ³⁹	BLDW	BF5801	GP-1108	BLDW
BC1054	GP-14 ²³	PBR	BDX2812	G-1175 ¹⁰⁸	COM	BF1223-SP	PFF831 ⁴¹	BLDW	BF5810	GP-27	BLDW
BC1054	GP-5	PBR	BE16	GA-113	STP	BF1223-SP	R 60 P ⁴²	BLDW	BF5812	GPP-1000	BLDW
BC1055	GP-22	PBR	BE171	GA-100	AVAT	BF1224	GP-1224	BLDW	BF5813	S 3202 ⁴⁰	BLDW
BC1056	GP-1	PBR	BE172	GA-113	AVAT	BF1225	GPP-11	BLDW	BF584	GP-56	BLDW
BC1059	GP-13	PBR	BE179	GA-101	AVAT	BF1226	GPP-1122	BLDW	BF585	GP-1101 ⁴	BLDW
BC1062	GP-20	PBR	BE391	G-836	WIPA	BF-1232	GP-1232	BLDW	BF-585	GP-1101	BLDW
BC1063	GP-1	PBR	BE441	G-834	WIPA	BF1235	GPP-1122	BLDW	BF586	GP-1122	BLDW
BC1065	GP-36	PBR	BE50	G-500	AMS	BF1236	GPP-418	BLDW	BF586-D	GPP-1122	BLDW
BC1075	GP-46	PBR	BE580	G-833	WIPA	BF1237	GPP-419	BLDW	BF587	GP-1122	BLDW
BC1078	GP-406	PBR	BE59	GA-100	BARA	BF1242	GPP-103	BLDW	BF587-D	GPP-1122	BLDW
BC1079	GP-68	PBR	BE59	GA-100	PRET	BF1248	GPP-14	BLDW	BF588	GP-78	BLDW
BC1082	GP-77	PBR	BE59	GA-100	STP	BF1249	GPP-103 ⁴⁰	BLDW	BF592	GP-92	BLDW
BC1083	GP-51	PBR	BE59E	GA-113	PRET	BF1249	GPP-11 ³⁹	BLDW	BF593	GP-93	BLDW
BC1085	GP-52 ¹⁰	PBR	BE73	GA-101	BARA	BF1249-SP	GPP-103 ⁴⁰	BLDW	BF596	GP-55	BLDW
BC1085	GP-691 ⁴⁸	PBR	BE73	GA-101	PRET	BF1249-SP	GPP-11 ³⁹	BLDW	BF597	GPP-19	BLDW
BC1085A	GP-52 ¹⁰	PBR	BE73	GA-101	STP	BF1249-SP	GPP-103 ⁴⁰	HAS	BF614	GP-749	BLDW
BC1085A	GP-691 ⁴⁸	PBR	BE75	G-750	AMS	BF1249-SP	GPP-11 ³⁹	HAS	BF630	GA-186	DEUS
BC1086	GP-38	PBR	BE87	GA-113	BARA	BF1252	GPP-11	BLDW	BF6591	GA-176	CAC
BC1088	GP-462	PBR	BE87	GA-113	PRET	BF1257	GPP-1122	BLDW	BF700	G-1121F	MNH
BC1089	GP-38	PBR	BE87	GA-113	STP	BF1258	GPP-11	BLDW	BF700X	G-1121F	MNH
BC1091	GP-81	PBR	BE88	GA-113	BARA	BF1259	GPP-1000	BLDW	BF707	G-1121F	MNH
BC1092	GP-46	PBR	BE88	GA-113	STP	BF1263-SP	GPP-1003S	BLDW	BF7529	GP-1105	BLDW
BC1094	GP-3816	PBR	BES1018	GA-71	TEC	BF1268	GPP-11	BLDW	BF7530-MPG	GP-1109 ²²	BLDW
BC1101	GP-34	PBR	BF100	GG-123	APCO	BF1269	GPP-1122	BLDW	BF7530-MPG	GP-62 ²⁰	BLDW
BC1104	GP-3600	PBR	BF1003	GG-146	BLDW	BF1272-SP	GPP-1022S	BLDW	BF7534	GPP-111	BLDW
BC1105	GP-81 ³¹	PBR	BF1006	GG-214	BLDW	BF1274-SP	GPP-1007S	BLDW	BF7534	GPP-524	BLDW
BC1105	GP-9 ⁵⁸	PBR	BF1008	GG-72	BLDW	BF1276	GPP-1122	BLDW	BF7537	GG-298	BLDW
BC1106	GP-1	PBR	BF1010	GG-136	BLDW	BF1277SP	GPP-1007S	BLDW	BF7539	GP-96	BLDW
BC1111	GP-22	PBR	BF1045	GG-580	BLDW	BF1279	GPP-11	BLDW	BF7546	GPP-11	BLDW

Referencia Cruzada por Numero de Parte

Cross Reference by Part Number



Numero	Gonher	Fabricante	Numero	Gonher	Fabricante	Numero	Gonher	Fabricante	Numero	Gonher	Fabricante
Number	Gonher	Manufacturer	Number	Gonher	Manufacturer	Number	Gonher	Manufacturer	Number	Gonher	Manufacturer
BF7557	GP-11	BLDW	BF836-K4	GG-5 L	BLDW	BG1518	GP-1122	PBR	BM78669	GP-1101	CUMM
BF7557	GP-110	BLDW	BF-837	GG-208	BLDW	BG1519	GP-1122	PBR	BM78669	GP-14	CUMM
BF7558	GP-112 ²	BLDW	BF840	GG-5 L	BLDW	BG1522	G-277	PBR	BM78672	GPP-14	CUMM
BF7576	G-277	BLDW	BF840K2	GG-1	BLDW	BG1523	GP-26	PBR	BM78672	GPP-14	OLIV
BF7579	G-276	BLDW	BF840K3	GG-4	BLDW	BG1524	GP-27	PBR	BM78676	GPP-14	CUMM
BF7580	G-278	BLDW	BF840K3	GG-5 L	BLDW	BG1525	GP-56	PBR	BM78762	GPP-14	CUMM
BF7582	GPP-425	BLDW	BF840K4	GG-5 L	BLDW	BG1526	GP-1122	PBR	BM78793	GP-110	CUMM
BF7587	GP-749	BLDW	BF850K	GG-5 L	BLDW	BG1527	GPP-1122	PBR	BM78798	GP-1101	CUMM
BF7591-D	GPP-1122	BLDW	BF851	GG-1	BLDW	BG1528	GP-110	PBR	BM78798	GPP-14	CUMM
BF7608	GP-1122	BLDW	BF851	GG-4	BLDW	BG1532	GP-26	PBR	BM91119	G-1143	CUMM
BF7628	GP-458	BLDW	BF853	GG-46	BLDW	BG1533	GPP-1122	PBR	BM94090	G-566	CUMM
BF7629	GP-78	BLDW	BF856	G-294	BLDW	BG1534	GPP-1122	PBR	BM94254	G-1143	CUMM
BF7632	GP-1109 ²²	BLDW	BF858	GG-240	BLDW	BG1541	GP-55	PBR	BM95363	G-566	CUMM
BF7632	GP-62 ²⁰	BLDW	BF862	GP-19	BLDW	BG1542	GP-62	PBR	BM95543	G-613	CUMM
BF7633	GP-110	BLDW	BF863	GPP-18	BLDW	BG1543	GPP-18	PBR	BM95557	G-613	CUMM
BF7634	GP-1109	BLDW	BF865	GG-8 ¹⁰³	BLDW	BG1546	GP-1107	PBR	BM97627	G-566	CUMM
BF7641	GG-351	BLDW	BF865	GG-8 L ⁸⁰	BLDW	BG1548	GP-1122	PBR	BM98561	G-566	CUMM
BF7644	GP-96	BLDW	BF865K	GG-8 ¹⁰³	BLDW	BG1551	GP-85	PBR	BM99579	G-613	CUMM
BF7645	GPP-125	BLDW	BF865K	GG-8 L ⁸⁰	BLDW	BG157	GG-16	BRAV	BMSA12800	G-31	WAUK
BF7653	GP-96	BLDW	BF868	GG-3728	BLDW	BG157	GG-16	CRQR	BN16813	GP-52 ¹¹⁰	EAIR
BF7653	GP-96	HAS	BF873	GG-204	BLDW	BG1576	GP-96	PBR	BN16813	GP-691 ⁸⁸	EAIR
BF7658	GG-266	BLDW	BF874	G-297	BLDW	BG158	GG-16	BRAV	BO32-0033	GA-33 ¹¹²	JCBM
BF7660	GG-137	BLDW	BF874	G-297-B	BLDW	BG158	GG-17	CRQR	BO32-01074	GAK-16	JCBM
BF7662	GG-164	BLDW	BF876	GG-8	BLDW	BG30	GG-8 ¹⁰³	BRAV	BO32-10033	GA-33 ¹¹²	JCBM
BF7663	GP-1122	BLDW	BF877	GG-83	BLDW	BG30	GG-8 L ⁸⁰	CRQR	BP01-20-490	GG-150	MZDA
BF7665	GPP-420	BLDW	BF879	GG-8	BLDW	BG30	GG-8 ¹⁰³	CRQR	BP01-20-490A	GG-150	MZDA
BF7668	GG-986	BLDW	BF880	GP-56	BLDW	BG30	GG-8 L ⁸⁰	CRQR	BP11	G-6	BBR
BF7669	GG-265	BLDW	BF881	GG-5 L	BLDW	BG3144	GG-46	BRAV	BP11	G-6	BRGG
BF7670	GG-102	BLDW	BF884	G-297	BLDW	BG3144	GG-46	CRQR	BP14	G-1175 ¹⁰⁸	BRGG
BF7672	GPP-421	BLDW	BF884	G-297-B	BLDW	BG3169	GG-47	BRAV	BP15	G-191	BBR
BF7672-D	GPP-421	BLDW	BF885	GG-408	BLDW	BG3169	GG-47	CRQR	BP15	G-191	BRGG
BF7673	GPP-418	BLDW	BF888	GP-1107	BLDW	BG3170	GG-208	BRAV	BP15	G-191	BRIG
BF7673-D	GPP-418	BLDW	BF889	GG-42	BLDW	BG3173	GG-3728	BRAV	BP158	G-200	BBR
BF7674	GPP-419	BLDW	BF890	GG-79	BLDW	BG3178	GG-63	BRAV	BP158	G-200	BRGG
BF7674-D	GPP-419	BLDW	BF891	GPP-14	BLDW	BG3190	GG-264	BRAV	BP20	G-1163 ¹⁰⁸	BBR
BF7675	GPP-420	BLDW	BF892	GPP-1000	BLDW	BG35	GG-87	BRAV	BP20	G-1163 ¹⁰⁸	BRGG
BF7675-D	GPP-420	BLDW	BF896	GPP-18	BLDW	BG35	GG-87	CRQR	BP20	G-1163 ¹⁰⁸	BRIG
BF7677	GPP-423	BLDW	BF900	GP-1122	BLDW	BG4611	GG-61	BRAV	BP21	G-236	BBR
BF7677	GPP-423	HAS	BF900X	G-1123F	MNH	BG4618	GG-65	BRAV	BP21	G-236	BRGG
BF7679	GPP-424	BLDW	BF909	G-295	BLDW	BG4672	GG-580	BRAV	BP302-2	G-1174 ¹⁰⁸	BBR
BF7679-D	GPP-424	BLDW	BF912	G-293	BLDW	BG4702	GG-581	BRAV	BP304	G-1173 ¹⁰⁸	BBR
BF7681	GPP-425	BLDW	BF917X	G-296	MNH	BG4705	GG-7018 ⁹⁸	BRAV	BP304	G-1173 ¹⁰⁸	BRGG
BF7681-D	GPP-425	BLDW	BF917X	G-296-B	MNH	BG4705	GG-7019 ⁹⁷	BRAV	BP304	G-1173 ¹⁰⁸	BRIG
BF7682	GPP-426	BLDW	BF918-K	GG-8 L	BLDW	BG4705	GG-7020 ¹⁴⁴	BRAV	BP306	G-1174 ¹⁰⁸	BBR
BF7686	GG-116	BLDW	BF920	GG-87	BLDW	BG4714	GG-66	BRAV	BP306	G-1174 ¹⁰⁸	BRGG
BF7689	GP-1122	BLDW	BF928	GG-196	BLDW	BG5	GG-45	BRAV	BP306-2	G-1174 ¹⁰⁸	BBR
BF7711	GG-283	BLDW	BF929	GG-217	BLDW	BG5823	GP-56	PBR	BP308	G-1175 ¹⁰⁸	BBR
BF7713	GG-67	BLDW	BF932	GG-45	BLDW	BG9157	GG-203	BRAV	BP308	G-1175 ¹⁰⁸	BRGG
BF7719	GG-290	BLDW	BF933	GG-196	BLDW	BG9158	GG-196	BRAV	BP506	G-31	FIL
BF7720	GG-146	BLDW	BF944	GG-226	BLDW	BHA4952	GP-3816	LEYL	BP533	G-750	FIL
BF7721	GG-214	BLDW	BF948	GP-1101	BLDW	BIF5004	GG-189	BOG	BP534	G-31	FIL
BF7725	GG-3	BLDW	BF948-B	GP-1101	BLDW	BIF5130	GG-189	BOG	BP566	G-500	FIL
BF7736	GG-124	BLDW	BF948-JD	GPP-14	BLDW	BK4294	G-1123	DORM	BP572	G-139	FIL
BF7739	GG-307	BLDW	BF955	GG-25	BLDW	BK4294	G-1123F	DORM	BP579	G-870	FIL
BF7742	GG-308	BLDW	BF956	GP-92	BLDW	BL500	G-500	BBR	BP582	G-31	FIL
BF7753	GP-749	BLDW	BF957	GP-1101	BLDW	BL500	G-500	BRGG	BP599	GP-50	KNE
BF7760	GP-1101	BLDW	BF957-D	GPP-14	BLDW	BL500	G-500	BRIG	BP599EC	GP-50	FIL
BF7762	GP-209	BLDW	BF959	G-270	BLDW	BL750	G-750	BBR	BP616EC	GP-50	FIL
BF7763	GG-265 ³⁶	BLDW	BF965	GG-264	BLDW	BL750	GP-750	BRGG	BP632EC	GP-50	FIL
BF7768	GG-986	BLDW	BF966	GG-47	BLDW	BLM107020	GP-3816	LEYL	BP634	G-139	FIL
BF7772	GPP-1122	BLDW	BF970	GP-110	BLDW	BM23097	G-1175 ¹⁰⁸	ALCH	BP636EC	GP-50	FIL
BF7778	GPP-612	BLDW	BF-971	GP-26	BLDW	BM23097	G-1175 ¹⁰⁸	AUTC	BP9	G-33	BBR
BF7783-D	GPP-425	BLDW	BF976	GP-85	BLDW	BM23097	G-1175 ¹⁰⁸	CUMM	BP9	G-33	BRGG
BF7786-D	GPP-423	BLDW	BF976-B	GP-85	BLDW	BM23097	G-1175 ¹⁰⁸	EUCL	BP8010A	G-500	GEMI
BF7786-D	GPP-423	HAS	BF979	GP-1108	BLDW	BM23097	G-1175 ¹⁰⁸	EUCL	BP8010A	G-750	GEMI
BF7801	GG-307	BLDW	BF983	GP-110	BLDW	BM23097	G-1175 ¹⁰⁸	FIAT	BPH11	GP-5	FRM
BF7802	GG-101	BLDW	BF984	GP-1101	BLDW	BM23097	G-1175 ¹⁰⁸	KENW	BPH13	GP-13	FRM
BF7807	GG-204	BLDW	BF988	GP-1122	BLDW	BM23097	G-1175 ¹⁰⁸	LORA	BPH13A	GP-13	FRM
BF7809	GG-47	BLDW	BF991	GP-1105	BLDW	BM59678	GP-1101	ALCH	BPH25	GP-20	FRM
BF7813	GP-548	BLDW	BF992	GP-62	BLDW	BM59678	GP-1101	AUSW	BPH2825	GP-38	FRM
BF7813	GP-548	HAS	BF9T-6714-AA	GP-54 ¹¹	FORD	BM59678	GP-1101	BROK	BPH30	GP-3	FRM
BF7815	GP-1109	BLDW	BF9T-6714-AA	GP-66 ¹⁰	FORD	BM59678	GP-1101	CHRY	BPH373	GP-23	FRM
BF7815	GP-1109	HAS	BFA103	GAD-1 ⁸⁷	BRAV	BM59678	GP-1101	CLRK	BPH43	GP-81 ¹¹	FRM
BF782	GP-1122	BLDW	BFA103	GAD-1 ⁸⁷	CRQR	BM59678	GP-1101	CUMM	BPH43	GP-9 ⁹⁸	FRM
BF785	GP-85	BLDW	BFA11	G-1123	CAV	BM59678	GP-1101	DIAM	BPH49A	GP-51	FRM
BF786	GP-155	BLDW	BFA11	G-1123F	CAV	BM59678	GP-1101	EMCO	BPH6349	GP-3000	FRM
BF788	GP-1122	BLDW	BFA15	GA-3490	BRAV	BM59678	GP-1101	EUCL	BPH8A	GP-1	FRM
BF7903	GG-116	BLDW	BFA16	GA-2740	BRAV	BM59678	GP-1101	FORD	BQF1162	G-1121	ROLK
BF7913	GP-55	BLDW	BFA16	GA-2740	CRQR	BM59678	GP-1101	FWDX	BR23	G-6	BBR
BF7921	GPP-1122	BLDW	BFA5	G-1121	CAV	BM59678	GP-1101	GALN	BR23	G-6	BRGG
BF7921	GPP-1122	HAS	BF6535	GP-1	LEYL	BM59678	GP-1101	KENW	BR25	G-31	BBR
BF7922	GP-548	BLDW	BFU900X	G-1123F	MNH	BM59678	GP-1101	LETR	BR32	G-1175 ¹⁰⁸	BBR
BF7923	GP-1105	BLDW	BG118	GG-5 L	BRAV	BM59678	GP-1101	OLIV	BR3658	G-200	BBR
BF794	GG-61	BLDW	BG119	GG-6	BRAV	BM59678	GP-1101	STER	BR4	G-1173 ¹⁰⁸	COM
BF7940	GP-548	BLDW	BG119	GG-6	CRQR	BM59678	GP-1101	WHIT	BR6	G-31	BBR
BF795	GG-65	BLDW	BG120	GG-7	BRAV	BM68635	GP-1101	ALCH	BR6	G-31	BRGG
BF805	GG-203	BLDW	BG120	GG-7	CRQR	BM68635	GP-1101	CUMM	BR6	G-31	BBR
BF825	G-296	BLDW	BG131	GG-19	BRAV	BM68635	GP-1101	FORD	BR8	G-1175 ¹⁰⁸	COM
BF825	G-296-B	BLDW	BG131	GG-19	CRQR	BM68635	GP-1101	WHIT	BRH0282	GA-892	JCBM
BF832	GG-67	BLDW	BG1500	GPP-14	PBR	BM68669	GP-1101	CUMM	BRP0027	GA-360	SUMI
BF833	GG-1	BLDW	BF1502	GP-1101	PBR	BM73500	G-500	CUMM	BRP0028	GA-361	SUMI
BF833	GG-4	BLDW	BG1503	GP-1122	PBR	BM73750	G-750	CUMM	BRP0069	GAK-403	SUMI
BF833-K2	GG-1	BLDW	BG1505	GP-110	PBR	BM75654	GP-14	CUMM	BRP0218	GAK-403	SUMI
BF833-K2	GG-4	BLDW	BG1509	GP-1108	PBR	BM76976	GP-110	CUMM	BRU6932	GP-1122	LEYL
BF83											

Numero	Gonher	Fabricante	Numero	Gonher	Fabricante	Numero	Gonher	Fabricante	Numero	Gonher	Fabricante
Number	Gonher	Manufacturer	Number	Gonher	Manufacturer	Number	Gonher	Manufacturer	Number	Gonher	Manufacturer
BSA25	GA-853R	TFS	BT8845	GP-761H	BLDW				C10789169	G-834	COMA
BSA6731A	G-6	AMHO	BT8846	GP-761H	BLDW				C10789169	G-834	HOLM
BSF42	GPP-425	TFS	BT8847	GP-761H	BLDW				C109	GP-42	CAM2
BSF45	GP-166 ⁹⁵	TFS	BT8848-MPG	GP-761H	BLDW				C11	GP-5	FLAG
BSF45	GP-3937 ¹¹	TFS	BT8849-MPG	GP-761H	BLDW				C110	GP-157	TOKO
BSF5066	GG-124	TFS	BT8850-MPG	GP-761H	BLDW				C110	GP-157	VIC
BSF5282	GP-96	TFS	BT8851-MPG	GP-761H	BLDW				C1101	GP-38	SAKU
BSFS19525	GPP-423	TFS	BT8852-MPG	GP-761H	BLDW				C1102	GP-81	SAKU
BSFS19530	GPP-425	TFS	BT8852-MPG	GP-761H	HAS				C-1102-2	GP-81 ²¹	SAKU
BSH5036	GP-761H	TFS	BT8853-MPG	GP-761H	BLDW				C-1102-2	GP-9 ⁸	SAKU
BSH5266	GP-166 ⁹⁵	TFS	BT8855-MPG	GP-761H	BLDW				C1102-3	GP-81	SAKU
BSH5266	GP-3937 ¹¹	TFS	BT8856-MPG	GP-761H	BLDW				C1103	GP-3600	SAKU
BSH6107	GP-171 ¹⁶	TFS	BT8860	GP-761H	BLDW				C1104	GP-1	SAKU
BSH6555	GP-761H	TFS	BT8861	GP-761H	BLDW				C-1105	GP-58	SAKU
BSH6561	GP-761H	TFS	BT8862	GP-761H	BLDW				C-1106	GP-171	SAKU
BSH6572	GP-761H	TFS	BT8863	GP-761H	BLDW				C110-60	GP-1121	FIL
BSH6606	GP-3766	TFS	BT8898	GP-317H	BLDW				C1107	GP-58	SAKU
BSH7551	GP-317H	TFS	BT8903	GP-66 ²¹	BLDW				C1109	GP-157	SAKU
BSL3707	GP-462	TEHO	BT9343-MPG	GP-34	BLDW				C-1109-1	GP-157	SAKU
BSL3707	GP-462	TFS	BT9356	GP-34	BLDW				C1109-3	GP-157	SAKU
BSL55	GP-149	TFS	BT9356	GP-34	HAS				C111	GP-46	CAM2
BSL566	G-870	TFS	BT958	GP-66	BLDW				C111	GP-46	CIGO
BSL785	GP-28 ⁹	TFS	BTA113	GA-75	BUMP				C1110	GP-58	VIC
BSL785	GP-430 ⁸	TFS	BTA124	GA-3300	BUMP				C1110	GP-58	SAKU
BSL796	GP-44	TFS	BTA16	GA-2740	BUMP				C1110-5	GP-58	SAKU
BT111	GP-171 ¹⁹	BLDW	BTA3138	GA-54	BUMP				C1112	G-1174	FRM
BT111	GP-171 ¹⁹	HAS	BTA3149	GA-3523	BUMP				C11120	GPP-19	MNH
BT112	GP-14	BLDW	BTA3192	GA-271	BUMP				C1113	GA-44	MNH
BT215	GP-3600	BLDW	BTA3193	GA-735 ¹²⁴	BUMP				C1114	GP-297	FRM
BT216	GP-1	BLDW	BTA3195	GA-3588	BUMP				C1114	G-297-B	FRM
BT217	GP-31	BLDW	BTA3380	GA-3647	BUMP				C1114	GP-2951 ⁹²	SAKU
BT223	GP-58	BLDW	BTA3384	GA-89	BUMP				C1114	GP-58 ⁹⁴	SAKU
BT230	GP-9586	BLDW	BTA3474	GA-3681	BUMP				C11581015	GP-54 ¹¹	COMA
BT237	GP-31	BLDW	BTA4	GA-334	BUMP				C11581015	GP-66 ¹⁰	COMA
BT251	GP-31	BLDW	BTA45	GA-77	BUMP				C11581015	GP-54 ¹¹	HOLM
BT259	GP-14	BLDW	BTA52	GA-71	BUMP				C11581015	GP-66 ¹⁰	HOLM
BT261	GP-69	BLDW	BTA57	GA-80	BUMP				C1158-1015	GP-54	MNH
BT287	GP-34	BLDW	BTA59	GA-50	BUMP				C11581054	GA-467	COMA
BT287-10	GP-34	BLDW	BTA67	GA-192	BUMP				C11581390	GA-405	COMA
BT287-3	GP-34	BLDW	BTA74	GA-55	BUMP				C1158427	G-296	COMA
BT287-3	GP-34	HAS	BTA831	GA-85	BUMP				C1158427	G-296-B	COMA
BT334	GP-317H	BLDW	BTA84	GA-730	BUMP				C1158427	G-296	HOLM
BT339	GP-178	BLDW	BTA90	GA-303	BUMP				C1158427	G-296-B	HOLM
BT340	GP-51	BLDW	BTA91	GA-59	BUMP				C1117	GP-1	SAKU
BT342	GP-66	BLDW	BTA92	GA-57	BUMP				C1122	G-1174	FRM
BT343	GP-77	BLDW	BTA93	GA-325	BUMP				C1124APB	G-1173	FRM
BT353	GP-28	BLDW	BTA991	GA-86	BUMP				C1124APL	G-1173	FRM
BT354	GP-166	BLDW	BTO111	GP-46	BUMP				C1124APL	G-1173 ¹⁰⁸	REF
BT355	GP-54 ⁹⁰	BLDW	BTO123	GP-3429	BUMP				C1125M	G-1173 ¹⁰⁸	REF
BT364	GP-36	BLDW	BTO173	GP-3980	BUMP				C1126M	G-1175	REF
BT365	GP-54	BLDW	BTO195	GP-3600	BUMP				C1126PL	G-1175	FRM
BT365-10	GP-66	BLDW	BTO1A	GP-1	BUMP				C112777	GAVW-2	BROM
BT389	GP-34	BLDW	BTO241	GP-58	BUMP				C112777	GAVW-2	COMA
BT389-10	GP-34	BLDW	BTO252	GP-28 ⁹	BUMP				C1127APB	G-1176	FRM
BT420	GP-9	BLDW	BTO252	GP-430 ⁸	BUMP				C113	GP-156	VIC
BT427	GP-390	BLDW	BTO257	GP-310	BUMP				C1143	G-1143	FRM
BT464	GP-761H	BLDW	BTO291	GP-3531 EXP	BUMP				C1143PB	G-1143	FRM
BT486	GP-35	BLDW	BTO33	GP-20	BUMP				C1150531	GA-33 ¹²	DERR
BT5	GP-81	BLDW	BTO373	GP-3682	BUMP				C1150531	GA-33 ¹²	DUTZ
BT5	GP-9	BLDW	BTO40	GP-13	BUMP				C11505-31	GA-33 ¹²	COMA
BT536	GP-36	BLDW	BTO49	GP-3	BUMP				C11561655	GAK-403	POCL
BT541	GP-50	BLDW	BTO81	GP-81 ²¹	BUMP				C116	G-1121	PFX
BT564	GP-390 ⁹³	BLDW	BTO81	GP-9 ⁵⁸	BUMP				C1163PL	G-1163	FRM
BT595	GP-166 ⁹⁵	BLDW	BTQ9155A	GG-20	FORD				C11661	G-1166	FRM
BT595	GP-3937 ¹¹	BLDW	BW2001	GP-1011Q	PBR				C1166-1PL	G-1166	FRM
BT7237-MPG	GP-737	BLDW	BW2002	GP-1011Q	PBR				C1166-2PL	G-1166	FRM
BT7237-MPG	GP-737	HAS	BW2003	GP-2015W	PBR				C1166-3PL	G-1166	FRM
BT7339	GP-178	BLDW	BW2004	GP-2022W	PBR				C1166-4PL	G-1166	FRM
BT734	GP-761H	BLDW	BW2005	GP-2071W	PBR				C1166PL	G-1166	FRM
BT7349	GP-178	BLDW	BW2006	GP-1013Q	PBR				C117	G-31	ACD
BT744	GP-761H	BLDW	BW5070	GP-2071W	BLDW				C1172	G-1175 ¹⁰⁸	FRM
BT745	GP-761H	BLDW	BW5071	GP-2071W	BLDW				C1173PL	G-1173	FRM
BT746	GP-761H	BLDW	BW5072	GP-1010Q	BLDW				C1174PL	G-1174	FRM
BT747	GP-761H	BLDW	BW5073	GP-1011Q	BLDW				C1175PL	G-1175	FRM
BT749	GP-761H	BLDW	BW5074	GP-1012Q	BLDW				C1176	G-1176	FRM
BT758	GP-761H	BLDW	BW5082	GP-2071W	BLDW				C1178	G-1176	FRM
BT770	GP-761H	BLDW	BW5086	GP-2126Q	BLDW				C1179PB	G-1176	FRM
BT8307-MPG	GP-864H	BLDW	BW5134	GP-2071W	BLDW				C11816BPL	G-11816	FRM
BT8309MPG	GP-864H	BLDW	BW5136	GP-2071W	BLDW				C11816PL	G-11816	FRM
BT8314	GP-166	BLDW	BW5137	GP-2071W	BLDW				C11819PL	G-1123	FRM
BT8316	GP-3766	BLDW	BW5138	GP-1011Q	BLDW				C11819PL	G-1123F	FRM
BT8316-MPG	GP-3766	BLDW	BW5139	GP-1011Q	BLDW				C1184RO	G-1173 ¹⁰⁸	FRM
BT8327	GP-761H	BLDW	BW5140	GP-1013Q	BLDW				C1101	GP-1	VIC
BT8347	GP-66	BLDW	BW5142	GP-2108W	BLDW				C11860	G-1121	FRM
BT8377-MPG	GP-761H	BLDW	BW5177	GP-2022W	BLDW				C11860-1	G-1121	FRM
BT839	GP-66	BLDW	BW5178	GP-2015W	BLDW				C11860P1	G-1121	FRM
BT839-10	GP-66	BLDW	BW5179	GP-2022W	BLDW				C11860PB	G-1121	FRM
BT8409	GP-58 ⁸	BLDW	BY121172	GAK-16	JOHT				C11860PL	G-1121	FRM
BT8434	GP-310	BLDW	BYWA37020A	G-834	DORM				C11860PL	G-1121F	FRM
BT8504	GP-166	BLDW	BYWA37020A	G-834	GENE				C11861P1	G-1123	FRM
BT8834-MPG	GP-761H	BLDW	BYWA37020A	G-834	RUST				C11861P1	G-1123F	FRM
BT8834-MPG	GP-761H	HAS							C11861PB	G-1123	FRM
BT8840-MPG	GP-761H	BLDW							C11861PL	G-1123	FRM
BT8841-MPG	GP-761H	BLDW							C11861PL	G-1123F	FRM
BT8842-MPG	GP-761H	BLDW							C11861Z	G-1123F	FRM
BT8844	GP-761H	BLDW							C11863Z	G-1123F	FRM

C

C 13 103/1	GAD-29	MNH
C 14 177	GA-410	MNH
C 17 308	GA-8150	MNH
C 1995	GA-114	MNH
C 2295/3	GAVW-624	MNH
C 2493	GA-2193	MNH
C 2512	GA-292	MNH
C 2512/2	GA-1529	MNH
C 2538	GA-292	MNH
C 26 862	GA-904R	MNH
C 2693	GA-280	MNH
C 27 161	GA-27161	MNH
C 27 830	GA-864R	MNH
C 28 1053	GA-906R	MNH
C 28 940	GA-930R	MNH
C 29 108	GAVW-620	MNH
C 2998/5	GAVW-623	MNH
C 2998/5X	GAVW-623	MNH
C 30 126	GA-334	MNH
C 30 138	GA-334	MNH
C 30 138/1	GA-334	MNH
C 30 1622	GA-516R	MNH
C 30 195/2	GA-2195	MNH
C 3170/1-2	GA-2170	MNH
C 32 164	GA-2164	MNH
C 3251/1	GA-4319	MNH
C 34 104	GA-2104	MNH
C 34 1300	GA-682R	MNH
C 34 175	GA-2175	MNH
C 3479	GA-2179	MNH
C 3485	GA-2184	MNH
C 35 124	GA-283	MNH
C 37 132	GA-285	MNH
C010	GP-28 ⁹	VIC
C010	GP-430 ⁸	VIC
C0120-00013	GP-157	TOYO
C0120-00015	GP-58	TOYO
C02448	G-1173 ¹⁰⁸	FIAT
C025	GP-310	VIC
C065015	GA-2803T	DON
C0802	GP-1122	TECF
C09055-46	GP-36	POCL
COAE6714A	GP-1	DEAR
COAE-6714-A	GP-1	FORD
COAE-6714-B	GP-1	FORD
COAE-6731-A	GP-1	FORD
COLE-6714-A	GP-1	FORD
CONN-6708-A	GP-66	FORD
CONN-9155-A	G-1173	FORD
CONN-9155-B	G-1173 ¹⁰⁸	FORD
CONN-8951-A	GP-66	FORD
CONN-8951-B	GP-66	FORD
CONN-8951-C	GP-66	FORD
COTE-6731-A	G-330	FORD
COTE-6744-A	G-330	FORD
COTZ-6731-A	G-330	FORD
C1001	GP-3985	SAKU
C-1001-1	GP-3985	SAKU
C1002	GP-149	SAKU
C1002-1	GP-91	SAKU
C-1002-3	GP-149	SAKU
C-1002-7	GP-91	SAKU
C1003	G-1123	HARM
C1003	GP-40	SAKU
C1003-2	GP-40	SAKU
C1004	GP-3985	SAKU
C101	GP-28 ⁹	CHAM
C101	GP-430 ⁸	CHAM
C101	GP-1	TOKY
C101	GP-1	VIC
C1011	GP-149	SAKU
C1013	GP-149	SAKU
C1016	GP-149	SAKU

Referencia Cruzada por Numero de Parte

Cross Reference by Part Number



Numero	Gonher	Fabricante	Numero	Gonher	Fabricante	Numero	Gonher	Fabricante	Numero	Gonher	Fabricante
Number	Gonher	Manufacturer	Number	Gonher	Manufacturer	Number	Gonher	Manufacturer	Number	Gonher	Manufacturer
C11864Z		G-1121F FRM	C16011251		GP-28 ⁸ COMA	C1903		GP-9 ³⁸ SAKU	C219		GP-66 ¹⁰ VIC
C11868PL		G-1121 FRM	C16011251		GP-430 ⁹ COMA	C-1906		GP-81 SAKU	C22		GP-2071W KRA
C1188		GA-33 ¹¹² MNH	C16012050		GP-1122 COMA	C1907		GP-81 ³¹ SAKU	C2201		GP-81 SAKU
C119		GP-310 CAM2	C160121015		GP-54 ¹¹ COMA	C1907		GP-9 ³⁸ SAKU	C22117		GAVVW-4 MNH
C119		GP-1 CIGO	C160121015		GP-66 ¹⁰ COMA	C1908		GP-68 SAKU	C22117-1		GAVVW-4 MNH
C1191		GG-298 FRM	C16012150		GP-1122 COMA	C-1908-3		GP-68 SAKU	C2223		GP-68 SAKU
C1191-A		G-296-B FRM	C16012215		GP-54 ¹¹ COMA	C1909		GP-3600 SAKU	C2224		G-45 CIGO
C1191B		G-296 FRM	C16012215		GP-66 ¹⁰ COMA	C1910		GP-1 SAKU	C22281		GA-357 MNH
C1191B		G-296-B FRM	C1601251		GP-28 ⁸ COMA	C19157		GA-6127 MNH	C2256		GA-134 MNH
C1191PL		G-296 FRM	C1601251		GP-430 ⁹ COMA	C19171		GA-6127 MNH	C2263		GA-71 MNH
C1191PL		G-296-B FRM	C16012701		GP-28 ⁸ COMA	C193		GP-40 CAM2	C22631		GA-71 MNH
C11941		GG-48 FRM	C16012701		GP-430 ⁹ COMA	C193		GP-40 CIGO	C2278		GA-1572 MNH
C11941-PL		GG-48 FRM	C1602		GP-42 SAKU	C19335		GA-425 MNH	C-2282		GA-2182 MNH
C1196		GA-880R MNH	C1603		GP-3531 EXP SAKU	C19384		GA-781 MNH	C2290		GAVVW-4 MNH
C12		GG-7 FLAG	C-1603-1		GP-3531 EXP SAKU	C195		GP-3600 CAM2	C2314		GA-230 MNH
C12		GP-2071W KRA	C1605		GP-91 SAKU	C195		GP-3600 CIGO	C2318		GP-3600 CIGO
C1202		GP-58 SAKU	C1606		GP-462 SAKU	C19806-07		GA-21 AIM	C2320		GA-50 MNH
C1202702		GAK-403 LEYL	C1607		GP-462 SAKU	C19806-07-DD		GA-21 AIM	C2326		GA-8047 MNH
C1203		GP-58 SAKU	C1608		GP-462 SAKU	C19875		GA-21 AIM	C2339		GAD-3 MNH
C1204		GP-157 SAKU	C16-08		GA-27 ARAP	C1A		GP-1 CAM2	C23450		GA-230 MNH
C1205		GP-156 SAKU	C-1614		GP-149 SAKU	C1A		GP-1 CIGO	C24		GA-113 GOY
C121		GP-58 UNN	C16140		GA-1286 MNH	C1AZ-6731-A		GP-1 BLAW	C24		GP-2071W KRA
C12114		GA-18 MNH	C16154		GA-98 ¹¹² MNH	C1AZ-6731-A		GP-1 FORD	C-2401		GP-171 SAKU
C121141		GA-18 MNH	C1618		GAD-315 MNH	C1AZ-6731-AP		GP-1 FORD	C2401		GP-2951 ⁹² CAM2
C12119		GA-18 MNH	C16190		GAK-403 MNH	C1AZ9155A		GG-5 L FORD	C241		GP-58 ⁸⁴ CAM2
C1218		GP-205 CAM2	C1656APL		G-238 FRM	C1DZ-6741-A		G-750 FORD	C241		GP-58 ¹⁵ CIGO
C123		GP-3429 CAM2	C1660		G-222 FRM	C1DZ91555B		GG-5 L FORD	C-24-106		GA-2106 MNH
C123		GP-3429 CIGO	C1660A		G-222 FRM	C1H4115K		G-1123F DUTZ	C2420		GAD-116 MNH
C12366		GAK-20 PETI	C1678		G-169 FRM	C1H4115K		G-1123F KHDF	C2443		GA-230 MNH
C1270RO		G-1173 ¹⁰⁸ FRM	C1686		G-33 FRM	C1KE-9601-A		GA-77 FORD	C2444		GA-8047 MNH
C1281		GA-361 MNH	C169		G-1163 ¹⁰⁸ PFX	C1KE-9601-AR		GA-77 FORD	C24444		GA-8047 MNH
C13		GP-13 FLAG	C16901		GAK-403 MNH	C1KZ-9601-A		GA-77 FORD	C24444-1		GA-8047 MNH
C1301		GP-43 SAKU	C1691		G-191 FRM	C1TA-6731-A		G-750 FORD	C2446-1		GAD-3 MNH
C1306		GP-57 SAKU	C17		GP-81 CAM2	C1TT-6744-A		G-750 FORD	C24517		GA-360 MNH
C-1306-1		GP-57 SAKU	C17		GP-81 CIGO	C1TZ-3-FF		GA-77 FORD	C24650		GA-436 MNH
C13103		GAD-30 MNH	C1701		GP-462 SAKU	C1TZ6614A		G-750 FORD	C24650-1		GA-405 MNH
C13114-3		GA-49 MNH	C-1703		GP-36 SAKU	C1TZ-6714-A		G-750 FORD	C24719		GA-360 MNH
C13114-4		GA-49 MNH	C1703-1		GP-36 SAKU	C1TZ-6731-A		G-750 FORD	C24760		GA-966R MNH
C133-75		G-1123 ¹⁰⁸ FIL	C1707		G-331 FRM	C1TZ6731B		G-6 AUST	C2477		GA-471 MNH
C133-75		G-1123F ¹⁰⁸ FIL	C1711		GP-91 SAKU	C1TZ-6731-B		G-6 FORD	C24880		GA-616 MNH
C1342		GA-782 MNH	C17126		GA-206 MNH	C1TZ-6731-C		G-5000 FORD	C25		GP-20 FLAG
C1357		GA-200 MNH	C17127		GA-2804 T MNH	C1TZ-6731-CP		G-5000 FORD	C25 101		GA-215 MNH
C1357		GA-218 MNH	C1713		GP-462 SAKU	C1TZ-6731-D		G-330 FORD	C-25-114		GA-2114 MNH
C13571		GA-200 MNH	C17149		GA-206 MNH	C1TZ-6731-DP		G-330 FORD	C25114-1		GA-2114 MNH
C13571		GA-218 MNH	C1719		GP-91 SAKU	C1VE-6714-A		GP-1 FORD	C2512/1		GA-1529 MNH
C1357-2		GAD-30 MNH	C1720		G-159 FRM	C1ZE-9601-A		GA-77 FORD	C-25-135		GA-2135 MNH
C1358		GA-200 MNH	C1720		GP-3985 SAKU	C2		GP-68 FLAG	C-25-146		GA-2146 MNH
C1358		GA-218 MNH	C1721		G-331 FRM	C20		GP-2071W LEDR	C2517		GA-364 MNH
C136		G-1173 PFX	C1721		GP-149 SAKU	C20		GP-28 ⁸ CAM2	C2517		GP-28 ⁸ CAM2
C1362		GA-200 MNH	C173		GP-3980 CAM2	C2001		GP-20 SAKU	C252		GP-430 ⁸ CAM2
C1362		GA-218 MNH	C173		GP-3980 CIGO	C2008		GP-457 CIGO	C252		GP-28 ⁸ CIGO
C13621		GA-200 MNH	C17337		GA-853R MNH	C201		GP-38 VIC	C252		GP-430 ⁸ CIGO
C13621		GA-218 MNH	C174		G-500 FRM	C2017		G-3752 CIGO	C253		GP-81 CAM2
C1371		GA-1285 MNH	C17400		GA-589 MNH	C20187		GA-7360 MNH	C2531		GA-3490 MNH
C138		GP-157 CHAM	C174A		G-500 FRM	C2021		GA-2122 MNH	C2537/2		GA-386 MNH
C-1381		GA-2181 MNH	C174AP		G-500 FRM	C2039		GAVVW-10 MNH	C25387		GAC-7 GRP
C139		G-139 FRM	C174E		G-500 FRM	C205		GP-38 TOKO	C25387		GAC-7 MOB
C139APL		G-139 FRM	C174T		G-500 FRM	C205		GP-38 TOKY	C25387		GAC-7 PUR
C139PL		G-139 FRM	C175		GP-38 FRM	C205		GP-38 VIC	C25387		GAC-7 SHE
C13A		GP-205 FLAG	C175A		G-750 FRM	C206		G-31 ACD	C25421		GAK-625 MNH
C1403		GP-2951 SAKU	C175AP		G-750 FRM	C206		GP-171 VIC	C2545		GA-230 MNH
C1404		GP-156 SAKU	C175E		G-750 FRM	C2065		GA-432 MNH	C25552		GA-230 MNH
C141		GP-156 CHAM	C175P		G-750 FRM	C207		GP-3682 VIC	C255963		GA-39 ERF
C14179		GAK-16 MNH	C175T		G-750 FRM	C207L		GP-3682 TOKY	C2562		GA-216 MNH
C14179-1		GAK-216 MNH	C18		GP-81 CAM2	C207L		GP-3682 VIC	C256834		G-1143 ERF
C-1460		GA-2160 MNH	C18		GP-81 CIGO	C208		G-1143 ACD	C256838		G-750 ERF
C148		G-31 FRM	C1801		GP-38 SAKU	C208		GP-3682 VIC	C257		GP-310 CAM2
C14860		GAC-9 CIGO	C1802		GP-38 SAKU	C209		GP-171 CHAM	C257		GP-310 CIGO
C14860		GAC-9 GRP	C1803		GP-1 SAKU	C209L		GP-1 VIC	C26 862		GA-801R MNH
C14860		GAC-9 MIGH	C-1804		GP-171 SAKU	C20E-9176-A		GG-20 FORD	C2601		GP-3816 SAKU
C14860		GAC-9 MOB	C-1804-1		GP-171 SAKU	C20F9601A		GA-80 YELC	C2602		GP-38 SAKU
C14860		GAC-9 PUR	C1805		GP-3682 SAKU	C20F-9601-A		GA-80 FORD	C26100		GA-224 MNH
C14860		GAC-9 QKS	C-1805-4		GP-3682 SAKU	C20F-9601-Z		GA-80 FORD	C26110		GA-2110 MNH
C14860		GAC-9 SHE	C1805-6		GP-3682 SAKU	C20Z-9601-A		GA-80 FORD	C-26-110-1		GA-2110 MNH
C149		GP-28 ⁸ CHAM	C1806		GP-38 SAKU	C20Z-9601-AR		GA-80 FORD	C26126		GA-2146 MNH
C149		GP-430 ⁸ CHAM	C1809		GP-91 SAKU	C2101		GP-46 SAKU	C26144		GAVVW-622 MNH
C1502		GP-3985 SAKU	C-1809-1		GP-91 SAKU	C2102		GP-46 SAKU	C26151		GAVVW-622 MNH
C1503		GP-3985 SAKU	C1814		GP-156 SAKU	C2103		GP-3985 SAKU	C2645		GA-78 MNH
C1511		GP-42 SAKU	C-18-146-2		GA-2147 MNH	C-2105		GP-461 SAKU	C2652		GA-3490 MNH
C1514		GP-46 SAKU	C1815		GP-91 ⁷⁴ SAKU	C2106		GP-46 SAKU	C2656		GA-434 MNH
C1517		GP-462 SAKU	C1815-1		GP-91 SAKU	C21112181		GA-360 LEYL	C266		G-500 ACD
C15390		GAC-13 GRP	C1818		GP-3682 SAKU	C2119		GA-314 MNH	C267		G-750 ACD
C15390		GAC-13 MOB	C1820		GP-38 SAKU	C212		GP-3682 UNN	C2675		GA-303 MNH
C15390		GAC-13 QKS	C1821		GP-149 SAKU	C212		GP-51 VIC	C267X		G-750 ACD
C15390		GAC-13 SHE	C1822		GP-36 SAKU	C213		GP-28 ⁸ CAM2	C2681		GA-258 MNH
C15439		GAC-6 PUR	C184		G-31 FRM	C213		GP-430 ⁸ CAM2	C-2695-2		GA-2192 MNH
C156172		GP-1101 CUMM	C18436		GAK-625 MNH	C21317		GAK-20 MNH	C2700		GP-462 CAM2
C156172		GP-1101 ERF	C184P		G-330 BLDW	C2135		GA-349 MNH	C27139-7		GA-229 MNH
C158139		G-566 ERF	C-1858-1		GA-2158 MNH	C2135-2		GAD-3 MNH	C2714		GA-281 MNH
C159		G-31 ACD	C187		G-1121 PFX	C2136		GA-382 MNH	C271541		GAVVW-121 MNH
C16		GP-81 FLAG	C1891		GA-362 MNH	C2138/3		GA-381 MNH	C27192/1		GA-2124 MNH
C16		GP-2071W KRA	C19		GA-100 GOY	C2146		GA-71 MNH	C2722		GA-6619 ¹ MNH
C160		GP-40 CAM2	C1900PL		G-1175 FRM	C2159		GA-2159 MNH	C2722		GA-6620 ⁵ MNH
C160		GP-28 ⁸ CHAM	C1901		GP-166 SAKU	C2167		GP-171 CAM2	C2747		GA-4958 MNH
C160		GP-430 ⁸ CHAM	C1902		GP-68 SAKU	C218		GP-156 VIC	C28 1053		GA-864R MNH
C1601		GP-91 SAKU	C1903		GP-81 ³¹ SAKU	C219		GP-54 ¹¹ VIC	C2803		GP-91 SAKU

REFERENCIA CRUZADA

Numero	Gonher	Fabricante	Numero	Gonher	Fabricante	Numero	Gonher	Fabricante	Numero	Gonher	Fabricante
Number	Gonher	Manufacturer	Number	Gonher	Manufacturer	Number	Gonher	Manufacturer	Number	Gonher	Manufacturer
C28136	GA-VW-212	MNH	C30198	GA-143	MNH	C3682	GP-3682	FLAG	C45383	GAC-10 ²⁸	MOB
C281362	GA-VW-212	MNH	C3022	GA-3300	MNH	C36930	GA-264	MNH	C45383	GAC-8	MOB
C2818	GA-75	MNH	C3025	GA-303	MNH	C36930	GA-642	MNH	C45383	GAC-10 ²⁸	PUR
C2821	GP-2951 ⁶²	CAM2	C3027/1	GA-514	MNH	C36982	GA-2198 ⁷⁹	MNH	C45383	GAC-8	PUR
C2821	GP-58 ⁹⁴	CAM2	C3028	GA-328	MNH	C36982	GA-438 ³¹	MNH	C45383	GAC-10 ²⁸	QKS
C-28-214-1	GA-2141	MNH	C303	GP-40	TOKY	C37153/1	GA-VW-621	MNH	C45383	GAC-8	QKS
C2821A	GP-58	CIGO	C303	GP-40	VIC	C37153	GA-VW-621	MNH	C45383	GAC-10 ²⁸	SHE
C2825	GP-38	FLAG	C3033	GA-56	MNH	C3803	GP-3816	SAKU	C45383	GAC-8	SHE
C2843	GA-303	MNH	C304	GP-149	VIC	C3842	GA-140	MNH	C45384	GAC-1	GRP
C2844	GP-81	FLAG	C3042	GA-3566	MNH	C3853	GAC-10 ²⁸	BOG	C45384	GAC-1	MOB
C2846	GA-50	MNH	C3044	GA-3425	MNH	C3853	GAC-8	BOG	C45384	GAC-1	PUR
C2846/2	GA-4958	MNH	C30850-2	GA-467	MNH	C3872	GAC-2	BOG	C45384	GAC-1	QKS
C2849	GP-24 ²⁶	FLAG	C308831	GA-7716	MNH	C39219	GA-VW-616	MNH	C45384	GAC-1	SHE
C2849	GP-462 ⁹⁴	FLAG	C300B	G-31	FRM	C3936	G-339H	FRM	C4600	G-122	FRM
C2850	GP-310	FLAG	C30P	G-31	FRM	C3980	GP-3980	FLAG	C4600	G-338	FRM
C2856	GA-4303	MNH	C31	G-31	FRM	C3985	GP-3985	FLAG	C4612	GP-91	CIGO
C2856-1	GAD-15	MNH	C311011	GA-195	MNH	C3AE-6714-A	GP-1	FORD	C46155	GAK-403	CASE
C2860	GA-277	MNH	C311226	GA-6129	MNH	C3AF-9601-A	GA-77	FORD	C46155	GAK-403	DAVY
C28601	GA-277	MNH	C31126	GA-322	MNH	C3AZ-6731-A	GP-1	FORD	C4616	G-834	FRM
C2860-2	GA-4303	MNH	C-31-130	GA-2130	MNH	C3AZ-9601-A	GA-77	FORD	C4619	GP-3985	CAM2
C2861	GA-2161	MNH	C311390	GA-6129	MNH	C3NN-6714-A	GP-1	FORD	C4619	GP-3985	CIGO
C2861/2	GA-2161	MNH	C31152	GA-VW-120	MNH	C3RZ-6731-A	GP-13	FORD	C4620	GP-149	CAM2
C2865A	GP-42	FLAG	C311521	GA-VW-120	MNH	C3RZ-6731-B	GP-5	FORD	C4620	GP-149	CIGO
C2867	GP-149	CAM2	C31226	GA-6129	MNH	C3RZ-6731-C	GP-3	FORD	C4622	GP-91	CAM2
C2868	GAD-1	MNH	C314	GP-2015W	KRA	C3RZ-6731-CDP	GP-3	FORD	C4622	GP-91	CIGO
C2870	GP-28 ⁸	FLAG	C3160	GA-176	GOY	C3RZ-9601-B	GA-56	FORD	C4631	GP-205	CAM2
C2870	GP-430 ⁸	FLAG	C3173	GA-2173	MNH	C3RZ-9601-C	GA-71	FORD	C4631	GP-205	CIGO
C-2874	GA-2174	MNH	C31770	GA-26	MNH	C3RZ-9601-D	GA-71	FORD	C4635	G-153	FRM
C2876	GP-91	CAM2	C31P	G-31	FRM	C3TE-6744-A	G-6	FORD	C4636	G-122	FRM
C2876	GP-91	CIGO	C31PL	G-31	FRM	C40	GP-13	CAM2	C4636	G-338	FRM
C288	GP-3766	CIGO	C32	GP-2071W	LEDR	C40	GP-13	CIGO	C4651	GP-68	CAM2
C2883	G-143	FRM	C32	GP-2071W	LEE	C4006	GP-44	CAM2	C4651	GP-68	CIGO
C289	GP-3985	CAM2	C32 191/1	GA-VW-627	MNH	C4006	GP-44	CIGO	C4670	GP-81	CAM2
C291	GP-3531 EXP	CAM2	C321	GP-91	CAM2	C4007	GP-44	CAM2	C4670	GP-81	CIGO
C291	GP-3531 EXP	CIGO	C32123	GA-2123	MNH	C4011	GP-3980	CAM2	C4670	GP-81	FLAG
C-29-105	GA-2105	MNH	C32338	GA-475	MNH	C4011	GP-3980	CIGO	C470800200	GA-6127	MIT5
C-29-118	GA-2118	MNH	C32338/1	GA-5876	MNH	C406	GP-462	TOKY	C470800200	GA-6127	MIT5
C29198	GA-VW-626	MNH	C3240	GA-2719B	MNH	C406	GP-462	VIC	C-47-109	GA-2109	MNH
C2926	G-926	FRM	C3257	GA-2719B	MNH	C407	GP-3985	TOKY	C4712	GA-217	CIGO
C2933	G-163	FRM	C3260	GA-3300	MNH	C-40749	GA-2174	ROVE	C4731	GA-165	CIGO
C2938	GA-3425	MNH	C32640	GA-5648	MNH	C40F-9601-B	GA-80	FORD	C4872	GP-562	CAM2
C29381	GA-3425	MNH	C326400	GA-5648	MNH	C40Z-9601-A	GA-80	FORD	C4872	GP-562	CIGO
C2950	GA-75	MNH	C32640-1	GA-5648	MNH	C4109	G-1123	FRM	C49	GP-3	CAM2
C2951	GP-3816	FLAG	C3264010	GA-5648	MNH	C4109	G-1123F	FRM	C49	GP-3	CIGO
C2951A	GP-58	FLAG	C326400	GA-5648	MNH	C41110	GA-VW-617	MNH	C4AE-6714-A	GP-1	FORD
C29577	GA-27	MNH	C33	GP-20	CAM2	C4120	G-1163	FRM	C4AE-9176-A	GG-20	FORD
C296241	GA-9334	MNH	C33	GP-20	CIGO	C413	GP-149	VIC	C4AF-6714-A	GP-1	FORD
C2963/1	GA-2740	MNH	C33 189/1	GA-397	MNH	C415	GP-149	VIC	C4AZ-6731-A	GG-20	FORD
C2964	GAD-15	MNH	C330	GP-40	UNN	C4155	G-296	FRM	C4AZ-9365-A	GG-20	FORD
C2974	GAD-15	MNH	C3304232	GP-57	ERF	C4155	G-296-B	FRM	C4AZ-9365-B	GG-20	FORD
C29776	GA-9045	MNH	C3305367	GP-2071W	ERF	C416	G-1121F	PFX	C4AZ-9365-C	GG-20	FORD
C29920	GA-106 ⁶⁶	MNH	C3305369	GP-1011Q	ERF	C4161	G-297-B	FRM	C4EZ6731E	G-236	FORD
C29920	GA-326 ⁷¹	MNH	C3305370	GP-1013Q	ERF	C4163	G-297	FRM	C40F-9601-B	GA-80	FORD
C29939	GA-106 ⁶⁶	MNH	C3308638	GP-11	LEYL	C4163	G-297-B	FRM	C40Z-9601-A	GA-80	FORD
C29939	GA-326 ⁷¹	ERF	C33103	GA-2194	MNH	C417	G-1123F	PFX	C4R-9155-A	GG-1	FORD
C299670	GP-53	MNH	C3313279	GP-53	LEYL	C41783A	G-750	BUCY	C4R-9155-A	GG-4	FORD
C2AF-9601-Z	GA-80	FORD	C3313283	GP-57	LEYL	C41783A	G-750	CLRK	C4R-9155-B	GG-5 L	FORD
C2AZ-9155-A	GG-20	FORD	C3315115	GP-1011Q	DAF	C41783A	G-750	CUMM	C4R-6731-C	G-5000	FORD
C2AZ-9365-A	GG-20	FORD	C3315115	GP-1011Q	LEYL	C41783A	G-750	DAVI	C4RZ-6731-B	G-200	FORD
C2DE9155A	GG-5 L	FORD	C3315116	GP-2071W	DAF	C41783A	G-750	DIAM	C4RZ-6731-CDP	GP-3	FORD
C2D29155A	GG-5 L	FORD	C3315116	GP-2071W	LEYL	C41783A	G-750	EMCO	C4RZ-6731-E	G-236	FORD
C2N3587	GP-457	JAGU	C33156	GA-2156	MNH	C41783A	G-750	EUCL	C4TE6744A	G-6	FORD
C2OE-9176-A	GG-20	FORD	C33156/1	GA-2156	MNH	C41783A	G-750	KENW	C4TZ-6731-A	G-6	FORD
C2OF-9601-A	GA-80	FORD	C3318853	GP-3000	LEYL	C41783A	G-750	OLIV	C4TZ-9365-B	GG-20	FORD
C2OF-9601-Z	GA-80	FORD	C33445	GP-58	INGR	C41783A	G-750	WORT	C4Z9365A	GG-20	FORD
C2OZ-9601-A	GA-80	FORD	C3387A	GP-46	FLAG	C41783-A	G-750	WHIT	C4ZF-9601-A	GA-77	FORD
C2OZ-9601-AR	GA-80	FORD	C-3394	GA-2194	MNH	C42	GP-38	CIGO	C4ZF-9601-B	GA-78	FORD
C2RZ-9115-B	GG-5 L	FORD	C34109	GA-VW-2	MNH	C422	GP-2022W	KRA	C4ZF-9601-B1	GA-78	FORD
C2RZ9155B	GG-3	FORD	C341091	GA-VW-2	MNH	C426	G-1174 ¹⁰⁸	PFX	C4ZF-9601-B2	GA-78	FORD
C2S 20906	GG-106	JAGU	C3429	GP-3429	FLAG	C428	GP-2015W	KRA	C501	GP-38	VIC
C2S 2768	GG-106	JAGU	C3453	GA-VW-2	MNH	C429	GP-2022W	KRA	C501N	GP-3682	VIC
C2TA-6708-A	G-836	FORD	C3463	GA-VW-2	MNH	C43	GP-81 ³¹	FLAG	C502	GP-3985	TOKY
C2TZ-6708-A	G-836	FORD	C3474	GA-VW-2	MNH	C43	GP-9 ³⁸	FLAG	C503	GP-3985	VIC
C2TZ-6714-A	G-836	FORD	C3480	GA-4365	MNH	C43	G-1143	FRM	C504	GP-3985	VIC
C2TZ-6731-A	G-836	FORD	C3483-1	GA-4365	MNH	C43102	GA-VW-625	MNH	C5101	GP-1	SAKU
C2TZ-9155-B	G-11816	FORD	C-3484	GA-2184	MNH	C43515	GAK-20	DAVY	C5102	GP-31	SAKU
C2TZ-9155-C	G-1174 ¹⁰⁸	FORD	C351	G-1143	LBFI	C43PB	G-1143	FRM	C5103	GP-3600	SAKU
C2TZ-9365-A	G-11816	FORD	C351350	GA-885	MNH	C4451624	GP-54 ³¹	ASTN	C51334	G-870	VOK
C2TZ-9365-B	G-1174 ¹⁰⁸	FORD	C35154	GA-VW-619	MNH	C4451624	GP-66 ⁴⁰	ASTN	C5230	GP-128	CAM2
C30	GP-3	FLAG	C3531	GP-3531 EXP	FLAG	C4454	G-1121	FRM	C5230	GP-128	CIGO
C30	GP-1011Q	KRA	C3534	GA-390	MASE	C4457	GP-3682	CAM2	C5274	GP-765	CIGO
C30	GP-2071W	LEDR	C3534	GA-390	MNH	C4457	GP-3682	CIGO	C5288	GP-3675	CAM2
C30	GP-2071W	LEE	C3535	GP-3980	FLAG	C4458	GP-462	CIGO	C5288	GP-3675	CIGO
C301	GP-310	FRM	C35494	GAC-2	PUR	C4459	GP-149 ⁹⁹	CAM2	C5313	GP-408	CIGO
C301	GP-3985	VIC	C3562	GP-40	FLAG	C4459	GP-91 ⁹⁴	CAM2	C5335	GP-178	CIGO
C301240	GA-517R	MNH	C3569	GP-310	FLAG	C4459	GP-149 ⁹⁹	CIGO	C5401	GP-10	SAKU
C301251	GA-289	MNH	C-3569	GP-3569	FLAG	C4459	GP-91 ⁹⁴	CIGO	C-5501-1	GP-51	SAKU
C30130	GA-234	MNH	C35809	GA-375	MNH	C4466	GP-28 ⁶	CAM2	C-5501-1	GP-51	SAKU
C3014654	GP-43	ERF	C3600	GAC-13	BOG	C4466	GP-430 ⁹	CAM2	C-5503	GP-9586	SAKU
C30153	GA-241	MNH	C3600	GP-3600	FLAG	C4476	GP-157	CAM2	C-5603	GP-53	SAKU
C30153/1	GA-241	MNH	C3610	GP-156	BOG	C4477	GP-156	CAM2	C-5701-1	GP-53	SAKU
C301537	GA-467	MNH	C3614	GP-2951 ⁶²	FLAG	C4477	GP-156	CIGO	C-5702-1	GP-57	SAKU
C30170	GA-646	MNH	C3614	GP-58 ⁹⁴	FLAG	C4484	GP-212	CAM2	C-5702-3	GP-57	SAKU
C30189	GA-305	MNH	C361700	GA-356	MNH	C4484	GP-212	CIGO	C-5703	GP-390	SAKU
C30195	GA-2195	MNH	C36188	GA-VW-618	MNH	C45383	GAC-10 ²⁸	GRP	C-5704	GP-178	SAKU
			C36188/1	GA-VW-618	MNH	C45383	GAC-8	GRP	C-5704-1	GP-178	SAKU

Referencia Cruzada por Numero de Parte

Cross Reference by Part Number



Numero	Gonher	Fabricante	Numero	Gonher	Fabricante	Numero	Gonher	Fabricante	Numero	Gonher	Fabricante
Number	Gonher	Manufacturer	Number	Gonher	Manufacturer	Number	Gonher	Manufacturer	Number	Gonher	Manufacturer
C-5706	GP-3000	SAKU	C68147	GP-50	CATP	C8037	GP-310	SAKU	CA10389	GA-3095R	FRM
C-5707	GP-3001	SAKU	C68147	GP-50	TOWM	C804	GP-3531	EXP TOKO	CA103895	GA-3096R	FRM
C-5803	GP-36	SAKU	C6H0280	GP-1011Q	LINK	C804	GP-3531	EXP TOKY	CA104	GP-22	WIPA
CSAE-9176-A	GG-20	FORD	C6JZ-6714-A	GP-9	FORD	C804	GP-3531	EXP VIC	CA1043	GA-273	CENE
CSAZ-9365-A	GG-20	FORD	C6JZ-6714-B	GP-58	FORD	C-8041	GP-68	SAKU	CA1046	GA-174	CENE
CSA29635A	GG-20	FORD	C6JZ-9600-A	GAK-16	FORD	C805	GP-462	TOKY	CA10468	GA-171	FRM
CSN9176A	G-296	FORD	C6JZ-9600-B	GAK-403	FORD	C805	GP-462	VIC	CA10564	GA-110	FRM
CSN9176A	G-296-B	FORD	C6RZ-6A631-A	GA-39	FORD	C806	GP-91	VIC	CA106	GA-70	FRM
CSN9176C	G-296	FORD	C6T-6731-A	G-566	FORD	C81	GP-81 ³¹	CAM2	CA1061	GA-275	CAM2
CSN9176C	G-296-B	FORD	C6TE-6744-A	G-5000	FORD	C81	GP-9 ³⁸	CAM2	CA1061	GA-275	CENE
CSNE-9167-A	G-296	FORD	C6TE-6744-C	G-5000	FORD	C81	GP-81 ³¹	CIGO	CA1096	GA-6479	CENE
CSNE-9167-A	G-296-B	FORD	C6TS-9600-T	GA-26	FORD	C81	GP-9 ³⁸	CIGO	CA1097	GA-7007	CENE
CSNE-9176	G-296	FORD	C6TZ-6731A	G-566	FORD	C820	GP-68	CAM2	CA110A	GAD-3	CAM2
CSNE-9176	G-296-B	FORD	C6TZ-9155-A	GPP-14	FORD	C8246	G-162H	FRM	CA110A	GAD-3	CIGO
CSNE-9176-A	G-296	FORD	C6TZ-9155-B	GP-1101	FORD	C833PL	G-870	FRM	CA111	GA-230	CENE
CSNE-9176-A	G-296-B	FORD	C6TZ-9600-A	GAK-16	FORD	C843	G-971	CIGO	CA111	GA-230	DEL
CSNE-9176-AC	G-296	FORD	C6TZ-9600-A1	GAK-16	FORD	C8662	G-128	FRM	CA113	GA-75	CAM2
CSNE-9176-AC	G-296-B	FORD	C7003	GP-5	SAKU	C870	G-870	FRM	CA113	GA-75	CIGO
CSNE-9176-C	G-296	FORD	C-7005	GP-53	SAKU	C870PL	G-870	FRM	CA113	GP-462	WIPA
CSNE-9601-A	GA-77	FORD	C703A	GP-58	TOKY	C8764	G-222	FRM	CA1135	GA-7017	CENE
CSNE-9A641-A	GA-18	FORD	C704-L	G-500	BLDW	C8848	G-1175	FRM	CA1149	GAVW-2	CAM2
CSNN-6708-A	GP-66	FORD	C704-LS	G-500	BLDW	C89	GA-39	MNH	CA1149	GAVW-2	CIGO
CSNN-6714-A	GP-81	FORD	C710	GA-39	MNH	C8AF6714A	GP-1	FORD	CA115	GA-55	FRM
CSNN-6714-B	GP-81	FORD	C-7101-1	GP-51	SAKU	C8AF-9600-C	GA-85	FORD	CA116	GA-200	CENE
CSR-6731-A	G-333	FORD	C7102	GP-81	SAKU	C8AF-9601-A	GA-85	FORD	CA116	GA-218	CENE
CSR-6731-C	GP-66	FORD	C73	GP-24 ²⁶	CAM2	C8AZ-9601-A	GA-85	FORD	CA117	GP-3816	WIPA
CSRA5744C	G-330	FORD	C73	GP-462 ²⁴	CAM2	C8H0076	GP-3000	LINK	CA119	GP-28 ⁶	WIPA
CSRA-6731-A	G-566	FORD	C73	GP-462 ²⁴	CIGO	C8HA-9600-Z	GA-27	FORD	CA119	GP-430 ⁸	WIPA
CSRA-6744-A	G-6	FORD	C73	GA-101	GOY	C8HS-9600-Z	GA-27	FORD	CA120	GA-74	CAM2
CSRA-6744-C	G-330	FORD	C7500-M	G-750	BLDW	C8HZ9601E	GA-9334	FORD	CA120	GA-74	CIGO
CSTE6744A	G-5000	LNCR	C7500-E	G-750	BLDW	C8PJ-6714-A	GP-13	FORD	CA120PL	GA-7	FRM
CSTE-6744-A	G-5000	FORD	C750-L	G-750	BLDW	C8R	GP-2071W	KRA	CA121	GP-46	WIPA
CSTE-6744-A2	G-5000	FORD	C750-L	G-750	BLDW	C8TF-9600-A	GA-303	FORD	CA122	GP-40	WIPA
CSTE-9600-E	GA-27	FORD	C77N-F933-A	GP-54 ¹¹	FORD	C8TF-9601-A	GA-303	FORD	CA123	GA-3300	CAM2
CSTS-9600-E	GA-78	FORD	C77N-F933-A	GP-66 ¹⁰	FORD	C8TZ-9601-A	GA-303	FORD	CA123	GP-3985	WIPA
CSTS-9600-F	GA-27	FORD	C-7910	GP-14	SAKU	C8TZ-9601-D	GA-303	FORD	CA124	GA-3300	CAM2
CSUC-9155-A	GG-19	FORD	C7921	GP-171	SAKU	C8VF-9600-C	GA-85	FORD	CA124	GA-3300	CIGO
CSUE-9155-A	GG-19	FORD	C-7926	GP-171	SAKU	C901	GP-91	VIC	CA126	GP-40	WIPA
CSUZ-9155-A	GG-19	FORD	C-7927	GP-3000 ¹³	SAKU	C9201	GP-91	SAKU	CA127	GP-58	WIPA
CSZ-9601-B	GA-78	FORD	C-7937	GP-9	SAKU	C9262	G-1046	FRM	CA129	GA-3424	CAM2
CSZZ-6731-A	GP-81 ³¹	FORD	C7940	GP-3675	SAKU	C92623	GP-46	PETI	CA129	GP-46	WIPA
CSZZ-6731-A	GP-9 ⁵⁸	FORD	C7AE-9155-A	GG-19	FORD	C9608	GG-111	FRM	CA130	GP-3816	WIPA
CSZZ-9601-A	GA-77	FORD	C7AF-9600-N	GA-78	FORD	C977	GP-50 ³⁰	ACD	CA1300	GA-673R	CENE
CSZZ-9601-B	GA-78	FORD	C7CC9A641A	GA-18	FORD	C9AF-9601-A	GP-171 ¹⁸	FORD	CA1301	GA-732R	CENE
CSZZ-9601-D	GA-78	FORD	C7JZ-9600-C	GAK-403	FORD	C9DZ-6731-A	GP-36	FORD	CA131	GA-3425	CAM2
C6002112110	GP-58 ⁹	CUMM	C7NN-6714-A	GP-1	FORD	C9NN-6714-A	GP-1	FORD	CA133	GA-78	FRM
C60279	GP-11	LINK	C7NN-6714-B	GP-1	FORD	C9NN-9601-B	GA-18	FORD	CA135	GA-75	CENE
C6101	GP-54 ¹¹	SAKU	C7NN-6714-B5	GP-1	FORD	C9PJ-6714-A	GP-38	FORD	CA135	GA-75	DEL
C6101	GP-66 ¹⁰	SAKU	C7NN-9176-A	G-296	FORD	C9TZ-6731-A	GP-36	FORD	CA13572	GAD-30	MFI
C6102	GP-51	SAKU	C7NN-9176-A	G-296-B	FORD	C9TZ-6731-B	GP-36	FORD	CA136	GA-55	FRM
C-6202	GP-36	SAKU	C7NN-9A641-A	GA-18	FORD	C9TZ-9365-A	G-296	FORD	CA136	GA-55	RKHL
C6204	GP-54 ¹¹	SAKU	C7NN-9A641-C	GA-18	FORD	C9TZ-9365-A	G-296-B	FORD	CA137	GP-3816	WIPA
C6204	GP-66 ¹⁰	SAKU	C7NN-F933-A	GP-66	FORD	C9TZ-9601-A	GA-26	FORD	CA1372	GA-134	FRM
C6205	GP-28 ⁸	SAKU	C7TF-9365-C	G-296	FORD	C9TZ-9601-B	GA-27	FORD	CA1380	GAD-3	CENE
C6205	GP-430 ⁸	SAKU	C7TF-9365-C	G-296-B	FORD	C9Z-9601-A	GA-3300	FORD	CA139	GP-3816	WIPA
C6206	GP-28 ⁸	SAKU	C7TS-9600-A	GA-27	FORD	C9ZF-9601-A	GA-3300	FORD	CA141	GA-140	CENE
C6206	GP-430 ⁸	SAKU	C7TS-9600-G	GA-26	FORD	C9ZZ-9601-A	GA-3300	FORD	CA142	GA-3566	CENE
C6208	GP-81 ³¹	SAKU	C7TS-9601-A	GA-27	FORD	CA10013	GA-383	FRM	CA146	GA-71	FRM
C6208	GP-9 ⁵⁸	SAKU	C7TZ-6731-A	G-836	FORD	CA10071	GA-1571	FRM	CA146	GA-71	RKHL
C6209	GP-40	SAKU	C7TZ-6731-B	G-834	FORD	CA10081	GA-114	FRM	CA1462	GA-589	FRM
C-6210	GP-54	SAKU	C7TZ-9155-A	GG-5 L	FORD	CA10085	GAVW-625	FRM	CA146PL	GA-71	FRM
C6211	GP-3816	SAKU	C7TZ-9365-A	G-296	FORD	CA10088	GA-363	FRM	CA148	GA-80	FRM
C6212	GP-58	SAKU	C7TZ-9365-C	G-296	FORD	CA10094	GA-1572	FRM	CA148	GA-80	RKHL
C6215	GP-54 ¹¹	SAKU	C7TZ-9365-C	G-296-B	FORD	CA101	GA-105	FRM	CA148PL	GA-80	FRM
C6215	GP-66 ¹⁰	SAKU	C8	G-1175 ¹⁰⁸	COM	CA10118	GA-489	FRM	CA15	GA-3490	CAM2
C6217	GP-54	SAKU	C8	GP-1	FLAG	CA10165	GA-340	FRM	CA1503	GA-885	FRM
C64	GP-3682	CAM2	C8	GP-2071W	KRA	CA10169	GA-320	FRM	CA151	GP-91	WIPA
C6402	GP-58 ¹⁵	SAKU	C8	GP-2126Q	KRA	CA10171	GA-464	FRM	CA1513	GA-135	FRM
C64682	G-31	WHIT	C8001	GP-1	SAKU	CA10173	GA-1540	FRM	CA15136000	G-296	BARS
C6502	GP-3	SAKU	C8002	GP-3	SAKU	CA10190	GA-265	FRM	CA15136000	G-296-B	BARS
C-6502-1	GP-3	SAKU	C8003	GP-38	SAKU	CA10191	GA-149	FRM	CA1517	GA-679	FRM
C6503	GP-20	SAKU	C8004	GP-3985	SAKU	CA10192	GA-492	FRM	CA15175Y	GA-680	FRM
C-6503-2	GP-20	SAKU	C8005	GP-91	SAKU	CA10193	GA-328	FRM	CA1520	GA-21	FRM
C6504	GP-13	SAKU	C8006	GP-58	SAKU	CA10199	GA-105	FRM	CA1533	GA-425	FRM
C6504-1	GP-13	SAKU	C8007	GP-81	SAKU	CA102	GA-105	CENE	CA15335Y	GA-426	FRM
C6504-4	GP-13	SAKU	C8009	GP-1	SAKU	CA102	GA-105	FRM	CA1541	GA-329	FRM
C6504-5	GP-13	SAKU	C8010	GP-58	SAKU	CA10228	GA-143	FRM	CA15415Y	GA-239	FRM
C6505	GP-46	SAKU	C8011	GP-171	SAKU	CA10234	GAD-116	FRM	CA1543	GA-891	FRM
C6506	GP-3429	SAKU	C8012	GP-40	SAKU	CA10236	GAVW-616	FRM	CA15435Y	GA-892	FRM
C-6506-1	GP-3429	SAKU	C8013	GP-46	SAKU	CA10242	GA-1542	FRM	CA1548	GA-483	FRM
C-6507	GP-3980	SAKU	C8014	GP-81	SAKU	CA10254	GA-1546	FRM	CA15485Y	GA-482	FRM
C6510	GP-3816	SAKU	C8016	GP-3816	SAKU	CA10256	GAVW-617	FRM	CA1553	GA-679	FRM
C-6511	GP-3980	SAKU	C8016-1	GP-3816	SAKU	CA10262	GA-437	FRM	CA15535Y	GA-680	FRM
C-6511-2	GP-3980	SAKU	C8017	G-128	FRM	CA10281	GA-701	FRM	CA1575	GA-6129	FRM
C-6512-2	GP-44	SAKU	C8018	GP-38	SAKU	CA102815Y	GA-702	FRM	CA1580	GA-109	FRM
C6602	GP-1	SAKU	C8018	GP-38	SAKU	CA10290	GA-27161	FRM	CA1580ASY	GA-119	FRM
C6603	GP-81 ³¹	SAKU	C8019	GP-36	SAKU	CA102PL	GA-105	FRM	CA15805Y	GA-119	FRM
C6603	GP-9 ⁵⁸	SAKU	C-8020	GP-171	SAKU	CA103	GAD-1	CAM2	CA1581	GA-229	FRM
C6603-1	GP-58	SAKU	C8028	GP-36	SAKU	CA10305	GA-4862R	FRM	CA1588	GA-589	FRM
C6701	GP-46	SAKU	C803	GP-42	TOKO	CA103055Y	GA-4863	FRM	CA15885Y	GA-588	FRM
C6701-1	GP-46	SAKU	C803	GP-42	TOKY	CA1031	GA-277	CENE	CA1589	GA-416	FRM
C-6701-6	GP-46	SAKU	C803	GP-42	VIC	CA10328	GAVW-618	FRM	CA1596	GA-209	FRM
C67452	G-870	VOK	C-8030	GP-91	SAKU	CA1032A	GA-5056	CENE	CA1596ASY	GA-210	FRM
C-6801	GP-66	SAKU	C8032	GP-3816	SAKU	CA10344	GA-341	FRM	CA159		

Numero	Gonher	Fabricante	Numero	Gonher	Fabricante	Numero	Gonher	Fabricante	Numero	Gonher	Fabricante
Number	Gonher	Manufacturer	Number	Gonher	Manufacturer	Number	Gonher	Manufacturer	Number	Gonher	Manufacturer
CA15995Y	GA-108	FRM	CA2663	GA-200	FRM	CA3359	GA-234	FRM	CA3647	GA-3647	FRM
CA16	GA-2740	CAM2	CA2663	GA-218	FRM	CA3377	GA-21	FRM	CA3647	GA-3647	RKHL
CA16	GA-2740	CIGO	CA2663A	GA-200	FRM	CA3372	GAVW-2	FRM	CA3660	GA-277	FRM
CA160	GA-70	FRM	CA2668	GA-303	FRM	CA3373	GAVW-2	FRM	CA3681	GA-3681	FRM
CA160	GA-70	RKHL	CA2676	GAD-3	FRM	CA3373	GAVW-2	RKHL	CA3681	GA-3681	RKHL
CA160PL	GA-70	FRM	CA268	GA-5648	FRM	CA3379	GAVW-2	FRM	CA3684	GA-219	FRM
CA1612	GA-127	CENE	CA270	G-296	WIPA	CA338	GA-3300	FRM	CA3685	GA-730	FRM
CA1613	GA-128	CENE	CA270	G-296-B	WIPA	CA3380	GA-3647	CAM2	CA3686	GA-422	FRM
CA1617	GA-442	CENE	CA2719	GA-2719B	FRM	CA3380	GA-3647	CIGO	CA3705	GA-154	CAC
CA168	GP-91	WIPA	CA2719A	GA-2719B	FRM	CA3384	GA-89	CAM2	CA3705	GA-154	FRM
CA1695	GA-395	CIGO	CA2719B	GA-2719B	FRM	CA3384	GA-89	CIGO	CA3717	GA-274	FRM
CA1697	GA-277	CAM2	CA2729	GA-50	FRM	CA3384	GAVW-2	FRM	CA3717	GA-274	RKHL
CA170	GA-73 ⁸¹	FRM	CA273	G-297-B	WIPA	CA3398	GA-3566	CAM2	CA3750	GA-3551 ⁵⁵	FRM
CA1750	GA-54	CENE	CA2740	GA-2740	FRM	CA3398	GA-3566	CIGO	CA3750	GA-3551 XT ⁹⁴	FRM
CA1750	GA-54	DEL	CA2740	GA-2740	RKHL	CA3399	GAVW-4	FRM	CA376	GAD-30	CENE
CA1754	GA-1617	CIGO	CA2750	GA-302	FRM	CA340	GA-86	FRM	CA3774	GA-229	FRM
CA1754	GA-1617	FRM	CA279	GA-216	CENE	CA340A	GA-86	FRM	CA3784	GA-230	CAC
CA176	GA-56 ³⁰	FRM	CA280	GA-471	CENE	CA340A	GA-86	RKHL	CA3784	GA-231	FRM
CA176PL	GA-56 ³⁰	FRM	CA2800	GA-388	FRM	CA3422	GAVW-2	FRM	CA3794	GA-229	FRM
CA178A	G-297-B	PFX	CA2810	G-335	SOPA	CA3424	GA-3424	FRM	CA380	GA-70	CENE
CA184	GA-77	FRM	CA2818	GA-75	MFI	CA3425	GA-3425	FRM	CA380	GA-70	DEL
CA184	GA-77	RKHL	CA283A	GA-8150	FRM	CA3425	GA-3425	RKHL	CA381	GA-74	FRM
CA184PL	GA-77	FRM	CA287	GA-287	FRM	CA3441	GA-277	FRM	CA381	GA-74	RKHL
CA186PL	GA-50	FRM	CA288	GA-1203	FRM	CA3441	GA-277	RKHL	CA3814	GA-3814	FRM
CA187	GA-90	FRM	CA2890	GA-6619 ¹	CENE	CA3441M	GAVW-10	FRM	CA3814	GA-3814	RKHL
CA187PL	GA-90	FRM	CA2890	GA-6620 ²	CENE	CA3445	GA-3445	FRM	CA383	GA-71	CENE
CA189	GA-50	FRM	CA292	GA-37	FRM	CA345	GAK-403	FRM	CA383	GA-71	DEL
CA189	GA-50	RKHL	CA293	GAD-15	CAM2	CA3465	GA-277	CAM2	CA3860	GAVW-120	CENE
CA189PL	GA-50	FRM	CA293	GAD-15	CENE	CA3465	GA-277	CIGO	CA3864	GA-1095	FRM
CA19	GA-100	FRM	CA295	GAVW-4	CENE	CA3468	GAVW-4	FRM	CA3873	GAVW-2	FRM
CA190	GA-39	CUMM	CA296	GAVW-2	CENE	CA347	GA-429	FRM	CA388	GA-3501	FRM
CA190	GA-39	FRM	CA296	GAVW-2	DEL	CA3471	GA-3490	FRM	CA3880	GA-3501	CENE
CA190PL	GA-39	FRM	CA29631	GA-2740	MFI	CA3472	GA-274	CAM2	CA3901	GA-3901	FRM
CA192	GA-192	FRM	CA297	GA-4365	CENE	CA3472	GA-274	CIGO	CA3901	GA-3901	RKHL
CA192	GA-192	RKHL	CA297	GA-4365	DEL	CA3474	GA-3681	CAM2	CA3902	GA-253	FRM
CA19DP	GA-100	FRM	CA298	GAVW-4	CENE	CA3474	GA-3681	CIGO	CA3902	GA-253	RKHL
CA19FP	GA-100	FRM	CA298	GAVW-4	DEL	CA349	GA-349	FRM	CA3913	GA-694	FRM
CA2014	GA-414R	CIGO	CA299	GAVW-2	CENE	CA3490	GA-3490	FRM	CA3914	GA-392	FRM
CA201CD1	GP-66	MODI	CA299	GAVW-2	DEL	CA3490	GA-3490	RKHL	CA3915	GA-3915	FRM
CA201CV1	GP-66	MODI	CA3	GA-75	CAM2	CA3497	GA-75	FRM	CA3915	GA-3915	RKHL
CA2096	GA-6619	FRM	CA300	GA-277	CENE	CA3501	GA-3501	FRM	CA3916	GA-3916	FRM
CA216	GA-1008	FRM	CA3000	GA-277	CENE	CA3501	GA-3501	RKHL	CA3916	GA-3916	RKHL
CA223	GA-29	FRM	CA300-A1	GA-70	IMPL	CA3501HD	GA-3501	FRM	CA3924	GA-153	FRM
CA224	GA-8047	FRM	CA300-A6	GA-70	IMPL	CA351	GA-75	FRM	CA3924	GA-153	RKHL
CA226	GA-9334	FRM	CA302	GA-4303	CENE	CA351	GA-75	RKHL	CA3945	GA-3501	FRM
CA229	GA-18	FRM	CA302	GA-4303	DEL	CA3510	GA-195	CENE	CA3989	GA-398	FRM
CA23	GA-113	FRM	CA3022	GA-3300	MFI	CA3517	GA-377	FRM	CA3989SY	GA-398	FRM
CA2314	GA-230	MFI	CA303	GA-303	FRM	CA3518	GA-372	FRM	CA3990	GA-3551 ⁵⁵	FRM
CA2318	GA-429	CAM2	CA303	GA-303	RKHL	CA352	GAD-1	FRM	CA3990	GA-3551 XT ⁹⁴	FRM
CA233	GA-9045	FRM	CA3033	GA-56	MFI	CA3523	GA-3523	FRM	CA3997	GA-216	FRM
CA234	GA-382	CAM2	CA305	GA-730	FRM	CA3523	GA-3523	RKHL	CA4	GA-70	CAM2
CA234	GA-1287	FRM	CA305	GA-730	RKHL	CA3524	GA-2740	FRM	CA4	GA-70	CIGO
CA2340	GA-382	CENE	CA306	GA-3445	CENE	CA3527	GA-77	FRM	CA401	GP-40	WIPA
CA235	GA-1284	FRM	CA3070	GA-2740	CENE	CA3529	GA-70	FRM	CA4010	GA-272	FRM
CA2350	GAD-30	CENE	CA3070	GA-3490	CENE	CA352B	GAD-1	FRM	CA403	GA-56	CENE
CA236	GA-1286	FRM	CA309	GA-3490	CENE	CA353	GA-3901	CAM2	CA403	GP-42	WIPA
CA237	GA-1285	FRM	CA31	GA-135	FRM	CA353	GAD-3	FRM	CA4040	GA-129	CENE
CA239	GA-375	FRM	CA3105	GA-49	FRM	CA353	GAD-3	RKHL	CA407	GP-3531 EXP	WIPA
CA24	GAD-3	CAM2	CA312	GA-192	CENE	CA3537	GA-54	FRM	CA409	GA-50	CENE
CA24	GA-113	FRM	CA312	GA-192	DEL	CA3537	GA-54	RKHL	CA409	GA-50	DEL
CA240	GA-37	FRM	CA3138	GA-54	CAM2	CA3538	GA-140	CAM2	CA409	G-143	SOPA
CA240PL	GA-37	FRM	CA3138	GA-54	CIGO	CA3538	GA-154	FRM	CA415	GA-142	CENE
CA248	GA-29	FRM	CA314	GA-78	CENE	CA3549	GA-89	FRM	CA415	GP-81 ¹¹	WIPA
CA24DP	GA-113	FRM	CA314	GA-78	DEL	CA3549	GA-89	RKHL	CA415	GP-9 ⁸	WIPA
CA24FP	GA-113	FRM	CA3149	GA-3523	CAM2	CA3550	GA-2110	CENE	CA417	GA-55	CENE
CA250	GA-39	CUMM	CA3149	GA-3523	CIGO	CA3559	GA-271	FRM	CA417	GA-55	DEL
CA2512	GA-826	FRM	CA318	GA-230	CENE	CA3559	GA-271	RKHL	CA4215	GA-467	FRM
CA2512SY	GA-827	FRM	CA3192	GA-271	CAM2	CA3565	GA-200	CAC	CA4223	GA-6128	FRM
CA2520	GA-362	CENE	CA3192	GA-271	CIGO	CA3565	GA-218	CAC	CA4244	GAD-3	FRM
CA2521SY	GA-416	FRM	CA3193	GA-735 ¹²⁴	CAM2	CA3565	GA-200	FRM	CA4252	GA-2719B	FRM
CA2524	GAK-216	FRM	CA3193	GA-735 ¹²⁴	CIGO	CA3565	GA-218	FRM	CA4278	GAD-15	CAM2
CA253	GA-16	FRM	CA3194	GA-467	FRM	CA3566	GA-3566	FRM	CA4278	GAD-15	CIGO
CA2531	GA-3490	MFI	CA3195	GA-3588	CAM2	CA3580	GA-180	CENE	CA4294	GA-2122	FRM
CA2539	GA-493 ⁰⁸	FRM	CA3195	GA-3588	CIGO	CA3586	GA-85	FRM	CA4298SY	GA-416	FRM
CA254	GA-2194	CENE	CA320	GP-22	WIPA	CA3588	GA-477	CIGO	CA4303	GA-4303	FRM
CA254	GA-20	FRM	CA3203	GA-21 ⁸¹	FRM	CA3588	GA-3588	FRM	CA4303	GA-4303	RKHL
CA254	GAK-20	FRM	CA324	GA-85	FRM	CA3588	GA-3588	RKHL	CA4309	GAD-15	FRM
CA2541	GA-251	FRM	CA3240	GA-2719B	MFI	CA359	GA-139	CAM2	CA4309	GAD-15	RKHL
CA255	GA-24	FRM	CA3245	GAD-30	FRM	CA3590	GA-3916	CAM2	CA4325	GA-4325	FRM
CA25552	GA-230	MFI	CA324A	GA-85	FRM	CA3590	GA-139	CENE	CA4325	GA-4325	RKHL
CA2556	GAK-625	FRM	CA324A	GA-85	RKHL	CA3590	GA-3916	CIGO	CA4342	GA-253	CIGO
CA256	GA-33 ¹¹²	FRM	CA325	GA-325	FRM	CA3591	GA-3814	CAM2	CA4343	GA-5056	CAM2
CA257	GA-26	FRM	CA325	GA-325	RKHL	CA3591	GA-3814	CIGO	CA4343	GA-5056	CIGO
CA2571	GAP-381	FRM	CA326	GA-59	FRM	CA3592	GA-273	CAM2	CA4347	GA-153	CAM2
CA2579	GA-826	FRM	CA326	GA-59	RKHL	CA3592	GA-273	CIGO	CA4347	GA-153	CIGO
CA258	GA-403	FRM	CA3261	GAK-20	FRM	CA3597	GA-734 ⁸¹	FRM	CA4354	GA-230	FRM
CA2588	GA-493 ⁰⁸	FRM	CA327	GA-57	FRM	CA3597	GA-735 ¹²⁴	FRM	CA4356	GA-390	CIGO
CA259	GAVW-4	CENE	CA327	GA-57	RKHL	CA3597	GA-735 ¹²⁴	RKHL	CA4361	GA-139	CAM2
CA259	GA-27	FRM	CA3280	GA-405	FRM	CA3597A	GA-735	FRM	CA4361	GA-139	CIGO
CA2595	GA-563	FRM	CA329	GA-135 ³⁰	FRM	CA3603	GA-373	FRM	CA4361	GAK-458	FRM
CA260	G-31	SOPA	CA329	GA-35	FRM	CA362	GA-2984	FRM	CA4365	GA-4365	CAC
CA2618	GAD-1	FRM	CA3290	GA-436	FRM	CA3621	GA-140	FRM	CA4365	GA-4365	FRM
CA2631	GA-8	FRM	CA3290A	GA-405	FRM	CA3637	GA-3637	FRM	CA4372	GA-3901	CAM2
CA2631-2	GA-8	FRM	CA3300	GA-3300	FRM	CA3637	GA-3637	RKHL	CA4372	GA-3901	CIGO
CA2643	GA-303	FRM	CA3300	GA-3300	RKHL	CA3642	GA-101	FRM	CA4375	GA-362	CAM2
CA2662	GAVW-2	FRM	CA3351	GA-3501	FRM	CA3642DP	GA-101	FRM	CA4375	GA-362	CIGO

Referencia Cruzada por Numero de Parte

Cross Reference by Part Number



Numero	Gonher	Fabricante	Numero	Gonher	Fabricante	Numero	Gonher	Fabricante	Numero	Gonher	Fabricante				
Number	Gonher	Manufacturer	Number	Gonher	Manufacturer	Number	Gonher	Manufacturer	Number	Gonher	Manufacturer				
CA4378		GA-174	CAM2	CA5111		GA-2156	FRM	CA6545		GAVW-120	FRM	CA76875Y		GA-459	FRM
CA4378		GA-174	CIGO	CA5148		GA-384	CIGO	CA6546		GA-139	FRM	CA7688		GA-529	FRM
CA4383		GA-471	FRM	CA5150		GA-172	CIGO	CA6547		GAD-30	FRM	CA7695		GA-197R	FRM
CA4404		GAVW-120	FRM	CA5155		GA-130	CIGO	CA6555		GA-275	FRM	CA7698		GA-389	FRM
CA4425		GA-18	FRM	CA518		GA-80	CENE	CA6558		GA-2106	FRM	CA77		GA-7	FRM
CA4468		GA-195	CAM2	CA518		GA-80	DEL	CA6575		GAVW-121	FRM	CA7703		GA-403	FRM
CA4468		GA-195	CIGO	CA5192		GA-158	CAM2	CA6576		GA-276	FRM	CA7726		GA-6	FRM
CA4471		GA-471	CAM2	CA5192		GA-158	CIGO	CA6591		GA-176	FRM	CA7727		GA-518R	FRM
CA4479		GA-6479	CAM2	CA52		GA-71	CAM2	CA6591DP		GA-176	FRM	CA7730		GA-3588	CENE
CA4479		GA-6479	CIGO	CA52		GA-71	CIGO	CA660		GA-230	FRM	CA7730		GA-3588	DEL
CA4487		GA-382	CAM2	CA5227		GA-279	CIGO	CA660PL		GA-230	FRM	CA7730		GA-175	FRM
CA4487		GA-382	CIGO	CA5229		GA-2121	FRM	CA6619		GA-6619 ⁵	FRM	CA7733		GA-128	FRM
CA45		GA-77	CAM2	CA523		GA-360	FRM	CA6619		GA-6620 ⁵	FRM	CA7737		GA-128	FRM
CA45		GA-77	CIGO	CA523AY		GA-361	FRM	CA661PL		GA-230	FRM	CA7738		GA-127	FRM
CA4521		GA-2194	FRM	CA523SY		GA-361	FRM	CA663		GA-4958	CENE	CA7746		GA-1616	FRM
CA4576		GA-2110	FRM	CA5248		GA-163	CAM2	CA665		GA-390	CENE	CA7764		GA-172	FRM
CA4613		GA-142	CIGO	CA5248		GA-163	CIGO	CA6664		GA-166	FRM	CA7774		GA-1616	FRM
CA4625		GA-2106	CIGO	CA5265		GA-8606	CIGO	CA6671		GA-389	FRM	CA7775		GA-476	FRM
CA4632		GA-275	CAM2	CA5272		GA-472	CIGO	CA669		GA-85	CENE	CA7800		GA-166	CENE
CA4632		GA-275	CIGO	CA5291		GA-780	CIGO	CA669		GA-85	DEL	CA7810		GA-154	CENE
CA4645		GA-6690	CAM2	CA5301		GAVW-120	FRM	CA6690		GA-6690	FRM	CA7816		GA-6690	CENE
CA4645		GA-6690	CIGO	CA531		GP-1	WIPA	CA67		GA-192	CAM2	CA7821		GA-276	CENE
CA4648		GA-133	CAM2	CA5314		GA-348	CIGO	CA67		GA-192	CIGO	CA7823		GAD-117	CENE
CA4648		GA-133	CIGO	CA5323		GA-224	CIGO	CA670		GA-86	CENE	CA7823		GAD-17	CENE
CA4650		GA-604	CAM2	CA5324		GA-168	CIGO	CA670		GA-86	DEL	CA7826		GA-133	CENE
CA4650		GA-604	CIGO	CA-5329		GA-2160	FRM	CA671		GA-3424	CENE	CA7828		GA-386	CENE
CA4656		GA-7017	CIGO	CA5330		GA-6479 ⁹⁰	CIGO	CA671		GA-3424	DEL	CA7833		GA-7142	CENE
CA4669		GAD-294	CIGO	CA5345		GA-410	FRM	CA672		GA-3425	CENE	CA7836		GA-604	CENE
CA4680		GA-386	CAM2	CA5350		GA-2114	FRM	CA672		GA-3425	DEL	CA7837		GA-166	CENE
CA4680		GA-386	CIGO	CA536		GA-356	FRM	CA68007		GA-386	FRM	CA7841		GA-322	CENE
CA4690		GA-322	CAM2	CA5365Y		GA-357	FRM	CA681PL		GPP-19	FRM	CA7842		GA-381	CENE
CA4690		GA-322	CIGO	CA5370		GAVW-121	FRM	CA6820		GA-215	FRM	CA7843		GA-7344	CENE
CA4700		GA-701 ¹⁰⁴	BLDW	CA5377		GAVW-212	FRM	CA6828		GA-133	FRM	CA7845		GA-300	CENE
CA4712		GA-217	CAM2	CA5378		GA-240	CIGO	CA6849		GAD-129	FRM	CA7849		GAVW-121	CENE
CA4712		GA-217	CIGO	CA5396		GA-248	CIGO	CA6850		GAD-294	FRM	CA785		GA-3647	CENE
CA4720		GA-7344	CIGO	CA5397		GA-194	CIGO	CA6856		GA-2804 T	FRM	CA7850		GA-3647	CENE
CA4721		GA-198	CAM2	CA542		GA-31	FRM	CA6900		GAD-117	FRM	CA7854		GA-217	CENE
CA4721		GA-198	CIGO	CA5446		GA-780	CIGO	CA6900		GAD-17	FRM	CA7857		GAD-118	CENE
CA4722		GA-5466	CIGO	CA5450		GA-2106	CENE	CA69165Y		GA-459	FRM	CA7858		GA-432	CENE
CA4727		GA-300	CAM2	CA5462		GA-490	CIGO	CA6918		GA-608	FRM	CA7862		GA-141	CENE
CA4727		GA-300	CIGO	CA5466		GA-5466	FRM	CA6931		GAD-29	FRM	CA7863		GA-165	CENE
CA4731		GA-165	CAM2	CA-5488		GA-2173	FRM	CA694		GA-105	FRM	CA7872		GA-164	CENE
CA4731		GA-165 ¹¹³	CIGO	CA5496		GA-134	FRM	CA697		GAD-1	FRM	CA7874		GA-175	CENE
CA4732		GA-3490	FRM	CA5513		GAVW-620	FRM	CA698		GAD-1	FRM	CA7876		GA-605	CENE
CA4799		GA-381	CIGO	CA5522		GA-2146	FRM	CA7		GA-4303	CAM2	CA7877		GA-3901	CENE
CA4819		GA-141	CAM2	CA-5538		GA-2118	FRM	CA7		GA-4303	CIGO	CA7878		GA-240	CENE
CA4819		GA-141	CIGO	CA-5539		GA-2195	FRM	CA7		G-31	SOPA	CA7879		GA-132	CENE
CA4828		GA-4828	FRM	CA5595		GA-595	FRM	CA7007		GA-7007	FRM	CA7880		GA-514	CENE
CA4828		GA-4828	RKHL	CA5626PU		GA-864R	FRM	CA7017		GA-7017	FRM	CA7881		GA-434	CENE
CA4830		GA-180	FRM	CA5641		GA-2193	FRM	CA7094		GA-604	FRM	CA7882		GA-1616	CENE
CA4830		GA-180	RKHL	CA-5657		GA-2174	FRM	CA7139		GA-197R	FRM	CA7884		GAVW-622	CENE
CA4831		GAD-118	CIGO	CA-5673		GA-2182	FRM	CA7139SY		GA-768R	FRM	CA7885		GA-2114	CENE
CA4832		GA-432	CAM2	CA573		GA-879	FRM	CA7140		GA-682R ¹⁰⁴	FRM	CA7886		GA-2184	CENE
CA4832		GA-432	CIGO	CA5741		GA-853R	FRM	CA7140SY		GA-683R ¹⁰⁸	FRM	CA7892		GA-5466	CENE
CA4852		GA-392	CIGO	CA5777		GA-475	FRM	CA7142		GA-7142	FRM	CA7893		GA-595	CENE
CA4858		GA-127	CIGO	CA-5782		GA-2175	FRM	CA7174		GA-381	FRM	CA7938		GA-286	CIGO
CA4873		GA-514	CIGO	CA5876		GA-5876	FRM	CA71PL		GA-44	FRM	CA7981		GA-183R	CIGO
CA4877		GA-175	CIGO	CA589		GA-403	FRM	CA7280		GA-3637	CENE	CA8004		GA-1615	FRM
CA4878		GA-1615	CAM2	CA-5891		GA-2146	FRM	CA73		GA-44	FRM	CA8007		GA-2193	FRM
CA4878		GA-1615	CIGO	CA59		GA-50	CAM2	CA7337		GA-2184	FRM	CA803		GA-77	CENE
CA4879		GA-1616	CAM2	CA59		GA-50	CIGO	CA7344		GA-7344	FRM	CA8037		GA-732R	FRM
CA4879		GA-1616	CIGO	CA592		GA-376	FRM	CA7351		GA-322	FRM	CA8038		GA-673R	FRM
CA4880		GA-164	CAM2	CA595		GA-378	FRM	CA7365		GA-217	FRM	CA8039		GA-1615	FRM
CA4880		GA-164	CIGO	CA596		GA-6880	FRM	CA73PL		GA-44	FRM	CA804		GA-90	CENE
CA-4894		GA-2122	FRM	CA597		GA-229	FRM	CA74		GA-55	CAM2	CA8040		GA-384	FRM
CA4924		GAD-117	FRM	CA5970		GA-234	FRM	CA74		GA-55	CIGO	CA8041		GA-384	FRM
CA4939		GA-139	FRM	CA598		GA-7716	FRM	CA74		GA-11	FRM	CA8060		GA-49	FRM
CA4958		GA-4958	FRM	CA5985Y		GA-7360	FRM	CA7414		GA-141	FRM	CA8067		GA-198	FRM
CA4995		GAVW-121	CIGO	CA-5994		GA-2147	FRM	CA7417		GA-198	FRM	CA8069		GA-244	FRM
CA4999		GA-4999	BLDW	CA6		G-31	SOPA	CA7420		GA-514	FRM	CA8080		GAVW-622	FRM
CA501		GP-54	WIPA	CA600		GA-4828	CENE	CA7421		GA-165	FRM	CA8099		GA-2118	FRM
CA502		GA-6129	FRM	CA601		GA-735 ¹²⁴	CENE	CA7426		GA-432	FRM	CA812		GA-730	CENE
CA5028		GA-403	FRM	CA601		GA-735 ¹²⁴	DEL	CA7431		GAVW-121	FRM	CA813		GA-59	CENE
CA5029		GA-8	FRM	CA602		GA-271	CENE	CA7432		GA-132	FRM	CA8133		GA-163	FRM
CA502SY		GA-6127	FRM	CA602		GA-271	DEL	CA7438		GA-442	FRM	CA814		GA-57	CENE
CA5031		GA-57	FRM	CA6040		GA-4325	CENE	CA7440		GA-300	FRM	CA8141		GA-1614	FRM
CA5032		GA-75	FRM	CA6067		GA-1614	CIGO	CA7448		GA-781	FRM	CA8142		GA-130	FRM
CA5033		GA-85	FRM	CA611		GA-3814	CENE	CA7448SY		GA-782	FRM	CA816		GA-325	CENE
CA5034		GA-59	FRM	CA6305		GA-390	FRM	CA7462SY		GA-357	FRM	CA8169		GAVW-626	FRM
CA5037		GA-329	FRM	CA6318		GA-6127	FRM	CA7466		GA-221R	FRM	CA817		GA-303	CENE
CA5042		GA-442	CIGO	CA6324		GA-616	FRM	CA7487		GA-499R	FRM	CA8177		GA-2193	FRM
CA5042		GA-642	FRM	CA6326		GA-371	FRM	CA7492		GA-2804 T	FRM	CA8180		GA-539R	FRM
CA5048		GA-132	CIGO	CA6333		GA-382	FRM	CA74PL		GA-11	FRM	CA8193		GA-966R	FRM
CA5056		GA-5056	FRM	CA6359		GAVW-2	FRM	CA753		GA-89	CENE	CA8193SY		GA-967R ¹⁰⁸	FRM
CA5056		GA-5056	RKHL	CA6362		GA-362	FRM	CA7530		GA-89	CENE	CA-8194		GA-2141	FRM
CA5057		GA-5057	INTF	CA6366		GA-174	FRM	CA7597		GA-164	FRM	CA8197SY		GA-768R	FRM
CA5058		GA-273	FRM	CA6366		GA-174	RKHL	CA76		GA-12	FRM	CA8205		GA-301	FRM
CA5058		GA-273	RKHL	CA6376		GA-142	FRM	CA7605		GA-605	FRM	CA8208		GA-607	FRM
CA507		GA-106 ⁹⁶	FRM	CA6379		GAD-15	FRM	CA7614		GAVW-620	FRM	CA-8220		GA-2105	FRM
CA507		GA-326 ⁷¹	FRM	CA6395		GA-195	FRM	CA7620		GA-2198 ⁷⁹	FRM	CA8221		GA-279	FRM
CA507SY		GA-206	FRM	CA6395		GA-195	RKHL	CA7620		GA-438 ⁸¹	FRM	CA8225		GA-145	FRM
CA5090		GA-673R	CAM2	CA6479		GA-6479	FRM	CA7628		GAD-118	FRM	CA8226		GA-518R	FRM
CA5090		GA-673R	CIGO	CA6479		GA-6479	RKHL	CA7640		GA-240	FRM	CA8229		GA-890R	FRM
CA510		GA-98 ¹¹²	FRM	CA6491											

Numero	Gonher	Fabricante	Numero	Gonher	Fabricante	Numero	Gonher	Fabricante	Numero	Gonher	Fabricante
Number	Gonher	Manufacturer	Number	Gonher	Manufacturer	Number	Gonher	Manufacturer	Number	Gonher	Manufacturer
CA8243	GA-158	FRM	CA9332	GA-395	FRM	CAK253	GAK-16	FRM	CC05	GA-113	ATL
CA825	GA-75	CENE	CA9345	GA-414R	FRM	CAK254	GA-20	FRM	CC0Z-6714-AG	GP-81	FORD
CA8260	GA-3681	CENE	CA9346	GA-799R	FRM	CAK254	GAK-20	FRM	CC1133PL	GC-1133	FRM
CA8262	GA-467	FRM	CA93465Y	GA-798R	FRM	CAK255	GA-24 ¹¹²	FRM	CC11AZ-6731-A	GP-1	FORD
CA8269	GA-472	FRM	CA9359	GA-293	FRM	CAK256	GA-33 ¹¹²	FRM	CC172	G-296	SOPA
CA828	GA-3523	CENE	CA9360	GA-264	FRM	CAK257	GA-26	FRM	CC172	G-296-B	SOPA
CA8308	GA-853R	FRM	CA9401	GA-490	FRM	CAK258	GAK-403	FRM	CC1A2-6731-A	GP-1	FORD
CA831	GA-85	CAM2	CA9409	GA-2124	FRM	CAK259	GA-27	FRM	CC1CZ-6731-D	G-236	FORD
CA83-1	GA-85	CIGO	CA9418	GA-516R	FRM	CAK4298	GAK-216	FRM	CC1CZ-6731-E	G-200	FORD
CA84	GA-730	CAM2	CA94185Y	GA-517R	FRM	CAK42985Y	GA-416	FRM	CC1CZ-6731-G	GP-50	FORD
CA84	GA-730	CIGO	CA9471	GA-448	FRM	CAK4413	GAK-403	FRM	CC3AE-6714-B	GP-1	FORD
CA840	GA-429	CENE	CA9482	GA-263	FRM	CAK4414	GAK-625	FRM	CC3CZ-6731-A	G-330	FORD
CA842	GA-74	CENE	CA9482	GA-5466	FRM	CAK4928	GAK-1532	FRM	CC3CZ-6731-B	GP-5	FORD
CA8466	GA-930R	FRM	CA9492	GA-367	FRM	CAK50475	GAK-16	FRM	CC3CZ-6731-C	GP-13	FORD
CA8475	GA-170	FRM	CA9493	GA-184	FRM	CAK50485	GAK-20	FRM	CC3CZ-6731-D	GP-3	FORD
CA8492	GA-600R	FRM	CA9511	GA-284	FRM	CAK50505	GAK-403	FRM	CC3RZ-9601-A	GA-50	FORD
CA85115Y	GA-723R	FRM	CA9516	GA-4999	FRM	CAK50515	GA-27	FRM	CC3RZ-9601-B	GA-56	FORD
CA8535	GA-712R	FRM	CA9519	GA-623	FRM	CAK50525	GA-33 ¹¹²	FRM	CC3RZ-9601-C	GA-70	FORD
CA8548	GA-304	FRM	CA9550	GA-880R	FRM	CAK510	GA-98 ¹¹²	FRM	CC3RZ-9601-D	GA-71	FORD
CA857	GAD-3	CENE	CA9563	GA-158	FRM	CAK6916	GAK-458	FRM	CC9213	G-296	SOPA
CA858	GAD-1 ⁸⁷	CENE	CA9564	GA-138	FRM	CAK7322	GAK-16	FRM	CC9213	G-296-B	SOPA
CA859	GA-100	CENE	CA9589	GA-488	FRM	CAK7667	GAK-458	FRM	CC9233	G-297-B	SOPA
CA8596	GA-697R	FRM	CA9590	GA-289	FRM	CAK7687	GAK-458	FRM	CC9244	G-296	SOPA
CA8598	GA-435R	FRM	CA9600	GA-269	FRM	CAK8259	GAK-1532	FRM	CC9244	G-296-B	SOPA
CA8602	GA-621	FRM	CA9601	GA-281 ⁸¹	FRM	CAK8390	GAK-403	FRM	CCIAZ-6713-D	GP-1	FORD
CA8606	GA-8606	FRM	CA9601	GA-284 ⁵⁷	FRM	CAM6089	GA-2122	LEYL	CCIAZ-6731-A	GP-1	FORD
CA862	GA-3300	CENE	CA9609	GA-196	FRM	CANP110	G-1173 ¹⁰⁸	SOPA	CCICZ-6731-E	G-200	FORD
CA8625	GA-2106	FRM	CA9610	GA-291	FRM	CANP117	G-1121	SOPA	CCICZ-6731-F	GP-5	FORD
CA8634	GA-258	FRM	CA9634	GA-241	FRM	CANP118	G-1123	SOPA	CCICZ-6731-G	GP-50	FORD
CA8651	GA-626	FRM	CA9639	GA-801R ¹⁰⁴	FRM	CANP120	G-1173	SOPA	CCITZ-6731-A	G-5000	FORD
CA8659	GA-966R	FRM	CA96395Y	GA-802R ¹⁰⁸	FRM	CANP124	G-1123	SOPA	CCITZ-6731-D	G-330	FORD
CA86675Y	GA-459	FRM	CA9646	GA-646	FRM	CANP125	G-1121	SOPA	CCKM1001	G-750	AIM
CA867	GAD-1 ⁸⁷	CENE	CA9651	GA-2160	FRM	CANP167	GP-1011Q	SOPA	CCSC1001	GP-1011Q	AIM
CA-8674	GA-2159	FRM	CA9652	GA-397	FRM	CANP174	G-1121	SOPA	CCS1002	GP-1011Q	AIM
CA868	GA-2719B	CENE	CA9662	GA-510	FRM	CANP176	G-1163	SOPA	CCSF1005	GPP-14	AIM
CA8720	GA-2130	FRM	CA9669	GA-597	FRM	CANP178	G-1175 ¹⁰⁸	SOPA	CCSL1003	GP-53	AIM
CA8736	GA-280	FRM	CA9681	GA-606	FRM	CANP185	G-1174	SOPA	CCSM1001	GP-57	AIM
CA8737	GA-853R	FRM	CA9681	GA-606	SECU	CANP196	G-1121	SOPA	CD0817-503-817	GA-588	AIM
CA8747	GA-258	FRM	CA9683	GA-380	FRM	CANP9211	G-1173	SOPA	CD0817-503-826	GA-589	AIM
CA8754	GA-6479	FRM	CA9687	GA-1617	FRM	CANP9222	GG-48	SOPA	CD0817-503-830	GA-588	AIM
CA8755	GA-348	FRM	CA9689	GA-2161	FRM	CAP24	G-870	SOPA	CD0817-610-826	GA-589	AIM
CA8755A	GA-348	FRM	CA971	GA-274	CENE	CAP255	G-238	SOPA	CD0817-610-830	GA-588	AIM
CA8756	GA-348	FRM	CA9721	GA-909R	FRM	CAP256	G-238	SOPA	CD0817-610G	GA-589	AIM
CA8760	GA-183	FRM	CA97215Y	GA-908R ¹⁰⁸	FRM	CAP270	G-870	SOPA	CD0817-650G	GA-588 ¹⁰⁸	AIM
CA8766	GA-491	FRM	CA974	GA-3916	CENE	CAP277	G-330	SOPA	CD0817-650G	GA-589 ¹⁰⁴	AIM
CA8767	GA-2195	FRM	CA9762	GA-249	FRM	CAP280	G-33	SOPA	CD0817-660G	GA-588 ¹⁰⁸	AIM
CA8768	GA-2198 ⁷⁹	FRM	CA9778	GA-415	FRM	CAP281	G-335	SOPA	CD0817-660G	GA-589 ¹⁰⁴	AIM
CA8768	GA-438 ³¹	FRM	CA9833	GA-288R	FRM	CAP286	G-834	SOPA	CD0817-603-826	GA-589	AIM
CA-8789	GA-2181	FRM	CA9838	GA-289	FRM	CAP305	G-5000	SOPA	CD0817-803-830	GA-588	AIM
CA8797	GA-314	FRM	CA9875	GA-486	FRM	CAP318	G-871	SOPA	CD0916-500-826	GA-425	AIM
CA8797	GA-323	FRM	CA9888	GAD-34	FRM	CAP321	G-139	SOPA	CD0916-500-830	GA-426	AIM
CA8805	GA-278R	FRM	CA9898	GA-596	FRM	CAP324	G-331	SOPA	CD0916-514-825	GA-425	AIM
CA8817	GA-477	CAC	CA9901	GA-624R	FRM	CAP384	G-33	SOPA	CD0916-514-826	GA-425	AIM
CA8817	GA-477	FRM	CA9902	GA-324	FRM	CAP397	G-191	SOPA	CD0916-514-830	GA-426	AIM
CA8867	GA-477	FRM	CA991	GA-86	CAM2	CAP435	G-331	SOPA	CD0916-525-826	GA-425	AIM
CA888	GA-113	CENE	CA99-1	GA-86	CIGO	CAP441	G-163	SOPA	CD0916-525-830	GA-426	AIM
CA8911	GA-194	FRM	CA9956	GA-624	FRM	CAP51	G-6	SOPA	CD0916-610-826	GA-425	AIM
CA8918	GA-286	FRM	CA9957	GA-281	FRM	CAP60	G-836	SOPA	CD0916-610-830	GA-426	AIM
CA8925	GA-780	FRM	CA9959	GA-334	FRM	CAP64	G-191	SOPA	CD0916-610G	GA-425	AIM
CA-8937	GA-2136	FRM	CAC9630	GG-246	JAGU	CAP72	G-225	SOPA	CD0916-650G	GA-425 ¹⁰⁴	AIM
CA8956	GA-479	FRM	CAC9630	GG-408	JAGU	CAP9	G-870	SOPA	CD0916-650G	GA-426 ¹⁰⁸	AIM
CA8958	GA-433	FRM	CAC9630	GG-246	LEYL	CAP96	G-834	SOPA	CD0916-660G	GA-425 ¹⁰⁴	AIM
CA8963	GA-2123	FRM	CAC-9630	GG-408	BLEY	CAPN-9162-A	G-1173 ¹⁰⁸	FORD	CD0916-660G	GA-426 ¹⁰⁸	AIM
CA-8964	GA-2158	FRM	CAC-9630	GG-408	BLMI	CAPN-99126-A	G-1173 ¹⁰⁸	FORD	CD1117-500-826	GA-679	AIM
CA8966	GA-2147	FRM	CAF 1713	GAC-1	LUF	CAPN-99162	G-1173	FORD	CD1117-500-827	GA-680	AIM
CA8969	GA-168	FRM	CAF1700	GAC-9	CAMP	CAPN-99162-A	G-1173 ¹⁰⁸	FORD	CD1117-505-826	GA-679	AIM
CA8970	GA-216	FRM	CAF1700	GAC-9	CIGO	CASQ8	G-1175	ROLK	CD1117-505-830	GA-680	AIM
CA8997	GA-224	FRM	CAF1700	GAC-9	DEUS	CAV296	G-296	CAV	CD1117-509-826	GA-679	AIM
CA9	GA-870	SOPA	CAF1700	GAC-9	LUF	CAV296	G-296-B	CAV	CD1117-512-826	GA-679	AIM
CA90	GA-303	CAM2	CAF1700	GAC-9	SECU	CB11	GA-135	HAS	CD1117-512-830	GA-680	AIM
CA90	GA-303	CIGO	CAF1700	GAC-9	VALV	CB131	GA-101	CAM2	CD1117-610-826	GA-679	AIM
CA9007	GA-2114	FRM	CAF1700	GAC-9	WARN	CB14	GA-100	HAS	CD1117-610-830	GA-680	AIM
CA9009	GA-968R	FRM	CAF-1702	GAC-10 ²⁸	MIGH	CB14CO	GA-100	FEDE	CD1117-610G	GA-679	AIM
CA9050	GA-153	CENE	CAF-1702	GAC-8	MIGH	CB161	GA-113	CAM2	CD1117-650G	GA-679 ¹⁰⁴	AIM
CA9053	GA-183R	FRM	CAF1704	GAC-7	CAMP	CB25	GA-101	HAS	CD1117-650G	GA-680 ¹⁰⁸	AIM
CA9054	GA-248	FRM	CAF1704	GAC-7	SECU	CB2A-6731-A	G-330	FORD	CD1117-660G	GA-679 ¹⁰⁴	AIM
CA906	GA-3490	CENE	CAF1708	GAC-13	CIGO	CB35	GA-176	HAS	CD1117-660G	GA-680 ¹⁰⁸	AIM
CA9073	GA-305	FRM	CAF1708	GAC-13	LUF	CB35	GA-176	SHE	CD8013	G-1123	DIA
CA-9075	GA-2192	FRM	CAF1708	GAC-13	VALV	CB35CO	GA-176	FEDE	CD8013	G-1123	DIA
CA9098	GA-4319	FRM	CAF1708	GAC-13	WARN	CB48	GA-186	HAS	CD8013	G-1123	DIA
CA91	GA-59	CAM2	CAF1713	GAC-1	CAMP	CB5	GA-39	HAS	CD50817-60G	GA-588 ¹⁰⁸	AIM
CA91	GA-59	CIGO	CAF1713	GAC-1	SECU	CB59	GA-100	CAM2	CD50817-60G	GA-589 ¹⁰⁴	AIM
CA-9102	GA-2135	FRM	CAF1721	GAC-10 ²⁸	CAMP	CB6591	GA-176	FRM	CD50916-610G	GA-425 ¹⁰⁴	AIM
CA9115	GA-364	FRM	CAF1721	GAC-8	CAMP	CB6591	GA-176	FRM	CD50916-610G	GA-426 ¹⁰⁸	AIM
CA9117	GA-2803T	FRM	CAF1721	GAC-10 ²⁸	SECU	CBC7083	GG-46	JAGU	CD51117-610G	GA-679 ¹⁰⁴	AIM
CA9170	GA-392	CENE	CAF1721	GAC-8	SECU	CBC7083	GG-46	LEYL	CD51117-610G	GA-680 ¹⁰⁸	AIM
CA918	GA-3915	CENE	CAF1756	GAC-7	LUF	CBO4020	GS-2034	ROMA	CDU1179	GP-3816	LEYL
CA92	GA-57	CAM2	CAF1758	GAC-6	LUF	CBO4021	GS-2033	ROMA	CDU1268	GP-455	LAND
CA92	GA-57	CIGO	CAF7702	GAC-10 ²⁸	CAMP	CBO76	G-1121F	ROMA	CDU1268	GP-455	LAND
CA9240	GA-904R	FRM	CAF7702	GAC-8	CAMP	CBPN-18649-A	GP-81	FORD	CDU1268	GP-455	ROVE
CA925	GA-253	CAM2	CAK1532	GAK-1532	FRM	CBU1124	GP-178	DAF	CDU1937	GP-455	LEYL
CA925	GA-253	CENE	CAK1563	GA-33 ¹¹²	FRM	CBU1124	GP-178	LEYL	CE194A	G-870	PUR
CA9269	GA-413R	FRM	CAK1563	GA-33 ¹¹²	FRM	CBU1177	GPP-1122	DAF	CE1ADKN-18662-B	G-871	FORD
CA9284	GA-391	FRM	CAK1567	GAK-20	FRM	CBU1920	GPP-1122	DAF	CE213A	G-871	PUR
CA93	G-31	SOPA	CAK2521	GAK-216	FRM	CBU1920	GPP-1122	LEYL	CE213A1	G-871	PUR
CA9315	GA-2184	FRM	CAK2523	GAK-625	FRM	CBU1937	GP-455	LEYL	CE213A2	G-871	PUR
			CAK253	GAK-16	FRM	CBU2676	GP-178	DAF	CF 1551	GA-890R	MNH

Referencia Cruzada por Numero de Parte

Cross Reference by Part Number



Numero	Gonher	Fabricante	Numero	Gonher	Fabricante	Numero	Gonher	Fabricante	Numero	Gonher	Fabricante
Number	Gonher	Manufacturer	Number	Gonher	Manufacturer	Number	Gonher	Manufacturer	Number	Gonher	Manufacturer
CF 17170/1	GA-683R	MNH	CF351	GA-75	FSN	CF50E10	GP-34	CAN	CFA1072AP	GA-278R	AUPD
CF01	GA-100	CSP	CF35155	GA-130	FSN	CF510	GP-457	CASI	CFA1079	GA-479	CASI
CF02	GA-113	CSP	CF35192	GA-158	FSN	CF510AP	GP-457	AUPD	CFA1080	GA-780	CASI
CF04	GA-101	CSP	CF352	GAD-1	FSN	CF512	G-45	CASI	CFA1080	GA-398	MTR
CF0608	GP-317H	TIKO	CF353	GAD-3	FSN	CF512AP	G-45	AUPD	CFA1080AP	GA-780	AUPD
CF1004	GA-C-9	GKIN	CF3531	GP-3531 EXP	CASI	CF5148	GA-384	TIRP	CFA1081	GAD-30	MTR
CF1007	GA-C-1	GKIN	CF3531AP	GP-3531 EXP	AUPD	CF52	GP-3980	CASI	CFA1083	GA-224	CASI
CF1013	GA-C-13	GKIN	CF3562	GP-40	CASI	CF522	G-72	HAS	CFA1083	GAD-30	MTR
CF-10135	GA-C-6	FRM	CF3562AP	GP-40	AUPD	CF5247	G-954	SERC	CFA1083AP	GA-224	AUPD
CF1020	GA-426	MNH	CF-3566	GA-3566	FSN	CF5250	G-112	SERC	CFA1084	GA-168	CASI
CF103	G-1175 ¹⁰⁸	CUMM	CF3575	GA-271	FSN	CF5250	G-112	SERV	CFA1084AP	GA-168	AUPD
CF1033	GA-C-7	GKIN	CF3580	GA-274	FSN	CF5274	G-765	SERC	CFA1101	GA-258	CASI
CF104	GP-1101	CUMM	CF3592	GA-273	FSN	CF5276	G-918	SECU	CFA1101	GA-258	HAS
CF105	GP-1101	CUMM	CF3614	GP-58	CASI	CF5280	G-984	SERC	CFA1103	GA-248	CASI
CF105D	GP-14	CUMM	CF3614AP	GP-58	AUPD	CF52AP	GP-3980	AUPD	CFA1103AP	GA-248	AUPD
CF107	GP-81	CASI	CF3637	GA-3637	FSN	CF5309	G-45	SERC	CFA1108	GA-183R	HAS
CF107AP	GP-81	AUPD	CF3651A	GP-171	CASI	CF5436	G-49	SERC	CFA1109	GA-413R	CASI
CF108	G-1143	CUMM	CF3651AAP	GP-171	AUPD	CF548	G-49	CASI	CFA1109AP	GA-413R	AUPD
CF11	GG-5 L	CAM2	CF3682	GP-3682	CASI	CF548AP	G-49	AUPD	CFA1112	GA-224	CASI
CF110	GP-68	CASI	CF3682AP	GP-3682	AUPD	CF5515	G-3752	SERC	CFA1112AP	GA-224	AUPD
CF-110	GA-C-6	ACD	CF3807	GP-462	CASI	CF558	G-3752	CASI	CFA1121	GA-194	HAS
CF110AP	GP-68	AUPD	CF3807AP	GP-462	AUPD	CF563	GP-58 ⁹	CASI	CFA1125	GA-6479 ⁹⁰	CASI
CF111	GA-C-9	ACD	CF381	GA-74	FSN	CF565	GP-6811	CASI	CFA1125AP	GA-6479 ⁹⁰	AUPD
CF1115	GG-20	CAM2	CF3814	GA-3814	FSN	CF565AP	GP-6811	AUPD	CFA1127	GA-395	CASI
CF113	GA-C-13	ACD	CF391	GP-3985	CASI	CF5663	GAC-10 ²⁸	FRM	CFA1127AP	GA-395	AUPD
CF113	GP-91	CASI	CF391AP	GP-3985	AUPD	CF5663	GAC-8	FRM	CFA1128	GA-477	CASI
CF113AP	GP-91	AUPD	CF402	GP-91	CASI	CF5817	GAC-1	FRM	CFA1128	GA-477	HAS
CF118	GG-5 L	CAM2	CF402AP	GP-91	AUPD	CF6001	GA-416	MNH	CFA1128AP	GA-477	AUPD
CF1279	GA-279	TIRP	CF410	GP-157	CASI	CF613	GP-406	CASI	CFA113	GA-75	CASI
CF131	GG-19	CAM2	CF410AP	GP-157	AUPD	CF6311	G-911	SECU	CFA1130	GA-780	CASI
CF133	GA-78	FSN	CF4244	GAD-3	FSN	CF640	GA-3424	FSN	CFA1130AP	GA-780	AUPD
CF1330	GA-905R	MNH	CF4278	GAD-15	FSN	CF641	GA-3425	FSN	CFA1133	GA-264	CASI
CF136	GA-55	FSN	CF4325	GA-4325	FSN	CF713	GA-735 ¹²⁴	FSN	CFA1133AP	GA-264	AUPD
CF14	GA-113	CSP	CF4326	GA-78	FSN	CF735	GA-54	FSN	CFA1135	GA-414R	CASI
CF146	GA-71	FSN	CF4339	GA-3915	FSN	CF736	GA-3523	FSN	CFA1135AP	GA-414R	AUPD
CF148	GA-80	FSN	CF4342	GA-253	FSN	CF749	GA-4303	FSN	CFA1139	GA-490	CASI
CF1519	GA-348	TIRP	CF4343	GA-5056	FSN	CF753	GA-89	FSN	CFA1139AP	GA-490	AUPD
CF16	GP-81 ³¹	CASI	CF4361	GA-139	FSN	CF771	G-1123	SOPA	CFA113AP	GA-75	AUPD
CF16	GP-9 ⁵⁸	CASI	CF4372	GA-3901	FSN	CF772	G-1121	SOPA	CFA1161	GA-263	CASI
CF160	GA-70	FSN	CF4375	GA-362	FSN	CF773	GA-3588	FSN	CFA1161	GA-5466	CASI
CF16AP	GP-81 ³¹	AUPD	CF4378	GA-174	FSN	CF785	GA-3647	FSN	CFA1219	GA-1617	CASI
CF16AP	GP-9 ⁵⁸	AUPD	CF441	GP-3766	CASI	CF790	GA-75	FSN	CFA133	GA-78	CASI
CF176	GA-56 ⁹⁰	FSN	CF441AP	GP-3766	AUPD	CF7935	GA-VW-621	FSN	CFA136	GA-300	CASI
CF178	GG-1143	CUMM	CF4468	GA-195	FSN	CF7935	GA-VW-621	TIRP	CFA136AP	GA-300	AUPD
CF184	GA-77	FSN	CF4468	GA-195	TIRP	CF801	GA-2740	FSN	CFA137	GA-7344	CASI
CF187	GA-90	FSN	CF4479	GA-6479	FSN	CF8046	GAC-9	FRM	CFA137AP	GA-7344	AUPD
CF189	GA-50	FSN	CF45	GP-3429	CASI	CF826	GA-3681	FSN	CFA148	GAD-118	CASI
CF19	GA-100	FSN	CF45AP	GP-3429	AUPD	CF840	GA-416	MNH	CFA148AP	GAD-118	AUPD
CF192	GA-192	FSN	CF462	GP-212	CASI	CF8603	GAC-13	FRM	CFA150	GA-432	CASI
CF1A	GP-1	CASI	CF4632	GA-275	FSN	CF8631	GAC-1	FRM	CFA2001	GA-3551 ²⁵	MTR
CF1A	GP-3569	CASI	CF4645	GA-6690	FSN	CF8644	GAC-10 ²⁸	FRM	CFA2001	GA-3551 XT ²⁴	MTR
CF1AAP	GP-1	AUPD	CF4648	GA-133	FSN	CF8644	GAC-8	FRM	CFA2002	GA-253	MTR
CF20	GP-6	BORR	CF4650	GA-604	FSN	CF8812	G-963	SERC	CFA2004	GA-153	MTR
CF21	GG-123	CAM2	CF4650	GA-604	TIRP	CF8838	GAC-4	FRM	CFA209	GA-164	CASI
CF213	GP-3600	CASI	CF4680	GA-386	TIRP	CF905	GA-153	FSN	CFA209AP	GA-164	AUPD
CF213AP	GP-3600	AUPD	CF-4680	GA-386	FSN	CF9118	GAC-7	FRM	CFA2242	GA-3501	CASI
CF23	GA-101	FSN	CF4690	GA-322	TIRP	CF923	GA-892	MNH	CFA244	GA-5466	CASI
CF237	GP-212	CASI	CF-4690	GA-322	FSN	CF9366	GAC-6	FRM	CFA244AP	GA-5466	AUPD
CF24	GP-20	CASI	CF47	GP-46	CASI	CF9597A	GAC-2	FRM	CFA258	GA-198	CASI
CF24	GA-113	FSN	CF4712	GA-217	FSN	CF9612	GA-904R	FRM	CFA258AP	GA-198	AUPD
CF240	GP-149	CASI	CF4722	GA-5466	TIRP	CF9613	GA-905R	FRM	CFA2719	GA-2719B	CASI
CF240AP	GP-149	AUPD	CF4731	GA-165	FSN	CF9614	GA-906R	FRM	CFA2719AP	GA-2719B	AUPD
CF24AP	GP-20	AUPD	CF4731	GA-165	TIRP	CF9615	GA-907R	FRM	CFA2740	GA-2740	CASI
CF25	GP-3	CASI	CF4757	G-971	SERC	CF974	GA-3916	FSN	CFA2740AP	GA-2740	AUPD
CF25148	GA-384	FSN	CF479	G-112	CASI	CFA1014	GA-130	CASI	CFA307	GA-175	CASI
CF25AP	GP-3	AUPD	CF4799	GA-381	TIRP	CFA1014AP	GA-130	AUPD	CFA307AP	GA-175	AUPD
CF2709	GAD-1	FSN	CF-4799	GA-381	FSN	CFA1016	GA-1614	CASI	CFA325	GA-325	CASI
CF2719	GA-2719B	FSN	CF479AP	G-112	AUPD	CFA1016AP	GA-1614	AUPD	CFA3373	GA-VW-2	CASI
CF279	GP-205	CASI	CF47AP	GP-46	AUPD	CFA1026AP	GA-217	AUPD	CFA3373AP	GA-VW-2	AUPD
CF279AP	GP-205	AUPD	CF4819	GA-141	FSN	CFA1030	GA-172	CASI	CFA3425	GA-3425	CASI
CF2951	GP-2951	CASI	CF4828	GA-4828	FSN	CFA1030AP	GA-172	AUPD	CFA3425AP	GA-3425	AUPD
CF2951AP	GP-2951	AUPD	CF483	GG-3728	CAM2	CFA1031	GA-384	CASI	CFA3441	GA-277	CASI
CF299	GP-562	CASI	CF483	GP-128	CASI	CFA1031	GA-384	HAS	CFA3441AP	GA-277	AUPD
CF299AP	GP-562	AUPD	CF4831	GAD-118	TIRP	CFA1031AP	GA-384	AUPD	CFA3445	GA-3445	CASI
CF30	GG-7	BORR	CF-4832	GA-432	FSN	CFA1032	GA-5056	CASI	CFA347	GA-429	CASI
CF30	GG-8 ¹⁰³	CAM2	CF483AP	GP-128	AUPD	CFA1032AP	GA-5056	AUPD	CFA352	GAD-1	CASI
CF30	GG-8 L ⁸⁰	CAM2	CF487	GP-3675	CASI	CFA1034	GA-607	CASI	CFA3523	GA-3523	CASI
CF303	GA-303	FSN	CF4873	GA-514	TIRP	CFA1034AP	GA-607	AUPD	CFA3523AP	GA-3523	AUPD
CF305	GA-730	FSN	CF4879	GA-1616	FSN	CFA1037	GA-163	CASI	CFA352AP	GAD-1	AUPD
CF308	GP-156	CASI	CF487AP	GP-3675	AUPD	CFA1037AP	GA-163	AUPD	CFA353	GAD-3	CASI
CF3144	GG-46	CAM2	CF4880	GA-164	FSN	CFA1040	GA-279	CASI	CFA353AP	GAD-3	AUPD
CF3160	GA-176	FSN	CF489	G-765	CASI	CFA1040AP	GA-279	AUPD	CFA3549	GA-89	CASI
CF3175	GG-196	CAM2	CF489AP	G-765	AUPD	CFA1041	GA-244	CASI	CFA3549AP	GA-89	AUPD
CF324	GA-85	FSN	CF490	GP-171	CASI	CFA1041AP	GA-244	AUPD	CFA3559	GA-271	CASI
CF324 A	GA-85	FSN	CF490AP	GP-171	AUPD	CFA1043	GA-273	CASI	CFA3559AP	GA-271	AUPD
CF325	GA-325	FSN	CF493	GP-28 ⁸	CASI	CFA1043AP	GA-273	AUPD	CFA3566	GA-3566	CASI
CF326	GA-59	FSN	CF493	GP-430 ⁹	CASI	CFA1044	GA-8606	CASI	CFA3588	GA-3588	CASI
CF327	GA-57	FSN	CF493AP	GP-28 ⁸	AUPD	CFA1044AP	GA-8606	AUPD	CFA3588AP	GA-3588	AUPD
CF3300	GA-3300	FSN	CF493AP	GP-430 ⁹	AUPD	CFA1046	GA-174	CASI	CFA3597	GA-735 ²⁴	CASI
CF3373	GA-VW-2	FSN	CF494	GP-58	CASI	CFA1046AP	GA-174	AUPD	CFA3621	GA-140	CASI
CF340	GA-86	FSN	CF494AP	GP-58	AUPD	CFA1052	GA-348	CASI	CFA3637	GA-3637	CASI
CF340 A	GA-86	FSN	CF508	GP-178	CASI	CFA1052AP	GA-348	AUPD	CFA3647	GA-3647	CASI
CF3441	GA-277	FSN	CF508AP	GP-178	AUPD	CFA1066	GA-154	MTR	CFA3647AP	GA-3647	AUPD
CF3490	GA-3490	FSN	CF509	GA-491	CASI	CFA1070	GA-491	CASI	CFA3681	GA-3681	CASI
CF3506	GP-44	CASI	CF509	GA-491	HAS	CFA1070	GA-491	HAS	CFA3681AP	GA-3681	AUPD
CF3506AP	GP-44	AUPD	CF509AP	GP-408	AUPD	CFA1072	GA-278R	CASI	CFA3717		

Numero	Gonher	Fabricante	Numero	Gonher	Fabricante	Numero	Gonher	Fabricante	Numero	Gonher	Fabricante
Number	Gonher	Manufacturer	Number	Gonher	Manufacturer	Number	Gonher	Manufacturer	Number	Gonher	Manufacturer
CFA3717AP	GA-274	AUPD	CFA98	GA-141	CASI	CFP120	GG-7	CAM2	CH2961	G-163	FRM
CFA381	GA-74	CASI	CFA981	GAD-294	CASI	CFP157	GG-16	CAM2	CH2962	G-143	FRM
CFA3814	GA-3814	CASI	CFA981AP	GAD-294	AUPD	CFP158	GG-17	CAM2	CH2963	G-163	FRM
CFA3814AP	GA-3814	AUPD	CFA987	GA-322	CASI	CFP552055	GP-1013Q	DON	CH2980	G-133	FRM
CFA381AP	GA-74	AUPD	CFA987AP	GA-322	AUPD	CFP554013	GP-1013Q	DON	CH2980	G-989	FRM
CFA3901	GA-3901	CASI	CFA98AP	GA-141	AUPD	CFP554016	GP-1011Q	DON	CH3	GG-61	GKIN
CFA3901AP	GA-3901	AUPD	CFA990	GA-381	CASI	CFP554018	GP-1011Q	DON	CH33	G-33	FRM
CFA391	GA-132	CASI	CFA990AP	GA-381	AUPD	CFP554071	GP-2071W	DON	CH330	G-330	FRM
CFA391AP	GA-132	AUPD	CFA992	GA-165	CASI	CFP554072	GP-1010Q	DON	CH330PL	G-330	FRM
CFA4	GA-70	CASI	CFA992AP	GA-165	AUPD	CFP554073	GP-1011Q	DON	CH331PL	G-331	FRM
CFA411	GA-595	CASI	CFA993	GA-217	CASI	CFP554422	GP-2022W	DON	CH333PL	G-333	FRM
CFA411AP	GA-595	AUPD	CFA993AP	GA-217	AUPD	CFP554744	GP-2071W	DON	CH335PL	G-335	FRM
CFA417	GA-1616	CASI	CFA994	GA-442	CASI	CFP554860	GP-2015W	DON	CH33APL	G-33	CAC
CFA417AP	GA-1616	AUPD	CFA994AP	GA-442	AUPD	CFPN-6714-A	GP-1	FORD	CH33APL	G-33	FRM
CFA4278	GAD-15	CASI	CFG1004	GG-243	MTR	CFPN-6731-A	G-5000	FORD	CH33-PL	G-33	FRM
CFA4278AP	GAD-15	AUPD	CFG1005	GG-61	MTR	CFPN-6731-AB	G-5000	FORD	CH33PL1	G-33	FRM
CFA4303	GA-4303	CASI	CFG866	GG-208	MTR	CFPN-6731-B	G-5000	FORD	CH35	GG-265	GKIN
CFA4303AP	GA-4303	AUPD	CFL1003	GP-3980	MTR	CFRS351012P	GP-66	CAN	CH3543	G-33	FRM
CFA439	GA-127	CASI	CFL182	GP-310	MTR	CFRS352512P	GP-66	CAN	CH36	GG-267	GKIN
CFA445	GA-240	CASI	CFL814	GP-44	MTR	CFS-1215	GP-359	TOKY	CH37	GG-283	ATL
CFA45	GA-77	CASI	CFA100F	GA-16	CANF	CG11	GG-6	FRM	CH38	GG-265 ³⁶	ATL
CFA45AP	GA-77	AUPD	CFM102F	GA-27	CANF	CG11	GG-6	TVI	CH39	GG-97	GKIN
CFA463	GA-127	CASI	CFM1052	GA-89	CANF	CG11D	GG-6	FRM	CH4	GG-65	GKIN
CFA463AP	GA-127	AUPD	CFM1055	GA-398	CANF	CG11DP	GG-6	FRM	CH4475	G-133	FRM
CFA479AP	G-112	AUPD	CFM1100	GA-371	CANF	CG12	GG-7	FRM	CH4475	G-989	FRM
CFA481	GA-481	CASI	CFM1125	GA-372	CANF	CG12	GG-7	TVI	CH5	GG-67	ATL
CFA4828	GA-4828	CASI	CFM1160	GA-694	CANF	CG12DP	GG-7	FRM	CH5	GG-67	GKIN
CFA4828AP	GA-4828	AUPD	CFM1162	GA-389	CANF	CG13	GG-123	FRM	CH5320	G-963	FRM
CFA484	GA-1615	CASI	CFM122F	GA-26	CANF	CG13DP	GG-123	FRM	CH5576	G-162H	FRM
CFA484AP	GA-1615	AUPD	CFM134F	GA-33 ¹¹²	CANF	CG157	GG-203	CAM2	CH5957	G-3827	FRM
CFA4958	GA-4958	CASI	CFM135F	GAK-403	CANF	CG20	GG-20	FRM	CH6	GG-6	FRM
CFA4AP	GA-70	AUPD	CFM142	GA-18	CANF	CG20DP	GG-20	FRM	CH6068	GP-3600	FRM
CFA513	GA-673R	CASI	CFM16	GA-422	CANF	CG3	GG-1	CAM2	CH6848	G-971	FRM
CFA513AP	GA-673R	AUPD	CFM202	GAP-379	CANF	CG3	GG-4	CAM2	CH69L	G-6	FRM
CFA57	GA-80	CASI	CFM249	GA-206	CANF	CG3388	GG-16	FRM	CH7504	G-870	FRM
CFA57AP	GA-80	AUPD	CFM286	GA-106 ⁴⁶	CANF	CG3388DP	GG-16	FRM	CH7507	G-238	FRM
CFA59	GA-50	CASI	CFM286	GA-326 ⁷¹	CANF	CG3389	GG-17	FRM	CH7707	G-143	FRM
CFA59AP	GA-50	AUPD	CFM287	GA-356	CANF	CG46-CC5	GP-761H	FAY	CH7708	G-133	FRM
CFA6395	GA-195	CASI	CFM323	GA-6129	CANF	CG5	GG-45	CAM2	CH7708	G-989	FRM
CFA6395AP	GA-195	AUPD	CFM324	GA-6127	CANF	CG6566	GG-65	CASI	CH8	GG-7018 ³⁸	ATL
CFA67	GA-192	CASI	CFM38	GA-37	CANF	CG769	G-1123	SOPA	CH8	GG-7019 ³⁷	ATL
CFA67AP	GA-192	AUPD	CFM385	GA-360	CANF	CG770	G-1121	SOPA	CH8	GG-7020 ¹⁴⁴	ATL
CFA735	GA-54	CASI	CFM432	GA-361	CANF	CH0511106	GA-33 ¹¹²	VIRG	CH8	GG-7018 ³⁸	GKIN
CFA735AP	GA-54	AUPD	CFM436	GA-357	CANF	CH1	GG-264	GKIN	CH8	GG-7019 ³⁷	GKIN
CFA74	GA-55	CASI	CFM439	GA-31	CANF	CH10	GG-72	GKIN	CH8	GG-7020 ¹⁴⁴	GKIN
CFA74AP	GA-55	AUPD	CFM528	GA-879	CANF	CH10358	G-911	FRM	CH801BPL	G-801	FRM
CFA816	GA-4325	CASI	CFM552R	GA-378	CANF	CH11	GG-249	ATL	CH801M	G-871	FRM
CFA83	GA-85	CASI	CFM567	GA-376	CANF	CH11	GG-249	GKIN	CH801PL	G-871	REF
CFA83AP	GA-85	AUPD	CFM573F	GA-98 ¹¹²	CANF	CH11832	GA-33 ¹¹²	JOND	CH803APL	G-162H	FRM
CFA84	GA-730	CASI	CFM578	GA-356	CANF	CH11860PL	G-1121	FRM	CH803PL	G-225	FRM
CFA8423	GA-158	CASI	CFM587	GA-7716	CANF	CH119PL	G-119	FRM	CH803PL1	G-225	FRM
CFA8423AP	GA-158	AUPD	CFM601F	GAK-1532	CANF	CH12	GG-84	ATL	CH-8081	G-954	FRM
CFA861	GA-180	CASI	CFM616	GA-6880	CANF	CH12	GG-84	GKIN	CH8087	G-975	FRM
CFA890	GA-390	CASI	CFM618	GA-229	CANF	CH12767	GA-33 ¹¹²	JOND	CH-8087	G-975	SECU
CFA890AP	GA-390	AUPD	CFM622	GA-7360	CANF	CH129PL	G-6	FRM	CH811PL	G-871	FRM
CFA892	GA-392	CASI	CFM632F	GAK-216	CANF	CH14	G-5000	FRM	CH813	G-813	FRM
CFA892AP	GA-392	AUPD	CFM65	GA-5648	CANF	CH14PL	G-5000	FRM	CH813PL	G-813	FRM
CFA894	GA-139	CASI	CFM654	GA-679	CANF	CH155PL	G-152	FRM	CH8158	G-112	FRM
CFA894AP	GA-139	AUPD	CFM655	GA-425	CANF	CH16	GG-72	GKIN	CH815PL	G-870	FRM
CFA90	GA-303	CASI	CFM659	GA-509 ¹⁴	CANF	CH1652PL	G-33	FRM	CH815PL1	G-870	FRM
CFA905	GA-153	CASI	CFM660	GA-329	CANF	CH1725	G-163	FRM	CH816PL	G-816	FRM
CFA905AP	GA-153	AUPD	CFM663	GA-483	CANF	CH1725G	G-33	FRM	CH820	G-870	FRM
CFA90AP	GA-303	AUPD	CFM664	GA-482	CANF	CH18	GG-243	ATL	CH820PL	G-870	FRM
CFA91	GA-59	CASI	CFM676	GA-239	CANF	CH18	GG-99	GKIN	CH820PLB	G-870	FRM
CFA910	GA-153	CASI	CFM697	GA-2984	CANF	CH18289	GA-892	JOND	CH-8213	G-984	FRM
CFA910AP	GA-153	AUPD	CFM698	GA-589	CANF	CH191	G-191	FRM	CH825PL	G-871	FRM
CFA913	GA-362	CASI	CFM699	GA-588	CANF	CH191APL	G-191	FRM	CH828PL	G-870	FRM
CFA913AP	GA-362	AUPD	CFM729	GA-826	CANF	CH191PL	G-191	FRM	CH828PL	G-870	FRM
CFA918	GA-3915	CASI	CFM730	GA-3501	CANF	CH2	GG-67	GKIN	CH831PL	G-613	FRM
CFA918AP	GA-3915	AUPD	CFM76	GA-8047	CANF	CH20	GG-243	ATL	CH834	G-834	FRM
CFA91AP	GA-59	AUPD	CFM77	GA-1285	CANF	CH20	GG-243	GKIN	CH834PL	G-834	FRM
CFA92	GA-57	CASI	CFM777F	GAK-625	CANF	CH200PL	G-200	FRM	CH834PL-1	G-834	FRM
CFA921	GA-382	CASI	CFM78	GA-9334	CANF	CH21	GG-95	GKIN	CH834PL11	G-834	FRM
CFA92AP	GA-382	AUPD	CFM782F	GA-33 ¹¹²	CANF	CH211	G-566	FRM	CH836PL	G-836	FRM
CFA939	GA-142	CASI	CFM79	GA-1286	CANF	CH211A	G-566	FRM	CH836PL-1	G-836	FRM
CFA939AP	GA-142	AUPD	CFM799	GA-608	CANF	CH218	G-34	CAC	CH845PL	G-871	FRM
CFA94	GA-3300	CASI	CFM80	GA-1008	CANF	CH218	G-34	FRM	CH848	G-833	FRM
CFA94AP	GA-3300	AUPD	CFM81	GA-1284	CANF	CH22	GG-104	GKIN	CH8481	G-180	FRM
CFA951	GA-275	CASI	CFM82	GA-1203	CANF	CH236APL	G-236	FRM	CH-8481	G-180	SECU
CFA951AP	GA-275	AUPD	CFM822	GA-405	CANF	CH236PL	G-236	CAC	CH848PL	G-833	FRM
CFA953	GA-6479	CASI	CFM824	GA-6128	CANF	CH238APL	G-238	FRM	CH8712	G-72	FRM
CFA953AP	GA-6479	AUPD	CFM83	GA-375	CANF	CH238PL	G-238	FRM	CH-8712	G-72	SECU
CFA958	GA-133	CASI	CFM84	GA-9045	CANF	CH26	GP-46	SHE	CH8765	G-765	FRM
CFA958AP	GA-133	AUPD	CFM85	GA-1287	CANF	CH2821A	G-613	FRM	CH-8765	G-765	SECU
CFA962	GA-2106	CASI	CFM852	GAP-381	CANF	CH2821B	G-613	FRM	CH87682993	GA-853R	CASE
CFA962AP	GA-2106	AUPD	CFM855	GA-251	CANF	CH2832	G-870	FRM	CH-8776	G-910	FRM
CFA967	GA-7017	CASI	CFM858	GA-493 ¹⁰⁸	CANF	CH2850	GG-1	FRM	CH8806	G-45	FRM
CFA967AP	GA-7017	AUPD	CFM860	GA-372	CANF	CH2850	GG-4	FRM	CH8902	G-918	FRM
CFA974	GA-3916	CASI	CFM881	GA-107	CANF	CH28501	G-870	FRM	CH8905	G-25	FRM
CFA974AP	GA-3916	AUPD	CFM883	GA-109	CANF	CH28502	G-870	FRM	CH8905ECO	G-25	FRM
CFA976	GA-386	CASI	CFM884	GA-563	CANF	CH2853	GP-81	FRM	CH9	GG-7018 ³⁸	ATL
CFA976AP	GA-386	AUPD	CFM923	GA-209	CANF	CH2870A	GP-28 ⁸	FRM	CH9	GG-7019 ³⁷	ATL
CFA977	GA-6690	CASI	CFM924	GA-210	CANF	CH2870A	GP-430 ⁸	FRM	CH9	GG-7020 ¹⁴⁴	ATL
CFA977AP	GA-6690	AUPD	CFM935	GA-108	CANF	CH2874	GP-58 ¹⁵	FRM	CH9	GG-7018 ³⁸	GKIN
CFA979	GA-604	CASI	CFM957	GA-373	CANF	CH2880	G-834	FRM	CH9	GG-7019 ³⁷	GKIN
CFA979AP	GA-604	AUPD	CFP119	GG-6	CAM2	CH2949	G-833	FRM	CH9	GG-7020 ¹⁴⁴	GKIN

Referencia Cruzada por Numero de Parte

Cross Reference by Part Number



Numero	Gonher	Fabricante	Numero	Gonher	Fabricante	Numero	Gonher	Fabricante	Numero	Gonher	Fabricante
Number	Gonher	Manufacturer	Number	Gonher	Manufacturer	Number	Gonher	Manufacturer	Number	Gonher	Manufacturer
CH9018		G-49 FRM	CLH562		GP-28 ⁸ GIS	CN43		GP-81 ³¹ DYLI	CNA3549		GA-89 CON
CH913PL		G-813 FRM	CLH562		GP-430 ⁹ GIS	CN43		GP-9 ³⁸ DYLI	CNA3549		GA-89 DYLI
CH9260		G-3754 FRM	CLH727-2		GP-14 GIS	CN51050		GP-50 CON	CNA3559		GA-271 CON
CH9301		G-918 FRM	CLH80		GP-81 ³¹ GIS	CN51050		GP-50 DYLI	CNA3559		GA-271 DYLI
CH9389		G-3754 FRM	CLH80		GP-9 ³⁸ GIS	CN51243		GP-14 CON	CNA3588		GA-3588 CON
CH-9432		G-25 FRM	CLH828		GP-46 GIS	CN51243		GP-14 DYLI	CNA3588		GA-3588 DYLI
CH-9432 ECO		G-25 FRM	CLH85		GP-81 ³¹ GIS	CN51750		G-750 CON	CNA3597		GA-735 ¹²⁴ CON
CH9443		G-141 FRM	CLH85		GP-9 ³⁸ GIS	CN51750		G-750 DYLI	CNA3597		GA-735 ¹²⁴ DYLI
CH945PL		G-871 FRM	CLH9		GP-50 GIS	CN51758		GP-34 CON	CNA3637		GA-3637 CON
CH9461		G-466 FRM	CL-IH540		G-333 WIN	CN51758		GP-34 DYLI	CNA3637		GA-3637 DYLI
CH-9461		G-466 SECU	CL-P101		G-870 WIN	CN51775		GP-1 CON	CNA3647		GA-3647 CON
CH9549		G-3752 FRM	CL-P76		G-236 WIN	CN7		GP-50 CON	CNA3647		GA-3647 DYLI
CH958PL		G-834 FRM	CL-P76-2		G-236 WIN	CN8		G-6 CON	CNA3681		GA-3681 CON
CH9641		G-70 FRM	CL-PF141		G-200 WIN	CN8		G-6 DYLI	CNA3681		GA-3681 DYLI
CH-9641		G-70 SECU	CL-PF147		G-119 WIN	CN8A		GP-1 CON	CNA381		GA-74 CON
CH97710		GP-761H CHP	CL-PF151		G-33 WIN	CN8A		GP-1 DYLI	CNA381		GA-74 DYLI
CH983PL		G-871 FRM	CL-PF166		G-34 WIN	CN9		G-236 CON	CNA3814		GA-3814 CON
CH9911		G-313 FRM	CM2		GP-68 CAST	CN9		G-236 CON	CNA3814		GA-3814 DYLI
CH993		G-871 FRM	CM2		GP-2127W KRA	CN963B		GP-3600 ⁸⁴ CON	CNA3916		GA-3916 CON
CH993PL		G-871 FRM	CM910		GAK-16 MINN	CN963B		GP-38 ⁸⁷ CON	CNA3916		GA-3916 DYLI
CH9972		G-912 FRM	CM910		GAK-16 WHIT	CN966		GP-3816 CON	CNA3924		GA-153 CON
CH-9972		G-912 SECU	CM9-10		GAK-16 PETI	CN966		GP-3816 DYLI	CNA3924		GA-153 DYLI
CHF14205		GAK-403 CLRK	CM9-21		GAK-403 PETI	CNA1		GA-56 CON	CNA4303		GA-4303 CON
CHF513		GG-8 ¹⁰³ COBR	CM94		GA-33 ¹¹² WHIT	CNA1		GA-56 DYLI	CNA4303		GA-4303 DYLI
CHF513		GG-8 ¹⁸⁰ COBR	CM9-4		GA-33 ¹¹² PETI	CNA133		GA-78 CON	CNA5058		GA-273 CON
CHF536		GG-196 COBR	CM940		GA-33 ¹¹² MINN	CNA133		GA-78 DYLI	CNA5058		GA-273 DYLI
CHF549		GG-264 COBR	CM9-7		GAK-16 PETI	CNA136		GA-55 CON	CNA6		GA-71 CON
CHF563		GG-61 COBR	CMK2		GP-1010Q PUR	CNA136		GA-55 DYLI	CNA6366		GA-174 CON
CHF566		GG-65 COBR	CMK2		GP-1101 PUR	CNA146		GA-71 CON	CNA6366		GA-174 DYLI
CHF567		GG-67 COBR	CMP97		GAK-16 PETI	CNA146		GA-71 DYLI	CNA7		GA-80 CON
CHF568		GG-245 COBR	CN1		GP-1 CON	CNA148		GA-80 CON	CNA7		GA-80 DYLI
CHN422		GP-1122 GIS	CN1		GP-1 DYLI	CNA148		GA-80 DYLI	CNA9		GA-70 CON
CHW33PL		G-33 FRM	CN113		GP-13 CON	CNA160		GA-70 CON	CNA9		GA-70 DYLI
CIAZ-6731-A		GP-1 FORD	CN113		GA-71 DYLI	CNA160		GA-70 DYLI	CNAB19		GA-100 DYLI
CITZ-6731-C		G-5000 FORD	CN116		GP-81 CON	CNA18		GA-78 CON	CNA-819		GA-100 CON
CL18662A		G-871 WIN	CN116		GP-81 DYLI	CNA18		GA-78 DYLI	CNAB24		GA-113 DYLI
CL1866A		G-871 WIN	CN13		GP-13 DYLI	CNA184		GA-77 CON	CNA-824		GA-113 CON
CL2393448		GAK-1532 TOTL	CN14		G-333 CON	CNA184		GA-77 DYLI	CNAP192		GA-113 DYLI
CL33PL		G-33 WIN	CN15		G-330 CON	CNA189		GA-50 CON	CNG11		GG-6 CON
CL355T		G-330 WIN	CN16		GP-20 CON	CNA189		GA-50 DYLI	CNG11		GG-6 DYLI
CL500		G-500 CUMM	CN16N		GP-81 CON	CNA19		GA-55 CON	CNG12		GG-7 CON
CL501		G-750 CUMM	CN18		GP-3 CON	CNA19		GA-55 DYLI	CNG12		GG-7 DYLI
CL516		G-566 CUMM	CN18		GP-13 DYLI	CNA192		GA-192 CON	CNG13		GG-123 CON
CL613		G-613 CUMM	CN1R		GP-1 CON	CNA192		GA-192 DYLI	CNG13		GG-123 DYLI
CL632B		GP-14 CUMM	CN1R		GP-1 DYLI	CNA2		GA-77 CON	CNG2		GG-20 CON
CL6H9999-1		G-238 WIN	CN2		GP-5 CON	CNA2		GA-77 DYLI	CNG20		GG-20 CON
CL6PL		G-6 WIN	CN2		GP-5 DYLI	CNA21		GA-85 CON	CNG20		GG-20 DYLI
CL750		G-750 CUMM	CN24006		GGP-25 CON	CNA21		GA-85 DYLI	CNG22		GG-19 CON
CL7M3800		G-191 WIN	CN24006		GGP-25 DYLI	CNA21A		GA-85 DYLI	CNG22		GG-19 DYLI
CL994579		GP-66 SMH	CN25		GP-20 CON	CNA21-A		GA-85 CON	CNG3		GG-5 L CON
CL994579		GP-9586 TOTL	CN25		GP-20 DYLI	CNA22		GA-730 CON	CNG3		GG-5 L DYLI
CL-AC20		G-813 WIN	CN2825		GP-38 CON	CNA22		GA-730 DYLI	CNG3388		GG-16 CON
CL-AC70		G-836 WIN	CN2849A		GP-24 ²⁶ CON	CNA23		GA-59 CON	CNG3388		GG-16 DYLI
CL-AC72		G-834 WIN	CN2849A		GP-462 ²⁴ CON	CNA23		GA-59 DYLI	CNG3389		GG-17 CON
CL-AR1400		G-331 WIN	CN2849A		GP-24 ²⁶ DYLI	CNA24		GA-57 CON	CNG3389		GG-17 DYLI
CLE325		GA-27 WORT	CN2849A		GP-462 ²⁴ DYLI	CNA24		GA-57 DYLI	CNG3499		GG-8 ¹⁰³ CON
CLE347		GA-27 WORT	CN2850		GP-1 CON	CNA2740		GA-2740 DYLI	CNG3499		GG-8 L ⁸⁰ CON
CLE348		GA-26 WORT	CN2865		GP-42 DYLI	CNA3		GA-50 CON	CNG3596		GG-87 CON
CLE350		GA-26 WORT	CN2865A		GP-42 CON	CNA3		GA-50 DYLI	CNG3596		GG-87 DYLI
CLE354		GA-26 WORT	CN2865A		GP-42 DYLI	CNA303		GA-303 CON	CNG3727		GG-46 CON
CLE357		GAK-20 WORT	CN2870		GP-3600 ⁸⁴ CON	CNA303		GA-303 DYLI	CNG3727		GG-46 DYLI
CLE357-A		GAK-20 WORT	CN2870		GP-38 ⁸⁷ CON	CNA305		GA-730 CON	CNG3802		GG-47 CON
CLE361		GAK-20 WORT	CN2870		GP-28 ⁸ DYLI	CNA305		GA-730 DYLI	CNG3802		GG-47 DYLI
CLE365		GA-27 WORT	CN2870		GP-430 ⁹ DYLI	CNA324A		GA-85 CON	CNG4165		GG-45 DYLI
CLE370		GA-27 WORT	CN2951		GP-58 CON	CNA324A		GA-85 DYLI	CNG4775		GG-208 DYLI
CLE371		GA-33 ¹¹² WORT	CN2951		GP-58 DYLI	CNA325		GA-325 CON	CNG6		GG-5 L CON
CLE385		GA-26 WORT	CN3		G-200 CON	CNA325		GA-325 DYLI	CNH1207		GPP-1122 GIS
CLE390		GAK-625 ¹⁰⁴ WORT	CN3		G-200 DYLI	CNA326		GA-59 CON	CNH526		GP-110 GIS
CLE391		GA-106 ⁹⁷ WORT	CN30		GP-3 CON	CNA326		GA-59 DYLI	CNH539		GP-1101 GIS
CLE391		GA-206 ¹⁰⁸ WORT	CN30		GP-3 DYLI	CNA327		GA-57 CON	CNH799		GP-1122 GIS
CLE391		GA-326 ⁷² WORT	CN33107		GP-1101 CON	CNA327		GA-57 DYLI	CO1		GP-171 ¹⁶ CENE
CLG308		GP-58 GIS	CN33107		GP-1101 DYLI	CNA3300		GA-3300 CON	CO100		G-333 CENE
CLH302		GP-171 ¹⁶ GIS	CN33109		GP-1101 CON	CNA3300		GA-3300 DYLI	CO103		GP-5 CENE
CLH3021		GP-1 GIS	CN33109		GP-1101 DYLI	CNA3373		GAVW-2 CON	CO106		G-330 CENE
CLH303		GP-81 ³¹ GIS	CN3387		GP-46 CON	CNA3373		GAVW-2 DYLI	CO109		G-871 CENE
CLH303		GP-9 ³⁸ GIS	CN3387		GP-46 DYLI	CNA338		GA-3300 DYLI	CO1096		GP-1 CENE
CLH336		GP-13 GIS	CN3429		GP-3429 CON	CNA340A		GA-86 DYLI	CO120		G-813 CENE
CLH343		GP-171 GIS	CN3429		GP-3429 DYLI	CNA3424		GA-3424 CON	CO1218		GP-205 CENE
CLH347		GP-46 GIS	CN3531		GP-3531 EXP CON	CNA3424		GA-3424 DYLI	CO129		GP-3 CENE
CLH348-1		GP-38 GIS	CN3531		GP-3531 EXP DYLI	CNA3425		GA-3425 CON	CO1392		GP-23 CENE
CLH349-1		GP-5 GIS	CN3535		GP-3980 CON	CNA3425		GA-3425 DYLI	CO145		GP-834 CENE
CLH350-1		GP-36 GIS	CN3535		GP-3980 DYLI	CNA3441		GA-277 CON	CO177		GP-81 CENE
CLH351		GP-54 GIS	CN3562		GP-40 CON	CNA3441		GA-277 DYLI	CO178		GP-50 CENE
CLH355		GP-81 GIS	CN3562		GP-40 DYLI	CNA3447		GA-429 CON	CO190		GP-81 CENE
CLH387		GP-3600 GIS	CN3614		GP-58 CON	CNA347		GA-429 DYLI	CO205		G-1174 ¹⁰⁸ CENE
CLH388		GP-54 GIS	CN373		GP-23 CON	CNA349		GA-349 CON	CO211		G-1173 ¹⁰⁸ CENE
CLH389		GP-1 GIS	CN373		GP-23 DYLI	CNA349		GA-349 DYLI	CO2286		GP-562 CENE
CLH406-1		GP-58 GIS	CN3807		GP-462 DYLI	CNA3490		GA-3490 CON	CO241		G-119 CENE
CLH408/1		GP-28 ⁸ GIS	CN3985		GP-3985 CON	CNA3490		GA-3490 DYLI	CO242		G-870 CENE
CLH408/1		GP-430 ⁸ GIS	CN3985		GP-3985 DYLI	CNA351		GA-75 CON	CO2448		G-1173 ¹⁰⁸ FIAT
CLH4111		GP-3816 GIS	CN4		GP-13 CON	CNA351		GA-75 DYLI	CO260		G-1175 ¹⁰⁸ DYLI
CLH4171		GP-3600 GIS	CN4		GP-13 DYLI	CNA352		GAD-1 CON	CO274		GPP-18 CENE
CLH420		GP-38 ⁸⁴ GIS	CN400		GP-3600 CON	CNA3523		GA-3523 CON	CO274		GPP-18 DEL
CLH426		GP-406 GIS	CN400		GP-3600 DYLI	CNA3523		GA-3523 DYLI	CO2808		GP-91 CENE
CLH433		GP-462 GIS	CN43		GP-81 ³¹ CON	CNA3537		GA-54 CON	CO2814		GP-22 CENE
CLH56		GP-50 GIS	CN43		GP-9 ³⁸ CON	CNA3537		GA-54 DYLI	CO2815		GP-3569 CENE

REFERENCIA CRUZADA

Para números Gonher con Superíndice vea página 651
For Gonher with Superscript numbers see page 651

Visite nuestro sitio en internet www.grupogonher.com
Visit our web site www.grupogonher.com

Numero	Gonher	Fabricante	Numero	Gonher	Fabricante	Numero	Gonher	Fabricante	Numero	Gonher	Fabricante
Number	Gonher	Manufacturer	Number	Gonher	Manufacturer	Number	Gonher	Manufacturer	Number	Gonher	Manufacturer
CO2816	GP-3531	EXP CENE	CP9H4729P	G-1166	UNI	CU-2545	GAC-3	MNH	CW1011	GP-1010Q	CUMM
CO2818	GP-36	CENE	CP9M9740P	G-152	UNI	CU256838	G-750	LEYL	CW1012	GP-1010Q	CUMM
CO2819	GP-36	CENE	CPA-6731-A	G-6	FORD	CU-2882	GAC-10 ³⁸	MNH	CW1107MP	GP-1101	WIX
CO2821	GP-58	CENE	CPL1133CC	GC-1133	FCAR	CU-2882	GAC-8	MNH	CW1108MP	GP-1101	WIX
CO2822	GP-38	CENE	CPL1143	G-1143	FCAR	CU-2945	GAC-4	MNH	CW1109MP	GP-1101	WIX
CO2841	GP-156	CENE	CPL155	G-152	FCAR	CU299080	GP-2071W	LEYL	CW1112MP	G-1123	WIX
CO2861	GP-28 ⁸	CENE	CPL2020	GS-2033	INDUCL	CU299083	GP-1011Q	LEYL	CW1112MP	G-1123F	WIX
CO2862	GP-430 ⁸	CENE	CPL20405	GS-2034	FCAR	CU299202	GP-55	KOMA	CW113MP	G-1173 ⁹⁸	WIX
CO2862	GP-36	CENE	CPL20405	GS-2034	INDUCL	CU299670	GP-53	KOMA	CW1143MP	G-1143	WIX
CO2863	GP-3985	CENE	CPL211	G-566	FCAR	CU299670	GP-53	LEYL	CW1172MP	G-296	WIX
CO2865	GP-3985	CENE	CPL500	G-500	FCAR	CU3304232	GP-57	KOMA	CW1172MP	G-296-B	WIX
CO2872	GP-3985 ⁸³	CENE	CPL613	G-613	FCAR	CU3304232	GP-57	LEYL	CW1173MP	G-1121	WIX
CO2874	GP-46	CENE	CPN-18649-A	G-6	FORD	CU3305367	GP-2071W	KOMA	CW117MP	G-1176	WIX
CO2876	GP-91	CENE	CPN18649Z	G-6	FORD	CU3307885	GP-53	KOMA	CW12701M	GP-31	WIX
CO2892	GP-452	CENE	CPN-6731	G-6	FORD	CU3314581	GP-2071W	LEYL	CW129MP	G-34	WIX
CO309	GP-3429	CENE	CPN-6731-A	G-6	FORD	CU-3448	GAC-5	MNH	CW133MP	G-33	WIX
CO394	GP-26	CENE	CPN-6731-AB	G-6	FORD	CU3554	GAC-1	MNH	CW133MPWP	G-33	WIX
CO396	GP-81 ³¹	CENE	CPN-6731-B	G-6	FORD	CU5257	GAC-9	MNH	CW133P	G-33	WIX
CO396	GP-9 ⁵⁸	CENE	CPN-6882-A	GP-1	FORD	CU701645	GA-39	LEYL	CW136MP	G-33	WIX
CO4000	GP-28 ⁸³	CENE	CR1A	GA-70	SAFE	CUA744	GAK-403	HARM	CW138MP	G-119	WIX
CO4000	GP-3600 ⁵⁹	CENE	CR2	GA-71	SAFE	CUA777	GA-16 ¹¹²	HARM	CW142MP	GP-331	WIX
CO414	GP-28 ⁸³	CENE	CR3	GA-730	SAFE	CUA777	GAK-16 ³⁴	HARM	CW151MP	G-335	WIX
CO414	GP-3600 ⁵⁹	CENE	CRF504679	GAK-403	LEYL	CUA787	GAK-20	HARM	CW1551MP	GP-66	WIX
CO425	GP-40 ⁹⁴	CENE	CRF508027	GA-360	LEYL	CUFF105D	GP-1101	KOMA	CW1551P	GP-66	WIX
CO425	GP-91 ⁷⁸	CENE	CRF512748	GA-106 ⁴⁶	LEYL	CUFF108	G-1143	KOMA	CW1553MP	GP-66	WIX
CO427	GP-2951 ⁶²	CENE	CRF512748	GA-326 ⁷¹	LEYL	CUFF202	GP-55	KOMA	CW1553P	GP-66	WIX
CO427	GP-58 ⁹⁴	CENE	CS10145	GS-1261	FRM	CUK 2862	GAC-10 ²⁸	MNH	CW156MP	G-333	WIX
CO429	GP-24 ²⁶	CENE	CS1133PL	GS-1133	FRM	CUK 2862	GAC-8	MNH	CW161MP	G-191	WIX
CO429	GP-46 ²⁴	CENE	CS155	G-296	PFX	CUK2545	GAC-3	MNH	CW163MP	G-152	WIX
CO437	GP-42	CENE	CS155	G-296-B	PFX	CULF3548	GP-3000 ²³	KOMA	CW168MP	G-238	WIX
CO442	GP-310	CENE	CS157	G-296	PFX	CULF516	G-566	KOMA	CW180MP	G-1166	WIX
CO445	GP-46	CENE	CS157	G-296-B	PFX	CULF613	G-613	KOMA	CW181MP	G-1166	WIX
CO446	GP-44	CENE	CS157A	G-296	PFX	CULF670	GP-53	KOMA	CW183MP	G-871	WIX
CO447	GP-3980	CENE	CS157A	G-296-B	PFX	CULF6705C	GP-53	KOMA	CW185MP	G-871	WIX
CO447A	GP-3980	CENE	CS159	G-296	PFX	CULF750	G-750	KOMA	CW187MP	G-1166	WIX
CO5005	GP-3000	COP	CS159	G-296-B	PFX	CULF750A	G-750	KOMA	CW188MP	G-813	WIX
CO51	GP-20	CENE	CS162	GP-1122	PFX	CUWF2010	GP-2071W	KOMA	CW189MP	G-1166	WIX
CO52	GP-13	CENE	CS163A	GP-110	PFX	CUWF2012	GP-1011Q	KOMA	CW190MP	GP-81	WIX
CO54	GP-3	CENE	CS178	G-297-B	PFX	CUWF2014	GP-1013Q	KOMA	CW193MP	G-871	WIX
CO7505	GP-750	COP	CS178A	G-297-B	PFX	CUWF2016	GP-1011Q	KOMA	CW194MP	G-11816	WIX
CO780	GP-178	CENE	CS182	GP-1122	PFX	CUWF2051	GP-2071W	KOMA	CW196MP	GP-66	WIX
CO784	GP-3766	CENE	CS183	GP-1122	PFX	CUWF2053	GP-2071W	KOMA	CW197MP	G-222	WIX
CO820	GP-68	CENE	CS183	GP-1122	PFX	CUWF2054	GP-1013Q	KOMA	CW2010	GP-2071W	CUMM
CO834	GP-963	CENE	CS195	GP-1122	PFX	CUWF2055	GP-1013Q	KOMA	CW2016	GP-1011Q	CUMM
CO843	GP-971	CENE	CS197	GP-1122	PFX	CV2	GA-100	COP	CW203MP	G-33	WIX
CO88	GP-34	CENE	CS197	GP-1122	PFX	CV2	GA-100	CYC	CW218MP	GP-84	WIX
CO903	GP-212	CENE	CS197A	GP-1122	PFX	CV325	GP-81 ³¹	SOPA	CW219MP	GP-83	WIX
CO95	GP-236	CENE	CS197B	GP-1122	PFX	CV325	GP-9 ⁵⁸	SOPA	CW239MP	G-31	WIX
CO97	GP-50	CENE	CS197B	GP-1122	PFX	CV339	GP-171	SOPA	CW242MP	G-139	WIX
CO99	GP-200	CENE	CS198	GP-1122	PFX	CV346	GP-38	SOPA	CW243MP	GP-14	WIX
CO998	GP-333	CENE	CS3504	GS-2033	FRM	CV349	GP-81	SOPA	CW244MP	GP-14	WIX
COAE-6714-A	GP-1	FORD	CS3558	GS-2034	FRM	CV365	GP-38	SOPA	CW253MP	G-338	WIX
COAE-6714-B	GP-1	FORD	CS418	GP-1122	PFX	CV366	GP-46	SOPA	CW270M	G-330	WIX
COAE-6731-A	GP-1	FORD	CS428	GP-27	PFX	CV368	GP-1	SOPA	CW270MP	G-330	WIX
COLE-6714-A	GP-1	FORD	CS5043	2010PM-OR ⁷	FRM	CV378	GP-81	SOPA	CW271MP	GP-20	WIX
CONN-6708-A	GP-66	FORD	CS5043	2010TM-OR ⁷	FRM	CV379	GP-46	SOPA	CW272M	G-5000	WIX
CONN-B951-A	GP-66	FORD	CS7715	G-178	FRM	CV394	GP-28 ⁸	SOPA	CW452MP	GP-310	WIX
CONN-B951-B	GP-66	FORD	CS7772A	G-128	FRM	CV394	GP-430 ⁸	SOPA	CW453MP	GP-66	WIX
CONN-B951-C	GP-66	FORD	CS8597	2010PM-OR	FRM	CV395	GP-3816	SOPA	CW475MP	G-6	WIX
COTE6731A	GP-330	FORD	CS8629	G-862	FRM	CV401	GP-38	SOPA	CW487MP	G-169	WIX
COTE6744A	GP-330	FORD	CS8941	GS-1261	FRM	CV402	GP-3600	SOPA	CW500	G-31	WIX
CP1032-30	GP-51	LENZ	CS9667	G-1047	FRM	CV404	GP-1	SOPA	CW511MP	G-1173	WIX
CP105CR	GP-13	NEL	CSG100P05A	GP-34	MPP	CV4170	GA-106 ⁴⁶	ROLS	CW512MP	G-1175	WIX
CP105CR	GP-13	WIN	CSG100P10A	GP-34	MPP	CV4170	GA-326 ⁷¹	ROLS	CW550MLWP	G-500	WIX
CP11SCR	GP-5	WIN	CSG150P10A	GP-34	MPP	CV4180	GA-360	ROLS	CW550MS	G-500	WIX
CP1282-10-50	GP-34	LENZ	CSG30BP10A	GP-58	MPP	CV424	GP-462	SOPA	CW550MSWP	G-500	WIX
CP12821056	GP-34	LENZ	CSG50P10A	GP-66	MPP	CV425	GP-54 ⁴¹	SOPA	CW581MP	GP-14	WIX
CP1282-25-50	GP-34	LENZ	CSG50P10A	GP-66	MPP	CV425	GP-66 ¹⁰	SOPA	CW61MP	G-1173	WIX
CP190	GP-562	CAPA	CSG50-P10AN	GP-66	MPP	CV428	GP-3600	SOPA	CW62MP	G-1175 ⁹⁸	WIX
CP23110	GP-33	BAUD	CSG50P25	GP-66	MICP	CV428T	GP-3600	SOPA	CW641MP	G-1166	WIX
CP3555CR	GP-1	WIN	CSG50P25A	GP-66	DAVS	CV440	GP-1	SOPA	CW71	G-1176	WIX
CP355T	GP-330	WIN	CSG50P25A	GP-66	MPP	CV448	GP-462	SOPA	CW74MP	G-1174	WIX
CP3800	GP-191	UNI	CSG50P25A	GP-66	MPP	CV461	GP-3985	SOPA	CW750M	G-750	WIX
CP3800P	GP-191	UNI	CSG50-P25AN	GP-66	MPP	CV463	GP-54 ⁴¹	SOPA	CW750MLWP	G-750	WIX
CP4551H	GP-335	WIN	CSG70P10A	GP-66	MPP	CV463	GP-66 ¹⁰	SOPA	CW750MS	G-750	WIX
CP4551H	GP-335	NEL	CSM6500	GP-2071W	COO	CV466	GP-40	SOPA	CW750MSWP	G-750	WIX
CP4551H	GP-335	WIN	CSM6502	GP-1011Q	COO	CV477	GP-50	SOPA	CW80MP	G-1163	WIX
CP455T	GP-6	WIN	CSM6503	GP-2071W	COO	CV5	GA-113	COP	CW84MP	GP-81	WIX
CP4N0015	GP-381	UNI	CSM6504	GP-1011Q	COO	CV5	GA-113	CYC	CW99MP	G-834	WIX
CP555T	GP-5000	NEL	CT4975	GP-1	JENS	CV500	GP-3985	SOPA	CY01-13-Z40A	GA-1542	MZDA
CP555T	GP-5000	WIN	CT4X9	G-152	ROLK	CV512	GP-68	SOPA	CYAZ-9365-A	GG-20	FORD
CP5L7564	GP-1166	UNI	CT4X9BP	G-191	ROLK	CV513	GP-51	SOPA			
CP5L7564-P	GP-1166	UNI	CT4X9FF	G-191	ROLK	CV517	GP-77	SOPA			
CP6700	GP-191	UNI	CT4X9HYD	G-191	ROLK	CV518	GP-52 ¹¹⁰	SOPA			
CP6H5931	GP-1166	UNI	CT4X9SF	G-191	ROLK	CV518	GP-691 ⁴⁸	SOPA			
CP6H5932	GP-1166	UNI	CT5H6886	G-238	ROLK	CV546	GP-66	SOPA			
CP6H5932-P	GP-1166	UNI	CTI29600C	GAK-403	FORD	CVF19	GA-100	WMP			
CP6L4714	GP-379	UNI	CTQ4X9BP	G-191	ROLK	CVF24	GA-113	WMP			
CP752-10	GP-66	LENZ	CTQ4X9FF	G-191	ROLK	CVN197	GP-1122	SOPA			
CP752-30	GP-66	LENZ	CTQ4X9SF	G-191	ROLK	CVN198	GP-1122	SOPA			
CP75CR	GP-5	WIN	CTQ5H6886	G-238	ROLK	CVN9227	GP-1122	SOPA			
CP9999	GP-238	UNI	CTZ-6731-A	G-836	FORD	CVN9231	G-1121	SOPA			
CP9999P	GP-238	UNI	CU 3567	GAC-7	MNH	CVN9249	GP-1122	SOPA			
CP9H1252	GP-1166	UNI	CU156172	GP-1101	LEYL	CVN9266	GP-1122	SOPA			
CP9H1252P	GP-1166	UNI	CU158139	G-566	LEYL	CVU1177	GP-1122	LEYL			
CP9H4729	GP-1166	UNI	CU2433	GAC-11	MNH	CW1010	GP-2071W	CUMM			

Números Nuevos

Referencia Cruzada por Numero de Parte

Cross Reference by Part Number



Numero	Gonher	Fabricante	Numero	Gonher	Fabricante	Numero	Gonher	Fabricante	Numero	Gonher	Fabricante
Number	Gonher	Manufacturer	Number	Gonher	Manufacturer	Number	Gonher	Manufacturer	Number	Gonher	Manufacturer
D			D12E5KFR2	G-1121F	HEN	D2HA-8A424-AB	GP-1011Q	FORD	D483	GP-24 ²⁶	DEUS
D001445	GP-3985	MIT	D12E5KP	G-1121	HEN	D2HZ-8A424-A	GP-2071W	FORD	D483	GP-462 ²⁴	DEUS
D001450	GP-3985	MIT	D12E9155AA	GG-5 L	FORD	D2NN-6714-C	GP-31	FORD	D484	GP-28 ⁶	DEUS
D0150561	GAK-20	DERR	D12F-9155-AA	GG-124	FORD	D2NN-9176-A	G-296	FORD	D484	GP-430 ⁸	DEUS
D0150561	GAK-20	DUTZ	D12F-9601-BA	GA-349	FORD	D2NN-9176-A	G-296-B	FORD	D485	GP-3600	DEUS
D01505-61	POCL		D13	GP-3531	EXP	D2NP181118	GA-7716	EMCO	D486	GP-3429	DEUS
D05E200M	G-31	HENS	D1301	G-1121	HARM	D2PJ-6714-AA	GP-24	FORD	D487	GP-3980	DEUS
D065008	GA-2804 T	DON	D135	G-871	TEHO	D2RY-9600-E	GA-303	FORD	D48861	G-33	GALN
D070001	GP-420	MIT	D139225	GG-5 L	CASE	D3	GP-3	SRS	D489	GP-28 ⁹	DEUS
D08505-89	GP-77	POCL	D13E24314	G-133	HEN	D300	GP-212	DEUS	D489	GP-430 ⁸	DEUS
D0950524	G-24	CASE	D13E24314	G-989	HEN	D300	GP-3000	KRA	D490	GP-44	DEUS
DOAF-9600-A	GA-85	FORD	D14	G-31	SRS	D300MJ	GP-3000	TIMB	D491	GP-3682	DEUS
DOAF-9600-B	GA-85	FORD	D141096	GP-761H	DAEW	D300TJ	GP-3000	KRA	D4916	G-1173 ¹⁰⁸	ALCH
DOAF-9600-E	GA-303	FORD	D141G10A	G-834	MASE	D300U	GP-3000	KRA	D49198	GA-33 ¹¹²	CASE
DODF-9600-E	GA-303	FORD	D144020	GP-166 ⁶⁵	DAEW	D301	GP-3000 ¹³	KRA	D492	GP-212	DEUS
DODZ9D695A	GA-113	FORD	D144020	GP-3937 ¹	DAEW	D3248	GA-357	STEI	D498	GP-462	DEUS
DOGF-9600-A	GA-86	FORD	D145357	GG-5 L	CASE	D330	GP-3531	EXP	D4HA-9600-AA	GA-6129	FORD
DOGF-9601-A	GA-86	FORD	D146	GA-71	FRM	D330	GP-3001	KRA	D4HA-9600-BA	GA-106 ⁶⁶	FORD
DOGY-9601-A	GA-86	FORD	D148	G-225	MAST	D331	GP-91	DEUS	D4HA-9600-BA	GA-326 ⁷¹	FORD
DOGZ-9601-A	GA-86	FORD	D148	G-331	TEHO	D332	GP-42	DEUS	D4HF9601A	GA-89	FORD
DOHA-6714-A	G-750	FORD	D151	GP-36	KRA	D333	GP-40	DEUS	D4HZ-9155-A	G-1143	FORD
DOHA-67311	GA-106 ⁶⁶	FORD	D156172	GP-1101	CHRY	D34E202H	G-984	HEN	D4HZ-9365-A	G-1143	FORD
DOHA-9600-T	GA-326 ⁷¹	FORD	D156172	GP-1101	CUMM	D362	GP-149 ⁹⁹	DEUS	D4NN-B486-B	GP-166 ¹⁰⁰	FORD
DOHA-9600-T	GA-326 ⁷¹	FORD	D156172	GP-1101	CUMM	D362	GP-91 ⁷⁸	DEUS	D4NN-B486-D	GP-166 ¹⁰⁰	FORD
DOHA-9600-U	GA-6129	FORD	D162	G-222	MASE	D36261	GAK-403	CASE	D4TF-9600-FB	GA-85	FORD
DOHZ-9601-G	GA-106 ⁶⁶	FORD	D162	G-222	MASE	D363	GP-22	DEUS	D4ZF-9601-A	GA-3300	FORD
DOHZ-9601-G	GA-326 ⁷¹	FORD	D163	G-152	MASE	D365	GP-58	DEUS	D4ZF-9601-AA	GA-3300	FORD
DOHZ-9601-H	GA-6129	FORD	D165	G-143	TEHO	D366	GP-2951 ¹²	DEUS	D4ZZ-6731-B	GP-81 ²¹	FORD
DONN-9176-B	G-296	FORD	D168	G-163	TEHO	D366	GP-58	DEUS	D4ZZ-6731-B	GP-9 ⁸	FORD
DONN-9176-B	G-296-B	FORD	D179	G-5000	MASE	D367	GP-46	DEUS	D4ZZ-9601-A	GA-3300	FORD
DONN-9176-B	G-296-B	FORD	D179	G-5000	MAST	D368	GP-157	DEUS	D4ZZ-9601-AA	GA-3300	FORD
DONN-9N074-B	G-296	FORD	D1809	GP-642	KRA	D369	GP-156	DEUS	D5	G-870	MASE
DONN-9N074-B	G-296-B	FORD	D182	GP-69	KRA	D370	GP-149	DEUS	D5	G-870	MAST
DONN-F933-A	GP-66	FORD	D18228P	GAK-16	HYDA	D371	GP-91	DEUS	D5	GP-46	SRS
DOOF-9600-A	GA-85	FORD	D18-228P	GAK-16	DYNA	D377	GP-44	DEUS	D5	G-870	TEHO
DOOF-9600-B	GA-85	FORD	D18231P	GAK-16	HYDA	D37975	GAK-403	CASE	D50917	GAK-403	CASE
DOOF-9600-D	GA-3300	FORD	D18-231P	GAK-16	DYNA	D388	GP-81	DEUS	D50917	GAK-403	DAVY
DORY-6731-A	GP-3600 ⁵⁸	FORD	D185	G-222	TEHO	D390	GP-9000	KRA	D50918	GAK-20	CASE
DORY-6731-A	GP-38 ⁸⁹	FORD	D189	GA-50	FRM	D391	GP-9001	KRA	D50918	GAK-20	DAVY
DOTZ-6731-B	G-500	FORD	D192	GA-192	FRM	D3AZ-9155-A	GG-19	FORD	D50938	GAK-20	CASE
DOTZ-6731-C	G-500	FORD	D1980	GP-171 ¹⁶	ROGR	D3AZ-9155-C	GG-19	FORD	D50A	G-225	MAST
D1	GP-1	SRS	D1AF-6D695-A	GA-113	FORD	D3BZ-9600-A	GA-3300	FORD	D50A	G-225	TEHO
D10	GP-58	SRS	D1AF-6D695-AA	GA-113	FORD	D3DZ-9600-A	GA-303	FORD	D516823	GP-761H	DAEW
D101	G-296	TEHO	D1AF-9D695-AA	GA-113	FORD	D3DZ-9600-B	GA-3300	FORD	D52382	G-169	GALN
D101	G-296-B	TEHO	D1AZ-6D695-A	GA-113	FORD	D3F9601AA	GA-74	FORD	D52382M	G-169	GALN
D102713	GAK-16	GALN	D1AZ-9D695-A	GA-113	FORD	D3HE-9176-AA	GP-1101 ¹⁴	FORD	D53268	G-1174 ¹⁰⁸	ALCH
D103	G-297-B	TEHO	D1FZ9601A	GA-349	FORD	D3HF-6714-AA	GP-31	FORD	D53268	G-1174 ¹⁰⁸	FIAT
D103258	GA-106 ⁶⁶	GALN	D1FZ-9601-B	GA-349	FORD	D3HZ-6731-B	GP-31	FORD	D534	GP-3569	DEUS
D103258	GA-326 ⁷¹	GALN	D1FZ-9601-BA	GA-349	FORD	D3HZ-9155-A	GP-1101 ¹⁴	FORD	D536	GP-13	DEUS
D103259	GA-206	GALN	D1NL-9155-A	GG-20	FORD	D3HZ-9365-A	GP-1101 ¹⁴	FORD	D53628	G-1174 ¹⁰⁸	ALCH
D106587	GA-360	HITA	D1NN-9600-A	GA-589	FORD	D3OZ-9600-A	GA-86	FORD	D539	GP-1	DEUS
D108775	GG-1	GALN	D1NN-9601-A	GA-589	FORD	D3OZ-9600-B	GA-86	FORD	D53F	GP-1122	MASE
D108775	GG-4	GALN	D1NN-9R500-A	GA-588	FORD	D3VE-9155-A4A	GG-19	FORD	D540	GP-205	DEUS
D10A	G-834	MASE	D1NN-F933-A	GP-66	FORD	D3VE-9155-AA	GG-19	FORD	D543	GP-36	DEUS
D10A	G-834	MAST	D1PJ-6714-AA	GP-3600	FORD	D3VE-9155-AB	GG-19	FORD	D544	GP-36	DEUS
D10A	G-834	TEHO	D1PJ-6731-A	GP-3600	FORD	D3ZF-9601-AA	GA-74	FORD	D545	GP-171 ¹⁶	DEUS
D10E10KFR	G-1123F	HEN	D1PL-6731-A	GP-28 ⁸	FORD	D3ZZ-9600-A	GA-74	FORD	D550	G-6	KRA
D10E10KFR2	G-1123F	HEN	D1PL-6731-A	GP-430 ⁸	FORD	D3ZZ-9600-B	GA-86	FORD	D551	G-330	KRA
D10E10KFR4	G-1123F	HEN	D1PZ-6731-A	GP-3600	FORD	D3ZZ-9600-C	GA-86	FORD	D55164	GA-33 ¹¹²	CASE
D10E10KFRH	G-1123F	HEN	D1RY-6731-A	GP-9	FORD	D3ZZ-9601-A	GA-74	FORD	D552	G-5000	KRA
D10E10KP	G-1123	HEN	D1ZF-9601-BA	GA-349	FORD	D3ZZ-9601-AR	GA-74	FORD	D55203	GA-33 ¹¹²	CASE
D11	GP-40	SRS	D1ZZ-9D695-A	GA-113	FORD	D4	GP-81 ²¹	SRS	D552A	G-5000	KRA
D111	G-335	MASE	D2	GP-81	KRA	D4	GP-9 ⁸	SRS	D570	G-200	DEUS
D111	G-335	MAST	D2	GP-20	SRS	D4005	GP-3	DEUS	D572	GP-171	DEUS
D111	G-335	TEHO	D21E142H	G-971	HEN	D4007	G-330	DEUS	D58544-A	GA-5648	IHCO
D112	G-238	MASE	D22	GP-1	KRA	D4008	GP-50	DEUS	D59941	GA-5648	CUMM
D112	G-238	TEHO	D22	G-1121	MASE	D4009	G-870	DEUS	D59941	GA-5648	GALN
D114359	GAK-403	GALN	D22	G-1121	MAST	D401	GP-3985	DEUS	D59949	GG-1	CASE
D11436	GAK-403	GALN	D22	G-1121	TEHO	D4011	GP-3985	DEUS	D59949	GP-3766	DEUS
D114360	GAK-403	GALN	D23	G-1123	MAST	D4012	G-236	DEUS	D5HZ-8A424-A	GP-2071W	FORD
D1150532	GAK-16	DERR	D23	G-1123	TEHO	D4013	G-5000	DEUS	D5NN-9R500-C	GA-827	FORD
D1150532	GAK-16	DUTZ	D24	GP-81	KRA	D4019	G-34	DEUS	D5NNF914A	GP-35	FORD
D11505-32	POCL		D24	G-870	TEHO	D402	GP-171	DEUS	D5NN-F933-A	GP-66	FORD
D117364	GP-50	GALN	D24E11028	G-963	HEN	D4021	GP-50	DEUS	D5PJ-6744-AA	G-750	FORD
D118	G-613	MASE	D245	GP-81	KRA	D4024	G-871	DEUS	D5PZ-6731-A	G-750	FORD
D118	G-613	MAST	D258W1	GA-37	BROK	D40349	GA-33 ¹¹²	CASE	D5PZ-6731-B	G-750	FORD
D11917	G-296	ROLS	D25S	GP-5	KRA	D4037	GP-452	DEUS	D5PZ-6731-C	G-750	FORD
D11917	G-296-B	ROLS	D27-05419	GA-33 ¹¹²	LSTR	D406	GP-81	DEUS	D5PZ-6731-D	G-750	FORD
D11927	G-296	ROLS	D272-6731-A	GP-462	FORD	D407	GP-68	DEUS	D5Z6731A	GP-9	FORD
D11927	G-296-B	ROLS	D272-6731-ADP	GP-24 ²⁶	FORD	D42	GP-81	KRA	D6	GP-3429	SRS
D119394	GA-33 ¹¹²	GALN	D272-6731-ADP	GP-462 ²⁴	FORD	D42F-9601-AA	GA-3300	FORD	D600	GP-38	DEUS
D11E17414	G-163	HEN	D28424	G-1173 ¹⁰⁸	CASE	D4ZZ-9601-A	GA-3300	FORD	D603	GP-28 ⁶	DEUS
D11E25114	G-143	HEN	D28E160H01E	G-3827	HEN	D430	GP-81 ²¹	DEUS	D603	GP-430 ⁸	DEUS
D12	GP-42	SRS	D29869	GP-1	CASE	D430	GP-9 ⁸	DEUS	D605	GP-3766	DEUS
D120301	GP-1107	GALN	D29891	GP-1	CASE	D431	GP-20	DEUS	D6150548	GG-5 L	PPM
D120302	GP-1105	GALN	D29896	GP-1	CASE	D432	GP-3	DEUS	D62845	GP-81	CASE
D120303	GP-69	GALN	D2AE-9155-CA	GG-19	FORD	D433	GP-3985 ⁵³	DEUS	D63	G-31	TEHO
D120594	GP-761H	CASE	D2AE-9176-AA	GG-20	FORD	D434	GP-3985	DEUS	D64	G-31	TEHO
D122	G-1163 ¹⁰⁸	MAST	D2AE-9601-AA	GA-75	FORD	D435	GP-46	DEUS	D64003	GAK-16	CASE
D122	G-1163 ¹⁰⁸	TEHO	D2AE-9601-AR	GA-75	FORD	D436	G-963	DEUS	D650	GP-31	DEUS
D122562	GP-761H	CASE	D2AF-9601-AA	GA-75	FORD	D43712	GA-33 ¹¹²	CASE	D651	GP-178	DEUS
D122926	GP-69	GALN	D2AZ-9600-A	GA-75	FORD	D45	GP-31	KRA	D654	GP-31	DEUS
D126922	GP-761H	CASE	D2AZ-9600-B	GA-75	FORD	D45161	G-1173 ¹⁰⁸	CASE	D66337	GA-7	CASE
D127	G-330	MA									

Numero	Gonher	Fabricante	Numero	Gonher	Fabricante	Numero	Gonher	Fabricante	Numero	Gonher	Fabricante
Number	Gonher	Manufacturer	Number	Gonher	Manufacturer	Number	Gonher	Manufacturer	Number	Gonher	Manufacturer
D6NN-6714-AG-5000	FORD	D8NN-F933-ABSGP-66	FORD	DA2910GA-5056	DEFS	DA6807GA-386	DEFS
D6NN-6744-AG-5000	FORD	D8NN-F933-ACGP-66	FORD	DA2911GA-132	DEFS	DA6828GA-133	DEFS
D6NN-8486-AGP-166 ⁰⁰	FORD	D8NNF966ABGP-66	FORD	DA3011GA-6479	DEFS	DA6850GAD-294	DEFS
D6OF-9600-CBGA-86	FORD	D8NNM903FAGP-35	FORD	DA3012GA-2106	DEFS	DA7017GA-7017	DEFS
D7GP-3980	SRS	D8PJ-6714-AAGP-9	FORD	DA3020GA-735 ¹²⁴	DEFS	DA7094GA-604	DEFS
D701GPP-1122	BOG	D8PJ-9601-AAGA-26	FORD	DA303GA-303	DEFS	DA7174GA-381	DEFS
D71450GAK-20	GALN	D8PJ-9601-BAGA-27	FORD	DA3180GA-362	DEFS	DA7344GA-7344	DEFS
D71490GAK-20	GALN	D8PZ-6731-AGP-81	FORD	DA3181GA-1615	DEFS	DA7351GA-322	DEFS
D72854GAK-16	CASE	D9G-836	TEHO	DA3220GA-390	DEFS	DA7414GA-141	DEFS
D73873GA-5648	GALN	D90362GA-106 ⁴⁶	KOEH	DA3223GA-198	DEFS	DA7417GA-198	DEFS
D73893GA-5648	GALN	D90362GA-326 ⁷¹	KOEH	DA3226GA-3647	DEFS	DA7421GA-165	DEFS
D75435G-500	GALN	D90512GA-26	GALN	DA324AGA-85	DEFS	DA7432GA-132	DEFS
D76491G-750	GALN	D911517GAK-20	HITA	DA326GA-59	DEFS	DA7440GA-300	DEFS
D76986GAK-20	GALN	D911519GA-360	HITA	DA327GA-57	DEFS	DA7597GA-164	DEFS
D77801X2GA-106 ⁴⁷	KOEH	D914453GA-361	HITA	DA3300GA-3300	DEFS	DA7598GA-604	DEFS
D77801X2GA-206 ⁰⁸	KOEH	D93G-191	MASE	DA3320GA-139	DEFS	DA7730GA-175	DEFS
D77801X2GA-326 ⁷²	KOEH	D93G-191	MAST	DA3373GAVW-2	DEFS	DA7774GA-1616	DEFS
D77E-9601-AGA-2740	FORD	D93G-191	TEHO	DA3420GAD-3	DEFS	DA7778GAD-3	ASAH
D77Z-9601-AGA-2740	FORD	D94236GP-761H	CASE	DA351GA-75	DEFS	DA80353GAD-27	GRAD
D78103XGA-360 ⁰⁴	KOEH	D95073XGA-27	KOEH	DA352GAD-1	DEFS	DA80353GA-27	WARN
D78103XGA-361 ⁰⁸	KOEH	D95080XGAK-20	KOEH	DA3520GA-54	DEFS	DA8038GA-673R	DEFS
D78280G-33	GALN	D97068G-613	GALN	DA3537GA-54	DEFS	DA8039GA-1615	DEFS
D79360G-33	GALN	D97073G-333	GALN	DA3549GA-89	DEFS	DAE9601AAGA-75	FORD
D7AF9601AGA-85	FORD	D97140GA-360 ⁰⁴	GALN	DA3559GA-271	DEFS	DAHZ9665AG-1143	FORD
D7AF-9601-AAGA-85	FORD	D97140GA-361 ⁰⁸	GALN	DA3588GA-3588	DEFS	DAV111GP-54	DORM
D7AF-9601-BAGA-86	FORD	D97335GALN	GALN	DA3610GA-275	DEFS	DAZF9601AGA-3300	FORD
D7AZ-9601-AGA-85	FORD	D98927GA-106 ⁴⁷	GALN	DA3647GA-3647	DEFS	DBPN-6731-AG-5000	FORD
D7AZ-9601-ARGA-85	FORD	D98927GA-206 ⁰⁸	GALN	DA3660GA-277	DEFS	DC135GP-40	LAZO
D7AZ-9601-BGA-86	FORD	D98927GA-326 ⁷³	GALN	DA3717GA-274	DEFS	DC136GA-3490	LAZO
D7AZ-9601-BRGA-86	FORD	D99447GA-6127 ⁰⁸	GALN	DA3722GA-50	DEFS	DC1442G-296	DIA
D7EF-9601-AGA-3425	FORD	D99447GA-6129 ⁰⁴	GALN	DA3724GA-77	DEFS	DC1442G-296-B	DIA
D7EF-9601-AAGA-3425	FORD	D99501GP-1108	GALN	DA3730GA-3588	DEFS	DC150G-1123	DIA
D7FZ-9601-AGA-3425	FORD	D99737GA-360	GALN	DA3732GA-192	DEFS	DC207GG-196	LAZO
D7FZ-9601-AAGA-3425	FORD	D99739GA-361	GALN	DA381GA-74	DEFS	DC222GA-4325	LAZO
D7FZ-9601-ARGA-3425	FORD	D99876GP-110	GALN	DA3810GA-300	DEFS	DC25G-1173 ⁰⁸	DIA
D7TA-9155-ABGG-5 L	FORD	D9AE-6714-AAGP-1	FORD	DA3814GA-3814	DEFS	DC6072G-1143	DIA
D7TZ-9155-DGG-5 L	FORD	D9AZ-6731-AGP-1	FORD	DA3820GA-70	DEFS	DC6310G-1121	DIA
D7ZE-9601-AGA-2740	FORD	D9AZ6731BGP-1	FORD	DA3822GA-3681	DEFS	DC711G-1163 ⁰⁸	DIA
D7ZF-9601-AAGA-3424	FORD	D9FL-9150-BG-296	FORD	DA3823GA-142	DEFS	DCQ123GA-39	ROLK
D7ZF-9601-BAGA-3424	FORD	D9FL-9150-BG-296-B	FORD	DA3901GA-3901	DEFS	DCQ126GP-1101	ROLK
D7ZZ-9601-AGA-3424	FORD	D9HT-9155-ABGG-20	FORD	DA3902GA-253	DEFS	DD148G-870	LAZO
D7ZZ-9601-AAGA-3424	FORD	D9HZ-6731-AGP-9586	FORD	DA3910GA-4958	DEFS	DD150GP-310	LAZO
D7ZZ-9601-ARGA-3424	FORD	D9HZ-6731-BGP-9586	FORD	DA3916GA-3916	DEFS	DD156GG-45	LAZO
D8GP-310	SRS	D9HZ-9155-AGG-20	FORD	DA3920GA-78	DEFS	DD158GG-94	LAZO
D801GP-23	DEUS	D9HZ-9155-BGP-55	FORD	DA3922GAD-1	DEFS	DD163GA-4303	LAZO
D80480GAK-403	CASE	D9NN-6714-DAGP-81	FORD	DA3924GA-3523	DEFS	DD165GA-75	LAZO
D80512GA-26	GALN	D9NN-6714-EAGP-1	FORD	DA3924AGA-153	DEFS	DD166GAD-1	LAZO
D80538GP-34	CASE	D9NN-6714-FAGP-81	FORD	DA3926GA-3490	DEFS	DD168GAD-3	LAZO
D80963G-335	GALN	D9NN-9601-AAGA-589	FORD	DA4020GA-4325	DEFS	DD169GAD-3	LAZO
D81G-33	TEHO	D9PJ-6714-AAGP-9586	FORD	DA4120GA-74	DEFS	DD170GAD-1	LAZO
D81410GAK-16	GALN	D9PZ-9155-AGG-123	FORD	DA4122GA-75	DEFS	DD211GP-38	LAZO
D81AG-33	MASE	DA0785GA-360	LETR	DA4220GA-2740	DEFS	DD220GG-45	LAZO
D81AG-33	MAST	DA0785GA-360	WABC	DA4222GA-303	DEFS	DD223GAD-15	LAZO
D82289G-1143	GALN	DA111GP-1	DORM	DA429-4G-296	DORM	DDA4G-1173 ⁰⁸	COM
D82507GAK-20	GALN	DA111GP-1	GENE	DA429-4G-296-B	DORM	DDEDAG-1173 ⁰⁸	COM
D83389G-1143	GALN	DA136GA-55	DEFS	DA4303GA-4303	DEFS	DDEDAG-1174 ⁰⁸	COM
D84370GAK-16	GALN	DA1467GPP-14	KOMA	DA4309GAD-15	DEFS	DDDEDG-1175 ⁰⁸	COM
D84371GAK-20	GALN	DA1467GPP-14	LETR	DA4320GA-3424	DEFS	DDDED8MG-1175 ⁰⁸	COM
D84487GA-27	KOEH	DA1467GPP-14	WABC	DA4322GA-3425	DEFS	DDDED-T6G-1173 ⁰⁸	COM
D85G-200	MASE	DA1510GA-7017	DEFS	DA4325GA-4325	DEFS	DDN-99162-AG-11816	FORD
D850GP-562	DEUS	DA160GA-70	DEFS	DA4420GA-75	DEFS	DDPB-6731-AG-5000	FORD
D85461G-566	GALN	DA1850GA-153	DEFS	DA4430GA-59	DEFS	DDPN-6731-AG-5000	FORD
D85830G-335	GALN	DA1912GA-271	DEFS	DA4450GA-89	DEFS	DDX18910GA-892	JOND
D85832G-1163 ⁰⁸	GALN	DA192GA-192	DEFS	DA4460GA-673R	DEFS	DE48149G-1173 ⁰⁸	ALCH
D86325G-1174 ⁰⁸	GALN	DA2010GA-386	DEFS	DA4520GA-3566	DEFS	DE48149G-1173	FIAT
D86327G-1173 ⁰⁸	GALN	DA2011GAVW-2	DEFS	DA46164GA-27	GRAD	DE4916G-1173 ⁰⁸	ALCH
D86329G-119	GALN	DA2012GA-277	DEFS	DA46164GA-27	WARN	DE4916G-1173	FIAT
D86943XGA-27	KOEH	DA2120GA-604	DEFS	DA4620GA-3300	DEFS	DE53267G-1173 ⁰⁸	ALCH
D87863GA-39	GALN	DA2210GA-174	DEFS	DA46316GA-27	GRAD	DE53267G-1173	FIAT
D87872GP-1101	GALN	DA2211GA-165	DEFS	DA46316GA-27	WARN	DE53268G-1174 ⁰⁸	ALCH
D87Z-6731-AGP-462	FORD	DA2260GA-253	DEFS	DA46317GA-26	GRAD	DE53268G-1174 ⁰⁸	FIAT
D88818G-159	GALN	DA2310GA-273	DEFS	DA46317GA-26	WARN	DE53269G-1173 ⁰⁸	ALCH
D88913G-1175 ⁰⁸	GALN	DA2311GA-3916	DEFS	DA4720GA-57	DEFS	DE53269G-1173	FIAT
D8FZ-6A666-BGP-28 ⁸	FORD	DA2410GA-4303	DEFS	DA4722GA-2719B	DEFS	DE53629G-1173 ⁰⁸	ALCH
D8FZ-6A666-BGP-430 ⁸	FORD	DA2460GA-175	DEFS	DA4830GA-180	DEFS	DE53629G-1173	FIAT
D8FZ-9601-BGA-3425	FORD	DA2510GAD-15	DEFS	DA4920GA-85	DEFS	DE53268G-1174	ALCH
D8HZ-4A420-AGP-3	FORD	DA2512GA-3915	DEFS	DA4922GA-86	DEFS	DE6150G-1173 ⁰⁸	ALCH
D8HZ-9601-AGA-372	FORD	DA2514GA-133	DEFS	DA4930GA-730	DEFS	DE61650G-1173 ⁰⁸	ALCH
D8NN-6714-AAGP-54 ⁰	FORD	DA2515GA-5466	DEFS	DA4931GAD-294	DEFS	DE61690G-1173 ⁰⁸	ALCH
D8NN-6714-D8GP-77	FORD	DA2516GA-432	DEFS	DA4939GA-139	DEFS	DE61690G-1173	FIAT
D8NN-6714-DAGP-77	FORD	DA2520GA-195	DEFS	DA5051G-500	LETR	DE61833G-1173 ⁰⁸	ALCH
D8NN-6714-DASGP-77	FORD	DA2524GA-180	DEFS	DA5051G-500	WABC	DE61833G-1173	FIAT
D8NN-6714-GAGP-1	FORD	DA2525GA-6690	DEFS	DA5056GA-5056	DEFS	DE62485G-1173 ⁰⁸	ALCH
D8NN-9176-AAG-297-B	FORD	DA2540GA-4828	DEFS	DA5058GA-273	DEFS	DE62485G-1173	FIAT
D8NN-9618-AAGA-616	FORD	DA2610GA-274	DEFS	DA5430GA-55	DEFS	DE62633G-1175 ⁰⁸	ALCH
D8NN-9B618-AAGA-616	FORD	DA2611GA-3901	DEFS	DA5466GA-5466	DEFS	DE62633G-1175 ⁰⁸	FIAT
D8NN-9N074-AG-296	FORD	DA2612GA-382	DEFS	DA5514AGAK-403	GENE	DE62639G-1173 ⁰⁸	ALCH
D8NN-9N074-AG-296-B	FORD	DA2670GA-1616	DEFS	DA5514-AGAK-403	DORM	DE62833G-1175 ⁰⁸	ALCH
D8NN-9N074-AAG-296	FORD	DA2710GA-164	DEFS	DA6333GA-382	DEFS	DE62833G-1175 ⁰⁸	FIAT
D8NN-9N074-AAG-296-B	FORD	DA2711GA-381	DEFS	DA6362GA-362	DEFS	DE63267G-1173 ⁰⁸	ALCH
D8NN-9R500-AAGA-398	FORD	DA2719BGA-2719B	DEFS	DA6366GA-174	DEFS	DE64473G-1176	ALCH
D8NN-8486-AAGP-166 ⁰⁰	FORD	DA2720GA-3814	DEFS	DA6376GA-142	DEFS	DE64478G-1176	ALCH
D8NN-8486-CAGP-166 ⁰⁰	FORD	DA2721GA-141	DEFS	DA6395GA-195	DEFS	DE64478G-1175 ⁰⁸	DAVI
D8NN-8486-EAGP-166 ⁰⁰	FORD	DA2822GA-7344	DEFS	DA6479GA-6479	DEFS	DE64478G-1175 ⁰⁸	DIAM
D8NN-F933-AGP-66	FORD	DA2823GA-322	DEFS	DA6555GA-275	DEFS	DE64478G-1175 ⁰⁸	FIAT
D8NN-F933-ABGP-66	FORD	DA2824GA-514	DEFS	DA6690GA-6690	DEFS	DE64559G-1173 ⁰⁸	ALCH

Referencia Cruzada por Numero de Parte

Cross Reference by Part Number



Numero	Gonher	Fabricante	Numero	Gonher	Fabricante	Numero	Gonher	Fabricante	Numero	Gonher	Fabricante
Number	Gonher	Manufacturer	Number	Gonher	Manufacturer	Number	Gonher	Manufacturer	Number	Gonher	Manufacturer
DE64559	G-1173 ⁰⁸	AUSW	DIPZ-6731-A	GP-430 ⁸	FORD	DL5434	GP-3531	EXF	DO933	GP-57	CLEN
DE64559	G-1173	FIAT	DITS-9600-AA	GAK-20	FORD	DL5436	GP-42	DEFS	DO934	GP-53	CLEN
DE64599	G-1173 ⁰⁸	ALCH	DIZF-9601-BA	GA-349	FORD	DL5570	GP-3985	DEFS	DO935	GP-52 ¹⁰	CLEN
DE64599	G-1173	FIAT	DK101	GP-51	MASE	DL5571	GP-81	DEFS	DO935	GP-691 ⁴⁸	CLEN
DE65245	G-750	ALCH	DK106	GP-46	MASE	DL5630	GP-81 ³¹	DEFS	DOGF-9601-A	GA-86	FORD
DE65568	G-1175 ⁰⁸	ALCH	DK107F	G-297-B	MAST	DL5630	GP-9 ⁵⁸	DEFS	DOGY-9601-A	GA-86	FORD
DE65853	G-1173 ⁰⁸	ALCH	DK11	GP-50	MASE	DL5632	GP-3	DEFS	DOGZ9601A	GA-86	FORD
DE65853	G-1173	FIAT	DK11	GP-50	MAST	DL5634	GP-20	DEFS	DOHZ-9601-G	GA-106 ⁶	FORD
DE65874	G-1175 ⁰⁸	ALCH	DK110	GP-77	MAST	DL5636	GP-68	DEFS	DOHZ-9601-G	GA-326 ⁷¹	FORD
DE66270	G-1176	ALCH	DK111	GP-3985	MAST	DL5833	GP-13	DEFS	DOHZ-9601-H	GA-6129	FORD
DE67515	G-1175 ⁰⁸	ALCH	DK112	GP-1	MASE	DL5850	GP-310	DEFS	DONN-6714-A	GP-1	FORD
DE67575	G-1176	ALCH	DK112	GP-1	MAST	DL5850	GP-3569	DEFS	DONN-6714-B	GP-1	FORD
DE67714	G-1175	ALCH	DK113	GP-40	MASE	DL5851	GP-1	DEFS	DONN-9176-B	G-296	FORD
DE67714	G-1175 ⁰⁸	DAVI	DK15	GP-54	MAST	DL5853	GP-13	DEFS	DONN-9176-B	G-296-B	FORD
DE67714	G-1175	DIAM	DK20F	G-296	MASE	DL5870	GP-205	DEFS	DONN-9818-B	GA-18	FORD
DE67714	G-1175 ⁰⁸	FIAT	DK20F	G-296-B	MASE	DL6607	GP-91	DEFS	DONN-9N074-B	G-296	FORD
DE73605	G-1173 ⁰⁸	ALCH	DK20F	G-296	MAST	DL6930	GP-3766	DEFS	DONN-9N074-B	G-296-B	FORD
DE73605	G-1173	FIAT	DK20F	G-296-B	MAST	DL7317	GP-149 ⁹²	DEFS	DOPN-6731-A	G-5000	FORD
DEL150694	GA-694	DON	DK23F	GP-1101	MASE	DL7317	GP-91 ⁷⁸	DEFS	DORZ-6731-A	GP-28 ⁹	FORD
DEL150694	GA-694	UNI	DK27	GP-462	MAST	DL7328	GP-81	DEFS	DORY-6731-A	GP-430 ⁸	FORD
DEL153551	GA-351 ⁵⁵	DON	DK32	GP-81	MASE	DL7758	GA-27	LETR	DOTZ-6731-B	G-500	FORD
DEL153551	GA-351 ⁵⁵	DON	DK32	GP-81	MAST	DL7758	GA-27	WABC	DP25	GGP-25	FLUX
DEL153551	GA-351 ⁵⁵	UAC	DK34	GP-171	MAST	DL8A	GP-1	DEFS	DP3431	GP-85	FLUX
DEL153551	GA-351 ⁵⁵	UNI	DK37	GP-36	MAST	DL9601-A	GAK-20	FORD	DP752-10	GP-66	RIPL
DEL154575	GA-389	DON	DK40	GP-38	MASE	DM104	GA-2740	LAZO	DP752-30	GP-66	RIPL
DEL154575	GA-389	DON	DK40	GP-38	MAST	DM109	GP-24 ²⁶	LAZO	DPHZ-9155-B	GP-55	FORD
DEL154575	GA-389	DON	DK47	GP-81	MASE	DM109	GP-462 ²⁴	LAZO	DR104	GP-1101	DIAM
DF1	GP-1	VALV	DK49	GP-28 ⁹	MAST	DM16304	GP-81	DEAR	DR250	GA-39	DIAM
DF18	G-1163 ⁰⁸	KNE	DK49	GP-430 ⁸	MAST	DM16304	GP-81	INTM	DR750D	G-750	DIAM
DF2	GP-20	VALV	DK53F	GP-1122	MASE	DMS04AN	GP-66	MANO	DS1108	GP-1107	FLUX
DF207	GP-9	CLEN	DK54	GP-1	MASE	DMS04BN	GP-66	MANO	DS1121	GP-78	FLUX
DF21	G-297-B	KNE	DK54	GP-1	MAST	DMS511AN	GP-34	DELA	DS141	GG-5 L	LAZO
DF296	G-296	GKIN	DK56	GP-20	MASE	DN220	G-296	CLEN	DT1	GA-59	SRS
DF296	G-296-B	GKIN	DK56	GP-20	MAST	DN220	G-296-B	CLEN	DT10	GA-3300	SRS
DF297CX	GA-29	ACD	DK60	GP-1	MASE	DN222	G-297-B	CLEN	DT11	GA-71	SRS
DF3	GP-3	VALV	DK60	GP-1	MAST	DN251	GPP-111	CLEN	DT11	GA-71	WIX
DF3710	GP-92	CAC	DK67	GP-81	MASE	DN251	GPP-524	CLEN	DT112	GA-105	WIX
DF3711	GP-1122	CAC	DK68	GP-1	MASE	DN256	GP-1122	CLEN	DT12	GA-730	SRS
DF4	GP-81 ³¹	VALV	DK68	GP-1	MAST	DN260	GP-1122	CLEN	DT1222	GAK-16	WIX
DF4	GP-9 ⁵⁸	VALV	DK75	GP-3600	MASE	DN264	GP-110	CLEN	DT1234	GAK-20	WIX
DF888	GP-9	CLEN	DK75	GP-3600	MAST	DN273	GP-1101	CLEN	DT1240	GA-27	WIX
DFE04202	GA-18	BRGS	DK77F	GP-110	MASE	DN306	GP-1122	CLEN	DT1243	GA-26	WIX
DFE09003	GA-360	BRGS	DK8	GP-13	MASE	DN318	GP-62	CLEN	DT1246	GAK-403	WIX
DFE-4533	GA-135	PAI	DK81	GP-1122	MAST	DN845	G-294	CLEN	DT1275	GA-33 ¹²	WIX
DFE-4535	GA-135	PAI	DK85	GP-81 ³¹	MAST	DN871	G-295	CLEN	DT14	GA-735 ¹²⁴	SRS
DFP195	G-1123	SOPA	DK85	GP-9 ⁵⁸	MAST	DN916	GP-1122	CLEN	DT152	GP-1	LAZO
DG13	GP-13	FRM	DK86	GP-3	MASE	DN997	GP-96	CLEN	DT155	GP-1	LAZO
DG16	GP-81	FRM	DK87	GP-3985	MAST	DNP12D8627	GP-1101	KOMA	DT174	GAD-1	LAZO
DG2	GP-68	FRM	DK89	GP-390 ⁹³	MAST	DNP13D8627	GP-1101	KOMA	DT176	GA-2719B	LAZO
DG25	GP-20	FRM	DK94	GP-3429	MASE	DO1450	GP-3985	MIT	DT18065	GA-5648	WIX
DG2825	GP-38	FRM	DK94	GP-3429	MAST	DO205	GP-3985	CLEN	DT189	GG-45	LAZO
DG2849A	GP-462	FRM	DL16	GP-81	DEFS	DO214	GP-50	CLEN	DT190	GG-76	LAZO
DG2870A	GP-28	FRM	DL2	GP-68	DEFS	DO215	GP-3816	CLEN	DT194	GG-202	LAZO
DG2951	GP-58	FRM	DL25	GP-20	DEFS	DO218	GP-28 ⁹	CLEN	DT195	GP-58	LAZO
DG30	GP-3	FRM	DL2870A	GP-28 ⁹	DEFS	DO218	GP-430 ⁸	CLEN	DT2	GA-75	SRS
DG3387A	GP-46	FRM	DL2870A	GP-430 ⁸	DEFS	DO224	GP-81	CLEN	DT20	GA-70	WIX
DG3429	GP-3429	FRM	DL2951	GP-157	DEFS	DO225	GP-1	CLEN	DT202	GG-203	LAZO
DG3531	GP-3531	EXP	DL30	GP-3	DEFS	DO229	GP-46	CLEN	DT2119	GA-360	WIX
DG3593A	GP-149	FRM	DL3330	GP-91	DEFS	DO231	GP-38	CLEN	DT250	GA-37	WIX
DG3600	GP-3600	FRM	DL3387A	GP-46	DEFS	DO236	GP-36	CLEN	DT3	GA-57	SRS
DG3614	GP-58	FRM	DL3410	GP-157	DEFS	DO248	GP-22	CLEN	DT371	GA-44	WIX
DG3682	GP-3682	FRM	DL3430	GP-91	DEFS	DO255	GP-81	CLEN	DT372	GA-11	WIX
DG3950	GP-40	FRM	DL3506	GP-44	DEFS	DO259	GP-68	CLEN	DT4	GA-70	SRS
DG3980	GP-3980	FRM	DL3530	GP-91	DEFS	DO263	GP-54 ¹¹	CLEN	DT42	GAP-381	WIX
DG3985	GP-40	FRM	DL3531	GP-3531	EXP	DO263	GP-66 ¹⁰	CLEN	DT5	GA-55	SRS
DG43	GP-81 ³¹	FRM	DL3569	GP-310	DEFS	DO266	GP-9586	CLEN	DT54	GA-77	WIX
DG43	GP-9 ⁵⁸	FRM	DL3600	GP-3600	DEFS	DO272B	GP-46	CLEN	DT55	GA-80	WIX
DG4967	GP-157	FRM	DL3614	GP-2951 ⁶²	DEFS	DO281	GP-5	CLEN	DT5	GA-50	SRS
DG5	GP-205	FRM	DL3614	GP-58	DEFS	DO282	GP-38	CLEN	DT6	GA-78	WIX
DG8A	GP-1	FRM	DL3675	GP-3429	DEFS	DO288	GP-40	CLEN	DT7	GA-85	SRS
DGNP-6731-A	G-5000	FORD	DL3950	GP-40	DEFS	DO290	GP-406	CLEN	DT716	GA-39	WIX
DH1021	G-152	DIA	DL3980	GP-3980	DEFS	DO294	GP-3600	CLEN	DT8	GA-303	SRS
DH1120	G-330	DIA	DL3985	GP-3985	DEFS	DO295	GP-13	CLEN	DT8047	GA-8047	WIX
DH1123	G-33	DIA	DL43	GP-81 ³¹	DEFS	DO296	GP-3980	CLEN	DT8048	GA-1285	WIX
DH1123A	G-33	DIA	DL43	GP-9 ⁵⁸	DEFS	DO300	GP-51	CLEN	DT83	GA-50	WIX
DH122	GG-1	LAZO	DL4386	GP-157	DEFS	DO317	GP-5	CLEN	DT885	GA-192	WIX
DH122	GG-4	LAZO	DL4490	GP-2951 ⁶²	DEFS	DO327	GP-40	CLEN	DT9	GA-77	SRS
DH123	GP-42	LAZO	DL4490	GP-58	DEFS	DO329	GP-42	CLEN	DT9045	GA-9045	WIX
DH125	G-31	DIA	DL4492	GP-3816	DEFS	DO330	GP-3	CLEN	DT9046	GA-1287	WIX
DH130	GA-3490	LAZO	DL4496	GP-46	DEFS	DO332	GP-40	CLEN	DT91	GA-56	WIX
DH133	GP-3531	EXP	DL4510	GP-44	DEFS	DO340	GP-3531	EXP	DT93	GA-90	WIX
DH142	G-871	DIA	DL4632	GP-3429	DEFS	DO341	GP-3682	CLEN	DT9334	GA-9334	WIX
DH143	G-200	DIA	DL4650	GP-212	DEFS	DO342	GP-390 ⁹³	CLEN	DT9335	GA-1286	WIX
DH207	G-1143	DIA	DL4681	GP-38	DEFS	DO716	GP-1	ASAH	DT9378	GA-1008	WIX
DH224	G-335	DIA	DL4810	GP-3600	DEFS	DO721	GP-58	ASAH	DT9379	GA-1284	WIX
DH230	G-222	DIA	DL4812	GP-28 ⁹	DEFS	DO722	GP-156	ASAH	DT95	GA-55	WIX
DH2501	GP-28 ⁹	DEFS	DL4812	GP-430 ⁸	DEFS	DO826	GP-67	CLEN	DT9853	GA-375	WIX
DH301	G-813	DIA	DL4814	GP-3980	DEFS	DO833	GP-3429	CLEN	DU1054	GA-6127	COO
DH387	G-152	SOPA	DL4816	GP-24 ²⁶	DEFS	DO834	GP-3682	CLEN	DU12065	GA-360	COO
DH393	G-222	SOPA	DL4816	GP-462 ²⁴	DEFS	DO847	GP-171	CLEN	DU1206ST	GA-360	COO
DH7138	G-871	DIA	DL4830	GP-38	DEFS	DO854	GP-91	CLEN	DU1206T	GA-360	COO
DH713820	G-871	DIA	DL4967	GP-157	DEFS	DO874	GP-77	CLEN	DU1206T	GA-360	COO
DH714	G-870	DIA	DL5	GP-205	DEFS	DO894	GP-28 ⁹	CLEN	DU1206T	GA-360	DON
DH80	G-238	DIA	DL5343	GP-91	DEFS	DO894	GP-430 ⁸	CLEN	DU1206TS	GA-360	COO
DIPJ-6714-AA	GP-28 ⁹	FORD	DL5430	GP-81	DEFS	DO896	GP-171	CLEN	DU1518S	GA-106 ⁶	COO
DIPJ-6714-AA	GP-430 ⁸	FORD	DL5432	GP-40	DEFS	DO924	GP-1				

Numero	Gonher	Fabricante	Numero	Gonher	Fabricante	Numero	Gonher	Fabricante	Numero	Gonher	Fabricante
Number	Gonher	Manufacturer	Number	Gonher	Manufacturer	Number	Gonher	Manufacturer	Number	Gonher	Manufacturer
DU1518STS	GA-106 ⁴⁶	COO	E-0773	GA-415	KENG	E140-33	G-870	HEN	E1P1-9155-AA	GP-93	FORD
DU1518STS	GA-326 ⁷¹	COO	E091540K	G-500	HEN	E140-41	G-335	HEN	E1PZ-9155-A	GP-93	FORD
DU1518T	GA-106 ⁴⁶	COBE	EOHT-9155-C1A	GP-92	FORD	E14057	G-331	HEN	E1PZ-9155-B	GP-93	FORD
DU1518T	GA-326 ⁷¹	COBE	EOHT-9155-C2A	GP-92	FORD	E142	GA-89	KENG	E1TZ-9601-A	GA-2740	FORD
DU1518T	GA-106 ⁴⁶	DON	EOHZ-6731-A	GP-13	FORD	E1420	GA-89	KENG	E1ZE-6714-AA	GP-1	FORD
DU1518T	GA-326 ⁷¹	DON	EOHZ-9155-C	GP-92	FORD	E145	GA-57	KENG	E1ZE-9155-A4A	GG-87	FORD
DU1518TS	GA-106 ⁴⁶	COO	EOHZ-9155-D	GP-92	FORD	E1450	GA-57	KENG	E1ZE-9155-AA	GG-87	FORD
DU1518TS	GA-326 ⁷¹	COO	EONN-6714-AA	GP-77	FORD	E148-20	G-871	HEN	E2	GA-100	SRS
DU1543	GA-27	COO	EONN-6714-AAS	GP-77	FORD	E150	GA-59	KENG	E20	GG-251	GUD
DU1958	GA-6129	COO	EONN-9R500-AA	GA-588	FORD	E150	GA-100	PDX	E200M	G-31	HEN
DU2399	GA-33 ¹¹²	COO	EOTE-9601-AA	GA-75	FORD	E151	GA-325	KENG	E20-14	G-31	HEN
DU664	GA-33 ¹¹²	COO	EOTZ-9601-B	GA-80	FORD	E151	GA-113	PDX	E20-14-99	G-31	HEN
DU664	GA-33 ¹¹²	DON	EOTZ-9601-C	GA-588	FORD	E1510	GA-325	KENG	E202H01D34	G-984	HEN
DU664S	GA-33 ¹¹²	COO	EOTZ-9601-D	GA-589	FORD	E1514580	GA-356 ¹⁰⁴	CLRK	E2-17	GA-26	ERO
DU664STS	GA-33 ¹¹²	COO	EOZE-9155-BA	GG-87	FORD	E1514580	GA-357 ¹⁰⁸	CLRK	E-2190	GA-3445	KENG
DU664TS	GA-33 ¹¹²	COO	EOZZ-9155-A	GG-87	FORD	E152	GA-113	PDX	E21L	GAVW-2	HEN
DU750	GA-16	COO	E100	GA-71	KENG	E15233	G-871	HEN	E-2296	GA-412R	KENG
DU770CT	GA-403	DON	E1000	GA-71	KENG	E153	GA-730	KENG	E229-86H	G-238	HEN
DU770S	GA-403	COO	E1001H	G-112	HEN	E153	GA-113	PDX	E22L	GAVW-4	HEN
DU770STS	GA-403	COO	E100-34	G-836	HEN	E1530	GA-730	KENG	E2-3	GAK-20	ERO
DU770T	GA-403	DON	E101	GP-3531 EXP	CHAM	E15633	G-871	HEN	E230059	GAK-20	AMHO
DU770TS	GA-403	COO	E1015	GA-3647	KENG	E157	GA-85	KENG	E230059	GAK-20	BROS
DU8792	GA-20	DON	E10-18	G-225	HEN	E1570	GA-85	KENG	E230070	GA-27	AMHO
DU879T	GA-20	COBE	E10-18H	G-162H	HEN	E158	GA-86	KENG	E230070	GA-27	BROS
DU879T	GA-20	DON	E103	GA-3523	KENG	E1580	GA-86	KENG	E230113	GAK-403	AMHO
DU879TS	GA-20	COO	E1035	GA-3681	KENG	E15H	G-25	HEN	E230114	GAK-16	AMHO
DX103US	GP-81 ³¹	DIEX	E103999	GP-1	CALS	E15HD58	G-72	HEN	E230114	GAK-16	BROS
DX103US	GP-9 ⁵⁸	DIEX	E104	GA-80	KENG	E15R4T2V	G-1173 ¹⁰⁸	COM	E230115	GAK-403	BROS
DX118	G-335	DIEX	E1040	GA-80	KENG	E15R8T2V	G-1175 ¹⁰⁸	COM	E230118	GAK-16	AMHO
DX1294CL	GP-34	DEL	E105	GA-349	KENG	E160H01	G-3827	HEN	E230-36H	G-33	HEN
DX214	GA-1285	DIA	E1050	GA-349	KENG	E160H01D28	G-3827	HEN	E23057H	G-143	HEN
DX215	GA-1286	DIA	E106HD34	G-954	HEN	E161H01	G-3754	HEN	E235-41	G-191	HEN
DX221	G-834	DIEX	E107	GA-50	KENG	E161H01D28	G-3754	HEN	E235410	G-191	HEN
DX2319	GA-18	DIA	E1070	GA-50	KENG	E161L	GAVW-622	HEN	E235-411	G-191	HEN
DX2319	GA-18	DIA	E108	GA-77	KENG	E161L01	GAVW-622	HEN	E23541C	G-191	HEN
DX2319	GA-18	REOT	E1080	GA-77	KENG	E165	GA-55	KENG	E24-01	GA-5648	ERO
DX231US	GP-1101	DIEX	E109	GP-42	EVGR	E1650	GA-55	KENG	E240L	GA-475	HEN
DX3124	GA-1284	DIA	E109	GA-78	KENG	E17	GP-81	EVGR	E240L01	GA-5876	HEN
DX3126	GA-1008	DIA	E1090	GA-78	KENG	E173L	GA-2114	HEN	E241	GP-2951 ⁹²	EVGR
DX315	GA-1287	DIA	E10KP	G-1123	HEN	E17414	G-163	HEN	E241	GP-58	EVGR
DX3156	GA-1287	DIA	E10KPF1	G-1123 ¹⁰⁸	HEN	E175L	GAVW-121	HEN	E24314	G-133	HEN
DX33US	GP-20	DIEX	E10KPF1	G-1123 ¹⁰⁸	HEN	E176	G-871	VOK	E24314	G-989	HEN
DX52A	G-870	DIEX	E10R6	G-1174 ¹⁰⁸	COM	E17Z-9601-A	GA-2740	FORD	E247	GA-7	KENG
DX52AA	G-870	DIEX	E110	GA-70	KENG	E183L	GA-3300	HEN	E2470	GA-7	KENG
DX5530	GA-8	SCHU	E1100	GA-70	KENG	E185L	GA-349	HEN	E2-5	GAK-403	ERO
DX5US	GP-5	DIEX	E110HD24	G-963	HEN	E188L	GA-303	HEN	E25114	G-143	HEN
DX600	GA-44	DIA	E110Z9	G-11816	FORD	E189L	GA-50	HEN	E25-25	G-1143	HEN
DX610	GA-8047	DIA	E111	GP-46	EVGR	E19	GG-189	GUD	E2-6	GAK-16	ERO
DX611	GA-5648	DIA	E1-11	GA-106 ⁴⁶	ERO	E1929155A	GP-93	FORD	E2605001	G-834	HEN
DX613	GA-9334	DIA	E1-11	GA-326 ⁷¹	ERO	E195	GP-3600	EVGR	E2605001	G-834	HENL
DX642A	G-238	DIA	E-1117	GA-390	KENG	E195	GA-54	KENG	E2605101	G-296	HENL
DX716	GA-7716	DIA	E1118	GA-3588	KENG	E1950	GA-54	KENG	E2605101	G-296-8	HENL
DX7269	GA-375	DIA	E112	GA-90	KENG	E19505-65	PPP-11	POCL	E2610	GAD-1 ⁹⁷	KENG
DX73	GA-11	DIA	E1120	GA-90	KENG	E1958	GA-735 ¹²⁴	KENG	E2630	GAD-3	KENG
DX736	GA-7360	DIA	E112L	GA-49	HEN	E195K	G-1175 ³³	HEN	E2670	GA-230	KENG
DXA1	GA-71	DIEX	E114-205	G-813	HEN	E195K	G-1176 ¹⁰⁹	HEN	E-2690	GA-3566	KENG
DXA16546	GAD-1	DIEX	E115	GA-192	KENG	E196L	GA-230	HEN	E-2730	GA-4958	KENG
DXA16546C	GAD-3	DIEX	E1-15	GA-356	ERO	E1A	GP-1	EVGR	E2740	GA-3490	KENG
DXA4	GA-70	DIEX	E1150	GA-192	KENG	E1AC1006	GAC-13	VALV	E276	GAD-1	KENG
DXA45	GA-77	DIEX	E117-21	G-330	HEN	E1AC1007	GAC-9	VALV	E2760	GAD-1 ⁹⁷	KENG
DXA52	GA-71	DIEX	E117-26	G-225	HEN	E1AC1017	GAC-1	VALV	E-2790	GA-2740	KENG
DXA57	GA-80	DIEX	E117-26E	G-225	HEN	E1AC2026	GAC-10 ²⁸	VALV	E27E-9601-AA	GA-3637	FORD
DXA59	GA-50	DIEX	E11730	G-834	HEN	E1AC2026	GAC-8	VALV	E27E-9601-BA	GA-3637	FORD
DXA68	GA-78	DIEX	E117-33	G-834	HEN	E1ADKN-18631-C	G-836	FORD	E27Z-9155-A	GG-208	FORD
DXA84	GA-730	DIEX	E11734	G-834	HEN	E1ADKN-18662-A	G-871	FORD	E281L	GA-436	HEN
DXA91	GA-59	DIEX	E117K	G-1163 ¹⁰⁸	HEN	E1ADKN-18662-B	G-801	FORD	E2820	GA-2719B	KENG
DXT114	G-122	DIEX	E117L	GA-405	HEN	E1ADKN-18662-B	G-871	FORD	E2830	GA-75	KENG
DXT114	G-338	DIEX	E118	GA-3424	KENG	E1ADKN-6731	G-870	FORD	E288	GP-3766	EVGR
DXT203	G-139	DIEX	E1-18	GA-6129	ERO	E1ADKN-6731-A	G-871	FORD	E29022	GAD-3	FORD
			E1180	GA-3424	KENG	E1ADKN-99162-A	G-11816	FORD	E291	GP-3531 EXP	EVGR
			E118L	GA-467	HEN	E1ADKN-99162-B	G-11816	FORD	E-2970	GA-140	KENG
			E118L02	GA-467	HEN	E1ADKN-99162-C	G-11816	FORD	E29L	GAVW-2	HEN
			E1-2	GA-360	ERO	E1DDKN-6731-A	G-871	FORD	E2HZ-9601-B	GA-642	FORD
			E120	GA-303	KENG	E1DIN73358	G-1123	HEN	E2PJ-6714-AA	GP-3766	FORD
			E1200	GA-303	KENG	E1EE-6714-A	GP-3600	FORD	E2PJ-9155-AA	GP-155	FORD
			E120-20	G-6	HEN	E1EE-6714-AA	GP-3600	FORD	E3	GA-113	SRS
			E1205001	G-836	HENL	E1EE-9155-FA	GG-87	FORD	E300	GG-45	PROG
			E123	GP-3429	EVGR	E1EE-9601-AB	GA-734 ⁸¹	FORD	E32-01	GA-98 ¹²	ERO
			E123	GA-56	KENG	E1EE-9601-AB	GA-735 ¹²⁴	FORD	E32-03	GAK-625	ERO
			E1230	GA-56	KENG	E1FZ-6731-A	GP-3600	FORD	E33	GP-20	EVGR
			E1243	GA-26	HDA	E1FZ-9601-A	GA-734 ⁸¹	FORD	E334L	GA-2160	HEN
			E125	GA-429	KENG	E1FZ-9601-A	GA-735 ¹²⁴	FORD	E33L	GA-277	HEN
			E1250	GA-429	KENG	E1FZ9601AB	GA-734 ⁸¹	FORD	E35E-9155-C2B	GG-47	FORD
			E12505-60	GA-9334	POCL	E1FZ9601AB	GA-735 ¹²⁴	FORD	E35H D102	G-141	HEN
			E128	GA-3425	KENG	E1FZ-9601-AR	GA-734 ⁸¹	FORD	E36534	GP-1	CASE
			E1280	GA-3425	KENG	E1FZ-9601-AR	GA-735 ¹²⁴	FORD	E3655	GG-19	AUTN
			E129	GA-75	KENG	E1HF9601AA	GA-89	FORD	E3658	GG-123	AUTN
			E1290	GA-75	KENG	E1HT-9155-AA	GP-55	FORD	E36623	G-296	CASE
			E12980181	GP-152 ⁹⁰	EUCL	E1HZ-9365-A	GP-55	FORD	E36623	G-296-B	CASE
			E129L	GA-106 ⁴⁶	HEN	E1HZ9601A	GA-89	FORD	E37CL9	G-11816	FORD
			E129L	GA-326 ⁷¹	HEN	E1NN-6714-AA	GP-42	FORD	E37E-9601-AA	GA-3425	FORD
			E12R4	G-1173 ¹⁰⁸	COM	E1NN-6714-AB	GP-42	FORD	E37E-9601-BA	GA-3637	FORD
			E130	GA-75	KENG	E1NN-6714-BA	GP-28 ⁶	FORD	E37E-9601-BB	GA-3637	FORD
			E1325	GA-74	KENG	E1NN-6714-BA	GP-430 ⁹	FORD	E37E-9601-CB	GA-3637	FORD
			E135	GA-3300	KENG	E1NN-6714-BB	GP-38	FORD	E37L	GA-2194	HEN
			E1350	GA-3300	KENG	E1NN6731BA	GP-3682	FORD	E37L01	GA-2194	HEN

E

E 19 HD 83	G-466	HEN
E 23 H D 81	G-25	HEN
E 485 L	GA-2184	HEN
E 834 L	GA-27161	HEN
E02432-52	GP-36	POCL
E0250566	GA-892	DERR
E0250566	GA-892	DUTZ
E02505-66	GA-892	POCL
E026050001	G-834	LIN
E0771	GA-184	KENG

Referencia Cruzada por Numero de Parte

Cross Reference by Part Number



Numero	Gonher	Fabricante	Numero	Gonher	Fabricante	Numero	Gonher	Fabricante	Numero	Gonher	Fabricante
Number	Gonher	Manufacturer	Number	Gonher	Manufacturer	Number	Gonher	Manufacturer	Number	Gonher	Manufacturer
E380071	G-200	AMHO	E4ZE-9601-CA	GA-74	FORD	E70210066	GA-892	SAXB	E99A-9B072-AA	GG-47	FORD
E380071	G-200	BROS	E4ZZ-9601-AR	GA-303	FORD	E70211003	GA-6129	SAXB	E99Z-9B072	GG-47	FORD
E380084	GP-1	BROS	E500150	GA-33 ¹¹²	DON	E70211301	GA-6127	SAXB	E99Z-9B072-A	GG-47	FORD
E380087	G-1174 ¹⁰⁸	BROS	E500160	GAK-16	DON	E70211501	GA-356	SAXB	E9AE-6714-B	GP-1	FORD
E380089	G-119	BROS	E500170	GAK-403	DON	E70211703	GA-360	SAXB	E9FE-9601-AB	GA-275	FORD
E380138	GA-27	BROS	E500190	GAK-20	DON	E70211803	GAK-625	SAXB	E9GZ-6731-A	GP-91	FORD
E380141	GP-81	AMHO	E500665	GAK-20	DON	E70211902	GA-206	SAXB	E9HN-6714-BA	GP-54 ⁹⁰	FORD
E380141	GP-81	BROS	E500667	GA-33 ¹¹²	DON	E70211905	GA-106 ⁹⁶	SAXB	E9NN-6714-AA	GP-81	FORD
E383-22	G-750	HEN	E500679	GAK-403	DON	E70211905	GA-326 ⁹¹	SAXB	E9NN-9601-AA	GA-589	FORD
E38874	GP-81 ³¹	CATP	E501042	GAK-216	DON	E70807	GAK-403	CASE	E9PJ-6714-AA	GP-3000	FORD
E38874	GP-9 ⁵⁸	CATP	E502-07-002-5	G-31	NSU	E70L	GPP-19	HEN	E9SE-9155-AA	GG-30	FORD
E3EE9011C	GG-47	FORD	E503067	GA-33 ¹¹²	DON	E732L	GA-VW-616	HEN	E9SE-9601-AB	GA-275	FORD
E3EE-9155-C	GG-47	FORD	E5050001	G-813	HENL	E73Z-6731-B	GP-3985	FORD	E9SZ-9155-A	GG-30	FORD
E3EE-9155-C2C	GG-47	FORD	E508-13-470	GG-208	MZDA	E7410062	GP-40	PELJ	E9SZ-9601-A	GA-275	FORD
E3EE-9155-CB	GG-47	FORD	E5120700509	GP-28 ⁹	VAG	E7413008	GP-149	PELJ	E9TA9B072C	GG-47	FORD
E3EE-9155-CC	GG-47	FORD	E5120700509	GP-430 ⁹	VAG	E75-1K	G-296	HEN	E9TA-9B072-CA	GG-47	FORD
E3EE-9155-F4A	GG-87	FORD	E5120700509	GP-28 ⁹	VOLK	E75-1K	G-296-B	HEN	E9TE-6714-B1A	GP-171 ¹⁶	FORD
E3EE-9155-FA	GG-87	FORD	E5120700509	GP-430 ⁹	VOLK	E75-25K	G-1173 ¹⁰⁸	HEN	E9TZ-9B072-CA	GG-47	FORD
E3FZ-9155-A	GG-87	FORD	E512-07-005-09	GP-28 ⁹	NSU	E761K	G-297-B	HEN	EA110A	GAD-3	EVGR
E3FZ-9155-C	GG-47	FORD	E512-07-005-09	GP-430 ⁹	NSU	E7797	GA-229	HDA	EA113	GA-75	EVGR
E3FZ-9155-F	GG-87	FORD	E530	G-31	SEAG	E79500043	GP-3985	SAXB	EA1149	GA-VW-2	EVGR
E3HZ-6731-A	GP-57	FORD	E531	G-31	SEAG	E79L	GA-71	HEN	EA120	GA-74	EVGR
E3L	GA-303	HEN	E55891099	GP-22	RENA	E7DE-9155-AA	GG-47	FORD	EA129	GA-3424	EVGR
E3TZ-6731-A	GP-3766	FORD	E55E-9155-AA	GG-47	FORD	E7DZ-9155-A	GG-47	FORD	EA131	GA-3425	EVGR
E3TZ-9155-A	GP-155	FORD	E5778M	GP-1	CHRY	E7GZ-6731-A	GP-91	FORD	EA300	GA-277	EVGR
E3TZ-9601-A	GA-3637	FORD	E5778M	GP-1	MOP	E7GZ-9155-A	GG-76	FORD	EA3138	GA-54	EVGR
E3TZ-9601-B	GA-3637	FORD	E5779M	GP-1	CHRY	E7HN-9N327-AA	GP-1122	FORD	EA3149	GA-3523	EVGR
E3TZ-9601-C	GA-3501	FORD	E5779M	GP-1	MOP	E7HT-8A424-BA	GP-1010Q	FORD	EA3192	GA-271	EVGR
E3TZ-9601-E	GA-3425	FORD	E59E-9601-A	GA-277	FORD	E7HT-9J288-BA	GPP-14	FORD	EA3193	GA-735 ¹²⁴	EVGR
E3TZ-9601-H	GA-3637	FORD	E59E-9601-AA	GA-277	FORD	E7HZ-3965-A	GP-1122	FORD	EA3195	GA-3588	EVGR
E3TZ-9601-J	GA-3637	FORD	E5D323603	GA-471	MTR	E7HZ-4N184-A	GPP-14	FORD	EA3357	GA-3637	EVGR
E3TZ-9601-K	GA-3501	FORD	E5D3-23-603	GA-471	MZDA	E7HZ-6731-A	GP-54	FORD	EA3384	GA-89	EVGR
E3TZ-9601-L	GA-3501	FORD	E5D3-23-603A	GA-471	MZDA	E7HZ-8A424-B	GP-2071W	FORD	EA3398	GA-3566	EVGR
E3ZE-6714-CA	GP-1	FORD	E5D3-23-603A9A	GA-471	MZDA	E7HZ-8A424-C	GP-2071W	FORD	EA3465	GA-277	EVGR
E3ZE-9601-BA	GA-730	FORD	E5HN-6714-AA	GP-54	FORD	E7HZ-9365-A	GP-1122	FORD	EA3466	GA-4828	EVGR
E3ZZ-9601-B	GA-730	FORD	E5HN-9N327-AA	GP-1122	FORD	E7HZ-9365-B	GP-1122	FORD	EA3467	GA-4325	EVGR
E4007	GP-44	EVGR	E5HT-9155-DA	GPP-14	FORD	E7HZ-9J288-A	GPP-14	FORD	EA3472	GA-274	EVGR
E4011	GP-3980 ⁴⁴	EVGR	E5HZ-9601-A	GA-89	FORD	E7HZ-9N184-A	GPP-14	FORD	EA3474	GA-3681	EVGR
E4011	GP-48 ¹⁷	EVGR	ESK	G-1121	HEN	E7HZ-9N184-B	GPP-14	FORD	EA3538	GA-140	EVGR
E405001	GP-81 ³¹	HENL	ESKF	G-1121	HEN	E7NN-6714-AA	GP-1	FORD	EA3591	GA-3814	EVGR
E405001	GP-9 ⁵⁸	HENL	ESKFR	G-1121F	HEN	E7NN-6714-BA	GP-77	FORD	EA3592	GA-273	EVGR
E4099601	GP-1011Q	VOLV	ESKFR2	G-1121	HEN	E7NN-6714-BB	GP-77	FORD	EA4	GA-70	EVGR
E41687	GAK-16	CASE	ESKP	G-1121	HEN	E7NN-6714-CA	GP-54 ⁹⁰	FORD	EA4278	GAD-15	EVGR
E41L	GA-2110	HEN	ESNN-8A424-AA	GP-2071W	FORD	E7NN-6714-DA	GP-81 ³¹	FORD	EA4299	GA-180	EVGR
E4308BP	G-31	ROLK	E5SE-9155-A	GG-47	FORD	E7NN-6714-DA	GP-9 ⁵⁸	FORD	EA4327	GA-4958	EVGR
E434L	GA-853R	HEN	E5TE-9601-AB	GA-5056	FORD	E7NN-6714-DA	G-5000	FORD	EA4339	GA-3915	EVGR
E43790	GAK-16	CASE	E5TE-9601-ABM	GA-5056	FORD	E7NN-9176-AA	G-296	FORD	EA4342	GA-253	EVGR
E438	GA-11	KENG	E5TE-9D695-AB	GA-176	FORD	E7NN-9176-AA	G-296-B	FORD	EA4343	GA-5056	EVGR
E43A-9155-BA	GG-42	FORD	E5TZ-9155-A	G-294	FORD	E7RY-9155-A	GG-261	FORD	EA4347	GA-153	EVGR
E43A-9601-CA	GA-274	FORD	E5TZ-9601-B	GA-5056	FORD	E7TE-6D695-BA	GA-176	FORD	EA4372	GA-3901	EVGR
E43D9601AA	GA-74	FORD	E5TZ-9D695-A	GA-176	FORD	E7TE-9601-AC	GA-174	FORD	EA4375	GA-362	EVGR
E43E9155B8	GG-42	FORD	E5TZ-9N327-A	G-294	FORD	E7TE-9D695-BA	GA-176	FORD	EA4378	GA-174	EVGR
E43E-9155-B4B	GG-42	FORD	E6	GA-101	SRS	E7TZ-6731-A	GP-171 ¹⁶	FORD	EA4468	GA-195	EVGR
E43E-9155-B4C	GG-42	FORD	E6050036	GA-33 ¹¹²	PELJ	E7TZ-9600-A	GA-3501	FORD	EA4471	GA-471	EVGR
E43E-9155-BC	GG-42	FORD	E6050119	GP-761H	PELJ	E7TZ-9600-C	GA-3501	FORD	EA4479	GA-6479	EVGR
E43E-9601-CA	GA-274	FORD	E6050140	GA-3501	PELJ	E7TZ-9601-A	GA-3501	FORD	EA4487	GA-382	EVGR
E43E-9601-CB	GA-274	FORD	E610	GG-76	PROG	E7TZ-9601-B	GA-174	FORD	EA45	GA-77	EVGR
E43Z6301C	GA-274	FORD	E610G	GG-45	PROG	E7TZ-9D695-A	GA-176	FORD	EA4632	GA-275	EVGR
E43Z-9155-C	GG-42	FORD	E610H	G-45	HEN	E8047	GA-376	HDA	EA4643	GA-166	EVGR
E43Z-9601-C	GA-274	FORD	E620	GG-45	PROG	E81	GP-81 ³¹	EVGR	EA4645	GA-6690	EVGR
E440	GA-12	KENG	E622H	G-765	HEN	E81	GP-9 ⁵⁸	EVGR	EA4656	GA-7017	EVGR
E4457	GP-3682	EVGR	E630	GG-203	PROG	E81464X	GAK-20	KOEH	EA4680	GA-386	EVGR
E4459	GP-149 ⁶⁹	EVGR	E630H	G-49	HEN	E8299	GA-6880	HDA	EA4712	GA-217	EVGR
E4459	GP-91 ⁷⁸	EVGR	E640	GG-203	PROG	E83C9B072A	GG-47	FORD	EA4715	GA-7142	EVGR
E4477	GP-156	EVGR	E641L	GA-364	HEN	E83C-9B072-AA	GG-47	FORD	EA4731	GA-165	EVGR
E4631	GP-205	EVGR	E65502	G-813	CASE	E8483	GA-483	HDA	EA52	GA-71	EVGR
E4651	GP-68	EVGR	E6587	GA-360	HDA	E8494	GA-493 ¹⁰⁸	HDA	EA57	GA-80	EVGR
E47E-9601-AA	GA-325	FORD	E662L	GA-VW-617	HEN	E8544	GA-107	HDA	EA59	GA-50	EVGR
E47E-9601-BA	GA-3425	FORD	E6632	GA-6129	HDA	E85L	GA-44	HEN	EA67	GA-192	EVGR
E49	GP-3	EVGR	E6769	GA-106 ⁴⁶	HDA	E87229X	GAK-20	KOEH	EA7	GA-4303	EVGR
E49562280	GP-40	TALB	E6769	GA-326 ⁷¹	HDA	E88Z-6731-A	GP-91	FORD	EA74	GA-55	EVGR
E4AE-9601-AA	GA-75	FORD	E680L	GA-39	HEN	E88Z-9155-A	GG-208	FORD	EA831	GA-85	EVGR
E4EE-6714-B2A	GP-3600	FORD	E68GF9	G-225	FORD	E8GY-9601-A	GA-471	FORD	EA84	GA-730	EVGR
E4EE9601AA	GA-734 ⁹¹	FORD	E6918	GA-378	HDA	E8HN-8A424-AA	GP-2071W	FORD	EA91	GA-59	EVGR
E4EE9601AA	GA-735 ¹²⁴	FORD	E6AE9601B	GA-273	FORD	E8HT-9J288-AA	GPP-14	FORD	EA92	GA-57	EVGR
E4EE-9601-CA	GA-735 ¹²⁴	FORD	E6AE-9601-BC	GA-273	FORD	E8HZ-4A420-A	GP-81 ³¹	FORD	E993	GA-325	EVGR
E4EM-6714-A2	GP-3600	FORD	E6AZ-9601-B	GA-273	FORD	E8HZ-4A420-A	GP-9 ⁵⁸	FORD	E9A4	GA-3300	EVGR
E4FZ-6731-A	GP-3600	FORD	E6HT-9155-A	GP-26	FORD	E8HZ-6731-A	GP-3000	FORD	EA991	GA-86	EVGR
E4FZ-6731-AB	GP-3600	FORD	E6HT-9155-AA	GP-26	FORD	E8NN-6714-AA	GP-81	FORD	EA103	GA-442	AMS
E4FZ-9601-A	GA-277	FORD	E6HZ-6731-A	GP-77	FORD	E8NN-6714-BA	GP-81	FORD	EA106	GA-240	AMS
E4FZ-9601-CR	GA-735 ¹²⁴	FORD	E6HZ-9155-A	GP-1122	FORD	E8NN-6714-CA	GP-81	FORD	EA126	GA-VW-620	AMS
E4HS-6714-AA	GP-57	FORD	E6HZ-9155-C	GP-1122	FORD	E8NN-8A424-BB	GP-1010Q	FORD	EA170	GA-248	AMS
E4HS-6728-AA	GP-57	FORD	E6HZ-9155-D	GPP-14	FORD	E8TA-9600-C	GA-3501	FORD	EA189	GA-488	AMS
E4HZ-6731-A	GP-53	FORD	E6HZ-9155-E	GP-26	FORD	E8TZ-9600-C	GA-3501	FORD	EA200	GA-1617	AMS
E4HZ-6731-B	GP-53	FORD	E6HZ-9155-F	GP-1122	FORD	E-9030	GA-390	KENG	EA201	GA-477	AMS
E4NN-6714-AA	GP-171	FORD	E6HZ-9155-G	GP-1122	FORD	E91540K	G-500	HEN	EA204	GA-414R	AMS
E4NN-6714-BA	GP-81	FORD	E6HZ-9365-A	GP-1122	FORD	E9155	GA-356	HDA	EA205	GA-322	AMS
E4TE-9601-AA	GA-3300	FORD	E6HZ-9365-B	GP-1122	FORD	E-9209	GA-142	KENG	EA419	GA-1614	AMS
E4TE-9601-CA	GA-75	FORD	E6HZ-9365-C	GP-1122	FORD	E9257	GA-2136	KENG	EA484	GA-395	AMS
E4TE9601EA	GA-85	FORD	E6NN-9B618-AA	GA-18	FORD	E92Z3731A	GP-149	FORD	EA52	GA-55	AMS
E4T-9600-CA	GA-3501	FORD	E								

Numero	Gonher	Fabricante	Numero	Gonher	Fabricante	Numero	Gonher	Fabricante	Numero	Gonher	Fabricante
Number	Gonher	Manufacturer	Number	Gonher	Manufacturer	Number	Gonher	Manufacturer	Number	Gonher	Manufacturer
EAC5672	GAVV-4	JAGU	EBA150094	GA-378	DON	EFA153	GA-218	MTR	EFG8	GP-1122	MTR
EAC5672	GAVV-4	LEYL	EBA150113	GA-378	DON	EFA154	GA-200	MTR	EFG80	GP-1122	MTR
EAF5001	GA-26 ¹²	DON	EBA150114	GA-378	DON	EFA154	GA-218	MTR	EFG83	GP-78	MTR
EAF5007	GA-229	DON	EBA150117	GA-378	DON	EFA157	GA-71	MTR	EFG88	G-296	MTR
EAF5008	GA-378	DON	EBA150128	GA-6880	DON	EFA158	GA-230	MTR	EFG88	G-296-B	MTR
EAF5025	GA-372	DON	EBA150174	GA-6880	DON	EFA160	GAVW-2	MTR	EFG9	GP-1122	MTR
EAF5034	GA-360	DON	EBA155000	GA-378	DON	EFA161	GA-303	MTR	EFL030	G-834	MTR
EAF5038	GA-879	DON	EBA155005	GA-378	DON	EFA194	GAVW-2	MTR	EFL037	GP-81	MTR
EAF5053	GA-3551 ³⁵	DON	EBB120271	GA-209	DON	EFA204	GA-2740	MTR	EFL039	GP-81	MTR
EAF5053	GA-3551 XT ⁶⁴	DON	EBB140044	GA-107	DON	EFA223	GA-3425	MTR	EFL090	GP-81	MTR
EAF5057	GA-885	DON	EBB150014	GA-6880	DON	EFA225	GAK-216	MTR	EFL091	GP-462	MTR
EAF5067	GA-197R	DON	EBB160007	GA-376	DON	EFA234	GA-360	MTR	EFL1	GP-1	MTR
EAF5102	GA-608	DON	EBB160019	GA-376	DON	EFA239	GAVW-2	MTR	EFL101	GP-3600	MTR
EAF5105	GA-966R	DON	EBB160022	GA-376	DON	EFA243	GAVW-4	MTR	EFL103	G-566	MTR
EAF5106	GA-518R	DON	EBB160030	GA-375	DON	EFA246	GA-4365	MTR	EFL104	G-750	MTR
EAF5107	GA-968R	DON	EBB160031	GA-375	DON	EFA247	GA-3425	MTR	EFL114	GP-22	MTR
EAF5109	GA-930R	DON	EBB160032	GA-375	DON	EFA250	GAVW-2	MTR	EFL119	GP-38	MTR
EAF5187	GA-3501	DON	EBB160033	GA-376	DON	EFA252	GAVW-2	MTR	EFL12	GP-81 ¹¹	MTR
EAF5188	GA-422	DON	EBB160034	GA-376	DON	EFA254	GAD-3	MTR	EFL12	GP-9 ⁸	MTR
EAF5189	GA-642	DON	EBB160040	GA-1203	DON	EFA261	GA-277	MTR	EFL122	GP-81	MTR
EA012	GP-81	AMS	EBB160041	GA-1203	DON	EFA264	GA-360	MTR	EFL123	G-834	MTR
EA013	GP-149	AMS	EBB160042	GA-1203	DON	EFA269	GA-49	MTR	EFL125	GP-3682	MTR
EA014	GP-149	AMS	EBB160047	GA-376	DON	EFA281	GA-3490	MTR	EFL129	GP-462	MTR
EA023	GP-3980	AMS	EBB160048	GA-376	DON	EFA297	GA-49	MTR	EFL130	GP-462	MTR
EA039	GP-3569	AMS	EBB160049	GA-376	DON	EFA300	GA-33 ¹²	MTR	EFL137	GP-31	MTR
EA059	GP-408	AMS	EBB160072	GA-376	DON	EFA302	GAK-16	MTR	EFL14	G-870	MTR
EA080	GP-178	AMS	EBG120108	GA-239 ¹⁰⁸	DON	EFA305	GAK-403	MTR	EFL141	GP-53	MTR
EA088	G-3752	AMS	EBG120108	GA-329 ¹⁰⁴	DON	EFA309	GAK-625	MTR	EFL143	GP-3980	MTR
EAZ-1354	GP-457	JAGU	EBP100240	GA-27	DON	EFA312	GAK-20	MTR	EFL147	GP-42	MTR
EBA092001	GA-372	DON	EC206	GA-100	BORG	EFA318	GA-436	MTR	EFL149	GP-3600	MTR
EBA092005	GA-372	DON	EC207	GA-113	BORG	EFA319	GA-405	MTR	EFL150	GP-455	MTR
EBA092006	GA-372	DON	EC208	GA-113	BORG	EFA322	GA-27	MTR	EFL151	GP-3531 EXP	MTR
EBA092011	GA-372	DON	EC212	GA-101	DON	EFA327	GA-106 ⁶⁵	MTR	EFL155	GP-3985	MTR
EBA092018	GA-372	DON	EC431	G-1175 ¹⁰⁸	UNI	EFA327	GA-326 ¹¹	MTR	EFL157	GP-28 ⁹	MTR
EBA092019	GA-373	DON	EC432	G-1175 ¹⁰⁸	UNI	EFA328	GA-467	MTR	EFL157	GP-430 ⁸	MTR
EBA092027	GA-372	DON	EC631	G-1175 ¹⁰⁸	UNI	EFA353	GA-2194	MTR	EFL160	GP-43	MTR
EBA092031	GA-372	DON	EC632	G-1175 ¹⁰⁸	UNI	EFA367	GAD-3	MTR	EFL161	GP-54 ¹¹	MTR
EBA092032	GA-372	DON	EC831	G-1175 ¹⁰⁸	UNI	EFA38	GAK-403	MTR	EFL161	GP-66 ¹⁰	MTR
EBA092033	GA-372	DON	EC832	G-1175 ¹⁰⁸	UNI	EFA428	GAD-3	MTR	EFL166	GP-28 ⁹	MTR
EBA092037	GA-372	DON	ECD065002	GA-2804 T	DON	EFA44	GAK-20	MTR	EFL166	GP-430 ⁸	MTR
EBA130017	GA-229	DON	ECD065008	GA-2804 T	DON	EFA445	GA-2110	MTR	EFL167	GP-40	MTR
EBA130018	GA-229	DON	ECG092000	GA-372	DON	EFA493	GA-2156	MTR	EFL170	GP-51	MTR
EBA130022	GA-509 ¹⁴	DON	ECG092001	GA-372	DON	EFA494	GA-471	MTR	EFL172	GP-77	MTR
EBA130023	GA-229	DON	ECG092004	GA-372	DON	EFA501	GAVW-120	MTR	EFL179	GP-143	MTR
EBA130024	GA-229	DON	ECG092005	GA-373	DON	EFA52	GA-303	MTR	EFL181	G-133	MTR
EBA130025	GA-229	DON	ECG092014	GA-372	DON	EFA523	GAVW-622	MTR	EFL181	G-989	MTR
EBA130026	GA-229	DON	ECG092995	GA-373	DON	EFA528	GA-4303	MTR	EFL184	G-31	MTR
EBA130027	GA-229	DON	ECG112009	GA-389	DON	EFA535	GAD-15	MTR	EFL191	G-834	MTR
EBA130028	GA-229	DON	ECG112401	GA-694	DON	EFA562	GAVW-121	MTR	EFL196	G-330	MTR
EBA130031	GA-229	DON	ECG112410	GA-694	DON	EFA70	GA-44	MTR	EFL200	G-871	MTR
EBA130034	GA-229	DON	ECG112417	GA-694	DON	EFA73	GA-230	MTR	EFL204	G-238	MTR
EBA130035	GA-229	DON	ECG112504	GA-3551 ³⁵	DON	EFA78	GA-71	MTR	EFL208	G-813	MTR
EBA130045	GA-229	DON	ECG112504	GA-3551 XT ⁶⁴	DON	EFA80	GA-200	MTR	EFL212	G-33	MTR
EBA130048	GA-493 ¹⁰⁸	DON	ECG130005	GA-229	DON	EFA80	GA-218	MTR	EFL213	G-31	MTR
EBA130049	GA-229	DON	ECG130007	GA-229	DON	EFA85	GA-50	MTR	EFL215	GP-54	MTR
EBA130051	GA-229	DON	ECG130023	GA-229	DON	EFA934	GA-516R	DPHI	EFL223	GP-54 ¹¹	MTR
EBA130053	GA-229	DON	ECG132000	GA-371	DON	EFF9091	GP-27	DON	EFL222	GP-66 ¹⁰	MTR
EBA130054	GA-229	DON	ECG150002	GA-6880	DON	EFF9440	GP-85	DON	EFL223	GP-171	MTR
EBA130056	GA-229	DON	ECG150004	GA-6880	DON	EFF9441	GP-84	DON	EFL224	GP-36	MTR
EBA130059	GA-493 ¹⁰⁸	DON	ECG-6714-A	GP-1	FORD	EFG029	G-1121	MTR	EFL227	G-834	MTR
EBA130060	GA-493 ¹⁰⁸	DON	ECJ9601	GA-73	FORD	EFG106	GPP-1122	MTR	EFL228	G-191	MTR
EBA130064	GA-229	DON	ECO-101	G-3754	INDUCL	EFG107	GG-251	MTR	EFL229	G-143	MTR
EBA130067	GA-229	DON	ECO-103	G-1046	INDUCL	EFG113	GG-226	MTR	EFL233	G-833	MTR
EBA130080	GA-229	DON	ECT-9155-A	GG-20	FORD	EFG12	GP-1101	MTR	EFL252	GP-68	MTR
EBA132004	GA-371	DON	ECT-9176-A	GG-20	FORD	EFG12	GPP-14	MTR	EFL254	GP-3985	MTR
EBA135000	GA-229	DON	ECZ-6714-A	GP-1	FORD	EFG13	GP-1101	MTR	EFL257	GP-46	MTR
EBA150002	GA-378	DON	ECZ-6714-B	GP-1	FORD	EFG13	GPP-14	MTR	EFL260	GP-3980	MTR
EBA150003	GA-6880	DON	ECZ-6714-C	GP-1	FORD	EFG22	GG-246	MTR	EFL266	G-33	MTR
EBA150005	GA-378	DON	EDA 215	GA-2160	LUC	EFG24	G-297-B	MTR	EFL269	G-31	MTR
EBA150006	GA-378	DON	EDC-6714-A	GP-1	FORD	EFG25	GP-1122	MTR	EFL271	GP-46	MTR
EBA150007	GA-6880	DON	EDC9601B	GA-77	FORD	EFG27	G-1123	MTR	EFL273	GP-40	MTR
EBA150009	GA-378	DON	EDD246	GP-77	CSYS	EFG28	G-1121	MTR	EFL279	GP-3682	MTR
EBA150010	GA-378	DON	EDD310	GP-51	CSYS	EFG29	G-1121	MTR	EFL283	GP-3816	MTR
EBA150011	GA-378	DON	EDD750	GP-52 ¹⁰	CSYS	EFG296	G-296	MTR	EFL284	GP-28 ⁹	MTR
EBA150013	GA-6880	DON	EDD750	GP-691 ⁴⁸	CSYS	EFG296	G-296-B	MTR	EFL284	GP-430 ⁸	MTR
EBA150014	GA-6880	DON	EDG120221	GA-37	DON	EFG3	G-296	MTR	EFL285	GP-40	MTR
EBA150015	GA-6880	DON	EDG130010	GA-37	DON	EFG3	G-296-B	MTR	EFL286	GP-3682	MTR
EBA150016	GA-378	DON	EDG130020	GA-37	DON	EFG307	GPP-111	MTR	EFL290	GP-3985	MTR
EBA150017	GA-378	DON	EDG130030	GA-37	DON	EFG307	GPP-524	MTR	EFL291	GP-1	MTR
EBA150018	GA-378	DON	EDG-6714-A	GP-1	DON	EFG315	G-296	MTR	EFL30	G-834	MTR
EBA150020	GA-6880	DON	EDG-6714-C	GP-1	DON	EFG315	G-296-B	MTR	EFL302	GP-81	MTR
EBA150022	GA-378	DON	EDL-6744-A	G-5000	FORD	EFG32	GG-246	MTR	EFL316	GP-1	MTR
EBA150023	GA-378	DON	EDL-6744-A	G-5000	WHIL	EFG33	G-1121	MTR	EFL317	GP-38	MTR
EBA150024	GA-378	DON	EDL-6744-A2	G-5000	FORD	EFG35	GP-1122	MTR	EFL318	GP-1	MTR
EBA150030	GA-6880	DON	EDNN6714AA	GP-77	FORD	EFG41	GG-189	MTR	EFL34	G-613	MTR
EBA150033	GA-378	DON	EDPN-9N074-AA	G-296	FORD	EFG48	GPP-1122	MTR	EFL35	G-834	MTR
EBA150034	GA-378	DON	EDPN-9N074-AA	G-296-B	FORD	EFG5	G-296	MTR	EFL361	GP-462	MTR
EBA150039	GA-378	DON	EE38262	GA-6129	OSHK	EFG5	G-296-B	MTR	EFL366	GP-9	MTR
EBA150043	GA-6880	DON	EE39462	GA-27	OSHK	EFG50	GP-1122	MTR	EFL368	GP-3682	MTR
EBA150045	GA-6880	DON	EEA-6714-A	G-6	FORD	EFG51	GG-5 L	MTR	EFL37	GP-81	MTR
EBA150058	GA-378	DON	EF68	GS-1133	LEMN	EFG57	GP-1122	MTR	EFL371	GP-81	MTR
EBA150059	GA-6880	DON	EFA 553	GA-2160	FORD	EFG63	GP-1122	MTR	EFL380	GP-455	MTR
EBA150060	GA-378	DON	EFA105	GA-71	MTR	EFG67	G-1121F	MTR	EFL383	GP-462	MTR
EBA150061	GA-378	DON	EFA106	GAD-1	MTR	EFG74	G-1163 ¹⁰⁸	MTR	EFL386	GP-68	MTR
EBA150063	GA-378	DON	EFA107	GAD-3	MTR	EFG75	G-1173 ¹⁰⁸	MTR	EFL388	GP-9	MTR
EBA150093	GA-6880	DON	EFA153	GA-200	MTR	EFG77	G-297-B	MTR	EFL390	GP-9	MTR

Referencia Cruzada por Numero de Parte

Cross Reference by Part Number



Numero	Gonher	Fabricante	Numero	Gonher	Fabricante	Numero	Gonher	Fabricante	Numero	Gonher	Fabricante
Number	Gonher	Manufacturer	Number	Gonher	Manufacturer	Number	Gonher	Manufacturer	Number	Gonher	Manufacturer
EFL391		GP-157 MTR	EGB120097	GA-9334 ¹⁰⁴	DON	EL1291	GA-218	LAUT	ELA-224	GA-8047	ENLI
EFL40		G-871 MTR	EGB120109	GA-239 ¹⁰⁸	DON	EL1354	GA-18	LAUT	ELA-226	GA-9334	ENLI
EFL404		G-70 MTR	EGB120109	GA-329 ¹⁰⁴	DON	EL1357	GA-18	LAUT	ELA-229	GA-18	ENLI
EFL48		GP-28 ⁸ MTR	EGB120117	GA-7360 ¹⁰⁸	DON	EL1388	GA-200	LAUT	ELA-233	GA-9045	ENLI
EFL48		GP-430 ⁸ MTR	EGB120117	GA-7716 ¹⁰⁴	DON	EL1388	GA-218	LAUT	ELA-234	GA-1287	ENLI
EFL486		G-963 MTR	EGB120118	GA-7360 ¹⁰⁸	DON	EL-139	G-139	ENLI	ELA-235	GA-1284	ENLI
EFL487		GP-149 MTR	EGB120118	GA-7716 ¹⁰⁴	DON	EL-14	G-5000	ENLI	ELA-236	GA-1286	ENLI
EFL488		GP-156 MTR	EGB120119	GA-9334 ¹⁰⁴	DON	EL-155	G-152	ENLI	ELA-237	GA-1285	ENLI
EFL49		GP-22 MTR	EGB120161	GA-1286 ¹⁰⁸	DON	EL-1660	G-222	ENLI	ELA-239	GA-375	ENLI
EFL493		GP-1 MTR	EGB120161	GA-9334 ¹⁰⁴	DON	EL-1666	G-1166	ENLI	ELA-253	GA-16	ENLI
EFL51		GP-46 MTR	EGB160063	GA-356	DON	EL1680	GA-200	LAUT	ELA-254	GA-20	ENLI
EFL52		GP-81 MTR	EH221	G-6	KNE	EL1680	GA-218	LAUT	ELA-255	GA-24	ENLI
EFL54		GP-81 ³¹ MTR	EH241	G-870	MAHL	EL-1720	G-159	ENLI	ELA-256	GA-33	ENLI
EFL54		GP-9 ⁵⁸ MTR	EH243	G-6	KNE	EL-1721	G-331	ENLI	ELA-257	GA-26	ENLI
EFL57		GP-81 MTR	EH2431	G-6	KNE	EL-1725	G-33	ENLI	ELA-2571	GAP-381	ENLI
EFL59		GP-3 MTR	EH2432	G-6	KNE	EL1862	GA-71	LAUT	ELA-258	GA-403	ENLI
EFL62		GP-50 MTR	EH249	G-870	KNE	EL-191	G-191	ENLI	ELA-259	GA-27	ENLI
EFL66		G-834 MTR	EH2491	G-870	KNE	EL-200	G-200	ENLI	ELA-268	GA-5648	ENLI
EFL69		G-225 MTR	EH2491	G-870	MAHL	EL-211	G-566	ENLI	ELA-287	GA-287	ENLI
EFL71		G-870 MTR	EH249-12	G-870	KNE	EL-218	G-34	ENLI	ELA-288	GA-1203	ENLI
EFL74		GP-1 MTR	EH249-2	G-870	KNE	EL-236	G-236	ENLI	ELA-3203	GA-21	ENLI
EFL78		GP-81 MTR	EH258	GP-81	KNE	EL-238	G-238	ENLI	ELA-329	GA-35	ENLI
EFL8		G-836 MTR	EH259	G-813	KNE	EL-2821	G-613	ENLI	ELA-3517	GA-377	ENLI
EFL80		GP-5 MTR	EH262	G-871	KNE	EL3001	GA-71	LAUT	ELA-3603	GA-373	ENLI
EFL83		GP-38 MTR	EH268	G-225	KNE	EL3029	GA-200	LAUT	ELA3989	GA-398	ENLI
EFL84		GP-3816 MTR	EH2681	G-162H	KNE	EL3029	GA-218	LAUT	ELA-4223	GA-6128	ENLI
EFL85		G-225 MTR	EH268C20	G-225	KNE	EL3030	GA-230	LAUT	ELA-502	GA-6128	ENLI
EFL86		G-162H MTR	EH275	G-871	KNE	EL3040	GA-360	LAUT	ELA-502SY	GA-6127	ENLI
EFL86		G-225 MTR	EH275-1	G-871	KNE	EL3047	GAK-403	LAUT	ELA-507	GA-106	ENLI
EFL87		G-162H MTR	EH316	G-871	KNE	EL3049	GA-360	LAUT	ELA-507SY	GA-206	ENLI
EFL87		G-225 MTR	EH3230	G-836	KNE	EL3050	GAK-20	LAUT	ELA-523	GA-360	ENLI
EFL89		GP-58 FORD	EH323-1	G-836	KNE	EL3052	GAK-16	LAUT	ELA-523SY	GA-360	ENLI
EFL89		GP-58 MTR	EH324	G-1174 ¹⁰⁸	KNE	EL3053	GA-33 ¹¹²	LAUT	ELA-536	GA-356	ENLI
EFL90		GP-81 ³¹ MTR	EH3240	G-1174 ¹⁰⁸	KNE	EL3054	GA-106 ⁴⁶	LAUT	ELA-536SY	GA-357	ENLI
EFL90		GP-9 ⁵⁸ MTR	EH3250	G-33	KNE	EL3054	GA-326 ⁷¹	LAUT	ELA-542	GA-31	ENLI
EFL910		GP-58 ⁹ MTR	EH335	G-33	KNE	EL3064	GAVW-2	LAUT	ELA-592	GA-376	ENLI
EFL98		GP-22 MTR	EH347	G-500	KNE	EL3065	GA-8047	LAUT	ELA-595	GA-378	ENLI
EFO-B8C6731A		G-330 UNI	EH365	G-330	KNE	EL3078	GA-49	LAUT	ELA-598	GA-7716	ENLI
EFP-B8C6731A		G-330 UNI	EH391	G-834	KNE	EL3084	GA-405	LAUT	ELA-598SY	GA-7360	ENLI
EGB095405		GA-1008 ¹⁰⁴ DON	EH391	G-834	MAHL	EL3089	GA-436	LAUT	ELA6324	GA-616	ENLI
EGB095405		GA-1284 ¹⁰⁸ DON	EH391-0	G-834	KNE	EL-31	G-31	ENLI	ELA-6326	GA-371	ENLI
EGB095406		GA-1008 ¹⁰⁴ DON	EH518	G-834	KNE	EL3125	GA-3425	LAUT	ELA-74	GA-70	ENLI
EGB095406		GA-1284 ¹⁰⁸ DON	EIADDN-99162-A	G-11816	FORD	EL3128	GA-277	LAUT	ELA-76	GA-12	ENLI
EGB095407		GA-1008 ¹⁰⁴ DON	EIADDN-99162-B	G-11816	FORD	EL3157	GAD-1	LAUT	ELA-77	GA-12	ENLI
EGB095407		GA-1284 ¹⁰⁸ DON	EIADKN-18631-C	G-836	FORD	EL3158	GAD-3	LAUT	EIADKN-18662-B	G-871	FORD
EGB095408		GA-1008 ¹⁰⁴ DON	EIADKN-18662-A	G-871	FORD	EL3161	GA-2740	LAUT	ELCA5008	G-1121	LAUT
EGB095408		GA-1284 ¹⁰⁸ DON	EIADKN-18662-B	G-871	FORD	EL3162	GA-3490	LAUT	ELCA5009	G-1123	LAUT
EGB095409		GA-1008 ¹⁰⁴ DON	EIADKN-6731	G-871	FORD	EL3163	GAD-3	LAUT	EL3429	GG-246	LAUT
EGB095409		GA-1284 ¹⁰⁸ DON	EIADKN-6731-A	G-871	FORD	EL3166	GA-230	LAUT	EL3567	GG-251	PERM
EGB095410		GA-1008 ¹⁰⁴ DON	EIADKN-99162-A	G-11816	FORD	EL3167	GA-230	LAUT	EL3574	GG-189	LAUT
EGB095410		GA-1284 ¹⁰⁸ DON	EIADKN-99162-B	G-11816	FORD	EL3170	GAD-3	LAUT	ELF3998	GP-193	DON
EGB095412		GA-1008 ¹⁰⁴ DON	EIADKN-99162-C	G-11816	FORD	EL3178	GAVW-4	LAUT	ELF5000	G-500	UNI
EGB095412		GA-1284 ¹⁰⁸ DON	EIADKN-N1866-2B	G-871	NISS	EL3193	GAVW-2	LAUT	ELF-5000	G-500	ENLI
EGB110011		GA-1285 ¹⁰⁸ DON	EIDDDN-99162-B	G-11816	FORD	EL3196	GAD-3	LAUT	ELF5000H	G-500	UNI
EGB110011		GA-8047 ¹⁰⁴ DON	EJPI-6714-AA	GP-3766	FORD	EL3206	GAVW-2	LAUT	ELF7300	GP-3001	DON
EGB110012		GA-1285 ¹⁰⁸ DON	EK402	G-1121	KNE	EL3252	GA-349	PERM	ELF7349	GP-178	DON
EGB110012		GA-8047 ¹⁰⁴ DON	EK404	G-1123	KNE	EL3255	GA-303	LAUT	ELF750	G-750	UNI
EGB110022		GA-1285 ¹⁰⁸ DON	EK404	G-1123F	KNE	EL3259	GA-3425	LAUT	ELF7500	G-750	UNI
EGB110022		GA-8047 ¹⁰⁴ DON	EK433	G-870	KNE	EL-33	G-33	ENLI	ELF7500C	G-750	UNI
EGB110023		GA-1285 ¹⁰⁸ DON	EK433	G-870	MAHL	EL-330	G-330	ENLI	ELF7500F	G-750	UNI
EGB110023		GA-8047 ¹⁰⁴ DON	EK443	G-1121	KNE	EL-331	G-331	ENLI	ELF7500H	G-750	UNI
EGB110024		GA-1285 ¹⁰⁸ DON	EK455	G-1173 ¹⁰⁸	KNE	EL-333	G-333	ENLI	ELF-7500M	G-750	ENLI
EGB110024		GA-8047 ¹⁰⁴ DON	EK491	G-1121	KNE	EL-335	G-335	ENLI	ELF7500SIS	G-750	UNI
EGB110025		GA-1285 ¹⁰⁸ DON	EK497-1	G-1175 ¹⁰⁸	KNE	EL-3558	GS-2033	ENLI	ELF7616	GP-69	DON
EGB110025		GA-8047 ¹⁰⁴ DON	EK518	G-296	KNE	EL402	GPP-19	KNE	ELF7680	GP-36	DON
EGB120062		GA-1286 ¹⁰⁸ DON	EK518	G-296-B	KNE	EL422	GA-44	KNE	ELF7739	GP-51	DON
EGB120062		GA-9334 ¹⁰⁴ DON	EK78	G-33	FDY	EL4308	G-31	UNI	ELF7947	GP-359	DON
EGB120063		GA-1286 ¹⁰⁸ DON	EL 3452	GA-2160	LAUT	EL4308F	G-31	UNI	ELG5205	G-1121	LAUT
EGB120063		GA-9334 ¹⁰⁴ DON	EL 3452	GA-2160	MECF	EL447	GA-230	KNE	ELG5208	G-1163 ¹⁰⁸	LAUT
EGB120064		GA-1286 ¹⁰⁸ DON	EL 3452	GA-2160	PERM	EL458	GPP-19	KNE	ELG5209	G-296	LAUT
EGB120064		GA-9334 ¹⁰⁴ DON	EL 3782	GA-410	LAUT	EL4636	G-122	ENLI	ELG5209	G-296-B	LAUT
EGB120067		GA-1286 ¹⁰⁸ DON	EL 3782	GA-410	MECF	EL-6	G-6	ENLI	ELH 4302	G-25	LAUT
EGB120067		GA-9334 ¹⁰⁴ DON	EL1001	GA-71	LAUT	EL78	G-33	LEE	ELH 4302	G-25	MECF
EGB120069		GA-1286 ¹⁰⁸ DON	EL-1133CC	GC-1133	ENLI	EL-8	GP-88	ENLI	ELH4016	G-225	LAUT
EGB120069		GA-9334 ¹⁰⁴ DON	EL-1133CS	GS-1133	ENLI	EL-801	G-871	ENLI	ELH4020	G-870	LAUT
EGB120072		GA-1286 ¹⁰⁸ DON	EL-1143	G-1143	ENLI	EL-813	G-813	ENLI	ELH4062	GP-46	LAUT
EGB120072		GA-9334 ¹⁰⁴ DON	EL-1163	G-1163	ENLI	EL-816	G-816	ENLI	ELH4069	GP-81	LAUT
EGB120073		GA-1286 ¹⁰⁸ DON	EL-1166	G-1166	ENLI	EL-820	G-870	ENLI	ELH4073	GP-22	LAUT
EGB120073		GA-9334 ¹⁰⁴ DON	EL-1173	G-1173	ENLI	EL-834	G-834	ENLI	ELH4080	GP-46	LAUT
EGB120075		GA-1286 ¹⁰⁸ DON	EL-1174	G-1174	ENLI	EL-856	G-294	ENLI	ELH4082	GP-22	LAUT
EGB120075		GA-9334 ¹⁰⁴ DON	EL-1175	G-1175	ENLI	ELA-151	GA-101	ENLI	ELH4091	GP-462	LAUT
EGB120076		GA-1286 ¹⁰⁸ DON	EL-11816	G-11816	ENLI	ELA-1543	GA-891	ENLI	ELH4095	GP-28 ⁸	LAUT
EGB120076		GA-9334 ¹⁰⁴ DON	EL-11860	G-1121	ENLI	ELA-1543SY	GA-892	ENLI	ELH4095	GP-430 ⁸	LAUT
EGB120078		GA-7360 ¹⁰⁸ DON	EL-11861	G-1123	ENLI	ELA-1548	GA-483	ENLI	ELH4104	GP-40	LAUT
EGB120078		GA-7716 ¹⁰⁴ DON	EL-119	G-119	ENLI	ELA-1548SY	GA-482	ENLI	ELH4105	GP-46	LAUT
EGB120079		GA-7360 ¹⁰⁸ DON	EL-11941	GG-48	ENLI	ELA-1553	GA-679	ENLI	ELH4146	GP-40	LAUT
EGB120079		GA-7716 ¹⁰⁴ DON	EL123716	GA-39	CUMM	ELA-1553SY	GA-680	ENLI	ELH4302	GP-14	LAUT
EGB120081		GA-1287 ¹⁰⁸ DON	EL126	G-836	LEE	ELA-1580	GA-109	ENLI	ELH4305	GP-36	LAUT
EGB120081		GA-9045 ¹⁰⁴ DON	EL1262	GA-71	LAUT	ELA-1581	GA-229	ENLI	ELH4403	G-834	LAUT
EGB120082		GA-1287 ¹⁰⁸ DON	EL1266	GA-200	LAUT	ELA-1596	GA-209	ENLI	ELH4404	G-836	LAUT
EGB120082		GA-9045 ¹⁰⁴ DON	EL1266	GA-218	LAUT	ELA-1					

Numero	Gonher	Fabricante	Numero	Gonher	Fabricante	Numero	Gonher	Fabricante	Numero	Gonher	Fabricante
Number	Gonher	Manufacturer	Number	Gonher	Manufacturer	Number	Gonher	Manufacturer	Number	Gonher	Manufacturer
ELHA4062	GP-46	LAUT	EP30	G-331	PUR	F000G475	GG-87	MOP	F1	GP-66	CRSS
ELHA4064	GP-46	LAUT	EP305	G-153	PUR	F000G477	GG-264	MOP	F1	GG-196	LUC
ELHA4069	GP-81	LAUT	EP30HD	G-331	PUR	F000G481	GG-46	MOP	F1	GG-20	PRET
ELHA4070	GP-81 ³¹	LAUT	EP-30-HD	G-331	PUMX	F000G483	GG-3728	MOP	F1	GP-1	REX
ELHA4070	GP-9 ⁵⁸	LAUT	EP36A	G-31	ENV	F000G486	GG-65	MOP	F10	GP-14	FAME
ELHA4073	GP-22	LAUT	EP36C	G-31	ENV	F000G800	GG-47	MOP	F10	GG-19	SRS
ELM20006	GAK-16	WORT	EP5134	GA-475	GPC	F000PH29	GP-13	MOP	F100001160024	GP-36	FEND
ELM2006	GAK-16	WORT	EP5135	GA-5876	GPC	F000PH45	GP-3429	MOP	F100001160243	GP-1122	FEND
ELM24	GA-26	WORT	EP5139	GA-4365	GPC	F000PH47	GP-46	MOP	F100001160243	GP-1122	HANO
ELM40	GAK-20	WORT	EP58	GG-5 L	PFX	F0012	GG-5 L	BOG	F100001173481	GP-36	FEND
ELM44	GA-32 ¹¹²	WORT	EP71	G-1163 ¹⁰⁸	UNI	F0016	GG-196	BOG	F100001174418	GP-36	FEND
ELM45	GAK-20	WORT	EP76	G-236	UNI	F0018	GG-203	BOG	F10021	GG-123	EVGR
ELM46	GA-26	WORT	EP78	G-33	PUR	F003491	GP-1	RIKL	F10021	GG-123	PUR
ELM5	GA-33 ¹¹²	TRAN	EP78	GA-33 ¹¹²	WISC	F003590	G-613	RIKL	F10021M	GG-123	PUR
ELM50	GAK-16	WORT	EP-78	G-33	PUMX	F003592	GP-31	RIKL	F10035	GG-87	EVGR
ELM510	GA-18	UNI	EP781	G-33	PUR	F006815	GA-27	RIKL	F10035	GG-87	PUR
ELM68	GA-26	WORT	EP7810	G-33	PUR	F006924	GG-20	RIKL	F10035M	GG-87	PUR
ELM78	GAK-625	WORT	EP94	G-1176	PUR	F008231	GP-66	TIMB	F100A88	GA-363	INTF
ELM80	GP-34	WORT	EPA6731	G-6	UNI	F00AF110	GAD-3	MOP	F1001	GP-66	GRES
ELM83	GA-106 ⁴⁶	WORT	EPG130077	GA-890R ¹⁰⁸	DON	F00AF123	GA-2719B	MOP	F101	GG-215	LUC
ELM83	GA-326 ⁷¹	WORT	EPG130077	GA-930R ¹⁰⁴	DON	F00AF132	GA-50	MOP	F101	GP-22	MICF
ELP119	GA-7	UNI	EPG130079	GA-890R ¹⁰⁸	DON	F00AF133	GA-78	MOP	F10119	GG-6	EVGR
ELP132	GA-50	UNI	EPG130079	GA-930R ¹⁰⁴	DON	F00AF178	GA-192	MOP	F10119	GG-6	PUR
ELP133	GA-80	UNI	EPG130089	GA-890R ¹⁰⁸	DON	F00AF212	GA-55	MOP	F10119M	GG-6	PUR
ELP2137	GA-44	UNI	EPG130089	GA-930R ¹⁰⁴	DON	F00AF293	GAD-15	MOP	F10120	GG-7	EVGR
ELP3	GA-71	UNI	EPG150048	GA-683R	DON	F00AF300	GA-277	MOP	F10120	GG-7	PUR
ELP3064	GAVW-2	LAUT	EPG150049	GA-683R ¹⁰⁸	DON	F00AF302	GA-4303	MOP	F10120M	GG-7	PUR
ELP3128	GA-277	LAUT	EPN-6731	G-813	FRIG	F00AF307	GA-2740	MOP	F10131	GG-19	EVGR
ELP3178	GAVW-4	LAUT	EPN-6731-A	G-870	FORD	F00AF329	GA-57	MOP	F10131	GG-19	PUR
ELP3183	GA-2194	LAUT	EPN-6731-B	G-813	FORD	F00AF348	GA-59	MOP	F10131M	GG-19	EVGR
ELP3193	GAVW-2	LAUT	EPN-99162-A	G-11816	FORD	F00AF574	GA-74	MOP	F10157	GG-16	PUR
ELP3198	GAVW-2	LAUT	EPN-99162-B	G-11816	FORD	F00AF584	GA-3300	MOP	F10157	GG-16	PUR
ELP3203	GAVW-2	LAUT	EPN-99167-A	G-11816	FORD	F00AF601	GA-735 ¹²⁴	MOP	F10157M	GG-16	PUR
ELP3325	GA-2110	LAUT	EPPE63	G-33	PETI	F00AF602	GA-2719B	MOP	F10158	GG-17	EVGR
ELP3333	GA-4365	LAUT	EQ305	G-31	GRAF	F00AF611	GA-3814	MOP	F10158	GG-17	PUR
ELP3355	GAD-15	LAUT	ERC1444	GP-1	LEYL	F00AF640	GA-3424	MOP	F10158M	GG-17	PUR
ELP3358	GAD-15	LAUT	ERC8721	GP-1	LEYL	F00AF735	GA-54	MOP	F103	GP-66	GRES
ELP3489	GAVW-121	LAUT	ERK-35176	GA-33 ¹¹²	FORD	F00AF736	GA-3523	MOP	F103	GG-232	LUC
ELP3494	GA-2114	LAUT	ERK-39083	GP-66	FORD	F00AF773	GA-3588	MOP	F104	GP-40	CHAM
ELP3829	GA-234	OPEL	ERR3340	GP-430 ¹	LAND	F00AF785	GA-3647	MOP	F105	GP-40	CHAM
ELP3837	GA-2174	LAUT	ERR3340	GP-81 ¹	LAND	F00AF905	GA-153	MOP	F105	GG-185	LUC
ELP3837	GA-2174	MECF	ERR3340	GP-432	ROVE	F00AF971	GA-2740	MOP	F1053	GG-5 L	BOG
ELP4	GA-70	UNI	ES77	GG-1	PERM	F00AF974	GA-3916	MOP	F107	GG-215	LUC
EM 76.76 P	G-25	OTUR	ES77	GG-4	PERM	F00PH228	GP-81	MOP	F109	GP-42	CHAM
EMP67	GA-33 ¹¹²	PETI	ES8933003007	GG-243	CHRY	F00PH400	GP-3600	MOP	F109	GG-203	LUC
EN1082	G-70	KNE	ESE1ZE-6714-AA	GP-1	FORD	F00PH51A	GP-3980	MOP	F109	GP-42	MICF
EN120	G-31	KNE	ESP	G-750	HARV	F00PH820	GP-68	MOP	F11	GG-6	FLAG
EN1200	G-31	KNE	ESR1445	GA-2146	LAND	F014589	GA-24	RIKL	F11	GG-123	SRS
EN1201	G-31	KNE	ESR1445	GA-2146	ROVE	F0150540	GA-33	DUTZ	F1-1	GA-70	IMPL
EN120-3	G-31	KNE	ESR4065	GG-46	LAND	F01505-40	GAK-403	POCL	F1101	GP-1101	HUT
EN120-5	G-31	KNE	ESR-4103	GA-2174	ROVE	F015200060160	G-1121	FEND	F1103	GG-152	FRM
EN1208	G-31	KNE	ESR-4238	GA-2146	LAND	F0152000601631	G-1121F	FEND	F112	GG-246	LUC
EN120-M	G-31	KNE	ESR-4238	GA-2146	ROVE	F015200060180	G-1121	FEND	F1124APB	G-1173	FRM
EN150	G-1143	KNE	ET15499	GP-157	JOND	F015907	GP-1101	RIKL	F1125APBT4	G-1173	FRM
EN241	G-191	KNE	ET15499	GP-157	KAWA	F015909	GP-1101	RIKL	F1125PB2	G-1173 ¹⁰⁸	ROLK
EN241-0	G-191	KNE	ET97262	GP-81	EATN	F016295	GP-2071W	RIKL	F1125PBT4	G-1173 ¹⁰⁸	ROLK
EN313	G-31	KNE	ET97262	GP-81	YALE	F018788	GP-66	RIKL	F1127PB2	G-1175 ¹⁰⁸	ROLK
EN330	G-31	KNE	ETC4953	GP-1	LEYL	F02505-66	GA-892	POCL	F1135-2PL	G-1175 ¹⁰⁸	FRM
EN331	G-1166	KNE	ETC6599	GP-1	LEYL	F026630	GG-1	RIKL	F1143	GG-1143	FRM
EN334	G-870	KNE	ETT2-9600-A	GA-3501	FORD	F026630	GG-4	RIKL	F1143	G-1143	ROLK
EN334	G-870	MAHL	EX4200	G-1173 ¹⁰⁸	WIN	F027103	G-500	RIKL	F1143PB	G-1143	FRM
EN363	G-31	KNE	EYB200005	GA-1287	DON	F027104	G-566	RIKL	F1143PBM	G-1143	FRM
EN3631	G-31	KNE	EYB200005	GA-9045 ¹⁰⁴	DON	F02Z-9155-A	GG-47	FORD	F115	GG-5 L	LUC
EN3632	G-31	KNE	EYB200007	GA-1287	DON	F031F	GG-203	ASAH	F1158	GG-76	ASAH
EN363-3	G-31	KNE	EYB200007	GA-9045 ¹⁰⁴	DON	F044979	GA-966R	JOND	F1159	GG-202	ASAH
EN-7617	G-293	CATP	EYB200008	GA-1287	DON	F08N-9176-AA	GPP-1287 ³⁹	FORD	F116	GG-298	KRA
ENC320	G-31	KNE	EYB200008	GA-9045 ¹⁰⁴	DON	F08N-9176-AA	PFF831 ⁴¹	FORD	F116	GG-298	LUC
ENC320D	G-31	KNE	EYB200009	GA-1287	DON	F08N-9176-AA	R 60 P ⁴²	FORD	F119	GP-1	MICF
EOHT-9155-C1A	GP-92	FORD	EYB200009	GA-9045 ¹⁰⁴	DON	F09505-49	GP-110	POCL	F-11A69	GA-320	INTF
EOHT-9155-C2A	GP-92	FORD	EZ32-6731-B	GP-3985	FORD	F09917881	GA-24	FIAT	F118A	GP-66	CRSS
EOHZ-6731-A	GP-13	FORD	Números Nuevos			F0AF1031	GA-277	MOP	F11CA	GP-66	CRSS
EOHZ-9155-C	GP-92	FORD				F0AF1032	GA-5056	MOP	F12	GG-7	FLAG
EONN-6714-AA	GP-77	FORD				F0AF1043	GA-273	MOP	F12	GG-5 L	SRS
EONN-6714-AAS	GP-77	FORD				F0AF1046	GA-174	MOP	F120	GG-208	LUC
EONN-9N627-AA	GA-589	FORD				F0AF1061	GA-275	MOP	F121	GP-92	KRA
EONN-9R500-AA	GA-588	FORD				F0AF1096	GA-6479	MOP	F122	GP-93	KRA
EOTE-9601-AA	GA-75	FORD				F0AF1135	GA-7017	MOP	F12505-61	GA-1286	POCL
EOTE-9601-BA	GA-80	FORD				F0AF7828	GA-386	MOP	F1252	GG-45	ASAH
EOTZ-9601-C	GA-588	FORD				F0AF7841	GA-322	MOP	F128	GG-142	LUC
EOTZ-9601-D	GA-589	FORD				F0HZ-6731-A	GP-54 ⁹⁰	FORD	F129	GG-148	LUC
EQZE-9155-BA	GG-87	FORD				F0HZ-6731-B	GP-54 ⁹⁰	FORD	F-12A06	GA-2159	INTF
EQZZ-9155-A	GG-87	FORD				FONN-6714-CA	GP-761H	FORD	F1226731B	GP-149	FORD
EP126	G-836	PUR				FONN6714CA12H	GP-761H	NEWH	F13	GG-123	FLAG
EP1321	G-191	PUR				FONN-6714-CA12H	GP-761H	FORD	F13	GG-123	FLAG
EP135	G-333	PUR				FONN-9176-BA	GPP-1122	FORD	F13	GG-7	SRS
EP-135	G-333	PUMX				FOPH2817	GP-3531	EXP	F130	GG-246	LUC
EP179	G-813	PUR				FOPH2827	GP-3682	MOP	F130	GG-408	LUC
EP-179	G-813	PUMX				FOPH2827	GP-37	MOP	F131	GP-85	KRA
EP202	GS-1133	PUR	F0000AF4	GA-70	MOP	FOPH2827	GP-171	MOP	F131	GG-261	LUC
EP-202	GS-1133	PUMX	F0000G16	GG-19	MOP	FOPH2840	GP-157	MOP	F131U	GP-85	KRA
EP203	G-133	PUR	F0009	GG-45	BOG	FOPH2867	GP-149	MOP	F132	GG-261	LUC
EP205	G-222	PUR	F000AF52	GA-303	MOP	FOPH2868	GP-91	MOP	F132	GG-408	LUC
EP207	GC-1133	PUR	F000AF97	GA-75	MOP	FOPH2876	GP-91	MOP	F132	GG-408	LUC
EP-207	GC-1133	PUMX	F000G180	GG-45	MOP	FOTE-9155-AA	GG-1872	FORD	F135	GG-190	LUC
EP-21	G-1166	PUMX	F000G231	GG-203	MOP	FOTZ-9155-B	GG-1872	FORD	F1353	GG-203	ASAH
EP-247	G-1166	PUMX	F000G243	GG-196	MOP	F1	GG-31	CHP	F1354	GG-203	ASAH
			F000G246	GG-94	MOP						

Referencia Cruzada por Numero de Parte

Cross Reference by Part Number



Numero	Gonher	Fabricante	Numero	Gonher	Fabricante	Numero	Gonher	Fabricante	Numero	Gonher	Fabricante
Number	Gonher	Manufacturer	Number	Gonher	Manufacturer	Number	Gonher	Manufacturer	Number	Gonher	Manufacturer
F1357	GG-204	ASAH	F1903	GS-2034	SAKU	F21124	GG-4	PUR	F298R	GP-749	KRA
F1358	GG-208	ASAH	F-1904	2010PM-OR ³	SAKU	F21124M	GG-1	PUR	F-2KA53	GA-16	INTF
F136	GG-181	LUC	F-1904	2010TM-OR ³	SAKU	F21124M	GG-4	PUR	F-2KA53	GAK-16	INTF
F137	GG-214	LUC	F1907	GS-2033	SAKU	F211X	GG-1	VIC	F2Y0-14-302	GP-91	MZDA
F138204060020	GP-110	FEND	F192	GP-1105	KRA	F211X	GG-4	VIC	F3	GG-196	LUC
F139	GG-185	LUC	F193	GP-62	KRA	F213	GP-28 ⁵	MICF	F3	GP-50	REX
F139215310010	GP-171	FEND	F1955	GG-185	ASAH	F213	GP-430 ⁸	MICF	F3	G-152	ROLK
F-13A06	GA-2160	INTF	F198	GP-56	KRA	F217	GG-114	LUC	F3	GG-17	SRS
F13BA	GP-66	CRSS	F198R	GP-749	KRA	F218	GP-155	KRA	F30	G-31	FRM
F13CA	GP-66	CRSS	F198U	GP-56	KRA	F218	GG-160	LUC	F3003	GG-5 L	BOG
F14	GP-13	MICF	F199	GP-55	KRA	F219	GP-78	KRA	F305A	GA-730	INTF
F14	GG-19	PRET	F199U	GP-55	KRA	F21A03	GA-364	INTF	F30BP	G-31	ROLK
F14	GG-87	SRS	F1A	GP-1	MICF	F22	GG-19	FACE	F30P	G-31	FRM
F141	GG-261	LUC	F1A	GP-1	REX	F22	GG-19	FLAG	F30-SERIES	G-31	FRM
F142	GG-214	LUC	F1AE-6714-BC	GP-68	FORD	F220	GP-1101	KRA	F31	G-31	FRM
F144	GP-110	KRA	F1AZ-6731-A	GP-68	FORD	F221	GP-92	KRA	F3212	GS-2033	KRA
F144	GG-251	LUC	F1AZ-6731-BD	GP-68	FORD	F225L205	G-31	CONT	F326A	GA-59	INTF
F146	GG-151	LUC	F1CZ-9601-A	GA-133	FORD	F226L205	G-31	CONT	F32A45	GAD-30	INTF
F146A	GA-71	INTF	F1HZ-0601-A	GA-529	FORD	F226L205	G-31	TELE	F32Z-6731-A	GP-149	FORD
F149	GG-146	LUC	F1HZ-9365-A	GPP-1287 ³⁹	FORD	F226L206	G-31	CONT	F32Z-9155-A	GG-268	FORD
F-14A06	GA-2152	INTF	F1HZ-9365-A	PFF831 ⁴¹	FORD	F226L319	G-31	CONT	F32Z-9601A	GA-432	FORD
F-14A44	GA-114	INTF	F1HZ-9365-A	R 60 P ⁴²	FORD	F227F502	GA-33	CONT	F33	GG-188	LUC
F-14A85	GA-323	INTF	F1HZ-9601-A	GA-529	FORD	F23	GG-203	LUC	F33141	GG-240	EVGR
F152	GP-1122	KRA	F1HZ-9601-B	GA-682R	FORD	F-23	GG-457	ATL	F33141	GG-240	PUR
F152	GG-115	LUC	F1HZ-9601-C	GA-529	FORD	F23162	GG-208	EVGR	F33144	GG-46	EVGR
F153	GP-1122	KRA	F1SE-9155-AA	GG-92	FORD	F23162	GG-208	PUR	F33144	GG-46	PUR
F153	GPP-1122	KRA	F1SZ-9155-A	GG-92	FORD	F23162M	GG-208	PUR	F33144M	GG-46	PUR
F154	GP-1122	KRA	F2	GG-5 L	FACE	F23170	GG-208	EVGR	F33165	GG-242	GRP
F154R	GPP-1122	KRA	F2	GG-5 L	FLAG	F23170	GG-208	PUR	F33165	GG-242	PUR
F154S	GPP-1122	KRA	F2	GG-45	LUC	F23170M	GG-208	PUR	F33165	GG-242	QKS
F155	GG-185	LUC	F2	GG-16	SRS	F23171	GG-42	EVGR	F33165	GG-242	SHE
F156	GP-1122	KRA	F20	GG-20	FLAG	F23171	GG-42	PUR	F33165M	GG-242	PUR
F1567	GG-185	ASAH	F20	GP-81	MICF	F23171M	GG-42	PUR	F33173	GG-3728	EVGR
F157	GP-1122	KRA	F-20	GP-68	ATL	F23172	GG-5 L	PUR	F33173	GG-3728	PUR
F157	GG-46	LUC	F20001	GG-45	EVGR	F23172M	GG-5 L	PUR	F33173M	GG-3728	PUR
F158	GP-83	KRA	F20001	GG-45	PUR	F235	GP-92	FLG	F334	GP-28 ⁶	LUC
F159	GP-84	KRA	F20001M	GG-45	PUR	F2354	GG-63	ASAH	F334	GP-430 ⁸	LUC
F155	GP-81	CRSS	F20002	GG-76	EVGR	F238202310010	GP-310	FEND	F3340	G-1173	CONT
F16	GP-81 ³¹	MICF	F20002	GG-76	PUR	F23E-9001-BB	GA-217	FORD	F3356	GPP-111	ASAH
F16	GP-9 ³⁸	MICF	F20002M	GG-76	PUR	F23E-9601-B	GA-217	FORD	F3356	GPP-524	ASAH
F16	GG-1	SRS	F20004	GG-1	EVGR	F23E-9601-BB	GA-217	FORD	F3359	GG-45	FLAG
F16	GG-4	SRS	F20004	GG-4	EVGR	F23Z-9601-B	GA-217	FORD	F3388	GG-16	FLAG
F-16	GP-81	ATL	F20004	GG-1	PUR	F-24	G-3752	ATL	F3389	GG-17	FLAG
F160	GG-185	LUC	F20004	GG-4	PUR	F2408A	GP-34	ROGR	F33A00	GA-3300	INTF
F160A	GA-70	INTF	F20004M	GG-1	PUR	F24404	GG-203	EVGR	F33A59	GA-234	INTF
F161	GP-1101	KRA	F20004M	GG-4	PUR	F24404	GG-203	PUR	F33A79	GAVW-2	INTF
F161A	GP-1101	KRA	F20005	GG-45	PUR	F24404M	GG-203	PUR	F33A84	GAVW-2	INTF
F165	GG-187	LUC	F20011	GG-5 L	EVGR	F2457	GG-137	ASAH	F33A95	GA-163	INTF
F1652	GG-298	ASAH	F20011	GG-3	PUR	F245F3	GG-16	CONT	F33A99	GAVW-4	INTF
F166	GPP-18	KRA	F20011	GG-5	PUR	F24673	GG-203	EVGR	F344	GPP-14	DEL
F166	GG-187	LUC	F20011M	GG-5 L	PUR	F24673	GG-203	PUR	F346	GP-110	KRA
F166B	GPP-18	KRA	F20030	GG-8 ¹⁰³	EVGR	F24673M	GG-203	PUR	F34713	GG-260	EVGR
F16A88	GA-168	INTF	F20030	GG-8 L ⁸⁰	EVGR	F24A04	GA-490	INTF	F34713	GG-260	PEP
F17	GG-202	LUC	F20030	GG-8 ¹⁰³	PUR	F-24A61	GA-397	INTF	F34713	GG-260	PUR
F17	GG-46	SRS	F20030	GG-8 L ⁸⁰	PUR	F24F300	GAK-16	CONT	F34713M	GG-260	PUR
F-17	GP-1	ATL	F20030M	GG-8 ¹⁰³	PUR	F25	GP-3	MICF	F347A	GA-429	INTF
F170	GP-1108	KRA	F20030M	GG-8 L ⁸⁰	PUR	F25	GP-3	REX	F3499	GG-8 ¹⁰³	FLAG
F171	GP-1107	KRA	F20117	GG-1	EVGR	F253	GG-76	ASAH	F3499	GG-8 L ⁸⁰	FLAG
F171	GG-137	LUC	F20117	GG-4	EVGR	F258	GG-196	ASAH	F34A24	GA-3424	INTF
F173	GP-3980	MICF	F20117	GG-1	PUR	F-25A10	GA-281	INTF	F-34A50	GA-328	INTF
F174	GP-11	KRA	F20117	GG-4	PUR	F26	GG-76	LUC	F351A	GA-75	INTF
F17526	GAK-403	FAIR	F20117M	GG-1	PUR	F2601	G-1121	SAKU	F353A	GAD-3	INTF
F175P	G-750	FRM	F20117M	GG-4	PUR	F-2601-1	G-1121	SAKU	F3549957	GP-81 ³¹	MOP
F175PW	G-750	FRM	F20118	GG-5 L	EVGR	F2602	G-1121F	SAKU	F3549957	GP-9 ³⁸	MOP
F176	GG-185	LUC	F20118	GG-5 L	PUR	F2604	G-1123	SAKU	F3562	GP-40	MICF
F17638	GAK-16	FAIR	F20118M	GG-5 L	PUR	F-26A04	GA-475	INTF	F3596	GG-87	FLAG
F178	GPP-18	KRA	F201-20-490A	GG-142	MZDA	F26A62	GAVW-22	INTF	F35A37	GA-54	INTF
F178	GG-227	LUC	F20162	GG-188	GRP	F27	GG-196	SRN	F35A47	GA-3647	INTF
F178B	GG-188	KRA	F20162	GG-188	PUR	F27505-06	GP-1101	POCL	F35A59	GA-271	INTF
F179	GPP-19	KRA	F20162	GG-188	QKS	F275203010020	GP-36	FEND	F35A88	GA-3588	INTF
F-17A22	GA-340	INTF	F20162	GG-188	SHE	F278201060040	G-296	FEND	F35A97	GA-734	INTF
F17F	GG-202	LUC	F20162M	GG-188	PUR	F278201060040	G-296-B	FEND	F35A97	GA-735 ¹²⁴	INTF
F18	GAD-3	IMPC	F20247	GG-194	GRP	F-27A40	GA-2740	INTF	F36	G-31	FRM
F18	GP-81	MICF	F20247	GG-194	PUR	F-27A50	GA-302	INTF	F36	GG-87	LUC
F18	GG-47	SRS	F20247	GG-194	QKS	F28	GP-1101	KRA	F-36A12	GAVW-623	INTF
F-18	GP-3600	ATL	F20247	GG-194	SHE	F283G	GP-1	WAUK	F36A60	GA-277	INTF
F180201060030	GP-1122	FEND	F20251	GG-76	EVGR	F284201310040	GP-54 ³¹	FEND	F37	GG-246	LUC
F181200060030	GP-1122	FEND	F20251	GG-76	PUR	F284201310040	GP-66 ³⁰	FEND	F3708	GPP-1122	LUC
F183	GP-26	KRA	F20251M	GG-76	PUR	F288	GP-1122	KRA	F3715	GP-3569	LUC
F183A	GP-26	KRA	F20265	GG-204	EVGR	F-28A11	GA-110	INTF	F3718	GP-20	LUC
F183AR	S 3202 ⁴⁰	KRA	F20265	GG-204	PUR	F28F	GG-203	LUC	F3727	GG-46	FLAG
F183AS	GP-26	KRA	F20265M	GG-204	PUR	F29	GG-1	LUC	F3728	GG-3728	FLAG
F184	GP-27	KRA	F208	GP-462	CHAM	F29	GG-4	LUC	F3749	GG-46	LUC
F184A	GA-77	INTF	F-20A82	GA-391	INTF	F290	GP-96	KRA	F3758	GP-81	LUC
F184A	GA-80	INTF	F-21	GP-562	ATL	F291200090100	GA-405	FEND	F3767	GP-155	FLAG
F184A	GP-27	KRA	F21111	GG-5 L	EVGR	F29157	GG-203	EVGR	F3769	GG-42	FLAG
F1856	GG-185	ASAH	F21111	GG-5 L	PUR	F29157	GG-203	PUR	F377	GP-1109 ²⁷	KRA
F187	GG-150	LUC	F21111M	GG-5 L	PUR	F29158	GG-196	PUR	F377	GP-62 ²⁰	KRA
F189A	GA-50	INTF	F21115	GG-20	EVGR	F29158M	GG-196	PUR	F3774	GP-3531	EXP
F18A36	GA-183R	INTF	F21115	GG-20	PUR	F29160	GG-5 L	PUR	F3781	GP-36	LUC
F18A83	GA-437	INTF	F21115M	GG-20	PUR	F29160M	GG-5 L	PUR	F37A17	GA-274	INTF
F19	GA-55	IMPC	F21117	GG-1	PUR	F29163	GG-8	EVGR	F38	GG-246	LUC
F-19	GP-3766	ATL	F21117	GG-4	PUR	F29163	GG-8	PUR	F3802	GG-47	FLAG
F-19	GA-55	IMPL	F21124	GG-1	EVGR	F29163	GG-8 L	PUR	F381A	GA-74	INTF
F1901	GG-87	SAKU	F21124	GG-4	EVGR	F29163M	GG-8	PUR	F38874	GP-81 ³¹	CASE
F1902	GS-2033	SAKU	F21124	GG-1	PUR	F29163M	GG-8 L	PUR	F38874	GP-9 ³⁸	CASE

REFERENCIA CRUZADA

Numero	Gonher	Fabricante	Numero	Gonher	Fabricante	Numero	Gonher	Fabricante	Numero	Gonher	Fabricante
Number	Gonher	Manufacturer	Number	Gonher	Manufacturer	Number	Gonher	Manufacturer	Number	Gonher	Manufacturer
F38A14	GA-3814	INTF	F44705	GG-7020 ¹⁴	PUR	F-481	GG-46	FACE	F50Z-9601-BA	GA-1615	FORD
F398	GP-110	KRA	F44705M	GG-7018 ³⁸	PUR	F483	GG-3728	PRET	F51	GG-8	LUC
F399	GP-1109	KRA	F44705M	GG-7019 ³⁷	PUR	F-483	GG-3728	FACE	F5104	GG-246	BOG
F39A01	GA-3901	INTF	F44705M	GG-7020 ¹⁴	PUR	F48A28	GA-4828	INTF	F5109	GPP-19	FLG
F39A02	GA-253	INTF	F44710	GG-187	EVGR	F49A39	GA-139	INTF	F512	GG-16	FACE
F-39A14	GA-392	INTF	F44710	GG-187	PUR	F4E-030-CCB	GP-66	PTI	F513	GG-17	FACE
F39A16	GA-3916	INTF	F44710M	GG-187	PUR	F4E-030-DCB	GP-66	PTI	F5133	GG-246	BOG
F39A24	GA-153	INTF	F44781	GG-185	PUR	F4E040CCB	GP-66	PTI	F5143	GG-226	BOG
F3F030HC	GP-3766	PTI	F44781M	GG-185	PUR	F4E040DCB	GP-66 ²¹	PTI	F5145	GG-246	BOG
F3HZ-6731-A	GP-178	FORD	F44782	GG-151	GRP	F4E050BCB	GP-34	PTI	F515	GG-19	FACE
F3HZ-6731-B	GP-178	FORD	F44782	GG-151	PUR	F4E050CCB	GP-34	PTI	F51600	GGP-25	PUR
F3HZ-6731-C	GP-178	FORD	F44782	GG-151	QKS	F4E-050-DCB	GP-34	PTI	F5198	GG-189	BOG
F3HZ-8A424-D	GP-1011Q	FORD	F44782	GG-151	SHE	F4E050JCB	GP-864H	PTI	F5200	GG-246	BOG
F3HZ-9365-C	GPP-1122	FORD	F44782M	GG-151	PUR	F4E050JCB	GP-864H	PUR	F5201	GG-251	BOG
F3HZ-9365-E	GPP-1122	FORD	F44788	GG-185	EVGR	F4F030GCB	GP-3766	PTI	F5203	GG-189	BOG
F3HZ-9601-A	GA-1977	FORD	F44788	GG-185	PUR	F4F030HC	GP-3766	PTI	F5206	GG-251	BOG
F3HZ-9601-B	GA-197R	FORD	F44788M	GG-185	PUR	F4HZ9162B	GPP-1122	MTR	F521	G-870	LUC
F3HZ-9601-D	GA-197R	FORD	F44789	GG-227	GRP	F4TE-9D695-AA	GA-186	FORD	F521	G-870	LUC
F3HZ-9605-A	GA-768R	FORD	F44789	GG-227	PUR	F4TZ-6731-A	GP-562	FORD	F5280	GG-106	BOG
F3HZ-9R500-A	GA-768R	FORD	F44789	GG-227	QKS	F4TZ-9D695-A	GA-186	FORD	F53119	GS-2034	PUR
F3TZ-9155-AFFV	GG-239	FORD	F44789	GG-227	SHE	F4TZ-9N184-A	G-178	FORD	F53121	GG-48	PUR
F3XY-6731-A	GP-3682	FORD	F44789M	GG-227	PUR	F4TZ-9N184-B	G-178	FORD	F53123	G-293	PUR
F3XY-6731-A	GP-37	FORD	F44829	GG-185	EVGR	F4ZX-9601-A	GA-175	FORD	F53125	GP-1122	PUR
F3XY-9155-A	GG-94	FORD	F44829	GG-185	PUR	F4ZX-9601-AC	GA-175	FORD	F53128	GG-94	PUR
F3XY-9155-F	GG-94	FORD	F44829M	GG-185	PUR	F4ZZ-9601-A	GA-175	FORD	F53135	G-297	PUR
F3XY-9601-A	GAD-118	FORD	F44830	GG-185	EVGR	F4ZZ-9601-AC	GA-175	FORD	F53135	G-297-B	PUR
F4	GG-94	LUC	F44830M	GG-185	PUR	F5	GG-19	LUC	F53148	2010PM-OR ⁷	PUR
F4	GG-45	SRS	F44830M	GG-185	PUR	F5	GP-5	REX	F53148	2010TM-OR ⁷	PUR
F400651042	GP-54 ¹¹	EAIR	F44861	GG-185	EVGR	F5	GG-1	SRS	F53149	GG-2034	PUR
F400651042	GP-66 ¹⁰	EAIR	F44861	GG-185	PUR	F5	GG-4	SRS	F53156	G-270	PUR
F40163	GG-208	EVGR	F44861M	GG-185	PUR	F50	GG-196	LUC	F53159	GG-215	EVGR
F40163	GG-208	PUR	F44870	GG-160	EVGR	F50015	GP-1101	PUR	F53159	GG-215	PUR
F40163M	GG-208	PUR	F44870	GG-160	PUR	F50016	GPP-14	PUR	F53163	GG-181	EVGR
F402351072	GP-28 ⁸	EAIR	F44870M	GG-160	PUR	F5002	GG-5 L	BOG	F53163	GG-181	PUR
F402351072	GP-430 ⁸	EAIR	F-44A94	GA-314	INTF	F50025	G-11816	PUR	F53168	GG-220	GRP
F40263	GG-185	EVGR	F44AW2	GA-215	INTF	F50032	GP-62	PUR	F53168	GG-220	PUR
F40263	GG-185	PUR	F44R	GP-1101	KRA	F50063	G-1173	PUR	F53168	GG-220	QKS
F40263M	GG-185	PUR	F45	GP-77	FAME	F50065	G-1174 ¹⁰⁸	PUR	F53168	GG-220	SHE
F4058	GG-1	BOG	F45	GP-3429	MICF	F50071	G-1163	PUR	F53185	GG-67	EVGR
F4058	GG-4	BOG	F45057	GG-185	EVGR	F50072	G-1163	PUR	F53185	GG-67	PEP
F4061	GG-5 L	BOG	F45057	GG-185	PUR	F50077	GG-185	PUR	F53185	GG-67	PUR
F414	GP-1	LUC	F45057M	GG-185	PUR	F50078	GPP-19	PUR	F53188	G-294	EVGR
F41A00	GAD-117	INTF	F45058	GG-185	EVGR	F50086	GP-1122	PUR	F53189	GP-1122	PUR
F41A00	GAD-17	INTF	F45058	GG-185	PUR	F50131	GP-1101	PUR	F53190	GG-264	EVGR
F41A16	GAVV-212	INTF	F45058M	GG-185	PUR	F50147	G-295	PUR	F53190	GG-264	PUR
F42	GG-246	LUC	F45059	GG-185	EVGR	F50149	G-296	PUR	F53191	GG-246	EVGR
F4200	G-1173 ¹⁰⁸	WIN	F45059	GG-185	PUR	F50149	G-296-B	PUR	F53191	GG-408	GRP
F4200	G-1173 ¹⁰⁸	WIN	F45059M	GG-185	PUR	F50151	G-1173 ¹⁰⁸	PUR	F53191	GG-246	GRP
F427	GG-6	PRET	F45067	GG-114	EVGR	F50154	GG-3	EVGR	F53191	GG-408	PUR
F4300	G-1173 ¹⁰⁸	WIN	F45067	GG-114	PUR	F50154	GG-3	PUR	F53191	GG-408	QKS
F43178	GG-63	EVGR	F45067M	GG-114	PUR	F50155	G-296	EVGR	F53191	GG-408	SHE
F43178	GG-63	PUR	F45068	GG-185	EVGR	F50155	G-296-B	EVGR	F53193	GG-246	EVGR
F43178M	GG-63	PUR	F45068	GG-185	PUR	F50155	G-296	PUR	F53193	GG-246	PUR
F43182	GG-232	GRP	F45068M	GG-185	PUR	F50155	G-296-B	PUR	F535	GG-870	LUC
F43182	GG-232	PUR	F45069	GG-164	GRP	F50156	GG-203	EVGR	F538	GG-48	KRA
F43182	GG-232	QKS	F45069	GG-164	PUR	F50156	GG-203	PUR	F5386	GG-48	KRA
F43182	GG-232	SHE	F45069	GG-164	QKS	F5021	GG-246	BOG	F53A50	GA-272	INTF
F43187	GG-76	EVGR	F45069	GG-164	SHE	F50218	GP-1101 ²⁴	PUR	F5401	GG-246	BOG
F43187	GG-76	PUR	F45069M	GG-164	PUR	F50227	GP-92	PUR	F5403	GG-246	BOG
F43187M	GG-76	PUR	F45071	GG-185	EVGR	F50228	GP-93	PUR	F542	G-1123	KRA
F431892	GPP-426	TIMB	F45071	GG-185	PUR	F5024	GG-226	BOG	F543	GG-1123	KRA
F4320	G-1173 ¹⁰⁸	WIN	F45071M	GG-185	PUR	F5025	GG-246	BOG	F544	G-1121	KRA
F4330	G-1173 ¹⁰⁸	WIN	F45134	GG-164	EVGR	F50255	GG-76	EVGR	F54423	GPP-18	PUR
F433618	GPP-425	TIMB	F45134	GG-164	GRP	F50255	GG-76	PUR	F54424	GP-1122	PUR
F4330	G-1173 ¹⁰⁸	WIN	F45134	GG-164	PUR	F50274	GP-92	PUR	F54493	GG-217	EVGR
F434072	GA-697R	TIMB	F45134	GG-164	QKS	F50279	GG-215	EVGR	F54493	GG-217	PUR
F435510	GP-761H	JOND	F45134	GG-164	SHE	F50279	GG-215	PUR	F54495	GG-39	GRP
F436	GP-81	LUC	F45134M	GG-164	PUR	F50282	GG-213	GRP	F54495	GG-39	PUR
F43A09	GAD-15	INTF	F45191	GG-164	EVGR	F50282	GG-213	PUR	F54495	GG-39	QKS
F44	GPP-14	KRA	F45191	GG-164	GRP	F50282	GG-213	QKS	F54495	GG-39	SHE
F441	GP-28 ⁸	LUC	F45191	GG-164	PUR	F50282	GG-213	SHE	F545	G-1121	KRA
F441	GP-430 ⁸	LUC	F45191	GG-164	QKS	F50284	GP-1122	PUR	F54562	GPP-14	PUR
F441	GG-7	PRET	F45191	GG-164	SHE	F50298	GP-155	EVGR	F54611	GG-61	EVGR
F443	GP-42	LUC	F45191M	GG-164	PUR	F50298	GP-155	PUR	F54611	GG-61	PUR
F4451	GG-196	ASAH	F459	GG-1	ASAH	F5030	GG-251	BOG	F54617	GG-67	EVGR
F44608	G-801	LUC	F459	GG-4	ASAH	F504	GG-123	PDX	F54617	GG-67	PUR
F44658	GG-148	EVGR	F46	GPP-14	KRA	F50453	G-1121	EVGR	F54618	GG-65	EVGR
F44658	GG-148	GRP	F4611	GG-61	PRET	F50453	G-1121	PUR	F54618	GG-65	GRP
F44658	GG-148	PUR	F4619	G-870	LUC	F50453	G-1121F	PUR	F54618	GG-65	PUR
F44658	GG-148	QKS	F4622	G-296	LUC	F50454	G-1123	PUR	F54618	GG-65	QKS
F44658	GG-148	SHE	F4622	G-296-B	LUC	F505	GG-6	PDX	F54618	GG-65	SHE
F44658M	GG-148	PUR	F4644	GP-81 ³¹	LUC	F506	GG-7	PDX	F54637	GG-181	EVGR
F44662	GG-185	EVGR	F4644	GP-9 ⁵⁸	LUC	F5065	GG-246	BOG	F54637	GG-181	PUR
F44662	GG-185	PUR	F4683	GG-836	LUC	F5066	GG-226	BOG	F54638	GG-190	EVGR
F44662M	GG-185	PUR	F4686	GG-834	LUC	F507	GG-19	PDX	F54638	GG-190	PUR
F44662MM7	GG-185	PUR	F4689	GG-246	LUC	F5079	GG-246	BOG	F54664	GG-220	GRP
F44663	GG-137	EVGR	F-46A60	GAD-34	INTF	F508	GG-20	PDX	F54664	GG-220	PUR
F44663	GG-137	PUR	F47	G-296	LUC	F508-13-470	GG-208	MZDA	F54664	GG-220	QKS
F44663M	GG-137	PUR	F47	G-296-B	LUC	F5087	GG-246	BOG	F54664	GG-220	SHE
F44673	GG-203	PUR	F470	GG-16	PRET	F509	GG-5 L	PDX	F54665	GG-146	EVGR
F44703	GG-185	PUR	F471	GG-246	BOG	F5091	GG-246	BOG	F54665	GG-146	GRP
F44705	GG-7018 ³⁸	EVGR	F4712	G-1123F	DUTZ	F5095	GG-251	BOG	F54665	GG-146	PEP
F44705	GG-7019 ³⁷	EVGR	F476	GG-240	PRET	F50A56	GA-5056	INTF	F54665	GG-146	PUR
F44705	GG-7020 ¹⁴	EVGR	F47A	GP-46	MICF	F50A58	GA-273	INTF	F54665	GG-146	QKS
F44705	GG-7018 ³⁸	PUR	F4804	G-33	CLEV	F50X-9601-AB	GA-1615	FORD	F54665	GG-146	SHE
F44705	GG-7019 ³⁷	PUR	F481	GG-46							

Referencia Cruzada por Numero de Parte

Cross Reference by Part Number



Numero	Gonher	Fabricante	Numero	Gonher	Fabricante	Numero	Gonher	Fabricante	Numero	Gonher	Fabricante
Number	Gonher	Manufacturer	Number	Gonher	Manufacturer	Number	Gonher	Manufacturer	Number	Gonher	Manufacturer
F54672	GG-256	GRP	F565	G-834	LUC	F60273	GG-226	PUR	F-6502	G-1173	SAKU
F54672	GG-580	PEP	F-56A26	GA-289	INTF	F60312	GP-1108	PUR	F6503	G-1175	SAKU
F54672	GG-256	PUR	F57	GG-76	LUC	F60323	GP-53	PUR	F65039	GG-95	EVGR
F54672	GG-256	QKS	F-5701	G-1143	SAKU	F604	GP-3	LUC	F65039	GG-95	PUR
F54672	GG-256	SHE	F5702	G-1143	SAKU	F60454	G-1123	PUR	F65041	GPP-1287 ³¹	PUR
F54675	GP-1232	PUR	F5704	G-1143 ³⁰	SAKU	F60454	G-1123F	PUR	F65041	PPF831 ⁴¹	PUR
F54686	GG-177	GRP	F57042	GP-1122	PUR	F61	GG-5 L	PRET	F65041	R 60 P ⁴²	PUR
F54686	GG-177	PUR	F57336	GP-1122	PUR	F612	GP-20	LUC	F6505	G-1174	SAKU
F54686	GG-177	QKS	F57629	G-296	PUR	F614	GP-5	LUC	F65061	GP-749	PUR
F54686	GG-177	SHE	F57629	G-296-B	PUR	F6201	GP-22	LUC	F65070	GG-104	EVGR
F54708	GG-150	EVGR	F577	G-225	LUC	F6202	GP-3600	LUC	F65070	GG-104	PUR
F54708	GG-150	GRP	F-57A24	GA-2158	INTF	F6203	GP-1	LUC	F6510	GP-38	LUC
F54708	GG-150	PUR	F57X-9601-AA	GA-1616	FORD	F622	GP-58	LUC	F65120	GPP-547 ³⁹	PUR
F54708	GG-150	QKS	F57Z-9601-A	GA-1616	FORD	F627	GG-5 L	PRET	F65120	PPF831 ⁴¹	PUR
F54708	GG-150	SHE	F58	GG-208	LUC	F628	GP-81	LUC	F65120	R 60 P ⁴²	PUR
F54714	GG-66	EVGR	F580A	GA-179	INTF	F6300	G-1174 ¹⁰⁸	WIN	F65138	GG-267	GRP
F54714	GG-66	PUR	F-583A	GA-196	INTF	F63169	GG-47	EVGR	F65138	GG-267	PUR
F54718	GG-72	EVGR	F589	G-200	PUR	F63169	GG-47	PUR	F65138	GG-267	QKS
F54718	GG-72	PEP	F59016	GP-26	PUR	F63177	GG-246	EVGR	F65139	GG-265	PUR
F54718	GG-72	PUR	F59030	GG-182	PUR	F63177	GG-246	PUR	F65140	GG-1133	PUR
F54724	GG-92	PUR	F59071	GG-1163	PUR	F63180	GG-298	EVGR	F65166	GPP-1122	PUR
F54725	GGP-25	PUR	F59158	GG-196	EVGR	F63180	GG-298	PUR	F65169	GPP-419	PUR
F54780	GG-62	PUR	F59160	GG-5 L	EVGR	F63188	G-294	PUR	F65170	GPP-419	PUR
F54790	GG-214	EVGR	F59161	GG-79	EVGR	F63A62	GA-362	INTF	F65170	GPP-426	PUR
F54790	GG-214	PUR	F59161	GG-79	PUR	F63A66	GA-174	INTF	F65171	GPP-419	PUR
F54794	GG-92	EVGR	F59265	GP-1122	EVGR	F6401	GG-48	SAKU	F65171	GPP-421	PUR
F54794	GG-94	PUR	F59265	GP-1122	PUR	F6429	GP-38	LUC	F652	GP-81	LUC
F54822	GG-189	EVGR	F59292	G-862	PUR	F64424	GPP-1122	PUR	F65213	GP-110	PUR
F54822	GG-189	PUR	F59453	G-1121F	PUR	F64492	GG-142	EVGR	F65214	GP-1109 ²²	PUR
F54833	GG-136	EVGR	F599	G-1123	KRA	F64492	GG-142	GRP	F65214	GP-62 ³⁰	PUR
F54833	GG-136	GRP	F5OX-9601-AB	GA-1615	FORD	F64492	GG-142	PUR	F65217	GG-64	EVGR
F54833	GG-136	PUR	F5OY-9601-A	GA-1615	FORD	F64492	GG-142	QKS	F65217	GG-64	PUR
F54833	GG-136	QKS	F5RZ-19N619-A	GAC-9	FORD	F64492	GG-142	SHE	F65238	GG-267	EVGR
F54833	GG-136	SHE	F5RZ-19N619-B	GAC-9	FORD	F6457	GG-28 ⁹	LUC	F65238	GG-267	GRP
F54846	GG-234	GRP	F5RZ-19N619-BA	GAC-9	FORD	F6457	GP-430 ⁸	LUC	F65238	GG-267	PUR
F54846	GG-234	PUR	F5RZ-19N619-C	GAC-9	FORD	F6458	GP-46	LUC	F65238	GG-267	QKS
F54846	GG-234	QKS	F5RZ-6731-B	GP-31	FORD	F646	GP-50	LUC	F65238	GG-267	SHE
F54846	GG-234	SHE	F5RZ-9601-B	GA-128	FORD	F64621	GG-30	EVGR	F65239	GG-265	EVGR
F549	G-801	LUC	F5RZ-9601-C	GA-127	FORD	F64621	GG-30	PEP	F65239	GG-265	PUR
F54A66	GA-5466	INTF	F5TZ-9601-A	GA-442	FORD	F64621	GG-30	PUR	F65255	GP-78	PUR
F54A96	GA-134	INTF	F5UZ-9601-A	GA-VW-620	FORD	F64628	GG-243	EVGR	F65273	G-128	PUR
F55	GG-76	LUC	F6	G-1174	HUT	F64628	GG-243	PEP	F65277	GG-986	EVGR
F55055	G-178	EVGR	F6	GP-20	MICF	F64628	GG-243	PUR	F65277	GG-986	PUR
F55055	G-178	PUR	F60017	GP-26	PUR	F6464	GP-22	LUC	F65285	GG-102	EVGR
F55073	GG-146	GRP	F60021	G-1166	PUR	F64641	GG-189	EVGR	F65285	GG-102	PUR
F55073	GG-146	PUR	F60024	GPP-11	PUR	F64641	GG-189	PUR	F65299	GPP-419	PUR
F55073	GG-146	QKS	F60025	S 3202 ⁴⁰	PUR	F6465	GP-36	LUC	F-654	G-25	FIBA
F55073	GG-146	SHE	F60026	GPP-11	PUR	F6466	GP-81	LUC	F65416	GG-420	PUR
F551	G-836	LUC	F60027	GP-11	PUR	F6467	GP-462	LUC	F6542	GP-46	LUC
F55110	GPP-418	PUR	F60030	GP-84	PUR	F64685	GG-580	EVGR	F65422	GG-239	GRP
F55114	GG-185	EVGR	F60031	GP-83	PUR	F64685	GG-580	PEP	F65422	GG-239	PUR
F55114	GG-185	PUR	F60032	GP-1105	PUR	F64685	GG-580	PUR	F65422	GG-239	QKS
F55141	GG-1133	PUR	F60038	GP-11	PUR	F6469	GP-42	LUC	F65422	GG-239	SHE
F5517	G-162H	LUC	F60042	GP-1107	PUR	F64702	GG-581	EVGR	F65455	GG-47	PUR
F5517K	G-162H	LUC	F60042	GP-1109	PUR	F64702	GG-581	PEP	F65472	GG-308	GRP
F55187	G-277	PUR	F60043	GG-581	PUR	F64702	GG-581	PUR	F65472	GG-308	PUR
F55188	G-276	PUR	F60046	GP-1107	PUR	F64704	GG-247	GRP	F65472	GG-308	QKS
F55190	GPP-425	PUR	F60053	GP-110	PUR	F64704	GG-247	PUR	F65472	GG-308	SHE
F55212	GS-1261	PUR	F60059	G-1174 ¹⁰⁸	PUR	F64704	GG-247	QKS	F65481	GG-101	PUR
F55233	G-1143 ³⁰	PUR	F60096	GP-26	PUR	F64704	GG-247	SHE	F6550	GP-3985 ⁴³	LUC
F55275	GG-351	EVGR	F60097	GP-27	PUR	F64706	GG-115	EVGR	F65500	GP-307	PUR
F55275	GG-351	PUR	F600F325	GAK-16	CONT	F64706	GG-115	GRP	F6555	GP-3985	LUC
F55292	G-862	EVGR	F600F466	GAK-16	CONT	F64706	GG-115	PUR	F65563	GG-419	PUR
F55292	G-862	PUR	F600L214	G-31	CATP	F64706	GG-115	QKS	F65574	GG-101	PUR
F55293	GPP-419	PUR	F600L214	G-31	CONT	F64706	GG-115	SHE	F6571	GP-22	LUC
F55294	GPP-425	PUR	F600L214	G-31	TELE	F64707	GG-249	EVGR	F6577	GP-81	LUC
F55325	GPP-1122	PUR	F600L214	G-31	TOWM	F64707	GG-249	PEP	F6578	GP-91	LUC
F5534	GP-81	LUC	F600L215	G-31	CONT	F64707	GG-249	PUR	F658	GP-81 ³¹	LUC
F55360	GS-1261	PUR	F600L215	G-31	TELE	F64711	GG-1872	EVGR	F658	GP-9 ³⁸	LUC
F55365	GG-206	GRP	F600L221	G-31	CONT	F64711	GG-1872	PUR	F6581	GP-40	LUC
F55365	GG-206	PUR	F600L221	G-31	TELE	F64728	GG-92	EVGR	F6583	GP-3985	LUC
F55365	GG-206	QKS	F600L3750	GP-1	CONT	F64728	GG-92	PUR	F6584	GP-3682	LUC
F55365	GG-206	SHE	F600L4340	GP-50	CONT	F6473	GP-38	LUC	F6584	GP-37	LUC
F554	GG-5 L	ASAH	F601	GG-1	PDX	F64746	GPP-1122	PUR	F6585	GP-171	LUC
F5541	GP-50	LUC	F601	GG-4	PDX	F64795	GG-268	EVGR	F6586	GP-157	LUC
F55412	GG-290	PUR	F60132	GP-1108	PUR	F64795	GG-268	PEP	F6588	GP-156	LUC
F55417	GG-187	GRP	F60132	GP-1108	WALM	F64795	GG-268	PUR	F6591	GP-462	LUC
F55417	GG-187	PUR	F60134	G-1123	PUR	F64816	GG-99	GRP	F6593	GP-3682	LUC
F55417	GG-187	QKS	F60145	GG-251	EVGR	F64816	GG-99	PUR	F6593	GP-37	LUC
F55417	GG-187	SHE	F60146	GG-251	PEP	F64816	GG-99	QKS	F6594	GP-462	LUC
F5542	GP-20	LUC	F60146	GG-251	PUR	F64816	GG-99	SHE	F6595	GP-462	LUC
F5547	GP-3	LUC	F60150	G-1175	PUR	F64817	GG-84	EVGR	F6596	GP-212	LUC
F55493	GG-299	PUR	F60152	GPP-1122	EVGR	F64817	GG-84	GRP	F65A45	GA-VW-120	INTF
F55493	GG-66	PUR	F60152	GPP-1122	PUR	F64817	GG-84	PPRO	F65A55	GA-275	INTF
F55529	GG-265 ³⁶	PUR	F602	GG-45	PDX	F64817	GG-84	PUR	F65A76	GA-276	INTF
F55577	GG-209	PUR	F60217	GP-1122	PUR	F64817	GG-84	QKS	F65Z-19N619-AB	GAC-1	FORD
F55580	GPP-612	PUR	F60222	GPP-111	EVGR	F64817	GG-84	SHE	F66	GG-47	LUC
F5559	GG-142	ASAH	F60222	GPP-524	EVGR	F64857	GG-261	GRP	F6602	GP-46	LUC
F55590	G-1047	PUR	F60222	GPP-111	PUR	F64857	GG-261	PUR	F6603	GP-156	LUC
F5578	GP-3816	LUC	F60222	GPP-524	PUR	F64857	GG-261	QKS	F6605	GP-46	LUC
F558	GG-208	ASAH	F60231	GPP-11	PUR	F64857	GG-261	SHE	F66065	S 3202 ⁴⁰	PUR
F5596	GP-22	LUC	F60231	GPP-14	PUR	F64863	GPP-18	PUR	F6608	GP-40	LUC
F56	GG-194	LUC	F60232	GP-11 ⁷⁶	PUR	F64997	GP-78	PUR	F6609	GP-3985	LUC
F5600	G-1176	KRA	F60232	GP-1101 ⁴⁵	PUR	F64A79	GA-6479	INTF	F6613	GP-157	LUC
F5600	GP-81	LUC	F60233	GP-110	PUR	F64A-91	GA-129	INTF	F6618	GP-58	LUC
F5601	GG-246	BOG	F60273	GG-226	EVGR	F6501	G-1173	SAKU	F6620	GP-452	LUC

REFERENCIA CRUZADA

Numero	Gonher	Fabricante	Numero	Gonher	Fabricante	Numero	Gonher	Fabricante	Numero	Gonher	Fabricante
Number	Gonher	Manufacturer	Number	Gonher	Manufacturer	Number	Gonher	Manufacturer	Number	Gonher	Manufacturer
F6622	GP-156	LUC	F75A97	GA-164	INTF	F87A55	GA-348	INTF	FA 1626	GAC-9	MTR
F6623	GP-3682	LUC	F763	G-1173 ¹⁰⁸	KRA	F880	GA-230	LUC	FA 1682	GA-433	FORD
F6623	GP-37	LUC	F764	G-1173 ¹⁰⁸	KRA	F88A05	GA-278R	INTF	FA 1682	GA-433	MTR
F664	GP-58	LUC	F764H	G-1173 ¹⁰⁸	KRA	F895	GA-303	LUC	FA 5602 ECO	G-25	FIA
F668	GP-38	LUC	F765	G-1174 ¹⁰⁸	KRA	F8954	GG-208	ASAH	FA 723-R	GA-3445	MTR
F-66A00	GAD-315	INTF	F768	G-1175	KRA	F-89A11	GA-194	INTF	FA 734	GA-642	MTR
F66A19	GA-6619 ¹	INTF	F769	G-1175	KRA	F89A25	GA-780	INTF	FA 767	GA-3566	MTR
F66A19	GA-6620 ²	INTF	F769G	G-1175	KRA	F-89A70	GA-216	INTF	FA 794	GA-885	MTR
F66A19A	GA-6619 ¹	INTF	F769H	G-1176	KRA	F89A97	GA-224	INTF	FA 986	GA-140	MTR
F66A19A	GA-6620 ²	INTF	F76A14	GA-VW-620	INTF	F89Z-9155-A	GG-986	FORD	FA051	GAD-3	ASAH
F-66A90	GA-6690	INTF	F76A28	GAD-118	INTF	F8A05	GA-301	INTF	FA1	GA-56	ADP
F67	GP-58	LUC	F77	GG-217	LUC	F8AZ-9601-AA	GA-1615	FORD	FA1	GA-77	MTR
F67221	GG-255	EVGR	F770	GA-4365	LUC	F8CZ-6731-AA	GP-128	FORD	FA10	GA-85	ADP
F67221	GG-255	PUR	F771	G-1163	KRA	F8XZ-9155-AA	GG-63	FORD	FA10	GA-70	MTR
F678	GP-1	LUC	F771	GA-75	LUC	F9	GG-3	LUC	FA10	GP-66	PRIN
F67X-9601-AA	GA-1614	FORD	F778	GA-VW-2	LUC	F9	GG-6	SRS	FA1000	GA-3637	MTR
F67Z-9601-AA	GA-1614	FORD	F779	GA-VW-4	LUC	F91	GG-251	LUC	FA1001	GA-3637	MTR
F68	GG-79	LUC	F77A30	GA-175	INTF	F9107	GA-200	LUC	FA1007	GA-734 ⁴¹	MTR
F682665	GA-360	EUCL	F77A37	GA-128	INTF	F9107	GP-58	LUC	FA1007	GA-735 ²⁴	MTR
F684	GP-58	LUC	F77A38	GA-127	INTF	F9132	GAD-3	LUC	FA101	GP-66	GRES
F68A49	GAD-129	INTF	F77A64	GA-172	INTF	F914	GA-77	LUC	FA101234	GAK-20	FLEE
F68A50	GAD-294	INTF	F77A74	GA-1616	INTF	F9150	GA-3300	LUC	FA101237	GA-24	FLEE
F69	GG-185	LUC	F77X-9601-AA	GA-158	FORD	F91521	GP-317H	TIKO	FA101240	GA-27	FLEE
F69031	GP-78	PUR	F77Z-9601-AA	GA-158	FORD	F9153	GA-50	LUC	FA101243	GA-26	FLEE
F69031	GP-78	WALM	F78	GP-26	KRA	F9160	GA-2740	LUC	FA101246	GAK-403	FLEE
F694	GP-3985 ⁸³	LUC	F780	GA-VW-4	LUC	F9161	GAD-3	LUC	FA101275	GA-33	FLEE
F69A00	GAD-117	INTF	F785	GA-2719B	LUC	F9176	GAD-1 ⁸⁷	LUC	FA1015	GA-3501	MTR
F69A00	GAD-17	INTF	F7862	GG-185	ASAH	F9196	GA-VW-2	LUC	FA1017	GA-85	MTR
F6HZ-9601-AB	GA-930R	FORD	F795	GG-87	FACE	F9235	GA-271	LUC	FA1018	GA-74	MTR
F6M	GG-5 L	LUC	F795	GG-87	PRET	F9245	GA-VW-2	LUC	FA1019	GA-303	MTR
F6P	GG-5 L	LUC	F797	G-1176	KRA	F9250	GAD-30	LUC	FA1019R	GA-303	MTR
F6QA01	GA-VW-624	INTF	F798	G-1176	KRA	F9258	GA-VW-4	LUC	FA1020	GA-80	MTR
F6RZ-9601-CA	GA-128	FORD	F7CX-9601-AA	GA-130	FORD	F927	GAD-1 ⁸⁷	LUC	FA1020R	GA-80	MTR
F6ZX-9601-AA	GA-1615	FORD	F7CZ-9601-A	GA-130	FORD	F9274	GA-4325	LUC	FA1021	GA-85	MTR
F6ZZ-9601-A	GA-1615	FORD	F-7HA01	GA-VW-627	INTF	F9278	GA-390	LUC	FA1022	GA-75	MTR
F70062	GPP-1000	PUR	F-7KA12	GA-VW-625	INTF	F9279	GA-4958	LUC	FA1023	GA-3300	MTR
F70085	GP-56	PUR	F8	GG-8 ¹⁰³	SRS	F9280	GA-78	LUC	FA1024	GA-3300	MTR
F70134	GP-55	PUR	F8	GG-8 L ⁸⁰	SRS	F9284	GAD-15	LUC	FA1024R	GA-3300	MTR
F70150	GP-85	PUR	F800G	G-1166	KRA	F-92A69	GA-413R	INTF	FA1025	GA-75	MTR
F7019-113	G-1121	CAV	F800H	G-1166	KRA	F9306	GA-471	LUC	FA1026	GA-3425	MTR
F7019-122	G-1123	CAV	F801-23-603	GA-2740	MZDA	F9309	GA-216	LUC	FA1027	GA-3425	MTR
F7019-122	G-1123F	CAV	F802-23-802	GP-462	MZDA	F9313	GA-139	LUC	FA1027R	GA-3425	MTR
F7019-221	G-1121	CAV	F80A04	GA-1615	INTF	F9315	GA-195	LUC	FA1029	GA-735 ²⁴	MTR
F702	GA-303	LUC	F80A37	GA-732R	INTF	F9317	GA-180	LUC	FA1029R	GA-735 ²⁴	MTR
F70230	G-1143	PUR	F80A38	GA-673R	INTF	F9318	GA-VW-4	LUC	FA103	GA-4303	ECO
F703	GA-145	KRA	F80A60	GA-49	INTF	F9321	GA-390	LUC	FA103	GP-66	GRES
F703	GA-4303	LUC	F80A69	GA-244	INTF	F9331	GA-382	LUC	FA1031	GA-277	MTR
F7031-102	G-1123	CAV	F80A80	GA-VW-622	INTF	F9334	GA-6690	LUC	FA1032	GA-5056	CAC
F7031-102	G-1123F	CAV	F81	GG-63	LUC	F9340	GA-471	LUC	FA1032	GA-5056	MTR
F7031-105	G-1123	CAV	F816200060010	GPP-1122	FEND	F9342	GAD-30	LUC	FA1033	GA-176	MTR
F7031-105	G-1123F	CAV	F81A41	GA-1614	INTF	F9343	GA-362	LUC	FA1034	GA-390	MTR
F7031-57	G-1123	CAV	F81A42	GA-130	INTF	F9345	GA-78	LUC	FA1035	GA-230	MTR
F7031-57	G-1123F	CAV	F81A-9601-AA	GA-472	FORD	F9347	GA-4325	LUC	FA1036	GA-70	MTR
F7031-6	G-1123	CAV	F8129155AC	GG-986	MTR	F9352	GA-2110	LUC	FA1037	GA-200	MTR
F7031-6	G-1123F	CAV	F812-9601-AB	GA-472	FORD	F9353	GA-2110	LUC	FA1037	GP-58	MTR
F71	G-1163	HUT	F812-9N184-AA	G-862	FORD	F9359	GAD-3	LUC	FA1038	GA-4828	MTR
F71000	GPP-1000	PUR	F8210	GA-7	LUC	F9369	GA-142	LUC	FA103951	GAP-379	FLEE
F71001	GPP-1000	PUR	F8221	GA-7	LUC	F9379	GA-4325	LUC	FA1040	GA-89	MTR
F7111-296	G-296	CAV	F824201310040	GP-54 ¹¹	FEND	F9381	GA-VW-4	LUC	FA1041	GA-422	MTR
F7111-296	G-296-B	CAV	F824201310040	GP-66 ¹⁰	FEND	F9383	GAD-30	LUC	FA1043	GA-273	CAC
F7111-296	G-296	LUC	F8251	G-296	JCBM	F9393	GA-4828	LUC	FA1043	GA-273	MTR
F7111-296	G-296-B	LUC	F8251	G-296-B	JCBM	F9394	GA-277	LUC	FA1045	GA-277	MTR
F71601	GGP-25	PUR	F8265	GA-71	LUC	F9396	GA-2106	LUC	FA1046	GA-174	CAC
F716200510020	G-3754	FEND	F8271	GAD-1	LUC	F9397	GA-2106	LUC	FA1046	GA-174	MTR
F720	G-278	KRA	F8278	GA-VW-2	LUC	F9398	GA-2106	LUC	FA1047	GA-176	GKIN
F7205	GA-140	LUC	F8285	GA-230	LUC	F9399	GA-386	LUC	FA1047	GA-176	MIGH
F721	G-277	KRA	F828-F	G-1163	BLDW	F93A45	GA-414R	INTF	FA1047	GA-176	MTR
F7211	GA-3566	LUC	F8299	GA-50	LUC	F93A59	GA-293	INTF	FA1047	GA-176	PROG
F7212	GA-735 ²⁴	LUC	F82A21	GA-279	INTF	F94	GG-196	LUC	FA1047	GA-176	SECU
F7217	GA-3490	LUC	F82A43	GA-158	INTF	F-94A93	GA-184	INTF	FA105	GA-277	ECO
F73	GP-24 ²⁶	MICF	F8300	GA-303	LUC	F950-F	G-1123F	BLDW	FA1050	GA-471	MTR
F73	GP-462 ⁹⁴	MICF	F8300	G-1175	WIN	F953-F	G-1121F	BLDW	FA1051	GA-275	MTR
F73	GP-24 ²⁶	NIPP	F8301	GA-230	LUC	F96	GG-3	LUC	FA1052	GA-589	MTR
F73008	GS-2033	PUR	F8300	G-1175 ¹⁰⁸	WIN	F961	G-296	KRA	FA1057	GA-3501	MTR
F7306	GG-5 L	LUC	F8330	G-1175	WIN	F961	G-296-B	KRA	FA106032	GA-403	FLEE
F7326	GA-2194	LUC	F8330	G-1176	WIN	F961A	G-296	KRA	FA1061	GA-275	MTR
F7351	GA-3490	LUC	F834	G-1121	BLDW	F961A	G-296-B	KRA	FA106587	GA-360	FLEE
F7358	GA-3425	LUC	F834-F	G-1121F	BLDW	F963	G-297	KRA	FA106641	GA-6127	FLEE
F7359	GA-3300	LUC	F84	G-297-B	KRA	F963	G-297-B	KRA	FA106769	GA-106 ⁴⁶	FLEE
F7360	GA-2719B	LUC	F84	GG-220	LUC	F964	G-297	KRA	FA106769	GA-326 ⁷¹	FLEE
F7363	GA-277	LUC	F845	G-297-B	KRA	F964	G-297-B	KRA	FA106775	GA-206	FLEE
F7369	GA-3445	LUC	F84514	GAK-16	CASE	F-96A01	GA-284	INTF	FA1071	GA-274	MTR
F7385	GA-VW-2	LUC	F84514C	GAK-16	CASE	F96A20	GA-285	INTF	FA1072	GA-133	MTR
F73A65	GA-217	INTF	F84574	GAK-16	CASE	F-96A21	GA-288R	INTF	FA1072R	GA-133	MTR
F74A14	GA-141	INTF	F84998	GAK-16	CASE	F-96A81	GA-606	INTF	FA1073	GA-217	MTR
F74A17	GA-198	INTF	F-85	GP-128	ATL	F96A87	GA-1617	INTF	FA1076	GA-529	MTR
F74A21	GA-165	INTF	F855	GG-76	ASAH	F97	GG-208	LUC	FA1077	GA-682R	MTR
F74A31	GA-VW-121	INTF	F856	GG-208	ASAH	F971	GAD-1	LUC	FA1081	GAD-30	MTR
F74A32	GA-132	INTF	F860	GG-246	LUC	F99	GG-246	LUC	FA1082	GA-2194	MTR
F74A40	GA-300	INTF	F866	GAD-1	LUC	F-99A02	GA-324	INTF	FA1085	GA-3916	MTR
F75	GG-214	LUC	F86A02	GA-VW-621	INTF	F9929	G-11816	FORD	FA1086	GA-3814	MTR
F750-L	G-750	BLDW	F86A06	GA-8606	INTF	FA 1090	GA-4958	MTR	FA1087	GAD-117	MTR
F75185	GP-749	PUR	F86A51	GA-VW-626	INTF	FA 1095	GA-390	MTR	FA1087	GAD-15	MTR
F75326	GPP-10075	PUR	F87	GG-220	LUC	FA 1105	GA-382	MTR	FA1089	GA-78	MTR
F756	G-270	KRA	F-87A36	GA-280	INTF	FA 1116	GA-604	MTR	FA1091	GA-3915	MTR
F759	G-295	KRA	F87A47	GA-258	INTF	FA 1122	GA-432	MTR	FA109155	GA-356	FLEE

Referencia Cruzada por Numero de Parte

Cross Reference by Part Number



Numero	Gonher	Fabricante	Numero	Gonher	Fabricante	Numero	Gonher	Fabricante	Numero	Gonher	Fabricante
Number	Gonher	Manufacturer	Number	Gonher	Manufacturer	Number	Gonher	Manufacturer	Number	Gonher	Manufacturer
FA109159	GA-357	FLEE	FA1668	GA-1615	MTR	FA250	GA-39	CUMM	FA4283	G-1174 ¹⁰⁸	FIA
FA1092	GA-253	MTR	FA1669	GA-472	MTR	FA250	GA-230	MTR	FA4287	G-33	FIA
FA1094	GA-153	MTR	FA1673	GA-1616	MTR	FA250C5S	GA-18	FLEE	FA4287A	G-33	FIA
FA1097	GA-139	MTR	FA1675	GA-472	MTR	FA2510	GA-281	INTF	FA4300	GA-39	PERM
FA1099	GA-3901	MTR	FA1679	GA-479	MTR	FA2512	GA-826	FRM	FA4303	G-836	FIA
FA10R	GA-701	MTR	FA1680	GA-780	MTR	FA2512	GA-827	FRM	FA4307	GG-48	FIA
FA11	GA-59	ADP	FA1683	GA-224	MTR	FA253	GA-37	CUMM	FA4327	GG-48	FIA
FA11	G-191	FAME	FA1688	GA-168	MTR	FA2704	G-870	TEC	FA4341	G-152	FIA
FA11	GA-105	MTR	FA1695	GA-395	MTR	FA2716	G-813	TEC	FA4345	G-6	FIA
FA1100	GA-362	MTR	FA1696	GA-224	MTR	FA273	GA-31	MTR	FA4361	G-801	FIA
FA1101	GA-195	MTR	FA1697	GA-1615	MTR	FA284	GA-29	MTR	FA439	GA-80	FIA
FA1108	GA-6619 ¹	MTR	FA1699	GA-966R	MTR	FA-2874	GA-2174	FIBA	FA4403	GP-1	FIA
FA1108	GA-6620 ²	MTR	FA170	GA-21	MTR	FA289	GA-6127	MTR	FA4405	G-335	FIA
FA1112	GA-6690	MTR	FA1701	GA-132	MTR	FA291	GA-135	MTR	FA4407	G-1163	FIA
FA1116	GA-529	MTR	FA1702	GA-134	MTR	FA291FP	GA-135	MTR	FA4447	G-834	FIA
FA1117	GA-217	MTR	FA1703	GA-165	MTR	FA2S1285	GA-1285	FLEE	FA4458	G-1173	FIA
FA1118	GA-217	MTR	FA1704	GAD-30	MTR	FA2S1286	GA-1286	FLEE	FA4483	G-834	FIA
FA1119	GA-197R	MTR	FA1705	GAVW-621	MTR	FA2S1287	GA-1287	FLEE	FA4483B	G-834	FIA
FA1120	GA-768R	MTR	FA1706	GAVW-620	MTR	FA3	GA-80	MTR	FA451	GA-70	APL
FA1121	GAD-118	MTR	FA1707	GAVW-620	MTR	FA30	GA-153	MTR	FA4531A	GP-58	FIA
FA1127	GA-6479	MTR	FA171	GA-75	ECO	FA305	GA-730	FRED	FA4558	G-330	FIA
FA-11-5069	GA-879	FLEE	FA1710	GA-780	MTR	FA31	GA-192	MTR	FA4592	G-238	FIA
FA116880	GA-6880	FLEE	FA1711	GA-479	MTR	FA3126	GAK-16	PERM	FA4616	G-222	FIA
FA116918	GA-378	FLEE	FA1732	GA-134	MTR	FA3138	GA-54	FRML	FA4637	G-33	FIA
FA117797	GA-229	FLEE	FA1744	GA-158	MTR	FA3193	GA-892	PERM	FA4637A	G-33	FIA
FA118047	GA-276	FLEE	FA1746	GA-4999	MTR	FA31R	GA-192	MTR	FA4648	GG-202	FIA
FA1206	GA-2159	INTF	FA175	G-750	FAME	FA32	GA-3588	MTR	FA4709	G-870	FIA
FA120PL	GA-7	FRM	FA1750	GA-780	MTR	FA329	GA-57	FRED	FA473	GA-77	APL
FA123	GA-11	MTR	FA1754	GA-1617	MTR	FA3293	GAK-20	PERM	FA474	GA-90	APL
FA128	GAK-16	MTR	FA176	G-500	FAME	FA3297	GA-200	PERM	FA4749	G-1163	FIA
FA129	GAK-20	MTR	FA1760	GA-281	MTR	FA3297	GP-58	PERM	FA476	GA-90	APL
FA129472	GA-372	FLEE	FA1762	GA-172	MTR	FA33	GA-70	MTR	FA479	GA-230	APL
FA129544	GA-107	FLEE	FA1763	GA-172	MTR	FA3300	GA-24	PERM	FA-485	GA-323	DANT
FA130	GA-24	MTR	FA1764	GA-172	MTR	FA332	GA-325	FRED	FA4862	GP-28 ⁹	FIA
FA130959	GA-373	FLEE	FA1765	GA-278R	MTR	FA3321	GA-436	PERM	FA4862	GP-430 ⁸	FIA
FA131	GAK-403	MTR	FA1766	GA-132	MTR	FA3338A	GA-50	FRM	FA4873	G-163	FIA
FA132	GA-50	FRED	FA1768	GA-59	MTR	FA3359	GA-234	INTF	FA4889	G-163	FIA
FA132	GA-33	MTR	FA1778	GA-4999	MTR	FA3384	GAVW-2	INTF	FA4889A	G-163	FIA
FA1331	GA-139	MTR	FA178	GAVW-2	ECO	FA34	GA-3916	MTR	FA4901	G-143	FIA
FA1338	GA-3901	MTR	FA178	GA-192	FRED	FA3437	GAK-403	PERM	FA491A	G-143	FIA
FA1345	GA-216	MTR	FA-1780	GA-1540	MTR	FA3454	GA-49	PERM	FA4936	GP-390 ⁹³	FIA
FA1348	GA-392	MTR	FA-1782	GA-1571	MTR	FA3470	GA-467	PERM	FA4953	G-133	FIA
FA1351	GA-2106	MTR	FA-1785	GA-1572	MTR	FA348	GA-59	FRED	FA4953	G-989	FIA
FA1352	GA-129	MTR	FA1791	GAD-117	MTR	FA35	GA-49	MTR	FA4995	G-331	FIA
FA136	GA-9045	MTR	FA1791	GAD-15	MTR	FA35-10	GP-66	FAY	FA49853	GA-375	FLEE
FA1360	GA-276	MTR	FA18	GA-78	ADP	FA352	GAVW-10	MTR	FA4M8047	GA-8047	FLEE
FA1366	GA-142	MTR	FA1801	GA-2194	PERM	FA3525	GP-66	FAY	FA4M9334	GA-9334	FLEE
FA137	GA-1287	MTR	FA1808	GA-277	PERM	FA36	GA-90	MTR	FA4M9378	GA-1008	FLEE
FA138	GA-9334	MTR	FA1812	GA-8606	MTR	FA362	GA-2984	FLEE	FA50	GA-85	FRED
FA1381	GA-253	MTR	FA1814	GAVW-2	PERM	FA362-SERIES	GA-2984	FLEE	FA50	GA-85	MTR
FA1386	GAVW-120	MTR	FA1816	GAD-15	PERM	FA3642	GA-106 ⁶⁶	PERM	FA501	GA-39	MTR
FA139	GA-1286	MTR	FA1830	GA-164	MTR	FA3642	GA-326 ⁷¹	PERM	FA504	GA-37	MTR
FA140	GA-375	MTR	FA1836	GA-392	MTR	FA3643	GA-360	PERM	FA51110	GP-34	FAY
FA1400	GAD-30	MTR	FA1837	GA-279	MTR	FA3644	GA-6129	PERM	FA51125	GP-34	FAY
FA146	GA-71	FRED	FA184	GA-77	FRED	FA3650	GA-206	PERM	FA5129	G-870	FIA
FA151	GA-349 ⁵⁸	ECO	FA185	GA-206	MTR	FA3651	GA-361	PERM	FA5156	G-963	FIA
FA151	GAD-3	ECO	FA1850	GA-397	MTR	FA-367	GA-323	FIBA	FA519	GA-44	MTR
FA155	GAVW-2	MTR	FA1864	GA-285	MTR	FA3675	GA-230	PERM	FA52	GA-303	FRED
FA156	GAD-3	MTR	FA188	GA-3490	ECO	FA3695	GA-229	PERM	FA52	GA-303	MTR
FA158	GA-361	MTR	FA188	GA-360	MTR	FA37	GAD-15	MTR	FA524	GA-8047	MTR
FA1580	GA-109	FLEE	FA-1883	GA-437	MTR	FA3702	GA-405	PERM	FA525	GA-1285	MTR
FA1580	GA-109	FRM	FA-1884	GA-1542	MTR	FA38	GAD-294	MTR	FA52R	GA-303	MTR
FA1580-SERIES	GA-109	FRM	FA189	G-139	FAME	FA39	GA-55	MTR	FA536	GA-1008	MTR
FA1581	GA-229	FRM	FA1893	GA-71	PERM	FA39-R	GA-55	MTR	FA537	GA-1284	MTR
FA1581-SERIES	GA-229	FRM	FA189PL1	GA-50	FRM	FA3-R	GA-80	MTR	FA54	GA-3300	FRED
FA1596	GA-209	FLEE	FA189PL2	GA-50	FRM	FA4	GA-70	ADP	FA5442	G-25	FIA
FA15961	GA-209	FRM	FA192	GA-356	MTR	FA4	GA-70	FRED	FA546	GA-5648	MTR
FA15962	GA-209 ¹⁰⁴	FRM	FA193	GA-2740	ECO	FA40	G-238	FAME	FA547	GA-5648	MTR
FA15962	GA-210	FRM	FA196	GA-357	MTR	FA4005	G-238	FIA	FA5626	GA-289	INTF
FA1596-SERIES	GA-209 ¹⁰⁴	FRM	FA19A35	GA-334	INTF	FA400507	G-238	FIA	FA565	GA-360	MTR
FA1596-SERIES	GA-210	FRM	FA1P7360	GA-7360	FLEE	FA4009	G-870	FIA	FA57	GA-80	FILC
FA1599-SERIES	GA-107	FRM	FA1P7716	GA-7716	FLEE	FA4012	G-801	FIA	FA571	GA-26	MTR
FA1599-SERIES	GA-108	FRM	FA1P8482	GA-4828	FLEE	FA4012A	G-801	FIA	FA57-10	GP-34	FAY
FA160	GA-21	MTR	FA1P8483	GA-483	FLEE	FA4012B	G-801	FIA	FA572	GA-27	MTR
FA1600	GA-7017	MTR	FA1R	GA-77	MTR	FA4012D	G-801	FIA	FA5725	GP-34	FAY
FA1603	GA-186	MIGH	FA2	GA-55	ADP	FA4012G	G-801	FIA	FA574	GA-74	MTR
FA1603	GA-186	MTR	FA2	GA-56	MTR	FA4018	G-225	FIA	FA574R	GA-74	MTR
FA1604	GAVW-2	PERM	FA20093	G-870	TEC	FA4043	G-1121	FIA	FA576	GA-113	KEM
FA1605	GAVW-2	PERM	FA2031	G-871	LEYL	FA4043-2	G-1121	FIA	FA576	GA-113	MIGH
FA1607	GAVW-4	PERM	FA2031	G-801	TEC	FA4092	G-31	FIA	FA576	GA-113	MTR
FA161	GAD-1	MTR	FA208	GA-7	MTR	FA4092C	G-31	FIA	FA579	GA-100	MTR
FA1611	GA-175	MTR	FA2106	G-871	LEYL	FA4134	G-1143	FIA	FA579DP	GA-100	MTR
FA1612	GA-127	MTR	FA2106	G-801	TEC	FA4136	G-31	FIA	FA579R	GA-100	MTR
FA1613	GA-128	MTR	FA212	GA-55	FRED	FA4136A	G-31	FIA	FA583	GA-196	MTR
FA1614	GA-300	MTR	FA215	GA-403	MTR	FA4154	G-1173	FIA	FA-583	GA-196	INTF
FA1615	GA-1615	MTR	FA223	GA-7	MTR	FA4154A	G-1173	FIA	FA584	GA-2719B ¹²²	MTR
FA1616	GA-1616	MTR	FA23	GA-78	MTR	FA4161-2	G-1123	FIA	FA584	GA-3300 ⁹⁸	MTR
FA1617	GA-442	MTR	FA232	GA-98 ¹¹²	MTR	FA41622	G-1123	FIA	FA584-R	GA-2719B ¹²²	MTR
FA1618	GAVW-620	MTR	FA23R	GA-78	MTR	FA4181	G-801	FIA	FA584-R	GA-3300 ⁹⁸	MTR
FA161-R	GAD-1 ⁸⁷	MTR	FA2401PL	GA-37	FRM	FA4207	G-801	FIA	FA588	GA-429	MTR
FA1632	GA-1615	MTR	FA2402PL	GA-37	FRM	FA4221	G-225	FIA	FA592	GA-376	FRM
FA1634	GA-1615	MTR	FA240PL	GA-37	FRM	FA4225	G-191	FIA	FA592-SERIES	GA-376	FRM
FA1635	GA-930R	MTR	FA240PL-SERIES	GA-37	FRM	FA4238	G-1175 ¹⁰⁸	FIA	FA595	GA-378	FRM
FA1641	GA-1614	MTR	FA244	GA-12	MTR	FA4241	G-1176	FIA	FA595-SERIES	GA-378	FRM
FA1643	GA-130	MTR	FA247	GA-18	MTR	FA4247	G-813	FIA	FA596	GA-200	PUR
FA1658	GA-158	MTR	FA25	GP-66	PRIN	FA4247A	G-813	FIA	FA596	GP-58	PUR

REFERENCIA CRUZADA

Para números Gonher con Superíndice vea página 651
For Gonher with Superscript numbers see page 651

Numero	Gonher	Fabricante	Numero	Gonher	Fabricante	Numero	Gonher	Fabricante	Numero	Gonher	Fabricante
Number	Gonher	Manufacturer	Number	Gonher	Manufacturer	Number	Gonher	Manufacturer	Number	Gonher	Manufacturer
FA597	GA-376	MTR	FA858	GA-826	MTR	FAF124	GA-3300	ROAD	FB2063	GP-3816	TEC
FA598	GA-378	MTR	FA859	GA-827	MTR	FAF15	GA-3490	MEDC	FB2064	GP-3816	TEC
FA6	GA-57	ADP	FA860	GA-109	MTR	FAF15	GA-3490	ROAD	FB2065	GP-38	TEC
FA600	GA-VW-2	MTR	FA866	GA-75	MTR	FAF16	GA-2740	MEDC	FB2066	GP-28 ⁹⁴	TEC
FA601	GA-229	MTR	FA869	GA-3490	MTR	FAF16	GA-2740	ROAD	FB2066	GP-3600 ⁹⁴	TEC
FA602	GA-7716	MTR	FA87	GA-113	ATL	FAF1697	GA-277	MEDC	FB2066	GP-430 ⁹⁵	TEC
FA603	GA-7360	MTR	FA87	G-152	FAME	FAF1697	GA-277	ROAD	FB2068	GP-1	TEC
FA604	GA-50	MTR	FA87	GA-113	GKIN	FAF23	GA-230	MEDC	FB2069	GP-3816	TEC
FA612	GA-85	MTR	FA87	GA-113	KEM	FAF23	GA-230	ROAD	FB2071	GP-1	TEC
FA612-R	GA-85	MTR	FA87	GA-113	MTR	FAF24	GAD-3	MEDC	FB2086	GP-36	TEC
FA613	GA-86	MTR	FA87	GA-113	PROG	FAF24	GAD-3	ROAD	FB2088	GP-38	TEC
FA613-R	GA-86	MTR	FA87	GA-113	SECU	FAF2497	GAD-3	MEDC	FB2091	GP-3600	TEC
FA617	GA-2740	MTR	FA874	GA-VW-4	MTR	FAF3	GA-75	MEDC	FB2092	GP-38	TEC
FA620	GA-6880	MTR	FA8788A	GA-113	HERI	FAF3	GA-75	ROAD	FB2095	GP-28 ⁹	TEC
FA623	GA-483	MTR	FA87DP	GA-113	MTR	FAF-4555	GG-6	PAI	FB2095	GP-430 ⁸	TEC
FA624	GA-482	MTR	FA88	GA-113	KEM	FAF-4563	GA-229	PAI	FB2097	GP-40	TEC
FA625	GA-329	MTR	FA88	GA-113	MTR	FAF-4564	GA-378	PAI	FB2098	GP-462	TEC
FA626	GA-239	MTR	FA88	GA-113	PROG	FAF-4569	GA-493 ¹⁰⁸	PAI	FB2099	GP-3816	TEC
FA637	GA-3501	MTR	FA88	GA-113	SECU	FAF7	GA-4303	ROAD	FB25	GP-34	PRIN
FA640	GA-3424	MTR	FA880	GAK-20	MTR	FAF90	GA-303	MEDC	FB3114	G-500	FIA
FA640-R	GA-3424	MTR	FA88DP	GA-113	MTR	FAF90	GA-303	ROAD	FB3140	GP-31	FIA
FA641	GA-3425	MTR	FA89	GA-6129	MTR	FAN353	GA-2719B	FUJI	FB33	GA-39	ACD
FA641R	GA-3425	MTR	FA8R	GA-71	MTR	FAN430	GA-2740	FUJI	FB330	GA-39	ACD
FA649	GA-679	MTR	FA90	GA-106 ⁶⁹	MTR	FAN552	GA-4325	FUJI	FB3329	G-750	FIA
FA650	GA-680	MTR	FA90	GA-326 ⁷¹	MTR	FAN570A	GA-3490	FUJI	FB3338	G-836	TEC
FA652	GA-625	MTR	FA903	GA-360	MTR	FAP009	GA-VW-2	FISP	FB3395	G-5000	FIA
FA653	GA-426	MTR	FA904	GA-361	MTR	FAP011	GP-81	FISP	FB3500	GP-40	TEC
FA660	GA-679	MTR	FA911H	G-191	FAME	FAP024	GA-VW-2	FISP	FB3511	GP-3816	TEC
FA661	GA-680	MTR	FA92	GA-349	MTR	FAP025	GA-4365	FISP	FB5007	GP-53	TEC
FA662	GA-891	MTR	FA920	GA-373	MTR	FAP110	GA-349	FRML	FB5300	GP-58 ¹⁵	TECF
FA663	GA-892	MTR	FA934	GA-2984	MTR	FAP113	GA-75	FRML	FB5303	GP-28 ⁶	TEC
FA665	GA-372	MTR	FA935	GA-135	MTR	FAP120	GA-74	FRML	FB5303	GP-430 ⁸	TEC
FA666	GA-377	MTR	FA935FP	GA-135	MTR	FAP124	GA-3300	FRML	FB5311	GP-3816	TEC
FA672	GA-50	MTR	FA938	GAD-3	MTR	FAP164	GA-VW-2	FISP	FB5312	GP-28 ⁹⁴	TEC
FA676	G-566	FAME	FA939	GA-3300	MTR	FAP203	GA-VW-4	FISP	FB5312	GP-3600 ⁹⁴	TEC
FA676	G-566	MTR	FA940	G-238	FAME	FAP207	GA-277	FISP	FB5312	GP-430 ⁸⁵	TEC
FA6775	GA-206	FLEE	FA943	GA-VW-22	MTR	FAP211	GA-VW-2	FISP	FB5313	GP-38	TEC
FA68	GA-3300	MTR	FA949	GA-271	MTR	FAP31	GA-56	FRML	FB5324	GP-455	TEC
FA7	GA-80	ADP	FA95	GA-77	MTR	FAP4	GA-70	FRML	FB5404	GP-46	TEC
FA7	GA-50	MTR	FA954	GA-33	MTR	FAP45	GA-77	FRML	FB5417	GP-3531	EXP
FA704	GA-80 ¹¹³	MTR	FA9620	GA-285	INTF	FAP505	GA-VW-2	FISP	FB5418	GP-50	TEC
FA706	GA-3523	MTR	FA97	GA-75	FRED	FAP52	GA-71	FRML	FB5419	GP-46	TEC
FA709	GA-107	MTR	FA97	GA-75	MTR	FAP59	GA-50	FRML	FB5421	GP-40	TEC
FA71	GA-59	MTR	FA971	GA-274	MTR	FAP67	GA-192	FRML	FB5442	GP-51	TEC
FA711	GA-493 ¹⁰⁸	MTR	FA979	GA-589	MTR	FAP68	GA-78	FRML	FB5443	GP-51	TEC
FA713	GA-734 ⁸¹	MTR	FA97R	GA-75	MTR	FAP74	GA-55	FRML	FB5449	GP-3531	EXP
FA713	GA-735 ¹²⁴	MTR	FA980	GA-588	MTR	FAP831	GA-85	FRML	FB59	GA-100	ACD
FA713R	GA-734 ⁸¹	MTR	FA981	GA-730	MTR	FAP84	GA-730	FRML	FB59	GA-100	GKIN
FA713R	GA-735 ¹²⁴	MTR	FA982	GA-3425	MTR	FAP90	GA-303	FRML	FB59	GA-100	KEM
FA717	GA-89	MTR	FA987	GA-2719B	MTR	FAP91	GA-59	FRML	FB59	GA-100	MIGH
FA719	GA-2740	MTR	FA99	GA-325	MTR	FAP92	GA-57	FRML	FB59	GA-100	PROG
FA71R	GA-59	MTR	FA992	GA-3647	MTR	FAP93	GA-325	FRML	FB59	GA-100	SECU
FA72	GA-730	MTR	FA993	GA-4325	MTR	FAP991	GA-86	FRML	FB59	GA-100	UNN
FA721	GA-54	MTR	FA994	GA-3681	MTR	FAR00001	GAD-3	CHRY	FB598	GA-100	ACD
FA721R	GA-54	MTR	FA999	GA-277	MTR	FAR00002	GA-77	CHRY	FB6	G-1174 ¹⁰⁸	COM
FA724	GA-89	MTR	FA99R	GA-325	MTR	FAR00003	GA-74	CHRY	FB60	GA-113	ACD
FA727	GA-101	MTR	FAC00002	GP-9	CHRY	FAR00005	GA-734 ⁸¹	CHRY	FB608	GA-113	ACD
FA728	GA-3637	MTR	FAC00003	GP-1	CHRY	FAR00010	GA-VW-4	CHRY	FB619	GG-1	KNE
FA729	GA-3637	MTR	FAC00006	GP-58	CHRY	FAR00011	GA-VW-2	CHRY	FB619	GG-4	KNE
FA72R	GA-730	MTR	FAC00009	GP-28	CHRY	FAR00012	GA-730	CHRY	FB623	GG-5	L
FA735	GA-54	FRED	FAC00010	GP-3980 ⁶⁴	CHRY	FAR00013	GA-271	CHRY	FB629	GG-5	L
FA735	GA-1285	MTR	FAC00010	GP-48 ¹¹⁷	CHRY	FAR00014	GA-70	CHRY	FB629S	GG-1	KNE
FA736	GA-3523	FRED	FAC111	GA-378	FISP	FAR00015	GA-71	CHRY	FB629S	GG-4	KNE
FA736	GA-1284	MTR	FAC112	GA-71	FISP	FAR00016	GA-429	CHRY	FB629S	GG-124	MAHL
FA738	GAK-625	MTR	FAC113	GA-200	FISP	FAR00017	GA-50	CHRY	FB639	GP-1122	KNE
FA73PL	GA-44	FRM	FAC113	GP-58	FISP	FAR00018	GA-54	CHRY	FB650	GP-1122	KNE
FA74	GA-86	FRED	FAC201	GA-3425	FISP	FAR00019	GA-59	CHRY	FB657	GG-246	KNE
FA74	GA-86	MTR	FAC439	GA-2194	FISP	FAR00020	GA-272	CHRY	FB674	GG-5	L
FA740	GA-379	MTR	FAC515	GA-230	FISP	FAR5465	GAK-20	FUJI	FB677	GA-176	UNN
FA746	GA-3501	MTR	FAC681	GAK-216	FISP	FAR618	GA-3490	FUJI	FB683	GG-251	KNE
FA74PL	GA-11	FRM	FAC800	GA-459	FISP	FAR620	GA-2740	FUJI	FB73	GA-101	ACD
FA75	GA-57	MTR	FAC801	GAK-458	FISP	FAR653	GA-2740	FUJI	FB73	GA-101	GKIN
FA752	GA-277	MTR	FAC805	GA-892	FISP	FAR709	GAD-3	FUJI	FB73	GA-101	KEM
FA753	GA-4303	MTR	FAC806	GA-18	FISP	FAR713	GAD-30	FUJI	FB73	GA-101	MIGH
FA757	GA-42	MTR	FAC929	GAK-403	FISP	FAR722	GAD-1	FUJI	FB73	GA-101	PROG
FA75R	GA-57	MTR	FAC931	GA-360	FISP	FAR726	GA-4303	FUJI	FB73	GA-101	SECU
FA768	GA-3588	MTR	FAC958	GA-303	FISP	FAR726A	GA-4303	FUJI	FB73	GA-101	UNN
FA773	GA-6128	MTR	FAC965	GA-71	FISP	FAR729	GAD-15	FUJI	FB73B	GA-101	ACD
FA78	GA-71	PUR	FAC973	GA-49	FISP	FB10	GP-34	PRIN	FB-7577	GP-57	KORO
FA780	GA-509 ¹⁴	MTR	FAC980	GA-405	FISP	FB101	GP-66	GRES	FB-79	GP-51	KORO
FA79	GA-113	KEM	FAC983	GA-24	FISP	FB102	GA-101	ACD	FB79	GA-176	MIGH
FA-79	GA-113	MTR	FAC988	GA-106 ⁶⁶	FISP	FB103	GP-66	GRES	FB8	G-1175 ¹⁰⁸	COM
FA7R	GA-50	MTR	FAC988	GA-326 ⁷¹	FISP	FB-105	GP-43	KORO	FB821/2	GG-261	KNE
FA8	GA-77	ADP	FAC989	GA-436	FISP	FB106	GA-176	ACD	FB8213	GG-246	KNE
FA8	GA-71	MTR	FAC990	GA-33	FISP	FB111	GA-186	ACD	FB-95	GP-53	KORO
FA806	GA-209	MTR	FAC991	GAK-16	FISP	FB1277	G-31	FIA	FB-96	GP-53	KORO
FA807	GA-210	MTR	FAC992	GAK-20	FISP	FB1277A	G-31	FIA	FB-99	GP-52 ¹¹⁰	KORO
FA8141	GA-1614	INTF	FAC993	GA-206	FISP	FB1518	G-143	FIA	FB-99	GP-691 ⁸⁸	KORO
FA817	GA-251	MTR	FAC999	GA-361	FISP	FB1519	G-163	FIA	FBD-103	GP-3000	KORO
FA822	GAK-1532	MTR	FAF103	GAD-1 ⁸⁷	ROAD	FB16	GA-113	UNN	FBF-580	GP-26	KORO
FA828	GA-18	MTR	FAF110	GA-349	MEDC	FB17	GA-113	UNN	FBF-581	GP-27	KORO
FA836	GA-229	MTR	FAF110	GA-349	ROAD	FB18	GA-113	UNN	FBF-584	GP-56	KORO
FA837	GAK-216	MTR	FAF1149	GA-VW-2	MEDC	FB2055	GP-3816	TEC	FBF-592	GP-92	KORO
FA838	GA-416	MTR	FAF1149	GA-VW-2	ROAD	FB2058	GP-1	TEC	FBF-593	GP-93	KORO
FA840	GA-108	MTR	FAF118	GAD-1 ⁸⁷	ROAD	FB2059	GP-81 ³¹	TEC	FBF-7557	GP-110	KORO
FA846	GA-31	MTR	FAF124	GA-3300	MEDC	FB2059	GP-9 ⁹⁸	TEC	FBF-876	GP-84	KORO

Referencia Cruzada por Numero de Parte

Cross Reference by Part Number



Numero	Gonher	Fabricante	Numero	Gonher	Fabricante	Numero	Gonher	Fabricante	Numero	Gonher	Fabricante
Number	Gonher	Manufacturer	Number	Gonher	Manufacturer	Number	Gonher	Manufacturer	Number	Gonher	Manufacturer
FBF-877	GP-83	KORO	FC261	GA-356	GPC	FC6203	GP-1122	SAKU	FC6158	GG-196	PUR
FBF-948	GP-1101	KORO	FC262	GA-357	GPC	FC6205	GP-1122	SAKU	FC6162	GG-203	PUR
FBF-957	GP-1101	KORO	FC266K	GA-33	GPC	FC-6205-1	GP-1122	SAKU	FC6163	GG-208	PUR
FBF-976	GP-85	KORO	FC269K	GA-27	GPC	FC624	GA-7360	GPC	FC62	GG-76	PUR
FBG2344	G-871	TEC	FC270	GA-6129	GPC	FC6501	GP-26	SAKU	FC6256	GG-204	PUR
FBM011	GG-251	WOW	FC271US	GP-1107	FILC	FC6502	GP-27	SAKU	FC64	GG-1	PUR
FBM1124APB	G-1173 ⁰⁸	FRM	FC273	GA-8047	GPC	FC6503	GP-92	SAKU	FC64	GG-4	PUR
FBM1127APB	G-1176 ⁰⁸	FRM	FC274	GA-1285	GPC	FC6504	GP-93	SAKU	FC65	GG-1	PUR
FBM1900PL	G-1176	FRM	FC275	GA-9045	GPC	FC651	GA-251	GPC	FC65	GG-4	PUR
FBU8633	GP-3985	LEYL	FC276	GA-1287	GPC	FC6801	GP-1122	SAKU	FCH1652P	G-33	UNI
FBW-5071	GP-2071W	KORO	FC277	GA-9334	GPC	FC71	GP-46	PUR	FCH1652PL	G-33	UNI
FBW-5137	GP-2071W	KORO	FC278	GA-1286	GPC	FC7101	GP-1122	SAKU	FCL1697	GA-277	OHFC
FBW-5138	GP-1011Q	KORO	FC291	GA-1284	GPC	FC-7102	GP-96	SAKU	FCL1697	GA-277	POWF
FBW-5139	GP-1011Q	KORO	FC292	GA-1008	GPC	FC711	G-1174	FAME	FCL2173	GA-16 ¹¹²	FCL
FBW-5178	GP-2015W	KORO	FC294	GA-229	GPC	FC714	GA-153	GPC	FCL2173	GAK-16 ¹⁴	FCL
FBW-5179	GP-2022W	KORO	FC30	G-31	UNI	FC735	G-296	FAME	FCL2181	GA-98 ¹¹²	FCL
FC100	G-1121F	PERM	FC302	GA-467	GPC	FC735	G-296-B	FAME	FCL2203	GA-357	FCL
FC101	G-1123F	PERM	FC3027	GA-70	GPC	FC737	GA-853R	GPC	FCL7102	G-152	FCL
FC101	GP-22	PUR	FC308V	GPP-1122	PERM	FC-750-E	G-750	KORO	FCL7121	G-834	FCL
FC1027	G-1121F	FIA	FC309	GA-361	GPC	FC759	GA-483	GPC	FCL714	G-870	FCL
FC10278	G-1121F	FIA	FC3129	GA-165	PERM	FC-7903	GP-1122	SAKU	FCL7157	G-834	FCL
FC1027B	G-1121F	FIA	FC3129	GA-165	PERM	FC7908	GPP-1122	SAKU	FCL7177	GP-52 ¹¹⁰	FCL
FC104	GA-360	DITX	FC313	GG-196	TOKO	FC7912	GPP-1291 ³⁹	SAKU	FCL7177	GP-69 ¹⁴⁸	FCL
FC104	GA-360	GPC	FC313	GG-196	TOKY	FC-7912	PFF831 ⁴¹	SAKU	FCL7185	GP-53	FCL
FC104	GP-46	PUR	FC318K	GA-26	GPC	FC-7912	R 90 P ⁴²	SAKU	FCL7202	G-870	FCL
FC105V	GP-1122	PERM	FC318K	GAK-458	GPC	FC793	GA-517R	GPC	FCL7203	G-870	FCL
FC107	GG-246	PERM	FC319	GA-459	GPC	FC805	GG-1	TOKY	FCL7221	GG-124	FCL
FC109	GP-46	PUR	FC3196	G-1123	FIA	FC805	GG-4	TOKY	FCL7224	GP-462	FCL
FC109	GG-76	VIC	FC3229	GA-472	PERM	FC81	GP-22	PUR	FCL7225	GP-3985	FCL
FC109-1	GP-46	PUR	FC325	GA-759	GPC	FC810	GA-880R	GPC	FCL7231	GP-38	FCL
FC-1101	GP-1101	SAKU	FC3257	GA-780	PERM	FC834	G-834	CAC	FCL7234	GP-28 ⁶	FCL
FC1104	GG-298	SAKU	FC3257	GA-780	PERM	FC842	GAD-30	GPC	FCL7234	GP-430 ⁸	FCL
FC1105	GG-298	SAKU	FC3291	GA-248	PERM	FC882	GA-499R	GPC	FCL7236	GP-58 ¹⁵	FCL
FC1124	G-1173 ⁰⁸	UNI	FC3291	GA-248	PERM	FC890	GA-930R	GPC	FCL7287	GP-28 ⁶	FCL
FC1127	G-1175 ⁰⁸	UNI	FC3298	GA-224	PERM	FC904	GA-673R	GPC	FCL7287	GP-430 ⁸	FCL
FC1133PL	GC-1133	FRM	FC331K	GAK-16	GPC	FC907	GA-197R	GPC	FCL7299	GPP-1122	FCL
FC1217	G-31	FIA	FC334	GA-426	GPC	FC910	GA-930R	GPC	FCL731	GP-54 ¹¹	FCL
FC1294	G-1173	FIA	FC338	GA-416	GPC	FC917	GA-768R	GPC	FCL731	GP-66 ¹⁰	FCL
FC1305	GP-1101	SAKU	FC342	GA-329	GPC	FC937	GG-76	TOKY	FCL7330	GP-54 ¹¹	FCL
FC133	GP-46	PUR	FC343	GA-239	GPC	FC966	GA-966R	GPC	FCL7330	GP-66 ¹⁰	FCL
FC141	G-200	CAC	FC349K	GAK-1532	GPC	FC967	GA-967R	GPC	FCL734	GA-1121F	FCL
FC14958	G-1123F	FIA	FC353K	GAK-216	GPC	FCA105	GAD-1	PUR	FCL7360	G-1121F	FCL
FC14958	G-1123F	FIA	FC368	GP-1101	APL	FCA1076	GAVW-22	PUR	FCL744	G-1121F	FCL
FC1503	G-1175	MIGH	FC381K	GA-26 ¹¹²	GPC	FCA110	GA-349 ⁹⁸	PUR	FCL7443	GP-53	FCL
FC158	GG-298	VIC	FC400	GG-5 L	PERM	FCA110	GAD-3	PUR	FCL7444	GP-57	FCL
FC161	G-1121	TFIL	FC404	G-335	DEL	FCA110A	GA-349 ⁹⁸	PUR	FCL7445	GP-3000	FCL
FC164	G-1121F	TFIL	FC405	GG-5 L	TOKY	FCA110A	GAD-3	PUR	FCL7446	GPP-11	FCL
FC1702	G-296	SAKU	FC407	G-152	DEL	FCA1133	GAVW-22	PUR	FCL7447	GP-1101	FCL
FC1702	G-296-B	SAKU	FC428K	GAK-16	GPC	FCA1149	GAVW-2	PRET	FCL7448	GP-178	FCL
FC175	G-238	DEL	FC439	GA-5648	GPC	FCA1149	GAVW-2	PUR	FCL7449	GPP-1122	FCL
FC180	G-331	DEL	FC43F	G-1143	UNI	FCA1153	GAVW-4	MINL	FCL7450	GP-9586	FCL
FC1805	GP-110	SAKU	FC445	GA-375	GPC	FCA1153	GAVW-4	PUR	FCL7451	GP-2071W	FCL
FC184	GP-1	APL	FC451	GA-378	GPC	FCA122	GAVW-2	PUR	FCL7452	GP-1011Q	FCL
FC187	GP-81	APL	FC471	GA-9334	GPC	FCA124	GA-3300	PUR	FCL7453	GP-1012Q	FCL
FC1902	GPP-419	SAKU	FC479	GA-6880	GPC	FCA15	GA-3490	PRET	FCL7455	GP-51	FCL
FC196	GP-13	APL	FC498	GAD-30	GPC	FCA15	GA-3490	PUR	FCL7501	GP-96	FCL
FC2017	GA-890R	GPC	FC504K	GAK-16	GPC	FCA-15	GA-3490	POWF	FCL7519	GP-3985	FCL
FC202	GAK-625	DITX	FC505V	GP-84	PERM	FCA16	GA-2740	PRET	FCL7555	GP-54 ¹¹	FCL
FC202K	GAK-625	GPC	FC-5101	G-297	SAKU	FCA16	GP-66 ¹⁰	PUR	FCL7555	GP-66 ¹⁰	FCL
FC204K	GAK-16	GPC	FC-5101	G-297-B	SAKU	FCA-16	GA-2740	ROAD	FCL7573	GP-3766	FCL
FC205	GAK-403	DITX	FC5104	G-296	SAKU	FCA1697	GA-277	PRET	FCL796	GP-78	FCL
FC205K	GAK-403	GPC	FC5104	G-296-B	SAKU	FCA1697	GA-277	PUR	FCL8360	G-1121F	FCL
FC206	GA-18	GPC	FC5105	G-297	SAKU	FCA17	GAD-3	PUR	FCL8652	G-3827	FCL
FC210	GG-45	TOKO	FC5105	G-297-B	SAKU	FCA23	GA-230	PUR	FCO-001	G-613	ACT
FC210	GG-45	TOKY	FC5107	GG-298	SAKU	FCA24	GAD-3	PUR	FCO-003	GP-57	ACT
FC2101	G-297	SAKU	FC527K	GAK-1532	GPC	FCA3	GA-75	PUR	FCO-004	GP-53	ACT
FC2101	G-297-B	SAKU	FC530	GAD-1	GPC	FCA3004	GAK-20	SOPA	FCO-005	G-566	ACT
FC2122	GA-600R	GPC	FC5401	GP-1107	SAKU	FCA3005	GA-33	SOPA	FCO-021	G-750	ACT
FC213	GAK-20	DITX	FC5402	GP-1108	SAKU	FCA3006	GAK-403	SOPA	FCO-024	GP-43	ACT
FC213K	GAK-20	GPC	FC-5501	GP-110	SAKU	FCA3007	GA-24	SOPA	FC01	GP-1	PUR
FC215	GA-892	DITX	FC-5502-1	GP-749	SAKU	FCA3008	GAK-16	SOPA	FC0101	GP-22	PUR
FC215	GA-892	GPC	FC-5504	GP-1109 ²³	SAKU	FCA3024	GA-360	SOPA	FC0109	GP-42	PUR
FC217	GA-405	DITX	FC-5504	GP-62 ²⁰	SAKU	FCA3025	GA-106 ⁴⁶	SOPA	FC01091	GP-46	PUR
FC217	GA-405	GPC	FC5507	GP-110	SAKU	FCA3025	GA-326 ¹¹	SOPA	FC0119	GP-1	PUR
FC2174	GA-712R	GPC	FC552	GAD-30	GPC	FCA3200	GA-229	SOPA	FC0160	GP-3985	PUR
FC218	GA-436	DITX	FC-5602	GA-361	SAKU	FCA3201	GA-361	SOPA	FC0167	GP-3531 EXP	PUR
FC218	GA-436	GPC	FC5608-1	GPP-11	SAKU	FCA3224	GA-27	SOPA	FC017	GP-81	PUR
FC218	GG-76	TOKY	FC-5701	GP-1101	SAKU	FCA3304	GA-6129	SOPA	FC018	GP-81	PUR
FC219	GA-49	DITX	FC-5702	GA-6127	SAKU	FCA3305	GA-6127	SOPA	FC0193	GP-40	PUR
FC219	GA-49	GPC	FC-5703-1	GP-55	SAKU	FCA3309	GA-892	SOPA	FC020	GP-81	PUR
FC2195	GA-518R	GPC	FC5704	GP-1122	SAKU	FCA3315	GAK-625	SOPA	FC0201	GP-3816	PUR
FC2197	GA-683R	GPC	FC-5704-1	GP-1122	SAKU	FCA3322	GA-206	SOPA	FC02106	G-834	PUR
FC2199	GA-723R	GPC	FC-5705	GPP-11	SAKU	FCA3323	GA-7716	SOPA	FC0213	GP-28 ⁶	PUR
FC222	GA-24	DITX	FC-5706	GPP-18	SAKU	FCA3324	GA-7360	SOPA	FC0213	GP-430 ⁸	PUR
FC222K	GA-24	GPC	FC-5708	GPP-1122	SAKU	FCA3394	GA-6129	SOPA	FC02166	GP-3682	PUR
FC2301	GPP-19	SAKU	FC5708-1	GPP-1122	SAKU	FCA3436	GA-4365	MINL	FC02167	GP-171	PUR
FC2302	GPP-18	SAKU	FC5708-3	GPP-1122	SAKU	FCA3436	GA-4365	PUR	FC0241	GP-58	PUR
FC-2303	GP-84	SAKU	FC-5709	GPP-1000	SAKU	FCA4278	GAD-15	PUR	FC0252	GP-28 ⁶⁵	PUR
FC-2304	GP-83	SAKU	FC589	GA-7716	GPC	FCA7	GA-4303	PUR	FC0252	GP-3816 ²⁵	PUR
FC233	GA-416	GPC	FC59	G-1174	MIGH	FCA90	GA-303	PUR	FC0252	GP-430 ⁶⁶	PUR
FC234K	GAK-216	GPC	FC590K	GAK-16	GPC	FCF-002	GP-1101	ACT	FC0257	GP-310	PUR
FC236K	GA-98 ¹¹²	GPC	FC603	GP-58 ¹⁵	PUR	FCG1	GG-45	PUR	FC0258	GP-58	PUR
FC242	GA-106 ⁴⁶	GPC	FC609	GA-563	GPC	FCG152	GPP-1122	PUR	FC028	GP-3816	PUR
FC242	GA-326 ⁷¹	GPC	FC615	GAD-30	GPC	FCG154	GG-3	PUR	FC0291	GP-3531 EXP	PUR
FC243	GA-206	GPC	FC6201	GP-1122	SAKU	FCG155	GG-246	PUR	FC0292	GP-149 ¹⁴	PUR
FC250	GA-589	GPC	FC-6202	GP-1122	SAKU	FCG157	GG-203	PUR	FC0292	GP-6811	PUR

REFERENCIA CRUZADA

Para números Gonher con Superíndice vea página 651
For Gonher with Superscript numbers see page 651

Numero	Gonher	Fabricante	Numero	Gonher	Fabricante	Numero	Gonher	Fabricante	Numero	Gonher	Fabricante
Number	Gonher	Manufacturer	Number	Gonher	Manufacturer	Number	Gonher	Manufacturer	Number	Gonher	Manufacturer
FCO321	GP-462	PUR	FD771	GP-1105	MTR	FD548	GG-87	COBR	FE269	GG-67	AUP
FCO373	GP-3682	PUR	FD771FP	GP-1105	MTR	FD560	GG-47	COBR	FE277	GP-44	AUP
FCO3970	GP-81	PUR	FD772	GP-62	MTR	FD598	GP-155	COBR	FE278	GP-3985	AUP
FCO42	GP-38	PUR	FD772FP	GP-62	MTR	FDO-016	G-33	ACT	FE280	GG-247	AUP
FCO64	GP-3600 ²⁷	PUR	FD773	G-1175	MTR	FDO-034	GP-9586	ACT	FE282	GG-79	AUP
FCO64	GP-3682 ⁸⁸	PUR	FD776	GP-56	MTR	FDW-028	GP-1013Q	ACT	FE289	GP-46	AUP
FCO64	GP-38 ¹²²	PUR	FD776FP	GP-56	MTR	FDW-029	GP-1011Q	ACT	FE292	GP-81	AUP
FCO73	GP-24 ²⁶	PUR	FD78	GP-84	MTR	FDW3525	GP-92	PARK	FE295	GG-72	AUP
FCO73	GP-462 ⁹⁴	PUR	FD782	GS-2033	MTR	FDW3825	GP-26	PARK	FE3	GA-113	NOF
FCS1133PL	GC-1133 ³²	FRM	FD782FP	GS-2033	MTR	FE01-13-470	GG-208	MZDA	FE30	G-330	AUP
FCS1133PL	GS-1133 ¹¹¹	FRM	FD783	GP-85	MTR	FE06420	G-870	FODNA	FE302	GP-178	AUP
FCS1133PLM	GC-1133 ³²	FRM	FD784	GP-1122	MTR	FE1	GP-1	AUP	FE308	GP-157	AUP
FCS1133PLM	GS-1133 ¹¹¹	FRM	FD784A	GPP-1122	MTR	FE1005	G-870	FIA	FE311	GG-208	AUP
FCS15	GPP-14	FAME	FD785	GP-1122	MTR	FE1010	G-801	FIA	FE312	GG-63	AUP
FCS23	GP-85	FAME	FD786	GPP-19	MTR	FE111	G-333	AUP	FE314	GG-142	AUP
FCS24	GP-84	FAME	FD787	GP-18	MTR	FE120	GP-3	AUP	FE32	GG-236	AUP
FCS25	GP-83	FAME	FD788	GP-1101	MTR	FE124	G-34	AUP	FE3375	G-1121	FIA
FCS44	GP-27	FAME	FD788FP	GP-1101	MTR	FE125	GP-13	AUP	FE35	GP-3	AUP
FCW-023	GP-2071W	ACT	FD789	GP-93	MTR	FE1250	G-870	FIA	FE37	GG-236	AUP
FD108	G-1143	MTR	FD789FP	GP-93	MTR	FE128	GG-19	AUP	FE39	GP-50	AUP
FD108FP	G-1143	MTR	FD78FP	GP-84	MTR	FE1283	G-1173	FIA	FE3R-14-302	GP-91	KIA
FD1261F	GS-1261	MIGH	FD79	GP-83	MTR	FE129	GP-38	AUP	FE40	G-200	AUP
FD1271	G-1123	FIA	FD792	GP-55	MTR	FE131	G-870	AUP	FE41	GG-1	AUP
FD1282	G-1173	FIA	FD793	GP-85	MTR	FE133	GP-5	AUP	FE41	GG-4	AUP
FD1283	G-296	FIA	FD793FP	GP-85	MTR	FE134	GP-3	AUP	FE43	GP-5	AUP
FD1283	G-296-B	FIA	FD796	GS-2034	MTR	FE135	GG-123	AUP	FE44	GG-20	AUP
FD148	G-1174 ⁰⁸	MTR	FD79FP	GP-83	MTR	FE136	GP-20	AUP	FE47	GP-81 ³¹	AUP
FD149	G-1176	MTR	FD802	GG-3	MTR	FE139	G-6	AUP	FE47	GP-9 ⁸⁸	AUP
FD150	G-1175	MTR	FD803	GP-92	MTR	FE141	GG-6	AUP	FE48	GP-50	AUP
FD150FP	G-1175	MTR	FD804	GP-93	MTR	FE142	GP-3600 ²⁷	AUP	FE49	G-871	AUP
FD152	GP-1101	MTR	FD807	2010PM-OR ⁷	MTR	FE142	GP-38 ⁸⁹	AUP	FE55	GP-81 ³¹	AUP
FD152FP	GP-1101	MTR	FD807	2010TM-OR ²	MTR	FE143	GG-7	AUP	FE55	GP-9 ⁸⁸	AUP
FD154	G-1173	MTR	FD808	G-293	MTR	FE146	GP-24 ⁸⁵	AUP	FE59	G-836	AUP
FD154FP	G-1173	MTR	FD809	G-1176	MTR	FE146	GP-462 ⁹⁴	AUP	FE59	G-225	AUP
FD157	G-296	MTR	FD810	G-297	MTR	FE147	GP-3816	AUP	FE6	G-31	AUP
FD157	G-296-B	MTR	FD810	G-297-B	MTR	FE148	GP-1	AUP	FE60	GP-81	AUP
FD157FP	G-296	MTR	FD811	GP-155	MIGH	FE151	GP-81 ³¹	AUP	FE63	GP-50	AUP
FD157FP	G-296-B	MTR	FD811	GP-155	MTR	FE151	GP-9 ⁸⁸	AUP	FE64	GP-50	AUP
FD159	G-1166	MTR	FD8110	GP-155	GKIN	FE156	GP-81	AUP	FE69	GP-20	AUP
FD165	G-1163	MTR	FD811FP	GP-155	MTR	FE159	GP-23	AUP	FE7	GA-101	NOF
FD168	G-1175 ⁰⁸	MTR	FD816	GPP-11	MTR	FE160	GP-81 ³¹	AUP	FE160	G-5000	UNI
FD172	GA-113	COBR	FD816FP	GPP-11	MTR	FE160	GP-9 ⁸⁸	AUP	FEH1-13-320A	GA-216	MZDA
FD180	GPP-14	MTR	FD817	S 3202 ⁸⁰	MTR	FE161	G-1121F	TFIL	FEH5-13-320A	GA-216	MZDA
FD1800	GP-50	DIA	FD817FP	S 3202 ⁸⁰	MTR	FE163	GP-44	AUP	FEM4081	G-1123F	COO
FD187	GA-176	COBR	FD818	GPP-11	MTR	FE164	GP-46	AUP	FEM4093	G-1173 ⁰⁸	COO
FD206	G-1173 ⁰⁸	MTR	FD818FP	GPP-11	MTR	FE164	G-1121F	TFIL	FER111	GP-46	FRML
FD259	GP-81	MTR	FD819	GPP-11	MTR	FE166	GP-28 ⁵	AUP	FER123	GP-3429	FRML
FD26	GP-50	DIA	FD819FP	GPP-11	MTR	FE166	GP-430 ⁸	AUP	FER160	GP-40	FRML
FD260	GP-92	MTR	FD82	GG-48	MTR	FE167	GP-42	AUP	FER173	GP-3980	FRML
FD260FP	GP-92	MTR	FD820	GP-55	MTR	FE168	GP-46	AUP	FER1A	GP-1	FRML
FD263	GP-55	MTR	FD8226	GP-81	DIA	FE169	GG-16	AUP	FER33	GP-20	FRML
FD263FP	GP-55	MTR	FD8227	GP-5	DIA	FE17	GP-1	AUP	FER40	GP-13	FRML
FD267	GP-93	MTR	FD823	GP-1122	MTR	FE170	GG-17	AUP	FER42	GP-38	FRML
FD273	G-297	WIPA	FD8234	GP-36	DIA	FE171	GP-23	AUP	FER49	GP-3	FRML
FD273	G-297-B	WIPA	FD8235	GP-1122	DIA	FE173	GP-20	AUP	FER5	GP-5	FRML
FD29	G-11816	MTR	FD8236	GP-1122	DIA	FE174	GP-3429	AUP	FER81	GP-81 ³¹	FRML
FD30	G-1174 ⁰⁸	MTR	FD8237	GP-46	DIA	FE177	GG-45	AUP	FER81	GP-9 ⁸⁸	FRML
FD3368	GPP-1287 ³⁹	MTR	FD824	G-294	MIGH	FE179	GP-1	AUP	FEW4022	GS-2034	COO
FD3368	PFF831 ⁴¹	MTR	FD824	G-294	MTR	FE187	G-236	AUP	FEW4073	2010PM-OR ⁷	COO
FD3368	R 60 ⁸²	MTR	FD8240	GP-10	DIA	FE19	GP-1	AUP	FEW4073	2010TM-OR ²	COO
FD3370	GPP-14	MTR	FD8245	GP-81	DIA	FE193	GG-6	AUP	FEYO-14-302	GP-91	MZDA
FD3372	GP-1122	MTR	FD8247	GP-58 ¹⁵	DIA	FE196	GG-5 L	AUP	FEYO-14-302	GP-149	MZDA
FD3525	GGP-25	PARK	FD825	G-294	MTR	FE197	GG-8 ¹⁰³	AUP	FF001	GG-45	ALCO
FD3825	GGP-25	PARK	FD828	GP-26	MTR	FE197	GG-8 L ⁸⁰	AUP	FF002	GG-196	ALCO
FD4595	G-178	MTR	FD83	G-297	MTR	FE199	GP-46	AUP	FF004	GG-203	ALCO
FD4595A	G-178	MTR	FD83	G-297-B	MTR	FE2	GA-100	NOF	FF005	GG-208	ALCO
FD4596	G-862	MIGH	FD830	GPP-111	MTR	FE20	GP-50	AUP	FF006	GG-196	ALCO
FD4596	G-862	MTR	FD830	GPP-524	MTR	FE201	GP-54 ³¹	AUP	FF011	GG-204	ALCO
FD4596P	G-862	IPC	FD8370	GPP-1122	DIA	FE201	GP-66 ⁴⁰	AUP	FF012	GG-5 L	ALCO
FD4604	G-1047	ATL	FD84	GP-14	MTR	FE204	GP-3980	AUP	FF017	GG-76	ALCO
FD4604	G-1047	MTR	FD84FP	GPP-14	MTR	FE205	GG-76	AUP	FF-08	GG-5 L	ATL
FD59	G-1123	MTR	FD85	GC-1133	MTR	FE206	GG-45	AUP	FF1	GG-123	FLK
FD59	G-1123F	MTR	FD86	GS-1133	MTR	FE209	GP-40	AUP	FF1	GG-123	SRN
FD60	G-1121	MTR	FD92	GP-1107	MTR	FE21	G-200	AUP	FF10	G-1174 ⁰⁸	CUMM
FD61	GP-85	MTR	FD92FP	GP-1107	MTR	FE211	GG-196	AUP	FF100	GG-246	DEUS
FD61FP	GP-85	MTR	FD93	GP-110	MTR	FE213	GP-58	AUP	FF1005	G-128	FLG
FD6221	GP-1122	DIA	FD96	GPP-1000	MTR	FE215	GP-3600	AUP	FF1007	GP-749	HAS
FD6404	G-1047	MIGH	FDA-025	GA-371	ACT	FE216	GG-87	AUP	FF1008	GP-1122	HAS
FD65	GP-1101	MTR	FDA3003	GA-71	SOPA	FE217	GG-1	AUP	FF101	GG-6	DEUS
FD65FP	GP-1101	MTR	FDA3103	GA-1008	SOPA	FE217	GG-4	AUP	FF1010	GG-177	DPHI
FD66	GP-11	MTR	FDA3104	GA-1284	SOPA	FE219	GG-203	AUP	FF1010	GG-256	DPHI
FD67	GP-11	MTR	FDA3105	GA-9334	SOPA	FE222	GP-3569	AUP	FF1010	GPP-14	HAS
FD68	GP-1122	MTR	FDA3106	GA-1286	SOPA	FE223	GPP-1122	AUP	FF1012	GPP-19	HAS
FD70	GPP-18	MTR	FDA3110	GA-1287	SOPA	FE224	GP-40	AUP	FF1014	GPP-18	HAS
FD71	GP-110	MTR	FDA3111	GA-9045	SOPA	FE233	GP-3531 EXP	AUP	FF1015	GG-65	DPHI
FD71FP	GP-110	MTR	FDA3116	GA-8047	SOPA	FE24	G-870	AUP	FF1016	GG-177	DPHI
FD72	GP-1105	MTR	FDA3117	GA-1285	SOPA	FE243	GG-47	AUP	FF1016	G-128	FLG
FD72FP	GP-1105	MTR	FDA3138	GAK-20	SOPA	FE244	GG-42	AUP	FF1016	GP-1108	HAS
FD744	GP-110	DIA	FDA3143	GA-436	SOPA	FE245	GG-46	AUP	FF1017	GG-220	DPHI
FD764	G-1143	MTR	FDA3166	GA-49	SOPA	FE248	GG-264	AUP	FF1017	GPP-11	HAS
FD766	GP-26	MTR	FDA3263	GA-405	SOPA	FE250	GP-22	AUP	FF1018	GPP-14	HAS
FD766FP	GP-26	MTR	FD766FP	GP-26	ACT	FE253	GP-38	AUP	FF1019	GG-256	DPHI
FD767	GP-27	MTR	FD767FP	GP-27	ACT	FE256	GG-65	AUP	FF1019	GPP-1122	HAS
FD767FP	GP-27	MTR	FD767FP	GP-27	MTR	FE261	GG-65	AUP	FF102	GG-7	DEUS
FD768	GP-78	MTR	FD768	GP-78	MTR	FE264	GG-208	AUP	FF102	G-871	FIL
FD768FP	GP-78	MTR	FD768FP	GP-78	MTR	FE268	GG-67	AUP	FF102	GG-63	IAPC

Referencia Cruzada por Numero de Parte

Cross Reference by Part Number



Numero	Gonher	Fabricante	Numero	Gonher	Fabricante	Numero	Gonher	Fabricante	Numero	Gonher	Fabricante
Number	Gonher	Manufacturer	Number	Gonher	Manufacturer	Number	Gonher	Manufacturer	Number	Gonher	Manufacturer
FF1022	GPP-1000 HAS	FF1101-D	GPP-418 HAS	FF167-A	G-296-B FLG	FF25	GG-47 ATL
FF1024	GP-1122 HAS	FF1101F	GP-1101 CHP	FF16-7D	GP-26 COP	FF250	G-1166 DEL
FF1027	GPP-18 HAS	FF1102	GPP-419 HAS	FF16-7D	GP-26 CYC	FF250EC	GP-13 FIL
FF1028	GP-11 ²³ HAS	FF1103	GPP-420 HAS	FF17	GG-17 SRN	FF253	G-1166 DEL
FF102L	G-871 FIL	FF1103-D	GPP-420 HAS	FF-17	GG-19 ATL	FF253	G-152 FIL
FF102MF	G-870 FIL	FF1104	G-178 HAS	FF171	GP-84 FLG	FF259	G-333 FIL
FF102T	G-871 FIL	FF1106	G-1166 FLG	FF172	GP-83 FLG	FF-26	GG-46 ATL
FF103	G-1175 ⁰⁸ CUMM	FF1106	G-277 HAS	FF173	G-6 FIL	FF260	G-1175 ⁰⁸ DEL
FF103	GG-16 DEUS	FF1107-SP	GPP-1007S HAS	FF178	G-1143 FLG	FF263CS	G-5000 FIL
FF103	G-813 FIL	FF1108	GP-1107 COP	FF179	GG-19 FLG	FF267EC	GP-31 FIL
FF1030	GG-150 DPHI	FF1108-SP	GPP-1022S HAS	FF180	G-330 FIL	FF269	GP-110 ³⁰ DEL
FF1031	GPP-1122 HAS	FF111	G-870 FIL	FF180	GG-6 FLG	FF269	GP-1105 ⁹⁷ DEL
FF1035	GG-245 DPHI	FF1112	GPP-1291 ³⁹ HAS	FF181	GG-7 FLG	FF-27	GG-5 L ATL
FF1036	GG-99 DPHI	FF1112	PFF831 ⁴¹ HAS	FF182	GP-78 FLG	FF271EC	GP-20 FIL
FF1038	GPP-14 HAS	FF1112	R 90 P ⁴² HAS	FF184	GP-1105 ¹²¹ FLG	FF280EC	GP-81 FIL
FF104	GPP-1101 CUMM	FF1112-SP	GPP-1291 ³⁹ HAS	FF184	GP-1108 ⁹⁷ FLG	FF2825US	GP-38 FILG
FF104	GG-17 DEUS	FF1112-SP	PFF831 ⁴¹ HAS	FF185	G-335 FIL	FF-29	GG-204 ATL
FF104	G-225 FIL	FF1112-SP	R 90 P ⁴² HAS	FF185	GP-110 FLG	FF294EC	GP-81 ¹¹ FIL
FF104	GP-11 ²³ FLG	FF1114	G-862 HAS	FF187	G-1176 FLG	FF294EC	GP-9 ⁹⁸ FIL
FF104	GP-1101 FLG	FF1115-SP	GPP-1007S HAS	FF189	GP-110 FLG	FF295	G-33 FIL
FF1040	GG-84 DPHI	FF1116	GP-1122 HAS	FF189EC	GP-81 FIL	FF295	GGP-25 BWS
FF1040	GPP-1287 ³⁹ HAS	FF1118	GP-1108 COP	FF190	GP-110 FLG	FF2D	GP-26 CHP
FF1040	PFF831 ⁴¹ HAS	FF1118	GP-1105 HAS	FF192	GP-110 FLG	FF2D	GGP-25 LUF
FF1040	R 60 P ⁴² HAS	FF112	G-238 FIL	FF193	GPP-1000 FLG	FF3	G-162H ACD
FF1040-SP	GPP-1287 ³⁹ HAS	FF112-1	G-222 FIL	FF194	GPP-1000 FLG	FF3	G-1175 ⁰⁸ CUMM
FF1040-SP	PFF831 ⁴¹ HAS	FF1123	GG-5 L HAS	FF195	GPP-1000 FLG	FF3	GG-7 FLK
FF1040-SP	R 60 P ⁴² HAS	FF1124	GPP-426 HAS	FF196	GP-1101 FLG	FF3	GG-7 SRN
FF1041	GPP-547 ⁴⁰ HAS	FF1124A	G-1173 ⁰⁸ COP	FF197	GP-1101 FLG	FF30	GA-100 FLK
FF1041	PFF831 ⁴¹ HAS	FF1124-D	GPP-426 HAS	FF198	GPP-14 FLG	FF30	GG-1 IAPC
FF1041	R 60 P ⁴² HAS	FF1128	GP-1101 HAS	FF2	GP-26 CHP	FF30	GG-4 IAPC
FF1041-SP	GPP-547 ³⁹ HAS	FF1129	GP-749 HAS	FF2	GGP-25 COP	FF30	GG-203 SRN
FF1041-SP	PFF831 ⁴¹ HAS	FF112B	G-238 FIL	FF2	GGP-25 CYC	FF303	GG-148 IAPC
FF1041-SP	R 60 P ⁴² HAS	FF113	G-191 FIL	FF2	GG-6 FLK	FF305	GG-190 IAPC
FF1042	GPP-1291 ³⁹ HAS	FF113	G-191 FRM	FF2	GGP-25 LUF	FF305EC	GP-58 FIL
FF1042	S 3226 P ⁴⁰ HAS	FF1132	GS-2034 HAS	FF2	GG-6 SRN	FF307	GG-87 DEUS
FF1043	GG-164 DPHI	FF1135	GS-2033 HAS	FF20	G-871 ACD	FF307EC	GP-36 FIL
FF1044	GP-1224 HAS	FF114	G-33 FIL	FF20	GG-20 FSN	FF309	GG-42 DEUS
FF1048	GP-1105 HAS	FF114	GG-20 FLG	FF-20	GG-8 ¹⁰³ ATL	FF31	GA-113 FLK
FF104A	G-225 FIL	FF1144	G-1046 HAS	FF-20	GG-8 L ⁸⁰ ATL	FF311EC	GP-54 FIL
FF104ZF	G-162H FIL	FF1145	G-1047 HAS	FF200	GPP-18 FLG	FF313	GG-1 DEUS
FF105	GP-11 ⁷⁶ CUMM	FF114M	G-33 FIL	FF200-1EC	GP-14 FIL	FF313	GG-4 DEUS
FF105	GP-1101 ⁷⁶ CUMM	FF115	G-1176 FLG	FF200EC	GP-5 FIL	FF316	G-566 FIL
FF105	GP-11 ⁷⁶ FLG	FF115	GG-94 IAPC	FF202	GG-19 DEUS	FF3178	GG-63 FSN
FF105	GP-1101 ⁴⁵ FLG	FF116	G-1166 FLG	FF202	GP-55 FLG	FF3178	GG-63 TIRP
FF105	GPP-1122 IAPC	FF1160	GS-1261 HAS	FF202	GP-55 KOMA	FF318EC	GP-54 FIL
FF1050	G-277 HAS	FF1164-SPS	GPP-1003S HAS	FF203	G-295 FLG	FF3190	GG-264 FSN
FF1051	G-276 HAS	FF118	G-335 FILG	FF204	GP-62 FLG	FF32	GA-113 FLK
FF1052	G-278 HAS	FF119	G-200 FIL	FF206	GP-27 FLG	FF322	G-870 FIL
FF1056	GP-749 HAS	FF1191A	G-296 COP	FF207	GP-26 FLG	FF324	GP-338 FIL
FF105C	GPP-14 FLG	FF1191A	G-296-B COP	FF209	GP-1107 FLG	FF-33	GG-1 ATL
FF105D	GPP-14 CUMM	FF12	GG-16 ATL	FF-21	GG-16 ATL	FF-33	GG-4 ATL
FF105D	GPP-11 FLG	FF12	GG-45 SRN	FF210	G-1166 DEL	FF3359	GG-45 FSN
FF105D	GPP-14 FLG	FF1212	GPP-11 FLG	FF210	GP-1101 ⁴⁵ FLG	FF3388	GG-16 FSN
FF106	G-1174 FLG	FF123	G-1173 ⁰⁸ DEL	FF211	G-1173 ⁰⁸ DEL	FF3389	GG-17 FSN
FF1060	GPP-1000 HAS	FF1232	GS-2034 HAS	FF211	GP-56 FLG	FF340	GP-1101 DEL
FF1062	GPP-1287 ³⁹ HAS	FF1235	GS-2033 HAS	FF213	GP-11 FLG	FF341	GGP-14 DEL
FF1062	PFF831 ⁴¹ HAS	FF124	G-836 FIL	FF213	GP-110 FLG	FF343	GP-1101 DEL
FF1062	S 3225 P ⁴² HAS	FF126	GG-181 IAPC	FF214	GPP-1122 FLG	FF3499	GG-8 ⁰³ FSN
FF1062-SP	GPP-1287 ³⁹ HAS	FF1260	GS-1261 HAS	FF215	GP-1122 FLG	FF3499	GG-8 L ⁸⁰ FSN
FF1062-SP	PFF831 ⁴¹ HAS	FF127	GG-185 IAPC	FF216	GP-26 FLG	FF353	G-813 FIL
FF1062-SP	S 3225 P ⁴² HAS	FF13	GG-123 FSN	FF217	GS-2033 FLG	FF356	G-152 FIL
FF1063	GPP-103 ⁴⁰ HAS	FF13	GG-1 SRN	FF218	G-119 FIL	FF36	GA-101 FLK
FF1063	GPP-11 ³⁹ HAS	FF13	GG-4 SRN	FF219	GG-17 FLG	FF-36	GG-94 ATL
FF1064	GPP-11 HAS	FF132	G-236 FIL	FF219EC	GP-81 ³¹ FIL	FF361	G-613 FIL
FF107	GG-185 IAPC	FF134	G-1163 FLG	FF219EC	GP-9 ⁹⁸ FIL	FF363	GP-78 DEL
FF1070	GPP-18 HAS	FF137	G-331 FIL	FF22	GG-19 FSN	FF364	GP-1105 DEL
FF1072	GP-26 HAS	FF138	GG-217 IAPC	FF-22	GG-17 ATL	FF365	GP-62 DEL
FF1073	S 3202 ⁴⁰ HAS	FF-14	GG-7 ATL	FF220	GG-16 FLG	FF365EC	GP-22 DEL
FF1074	GP-11 HAS	FF140	GG-79 IAPC	FF2203	GP-1101 FLG	FF366EC	GP-81 FIL
FF1076	GP-1109 ²² HAS	FF141	G-1176 FLG	FF221	G-834 FLG	FF-38	GG-63 ATL
FF1076	GP-62 ²⁰ HAS	FF142	G-1176 FLG	FF222	GP-85 FLG	FF3802	GG-47 FSN
FF1077	GP-96 HAS	FF143	G-834 FIL	FF223	GPP-19 FLG	FF38EC	GP-81 ³¹ FIL
FF1078	GGP-125 HAS	FF143	G-1173 ⁰⁸ FLG	FF224	GPP-18 FLG	FF38EC	GP-9 ⁹⁸ FIL
FF1079	GP-110 HAS	FF144	G-11816 FLG	FF226	G-1166 DEL	FF39	G-11816 COP
FF108	G-1143 CUMM	FF145	GG-251 IAPC	FF229	GP-1107 FLG	FF-39	GG-194 ATL
FF108	G-6 FIL	FF146	G-1121 FLG	FF229	GP-1109 FLG	FF391EC	GP-68 FIL
FF108	G-1143 FLG	FF146	G-1121F FLG	FF-23	GG-87 ATL	FF394EC	GP-66 FIL
FF108	G-1143 KOMA	FF147	G-1123 FLG	FF231	GP-1122 FLG	FF39867	GPP-19 COP
FF1085	GPP-1122 HAS	FF147	G-1123F FLG	FF232	GPP-11 FLG	FF39868	GPP-18 COP
FF1087	GP-1109 HAS	FF149	GG-3 FLG	FF235	GP-92 FLG	FF3A	G-1175 ⁰⁸ CUMM
FF1088	GPP-419 HAS	FF150	GG-261 IAPC	FF235EC	GP-81 ³¹ FIL	FF4	GP-1101 CUMM
FF109	G-1173 FLG	FF151	G-225 FIL	FF235EC	GP-9 ⁹⁸ FIL	FF4	GG-204 IAPC
FF1093	GS-1261 HAS	FF157	GG-5 L FLG	FF236	G-330 FIL	FF4011	G-296 DEUS
FF1095	G-128 HAS	FF157	GG-203 FSN	FF237EC	GP-58 FIL	FF4011	G-296-B DEUS
FF1097	GP-458 HAS	FF158	GG-196 FSN	FF238	GG-45 FIL	FF4012	GG-48 FLG
FF1098	GPP-424 HAS	FF16	GG-45 COP	FF238	GG-45 FLG	FF4013	GP-1122 FLG
FF1098-D	GPP-424 HAS	FF16	GGP-25 CYC	FF239	GG-8 ¹⁰³ FLG	FF4016	GG-189 DEUS
FF1099	GPP-425 HAS	FF16	GG-16 SRN	FF239	GG-8 L ⁸⁰ FLG	FF402	GG-45 DEUS
FF11	GG-6 FSN	FF1601	GGP-25 COP	FF239EC	GP-81 FIL	FF403	GG-1 DEUS
FF110	G-871 FIL	FF1601-7D	GGP-25 ⁶¹ COP	FF24	GG-45 SRN	FF403	GG-4 DEUS
FF110	G-1175 FLG	FF1601-7D	GP-26 ⁵² COP	FF244	G-1163 ⁰⁸ DEL	FF4031	G-178 DEUS
FF1100	GPP-419 HAS	FF161	GG-5 L FLG	FF247EC	GP-14 FIL	FF4033	

Numero	Gonher	Fabricante	Numero	Gonher	Fabricante	Numero	Gonher	Fabricante	Numero	Gonher	Fabricante
Number	Gonher	Manufacturer	Number	Gonher	Manufacturer	Number	Gonher	Manufacturer	Number	Gonher	Manufacturer
FF4052A	G-297	FLG	FF5027	GG-87	FLG	FF5228	G-1123	FLG	FF5D	GGP-14	CUMM
FF4052-A	G-297-B	FLG	FF503	GG-123	AVAT	FF523	GG-76	AVAT	FF6	GP-50	ACD
FF4062	GP-1122	FLG	FF5033	GP-1122	FLG	FF5232	GG-246	FLG	FF60	GG-76	IAPC
FF4063	GP-1122	FLG	FF5034	GP-92	FLG	FF5233	GG-8 L	FLG	FF600	GG-246	DEUS
FF407	GG-196	DEUS	FF5035	GP-155	FLG	FF5236	GG-204	FLG	FF601	GG-30	DEUS
FF407EC	GP-42	FIL	FF5037	GP-85 ⁹⁰	FLG	FF5238	GG-79	FLG	FF603	GG-260	DEUS
FF408EC	GP-462	FIL	FF5038	GPP-18	FLG	FF5239	GG-5 L	FLG	FF607	GG-256	DEUS
FF4092	GP-26	FLG	FF504	GG-16	AVAT	FF524	GG-1	AVAT	FF608	GG-92	DEUS
FF41	GG-45	FLK	FF504	GG-46	DEUS	FF524	GG-4	AVAT	FF610	GG-84	DEUS
FF410	GG-194	DEUS	FF5040	GP-1122	FLG	FF5244	GG-1872	FLG	FF613	GG-164	DEUS
FF413	GG-208	DEUS	FF5045	G-270	FLG	FF5245	GP-110	FLG	FF617	GG-203	DEUS
FF414	GG-202	DEUS	FF5046	GPP-1122	FLG	FF5253	GPP-11	FLG	FF62	GG-87	FLK
FF4141	G-1121F	FLG	FF5047	GPP-1122	FLG	FF5254	GPP-14	FLG	FF-62	GG-256	ACD
FF416	GG-76	DEUS	FF504EC	GP-31	FIL	FF5264	GP-749	FLG	FF620	GG-213	DEUS
FF417	GG-203	DEUS	FF505	GG-17	AVAT	FF5269	GP-78	FLG	FF625	GG-164	DEUS
FF418	GG-208	DEUS	FF505	GG-3728	DEUS	FF5271	GP-1122	FLG	FF63	GG-202	FLK
FF419	GG-5 L	DEUS	FF505	G-33	FIL	FF5272	GP-96	FLG	FF-63	GG-190	ATL
FF42000	GP-1122	FLG	FF5052	GP-1122	FLG	FF5275	G-278	FLG	FF631	GG-151	DEUS
FF42001	GP-1122	FLG	FF5053	G-121F	FLG	FF5276	G-276	FLG	FF634	GG-185	DEUS
FF42002	GP-1122	FLG	FF5054	G-1123F	FLG	FF5277	G-277	FLG	FF636	GG-185	DEUS
FF42006	GPP-1122	FLG	FF5056	GPP-18	FLG	FF5278	G-128	FLG	FF-64	GG-188	FLK
FF422	GG-76	DEUS	FF506	GG-19	AVAT	FF5284	GP-1122	FLG	FF646	GG-232	DEUS
FF424EC	GP-1	FIL	FF506	GG-242	DEUS	FF5287	GG-298	FLG	FF647	GG-206	DEUS
FF425	GG-20	DEUS	FF5060	GPP-1122	FLG	FF52A	G-870	FLG	FF65	GG-208	FLK
FF425EC	GP-3816	FIL	FF5066	GG-1	FLG	FF52EC	GP-3985	FIL	FF65	GG-45	IAPC
FF427	GG-76	DEUS	FF5066	GG-4	FLG	FF53	GG-196	FLK	FF651	GG-94	DEUS
FF428	GG-203	DEUS	FF5067	GP-1107	FLG	FF-53	GG-65	ATL	FF658	GG-39	DEUS
FF429	GG-208	DEUS	FF507	GG-255	DEUS	FF5301	GP-1224	FLG	FF6593	GG-986	TIRP
FF43	GG-16	FLK	FF5074	GP-1122	FLG	FF5308	GP-749	FLG	FF-66	GG-1872	ATL
FF432	GG-188	DEUS	FF5074CS	GP-1122	FLG	FF5309	GP-1109 ²²	FLG	FF660	GG-185	DEUS
FF433	GG-3	DEUS	FF5076	GPP-11	FLG	FF5309	GP-62 ²⁰	FLG	FF662	GG-137	DEUS
FF433EC	GP-28 ⁸	FIL	FF5078	GP-78	FLG	FF5314	G-128	FLG	FF663	GG-63	DEUS
FF433EC	GP-430 ⁸	FIL	FF508	GG-66	DEUS	FF5315	G-128	FLG	FF664	GG-7018 ³⁸	DEUS
FF436EC	GP-22	FIL	FF508EC	GP-390 ⁹³	FIL	FF5319	GP-749	FLG	FF664	GG-7019 ³⁷	DEUS
FF437EC	GP-3600	FIL	FF5091	GP-1122	FLG	FF5320	GP-110	FLG	FF664	GG-7020 ¹⁴⁴	DEUS
FF44	GG-17	FLK	FF5095	GP-1122	FLG	FF5321	GP-1109 ²²	FLG	FF-67	GG-66	ATL
FF447EC	GP-38	FIL	FF5097	GG-47	FLG	FF5321	GP-62 ²⁰	FLG	FF671	GG-227	DEUS
FF45	GG-76	IAPC	FF51	GG-76	FLK	FF5324	GP-1109	FLG	FF676	GG-79	DEUS
FF46	G-5000	FIL	FF-51	GG-261	ATL	FF5327	GP-1122	FLG	FF677	GG-64	DEUS
FF460	G-191	FIL	FF5100	G-1121	FLG	FF533	GG-203	AVAT	FF679	GG-47	DEUS
FF4611	GG-61	FSN	FF5113	GP-1122	FLG	FF5330	GP-1122	TEC	FF-68	GG-7018 ³⁸	ATL
FF4618	GG-65	FSN	FF5117	GPP-1122	FLG	FF5332	GP-1122	TEC	FF-68	GG-7019 ³⁷	ATL
FF465EC	GP-3600	FIL	FF513	GG-8 ¹⁰³	AVAT	FF5333	GP-27	FLG	FF-68	GG-7020 ¹⁴⁴	ATL
FF-4672	GG-256	FSN	FF513	GG-8 L ⁸⁰	AVAT	FF5334	GP-1101	FLG	FF680	GG-1122	DEUS
FF467EC	GP-3682	FIL	FF5133	GG-3728	FLG	FF5354	GG-251	TEC	FF681	GG-217	DEUS
FF-4702	GG-177 ⁴³	FSN	FF5135	GPP-1122	FLG	FF5357	GG-189	TEC	FF684	GG-246	DEUS
FF-4702	GG-581 ¹¹⁶	FSN	FF5136	GP-1101	FLG	FF5369	G-128	FLG	FF685	GG-245	DEUS
FF4705	GG-7018 ³⁸	FSN	FF5137	GP-1101	FLG	FF5369W	G-128	FLG	FF-69	GG-79	ATL
FF4705	GG-7019 ³⁷	FSN	FF5139	GPP-1122	FLG	FF5376	GP-1105	FLG	FF692	GG-187	DEUS
FF4705	GG-7020 ¹⁴⁴	FSN	FF514	GG-1	AVAT	FF5380	G-1046	FLG	FF694	GG-223	DEUS
FF4705	GG-7018 ³⁸	TIRP	FF514	GG-4	AVAT	FF540A	G-1175	COP	FF695	GG-185	DEUS
FF4705	GG-7019 ³⁷	TIRP	FF515	GG-5 L	AVAT	FF541	G-295	CYC	FF696	GG-160	DEUS
FF4705	GG-7020 ¹⁴⁴	TIRP	FF5156	GPP-1122	FLG	FF541	G-295	GLD	FF697	GG-232	DEUS
FF4711	GG-1872	FSN	FF5157	GP-110	FLG	FF5418	G-862	FLG	FF698	GG-268	DEUS
FF4711	GG-1872	TIRP	FF5160	GPP-111	FLG	FF5420	GP-548	FLG	FF699	GG-136	DEUS
FF4714	GG-66	FSN	FF5160	GP-524	FLG	FF5421	GP-548	FLG	FF7	GG-19	FLK
FF4714	GG-66	TIRP	FF5161	GP-1105	FLG	FF5422	GP-1122	FLG	FF7	GG-20	SRN
FF476EC	GP-54 ¹¹	FIL	FF5165	GPP-111	FLG	FF5426	GPP-14	FLG	FF70	GG-203	IAPC
FF476EC	GP-66 ¹⁰	FIL	FF5165	GP-524	FLG	FF543	GG-20	AVAT	FF700	GG-181	DEUS
FF477EC	GP-1	FIL	FF5167	GP-1122	FLG	FF5455	GG-986	FLG	FF701	GG-215	DEUS
FF480EC	GP-77	FIL	FF516EC	GP-51	FIL	FF5456	GG-30	FLG	FF703	GG-65	DEUS
FF481	GG-46	FSN	FF517	GG-45	AVAT	FF5458	GP-458	FLG	FF704	GG-184	DEUS
FF481	GG-46	TIRP	FF5171	GPP-1122	FLG	FF5468	GG-189	TEC	FF705	GG-190	DEUS
FF482	GP-78	COP	FF5174	GG-203	FLG	FF547	GG-5 L	AVAT	FF706	GG-146	DEUS
FF483	GG-3728	FSN	FF5175	GG-61	FLG	FF548	GG-87	AVAT	FF707	GG-181	DEUS
FF-49	GG-245	ATL	FF5176	GG-94	FLG	FF5480	GG-1	FLG	FF71	G-1163 ¹⁰⁸	COP
FF4B	GP-1101	CUMM	FF5177	GG-187	FLG	FF5480	GG-4	FLG	FF71	GG-94	FLK
FF4D	GP-1101	CUMM	FF5178	GG-264	FLG	FF5485	GP-548	FLG	FF711	GG-185	DEUS
FF5	GP-1101	CHP	FF5179	GG-196	FLG	FF5488	GP-1109	FLG	FF720	GG-220	DEUS
FF5	GP-1101	CUMM	FF517EC	GP-51	FIL	FF5494	GP-1122	FLG	FF722	GG-220	DEUS
FF5	GG-20	FLK	FF5180	GG-63	FLG	FF5503	GG-66	FLG	FF723	GG-214	DEUS
FF5	GG-194	IAPC	FF5181	GG-208	FLG	FF552	GG-203	AVAT	FF729	GG-185	DEUS
FF5	GG-19	SRN	FF5182	GG-185	FLG	FF555	GG-246	AVAT	FF730	GG-246	DEUS
FF50	GG-45	FLK	FF5183	GG-208	FLG	FF560	GG-46	AVAT	FF730	GG-408	DEUS
FF50	GG-188	IAPC	FF5184	GG-256	FLG	FF561	GG-3728	AVAT	FF731	GG-264	DEUS
FF5002	G-297	FLG	FF5185	GG-226	FLG	FF5612	GP-548	FLG	FF732	GG-67	DEUS
FF5002	G-297-B	FLG	FF5186	GG-251	FLG	FF562	GP-92	AVAT	FF733	GG-61	DEUS
FF500-41	G-295	COP	FF5190	GG-63	FLG	FF5624	GP-749	FLG	FF735	GG-148	DEUS
FF5006	GG-5 L	FLG	FF5192	GG-76	FLG	FF5625	GPP-612	FLG	FF736	GG-150	DEUS
FF501	GG-6	AVAT	FF5193	GG-65	FLG	FF563	GP-1122	AVAT	FF737	GG-243	DEUS
FF5011	GP-26	FLG	FF5194	GG-220	FLG	FF5632	GP-548	FLG	FF739	GG-79	DEUS
FF5012	GPP-25	FLG	FF5196	GG-208	FLG	FF564	GG-123	AVAT	FF742	GG-247	DEUS
FF5015	GG-5 L	FLG	FF5199	GG-177 ⁴³	FLG	FF567	GG-47	AVAT	FF743	GG-72	DEUS
FF5016	GG-3	FLG	FF5199	GG-581 ¹¹⁶	FLG	FF570	GG-196	AVAT	FF744	GG-177	DEUS
FF5016	GG-5	FLG	FF-52	GG-251	ATL	FF576	GG-208	AVAT	FF745	GG-1872	DEUS
FF5016	GG-5 L	FLG	FF5200	GG-67	FLG	FF578	GG-203	AVAT	FF748	GG-99	DEUS
FF5017	GP-1105	FLG	FF5206	GP-27	FLG	FF58	GG-203	FLK	FF75	GG-203	IAPC
FF5018	GP-1122	FLG	FF5207	GP-26	FLG	FF580	GG-196	AVAT	FF750	GPP-111	DEUS
FF5019	GP-78	FLG	FF520EC	GP-3985	FIL	FF581	GG-42	AVAT	FF750	GPP-524	DEUS
FF501MF	G-1121F	FIL	FF5213	GG-188	FLG	FF584	G-294	AVAT	FF752	GG-115	DEUS
FF502	GG-7	AVAT	FF5214	GG-232	FLG	FF587-12	GPP-18	COP	FF754	GG-249	DEUS
FF502	GG-240	DEUS	FF5215	GG-213	FLG	FF-59	GG-142	ATL	FF761	GG-251	DEUS
FF5020	GP-1108	FLG	FF5216	GG-194	FLG	FF590	GG-94	AVAT	FF762	GG-226	DUTZ
FF5021	GP-93	FLG	FF5217	GG-213	FLG	FF599AR	GP-1	FIL	FF764	G-294	DEUS
FF5024	GG-240	FLG	FF522	GG-45	AVAT	FF5D	GPP-14	CHP	FF765	GP-92	DEUS
FF5026	GG-46	FLG	FF5225	GG-67	FLG	FF5D	GPP-14	COP	FF767	GG-261	DEUS

Referencia Cruzada por Numero de Parte

Cross Reference by Part Number



Numero	Gonher	Fabricante	Numero	Gonher	Fabricante	Numero	Gonher	Fabricante	Numero	Gonher	Fabricante
Number	Gonher	Manufacturer	Number	Gonher	Manufacturer	Number	Gonher	Manufacturer	Number	Gonher	Manufacturer
FF776	GG-580	DEUS	FF986	GP-1107	HAS	FFP550218	GP-84	DON	FFR8180	GG-6	FLR
FF780	GG-67	DEUS	FF9909	GG-8 L	IAPC	FFP550219	GP-83	DON	FFR8181	GG-7	FLR
FF781	GG-142	DEUS	FF992	GP-26	HAS	FFP550316	G-1143 ⁹⁰	DON	FFR8182	GP-78	FLR
FF785	G-178	DEUS	FF992CO	GP-26	FEDE	FFP550431	GP-85	DON	FFR8184	GP-1108	FLR
FF795	GG-234	DEUS	FF993	GP-27	HAS	FFP550439	GPP-18	DON	FFR8185	GP-110	FLR
FF795	GG-87	FSN	FF993CO	GP-27	FEDE	FFP550440	GP-1122	DON	FFR8187	G-1176	FLR
FF796	GG-214	DEUS	FF994	GPP-18	HAS	FFP550470	GG-16	DON	FFR8192	GP-110	FLR
FF8	G-1143	CUMM	FF995	GPP-19	HAS	FFP550471	GG-17	DON	FFR8194	GPP-1000	FLR
FF8	GG-1	SRN	FF996	G-295	HAS	FFP550474	GG-8 ¹⁰³	DON	FFR8196	GP-1101	FLR
FF8	GG-4	SRN	FF996CO	G-295	FEDE	FFP550474	GG-8 L ⁸⁰	DON	FFR8198	GPP-14	FLR
FF80	GG-45	IAPC	FF997	GP-1101 ⁵⁴	HAS	FFP550475	GG-87	DON	FFR8200	GPP-18	FLR
FF815	GP-26	COP	FF998	GP-56	HAS	FFP550522	G-1174	DON	FFR8202	GP-55	FLR
FF815	GP-155	DEUS	FF998CO	GP-56	FEDE	FFP550540	G-1175	DON	FFR8203	G-295	FLR
FF816	GP-27	COP	FFA10792A	GA-6129	FINN	FFP550587	GPP-1122	DON	FFR8204	GP-62	FLR
FF825	GP-55	HAS	FFA10792B	GA-6127	FINN	FFP550811	GP-155	DON	FFR8206	GP-27	FLR
FF826	GP-1122	HAS	FFA57	GA-80	FILG	FFP550861	G-1123	DON	FFR8207	GP-26	FLR
FF827	GP-1122	HAS	FFA732	GA-7	FINN	FFP550868	GPP-18	DON	FFR8209	GP-1107	FLR
FF828	GP-78	HAS	FFA734	GA-44	FINN	FFP550915	GP-26	DON	FFR8210	GP-1101 ⁵⁴	FLR
FF829	GP-1101	HAS	FFA740	GA-71	FINN	FFP550916	GP-27	DON	FFR8211	GP-56	FLR
FF830	GS-2033	HAS	FFA764	GAD-3	FINN	FFP550928	GP-93	DON	FFR8213	GP-110	FLR
FF832	GP-1122	HAS	FFA788	GA-436	FINN	FFP550936	GP-92	DON	FFR8214	GPP-1122	FLR
FF832CO	GP-1122	FEDE	FFA792A	GA-6129	FINN	FFP550943	GP-1122	DON	FFR8215	GP-1122	FLR
FF833	G-293	HAS	FFA792B	GA-6127	FINN	FFP550944	GP-92	DON	FFR8216	GP-26	FLR
FF834	GPP-1122	HAS	FFA798	GAK-403	FINN	FFP550959	GP-85 ⁹⁰	DON	FFR8217	GS-2033	FLR
FF835	GP-62	HAS	FFA799	GA-106 ⁴⁶	FINN	FFP551130	G-295	DON	FFR8219	GG-17	FLR
FF836	G-297-B	HAS	FFA799	GA-326 ⁷¹	FINN	FFP551915	GP-26	DON	FFR8220	GG-16	FLR
FF837	GP-92	HAS	FFA803	GA-9334	FINN	FFP552010	2010PM-OR ²	DON	FFR82203	GP-1101	FLR
FF838	GP-93	HAS	FFA827	GA-405	FINN	FFP552010	2010TM-OR ²	DON	FFR8222	GP-85	FLR
FF840	GP-92	HAS	FFA892	GA-49	FINN	FFP552020	GS-2033	DON	FFR8223	GPP-19	FLR
FF843	GP-1122	HAS	FFA911	GAK-20	FINN	FFP552040	GS-2034	DON	FFR8224	GPP-18	FLR
FF844	GA-1286	FINN	FFA944	GA-1286	FINN	FFP552250	GP-1101	DON	FFR8231	GP-1122	FLR
FF844CO	GP-92	FEDE	FFA945	GA-7716	FINN	FFP552251	GP-1101	DON	FFR8235	GP-92	FLR
FF846	GP-85 ⁹⁰	HAS	FFA946	GA-7360	FINN	FFP552603	GP-78	DON	FFR8238	GG-45	FLR
FF848	2010PM-OR ⁷	HAS	FF-E0001	G-1123	GFF	FFP553004	GP-1122	DON	FFR8239	GG-8 ¹⁰³	FLR
FF848	2010TM-OR ²	HAS	FF-E0005-E	G-1121F	GFF	FFP553261	G-1173	DON	FFR8239	GG-8 L ⁸⁰	FLR
FF849	GP-2934	HAS	FF-E0007-P	G-296	GFF	FFP553693	GP-62	DON	FFR8249	GG-123	FLR
FF851	GG-196	IAPC	FF-E0007-P	G-296-B	GFF	FFP553854	GP-1105	DON	FFR84012	GG-48	FLR
FF851	GP-155	HAS	FF-E0031	GG-48	GFF	FFP553855	GP-1107	DON	FFR84013	GP-1122	FLR
FF851CO	GP-155	FEDE	FF-E0040	GS-2033	GFF	FFP554347	GP-26	DON	FFR84033	G-1123F	FLR
FF855	G-294	HAS	FF-E0042	G-1143	GFF	FFP555001	GPP-11	DON	FFR84052	G-297-B	FLR
FF855CO	G-294	FEDE	FF-E0046-P	G-297-B	GFF	FFP555002	S 3202 ⁹⁰	DON	FFR84052A	G-297-B	FLR
FF856	G-297	HAS	FF-E0075	G-1175	GFF	FFP555010	GPP-11	DON	FFR84062	GP-1122	FLR
FF856	G-297-B	HAS	FFF-4550	GP-84	PAI	FFP555020	S 3202 ⁹⁰	DON	FFR84063	GP-1122	FLR
FF863	GPP-11	HAS	FFF-4551	GP-85	PAI	FFP555095	GP-1122	DON	FFR84141	G-1121F	FLR
FF864	GPP-11	HAS	FFF-4590	GP-83	PAI	FFP555110	GPP-103 ⁹⁰	DON	FFR85006	GG-5 L	FLR
FF867	GPP-11	HAS	FFH10507	G-1121F	FINN	FFP555110	GPP-11 ³⁹	DON	FFR85011	GP-26	FLR
FF875	GG-95	DEUS	FFH507	G-1121F	FINN	FFP555627	GP-1108	DON	FFR85012	GGP-25	FLR
FF885	GP-92	HAS	FFH509	G-1123	FINN	FFP555823	GP-56	DON	FFR85015	GG-5 L	FLR
FF896	GP-1122	HAS	FFJD16	G-296	DON	FFP556245	G-296	DON	FFR85017	GP-1105	FLR
FF899	GP-26	HAS	FFK164	G-330	FINN	FFP556245	G-296-B	DON	FFR85018	GP-1122	FLR
FF90	GG-213	IAPC	FFP10	GP-110	FINN	FFP557440	GP-110	DON	FFR85019	GP-78	FLR
FF900	G-1166	HAS	FFP10010	G-834	FINN	FFP558000	GPP-11	DON	FFR85020	GP-1108	FLR
FF901	GG-267	DEUS	FFP10031	G-162H	FINN	FFP558010	S 3202 ⁹⁰	DON	FFR85021	GP-93	FLR
FF902	G-1163 ⁰⁸	HAS	FFP104	G-330	FINN	FFP558020	GPP-11	DON	FFR85024	GG-240	FLR
FF903	GG-1	IAPC	FFP10506	G-1121	FINN	FFP558030	GPP-11	DON	FFR85026	GG-46	FLR
FF903	GG-4	IAPC	FFP10508	G-1123	FINN	FFP558050	GPP-11	DON	FFR85027	GG-87	FLR
FF904	GG-87	IAPC	FFP10525	G-296	FINN	FFP558712	GPP-18	DON	FFR85033	GP-1122	FLR
FF906	G-1173 ⁰⁸	HAS	FFP10525	G-296-B	FINN	FFP559803	G-293	DON	FFR85034	GP-92	FLR
FF907	GG-61	IAPC	FFP112	G-5000	FINN	FFP6	G-870	FINN	FFR85035	GP-155	FLR
FF909	G-1174	HAS	FFP170093	GP-62	DON	FFP60	G-191	FINN	FFR85037	GP-85 ⁹⁰	FLR
FF922	GP-1101	HAS	FFP170104	GP-1101	DON	FFP69	G-335	FINN	FFR85038	GPP-18	FLR
FF927	G-11816	HAS	FFP170202	GP-55	DON	FFP78	G-613	FINN	FFR85040	GP-1122	FLR
FF934	GG-48	HAS	FFP170212	GPP-11	DON	FFP9	G-836	FINN	FFR85046	GPP-1122	FLR
FF937	G-1166	HAS	FFP170218	GP-84	DON	FFP92	G-236	FINN	FFR85047	GPP-1122	FLR
FF939	G-1143 ⁹⁰	HAS	FFP170219	GP-83	DON	FFP922010	2010PM-OR ⁷	DON	FFR85052	GP-1122	FLR
FF945	GP-1101	HAS	FFP170431	GP-85	DON	FFP922010	2010TM-OR ²	DON	FFR85053	G-1121F	FLR
FF945CO	GP-1101	FEDE	FFP170627	GP-1108	DON	FFP922020	GS-2033	DON	FFR85054	G-1123F	FLR
FF95	GG-208	IAPC	FFP170680	GP-36	DON	FFP922040	GS-2034	DON	FFR85056	GPP-18	FLR
FF950	GG-46	IAPC	FFP170792	G-1166	DON	FFPA1102810	G-24	FINN	FFR85060	GPP-1122	FLR
FF952	GG-19	IAPC	FFP170811	GP-155	DON	FFPA11028T	G-24	FINN	FFR85066	GG-1	FLR
FF954	GPP-14	HAS	FFP170823	GP-56	DON	FFPAV1102810	G-24	FINN	FFR85066	GG-4	FLR
FF955	GP-85	HAS	FFP170915	GP-26	DON	FFR8104	GP-1101	FLR	FFR85067	GP-1107	FLR
FF957	G-1121	HAS	FFP170916	GP-27	DON	FFR8105	GP-1101	FLR	FFR85074	GP-1122	FLR
FF958	GS-1133	HAS	FFP170928	GP-93	DON	FFR8105C	GPP-14	FLR	FFR85076	G-277	FLR
FF962	GP-110	HAS	FFP170936	GP-92	DON	FFR8105D	GPP-14	FLR	FFR85078	GP-78	FLR
FF963	G-296	HAS	FFP232	G-143	FINN	FFR8108	G-1143	FLR	FFR85091	GP-1122	FLR
FF963	G-296-B	HAS	FFP31	G-225	FINN	FFR8109	G-1173	FLR	FFR85095	GP-1122	FLR
FF963CO	G-296	FEDE	FFP36	G-870	FINN	FFR8110	G-1175	FLR	FFR85097	GG-47	FLR
FF963CO	G-296-B	FEDE	FFP49	G-238	FINN	FFR8114	GG-20	FLR	FFR85100	G-1121	FLR
FF964	GPP-25	HAS	FFP506	G-1121	FINN	FFR8115	G-1176	FLR	FFR85109	GPP-19	FLR
FF966	GG-208	IAPC	FFP508	G-1123	FINN	FFR8121	G-1173	FLR	FFR85113	GP-1122	FLR
FF968	GPP-14	HAS	FFP511	G-1123	FINN	FFR8134	G-1163	FLR	FFR85117	GPP-1122	FLR
FF970	G-1143	HAS	FFP516	G-1121	FINN	FFR8142	G-1176	FLR	FFR85133	GG-3728	FLR
FF970	GG-196	IAPC	FFP524384	GA-3588	DON	FFR8143	G-1173	FLR	FFR85135	GPP-1122	FLR
FF973	G-1175	HAS	FFP525	G-296	FINN	FFR8146	G-1121	FLR	FFR85136	GP-1101	FLR
FF975	GG-146	IAPC	FFP525	G-296-B	FINN	FFR8147	G-1123	FLR	FFR85137	GP-1101	FLR
FF976	GG-151	IAPC	FFP550012	GG-5 L	DON	FFR8149	GG-3	FLR	FFR85139	GPP-1122	FLR
FF978	GG-185	IAPC	FFP550022	GG-123	DON	FFR8157	GG-5 L	FLR	FFR85156	GPP-1122	FLR
FF980	GP-84	HAS	FFP550043	G-1143	DON	FFR8167	G-296	FLR	FFR85157	GP-110	FLR
FF980	GG-220	IAPC	FFP550060	G-1121	DON	FFR8167	G-296-B	FLR	FFR85160	GPP-111	FLR
FF981	GP-83	HAS	FFP550105	GP-1101	DON	FFR8167A	G-296	FLR	FFR85160	GPP-524	FLR
FF984	GP-110	HAS	FFP550106	GP-1101	DON	FFR8167A	G-296-B	FLR	FFR85161	GP-1105	FLR
FF984	GG-46	IAPC	FFP550115	GPP-25	DON	FFR8171	GP-84	FLR	FFR85165	GPP-111	FLR
FF984CO	GP-110	FEDE	FFP550202	GP-55	DON	FFR8172	GP-83	FLR	FFR85165	GPP-524	FLR
FF985	GP-1108	HAS	FFP550214	GG-20	DON	FFR8178	G-1143	FLR	FFR85167	GP-1122	FLR
FF985	GG-232	IAPC	FFP550215	GP-92	DON	FFR8179	GG-19	FLR	FFR85171	GPP-1122	FLR

REFERENCIA CRUZADA

Para números Gonher con Superíndice vea página 651
For Gonher with Superscript numbers see page 651

Numero	Gonher	Fabricante	Numero	Gonher	Fabricante	Numero	Gonher	Fabricante	Numero	Gonher	Fabricante
Number	Gonher	Manufacturer	Number	Gonher	Manufacturer	Number	Gonher	Manufacturer	Number	Gonher	Manufacturer
FFR85174	GG-203	FLR	FFUP531	GP-1122	FINN	FG38	G-296	MTR	FG834	GG-202	MTR
FFR85175	GG-61	FLR	FG 1036	GG-308	MTR	FG38	G-296-B	MTR	FG836	GG-204	MTR
FFR85176	GG-94	FLR	FG 846	GG-142	MTR	FG390	G-1163 ¹⁰⁸	APL	FG840	GG-42	BARA
FFR85177	GG-187	FLR	FG 846	GG-188	MTR	FG4	GG-6	ADP	FG840	GG-42	MTR
FFR85178	GG-264	FLR	FG 858	GG-261	MTR	FG402	G-1173	APL	FG840A	GG-42	GKIN
FFR85179	GG-196	FLR	FG 900	GG-220	MTR	FG403	G-1174 ¹⁰⁸	APL	FG840A	GG-42	MIGH
FFR85180	GG-63	FLR	FG1	GG-20	BARA	FG409	G-1173	APL	FG840A	GG-42	PROG
FFR85181	GG-208	FLR	FG1	GG-20	GKIN	FG415	G-1123	APL	FG842	GG-246	MTR
FFR85182	GG-185	FLR	FG1	GG-20	MTR	FG4-16K	GG-1	COP	FG849	GG-8 L	MTR
FFR85183	GG-208	FLR	FG1	GG-20	PRET	FG4-16K	GG-4	COP	FG850	GG-240	MTR
FFR85184	GG-580	FLR	FG1	GG-20	PROG	FG4-16K	GG-1	GLD	FG851	GG-46	MTR
FFR85185	GG-226	FLR	FG100	GG-1	MTR	FG4-16K	GG-4	GLD	FG852	GG-3728	MTR
FFR85186	GG-251	FLR	FG100	GG-4	MTR	FG427	GG-6	COP	FG856	GG-76	MTR
FFR85190	GG-63	FLR	FG1006	GG-47	MTR	FG427	GG-6	GLD	FG859	GP-1122	MTR
FFR85192	GG-76	FLR	FG1009	GG-47	MTR	FG441	GG-7	COP	FG859-A	GP-1122	MTR
FFR85193	GG-65	FLR	FG1011	GG-101	ATL	FG441	GG-7	GLD	FG860	GP-1122	MTR
FFR85196	GG-208	FLR	FG1011	GG-101	MIGH	FG470	GG-16	COP	FG861	GG-208	MTR
FFR85199	GG-581	FLR	FG1011	GG-101	MTR	FG470	GG-16	GLD	FG862	GG-30	GKIN
FFR85200	GG-67	FLR	FG1011	GG-101	SERC	FG471	GG-17	COP	FG862	GG-30	MIGH
FFR85206	GP-27	FLR	FG1012	GG-307	MTR	FG471	GG-17	GLD	FG862	GG-30	MTR
FFR85207	GP-26	FLR	FG102	GG-1	MTR	FG48	GG-20	MTR	FG862	GG-30	PROG
FFR85213	GG-203	FLR	FG102	GG-4	MTR	FG5	GG-20	ADP	FG864	GG-142	MIGH
FFR85214	GG-232	FLR	FG-1026	GG-66	MTR	FG5-16	GG-5 L	COP	FG864	GG-142	MTR
FFR85225	GG-67	FLR	FG1027	G-1121F	FIA	FG5-16	GG-5 L	GLD	FG-864	GG-142	PROG
FFR85228	G-1123	FLR	FG103	GG-87	MTR	FG59	G-1123	MTR	FG872	GG-1872	GKIN
FFR85232	GG-246	FLR	FG1036	GG-308	GKIN	FG6	GG-6	ADP	FG872	GG-1872	MIGH
FFR85233	GG-8 L	FLR	FG1060	GG-47	ATL	FG61	GP-1108	MTR	FG872	GG-1872	MTR
FFR85236	GG-204	FLR	FG1060	GG-47	MTR	FG6-16	GG-5 L	COP	FG872	GG-1872	PROG
FFR85239	GG-5 L	FLR	FG1071	GG-307	ATL	FG6-16	GG-5 L	GLD	FG872	GG-1872	TVI
FFR85244	GG-1872	FLR	FG1072	GG-307	MTR	FG6-16K	GG-5 L	COP	FG872A	GG-1872	MTR
FFR85245	GP-110	FLR	FG1081	GG-986	MTR	FG6-16K	GG-5 L	GLD	FG873	GG-47	MTR
FFR85253	G-277	FLR	FG1083	GG-101	MTR	FG66	GG-32	MTR	FG877	GG-239	MIGH
FFR85254	GPP-14	FLR	FG111	GG-20	APL	FG7	GG-1	MTR	FG877	GG-239	MTR
FFR85264	GP-749	FLR	FG129	G-1121	APL	FG7	GG-4	MTR	FG881	GG-92	GKIN
FFR85269	GP-78	FLR	FG13	GG-123	COP	FG70	GPP-18	MTR	FG881	GG-92	MIGH
FFR85272	GP-96	FLR	FG13	GG-123	GLD	FG71	GP-110	MTR	FG881	GG-92	MTR
FFR85275	G-278	FLR	FG131	GG-19	FRML	FG762	GP-1101 ³⁴	MTR	FG881A	GG-92	MTR
FFR85276	G-276	FLR	FG133	G-1123	APL	FG764	G-1143	MTR	FG883	GG-251	MTR
FFR85277	G-277	FLR	FG139	G-1121	APL	FG765	G-1143	MTR	FG884	GG-215	MTR
FFR85278	G-128	FLR	FG13P	GG-123	GLD	FG766	GP-26	MTR	FG885	GG-185	MTR
FFR85284	GP-1122	FLR	FG14	GG-19	BARA	FG767	GP-27	MTR	FG886	GG-246	MTR
FFR85287	GG-298	FLR	FG14	GG-19	GKIN	FG768	GP-78	MTR	FG887	GG-63	MTR
FFR85301	GP-1224	FLR	FG14	GG-19	MTR	FG775	GG-16	MTR	FG888	GG-264	MTR
FFR85308	GP-749	FLR	FG14	GG-19	PRET	FG775DP	GG-16	MTR	FG889	GG-214	MTR
FFR85309	GP-1109 ²²	FLR	FG14A	GG-19	MIGH	FG776	GG-17	MTR	FG89	GG-25	MTR
FFR85309	GP-62 ²⁰	FLR	FG14A	GG-19	PROG	FG776DP	GG-17	MTR	FG891	GG-61	MTR
FFR85314	G-128	FLR	FG14A	GG-19	TVI	FG777	GG-5 L	MTR	FG892	GG-65	MTR
FFR85315	G-128	FLR	FG14-A	GG-19	MTR	FG777A	GG-5 L	MTR	FG893	GG-190	MTR
FFR85319	GP-749	FLR	FG14ADP	GG-19	MTR	FG778	GG-123	MIGH	FG895	GG-94	MIGH
FFR85320	GP-110	FLR	FG14-B	GG-19	MTR	FG77U	GG-29	MTR	FG895	GG-94	MTR
FFR85321	GP-1109 ²²	FLR	FG14BDP	GG-19	MTR	FG78	GP-84	MTR	FG896	GG-268	GKIN
FFR85321	GP-62 ²⁰	FLR	FG14C	GG-19	MTR	FG781	GG-123	MTR	FG896	GG-268	MIGH
FFR85324	GP-1109	FLR	FG14CDP	GG-19	MTR	FG788	GG-123	MTR	FG896	GG-268	MTR
FFR85333	GP-27	FLR	FG15	GG-5 L	PROG	FG789	GG-20	MTR	FG897	GG-94	MTR
FFR85369	G-128	FLR	FG-157	GG-1992	MTR	FG79	GP-83	MTR	FG899	GG-196	MTR
FFR85369W	G-128	FLR	FG17	GG-19	COP	FG790	GGP-25	MTR	FG9	GG-5 L	ADP
FFR85380	G-1046	FLR	FG17	GG-19	GLD	FG795	GG-87	BARA	FG900	GG-204	MTR
FFR85418	G-862	FLR	FG1-A	GG-20	MTR	FG795	GG-87	GKIN	FG901	GG-5 L	MTR
FFR85420	GP-548	FLR	FG1AFP	GG-20	MTR	FG795	GG-87	MIGH	FG911	GG-217	MTR
FFR85455	GG-986	FLR	FG1DP	GG-20	MTR	FG795	GG-87	MTR	FG919	GG-184	MTR
FFR85456	GG-30	FLR	FG2	GG-19	ADP	FG795	GG-87	PRET	FG92	GP-1107	MTR
FFR85458	GP-458	FLR	FG2	GG-5 L	MTR	FG795	GG-87	PROG	FG920	GG-185	MTR
FFR85480	GG-1	FLR	FG21	GG-123	FRML	FG795	GG-87	TVI	FG925	GG-115	MTR
FFR85480	GG-4	FLR	FG21	GG-20	MTR	FG795-A	GG-87	MTR	FG926	GG-580	MTR
FFR854800	GG-1	FLR	FG22	GG-20	MTR	FG795ADP	GG-87	MTR	FG927	GG-187	MTR
FFR854800	GG-4	FLR	FG228A	GG-20	GLD	FG796	GG-199	MTR	FG929	GG-181	MTR
FFR85485	GP-548	FLR	FG23	GG-20	MTR	FG797	GG-8 ¹⁰³	MTR	FG946	GG-79	MTR
FFR85503	GG-66	FLR	FG2303	G-871	TEC	FG797	GG-8 L ⁸⁰	MTR	FG954	GG-203	MTR
FF-S1001	GP-110	GFF	FG2306	G-871	AUST	FG798	GG-196	MTR	FG978	GG-72	MTR
FF-S1008	GP-1122	GFF	FG2306	G-871	LEYL	FG8	GG-7	ADP	FG986	GG-986	ATL
FF-S1009-DV	G-277	GFF	FG2306	G-871	TEC	FG8	GG-5 L	MIGH	FG986	GG-986	GKIN
FF-S1012	GP-749	GFF	FG2313	G-870	AUST	FG8	GG-5 L	MTR	FG986	GG-986	MIGH
FF-S1013	GP-56	GFF	FG2313	G-870	LEYL	FG800	GG-47	BARA	FG986	GG-986	MTR
FF-S1014	GP-26	GFF	FG2313	G-870	TEC	FG800	GG-47	GKIN	FG986B	GG-986	TVI
FF-S1014-S	GGP-25	GFF	FG2314	G-871	TEC	FG800	GG-47	MIGH	FG993	GG-63	MTR
FF-S1015	GP-1122	GFF	FG2336	GP-58	TEC	FG800	GG-47	MTR	FG995	GG-63	MTR
FF-S1016	GP-83	GFF	FG2338	G-871	TEC	FG800	GG-47	PRET	FGI-006	GG-62	INTF
FF-S1018	GGP-111	GFF	FG2344	G-871	TEC	FG800A	GG-47	TVI	FGI-008	GG-170	INTF
FF-S1018	GGP-524	GFF	FG2344FF	G-871	ROLK	FG800-A	GG-47	MTR	FGI-01	GG-29	INTF
FF-S1020	GP-26	GFF	FG2345	G-871	TEC	FG800ADP	GG-47	MTR	FGI-012	GG-64	INTF
FF-S1021	GP-93	GFF	FG2362	G-870	TEC	FG800DP	GG-47	MTR	FGI-019	GG-46	INTF
FF-S1022	GP-92	GFF	FG2376	G-871	TEC	FG802	GP-55	MTR	FGI-02	GG-42	INTF
FF-S1023	GGP-14	GFF	FG2399FF	G-871	ROLK	FG803	GG-208	MTR	FGI-023	GG-3728	INTF
FF-S1024	GP-1101	GFF	FG24	GG-20	MTR	FG805	GG-45	MTR	FGI-024	GG-5 L	INTF
FF-S1027	GP-1122	GFF	FG2412	G-871	TEC	FG809	GG-196	MTR	FGI-026	GG-66	INTF
FF-S1027-P-DV	GGP-1122	GFF	FG2413	G-871	TEC	FG811	GG-76	MTR	FGI-027	GG-63	INTF
FF-S1028	GP-55	GFF	FG2439	G-871	TEC	FG813	GG-1	MTR	FGI-028	GG-251	INTF
FF-S1031	GP-1122	GFF	FG25	G-296	MTR	FG813	GG-4	MTR	FGI-03	GG-25	INTF
FF-S1034	GGP-118	GFF	FG25	G-296-B	MTR	FG816	GG-203	MTR	FGI-032	GG-45	INTF
FF-S1035	GP-78	GFF	FG30	G-1174 ¹⁰⁸	MTR	FG817	GG-203	MTR	FGI-037	GG-137	INTF
FF-S1036	GP-85	GFF	FG3309FF	G-813	ROLK	FG824	G-294	MIGH	FGI-04	GG-5 L	INTF
FFUP401	GP-1	FINN	FG34	GG-7	MTR	FG826	GG-1	MTR	FGI-05	GG-8 L	INTF
FFUP408	GP-36	FINN	FG34DP	GG-7	MTR	FG826	GG-4	MTR	FGI-06	GG-62	INTF
FFUP412	GP-38	FINN	FG35	GG-6	MTR	FG827	GP-110	MTR	FGI-07	GG-19	INTF
FFUP419	GP-462	FINN	FG35DP	GG-6	MTR	FG830	GG-1	MTR	FGI-09	GG-87	INTF
FFUP422	GP-81	FINN	FG36	GG-5 L	MTR	FG830	GG-4	MTR	FGI-10	GG-30	INTF

Referencia Cruzada por Numero de Parte

Cross Reference by Part Number



Numero	Gonher	Fabricante	Numero	Gonher	Fabricante	Numero	Gonher	Fabricante	Numero	Gonher	Fabricante
Number	Gonher	Manufacturer	Number	Gonher	Manufacturer	Number	Gonher	Manufacturer	Number	Gonher	Manufacturer
FGI-100		GPP-111 INTF	FGI-269D		GPP-612 INTF	FH239		G-139 APL	FHG140023		GA-326 ⁷¹ DON
FGI-101		GPP-524 INTF	FGI-27		GG-63 INTF	FH249		G-152 LOCK	FHG140054		GA-106 ⁶⁷ DON
FGI-10112		GG-245 INTF	FGI-28		GG-251 INTF	FH257		G-500 APL	FHG140054		GA-206 ¹⁰⁸ DON
FGI-10113		GG-247 INTF	FGI-29		GG-98 INTF	FH258		G-750 APL	FHG140054		GA-326 ⁷² DON
FGI-10200		GG-915 INTF	FGI-30		GG-41 INTF	FH264		G-200 APL	FHG140055		GA-106 ⁶⁶ DON
FGI-102A		GG-137 INTF	FGI-32		GG-45 INTF	FH271		G-238 APL	FHG140055		GA-326 ⁷¹ DON
FGI-103		GG-262 INTF	FGI-33		GG-39 INTF	FH284		G-333 APL	FHG140061		GA-106 ⁶⁷ DON
FGI-103A		GG-262 INTF	FGI-34		GG-5 INTF	FH300		G-834 PERM	FHG140061		GA-206 ¹⁰⁸ DON
FGI-104		GG-261 INTF	FGI-35		GG-709 INTF	FH301V		GP-9 PERM	FHG140061		GA-326 ⁷² DON
FGI-105		GG-102 INTF	FGI-36		GG-7018 INTF	FH303V		GP-9 PERM	FHG140065		GA-106 ⁶⁶ DON
FGI-107A		GG-240 INTF	FGI-37		GG-137 INTF	FH304V		GP-9 PERM	FHG140065		GA-326 ⁷¹ DON
FGI-11		GG-47 INTF	FGI-38A		GG-84 INTF	FH306V		GP-2071W PERM	FHG140103		GA-106 ⁶⁶ DON
FGI-110A		GG-242 INTF	FGI-39A		GG-99 INTF	FH319		G-870 APL	FHG140103		GA-326 ⁷¹ DON
FGI-111A		GG-243 INTF	FGI-41A		GG-104 INTF	FH33PL		G-33 FRM	FHG140121		GA-106 ⁶⁶ DON
FGI-112A		GG-245 INTF	FGI-42		GG-1992 INTF	FH33PLOE		G-33 FRM	FHG140121		GA-326 ⁷¹ DON
FGI-113A		GG-247 INTF	FGI-43		GG-264 INTF	FH344		GP-13 APL	FHG140164		GA-106 ⁶⁶ DON
FGI-115A		GG-581 INTF	FGI-44		GG-65 INTF	FH36		GP-66 MTR	FHG140164		GA-326 ⁷¹ DON
FGI-117A		GG-249 INTF	FGI-44A		GG-65 INTF	FH45		G-169 MTR	FHG160046		GA-6127 ¹⁰⁸ DON
FGI-12		GG-64 INTF	FGI-45		GG-184 INTF	FH46		G-33 MTR	FHG160046		GA-6129 ¹⁰⁴ DON
FGI-120		GG-65 INTF	FGI-46		GG-181 INTF	FH500		G-750 PERM	FHG160048		GA-6127 ¹⁰⁸ DON
FGI-120A		GG-65 INTF	FGI-47		GG-94 INTF	FH502V		GP-57 PERM	FHG160048		GA-6129 ¹⁰⁴ DON
FGI-121		GG-8 INTF	FGI-49		GG-185 INTF	FH503V		GP-53 PERM	FHG160049		GA-6129
FGI-122		GG-20 INTF	FGI-50		GG-187 INTF	FH55		G-122 MTR	FHG160053		GA-6127 ¹⁰⁸ DON
FGI-123		GG-123 INTF	FGI-51		GG-63 INTF	FH55		G-338 MTR	FHG160053		GA-6129 ¹⁰⁴ DON
FGI-124		GG-114 INTF	FGI-51A		GG-63 INTF	FH61		GP-34 MTR	FHG160057		GA-6129
FGI-125		GG-50 INTF	FGI-52		GG-160 INTF	FH6PL		G-6 FRM	FHG160078		GA-6127 ¹⁰⁸ DON
FGI-126		GG-255 INTF	FGI-53A		GG-111 INTF	FH6PLOE		G-6 FRM	FHG160078		GA-6129 ¹⁰⁴ DON
FGI-127		GG-194 INTF	FGI-56		GG-1 INTF	FH7		GP-156 MTR	FHG160087		GA-6127 ¹⁰⁸ DON
FGI-13		GG-256 INTF	FGI-56		GG-4 INTF	FH71		GP-46 PUR	FHG160087		GA-6129 ¹⁰⁴ DON
FGI-132		GG-82 INTF	FGI-57		GG-1 INTF	FH72		G-33 MTR	FHG160093		GA-6127 ¹⁰⁸ DON
FGI-133		GG-98 INTF	FGI-57		GG-4 INTF	FH77		GP-66 MTR	FHG160093		GA-6129 ¹⁰⁴ DON
FGI-134		GG-265 INTF	FGI-58		GG-6 INTF	FH78		G-222 MTR	FHG160116		GA-6129
FGI-135A		GG-267 INTF	FGI-59		GG-7 INTF	FH84		GP-14 MTR	FHG160132		GA-6129
FGI-136		GG-252 INTF	FGI-60		GG-16 INTF	FH86		GP-166 MTR	FHG160151		GA-6129
FGI-136A		GG-252 INTF	FGI-61		GG-17 INTF	FHB6PL		G-6 FRM	FHG160154		GA-6129
FGI-137		GG-266 INTF	FGI-62		GG-79 INTF	FHD02L		GG-184 WOW	FHG160171		GA-6127 ¹⁰⁸ DON
FGI-138A		GG-195 INTF	FGI-63		GG-188 INTF	FHD05L		GG-214 WOW	FHG160171		GA-6129 ¹⁰⁴ DON
FGI-139		GG-1 INTF	FGI-64		GG-189 INTF	FHD08L		GG-215 WOW	FHG160179		GA-6129
FGI-139		GG-4 INTF	FGI-65		GG-190 INTF	FHD10L		GG-181 WOW	FHG160189		GA-6129
FGI-143		GG-115 INTF	FGI-66		GG-196 INTF	FHD11L		GG-181 WOW	FHG160204		GA-6127 ¹⁰⁸ DON
FGI-145		GG-268 INTF	FGI-67		GG-199 INTF	FHD12L		GG-190 WOW	FHG160204		GA-6129 ¹⁰⁴ DON
FGI-146		GG-116 INTF	FGI-68		GG-76 INTF	FHD13IP		GG-208 WOW	FHG160225		GA-6129
FGI-147		GG-117 INTF	FGI-69		GG-202 INTF	FHD14IP		GG-208 WOW	FHG160254		GA-6129
FGI-148		GG-124 INTF	FGI-70		GG-203 INTF	FHG065103		GAK-1532 ¹⁰⁴ DON	FHM801		G-871 FRM
FGI-149		GG-126 INTF	FGI-72		GG-204 INTF	FHG065104		GAK-1532 ¹⁰⁴ DON	FI206		G-1123 PERM
FGI-14A		GG-95 INTF	FGI-73		GG-207 INTF	FHG065113		GAK-1532 ¹⁰⁴ DON	FI216		G-1121 PERM
FGI-150		GG-131 INTF	FGI-74		GG-208 INTF	FHG065115		GAK-1532 ¹⁰⁴ DON	FI280		GP-66 PERM
FGI-151		GG-164 INTF	FGI-75		GG-213 INTF	FHG065135		GA-416 ¹⁰⁸ DON	FI287		G-1121F PERM
FGI-152		GG-142 INTF	FGI-76		GG-298 INTF	FHG065135		GAK-216 ¹⁰⁴ DON	FI288		G-1123F PERM
FGI-153		GG-146 INTF	FGI-77		GG-214 INTF	FHG065152		GAK-216 DON	FI3501		GA-44 FIA
FGI-155		GG-148 INTF	FGI-78		GG-215 INTF	FHG065175		GAK-216 DON	FI3670		GA-230 FIA
FGI-157		GG-150 INTF	FGI-79		GG-217 INTF	FHG065183		GAK-1532 ¹⁰⁴ DON	FI-9		GA-55 IMPL
FGI-158		GG-136 INTF	FGI-85		GG-151 INTF	FHG065212		GAK-1532 ¹⁰⁴ DON	FIG7000		GG-246 COO
FGI-15A		GG-72 INTF	FGI-86		GG-246 INTF	FHG065218		GAK-1532	FIG7002		GG-251 COO
FGI-16		GG-67 INTF	FGI-87		GG-223 INTF	FHG065220		GAK-1532 ¹⁰⁴ DON	FIG7004		GG-5 L COO
FGI-165		GG-167 INTF	FGI-88		GG-226 INTF	FHG065256		GAK-1532 ¹⁰⁴ DON	FIG7012		GG-189 COO
FGI-166		GG-177 INTF	FGI-90		GG-227 INTF	FHG065261		GAK-1532 ¹⁰⁴ DON	FIG7020		GG-185 COO
FGI-167		GG-260 INTF	FGI-92		GG-232 INTF	FHG065359		GAK-1532 ¹⁰⁴ DON	FIG7048		GG-146 COO
FGI-168		GG-106 INTF	FGI-94		GG-234 INTF	FHG065360		GAK-1532 ¹⁰⁴ DON	FIG7050		GG-185 COO
FGI-168A		GG-106 INTF	FGI-97A		GG-263 INTF	FHG065410		GAK-1532 ¹⁰⁴ DON	FIG7052		GG-215 COO
FGI-17		GG-32 INTF	FGI-98		GG-237 INTF	FHG080136		GA-891 ¹⁰⁴ DON	FIG7059		GG-181 COO
FGI-174		GG-8 L INTF	FGI-99		GG-239 INTF	FHG080136		GA-892 ¹⁰⁸ DON	FIG7065		GG-79 COO
FGI-176		GG-290 INTF	FGM02L		GG-3728 WOW	FHG080178		GA-891 ¹⁰⁴ DON	FIG7076		GG-185 COO
FGI-176A		GG-290 INTF	FGM04L		GG-46 WOW	FHG080178		GA-892 ¹⁰⁸ DON	FI-25		GP-26 CLRK
FGI-18		GG-1872 INTF	FGM07L		GG-260 WOW	FHG090021		GAK-625 ¹⁰⁴ DON	FIJWS5		G-1121 BOG
FGI-186		GG-161 INTF	FGM08L		GG-66 WOW	FHG090022		GAK-625 ¹⁰⁴ DON	FIJS11514		G-1121 BOG
FGI-186A		GG-161 INTF	FGM09L		GG-146 WOW	FHG090023		GAK-625 ¹⁰⁴ DON	FILIA21		GG-5 L BOG
FGI-19		GG-46 INTF	FGM10L		GG-146 WOW	FHG090024		GAK-625	FIS11512		G-1121 BOG
FGI-190		GG-291 INTF	FGM11L		GG-581 WOW	FHG090025		GAK-625	FIS11512Z		G-1121 BOG
FGI-191A		GG-210 INTF	FGQ20		GG-20 ROLK	FHG090038		GAK-625 ¹⁰⁴ DON	FIS11514Z		G-1121 BOG
FGI-192		G-296 INTF	FH1		G-122 MTR	FHG090182		GAK-625 ¹⁰⁴ DON	FIS11613Z		G-1123F BOG
FGI-192		G-296 B INTF	FH1		G-338 MTR	FHG090183		GAK-625 ¹⁰⁴ DON	FIS116512Z		G-1121 BOG
FGI-194		GG-206 INTF	FH10		GP-66 MTR	FHG120012		GA-360 DON	FIS116516Z		G-1121F BOG
FGI-195		GG-5 L INTF	FH107		G-871 APL	FHG120014		GA-360 ¹⁰⁴ DON	FIS116U22		G-1121 BOG
FGI-20		GG-580 INTF	FH108		G-31 APL	FHG120014		GA-361 ¹⁰⁸ DON	FIS116U22Z		G-1121F BOG
FGI-200		GG-915 INTF	FH11		GP-66 MTR	FHG120017		GA-360 ¹⁰⁴ DON	FIS116U23Z		GP-10 BOG
FGI-201		GG-169 INTF	FH110		G-870 APL	FHG120017		GA-361 ¹⁰⁸ DON	FIS11851Z		G-1123 BOG
FGI-205		GG-298 INTF	FH112		G-813 APL	FHG120036		GA-360 ¹⁰⁴ DON	FIS12051Z		G-1123 BOG
FGI-21		GG-92 INTF	FH115		G-836 PERM	FHG120036		GA-361 ¹⁰⁸ DON	FIS121511Z		G-1123 BOG
FGI-212A		GG-915 INTF	FH119		G-133 PERM	FHG120037		GA-360 DON	FIS124P92Z		G-31 BOG
FGI-214		GG-283 INTF	FH119		G-989 PERM	FHG120038		GA-360 DON	FIS12551Z		G-1123 BOG
FGI-22		GG-61 INTF	FH120		G-191 PERM	FHG120049		GA-360 ¹⁰⁴ DON	FIS12651Z		G-1123 BOG
FGI-222		GG-182 INTF	FH124		G-836 APL	FHG120049		GA-361 ¹⁰⁸ DON	FIS12752Z		G-1121 BOG
FGI-227		GG-419 INTF	FH125		G-31 PERM	FHG120062		GA-360 DON	FIS128P2Z		G-1123 BOG
FGI23		GG-3728 INTF	FH126		G-31 PERM	FHG120065		GA-360 ¹⁰⁴ DON	FIS128S1Z		G-1123 BOG
FGI-235		GG-97 INTF	FH127		G-31 APL	FHG120065		GA-361 ¹⁰⁸ DON	FIS128S2Z		G-1121 BOG
FGI-235A		GG-97 INTF	FH130		G-33 APL	FHG120096		GA-360 ¹⁰⁴ DON	FIS131P1Z		G-1121 BOG
FGI-239		GG-291 INTF	FH131V		GP-54 PERM	FHG120096		GA-361 ¹⁰⁸ DON	FIS131P2Z		G-1123 BOG
FGI-23A		GG-3728 INTF	FH133V		GP-171 PERM	FHG120115		GA-360 ¹⁰⁴ DON	FIS132P1		G-1121 BOG
FGI-24		GG-3 INTF	FH136V		GP-77 PERM	FHG120115		GA-361 ¹⁰⁸ DON	FIS132P1Z		G-1121 BOG
FGI-242		GG-369 INTF	FH148		G-834 APL	FHG140018		GA-106 ⁶⁶ DON	FIS132P2Z		G-1123 BOG
FGI-243		GG-409 INTF	FH1506		G-871 FIA	FHG140018		GA-326 ⁷¹ DON	FIS132U8		G-1121 BOG
FGI-244		GG-351 INT									

Numero	Gonher	Fabricante	Numero	Gonher	Fabricante	Numero	Gonher	Fabricante	Numero	Gonher	Fabricante
Number	Gonher	Manufacturer	Number	Gonher	Manufacturer	Number	Gonher	Manufacturer	Number	Gonher	Manufacturer
FK9312	G-1123	TEC	FL234	GP-14	MTR	FL500	GP-58	MTR	FL775	GP-46	MTR
FK9314	G-297-B	TEC	FL24	G-5000	MTR	FL504	G-31	CUMM	FL776	GP-20	MTR
FK9324	G-1121	TEC	FL259	GP-58	MTR	FL504	GP-58	MTR	FL778	G-139	MTR
FK9366	G-296	TEC	FL260	GP-81	MTR	FL505	GP-28	MTR	FL78	G-139	MTR
FK9366	G-296-B	TEC	FL262	G-162H	MTR	FL515	G-6	CUMM	FL780	GP-54 ⁹⁰	MTR
FK9371	GG-20	TEC	FL264	GP-81	MTR	FL516	G-566	CUMM	FL781	GP-77	MTR
FK9416	GG-48	TEC	FL265	GP-54	MTR	FL52A	G-870	FILC	FL782	GP-58	MTR
FL 6803	GA-2160	FIA	FL267	GP-81 ³¹	MTR	FL556	G-566	CUMM	FL783	GP-54	MTR
FL1	GP-1	MTR	FL267	GP-9 ⁵⁸	MTR	FL566	G-566	CUMM	FL784	GP-3766	MTR
FL10	GP-3	MTR	FL268	GP-81 ³¹	MTR	FL600	GP-3600	MTR	FL784FP	GP-3766	MTR
FL10DP	GP-3	MTR	FL268	GP-9 ⁵⁸	MTR	FL6002	GA-44	FIA	FL787	GP-81	MTR
FL12	GP-13	MTR	FL269	GP-81 ³¹	MTR	FL6124	GA-71	FIA	FL788	GP-31	MTR
FL124	G-813	MTR	FL269	GP-9 ⁵⁸	MTR	FL6181	GA-1008	FIA	FL789	G-339H	MTR
FL128	G-870	MTR	FL271	GP-28 ⁸⁴	MTR	FL6182	GA-1284	FIA	FL790	GP-43	MTR
FL129	G-871	MTR	FL271	GP-3816 ⁸⁴	MTR	FL6186	GA-230	FIA	FL791	GP-3600	MTR
FL12DP	GP-13	MTR	FL271	GP-430 ⁸⁵	MTR	FL6186A	GA-230	FIA	FL793	GP-58	MTR
FL12FP	GP-13	MTR	FL273	G-613	MTR	FL6194	GA-8047	FIA	FL794	GP-3985 ⁹³	MTR
FL13	GP-38	MTR	FL274-99189	GP-51	NISS	FL6195	GA-1285	FIA	FL795	GP-3985	MTR
FL133	G-834	MTR	FL275	GP-34	MTR	FL6200	GA-18	FIA	FL796	GP-68	MTR
FL135	G-11816	MTR	FL276	GP-3600	MTR	FL6202	GA-9045	FIA	FL797	GP-57	MTR
FL137	GP-33	MTR	FL278	GP-50	MTR	FL6203	GA-1287	FIA	FL797A	GP-57	MTR
FL137FP	G-333	MTR	FL281	GP-1	MTR	FL6207	GA-230	FIA	FL799	GP-462	MTR
FL13A	GP-28 ⁸⁴	MTR	FL2825US	GP-38	FILC	FL6276	GA-1286	FIA	FL800	GP-28	MTR
FL13A	GP-3600 ⁹⁴	MTR	FL286	GP-81	MTR	FL6277	GA-9334	FIA	FL801	GP-3682	MTR
FL13A	GP-430 ⁸⁵	MTR	FL287	GP-37	MTR	FL6312	GA-12	FIA	FL802	GP-9586	MTR
FL13B	GP-38	MTR	FL29	GP-33	MTR	FL6325	GA-200	FIA	FL803	GP-149 ⁷⁵	MTR
FL143	G-750	MTR	FL291	GP-69	MTR	FL6325	GP-58	FIA	FL803	GP-91 ⁸⁴	MTR
FL146	G-31	MTR	FL292	GP-36	MTR	FL6338	GA-50	FIA	FL804	GP-53	MTR
FL147	G-330	MTR	FL293	GP-81	MTR	FL6339	GA-349	FIA	FL804FP	GP-53	MTR
FL148	G-1174	MTR	FL295	GP-24	MTR	FL6364	GAD-3	FIA	FL810	GP-91	MTR
FL150	G-1175	MTR	FL295-DP	GP-24	MTR	FL6367	GAD-3	FIA	FL811	GP-54	MTR
FL152	GP-1101	MTR	FL299	GP-31	MTR	FL6376	GA-2719B	FIA	FL811B	GP-54 ⁹⁰	MTR
FL154	G-1173	MTR	FL299FP	GP-31	MTR	FL6397	GAD-3	FIA	FL813	GP-3985	MTR
FL157	G-296	MTR	FL299FP	G-33	MTR	FL6406	GA-98 ¹¹²	FIA	FL814	GP-462	MTR
FL157	G-296-B	MTR	FL2DP	GP-5	MTR	FL6413	GA-892	FIA	FL815	GP-91	MTR
FL16181	GA-1008	FIA	FL3	GP-50	MTR	FL6426	GA-7716	FIA	FL816	GP-91	MTR
FL16182	GA-1284	FIA	FL300	GP-81 ³¹	MTR	FL6427	GA-33 ¹¹²	FIA	FL818	GP-91	MTR
FL16194	GA-8047	FIA	FL300	GP-9 ⁵⁸	MTR	FL6429	GA-7360	FIA	FL819	GP-3000	MTR
FL16195	GA-1285	FIA	FL300DP	GP-81 ³¹	MTR	FL6439	GA-416	FIA	FL820	GP-68	MTR
FL162	GP-66	MTR	FL300DP	GP-9 ⁵⁸	MTR	FL6440	GAK-216	FIA	FL820S	GP-68	MTR
FL16200	GA-18	FIA	FL303	GP-69	MTR	FL6442	GA-5648	FIA	FL821	GP-149	MTR
FL16202	GA-9045	FIA	FL305	GP-10	MTR	FL6442N	GPP-103 ⁹⁰	NISS	FL822	GP-149	MTR
FL16203	GA-1287	FIA	FL305FP	GP-10	MTR	FL6442N	GPP-11 ³⁹	NISS	FL83	G-191	MTR
FL16276	GA-1286	FIA	FL306	GP-3985	MTR	FL6446	GA-360	FIA	FL835	GP-83	MTR
FL16277	GA-9334	FIA	FL307	GP-51	MTR	FL6457	GA-459	FIA	FL836	GP-157	MTR
FL163	GP-500	MTR	FL307FP	GP-51	MTR	FL6467	GA-405	FIA	FL837	GP-3985	MTR
FL163FP	G-500	MTR	FL308	GP-23	MTR	FL6479	GA-39	FIA	FL839	GP-3682	MTR
FL16426	GA-7716	FIA	FL308FP	GP-23	MTR	FL6489	GAK-16	FIA	FL840	GP-58	MTR
FL16428	GA-7716	FIA	FL310	GP-50	MTR	FL6490	GAK-403	FIA	FL842	GP-81	MTR
FL16429	GA-7360	FIA	FL311	G-153	MTR	FL6497	GA-12	FIA	FL88	G-238	MTR
FL16597	GA-483	FIA	FL313	GP-22	MTR	FL6513	GA-6127	FIA	FL880	GP-1	MTR
FL16598	GA-482	FIA	FL315	GP-42	MTR	FL6514	GA-6129	FIA	FL89	G-31	MTR
FL170	G-566	MTR	FL317	G-159	MTR	FL6516	GA-206	FIA	FL896	GP-178	MTR
FL170FP	G-566	MTR	FL319	GP-53	MTR	FL6535	GAD-1	FIA	FL9	GP-20	MTR
FL173	GP-81 ³¹	MTR	FL319A	GP-53	MTR	FL6544	GA-2740	FIA	FL90	G-331	MTR
FL173	GP-9 ⁵⁸	MTR	FL319AFP	GP-53	MTR	FL6558	GAD-3	FIA	FL910	GP-58 ⁹	MTR
FL173A	GP-81 ³¹	MTR	FL319FP	GP-53	MTR	FL6559	GA-3490	FIA	FL915-99003	GP-1011Q	NISS
FL173A	GP-9 ⁵⁸	MTR	FL321	GP-46	MTR	FL6560	GA-303	FIA	FL920	GP-171	MTR
FL175	GP-14	MTR	FL322	GP-3600	MTR	FL6563	GAD-3	FIA	FL94	GP-335	MTR
FL181	GP-170	MTR	FL323	GP-50	MTR	FL6567	GAD-3	FIA	FL9DP	GP-20	MTR
FL181	GP-310 ⁸⁶	MTR	FL326	GP-52 ¹¹⁰	MTR	FL6576	GA-3425	FIA	FLC717	GP-51	FCL
FL181FP	GP-310	MTR	FL326	GP-691 ⁴⁸	MTR	FL6577	GA-57	FIA	FLC717	GP-3600	MTR
FL1995	GP-562	MTR	FL326FP	GP-52 ¹¹⁰	MTR	FL6614	GAD-3	FIA	FLI 6886	GA-410	FIA
FL1997	GP-36	MTR	FL326FP	GP-691 ⁴⁸	MTR	FL6625	GA-2122	FIA	FLI6002	GA-44	FIA
FL1998	GP-149	MTR	FL327	GP-390 ⁹³	MTR	FL6628	GA-3637	FIA	FLI6181	GA-1008	FIA
FL1A	GP-1	MTR	FL329	GP-1	MTR	FL6629	GA-50	FIA	FLI6182	GA-1284	FIA
FL1DP	GP-1	MTR	FL330	GP-44	MTR	FL6633	GA-230	FIA	FLI6194	GA-8047	FIA
FL1HP	GP-1	MTR	FL331	GP-3429	MTR	FL6656	G-225	FIA	FLI6195	GA-1285	FIA
FL2	GP-5	MTR	FL332	GP-81	MTR	FL6699	GAD-30	FIA	FLI6200	GA-18	FIA
FL20	G-6	MTR	FL332DP	GP-81	MTR	FL6743	GA-4325	FIA	FLI6202	GA-9045	FIA
FL200	GP-81 ³¹	MTR	FL336	G-836	MTR	FL6830	GA-3588	FIA	FLI6203	GA-1287	FIA
FL200	GP-9 ⁵⁸	MTR	FL337	GP-9586	MTR	FL73MUS	GP-3985	FILC	FLI6246	GAK-20	FIA
FL2002	GP-3675	MTR	FL337FP	GP-9586	MTR	FL750	G-750	CUMM	FLI6276	GA-1286	FIA
FL2005	GP-128	MTR	FL338	GP-171 ¹⁶	MTR	FL750	GP-750	MTR	FLI6277	GA-9334	FIA
FL2007	GP-149	MTR	FL339	GP-81	MTR	FL750-FP	G-750	MTR	FLI6406	GA-98 ¹¹²	FIA
FL2008	GP-457	MTR	FL35US	GP-53	FILC	FL751	G-750	MTR	FLI6413	GA-892	FIA
FL2016	G-3752	MTR	FL36RNS	G-11816	INJ	FL751-FP	G-750	MTR	FLI6426	GAK-20	FIA
FL2017A	G-70	MTR	FL39	G-119	MTR	FL752	GP-462	MTR	FLI6427	GA-33 ¹¹²	FIA
FL-2017B	G-70	MTR	FL4	GP-81	MTR	FL754	GP-44	MTR	FLI6428	GA-7716	FIA
FL2021	GP-457	MTR	FL40	G-33	MTR	FL755	GP-3	MTR	FLI6429	GA-7360	FIA
FL206	G-1173	MTR	FL400	GP-3600	MTR	FL756	G-871	MTR	FLI6439	GA-416	FIA
FL208	G-222	MTR	FL400-A	GP-3600	MTR	FL757	GP-3531	EXP	FLI6440	GAK-216	FIA
FL208-05D01	GP-3985	NISS	FL400S	GP-3600	MTR	FL758	G-6	MTR	FLI6442	GA-5648	FIA
FL208-29007	GP-51	NISS	FL401	GP-28 ⁸	MTR	FL759	GP-53	MTR	FLI6446	GA-360	FIA
FL209-01D20	GP-54	NISS	FL401	GP-430 ⁸	MTR	FL760	GP-53	MTR	FLI6457	GA-459	FIA
FL218	GP-457	MTR	FL402	GP-3980	MTR	FL760FP	GP-53	MTR	FLI6458	GA-49	FIA
FL219	G-834	MTR	FL403	GP-40	MTR	FL761	GP-54 ¹¹	MTR	FLI6467	GA-405	FIA
FL22	G-200	MTR	FL403-99008	GP-110	NISS	FL761	GP-66 ¹⁰	MTR	FLI6471	GA-436	FIA
FL221	G-836	MTR	FL404	GP-40	MTR	FL762	GP-67	MTR	FLI6488	GA-18	FIA
FL221M	G-834	FILC	FL405	GP-31	MTR	FL763	GP-54	MTR	FLI6489	GAK-16	FIA
FL223	GP-36	MTR	FL406	GP-69	MTR	FL763FP	GP-69	MTR	FLI6490	GAK-403	FIA
FL223FP	GP-36	MTR	FL408	GP-40	MTR	FL770	GP-50 ²⁰	MTR	FLI6494	GAK-403	FIA
FL225	G-34	MTR	FL41	GP-31	MTR	FL772	GP-69	MTR	FLI6495	GAK-625	FIA
FL228	GP-81 ³¹	MTR	FL42	G-1143	MTR	FL772FP	GP-69	MTR	FLI6496	GA-106 ⁹	FIA
FL228	GP-9 ⁵⁸	MTR	FL5	GP-81	MTR	FL773	GP-88	MTR	FLI6496	GA-326 ⁷¹	FIA
FL23	G-236	MTR	FL500	G-500	CUMM	FL773FP	GP-88	MTR	FLI6508	GAK-16	FIA

Referencia Cruzada por Numero de Parte

Cross Reference by Part Number



Numero	Gonher	Fabricante	Numero	Gonher	Fabricante	Numero	Gonher	Fabricante	Numero	Gonher	Fabricante
Number	Gonher	Manufacturer	Number	Gonher	Manufacturer	Number	Gonher	Manufacturer	Number	Gonher	Manufacturer
FLI6513	GA-6127	FIA	FO166	GA-27	PSIL	FOE279	GP-430 ⁹	FISP	FP587F	GPP-1122	APOL
FLI6514	GA-6129	FIA	FO17	GP-24 ²⁶	FRED	FOE280	GP-3816	FISP	FP587F	GPP-1122	BWS
FLI6515	GAK-403	FIA	FO17	GP-462 ²⁴	FRED	FOE286	GP-46	FISP	FP587F	GPP-1122	CAM2
FLI6516	GA-206	FIA	FO178	GAK-16	PSIL	FOE299	GP-1	FISP	FP587F	GPP-1122	CHP
FLI6580	GAK-216	FIA	FO180	GA-26	PSIL	FOE354	GP-40	FISP	FP587F	GPP-1122	LEE
FLI6581	GA-416	FIA	FO184	GA-33 ¹¹²	PSIL	FOE355	GP-46	FISP	FP587F	GPP-1122	LUF
FLI6585	GA-589	FIA	FO217	GP-3816	ECO	FOF-4570	GP-51	PAI	FP587F	GPP-1122	WARN
FLI6586	GA-588	FIA	FO233	GP-24 ²⁶	ECO	FOHZ-6714-BA	GP-54 ⁹⁰	FORD	FP587-F	GPP-1122	MIGH
FLI6588	GAK-525	FIA	FO233	GP-462 ²⁴	ECO	FONN6714AA	GP-54	NEWH	FP603	GP-78	BWS
FLI6589	GA-356	FIA	FO235	GP-28 ⁸⁴	ECO	FONN6714CA12H	GP-761H	NEWH	FP603	GP-78	CHP
FLI6590	GA-357	FIA	FO235	GP-3600 ⁹⁹	ECO	FOQ15992AFF	G-871	ROLK	FP603	GP-78	LUF
FLI6592	GA-229	FIA	FO235	GP-430 ⁸⁵	ECO	FOS812	G-31	FISP	FP625	GP-1105	LUF
FLI6597	GA-483	FIA	FO24	GP-20	FRED	FOTE-9155-AA	GG-1872	FORD	FP7	GP-5	CHP
FLI6598	GA-482	FIA	FO243	GP-42	ECO	FOTZ9601B	GG-1872	FORD	FP815F	GP-26	CHP
FLI6619	GA-467	FIA	FO246	GP-3531	EXP	FP 4	GAC-9	MTR	FP816F	GP-27	CHP
FLI6621	GAK-403	FIA	FO25	GP-3	FRED	FP 7-A	GAC-1	MTR	FP862F	GPP-19	CHP
FLI6713	GA-27	FIA	FO2849	GP-24 ²⁶	FRED	FP100	GP-1	MON	FP862F	GPP-19	LUF
FLM20006	GAK-16	WORT	FO2849	GP-462 ²⁴	FRED	FP101	GP-20	MON	FP862F	GPP-19	SECU
FLP2213	GP-171	LUF	FO2870A	GP-28 ⁸	FRED	FP101FD	GPP-11	CHP	FP863F	GPP-18	CHP
FLP943F	GP-1122	AIRT	FO2870A	GP-430 ⁸	FRED	FP102	GP-3	MON	FP863F	GPP-18	LUF
FLR161	GA-33	WORT	FO29	GP-13	FRED	FP103	GP-81 ³¹	MON	FP863F	GPP-18	SECU
FLR170	G-33	WORT	FO2A	GA-77	SAFE	FP103	GP-9 ³⁸	MON	FP925F	GP-1107	LUF
FLR20003	G-31	WORT	FO3	GP-3	ADP	FP104	GP-5	MON	FP929F	GP-1107	CHP
FLR225	GA-7	WORT	FO3	GA-75	SAFE	FP105	GP-13	MON	FP9364	G-833	TEC
FLR230	G-750	WORT	FO318	GP-3816	KNE	FP11	GP-13	CHP	FP9366	G-296	TEC
FLR234	G-750	WORT	FO3387A	GP-46	FRED	FP1101	GP-1101	UNI	FP9366	G-296-B	TEC
FLR254	GP-1	WORT	FO3429	GP-3429	FRED	FP1101F	GP-1101	CHP	FP9371	GG-20	TEC
FLR308	GA-11	WORT	FO355	GP-81	KNE	FP1101F	GP-1101	UNI	FP9390	G-870	TEC
FLR325	GA-27	WORT	FO355-1	GP-81	KNE	FP1115	GG-20	FRML	FP94	GG-19	STAM
FLR338	GA-27	WORT	FO356	GP-50	KNE	FP119	GG-6	FRML	FP9410	GP-81	TEC
FLR365	GP-13	WORT	FO370	GP-50	KNE	FP12	GP-3	CHP	FP9416	GG-48	TEC
FM217	G-6	DEAR	FO371	GP-1	KNE	FP120	GG-7	FRML	FP941F	GPP-111	CHP
FM217	G-6	INTM	FO371-3	GP-14	KNE	FP1201	GG-20	BLKS	FP941F	GPP-524	CHP
FM26	G-6	DEAR	FO373	GP-81	KNE	FP152499B	GP-14	CHP	FP941F	GPP-111	CIGO
FM26	G-6	INTM	FO3732	GP-54 ¹¹	MAHL	FP16	GP-81	CHP	FP941F	GPP-524	CIGO
FM261	G-6	DEAR	FO3732	GP-66 ¹⁰	MAHL	FP1652	GP-66	CHP	FP941F	GPP-111	LUF
FM261	G-6	INTM	FO373-2	GP-81 ³¹	KNE	FP190	GP-81	APOL	FP941F	GPP-524	LUF
FM820A	G-870	FMEX	FO373-2	GP-9 ⁵⁸	KNE	FP190	GP-81	CAM2	FP9435	G-836	TEC
FM834A	G-834	FMEX	FO376	GP-50	KNE	FP190	GP-81	CHP	FP9436	G-834	TEC
FMA-030	GA-209	ACT	FO382	GP-81	KNE	FP190	GP-81	GRAN	FP9484	G-238	TEC
FMA-031	GA-210	ACT	FO383	GP-171	KNE	FP190	GP-81	LUF	FP9502	G-871	TEC
FMA163K	GAK-1532	FILT	FO383	GP-9	MAHL	FP190	GP-81	SECU	FP9587F	GPP-1122	LEE
FMA253K	GA-16 ¹¹²	FMEX	FO384	GP-54 ¹¹	KNE	FP190T	GP-81	CHP	FP9587F	GPP-1122	LEEM
FMA253K	GAK-16 ³⁴	FMEX	FO384	GP-66 ¹⁰	KNE	FP1980	GP-81	WARN	FPA-015	GAK-403	ACT
FMA257K	GA-26 ¹¹²	FMEX	FO384	GP-54 ¹¹	MAHL	FP20	GP-14	BWS	FPA-2520	GA-109	KORO
FMA2800	GA-388	FMEX	FO384	GP-66 ¹⁰	MAHL	FP20	GP-14	CHP	FPA3003	GA-71	SOPA
FMA536SY	GA-357	FMEX	FO385	GP-81	KNE	FP20	GP-14	LUF	FPA3022	GA-77	SOPA
FMC1FF	GP-1	ROLK	FO385	GP-9	MAHL	FP-20-HD	G-33	KORO	FPA3036	GA-230	SOPA
FMC31	G-296	ROLK	FO386	GP-54 ¹¹	KNE	FP218F	GP-84	CHP	FPA3055	GA-71	SOPA
FMC31	G-296-B	ROLK	FO386	GP-66 ¹⁰	KNE	FP219F	GP-83	CHP	FPA3073	GA-200	SOPA
FMC4FF	G-6	ROLK	FO386	GP-54 ¹¹	MAHL	FP24	GP-20	CHP	FPA3073	GP-58	SOPA
FMC5FF	G-5000	ROLK	FO386	GP-66 ¹⁰	MAHL	FP251F	GP-1108	BWS	FPA3098	GA-2719B	SOPA
FMCQ1FF	GP-1	ROLK	FO3861	GP-54 ¹¹	MAHL	FP251F	GP-1108	CHP	FPA3122	GAD-3	SOPA
FMCQ4FF	G-6	ROLK	FO3861	GP-66 ¹⁰	MAHL	FP251F	GP-1108	LUF	FPA3132	GAD-1	SOPA
FMD011	GG-217	WOW	FO386-1	GP-54 ¹¹	KNE	FP3300	G-871	TEC	FPA3192	GA-3425	SOPA
FMD031	GG-148	WOW	FO386-1	GP-66 ¹⁰	KNE	FP3305	G-870	TEC	FPA3253	GAVW-2	SOPA
FMD051	GG-142	WOW	FO4	G-200	ADP	FP3305-105	G-870	TEC	FPA3254	GA-277	SOPA
FMD061	GG-150	WOW	FO400	GP-3600	FRED	FP3306	G-870	TEC	FPA3296	GAVW-4	SOPA
FMD081	GG-1872	WOW	FO5	GP-20	ADP	FP3309	G-813	TEC	FPA3297	GAVW-2	SOPA
FMD091P	GG-208	WOW	FO-505P	GP-112	JAPA	FP3312	G-870	TEC	FPA3349	GA-4365	SOPA
FMF-020	G-1121	ACT	FO51	GP-3980	FRED	FP3313	G-871	TEC	FPA3350	GA-2194	SOPA
FMO-019	GP-88	ACT	FOC201	G-871	FISP	FP3316	G-813	TEC	FPE30-10	GP-66	FILP
FMS011	GG-185	WOW	FOC221	G-33	FISP	FP3318	G-871	TEC	FPE30-10N	GP-66	FILP
FMS041	GG-114	WOW	FOC271	G-813	FISP	FP3331	G-836	TEC	FPE30-25	GP-66	FILP
FMS061P	GG-196	WOW	FOC272	G-871	FISP	FP3335	G-836	TEC	FPE3025N	GP-66	MIFP
FNC012	G-1173	FISP	FOC302	G-163	FISP	FP3338	G-836	TEC	FPE30-25N	GP-66	FILP
FNC016	G-296	FISP	FOC303	G-133	FISP	FP3339	G-834	TEC	FPE50-10	GP-34	FILP
FNC016	G-296-B	FISP	FOC303	G-989	FISP	FP3692F	GP-1105	CHP	FPE50-10N	GP-34	FILP
FNC025	G-1173	FISP	FOC304	G-143	FISP	FP3693F	GP-62	CHP	FPE70-10N	GP-34	FILP
FNC026	G-1163	FISP	FOC420	G-225	FISP	FP41	GAC-7	MTR	FPE70-25N	GP-34	FILP
FNC042	G-1123	FISP	FOC453	G-834	FISP	FP431F	GP-85	CHP	FPF-010	G-297-B	ACT
FNC052	G-297-B	FISP	FOC473	G-834	FISP	FP4378	G-296	FIA	FPF-011	G-296	ACT
FNC053	G-1121	FISP	FOC475	G-836	FISP	FP4378	G-296-B	FIA	FPF-011	G-296-B	ACT
FNC161	G-1123	FISP	FOE007	GP-38	FISP	FP440F	GP-110	CHP	FPF-116	G-1143	KORO
FNE212	GP-1122	FISP	FOE011	GP-81	FISP	FP4671	GP-1122	FIA	FPF-902	G-1175	KORO
FNE236	GP-1122	FISP	FOE012	GP-81	FISP	FP4683	GP-1122	FIA	FPF-906	G-1173	KORO
FNE237	GP-1122	FISP	FOE013	GP-50	FISP	FP4685	GP-1122	FIA	FG057511	GA-880R ¹⁰⁴	DON
FNE238	GPP-1122	FISP	FOE036	GP-81	FISP	FP4712	GP-1122	FIA	FG057512	GA-880R ¹⁰⁴	DON
FNE242	GP-1122	FISP	FOE070	GP-462	FISP	FP4779	G-297-B	FIA	FG057513	GA-880R ¹⁰⁴	DON
FNE243	GP-1122	FISP	FOE071	GP-54 ¹¹	FISP	FP4932	GP-1122	FIA	FG057514	GA-880R ¹⁰⁴	DON
FNE244	GP-1122	FISP	FOE071	GP-66 ¹⁰	FISP	FP4935A	GP-1122	FIA	FG082526	GA-853R ¹⁰⁴	DON
FNE315	GP-1122	FISP	FOE167	GP-3985	FISP	FP4935A	GPP-1122	FIA	FG082527	GA-853R ¹⁰⁴	DON
FNP146	G-1121	FISP	FOE175	GP-171	FISP	FP4980	GP-1122	FIA	FG082528	GA-853R ¹⁰⁴	DON
FNP403	G-1174	FISP	FOE176	GP-46	FISP	FP5	GP-5	CHP	FG082548	GA-853R ¹⁰⁴	DON
FNP410	G-1123F	FISP	FOE182	GP-3985	FISP	FP5002	GP-11 ²⁴	CHP	FPH8212	GP-212	STER
FNS011	GG-63	WOW	FOE186	GP-77	FISP	FP5002	GP-11 ²³	LUF	FPD-007	GP-31	ACT
FNS021	GG-137	WOW	FOE189	GP-54	FISP	FP5092	GPP-111	FIA	FPD-008	GP-1	ACT
FO011A	GP-91	ASAH	FOE190	GP-51	FISP	FP5092	GPP-524	FIA	FPF134	G-870	FUJI
FO031	GG-203	ASAH	FOE194	GP-406	FISP	FP5823	GP-56	CHP	FPF162	G-870	FUJI
FO1	GP-1	ADP	FOE195	GP-68	FISP	FP585F	GP-1122	LUF	FPF162A	G-870	FUJI
FO1	GP-1	FRED	FOE197	GP-3600	FISP	FP586F	GP-1122	BWS	FP5060	GP-3985	FUJI
FO1	GA-85	SAFE	FOE230	GP-3816	FISP	FP586F	GP-1122	CAM2	FP5061	GP-3985	FUJI
FO100	GP-34	PSIL	FOE263	GP-28 ⁸	FISP	FP586F	GP-1122	CHP	FP5109	GP-38	FUJI
FO122	G-33	PSIL	FOE263	GP-430 ⁸	FISP	FP586F	GP-1122	LUF	FP5109B	GP-58	FUJI
FO16	GP-81 ³¹	FRED	FOE264	GP-36	FISP	FP586F	GP-1122	LUF	FP5135	GP-38	FUJI
FO16	GP-9 ³⁸	FRED	FOE279	GP-28 ⁸	FISP	FP587F					

Numero	Gonher	Fabricante	Numero	Gonher	Fabricante	Numero	Gonher	Fabricante	Numero	Gonher	Fabricante
Number	Gonher	Manufacturer	Number	Gonher	Manufacturer	Number	Gonher	Manufacturer	Number	Gonher	Manufacturer
FPS136	GP-1	FUJI	FS1247	GPP-14	FLG	FS19847	GPP-1291 ³⁹	FLG	FS97	GP-27	MIGH
FPS136A	GP-171	FUJI	FS1251	GPP-1122	FLG	FS19847	S 3226 P ⁴⁰	FLG	FSB021	GG-79	WOW
FPS170	GP-3985	FUJI	FS1261	GS-1261	FLG	FS19855	GS-1261	FLG	FSD8-20-490	GG-268	MZDA
FPS170A	GP-40	FUJI	FS1268	GS-1261	FLG	FS19865	GPP-423	FLG	FSF-4529	G-169	PAI
FPS200A	GP-462	FUJI	FS1276	GPP-1122	FLG	FS1A	GG-1	ACD	FSF-4530	G-159	PAI
FPS208A	GP-42	FUJI	FS1277	GG-4	FLG	FS1A	GG-4	ACD	FSM4000	GP-56	COO
FPS208B	GP-3531 EXP	FUJI	FS1280	GPP-18	FLG	FS1B	GG-1	ACD	FSM4001	GP-62	COO
FPS290	GP-91	FUJI	FS1282	GPP-14	FLG	FS1B	GG-4	ACD	FSM4009	GP-1108	COO
FPT500	G-500	PUR	FS1284	GP-92	FLG	FS20102	2010TM-OR	FLG	FSM4011	GP-1107	COO
FPT750	G-750	PUR	FS1284	GPP-1060	FLG	FS20103	2010PM-OR	FLG	FSM4014	GP-1105	COO
FPT-750	GP-54 ¹¹	PUMX	FS1287	GPP-1287 ³⁹	FLG	FS20201	GS-2033	FLG	FSM4017	GP-92	COO
FPT-750	GP-66 ¹⁰	PUMX	FS1287	PFF831 ⁴¹	FLG	FS20401	GS-2034	FLG	FSM4018	GP-85 ³⁰	COO
FPT750B	G-750	PUR	FS1287	R 60 P ⁴²	FLG	FS21402U	G-1173 ¹⁰⁸	BANR	FSM4019	GP-93	COO
FPT750DP	G-750	PUR	FS1291	GPP-1291 ³⁹	FLG	FS21404U	G-1173 ¹⁰⁸	BANR	FSM4023	GP-83	COO
FPT750H	G-750	PUR	FS1291	S 3226 P ⁴⁰	FLG	FS21776U	G-31	BANR	FSM4024	GP-1101	COO
FPT750P	G-750	PUR	FS1293	GS-2033	FLG	FS21776U	G-31	NORB	FSM4029	GPP-1000	COO
FR1023	GA-563	FAME	FS1294	GS-2034	FLG	FS229	GPP-424	KRA	FSM4035	GP-26	COO
FR1027	GA-251	FAME	FS1298	G-178	FLG	FS231	GPP-420	KRA	FSM4042	GPP-18	COO
FR1032	GA-89	FAME	FS132	GPP-425	KRA	FS232	GPP-425	KRA	FSM4044	GPP-19	COO
FR3	G-1121F	KNE	FS150F	GP-85	MIGH	FS232	GP-1101	MIGH	FSM4047	GPP-14	COO
FR3D	G-1121F	KNE	FS1602	GG-208	SAKU	FS233	GPP-103 ⁴⁰	KRA	FSM4067	GPP-19	COO
FR3D	G-1121F	MAHL	FS1603	GG-76	SAKU	FS233	GPP-11 ³⁹	KRA	FSM4076	GP-1122	COO
FR4D	G-1121F	KNE	FS-1704	GG-142	SAKU	FS234	GPP-419	KRA	FSM4079	GPP-14	COO
FR865	GA-405	FAME	FS-1712	GG-148	SAKU	FS235	GPP-418	KRA	FSM4083	GP-1122	COO
FR870	GA-39	FAME	FS-1715	GG-136	SAKU	FS236	GPP-419	KRA	FSM4104	GP-1122	COO
FR973	GA-59	FAME	FS-1719	GG-217	SAKU	FS237	GPP-419	KRA	FSM4111	GP-96	COO
FR975	GA-425	FAME	FS1802	GG-45	SAKU	FS239	GPP-1287 ³⁹	KRA	FSM4118	GP-1122	COO
FR976	GA-426	FAME	FS183	S 3202 ⁴⁰	KRA	FS239	PFF831 ⁴¹	KRA	FSM4145	GPP-423	COO
FR983	GA-436	FAME	FS-1901	GG-5 L	SAKU	FS239	R 60 P ⁴²	KRA	FSM4166	GP-548	COO
FR988	GA-192	FAME	FS19513	S 3202 ⁴⁰	FLG	FS239R	GPP-1287 ³⁹	KRA	FSR-8014	GA-516R	FAME
FR560X25M	GP-34	VICK	FS19514	GPP-425	FLG	FS239R	PFF831 ⁴¹	KRA	FSR81000	GPP-1000	FLR
FS0129800	G-178	CUMM	FS19515	GPP-419	FLG	FS239R	R 60 P ⁴²	KRA	FSR81001	GP-11	FLR
FS0129800	G-178	FLG	FS19516	GPP-418	FLG	FS240	GPP-14	KRA	FSR81003	GPP-10035	FLR
FS1	GG-5 L	ACD	FS19517	GPP-419	FLG	FS243	GPP-11	KRA	FSR81005	G-128	FLR
FS10	GG-1	ACD	FS19520	GPP-1060	FLG	FS244	GPP-11	KRA	FSR81006	GP-1109 ²²	FLR
FS10	GG-4	ACD	FS19520	S 3202 ⁴⁰	FLG	FS244U	GPP-11	KRA	FSR81006	GP-62 ³⁰	FLR
FS1000	GPP-1000	FLG	FS19521	GPP-1287 ³⁹	FLG	FS245	GPP-426	KRA	FSR81007	GPP-10075	FLR
FS1001	GPP-11	FLG	FS19521	PFF831 ⁴¹	FLG	FS246	GPP-547 ³⁹	KRA	FSR81016	G-128	FLR
FS1001	GG-196	SAKU	FS19521	S 3225 P ⁴²	FLG	FS246	PFF831 ⁴¹	KRA	FSR81021	GS-557	FLR
FS1003	GPP-10035	FLG	FS19523	G-559	FLG	FS246	R 60 P ⁴²	KRA	FSR81022	GPP-10225	FLR
FS1004-1	GG-5 L	SAKU	FS19525	GPP-423	FLG	FS248	GPP-424	KRA	FSR81029	G-128	FLR
FS1005	G-128	FLG	FS19526	GPP-425	FLG	FS249	GPP-419	KRA	FSR81029W	G-128	FLR
FS1007	GPP-10075	FLG	FS19530	GPP-425	FLG	FS249	GPP-421	KRA	FSR81040	GPP-10075	FLR
FS1015	GPP-103	FLG	FS19531	GPP-419	FLG	FS251	GPP-423	KRA	FSR81201	G-1143 ⁴⁰	FLR
FS1016	G-128	FLG	FS19532	GPP-1291 ³⁹	FLG	FS252	GPP-423	KRA	FSR81202	GC-1133	FLR
FS-1018	GG-185	SAKU	FS19532	PFF831 ⁴¹	FLG	FS254	GPP-426	KRA	FSR81203	GS-1133	FLR
FS-1020	GG-185	SAKU	FS19532	R 90 P ⁴²	FLG	FS30	GP-84	MIGH	FSR81205	G-293	FLR
FS1021	GS-557	FLG	FS19534	GPP-1122	FLG	FS301	GG-6	NOF	FSR81206	GS-2033	FLR
FS-1021	GG-185	SAKU	FS19536	G-128	FLG	FS302	GG-19	NOF	FSR81207	GS-2034	FLR
FS1022	GPP-10225	FLG	FS19536W	G-128	FLG	FS303	GG-7	NOF	FSR81208	2010PM-OR ⁷	FLR
FS1029	G-128	FLG	FS19546	GPP-426	FLG	FS304	GG-16	NOF	FSR81208	2010TM-OR ²	FLR
FS1029W	G-128	FLG	FS19547	GPP-547 ³⁹	FLG	FS305	GG-17	NOF	FSR81209	G-294	FLR
FS1031	GPP-10075	FLG	FS19547	PFF831 ⁴¹	FLG	FS306	GG-45	NOF	FSR81212	GPP-11	FLR
FS1040	GPP-10075	FLG	FS19547	R 60 P ⁴²	FLG	FS307	GG-123	NOF	FSR81214	GPP-11	FLR
FS1102	GG-76	SAKU	FS19548	GPP-547 ³⁹	FLG	FS308	GG-76	NOF	FSR81215	GPP-11	FLR
FS1103	GG-203	SAKU	FS19548	PFF831 ⁴¹	FLG	FS309	GG-1	NOF	FSR81220	GPP-14	FLR
FS1104	GG-202	SAKU	FS19548	R 60 P ⁴²	FLG	FS309	GG-4	NOF	FSR81221	GPP-1122	FLR
FS-1106	GG-185	SAKU	FS19551	GPP-1291 ³⁹	FLG	FS31	GP-83	MIGH	FSR81222	GPP-11	FLR
FS-1108	GG-185	SAKU	FS19551	PFF831 ⁴¹	FLG	FS310	GG-20	NOF	FSR81225	GPP-11	FLR
FS-1113	GG-185	SAKU	FS19551	R 90 T ⁴²	FLG	FS312	GG-8 ¹⁰³	NOF	FSR81226	GPP-1122	FLR
FS11-13-240	GA-432	MZDA	FS19554	GPP-419	FLG	FS312	GG-8 L ⁸⁰	NOF	FSR81235	GPP-1122	FLR
FS11-20-490A	GG-268	MZDA	FS19554	GPP-421	FLG	FS313	GG-45	NOF	FSR81240	GPP-14	FLR
FS11-20-490B	GG-268	MZDA	FS19555	GPP-424	FLG	FS318	GG-196	NOF	FSR81241	GPP-14	FLR
FS-1125	GG-185	SAKU	FS19557	GS-557	FLG	FS319	GG-203	NOF	FSR81242	GPP-103 ⁴⁰	FLR
FS-1127	GG-185	SAKU	FS19558	G-128	FLG	FS320	GG-203	NOF	FSR81242	GPP-11 ³⁹	FLR
FS1129	GG-185	SAKU	FS19559	G-559	FLG	FS344	GPP-1000	KRA	FSR81242B	GPP-103 ⁴⁰	FLR
FS1202	GC-1133	FLG	FS19572	GPP-419	FLG	FS345	GPP-11	KRA	FSR81242B	GPP-11 ³⁹	FLR
FS1203	GS-1133	FLG	FS19573	GPP-420	FLG	FS354	GPP-10035	KRA	FSR81243	S 3202 ⁴⁰	FLR
FS1205	G-293	FLG	FS19575	2010PM-OR	FLG	FS355	GPP-10225	KRA	FSR81247	GPP-14	FLR
FS1206	GS-2033	FLG	FS19577	GPP-424	FLG	FS357	GPP-10075	KRA	FSR81251	GPP-1122	FLR
FS1207	GS-2034	FLG	FS19579	GS-1261	FLG	FS3632	GPP-425	KRA	FSR81261	GS-1261	FLR
FS1208	2010PM-OR ⁷	FLG	FS19581	GPP-1122	FLG	FS366	GPP-18	KRA	FSR81268	GS-1261	FLR
FS1208	2010TM-OR ²	FLG	FS19583	GPP-419	FLG	FS4	GG-5 L	ACD	FSR81276	GPP-1122	FLR
FS1208N1	2010PM-OR ⁷	FLG	FS19585	GPP-425	FLG	FS404	G-335	DEL	FSR81277	GP-92	FLR
FS1208N1	2010TM-OR ²	FLG	FS19588	GPP-425	FLG	FS5	GG-1	ACD	FSR81280	GPP-18	FLR
FS1209	G-294	FLG	FS19589	GG-4	ACD	FS5	GG-4	ACD	FSR81282	GPP-14	FLR
FS1212	GPP-11	FLG	FS19593	GPP-1060	FLG	FS56-20-490A	GG-94	MZDA	FSR81284	GP-92	FLR
FS1212W	GPP-11	FLG	FS19593	GPP-1291 ³⁹	FLG	FS56-20-490B	GG-94	MZDA	FSR81287	GPP-1287 ³⁹	FLR
FS1213	S 3202 ⁴⁰	FLG	FS19593	S 3226 P ⁴⁰	FLG	FS585	GS-1261	KRA	FSR81287	PFF831 ⁴¹	FLR
FS1214	GPP-11	FLG	FS19596	GPP-10035	FLG	FS651	G-128	KRA	FSR81287	R 60 P ⁴²	FLR
FS1215	GPP-11	FLG	FS19599	GPP-1122	FLG	FS743	G-294	KRA	FSR81291	GPP-1291 ³⁹	FLR
FS1220	GPP-14	FLG	FS19614	GPP-423	FLG	FS745	GS-2034	KRA	FSR81291	S 3226 P ⁴⁰	FLR
FS1221	GPP-1122	FLG	FS19619	GPP-423	FLG	FS745-1	GS-2034	KRA	FSR81293	GS-2033	FLR
FS1222	GPP-11	FLG	FS19621	GPP-420	FLG	FS745R	GS-2034	KRA	FSR81294	GS-2034	FLR
FS1225	GPP-11	FLG	FS19754	R120P	FLG	FS746	G-1143 ⁴⁰	KRA	FSR81298	G-178	FLR
FS1226	GPP-1122	FLG	FS19773	GPP-1122	FLG	FS748	2010PM-OR ⁷	KRA	FSR819513	S 3202 ⁴⁰	FLR
FS1232	GP-1232	FLG	FS19793	GPP-423	FLG	FS748	2010TM-OR ²	KRA	FSR819514	GPP-425	FLR
FS1234B	GPP-14	FLG	FS19797	G-1047	FLG	FS749	G-178	KRA	FSR819515	GPP-419	FLR
FS1235	GPP-1122	FLG	FS19800	GS-1261	FLG	FS750	G-862	KRA	FSR819516	GPP-418	FLR
FS1240	GPP-14	FLG	FS19800E	GS-1261	FLG	FS753	GS-2033	KRA	FSR819517	GPP-419	FLR
FS1241	GPP-14	FLG	FS19845	GPP-1291 ³⁹	FLG	FS753-1	GS-2033	KRA	FSR819520	S 3202 ⁴⁰	FLR
FS1242	GPP-103 ⁴⁰	FLG	FS19845	PFF831 ⁴¹	FLG	FS758	G-293	KRA	FSR819521	GPP-1287 ³⁹	FLR
FS1242	GPP-11 ³⁹	FLG	FS19845	R 90 P ⁴²	FLG	FS8002	GG-251	SAKU	FSR819521	PFF831 ⁴¹	FLR
FS1242B	GPP-103 ⁴⁰	FLG	FS19846	GPP-1287 ³⁹	FLG	FS8003	GG-94	SAKU	FSR819521	S 3225 P ⁴²	FLR
FS1242B	GPP-11 ³⁹	FLG	FS19846	PFF831 ⁴¹	FLG	FS85	GP-56	MIGH	FSR819523	G-559	FLR
FS1243	S 3202 ⁴⁰	FLG	FS19846	S 3225 P ⁴²	FLG	FS96	GP-26	MIGH	FSR819525	GPP-423	FLR

Referencia Cruzada por Numero de Parte

Cross Reference by Part Number



Numero	Gonher	Fabricante	Numero	Gonher	Fabricante	Numero	Gonher	Fabricante	Numero	Gonher	Fabricante
Number	Gonher	Manufacturer	Number	Gonher	Manufacturer	Number	Gonher	Manufacturer	Number	Gonher	Manufacturer
FSR819526		GPP-425	FLR	FT4788		G-296	FIA	FT8806		GG-208	MICF
FSR819530		GPP-425	FLR	FT4788		G-296-B	FIA	FTG110011		GA-616	DON
FSR819531		GPP-419	FLR	FT4790		GP-310	FIA	FTG110033		GA-616	DON
FSR819532		GPP-1291 ³⁹	FLR	FT4790A		GP-310	FIA	FTT021		GG-185	WOW
FSR819532		PFF831 ⁴¹	FLR	FT4796		GP-46	FIA	FTT031		GG-185	WOW
FSR819532		R 90 P ⁴²	FLR	FT4796A		GP-46	FIA	FTT051		GG-185	WOW
FSR819534		GPP-1122	FLR	FT4797		GP-462	FIA	FTT061		GG-185	WOW
FSR819536		G-128	FLR	FT4799		GP-1122	FIA	FTT081		GG-185	WOW
FSR819536W		G-128	FLR	FT4801		GP-1122	FIA	FTT111		GG-187	WOW
FSR819546		GPP-426	FLR	FT4802		GP-1122	FIA	FTT171P		GG-76	WOW
FSR819547		GPP-547 ³⁹	FLR	FT4803		GP-81	FIA	FTT191P		GG-202	WOW
FSR819547		PFF831 ⁴¹	FLR	FT4807		GP-1122	FIA	FU52AFF		G-870	ROLK
FSR819547		R 60 P ⁴²	FLR	FT4809		GP-171	FIA	FVG140195		GA-251 ¹⁰⁴	DON
FSR819548		GPP-547 ³⁹	FLR	FT4819		GP-9	FIA	FVG140319		GA-251 ¹⁰⁴	DON
FSR819548		PFF831 ⁴¹	FLR	FT4826		GP-81 ³¹	FIA	FW10		GP-2022W	MTR
FSR819548		R 60 P ⁴²	FLR	FT4826		GP-9 ⁵⁸	FIA	FW10FP		GP-2022W	MTR
FSR819551		GPP-1291 ³⁹	FLR	FT4829		GP-81	FIA	FW18		GP-2071W	MTR
FSR819551		PFF831 ⁴¹	FLR	FT4837		GP-3816	FIA	FW19		GP-2071W	MTR
FSR819551		R 90 P ⁴²	FLR	FT4842		G-296	FIA	FW2		GP-2071W	MTR
FSR819554		GPP-419	FLR	FT4842		G-296-B	FIA	FW2A		GP-2071W	MTR
FSR819554		GPP-429	FLR	FT4858		GP-2071W	FIA	FW2AFP		GP-2071W	MTR
FSR819555		GPP-424	FLR	FT4862		GP-28 ⁹	FIA	FW7		GP-2015W	MTR
FSR819557		GS-557	FLR	FT4862		GP-430 ⁹	FIA	FW7FP		GP-2015W	MTR
FSR819559		G-559	FLR	FT4863		GP-1	FIA	FW8		GP-1013Q	MTR
FSR819572		GPP-419	FLR	FT4876		GP-3600	FIA	FW8A		GP-1012Q	MTR
FSR819573		GPP-420	FLR	FT4878		GP-501	FIA	FW9		GP-1011Q	MTR
FSR819575		2010PM-OR	FLR	FT4879		GP-77	FIA	FW9A		GP-1011Q	MTR
FSR819577		GPP-424	FLR	FT4888		GP-58	FIA	FW9B		GP-1011Q	MTR
FSR819579		GS-1261	FLR	FT4902		GP-81	FIA	FWA052526		GA-33 ¹¹²	DON
FSR819583		GPP-419	FLR	FT4903		G-295	FIA	FWA052527		GA-33 ¹¹²	DON
FSR819585		GPP-425	FLR	FT4904		GP-38	FIA	FWA052542		GA-33 ¹¹²	DON
FSR819588		GPP-425	FLR	FT4905		GP-462	FIA	FWA052551		GA-33 ¹¹²	DON
FSR819589		GPP-421	FLR	FT4906		GP-42	FIA	FWA052552		GA-33 ¹¹²	DON
FSR819593		GPP-1291 ³⁹	FLR	FT4907		GP-149	FIA	FWA065006		GAK-16	DON
FSR819593		S 3226 P ⁴⁰	FLR	FT4908		GP-462	FIA	FWA065007		GAK-16	DON
FSR819596		GPP-10035	FLR	FT4909		GP-38	FIA	FWA065015		GAK-16	DON
FSR819597		GPP-1122	FLR	FT4911		GP-3985	FIA	FWA065016		GAK-16	DON
FSR819614		GPP-423	FLR	FT4925		GP-81	FIA	FWA065027		GAK-16	DON
FSR819619		GPP-423	FLR	FT4931		GP-3531 EXP	FIA	FWA080022		GAK-403	DON
FSR819621		GPP-420	FLR	FT4932		GP-1122	FIA	FWA080026		GAK-403	DON
FSR819773		GPP-1122	FLR	FT4936		GP-390 ⁹³	FIA	FWA080027		GAK-403	DON
FSR820102		2010TM-OR	FLR	FT4937		GP-1108	FIA	FWA080031		GAK-403	DON
FSR820103		2010PM-OR	FLR	FT4939		GP-56	FIA	FWA080034		GAK-403	DON
FSS4010		GP-78	COO	FT4940		GP-521 ¹⁰	FIA	FWA080046		GAK-403	DON
FS4052		GP-155	COO	FT4940		GP-691 ⁴⁸	FIA	FWA080515		GA-98 ¹¹²	DON
FS-TYPE		G-296	CAV	FT4941		GP-26	FIA	FWA080516		GA-98 ¹¹²	DON
FS-TYPE		G-296-B	CAV	FT4942		GP-27	FIA	FWA080517		GA-98 ¹¹²	DON
FSW4074		G-293	COO	FT4947		GP-40	FIA	FWA080518		GA-98 ¹¹²	DON
FSW4099		GPP-11	COO	FT4956		GP-3985	FIA	FWA080519		GA-98 ¹¹²	DON
FSW4101		GPP-1122	COO	FT4963		GP-310	FIA	FWA080520		GA-98 ¹¹²	DON
FSW4151		GPP-419	COO	FT4966		GP-13	FIA	FWA100002		GAK-20	DON
FSW4153		GPP-425	COO	FT4967		GP-3	FIA	FWA100012		GAK-20	DON
FT111		GG-214	MICF	FT4968		GP-20	FIA	FWA100017		GAK-20	DON
FT1134		GG-164	MICF	FT4969		GP-5	FIA	FWA100019		GAK-20	DON
FT4		G-333	MTR	FT4970		GP-46	FIA	FWA100021		GAK-20	DON
FT4336		GP-50	FIA	FT4970A		GP-46	FIA	FWA100045		GAK-20	DON
FT4403		GP-171 ¹⁶	FIA	FT4971		GP-9586	FIA	FWA100049		GAK-20	DON
FT4409		GP-1101	FIA	FT4972		GP-3429	FIA	FWA100051		GAK-20	DON
FT4418		GP-50	FIA	FT4981		GP-3682	FIA	FWA100064		GAK-20	DON
FT4512		GP-81	FIA	FT4984		GP-69	FIA	FWA100065		GAK-20	DON
FT4526		GP-50	FIA	FT4986		GP-9	FIA	FWA140000		GA-27	DON
FT4531		GP-3816	FIA	FT4993		GP-40	FIA	FWA140002		GA-27	DON
FT4538		GP-3816	FIA	FT4993		GP-58	FIA	FWA140003		GA-27	DON
FT4573		GP-38	FIA	FT4998		GP-46	FIA	FWA140007		GA-27	DON
FT4580		GP-14	FIA	FT5		G-152	MTR	FWA140017		GA-27	DON
FT4627		GP-81	FIA	FT5018		GP-9	FIA	FWA140018		GA-27	DON
FT4653		GP-36	FIA	FT5021		GP-54 ⁹⁰	FIA	FWA140019		GA-27	DON
FT4657		GP-54 ¹¹	FIA	FT5042		GP-3985	FIA	FWA140021		GA-27	DON
FT4657		GP-66 ¹⁰	FIA	FT5058		GP-28 ¹⁰	FIA	FWA140027		GA-27	DON
FT4657HP		GP-66	FIA	FT5058		GP-430 ⁹	FIA	FWA140031		GA-27	DON
FT4662		GP-68	FIA	FT5089		GP-28 ⁸	FIA	FWA140032		GA-27	DON
FT4662A		GP-68	FIA	FT5089		GP-430 ⁹	FIA	FWA140033		GA-27	DON
FT4663		GP-406	FIA	FT5098		GP-53	FIA	FWA140036		GA-27	DON
FT4670		GP-31	FIA	FT5102		GP-40	FIA	FWA140038		GA-27	DON
FT4674		GP-81 ³¹	FIA	FT5119		GP-9	FIA	FWA140046		GA-27	DON
FT4674		GP-9 ⁵⁸	FIA	FT5120		GP-9	FIA	FWA140048		GA-27	DON
FT4682		GP-46	FIA	FT5126		GP-38	FIA	FWA140052		GA-27	DON
FT4702		GP-1	FIA	FT5130		GP-455	FIA	FWA140056		GA-27	DON
FT4710		GP-81	FIA	FT5140		GG-189	FIA	FWA140057		GA-27	DON
FT47101F		GP-81	FIA	FT5141		GG-251	FIA	FWA140071		GA-27	DON
FT4712		GP-1122	FIA	FT5144		GP-28 ⁸	FIA	FWA140076		GA-27	DON
FT4737		GP-110	FIA	FT5144		GP-430 ⁹	FIA	FWA140086		GA-27	DON
FT4739		GP-22	FIA	FT5147		GP-462	FIA	FWA140087		GA-27	DON
FT4747		GP-3600	FIA	FT5149		GP-291	FIA	FWA140088		GA-27	DON
FT4750		GP-46	FIA	FT5162		G-294	FIA	FWA140096		GA-27	DON
FT4756		GP-3816	FIA	FT5198		GG-246	FIA	FWA140097		GA-27	DON
FT4760		GP-28 ⁸	FIA	FT5201		GG-246	FIA	FWA140099		GA-27	DON
FT4760		GP-430 ⁹	FIA	FT5202		GG-226	FIA	FWA140102		GA-27	DON
FT4761		GP-3816	FIA	FT5203		GG-246	FIA	FWA140107		GA-27	DON
FT4771		GP-81 ³¹	FIA	FT5207		GG-5 L	FIA	FWA140113		GA-27	DON
FT4771		GP-9 ⁵⁸	FIA	FT5240		GP-1122	FIA	FWA140114		GA-27	DON
FT4775		GP-81	FIA	FT5317		GP-96	FIA	FWA140115		GA-27	DON
FT4776		GP-81	FIA	FT7267		GG-1	MICF	FWA140119		GA-27	DON
FT4777		GP-54	FIA	FT7267		GG-4	MICF	FWA140136		GA-27	DON
FT4777HP		GP-66	FIA	FT74		GP-171 ¹⁶	MTR	FWA140142		GA-27	DON
FT4781		GP-81	FIA	FT75		GP-66	MTR	FWA140146		GA-27	DON

Para números Gonher con Superíndice vea página 651
For Gonher with Superscript numbers see page 651

Referencia Cruzada por Numero de Parte

Cross Reference by Part Number



Numero	Gonher	Fabricante	Numero	Gonher	Fabricante	Numero	Gonher	Fabricante	Numero	Gonher	Fabricante
Number	Gonher	Manufacturer	Number	Gonher	Manufacturer	Number	Gonher	Manufacturer	Number	Gonher	Manufacturer
G14	GG-4	WARN	G180	GG-45	PARP	G226	GG-268	KRA	G265	GG-3	KRA
G14-0426	GA-109	GAR	G180	GG-45	TRUS	G227	GG-92	KRA	G267	GG-177	KRA
G-141	G-141	GONH	G180	GG-45	WARN	G228	GG-256	KRA	G268	GG-251	KRA
G14-1317	GA-389	GAR	G-180	G-180	GONH	G22A	GG-19	FRM	G-270	G-270	GONH
G1419	G-25	COO	G181	GG-1	AIRT	G22ADP	GG-19	FRM	G27-0336	GA-251	GAR
G14-2100	GA-371	GAR	G181	GG-4	AIRT	G230	GG-67	KRA	G271	GG-102	KRA
G-143	G-143	GONH	G181	GG-1	APOL	G231	GG-249	KRA	G-276	G-276	GONH
G145	GG-79	AIRT	G181	GG-4	APOL	G235	GG-164	KRA	G277	GG-5 L	KRA
G145	GG-79	BWS	G181	GG-1	BWS	G2351	GG-164	KRA	G-277	G-277	GONH
G145	GG-79	CENE	G181	GG-4	BWS	G236	GG-160	KRA	G-278	G-278	GONH
G145	GG-79	CHP	G181	GG-1	CHP	G-236	G-236	GONH	G285	GG-986	KRA
G145	GG-79	CIGO	G181	GG-4	CHP	G238	GG-246	KRA	G286	GG-226	KRA
G145	GG-79	GRAN	G181	GG-1	LUF	G238	GG-408	KRA	G2902	GG-215	AIRT
G145	GG-220	KRA	G181	GG-4	LUF	G-238	G-238	GONH	G2902	GG-215	CHP
G145	GG-79	LUF	G181	GG-1	WARN	G239	GG-104	KRA	G2902	GG-215	LUF
G145	GG-79	MASE	G181	GG-4	WARN	G-24	G-24	GONH	G2902	GG-215	MIGH
G145	GG-79	PARP	G182	GG-142	KRA	G241	GG-45	ACE	G2902	GG-215	WARN
G145	GG-79	TIRP	G183	GG-185	KRA	G241	GG-45	AIRT	G2903	GG-220	CENE
G145	GG-79	TRUS	G184	GG-185	KRA	G241	GG-45	APOL	G2903	GG-220	CHAM
G145	GG-79	WARN	G185	GG-261	KRA	G241	GG-45	CAM2	G2903	GG-220	CHP
G147	GG-5 L	KRA	G186	G-1176 ¹⁰⁸	GUD	G241	GG-45	CENE	G2903	GG-220	GRAN
G14-8732	GAK-16	GAR	G186	GG-151	KRA	G241	GG-45	CHP	G2903	GG-220	LUF
G15	GG-5 L	FRM	G187	GG-7018 ³⁸	KRA	G241	GG-45	GRAN	G2903	GG-220	MASE
G15	GG-47	SUN	G187	GG-7019 ³⁷	KRA	G241	GG-146	KRA	G2903	GG-220	MIGH
G15	GG-5 L	TVI	G187	GG-7020 ¹³⁴	KRA	G241	GG-45	LUF	G2903	GG-220	PARP
G150048	GA-683R	DON	G188	GG-580	KRA	G241	GG-45	MASE	G2903	GG-220	SECU
G150049	GA-683R	DON	G189	GG-247	KRA	G241	GG-45	MIGH	G2903	GG-220	TRUS
G150564	GP-1122	CASE	G190	GG-260	KRA	G241	GG-45	WARN	G2903	GG-220	WARN
G15-0694	GA-694	GAR	G191	GG-72	KRA	G242	GG-76	ACE	G2906	GG-194	CENE
G151	GG-217	KRA	G-191	G-191	GONH	G242	GG-76	AIRT	G2906	GG-194	CHAM
G152	G-1123	GUD	G192	GG-72	KRA	G242	GG-76	APOL	G2906	GG-194	CHP
G152	GG-65	KRA	G195	GG-146	KRA	G242	GG-76	BWS	G2906	GG-194	GRAN
G-152	G-152	GONH	G197	GG-220	KRA	G242	GG-76	CHP	G2906	GG-194	LUF
G153	G-1123	GUD	G19-8060	GA-21	GAR	G242	GG-76	GRAN	G2906	GG-194	MIGH
G153	GG-243	KRA	G1DP	GG-1	FRM	G242	GG-76	LUF	G2906	GG-194	PARP
G-153	G-153	GONH	G1DP	GG-4	FRM	G242	GG-76	MASE	G2906	GG-194	SECU
G154	GG-61	KRA	G1M	GG-1	FRM	G242	GG-76	PARP	G2906	GG-194	TRUS
G155	GG-67	KRA	G1M	GG-4	FRM	G242	GG-76	TRUS	G2906	GG-194	WARN
G156	GG-187	KRA	G1MDP	GG-1	FRM	G242	GG-76	WARN	G-2906	GG-194	MASE
G157	GG-203	GOY	G1MDP	GG-4	FRM	G243	GG-196	AIRT	G2908	GG-251	AIRT
G158	GG-196	GOY	G1P-7360	GA-7360	GAR	G243	GG-196	APOL	G2908	GG-251	BWS
G158	GG-251	KRA	G1P-7716	GA-7716	GAR	G243	GG-196	BWS	G2908	GG-251	CENE
G159	GG-5 L	KRA	G1P-8482	GA-482	GAR	G243	GG-196	CENE	G2908	GG-251	CHP
G-159	G-159	GONH	G1P-8483	GA-483	GAR	G243	GG-196	CHP	G2908	GG-251	CIGO
G15DP	GG-5 L	FRM	G2	GG-124	FRM	G243	GG-196	GRAN	G2908	GG-251	GRAN
G15M	GG-5 L	TVI	G2	GG-3	FRM	G243	GG-164	KRA	G2908	GG-251	LUF
G16	GG-19	ACE	G2	GG-5 L	GOY	G243	GG-196	LUF	G2908	GG-251	MASE
G16	GG-19	AIRT	G2	GG-19	SUN	G243	GG-196	MASE	G2908	GG-251	PARP
G16	GG-19	APOL	G-200	GG-200	GONH	G243	GG-196	PARP	G2908	GG-251	TRUS
G16	GG-19	BWS	G20012	GG-64	FRM	G243	GG-196	TRUS	G2908	GG-251	WARN
G16	GG-19	CENE	G20051	GG-1992	FRM	G243	GG-196	WARN	G2909	GG-189	AIRT
G16	GG-19	CHP	G20-0541	GA-21	GAR	G244	GG-8	AIRT	G2909	GG-189	BWS
G16	GG-19	CIGO	G201	GG-46	CHAM	G244	GG-8	APOL	G2909	GG-189	CENE
G16	GG-19	GRAN	G201	GG-137	KRA	G244	GG-8	CAM2	G2909	GG-189	CHP
G16	GG-19	LUF	G203	G-801	GUD	G244	GG-8	CHP	G2909	GG-189	GRAN
G16	GG-19	MASE	G203T	G-801	GUD	G244	GG-114	KRA	G2909	GG-189	LUF
G16	GG-19	PARP	G204	G-801	GUD	G244	GG-8	LUF	G2909	GG-189	MASE
G16	GG-19	REX	G20405M	GS-2034	GEMI	G244	GG-8	MASE	G2909	GG-189	MIGH
G16	GG-3728	SUN	G205	GG-801	COO	G244	GG-8	MIGH	G2909	GG-189	SECU
G16	GG-19	TRUS	G205	GG-801	GUD	G244	GG-8	WARN	G2909	GG-189	WARN
G16	GG-19	WARN	G205	GG-185	KRA	G246	GG-94	AIRT	G2917	GG-202	AIRT
G160	GG-208	KRA	G205C	G-870	GUD	G246	GG-94	APOL	G2917	GG-202	CENE
G160077	GA-356 ⁰⁴	DON	G206	G-870	COO	G246	GG-94	BWS	G2917	GG-202	CHP
G160077	GA-357 ⁰⁸	DON	G206	G-870	GUD	G246	GG-94	CAM2	G2917	GG-202	GRAN
G161006	GA-563 ⁰⁴	DON	G206	GG-185	KRA	G246	GG-94	CENE	G2917	GG-202	LUF
G161020	GA-563 ⁰⁴	DON	G206	G-870	LEYL	G246	GG-94	CHP	G2917	GG-202	MIGH
G162	GG-215	KRA	G207	GG-227	KRA	G246	GG-94	CIGO	G2917	GG-202	PARP
G-162H	G-162H	GONH	G21	GG-5 L	FRM	G246	GG-94	GRAN	G2917	GG-202	TRUS
G163	GG-181	KRA	G212	GG-30	KRA	G246	GG-94	KRA	G2917	GG-202	WARN
G-163	G-163	GONH	G213	GG-1872	KRA	G246	GG-94	LUF	G2918	GG-246	AIRT
G164	GG-190	KRA	G214	GG-870	COO	G246	GG-94	PARP	G2918	GG-246	CHP
G165	G-1176	COO	G214	GG-66	KRA	G246	GG-94	TRUS	G2918	GG-246	LUF
G165	G-1176	GUD	G215	GG-177	KRA	G246	GG-94	WARN	G2918	GG-246	WARN
G165	GG-181	KRA	G216	GG-136	KRA	G24-6501	GA-405	GAR	G2920	GG-298	AIRT
G167	GG-580	KRA	G219	GG-185	KRA	G248	GG-164	KRA	G2920	GG-298	CHP
G168	G-1123	GUD	G22	GG-123	ACE	G-25	G-25	GONH	G2920	GG-298	LUF
G168	GG-196	KRA	G22	GG-123	AIRT	G251	GG-185	KRA	G2920	GG-298	MIGH
G169	G-1121	COO	G22	GG-123	APOL	G252	GG-1	AIRT	G2920	GG-298	WARN
G169	G-1121	GUD	G22	GG-123	BWS	G252	GG-4	AIRT	G2925	GG-208	AIRT
G169	GG-214	KRA	G22	GG-123	CENE	G252	GG-1	APOL	G2925	GG-208	CHP
G-169	G-169	GONH	G22	GG-123	CHP	G252	GG-4	APOL	G2925	GG-208	LUF
G171	GG-203	SUN	G22	GG-19	FRM	G252	GG-1	BWS	G2925	GG-208	WARN
G171	GG-214	KRA	G22	GG-19	GOY	G252	GG-4	BWS	G2928	GG-63	CHP
G175	G-1173 ⁰⁸	GUD	G22	GG-123	GRAN	G252	GG-1	CHP	G2928	GG-63	CIGO
G-178	G-178	GONH	G22	GG-123	LUF	G252	GG-4	CHP	G2928	GG-63	LUF
G179	GG-150	KRA	G22	GG-123	MASE	G252	GG-1	GRAN	G2928	GG-63	WARN
G-179	G-179	GONH	G22	GG-123	PARP	G252	GG-4	GRAN	G2929	GPP-111	CHP
G180	GG-45	AIRT	G22	GG-123	REX	G252	GG-1	LUF	G2929	GPP-524	CHP
G180	GG-45	APOL	G22	GG-123	TRUS	G252	GG-4	LUF	G-293	G-293	GONH
G180	GG-45	BWS	G22	GG-123	WARN	G252	GG-1	WARN	G2930	GG-63	AIRT
G180	GG-45	CENE	G-222	G-222	GONH	G252	GG-4	WARN	G2930	GG-63	CENE
G180	GG-45	CHP	G22A	GG-84	KRA	G253	GG-351	KRA	G2930	GG-5 L	CHP
G180	GG-45	GRAN	G225	GG-7018 ³⁸	KRA	G256	GG-580	KRA	G2930	GG-63	GRAN
G180	GG-115	KRA	G225	GG-7019 ³⁷	KRA	G259	GG-266	KRA	G2930	GG-63	LUF
G180	GG-45	LUF	G225	GG-7020 ¹³⁴	KRA	G260	GG-265	KRA	G2931	G-1121	CHP
G180	GG-45	MASE	G-225	G-225	GONH	G261	GG-267	KRA	G2933	GG-246	AIRT

REFERENCIA CRUZADA

Para números Gonher con Superíndice vea página 651
For Gonher with Superscript numbers see page 651

Numero	Gonher	Fabricante	Numero	Gonher	Fabricante	Numero	Gonher	Fabricante	Numero	Gonher	Fabricante
Number	Gonher	Manufacturer	Number	Gonher	Manufacturer	Number	Gonher	Manufacturer	Number	Gonher	Manufacturer
G2933	GG-246	CENE	G2961	GG-188	DEUS	G2990	GG-76	LUF	G3727FP	GG-46	FRM
G2933	GG-246	CHP	G2961	GG-188	GRAN	G2990	GG-76	WARN	G3728	GG-3728	FRM
G2933	GG-246	GRAN	G2961	GG-188	LUF	G2991	GG-246	AIRT	G3728	GG-3728	TVI
G2933	GG-246	LUF	G2961	GG-188	SECU	G2991	GG-246	CENE	G3728DP	GG-3728	FRM
G2933	GG-246	WARN	G2961	GG-188	WARN	G2991	GG-246	CHP	G3736	GG-189	FRM
G2934	GG-226	AIRT	G-2961	GG-188	MASE	G2991	GG-246	GRAN	G3737	GG-189	FRM
G2934	GG-226	CENE	G2962	GG-232	AIRT	G2991	GG-246	LUF	G-3744	GG-261	FRM
G2934	GG-226	CHP	G2962	GG-232	CENE	G2991	GG-246	MIGH	G-3744	GG-261	PROG
G2934	GG-226	CIGO	G2962	GG-232	CHP	G2991	GG-246	PARP	G3745	GG-246	FRM
G2934	GG-226	GRAN	G2962	GG-232	DEUS	G2991	GG-246	TRUS	G3746	GG-226	FRM
G2934	GG-226	LUF	G2962	GG-188	GRAN	G2991	GG-246	WARN	G3746DP	GG-226	FRM
G2934	GG-226	MIGH	G2962	GG-232	LUF	G2DP	GG-5 L	FRM	G3747	GG-408	FRM
G2934	GG-226	PARP	G2962	GG-232	WARN	G2FP	GG-5 L	FRM	G3747DP	GG-246	FRM
G2934	GG-226	TRUS	G-2962	GG-232	MASE	G2S	GG-5 L	FRM	G3748	GG-246	FRM
G2934	GG-226	WARN	G2963	GG-39	CENE	G2S-1284	GA-1284	GAR	G-3752	G-3752	GONH
G2936	GG-76	AIRT	G2963	GG-39	CHAM	G2S-1285	GA-1285	GAR	G-3753	G-3753	GONH
G2936	GG-76	CHP	G2963	GG-39	GRAN	G2S-1286	GA-1286	GAR	G-3754	G-3754	GONH
G2936	GG-76	LUF	G2963	GG-39	LUF	G2S-1287	GA-1287	GAR	G3769	GG-42	FRM
G2936	GG-76	MASE	G2963	GG-39	PARP	G3	GG-5	FRM	G3769DP	GG-42	FRM
G2936	GG-76	MIGH	G2963	GG-39	SECU	G3/8	GG-5 L	CHP	G38	GG-5 L	ACE
G2936	GG-76	WARN	G2963	GG-39	TRUS	G3/8	GG-5 L	LUF	G38	GG-5 L	AIRT
G294	GG-290	KRA	G2963	GG-39	WARN	G-31	G-31	GONH	G38	GG-5 L	APOL
G-294	G-294	GONH	G-2963	GG-39	MASE	G-313	G-313	GONH	G38	GG-5 L	BWS
G2946	GG-246	AIRT	G2965	GG-208	AIRT	G3178	GG-63	GOY	G38	GG-5 L	CENE
G2946	GG-261	CENE	G2965	GG-208	CHP	G3190	GG-264	GOY	G38	GG-5 L	GRAN
G2946	GG-261	CRQ	G2966	GG-6	AIRT	G3243	GG-101	KRA	G38	GG-5 L	MASE
G2946	GG-261	GRAN	G-296-B	G-296-B	GONH	G33	G-1173 ¹⁰⁸	COO	G38	GG-5 L	REX
G2946	GG-261	LUF	G-297	G-297	GONH	G33	G-1173 ¹⁰⁸	GUD	G38	GG-5 L	VALV
G2946	GG-261	MIGH	G2970	GG-185	AIRT	G-33	G-33	GONH	G38	GG-5 L	WARN
G2946	GG-261	SECU	G2970	GG-185	CHP	G-330	G-330	GONH	G3802	GG-47	FRM
G2946	GG-261	WARN	G2970	GG-185	GRAN	G-330	G-330	MOTF	G3802	GG-47	GOY
G2947	GG-246	AIRT	G2970	GG-185	LUF	G-331	G-331	GONH	G3802	GG-47	PROG
G2947	GG-408	CAMP	G2972	GG-213	CENE	G-333	G-333	GONH	G3802A	GG-47	FRM
G2947	GG-246	CENE	G2972	GG-213	CHAM	G-335	G-335	GONH	G3802ADP	GG-47	FRM
G2947	GG-408	CENE	G2972	GG-213	CHP	G3359	GG-45	FRM	G3802AFP	GG-47	FRM
G2947	GG-246	CHP	G2972	GG-213	DEUS	G3359	GG-45	GOY	G3802DP	GG-47	FRM
G2947	GG-246	GRAN	G2972	GG-213	GRAN	G3359	GG-45	MNH	G-3827	G-3827	GONH
G2947	GG-408	GRAN	G2972	GG-213	LUF	G3359	GG-45	TVI	G3829	GG-251	FRM
G2947	GG-246	LUF	G2972	GG-213	MIGH	G3359A	GG-45	FRM	G3829DP	GG-251	FRM
G2947	GG-408	LUF	G2972	GG-213	PARP	G3359DP	GG-45	FRM	G3850	GG-1872	FRM
G2947	GG-246	MIGH	G2972	GG-213	SECU	G-338	G-338	GONH	G3850DP	GG-1872	FRM
G2947	GG-408	MIGH	G2972	GG-213	TRUS	G3388	GG-16	GOY	G3870	GG-242	FRM
G2947	GG-246	PARP	G2972	GG-213	WARN	G3389	GG-17	GOY	G3875	GG-194	FRM
G2947	GG-408	PARP	G-2972	GG-213	MASE	G-339H	G-339H	GONH	G-3875	GG-194	PROG
G2947	GG-408	SECU	G2974	GG-185	AIRT	G-34	G-34	GONH	G3893	GG-62	FRM
G2947	GG-246	TRUS	G2974	GG-185	BWS	G341	GG-203	AIRT	G3895	GG-264	FRM
G2947	GG-408	TRUS	G2974	GG-185	CENE	G341	GG-203	APOL	G3895	GG-264	PROG
G2947	GG-246	WARN	G2974	GG-185	CHP	G341	GG-203	BWS	G3895DP	GG-264	FRM
G2947	GG-408	WARN	G2974	GG-185	GRAN	G341	GG-203	CENE	G3897	GG-67	FRM
G-2947	GG-408	MASE	G2974	GG-185	LUF	G341	GG-203	CHP	G3969	GG-215	FRM
G-295	G-295	GONH	G2974	GG-185	MASE	G341	GG-203	GRAN	G3DP	GG-5 L	FRM
G2952	GG-246	AIRT	G2974	GG-185	PARP	G341	GG-203	LUF	G-409	G-409	GONH
G2952	GG-246	CHP	G2974	GG-185	TRUS	G341	GG-203	MASE	G4143	GG-196	FRM
G2952	GG-246	LUF	G2974	GG-185	WARN	G341	GG-203	PARP	G4143	GG-196	PROG
G2952	GG-246	WARN	G2975	GG-214	AIRT	G341	GG-203	TRUS	G4143	GG-196	TVI
G2953	GG-65	AIRT	G2975	GG-214	CHP	G341	GG-203	WARN	G4143DP	GG-196	FRM
G2953	GG-245	CENE	G2975	GG-214	CIGO	G-341	G-341	GONH	G4164	GG-116	FRM
G2953	GG-245	CHAM	G2975	GG-214	GRAN	G342	GG-208	AIRT	G4164	GG-116	TVI
G2953	GG-245	GRAN	G2975	GG-214	LUF	G342	GG-208	CENE	G4164DP	GG-116	FRM
G2953	GG-245	MIGH	G2975	GG-214	MASE	G342	GG-208	CHP	G4165	GG-199	FRM
G2953	GG-245	SECU	G2975	GG-214	PARP	G342	GG-208	GRAN	G4166	GG-76	FRM
G2953	GG-245	WARN	G2975	GG-214	TRUS	G342	GG-208	LUF	G4166	GG-76	TVI
G2954	GG-208	AIRT	G2975	GG-214	WARN	G342	GG-208	PARP	G4166DP	GG-76	FRM
G2954	GG-208	BWS	G2977	GG-196	CHP	G342	GG-208	TRUS	G4167	GG-202	FRM
G2954	GG-208	CENE	G2978	GG-3	AIRT	G342	GG-208	WARN	G4167DP	GG-202	FRM
G2954	GG-208	CHP	G2978	GG-3	CAM2	G3499	GG-8 L ⁸⁰	FRM	G4169	GG-5 L	FRM
G2954	GG-208	GRAN	G2978	GG-3	CHP	G3499	GG-8 ¹⁰³	GOY	G4177	GG-203	FRM
G2954	GG-208	LUF	G2978	GG-3	GRAN	G3499	GG-8 L ⁸⁰	GOY	G4177DP	GG-203	FRM
G2954	GG-208	MASE	G2978	GG-3	MASE	G3499	GG-8 ¹⁰³	PROG	G4191	GG-203	TVI
G2954	GG-208	PARP	G2978	GG-3	MIGH	G3499	GG-8 L ⁸⁰	PROG	G4191DP	GG-203	FRM
G2954	GG-208	TRUS	G2978	GG-3	SECU	G3499	GG-8 ¹⁰³	TVI	G4194	GG-94	PROG
G2954	GG-208	WARN	G2979	GG-196	AIRT	G3499	GG-8 L ⁸⁰	TVI	G427	GG-6	ACE
G2956	GG-181	AIRT	G2979	GG-196	CHP	G3499DP	GG-8 ¹⁰³	FRM	G427	GG-6	APOL
G2956	GG-181	BWS	G2979	GG-196	LUF	G3499DP	GG-8 L ⁸⁰	FRM	G427	GG-6	BWS
G2956	GG-181	CENE	G-297-B	G-297-B	GONH	G3596	GG-87	FRM	G427	GG-6	CENE
G2956	GG-181	CHP	G2981	GG-5 L	AIRT	G3596DP	GG-87	FRM	G427	GG-6	CHP
G2956	GG-181	CIGO	G2981	GG-5 L	CHP	G3603	GG-5 L	TVI	G427	GG-6	GRAN
G2956	GG-181	GRAN	G2981	GG-5 L	LUF	G3606	GG-5 L	FRM	G427	GG-6	LUF
G2956	GG-181	LUF	G2981	GG-5 L	MIGH	G3606	GG-5 L	PROG	G427	GG-6	MASE
G2956	GG-181	PARP	G2981	GG-5 L	WARN	G3606DP	GG-5 L	FRM	G427	GG-6	PARP
G2956	GG-181	TRUS	G2985	GG-215	AIRT	G3641	GG-79	FRM	G427	GG-6	REX
G2956	GG-181	WARN	G2985	GG-215	CENE	G3641	GG-79	PROG	G427	GG-6	TRUS
G2957	GG-217	AIRT	G2985	GG-215	CHP	G3641DP	GG-79	FRM	G427	GG-6	WARN
G2957	GG-217	CENE	G2985	GG-215	GRAN	G3692	GG-240	FRM	G43-0051	GA-37	GAR
G2957	GG-217	CHP	G2985	GG-215	LUF	G3692DP	GG-240	FRM	G43-0313	GA-426	GAR
G2957	GG-217	CIGO	G2985	GG-215	MASE	G3703	GG-188	FRM	G43-0344	GAK-1532	GAR
G2957	GG-217	GRAN	G2985	GG-215	MIGH	G-3703	GG-188	PROG	G43-0362	GA-2984	GAR
G2957	GG-217	LUF	G2985	GG-215	WARN	G3703DP	GG-203	FRM	G43-0414	GA-680	GAR
G2957	GG-217	MASE	G2987	GG-189	AIRT	G3713	GG-246	FRM	G43-0510	GA-18	GAR
G2957	GG-217	MIGH	G2987	GG-189	CENE	G3713	GG-246	PROG	G43-0725	GA-425	GAR
G2957	GG-217	WARN	G2987	GG-189	GRAN	G3713DP	GG-246	FRM	G43-0926	GA-679	GAR
G296	GG-209	KRA	G2987	GG-189	LUF	G3724	GG-8	FRM	G43-0936	GA-826	GAR
G-296	G-296	GONH	G2987	GG-189	PARP	G3724	GG-8	PROG	G43-1008	GA-29	GAR
G2961	GG-203	AIRT	G2987	GG-189	TRUS	G3724DP	GG-8	FRM	G43-1580	GA-109	GAR
G2961	GG-188	CENE	G2990	GG-76	AIRT	G3727	GG-46	FRM	G43-1581	GA-119	GAR
G2961	GG-188	CHP	G2990	GG-76	CHP	G3727DP	GG-46	FRM			

Referencia Cruzada por Numero de Parte

Cross Reference by Part Number



Numero	Gonher	Fabricante	Numero	Gonher	Fabricante	Numero	Gonher	Fabricante	Numero	Gonher	Fabricante
Number	Gonher	Manufacturer	Number	Gonher	Manufacturer	Number	Gonher	Manufacturer	Number	Gonher	Manufacturer
G43-1596	GA-209	GAR	G477	GG-264	CHP	G489	GG-67	GRAN	G516	GG-5 L	PARP
G43-1597	GA-210	GAR	G477	GG-264	CIGO	G489	GG-67	LUF	G516	GG-5 L	TRUS
G43-1599	GA-108	GAR	G477	GG-264	GRAN	G489	GG-67	PARP	G516	GG-5 L	WARN
G43-1600	GA-608	GAR	G477	GG-264	LUF	G489	GG-67	WARN	G517	G-801	COO
G43-3000	GAD-30	GAR	G477	GG-264	PARP	G4894	GG-98	FRM	G517	G-801	GUD
G43-8390	GA-679	GAR	G477	GG-98	PROG	G-49	GG-98	GONH	G5237	GG-137	FRM
G441	GG-7	ACE	G477	GG-264	TRUS	G490	GG-142	AIRT	G5237DP	GG-137	FRM
G441	GG-7	AIRT	G477	GG-264	WARN	G490	GG-142	CENE	G5258	GG-142	COO
G441	GG-7	APOL	G4773	GG-207	FRM	G490	GG-142	CHAM	G5288	G-1166	GUD
G441	GG-7	BWS	G4774	GG-208	FRM	G490	GG-142	CHP	G529	G-33	COO
G441	GG-7	CENE	G4774	GG-208	TVI	G490	GG-142	CIGO	G529	G-33	GUD
G441	GG-7	CHP	G4774DP	GG-208	FRM	G490	GG-142	GRAN	G529TF	G-33	GUD
G441	GG-7	GRAN	G4775	GG-208	FRM	G490	GG-142	LUF	G5312	GG-5 L	FRM
G441	GG-7	LUF	G4775	GG-208	PROG	G490	GG-142	PARP	G-5320 USA	G-963	GUSA
G441	GG-7	MASE	G4775	GG-208	TVI	G490	GG-142	SECU	G5355	GG-185	FRM
G441	GG-7	REX	G4775DP	GG-208	FRM	G490	GG-142	TRUS	G536	G-1123	COO
G441	GG-7	TRUS	G4776	GG-76	FRM	G490	GG-142	WARN	G536	G-1123	GUD
G441	GG-7	WARN	G4776DP	GG-76	FRM	G4917	GG-213	FRM	G536F	G-1123F	GUD
G-45	G-45	GONH	G4777	GG-63	FRM	G492	GG-5 L	AIRT	G536F	G-236	COO
G45006	G-1173 ¹⁰⁸	CASE	G4777	GG-63	PROG	G492	GG-5 L	CHP	G537	G-236	GUD
G45210	GP-1	CASE	G4777DP	GG-63	FRM	G492	GG-5 L	LUF	G540	G-1175	COO
G45306	GP-1	CASE	G478	GG-5 L	AIRT	G492	GG-5 L	WARN	G540	G-1175	GUD
G454	GG-5 L	LUF	G478	GG-5 L	APOL	G495	GG-246	AIRT	G543	G-1121	COO
G4611	GG-61	GOY	G478	GG-5 L	BWS	G495	GG-261	CHAM	G543	G-1121	GUD
G4612	GG-264	FRM	G478	GG-5 L	CAM2	G495	GG-261	GRAN	G54306	GP-1	CASE
G4618	GG-65	GOY	G478	GG-5 L	CHP	G496	GG-30	AIRT	G54307	G-1163	CASE
G-466	G-466	GONH	G478	GG-5 L	LUF	G496	GG-30	CENE	G543F	G-1121F	GUD
G4672	GG-580	GOY	G478	GG-5 L	PARP	G496	GG-30	CHP	G544	G-870	GUD
G470	GG-16	AIRT	G478	GG-5 L	TRUS	G496	GG-30	GRAN	G546	G-834	COO
G470	GG-16	APOL	G478	GG-5 L	WARN	G496	GG-30	LUF	G546	G-834	GUD
G470	GG-16	BWS	G481	GG-46	AIRT	G496	GG-30	PARP	G5471	GG-263	FRM
G470	GG-16	CENE	G481	GG-46	APOL	G496	GG-30	TRUS	G548	G-870	COO
G470	GG-16	CHP	G481	GG-46	BWS	G496	GG-30	WARN	G548	G-870	GUD
G470	GG-16	CIGO	G481	GG-46	CENE	G499	GG-190	GRAN	G55	GG-188	KRA
G470	GG-16	GRAN	G481	GG-46	CHP	G499	GG-190	BWS	G551	G-238	COO
G470	GG-16	LUF	G481	GG-46	CIGO	G499	GG-190	CENE	G551	G-238	GUD
G470	GG-16	PARP	G481	GG-46	FRM	G499	GG-190	CHP	G552	G-238	COO
G470	GG-16	TRUS	G481	GG-46	GOY	G499	GG-190	GRAN	G552	G-238	GUD
G470	GG-16	WARN	G481	GG-46	GRAN	G499	GG-190	LUF	G553	G-834	COO
G4702	GG-581	GOY	G481	GG-46	LUF	G499	GG-190	PARP	G553	G-834	GUD
G471	GG-17	AIRT	G481	GG-46	MASE	G499	GG-190	TRUS	G554	G-836	GUD
G471	GG-17	APOL	G481	GG-46	PARP	G499	GG-190	WARN	G5540	GG-419	FRM
G471	GG-17	BWS	G481	GG-46	TRUS	G4L-9853	GA-375	GAR	G-559	G-559	GONH
G471	GG-17	CENE	G481	GG-46	WARN	G4M-8047	GA-8047	GAR	G5603	GG-114	FRM
G471	GG-17	CHP	G482	GG-67	AIRT	G4M-9334	GA-9334	GAR	G562	GG-5 L	AIRT
G471	GG-17	CIGO	G482	GG-67	BWS	G4M-9378	GA-1008	GAR	G562	GG-580	BWS
G471	GG-17	GRAN	G482	GG-67	CENE	G4N-0015	GAP-381	GAR	G562	GG-256	CENE
G471	GG-17	LUF	G482	GG-67	CHP	G5	GG-6	SUN	G562	GG-256	CHAM
G471	GG-17	PARP	G482	GG-67	GRAN	G-500	G-500	GONH	G562	G-813	COO
G471	GG-17	TRUS	G482	GG-67	LUF	G-5000	G-5000	GONH	G562	GG-256	GRAN
G471	GG-17	WARN	G482	GG-67	MIGH	G501	GG-181	AIRT	G562	G-813	GUD
G4711	GG-1872	GOY	G482	GG-67	WARN	G501	GG-181	CENE	G562	GG-256	LUF
G4714	GG-45	FRM	G-482	GG-242	MASE	G501	GG-181	CHP	G562	GG-256	PARM
G4715	GG-204	FRM	G483	GG-3728	AIRT	G501	GG-181	CIGO	G562	GG-256	SECU
G4715	GG-204	TVI	G483	GG-3728	APOL	G501	GG-181	GRAN	G562	GG-256	TRUS
G4715DP	GG-204	FRM	G483	GG-3728	BWS	G501	GG-181	GUD	G562	GG-580	TRUS
G474	GG-8 ¹⁰³	AIRT	G483	GG-3728	CENE	G501	GG-181	LUF	G562	GG-256	WARN
G474	GG-8 L ⁸⁰	AIRT	G483	GG-3728	CHP	G501	GG-181	MIGH	G562	GG-580	WARN
G474	GG-8 ¹⁰³	APOL	G483	GG-3728	GOY	G501	GG-181	WARN	G-566	G-566	GONH
G474	GG-8 L ⁸⁰	APOL	G483	GG-3728	GRAN	G502	GG-148	AIRT	G569	G-331	COO
G474	GG-8 ¹⁰³	CHP	G483	GG-3728	LUF	G502	GG-148	CENE	G569	G-331	GUD
G474	GG-8 L ⁸⁰	CHP	G483	GG-3728	MASE	G502	GG-148	CHAM	G570	G-200	COO
G474	GG-8 ¹⁰³	CIGO	G483	GG-3728	PARP	G502	GG-148	CHP	G570	G-200	GUD
G474	GG-8 L ⁸⁰	CIGO	G483	GG-3728	TRUS	G502	GG-148	CIGO	G572	GG-146	AIRT
G474	GG-8 ¹⁰³	LUF	G483	GG-3728	WARN	G502	GG-148	GRAN	G572	GG-146	CENE
G474	GG-8 L ⁸⁰	LUF	G484	GG-185	AIRT	G502	GG-148	LUF	G572	GG-146	CHAM
G474	GG-8 ¹⁰³	PARP	G484	GG-185	CENE	G502	GG-148	MIGH	G572	GG-146	CHP
G474	GG-8 L ⁸⁰	PARP	G484	GG-185	CHP	G502	GG-148	SECU	G572	GG-146	CIGO
G474	GG-8 ¹⁰³	TRUS	G484	GG-185	GRAN	G502	GG-148	WARN	G572	GG-146	GRAN
G474	GG-8 L ⁸⁰	TRUS	G484	GG-185	LUF	G505	GG-8 ¹⁰³	AIRT	G572	GG-146	LUF
G474	GG-8 ¹⁰³	WARN	G484	GG-185	PARP	G505	GG-8 L ⁸⁰	AIRT	G572	GG-146	PARP
G474	GG-8 L ⁸⁰	WARN	G484	GG-185	TRUS	G505	GG-62	LUF	G572	GG-146	SECU
G475	GG-87	AIRT	G484	GG-185	WARN	G510	GG-76	AIRT	G572	GG-146	TRUS
G475	GG-87	APOL	G4841	GG-185	FRM	G510	GG-76	CENE	G572	GG-146	WARN
G475	GG-87	BWS	G485	GG-61	AIRT	G510	GG-76	CHP	G573	GG-580	AIRT
G475	GG-87	CAM2	G485	GG-61	CENE	G510	GG-76	GRAN	G573	GG-580	BWS
G475	GG-87	CENE	G485	GG-61	CHP	G510	GG-76	LUF	G573	GG-580	CENE
G475	GG-87	CHP	G485	GG-61	GRAN	G510	GG-76	WARN	G573	GG-580	CHP
G475	GG-87	GRAN	G485	GG-61	LUF	G512	G-6	COO	G573	GG-580	GRAN
G475	GG-87	LUF	G485	GG-61	PARP	G513	GG-185	AIRT	G573	GG-580	LUF
G475	GG-87	MASE	G485	GG-61	TRUS	G513	GG-185	BWS	G573	GG-580	PARP
G475	GG-87	PARP	G485	GG-61	WARN	G513	GG-185	CENE	G573	GG-580	TRUS
G475	GG-87	TRUS	G486	GG-65	AIRT	G513	GG-185	CHP	G573	GG-580	WARN
G475	GG-87	WARN	G486	GG-65	BWS	G513	GG-185	GRAN	G5738	GG-252	FRM
G4760	GG-240	AIRT	G486	GG-65	CENE	G513	GG-185	LUF	G-5774	GG-351	FRM
G4760	GG-240	BWS	G486	GG-65	CHP	G513	GG-185	MIGH	G578	GG-66	AIRT
G4760	GG-240	CENE	G486	GG-65	GRAN	G513	GG-185	WARN	G578	GG-66	BWS
G4760	GG-240	CHP	G486	GG-65	LUF	G515	G-225	COO	G578	GG-66	CENE
G4760	GG-240	GRAN	G486	GG-65	PARP	G515	G-225	GUD	G578	GG-66	CHP
G4760	GG-240	LUF	G486	GG-65	SECU	G516	GG-5 L	ACE	G578	GG-66	CIGO
G4760	GG-240	WARN	G486	GG-65	TRUS	G516	GG-5 L	AIRT	G578	GG-66	GRAN
G4763	GG-196	FRM	G486	GG-65	WARN	G516	GG-5 L	APOL	G578	GG-66	LUF
G4763DP	GG-196	FRM	G489	GG-67	CENE	G516	GG-5 L	CHP	G578	GG-66	PARP
G477	GG-264	AIRT	G489	GG-67	CHP	G516	GG-5 L	LUF	G578	GG-66	TRUS
G477	GG-264	BWS	G489	GG-190	CIGO	G516	GG-5 L	MASE	G578	GG-66	WARN
G477	GG-264	CENE	G489	GG-67	CIGO	G516	GG-5 L	MIGH	G579	GG-48	COO

REFERENCIA CRUZADA

Para números Gonher con Superíndice vea página 651
For Gonher with Superscript numbers see page 651

Numero	Gonher	Fabricante	Numero	Gonher	Fabricante	Numero	Gonher	Fabricante	Numero	Gonher	Fabricante
Number	Gonher	Manufacturer	Number	Gonher	Manufacturer	Number	Gonher	Manufacturer	Number	Gonher	Manufacturer
G579	GG-48	GUD	G6304	GG-243	MIGH	G6351	GG-137	AIRT	G6380	GG-151	CHAM
G58	GG-87	KRA	G6304	GG-243	WARN	G6351	GG-137	CHP	G6380	GG-151	GRAN
G580	GG-581	AIRT	G6316	GG-185	AIRT	G6351	GG-137	CIGO	G6380	GG-151	LUF
G580	GG-581	BWS	G6317	GG-185	CHP	G6351	GG-137	LUF	G6380	GG-151	WARN
G580	GG-581	CHP	G6317	GG-185	LUF	G6351	GG-137	PARP	G6381	GG-268	AIRT
G580	GG-177 ⁴³	LUF	G6317	GG-185	MIGH	G6351	GG-137	WARN	G6381	GG-268	CHP
G580	GG-581 ¹⁶	LUF	G6317	GG-185	WARN	G6352	GG-203	AIRT	G6381	GG-268	LUF
G580	GG-581	PARP	G6319	GG-115	AIRT	G6352	GG-203	CHP	G6381	GG-268	MIGH
G580	GG-256	SECU	G6319	GG-115	CENE	G6352	GG-203	GRAN	G6381	GG-268	PARP
G580	GG-581	TRUS	G6319	GG-115	CHAM	G6352	GG-203	LUF	G6381	GG-268	TRUS
G580	GG-581	WARN	G6319	GG-115	CHP	G6352	GG-203	MIGH	G6381	GG-268	WARN
G581	G-833	COO	G6319	GG-115	CIGO	G6352	GG-203	WARN	G6382	GG-232	CENE
G581	G-833	GUD	G6319	GG-115	GRAN	G6357	GG-227	CENE	G6382	GG-232	DEUS
G5857	GG-291	FRM	G6319	GG-115	LUF	G6357	GG-227	CHAM	G6382	GG-232	GRAN
G5870	GG-102	FRM	G6319	GG-115	SECU	G6357	GG-227	CHP	G6382	GG-232	LUF
G587F	GP-1122	AIRT	G6319	GG-115	WARN	G6357	GG-227	GRAN	G6382	GG-232	MIGH
G588	G-333	COO	G6320	GG-150	AIRT	G6357	GG-227	LUF	G6382	GG-232	SECU
G588	G-333	GUD	G6320	GG-150	CHAM	G6357	GG-227	WARN	G6382	GG-232	WARN
G59	GG-196	KRA	G6320	GG-150	CIGO	G6360	GG-247	CENE	G6384	GG-255	AIRT
G594	G-801	COO	G6320	GG-115	GRAN	G6360	GG-247	CHAM	G6384	GG-255	CHP
G594	G-801	GUD	G6320	GG-150	LUF	G6360	GG-247	DEUS	G6384	GG-255	CIGO
G5982	GG-206	FRM	G6320	GG-150	SECU	G6360	GG-247	GRAN	G6384	GG-255	LUF
G5987	GG-189	WARN	G6320	GG-150	WARN	G6360	GG-247	MIGH	G6384	GG-255	MIGH
G5995	GG-64	FRM	G6323	GG-185	AIRT	G6360	GG-247	SECU	G6384	GG-255	PARP
G6	GG-20	ACE	G6323	GG-185	CHP	G6360	GG-247	WARN	G6384	GG-255	TRUS
G6	GG-20	AIRT	G6324	GG-187	AIRT	G6361	GG-7018 ³⁸	AIRT	G6384	GG-255	WARN
G6	GG-20	APOL	G6324	GG-187	CENE	G6361	GG-7019 ³⁷	AIRT	G6385	GG-136	AIRT
G6	GG-20	BWS	G6324	GG-187	CHP	G6361	GG-7020 ¹⁴	AIRT	G6385	GG-136	CENE
G6	GG-20	CENE	G6324	GG-187	GRAN	G6361	GG-7018 ³⁸	CENE	G6385	GG-136	CHAM
G6	GG-20	CHP	G6324	GG-187	LUF	G6361	GG-7019 ³⁷	CENE	G6385	GG-136	CHP
G6	GG-4	FRM	G6324	GG-187	PARP	G6361	GG-7020 ¹⁴	CENE	G6385	GG-136	CIGO
G6	GG-20	GRAN	G6324	GG-187	TRUS	G6361	GG-7018 ³⁸	CHP	G6385	GG-136	GRAN
G6	GG-20	LUF	G6324	GG-187	WARN	G6361	GG-7019 ³⁷	CHP	G6385	GG-136	LUF
G6	GG-20	MASE	G6326	GG-67	AIRT	G6361	GG-7020 ¹⁴	CHP	G6385	GG-136	MIGH
G6	GG-20	PARP	G6326	GG-67	CHP	G6361	GG-7018 ³⁸	CIGO	G6385	GG-136	SECU
G6	GG-123	SUN	G6326	GG-67	LUF	G6361	GG-7019 ³⁷	CIGO	G6385	GG-136	WARN
G6	GG-20	TRUS	G6326	GG-67	WARN	G6361	GG-7020 ¹⁴	CIGO	G6386	GG-234	CENE
G6	GG-20	WARN	G6328	GG-204	CIGO	G6361	GG-7018 ³⁸	GRAN	G6386	GG-234	CHAM
G-6	G-6	GONH	G6330	GG-214	AIRT	G6361	GG-7019 ³⁷	GRAN	G6386	GG-234	LUF
G60	GG-76	KRA	G6330	GG-214	CHP	G6361	GG-7020 ¹⁴	GRAN	G6386	GG-234	MIGH
G601	GG-246	GUD	G6330	GG-214	CIGO	G6361	GG-7018 ³⁸	LUF	G6386	GG-234	SECU
G601-13-240	GA-2106	MZDA	G6330	GG-214	GRAN	G6361	GG-7019 ³⁷	LUF	G6386	GG-234	WARN
G60146	GG-251	PUR	G6330	GG-214	LUF	G6361	GG-7020 ¹⁴	LUF	G6387	GG-94	AIRT
G602-20-490	GG-115	MZDA	G6330	GG-214	MASE	G6361	GG-7018 ³⁸	PARP	G6387	GG-94	CHP
G602-20-490A	GG-115	MZDA	G6330	GG-214	MIGH	G6361	GG-7019 ³⁷	PARP	G6387	GG-94	CIGO
G602-20-490B	GG-115	MZDA	G6330	GG-214	WARN	G6361	GG-7020 ¹⁴	PARP	G6387	GG-94	LUF
G603	G-335	COO	G6332	GG-242	CENE	G6361	GG-7018 ³⁸	TRUS	G6387	GG-94	MIGH
G603	G-335	GUD	G6332	GG-242	GRAN	G6361	GG-7019 ³⁷	TRUS	G6387	GG-94	PARP
G604	G-1163	GUD	G6332	GG-242	LUF	G6361	GG-7020 ¹⁴	TRUS	G6387	GG-94	TIRP
G606	G-834	GUD	G6332	GG-242	SECU	G6361	GG-7018 ³⁸	WARN	G6387	GG-94	WARN
G607-20-490	GG-115	MZDA	G6332	GG-242	WARN	G6361	GG-7019 ³⁷	WARN	G6388	GG-249	AIRT
G607-20-490A	GG-115	MZDA	G6335	GG-63	AIRT	G6361	GG-7020 ¹⁴	WARN	G6388	GG-249	CENE
G607-20-490B	GG-115	MZDA	G6335	GG-63	CHP	G6362	GG-72	CHP	G6388	GG-249	CHP
G61	GG-45	KRA	G6335	GG-63	CIGO	G6362	GG-72	WARN	G6388	GG-249	CIGO
G-613	G-613	GONH	G6335	GG-63	LUF	G6365	GG-72	AIRT	G6388	GG-249	GRAN
G62	G-1123	GUD	G6335	GG-63	PARP	G6365	GG-72	CENE	G6388	GG-249	LUF
G62	GG-202	KRA	G6335	GG-63	TRUS	G6365	GG-72	CHP	G6388	GG-249	WARN
G625	G-1174 ⁰⁸	COO	G6335	GG-63	WARN	G6365	GG-72	GRAN	G6389	GG-84	AIRT
G629	G-296	COO	G6336	GG-150	AIRT	G6365	GG-72	LUF	G6389	GG-84	CHP
G629	G-296-B	COO	G6336	GG-150	CENE	G6365	GG-72	PARP	G6389	GG-84	GRAN
G629	G-296	GUD	G6336	GG-150	CHAM	G6365	GG-72	TRUS	G6389	GG-84	LUF
G629	G-296-B	GUD	G6336	GG-150	CHP	G6365	GG-72	WARN	G6389	GG-84	PARP
G629-20-490	GG-115	MZDA	G6336	GG-150	CIGO	G6367	GG-1872	AIRT	G6389	GG-84	SECU
G63	GG-185	AIRT	G6336	GG-150	GRAN	G6367	GG-1872	CENE	G6389	GG-84	TRUS
G63	GG-204	AIRT	G6336	GG-150	LUF	G6367	GG-1872	CHP	G6389	GG-84	WARN
G63	GG-185	CHP	G6336	GG-150	PARP	G6367	GG-1872	CIGO	G6393	GG-99	CAMP
G63	GG-204	CHP	G6336	GG-150	SECU	G6367	GG-1872	GRAN	G6393	GG-99	CENE
G63	GG-246	CHP	G6336	GG-150	TRUS	G6367	GG-1872	LUF	G6393	GG-99	GRAN
G63	GG-185	LUF	G6336	GG-150	WARN	G6367	GG-1872	PARP	G6393	GG-99	MIGH
G63	GG-204	LUF	G6340	GG-64	AIRT	G6367	GG-1872	TRUS	G6393	GG-99	PARP
G63	GG-246	MIGH	G6340	GG-64	CENE	G6367	GG-1872	WARN	G6393	GG-99	SECU
G63	GG-185	PARP	G6340	GG-64	CHP	G6369	GG-185	AIRT	G6393	GG-99	TRUS
G63	GG-204	PARP	G6340	GG-64	CIGO	G6369	GG-185	CHP	G6393	GG-99	WARN
G63	GG-185	TRUS	G6340	GG-64	GRAN	G6369	GG-185	LUF	G6397	GG-223	CENE
G63	GG-204	TRUS	G6340	GG-64	LUF	G6369	GG-185	WARN	G6397	GG-223	CHAM
G63	GG-185	WARN	G6340	GG-64	PARP	G6371	GG-185	AIRT	G6397	GG-223	CHP
G63	GG-204	WARN	G6340	GG-64	WARN	G6371	GG-185	CHP	G6397	GG-223	DEUS
G630	G-330	COO	G6342	GG-177	CENE	G6371	GG-185	LUF	G6397	GG-214	FRM
G630	G-330	GUD	G6342	GG-177	CHAM	G6371	GG-185	PARP	G6397	GG-223	GRAN
G6302	GG-151	CHAM	G6342	GG-177	GRAN	G6371	GG-185	TRUS	G6397	GG-223	LUF
G6302	GG-151	GRAN	G6342	GG-177	LUF	G6371	GG-185	WARN	G6397	GG-223	MIGH
G6303	GG-220	CENE	G6342	GG-177	MIGH	G6378	GG-92	AIRT	G6397	GG-223	SECU
G6303	GG-220	CHAM	G6342	GG-177	SECU	G6378	GG-92	CHP	G6397	GG-223	WARN
G6303	GG-220	CHP	G6342	GG-177	WARN	G6378	GG-92	LUF	G6398	GG-98	AIRT
G6303	GG-220	GRAN	G6343	GG-190	FRM	G6378	GG-92	PARP	G6398	GG-98	CENE
G6303	GG-220	LUF	G6343DP	GG-181	FRM	G6378	GG-92	TRUS	G6398	GG-98	CHP
G6303	GG-220	PARP	G6344	GG-39	FRM	G6378	GG-92	WARN	G6398	GG-246	FRM
G6303	GG-220	SECU	G6345	GG-260	AIRT	G6379	GG-196	AIRT	G6398	GG-98	GRAN
G6303	GG-220	TRUS	G6345	GG-260	CENE	G6379	GG-196	CHP	G6398	GG-98	LUF
G6303	GG-220	WARN	G6345	GG-260	CHP	G6379	GG-151	GRAN	G6398	GG-98	WARN
G6304	GG-243	AIRT	G6345	GG-260	GRAN	G6379	GG-196	LUF	G6399	GG-185	AIRT
G6304	GG-243	CENE	G6345	GG-260	LUF	G6379	GG-196	PARP	G6399	GG-185	CHP
G6304	GG-243	CHP	G6345	GG-260	PARP	G6379	GG-196	TRUS	G6400	GG-106	FRM
G6304	GG-243	CIGO	G6345	GG-260	TRUS	G6379	GG-196	WARN	G6410	GG-8 ⁰³	FRM
G6304	GG-243	GRAN	G6345	GG-260	WARN	G-638	G-638	GONH	G6410	GG-8 L ⁰	FRM
G6304	GG-243	LUF	G6348	GG-41	FRM	G6380	GG-151	CENE	G6411	GG-5 L	FRM

Referencia Cruzada por Numero de Parte

Cross Reference by Part Number



Numero	Gonher	Fabricante	Numero	Gonher	Fabricante	Numero	Gonher	Fabricante	Numero	Gonher	Fabricante
Number	Gonher	Manufacturer	Number	Gonher	Manufacturer	Number	Gonher	Manufacturer	Number	Gonher	Manufacturer
G-6412	GG-245	FRM	G6536	GG-181	WARN	G6636	GG-206	SECU	G7428	GG-268	FRM
G6412DP	GG-65	FRM	G6536DP	GG-142	FRM	G664	GG-20	COO	G7429	GG-7018 ³⁸	FRM
G6424	GG-208	FRM	G6538	GG-114	AIRT	G664	GG-20	GUD	G7429	GG-7019 ³⁷	FRM
G6424	GG-5 L	MTR	G6538	GG-114	CHP	G6642	GG-265 ³⁶	CHP	G7429	GG-7020 ¹⁴⁴	FRM
G6426	GG-203	FRM	G6538	GG-114	CIGO	G6642	GG-265 ³⁶	CIGO	G75	GG-45	KRA
G6426DP	GG-203	FRM	G6538	GG-148	FRM	G6642	GG-265 ³⁶	FSN	G-75	GG-46	ATL
G6429	GG-207	FRM	G6538	GG-114	LUF	G6642	GG-265 ³⁶	LUF	G-750	G-750	GONH
G6429DP	GG-76	FRM	G6538	GG-114	PARM	G6642	GG-265 ³⁶	PARP	G751	GG-76	AIRT
G6435	GG-215	FRM	G6538	GG-114	WARN	G6642	GG-265 ³⁶	TIRP	G751	GG-76	CENE
G6435DP	GG-215	FRM	G6540	GG-146	AIRT	G666	G-139	GUD	G751	GG-76	GRAN
G6436	GG-208	FRM	G6540	GG-146	CENE	G6674	GG-220	FRM	G751	GG-76	WARN
G6436	GG-208	PROG	G6540	GG-146	CHAM	G6676	GG-115	FRM	G752	GG-203	AIRT
G6436DP	GG-208	FRM	G6540	GG-146	CHP	G6677	GG-146	FRM	G752	GG-203	CENE
G6438	GG-196	FRM	G6540	GG-146	CIGO	G6677DP	GG-146	FRM	G752	GG-203	CHP
G644	G-139	COO	G6540	GG-146	GRAN	G6678	GG-151	FRM	G752	GG-203	GRAN
G6442	GG-217	FRM	G6540	GG-146	LUF	G668	G-834	COO	G752	GG-203	LUF
G6448	GG-266	FRM	G6540	GG-146	PARP	G6680	GG-187	FRM	G752	GG-203	MIGH
G645	GG-266	AIRT	G6540	GG-146	SECU	G6680DP	GG-187	FRM	G752	GG-203	PARP
G645	GG-266	CHP	G6540	GG-146	WARN	G669	G-119	COO	G752	GG-203	TRUS
G645	GG-266	LUF	G6541	GG-185	AIRT	G669	G-119	GUD	G7596	GG-92	FRM
G645	GG-266	PARP	G6541	GG-185	CENE	G6691	GG-214	FRM	G7596DP	GG-92	FRM
G645	GG-266	WARN	G6541	GG-185	CHP	G67	G-1176	GUD	G7599	GG-160	FRM
G6453	GG-232	FRM	G6541	GG-185	GRAN	G672	G-870	COO	G76	G-750	COO
G6458	GG-208	FRM	G6541	GG-185	LUF	G672	G-870	GUD	G76	G-750	GUD
G6458DP	GG-208	FRM	G6541	GG-185	MIGH	G677	G-834	COO	G7603	GG-580	FRM
G6462	GG-185	FRM	G6541	GG-185	WARN	G677	G-834	GUD	G7609	GG-267	FRM
G6462	GG-185	PROG	G6543	GG-164	CAMP	G68	GG-8 ¹⁰³	KRA	G7609	GG-267	SECU
G6462DP	GG-185	FRM	G6543	GG-164	CENE	G68	GG-8 L ⁸⁰	KRA	G7610	GG-265	FRM
G6465	GG-185	FRM	G6543	GG-164	GRAN	G6825	GG-187	FRM	G7612	GG-220	FRM
G6465DP	GG-185	FRM	G6543	GG-164	LUF	G6826	GG-184	FRM	G7616	GG-223	FRM
G6468	GG-208	FRM	G6543	GG-164	SECU	G6826DP	GG-187	FRM	G7647	GG-185	FRM
G6507	GG-177 ⁴³	FRM	G6543	GG-164	WARN	G6831	GG-209	CHP	G7649	GG-239	FRM
G6507DP	GG-581	FRM	G6552	GG-164	AIRT	G6831	GG-209	CIGO	G765	G-225	GUD
G6511	GG-160	AIRT	G6552	GG-164	CHAM	G6831	GG-209	LUF	G-765	G-765	GONH
G6511	GG-160	CENE	G6552	GG-164	CHP	G6859	GG-185	FRM	G76818A1	G-1123	BOG
G6511	GG-160	CHP	G6552	GG-164	CIGO	G686	G-191	GUD	G-77	GP-3980	ATL
G6511	GG-160	GRAN	G6552	GG-164	DEUS	G688	G-801	COO	G77281	GP-1	GRAY
G6511	GG-160	LUF	G6552	GG-164	LUF	G6897	GG-148	FRM	G7740	GG-290	FRM
G6511	GG-160	PARP	G6552	GG-164	MIGH	G69	G-500	GUD	G7759	GG-65	FRM
G6511	GG-160	TRUS	G6552	GG-164	SECU	G-69	GP-20	ATL	G7760	GG-104	FRM
G6511	GG-160	WARN	G6552	GG-164	WARN	G6901	GG-260	FRM	G7765	GG-185	FRM
G6514	GG-95	AIRT	G6553	GG-185	FRM	G6936	GG-247	FRM	G7766	GG-185	FRM
G6514	GG-95	CHP	G6553DP	GG-185	FRM	G695	G-222	COO	G7766DP	GG-185	FRM
G6514	GG-95	LUF	G6561	GG-243	FRM	G695	G-222	GUD	G7767	GG-185	FRM
G6514	GG-95	WARN	G6561DP	GG-243	FRM	G696	G-870	GUD	G7768	GG-185	FRM
G6519	GG-580	AIRT	G6563	GG-61	FRM	G6Y0-14-302	GP-149	MZDA	G7769	GG-164	FRM
G6519	GG-256	CHAM	G6563	GG-61	PROG	G6Y0-14-302A	GP-149	MZDA	G7770	GG-164	FRM
G6519	GG-580	LUF	G6563DP	GG-61	FRM	G7	GG-20	SUN	G7771	GG-234	FRM
G6519	GG-256	SECU	G6566	GG-65	FRM	G70	GG-16	KRA	G7770	GG-29	FRM
G6519	GG-580	WARN	G6566	GG-65	PROG	G-70	G-70	GONH	G-79	G-765	ATL
G6526	GG-164	AIRT	G6566DP	GG-65	FRM	G7018	GG-7018 ³⁸	FRM	G795	GG-87	GOY
G6526	GG-164	CHAM	G6567	GG-67	FRM	G7018	GG-7018 ³⁸	PROG	G7M-9045	GA-9045	GAR
G6526	GG-164	CHP	G6567DP	GG-67	FRM	G7018	GG-7019 ³⁷	PROG	G7N-1308	GA-4828	GAR
G6526	GG-164	CIGO	G6568	GG-62	FRM	G7018	GG-7020 ¹⁴⁴	PROG	G8	GG-7	SUN
G6526	GG-164	LUF	G657	G-152	COO	G7019	GG-7019 ³⁷	FRM	G80	GG-5 L	KRA
G6526	GG-164	SECU	G657	G-152	GUD	G7019	GG-7018 ³⁸	PROG	G800	GG-47	AIRT
G6526	GG-164	WARN	G6570	GG-196	FRM	G7019	GG-7019 ³⁷	PROG	G800	GG-47	BWS
G6530	GG-267	AIRT	G6570DP	GG-196	FRM	G7019	GG-7020 ¹⁴⁴	PROG	G800	GG-47	CENE
G6530	GG-267	CENE	G6573	GG-185	FRM	G706	G-870	COO	G800	GG-47	CHP
G6530	GG-267	CHP	G6573DP	GG-185	FRM	G7072	GG-227	FRM	G800	GG-47	CIGO
G6530	GG-267	GRAN	G6579	GG-102	AIRT	G7092	GG-30	FRM	G800	GG-70	COO
G6530	GG-267	LUF	G6579	GG-102	CHP	G7092DP	GG-30	FRM	G800	GG-47	GRAN
G6530	GG-267	PARP	G6579	GG-102	LUF	G7099	GG-82	FRM	G800	G-870	GUD
G6530	GG-267	WARN	G6579	GG-102	WARN	G71	GG-17	KRA	G800	GG-47	LUF
G6531	GG-265	AIRT	G6580	GG-351	AIRT	G-71	GP-3	ATL	G800	GG-47	PARP
G6531	GG-265	CENE	G6580	GG-351	CHP	G7143	GG-64	FRM	G800	GG-47	TRUS
G6531	GG-265	CHP	G6580	GG-351	CIGO	G7144	GG-1	FRM	G800	GG-47	WARN
G6531	GG-265	GRAN	G6580	GG-351	LUF	G7144	GG-4	FRM	G80008	GP-81	GRAY
G6531	GG-265	LUF	G6580	GG-351	MIGH	G7146	GG-150	FRM	G8008	GG-146	FRM
G6531	GG-265	MASE	G6580	GG-351	WARN	G7194	GG-185	FRM	G-801	G-801	GONH
G6531	GG-265	PARP	G6591	GG-206	CHAM	G72	GG-203	KRA	G8018	GG-986	FRM
G6531	GG-265	SECU	G6591	GG-206	LUF	G-72	GP-205	ATL	G80-2821	GA-6128	GAR
G6531	GG-265	WARN	G6591	GG-206	PARP	G-72	G-72	GONH	G803	GG-208	AIRT
G6532	GG-104	AIRT	G6591	GG-206	WARN	G7248	GG-72	FRM	G803	GG-208	CENE
G6532	GG-104	CENE	G6593	GG-986	CHP	G7248	GG-72	PROG	G803	GG-208	CHP
G6532	GG-104	CHP	G6593	GG-986	CIGO	G7248DP	GG-72	FRM	G803	GG-208	GRAN
G6532	GG-104	GRAN	G6593	GG-986	LUF	G7295	GG-214	FRM	G803	G-330	GUD
G6532	GG-104	LUF	G6593	GG-986	PARP	G73	GG-203	KRA	G803	GG-208	LUF
G6532	GG-104	PARP	G6593	GG-986	WARN	G-73	GP-44	ATL	G803	GG-208	MIGH
G6532	GG-104	WARN	G6595	GG-187	CAMP	G7315	GG-66	FRM	G803	GG-208	PARP
G6534	GG-190	FRM	G6595	GG-187	PARP	G7315DP	GG-66	FRM	G803	GG-208	TRUS
G6534	GG-190	PROG	G6595	GG-187	SECU	G7332	GG-7020 ¹⁴⁴	FRM	G803	GG-208	WARN
G6534DP	GG-190	FRM	G6595	GG-187	WARN	G7333	GG-581	FRM	G80-3915	GA-106 ⁴⁶	GAR
G6535	GG-185	AIRT	G6597	GG-580	CHP	G7333DP	GG-580	FRM	G80-3915	GA-326 ⁷¹	GAR
G6535	GG-185	CENE	G6597	GG-290	PARP	G7355	GG-185	FRM	G8073	GG-95	FRM
G6535	GG-185	CHP	G6597	GG-290	WARN	G7356	GG-232	FRM	G8075	GG-164	FRM
G6535	GG-181	FRM	G6598	GG-182	LUF	G7370	GG-72	FRM	G8078	GG-351	FRM
G6535	GG-185	GRAN	G66	G-871	GUD	G73833	GG-20	GRAY	G80952	GG-20	GRAY
G6535	GG-185	LUF	G6613	GG-580	FRM	G7393	GG-255	FRM	G80R	GG-5 L	KRA
G6535	GG-185	WARN	G6613DP	GG-580	FRM	G7396	GG-136	FRM	G81	GG-1	KRA
G6535DP	GG-181	FRM	G6626	GG-307	CHP	G7398	GG-249	FRM	G81	GG-4	KRA
G6536	GG-181	AIRT	G6626	GG-307	CIGO	G7399	GG-99	FRM	G-81	GP-408	ATL
G6536	GG-181	CENE	G6626	GG-307	LUF	G7399DP	GG-243	FRM	G813	G-225	COO
G6536	GG-181	CHP	G6626	GG-307	WARN	G-74	GP-3429	ATL	G813	G-225	GUD
G6536	GG-142	FRM	G6636	GG-206	CAMP	G7404	GG-94	FRM	G-813	G-813	GONH
G6536	GG-181	LUF	G6636	GG-206	LUF	G7416	GG-84	FRM	G814	G-1143	GUD

REFERENCIA CRUZADA

Numero	Gonher	Fabricante	Numero	Gonher	Fabricante	Numero	Gonher	Fabricante	Numero	Gonher	Fabricante
Number	Gonher	Manufacturer	Number	Gonher	Manufacturer	Number	Gonher	Manufacturer	Number	Gonher	Manufacturer
G8154	GG-420	LUF	G-975	G-975	GONH	GA-171	GA-171	GONH	GA25042	GA-442	MICG
G-8158 USA	G-112	GUSA	G976	G-162H	GUD	GA-172	GA-172	GONH	GA25043	GA-442	MICG
G-816	G-816	GONH	G980	G-133	GUD	GA-174	GA-174	GONH	GA25049	GA-595	MICG
G8164	GG-185	FRM	G980	G-989	GUD	GA-175	GA-175	GONH	GA25076	GA-476	MICG
G817	G-1123	GUD	G-984	G-984	GONH	GA-175A USA	GA-1617	GUSA	GA25089	GA-301	MICG
G8174	GG-5 L	FRM	G-989	G-989	GONH	GA-176	GA-176	GONH	GA-251	GA-251	GONH
G8190	GG-95	FRM	G99	GG-123	KRA	GA-179	GA-179	GONH	GA25148	GA-384	MICG
G82	G-1173	GUD	G995A	G-143	GUD	GA-18	GA-18	GONH	GA253	GAK-16	GUIO
G82	GG-5 L	KRA	G996	G-163	GUD	GA-180	GA-180	GONH	GA-253	GA-253	GONH
G-82	G-49	ATL	G9960	GG-419	FRM	GA-183	GA-183	GONH	GA25301	GA-479	MICG
G-820 USA	G-870	GUSA	G9961	GG-369	FRM	GA-183R	GA-183R	GONH	GA25306	GA-278R	MICG
G8219	GG-266	FRM	G998	G-296	GUD	GA-184	GA-184	GONH	GA254	GAK-20	GUIO
G823	G-5000	COO	G998	G-296-B	GUD	GA-184 USA	GA-77	GUSA	GA25418	GA-395	MICG
G823	G-5000	GUD	GA 590	GA-2160	GIFF	GA-186	GA-186	GONH	GA25446	GA-780	MICG
G82R	GG-5 L	KRA	GA 671	GA-410	GIFF	GA-189 USA	GA-50	GUSA	GA25463	GA-263	MICG
G-83	GG-45	ATL	GA-100	GA-100	GONH	GA-192	GA-192	GONH	GA255	GA-24	GUIO
G-833	G-833	GONH	GA-10071 USA	GA-1571	GUSA	GA-192 USA	GA-192	GUSA	GA256	GA-33	GUIO
G-834	G-834	GONH	GA-1008	GA-1008	GONH	GA-193	GA-193	GONH	GA258	GAK-403	GUIO
G-834 USA	G-834	GUSA	GA-101	GA-101	GONH	GA-194	GA-194	GONH	GA-258	GA-258	GONH
G-836	G-836	GONH	GA-10173 USA	GA-1540	GUSA	GA-195	GA-195	GONH	GA-259	GA-259	GONH
G837	GG-42	COO	GA-10191 USA	GA-149	GUSA	GA-196	GA-196	GONH	GA-26	GA-26	GONH
G837	G-801	GUD	GA-10192 USA	GA-492	GUSA	GA-197R	GA-197R	GONH	GA26067	GA-1614	MICG
G839	G-801	COO	GA-10228 USA	GA-143	GUSA	GA-198	GA-198	GONH	GA-263	GA-263	GONH
G839	G-801	GUD	GA-10242 USA	GA-1542	GUSA	GA-20	GA-20	GONH	GA-264	GA-264	GONH
G84	GG-19	KRA	GA-10256 USA	GA-437	GUSA	GA-200	GA-200	GONH	GA-265	GA-265	GONH
G840	GG-42	AIRT	GA-10262 USA	GA-437	GUSA	GA-206	GA-206	GONH	GA2663	GA-200	GUIO
G840	GG-42	CENE	GA-10346 USA	GA-1529	GUSA	GA-209	GA-209	GONH	GA2663	GP-58	GUIO
G840	GG-42	CHP	GA-105	GA-105	GONH	GA-21	GA-21	GONH	GA2676	GAD-3	GUIO
G840	GG-42	GRAN	GA-106	GA-106	GONH	GA-210	GA-210	GONH	GA-269	GA-269	GONH
G840	GG-42	LUF	GA-107	GA-107	GONH	GA-2104	GA-2104	GONH	GA-27	GA-27	GONH
G840	GG-42	MIGH	GA-108	GA-108	GONH	GA-2105	GA-2105	GONH	GA-271	GA-271	GONH
G840	GG-42	PARP	GA1087	GA-436	GUIO	GA-2106	GA-2106	GONH	GA-27161	GA-27161	GONH
G840	GG-42	TRUS	GA1088	GA-49	GUIO	GA-2109	GA-2109	GONH	GA-27198	GA-27198	GONH
G840	GG-42	WARN	GA-109	GA-109	GONH	GA-2110	GA-2110	GONH	GA-27198 USA	GA-27198	GUSA
G841	G-566	COO	GA-1095	GA-1095	GONH	GA-2114	GA-2114	GONH	GA-272	GA-272	GONH
G841	G-566	GUD	GA-11	GA-11	GONH	GA-2118	GA-2118	GONH	GA-273	GA-273	GONH
G842	G-613	COO	GA-110	GA-110	GONH	GA-2121	GA-2121	GONH	GA-274	GA-274	GONH
G842	G-613	GUD	GA-113	GA-113	GONH	GA-2122	GA-2122	GONH	GA-2740	GA-2740	GONH
G-8481 USA	G-180	GUSA	GA-114	GA-114	GONH	GA-2123	GA-2123	GONH	GA-2740 USA	GA-2740	GUSA
G85105	GP-5	GRAY	GA1180	GA-206	GUIO	GA-2124	GA-2124	GONH	GA-275	GA-275	GONH
G855	G-34	COO	GA1181	GA-361	GUIO	GA-2130	GA-2130	GONH	GA-276	GA-276	GONH
G855	G-34	GUD	GA-119	GA-119	GONH	GA-2135	GA-2135	GONH	GA-277	GA-277	GONH
G857	G-34	GUD	GA1198	GAD-1	GUIO	GA-2136	GA-2136	GONH	GA-278R	GA-278R	GONH
G-862	G-862	GONH	GA-12	GA-12	GONH	GA-2141	GA-2141	GONH	GA-279	GA-279	GONH
G-870	G-870	GONH	GA-1203	GA-1203	GONH	GA-2146	GA-2146	GONH	GA-280	GA-280	GONH
G-871	G-871	GONH	GA-127	GA-127	GONH	GA-2147	GA-2147	GONH	GA-2803T	GA-2803T	GONH
G-8712 USA	G-72	GUSA	GA-128	GA-128	GONH	GA-215	GA-215	GONH	GA-2804 T	GA-2804 T	GONH
G8757	GG-210	FRM	GA-1284	GA-1284	GONH	GA-2156	GA-2156	GONH	GA-281	GA-281	GONH
G8758	GG-47	FRM	GA-1285	GA-1285	GONH	GA-2158	GA-2158	GONH	GA-283	GA-283	GONH
G-8765 USA	G-765	GUSA	GA-1286	GA-1286	GONH	GA-2159	GA-2159	GONH	GA-284	GA-284	GONH
G88	GG-1	KRA	GA-1287	GA-1287	GONH	GA-216	GA-216	GONH	GA-285	GA-285	GONH
G88	GG-4	KRA	GA-129	GA-129	GONH	GA-2160	GA-2160	GONH	GA-286	GA-286	GONH
G-8806 USA	G-45	GUSA	GA-130	GA-130	GONH	GA-2161	GA-2161	GONH	GA-287	GA-287	GONH
G8836	GG-299	LUF	GA-132	GA-132	GONH	GA-2164	GA-2164	GONH	GA-288R	GA-288R	GONH
G8861A	GG-307	FRM	GA-133	GA-133	GONH	GA-217	GA-217	GONH	GA-289	GA-289	GONH
G887	G-834	COO	GA-133 USA	GA-78	GUSA	GA-2170	GA-2170	GONH	GA-29	GA-29	GONH
G887	G-834	GUD	GA-134	GA-134	GONH	GA-2173	GA-2173	GONH	GA-291	GA-291	GONH
G8897	GG-97	FRM	GA-135	GA-135	GONH	GA-2174	GA-2174	GONH	GA-292	GA-292	GONH
G89	GG-1	KRA	GA-136 USA	GA-55	GUSA	GA-2175	GA-2175	GONH	GA-293	GA-293	GONH
G89	GG-4	KRA	GA-138	GA-138	GONH	GA-2179	GA-2179	GONH	GA-2945 USA	GA-1545	GUSA
G893	G-31	GUD	GA-139	GA-139	GONH	GA-218	GA-218	GONH	GA-2984	GA-2984	GONH
G8967	GG-187	FRM	GA-140	GA-140	GONH	GA-2181	GA-2181	GONH	GA-299	GA-299	GONH
G9	GG-16	SUN	GA-141	GA-141	GONH	GA-2182	GA-2182	GONH	GA-300	GA-300	GONH
G-9018 USA	G-49	GUSA	GA-142	GA-142	GONH	GA-2184	GA-2184	GONH	GA30057	GA-80	MICG
G91	GG-5 L	KRA	GA-143	GA-143	GONH	GA-219	GA-219	GONH	GA-301	GA-301	GONH
G-910	G-910	GONH	GA-145	GA-145	GONH	GA-2192	GA-2192	GONH	GA-302	GA-302	GONH
G-911	G-911	GONH	GA-146 USA	GA-71	GUSA	GA-2193	GA-2193	GONH	GA-303	GA-303	GONH
G912	G-297	COO	GA14650	GA-604	MICG	GA-2194	GA-2194	GONH	GA-303 USA	GA-303	GUSA
G912	G-297-B	COO	GA14656	GA-7017	MICG	GA-2195	GA-2195	GONH	GA-304	GA-304	GONH
G912	G-297	GUD	GA-148 USA	GA-80	GUSA	GA-2198	GA-2198	GONH	GA-305	GA-305	GONH
G912	G-297-B	GUD	GA-149	GA-149	GONH	GA-221R	GA-221R	GONH	GA-305 USA	GA-730	GUSA
G-912	G-912	GONH	GA-1529	GA-1529	GONH	GA-224	GA-224	GONH	GA-3095R	GA-3095R	GONH
G-918	G-918	GONH	GA-153	GA-153	GONH	GA229	GA-18	GUIO	GA-3096R	GA-3096R	GONH
G92	GG-6	KRA	GA-1530	GA-1530	GONH	GA-229	GA-229	GONH	GA-31	GA-31	GONH
G-926	G-926	GONH	GA-154	GA-154	GONH	GA-230	GA-230	GONH	GA-314	GA-314	GONH
G927	GG-48	GUD	GA-1540	GA-1540	GONH	GA-231	GA-231	GONH	GA-319	GA-319	GONH
G9272	GG-265 ³⁶	FRM	GA-1542	GA-1542	GONH	GA-234	GA-234	GONH	GA-320	GA-320	GONH
G9279	GG-7018 ³⁸	FRM	GA-1545	GA-1545	GONH	GA23436	GA-4365	MICG	GA32157	G-1174 ⁹⁸	HYST
G9279	GG-7019 ³⁷	FRM	GA-1546	GA-1546	GONH	GA-239	GA-239	GONH	GA32157	G-1174 ⁹⁸	INGR
G9279	GG-7020 ¹⁴	FRM	GA-155	GA-155	GONH	GA-24	GA-24	GONH	GA-322	GA-322	GONH
G93	GG-7	KRA	GA-1571	GA-1571	GONH	GA-240	GA-240	GONH	GA-323	GA-323	GONH
G-932	G-932	GONH	GA-1572	GA-1572	GONH	GA-241	GA-241	GONH	GA-324	GA-324	GONH
G9343	GG-308	FRM	GA-158	GA-158	GONH	GA24375	GA-362	MICG	GA-3245 USA	GAD-30	GUSA
G9344	GG-209	FRM	GA-16	GA-16	GONH	GA-244	GA-244	GONH	GA-324A USA	GA-85	GUSA
G94	GG-20	KRA	GA-160 USA	GA-70	GUSA	GA24468	GA-195	MICG	GA-325	GA-325	GONH
G941F	GPP-111	AIRT	GA-1614	GA-1614	GONH	GA24471	GA-471	MICG	GA-325 USA	GA-325	GUSA
G941F	GPP-524	AIRT	GA-1615	GA-1615	GONH	GA24645	GA-6690	MICG	GA-326	GA-326	GONH
G9437100139	G-33	COLS	GA-1616	GA-1616	GONH	GA24680	GA-386	MICG	GA-326 USA	GA-59	GUSA
G94A	GG-20	KRA	GA-1617	GA-1617	GONH	GA24690	GA-322	MICG	GA-327 USA	GA-57	GUSA
G952	G-331	GUD	GA-162 EXP	GA-162 EXP	GONH	GA24722	GA-5466	MICG	GA-328	GA-328	GONH
G-954	G-954	GONH	GA-163	GA-163	GONH	GA24731	GA-165	MICG	GA-329	GA-329	GONH
G9604	GG-283	FRM	GA-164	GA-164	GONH	GA-248	GA-248	GONH	GA-33	GA-33	GONH
G9611	GG-915	FRM	GA-165	GA-165	GONH	GA24831	GAD-118	MICG	GA-3300	GA-3300	GONH
G-963	G-963	GONH	GA-166	GA-166	GONH	GA24873	GA-514	MICG	GA-3300 USA	GA-3300	GUSA
G-971	G-971	GONH	GA-168	GA-168	GONH	GA-249	GA-249	GONH	GA-334	GA-334	GONH
G9729	GG-355	FRM	GA-170	GA-170	GONH	GA-250	GA-250	GONH	GA3373	GA-250	GUIO

Referencia Cruzada por Numero de Parte

Cross Reference by Part Number



Numero	Gonher	Fabricante	Numero	Gonher	Fabricante	Numero	Gonher	Fabricante	Numero	Gonher	Fabricante
Number	Gonher	Manufacturer	Number	Gonher	Manufacturer	Number	Gonher	Manufacturer	Number	Gonher	Manufacturer
GA-3373 USA		GAVW-2 GUSA	GA-3902 USA		GA-253 GUSA	GA-517R		GA-517R GONH	GA-7344 USA		GA-7344 GUSA
GA-340		GA-340 GONH	GA-391		GA-391 GONH	GA-518R		GA-518R GONH	GA-735		GA-735 GONH
GA-340A USA		GA-86 GUSA	GA-3914 USA		GA-392 GUSA	GA523		GA-360 GUIO	GA-7351 USA		GA-322 GUSA
GA-341		GA-341 GONH	GA-3915		GA-3915 GONH	GA-529		GA-529 GONH	GA-7360		GA-7360 GONH
GA-3424		GA-3424 GONH	GA-3915 USA		GA-3915 GUSA	GA52923		GA-3501 MICG	GA-7365 USA		GA-217 GUSA
GA-3424 USA		GA-3424 GUSA	GA-3916		GA-3916 GONH	GA-534R		GA-534R GONH	GA-74		GA-74 GONH
GA-3425		GA-3425 GONH	GA-3916 USA		GA-3916 GUSA	GA-539R		GA-539R GONH	GA-7414 USA		GA-141 GUSA
GA-3425 USA		GA-3425 GUSA	GA-392		GA-392 GONH	GA-54		GA-54 GONH	GA-7420 USA		GA-514 GUSA
GA34356		GA-390 MICG	GA-3924 USA		GA-153 GUSA	GA-5466		GA-5466 GONH	GA-7421 USA		GA-165 GUSA
GA34361		GA-139 MICG	GA-3933 USA		GAVW-616 GUSA	GA-5466 USA		GA-5466 GUSA	GA-7426 USA		GA-432 GUSA
GA-3445		GA-3445 GONH	GA-3936 USA		GAVW-618 GUSA	GA-5496 USA		GA-134 GUSA	GA-7431 USA		GAVW-121 GUSA
GA-3445 USA		GA-3445 GUSA	GA-395		GA-395 GONH	GA-55		GA-55 GONH	GA-7432 USA		GA-132 GUSA
GA34487		GA-382 MICG	GA-397		GA-397 GONH	GA55378		GA-240 MICG	GA-7438 USA		GA-442 GUSA
GA34613		GA-142 MICG	GA-398		GA-398 GONH	GA55521		GA-510 MICG	GA-7440 USA		GA-300 GUSA
GA34625		GA-2106 MICG	GA-3997 USA		GA-1546 GUSA	GA-5595 USA		GA-595 GUSA	GA-75		GA-75 GONH
GA34715		GA-7142 MICG	GA-403		GA-403 GONH	GA-56		GA-56 GONH	GA-758		GA-758 GONH
GA34799		GA-381 MICG	GA-4030 USA		GA-1530 GUSA	GA-563		GA-563 GONH	GA-759		GA-759 GONH
GA-348		GA-348 GONH	GA-404		GA-404 GONH	GA-5648		GA-5648 GONH	GA-7597 USA		GA-164 GUSA
GA-349		GA-349 GONH	GA-405		GA-405 GONH	GA-57		GA-57 GONH	GA-7614 USA		GAVW-620 GUSA
GA-3490		GA-3490 GONH	GA-410		GA-410 GONH	GA-5876		GA-5876 GONH	GA-7620 USA		GA-438 GUSA
GA-3490 USA		GA-3490 GUSA	GA-412R		GA-412R GONH	GA-588		GA-588 GONH	GA-7626 USA		GA-6 GUSA
GA-35		GA-35 GONH	GA-413R		GA-413R GONH	GA-589		GA-589 GONH	GA-7628 USA		GAD-118 GUSA
GA-3501		GA-3501 GONH	GA-414R		GA-414R GONH	GA-59		GA-59 GONH	GA-7640 USA		GA-240 GUSA
GA-3501 USA		GA-3501 GUSA	GA-415		GA-415 GONH	GA-595		GA-595 GONH	GA-7669 USA		GA-434 GUSA
GA-351 USA		GA-75 GUSA	GA-416		GA-416 GONH	GA-596		GA-596 GONH	GA-768R		GA-768R GONH
GA-352 USA		GAD-1 GUSA	GA-42		GA-42 GONH	GA-597		GA-597 GONH	GA-77		GA-77 GONH
GA35207		GA-217 MICG	GA-422		GA-422 GONH	GA-6		GA-6 GONH	GA-770R		GA-770R GONH
GA35227		GA-279 MICG	GA-425		GA-425 GONH	GA60074		GA-55 MICG	GA-7716		GA-7716 GONH
GA-3523		GA-3523 GONH	GA-426		GA-426 GONH	GA-600R		GA-600R GONH	GA-7730 USA		GA-175 GUSA
GA-3523 USA		GA-3523 GUSA	GA-429		GA-429 GONH	GA603015		GP-58 AVEL	GA-7737 USA		GA-128 GUSA
GA35244		GA-607 MICG	GA-4303		GA-4303 GONH	GA603016		GG-48 AVEL	GA-7738 USA		GA-127 GUSA
GA-353 USA		GAD-3 GUSA	GA-4303 USA		GA-4303 GUSA	GA-604		GA-604 GONH	GA-7764 USA		GA-172 GUSA
GA35305		GA-286 MICG	GA-4309 USA		GAD-15 GUSA	GA-605		GA-605 GONH	GA-7774 USA		GA-1616 GUSA
GA35323		GA-224 MICG	GA-4319		GA-4319 GONH	GA-606		GA-606 GONH	GA-78		GA-78 GONH
GA35330		GA-6479 ³⁰ MICG	GA-432		GA-432 GONH	GA-607		GA-607 GONH	GA-780		GA-780 GONH
GA-3536		GA-3536 GONH	GA-4325		GA-4325 GONH	GA-608		GA-608 GONH	GA-781		GA-781 GONH
GA-3536 USA		GA-3536 GUSA	GA-4325 USA		GA-4325 GUSA	GA-6127		GA-6127 GONH	GA-782		GA-782 GONH
GA-3537 USA		GA-54 GUSA	GA-433		GA-433 GONH	GA-6128		GA-6128 GONH	GA-798R		GA-798R GONH
GA35396		GA-248 MICG	GA-434		GA-434 GONH	GA-6129		GA-6129 GONH	GA-799R		GA-799R GONH
GA35414		GA-477 MICG	GA-435R		GA-435R GONH	GA-616		GA-616 GONH	GA-8		GA-8 GONH
GA35432		GA-264 MICG	GA-436		GA-436 GONH	GA-624R		GA-624R GLOB	GA-80		GA-80 GONH
GA35433		GA-414R MICG	GA-4365		GA-4365 GONH	GA-624R		GA-624R GONH	GA-8004 USA		GA-1615 GUSA
GA-3549 USA		GA-89 GUSA	GA-437		GA-437 GONH	GA-6305 USA		GA-390 GUSA	GA-801R		GA-801R GONH
GA-3551		GA-3551 GONH	GA-438		GA-438 GONH	GA-6333 USA		GA-382 GUSA	GA-802R		GA-802R GONH
GA-3551 XT		GA-3551 XT GONH	GA-4383 USA		GA-471 GUSA	GA-633R		GA-633R GONH	GA-8037 USA		GA-732R GUSA
GA35556		GA-415 MICG	GA-44		GA-44 GONH	GA-6362 USA		GA-362 GUSA	GA-8038 USA		GA-673R GUSA
GA35560		GA-289 MICG	GA-442		GA-442 GONH	GA-6366 USA		GA-174 GUSA	GA-803R		GA-803R GONH
GA35578		GA-380 MICG	GA44626		GA-6619 ¹ MICG	GA-6376 USA		GA-142 GUSA	GA-8040 USA		GA-384 GUSA
GA-3559 USA		GA-271 GUSA	GA44626		GA-6620 ¹ MICG	GA-6395 USA		GA-195 GUSA	GA-8047		GA-8047 GONH
GA-356		GA-356 GONH	GA-448		GA-448 GONH	GA-642		GA-642 GONH	GA-804R		GA-804R GONH
GA35633		GA-150 MICG	GA45091		GA-732R MICG	GA-646		GA-646 GONH	GA-8060 USA		GA-49 GUSA
GA-3566		GA-3566 GONH	GA45314		GA-348 MICG	GA-6479		GA-6479 GONH	GA-8067 USA		GA-198 GUSA
GA-3566 USA		GA-3566 GUSA	GA45780		GA-341 MCG	GA-6479 USA		GA-6479 GUSA	GA-8069 USA		GA-244 GUSA
GA-357		GA-357 GONH	GA-459		GA-459 GONH	GA-6545 USA		GAVW-120 GUSA	GA-808R		GA-808R GONH
GA-3588		GA-3588 GONH	GA-464		GA-464 GONH	GA-6555 USA		GA-275 GUSA	GA-809R		GA-809R GONH
GA-3588 USA		GA-3588 GUSA	GA-465R		GA-465R GONH	GA-6576 USA		GA-276 GUSA	GA-8133 USA		GA-163 GUSA
GA-3597 USA		GA-734 GUSA	GA-467		GA-467 GONH	GA-6591 USA		GA-176 GUSA	GA-8141 USA		GA-1614 GUSA
GA-3597A USA		GA-735 GUSA	GA-471		GA-471 GONH	GA660		GA-230 GUIO	GA-8142 USA		GA-130 GUSA
GA-360		GA-360 GONH	GA-472		GA-472 GONH	GA-6619		GA-6619 GONH	GA-8150		GA-8150 GONH
GA-361		GA-361 GONH	GA-475		GA-475 GONH	GA-6619 USA		GA-6619 ¹ GUSA	GA-8205 USA		GA-301 GUSA
GA-362		GA-362 GONH	GA-476		GA-476 GONH	GA-6619 USA		GA-6620 ¹ GUSA	GA-8221 USA		GA-279 GUSA
GA-3621 USA		GA-140 GUSA	GA-477		GA-477 GONH	GA-6620		GA-6620 GONH	GA-8225 USA		GA-145 GUSA
GA-363		GA-363 GONH	GA-479		GA-479 GONH	GA-6664 USA		GA-166 GUSA	GA-8243 USA		GA-158 GUSA
GA-3637		GA-3637 GONH	GA-482		GA-482 GONH	GA-6690		GA-6690 GONH	GA-826		GA-826 GONH
GA-364		GA-364 GONH	GA-4828		GA-4828 GONH	GA-6690 USA		GA-6690 GUSA	GA-827		GA-827 GONH
GA-3647		GA-3647 GONH	GA-4828 USA		GA-4828 GUSA	GA-673R		GA-673R GONH	GA-8475 USA		GA-170 GUSA
GA-3647 USA		GA-3647 GUSA	GA-483		GA-483 GONH	GA-679		GA-679 GONH	GA-85		GA-85 GONH
GA-3660 USA		GA-277 GUSA	GA-4830 USA		GA-180 GUSA	GA-680		GA-680 GONH	GA-853R		GA-853R GONH
GA-367		GA-367 GONH	GA-486		GA-486 GONH	GA-6807 USA		GA-386 GUSA	GA-8548 USA		GA-304 GUSA
GA-3681		GA-3681 GONH	GA-4862R		GA-4862R GONH	GA-6828 USA		GA-133 GUSA	GA-8558 USA		GA-433 GUSA
GA-3681 USA		GA-3681 GUSA	GA-4863		GA-4863 GONH	GA-682R		GA-682R GONH	GA-86		GA-86 GONH
GA-37		GA-37 GONH	GA-488		GA-488 GONH	GA-683R		GA-683R GONH	GA-8602 USA		GAVW-621 GUSA
GA-371		GA-371 GONH	GA-489		GA-489 GONH	GA-6850 USA		GAD-294 GUSA	GA-8606		GA-8606 GONH
GA-3717 USA		GA-274 GUSA	GA-49		GA-49 GONH	GA-6880		GA-6880 GONH	GA-8606 USA		GA-8606 GUSA
GA-372		GA-372 GONH	GA-490		GA-490 GONH	GA-694		GA-694 GONH	GA-864R		GA-864R GONH
GA-373		GA-373 GONH	GA-491		GA-491 GONH	GA-697R		GA-697R GONH	GA-8747 USA		GA-258 GUSA
GA-375		GA-375 GONH	GA-492		GA-492 GONH	GA-7		GA-7 GONH	GA-8756 USA		GA-348 GUSA
GA-376		GA-376 GONH	GA-4924 USA		GAD-117 GUSA	GA-70		GA-70 GONH	GA-8766 USA		GA-491 GUSA
GA-377		GA-377 GONH	GA-493		GA-493 GONH	GA-7007		GA-7007 GONH	GA-879		GA-879 GONH
GA-378		GA-378 GONH	GA-4939 USA		GA-139 GUSA	GA-701		GA-701 GONH	GA-8805 USA		GA-278R GUSA
GA-380		GA-380 GONH	GA-4958		GA-4958 GONH	GA-7017		GA-7017 GONH	GA-880R		GA-880R GONH
GA-381		GA-381 GONH	GA-4958 USA		GA-4958 GUSA	GA-7017 USA		GA-7017 GUSA	GA-885		GA-885 GONH
GA-381 USA		GA-74 GUSA	GA-498		GA-498 GONH	GA-702		GA-702 GONH	GA-888R		GA-888R GONH
GA-3814		GA-3814 GONH	GA-4999		GA-4999 GONH	GA-7033 USA		GA-241 GUSA	GA-89		GA-89 GONH
GA-3814 USA		GA-3814 GUSA	GA-499R		GA-499R GONH	GA-7094 USA		GA-604 GUSA	GA-890R		GA-890R GONH
GA-382		GA-382 GONH	GA-50		GA-50 GONH	GA-71		GA-71 GONH	GA-891		GA-891 GONH
GA-383		GA-383 GONH	GA-5056		GA-5056 GONH	GA-712R		GA-712R GONH	GA-8911 USA		GA-194 GUSA
GA-384		GA-384 GONH	GA-5056 USA		GA-5056 GUSA	GA-7142		GA-7142 GONH	GA-8918 USA		GA-286 GUSA
GA-386		GA-386 GONH	GA-5057		GA-5057 GONH	GA-7142 USA		GA-7142 GUSA	GA-892		GA-892 GONH
GA-388		GA-388 GONH	GA-5058 USA		GA-273 GUSA	GA-7174 USA		GA-381 GUSA	GA-8925 USA		GA-780 GUSA
GA-389		GA-389 GONH	GA507		GA-106 ⁴⁶ GUIO	GA-723R		GA-723R GONH	GA-8969 USA		GA-168 GUSA
GA-3896 USA		GAVW-619 GUSA	GA507		GA-326 ⁷¹ GUIO	GA-73		GA-73 GONH	GA-8970 USA		GA-216 GUSA
GA-39		GA-39 GONH	GA-509		GA-509 GONH	GA-730		GA-730 GONH	GA-8977 USA		GA-224 GUSA
GA-390		GA-390 GONH	GA-510		GA-510 GONH	GA-732R		GA-732R GONH	GA-90		GA-90 GONH
GA-3901		GA-3901 GONH	GA-514		GA-514 GONH	GA-734		GA-734 GONH	GA-9045		GA-9045 GONH
GA-3901 USA		GA-3901 GUSA	GA-516R		GA-516R GONH	GA-7344		GA-7344 GONH	GA-904R		GA-904R GONH

Para números Gonher con Superíndice vea página 651
For Gonher with Superscript numbers see page 651

Visite nuestro sitio en internet www.grupogonher.com
Visit our web site www.grupogonher.com

REFERENCIA CRUZADA

Numero	Gonher	Fabricante	Numero	Gonher	Fabricante	Numero	Gonher	Fabricante	Numero	Gonher	Fabricante
Number	Gonher	Manufacturer	Number	Gonher	Manufacturer	Number	Gonher	Manufacturer	Number	Gonher	Manufacturer
GA-9054 USA	GA-248	GUSA	GC-127A	GA-127	GC	GC-3388G	GG-16	GC	GCE10	GP-34	ZING
GA-905R	GA-905R	GONH	GC-128	GP-128	GC	GC-3389G	GG-17	GC	GCE25	GP-34	ZING
GA-906R	GA-906R	GONH	GC-128A	GA-128	GC	GC-340A	GA-86	GC	GCG-112	G-112	GC
GA-9073 USA	GA-305	GUSA	GC-129A	GA-129	GC	GC-3424A	GA-3424	GC	GCG-141	G-141	GC
GA-907R	GA-907R	GONH	GC-13	GP-13	GC	GC-3425A	GA-3425	GC	GCG-45	G-45	GC
GA-908R	GA-908R	GONH	GC-130A	GA-130	GC	GC-3429	GP-3429	GC	GCG-49	G-49	GC
GA-909R	GA-909R	GONH	GC-132A	GA-132	GC	GC-3445A	GA-3445	GC	GCG-70	G-70	GC
GA-930R	GA-930R	GONH	GC-133A	GA-133	GC	GC-347A	GA-429	GC	GCVW-120A	GAVW-120	GC
GA-9332 USA	GA-395	GUSA	GC-134A	GA-134	GC	GC-348A	GA-348	GC	GCVW-121A	GAVW-121	GC
GA-9334	GA-9334	GONH	GC-136A	GA-55	GC	GC-3499G	GG-8	GC	GCVW-1A	GAVW-2	GC
GA-9345 USA	GA-414R	GUSA	GC-137G	GG-137	GC	GC-3499G L	GG-8 L	GC	GCVW-212A	GAVW-212	GC
GA-9360 USA	GA-264	GUSA	GC-139	GP-149	GC	GC-3501A	GA-3501	GC	GCVW-2662A	GAVW-22	GC
GA-9401 USA	GA-490	GUSA	GC-139A	GA-139	GC	GC-351A	GA-75	GC	GCVW-3A	GAVW-4	GC
GA-9601 USA	GA-284	GUSA	GC-141A	GA-141	GC	GC-3523A	GA-3523	GC	GCVW-4A	GAVW-10	GC
GA-9646 USA	GA-646	GUSA	GC-146A	GA-71	GC	GC-3525A	GA-734	GC	GCVW-620A	GAVW-620	GC
GA-966R	GA-966R	GONH	GC-148A	GA-80	GC	GC-3531	GP-3531 EXP	GC	GCVW-621A	GAVW-621	GC
GA-967R	GA-967R	GONH	GC-156	GP-156	GC	GC-3535	GP-48	GC	GCVW-623A	GAVW-623	GC
GA-968R	GA-968R	GONH	GC-158A	GA-158	GC	GC-3537A	GA-54	GC	GCVW-624A	GAVW-624	GC
GA-98	GA-98	GONH	GC-160A	GA-70	GC	GC-3538A	GA-154	GC	GCVW-625A	GAVW-625	GC
GA-9875 USA	GA-486	GUSA	GC-1615A	GA-1615	GC	GC-3549A	GA-89	GC	GCVW-626A	GAVW-626	GC
GAC-1	GA-414R	GONH	GC-1616A	GA-1616	GC	GC-3566A	GA-3566	GC	GDH621001	GA-33	AVEL
GAC-10	GAC-10 ²⁸	GONH	GC-1617A	GA-1617	GC	GC-3597A	GA-735	GC	GE119	G-119	GUIO
GAC-10	GAC-8	GONH	GC-163A	GA-163	GC	GC-35A	GA-3588	GC	GE1400	G-5000	GUIO
GAC-11	GAC-11	GONH	GC-164A	GA-164	GC	GC-3600	GP-3600	GC	GE1656	G-222	GUIO
GAC-12	GAC-12	GONH	GC-165A	GA-165	GC	GC-3614	GP-58	GC	GE175	G-750	GUIO
GAC-13	GAC-13	GONH	GC-168A	GA-168	GC	GC-362A	GA-362	GC	GE191	G-191	GUIO
GAC-2	GAC-2	GONH	GC-170A	GA-73	GC	GC-3637A	GA-3637	GC	GE211	G-566	GUIO
GAC-3	GAC-3	GONH	GC-170G	GG-170	GC	GC-3647A	GA-3647	GC	GE238	G-238	GUIO
GAC-4	GAC-4	GONH	GC-172A	GA-172	GC	GC-3660A	GA-277	GC	GE3004	G-31	GUIO
GAC-5	GAC-5	GONH	GC-175A	GA-175	GC	GC-3681A	GA-3681	GC	GE3005	G-31	GUIO
GAC-6	GAC-6	GONH	GC-176A	GA-176	GC	GC-3682	GP-3682	GC	GE3006	G-143	GUIO
GAC-7	GAC-7	GONH	GC-179A	GA-179	GC	GC-3717A	GA-274	GC	GE3300	G-33	GUIO
GAC-8	GAC-10 ²⁸	GONH	GC-183RA	GA-183R	GC	GC-3784A	GA-230	GC	GE335	G-335	GUIO
GAC-8	GAC-8	GONH	GC-184A	GA-77	GC	GC-3802G	GG-47	GC	GE803	G-225	GUIO
GAC-9	GAC-9	GONH	GC1850	G-1121	GUIO	GC-381A	GA-74	GC	GE813	G-813	GUIO
GAD-1	GAD-1	GONH	GC1851	G-1123	GUIO	GC-3901A	GA-3901	GC	GE814	G-870	GUIO
GAD-116	GAD-116	GONH	GC-186A	GA-186	GC	GC-3902A	GA-253	GC	GE815	G-870	GUIO
GAD-117	GAD-117	GONH	GC1870	G-870	GUIO	GC-3916A	GA-3916	GC	GE820	G-870	GUIO
GAD-118	GAD-118	GONH	GC-1872G	GG-1872	GC	GC-391A	GA-391	GC	GE828	G-870	GUIO
GAD-129	GAD-129	GONH	GC-187A	GA-90	GC	GC-3924A	GA-153	GC	GE834	G-834	GUIO
GAD-15	GAD-15	GONH	GC-189A	GA-50	GC	GC-392A	GA-392	GC	GE836	G-836	GUIO
GAD-17	GAD-17	GONH	GC-192A	GA-192	GC	GC-3950	GP-40	GC	GE945	G-801	GUIO
GAD-29	GAD-29	GONH	GC-194A	GA-194	GC	GC-395A	GA-395	GC	GE958	G-834	GUIO
GAD-294	GAD-294	GONH	GC-196A	GA-196	GC	GC-3980	GP-3980	GC	GE123	GP-1	ROVE
GAD-3	GAD-3	GONH	GC-198A	GA-198	GC	GC-406	GP-406	GC	GE123	GP-1	UNP
GAD-30	GAD-30	GONH	GC-1G	GG-1	GC	GC4120	GG-20	GUIO	GEM1	GP-1	AUTG
GAD-315	GAD-315	GONH	GC-205	GP-205	GC	GC-413RA	GA-413R	GC	GEM17	GP-81	AUTG
GAD-34	GAD-34	GONH	GC-20G	GG-20	GC	GC-414R	GA-414R	GC	GEM33	GP-20	AUTG
GAD-36	GAD-36	GONH	GC-2159A	GA-2159	GC	GC-428	GP-428	GC	GEM40	GP-13	AUTG
GAK-1532	GAK-1532	GONH	GC-216A	GA-216	GC	GC-4325A	GA-4325	GC	GEM42	GP-38	AUTG
GAK-16	GAK-16	GONH	GC-217A	GA-217	GC	GC-44	GP-44	GC	GEM49	GP-3	AUTG
GAK-20	GAK-20	GONH	GC-218A	GA-218	GC	GC-442A	GA-442	GC	GEM5	GP-5	AUTG
GAK-216	GAK-216	GONH	GC-219A	GA-219	GC	GC-46G	GG-46	GC	GEM81	GP-81 ¹¹	AUTG
GAK-403	GAK-403	GONH	GC-224A	GA-224	GC	GC-470G	GG-6	GC	GEM81	GP-9 ⁹⁸	AUTG
GAK-458	GAK-458	GONH	GC-22G	GG-19	GC	GC-471G	GG-7	GC	GF01	GG-5 L	CSP
GAK-625	GAK-625	GONH	GC-231A	GA-231	GC	GC-477A	GA-477	GC	GF02	GG-17	CSP
GAP-379	GAP-379	GONH	GC-234A	GA-234	GC	GC-490A	GA-490	GC	GF03	GG-19	CSP
GAP-381	GAP-381	GONH	GC-240A	GA-240	GC	GC-4G	GG-4	GC	GF04	GG-16	CSP
GAT603015	GP-58	AVEL	GC-244A	GA-244	GC	GC-5058A	GA-273	GC	GF05	GG-6	CSP
GAT603016	GG-48	AVEL	GC-248A	GA-248	GC	GC-56A	GA-5056	GC	GF06	GG-45	CSP
GAVW-10	GAVW-10	GONH	GC-25	GP-20	GC	GC-5G	GG-5 L	GC	GF07	GG-7	CSP
GAVW-120	GAVW-120	GONH	GC-251G	GG-251	GC	GC-6344G	GG-39	GC	GF076	GG-79	MIGH
GAVW-121	GAVW-121	GONH	GC-252G	GG-252	GC	GC-6366A	GA-174	GC	GF08	GG-87	CSP
GAVW-2	GAVW-2	GONH	GC-258A	GA-258	GC	GC-63G	GG-63	GC	GF1	GG-5 L	CAR
GAVW-212	GAVW-212	GONH	GC-2663A	GA-200	GC	GC-6479A	GA-6479	GC	GF1	GG-1	HAS
GAVW-22	GAVW-22	GONH	GC-2719BA	GA-2719B	GC	GC-64G	GG-64	GC	GF1	GG-4	HAS
GAVW-4	GAVW-4	GONH	GC-272A	GA-272	GC	GC-6555A	GA-275	GC	GF10	GG-5 L	HAS
GAVW-616	GAVW-616	GONH	GC-2740A	GA-2740	GC	GC-6576A	GA-276	GC	GF100	GG-76	MIGH
GAVW-617	GAVW-617	GONH	GC-278RA	GA-278R	GC	GC-65G	GG-65	GC	GF100	GG-123	WELA
GAVW-618	GAVW-618	GONH	GC-279A	GA-279	GC	GC-6620A	GA-6620	GC	GF1000	GG-146	ATL
GAVW-619	GAVW-619	GONH	GC-280A	GA-280	GC	GC-6690A	GA-6690	GC	GF1000	GG-146	GKIN
GAVW-620	GAVW-620	GONH	GC-281A	GA-281	GC	GC-66G	GG-66	GC	GF1007	G-1121F	FIL
GAVW-621	GAVW-621	GONH	GC-2849	GP-24	GC	GC-68	GP-68	GC	GF101	GG-204	HAS
GAVW-622	GAVW-622	GONH	GC-284A	GA-284	GC	GC-6811	GP-6811	GC	GF101	GG-261	MIGH
GAVW-623	GAVW-623	GONH	GC-288RA	GA-288R	GC	GC-697A	GAD-1	GC	GF101	GG-6	WELA
GAVW-624	GAVW-624	GONH	GC-289A	GA-289	GC	GC-698A	GAD-3	GC	GF102	GG-226	MIGH
GAVW-625	GAVW-625	GONH	GC-291	GP-291	GC	GC-699A	GAD-15	GC	GF102	GG-7	WELA
GAVW-626	GAVW-626	GONH	GC-291A	GA-291	GC	GC-7087A	GA-271	GC	GF103	GG-87	HAS
GAVW-627	GAVW-627	GONH	GC-291G	GG-291	GC	GC-8	GP-1	GC	GF103	GG-246	MIGH
GC-102G	GG-102	GC	GC-298G	GG-298	GC	GC-81	GP-81	GC	GF103	GG-408	MIGH
GC1032	G-297	GUIO	GC-2G	GG-3	GC	GC-9	GP-9	GC	GF103	GG-16	WELA
GC1032	G-297-B	GUIO	GC-30	GP-3	GC	GC-91	GP-91	GC	GF1030	GG-76	GKIN
GC-105A	GA-105	GC	GC-300A	GA-300	GC	GC-927	GP-22	GC	GF1034	GP-1122	GUIO
GC-106G	GG-106	GC	GC-301A	GA-301	GC	GC-92G	GG-1992	GC	GF104	GG-251	MIGH
GC-10G	GG-45	GC	GC-302A	GA-302	GC	GC-94G	GG-94	GC	GF104	GG-17	WELA
GC-11	GP-5	GC	GC-303A	GA-303	GC	GC-966	GG-8	GC	GF105	GG-8	HAS
GC1124	G-1173	GUIO	GC-305A	GA-730	GC	GC-9660	GP-38	GC	GF105	GG-20	WELA
GC1125	G-1173	GUIO	GC-3105A	GA-49	GC	GC-9661	GP-28	GC	GF1050	GG-203	GKIN
GC-1133	G-1133	GONH	GC-314A	GA-314	GC	GC-986G	GG-986	GC	GF106	GG-19	WELA
GC1143	G-1143	GUIO	GC-3245A	GAD-30	GC	GC-99G	GG-99	GC	GF107	GG-240	HAS
GC1163	G-1163	GUIO	GC-324A	GA-85	GC	GCD-117A	GAD-117	GC	GF107	GG-181	MIGH
GC1173	G-1173	GUIO	GC-326A	GA-59	GC	GCD-17A	GAD-17	GC	GF1070	GPP-111	ATL
GC1174	G-1174 ⁰⁸	GUIO	GC-327A	GA-57	GC	GCD-19A	GA-6619	GC	GF1070	GPP-524	ATL
GC1175	G-1175	GUIO	GC-3300A	GA-3300	GC	GCD-294A	GAD-294	GC	GF1070	GPP-111	GKIN
GC1191	G-296	GUIO	GC-334A	GA-334	GC	GCD-29A	GAD-29	GC	GF1070	GPP-524	GKIN
GC1191	G-296-B	GUIO	GC-3387	GP-46	GC	GCD-34A	GAD-34	GC	GF108	GG-214	MIGH

Referencia Cruzada por Numero de Parte

Cross Reference by Part Number



Numero	Gonher	Fabricante	Numero	Gonher	Fabricante	Numero	Gonher	Fabricante	Numero	Gonher	Fabricante
Number	Gonher	Manufacturer	Number	Gonher	Manufacturer	Number	Gonher	Manufacturer	Number	Gonher	Manufacturer
GF11	GG-6	CAC	GF1476	GG-240	GKIN	GF2	GG-5 L	CAC	GF28	GG-7	HAS
GF11	GG-5 L	CAR	GF148	GG-39	HAS	GF2	GG-5 L	CAR	GF282	GPP-1122	PERM
GF11	GG-123	CSP	GF1481	GG-46	GKIN	GF2	GG-5 L	HAS	GF283	GG-580	HAS
GF11	GG-124	HAS	GF1483	GG-3728	GKIN	GF2	GPP-25	WIX	GF283	GP-1122	PERM
GF11	GG-5 L	PUR	GF149	GG-181	HAS	GF20	GG-20	CAC	GF284	GG-160	HAS
GF110	GG-3728	HAS	GF149	GG-136	MIGH	GF200	GG-185	MIGH	GF284	GG-160	SHE
GF110	GG-3728	SHE	GF15	GG-42	CSP	GF201	GP-1	GUL	GF285	GG-84	HAS
GF1101	GP-1101	GUIO	GF150	GG-115	MIGH	GF202	GG-208	GKIN	GF285	GG-84	SHE
GF111	GG-5 L	FRML	GF15010	GG-204	MIGH	GF202	GP-20	GUL	GF287	GG-177	HAS
GF111	GG-46	HAS	GF1516	GG-255	ATL	GF202	GG-164	MIGH	GF288	GG-185	HAS
GF111	GG-245	MIGH	GF1516	GG-255	GKIN	GF2020	GG-188	MIGH	GF288	GG-185	SHE
GF111	GG-87	WELA	GF152	GG-151	MIGH	GF203	GP-3	GUL	GF29	GG-45	CAR
GF11-1	GG-5	PUR	GF152	GG-76	WELA	GF203	G-178	MIGH	GF29	GG-1	CSP
GF11-11	GG-5 L	PUR	GF154	GG-185	MIGH	GF204	GG-208	GKIN	GF29	GG-4	CSP
GF11-11M	GG-5 L	PUR	GF154	GG-39	WELA	GF204	G-200	GUL	GF291	GG-114	HAS
GF11-1M	GG-5 L	PUR	GF156	GG-227	MIGH	GF205	GG-227	MIGH	GF292	GG-146	HAS
GF112	GG-242	HAS	GF156	GG-220	WELA	GF206	GP-13	GUL	GF296	GG-239	HAS
GF112	GG-203	MIGH	GF1561	GG-64	ATL	GF206	GG-190	HAS	GF297	GG-104	HAS
GF112	GG-1	WELA	GF1561	GG-64	GKIN	GF207	GP-3600 ¹⁰²	GUL	GF298	GG-265	HAS
GF112	GG-4	WELA	GF1562	GG-256	GKIN	GF207	GP-38 ⁸⁷	GUL	GF298	GG-265	SHE
GF11-24	GG-1	PUR	GF1563	GG-260	ATL	GF207	GG-181	HAS	GF299	GG-267	HAS
GF11-24	GG-4	PUR	GF1563	GG-260	GKIN	GF208	GG-208	GKIN	GF3	GG-5 L	HAS
GF11-24M	GG-1	PUR	GF157	GG-20	ACD	GF208	GP-81 ³¹	GUL	GF30	GG-1	CAR
GF11-24M	GG-4	PUR	GF157	GG-194	HAS	GF208	GP-9 ⁹⁸	GUL	GF30	GG-4	CAR
GF113	GG-76	MIGH	GF157	GG-20	MIGH	GF209	GG-142	HAS	GF30	GG-5 L	CSP
GF113	GG-5 L	WELA	GF157	GG-20	REF	GF209	GG-267	MIGH	GF30	GG-8 ¹⁰³	PUR
GF114	GG-5 L	WELA	GF1578	GG-66	GKIN	GF21	GG-123	FRML	GF30	GG-8 L ⁸⁰	PUR
GF115	GG-47	HAS	GF1580	GG-581	GKIN	GF21	GG-6	HAS	GF300	GG-45	GKIN
GF116	GG-42	HAS	GF1580A	GG-256	GKIN	GF21	GG-123	PUR	GF300	GG-164	HAS
GF117	GG-196	HAS	GF1580K	GG-580	GKIN	GF210	GP-31	GUL	GF300	GG-63	MIGH
GF117	GG-215	MIGH	GF159	GG-215	HAS	GF210	GG-265	MIGH	GF3000	GG-202	MIGH
GF11-7	GG-1	PUR	GF16	GG-208	CSP	GF211	GP-38	GUL	GF301	GG-256	GKIN
GF11-7	GG-4	PUR	GF16	GG-19	STP	GF211	GG-148	HAS	GF301	GA-50	GUL
GF11-7M	GG-1	PUR	GF160	GG-3	HAS	GF212	GP-24 ²⁶	GUL	GF301	GG-95	HAS
GF11-7M	GG-4	PUR	GF160	GG-20	KEM	GF212	GP-462 ²⁴	GUL	GF301	GG-95	SHE
GF118	GG-202	HAS	GF160	GG-220	MIGH	GF213	GP-310	GUL	GF3010	GG-264	TVI
GF118	GG-208	MIGH	GF160	GG-220	WELA	GF214	GP-46	GUL	GF301S	GG-63	TVI
GF11-8	GG-5 L	PUR	GF161	GG-185	WELA	GF215	GP-44	GUL	GF302	GG-196	GKIN
GF11-8M	GG-5 L	PUR	GF1611U	GG-177	GKIN	GF216	GP-3429	GUL	GF302	GA-85	GUL
GF11K	GG-1	PUR	GF1624K	GG-580	GKIN	GF217	GG-189	HAS	GF302	GG-164	HAS
GF11K	GG-4	PUR	GF1624K	GG-580	TVI	GF219	GG-187	HAS	GF3020	GG-67	TVI
GF11M	GG-5 L	PUR	GF164	GG-217	HAS	GF219	GG-187	SHE	GF302M	GG-94	TVI
GF12	GG-7	CAC	GF1645	GG-266	GKIN	GF21M	GG-123	PUR	GF303	GG-94	GKIN
GF12	GG-8 ¹⁰³	CSP	GF165	GG-264	WELA	GF22	GG-19	CAC	GF303	GA-59	GUL
GF12	GG-8 L ⁸⁰	CSP	GF166	GG-242	WELA	GF22	GG-45	CSP	GF3030	GG-61	TVI
GF12	GG-5 L	GUIO	GF167	GG-79	HAS	GF22	GG-123	HAS	GF3035	GG-65	TVI
GF120	GG-8 ¹⁰³	WELA	GF167	GG-79	SHE	GF22	GG-123	STP	GF304	GG-76	GKIN
GF120	GG-8 L ⁸⁰	WELA	GF168	GG-264	HAS	GF224	GG-234	HAS	GF304	GA-56	GUL
GF121	GG-217	MIGH	GF168	GG-264	SHE	GF225	GG-256	HAS	GF304	GG-111	HAS
GF121	GG-45	WELA	GF169	GG-65	HAS	GF225	GG-580	SHE	GF304	GG-94	MIGH
GF124	GG-188	HAS	GF169	GG-150	MIGH	GF-225D	GP-3569	GUL	GF3045	GG-243	TVI
GF125	GG-213	HAS	GF169	GG-65	SHE	GF229	GG-115	HAS	GF304M	GG-137	TVI
GF126	GG-208	HAS	GF17	GG-226	CSP	GF23	GG-76	CSP	GF305	GG-194	GKIN
GF126	GG-190	MIGH	GF170	GG-185	MIGH	GF230	GG-146	HAS	GF305	GA-55	GUL
GF126	GG-208	SHE	GF171	GG-181	WELA	GF230	GG-146	SHE	GF306	GA-77	GUL
GF127	GG-76	HAS	GF172	GG-84	MIGH	GF231	GG-30	HAS	GF3060	GG-7018 ³⁸	TVI
GF127	GG-181	MIGH	GF173	GG-20	ACD	GF233	GG-151	HAS	GF3060	GG-7019 ³⁷	TVI
GF128	GG-148	MIGH	GF173	GG-99	HAS	GF234	GG-150	HAS	GF3060	GG-7020 ¹⁴	TVI
GF128	GG-45	WELA	GF173	GG-7018 ³⁸	MIGH	GF235	GG-137	HAS	GF3065	GG-84	TVI
GF129	GG-76	WELA	GF173	GG-7019 ³⁷	MIGH	GF235	GG-137	SHE	GF307	GG-63	GKIN
GF13	GG-123	CAC	GF173	GG-7020 ¹⁴	MIGH	GF237	GG-220	HAS	GF307	GA-70	GUL
GF13	GG-46	CSP	GF173	GG-243	SHE	GF239	GG-580	HAS	GF307	GG-351	HAS
GF130	GG-61	MIGH	GF174	GG-67	HAS	GF240	GG-72	HAS	GF3070	GG-72	TVI
GF131	GG-19	FRML	GF174	GG-72	MIGH	GF24050	GG-45	MIGH	GF308	GG-266	HAS
GF131	GG-203	WELA	GF175	GGP-25	ACD	GF242	GG-151	HAS	GF3080	GG-95	TVI
GF13-1	GG-19	PUR	GF175	GG-61	HAS	GF242	GG-227	HAS	GF3095	GG-249	PUR
GF133	GG-65	MIGH	GF175	GG-249	MIGH	GF242	GG-232	HAS	GF30M	GG-8 ¹⁰³	PUR
GF134	GG-67	MIGH	GF175	GG-61	SHE	GF246	GG-177 ⁹³	HAS	GF30M	GG-8 L ⁸⁰	PUR
GF136	GG-246	HAS	GF175	GG-208	WELA	GF246	GG-581 ¹¹⁶	HAS	GF31	GG-19	CAR
GF136	GG-408	HAS	GF176	GP-1101 ³⁴	ACD	GF247	GG-1872	HAS	GF310	GA-71	GUL
GF137	GG-226	HAS	GF176	GG-194	WELA	GF248	GG-260	HAS	GF311	GA-78	GUL
GF137	GG-39	MIGH	GF177	GPP-1122	MIGH	GF25	GG-1	CSP	GF312	GG-137	ATL
GF138	GG-261	HAS	GF178	GG-99	MIGH	GF25	GG-4	CSP	GF312	GG-137	GKIN
GF139	GG-251	HAS	GF179	GG-137	MIGH	GF25020	GG-76	MIGH	GF312	GA-80	GUL
GF139	GG-187	MIGH	GF18	GG-63	CSP	GF257	G-296	PERM	GF312	GG-164	HAS
GF139	GG-251	SHE	GF18	GG-5 L	PUR	GF257	G-296-B	PERM	GF3141	GG-240	PUR
GF139	GG-3728	WELA	GF180	GG-185	MIGH	GF258	GG-66	HAS	GF3141M	GG-240	PUR
GF14	GG-19	CAR	GF181	GG-185	MIGH	GF26	GPP-1122	CSP	GF3144	GG-46	PUR
GF14	GG-94	CSP	GF182	GG-214	HAS	GF260	GG-268	HAS	GF3144M	GG-46	PUR
GF140	GG-261	HAS	GF182	GG-111	MIGH	GF260	GG-268	SHE	GF315	GA-57	GUL
GF140	GG-220	MIGH	GF185	GG-160	MIGH	GF26060	GG-203	MIGH	GF3159	GG-215	PUR
GF140	GG-246	SHE	GF186	GG-232	HAS	GF261	GG-92	HAS	GF3162	GG-208	PUR
GF140	GG-46	WELA	GF186	GG-95	MIGH	GF261	GG-92	SHE	GF3162M	GG-208	PUR
GF142	GG-5 L	ACD	GF187	GG-185	MIGH	GF262	GP-1122	PERM	GF317	GA-192	GUL
GF142	GG-47	WELA	GF188	GG-185	MIGH	GF27	GG-5 L	CSP	GF318	GA-75	GUL
GF143	GG-215	MIGH	GF189	GG-114	MIGH	GF27	GG-19	HAS	GF318	GG-102	HAS
GF144	GG-146	MIGH	GF18M	GG-5 L	PUR	GF270	GG-94	HAS	GF320	GA-349	GUL
GF144	GG-246	PUR	GF19	GG-264	CSP	GF270	GG-94	SHE	GF323	GA-105	GUL
GF144	GG-196	WELA	GF190	GG-185	MIGH	GF274	GG-136	HAS	GF326	GG-986	HAS
GF1441	GG-246	PUR	GF19085	GG-185	MIGH	GF276	GG-255	HAS	GF326	GG-986	SHE
GF145	GG-220	HAS	GF191	GG-208	HAS	GF277	GG-249	HAS	GF328	GA-730	GUL
GF145	GG-79	WELA	GF191	GG-164	MIGH	GF278	GG-67	HAS	GF328	GG-206	HAS
GF146	GG-251	PUR	GF192	GG-185	MIGH	GF278	G-297	PERM	GF330	GA-325	GUL
GF147	GG-63	HAS	GF195	GG-164	MIGH	GF278	G-297-B	PERM	GF332	GG-206	CHAM
GF147	GG-189	PUR	GF198	GG-146	MIGH	GF278	GG-67	SHE	GF332	GA-3300	GUL
GF147	GG-63	SHE	GF199	GG-104	MIGH	GF279	GG-64	HAS	GF332	GG-206	HAS

REFERENCIA CRUZADA

Para números Gonher con Superíndice vea página 651
For Gonher with Superscript numbers see page 651

Numero	Gonher	Fabricante	Numero	Gonher	Fabricante	Numero	Gonher	Fabricante	Numero	Gonher	Fabricante	
Number	Gonher	Manufacturer	Number	Gonher	Manufacturer	Number	Gonher	Manufacturer	Number	Gonher	Manufacturer	
GF334		GAD-1	GUL	GF441	GG-7	MIGH	GF5066	GG-226	ATL	GF590	GG-151	ACD
GF3347		GP-26	WIX	GF441	GG-7	PROG	GF5066	GG-226	GKIN	GF591	GG-206	MIGH
GF335		GAD-3	GUL	GF441	GG-7	STP	GF5091	GG-226	GKIN	GF593	GG-181	ACD
GF3359		GG-187	HAS	GF441A	GG-7	KEM	GF51	GG-5	L CSP	GF593	GG-190	ACD
GF3359		GG-45	CAC	GF441B	GG-7	ACD	GF510	GG-47	ACD	GF595	GG-187	MIGH
GF336		GA-100	GUL	GF445	GG-123	ACD	GF511	GG-202	ACD	GF5955	GG-76	CAC
GF338		GA-303	GUL	GF451	GG-1	ACD	GF512	GG-76	ACD	GF598	GG-220	ACD
GF3388		GG-16	CAC	GF451	GG-4	ACD	GF512	GG-76	KEM	GF6	GG-20	STP
GF3389		GG-17	CAC	GF453	GG-1	ACD	GF513	GG-188	ACD	GF60	GG-246	CSP
GF339		GA-86	GUL	GF453	GG-4	ACD	GF513	GG-203	KEM	GF600	GG-63	ACD
GF339		GG-7018 ³⁸	HAS	GF455	GG-123	ACD	GF514	GG-213	ACD	GF6001	GG-185	GKIN
GF339		GG-7019 ³⁷	HAS	GF455	GG-123	MIGH	GF514	GG-1	KEM	GF602	GG-185	ACD
GF339		GG-7020 ¹⁴	HAS	GF455	GG-123	PROG	GF514	GG-4	KEM	GF603	GG-181	ACD
GF34		GG-251	CSP	GF455B	GG-123	ACD	GF5145	GG-261	GKIN	GF6031	GG-185	MIGH
GF340		GA-113	GUL	GF461	GG-1	ACD	GF515	GG-42	ACD	GF6031	GG-185	TVI
GF340		GG-290	HAS	GF461	GG-4	ACD	GF516	GG-255	ACD	GF604	GG-190	ACD
GF340		GP-28 ⁶	PERM	GF461	GG-1	MIGH	GF516	GG-5	L KEM	GF6040	GG-220	GKIN
GF340		GP-430 ⁸	PERM	GF461	GG-4	MIGH	GF516	GG-255	MIGH	GF6042	GG-187	GKIN
GF341		GG-203	STP	GF466	GG-199	ACD	GF516	GG-5	L STP	GF6059	GG-185	GKIN
GF34100		GG-203	MIGH	GF466	GG-45	MIGH	GF516X	GG-5	L KEM	GF606	GG-215	ACD
GF342		GA-50	GUL	GF468	GG-19	ACD	GF517	GG-79	ACD	GF6061	GG-185	GKIN
GF344		GA-3300	GUL	GF470	GG-16	ACD	GF518	GG-246	ACD	GF6065	GG-185	GKIN
GF344		GG-209	HAS	GF470	GG-16	BARA	GF519	GG-246	ACD	GF607	GG-208	ACD
GF345		GA-3425	GUL	GF470	GG-16	GKIN	GF519	GG-408	ACD	GF607	GG-8 ¹⁰³	GKIN
GF345		GG-308	HAS	GF470	GG-16	KEM	GF519	GG-5	L KEM	GF607	GG-8 L ⁸⁰	GKIN
GF346		GA-86	GUL	GF470	GG-16	MIGH	GF52	GG-8	CSP	GF607	GG-8 ¹⁰³	MIGH
GF347		GA-85	GUL	GF470	GG-16	PRET	GF520	GG-226	ACD	GF607	GG-8 L ⁸⁰	MIGH
GF348		GA-3424	GUL	GF470	GG-16	PROG	GF5200	GG-94	MIGH	GF608	GG-208	ACD
GF348		GA-265 ³⁶	HAS	GF470	GG-16	STP	GF521	GG-246	ACD	GF609	GP-1101	PERM
GF3499		GG-8 ¹⁰³	CAC	GF470	GG-16	TVI	GF521	GG-19	KEM	GF61	GG-3	ACD
GF3499		GG-8 L ⁸⁰	CAC	GF4700	GG-208	MIGH	GF522	GG-189	ACD	GF61	GG-5	L ACD
GF35		GG-76	CAR	GF470A	GG-16	KEM	GF522	GG-45	AVAT	GF61	GG-5	L BARA
GF353		GG-307	HAS	GF470B	GG-16	ACD	GF523	GG-189	ACD	GF61	GG-203	CSP
GF354		GA-3523	GUL	GF471	GG-17	ACD	GF523	GG-45	AVAT	GF61	GG-5	L MIGH
GF354		GG-101	HAS	GF471	GG-17	BARA	GF525	GG-87	KEM	GF61	GG-5	L PRET
GF356		GA-271	GUL	GF471	GG-17	GKIN	GF527	GG-261	ACD	GF61	GG-5	L TVI
GF357		GA-735 ¹²⁴	GUL	GF471	GG-17	KEM	GF529	GG-264	ACD	GF610	GG-65	ACD
GF358		GG-204	HAS	GF471	GG-17	MIGH	GF53	GG-208	CSP	GF610	GG-8	GKIN
GF359		GG-47	HAS	GF471	GG-17	PRET	GF530	GG-67	ACD	GF6101	GG-298	GKIN
GF3596		GG-87	CAC	GF471	GG-17	PROG	GF531	GG-8 ¹⁰³	KEM	GF611	GG-177	ACD
GF36		GG-240	CSP	GF471	GG-17	STP	GF531	GG-8 L ⁸⁰	KEM	GF611	GG-1	MIGH
GF362		GG-986	HAS	GF471	GG-17	TVI	GF535	GG-76	ACD	GF611	GG-4	MIGH
GF3692		GG-240	CAC	GF471A	GG-17	KEM	GF535	GG-8	KEM	GF611U	GG-177	ACD
GF37		GG-5	L ACD	GF471B	GG-17	ACD	GF536	GG-264	KEM	GF611U	GG-177	MIGH
GF371		GPP-612	HAS	GF475	GG-87	STP	GF538	GG-251	ACD	GF613M	GG-5	L PROG
GF3713		GG-246	CAC	GF476	GG-240	ACD	GF538	GG-5	L KEM	GF614	GG-46	ACD
GF3724		GG-8	CAC	GF476	GG-240	BARA	GF539	GG-203	ACD	GF615	GG-220	ACD
GF3727		GG-46	CAC	GF476	GG-240	KEM	GF54	GG-5	L CSP	GF618	GG-46	ACD
GF3728		GG-3728	CAC	GF476	GG-240	MIGH	GF540	GG-208	ACD	GF618	GG-64	ACD
GF3745		GG-246	CAC	GF476	GG-240	PRET	GF5401	GG-246	GKIN	GF61A	GG-5	L PROG
GF3746		GG-226	CAC	GF476	GG-240	PROG	GF5403	GG-246	GKIN	GF61B	GG-5	L ACD
GF3747		GG-246	CAC	GF479	GG-5	L ACD	GF5405	GG-189	GKIN	GF61M	GG-5	L BARA
GF3748		GG-246	CAC	GF479	GG-5	L KEM	GF543	GG-20	AVAT	GF61M	GG-5	L GKIN
GF3769		GG-42	CAC	GF480	GG-8 ¹⁰³	ACD	GF545	GG-76	ACD	GF61M	GG-5	L PROG
GF39		GG-8 ¹⁰³	CAR	GF480	GG-8 L ⁸⁰	ACD	GF547	GG-185	ACD	GF61M	GG-5	L TVI
GF39		GG-8 L ⁸⁰	CAR	GF481	GG-46	ACD	GF548	GG-87	AVAT	GF61P	GG-5	L ACD
GF397		GG-223	MIGH	GF481	GG-46	BARA	GF55	GG-3728	CSP	GF61P	GG-5	L BARA
GF4		GG-5	L HAS	GF481	GG-46	KEM	GF550	GG-94	AVAT	GF61P	GG-5	L PROG
GF401		GG-19	GUL	GF481	GG-46	MIGH	GF550	GG-1	KEM	GF62	GG-20	ACD
GF402		GG-5	L GUL	GF481	GG-46	PRET	GF550	GG-4	KEM	GF62	GG-203	CSP
GF403		GG-5	L GUL	GF481	GG-46	PROG	GF551	GG-45	KEM	GF620	GG-581	ACD
GF404		GG-123	BARA	GF481	GG-46	STP	GF555	GG-246	ACD	GF620	GG-45	GKIN
GF404		GG-123	GUL	GF481	GG-46	TVI	GF556	GG-76	KEM	GF620K	GG-580	ACD
GF405		GG-6	GUL	GF481B	GG-46	ACD	GF557	GG-45	KEM	GF621	GG-46	ACD
GF406		GG-20	GUL	GF481Z	GG-46	BARA	GF559	GG-203	KEM	GF621	GG-76	GKIN
GF407		GG-7	GUL	GF482	GG-242	ACD	GF560	GG-188	KEM	GF622	GG-66	ACD
GF409		GG-16	GUL	GF482	GG-242	KEM	GF5603	GG-189	GKIN	GF622	GG-203	GKIN
GF410		GG-17	GUL	GF482	GG-242	MIGH	GF561	GG-64	ACD	GF624	GG-581	ACD
GF4102		GP-1122	GUIO	GF-482	GG-242	BARA	GF561	GG-213	KEM	GF624	GG-202	GKIN
GF41031		GG-202	MIGH	GF483	GG-3728	ACD	GF561	GG-64	MIGH	GF624K	GG-580	ACD
GF412		GG-5	L ACD	GF483	GG-3728	BARA	GF562	GG-256	ACD	GF624K	GG-580	MIGH
GF4143		GG-196	CAC	GF483	GG-3728	KEM	GF-562	GG-256	PROG	GF625	GG-256	ACD
GF4167		GG-202	CAC	GF483	GG-3728	MIGH	GF562A	GG-256	MIGH	GF625	GG-188	GKIN
GF4173		GG-123	CAC	GF483	GG-3728	PRET	GF563	GG-260	ACD	GF626	GG-46	ACD
GF4194		GG-94	CAC	GF483	GG-3728	PROG	GF563	GG-260	MIGH	GF626	GG-208	GKIN
GF42		GG-20	CSP	GF483	GG-3728	STP	GF565	GG-194	KEM	GF627	GG-66	ACD
GF421		GG-5	L ACD	GF484	GG-3728	ACD	GF567	GG-39	KEM	GF627	GG-5	L GKIN
GF427		GG-6	ACD	GF486	GG-196	ACD	GF572	GG-146	ACD	GF627	GG-66	TVI
GF427		GG-6	ATL	GF487	GG-87	ACD	GF573	GG-580	ACD	GF628	GG-213	GKIN
GF427		GG-6	BARA	GF488	GG-1	ACD	GF574	GG-208	KEM	GF62A	GG-20	ACD
GF427		GG-6	GKIN	GF488	GG-4	ACD	GF577	GG-243	ACD	GF62C	GG-20	ACD
GF427		GG-6	KEM	GF49	GP-155	CSP	GF578	GG-66	ACD	GF62G	GG-20	ACD
GF427		GG-6	MIGH	GF495	GG-94	ACD	GF578	GG-66	MIGH	GF62M	GG-20	ACD
GF427		GG-6	PROG	GF496	GG-203	ACD	GF578	GG-66	TVI	GF62P	GG-20	ACD
GF427		GG-6	STP	GF497	GG-203	ACD	GF580	GG-177 ⁴³	ACD	GF62T	GG-20	ACD
GF427A		GG-6	KEM	GF500	GG-3	ACD	GF580	GG-581 ¹¹⁶	ACD	GF63	GG-196	CSP
GF427B		GG-6	ACD	GF500	GG-5	L KEM	GF580	GG-196	KEM	GF630	GG-204	GKIN
GF434		GG-19	ACD	GF501	GG-3	ACD	GF580	GG-581	MIGH	GF633	GG-106	GMXC
GF44		GP-1122	CSP	GF5020	GG-246	GKIN	GF580	GG-581	TVI	GF637	GG-185	GKIN
GF4404		GG-203	PUR	GF5021	GG-246	MIGH	GF580A	GG-256	ACD	GF638	GG-7018 ³⁸	ACD
GF4404M		GG-203	PUR	GF5025	GG-246	MIGH	GF-580A	GG-256	PROG	GF638	GG-7019 ³⁷	ACD
GF441		GG-7	ACD	GF5030	GG-251	GKIN	GF580K	GG-580	ACD	GF638	GG-7020 ¹⁴⁴	ACD
GF441		GG-7	ATL	GF504	GG-196	MIGH	GF580K	GG-580	MIGH	GF639	GG-115	ATL
GF441		GG-7	BARA	GF505	GG-1	ACD	GF582	GG-177	ACD	GF639	GG-115	GKIN
GF441		GG-7	GKIN	GF505	GG-4	ACD	GF584	GG-142	ACD	GF642	GG-61	ACD
GF441		GG-7	KEM	GF5060	GG-351	GKIN	GF589	GG-146	ACD	GF642B	GG-61	ACD

Referencia Cruzada por Numero de Parte

Cross Reference by Part Number



Numero	Gonher	Fabricante	Numero	Gonher	Fabricante	Numero	Gonher	Fabricante	Numero	Gonher	Fabricante
Number	Gonher	Manufacturer	Number	Gonher	Manufacturer	Number	Gonher	Manufacturer	Number	Gonher	Manufacturer
GF643	GG-1872	ACD	GF735	GG-160	ACD	GF9110	GG-187	GKIN	GFE206	GP-1	UNP
GF643B	GG-1872	ACD	GF738	GG-223	ACD	GF915	GG-65	KEM	GFE208	GP-46	UNP
GF644	GG-46	ACD	GF74	GG-185	CSP	GF917	GG-247	KEM	GFE2083	GAVW-4	UNP
GF645	GG-266	ACD	GF742	GG-164	ACD	GF92	GG-76	CSP	GFE2084	GA-277	UNP
GF645	GG-208	GKIN	GF745	GG-185	ACD	GF93	G-294	CSP	GFE2087	GAVW-2	UNP
GF645	GG-266	MIGH	GF747	GG-185	ACD	GF94	GG-5 L	ACD	GFE2095	GA-3425	UNP
GF648	GG-76	GKIN	GF748	GG-247	ACD	GF95	GG-408	CHAM	GFE2096	GA-303	UNP
GF649	GG-581	ACD	GF749	GG-92	ACD	GF95	GG-246	CSP	GFE2097	GAVW-2	UNP
GF65	GG-5 L	ACD	GF752	GG-268	ACD	GF95	GG-116	HAS	GFE210	GP-58 ¹⁵	UNP
GF6501	GG-164	ATL	GF755	GG-84	ACD	GF97	G-1121	CSP	GFE2102	GA-360	UNP
GF6501	GG-164	GKIN	GF757	GG-249	ACD	GF987	GG-264	MIGH	GFE211	GP-22	UNP
GF6504	GG-164	ATL	GF76	GG-251	CSP	GF99	GG-5 L	ACD	GFE2110	GA-3300	UNP
GF6504	GG-164	GKIN	GF763	GG-7018 ³⁸	ACD	GF99	GG-5 L	HAS	GFE2129	GAVW-2	UNP
GF651	GG-46	ACD	GF763	GG-7019 ³⁷	ACD	GFA2016	GG-226	BARA	GFE2133	GA-4365	UNP
GF652	GG-46	ACD	GF763	GG-7020 ¹⁴	ACD	GFA-2017	GG-261	BARA	GFE2134	GA-2740	UNP
GF656	GG-187	ACD	GF765	GG-246	ACD	GFA2018	GG-246	BARA	GFE215	GP-38	UNP
GF657	GG-185	ACD	GF767	GG-246	ACD	GFA5025	GG-246	BARA	GFE2151	GAVW-2	UNP
GF658	GG-194	ACD	GF77	GG-215	CSP	GFA74	GA-55	PROG	GFE217	GP-3682	UNP
GF66	GG-203	CSP	GF7715	G-178	GKIN	GFA76	GG-79	BARA	GFE2170	GP-58	UNP
GF660	GG-185	ACD	GF7748	GS-1261	ATL	GFB2013	GG-251	BARA	GFE2175	GA-4303	UNP
GF661	GG-150	ACD	GF7751	G-862	GKIN	GFC3185	GG-67	BARA	GFE2177	GA-2194	UNP
GF664	GG-76	ACD	GF780	GG-61	ACD	GFC3190	GG-264	BARA	GFE2179	GA-2110	UNP
GF665	GG-214	ACD	GF783	GG-1872	ACD	GFC607	GG-8 ¹⁰³	BARA	GFE2182	GA-2156	UNP
GF667	GG-208	ACD	GF79	GG-79	CSP	GFC607	GG-8 L ⁸⁰	BARA	GFE-2254	GA-2174	ROVE
GF668	GG-217	ACD	GF79105	GG-220	MIGH	GFC626	GG-196	BARA	GFE229	GP-28 ⁶	UNP
GF67	GPP-111	CSP	GF795	GG-246	ACD	GFC627	GG-5 L	BARA	GFE229	GP-430 ⁸	UNP
GF67	GPP-524	CSP	GF796	GG-101	ACD	GFC751	GG-76	BARA	GFE232	GP-462	UNP
GF670	GG-227	ACD	GF797	GG-187	ACD	GFC752	GG-203	BARA	GFE233	GP-40	UNP
GF671	GG-5 L	MIGH	GF8	GG-5 L	CAR	GFD164	GG-45	BARA	GFE234	G-801	UNP
GF673	GG-115	ACD	GF800	GG-146	ACD	GFD165	GG-196	BARA	GFE235	GP-46	UNP
GF673	GG-115	AIRT	GF800	GG-47	CAC	GFD166	GG-76	BARA	GFE238	GP-3531 EXP	UNP
GF674	GG-148	ACD	GF800	GG-47	STP	GFD167	GG-94	BARA	GFE241	G-225	UNP
GF675	GG-185	ACD	GF8004	GG-114	ATL	GFD-168	GG-194	BARA	GFE-2412	GA-2135	ROVE
GF679	GG-137	ACD	GF8004	GG-114	GKIN	GFD309	GG-63	BARA	GFE242	G-834	UNP
GF68	GG-1	ACD	GF801	GG-114	ACD	GFE 2240	GA-2160	UNP	GFE244	GP-28 ⁶	UNP
GF68	GG-4	ACD	GF801	GG-246	KEM	GFE101	G-801	LEYL	GFE244	GP-430 ⁸	UNP
GF68	GG-1	BARA	GF802	GG-351	ACD	GFE101	G-801	UNP	GFE258	GP-3980	UNP
GF68	GG-4	BARA	GF803	GG-185	ACD	GFE104	G-870	LEYL	GFE261	GP-3682	UNP
GF68	GG-45	CSP	GF804	GG-185	ACD	GFE104	G-870	UNP	GFE263	GP-3682	UNP
GF68	GG-1	MIGH	GF804	GG-261	KEM	GFE1043	GA-8	UNP	GFE267	GP-3985	UNP
GF68	GG-4	MIGH	GF805	GG-79	KEM	GFE1045	GA-349	UNP	GFE271	GP-3985	UNP
GF681	GG-67	ACD	GF807	GG-185	ACD	GFE106	G-870	UNP	GFE272	GP-81	UNP
GF682	GG-185	ACD	GF808	GG-220	KEM	GFE1080	GA-50	UNP	GFE276	GP-462	UNP
GF683	GG-30	ACD	GF809	GG-164	ACD	GFE1092	GAK-216	UNP	GFE280	GP-455	UNP
GF685	GG-72	ACD	GF81	GG-242	CHAM	GFE1096	GA-2122	UNP	GFE282	GP-462	UNP
GF689	GG-67	ACD	GF810	GG-164	ACD	GFE1109	GA-3425	UNP	GFE292	GP-40	UNP
GF68M	GG-1	ATL	GF810	GG-94	KEM	GFE1119	GAVW-2	UNP	GFE-378	GP-453	ROVE
GF68M	GG-4	ATL	GF811	GG-47	KEM	GFE1131	GAVW-622	UNP	GFE50	GP-58	UNP
GF68M	GG-1	GKIN	GF812	GG-42	KEM	GFE114	GP-81	UNP	GFE5006	G-297	UNP
GF68M	GG-4	GKIN	GF815	GG-1872	ACD	GFE1144	GA-2156	UNP	GFE5006	G-297-B	UNP
GF69	GG-194	CHAM	GF819	GG-290	ACD	GFE116	GP-1	UNP	GFE5292	G-296	UNP
GF69	GG-194	CHP	GF822	GG-299	ACD	GFE117	GP-3816	LEYL	GFE5292	G-296-B	UNP
GF690	GG-245	ACD	GF824	GG-220	KEM	GFE117	GP-3816	UNP	GFE5296	G-296	UNP
GF692	GG-7018 ³⁸	ACD	GF831	GG-209	ACD	GFE120	G-870	LEYL	GFE5296	G-296-B	UNP
GF692	GG-7019 ³⁷	ACD	GF831	GG-209	ATL	GFE120	G-870	UNP	GFE5298	G-297	UNP
GF692	GG-7020 ¹⁴	ACD	GF831	GG-214	KEM	GFE1202	GA-360	UNP	GFE5298	G-297-B	UNP
GF693	GG-99	ACD	GF831	GG-209	MIGH	GFE1209	GAK-403	UNP	GFE5299	GPP-1122	UNP
GF694	GG-203	ACD	GF831	GG-209	SERC	GFE121	GP-81 ³¹	LEYL	GFE7000	GG-5 L	UNP
GF695	GG-208	ACD	GF84	GG-8 ¹⁰³	HAS	GFE121	GP-9 ⁹⁸	LEYL	GFE7004	GG-5 L	UNP
GF696	GG-234	ACD	GF84	GG-8 L ⁸⁰	HAS	GFE123	GP-5	LEYL	GFE7017	GG-251	UNP
GF698	GG-214	ACD	GF84	GG-8 ¹⁰³	SHE	GFE123	GP-5	UNP	GFE7018	GG-246	UNP
GF699	GG-215	ACD	GF84	GG-8 L ⁸⁰	SHE	GFE128	G-836	LEYL	GFE7019	GG-5 L	UNP
GF69M	GG-5 L	GKIN	GF848	GG-148	KEM	GFE128	G-836	UNP	GF30	G-834	LEYL
GF6A	GG-20	HAS	GF85	GG-45	HAS	GFE130	G-834	LEYL	GFH7030	GG-215	BARA
GF6ACO	GG-20	FEDE	GF850	GG-267	ACD	GFE130	G-834	UNP	GFH7040	GG-215	BARA
GF6W00	GG-194	MIGH	GF854	GG-234	KEM	GFE135	GP-1	UNP	GFH7050	GG-181	BARA
GF7	GG-1	CAR	GF855	GG-146	KEM	GFE139	GP-3816	AUSW	GFH7070	GG-190	BARA
GF7	GG-4	CAR	GF859	GG-206	ACD	GFE139	GP-3816	LEYL	GFH7080	GG-181	BARA
GF70	GG-76	CSP	GF86	GG-16	HAS	GFE139	GP-3816	UNP	GF1509	GP-19	BARA
GF70	GG-79	GKIN	GF862	GG-115	KEM	GFE148	GP-58	UNP	GF152481	GG-46	GUR
GF70	GG-79	TVI	GF862	GG-30	TVI	GFE151	GP-1	LEYL	GF152562	GG-580	GUR
GF700	GG-185	ACD	GF865	GG-214	KEM	GFE151	GP-1	UNP	GFM207	GG-189	BARA
GF701	GG-196	ACD	GF867	GG-46	ACD	GFE154	GP-36	LEYL	GFM9047	GG-217	BARA
GF7030	GG-215	GKIN	GF87	GG-298	CSP	GFE156	GP-3980	UNP	GFM9048	GG-232	BARA
GF7040	GG-215	GKIN	GF87	GG-17	HAS	GFE157	GP-455	UNP	GFM9078	GG-150	BARA
GF7050	GG-181	ATL	GF872	GG-65	KEM	GFE162	GP-36	LEYL	GFN-310	GG-39	BARA
GF7050	GG-181	GKIN	GF881	GG-92	TVI	GFE164	GP-58	UNP	GFP2019	GG-246	BARA
GF7050	GG-181	TVI	GF892	GG-150	KEM	GFE165	GP-3531 EXP	UNP	GFP-2019	GG-408	BARA
GF707	GG-215	ACD	GF896	GG-268	TVI	GFE166	GP-3816	UNP	GFT6031	GG-246	BARA
GF7070	GG-190	GKIN	GF898	GG-148	KEM	GFE167	GP-46	UNP	GF5-200	GG-188	BARA
GF7080	GG-181	ATL	GF898	GG-67	MIGH	GFE168	GP-1	UNP	GF5-201	GG-213	BARA
GF7080	GG-181	GKIN	GF899	GG-150	KEM	GFE171	GP-455	UNP	GF55005	GG-246	BARA
GF709	GG-203	ACD	GF90	GG-5 L	ACD	GFE175	GP-1	UNP	GFSA009	GG-76	MIGH
GF710	GG-136	ACD	GF90	GG-67	CSP	GFE182	G-833	UNP	GFT466	GG-45	BARA
GF7102	GG-214	ATL	GF9047	GG-217	ATL	GFE187	GP-1	UNP	GFT467	GG-76	BARA
GF7104	GG-160	GKIN	GF9047	GG-217	GKIN	GFE192	GP-3531 EXP	UNP	GFT468	GG-203	BARA
GF712	GG-94	ACD	GF9048	GG-232	GKIN	GFE2001	GA-71	UNP	GFT469	GG-203	BARA
GF713	GG-208	ACD	GF9053	GG-148	ATL	GFE2002	GA-200	UNP	GFT472	GG-202	BARA
GF714	GG-232	ACD	GF9053	GG-148	GKIN	GFE2002	GP-58	UNP	GFT6031	GG-185	BARA
GF718	GG-255	ACD	GF9054	GG-142	GKIN	GFE2005	GAD-3	UNP	GFT-6040	GG-220	BARA
GF72	GG-76	CSP	GF9078	GG-150	ATL	GFE2018	GAVW-2	UNP	GFT6042	GG-187	BARA
GF7200	GG-160	TVI	GF9078	GG-150	GKIN	GFE2020	GAVW-2	UNP	GFT680	GG-204	GUR
GF729	GG-232	ACD	GF9083	GG-185	GKIN	GFE2028	GAD-1	UNP	GFV2010	GG-246	BARA
GF7295	GG-146	ATL	GF9087	GG-136	ATL	GFE2039	GA-230	UNP	GFV-2010	GG-408	BARA
GF7295	GG-146	GKIN	GF9087	GG-136	GKIN	GFE2048	GAVW-4	UNP	GFV5010	GG-246	BARA
GF731	GG-76	ACD	GF91	GG-5 L	ACD	GFE205	GP-42	UNP	GG-1	GONH	

REFERENCIA CRUZADA

Para números Gonher con Superíndice vea página 651
For Gonher with Superscript numbers see page 651

Numero	Gonher	Fabricante	Numero	Gonher	Fabricante	Numero	Gonher	Fabricante	Numero	Gonher	Fabricante
Number	Gonher	Manufacturer	Number	Gonher	Manufacturer	Number	Gonher	Manufacturer	Number	Gonher	Manufacturer
GG-101	GG-101	GONH	GG-268	GG-268	GONH	GH2825	GP-38	GUIO	GM25	GP-20	GREA
GG-102	GG-102	GONH	GG-283	GG-283	GONH	GH2829	GP-54	GUIO	GM25230	GP-128	GREA
GG-104	GG-104	GONH	GG-29	GG-29	GONH	GH2830	GP-22	GUIO	GM2849	GP-24 ⁶⁰	GREA
GG-106	GG-106	GONH	GG-290	GG-290	GONH	GH2842	GP-36	GUIO	GM2849	GP-462 ⁹⁴	GREA
GG-111	GG-111	GONH	GG-291	GG-291	GONH	GH2843	GP-81	GUIO	GM2863	GP-3985	GREA
GG-114	GG-114	GONH	GG-298	GG-298	GONH	GH2846	GP-46	GUIO	GM2865	GP-42	GREA
GG-115	GG-115	GONH	GG-299	GG-299	GONH	GH2847	GP-22	GUIO	GM289	GP-3985	GREA
GG-116	GG-116	GONH	GG-3	GG-3	GONH	GH2895	GP-3600	GUIO	GM2951	GP-58	GREA
GG-117	GG-117	GONH	GG-3 USA	GG-5	GUSA	GH2897	GP-462	GUIO	GM2977	GP-3985 ⁹³	GREA
GG-1191 USA	GG-298	GUSA	GG-30	GG-30	GONH	GH2921	GP-54 ³¹	GUIO	GM3	GA-50	SAFE
GG-123	GG-123	GONH	GG-307	GG-307	GONH	GH2921	GP-66 ⁹⁰	GUIO	GM30	GP-3	GREA
GG-124	GG-124	GONH	GG-308	GG-308	GONH	GH4600	GP-3816	GUIO	GM30001	GP-1	GREA
GG-126	GG-126	GONH	GG-32	GG-32	GONH	GHF7131	G-24	GREY	GM30040	GP-13	GREA
GG-131	GG-131	GONH	GG-3359 USA	GG-45	GUSA	GL10183	GP-3816	MICG	GM30257	GP-310	GREA
GG-136	GG-136	GONH	GG-3499 USA	GG-8 L	GUSA	GL14006	GP-44	MICG	GM30257	GP-3569	GREA
GG-137	GG-137	GONH	GG-351	GG-351	GONH	GL14610	GP-149	MICG	GM30288	GP-3766	GREA
GG-142	GG-142	GONH	GG-355	GG-355	GONH	GL14612	GP-91	MICG	GM335	GP-2951 ⁹²	GREA
GG-146	GG-146	GONH	GG-369	GG-369	GONH	GL14619	GP-3985	MICG	GM335	GP-58	GREA
GG-148	GG-148	GONH	GG-3727 USA	GG-46	GUSA	GL15309	G-45	MICG	GM346	GP-58	GREA
GG-15 USA	GG-5 L	GUSA	GG-3728	GG-3728	GONH	GL15313	GP-408	MICG	GM34631	GP-205	GREA
GG-150	GG-150	GONH	GG-3802 A USA	GG-47	GUSA	GL15317	GP-457	MICG	GM3512	GP-22	GREA
GG-151	GG-151	GONH	GG-3829 USA	GG-251	GUSA	GL15436	G-49	MICG	GM3531	GP-3531 EXP	GREA
GG-16	GG-16	GONH	GG-3850 USA	GG-1872	GUSA	GL15505	G-70	MICG	GM3675	GP-44	GREA
GG-160	GG-160	GONH	GG-39	GG-39	GONH	GL20252	GP-28 ⁹	MICG	GM3682	GP-3682	GREA
GG-161	GG-161	GONH	GG-4	GG-4	GONH	GL20252	GP-430 ⁸	MICG	GM3682	GP-37	GREA
GG-164	GG-164	GONH	GG-408	GG-408	GONH	GL22167	GP-171	MICG	GM3850	GP-310	GREA
GG-167	GG-167	GONH	GG-409	GG-409	GONH	GL227	GP-46	PERM	GM3850	GP-3569	GREA
GG-169	GG-169	GONH	GG-41	GG-41	GONH	GL24011	GP-3980	MICG	GM3856	GP-40	GREA
GG-17	GG-17	GONH	GG-411	GG-411	GONH	GL24457	GP-3682	MICG	GM3870	GP-28 ⁹	GREA
GG-170	GG-170	GONH	GG-4164 USA	GG-116	GUSA	GL24466	GP-28 ⁹	MICG	GM3870	GP-430 ⁸	GREA
GG170-16722	GP-66	JOND	GG-419	GG-419	GONH	GL24466	GP-430 ⁸	MICG	GM4	GA-57	SAFE
GG170-31266	GP-51	JOND	GG-42	GG-42	GONH	GL244Z	GP-81 ³¹	PERM	GM400	GP-3600	GREA
GG170-32346	GP-66	JOND	GG-420	GG-420	GONH	GL244Z	GP-9 ⁹⁸	PERM	GM43	GP-81 ³¹	GREA
GG170-32373	GP-34	JOND	GG420-08567	GA-33	JOND	GL249	GP-171	PERM	GM43	GP-9 ⁹⁸	GREA
GG170-32375	GP-34	JOND	GG420-18567	GA-33	JOND	GL25274	G-765	MICG	GM44	GP-44	GREA
GG170-32672	GP-34	JOND	GG420-31259	GG-5 L	JOND	GL25288	GP-3675	MICG	GM44422	GP-178	GREA
GG-177	GG-177	GONH	GG420-32381	GAK-16	JOND	GL269	GP-22	PERM	GM4458	GP-462	GREA
GG-181	GG-181	GONH	GG420-32831	GAK-16	JOND	GL288X	GP-28 ⁹	PERM	GM4459	GP-149 ⁹⁹	GREA
GG-182	GG-182	GONH	GG-431	GG-431	GONH	GL288X	GP-430 ⁸	PERM	GM4459	GP-91 ²⁸	GREA
GG-184	GG-184	GONH	GG-45	GG-45	GONH	GL30001	GP-1	MICG	GM4477	GP-156	GREA
GG-185	GG-185	GONH	GG-46	GG-46	GONH	GL30257	GP-310	MICG	GM44872	GP-562	GREA
GG-187	GG-187	GONH	GG-47	GG-47	GONH	GL312	GP-51	PERM	GM45	GP-3429	GREA
GG-1872	GG-1872	GONH	GG-4715 USA	GG-204	GUSA	GL329	GP-14	PERM	GM4620	GP-149	GREA
GG-188	GG-188	GONH	GG-4777 USA	GG-63	GUSA	GL340	GP-28 ⁹	PERM	GM4622	GP-91	GREA
GG-189	GG-189	GONH	GG-48	GG-48	GONH	GL340	GP-430 ⁸	PERM	GM4651	GP-68	GREA
GG-19	GG-19	GONH	GG-5	GG-5	GONH	GL45335	GP-178	MICG	GM47	GP-46	GREA
GG-190	GG-190	GONH	GG-5 L	GG-5 L	GONH	GL45515	G-3752	MICG	GM51	GP-3980	GREA
GG-194	GG-194	GONH	GG-50	GG-50	GONH	GL553Z	GP-171 ⁹⁹	PERM	GM52	GP-3980	GREA
GG-195	GG-195	GONH	GG-5237 USA	GG-137	GUSA	GL562Z	GP-3985	PERM	GM786	GP-3985 ⁹³	GREA
GG-196	GG-196	GONH	GG-580	GG-580	GONH	GL568Z	GP-40	PERM	GM8	GP-1	GREA
GG-199	GG-199	GONH	GG-581	GG-581	GONH	GL597X	GP-54 ³¹	PERM	GM8A	GP-1	GREA
GG-1992	GG-1992	GONH	GG-6	GG-6	GONH	GL597X	GP-66 ⁹⁰	PERM	GMA11149	GAVV-2	GREA
GG-2 USA	GG-124	GUSA	GG-6 USA	GG-4	GUSA	GL681	GP-36	PERM	GMA13192	GA-271	GREA
GG-2 USA	GG-3	GUSA	GG-61	GG-61	GONH	GL682	GP-310	PERM	GMA133	GA-78	GREA
GG-20	GG-20	GONH	GG-62	GG-62	GONH	GLE10	GP-34	ZING	GMA136	GA-55	GREA
GG-202	GG-202	GONH	GG-63	GG-63	GONH	GLE25	GP-34	ZING	GMA14347	GA-153	GREA
GG-203	GG-203	GONH	GG-64	GG-64	GONH	GM1	GA-59	SAFE	GMA146	GA-71	GREA
GG-204	GG-204	GONH	GG-65	GG-65	GONH	GM10017	GP-81	GREA	GMA14650	GA-604	GREA
GG-206	GG-206	GONH	GG-6535 USA	GG-181	GUSA	GM10111	GP-46	GREA	GMA14656	GA-7017	GREA
GG-207	GG-207	GONH	GG-66	GG-66	GONH	GM10193	GP-40	GREA	GMA148	GA-80	GREA
GG-208	GG-208	GONH	GG-67	GG-67	GONH	GM10241	GP-58	GREA	GMA160	GA-70	GREA
GG-209	GG-209	GONH	GG-7	GG-7	GONH	GM10291	GP-3531 EXP	GREA	GMA176	GA-56	GREA
GG-210	GG-210	GONH	GG-7018	GG-7018	GONH	GM11	GP-5	GREA	GMA184	GA-77	GREA
GG-213	GG-213	GONH	GG-7019	GG-7019	GONH	GM13	GP-13	GREA	GMA187	GA-90	GREA
GG-214	GG-214	GONH	GG-7020	GG-7020	GONH	GM14006	GP-44	GREA	GMA189	GA-50	GREA
GG-215	GG-215	GONH	GG-7143 USA	GG-64	GUSA	GM14459	GP-149 ⁹⁹	GREA	GMA19	GA-100	GREA
GG-217	GG-217	GONH	GG-72	GG-72	GONH	GM14459	GP-91	GREA	GMA192	GA-192	GREA
GG-22 A USA	GG-119	GUSA	GG-7315 USA	GG-66	GUSA	GM14460	GP-91	GREA	GMA20070	GA-4303	GREA
GG-220	GG-220	GONH	GG-7404 USA	GG-94	GUSA	GM14477	GP-156	GREA	GMA23465	GA-277	GREA
GG-223	GG-223	GONH	GG-76	GG-76	GONH	GM14619	GP-3985	GREA	GMA23538	GA-140	GREA
GG-226	GG-226	GONH	GG-79	GG-79	GONH	GM14620	GP-149	GREA	GMA23592	GA-273	GREA
GG-227	GG-227	GONH	GG-8	GG-8	GONH	GM14622	GP-91	GREA	GMA24	GA-113	GREA
GG-232	GG-232	GONH	GG-8 L	GG-8 L	GONH	GM14670	GP-81	GREA	GMA24278	GAD-15	GREA
GG-234	GG-234	GONH	GG-8018 USA	GG-986	GUSA	GM16	GP-81	GREA	GMA24299	GA-180	GREA
GG-237	GG-237	GONH	GG-82	GG-82	GONH	GM16114	GP-3	KOHL	GMA24339	GA-3915	GREA
GG-239	GG-239	GONH	GG-84	GG-84	GONH	GM16532	GP-3980	KOHL	GMA24342	GA-253	GREA
GG-240	GG-240	GONH	GG-87	GG-87	GONH	GM171	GA-100	COBR	GMA24343	GA-5056	GREA
GG-242	GG-242	GONH	GG-915	GG-915	GONH	GM179	GA-101	COBR	GMA24372	GA-3901	GREA
GG-243	GG-243	GONH	GG-92	GG-92	GONH	GM2	GA-55	SAFE	GMA24375	GA-362	GREA
GG-245	GG-245	GONH	GG-94	GG-94	GONH	GM200	G-200	GREA	GMA24378	GA-174	GREA
GG-246	GG-246	GONH	GG-95	GG-95	GONH	GM20033	GP-20	GREA	GMA24468	GA-195	GREA
GG-247	GG-247	GONH	GG-97	GG-97	GONH	GM20049	GP-3	GREA	GMA24471	GA-471	GREA
GG-249	GG-249	GONH	GG-98	GG-98	GONH	GM20081	GP-81 ³¹	GREA	GMA24645	GA-6690	GREA
GG-25	GG-25	GONH	GG-986	GG-986	GONH	GM20081	GP-9 ⁹⁸	GREA	GMA24648	GA-133	GREA
GG-251	GG-251	GONH	GG-99	GG-99	GONH	GM20123	GP-3429	GREA	GMA24680	GA-386	GREA
GG-252	GG-252	GONH	GGP-125	GGP-125	GONH	GM20195	GP-3600	GREA	GMA24690	GA-322	GREA
GG-255	GG-255	GONH	GGP-25	GGP-25	GONH	GM20252	GP-28 ⁹	GREA	GMA24712	GA-217	GREA
GG-256	GG-256	GONH	GH1077	GP-91	GUIO	GM20252	GP-430 ⁸	GREA	GMA24720	GA-7344	GREA
GG-260	GG-260	GONH	GH1078	GP-42	GUIO	GM22821	GP-58	GREA	GMA24722	GA-5466	GREA
GG-261	GG-261	GONH	GH1401	GP-3	GUIO	GM24011	GP-3980	GREA	GMA24731	GA-165	GREA
GG-262	GG-262	GONH	GH2000	GP-14	GUIO	GM24457	GP-3682	GREA	GMA24819	GA-141	GREA
GG-263	GG-263	GONH	GH2500	GP-5	GUIO	GM24457	GP-37	GREA	GMA24831	GAD-118	GREA
GG-264	GG-264	GONH	GH27096	GP-51	ERF	GM24466	GP-28 ⁹	GREA	GMA24832	GA-432	GREA
GG-265	GG-265	GONH	GH2805	GP-50	GUIO	GM24466	GP-430 ⁸	GREA	GMA24858	GA-127	GREA
GG-266	GG-266	GONH	GH2807	GP-81	GUIO	GM24484	GP-212	GREA	GMA24873	GA-514	GREA
GG-267	GG-267	GONH	GH2809	GP-171	GUIO	GM24651	GP-68	GREA	GMA24880	GA-164	GREA

Referencia Cruzada por Numero de Parte

Cross Reference by Part Number



Numero	Gonher	Fabricante	Numero	Gonher	Fabricante	Numero	Gonher	Fabricante	Numero	Gonher	Fabricante
Number	Gonher	Manufacturer	Number	Gonher	Manufacturer	Number	Gonher	Manufacturer	Number	Gonher	Manufacturer
GMA25042	GA-442	GREA	GMA52923	GA-3501	GREA	GP16	GP-26	GUD	GP-3985	GP-3985	GONH
GMA25048	GA-132	GREA	GMA53384	GA-89	GREA	GP-16 USA	GP-81	GUSA	GP-3985 USA	GP-3985	GUSA
GMA25148	GA-384	GREA	GMA54669	GAD-294	GREA	GP-166	GP-166	GONH	GP-40	GP-40	GONH
GMA25248	GA-163	GREA	GMA60074	GA-55	GREA	GP170	G-1173	COO	GP-406	GP-406	GONH
GMA2709	GAD-187	GREA	GMA640	GA-3424	GREA	GP170	G-1173	GUD	GP-408	GP-408	GONH
GMA2719	GA-2719B	GREA	GMA641	GA-3425	GREA	GP171	GP-171	GONH	GP-4102 USA	GP-1122	GUSA
GMA30045	GA-77	GREA	GMA660	GA-230	GREA	GP172	G-801	COO	GP-42	GP-42	GONH
GMA30057	GA-80	GREA	GMA663	GA-4958	GREA	GP172	G-801	GUD	GP-42 USA	GP-54	GUSA
GMA30059	GA-50	GREA	GMA705	GAVW-4	GREA	GP-178	GP-178	GONH	GP-428	GP-428	GONH
GMA30067	GA-192	GREA	GMA713	GA-735 ¹²⁴	GREA	GP179	G-801	COO	GP-43	GP-43	GONH
GMA30110	GA-349 ⁵⁸	GREA	GMA73	GA-101	GREA	GP179	G-801	GUD	GP-43 USA	GP-9	GUSA
GMA30110	GAD-3	GREA	GMA735	GA-54	GREA	GP-193	GP-193	GONH	GP-430	GP-430	GONH
GMA303	GA-303	GREA	GMA736	GA-3523	GREA	GP2	G-31	COO	GP-432	GP-432	GONH
GMA305	GA-730	GREA	GMA749	GA-4303	GREA	GP2	G-31	GUD	GP-4386 USA	GP-156	GUSA
GMA324A	GA-85	GREA	GMA753	GA-86	GREA	GP-2 USA	GP-68	GUSA	GP-44	GP-44	GONH
GMA325	GA-325	GREA	GMA773	GA-3588	GREA	GP-20	GP-20	GONH	GP-452	GP-452	GONH
GMA326	GA-59	GREA	GMA785	GA-3647	GREA	GP-20 USA	GP-14	GUSA	GP-453	GP-453	GONH
GMA327	GA-57	GREA	GMA790	GA-75	GREA	GP-2015W	GP-2015W	GONH	GP-454	GP-454	GONH
GMA3300	GA-3300	GREA	GMA801	GA-2740	GREA	GP-2022W	GP-2022W	GONH	GP-455	GP-455	GONH
GMA33193	GA-735 ¹²⁴	GREA	GMA826	GA-3681	GREA	GP-205	GP-205	GONH	GP-457	GP-457	GONH
GMA33380	GA-3647	GREA	GMA905	GA-153	GREA	GP205C	G-870	COO	GP-458	GP-458	GLOB
GMA33466	GA-4828	GREA	GMAP3373	GAVW-2	GREA	GP205C	G-870	GUD	GP-458	GP-458	GONH
GMA33472	GA-274	GREA	GMAP3375	GA-271	GREA	GP-2071W	GP-2071W	GONH	GP-46	GP-46	GONH
GMA33590	GA-3916	GREA	GMAP3441	GA-277	GREA	GP-2108W	GP-2108W	GONH	GP-46 GOLD	GP-46 GOLD	GONH
GMA33591	GA-3814	GREA	GMAP3575	GA-271	GREA	GP-212	GP-212	GONH	GP-461	GP-461	GONH
GMA3373	GAVW-2	GREA	GMAP3580	GA-274	GREA	GP-2126Q	GP-2126Q	GONH	GP-462	GP-462	GONH
GMA340A	GA-86	GREA	GMAP3592	GA-273	GREA	GP-2127W	GP-2127W	GONH	GP-48	GP-48	GONH
GMA34356	GA-390	GREA	GMAP3593	GA-75	GREA	GP-22	GP-22	GONH	GP-490	GP-490	GONH
GMA34361	GA-139	GREA	GMAP4278	GAD-15	GREA	GP-23	GP-23	GONH	GP-4967 USA	GP-157	GUSA
GMA3441	GA-277	GREA	GMAP4339	GA-3915	GREA	GP236	G-870	COO	GP-49A USA	GP-51	GUSA
GMA3445	GA-345	GREA	GMAP4343	GA-5056	GREA	GP236	G-870	GUD	GP-5	GP-5	GONH
GMA34479	GA-6479	GREA	GMAP4356	GA-390	GREA	GP24	GPP-11	PUR	GP-5 USA	GP-205	GUSA
GMA34487	GA-382	GREA	GMAP4372	GA-3901	GREA	GP-24	GP-24	GONH	GP-50	GP-50	GONH
GMA34613	GA-142	GREA	GMAP4378	GA-174	GREA	GP25	S 3202 ⁴⁹	PUR	GP-50 USA	GP-50	GUSA
GMA34625	GA-2106	GRAN	GMAP4468	GA-195	GREA	GP-25 USA	GP-20	GUSA	GP505	G-1173	COO
GMA3467	GA-4235	GREA	GMAP4471	GA-471	GREA	GP26	GPP-11	PUR	GP505	G-1173	GUD
GMA347	GA-429	GREA	GMAP4479	GA-6479	GREA	GP-26	GP-26	GONH	GP506	G-1143	COO
GMA34721	GA-198	GREA	GMAP4487	GA-382	GREA	GP27	GPP-11	PUR	GP506	G-1143	GUD
GMA34799	GA-381	GREA	GMAP4632	GA-275	GREA	GP-27	GP-27	GONH	GP509	G-31	GUD
GMA34852	GA-392	GREA	GMAP4656	GA-7017	GREA	GP28	GP-56	PUR	GP-51	GP-51	GONH
GMA34877	GA-175	GREA	GMAP4680	GA-386	GREA	GP-28	GP-28	GONH	GP515	G-225	GUD
GMA34878	GA-1615	GREA	GMAP749	GA-4303	GREA	GP-28 GOLD	GP-28 GOLD	GONH	GP52	G-152	GUD
GMA34879	GA-1616	GREA	GMAP974	GA-3916	GREA	GP-2825 USA	GP-38	GUSA	GP-52	GP-52	GONH
GMA349	GA-349	GREA	GMF501	GG-6	COBR	GP-2849A USA	GP-24	GUSA	GP-53	GP-53	GONH
GMA3490	GA-3490	GREA	GMF502	GG-7	COBR	GP-2865A USA	GP-42	GUSA	GP-54	GP-54	GONH
GMA34995	GAVW-121	GREA	GMF503	GG-123	COBR	GP-2870A USA	GP-28	GUSA	GP-548	GP-548	GLOB
GMA351	GA-75	GREA	GMF504	GG-16	COBR	GP-291	GP-291	GONH	GP-548	GP-548	GONH
GMA35150	GA-172	GREA	GMF505	GG-17	COBR	GP-2951	GP-2951	GONH	GP-55	GP-55	GONH
GMA35155	GA-130	GREA	GMF562	GG-256	COBR	GP-2951 USA	GP-2951	GUSA	GP-556	GP-556	GONH
GMA35192	GA-158	GREA	GMF573	GG-580	COBR	GP-3	GP-3	GONH	GP-56	GP-56	GUSA
GMA352	GAD-187	GREA	GMF581	GG-46	COBR	GP-30 USA	GP-3	GUSA	GP-5618 USA	GP-457	GONH
GMA35227	GA-279	GREA	GMF582	GG-242	COBR	GP-3000	GP-3000	GONH	GP-562	GP-562	GONH
GMA35265	GA-8606	GREA	GMF583	GG-3728	COBR	GP-3001	GP-3001	GONH	GP-57	GP-57	GONH
GMA353	GAD-3	GREA	GMF592	GG-111	COBR	GP-31	GP-31	GONH	GP-58	GP-58	GONH
GMA3566	GA-3566	GREA	GMF592	GPP-524	COBR	GP-310	GP-310	GONH	GP-58 GOLD	GP-58 GOLD	GONH
GMA3575	GA-3274	GREA	GMF596	G-294	COBR	GP-317H	GP-317H	GLOB	GP6	G-31	GUD
GMA3580	GA-274	GREA	GMOHF378	GA-27	SCHM	GP-317H	GP-317H	GONH	GP-62	GP-62	GONH
GMA3621	GA-140	GREA	GN603129	G-836	AVEL	GP-3335 USA	GP-52	GUSA	GP-6349 USA	GP-3000	GUSA
GMA381	GA-74	GREA	GN6169991	G-801	AVEL	GP-3387A USA	GP-46	GUSA	GP-642	GP-642	GONH
GMA3814	GA-3814	GREA	GNT603129	G-836	AVEL	GP-34	GP-34	GONH	GP-66	GP-66	GONH
GMA40003	GA-75	GREA	GOH621001	GA-33	AVEL	GP-3429	GP-3429	GONH	GP-6607 USA	GP-91	GUSA
GMA40004	GA-70	GREA	GP-1	GP-1	GONH	GP-3429 USA	GP-3429	GUSA	GP-67	GP-67	GONH
GMA40015	GA-3490	GREA	GP-10	GP-10	GONH	GP-35	GP-35	GONH	GP-68	GP-68	GONH
GMA40016	GA-2740	GREA	GP-1010Q	GP-1010Q	GONH	GP-3506 USA	GP-44	GUSA	GP-6811	GP-6811	GONH
GMA40068	GA-78	GREA	GP-1011Q	GP-1011Q	GONH	GP-3531 EXP	GP-3531 EXP	GONH	GP-69	G-500	GUD
GMA40090	GA-303	GREA	GP-1012Q	GP-1012Q	GONH	GP-3531 USA	GP-3531 EXP	GONH	GP-69	GP-69	GONH
GMA40113	GA-75	GREA	GP-1013Q	GP-1013Q	GONH	GP-3535 USA	GP-48	GUSA	GP-691	GP-691	GONH
GMA40120	GA-74	GREA	GP108	G-191	COO	GP-3562	GP-3562	GONH	GP-7317 USA	GP-149	GUSA
GMA40124	GA-2719B ¹²²	GREA	GP108	G-191	GUD	GP-3569	GP-3569	GONH	GP-737	GP-737	GLOB
GMA40129	GA-3300 ⁵⁸	GREA	GP-11	GP-11	GONH	GP-3569 USA	GP-3569	GUSA	GP-737	GP-737	GONH
GMA40124	GA-3424	GREA	GP-110	GP-110	GONH	GP-359	GP-359	GONH	GP-749	GP-749	GONH
GMA40131	GA-3425	GREA	GP-1101	GP-1101	GONH	GP-36	GP-36	GONH	GP-754	GP-754	GONH
GMA4244	GAD-3	GREA	GP-1101A USA	GP-1101	GUSA	GP-36 USA	GP-36	GUSA	GP-761H	GP-761H	GONH
GMA42828	GA-4828	GREA	GP-1104 USA	GP-1104	GUSA	GP-3600	GP-3600	GONH	GP-77	GP-77	GONH
GMA43138	GA-54	GREA	GP-1105	GP-1105	GONH	GP-3600 GOLD	GP-3600 GOLD	GONH	GP-78	GP-78	GONH
GMA43149	GA-3523	GREA	GP-1107	GP-1107	GONH	GP-3600 USA	GP-3600	GUSA	GP-81	GP-81	GONH
GMA43195	GA-3588	GREA	GP-1108	GP-1108	GONH	GP-3614 USA	GP-58	GUSA	GP-8212 USA	GP-212	GUSA
GMA4326	GA-78	GREA	GP-1109	GP-1109	GONH	GP-3675	GP-3675	GONH	GP823	G-5000	COO
GMA43398	GA-3566	GREA	GP-1109 USA	GP-83	GUSA	GP-3675 USA	GP-3675	GUSA	GP823	G-5000	GUD
GMA43467	GA-4325	GREA	GP-1110 USA	GP-84	GUSA	GP-3682	GP-3682	GONH	GP-83	GP-83	GONH
GMA43474	GA-3681	GREA	GP-112	GP-112	GONH	GP-3682 USA	GP-3682	GUSA	GP-8316 USA	GP-128	GUSA
GMA4361	GA-139	GREA	GP-1121 USA	GP-78	GUSA	GP-37	GP-37	GONH	GP-84	GP-84	GONH
GMA44326	GA-78	GREA	GP-1122	GP-1122	GONH	GP-37 GOLD	GP-37 GOLD	GONH	GP-85	GP-85	GONH
GMA44327	GA-4958	GREA	GP-1224	GP-1224	GONH	GP-373 USA	GP-23	GUSA	GP-864H	GP-864H	GONH
GMA44626	GA-6619 ¹	GREA	GP-1232	GP-1232	GONH	GP-3766	GP-3766	GONH	GP-88	GP-88	GONH
GMA44626	GA-6620 ¹	GREA	GP-128	GP-128	GONH	GP-3766 USA	GP-3766	GUSA	GP-8873 USA	GP-408	GUSA
GMA44632	GA-275	GREA	GP-13	GP-13	GONH	GP-3786 USA	GP-562	GUSA	GP-8A USA	GP-1	GUSA
GMA44727	GA-300	GREA	GP-13 USA	GP-13	GUSA	GP-38	GP-38	GONH	GP-9	GP-9	GONH
GMA45047	GA-240	GREA	GP-14	GP-14	GONH	GP-3816	GP-3816	GONH	GP-9000	GP-9000	GONH
GMA45090	GA-673R	GREA	GP-145	GP-145	GONH	GP-3816 USA	GP-3816	GUSA	GP-9001	GP-9001	GONH
GMA45091	GA-732R	GREA	GP-149	GP-149	GONH	GP-390	GP-390	GONH	GP-91	GP-91	GONH
GMA50084	GA-730	GREA	GP-152	GP-152	GONH	GP-3937	GP-3937	GONH	GP-92	GP-92	GONH
GMA50091	GA-59	GREA	GP-155	GP-155	GONH	GP-3950 USA	GP-40	GUSA	GP-93	GP-93	GONH
GMA50092	GA-57	GREA	GP-156	GP-156	GONH	GP-3976 USA	GP-178	GUSA	GP-9586	GP-9586	GONH
GMA50831	GA-85	GREA	GP-157	GP-157	GONH	GP-3980	GP-3980	GONH	GP-96	GP-96	GONH
GMA50991	GA-86	GREA	GP159	G-1176	GUD	GP-3980 USA	GP-3980	GUSA	GP-9688 USA	GP-6811	GUSA

REFERENCIA CRUZADA

Para números Gonher con Superíndice vea página 651
For Gonher with Superscript numbers see page 651

Visite nuestro sitio en internet www.grupogonher.com
Visit our web site www.grupogonher.com

Numero	Gonher	Fabricante	Numero	Gonher	Fabricante	Numero	Gonher	Fabricante	Numero	Gonher	Fabricante
Number	Gonher	Manufacturer	Number	Gonher	Manufacturer	Number	Gonher	Manufacturer	Number	Gonher	Manufacturer
GP-18694-A		G-6 FORD	H1076X		G-989 MNH	H19W02		GP-54 HEN	H5991		G-871 TECF
GPP-1000		GPP-1000 GONH	H1081		G-191 MNH	H19W03		GP-31 HEN	H60030		GP-84 PUR
GPP-1003S		GPP-1003S GONH	H108379		GA-39 GRAD	H19W04		GP-31 HEN	H601		G-225 MNH
GPP-10075		GPP-10075 GONH	H108379		GA-39 WARM	H19W05		GP-54 HEN	H6010		G-162H MNH
GPP-1022S		GPP-1022S GONH	H10W		GP-81 HEN	H19W07		GP-54 HEN	H601-4		G-162H MNH
GPP-103		GPP-103 GONH	H10W01		GP-81 HEN	H19W0D01		GP-66 HEN	H6017		G-225 MNH
GPP-1060		GPP-1060 GONH	H10W02		GP-171 HEN	H19W0D02		GP-66 HEN	H60WK		GP-1122 HEN
GPP-1061		GPP-1061 GONH	H10W03		GP-171 HEN	H19W0K01		GP-110 HEN	H60WK01		GP-1122 HEN
GPP-11		GPP-11 GONH	H10W05		GP-3816 HEN	H200W		GP-51 HEN	H60WK03		GP-1122 HEN
GPP-111		GPP-111 GONH	H11W01		GP-22 HEN	H200W01		GP-51 HEN	H625627		GP-1108 KORO
GPP-111		GPP-111 GONH	H11W02		GP-291 HEN	H20120		GP-14 PUR	H672603		GP-78 KORO
GPP-1122		GPP-1122 GONH	H11WN		GP-50 HEN	H205WK		GP-1107 HEN	H675616		GP-69 KORO
GPP-1287		GPP-1287 GONH	H12105		G-33 MNH	H20W		GP-81 HEN	H7077		GP-66 INSL
GPP-1291		GPP-1291 GONH	H12105N		G-33 MNH	H20W01		GP-46 HEN	H7090WK30		GPP-1291 ³⁹
GPP-14		GPP-14 GONH	H12105X		G-33 MNH	H20W02		GP-40 HEN	H7090WK30		PFF831 ⁴¹
GPP-18		GPP-18 GONH	H121102		G-143 MNH	H217307		GP-66 DAVS	H7090WK30		R 90 P ⁴²
GPP-19		GPP-19 GONH	H12110-2X		G-143 MNH	H21W		GP-171 HEN	H70WK		GP-1122 HEN
GPP-418		GPP-418 GONH	H1221		GAK-403 ROGR	H24W01		GP-171 HEN	H70WK01		GP-1122 HEN
GPP-419		GPP-419 GONH	H1224		GA-106 ⁴⁶ QUIN	H25		GP-20 HOPE	H70WK02		GPP-1122 HEN
GPP-420		GPP-420 GONH	H1224		GA-326 ⁷¹ QUIN	H26025		G-159 PUR	H711		G-870 MNH
GPP-421		GPP-421 GONH	H1224		GA-106 ⁴⁶ ROGR	H26336		GG-5 L GRAD	H7110		G-871 MNH
GPP-423		GPP-423 GONH	H1224		GA-326 ⁷¹ ROGR	H26336		GG-5 L WASW	H712		G-871 MNH
GPP-424		GPP-424 GONH	H1225		GA-206 QUIN	H27096		GP-51 GARD	H712K		G-871 MNH
GPP-425		GPP-425 GONH	H1225		GA-206 ROGR	H27096		GP-51 GARE	H712N		G-834 MNH
GPP-426		GPP-426 GONH	H1226		GA-6129 ROGR	H2870A		GP-28 ⁶ HOPE	H7120		G-871 MNH
GPP-523		GPP-523 GONH	H1227		GA-6127 ROGR	H2870A		GP-430 ⁸ HOPE	H712T		G-871 MNH
GPP-524		GPP-511 GONH	H1260X		G-5000 MNH	H28895		GA-27 INGR	H712X		G-871 MNH
GPP-524		GPP-524 GONH	H1263-1		G-331 MNH	H28896		GA-27 INGR	H712Z		G-871 MNH
GPP-547		GPP-547 GONH	H1275		G-163 MNH	H28937		GA-27 INGR	H7271X		G-971 MNH
GRP-612		GPP-612 GONH	H1275X		G-163 MNH	H28938		GA-27 INGR	H75TM-9601-AA		GAVV-2 FORD
GRH27096		GP-51 LEYL	H1277		G-163 MNH	H30		GP-3 HOPE	H-77-FG-9601-AA		GA-2194 FORD
GS11		GG-6 SIEG	H1285		G-163 MNH	H30014		G-122 PUR	H804-99		G-870 MNH
GS-1133		GS-1133 GONH	H12W01		GP-81 ³¹ HEN	H30014		G-338 PUR	H804N		G-870 MNH
GS117		GG-213 KRA	H12W01		GP-9 ⁵⁸ HEN	H30030		G-331 PUR	H804T		G-870 KNE
GS12		GG-7 SIEG	H12W03		GP-22 HEN	H30059		GP-66 PUR	H804T		G-870 MNH
GS-1261		GS-1261 GONH	H13153		G-566 MNH	H300WD01		GP-52 ¹¹⁰ HEN	H804X		G-870 MNH
GS13		GG-123 SIEG	H131WK		GP-110 HEN	H300WD01		GP-691 ⁸⁸ HEN	H80WK01		GG-251 HEN
GS2		GG-5 L SIEG	H13201-1		GP-171 ISUZ	H30113		GP-166 ¹⁰⁰ PUR	H80WK03		GG-189 HEN
GS-2033		GS-2033 GONH	H137901		GAK-16 CASE	H30114		G-122 PUR	H80WK04		GG-189 HEN
GS-2034		GS-2034 GONH	H13WK		GP-1101 HEN	H30114		G-338 PUR	H8121T		G-1173 ¹⁰⁸ MNH
GS22		GG-19 SIEG	H141W		GP-28 ⁸ HEN	H30475H		GG-87 JOND	H819N		G-871 MNH
GS3389		GG-17 SIEG	H141W		GP-430 ⁸ HEN	H30475K		GG-87 JOND	H81WK01		GPP-1122 HEN
GS3727		GG-46 SIEG	H142W		GP-28 ⁸ HEN	H30WK		GP-1122 HEN	H820		G-813 MNH
GS-557		GS-557 GONH	H142W		GP-430 ⁸ HEN	H30WK01		GPP-1122 HEN	H8203		G-813 MNH
GY01-14-302B		GP-68 MZDA	H1496		G-238 MNH	H311647		GP-66 CASE	H820-3X		G-813 MNH
			H1497-1		G-222 MNH	H311647		GP-66 DAVS	H822-1X		G-1174 ¹⁰⁸ MNH
			H149710		G-222 MNH	H31WK		G-1121 HEN	H8251V		G-1175 ¹⁰⁸ MNH
			H149710		G-222 MNH	H31WK01		G-1121 HEN	H827-1N		G-871 MNH
			H14W03		GP-3600 HEN	H32010		GP-66 PUR	H82WK01		GG-5 L HEN
			H14W04		GP-3600 HEN	H32025		GP-66 PUR	H832X		G-1175 ¹⁰⁸ MNH
			H14W05		GP-38 HEN	H334540		GP-81 CASE	H835-1V		G-1176 MNH
			H14W06		GP-38 HEN	H3387A		GP-46 HOPE	H835-1X		G-1176 MNH
			H14W07		GP-28 ⁸ HEN	H341974		GP-34 CASE	H83WK01		GG-246 HEN
			H14W07		GP-430 ⁸ HEN	H3429		GP-3429 HOPE	H84WK01		GG-246 HEN
			H14W08		GP-3980 HEN	H35028		GP-761H PUR	H84WK02		GG-226 HEN
			H14W10		GP-3600 HEN	H35029		GP-761H PUR	H85505-01		GAK-625 POCL
			H14W11		GP-28 ⁸ HEN	H3505-37		GAK-20 WAIN	H88-4		G-238 LROI
			H14W11		GP-430 ⁸ HEN	H3505-38		GAK-20 WAIN	H8A		GP-1 HOPE
			H14W12		GP-28 ⁸ HEN	H3505-388		GAK-20 WAIN	H901W		GP-3816 HEN
			H14W12		GP-430 ⁸ HEN	H35235		GP-761H PUR	H90W		GP-3816 HEN
			H15W		GP-14 HEN	H3531		GP-3531 EXP HOPE	H90W01		GP-3816 HEN
			H16		GP-81 ³¹ HOPE	H3535		GP-3980 HOPE	H90W02		GP-3816 HEN
			H16		GP-9 ⁵⁸ HOPE	H36057		GP-761H PUR	H90W03		GP-46 HEN
H028937		GA-27 INGR	H16041		G-169 PUR	H3706-10M192		GP-66 FLUT	H90W04		GP-3816 HEN
H028938		GA-27 INGR	H16W		GP-3 HEN	H370615F19		GGP-25 CIM	H90W13		GP-461 HEN
H0575		GP-54 ¹¹ TECF	H16W01		GP-3600 HEN	H370615F19		GGP-25 FLUT	H90WK		GP-1122 HEN
H0575		GP-66 ¹⁰ TECF	H16W03		GP-3600 HEN	H3706-25M192N		GP-66 FLUT	H9131		G-122 MNH
H0606		GP-28 ⁸ TECF	H170-1W		GP-36 HEN	H371872		GP-66 CASE	H9131		G-338 MNH
H0606		GP-430 ⁸ TECF	H170WK		GP-749 HEN	H40029		GP-34 PUR	H9161X		G-296 MNH
H0621		GP-46 TECF	H17W01		GP-310 HEN	H40W		GP-81 HEN	H9161X		G-296-8 MNH
H0634		GP-46 TECF	H17W02		GP-1 HEN	H4104001		GP-66 FLUI	H925-1X		G-236 MNH
H0661		GP-171 TECF	H17W03		GP-1 HEN	H410-4001		GP-66 MIFP	H9253X		G-954 MNH
H0662		GP-36 TECF	H17W04		GP-36 HEN	H4104002		GP-66 FLUI	H9263X		G-963 MNH
H07452-1902		GA-360 ISHI	H17W05		GP-310 HEN	H410-4002		GP-66 MIFP	H9281		G-330 DUTZ
H102910		G-836 MNH	H17W06		GP-1 HEN	H411272		GP-36 CASE	H928-1		G-330 MNH
H1029-1N		G-836 MNH	H17W08		GP-1 HEN	H4119		G-330 DUTZ	H928-1T		G-330 MNH
H1032		G-6 MNH	H17W09		GP-14 HEN	H4119		G-330 FAUN	H928T		G-330 MNH
H-1032-1X		G-932 MNH	H17W0D02		GP-36 HEN	H413666		GG-5 L CASE	H935		G-139 MNH
H1034		G-834 MNH	H17WK02		GP-1122 HEN	H425256		GA-33 ¹¹² CASE	H936-1X		G-200 MNH
H1034-2X		G-834 MNH	H1808896		GP-69 KORO	H43623		GA-39 KOHL	H97W06		GP-91 HEN
H10343		G-834 MNH	H18180		G-153 MNH	H43-623		GA-39 LROI	H97W07		GP-157 HEN
H1034X		G-834 MNH	H181W		GP-54 ¹¹ HEN	H43-661		GA-12 BENX	H980106		GAK-403 RANG
H1038		G-834 MNH	H181W		GP-66 ¹⁰ HEN	H43-661		GA-12 LROI	H980106		GAK-403 RANS
H1038X		G-834 MNH	H18W		GP-54 HEN	H46049		G-339H PUR	H99737		GA-360 GALN
H1042-2		G-335 MNH	H18W01		GP-54 ¹¹ HEN	H5007-10M26		GP-34 FLUT	HAI13		GA-75 HECK
H104220		G-335 MNH	H18W01		GP-66 ¹⁰ HEN	H50078		G-33 PUR	HAI29		GA-3424 HECK
H1067-1		G-33 MNH	H18W02		GP-69 HEN	H50087		G-152 PUR	HAI32		GA-50 HECK
H1067-1X		G-33 MNH	H18W03		GP-54 ¹¹ HEN	H50205		G-222 PUR	HAI36		GA-55 HERI
H106712		G-33 MNH	H18W03		GP-66 ¹⁰ HEN	H50246		GP-66 PUR	HAI48		GA-80 HERI
H1072-11X		G-191 MNH	H18W04		GP-54 HEN	H50305		G-153 PUR	HAI78		GA-192 HECK
H10721X		G-191 MNH	H18WD01		GP-66 HEN	H5111-10M26		GP-34 FLUT	HA2104K		GA-26 MIGH
H1074		G-152 MNH	H18WK05		GP-548 HEN	H55221		GP-761H PUR	HA2314		GA-378 MIGH
H10740		G-152 MNH	H19226X		G-500 MNH	H56059		GP-761H PUR	HA25398		GA-293 QTEE
H10740		G-152 MNH	H19326X		G-500 MNH	H56060		GP-761H PUR	HA25405		GA-183R QTEE
H1076		G-133 MNH	H19W		GP-54 HEN	H56061		GP-761H PUR	HA25418		GA-395 HERI
H1076		G-989 MNH	H19W01		GP-54 HEN	H56062		GP-761H PUR	HA25446		GA-780 HERI
H1076X		G-133 MNH									

Números Nuevos

H

Referencia Cruzada por Numero de Parte

Cross Reference by Part Number



Numero	Gonher	Fabricante	Numero	Gonher	Fabricante	Numero	Gonher	Fabricante	Numero	Gonher	Fabricante
Number	Gonher	Manufacturer	Number	Gonher	Manufacturer	Number	Gonher	Manufacturer	Number	Gonher	Manufacturer
HA2740	GA-2740	JFL	HA8099	GA-2118	JFL	HCF11590	GAK-403	CLRK	HD09	GP-69	TEX
HA2893	GA-6880	MIGH	HA8141	GA-1614	HERI	HCF12112	GAK-20	AUSW	HDS7543	GP-34	ROMA
HA2897	GA-229	MIGH	HA8141	GA-2114	JFL	HCF12112	GAK-20	CLRK	HDZ104	GP-34	RYCO
HA3228	GA-209	MIGH	HA8162	GA-1617	HERI	HCF12445	GAK-20	AUSW	HDZ117	GP-78	RYCO
HA3295	GA-229	MIGH	HA8205	GA-301	HERI	HCF12445	GAK-20	CLAA	HDZ157	GP-1122	RYCO
HA3445	GA-3445	JFL	HA8208	GA-607	HERI	HCF12445	GAK-20	CLRK	HDZ179	GP-36	RYCO
HA3501	GA-3501	HERI	HA8221	GA-279	HERI	HCF14205	GAK-403	AUSW	HDZ209	GP-9586	RYCO
HA35396	GA-248	HERI	HA82799	G-871	MFI	HCF14205	GAK-403	CLRK	HDZ211	GP-51	RYCO
HA35404	GA-264	HERI	HA83	GA-85	HECK	HCF15919	GAK-403	CLAA	HDZ217	GP-55	RYCO
HA35414	GA-477	HERI	HA84	GA-730	HECK	HCF15919	GAK-403	CLRK	HDZ229	GP-43	RYCO
HA35414	GA-477	QTEE	HA8548	GA-304	JFL	HCF15974	GA-24 ³⁴	AUSW	HDZ232	GP-53	RYCO
HA35462	GA-490	HERI	HA8602	GAVW-621	HERI	HCF15974	GA-24 ³⁴	CLAA	HDZ233	GP-57	RYCO
HA3566	GA-3566	JFL	HA872	GA-3490	ASAH	HCF15974	GA-24 ³⁴	CLRK	HDZ235	GP-52 ¹⁰	RYCO
HA3621	GA-140	JFL	HA873	GA-2740	ASAH	HCF17443	GAK-20	CLRK	HDZ235	GP-691 ⁴⁸	RYCO
HA3649	GA-390	JFL	HA8747	GA-258	JFL	HCF17684	GA-27	CLRK	HDZ239	GP-43	RYCO
HA3997	GA-216	HERI	HA8754	GA-6479 ⁹⁰	HERI	HCF18339	GA-27	CLRK	HDZ240	GP-53	RYCO
HA4	GA-70	HECK	HA8755	GA-348	HERI	HCK-6731-A	G-6	FORD	HDZ265W	GP-2071W	RYCO
HA4365	GA-4365	HERI	HA8756	GA-348	HERI	HD222	GP-171 ¹⁶	ACD	HDZ300	GP-77	RYCO
HA4383	GA-471	HERI	HA8760	GA-183	HERI	HD222L	GP-171 ¹⁶	ACD	HDZ302	GP-56	RYCO
HA45	GA-77	HECK	HA8805	GA-278R	HERI	HD260F3330	G-1173 ¹⁰⁸	CONT	HDZ374	GP-3000	RYCO
HA4521	GA-2194	HERI	HA8918	GA-286	HERI	HD260F3340	G-1173 ¹⁰⁸	CATP	HE122-0323	GP-3600	JOND
HA4576	GA-2110	HERI	HA8925	GA-780	HERI	HD260F3340	G-1173 ¹⁰⁸	CLRK	HE122-0338	GP-3816	JOND
HA4939	GA-139	HERI	HA8956	GA-479	QTEE	HD260F3340	G-1173 ¹⁰⁸	CONT	HE122-0445	GP-3600	JOND
HA4958	GA-4958	JFL	HA8969	GA-168	HERI	HD260F3340	G-1173 ¹⁰⁸	GRAY	HE19-23-603	GA-216	MZDA
HA502	GA-26	CSP	HA8997	GA-224	HERI	HD260F3340	G-1173 ¹⁰⁸	TOWM	HE40-0000407	GP-81 ²¹	KOMA
HA507	GA-885	CHAM	HA90	GA-303	HECK	HD260F3348	G-1173 ¹⁰⁸	CONT	HE40-0000407	GP-9 ⁸⁸	KOMA
HA508	GA-378	CSP	HA91	GA-59	HECK	HD260F4139	G-1173 ¹⁰⁸	CONT	HE8115	G-750	LETR
HA510	GA-376	CSP	HA92	GA-57	HECK	HD260F4190	G-1173 ¹⁰⁸	CONT	HEM6001	G-162H	COO
HA513	GA-6880	CSP	HA9334	GA-9334	MIGH	HD260L5010	G-31	CONT	HEM6018	G-153	COO
HA514	GA-229	CSP	HA94	GA-3300	HECK	HD269W	GP-2022W	RYCO	HEM6025	G-191	COO
HA515	GA-3501	CSP	HA9492	GA-367	HERI	HD3408	GA-516R	VOX	HEM6041	G-331	COO
HA52	GA-71	HECK	HA99	GA-86	HECK	HD4053	GA-357	COO	HEM6045	G-191	COO
HA523	GA-372	CSP	HC	GP-42	HOND	HD48F	G-1176	UNI	HEM6056	G-339H	COO
HA527	GA-2984	CSP	HC10	GP-5	ACD	HD6838	G-1176	LETR	HEM6066	GP-66	COO
HA533	GA-209	CSP	HC11	GP-3	ACD	HDA0083	GA-357	HDA	HEM6087	G-333	COO
HA534	GA-107	CSP	HC155	G-152	FLUX	HDA-0876	GA-885	HDA	HEM6098	G-122	COO
HA5350	GA-2114	HERI	HC2	GP-1	ACD	HDA1243	GA-26 ¹¹²	HDA	HEM6098	G-338	COO
HA537	GA-373	CSP	HC2	GP-66	KNE	HDA1317	GA-389	HDA	HEM6176	G-162H	COO
HA538	GA-229	CSP	HC2	GP-66	MAHL	HDA4044	GA-616	HDA	HET6152	G-169	COO
HA539	GA-109	CSP	HC2	GP-66	SOPA	HDA4747	GA-98 ¹¹²	HDA	HET6153	G-159	COO
HA540	GA-493 ¹⁰⁸	CSP	HC34	GP-52 ¹¹⁰	MAHL	HDA-5069	GA-879	HDA	HET6154	G-33	COO
HA544	GA-9334	CSP	HC34	GP-691 ⁴⁸	MAHL	HDA5109	GA-1285	RYCO	HF1000	GP-58	HAS
HA5466	GA-5466	HERI	HC3510	GP-66	PARK	HDA5110	GA-1286	RYCO	HF19-23-802	GP-462	MZDA
HA5522	GA-2146	HERI	HC3525	GP-66	PARK	HDA5168	GA-26 ¹¹²	RYCO	HF28783	GP-58 ⁹	FLG
HA55400	GA-413R	HERI	HC47652CS	G-31	HERC	HDA5245	GA-616	RYCO	HF28810	GP-34	FLG
HA5595	GA-595	HERI	HCS	GP-66	KNE	HDA5284	GA-26 ¹¹²	RYCO	HF28916	GP-317H	FLG
HA602	GA-271	HECK	HCS	GP-66	MAHL	HDA5305	GA-98 ¹¹²	RYCO	HF28921	GP-66	FLG
HA6305	GA-390	HERI	HCS	GP-66	TECF	HDA5337	GA-357	RYCO	HF28922	GP-66	FLG
HA6305	GA-390	JFL	HC57216	GP-42	HOND	HDA5367	GA-98 ¹¹²	RYCO	HF28931	GP-317H	FLG
HA6333	GA-382	JFL	HC5725	GP-34	PARK	HDA5388	GA-6880	RYCO	HF28989	GP-66	FLG
HA6376	GA-142	HERI	HC6	GP-66	KNE	HDA5455	GA-616	RYCO	HF28992	GP-761H	FLG
HA6376	GA-142	JFL	HC6	GP-66	MAHL	HDA5493	GA-563	RYCO	HF30008	GP-3766	FLG
HA6395	GA-195	HERI	HC6	GP-66	TECF	HDA5499	GA-493 ¹⁰⁸	RYCO	HF30195	GP-3766	FLG
HA6558	GA-2106	HERI	HC62	GP-66	KNE	HDA5501	GA-16 ¹¹²	HDA	HF35018	GP-166	FLG
HA6619	GA-6619 ¹	HERI	HC62	GP-66	MAHL	HDA5501	GAK-16 ³⁴	HDA	HF35299	GP-761H	FLG
HA6619	GA-6620 ³	HERI	HC62	GP-66	TECF	HDA5668	GA-16 ¹¹²	RYCO	HF35308	GP-3682	FLG
HA669	GA-27	ASAH	HC7	GP-5	ACD	HDA5668	GAK-16 ³⁴	RYCO	HF501	GP-11	CSP
HA6690	GA-6690	HERI	HC7	GP-28 ⁹	KNE	HDA6869	GA-616	HDA	HF503	G-1143	CSP
HA6807	GA-386	HERI	HC7	GP-430 ⁹	KNE	HDA7703	GA-16 ¹¹²	HDA	HF504	GP-1101	CSP
HA6807	GA-386	JFL	HC7	GP-28 ⁹	MAHL	HDA7703	GAK-16 ³⁴	HDA	HF505	GP-14	CSP
HA6931	GA-29	HERI	HC7	GP-430 ⁹	MAHL	HDA8299	GA-6880	HDA	HF506	GP-1101	CSP
HA7017	GA-7017	HERI	HC7	GP-28 ⁹	TECF	HDA8407	GA-563	HDA	HF507	GP-84	CSP
HA7017	GA-7017	JFL	HC7	GP-430 ⁹	TECF	HDA8494	GA-493 ¹⁰⁸	HDA	HF508	GP-83	CSP
HA7094	GA-604	HERI	HC7400SDN4H	GP-3766 ¹⁰⁰	PAL	HDA9159	GA-357	HDA	HF509	GP-1107	CSP
HA7094	GA-604	JFL	HC7400SDN4Z	GP-3766 ¹⁰⁰	PAL	HDA9587	GA-509 ¹⁴	HDA	HF510	GP-110	CSP
HA713	GA-735 ¹²⁴	HECK	HC7400SDP4H	GP-3766 ¹⁰⁰	PAL	HDC3	GP-2015W	TEX	HF511	GP-56	CSP
HA7142	GA-7142	HERI	HC7400SKN4H	GP-3766 ¹⁰⁰	PAL	HDC4	GP-2022W	TEX	HF512	GP-26	CSP
HA7174	GA-381	HERI	HC7400SKP4H	GP-3766 ¹⁰⁰	PAL	HDF1	GP-1101	TEX	HF513	GP-27	CSP
HA7174	GA-381	JFL	HC7400SUN4H	GP-3766 ¹⁰⁰	PAL	HDF11	GP-110	TEX	HF514	GP-1108	CSP
HA7337	GA-2184	JFL	HC7400SUP4H	GP-3766 ¹⁰⁰	PAL	HDF12	GP-56	TEX	HF515	GP-85	CSP
HA735	GA-54	HECK	HC7500FDJ4H	GP-34	PAL	HDF13	GP-78	TEX	HF516	GP-92	CSP
HA7351	GA-322	HERI	HC7500SDJ8H	GP-34	PAL	HDF14	GP-1108	TEX	HF517	GP-93	CSP
HA7351	GA-322	JFL	HC7500SDT4H	GP-864H	PAL	HDF2	GP-26	TEX	HF518	GP-293	CSP
HA736	GA-3523	HECK	HC7500SUH4H	GP-34	PAL	HDF296	G-296	CAV	HF519	G-1175 ¹⁰⁸	CSP
HA74	GA-55	HECK	HC7500SUJ8H	GP-34	PAL	HDF296	G-296-B	CAV	HF520	GP-78	FLG
HA7420	GA-514	HERI	HC7500SUT4H	GP-864H	PAL	HDF296	GG-298	CAV	HF6006	GP-333	CSP
HA7420	GA-514	JFL	HC-7901	GP-166	SAKU	HDF3	GP-27	TEX	HF6008	G-338	FLG
HA7421	GA-165	HERI	HC9500FS-UJH	GP-34	PAL	HDF4	GP-83	TEX	HF6054	G-122	FLG
HA7426	GA-432	JFL	HC9500FSUKY	GP-34	PAL	HDF5	GP-84	TEX	HF6054	G-338	FLG
HA7438	GA-442	HERI	HC9500SUH4H	GP-34	PAL	HDF6	GP-85	TEX	HF6055	GP-66	FLG
HA7605	GA-605	HERI	HC9500SUJ4H	GP-34	PAL	HDF601	GP-1122	LUC	HF6056	GP-66	FLG
HA7614	GAVW-620	HERI	HC9500SUK4H	GP-34	PAL	HDF796	G-297-B	DPHI	HF6057	GP-66	FLG
HA7620	GA-2198 ⁷⁹	HERI	HCA1596	GA-209	FRM	HDF9	G-1175 ¹⁰⁸	TEX	HF6058	GP-66	FLG
HA7620	GA-438 ³¹	HERI	HCA-2485	GA-323	FNIG	HDO1	GP-51	TEX	HF6067	GP-34	FLG
HA7628	GA-118	HERI	HCA2541	GA-251	FRM	HDO10	GP-54 ¹¹	TEX	HF6072	G-191	FLG
HA7640	GA-240	HERI	HCA507	GA-106 ⁴⁶	FRM	HDO10	GP-66 ¹⁰	TEX	HF6079	G-331	FLG
HA7669	GA-434	JFL	HCA507	GA-326 ⁷¹	FRM	HDO11	G-566	TEX	HF6080	GP-66	FLG
HA773	GA-3588	HECK	HCA523	GA-360	FRM	HDO12	GP-36	TEX	HF6083	G-153	FLG
HA7775	GA-476	HERI	HCA8046	GAC-9	JFL	HDO13	GP-52 ¹¹⁰	TEX	HF6088	G-33	FLG
HA785	GA-3647	HECK	HCAK2523	GAK-625	FRM	HDO13	GP-691 ⁴⁸	TEX	HF6096	GP-81	FLG
HA8007	GA-2193	JFL	HCAK253	GAK-16	FRM	HDO3	GP-57	TEX	HF6097	G-152	FLG
HA8037	GA-732R	HERI	HCAK254	GAK-20	FRM	HDO4	GP-9586	TEX	HF6098	G-222	FLG
HA8040	GA-384	HERI	HCAK257	GA-26	FRM	HDO5	G-750	TEX	HF6107	GP-171 ¹⁶	FLG

Numero	Gonher	Fabricante	Numero	Gonher	Fabricante	Numero	Gonher	Fabricante	Numero	Gonher	Fabricante
Number	Gonher	Manufacturer	Number	Gonher	Manufacturer	Number	Gonher	Manufacturer	Number	Gonher	Manufacturer
HF6122	GP-54	FLG	HF7968	GP-66	FLG	HFR86280	GP-66	FLR	HL8087	G-975	JFL
HF6123	GP-166 ¹⁰⁰	FLG	HF7990	GP-317H	FLG	HFR86351	GP-171 ¹⁶	FLR	HL8158	G-112	HERI
HF6125	GP-34	FLG	HF807	GP-54	HAS	HFR86352	GP-9	FLR	HL8213	G-984	HERI
HF6130	GP-34	FLG	HF825	GP-761H	HAS	HFR86358	GP-34	FLR	HL834P1	G-834	HERI
HF6133	GP-34	FLG	HF855	GG-76	ASAH	HFR86360	GP-66	FLR	HL8481	G-180	QTEE
HF6137	GP-34	FLG	HF856	GG-1	ASAH	HFR86373	G-33	FLR	HL8712	G-72	QTEE
HF6141	GP-34	FLG	HF856	GG-4	ASAH	HFR86436	GP-34	FLR	HL8765	G-765	HERI
HF6141	GP-66 ⁹⁰	FLG	HF859	GP-761H	HAS	HFR86439	GP-34	FLR	HL8806	G-45	HERI
HF6157	GP-34	FLG	HF860	GP-761H	HAS	HFR86500	GP-66	FLR	HL8873	GP-408	HERI
HF6158	GP-58	FLG	HF861	GP-761H	HAS	HFR86502	GP-66	FLR	HMF600-L04340	GP-50	JOND
HF6159	GP-36	FLG	HF862	GP-761H	HAS	HFR86510	GP-66	FLR	HN-932-6N	GP-112	PHOE
HF6162	G-162H	FLG	HF869	GP-761H	HAS	HFR86511	GP-66	FLR	HO1	GP-1	HECK
HF6184	G-339H	FLG	HF871	GP-761H	HAS	HFR86517	GP-761H	FLR	HO111	GP-46	HECK
HF6197	G-191	FLG	HF904	GP-34	HAS	HFR86520	GP-66	FLR	HO16	GP-81 ²¹	HECK
HF6204	GP-317H	FLG	HF905	GP-9	HAS	HFR86521	GP-66 ²¹	FLR	HO16	GP-9 ⁸⁸	HECK
HF6206	GP-36	FLG	HF906	GP-34	HAS	HFR86550	GP-761H	FLR	HO193	GP-91 ⁷⁸	HECK
HF6270	G-33	FLG	HF907	GP-50	HAS	HFR86551	GP-761H	FLR	HO24	GP-20	HECK
HF6279	GP-66	FLG	HF910	GP-171	HAS	HFR86552	GP-761H	FLR	HO25	GP-3	HECK
HF6280	GP-66	FLG	HF919	GP-166 ⁶⁵	HAS	HFR86553	GP-761H	FLR	HO29	GP-13	HECK
HF6306	G-24	FLG	HF919	GP-3937 ¹¹	HAS	HFR86554	GP-761H	FLR	HO400	GP-3600	HECK
HF6351	GP-171 ¹⁶	FLG	HF922	GP-66	HAS	HFR86555	GP-761H	FLR	HO45	GP-3429	HECK
HF6352	GP-9	FLG	HF928	GP-166	HAS	HFR86557	GP-761H	FLR	HO501	G-33	CSP
HF6358	GP-34	FLG	HF929	GP-6811	HAS	HFR86561	GP-761H	FLR	HO502	G-500	CSP
HF6360	GP-66	FLG	HF930	GP-66	HAS	HFR86562	GP-761H	FLR	HO503	G-750	CSP
HF6373	G-33	FLG	HF961	GP-3766 ¹⁰⁰	HAS	HFR86563	GP-761H	FLR	HO504	G-750	CSP
HF639	GG-369	AMCO	HF963	GP-66 ⁹⁰	HAS	HFR86564	GP-761H	FLR	HO505	GP-566	CSP
HF6436	GP-34	FLG	HF978	GP-171 ¹⁶	HAS	HFR86565	GP-761H	FLR	HO506	GP-36	CSP
HF6439	GP-34	FLG	HF984	GP-761H	HAS	HFR86566	GP-761H	FLR	HO507	GP-51	CSP
HF6500	GP-66	FLG	HF989	GP-761H	HAS	HFR86568	GP-761H	FLR	HO508	GP-52 ¹¹⁰	CSP
HF6500E	GP-36	FLG	HF990	GP-864H	HAS	HFR86572	GP-761H	FLR	HO508	GP-691 ⁴⁸	CSP
HF6502	GP-66	FLG	HF906	GP-85	TEX	HFR86573	GP-761H	FLR	HO509	GP-10	CSP
HF6508	GP-36	FLG	HF-E9001	G-153	GFF	HFR86603	GP-3766 ¹⁰⁰	FLR	HO51	GP-3980	HECK
HF6510	GP-66	FLG	HF-E9009	G-152	GFF	HFR86606	GP-3766 ¹⁰⁰	FLR	HO510	GP-53	CSP
HF6511	GP-66	FLG	HF-E9010	G-191	GFF	HFR86675	GP-3766 ¹⁰⁰	FLR	HO511	GP-53	CSP
HF6517	GP-761H	FLG	HF-E9011	G-162H	GFF	HFR86677	GP-3766 ¹⁰⁰	FLR	HO512	GP-9586	CSP
HF6520	GP-66	FLG	HF-E9047	G-238	GFF	HFR86700	GP-34	FLR	HO513	GP-57	CSP
HF6521	GP-66 ²¹	FLG	HF-E9053	G-159	GFF	HFR86710	GP-34	FLR	HO514	GP-43	CSP
HF6550	GP-761H	FLG	HF-E9055	G-169	GFF	HFR86711	GP-34	FLR	HO515	GP-53	CSP
HF6551	GP-761H	FLG	HFP170064	G-222	DON	HFR86720	GP-34	FLR	HO816	GP-42	ASAH
HF6552	GP-761H	FLG	HFP170700	G-153	DON	HFR86721	GP-34	FLR	HO817	GP-3531 EXP	ASAH
HF6553	GP-761H	FLG	HFP170740	G-152	DON	HFR86725	GP-864H	FLR	HO818	GP-3531 EXP	ASAH
HF6554	GP-761H	FLG	HFP170951	G-33	DON	HFR86732	GP-864H	FLR	HOT1	GP-1	PUR
HF6555	GP-761H	FLG	HFP171603	G-331	DON	HFR86749	GP-34	FLR	HOT33	GP-20	PUR
HF6557	GP-761H	FLG	HFP550222	GP-171 ¹⁶	DON	HFR86753	GP-864H	FLR	HOT40	GP-13	PUR
HF6561	GP-761H	FLG	HFP550487	G-169	DON	HFR86781	GP-864H	FLR	HOT49	GP-3	PUR
HF6562	GP-761H	FLG	HFP550951	G-33	DON	HFR87534	GP-34	FLR	HOT5	GP-5	PUR
HF6563	GP-761H	FLG	HFP551551	GP-66	DON	HFR87569	GP-166	FLR	HOT81	GP-81 ²¹	PUR
HF6564	GP-761H	FLG	HFP552297	GP-66	DON	HFR87936	GP-166 ⁶⁵	FLR	HOT81	GP-9 ⁸⁸	PUR
HF6565	GP-761H	FLG	HFP554636	G-122	DON	HFR87936	GP-3937 ¹¹	FLR	HP 4559	GA-410	FFIL
HF6566	GP-761H	FLG	HFP554636	G-338	DON	HFR87968	GP-66	FLR	HP 669	GA-410	FFIL
HF6568	GP-761H	FLG	HFP555603	G-331	DON	HFR87990	GP-317H	FLR	HP1	GP-171 ¹⁶	APOL
HF657	GP-1101	ASAH	HFP556064	G-222	DON	HG111	GG-20	HUT	HP1	GP-171 ¹⁶	BWS
HF6572	GP-761H	FLG	HFP556700	G-153	DON	HG119	GG-6	HUT	HP1	GP-1	CHP
HF6573	GP-761H	FLG	HFP559740	G-152	DON	HG120	GG-7	HUT	HP1	GP-171 ¹⁶	FRM
HF6603	GP-3766	FLG	HFR828783	GP-58 ⁸	FLR	HG13	GG-19	HUT	HP1	GP-1	LUF
HF6606	GP-3766	FLG	HFR828810	GP-34	FLR	HG157	GG-16	HUT	HP1	GP-171 ¹⁶	PUR
HF6675	GP-3766	FLG	HFR828921	GP-66	FLR	HG158	GG-17	HUT	HP1	GP-171 ¹⁶	SERC
HF6677	GP-3766	FLG	HFR828922	GP-66	FLR	HG21	GG-123	HUT	HP1	GP-1	SERV
HF6700	GP-34	FLG	HFR828992	GP-761H	FLR	HG223127A	GP-46	CITR	HP1	GP-1	WARN
HF6710	GP-864H	FLG	HFR835018	GP-166	FLR	HG223127AR	GP-46	CITR	HP-2001	GP-3980	KENG
HF6711	GP-34	FLG	HFR86054	G-122	FLR	HG223127R	GP-46	CITR	HP3001	GP-1	KENG
HF6720	GP-34	FLG	HFR86054	G-338	FLR	HG22327	G-330	CITR	HP7	GP-58 ⁹⁰	FRM
HF6721	GP-34	FLG	HFR86055	GP-66	FLR	HH07503	GP-66	PARK	HPH3335	GP-52 ¹¹⁰	FRM
HF6725	GP-864H	FLG	HFR86056	GP-66	FLR	HH07515	GP-66	PARK	HPH3335	GP-691 ⁴⁸	FRM
HF6732	GP-864H	FLG	HFR86057	GP-66	FLR	HH12515	GP-34	PARK	HPH3690	GP-359	FRM
HF6749	GP-34	FLG	HFR86058	GP-66	FLR	HHF0004	GP-66	FMC	HPH3766	GP-3766	FRM
HF6753	GP-864H	FLG	HFR86067	GP-34	FLR	HKJ0033	GP-28 ⁸	LEYL	HPH3976A	GP-178	FRM
HF6781	GP-864H	FLG	HFR86072	G-191	FLR	HKJ0033	GP-430 ⁸	LEYL	HPH49A	GP-51	FRM
HF6840	GP-34	FLG	HFR86079	G-331	FLR	HKJ2208	GP-1	LEYL	HPH6349	GP-3000	FRM
HF700	G-153	HAS	HFR86080	GP-66	FLR	HL	G-750	DEL	HPH6349A	GP-3000	FRM
HF713	GP-761H	HAS	HFR86083	G-153	FLR	HL15436	G-49	HERI	HPH7405	GP-193	FRM
HF715	GP-761H	HAS	HFR86088	G-33	FLR	HL16	G-750	DEL	HPH9500	GP-3001	FRM
HF717	GP-761H	HAS	HFR86096	GP-81	FLR	HL17	G-750	DEL	HPU 4311	GA-2160	FFIL
HF718	GP-761H	HAS	HFR86097	G-152	FLR	HL18	G-750	DEL	HRF828921	GP-66	FLR
HF719	GP-761H	HAS	HFR86098	G-222	FLR	HL2870A	GP-28 ⁸	HERI	HRF828989	GP-66	FLR
HF720	GP-761H	HAS	HFR86107	GP-171 ¹⁶	FLR	HL2870A	GP-430 ⁸	HERI	HRF828992	GP-761H	FLR
HF725	GP-66	HAS	HFR86115	GP-166 ¹⁰⁰	FLR	HL3506	GP-44	HERI	HS	G-500	DEL
HF731	GP-66	HAS	HFR86118	G-33	FLR	HL3569	GP-310	HERI	HS47652C5	G-31	HERI
HF732	GP-66	HAS	HFR86121	GP-66	FLR	HL3569	GP-3569	JFL	HS7514	GP-66	GREY
HF734	GP-166 ¹⁰⁰	HAS	HFR86122	GP-54	FLR	HL3675	GP-3675	HERI	HS7600	GP-54	GREY
HF738	GP-34	FLG	HFR86123	GP-166 ¹⁰⁰	FLR	HL3682	GP-3682	HERI	HS7604	GP-761H	GREY
HF739	G-122	HAS	HFR86125	GP-34	FLR	HL3816	GP-3816	HERI	HS7607	GP-761H	GREY
HF739	G-338	HAS	HFR86130	GP-34	FLR	HL3976	GP-178	HERI	HS7620	GP-34	GREY
HF741	G-159	HAS	HFR86133	GP-34	FLR	HL3980	GP-3980	HERI	HS7644	GP-761H	GREY
HF742	G-339H	HAS	HFR86137	GP-34	FLR	HL3985	GP-3985	HERI	HS7645	GP-761H	GREY
HF743	G-33	HAS	HFR86138	GP-34	FLR	HL46	GP-3816	HERI	HS7646	GP-761H	GREY
HF7534	GP-34	FLG	HFR86141	GP-66 ⁹⁰	FLR	HL4681	GP-28 ⁸	HERI	HS7670	GP-58 ⁹	GREY
HF7569	GP-166	FLG	HFR86157	GP-34	FLR	HL4681	GP-430 ⁸	HERI	HS7674	GP-3766	GREY
HF7608	GP-66	FLG	HFR86158	GP-58	FLR	HL5320	G-963	HERI	HS7675	GP-761H	GREY
HF792	GP-14	HAS	HFR86159	GP-36	FLR	HL5618	GP-457	HERI	HS7693	GP-761H	GREY
HF7931	GP-81	FLG	HFR86162	G-162H	FLR	HL6552	GP-212	JFL	HSA600	GA-78	HAVO
HF7936	GP-166 ⁶⁵	FLG	HFR86184	G-339H	FLR	HL6607	GP-91	HERI	HSA602	GA-3915	HAVO
HF7936	GP-3937 ¹¹	FLG	HFR86205	GP-54	FLR	HL6813	GP-452	JFL	HSA602	GA-3915	TRE
HF7936N1	GP-166 ⁶⁵	FLG	HFR86206	GP-36	FLR	HL6848	G-971	HERI	HSA602	GA-3915	TEX
HF7936N1	GP-3937 ¹¹	FLG	HFR86270	G-33	FLR	HL7317	GP-149	HERI	HSA605	GA-139	HAVO
HF7955	GP-166	FLG	HFR86279	GP-66	FLR	HL8081	G-954	HERI	HSA605	GA-139	TEX

Referencia Cruzada por Numero de Parte

Cross Reference by Part Number



Numero	Gonher	Fabricante	Numero	Gonher	Fabricante	Numero	Gonher	Fabricante	Numero	Gonher	Fabricante
Number	Gonher	Manufacturer	Number	Gonher	Manufacturer	Number	Gonher	Manufacturer	Number	Gonher	Manufacturer
HSA608	GA-5056	HAVO	HSO115	GP-3985	HAVO	IC6394J	GA-1285	CATP	IS71-9155-BA	GG-915	FORD
HSA612	GA-216	TEX	HSO115	GP-3985	TEX	IC6395	GA-1286	CATP	IS04	GAD-3	MASE
HSA617	GAD-3	TEX	HSO118	GP-22	HAVO	IC6397J	GA-1287	CATP	IT 2015	GA-909R	RYTR
HSA625	GA-4828	HAVO	HSO118	GP-22	TEX	IC6403J	GA-5648	CATP	IT-10085	GA-29	RYTR
HSA625	GA-4828	TEX	HSO122	GP-42	HAVO	IC6404J	GA-9045	CATP	IT-10-1222	GAK-16	RYTR
HSA627	GA-362	HAVO	HSO122	GP-42	TEX	IC6406J	G-191	CATP	IT-10-1234	GA-26	RYTR
HSA627	GA-362	TEX	HSO127	GP-5	TEX	ID6	GA-37	OSHK	IT101243	GA-26 ¹¹²	RYTR
HSA629	GA-153	HAVO	HSO128	G-200	TEX	IDX158	GA-27	OSHK	IT-10-1246	GAK-403	RYTR
HSA629	GA-153	TEX	HSO129	GP-44	TEX	IDX28	GA-26	OSHK	IT-10-3443	GA-16	RYTR
HSA630	GAVW-4	HAVO	HSO131	GP-81	TEX	IDX6	GA-37	OSHK	IT-10-3951	GAP-379	RYTR
HSA630	GAVW-4	TEX	HSO132	GP-149	TEX	IDX83	GA-6129	OSHK	IT-10-6587	GA-360	RYTR
HSA634	GA-4365	HAVO	HSO134	GP-91	TEX	IF3351	GG-5 L	ASAH	IT-10-6632	GA-6128	RYTR
HSA634	GA-4365	TEX	HSO138	GP-178	TEX	IF3356	GPP-111	AEC	IT-10-6641	GA-6127	RYTR
HSA635	GA-230	HAVO	HSO140	G-971	TEX	IF3356	GPP-524	AEC	IT-10-6769	GA-106 ⁹⁰	RYTR
HSA635	GA-230	TEX	HU 612 X	G-141	MNH	IF3356	GPP-111	ASAH	IT-10-6769	GA-326 ⁷¹	RYTR
HSA636	GA-3501	HAVO	HU 711/51X	G-341	MNH	IF3356	GPP-524	ASAH	IT-10-6775	GA-206	RYTR
HSA638	GA-274	HAVO	HU 932/6 N	G-112	MNH	IFIZ-9155CA	GG-307	FORD	IT-10-6834	GA-361	RYTR
HSA638	GA-274	TEX	HU 610X	G-910	MNH	IH731FF	G-333	ROLK	IT-109	GA-35	RYTR
HSA641	GA-180	HAVO	HU711/2	G-70	MNH	IH994FF	G-335	ROLK	IT-10-9155	GA-356	RYTR
HSA641	GA-180	TEX	HU715/3X	G-975	MNH	IIM1001	GAK-16	TEHO	IT-10-9159	GA-357	RYTR
HSA649	GA-56	HAVO	HU715/4X	G-975	MNH	IIM1003	GAK-20	TEHO	IT-10-9726	GA-31	RYTR
HSA649	GA-56	TEX	HU718/1K	G-918	MNH	IIM1005	GAK-403	TEHO	IT-1113	GA-9334	RYTR
HSA656	GA-2194	TEX	HU718/4	G-180	MNH	IIM1025	GA-6129	TEHO	IT-1116	GA-9045	RYTR
HSA657	GA-230	HAVO	HU718/4X	G-180	MNH	IIM10251	GA-6127	TEHO	IT-114500	GA-892	RYTR
HSA657	GA-230	TEX	HU718/5	G-180	MNH	IIM1050	GA-356	TEHO	IT116880	GA-6880	RYTR
HSA660	GA-4303	TEX	HU718/5X	G-180	MNH	IIM106	GAD-1	TEHO	IT-117797	GA-229	RYTR
HSA670	GA-3637	HAVO	HU718/5X	G-918	MNH	IIM113	GA-360	TEHO	IT-118047	GA-376	RYTR
HSA670	GA-3637	TEX	HU719/7X	G-466	MNH	IIM115	GA-2740	TEHO	IT-11-9770	GA-33	RYTR
HSA674	GA-390	TEX	HU-719-6-X	G-313	MNH	IIM116	GP-58	TEHO	IT-12-0022	GAK-625	RYTR
HSA675	GA-3588	TEX	HU-727-1X	G-971	MNH	IIM125	GA-18	TEHO	IT-12-3412	GAP-381	RYTR
HSA677	GA-3901	TEX	HU819/1X	G-25	MNH	IIM155	GA-436	TEHO	IT128407	GA-563	RYTR
HSA678	GA-275	TEX	HU819X	G-72	MNH	IIM156	GA-405	TEHO	IT-12-9396	GA-377	RYTR
HSA680	GA-471	TEX	HU-925-4X	G-954	MNH	IIM182A	GA-49	TEHO	IT-12-9544	GA-107	RYTR
HSA681	GA-2106	TEX	HU926-3X	G-963	MNH	IIM199	GA-106 ⁹⁰	TEHO	IT-13-0959	GA-373	RYTR
HSA683	GA-382	TEX	HU931/5	G-3827	MNH	IIM199	GA-326 ⁷¹	TEHO	IT-13-1283	GA-891	RYTR
HSA690	GA-6479	TEX	HU931/5X	G-3827	MNH	IIM202	GA-8047	TEHO	IT-1412	GA-375	RYTR
HSA693	GA-195	TEX	HU-938-4X	G-984	MNH	IIM203	GA-9045	TEHO	IT-14-2100	GA-371	RYTR
HSA696	GA-3501	TEX	HU945-2X	G-3754	MNH	IIM204	GA-7716	TEHO	IT-15-3551	GA-3551 ³⁵	RYTR
HSA699	GA-129	TEX	HWA 104 094 01 04	GA-2104	AMG	IIM210	GA-33 ¹¹²	TEHO	IT-15-3551	GA-3551 XT ⁹⁴	RYTR
HSA701	GA-139	TEX	HX1	G-222	KNE	IIM229	GA-9334	TEHO	IT-1580	GA-109	RYTR
HSA704	GA-142	TEX	HX1	G-222	MAHL	IIM252	GA-4365	TEHO	IT-1596	GA-209	RYTR
HSA705	GA-6619 ¹	TEX	HX1	G-222	PUR	IIM275	GAK-16	TEHO	IT-15965	GA-210	RYTR
HSA705	GA-6620 ⁰	TEX	HX15	G-162H	KNE	IIM335	GA-483	TEHO	IT-15995	GA-108	RYTR
HSA706	GAD-294	HAVO	HX15	G-162H	MAHL	IIM375	GAK-216	TEHO	IT-160W	GA-378	RYTR
HSA706	GAD-294	TEX	HX15	G-162H	PUR	IMF517	GG-45	COBR	IT-18065	GA-5648	RYTR
HSA707	GA-386	HAVO	HX15	G-162H	TECF	IMF522	GG-45	COBR	IT-2000	GA-904R	RYTR
HSA709	GA-2110	HAVO	HX21	G-152	MAHL	IMF523	GG-76	COBR	IT-2000S	GA-905R	RYTR
HSA709	GA-2110	TEX	HX22	G-191	KNE	IMF524	GG-1	COBR	IT-2001	GA-808R	RYTR
HSA710	GA-133	HAVO	HX22	G-191	MAHL	IMF524	GG-4	COBR	IT-2001S	GA-809R	RYTR
HSA710	GA-133	TEX	HX22	G-191	TECF	IMF527	GG-196	COBR	IT-2002	GA-801R	RYTR
HSA711	GA-6690	TEX	HX23	G-238	KNE	IMF552	GG-188	COBR	IT-2002S	GA-802R	RYTR
HSA713	GAVW-120	TEX	HX23	G-238	MAHL	IMF554	GG-204	COBR	IT-2002SY	GA-802R	RYTR
HSA714	GA-604	TEX	HX23	G-238	TECF	IMF587	GG-196	COBR	IT2004	GA-801R	RYTR
HSA716	GA-165	TEX	HY1-306	G-1174 ¹⁰⁸	BBR	IN1214302	G-25	NISS	IT2004SY	GA-802R	RYTR
HSA717	GA-141	TEX	HY1-R306	G-1174 ¹⁰⁸	BBR	INF264	GP-1122	RAR	IT-2005	GA-673R	RYTR
HSA718	GA-300	TEX	HY2803	G-24	SCHU	INF4595	G-178	RAR	IT-2007	GA-682R	RYTR
HSA719	GA-7344	TEX	HY309112	GP-9	TOTL	INF831	GPP-1291 ³⁹	INTM	IT-2008	GA-732R	RYTR
HSA720	GA-7142	TEX	HY9566	G-152	SCHU	INF831	S 3226 P ⁹⁰	INTM	IT-2015S	GA-908R	RYTR
HSA724	GA-322	TEX	HY9736	GP-28 ⁸	SCHU	IO313	G-870	AEC	IT-2046	GA-197R	RYTR
HSA725	GA-381	TEX	HY9736	GP-430 ⁸	SCHU	IO313	R 90 T	AEC	IT-2046S	GA-768R	RYTR
HSA726	GA-217	TEX	Números Nuevos			IO313	G-870	ASAH	IT-2056	GA-906R	RYTR
HSA729	GAVW-2	HAVO				IO317	GP-3682	ASAH	IT-2056S	GA-907R	RYTR
HSA729	GAVW-2	TEX				IO320	G-870	ASAH	IT-2057	GA-803R	RYTR
HSA734	GAD-118	TEX				IO325	G-750	ASAH	IT-2057S	GA-804R	RYTR
HSA736	GA-164	TEX				IO331	GP-3985	ASAH	IT-2066	GA-966R	RYTR
HSA738	GA-5466	TEX				IO3312	GP-43	ASAH	IT-2066S	GA-967R	RYTR
HSA740	GA-166	TEX				IO332	GP-3985	AEC	IT2066SE	GA-967R	RYTR
HSA742	GAD-117	TEX				IO332	GP-3985	ASAH	IT-2076	GA-930R	RYTR
HSA742	GAD-117	TEX				IOF3569	GP-3569	CAC	IT-2076S	GA-890R	RYTR
HSA745	GA-175	TEX				IOF6552	GP-212	CAC	IT-2086	GA-682R	RYTR
HSA746	GA-1616	TEX				IR2005	GA-106 ⁹⁰	DLSL	IT-2086S	GA-683R	RYTR
HSA751	GA-1615	TEX				IR2005	GA-326 ⁷¹	DLSL	IT-2096	GA-221R	RYTR
HSA752	GA-132	TEX				IR2006	GA-206	DLSL	IT-2096S	GA-723R	RYTR
HSM6000	GP-66 ⁹⁰	COO				IR392	G-1121F	IRLE	IT-2098	GA-435R	RYTR
HSM6002	GP-171 ¹⁶	COO				IR641	G-1121F	IRLE	IT-237	GA-1285	RYTR
HSM6004	GP-54	COO				IS104	GAD-3	MAST	IT-2401	GA-405	RYTR
HSM6007	GP-66	COO				IS152	GA-436	MAST	IT3095	GA-3095R	RYTR
HSM6013	GP-66	COO				IS153	GA-18	MASE	IT3095SY	GA-3096R	RYTR
HSM6044	GP-66	COO	I11-1759	GP-40	LAZO	IS153	GA-18	MASE	IT-3-1	GA-39	RYTR
HSM6047	GP-34	COO	I15360	GP-310	GRAV	IS156	GA-49	MAST	IT-313	GA-426	RYTR
HSM6066	GP-66	COO	IA3362	GA-398	ASAH	IS164	GA-360	MASE	IT37	GA-44	RYTR
HSM6083	GP-66	COO	IA365	GA-26	ASAH	IS164	GA-360	MAST	IT-3770	GA-388	RYTR
HSM6101	GP-166 ¹⁰⁰	COO	IA368	GAD-1	ASAH	IS192	GA-2719B	MAST	IT-403	GA-403	RYTR
HSM6174	GP-166 ¹⁰⁰	COO	IA-369	GA-27	ASAH	IS215	GA-372	MASE	IT-414	GA-680	RYTR
HSO102	G-33	HAVO	IA377	GA-33 ¹¹²	ASAH	IS215	GA-372	MAST	IT-510	GA-18	RYTR
HSO104	G-34	HAVO	IA378	GAK-16	ASAH	IS228	GAK-403	MASE	IT-612	GA-1284	RYTR
HSO104	G-34	TEX	IA382	GAD-30	ASAH	IS229	GAK-16	MASE	IT-713	GA-1286	RYTR
HSO105	G-236	HAVO	IA382	GAK-403	ASAH	IS230	GAK-20	MASE	IT-716	GA-1287	RYTR
HSO105	G-236	TEX	IA5320	GA-7716	CATP	IS231	GAK-403	MASE	IT-725	GA-425	RYTR
HSO106	G-330	HAVO	IBE-87	GA-113	INTF	IS44	GAD-1	MAST	IT-727	GA-244	RYTR
HSO107	GP-23	HAVO	IC5320	GA-7716	CATP	IS44	GAD-1	MAST	IT-7360	GA-7360	RYTR
HSO107	GP-23	TEX	IC6382	GA-1203	CATP	IS5	GA-44	MAST	IT-74	GA-70	RYTR
HSO108	GP-3766	TEX	IC6386J	GA-375	CATP	IS54	GA-71	MASE	IT-75	GA-12	RYTR
HSO109	GP-3985	HAVO	IC6388J	GA-9334	CATP	IS54	GA-71	MASE	IT-7716	GA-7716	RYTR
HSO114	G-834	HAVO	IC6389J	GA-1284	CATP	IS56	GA-71	MASE	IT-812	GA-1008	RYTR
HSO114	G-834	TEX	IC6390J	GA-1008	CATP	IS56	GA-71	MASE	IT-8482	GA-482	RYTR
			IC6391J	GA-80							

Numero	Gonher	Fabricante	Numero	Gonher	Fabricante	Numero	Gonher	Fabricante	Numero	Gonher	Fabricante
Number	Gonher	Manufacturer	Number	Gonher	Manufacturer	Number	Gonher	Manufacturer	Number	Gonher	Manufacturer
IT-8483	GA-483	RYTR	J3193898	GG-19	MOP	J8992430	GG-19	MOP	JL4466	GP-430 ⁸	JFL
IT-8833	GA-287	RYTR	J3196333	GP-5	CHRY	J8992638	GG-5 L	CHRY	JL4476	GP-157	JFL
IT-907	GA-21	RYTR	J3196741	GP-5	CHRY	J8992661	GA-70	AMCO	JL4477	GP-156	JFL
IT-912	GA-8047	RYTR	J3198615	GG-5 L	CHRY	J8992661	GA-70	CHRY	JL4484	GP-212	JFL
IT-926	GA-679	RYTR	J3208320	GP-5	CHRY	J8992661	GA-70	MOP	JL4619	GP-3985	JFL
			J3212882	GG-5 L	CHRY	J8992873	GA-78	CHRY	JL4620	GP-149	JFL
			J3215877	GP-20	CHRY	J8992873	GA-78	JEEP	JL4631	GP-205	JFL
			J3215877	GP-20	JEEP	J8992873	GA-78	MOP	JL4651	GP-68	JFL
			J3215877	GP-20	MOP	J8993146	GP-20	CHRY	JL4670	GP-81	JFL
			J3222897	GP-20	JEEP	J8993146	GP-20	JEEP	JL49	GP-3	JFL
			J3222897	GP-20	MOP	J8993146	GP-20	MOP	JL81	GP-81 ³¹	JFL
			J3222899	GP-20	CHRY	J903202	GPP-1122	CASE	JL81	GP-9 ⁸	JFL
			J3222899	GP-20	JEEP	J903224	GP-390	CASE	JLA113	GA-75	JFL
			J3222899	GP-20	MOP	J903224	GP-390	SAMS	JLA1149	GA-VW-2	JFL
			J3225897	GP-20	CHRY	J903264	GP-178	CASE	JLA120	GA-74	JFL
			J3232126	GP-28 ⁸	CHRY	J903324	GP-390	CASE	JLA124	GA-3300	JFL
			J3232126	GP-430 ⁸	CHRY	J903410	GPP-18	CASE	JLA125	GA-3300	JFL
			J3240511	GP-3429	CHRY	J903640	GP-1122	CASE	JLA129	GA-3424	JFL
			J3241398	GP-46	CHRY	J908615	GP-178	CASE	JLA131	GA-3425	JFL
			J3250334	GP-28 ⁸	CHRY	J908616	GP-390	CASE	JLA15	GA-3490	JFL
			J3250334	GP-430 ⁸	CHRY	J911213	GPP-1122	CASE	JLA16	GA-2740	JFL
			J3250334	GP-28 ⁸	JEEP	J919562	GP-3000 ¹³	CASE	JLA3	GA-75	JFL
			J3250334	GP-430 ⁸	JEEP	J925274	GPP-18	CASE	JLA3080	GA-3445	JFL
			J3250334	GP-28 ⁸	MOP	J930942	GPP-18	CASE	JLA31	GA-56	JFL
			J3250334	GP-430 ⁸	MOP	J931062	GPP-1122	CASE	JLA3138	GA-54	JFL
			J3464085	GA-356	MOP	J932217	GP-178	CASE	JLA3149	GA-3523	JFL
			J3500079	GA-230	MOP	J934429	GP-390	CASE	JLA3192	GA-271	JFL
			J3564035	GAK-403	JEEP	J934430	GP-178	CASE	JLA3193	GA-735 ¹⁴	JFL
			J3564035	GAK-403	MOP	J937345	GP-178	CASE	JLA3195	GA-3588	JFL
			J3564042	GAK-16	JEEP	J942365	GP-3937	CASE	JLA3357	GA-3637	JFL
			J3564042	GAK-16	MOP	JA2092	G-139	UNI	JLA3380	GA-3647	JFL
			J3564047	GAK-20	JEEP	JA310893	GA-105	MOP	JLA3382	GA-390	JFL
			J3564047	GAK-20	MOP	JC212	GP-3682	JHFC	JLA3384	GA-89	JFL
			J3564049	GA-27	JEEP	JC215	GP-3682	JHFC	JLA3398	GA-3566	JFL
			J3564049	GA-27	MOP	JC414	GP-149	JHFC	JLA3436	GA-4365	JFL
			J3564085	GA-356	JEEP	JC-H01	GP-91	JHFC	JLA3463	GA-230	JFL
			J3564086	GA-357	JEEP	JD382L2160	G-33	CONT	JLA3465	GA-277	JFL
			J3564086	GA-357	MOP	JD7-01	G-139	WIN	JLA3466	GA-274	JFL
			J3564110	GA-229	JEEP	JD7-01P	G-139	WIN	JLA3467	GA-4325	JFL
			J3564110	GA-229	MOP	JDABP	G-139	ROLK	JLA3472	GA-274	JFL
			J3564116	GA-27	JEEP	JDR1400RFF	G-331	ROLK	JLA3474	GA-3681	JFL
			J3564116	GA-27	MOP	JDRQ1400RFF	G-331	ROLK	JLA3538	GA-140	JFL
			J3564118	GA-106 ⁴⁶	JEEP	JE01-20-490A	GG-148	MZDA	JLA3590	GA-3916	JFL
			J3564118	GA-326 ⁷¹	JEEP	JE15-13-240	GA-2106	MZDA	JLA3591	GA-3814	JFL
			J3564118	GA-106 ⁴⁶	MOP	JE15-14-302	GP-149	MZDA	JLA3592	GA-273	JFL
			J3564118	GA-326 ⁷¹	MOP	JE48-13-480	GG-136	MZDA	JLA4	GA-70	JFL
			J3564119	GA-206	JEEP	JE48-13-240	GA-6690	MZDA	JLA4278	GAD-15	JFL
			J3564119	GA-206	MOP	JE48-20-490	GG-136	MZDA	JLA4299	GA-180	JFL
			J3564120	GA-106 ⁴⁶	JEEP	JE49-20-490	GG-136	MZDA	JLA4327	GA-4958	JFL
			J3564120	GA-326 ⁷¹	JEEP	JE64-62	GG-48	PETT	JLA4339	GA-3915	JFL
			J3564120	GA-106 ⁴⁶	MOP	JE6463	GG-48	LSTR	JLA4342	GA-253	JFL
			J3564120	GA-326 ⁷¹	MOP	JE6463	GG-48	PETT	JLA4343	GA-5056	JFL
			J800394	GPP-10035	CASE	JE64-6A	GG-48	PETT	JLA4347	GA-153	JFL
			J800394	GPP-10225	CASE	JE6468	GG-48	LSTR	JLA4356	GA-390	JFL
			J8051330	GP-1	CHRY	JE64-6B	GG-48	PETT	JLA4372	GA-3901	JFL
			J8051330	GP-1	MOP	JEYO-14-302	GP-149	MZDA	JLA4375	GA-362	JFL
			J8121678	GA-57	CHRY	JEYO-14-302A	GP-149	MZDA	JLA4378	GA-174	JFL
			J8121678	GA-57	JEEP	JEYO-14-302	GP-149	MZDA	JLA4409	GA-VW-120	JFL
			J8121678	GA-57	MOP	JF01-13-200	GA-2106	MZDA	JLA4468	GA-195	JFL
			J8127168	GP-28 ⁸	CHRY	JF01-13-24	GA-2106	MZDA	JLA4471	GA-471	JFL
			J8127168	GP-430 ⁸	CHRY	JF15-13-240	GA-2106	MZDA	JLA4479	GA-6479	JFL
			J8132313	GP-46	CHRY	JFA488	GA-2174	JAPA	JLA4487	GA-382	JFL
			J8132313	GP-46	JEEP	JK816	G-870	LSTR	JLA45	GA-77	JFL
			J8132313	GP-46	MOP	JK81-6	G-870	PETT	JLA4613	GA-142	JFL
			J8132734	GG-16	CHRY	JL101	GP-22	JFL	JLA4625	GA-2106	JFL
			J8132734	GG-16	JEEP	JL109	GP-42	JFL	JLA4626	GA-6619 ¹	JFL
			J8132734	GG-16	MOP	JL111	GP-46	JFL	JLA4626	GA-6620 ⁵	JFL
			J837743	GP-178	CASE	JL119	GP-310	JFL	JLA4632	GA-275	JFL
			J843760	GPP-1122	CASE	JL123	GP-3429	JFL	JLA4645	GA-6690	JFL
			J8547031	GP-50	JEEP	JL17	GP-81	JFL	JLA4648	GA-133	JFL
			J8547031	GP-50	MOP	JL173	GP-3980	JFL	JLA4650	GA-604	JFL
			J8548078	GP-50	JEEP	JL18	GP-81	JFL	JLA4656	GA-7017	JFL
			J8548078	GP-50	MOP	JL193	GP-40	JFL	JLA4669	GAD-294	JFL
			J8548620	GP-50	MOP	JL195	GP-3600	JFL	JLA4680	GA-386	JFL
			J8555101	GA-71	JEEP	JL1A	GP-1	JFL	JLA4690	GA-322	JFL
			J8555101	GA-71	MOP	JL2167	GP-171	JFL	JLA4712	GA-217	JFL
			J8558238	GP-22	MOP	JL241	GP-58	JFL	JLA4799	GA-381	JFL
			J8990063	GA-105	CHRY	JL252	GP-28 ⁸	JFL	JLA4832	GA-432	JFL
			J8990499	GP-1	CHRY	JL252	GP-430 ⁸	JFL	JLA4873	GA-514	JFL
			J8990499	GP-1	JEEP	JL253	GP-3985 ⁶³	JFL	JLA5106	GA-2193	JFL
			J8990499	GP-1	MOP	JL257	GP-310	JFL	JLA52	GA-71	JFL
			J8990508	GP-50	CHRY	JL257	GP-3569	JFL	JLA57	GA-80	JFL
			J8990508	GP-50	JEEP	JL2821A	GP-58	JFL	JLA59	GA-50	JFL
			J8990508	GP-50	MOP	JL288	GP-3766	JFL	JLA67	GA-192	JFL
			J8990557	GA-105	CHRY	JL289	GP-3985	JFL	JLA68	GA-78	JFL
			J8990575	GA-105	CHRY	JL291	GP-3531 EXP	JFL	JLA7	GA-4303	JFL
			J8990688	GP-5	CHRY	JL33	GP-20	JFL	JLA74	GA-55	JFL
			J8990837	GP-5	CHRY	JL373	GP-3682	JFL	JLA83	GA-85	JFL
			J8990873	GP-5	CHRY	JL40	GP-13	JFL	JLA831	GA-85	JFL
			J8991012	GA-105	MOP	JL4007	GP-44	JFL	JLA84	GA-730	JFL
			J8991072	GP-5	CHRY	JL4011	GP-3980	JFL	JLA90	GA-303	JFL
			J8991386	GA-77	AMCO	JL4457	GP-3682	JFL	JLA91	GA-59	JFL
			J8991386	GA-77	CHRY	JL4458	GP-462	JFL	JLA92	GA-57	JFL
			J8991386	GA-77	MOP	JL4459	GP-149 ⁹⁹	JFL	JLA93	GA-325	JFL
			J8992430	GG-19	CHRY	JL4459	GP-91 ⁹⁴	JFL	JLA99	GA-86	JFL
			J8992430	GG-19	JEEP	JL4466	GP-28 ⁸	JFL	JLA991	GA-86	JFL

J

Referencia Cruzada por Numero de Parte

Cross Reference by Part Number



Numero	Gonher	Fabricante	Numero	Gonher	Fabricante	Numero	Gonher	Fabricante	Numero	Gonher	Fabricante
Number	Gonher	Manufacturer	Number	Gonher	Manufacturer	Number	Gonher	Manufacturer	Number	Gonher	Manufacturer
JLO1		GP-1 JFL	K08505-88		GP-66 ¹⁰ POCL	K32		GP-3682 KMA	KA12		GA-75 KND
JLO141		G-200 JFL	K09505-53		G-200 POCL	K32		GP-91 KND	KA122		GA-8047 KIRK
JLO33		GP-20 JFL	K098-100MI		G-225 FDY	K3222		GAK-216 JCBM	KA124		GA-5648 KIRK
JLO40		GP-13 JFL	K1		GP-1 KMA	K3223		GA-416 JCBM	KA126		GA-436 KIRK
JLO42		GP-38 JFL	K1		GP-1 KND	K33		GP-171 KMA	KA12K		GAK-16 KIRK
JLO49		GP-3 JFL	K10		GP-44 KMA	K33		GP-157 KND	KA13		GAK-20 KIRK
JLO5		GP-5 JFL	K10		GP-3980 KND	K34		GP-2951 ⁶² KMA	KA13		GA-55 KMA
JLO64		GP-3600 ²⁷ JFL	K10767		G-870 CHRY	K34		GP-58 ⁹⁴ KMA	KA13		GA-3424 KND
JLO64		GP-38 ⁸⁹ JFL	K10767		G-870 MOTA	K34		GP-91 KND	KA13K		GAK-20 KIRK
JLO81		GP-81 ³¹ JFL	K10767		G-871 ROOT	K35		G-31 FDY	KA15		GA-54 KND
JLO81		GP-9 ⁵⁸ JFL	K10767		G-870 TALB	K35		GP-44 KND	KA1595		GA-206 ASAH
JO103		GP-310 JAPN	K10L		G-871 FDY	K36		GP-40 KMA	KA1596		GA-106 ⁶⁶ ASAH
JO105		GP-38 JAPN	K11		GP-46 KMA	K36		GP-44 KND	KA1596		GA-326 ⁷¹ ASAH
JO106		GP-171 JAPN	K11		GP-3600 KND	K37		GP-128 KND	KA15K		GA-33 ¹²² KIRK
JO204		GP-38 JAPN	K12		GP-3980 KMA	K38		GP-310 KMA	KA16		GAK-403 KIRK
JO205		GP-1 JAPN	K12		GP-462 KND	K38		GP-3675 KND	KA16		GA-192 KND
JO401		GP-42 JAPN	K13		GP-40 KMA	K-38		GP-3569 KMA	KA1606		GA-6129 ASAH
JO405		GP-3531 EXP JAPN	K13		GP-310 KND	K39		GP-178 KND	KA1608		GA-6127 ASAH
JO502		GP-3985 ⁹³ JAPN	K13		GP-3569 KND	K3926		PPP-11 FRM	KA1609		GA-6128 ASAH
JO703		GP-3985 ⁶³ JAPN	K135		G-333 FDY	K4		G-200 KMA	KA1621		GA-39 ASAH
IS660		GG-48 JAGU	K14		GP-3600 KMA	K4		GP-3 KND	KA1623		GA-6127 ¹⁰⁸ ASAH
JUAF001		GA-6690 JURA	K14		GP-42 KND	K40		GP-562 KND	KA1623		GA-6129 ¹⁰⁴ ASAH
JUAF002		GA-180 JURA	K141		G-200 FDY	K4294		G-870 GENE	KA1632		GA-106 ⁶⁷ ASAH
JUAF004		GA-195 JURA	K15		GP-13 KMA	K434408		GAD-1 MITS	KA1632		GA-206 ¹⁰⁸ ASAH
JUAF009		GA-139 JURA	K15		GP-3531 EXP KND	K434797		GAD-1 MITS	KA1632		GA-326 ⁷² ASAH
JUAF010		GA-322 JURA	K16		GP-28 ⁸ KND	K45		GP-462 KMA	KA1637		GA-6127 ¹⁰⁸ ASAH
JUAF012		GA-5466 JURA	K16		GP-430 ⁹ KND	K464411-0		GAD-1 MITS	KA1637		GA-6128 ¹⁰⁴ ASAH
JUAF013		GA-198 JURA	K17		GP-58 KND	K466201		GP-3985 HYUN	KA16K		GAK-403 KIRK
JUAF023		GA-2719B JURA	K17505-62		GA-467 POCL	K4662010		GP-462 HYUN	KA17		GA-303 KMA
JUAF051		GA-6619 ¹ JURA	K18		GP-40 KND	K466201-0		GP-40 MITS	KA17		GA-3300 KND
JUAF051		GA-6620 ⁵ JURA	K19		GP-58 KND	K474		GAK-403 DEL	KA1706		GA-239 ASAH
JUAF053		GAD-15 JURA	K2		GP-5 KMA	K478		GAK-16 DEL	KA1707		GA-329 ASAH
JUAF054		GA-4303 JURA	K2		GP-5 KND	K478AIR		GA-16 ¹¹² DEL	KA1711		GA-360 ASAH
JUAF055		GAD-294 JURA	K20		GP-81 KMA	K478AIR		GAK-16 ⁹⁴ DEL	KA18		GA-360 KIRK
JUAF056		GAD-117 JURA	K20		GP-81 KND	K48		G-6 FDY	KA18		GA-730 KMA
JUAF056		GAD-17 JURA	K200037		GP-171 CASE	K480		GA-33 ¹¹² DEL	KA18		GA-3523 KND
JUAF058		GAD-3 JURA	K201-13-200		GA-434 KIA	K486201-1		GP-3985 MITS	KA19		GA-57 KMA
JUAF060		GAD-1 JURA	K21		GP-58 KMA	K49		G-330 FDY	KA19		GA-3647 KND
JUAF063		GAD-30 JURA	K22		GP-38 KMA	K493		GA-26 DEL	KA2		GA-50 KMA
JUAF101		GA-382 JURA	K22		GP-58 KND	K493AIR		GA-26 ¹¹² DEL	KA2		GA-71 KND
JUAF102		GA-386 JURA	K22001		GP-66 GRES	K5		GP-20 KMA	KA20		GA-75 KMA
JUAF104		GA-381 JURA	K22001A		GP-66 GRES	K5		GP-81 ³¹ KND	KA20		GA-271 KND
JUAF109		GA-172 JURA	K22002		GP-66 GRES	K5		GP-9 ⁹⁸ KND	KA21		GA-86 KMA
JUAF110		GA-384 JURA	K22006		GP-66 GRES	K50		G-31 FDY	KA21		GAD-1 KND
JUAF117		GA-170 JURA	K22007		GP-66 GRES	K500		G-500 FDY	KA22		GA-3300 KMA
JUAF119		GA-163 JURA	K23		GP-24 ²⁶ KMA	K525		G-31 KRA	KA22		GAD-3 KND
JUAF151		GA-133 JURA	K23		GP-462 ²⁴ KMA	K525G		G-31 KRA	KA23		GA-192 KMA
JUAF152		GA-2106 JURA	K23020		GP-34 GRES	K5319		G-870 JCBM	KA23		GA-735 ¹²⁴ KND
JUAF155		GA-216 JURA	K23041A		GP-34 GRES	K5351		G-1173 ¹⁰⁸ OLIV	KA24		GA-80 KND
JUAF164		GA-2740 JURA	K23042		GP-34 GRES	K5351		G-1173 ¹⁰⁸ WHIT	KA25		GA-54 KMA
JUAF181		GA-595 JURA	K23855		G-870 ROOT	K538		GA-27 DEL	KA25		GA-325 KND
JUAF187		GA-471 JURA	K23855		G-870 TALB	K545		GA-5648 DEL	KA26		GA-3300 KMA
JUAF201		GA-362 JURA	K24		GP-1 KMA	K5515		G-296 JCBM	KA26		GA-86 KND
JUAF202		GA-78 JURA	K24		GP-3682 KND	K5515		G-296-B JCBM	KA27		GA-3523 KMA
JUAF203		GA-605 JURA	K24477		G-870 CHRY	K570		GAK-20 DEL	KA27		GA-74 KND
JUAF206		GA-7142 JURA	K24477		G-870 MOTA	K575		G-31 KRA	KA28		GA-89 KND
JUAF208		GA-7344 JURA	K24477		G-870 ROOT	K6		GP-13 KND	KA29		GA-271 KMA
JUAF210		GA-16 JURA	K24477		G-870 TALB	K62594		G-296 CASE	KA29		GA-2740 KND
JUAF219		GA-476 JURA	K25		GP-42 KMA	K62594		G-296-B CASE	KA3		GA-77 KMA
JUAF223		GA-3490 JURA	K25		GP-3980 KND	K6275		GA-33 ¹¹² KOEH	KA3		GA-70 KND
JUAF226		GA-217 JURA	K-251C271		GP-2071W KENW	K6505		GAK-16 KOEH	KA30		GA-106 ⁶⁶ KIRK
JUAF229		GA-607 JURA	K-251C272		GP-1011Q KENW	K66172		GAK-403 JOND	KA30		GA-326 ⁷¹ KIRK
JUAF251		GA-142 JURA	K-251C341		GP-1011Q KENW	K66712		GAK-403 JOND	KA30		GA-735 ¹²⁴ KMA
JUAF254		GA-166 JURA	K-251C342		GP-2071W KENW	K68859		G-11816 CASE	KA30		GA-2719B KND
JUAF258		GA-244 JURA	K-251C390		GP-1101 KENW	K7		GP-50 KMA	KA31		GAVV-2 KND
JUAF351		GA-3647 JURA	K26		GP-28 ⁸ KMA	K7		GP-38 KND	KA32		GA-86 KMA
JUAF354		GAVW-2 JURA	K26		GP-430 ⁹ KMA	K703		GA-98 ¹¹² DEL	KA32		GA-277 KND
JUAF402		GA-132 JURA	K26		GP-149 ⁶⁹ KND	K703AIR		GA-98 ¹¹² DEL	KA34		GA-153 KND
JUAF403		GA-141 JURA	K26		GP-91 ³⁴ KND	K750		G-750 FDY	KA35		GA-3814 KND
JUAF405		GA-604 JURA	K26046		GA-106 ⁶⁶ LNCR	K76-1		G-236 FDY	KA37		GA-3916 KND
JV4294		G-297-B GENE	K26046		GA-326 ⁷¹ LNCR	K774		G-500 KRA	KA38		GA-273 KND
JV429-4		G-297-B DORM	K26290		G-870 CHRY	K775		G-750 KRA	KA39		GA-5056 KND
			K26290		G-870 MOTA	K783		GAK-625 DEL	KA4		GA-77 KND
			K26290		G-870 ROOT	K8		GP-46 KND	KA40		GA-3588 KND
			K26290		G-870 TALB	K82584		GGP-25 GILB	KA41		GA-100 KMA
			K27		GP-3531 EXP KMA	K8724		GP-66 KOEH	KA41		GA-274 KND
			K28		GP-58 KMA	K9		GP-81 ³¹ KMA	KA42		GA-113 KMA
			K28		GP-3985 KND	K9		GP-9 ⁹⁸ KMA	KA42		GA-174 KND
			K29		GP-68 KND	K9		GP-3429 KND	KA43		GAD-15 KND
			K29505-18		GP-1013Q POCL	K906708		G-296 CASE	KA44		GA-3901 KND
			K29769		G-833 CHRY	K906708		G-296-B CASE	KA45		GA-362 KND
			K29769		G-833 TALB	K915319		G-296 CASE	KA47		GA-386 KND
			K2A5-13-Z40A		GA-304 KIA	K915319		G-296-B CASE	KA48		GA-6479 KND
			K3		GP-13 KMA	K939		G-31 KRA	KA49		GA-165 KND
			K3		GP-20 KND	K955687		GP-1 CASE	KA5		GA-80 KMA
			K30		GP-81 KMA	K960911		G-296 CASE	KA5		GA-50 KND
			K30		GP-81 KND	K960911		G-296-B CASE	KA50		GAD-1 KMA
			K30052		G-836 CHRY	K966540-0		GP-91 MITS	KA50		GA-164 KND
			K30052		G-836 HUMB	KA1		GA-56 KMA	KA51		GAD-3 KMA
			K30052		G-836 MOTA	KA1		GA-55 ¹¹³ KND	KA52		GA-322 KND
			K30052		G-836 ROOT	KA10		GA-85 KMA	KA53		GAVV-2 KMA
			K30052		G-836 TALB	KA10		GA-57 KND	KA53		GA-253 KND
			K30053		G-836 ROOT	KA106		GA-49 KIRK	KA54		GA-6129 KIRK
			K306D006		GA-2804 T UNI	KA110		GA-27 KIRK	KA54		GA-735 ¹²⁴ KMA
			K306D14		GA-2804 T UAC	KA12		GAK-16 KIRK	KA54		GA-1616 KND
			K31		GP-205 KND	KA12		GA-59 KMA	KA55		GA-3490 KMA

REFERENCIA CRUZADA

Para números Gonher con Superíndice vea página 651
For Gonher with Superscript numbers see page 651

Visite nuestro sitio en internet www.grupogonher.com
Visit our web site www.grupogonher.com

Numero	Gonher	Fabricante	Numero	Gonher	Fabricante	Numero	Gonher	Fabricante	Numero	Gonher	Fabricante
Number	Gonher	Manufacturer	Number	Gonher	Manufacturer	Number	Gonher	Manufacturer	Number	Gonher	Manufacturer
KA55	GA-217	KND	KC29	GP-56	MAHL	KG8	GG-16	KMA	KO1522	G-222	ASAH
KA56	GA-271	KMA	KC29	GP-56	TECF	KG8	GG-87	KND	KO1533	GP-36	ASAH
KA56	GA-6690	KND	KC30	GP-26	KNE	KG9	GG-17	KMA	KO1535	G-191	ASAH
KA57	GA-514	KND	KC30	GP-26	MAHL	KG9	GG-8 ¹⁰³	KND	KO1541	GP-2071W	ASAH
KA58	GAD-1 ⁸⁷	KMA	KC31	GP-27	KNE	KG9	GG-8 L ⁸⁰	KND	KO1542	GP-53	ASAH
KA58	GA-604	KND	KC31	GP-27	MAHL	KH1205008	GP-58 ¹⁵	CUB	KO1543	GP-36	ASAH
KA59	GA-2719B	KMA	KC32	GP-1122	KNE	KIT1870	GA-106 ⁶⁷	WORT	KO1549	G-191	ASAH
KA59	GA-141	KND	KC32	GP-1122	MAHL	KIT1870	GA-206 ¹⁰⁸	WORT	KO1556	G-238	ASAH
KA6	GA-78	KMA	KC32	GP-1122	TECF	KIT1870	GA-326 ⁷²	WORT	KO1577	GP-36	ASAH
KA6	GA-303	KND	KC35	GP-1122	KNE	KIT1968	GA-360 ¹⁰⁴	WORT	KO1580	GP-2071W	ASAH
KA60	GA-2740	KMA	KC35	GP-1122	MAHL	KIT1968	GA-361 ¹⁰⁸	WORT	KO2105	GP-149	ASAH
KA60	GA-1615	KND	KC35	GP-1122	TECF	KJ01-13-Z40	GA-5466	MZDA	KOH-235116	GA-7	FORD
KA61	GA-300	KND	KC38	GP-1122	KNE	KJ22065	GAK-20	FORD	KP2023	GA-381	KBLU
KA62	GA-277	KMA	KC38	GP-1122	MAHL	KK966540000	GP-91	SATO	KP2432	GA-386	KBLU
KA62	GA-5466	KND	KC38	GP-1122	TECF	KL 111	GG-114	MAHL	KP2432	GA-604	KBLU
KA63	GA-75	KMA	KC43	GP-1122	KNE	KL 72	GG-291	MAHL	KP3018	GA-514	KBLU
KA63	GA-673R	KND	KC43	GP-1122	MAHL	KL 84	GG-106	MAHL	KP3125	GA-322	KBLU
KA64	GA-7344	KND	KC43	GP-1122	TECF	KL12	GG-5 L	MAHL	KR135	G-333	FDY
KA66	GA-158	KND	KC44	GPP-1122	KNE	KL13	GG-1	KNE	KR2203	GA-3566	KBLU
KA-66	GA-3566	KMA	KC4510	GP-1101	LETR	KL13	GG-4	KNE	KR2206	GA-2740	KBLU
KA67	GA-195	KND	KC5042	GP-1	LETR	KL13	GG-1	MAHL	KS5351	G-1173 ¹⁰⁸	OLIV
KA68	GA-127	KND	KC51	GPP-1122	MAHL	KL13	GG-4	MAHL	KS5351	G-1173 ¹⁰⁸	WHIT
KA69	GA-3523	KMA	KC6	GP-1122	KNE	KL13	GG-1	TECF	KS841	G-1173 ¹⁰⁸	OLIV
KA69	GA-132	KND	KC6	GP-1122	MAHL	KL13	GG-4	TECF	KS841	G-1173 ¹⁰⁸	WHIT
KA7	GA-71	KMA	KC6	GP-1122	PUR	KL14	GG-5 L	KNE	KSP0027	GA-360	SUMI
KA7	GA-730	KND	KC6	GP-1122	TECF	KL14	GG-5 L	MAHL	KSP0028	GA-361	SUMI
KA70	GA-3647	KMA	KC6086	G-33	LETR	KL14	GG-5 L	TECF	KTP0489	G-277	LINK
KA70	GA-384	KND	KC6086	G-33	WABC	KL1519	GA-498	CHGN	KTP559016	GP-110	DON
KA71	GA-18	KIRK	KC68	GP-1122	KNE	KL1519A1	GA-498	CHGN	KTP559016	GP-9586	DON
KA71	GA-274	KMA	KC68	GP-1122	MAHL	KL19	GG-189	KNE	KV12276	GP-761H	JOND
KA71	GA-163	KND	KC68	GP-1122	TECF	KL19	GG-189	MAHL	KV16429	GA-853R	JOND
KA72	GA-392	KND	KC75	GP-96	MAHL	KL195	GPP-612	MAHL	KV26882	GA-853R ¹⁰⁴	JOND
KA73	GA-279	KND	KC8	GP-1122	KNE	KL2	GG-251	KNE	KW-104	GP-1101	KENW
KA74	GA-8606	KND	KC8	GP-1122	MAHL	KL2	GG-251	MAHL	KW-105	GP-1101	KENW
KA75	GA-275	KND	KC8	GP-1122	PUR	KL23	GG-3	MAHL	KW-105D	GPP-14	KENW
KA76	GA-80	KMA	KC8	GP-1122	TECF	KL28	GG-261	KNE	KW-110	G-1175	KENW
KA78	GA-89	KMA	KCLE325	GA-27	WORT	KL29	GG-226	KNE	KW-1212	GPP-11	KENW
KA79	GA-3588	KMA	KD100	GP-1	KMA	KL29	GG-226	MAHL	KW-1213	S 3202 ⁴⁰	KENW
KA8	GA-70	KMA	KD1300	GP-13	KMA	KL29	GG-226	TECF	KW-185	GP-110	KENW
KA8	GA-85	KND	KD300	GP-3	KMA	KL30	GG-246	KNE	KW-2010	GP-2071W	KENW
KA81	GA-153	KMA	KD500	GP-20	KMA	KL30	GG-246	MAHL	KW-2018	GP-1011Q	KENW
KA82	GA-3916	KMA	KD6500	G-500	WABC	KL30	GG-246	TECF	KW-2051	GP-2071W	KENW
KA83	GA-4303	KMA	KD900	GP-81 ³¹	KMA	KL47-13-Z40	GA-7344	MZDA	KW-2052	GP-1011Q	KENW
KA84	GA-4325	KMA	KD900	GP-9 ⁵⁸	KMA	KL47-13-Z40A	GA-7344	MZDA	KW-2053	GP-1011Q	KENW
KA85	GA-3814	KMA	KF1	GP-1	FDY	KL5	GG-246	KNE	KW-2054	GP-1013Q	KENW
KA87	GA-277	KMA	KF11	GP-13	FDY	KL5	GG-246	MAHL	KW-2055	GP-1013Q	KENW
KA88	GA-5056	KMA	KF12	GP-3	FDY	KL5	GG-246	TECF	KW-206	GP-27	KENW
KA89K	GA-26	KIRK	KF126	G-836	FDY	KL511	G-834	KIRK	KW-207	GP-26	KENW
KA9	GA-59	KND	KF1545	G-1143	ASAH	KL6	GG-246	KNE	KW-211	GP-56	KENW
KA93	GA-3901	KMA	KF1560	GP-110	ASAH	KL6	GG-246	MAHL	KW-213	GP-110	KENW
KA94	GA-174	KMA	KF1561	G-277	ASAH	KL6	GG-246	TECF	KW-509	G-33	KENW
KAX000510	GA-33 ¹¹²	DON	KF16	GP-81 ³¹	FDY	KL60	GG-5 L	KNE	KW-516	G-566	KENW
KAX000512	GAK-403	DON	KF16	GP-9 ⁵⁸	FDY	KL60	GG-5 L	MAHL	KW-632B	GP-14	KENW
KAX002049	GAK-403	DON	KF25A	G-870	FDY	KL60	GG-5 L	TECF	KW-637	G-159	KENW
KAX002079	GA-360	DON	KF28	GP-81 ³¹	FDY	KL79	GG-102	KNE	KW-667	GP-51	KENW
KAX002333	GA-27	DON	KF28	GP-9 ⁵⁸	FDY	KL9	GG-251	KNE	KW-670	GP-53	KENW
KAX002371	GAK-20	DON	KF3	GP-50	FDY	KL9	GG-251	MAHL	KW-670SC	GP-53	KENW
KAX002401	GAK-20	DON	KF33	GP-20	FDY	KM11	GP-5	KMG	KW-691	GP-52 ¹¹⁰	KENW
KAX002416	GA-360	DON	KF40	GP-13	FDY	KM13	GP-13	KMG	KW-691	GP-691 ⁴⁸	KENW
KAX003611	GA-356 ¹⁰⁴	DON	KF404	GG-123	KEM	KM16	GP-81	KMG	KW-750	G-750	KENW
KAX003611	GA-357 ¹⁰⁸	DON	KF404A	GG-123	KEM	KM200	G-200	KMG	KW-750A	G-750	KENW
KAX003647	GA-229	DON	KF42	GP-38	FDY	KM25	GP-20	KMG	KW-750B	G-750	KENW
KAX003710	GA-229	DON	KF45	GP-3429	FDY	KM2825	GP-38	KMG	KW-750D	G-750	KENW
KAX005131	GA-378	DON	KF47	GP-46	FDY	KM2850	GP-1	KMG	KW-7505	G-750	KENW
KAX005502	GA-378	DON	KF51	GP-3980	FDY	KM2865	GP-42	KMG	KW-777	GP-57	KENW
KAX005670	GA-6880	DON	KF52	G-871	FDY	KM2870	GP-28 ⁸⁴	KMG	KW-852M	GA-378	KENW
KB2	GA-100	KND	KF52A	G-870	FDY	KM2870	GP-3600 ⁸⁴	KMG	KW-853M	GA-229	KENW
KB3	GA-113	KND	KF6	GP-5	FDY	KM2870	GP-38 ⁸⁷	KMG	KW-865	GA-6880	KENW
KB5	GA-101	KND	KF7	GP-5	FDY	KM2870	GP-430 ⁸⁵	KMG	KW-865M	GA-6880	KENW
KC15	GPP-14	MAHL	KF73	GP-462	FDY	KM30	GP-3	KMG	KW-872	GA-376	KENW
KC17	GP-1122	ASAH	KF77	GP-3531 EXP	FDY	KM43	GP-81 ³¹	KMG	KW-872M	GA-376	KENW
KC17	GP-1122	KNE	KFP670	GP-53	KRA	KM43	GP-9 ⁵⁸	KMG	KX1	G-1121	MAHL
KC17	GP-1122	MAHL	KG10	GG-196	KMA	KM45	GP-3429	KMG	KX2	GP-1122	KNE
KC17	GPP-1122	MAHL	KG11	GG-87	KMA	KM46	GP-44	KMG	KX22	GG-48	KNE
KC17	GP-1122	TECF	KG111-1	GG-20	FDY	KM47	GP-46	KMG	KX22	GG-48	MAHL
KC18	GPP-1122	KNE	KG111-6A	GG-19	FDY	KM8A	GP-1	KMG	KX23	G-296	KNE
KC18	GPP-1122	PUR	KG119	GG-6	FDY	KMA133	GA-78	KMG	KX23	G-296-B	KNE
KC19	GPP-1122	KNE	KG120	GG-7	FDY	KMA136	GA-55	KMG	KX23	G-296	MAHL
KC19	GPP-1122	MAHL	KG13	GG-46	KMA	KMA146	GA-71	KMG	KX23	G-296-B	MAHL
KC19	GPP-1122	TECF	KG1-4	GG-1	FDY	KMA148	GA-80	KMG	KX23	G-296	PUR
KC20	GP-1122	KNE	KG1-4	GG-4	FDY	KMA160	GA-70	KMG	KX23	G-296-B	PUR
KC20	GP-1122	MAHL	KG2	GG-20	KMA	KMA176	GA-56	KMG	KX24	G-297-B	KNE
KC20	GP-1122	PUR	KG2	GG-6	KND	KMA184	GA-77	KMG	KX24	G-297-B	MAHL
KC20	GP-1122	TECF	KG3	GG-5 L	KMA	KMA189	GA-50	KMG	KX24	G-297-B	PUR
KC23	GPP-1122	MAHL	KG3	GG-123	KND	KMA192	GA-192	KMG	KX27D	G-1123F	KNE
KC24	GG-5 L	KNE	KG3/8	GG-5 L	FDY	KMA303	GA-303	KMG	KX27D	G-1123F	MAHL
KC24	GP-1122	MAHL	KG4	GG-19	KMA	KMA305	GA-730	KMG	KX27D	G-1123F	TECF
KC24	GP-1122	PUR	KG4	GG-19	KND	KMA324A	GA-85	KMG	KX30	G-1163	KNE
KC24	GP-1122	TECF	KG404	GG-123	FDY	KMA326	GA-59	KMG	KX30	G-1163	MAHL
KC25	GP-1122	KNE	KG470	GG-16	FDY	KMA327	GA-57	KMG	KX35	G-1121	KNE
KC25	GP-1122	MAHL	KG471	GG-17	FDY	KMA3300	GA-3300	KMG	KX35	G-1121	MAHL
KC25	GP-1122	TECF	KG5	GG-6	KMA	KMA340A	GA-86	KMG	KX35	G-1121	PUR
KC28	GP-110	KNE	KG5	GG-16	KND	KMA351	GA-74	KMG	KX35	G-1121	TECF
KC28	GP-110	MAHL	KG6	GG-7	KMA	KMA352	GAD-1	KMG	KX36	G-1123	KNE
KC28	GP-110	TECF	KG6	GG-17	KND	KNJ0288	GP-317H	LINK	KX36	G-1123	MAHL
KC29	GP-56	KNE	KG7	GG-123	KMA	KO1503	G-222	ASAH	KX36	G-1123	TECF

Referencia Cruzada por Numero de Parte

Cross Reference by Part Number



Numero	Gonher	Fabricante	Numero	Gonher	Fabricante	Numero	Gonher	Fabricante	Numero	Gonher	Fabricante
Number	Gonher	Manufacturer	Number	Gonher	Manufacturer	Number	Gonher	Manufacturer	Number	Gonher	Manufacturer
KX40	G-1123	KNE	L104	GP-9 ⁵⁸	PRET	L11-3611	GA-4958	LAZO	L120037	GAK-20	GEHL
KX40	G-1123	MAHL	L106	GP-36	KRA	L11-3620	GA-390	LAZO	L120054	GAK-403	GEHL
KX40	G-1123	TECF	L106	GP-870	PFX	L11-3735	GA-4303	LAZO	L121	G-225	PFX
KX41	G-1175 ¹⁰⁸	KNE	L106	GP-13	PRET	L114	GP-20	PRET	L12222	GP-406	PUR
KX42	G-1173	KNE	L107	GP-871	PFX	L11-4189	GA-390	LAZO	L123	G-139	CHRY
KX42	G-1173 ¹⁰⁸	MAHL	L108	GP-3682	PRET	L11-4200	GA-216	LAZO	L123	G-139	MOP
KX43	G-1121F	KNE	L108576	GP-34	CASE	L11-4219	GA-4828	LAZO	L123	GP-28 ⁶	PRET
KX43	G-1121F	MAHL	L109	GP-331	CHRY	L11-4227	GA-362	LAZO	L123	GP-430 ⁸	PRET
KX43	G-1121F	TECF	L109	GP-3600	KRA	L11-4278	GA-471	LAZO	L125	GP-3531	EXP
KX44	G-1123F	KNE	L109	GP-331	MOP	L11-4316	GA-139	LAZO	L1261F	GS-1261	CHP
KX44	G-1123F	MAHL	L10F	GP-1163	APOL	L11-4464	GA-195	LAZO	L1261F	GS-1261	CIGO
KX44	G-1123F	TECF	L10F	GP-1163	BWS	L11-4728	GA-322	LAZO	L1261F	GS-1261	LUF
KX46	G-1121F	KNE	L10F	GP-1163	CAM2	L11-4753	GAD-29	LAZO	L1261F	GS-1261	PARP
KX46	G-1121F	MAHL	L10F	GP-1163	CHP	L11-4850	GG-185	LAZO	L1261F	GS-1261	WARN
KX46	G-1121F	TECF	L10F	GP-1163	LUF	L11-4855	GA-2106	LAZO	L127	GP-58	KRA
KX47	GG-20	MAHL	L10L	GP-871	LEE	L11-4868	GA-386	LAZO	L127	GP-1	MOP
KX48	G-295	MAHL	L11	GP-5	GOY	L11-4876	GA-6690	LAZO	L128	G-225	PFX
KX49D	G-1121F	KNE	L11	GP-5	KND	L11-4880	GA-3588	LAZO	L-128/166.0	GA-2160	AFIL
KX49D	G-1121F	MAHL	L11	GP-81	KRA	L11-4885	GA-195	LAZO	L13	GP-13	GOY
KX49D	G-1121F	TECF	L11	G-1174 ¹⁰⁸	MOP	L11-4905	GA-382	LAZO	L13	GP-46	KRA
KX67-2	G-1046	KNE	L11	GP-5	SUN	L11-4906	GAD-30	LAZO	L130	GP-310	KRA
KX67-2D	G-1046	KNE	L11	GP-5	VALV	L11-4928	GAD-30	LAZO	L130	GP-3569	KRA
KX68D	G-1121F	KNE	L-11	GP-5	FACE	L11-4936	GA-139	LAZO	L130	GP-1	MOP
KX68D	G-1121F	MAHL	L110	GP-58	KRA	L11-4960	GA-142	LAZO	L131	G-296	CHAM
KX68D	G-1121F	SOPA	L110	GP-836	PFX	L11-4979	GAD-3	LAZO	L131	G-296-B	CHAM
KYP18367	GA-5648	DON	L11091	GP-46	EVGR	L115	G-34	LEDR	L131	GP-20	CHRY
KYX000368	GA-5648	DON	L11091	GP-157	MIGH	L115	G-34	LEE	L131	GP-20	MOP
KYX000482	GA-26	DON	L11091	GP-46	PUR	L115	GP-3	PRET	L131	GP-3429	PRET
KYX002360	GA-356 ¹⁰⁴	DON	L1111	GP-77	KRA	L11-5002	GG-196	LAZO	L132	G-297-B	CHAM
KYX002360	GA-357 ¹⁰⁸	DON	L111	GP-871	MOP	L11-5010	GG-45	LAZO	L132	GP-46	PRET
KYX005251	GA-372	DON	L111	GP-310	PRET	L11-5029	GG-196	LAZO	L133	G-1121	CHAM
KYX005737	GA-229	DON	L11-1007	GP-40	LAZO	L11-5037	GG-94	LAZO	L133	G-34	CHRY
KYX006229	GA-2804	DON	L11-1031	GP-870	LAZO	L11-5096	GG-5	LAZO	L133	GP-68	KRA
KYX101243	GA-26 ¹¹²	DON	L11-1066	GP-38	LAZO	L11-5118	GG-5	LAZO	L133	G-191	LBFI
			L11-1074	GP-171	LAZO	L11-5177	GG-208	LAZO	L133	G-34	MOP
			L11-1090	GP-42	LAZO	L11-5223	GG-45	LAZO	L1335	GP-68	KRA
			L11-1104	GP-3531	EXP	L11-5231	GG-76	LAZO	L134	GP-13	CHRY
			L11-1139	GP-24 ²⁶	LAZO	L11-5266	GG-202	LAZO	L134	GP-3	MOP
			L11-1139	GP-462 ²⁴	LAZO	L11-5282	GG-203	LAZO	L-134/280.0	GA-410	AFIL
			L11-1201	GP-1	LAZO	L11-5312	GG-76	LAZO	L135	GP-171 ¹⁶	MOP
			L11-1224	GP-58	LAZO	L11-5320	GG-76	LAZO	L1350593	G-1143 ⁹⁰	POCL
			L11-1244	GP-58	LAZO	L11-5339	GG-194	LAZO	L136	GP-34	CHRY
			L11-1252	GP-3985	LAZO	L11-5398	GG-208	LAZO	L136	GP-3	MOP
			L11-1260	GP-3985 ⁶³	LAZO	L11-5428	GG-204	LAZO	L137	G-296	CHAM
			L11-1279	GP-3682	LAZO	L11-5436	GG-208	LAZO	L137	G-296-B	CHAM
			L11-1295	GP-3985	LAZO	L11-5444	GG-203	LAZO	L13786	G-296	FISP
			L11-1317	GP-3985 ⁶³	LAZO	L11-5487	GG-196	LAZO	L13786	G-296-B	FISP
			L11-1325	GP-462	LAZO	L11-5614	GG-63	LAZO	L138	GP-1	CHRY
			L11-1333	GP-3985	LAZO	L11-5665	GG-1	LAZO	L138	GP-1	MOP
			L11-1350	GP-58	LAZO	L11-5665	GG-4	LAZO	L139	G-1121F	CHAM
			L11-1384	GP-40	LAZO	L11-5673	GG-208	LAZO	L1393	GP-28 ⁶	KRA
			L11-1392	GP-40 ⁶⁴	LAZO	L11-5720	GG-215	LAZO	L1393	GP-430 ⁸	KRA
			L11-1392	GP-91 ⁷⁸	LAZO	L11-5738	GG-185	LAZO	L1393	GP-28	LEE
			L1114	GP-77	KRA	L11-5789	GG-63	LAZO	L140	G-1123F	CHAM
			L11-1406	GP-462	LAZO	L11-5800	GG-185	LAZO	L140	GP-88	KRA
			L11-1465	GP-171	LAZO	L11-5860	GG-213	LAZO	L14006	GP-44	FSN
			L11-1473	GP-2951 ⁶²	LAZO	L115894	GG-185	LAZO	L14006	GP-44	PUR
			L11-1473	GP-58 ²⁴	LAZO	L11-5967	GG-203	LAZO	L141	GP-31	KRA
			L11-1481	GP-171	LAZO	L116	GP-81	CHRY	L141	G-200	LEE
			L11-1805	GP-58	LAZO	L116	GP-81	MOP	L142	GA-70	CHRY
			L11-1830	GP-58	LAZO	L11-6025	GG-217	LAZO	L142	GA-70	MOP
			L11-1899	GP-157	LAZO	L11-6033	GG-220	LAZO	L142X	GA-70	CHRY
			L11-1910	GP-2951 ⁶²	LAZO	L11-6394	GG-232	LAZO	L143	GP-67	KRA
			L11-1910	GP-58 ²⁴	LAZO	L11-6408	GG-185	LAZO	L143	GP-3600	PRET
			L11-2135	GP-212	LAZO	L11-6440	GG-214	LAZO	L14459	GP-149 ⁶⁹	PUR
			L11-2178	GP-46	LAZO	L11-6470	GG-136	LAZO	L14459	GP-91 ²⁴	PUR
			L11-2208	GP-149 ⁶⁹	LAZO	L11-6475	GG-215	LAZO	L14476	GP-157	PUR
			L11-2208	GP-91 ²⁴	LAZO	L11-6483	GG-190	LAZO	L14477	GP-156	ECOL
			L11-2216	GP-157	LAZO	L11-6483	GG-181	LNCR	L14477	GP-156	PUR
			L11-2224	GP-3682	LAZO	L11-6488	GG-47	LAZO	L145	GA-73	CHRY
			L1246	GAK-16	CASE	L11-6556	GG-148	LAZO	L14610	GP-149	PUR
			L1247	GAK-16	CASE	L11-6569	GG-79 ⁹⁰	LAZO	L14612	GP-91	EVGR
			L113	GP-1	KRA	L11-6599	GG-208	LAZO	L14612	GP-91	PUR
			L11-3026	GA-4325	LAZO	L11-6607	GG-185	LAZO	L14619	GP-3985	ECOL
			L11-3069	GA-4303	LAZO	L11-6615	GG-47	LAZO	L14619	GP-3985	PUR
			L11-3085	GA-75	LAZO	L11-6705	GG-260	LAZO	L14620	GP-149	PUR
			L11-3093	GAD-1	LAZO	L11-6721	GG-79 ⁹⁰	LAZO	L14622	GP-91	ECOL
			L11-3107	GAD-3	LAZO	L11-6764	GG-185	LAZO	L14622	GP-91	PUR
			L11-3115	GAD-3	LAZO	L11-6785	GG-185	LAZO	L14670	GP-81	ECOL
			L11-3123	GAD-1	LAZO	L11-6815	GG-46	LAZO	L14670	GP-81	PUR
			L11-3140	GAD-15	LAZO	L11-6925	GG-185	LAZO	L147	GP-46	KRA
			L11-3166	GA-2740	LAZO	L11-6934	GG-184	LAZO	L148	GP-46	KRA
			L11-3204	GA-3490	LAZO	L11-6971	GG-146	LAZO	L149	GP-54	KRA
			L11-3220	GA-2740	LAZO	L11-6971	GG-146	LNCR	L151	GP-36	KRA
			L11-3263	GA-140	LAZO	L11-6998	GG-214	LAZO	L151R	GP-36	KRA
			L11-3298	GA-2719B	LAZO	L117	G-139	CHRY	L15309	G-45	EVGR
			L11-3301	GA-2719B	LAZO	L117	GP-3985	KRA	L15309	G-45	PUR
			L11-3336	GA-3566	LAZO	L117	GP-3985	LAZO	L15313	GP-408	EVGR
			L1133F	GC-1133	LUF	L117	G-139	MOP	L15313	GP-408	PUR
			L11-3409	GA-75	LAZO	L119	GG-6	LEDR	L15315	G-72	PUR
			L11-3417	GAD-30	LAZO	L119	GG-6	LEE	L15315	G-72	SHE
			L11-3476	GA-180	LAZO	L11R	GP-81	KRA	L15317	GP-457	PUR
			L11-3484	GA-2740	LAZO	L12	GP-212	KRA	L15386	G-49	PUR
			L1134F	GS-1133	CHP	L12	G-1175 ¹⁰⁸	MOP	L15436	G-49	PUR
			L1134F	GS-1133	LUF	L120	GG-7	LEDR	L15505	G-70	PUR
			L11-3590	GA-78	LAZO	L120	GG-7	LEE	L156	GA-105	CHRY

L

L09505-54	G-296	POCL
L09505-54	G-296-B	POCL
L1	GP-171 ¹⁶	KRA
L1	GP-5	MOP
L1	GP-1	VALV
L10	GP-28 ⁸	KRA
L10	GP-430 ⁸	KRA
L100	GAVW-2	BOG
L10017	GP-81	ECOL
L10017	GP-81	PUR
L10018	GP-81	ECOL
L10018	GP-81	PUR
L10028	GP-3816	EVGR
L10028	GP-3816	PUR
L1007	GP-1	CHRY
L1007	GP-1	MOP
L1008	GP-81 ³¹	CHRY
L1008		

Numero	Gonher	Fabricante	Numero	Gonher	Fabricante	Numero	Gonher	Fabricante	Numero	Gonher	Fabricante
Number	Gonher	Manufacturer	Number	Gonher	Manufacturer	Number	Gonher	Manufacturer	Number	Gonher	Manufacturer
L156	GA-105	MOP	L198	GA-730	MOP	L22	G-1173 ¹⁰⁸	CHRY	L274F	G-1174 ¹⁰⁸	CAM2
L156	G-33	PFX	L198X	GA-730	CHRY	L22	GP-1	KRA	L274F	G-1174	CHP
L157	G-152	LBFI	L19926	G-1121	JOND	L22	G-1173 ¹⁰⁸	MOP	L274F	G-1174	LUF
L159	GA-59	CHRY	L19927	G-1121	JOND	L220	GA-100	CHRY	L275	GP-57	KRA
L159	GA-56	MOP	L19V	GP-81 ³¹	CHRY	L220	GA-100	MOP	L276	GP-57	KRA
L16	GP-81 ³¹	KRA	L19V	GP-9 ⁵⁸	CHRY	L221	G-152	LBFI	L278	GP-193	KRA
L16	GP-9 ⁵⁸	KRA	L19V	GP-81 ³¹	MOP	L22167	GP-171	PUR	L28	G-119	CHRY
L161	G-335	LBFI	L19V	GP-9 ⁵⁸	MOP	L2222	GP-406	PPRO	L28	G-119	MOP
L1619	GP-166 ⁹⁵	KRA	L19X	GP-81 ³¹	CHRY	L223	G-191	LBFI	L280	GP-54 ⁹⁰	KRA
L1619	GP-3937 ¹¹	KRA	L19X	GP-9 ⁵⁸	CHRY	L226	GP-66 ⁹⁰	KRA	L281	GP-54	KRA
L1621	GP-166	KRA	L1F200	G-1173 ¹⁰⁸	LEE	L226U	GP-66 ⁹⁰	KRA	L2819	GP-36	VALV
L163	GA-77	CHRY	L20	G-33	ACD	L22821	GP-58	ECOL	L-2825	GP-38	FACE
L163	GP-42	KRA	L20	G-1174 ¹⁰⁸	CHRY	L22821	GP-58	PUR	L2841	GP-156	FACE
L163	GA-77	MOP	L20	G-1174 ¹⁰⁸	MOP	L2286	GP-562	VALV	L2849	GP-24 ²⁶	GOY
L16311	G-911	PUR	L200	GP-53	KRA	L229	GA-3425	CHRY	L2849	GP-462 ²⁴	GOY
L163A	GP-42	KRA	L20020	GP-81	EVGR	L23	G-31	CHRY	L-2849	GP-24 ²⁶	FACE
L164	GP-22	KRA	L20020	GP-81	PUR	L23	GP-50	KRA	L-2849	GP-462 ²⁴	FACE
L1650559	G-1143 ⁹⁰	POCL	L20024	GP-50	EVGR	L23	G-31	MOP	L-2850	GP-310	FACE
L165A	GP-91	KRA	L20024	GP-50	PUR	L233	GP-3766	KRA	L2862	GP-36	VALV
L166	G-813	PFX	L20033	GP-20	ECOL	L236	GP-171	KRA	L2863	GP-3985	KND
L167	GA-37	CHRY	L20033	GP-20	PUR	L238	G-238	LPM	L2863	GP-3985	MIGH
L167	GA-37	MOP	L20049	GP-3	ECOL	L23B	GP-50	KRA	L2863	GP-3985	VALV
L168	GA-71	CHRY	L20049	GP-3	PUR	L23F	G-11816	APOL	L-2863	GP-3985	FACE
L168	GA-71	MOP	L20064	GP-3600 ⁸⁹	PUR	L23F	G-11816	CAM2	L2865	GP-42	GOY
L169	GP-10	KRA	L20064	GP-38 ²⁷	PUR	L23F	G-11816	LUF	L2865	GP-42	VALV
L169	GP-69	KRA	L20073	GP-24 ²⁶	PUR	L24	GP-58	KRA	L-2865	GP-42	FACE
L169S	G-5000	LEE	L20073	GP-462 ²⁴	PUR	L24007	GP-44	PUR	L2870	GP-28 ⁶	FLUX
L17	GP-50	KRA	L20081	GP-81 ³¹	ECOL	L24011	GP-3980	ECOL	L2870	GP-430 ⁸	FLUX
L170	GA-80	CHRY	L20081	GP-9 ⁵⁸	ECOL	L24011	GP-3980	PUR	L2876	GP-91	VALV
L170	GA-80	MOP	L20081	GP-81 ³¹	PUR	L24457	GP-3682 ²³	PUR	L28812	G-963	EVGR
L171	GA-105	MOP	L20081	GP-9 ⁵⁸	PUR	L24457	GP-37 ⁵⁴	PUR	L28812	G-963	GRP
L1712	GP-166	KRA	L20089	GP-3600	PUR	L24458	GP-462	PUR	L28812	G-963	HERI
L172	GA-50	CHRY	L20099	G-834	PUR	L24484	GP-212	ECOL	L28812	G-963	MIGH
L172	GA-50	MOP	L200U	GP-53	KRA	L24484	GP-212	JFL	L28812	G-963	MOB
L175	GP-23	KRA	L201	GG-5 L	CHAM	L24484	GP-212	PUR	L28812	G-963	PUR
L175A	GP-23	KRA	L201	GP-53	KRA	L245	GP-31	KRA	L28812	G-963	SHE
L176	GP-10	KRA	L20123	GP-3429	ECOL	L24651	GP-68	ECOL	L289	GP-3985	FACE
L176	GA-7	MOP	L20123	GP-3429	PUR	L24651	GP-68	PUR	L289	GP-3985	GOY
L17662	GP-461	PUR	L20126	G-836	PUR	L248	GP-390	KRA	L289	GP-3985	MINL
L17695	GP-291	PUR	L20173	GP-3980	PUR	L249	GP-178	KRA	L289	GP-3985	PRET
L176A	GP-10	KRA	L20179	G-813	PUR	L24R	GP-171	KRA	L289	GP-40	VALV
L177	GA-33 ¹¹²	GRAY	L20195	GP-3600	ECOL	L245	GP-81	KRA	L29	GP-81	KRA
L177	GP-51	KRA	L20195	GP-3600	PUR	L25	GP-20	GOY	L290	GP-3985	VALV
L178	GA-90	CHRY	L201U	GP-53	KRA	L25	G-1163 ¹⁰⁸	MOP	L291	GP-152	KRA
L178	GA-90	MOP	L202	GA-2194	BOG	L251	GP-9586	KRA	L292	GP-149 ⁶⁹	FACE
L178	G-834	PFX	L202	GP-66	KRA	L25195	GP-81	PUR	L292	GP-91 ³⁴	FACE
L17819	GP-455	PUR	L2020F	GS-2033	BWS	L252	GP-761H	KRA	L292	GP-81	KRA
L17914	G-25	PUR	L2020F	GS-2033	CHP	L25230	GP-128	EVGR	L292	GP-149 ⁶⁹	VALV
L18	GP-3985	KRA	L2020F	GS-2033	LUF	L25230	GP-128	FSN	L292	GP-91 ³⁴	VALV
L180	GP-3600	KRA	L2021F	2010PM-OR ⁷	LUF	L25230	GP-128	PUR	L2941	GP-34	KRA
L181	GP-340	KRA	L2021F	2010TM-OR ⁷	LUF	L25247	G-954	EVGR	L2951	GP-2951 ¹²	GOY
L181	GA-37	MOP	L20250	GP-57	PUR	L25247	G-954	PUR	L2951	GP-58 ³⁴	GOY
L1817	GP-761H	KRA	L20252	GP-28 ⁸	ECOL	L25250	G-112	EVGR	L296F	G-296	AIRT
L182	GP-69	KRA	L20252	GP-430 ⁸	ECOL	L25250	G-112	PUR	L296F	G-296-B	AIRT
L183	G-613	LBFI	L20252	GP-28 ⁸	PUR	L25251	G-975	GRP	L296F	G-296	APOL
L183	GP-58	MIGH	L20252	GP-430 ⁸	PUR	L25251	G-975	MOB	L296F	G-296-B	APOL
L183	GP-3816	VALV	L20253	GP-3985	EVGR	L25251	G-975	PUR	L296F	G-296	BWS
L-183	GP-58	FACE	L20253	GP-3985	PUR	L25251	G-975	QKS	L296F	G-296-B	BWS
L18313	G-25	PUR	L20290	GP-3985	EVGR	L25251	G-975	SHE	L296F	G-296	CAM2
L186	GP-3600	KRA	L20290	GP-3985	PUR	L25274	G-765	PUR	L296F	G-296-B	CAM2
L187	GP-36	KRA	L202F	2010PM-OR ⁷	LUF	L25276	G-180	GRP	L296F	G-296	CENE
L188	GP-44	KRA	L202F	2010TM-OR ⁷	LUF	L25276	G-918	GRP	L296F	G-296-B	CENE
L189	GA-192	CHRY	L203	GG-246	CHAM	L25276	G-180	MOB	L296F	G-296	CHP
L189	GP-46	KRA	L203	GG-5 L	CHRY	L25276	G-918	MOB	L296F	G-296-B	CHP
L189	GA-192	MOP	L203	GG-5 L	MOP	L25276	G-180	PUR	L296F	G-296	GRAN
L18R	GP-3985	KRA	L204	GA-2110	BOG	L25276	G-918	PUR	L296F	G-296-B	GRAN
L19	GP-81 ³¹	CHRY	L204	GG-246	CHAM	L25276	G-180	QKS	L296F	G-296	LUF
L19	GP-9 ⁵⁸	CHRY	L204	GG-5	CHRY	L25276	G-918	QKS	L296F	G-296-B	LUF
L19	GP-3600	KRA	L205	GG-246	CHAM	L25288	GP-3675	EVGR	L296F	G-296	WARN
L19	GP-81 ³¹	MOP	L205	GP-3766	KRA	L25288	GP-3675	PUR	L296F	G-296-B	WARN
L19	GP-9 ⁵⁸	MOP	L206	GG-251	CHAM	L253	GP-761H	KRA	L296FE	G-296	LUF
L190	GA-78	CHRY	L20761	G-236	EVGR	L-253	GP-3985 ⁵³	FACE	L296FE	G-296-B	LUF
L190	GP-52 ¹⁰	KRA	L20761	G-236	PUR	L25401	GP-171	PUR	L297	GP-3980	KRA
L190	GP-691 ⁴⁸	KRA	L208	GP-35	KRA	L25522	GP-457	PUR	L297	GP-3985 ⁵³	FACE
L190	GA-78	MOP	L208U	GP-35	KRA	L25608	G-912	PUR	L2977	GP-3985 ⁵³	KND
L1904	GP-52 ¹⁰	KRA	L209	GP-44	KRA	L259503	GAK-16	GEHL	L2977	GP-3985 ⁵³	VALV
L1904	GP-691 ⁴⁸	KRA	L21	G-1173 ¹⁰⁸	MOP	L255	GP-5	KRA	L29A	GP-81	KRA
L190R	GP-52 ¹⁰	KRA	L210	GG-189	CHAM	L26	GP-81	KRA	L29S	GP-81	KRA
L190R-MO	GP-691 ⁴⁸	KRA	L210A	GP-58	KRA	L26	GP-1101	LBFI	L3	G-6	MOP
L190R-MO	GP-52 ¹⁰	KRA	L211	GP-53	KRA	L26	G-836	MOP	L30	GP-3	GOY
L190R-MO	GP-691 ⁴⁸	KRA	L211	GP-139	LBFI	L260	GP-36	FACE	L30	GP-50	KRA
L190R-U	GP-52 ¹⁰	KRA	L211U	GP-53	KRA	L262F	G-1175 ¹⁰⁸	LUF	L30	G-31	LPM
L190R-U	GP-691 ⁴⁸	KRA	L212	GP-43	KRA	L264	G-49	PFX	L300	GP-69	CHRY
L191	GAK-16	GRAY	L213	GP-38	KRA	L264A	G-49	PFX	L300	GP-69	MOP
L191	GP-69	KRA	L214	GG-20	CHRY	L264S	GP-38	KRA	L30001	GP-1	ECOL
L194	GA-55	CHRY	L214	GP-43	KRA	L265	GP-91	KRA	L30001	GP-1	PUR
L194	GP-34	KRA	L214	GG-20	MOP	L266	GP-91	KRA	L30003	GP-50	EVGR
L194	GA-55	MOP	L215	GG-123	CHRY	L267	GP-3682	KRA	L30003	GP-50	PUR
L194U	GP-34	KRA	L215	GG-123	MOP	L27	GP-5	KRA	L30005	GP-5	PUR
L195	GP-3429	KRA	L216	GG-226	CHAM	L27	GP-50	MOP	L30013	G-335	PUR
L1950594	GG-5 L	CASE	L217	GG-19	CHRY	L2700028	GA-33 ¹¹²	CHRY	L30014	G-139	PUR
L19505-94	GG-5 L	POCL	L217	GG-19	MOP	L271F	G-1176	LUF	L30015	GP-14	PUR
L197	GA-85	CHRY	L218	GG-6	CHRY	L27218	GP-171	PUR	L30026	GP-14	PUR
L197	GP-3980	KRA	L218	GG-6	MOP	L27221	G-834	PUR	L30040	GP-13	ECOL
L197	GA-85	MOP	L219	GG-7	CHRY	L274	GP-14	KRA	L30040	GP-13	PUR
L198	GA-730	CHRY	L219	GG-7	MOP	L274F	G-1174	APOL	L30042	GP-38	EVGR

Referencia Cruzada por Numero de Parte

Cross Reference by Part Number



Numero	Gonher	Fabricante	Numero	Gonher	Fabricante	Numero	Gonher	Fabricante	Numero	Gonher	Fabricante
Number	Gonher	Manufacturer	Number	Gonher	Manufacturer	Number	Gonher	Manufacturer	Number	Gonher	Manufacturer
L30042	GP-38	PUR	L324X	GP-1	CHRY	L38	GP-5	MOP	L4254048	GP-3985	HITA
L30048	G-6	PUR	L325	GP-22	CHRY	L38113	G-466	GRP	L429A-4	G-11816	DORM
L30049	G-330	PUR	L325	GP-1	MOP	L38113	G-466	MOB	L42FC	GP-38	LEE
L3005	GP-5	PUR	L326	GP-1	MOP	L38113	G-466	PUR	L43	GP-28	CHRY
L30052	G-870	EVGR	L327	GP-40	CHRY	L38113	G-466	SHE	L43	GP-81 ²¹	GOY
L30052	G-870	PUR	L327	GP-3985	MOP	L3850	GP-310	FACE	L43	GP-9 ⁸⁸	GOY
L30054	GP-36	PUR	L328	GP-54	KRA	L3850	GP-3569	GOY	L43	GP-50	KRA
L30066	GP-50	PUR	L329	GP-44	MOP	L3856	GP-40	GOY	L43	GP-3600	MOP
L30088	G-119	PUR	L33	GP-3816	KRA	L3870	GP-28 ⁹	GOY	L430	G-834	PFX
L300D1	GP-1	PUR	L33	G-33	LPM	L3870	GP-430 ⁸	GOY	L432	G-330	PFX
L301	GP-51	CHRY	L330	GP-42	MOP	L-3870	GP-28 ⁹	FACE	L438	G-31	PFX
L301	GP-51	MOP	L3306	GP-10	KND	L-3870	GP-430 ⁸	FACE	L43F	G-1143	CHP
L30119	GP-1	PUR	L3306	GP-10	MINL	L3887F	GPP-419	LUF	L43F	G-1143	LUF
L30121	GP-390 ⁹³	PUR	L3306	GP-10	VALV	L39	GP-54 ¹¹	FLUX	L44	GP-44	KND
L30124	GP-1 ⁹	PUR	L-3306	GP-10	FACE	L39	GP-66 ¹⁰	FLUX	L44	GP-44	MINL
L30135	G-333	PUR	L331	GAVW-4	BOG	L39	GP-14	KRA	L44	GP-44	VALV
L30137	GP-1	PUR	L331	GP-40	CHRY	L39001	GP-171 ¹⁶	EVGR	L-44	GP-44	FACE
L30138	GP-3600	PUR	L331	GP-40	MOP	L39001	GP-171 ¹⁶	PUR	L44-1295	GP-3985	LAZO
L30141	G-200	EVGR	L333	GP-3980	CHRY	L3919F	GPP-425	LUF	L443	G-133	PFX
L30141	G-200	PUR	L333	G-333	LPM	L392	GP-171	KRA	L443	G-989	PFX
L30169	G-500	PUR	L333	GP-3980	MOP	L39260	GP-54 ⁹⁰	PUR	L4422	GP-178	PUR
L302	GP-10	CHRY	L333	G-25	PFX	L3973F	GPP-612	CHP	L44444	GP-34	PUR
L302	GP-10	MOP	L3335	GP-52 ¹¹⁰	FLUX	L3973F	GPP-612	LUF	L4458	GP-462	GOY
L30215	GP-9586	PUR	L3335	GP-691 ⁴⁸	FLUX	L3973F	GPP-612	WARN	L4459	GP-91	GOY
L30224	GP-77	PUR	L334	GP-1	LUF	L39A	GP-14	KRA	L447	GP-761H	KRA
L30238	GP-68	PUR	L335	GP-58	CHP	L4	GP-50	CHRY	L44748	GP-452	GRP
L30255	GP-36	EVGR	L335	GP-58	CHRY	L4	GP-157	KRA	L44748	GP-452	MIGH
L30255	GP-36	PUR	L335	GP-58	GOY	L4	GP-50	MOP	L44748	GP-452	MOB
L30257	GP-310	ECOL	L335	GP-58	MOP	L-40	GP-69	FACE	L44748	GP-452	PUR
L30257	GP-3569	ECOL	L33711	G-33	CASE	L400	GP-3600	GOY	L44748	GP-452	QKS
L30257	GP-310	EVGR	L339	GP-754	KRA	L40010	G-871	EVGR	L44748	GP-452	SHE
L30257	GP-3569	GRP	L33913	GAK-20	CASE	L40010	G-801	PUR	L44757	G-971	EVGR
L30257	GP-3569	JFL	L34	GP-81	KRA	L40010	G-871	PUR	L44757	G-971	MIGH
L30257	GP-310	PUR	L34421	GP-390	PUR	L40017	GP-31	PUR	L44757	G-971	PEP
L30257	GP-3569	PUR	L345	G-813	CHRY	L40035	G-31	PUR	L44757	G-971	PUR
L30260	GP-36	EVGR	L345	GP-813	MOP	L40048	GP-10	PUR	L4477	GP-156	GOY
L30260	GP-36	MIGH	L34631	GP-205	ECOL	L40048	GP-54	PUR	L44872	GP-562	EVGR
L30260	GP-36	PUR	L34631	GP-205	PUR	L40048	GP-66	PUR	L44872	GP-562	MIGH
L30279	GP-359	PUR	L34733	GP-171	PUR	L40050	GP-31	PUR	L44872	GP-562	PUR
L30279	GP-43	PUR	L34875	GP-171	EVGR	L40068	GA-78	PUR	L449	GP-761H	KRA
L30288	GP-3766	EVGR	L34875	GP-171	PUR	L40084	GP-23	EVGR	L45	GP-3429	GOY
L30288	GP-3766	PUR	L349	GP-166 ⁶⁵	KRA	L40084	GP-23	PUR	L45	GP-31	KRA
L303	G-295	MOP	L349	GP-3937 ¹¹	KRA	L40087	GP-69	PUR	L450	GP-761H	KRA
L30341	GP-171 ¹⁶	EVGR	L35	GP-81	KRA	L40088	GP-69	PUR	L450	GP-761H	KRA
L30341	GP-171 ¹⁶	PUR	L35	G-31	LEE	L401	GA-303	CHRY	L45335	GP-178	PUR
L304	GP-26	CHRY	L350	GP-23	CHRY	L401	GA-303	MOP	L45391	GP-166 ⁶⁵	PUR
L304	GP-26	MOP	L350	GP-23	MOP	L40106	GP-54 ¹¹	PUR	L45391	GP-3937 ¹¹	PUR
L305	GP-27	CHRY	L3512	GP-22	KND	L40106	GP-66 ¹⁰	PUR	L455	GP-761H	PUR
L305	GP-562	KRA	L3512	GP-22	VALV	L40107	GP-31	PUR	L45515	GP-3752	KRA
L305	GP-27	MOP	L-3512	GP-22	FACE	L40110	GP-10	PUR	L456	GP-761H	KRA
L306	GA-203	BOG	L3514F	GG-48	LUF	L40110	GP-54	PUR	L457	GP-761H	KRA
L308	GPP-14	CHRY	L35197	GP-754	PUR	L40115	G-34	PUR	L45851	GP-3000 ¹³	PUR
L308	GPP-14	MOP	L35280	G-984	EVGR	L40127	GP-54	PUR	L4595F	G-178	CHP
L309	GP-110	CHRY	L35280	G-984	PUR	L40128	GP-67	PUR	L4595F	G-178	LUF
L309	GP-457	KRA	L3531	GP-3531	EXP	L40129	GP-88	PUR	L4595F	G-178	WARN
L309	GP-110	MOP	L35331	GP-3985	PUR	L402	GA-59	CHRY	L4596F	G-862	CHP
L310	GAD-3	BOG	L3535	GP-3980	FLUX	L402	GA-59	MOP	L4596F	G-862	LUF
L3101F	GPP-425	LUF	L35495	GA-106 ⁴⁶	CASE	L40210	GP-50 ⁹⁰	PUR	L4596F	G-862	WARN
L3102F	GPP-419	LUF	L35495	GA-326 ⁷¹	CASE	L403	GA-57	CHRY	L4604F	G-1047	CHP
L311	G-296	CHRY	L35495	GP-359	PUR	L403	GA-57	MOP	L4604F	G-1047	CIGO
L311	G-296-B	CHRY	L35496	GA-206	CASE	L40313	GP-43	PUR	L4604F	G-1047	LUF
L311	G-296	MOP	L35581	G-313	PUR	L40314	GP-35	PUR	L4604F	G-1047	WARN
L311	G-296-B	MOP	L3569F	G-297	LUF	L404	GA-325	CHRY	L46066	GP-359	PUR
L312	GP-31	CHRY	L3569F	G-297-B	LUF	L404	GA-325	MOP	L46066	GP-359	SERV
L312	GP-31	MOP	L3578	G-128	LUF	L407	GA-3425	BOG	L4622	GP-91	GOY
L31230	G-33	CASE	L-3578FN	G-128	LUF	L407	GA-3300	CHRY	L465	GP-78	BOG
L31240	G-1175 ¹⁰⁸	CASE	L3578N	G-128	LUF	L407	GA-3300	MOP	L4651	GP-68	GOY
L313	GP-78	MOP	L358	GP-91	KRA	L408	GA-2740	BOG	L4651	GP-68	PRET
L315	GP-54	CHRY	L3580F	G-178	AIRT	L408	GA-75	CHRY	L4670	GP-81	PUR
L315	GP-128	KRA	L3580F	G-178	CENE	L408	GA-75	MOP	L47	G-191	CHRY
L315	GP-10	MOP	L3580F	G-178	CHP	L409	GA-3490	BOG	L47	GP-46	GOY
L316	GP-66	CHRY	L3580F	G-178	GRAN	L409	GA-429	CHRY	L47	GP-58	KRA
L316	GP-66	MOP	L3580F	G-178	LUF	L409	GA-429	MOP	L47	GP-58	MOP
L316	G-25	PFX	L3580F	G-178	PARP	L41	GP-44	MOP	L47033	GP-54 ¹¹	PUR
L317	GP-14	CHRY	L3580F	G-178	WARN	L410	GA-86	CHRY	L47033	GP-66 ¹⁰	PUR
L317	GP-14	MOP	L35913	GA-20	CASE	L410	GA-86	MOP	L47356	G-31	PUR
L318	GP-66	MOP	L35913	GAK-20	CASE	L411	GA-74	CHRY	L47430	G-163	PUR
L319	GP-81	CHRY	L355	GP-81 ²¹	KRA	L411	GA-74	MOP	L48	G-6	LEE
L319	GP-81	MOP	L355	GP-9 ⁸⁸	KRA	L41127	G-613	PUR	L485	GP-761H	KRA
L32	GP-212	KRA	L36	GP-50	KRA	L413	GA-50	BOG	L4851	GP-3000 ¹³	LUF
L320	GP-46	CHRY	L3612	GP-53	FLUX	L414	GA-78	CHRY	L486	GP-761H	KRA
L320	GP-68	KRA	L364F	G-1166	LUF	L414	GA-78	MOP	L49	G-330	LEE
L320	GP-46	MOP	L364F1	G-1166	LUF	L417	GA-26	CHRY	L49075	GAK-20	CASE
L321	GP-44	MOP	L365	GP-149	KRA	L417	GA-26	MOP	L49087	GP-88	PUR
L32106	G-834	EVGR	L3675	GP-44	FACE	L419	GA-39	CHRY	L49087	GP-88	WALM
L32106	G-834	PUR	L3675	GP-44	GOY	L419	GA-39	MOP	L491	GP-761H	KRA
L321-14-300	G-70	MZDA	L37	GP-66	KRA	L4192631	G-277	HITA	L49127	G-613	PUR
L321-14-302	G-70	MZDA	L370	GP-408	KRA	L42	GP-40	CHRY	L494	GP-761H	KRA
L321-14-302-9U	G-70	MZDA	L37048	GP-1122	PUR	L42	GP-81 ²¹	KRA	L495	GP-761H	KRA
L322	GP-3429	CHRY	L37202	GP-36	PUR	L42	GP-9 ⁸⁸	KRA	L496	GP-761H	KRA
L322	GP-3429	MOP	L373	GP-23	KND	L42	GP-3985	MOP	L499	G-31	PFX
L323	GP-28	CHRY	L373	GP-23	MINL	L420	GA-27 ¹¹²	CHRY	L5	GP-40	KRA
L323	GP-28 ⁹	MOP	L373	GP-23	VALV	L420	GA-27 ¹¹²	MOP	L50	GP-50	KND
L323	GP-430 ⁸	MOP	L-373	GP-23	FACE	L42168	GP-54	PUR	L50	GP-390 ⁹³	KRA
L324	GP-1	CHRY	L37711	G-33	CASE	L423	G-31	PFX	L50	G-31	LEE
L324	GP-1	MOP	L38	GP-3816	KRA	L424	G-31	PFX	L50	GP-50	LPM

REFERENCIA CRUZADA

Para números Gonher con Superíndice vea página 651
For Gonher with Superscript numbers see page 651

Visite nuestro sitio en internet www.grupogonher.com
Visit our web site www.grupogonher.com

Numero	Gonher	Fabricante	Numero	Gonher	Fabricante	Numero	Gonher	Fabricante	Numero	Gonher	Fabricante
Number	Gonher	Manufacturer	Number	Gonher	Manufacturer	Number	Gonher	Manufacturer	Number	Gonher	Manufacturer
L50	GP-50	MINL	L551	G-330	KRA	L60F	G-1121	CAM2	L71	G-1163 ¹⁰⁸	LEE
L50	GP-50	VALV	L551	GA-86	MOP	L60F	G-1121	CHP	L71	G-236	MOP
L50	GP-50	FACE	L551A4	GAK-403	GENE	L60F	G-1121	GRAN	L72	GP-1	CHRY
L500	G-500	CHP	L551A-4	GAK-403	DORM	L60F	G-1121	LUF	L72	GP-36	KRA
L50005	G-191	PUR	L551C4	GA-5648	GENE	L60F	G-1121F	LUF	L72	GP-1	MOP
L50007	G-238	PUR	L551C-4	GA-5648	DORM	L60F	G-1121	MASE	L7203	G-70	KRA
L50031	G-926	PUR	L551E4	GA-360	GENE	L60F	G-1121	MIGH	L7221	G-33	ACD
L50041	G-566	PUR	L551E-4	GA-360	DORM	L60F	G-1121	WARN	L7264F	G-278	LUF
L50068	GP-51	PUR	L551J4	GAK-20	GENE	L61	GP-1	KRA	L727A	G-750	TFIL
L50070	GP-52 ¹⁰	PUR	L551J-4	GAK-20	DORM	L610	GG-8 ¹⁰³	CHRY	L73	GP-38 ⁸⁹	KRA
L50070	GP-691 ⁴⁸	PUR	L551K4	GAK-16	GENE	L610	GG-8 L ⁸⁰	CHRY	L7314	G-3752	KRA
L50077	GPP-18	PUR	L551K-4	GAK-16	DORM	L610	GG-8 ¹⁰³	MOP	L73A	GP-38	KRA
L50078	G-33	PUR	L551N4	GA-106 ⁴⁶	GENE	L610	GG-8 L ⁸⁰	MOP	L73B	GP-38 ⁸⁹	KRA
L50085	GP-56	PUR	L551N4	GA-326 ⁷¹	GENE	L611	GG-16	CHRY	L749	G-112	KRA
L50086	GP-1122	PUR	L551N-4	GA-106 ⁴⁶	DORM	L611	GG-16	MOP	L750	G-750	LEE
L500BP	G-500	ROLK	L551N-4	GA-326 ⁷¹	DORM	L612	GG-17	CHRY	L750BP	G-750	ROLK
L500HD	G-500	LEE	L551U	GAK-16	DORM	L612	GG-17	MOP	L750C	G-750	TFIL
L501	GA-3300	BOG	L551U	GAK-16	GENE	L613	GG-8 ¹⁰³	CHRY	L750HD	G-750	LEE
L50116	GP-53	PUR	L551U4	GAK-16	GENE	L613	GG-8 L ⁸⁰	CHRY	L750P	G-750	CHP
L502	G-31	PFX	L551U-4	GAK-16	DORM	L613	GG-8 ¹⁰³	MOP	L750P	G-750	LUF
L50250	GP-57	PFX	L552	GA-3424	CHRY	L613	GG-8 L ⁸⁰	MOP	L79	GP-1	KRA
L50250	GP-57	WALM	L552	G-5000	KRA	L617	GG-45	CHP	L76-1	G-236	LEE
L503	GA-7	CHRY	L552	GA-3424	MOP	L617	GG-1	MOP	L7620	GP-178	KRA
L503	GA-7	MOP	L553	GA-3425	CHRY	L617	GG-4	MOP	L76A	GP-1	KRA
L503	G-191	PFX	L553	GA-3425	MOP	L61F	G-1123	CHP	L771	G-335	PFX
L50300	GP-53	PUR	L55320	GP-51	PUR	L61F	G-1123	LUF	L777	GP-236	KRA
L50308	G-816	PUR	L-554	GA-3445	MOP	L61F	G-1123F	LUF	L780	GP-178	VALV
L50500	G-500	PUR	L56	GP-1101	CHRY	L62	GP-27	LBF	L784	GP-3766	KND
L50780	G-33	PUR	L56	GG-8 ¹⁰³	KRA	L622	GG-8 ¹⁰³	CHRY	L784	GP-3766	VALV
L509	GA-44	MOP	L56	GP-1101	MOP	L622	GG-8 L ⁸⁰	CHRY	L-784	GP-3766	FACE
L51	GP-3980	GOY	L560116	GP-53	WALM	L622	GG-8 ¹⁰³	MOP	L79	GP-3	KRA
L510	GA-71	CHRY	L56041	GA-106 ⁴⁷	CASE	L622	GG-8 L ⁸⁰	MOP	L79756	GG-1	CASE
L510	GA-71	MOP	L56041	GA-206 ¹⁰⁸	CASE	L624	GG-6	CHRY	L79756	GG-4	CASE
L512	GAD-1	CHRY	L56041	GA-326 ⁷²	CASE	L624	GG-6	MOP	L8	G-333	CHRY
L512	GAD-1	MOP	L562	GA-77	CHRY	L626	GG-196	MOP	L8	GP-36	KRA
L516	G-870	KRA	L563	GA-70	MOP	L627	GG-5 L	MIGH	L8	G-333	MOP
L517	G-119	KRA	L564	G-163	PFX	L628	G-122	KRA	L80	GP-13	CHRY
L519	GP-58	MOP	L565	G-143	PFX	L628	G-338	KRA	L80	GP-13	MOP
L52	GP-390 ⁹³	FLUX	L566	GA-3523	CHRY	L6285F	G-276	LUF	L802	G-191	KRA
L52	GP-3980	GOY	L566	G-34	KRA	L6286F	G-277	LUF	L804	G-238	KRA
L52	GP-3980	KND	L566	GA-3523	MOP	L629	GG-1	MOP	L806	G-152	KRA
L52	GP-3980	MINL	L57	GP-83	CHRY	L629	GG-4	MOP	L807A	G-222	KRA
L52	GP-36	MOP	L57	GP-38	KRA	L63	GP-58	KRA	L81	G-5000	CHRY
L52	GP-3980	PRET	L57	GP-83	MOP	L63	GP-77	LBF	L81	G-5000	MOP
L-52	GP-3980	FACE	L570	GA-2719B	CHRY	L63	GP-3	MOP	L811	G-5000	PFX
L52041	GAK-20	CASE	L570	GA-2719B	MOP	L630	G-331	KRA	L8138F	GPP-426	LUF
L52042	GAK-403	CASE	L573	GA-3490	CHRY	L630A	G-331	KRA	L816	G-139	KRA
L521	GP-38	MOP	L573	GA-3490	MOP	L631	GG-45	MOP	L82	G-871	MOP
L523	GP-3816	MOP	L57447	G-133	PUR	L632	GG-76	MOP	L8242F	GPP-424	LUF
L524	G-870	CHRY	L57447	G-989	PUR	L634	G-169	KRA	L827	G-870	PFX
L524	G-871	MOP	L575	GA-271	CHRY	L636	G-339H	KRA	L846	G-153	KRA
L525	G-31	KRA	L575	GA-271	MOP	L637	G-159	KRA	L857	GP-1	GRAV
L525	GP-38 ⁸⁰	MOP	L5788F	G-862	AIRT	L64	G-330	CHRY	L858	G-33	KRA
L526	GP-171 ¹⁶	MOP	L5788F	G-862	CHP	L64	GP-1	KRA	L859	G-191	KRA
L52764	G-222	CASE	L5788F	G-862	LUF	L64	GP-83	LBF	L8679F	GPP-425	LUF
L528	GP-40	CHRY	L5788F	G-862	WARN	L64	G-330	MOP	L8680F	GPP-423	LUF
L528	GP-3985	MOP	L58	GP-84	CHRY	L642	G-971	KRA	L8681F	GPP-421	LUF
L529	GP-28	CHRY	L58	GP-84	MOP	L647	G-984	KRA	L8682F	GPP-424	LUF
L529	GP-3600	MOP	L583	G-870	KRA	L65	GP-84	LBF	L8683F	GPP-420	LUF
L53	GP-54	KRA	L584	G-870	KRA	L650	G-963	KRA	L8684F	GPP-419	LUF
L530	GP-81	CHRY	L59	GP-34	CHRY	L65063	GP-152	PUR	L8684F	GPP-419	WARN
L530	G-836	KRA	L59	GP-34	MOP	L65063	GP-152	WALM	L8701F	G-1046	LUF
L530	GP-81	MOP	L59068	GP-51	PUR	L65236	GP-52 ¹¹⁰	PUR	L8706F	GPP-420	CHP
L531	GP-28	CHRY	L6	G-6	LEE	L65236	GP-691 ⁴⁸	PUR	L873	G-871	KRA
L531	GP-28 ⁸	MOP	L6	G-6	LPM	L653	G-954	KRA	L881	G-870	KRA
L531	GP-430 ⁸	MOP	L60	G-200	CHRY	L65328	GP-9000	PUR	L884	G-871	KRA
L532	G-834	KRA	L60	GP-24 ²⁶	KRA	L65329	GP-9001	PUR	L885	G-871	KRA
L532	GP-462	MOP	L60	GP-462 ²⁴	KRA	L658	G-163	KRA	L885G	G-871	KRA
L532G	G-834	KRA	L60	G-200	MOP	L659	G-143	KRA	L885H	G-871	KRA
L537	G-833	KRA	L600	GG-5	CHRY	L65A	GP-3816	KRA	L890	G-813	KRA
L54	GP-66	KRA	L60043	GPP-18	PUR	L66	GP-1	KRA	L896	G-566	KRA
L54	GP-31	MOP	L60046	GP-1107	PUR	L67	G-33	CHRY	L897	G-613	KRA
L540F	G-1175	APOL	L60069	GP-52 ¹¹⁰	PUR	L67	GP-81 ³¹	KRA	L897A	G-613	KRA
L540F	G-1175	BWS	L60069	GP-691 ⁴⁸	PUR	L67	GP-9 ⁹⁸	KRA	L8A	GP-1	GOY
L540F	G-1175	CAM2	L601	GG-47	CHRY	L67	G-33	MOP	L9	G-335	CHRY
L540F	G-1175	CHP	L60116	GP-53	PUR	L670	G-926	HITA	L9	G-335	MOP
L540F	G-1175	LUF	L603	GG-1	CHRY	L68	G-750	CHRY	L90	G-500	CHRY
L541	GA-349	CHRY	L603	GG-4	CHRY	L68	G-750	MOP	L90	G-500	MOP
L541	GA-349	MOP	L603	GG-1	MOP	L69	GP-1101	CHRY	L90	G-31	TFIL
L543	GAUVV-22	CHRY	L603	GG-4	MOP	L69	GP-50	KRA	L903	G-871	KRA
L54519	GP-3000	PUR	L607	GG-8 ¹⁰³	CHRY	L69	GP-1101	MOP	L91	G-871	MOP
L54519	GP-3000	WALM	L607	GG-8 L ⁸⁰	CHRY	L690	G-765	KRA	L918	G-162H	KRA
L54563	GP-77	PUR	L607	GG-8 ¹⁰³	MOP	L691PP	GP-52 ¹¹⁰	KOMA	L926	G-333	KRA
L547	GA-3300	CHRY	L607	GG-8 L ⁸⁰	MOP	L691PP	GP-691 ⁴⁸	KOMA	L927	G-335	KRA
L547	GA-3300	MOP	L60750	G-750	PUR	L695	G-45	KRA	L930	G-33	KRA
L548	GA-3300	CHRY	L60751	G-750	PUR	L7	G-31	CHRY	L930G	G-33	KRA
L548	GA-3300	MOP	L60752	G-750	PUR	L7	GP-81	GOY	L932A	G-33	KRA
L54836	GP-193	PUR	L609	GG-8 ¹⁰³	CHRY	L7	GP-3985	KRA	L932AG	G-33	KRA
L54836	GP-193	WALM	L609	GG-8 L ⁸⁰	CHRY	L7	GP-1101	MOP	L932AH	G-33	KRA
L54851	GP-3000 ¹³	LUF	L609	GG-8 ¹⁰³	MOP	L7	GP-81	VALV	L937	G-200	KRA
L54851	GP-3000 ¹³	PUR	L609	GG-8 L ⁸⁰	MOP	L-7	GP-81	FACE	L95402K	GAK-403	COO
L55	GP-1	MOP	L60A	GP-24 ²⁶	KRA	L70	GP-13	KRA	L95402K	GAK-403	GUD
L550	GA-85	CHRY	L60A	GP-462 ²⁴	KRA	L70085	GP-56	PUR	L95408	GA-360	COO
L550	GA-85	MOP	L60F	G-1121	AIRT	L7046	GP-461	KRA	L95408	GA-360	GUD
L550G	G-6	KRA	L60F	G-1121	APOL	L7082	G-49	KRA	L95411K	GAK-20	COO
L551	GA-86	CHRY	L60F	G-1121	BWS	L71	G-236	CHRY	L95411K	GAK-20	GUD

Referencia Cruzada por Numero de Parte

Cross Reference by Part Number



Numero	Gonher	Fabricante	Numero	Gonher	Fabricante	Numero	Gonher	Fabricante	Numero	Gonher	Fabricante
Number	Gonher	Manufacturer	Number	Gonher	Manufacturer	Number	Gonher	Manufacturer	Number	Gonher	Manufacturer
L95413K	GA-16	COO	LA1239	GA-216	KRA	LA1629	GA-158	KRA	LA324	GA-6127	KRA
L95413K	GA-16	GUD	LA1240	GA-471	KRA	LA1638F	GA-403	KRA	LA324A	GA-85	LONF
L95414K	GA-33 ¹¹²	COO	LA1245	GA-176	KRA	LA1639	GA-2198 ⁷⁹	KRA	LA325	GA-106 ⁶⁶	KRA
L95414K	GA-33 ¹¹²	GUD	LA1248	GA-362	KRA	LA1639	GA-438 ⁸¹	KRA	LA325	GA-326 ⁷¹	KRA
L95419	GA-106 ⁶⁶	COO	LA1249	GA-2110	KRA	LA1640	GA-607	KRA	LA325	GA-325	LONF
L95419	GA-326 ⁷¹	COO	LA1250	GA-153	KRA	LA1641	GA-279	KRA	LA326	GA-59	LONF
L95419	GA-106 ⁶⁶	GUD	LA1251	GA-142	KRA	LA1648	GA-539R	KRA	LA327	GA-57	LONF
L95419	GA-326 ⁷¹	GUD	LA1252	GA-3901	KRA	LA1653	GA-240	KRA	LA3300	GA-3300	LONF
L95423	GA-8047	COO	LA1253	GA-6479	KRA	LA1679	GA-781	KRA	LA333	GAD-1	KRA
L95423	GA-8047	GUD	LA1258F	GA-458	KRA	LA1680	GA-782 ¹⁰⁸	KRA	LA333A	GAD-1	KRA
L95424	GA-9045	COO	LA1259	GA-459	KRA	LA1704	GA-600R	KRA	LA3373	GAVW-2	LONF
L95424	GA-9045	GUD	LA1265	GAD-30	KRA	LA1711	GA-534R	KRA	LA340	GAD-3	KRA
L95425	GA-9334	COO	LA1266	GA-129	KRA	LA1717	GAVW-622	KRA	LA340A	GA-86	LONF
L95425	GA-9334	GUD	LA127	GA-349	KRA	LA1718	GA-2193	KRA	LA3424	GA-3424	LONF
L95426	GA-1008	COO	LA1274	GA-275	KRA	LA1719	GA-2114	KRA	LA3425	GA-3425	LONF
L95426	GA-1008	GUD	LA1284	GA-276	KRA	LA1719	GA-2193	KRA	LA3441	GA-277	LONF
L95431	GA-18	COO	LA1290	GA-2106	KRA	LA171AS	GA-27 ¹¹²	WAKO	LA348	GA-7	KRA
L95431	GA-18	GUD	LA1295	GA-26	KRA	LA1721	GA-2195	KRA	LA3490	GA-3490	LONF
L95440	GA-405	GUD	LA1303	GA-217	KRA	LA1722	GA-2118	KRA	LA351	GA-75	LONF
L9559F	G-559	LUF	LA1310	GA-7017	KRA	LA1728	GA-2146	KRA	LA352	GAD-1 ⁸⁷	LONF
L966	GP-58	FACE	LA1313	GA-133	KRA	LA172F	GAK-20	KRA	LA3523	GA-3523	LONF
L97	G-31	MOP	LA1315	GA-195	KRA	LA1731	GA-301	KRA	LA353	GA-230	KRA
L977	GP-31	KND	LA1317	GA-382	KRA	LA1732	GA-170	KRA	LA353	GAD-3	LONF
L977	GP-31	MINL	LA1331	GAD-117	KRA	LA1733	GA-163	KRA	LA3537	GA-54	LONF
L977	GP-31	VALV	LA1331	GAD-17	KRA	LA1737	GA-890R	KRA	LA3549	GA-89	LONF
L-977	GP-31	FACE	LA1332	GA-6619 ¹	KRA	LA1740	GAVW-621	KRA	LA355	GA-4325	WAKO
L98	G-834	CHRY	LA1332	GA-6620 ²	KRA	LA1753	GA-853R	KRA	LA3559	GA-271	LONF
L98	G-225	LEE	LA1333	GA-166	KRA	LA1757F	GAK-458	KRA	LA3588	GA-3588	LONF
L98	GA-834	MOP	LA1335	GA-6690	KRA	LA1758	GA-459	KRA	LA3597	GA-735	LONF
L9800F	GS-1261	LUF	LA1336	GA-386	KRA	LA1759F	GAK-458	KRA	LA3642	GA-101	LONF
L99420	GP-754	GEHL	LA1341	GA-7142	KRA	LA1768	GA-712R	KRA	LA3647	GA-3647	LONF
L99453	GA-853R	GEHL	LA134F	GA-33 ¹¹²	KRA	LA177	GA-21	KRA	LA3675	GAK-20	WAKO
L9A	GP-3531 EXP	KRA	LA1351	GAVW-120	KRA	LA1777	GAC-9	KRA	LA3681	GA-3681	LONF
LA0230	GP-1012Q	HOUG	LA136	GA-55	LONF	LA1790	GA-8606	KRA	LA374	GA-85	KRA
LA10	GA-56	KRA	LA1362	GA-322	KRA	LA1792	GA-472	KRA	LA374A	GA-85	KRA
LA1000	GA-735	KRA	LA1364	GA-7344	KRA	LA1805	GA-348	KRA	LA376	GA-303	KRA
LA1001	GA-271	KRA	LA1366	GA-381	KRA	LA1806	GA-348	KRA	LA377	GA-154	KRA
LA1002	GA-119	KRA	LA1385	GAVW-2	KRA	LA1807	GA-183	KRA	LA379	GA-57	KRA
LA100F	GAK-16	KRA	LA1394	GA-139	KRA	LA1808F	GAK-403	KRA	LA38	GA-37	KRA
LA101	GA-24	KRA	LA1403	GA-197R	KRA	LA181	GA-29	KRA	LA381	GA-325	KRA
LA101	GA-105	LPM	LA142	GA-18	KRA	LA1813	GAVW-626	KRA	LA381	GA-74	LONF
LA102F	GA-27 ¹¹²	KRA	LA1430	GA-768R	KRA	LA1824	GA-286	KRA	LA382	GA-59	KRA
LA1043F	GAK-1532	KRA	LA1433	GAD-129	KRA	LA1826	GA-168	KRA	LA383	GA-730	KRA
LA1052	GA-89	KRA	LA144	GA-55	KRA	LA1827	GA-278R	KRA	LA385	GA-360	KRA
LA1055	GA-398	KRA	LA1440	GAD-118	KRA	LA1832	GA-435R	KRA	LA392	GA-403	KRA
LA1057	GA-315	KRA	LA1441	GA-300	KRA	LA1834	GA-880R	KRA	LA40	GA-230	KRA
LA1064	GAD-30	KRA	LA1443	GA-176	KRA	LA184	GA-77	LONF	LA4094	GA-240	KRA
LA1067	GA-140	KRA	LA1444	GA-432	KRA	LA1853	GA-479	KRA	LA41	GA-90	KRA
LA1069	GAD-15	KRA	LA1447	GAD-294	KRA	LA1872	GA-224	KRA	LA417F	GAK-16	KRA
LA1070	GA-642	KRA	LA1449	GA-604	KRA	LA189	GA-50	LONF	LA432	GA-361	KRA
LA1072F	GAK-16	KRA	LA1450	GA-5466	KRA	LA19	GA-100	LONF	LA436	GA-357	KRA
LA1079	GA-3566	KRA	LA1451	GA-529	KRA	LA1909	GA-780	KRA	LA439	GA-31	KRA
LA1082	GA-59	KRA	LA1451	GA-604	KRA	LA1911	GA-183R	KRA	LA443	GA-135	KRA
LA1084	GA-3681	KRA	LA1455	GA-141	KRA	LA1917	GA-395	KRA	LA45	GA-3814	KRA
LA1085	GA-3647	KRA	LA1456	GA-165	KRA	LA192	GA-192	LONF	LA468	GA-27198	WAKO
LA1097	GA-616	KRA	LA1459	GA-2804 T	KRA	LA1920	GA-967R	KRA	LA-473	GA-3566	WAKO
LA1100	GA-371	KRA	LA1459R	GA-2804 T	KRA	LA1924	GA-286	KRA	LA48	GA-80	KRA
LA1108	GA-482	KRA	LA146	GA-71	LONF	LA1925	GA-3916	KRA	LA49	GA-3647	KRA
LA1109	GAD-30	KRA	LA1461	GAVW-2	KRA	LA1927	GA-248	KRA	LA496	GAD-3	KRA
LA1113F	GAK-16	KRA	LA1470	GA-198	KRA	LA1928	GA-477	KRA	LA5	GA-70	KRA
LA1125	GA-372	KRA	LA148	GA-80	LONF	LA1932	GA-414R	KRA	LA503	GA-100	KRA
LA1127	GA-436	KRA	LA1494	GA-514	KRA	LA2013	GA-415	KRA	LA516	GA-86	KRA
LA1136	GA-329	KRA	LA1505	GA-175	KRA	LA202	GAP-379	KRA	LA516A	GA-86	KRA
LA1141	GA-274	KRA	LA151	GA-37	KRA	LA207	GA-135	KRA	LA517	GA-113	KRA
LA1146	GA-4958	KRA	LA1511	GA-499R	KRA	LA229	GA-18	LPM	LA517P	GA-113	KRA
LA1147	GA-4828	KRA	LA1522	GA-198	KRA	LA23	GA-71	KRA	LA518	GA-885	KRA
LA1150	GA-5056	KRA	LA1531	GAVW-121	KRA	LA2351	GA-475	KRA	LA521	GA-1095	KRA
LA1151	GA-4303	KRA	LA1533	GA-518R	KRA	LA24	GA-113	LONF	LA523	GA-349 ⁸⁸	KRA
LA1159	GA-4607	KRA	LA1534	GA-221R	KRA	LA2455	GA-968R	KRA	LA523	GAD-3 ⁹⁴	KRA
LA1160	GA-694	KRA	LA1536	GA-164	KRA	LA249	GA-206	KRA	LA528	GA-879	KRA
LA1162	GA-389	KRA	LA1549	GA-186	KRA	LA252V	GAD-15	WAKO	LA552	GA-378	KRA
LA1165	GA-376	KRA	LA1559	GA-476	KRA	LA253	GAD-1	WAKO	LA552R	GA-378	KRA
LA1166	GA-467	KRA	LA1560	GA-127	KRA	LA254V	GAD-1	WAKO	LA553	GA-3300	KRA
LA1169	GA-3637	KRA	LA1565	GA-966R	KRA	LA259V	GAD-3	WAKO	LA558	GA-113	KRA
LA1170	GA-4325	KRA	LA1566	GA-595	KRA	LA261	GA-11	KRA	LA559	GA-113	KRA
LA1174	GA-139	KRA	LA156F	GAK-16	KRA	LA262	GA-12	KRA	LA562	GA-679	KRA
LA1176	GA-273	KRA	LA1570	GA-128	KRA	LA263	GA-7	KRA	LA563	GA-680	KRA
LA1177	GA-3916	KRA	LA1580	GA-376	KRA	LA265HD	GAD-1	LUF	LA567	GA-376	KRA
LA1177F	GAK-20	KRA	LA1589	GA-673R	KRA	LA267V	GAD-30	WAKO	LA569	GA-891	KRA
LA1182	GA-6	KRA	LA1590	GA-732R	KRA	LA2709	GAD-1 ⁸⁷	LONF	LA57	GA-50	KRA
LA1183	GA-6	KRA	LA1591	GA-442	KRA	LA2719	GA-27198	LONF	LA573F	GA-98 ¹¹²	KRA
LA1190	GA-8	KRA	LA1592	GA-1616	KRA	LA2725	GA-490	KRA	LA578	GA-356	KRA
LA1193	GA-3551 ⁵⁵	KRA	LA1594	GA-244	KRA	LA2740	GA-2740	LONF	LA586	GA-75	KRA
LA1193	GA-3551 XT ⁸⁴	KRA	LA1595	GA-384	KRA	LA2826	GA-328	KRA	LA587	GA-7716	KRA
LA1194	GA-2194	KRA	LA1596	GA-172	KRA	LA285V	GA-4303	WAKO	LA590	GA-74	KRA
LA1200	GA-174	KRA	LA16	GA-422	KRA	LA286	GA-106 ⁶⁶	KRA	LA595	GA-429	KRA
LA1205	GA-253	KRA	LA160	GA-70	LONF	LA286	GA-326 ⁷¹	KRA	LA601F	GAK-1532	KRA
LA1215	GA-390	KRA	LA1601	GAVW-620	KRA	LA287	GA-356	KRA	LA616	GA-6880	KRA
LA1218	GA-3915	KRA	LA1602	GA-1615	KRA	LA29	GA-77	KRA	LA618	GA-229	KRA
LA122	GA-26	KRA	LA1603	GA-1614	KRA	LA290V	GA-75	WAKO	LA621	GA-200	KRA
LA1220	GAVW-4	KRA	LA1604	GA-130	KRA	LA3	GA-50	KRA	LA621	GP-58	KRA
LA122F	GA-26	KRA	LA1610	GA-930R	KRA	LA303	GA-303	LONF	LA621A	GA-200	KRA
LA1230	GA-153	KRA	LA1614	GA-683R	KRA	LA305	GA-730	LONF	LA621A	GP-58	KRA
LA1233	GA-180	KRA	LA1619	GA-422	KRA	LA312	GA-21	KRA	LA622	GA-7360	KRA
LA1236	GA-390	KRA	LA161F	GA-98 ¹¹²	KRA	LA317	GA-26	KRA	LA626	GA-891	KRA
LA1237	GA-392	KRA	LA1624	GA-930R	KRA	LA323	GA-6129	KRA	LA628	GA-2740	KRA

REFERENCIA CRUZADA

Numero	Gonher	Fabricante	Numero	Gonher	Fabricante	Numero	Gonher	Fabricante	Numero	Gonher	Fabricante
Number	Gonher	Manufacturer	Number	Gonher	Manufacturer	Number	Gonher	Manufacturer	Number	Gonher	Manufacturer
LA632GAK-216	KRA	LAF1163GA-403	LUF	LAF234HDGAK-20	CHP	LAF4498GA-966R	LUF
LA632FGAK-216	KRA	LAF119GA-7	LUF	LAF234HDGAK-20	LUF	LAF4499GA-499R	LUF
LA633GA-416	KRA	LAF122GA-135	LUF	LAF234HDAGAK-20	LUF	LAF45GA-9045	BWS
LA65GA-5648	KRA	LAF1246GAK-403	BWS	LAF234HDBGAK-20	LUF	LAF45GA-9045	CHP
LA654GA-679	KRA	LAF1246GAK-403	CHP	LAF237GA-24	LUF	LAF45GA-9045	LUF
LA655GA-425	KRA	LAF1246GAK-403	LUF	LAF240GA-37	BWS	LAF4544GA-853R	LUF
LA658SGA-27 ¹¹²	WAKO	LAF1246AGAK-403	LUF	LAF240GA-37	CHP	LAF4575GA-389	LUF
LA659GA-509 ¹⁴	KRA	LAF1246BGAK-403	LUF	LAF240GA-37	LUF	LAF46GA-1287	CHP
LA660GA-329	KRA	LAF1248GAK-403	LUF	LAF241HDGA-27 ¹¹²	BWS	LAF46GA-1287	LUF
LA663GA-483	KRA	LAF1275GA-33 ¹¹²	BWS	LAF241HDGA-27 ¹¹²	CHP	LAF47GA-8047	BWS
LA664GA-482	KRA	LAF1275GA-33 ¹¹²	CHP	LAF241HDGA-27 ¹¹²	LUF	LAF47GA-8047	CHP
LA669GA-426	KRA	LAF1275GA-33 ¹¹²	LUF	LAF243GA-26 ¹¹²	CHP	LAF47GA-8047	LUF
LA670GA-680	KRA	LAF1275AGA-33 ¹¹²	LUF	LAF243GA-26	LUF	LAF4714GAP-379	BWS
LA676GA-239	KRA	LAF1275BGA-33 ¹¹²	LUF	LAF243AGA-26	LUF	LAF4714GAP-379	LUF
LA680FGAK-20	KRA	LAF131GA-18	CHP	LAF243BGA-26	LUF	LAF4747GA-98 ¹¹²	LUF
LA6834GA-263	KRA	LAF131GA-18	LUF	LAF2526GA-108	BWS	LAF48GA-1285	BWS
LA6871GA-798R	KRA	LAF132GA-50	LUF	LAF2526GA-108	LUF	LAF48GA-1285	CHP
LA6879GA-510	KRA	LAF133GA-78	LUF	LAF2536GA-518R	LUF	LAF48GA-1285	LUF
LA6888GA-380	KRA	LAF146GA-71	LUF	LAF2608GA-608	BWS	LAF4816GA-539R	LUF
LA69GA-105	KRA	LAF1465GA-758	LUF	LAF2608GA-608	LUF	LAF488GA-35	LUF
LA691GA-892	KRA	LAF1470GA-49	LUF	LAF268GA-5648	CHP	LAF500HDGA-37	LUF
LA697GA-2984	KRA	LAF148GA-80	LUF	LAF268GA-5648	LUF	LAF5022GA-600R	LUF
LA698GA-589	KRA	LAF15GAP-381	BWS	LAF268AGA-5648	LUF	LAF5043GA-98 ¹¹²	LUF
LA699GA-588	KRA	LAF15GAP-381	LUF	LAF268BGA-5648	LUF	LAF5043AGA-98 ¹¹²	LUF
LA70GA-105	KRA	LAF1617GA-442	CHP	LAF2821GA-6128	BWS	LAF5043BGA-98 ¹¹²	LUF
LA729GA-826	KRA	LAF1617GA-442	LUF	LAF2821GA-6128	LUF	LAF5069GA-879	LUF
LA730GA-3501	KRA	LAF1617GA-442	PARP	LAF292GA-135	BWS	LAF52GA-303	LUF
LA730AGA-3501	KRA	LAF1617GA-442	SECU	LAF292GA-135	CHP	LAF5225GA-26	LUF
LA732GAVW-2	KRA	LAF1617GA-442	TIRP	LAF292GA-135	LUF	LAF5255GA-26	BWS
LA733GA-75	KRA	LAF1617GA-442	TRUS	LAF292GA-35	LUF	LAF5255GA-26	CHP
LA737GA-349	KRA	LAF1617GA-442	WARN	LAF305GA-730	LUF	LAF5255GA-26	LUF
LA76GA-8047	KRA	LAF1646GA-4999	LUF	LAF31GA-56	LUF	LAF53GA-85	LUF
LA760GAD-3	WAKO	LAF1675GA-472	CHP	LAF313AMGA-426	LUF	LAF54GA-3300	LUF
LA767GA-2740	WAKO	LAF1675GA-472	LUF	LAF323GA-588	BWS	LAF5505GAK-16	LUF
LA777FGAK-625	KRA	LAF1675GA-472	WARN	LAF323GA-588	LUF	LAF5505AGAK-16	LUF
LA777GA-1285	KRA	LAF1680GA-780	CHP	LAF3233GA-701 ¹⁰⁴	LUF	LAF5505BGAK-16	LUF
LA78GA-9334	KRA	LAF1680GA-780	LUF	LAF327GA-57	LUF	LAF5573GAD-1	LUF
LA781FGAK-403	KRA	LAF1680GA-780	PARP	LAF329GA-57	LUF	LAF5590GA-410	LUF
LA782FGA-33 ¹¹²	KRA	LAF1680GA-780	TRUS	LAF3302GA-534R	CHP	LAF5633GA-633R	LUF
LA787GA-55	KRA	LAF1680GA-780	WARN	LAF3302GA-534R	LUF	LAF5720GA-723R	LUF
LA788GA-101	KRA	LAF1710GA-49	LUF	LAF332GA-325	LUF	LAF5722GA-435R	LUF
LA79GA-1286	KRA	LAF1718GA-405	BWS	LAF334GA-9334	BWS	LAF574GA-74	LUF
LA799GA-608	KRA	LAF1718GA-405	LUF	LAF334GA-9334	CHP	LAF5763GA-801R	LUF
LA80GA-1008	KRA	LAF1723GA-892	LUF	LAF334GA-9334	LUF	LAF5764GA-802R	LUF
LA809GA-2719B	KRA	LAF1726GA-467	BWS	LAF3346GA-2803T	LUF	LAF5813GA-781	LUF
LA81GA-349	KRA	LAF1726GA-467	LUF	LAF335GA-1286	BWS	LAF5847GA-890R	CHP
LA811GA-49	KRA	LAF1727GA-253	LUF	LAF335GA-1286	CHP	LAF5847GA-890R	LUF
LA82GA-1203	KRA	LAF1734GAK-216	BWS	LAF335GA-1286	LUF	LAF586GA-89	CHP
LA822GAK-216	KRA	LAF1734GAK-216	LUF	LAF348GA-59	LUF	LAF5873GA-968R	CHP
LA824GA-6128	KRA	LAF1735GA-416	BWS	LAF351GA-3551 ²⁵	BWS	LAF5873GA-968R	LUF
LA83GA-375	KRA	LAF1735GA-416	LUF	LAF3551GA-3551 XT ⁶⁴	BWS	LAF588GA-422	BWS
LA84GA-9045	KRA	LAF174GA-86	LUF	LAF3551GA-3551 ²⁵	LUF	LAF588GA-422	LUF
LA85GA-1287	KRA	LAF1754GA-206	LUF	LAF3551GA-3551 XT ⁶⁴	LUF	LAF5980GA-488	CAMP
LA852GAP-381	KRA	LAF1757GA-106 ⁶⁰	LUF	LAF3585GA-768R	LUF	LAF5980GA-488	LUF
LA855GA-251	KRA	LAF1757GA-326 ⁷¹	LUF	LAF3657GA-759 ¹⁰⁸	LUF	LAF5980GA-488	PARP
LA857GA-759	KRA	LAF1760GA-6129	LUF	LAF37GA-44	LUF	LAF601GA-735	LUF
LA858GA-493 ¹⁰⁸	KRA	LAF1770GA-377	LUF	LAF3702GA-436	LUF	LAF6032GA-403	BWS
LA860GA-372	KRA	LAF178GA-192	LUF	LAF3711GA-425	BWS	LAF6032GA-403	LUF
LA861GA-3425	KRA	LAF1810GA-251	BWS	LAF3711GA-425	CHP	LAF6080GA-6880	LUF
LA862GA-3424	KRA	LAF1810GA-251	LUF	LAF3711GA-425	LUF	LAF6127GA-885	LUF
LA881GA-107	KRA	LAF1814GA-398	LUF	LAF3715GA-436	LUF	LAF6142GA-930R	LUF
LA883GA-109	KRA	LAF1829GA-2804 T	CHP	LAF3779GA-20	LUF	LAF6401GA-426	BWS
LA884GA-563	KRA	LAF1829GA-2804 T	LUF	LAF3779GAK-20	LUF	LAF6401GA-426	LUF
LA887GAD-1	KRA	LAF1838GAK-388	LUF	LAF3779AGAK-20	LUF	LAF6587GA-360	BWS
LA89GA-44	KRA	LAF184GA-77	LUF	LAF3779BGAK-20	LUF	LAF6587GA-360	CHP
LA891GA-459	KRA	LAF1842GA-98 ¹¹²	LUF	LAF378GA-1008	LUF	LAF6587GA-360	LUF
LA903GA-3588	KRA	LAF1849GA-682R	LUF	LAF3781GA-967R	LUF	LAF6632GA-6129	BWS
LA91GA-39	KRA	LAF1866GAK-16	LUF	LAF379GA-1284	CHP	LAF6632GA-6129	CHP
LA914GAVW-2	KRA	LAF1878GA-197R	LUF	LAF379GA-1284	LUF	LAF6632GA-6129	LUF
LA915GA-277	KRA	LAF1899GA-388	LUF	LAF386GA-21	LUF	LAF6641GA-6127	BWS
LA918GA-3445	KRA	LAF1899GA-389	LUF	LAF3860GA-904R ¹⁰⁴	LUF	LAF6641GA-6127	CHP
LA919GA-230	KRA	LAF190GA-39	BWS	LAF3861GA-905R ¹⁰⁸	LUF	LAF6641GA-6127	LUF
LA922GA-3523	KRA	LAF190GA-39	CHP	LAF3862GA-909R	LUF	LAF6663GA-4862R	LUF
LA923GA-209	KRA	LAF190GA-39	LUF	LAF3863GA-908R ¹⁰⁸	LUF	LAF6664GA-4863	LUF
LA924GA-210	KRA	LAF1905GA-891	LUF	LAF3864GA-864R	LUF	LAF6769GA-106 ⁶⁶	BWS
LA934GA-3490	KRA	LAF1907GAK-16	LUF	LAF3864GA-906R	LUF	LAF6769GA-326 ⁷¹	BWS
LA935GA-108	KRA	LAF1918GA-6	LUF	LAF3865GA-907R	LUF	LAF6769GA-106 ⁶⁶	CHP
LA937GA-54	KRA	LAF1931GA-119	LUF	LAF388GA-3501	APOL	LAF6769GA-326 ⁷¹	CHP
LA95GA-192	KRA	LAF1953GA-221R	LUF	LAF388GA-3501	BWS	LAF6769GA-106 ⁶⁶	LUF
LA9511GA-244	WAKO	LAF1956GA-683R	LUF	LAF388GA-3501	CAM2	LAF6769GA-326 ⁷¹	LUF
LA957GA-373	KRA	LAF1981GA-329	LUF	LAF388GA-3501	CHP	LAF6775GA-206	LUF
LA-958VGA-140	WAKO	LAF1986GA-891	LUF	LAF388GA-3501	CIGO	LAF6834GA-361	BWS
LA96GA-78	KRA	LAF203GA-1203	CHP	LAF388GA-3501	GRAN	LAF6834GA-361	CHP
LA964GA-4365	KRA	LAF203GA-1203	LUF	LAF388GA-3501	LUF	LAF6834GA-361	LUF
LA970GA-3490	WAKO	LAF2100GA-371	BWS	LAF388GA-3501	MASE	LAF6880GA-6880	BWS
LA-9710VGA-381	WAKO	LAF2100GA-371	LUF	LAF388GA-3501	WARN	LAF6880GA-6880	CHP
LA983GA-827	KRA	LAF212GA-55	LUF	LAF388BGA-3501	LUF	LAF6880GA-6880	LUF
LA986GA-436	KRA	LAF222GA-16	BWS	LAF3890GA-890R	LUF	LAF68810GA-6880	LUF
LA993GA-360	KRA	LAF222GAK-16	BWS	LAF3930GA-930R	LUF	LAF6918GA-378	BWS
LA994GA-361	KRA	LAF222GAK-16	CHP	LAF3931GA-371	LUF	LAF6918GA-378	CHP
LA998GA-42	KRA	LAF222GAK-16	LUF	LAF3951GAP-379	LUF	LAF6918GA-378	LUF
LAF 1477GA-410	LUF	LAF222AGAK-16	LUF	LAF4GA-70	LUF	LAF6918DGA-378	LUF
LAF1008GA-29	LUF	LAF223GA-56 ⁹⁰	LUF	LAF414GA-426	LUF	LAF694GA-694	BWS
LAF101GA-105	LUF	LAF234GA-20	LUF	LAF414GA-680	LUF	LAF694GA-694	LUF
LAF1095GA-1095	LUF	LAF234GAK-20	LUF	LAF414AMGA-680	LUF	LAF6966GA-529	LUF
LAF115GA-90	LUF	LAF234HDGAK-20	BWS	LAF4272GA-21	LUF	LAF7136GA-416	LUF

Referencia Cruzada por Numero de Parte

Cross Reference by Part Number



Numero	Gonher	Fabricante	Numero	Gonher	Fabricante	Numero	Gonher	Fabricante	Numero	Gonher	Fabricante
Number	Gonher	Manufacturer	Number	Gonher	Manufacturer	Number	Gonher	Manufacturer	Number	Gonher	Manufacturer
LA725AM	GA-425	LUF	LA726AM	GA-679	LUF	LER111	GP-46	LEDR	LF1218	GP-205	LEE
LA73	GA-44	BWS	LA728	GA-2984	BWS	LER111	GP-46	LEE	LF1218HP	GP-205	LEEM
LA73	GA-44	CHP	LA728	GA-2984	CHP	LER111	GP-46	OHFC	LF126	GP-836	LEE
LA73	GA-44	LUF	LA728	GA-2984	LUF	LER-111	GP-46	POWF	LF1261F	GS-1261	LUF
LA7360	GA-7360	BWS	LA736	GA-826	CHP	LER123	GP-3429	OHFC	LF129	GP-14	HAS
LA7360	GA-7360	LUF	LA736	GA-826	LUF	LER-123	GP-3429	POWF	LF134	GP-3600	HAS
LA74	GA-11	LUF	LA737	GA-827	LUF	LER124	GP-44	OHFC	LF134CO	GP-3600	FEDE
LA7531	GA-1008	LUF	LA7373	GA-206	BWS	LER-124	GP-44	POWF	LF134F	GP-3600	FEDE
LA7640	GA-210	BWS	LA7373	GA-206	LUF	LER17	GP-81	LEDR	LF137	GP-390 ⁹³	HAS
LA7640	GA-210	LUF	LA7396	GA-377	LUF	LER17	GP-81	LEE	LF140	GP-171 ¹⁶	HAS
LA7672	GA-106 ⁴⁶	LUF	LA742	GA-109	LUF	LER173	GP-3980	OHFC	LF-140	GP-1 ⁹⁰	ATL
LA7672	GA-326 ⁷¹	LUF	LA7472	GA-372	BWS	LER-173	GP-3980	POWF	LF142CO	GP-81	FEDE
LA7702A	GA-26 ¹¹²	LUF	LA7472	GA-372	CHP	LER18	GP-81 ³¹	LEDR	LF142F	GP-81	FEDE
LA7702B	GA-26 ¹¹²	LUF	LA7472	GA-372	LUF	LER18	GP-9 ⁹⁸	LEDR	LF144	GP-40	HAS
LA7716	GA-7716	BWS	LA7538	GAK-1532	BWS	LER18	GP-81 ³¹	LEE	LF144CO	GP-40	FEDE
LA7716	GA-7716	CHP	LA7538	GAK-1532	CHP	LER18	GP-9 ⁹⁸	LEE	LF144F	GP-40	FEDE
LA7716	GA-7716	LUF	LA7538	GAK-1532	LUF	LER194	GP-40 ⁹⁴	OHFC	LF145	GP-3531	EXP
LA7797	GA-229	BWS	LA7544	GA-107	BWS	LER194	GP-91 ³⁸	OHFC	LF145CO	GP-3531	EXP
LA7797	GA-229	CHP	LA7544	GA-107	CHP	LER195	GP-3600	LEE	LF145F	GP-3531	EXP
LA7797	GA-229	LUF	LA7544	GA-107	LUF	LER195	GP-3600	OHFC	LF149	GP-22	HAS
LA78043	GA-106 ⁴⁶	LUF	LA7545	GA-209	BWS	LER-195	GP-3600	POWF	LF-149	GP-22	ATL
LA78044	GA-372	LUF	LA7545	GA-209	LUF	LER1A	GP-1	LEDR	LF154	GP-42	HAS
LA78047	GA-376	BWS	LA7559	GA-373	BWS	LER1A	GP-1	OHFC	LF154	GP-42	SHE
LA78047	GA-376	CHP	LA7559	GA-373	CHP	LER-1A	GP-1	POWF	LF155	GP-3816	HAS
LA78047	GA-376	LUF	LA7559	GA-373	LUF	LER252	GP-28 ⁶	OHFC	LF157	GP-58	HAS
LA7805	GA-6128	LUF	LA757	GA-75	LUF	LER252	GP-430 ⁸	OHFC	LF157CO	GP-58	FEDE
LA78088	GA-517R	CHP	LA79726	GA-31	CHP	LER28	GP-3816	LEDR	LF157F	GP-58	FEDE
LA78088	GA-517R	LUF	LA79726	GA-31	LUF	LER3	GP-50	LEDR	LF16	GP-81 ³¹	LEE
LA78098	GA-8	CHP	LA79762	GA-31	CHP	LER3	GP-50	LEE	LF16	GP-9 ⁹⁸	LEE
LA78098	GA-8	LUF	LAK253	GAK-16	LPM	LER3	GP-50	OHFC	LF16011	GP-58 ⁹	FLG
LA78146	GA-712R	CHP	LAK256	GA-33 ¹¹²	LPM	LER-3	GP-50	POWF	LF16015	GP-737	FLG
LA78146	GA-712R	LUF	LAS12253	G-1123	BUSS	LER33	GP-20	LEDR	LF16104	GP-3675	FLG
LA78149	GA-697R	LUF	LAS23	GA-113	LUF	LER33	GP-20	LEE	LF16109	GP-408	FLG
LA78155	GA-616	LUF	LAS24	GA-113	LUF	LER33	GP-20	OHFC	LF16115	GP-58	FLG
LA78195	GA-880R	CHP	LAS8548	GA-329	LUF	LER-33	GP-20	POWF	LF16144	G-3754	FLG
LA78195	GA-880R	LUF	LB11	GA-101	LEE	LER40	GP-3	LEDR	LF16166	G-3752	FLG
LA78390	GA-782	LUF	LB11	GA-101	LEEM	LER40	GP-3	LEE	LF16222	GP-3682	FLG
LA78407	GA-563	BWS	LB26	GA-176	AUTE	LER40	GP-13	OHFC	LF16227	GP-112	FLG
LA78407	GA-563	LUF	LB26	GA-176	LEE	LER-40	GP-13	POWF	LF164	GP-3675	HAS
LA78482	GA-482	BWS	LB26	GA-176	LEEM	LER42	GP-38	LEDR	LF164F	GP-3675	FEDE
LA78482	GA-482	CHP	LB59	GA-100	AUTE	LER49	GP-3	LEDR	LF16HP	GP-81 ³¹	LEE
LA78482	GA-482	LUF	LB59	GA-100	LEE	LER49	GP-3	LEE	LF16HP	GP-9 ⁹⁸	LEE
LA78483	GA-483	BWS	LB59	GA-100	LEEM	LER49	GP-3	OHFC	LF16HP	GP-81 ³¹	LEEM
LA78483	GA-483	CHP	LB73	GA-101	AUTE	LER-49	GP-3	POWF	LF16HP	GP-9 ⁹⁸	LEEM
LA78483	GA-483	LUF	LB73	GA-101	LEE	LEERS	GP-5	LEDR	LF17	GP-50	LEE
LA78494	GA-493 ¹⁰⁸	BWS	LB86	GA-113	LEE	LERS	GP-5	LEE	LF171	GP-871	HAS
LA78494	GA-493 ¹⁰⁸	CHP	LB87	GA-113	LEE	LERS	GP-5	OHFC	LF174	G-870	HAS
LA78494	GA-493 ¹⁰⁸	LUF	LB88	GA-113	LEE	LER-5	GP-5	POWF	LF179	G-813	LEE
LA78495	GA-493 ¹⁰⁸	CHP	LBUS519	G-297-B	LEVL	LER-64A	GP-28 ⁶	POWF	LF17HP	GP-81	LEE
LA7851	GA-29	LUF	LBUS5468	G-297-B	LEVL	LER-64A	GP-430 ⁶	POWF	LF17HP	GP-81	LEEM
LA7851	GA-9045	LUF	LC1059	G-834	KND	LER73	GP-462	LEDR	LF182	GP-225	HAS
LA78517E	GAK-216	LUF	LC1059	G-834	MINL	LER73	GP-24 ²⁶	OHFC	LF1820H	GP-81	LEE
LA78517E	GAK-216	LUF	LC1059	G-834	VALV	LER73	GP-462 ²⁴	OHFC	LF185	GP-836	HAS
LA78518	GA-416	LUF	LC-1059	G-834	FACE	LER-73	GP-24	POWF	LF186	G-834	HAS
LA78528	GAK-16	LUF	LC200	G-200	KND	LER81	GP-81 ³¹	LEDR	LF190HP	GP-81	LEEM
LA7853	GA-375	BWS	LC-200	G-200	FACE	LER81	GP-9 ⁹⁸	LEDR	LF196	GP-81 ³¹	HAS
LA7853	GA-375	CHP	LC-211	G-566	FACE	LER81	GP-81 ³¹	LEE	LF196	GP-9 ⁹⁸	HAS
LA7853	GA-375	LUF	LC218	G-34	KND	LER81	GP-9 ⁹⁸	LEE	LF196CO	GP-81 ³¹	FEDE
LA78545	GA-329	LUF	LC218	GP-81 ³¹	MINL	LER81	GP-81 ³¹	OHFC	LF196CO	GP-9 ⁹⁸	FEDE
LA78547	GA-239	BWS	LC218	G-34	VALV	LER81	GP-9 ⁹⁸	OHFC	LF196F	GP-81 ³¹	FEDE
LA78547	GA-239	LUF	LC-218	G-34	FACE	LER-81	GP-81 ³¹	POWF	LF196F	GP-9 ⁹⁸	FEDE
LA78548	GA-329	BWS	LC236	G-236	KND	LER-81	GP-9 ⁹⁸	POWF	LF198	GP-50	HAS
LA78548	GA-329	LUF	LC236	G-236	MINL	LER84	GP-23	LEDR	LF1A	GP-1	LEE
LA78552	GA-589	LUF	LC236	G-236	VALV	LER8509N	GP-33	FLR	LF1HP	GP-1	LEE
LA78572	GAK-1532	LUF	LC-236	G-236	FACE	LF01-14-302	G-70	MZDA	LF1HP	GP-1	LEEM
LA78577	GA-467	LUF	LC33	G-33	KND	LF0514302A	GP-58	MZDA	LF2	GP-1	LEE
LA78615	GA-18	LUF	LC33	G-33	MINL	LF1	GP-1	LEE	LF200	G-1173 ¹⁰⁸	LEE
LA78618	GA-459	LUF	LC33	G-33	VALV	LF100	GP-26	LUF	LF21	GG-123	LEDR
LA78619	GAK-458	LUF	LC-33	G-33	FACE	LF1014302	GP-58	MZDA	LF212	GP-5	HAS
LA78638	GAK-16	LUF	LC330	G-330	KND	LF10-14-302A	GP-58	MZDA	LF213	GP-28	HAS
LA78694	GA-888R	LUF	LC330	G-330	MINL	LF102F	GA-27 ¹¹²	KRA	LF213	GP-28 ⁶	LEE
LA78727	GA-642	LUF	LC330	G-330	VALV	LF103	G-31	HAS	LF213	GP-430 ⁸	LEE
LA7875	GA-21	LUF	LC-330	G-330	FACE	LF106	G-31	HAS	LF213FC	GP-28 ⁶	LEE
LA78833	GA-287	LUF	LC8170	G-954	TIRP	LF107	GP-81	HAS	LF213FC	GP-430 ⁸	LEE
LA78996	GA-475 ¹¹³	CHP	LC834	G-963	VALV	LF107CO	GP-81	FEDE	LF213HP	GP-28 ⁶	LEE
LA78996	GA-5876 ³⁵	CHP	LC8445	G-975	VALV	LF107F	GP-81	FEDE	LF213HP	GP-430 ⁸	LEE
LA78996	GA-475 ¹¹³	LUF	LC846	G-112	FLUX	LF108	GP-77	HAS	LF219	G-33	HAS
LA78996	GA-5876 ³⁵	LUF	LD3404	GP-50 ²⁰	FLUX	LF10HP	GP-171 ¹⁶	LEEM	LF222	GP-20	HAS
LA79001	GAK-625	BWS	LD427-2	G-31	CONT	LF11	GP-13	LEE	LF222CO	GP-20	FEDE
LA79001	GAK-625	LUF	LE10	GP-34	ZING	LF110	GP-68	HAS	LF222F	GP-20	FEDE
LA79096	GA-780	CHP	LE25	GP-34	ZING	LF110CO	GP-68	FEDE	LF223	G-34	HAS
LA79096	GA-780	LUF	LE25P	GP-34	ZING	LF110F	GP-68	FEDE	LF224	GP-13	HAS
LA79096	GA-780	PARP	LE3403	GP-149	FLG	LF111	GP-46	LEE	LF224CO	GP-13	HAS
LA79096	GA-780	WARN	LE580	G-31	WHIT	LF112	GP-871	HAS	LF224F	GP-13	FEDE
LA79099	GA-799R	LUF	LEB5040	G-31	COO	LF113	GP-91	HAS	LF225	GP-3	HAS
LA79102	GA-798R	LUF	LEF5006	G-191	COO	LF113CO	GP-91	FEDE	LF225CO	GP-3	FEDE
LA79155	GA-356	BWS	LEF5039	G-200	COO	LF113F	GP-91	FEDE	LF225F	GP-3	FEDE
LA79155	GA-356	CHP	LEF5054	G-335	COO	LF115	GP-1	HAS	LF226	GP-23	HAS
LA79155	GA-356	LUF	LEF5066	G-330	COO	LF115CO	GP-1	FEDE	LF226CO	GP-23	FEDE
LA79159	GA-357	BWS	LEF5068	G-139	COO	LF115F	GP-1	FEDE	LF226F	GP-23	FEDE
LA79159	GA-357	CHP	LEF5079	G-34	COO	LF117	GP-50	HAS	LF2286	GP-562	LEE
LA79159	GA-357	LUF	LER1	GP-1	LEDR	LF119	G-5000	HAS	LF23	GP-20	LEE
LA79201	GA-624R	LUF	LER1	GP-1	LEE	LF12	GP-3	LEE	LF230	GP-3429	HAS
LA7926	GA-679	BWS	LER1	GP-1	OHFC	LF120	G-971	HAS	LF230CO	GP-3429	FEDE
LA7926	GA-679	CHP	LER110	GP-10	LEDR	LF-120	G-971	ATL	LF230F	GP-3429	FEDE
LA7926	GA-679	LUF	LER110	GP-10	LEE	LF121	G-330	HAS	LF232	GP-44	HAS

Numero	Gonher	Fabricante	Numero	Gonher	Fabricante	Numero	Gonher	Fabricante	Numero	Gonher	Fabricante
Number	Gonher	Manufacturer	Number	Gonher	Manufacturer	Number	Gonher	Manufacturer	Number	Gonher	Manufacturer
LF232F	GP-44	FEDE	LF2868	GP-91	LEE	LF3406	GP-51	FLG	LF3649	GP-40	FLG
LF233	GP-46	HAS	LF2872	GP-3985	LEE	LF3407	GP-3985	FLG	LF364CO	GP-9586	FEDE
LF233CO	GP-46	FEDE	LF2876HP	GP-91	LEEM	LF340CO	GP-14	FEDE	LF3653	GP-36	FLG
LF233F	GP-46	FEDE	LF29	GP-13	LEE	LF3410	GP-57	FLG	LF3654	GP-556	FLG
LF2344	GP-3766	FLG	LF299	GP-562	HAS	LF3415	GP-36	FLG	LF3655	GP-68	FLG
LF237	GP-212	HAS	LF299F	GP-562	FEDE	LF3418	GP-171	FLG	LF3659	GP-1	FLG
LF238	GP-38	HAS	LF29HP	GP-13	LEE	LF3420	GP-69	FLG	LF3665	GP-36	FLG
LF238F	GP-38	FEDE	LF29HP	GP-13	LEEM	LF3421	GP-69	FLG	LF3666	GP-36	FLG
LF24	GP-20	LEE	LF2HP	GP-1	LEE	LF3433	GP-3985	FLG	LF3671	GP-193	FLG
LF240	GP-149	HAS	LF2HP	GP-1	LEEM	LF3434	GP-3682	FLG	LF3675	GP-51	FLG
LF240F	GP-149	FEDE	LF3	GP-50	LEE	LF3435	GP-171	FLG	LF3677	GP-3000	FLG
LF241	GP-88	HAS	LF30	GP-20	LEE	LF3437	GP-51	FLG	LF3679	GP-205	FLG
LF242	GP-24	HAS	LF300	GP-51	HAS	LF3443	GP-54	FLG	LF3681	GP-68	FLG
LF24HP	GP-20	LEE	LF3000	GP-3000	FLG	LF3443SC	GP-54 ⁹⁰	FLG	LF3682	GP-171	FLG
LF24HP	GP-20	LEEM	LF3000P	GP-3000	LYS	LF3451	GP-310	FLG	LF3690	GP-2951	FLG
LF25	GP-3	LEE	LF3000TP	GP-3000	FLG	LF3451	GP-3569	FLG	LF3691	GP-149	FLG
LF250	GP-193	HAS	LF301	G-963	HAS	LF3453	GP-53	FLG	LF3692	GP-91	FLG
LF250XS	GP-193	HAS	LF-301	G-963	ATL	LF3455	GP-88	FLG	LF3693F	GP-62	CHP
LF251	GP-57	HAS	LF308	GP-156	HAS	LF3460	GP-58	FLG	LF3703	GP-754	FLG
LF253	GP-81	LEE	LF310	GP-54	HAS	LF3462	GP-149	FLG	LF3706	GP-171	FLG
LF25HP	GP-3	LEE	LF311	GP-139	HAS	LF3466	GP-171 ¹⁵	FLG	LF371	G-333	HAS
LF25HP	GP-3	LEEM	LF313	GP-69	HAS	LF347	G-222	HAS	LF3714	GP-3985	HAS
LF261	GP-54	HAS	LF314	G-6	HAS	LF3470	GP-43	FLG	LF372	G-162H	FLG
LF270	GP-3985	HAS	LF315	GP-54 ¹¹	HAS	LF3473	GP-68	FLG	LF3729	GP-166 ⁹⁵	FLG
LF2700	GP-462	LEE	LF315	GP-66 ¹⁰	HAS	LF3476	GP-51	FLG	LF3729	GP-3937 ¹¹	FLG
LF2700HP	GP-462	LEE	LF317	GP-191	HAS	LF3477	GP-51	FLG	LF3731	GP-51	FLG
LF2700HP	GP-462	LEEM	LF319	G-236	HAS	LF3478	GP-43	FLG	LF3736	GP-22	FLG
LF272	GP-53	HAS	LF321	G-238	HAS	LF3478	GP-51	FLG	LF374	GP-46	HAS
LF272CO	GP-43	FEDE	LF325	GP-331	HAS	LF3480	GP-9	FLG	LF3746	GP-642	FLG
LF272XS	GP-53	HAS	LF327	GP-51	HAS	LF3481	GP-9	FLG	LF3746N1	GP-642	FLG
LF273	GP-359	HAS	LF328	GP-335	HAS	LF3486	GP-3980	FLG	LF3752	GP-36	FLG
LF273	GP-43	HAS	LF329	GP-88	HAS	LF3487	GP-1	FLG	LF3754	G-3754	FLG
LF278	GP-3000 ¹³	HAS	LF33	GP-20	LEE	LF3488	GP-13	FLG	LF3766	GP-3816	FLG
LF279	GP-205	HAS	LF330	G-566	HAS	LF3490	GP-490	FLG	LF3776	GP-462	FLG
LF279F	GP-205	FEDE	LF3306	GP-1	FLG	LF3494	GP-40	FLG	LF379	GP-171	HAS
LF27K	GG-45	WAKO	LF3307	GP-69	FLG	LF3495	GP-58	FLG	LF3795	GP-81	FLG
LF28	GP-58	LEE	LF3308	GP-50	FLG	LF3497	GP-54 ⁹⁰	FLG	LF379CO	GP-9	FEDE
LF2801	GP-3985	LEE	LF3309	GP-81	FLG	LF3501	GP-81 ³¹	FLG	LF379F	GP-171	FEDE
LF2801HP	GP-3985	LEE	LF3310	GP-3816	FLG	LF3501	GP-9 ⁹⁸	FLG	LF3805	GP-390	FLG
LF2802HP	GP-91	LEE	LF3311	GP-81	FLG	LF3503	GP-1 ⁹	FLG	LF3806	GP-178	FLG
LF2805HP	GP-462	LEE	LF3313	GP-1	FLG	LF3505	GP-81	FLG	LF3807	GP-359	FLG
LF2808	GP-149 ⁹⁹	LEE	LF3314	GP-310	FLG	LF3507	GP-35	FLG	LF3812	GP-462	FLG
LF2808	GP-91 ⁹⁴	LEE	LF3315	GP-68	FLG	LF352	GP-36	HAS	LF3827	G-3827	FLG
LF2809	GP-40	LEE	LF3316	GP-69	FLG	LF3521	G-834	FLG	LF384	GP-2951	HAS
LF2809HP	GP-40	LEE	LF3317	GP-35	FLG	LF3529	G-33	FLG	LF384	GP-2951	SHE
LF281	GP-359	HAS	LF3318	GP-34	FLG	LF3530	GP-1	FLG	LF-384	GP-2951	ATL
LF2812	GP-22	LEE	LF3320	G-163	FLG	LF3532	GP-36	FLG	LF384CO	GP-2951	FEDE
LF2812HP	GP-22	LEEM	LF3321	GP-51	FLG	LF3536	GP-462	FLG	LF384F	GP-2951	FEDE
LF2815HP	GP-310	LEE	LF3322	G-926	FLG	LF3537	GP-149	FLG	LF385	GP-3682	HAS
LF2815HP	GP-310	LEEM	LF3324	GP-1	FLG	LF3542	GP-57	FLG	LF3854	GP-359	FLG
LF-2815HP	GP-3569	LEE	LF3325	GP-53	FLG	LF3545	GP-57	FLG	LF3855	GP-58 ⁹	FLG
LF2816HP	GP-3816	LEE	LF3326	GP-57	FLG	LF3548	GP-3000 ¹³	FLG	LF385CO	GP-3682	FEDE
LF2816HP	GP-3816	LEEM	LF3327	G-143	FLG	LF3550	GP-3682	FLG	LF385F	GP-3682	FEDE
LF2818HP	GP-36	LEEM	LF3330	GP-171	FLG	LF3552	GP-178	FLG	LF386	GP-462	HAS
LF2819HP	GP-36	LEEM	LF3331	GP-36	FLG	LF3553	GP-390	FLG	LF386F	GP-462	FEDE
LF282	GP-52 ¹⁰	HAS	LF3333	GP-53	FLG	LF3554	GP-3980	FLG	LF387	GP-38	HAS
LF282	GP-691 ⁴⁸	HAS	LF3334	GP-38	FLG	LF3556	GP-10	HAS	LF3883	GP-152	FLG
LF2820HP	GP-81 ³¹	LEE	LF3335	GP-58	FLG	LF3559	GP-69	FLG	LF3885	GP-178	FLG
LF2820HP	GP-9 ⁹⁸	LEE	LF3336	GP-40	FLG	LF3560	GP-69	FLG	LF3886	GP-737	FLG
LF2821A	GP-58	LEE	LF3337	GP-3531 EXP	FLG	LF3567	GP-35	FLG	LF3894	GP-178	FLG
LF2821HP	GP-58	LEE	LF3338	GP-3816	FLG	LF3568	GP-28 ⁹	FLG	LF391	GP-3985	HAS
LF2823	GP-156	LEE	LF3339	GP-3600	FLG	LF3568	GP-430 ⁸	FLG	LF3914	G-3754	FLG
LF2825HP	GP-38	LEE	LF334	GP-50	HAS	LF356CO	GP-10	FEDE	LF3918	GP-642	FLG
LF2825HP	GP-38	LEEM	LF3340	G-133	FLG	LF3571	GP-54	FLG	LF3919	GP-69	FLG
LF2827	GP-3600	LEE	LF3340	G-989	FLG	LF3571	GP-66	FLG	LF391CO	GP-3985	FEDE
LF2827	GP-3682	LEE	LF3341	GP-81 ³¹	FLG	LF3580	GP-66	SCHR	LF391F	GP-3985	FEDE
LF2827HP	GP-3682	LEE	LF3341	GP-9 ⁹⁸	FLG	LF3583	GP-9	FLG	LF3921	GP-178	FLG
LF2827HP	GP-3682	LEEM	LF3342	GP-9586	FLG	LF3589	GP-57	FLG	LF3922	GP-390	FLG
LF282XS	GP-52 ¹⁰	HAS	LF3344	GP-3766	FLG	LF359	GP-52 ¹¹⁰	HAS	LF393	GP-3980	HAS
LF282XS	GP-691 ⁴⁸	HAS	LF3345	GP-390	FLG	LF359	GP-691 ⁴⁸	HAS	LF3932	GP-66	FLG
LF2830	GP-171	LEE	LF3346	GP-88	FLG	LF3591	GP-149	FLG	LF3933	GP-9	FLG
LF2830HP	GP-171	LEE	LF3349	GP-178	FLG	LF3599	GP-38	FLG	LF3934	GP-178	FLG
LF2830HP	GP-171	LEEM	LF335	G-152	HAS	LF3601	GP-3600	FLG	LF3935	GP-178	FLG
LF2832	GP-81 ³¹	LEE	LF3350	G-133	FLG	LF3604	GP-81	FLG	LF3937	GP-3937	FLG
LF2832	GP-9 ⁹⁸	LEE	LF3350	G-989	FLG	LF361	GP-69	HAS	LF393CO	GP-3980	FEDE
LF2832HP	GP-81 ³¹	LEE	LF3351	G-163	FLG	LF3610	G-191	FLG	LF393F	GP-3980	FEDE
LF2832HP	GP-9 ⁹⁸	LEE	LF3353	GP-1	FLG	LF3613	GP-58	FLG	LF3945	GP-3675	FLG
LF2835	GP-58	LEE	LF3357	G-31	FLG	LF3614	GP-157	FLG	LF3947	GP-31	FLG
LF2835H	GP-58	LEE	LF3359	GP-36	FLG	LF3615	GP-156	FLG	LF3948	GP-156	FLG
LF2835HP	GP-58	LEE	LF3360	GP-77	FLG	LF3617	GP-3675	FLG	LF395	GP-390	HAS
LF284	GP-152	HAS	LF3371	GP-171	FLG	LF361CO	GP-69	FEDE	LF3954	GP-52 ¹¹⁰	FLG
LF2840	GP-157	LEE	LF3374	GP-52 ¹¹⁰	FLG	LF362	GP-1 ⁹	HAS	LF3954	GP-691 ⁴⁸	FLG
LF2840HP	GP-157	LEE	LF3374	GP-691 ⁴⁸	FLG	LF3620	GP-193	FLG	LF3955	GP-3	FLG
LF2841	GP-156	LEE	LF3376	GP-171	FLG	LF3622	GP-359	FLG	LF3956	GP-1	FLG
LF2841HP	GP-156	LEE	LF3377	GP-81	FLG	LF3624	GP-3985	FLG	LF3959	GP-178	FLG
LF2841HP	GP-156	LEEM	LF3378	GP-81	FLG	LF3625	GP-54 ¹¹	FLG	LF3970	GP-3937	FLG
LF2856	GP-3985	LEE	LF3382	GP-10	FLG	LF3625	GP-66 ¹⁰	FLG	LF3972	GP-178	FLG
LF2856HP	GP-3985	LEE	LF339	GP-171	HAS	LF363	GP-36	HAS	LF3973	GP-51	FLG
LF2861	GP-28 ⁸	LEE	LF3390	GP-14	FLG	LF3630	GP-562	FLG	LF3996	GP-40	FLG
LF2861	GP-430 ⁸	LEE	LF3391	G-31	FLG	LF3635	GP-57	FLG	LF39K	GG-196	WAKO
LF2861HP	GP-28 ⁸	LEE	LF3393	GP-88	FLG	LF3638	GP-3985	FLG	LF400	GP-13	LEE
LF2861HP	GP-430 ⁸	LEE	LF340	GP-14	HAS	LF3639	GP-3000	FLG	LF400	GP-58	HAS
LF2863	GP-3985	LEE	LF3400	GP-81	FLG	LF364	GP-9586	HAS	LF400	GP-3600	LEE
LF2863HP	GP-3985	LEE	LF3400	GP-9 ⁹⁸	FLG	LF3640	GP-152	FLG	LF400HP	GP-3600	LEE
LF2867	GP-149	LEE	LF3401	GP-1	FLG	LF3641	GP-67	FLG	LF400HP	GP-3600	LEEM
LF2867HP	GP-149	LEEM	LF3402	GP-1	FLG	LF3644	GP-149	FLG	LF4014	GP-3816	FLG

Referencia Cruzada por Numero de Parte

Cross Reference by Part Number



Numero	Gonher	Fabricante	Numero	Gonher	Fabricante	Numero	Gonher	Fabricante	Numero	Gonher	Fabricante
Number	Gonher	Manufacturer	Number	Gonher	Manufacturer	Number	Gonher	Manufacturer	Number	Gonher	Manufacturer
LF4015	GP-81	FLG	LF492	GP-171	ATL	LF567	GP-691 ⁴⁸	HAS	LF750	G-750	HAS
LF4016	GP-81	FLG	LF493	GP-28 ⁹	HAS	LF569	G-1143	FLG	LF750A	G-750	FLG
LF4017	GP-54	FLG	LF493	GP-430 ⁹	HAS	LF572	G-31	FLG	LF750B	G-750	FLG
LF402	GP-91	HAS	LF493F	GP-28 ⁹	FEDE	LF576	GP-58	HAS	LF750BE	G-750	FLG
LF402CO	GP-91	FEDE	LF493F	GP-430 ⁹	FEDE	LF578	G-33	FLG	LF750C	G-750	FLG
LF402F	GP-91	FEDE	LF494	GP-58	HAS	LF580	GP-81	FLG	LF750D	G-750	FLG
LF4031	G-833	FLG	LF494F	GP-58	FEDE	LF581	GP-5	FLG	LF750S	G-750	FLG
LF404	GP-36	HAS	LF496	GP-31	HAS	LF583	GP-3	FLG	LF757	GP-34	FLG
LF4052	G-296	FLG	LF497	GP-490	HAS	LF584	G-3827	HAS	LF75FC	GP-42	LEE
LF4052	G-296-B	FLG	LF498	GP-9000	HAS	LF587	G-139	FLG	LF75HP	GP-42	LEE
LF4052A	G-296	FLG	LF499	GP-9001	HAS	LF587	GP-51	HAS	LF75HP	GP-42	LEEM
LF4052A	G-296-B	FLG	LF49F	GP-149	FEDE	LF59265	GP-1122	PUR	LF760	GP-36	FLG
LF4054	GP-54	FLG	LF5	GP-5	LEE	LF594	G-801	FLG	LF763	G-222	FLG
LF4056	GP-36	FLG	LF500	G-500	FLG	LF594	G-871	FLG	LF764	GP-81	FLG
LF408	GP-178	HAS	LF501	G-750	FLG	LF594	G-70	HAS	LF766	GP-9586	FLG
LF408F	GP-178	FEDE	LF50-13-240-9U	GA-596	MZDA	LF595	G-225	FLG	LF767	GP-3429	FLG
LF40HP	GP-46	LEE	LF50-13-240A	GA-596	MZDA	LF596	G-813	FLG	LF77	GP-3531	EXP
LF40HP	GP-46	LEEM	LF503	GP-58 ¹⁵	HAS	LF598	G-834	FLG	LF777	GP-57	FLG
LF410	GP-157	HAS	LF504	G-31	FLG	LF599	G-836	FLG	LF777	GP-57	KOMA
LF4104	GP-88	FLG	LF505	GP-359	HAS	LF6	GP-5	LEE	LF778	GP-50 ²⁰	FLG
LF410CO	GP-157	FEDE	LF5055	G-152	FLG	LF603	G-222	FLG	LF77HP	GP-3531	EXP
LF410F	GP-157	FEDE	LF507	GP-359	HAS	LF607	GP-50	FLG	LF78	GP-3531	EXP
LF4112	GP-77	FLG	LF508	GP-178	FEDE	LF608	GP-178	HAS	LF780	GP-46	FLG
LF413	GP-156	HAS	LF508	GP-178	HAS	LF613	G-613	FLG	LF780	GP-178	LEE
LF4143	G-162H	FLG	LF509	G-33	FLG	LF613	GP-406	HAS	LF780HP	GP-178	LEEM
LF4143	G-225	FLG	LF509	GP-408	HAS	LF617	G-169	HAS	LF781	GP-38	FLG
LF4144	G-143	FLG	LF-509	GP-408	ATL	LF623	GP-406	HAS	LF782	GP-3980	FLG
LF4145	G-163	FLG	LF509AN	G-33	FLG	LF626	GP-50	HAS	LF783	GP-46	FLG
LF415	GP-54	HAS	LF509F	GP-408	FEDE	LF630	G-331	FLG	LF784	GP-81 ²¹	FLG
LF4154	GP-54	FLG	LF509N	G-33	FLG	LF632B	GP-14	FLG	LF784	GP-9 ³⁸	FLG
LF42	GP-38	LEE	LF51	GP-3980	LEE	LF633	G-816	FLG	LF784	GP-3766	LEE
LF423	GP-81	HAS	LF510	GP-457	HAS	LF634	G-169	FLG	LF784HP	GP-3766	LEE
LF42500	GP-3816	FLG	LF510F	GP-457	FEDE	LF637	G-159	FLG	LF784HP	GP-3766	LEEM
LF42501	GP-46	FLG	LF511	G-33	FLG	LF64	GP-3600	LEE	LF785	GP-28 ⁹	FLG
LF42502	GP-44	FLG	LF-511	G-49	ATL	LF647	GP-20	FLG	LF785	GP-430 ⁸	FLG
LF42503	GP-3980	FLG	LF512	G-6	FLG	LF651	GP-3	FLG	LF786	GP-50	FLG
LF42504	GP-3600 ³⁸	FLG	LF512	G-45	HAS	LF652	G-34	FLG	LF787	GP-31	FLG
LF42504	GP-38 ⁸⁹	FLG	LF514	GP-5	FLG	LF653	GP-13	FLG	LF788	GP-50	FLG
LF426	GP-31	HAS	LF514	G-975	HAS	LF654	GP-36	FLG	LF78HP	GP-3531	EXP
LF426CO	GP-31	FEDE	LF515	GP-3001	HAS	LF655	GP-3600 ³⁸	FLG	LF78HP	GP-3531	EXP
LF429	G-613	HAS	LF516	G-566	FLG	LF655	GP-38 ⁸⁹	FLG	LF793	G-6	FLG
LF42FC	GP-38	LEE	LF516	G-566	KOMA	LF664	G-33	FLG	LF795	GP-42	FLG
LF430	GP-34	HAS	LF517	GP-310	HAS	LF667	GP-51	FLG	LF796	GP-44	FLG
LF432	GP-53	HAS	LF517	GP-3569	HAS	LF67	GP-51	LYS	LF797	GP-54 ¹¹	FLG
LF432CO	GP-53	FEDE	LF518	GP-1	HAS	LF670	GP-53	FLG	LF797	GP-66 ¹⁰	FLG
LF434	GP-31	HAS	LF519	G-238	FLG	LF670C	GP-53	FLG	LF798	GP-3985	FLG
LF435	GP-67	HAS	LF51A	GP-3980	LEE	LF670SC	GP-53	FLG	LF7HP	GP-5	LEE
LF436	GP-1	HAS	LF51AHP	GP-3980	LEE	LF671	G-122	FLG	LF8031	G-750	HAS
LF437	GP-3600	HAS	LF51AHP	GP-3980	LEEM	LF671	G-338	FLG	LF804	G-500	HAS
LF438	GP-53	HAS	LF51HP	GP-3980	LEE	LF673	GP-10	FLG	LF820	GP-68	LEE
LF439	GP-57	HAS	LF52	GP-54	FLG	LF673	GP-54	FLG	LF820HP	GP-68	LEEM
LF439CO	GP-57	FEDE	LF520	GP-81	HAS	LF678	GP-14	FLG	LF832HP	GP-23	LEEM
LF44	GP-44	LEE	LF522	G-333	FLG	LF680	GP-34	FLG	LF9000	GP-9000	FLG
LF440	GP-35	HAS	LF522	G-72	FLG	LF681	GP-66	FLG	LF9001	GP-9001	FLG
LF441	GP-3766	HAS	LF523	GP-149	HAS	LF689	GP-81 ³¹	FLG	LF9009	GP-3001	FLG
LF441CO	GP-3766	FEDE	LF525	GP-9 ³⁸	FLG	LF689	GP-9 ³⁸	FLG	LF9011	GP-9001	FLG
LF441F	GP-3766	FEDE	LF52A	G-870	LEE	LF690	GP-10 ⁶⁷	FLG	LF-903HP	GP-212	LEE
LF443	GP-54 ³⁰	HAS	LF530	G-180	HAS	LF690	GP-54	FLG	LF908	GP-40	MZDA
LF443	GP-77	HAS	LF530	G-918	HAS	LF691	GP-52 ¹¹⁰	FLG	LF922	GP-44	LEE
LF444	GP-68	HAS	LF531	GP-51	HAS	LF691	GP-691 ⁴⁸	FLG	LF9333	GP-53	FLG
LF448	GP-3000	HAS	LF531CO	GP-51	FEDE	LF691A	GP-52 ¹¹⁰	FLG	LF9620	GP-193	FLG
LF44HP	GP-44	LEE	LF534	GP-43	HAS	LF691A	GP-691 ⁴⁸	FLG	LF9691	GP-52 ¹¹⁰	FLG
LF44HP	GP-44	LEEM	LF539	G-926	HAS	LF692	GP-23	FLG	LF9691	GP-691 ⁴⁸	FLG
LF45	GP-3429	LEE	LF540	GP-66	FLG	LF694	GP-66	FLG	LF9691A	GP-52 ¹¹⁰	FLG
LF455	GP-9	HAS	LF540	G-133	HAS	LF694	GP-69	FLG	LF9691A	GP-691 ⁴⁸	FLG
LF457	GP-642	HAS	LF540	G-989	HAS	LF695	GP-67	FLG	LF9F1000	GPP-1000	LUF
LF458	G-143	HAS	LF542	GP-149	HAS	LF697	GP-31	FLG	LF9F1001	GPP-11	LUF
LF45HP	GP-3429	LEEM	LF543	GP-3985	HAS	LF699	GP-31	FLG	LF9F1003	GPP-10035	LUF
LF461	GP-6811	HAS	LF545	GP-54	HAS	LF7	GP-5	LEE	LF9F1006	G-294	AIRT
LF461F	GP-6811	FEDE	LF546	GP-452	HAS	LF700	GP-3600	FLG	LF9F1006	G-294	BWS
LF462	GP-212	HAS	LF548	G-49	HAS	LF701	GP-1	FLG	LF9F1006	G-294	CENE
LF463	GP-754	HAS	LF-548	G-49	ATL	LF702	GP-88	FLG	LF9F1006	G-294	CHP
LF465	GP-452	HAS	LF548F	G-49	FEDE	LF708	GP-36	FLG	LF9F1006	G-294	GRAN
LF466	GP-67	HAS	LF550	G-5000	FLG	LF711	GP-46	FLG	LF9F1006	G-294	LUF
LF47	GP-46	LEE	LF550	GP-3682	HAS	LF714	G-153	FLG	LF9F1006	G-294	MASE
LF470	GP-1	HAS	LF551	GP-24 ²⁶	FLG	LF716	GP-24 ²⁶	FLG	LF9F1006	G-294	MIGH
LF477	GP-171	HAS	LF551	GP-3937	HAS	LF716	GP-462 ²⁴	FLG	LF9F1006	G-294	WARN
LF478	GP-88	HAS	LF551A	GP-1	FLG	LF719	GP-69	FLG	LF9F1007	GPP-10075	LUF
LF479	G-112	FEDE	LF552	G-330	FLG	LF721	G-331	FLG	LF9F1022	GPP-10225	CHP
LF479	G-112	HAS	LF552	G-3754	HAS	LF729	G-238	FLG	LF9F1022	GPP-10035	LUF
LF481	G-984	HAS	LF553	GP-200	FLG	LF73	GP-462	LEE	LF9F1022	GPP-10225	LUF
LF482	G-954	HAS	LF553	G-466	HAS	LF733	GP-51	FLG	LF9F1101F	GP-1101	CHP
LF483	GP-128	HAS	LF554	GP-51	HAS	LF734	GP-43	FLG	LF9F1105	GPP-114	LUF
LF483F	GP-128	FEDE	LF555	G-152	FLG	LF736	G-191	FLG	LF9F1129	G-270	APOL
LF486	GP-145	HAS	LF556	GP-455	HAS	LF738	G-191	FLG	LF9F1129	G-270	CHP
LF487	GP-3675	HAS	LF558	GP-191	FLG	LF739	GP-390 ⁹³	FLG	LF9F1129	G-270	LUF
LF-487	GP-3675	ATL	LF558	G-3752	HAS	LF73FC	GP-3985	LEE	LF9F1131	G-293	LUF
LF487F	GP-3675	FEDE	LF558F	G-3752	FEDE	LF74	GP-3985	LEE	LF9F1223	GPP-1287 ³⁹	LUF
LF489	G-765	HAS	LF560	G-236	FLG	LF740	G-191	FLG	LF9F1223	PPF831 ⁴¹	LUF
LF489F	G-765	FEDE	LF562	G-750	HAS	LF742	GP-171	FLG	LF9F1223	R 60 P ⁴²	LUF
LF48K1	GG-76	WAKO	LF563	G-335	FLG	LF744	GP-69	FLG	LF9F1224	GP-1224	LUF
LF48K2	GG-203	WAKO	LF563	GP-58 ⁹	HAS	LF747	GP-53	FLG	LF9F15	GP-92	AIRT
LF48K3	GG-204	WAKO	LF565	GP-6811	HAS	LF74HP	GP-24 ²⁶	LEE	LF9F15	GP-92	CHP
LF490F	GP-171	FEDE	LF565F	GP-6811	FEDE	LF74HP	GP-462 ²⁴	LEE	LF9F15	GP-92	LUF
LF491	GP-149	HAS	LF566	G-870	FLG	LF75	GP-42	LEE	LF9F15	GP-92	WARN
LF492	GP-3569	HAS	LF567	GP-52 ¹¹⁰	HAS	LF750	G-750	FLG	LF9F2	GGP-25	LUF

REFERENCIA CRUZADA

Para números Gonher con Superíndice vea página 651
For Gonher with Superscript numbers see page 651

Numero	Gonher	Fabricante	Numero	Gonher	Fabricante	Numero	Gonher	Fabricante	Numero	Gonher	Fabricante
Number	Gonher	Manufacturer	Number	Gonher	Manufacturer	Number	Gonher	Manufacturer	Number	Gonher	Manufacturer
LFF202	GP-55	BWS	LFF8063	GPP-1287 ³⁹	LUF	LFP170777	GP-57	DON	LFP3746	GP-67	BWS
LFF202	GP-55	CHP	LFF8063	PFF831 ⁴¹	LUF	LFP170784	GP-3766	DON	LFP3746	GP-67	CHP
LFF2040	GP-55	LUF	LFF8063U	R 60 P ⁴²	LUF	LFP170832	GP-23	DON	LFP3746	GP-67	LUF
LFF22011	GS-2034	LUF	LFF8063U	GPP-1287 ³⁹	CHP	LFP171000	GP-3000	DON	LFP3791	GP-14	BWS
LFF22011	GGP-125	LUF	LFF8063U	PFF831 ⁴¹	CHP	LFP171250	GP-36	DON	LFP3791	GP-14	LUF
LFF22011	GP-1101	CHP	LFF8063U	R 60 P ⁴²	CHP	LFP190	GP-81	LUF	LFP3854	GP-1108	LUF
LFF22011	GP-1101	LUF	LFF8063U	GPP-1287 ³⁹	LUF	LFP1A	GP-1	LUF	LFP3855	GP-1107	CHP
LFF2749	GP-749	LUF	LFF8063U	PFF831 ⁴¹	LUF	LFP1T	GP-171 ¹⁶	LUF	LFP3855	GP-1107	LUF
LFF3290	GPP-1291 ³⁹	LUF	LFF8063U	R 60 P ⁴²	LUF	LFP20	GP-14	LUF	LFP3871	GP-88	BWS
LFF3290	PFF831 ⁴¹	LUF	LFF8064	GPP-1291 ³⁹	LUF	LFP201	GP-38	LUF	LFP3871	GP-88	CHP
LFF3290	R 90 P ⁴²	LUF	LFF8064	S 3226 P ⁴⁰	LUF	LFP2160	GP-193	BWS	LFP3871	GP-88	LUF
LFF3292	GPP-1291 ³⁹	CHP	LFF8065	GPP-14	LUF	LFP2160	GP-193	LUF	LFP3900	GP-390	BWS
LFF3292	PFF831 ⁴¹	CHP	LFF8103	GPP-1122	LUF	LFP218F	GP-84	BWS	LFP3900	GP-390	CHP
LFF3292	R 90 71 ²	CHP	LFF8215	GPP-418	LUF	LFP218F	GP-84	CHP	LFP3900	GP-390	LUF
LFF3292	GPP-1291 ³⁹	LUF	LFF8288	GP-1105	LUF	LFP218F	GP-84	LUF	LFP3970	GP-3937	LUF
LFF3292	PFF831 ⁴¹	LUF	LFF8650	GPP-1122	LUF	LFP219F	GP-83	BWS	LFP4005	GP-52 ¹¹⁰	BWS
LFF3292	R 90 71 ²	LUF	LFF8727	GPP-11	LUF	LFP219F	GP-83	CHP	LFP4005	GP-691 ⁴⁸	BWS
LFF3318	GP-34	FLG	LFF8928	GP-1122	LUF	LFP219F	GP-83	LUF	LFP4005	GP-52 ¹¹⁰	CHP
LFF3347	GP-110	LUF	LFF9003	GPP-11	LUF	LFP2215	GP-81	LUF	LFP4005	GP-691 ⁴⁸	CHP
LFF3349	GP-78	LUF	LFF9006	G-294	AUTE	LFP2216	GP-51	LUF	LFP4005	GP-52 ¹¹⁰	LUF
LFF3357	GPP-18	LUF	LFF9006	G-294	LEEM	LFP2221	GP-171	LUF	LFP4005	GP-691 ⁴⁸	LUF
LFF3403	G-1121F	LUF	LFF9013	GPP-11	LUF	LFP2222	GP-54 ¹¹	LUF	LFP4005HE	GP-52 ¹¹⁰	LUF
LFF3406	G-1121F	LUF	LFF902	S 3202 ⁴⁰	LUF	LFP2222	GP-66 ¹⁰	LUF	LFP4005HE	GP-691 ⁴⁸	LUF
LFF3417	GPP-18	LUF	LFF937	GP-92	LUF	LFP2229	GP-88	LUF	LFP4005RN	GP-52 ¹¹⁰	CHP
LFF3435	GPP-19	CHP	LFFH1560	G-222	LUF	LFP2234	GP-54	LUF	LFP4005RN	GP-691 ⁴⁸	CHP
LFF3501	G-297	LUF	LFFH170	GP-66	LUF	LFP2235	G-143	LUF	LFP4005RN	GP-52 ¹¹⁰	LUF
LFF3501	G-297-B	LUF	LFFH1702	G-339H	LUF	LFP2239	GP-81	LUF	LFP4005RN	GP-691 ⁴⁸	LUF
LFF3504	GP-1122	LUF	LFFH3653-25	GP-66	LUF	LFP2241	GP-9	LUF	LFP4022	GP-2022W	LUF
LFF3505	GPP-1122	LUF	LFFH4207	GP-36	LUF	LFP2244	GP-88	LUF	LFP4104	GP-88	LUF
LFF3506	GP-1122	LUF	LFFH4209	GP-66	LUF	LFP2251	GP-88	LUF	LFP431F	GP-85	BWS
LFF3518	GP-1122	LUF	LFFH4213	G-191	LUF	LFP2255	GP-3985	LUF	LFP431F	GP-85	CHP
LFF3521	GP-1122	LUF	LFFH4428	GP-761H	LUF	LFP2258	GP-81	LUF	LFP431F	GP-85	LUF
LFF3526	GP-26	LUF	LFFH4439	GP-761H	CHP	LFP2261	GP-58	LUF	LFP440F	GP-110	BWS
LFF3530	GP-78	LUF	LFFH4439	GP-761H	LUF	LFP2265	GP-3000 ¹³	LUF	LFP440F	GP-110	CHP
LFF3540	GPP-14	LUF	LFFH4471	GP-761H	LUF	LFP2267	GP-68	CHP	LFP440F	GP-110	LUF
LFF3579	GPP-547 ³⁹	LUF	LFFH4472	GP-761H	LUF	LFP2267	GP-68	LUF	LFP444F	GP-110	CHP
LFF3579	PFF831 ⁴¹	LUF	LFFH4473	GP-761H	LUF	LFP2268	GP-642	LUF	LFP444FX	GP-110	CHP
LFF3579	R 60 P ⁴²	LUF	LFFH4635	G-153	LUF	LFP227	GP-3600	LUF	LFP449	GP-34	BWS
LFF3579U	GPP-547 ³⁹	LUF	LFFH4636	G-122	LUF	LFP2271	GP-50	LUF	LFP449	GP-34	CHP
LFF3579U	PFF831 ⁴¹	LUF	LFFH4636	G-338	LUF	LFP228	GP-81	LUF	LFP449	GP-34	LUF
LFF3579U	R 60 P ⁴²	LUF	LFFH4910	GP-761H	LUF	LFP2285	GP-152	CHP	LFP45	GP-3429	LUF
LFF3584	GP-96	LUF	LFFH4915	GP-34	CATP	LFP2285	GP-152	LUF	LFP47	GP-46	LUF
LFF3806	GP-1122	BWS	LFFH4915	GP-34	LUF	LFP2286	GP-562	CHP	LFP5002	GP-110	LUF
LFF3806	GP-1122	CHP	LFFH4926	GP-166 ¹⁰⁰	LUF	LFP2286	GP-562	GRAN	LFP5016F	GP-56	LUF
LFF3806	GP-1122	LUF	LFFH4936	GP-761H	LUF	LFP2286	GP-562	LUF	LFP51	GP-66	CHP
LFF3807	GP-92	CHP	LFFH4950	GP-761H	LUF	LFP2286	GP-562	PARP	LFP51	GP-66	LUF
LFF4293	GP-1107	LUF	LFFH4955	GP-34	CHP	LFP2286	GP-562	SECU	LFP54	GP-10	BWS
LFF4294	GPP-11	LUF	LFFH4955	GP-34	LUF	LFP2286	GP-562	TRUS	LFP54	GP-10	CHP
LFF45	GPP-18	LUF	LFFH4959	GP-761H	CHP	LFP2286	GP-562	WARN	LFP54	GP-10	LUF
LFF4511	GGP-125	LUF	LFFH4959	GP-761H	LUF	LFP2288	GP-57	LUF	LFP54	GP-54	LUF
LFF4783	GP-1109 ²²	LUF	LFFH4960	GP-54	LUF	LFP2292	GP-31	LUF	LFP550008	GP-1	DON
LFF4783	GP-62 ²⁰	LUF	LFFH4961	GP-761H	LUF	LFP2294	GP-490	LUF	LFP550020	GP-14	DON
LFF5	GP-1101	BWS	LFFH4972	GP-761H	LUF	LFP2312	GP-36	LUF	LFP550024	GP-5	DON
LFF5	GP-1101	CHP	LFFH4987	GP-9	LUF	LFP2312	GP-36	LUF	LFP550025	GP-3	DON
LFF5	GP-1101	LUF	LFFH4988	GP-34	LUF	LFP2312	GP-36	LUF	LFP550025	GP-3	DON
LFF5002	R 60 P ⁴²	CHP	LFFH4990	GP-761H	LUF	LFP24	GP-20	LUF	LFP550035	GP-13	DON
LFF5002	GP-110	LUF	LFFH5015	GP-864H	LUF	LFP25	GP-3	LUF	LFP550045	GP-3429	DON
LFF5002	GP-11	LUF	LFFH5068-10	GP-34	LUF	LFP250F	GP-1101	LUF	LFP550047	GP-46	DON
LFF5485	GP-548	LUF	LFFH8252	GP-166 ⁶⁵	LUF	LFP251F	GP-1108	LUF	LFP550050	GP-50	DON
LFF5488	GP-1109	LUF	LFFH8252	GP-3937 ¹¹	LUF	LFP2538	GP-310	LUF	LFP550051	GP-3980	DON
LFF5766	GGP-103	LUF	LFFH8399	GP-34	LUF	LFP253F	GP-11	CHP	LFP550052	G-870	DON
LFF5766	R 60 P	LUF	LFFH8593	GP-66	LUF	LFP253F	GP-11	LUF	LFP550117	GP-31	DON
LFF5804	GP-749	LUF	LFFH8596	GP-66	LUF	LFP2546	GP-761H	LUF	LFP550132	G-33	DON
LFF58238	GP-749	LUF	LFFH8759G	GP-761H	LUF	LFP255F	GPP-14	LUF	LFP550141	G-200	DON
LFF5823B	GP-749	LUF	LFP1	GP-1	LUF	LFP2814	GP-53	LUF	LFP550147	G-119	DON
LFF5825	G-1123F	LUF	LFP1-1	GP-1	LUF	LFP2820	GP-81 ³¹	LUF	LFP550152	GP-390 ⁸³	DON
LFF5849	GPP-1287 ³⁹	LUF	LFP1101F	GP-1101	CHP	LFP2820	GP-9 ³⁸	LUF	LFP550173	GP-40	DON
LFF5849	PFF831 ⁴¹	LUF	LFP1101F	GP-1101	LUF	LFP29	GP-13	LUF	LFP550224	GP-20	DON
LFF5849	S 3225 P ⁴²	LUF	LFP1101F	GP-1101	LUF	LFP299	GP-31	LUF	LFP550227	GP-3682	DON
LFF5850	GPP-1291 ³⁹	LUF	LFP12	GP-3	LUF	LFP3	GP-50	LUF	LFP550237	GP-31	DON
LFF5850	S 3226 P ⁴⁰	LUF	LFP1280	GPP-18	LYS	LFP30	GP-20	LUF	LFP550299	GP-31	DON
LFF5851	GPP-1000	LUF	LFP142F	GP-110	LUF	LFP3000	GP-3000	CHP	LFP550335	GP-58	DON
LFF5874	GP-96	LUF	LFP143F	GP-1105	LUF	LFP3000	GP-3000	LUF	LFP550400	GP-3600	DON
LFF5926	GPP-14	CHP	LFP152499B	GP-14	LUF	LFP3000XL	GP-3001	LUF	LFP550484	G-191	DON
LFF5926	GPP-14	LUF	LFP16	GP-81 ³¹	LUF	LFP3191	GP-51	BWS	LFP550485	G-238	DON
LFF5D	GPP-14	CHP	LFP1652	GP-9 ³⁸	LUF	LFP3191	GP-51	CHP	LFP550487	G-169	DON
LFF5D	GPP-11	LUF	LFP1652	GP-66	BWS	LFP3191	GP-51	LUF	LFP550500	G-500	DON
LFF5D	GPP-14	LUF	LFP1652	GP-66	CHP	LFP3301F	GPP-18	BWS	LFP550516	G-566	DON
LFF6338	GP-1232	LUF	LFP1652	GP-66	LUF	LFP3301F	GPP-18	CHP	LFP550534	GP-58	DON
LFF762	GP-1101 ⁵⁴	BWS	LFP170004	GP-51	DON	LFP3301F	GPP-18	LUF	LFP550580	GP-81	DON
LFF762	GP-1101 ⁵⁴	CHP	LFP170008	GP-1	DON	LFP3328	GP-171	LUF	LFP550613	G-613	DON
LFF762	GP-1101 ⁵⁴	LUF	LFP170025	GP-3	DON	LFP3404	GP-50 ²⁰	CHP	LFP550637	G-159	DON
LFF8000	GPP-11	LUF	LFP170035	GP-13	DON	LFP3404	GP-50 ²⁰	LUF	LFP550670	GP-53	DON
LFF8010	S 3202 ⁴⁰	LUF	LFP170046	GP-67	DON	LFP3404A	GP-50 ²⁰	BWS	LFP550671	GP-53	DON
LFF8011	GPP-11	LUF	LFP170050	GP-50	DON	LFP3404A	GP-50 ²⁰	LUF	LFP550731	GP-54	DON
LFF8020	GPP-11	BWS	LFP170132	G-33	DON	LFP3413	GP-50	CHP	LFP550750	G-750	DON
LFF8020	GPP-11	LUF	LFP170207	GP-10	DON	LFP3413	GP-50	LUF	LFP550751	G-750	DON
LFF8030	GPP-11	LUF	LFP170484	G-191	DON	LFP3692F	GP-1105	CHP	LFP550777	GP-57	DON
LFF8038	GPP-11	LUF	LFP170485	G-238	DON	LFP3692F	GP-1105	LUF	LFP550784	GP-3766	DON
LFF8038	GPP-1291 ³⁹	LUF	LFP170487	G-169	DON	LFP3693	GP-62	CHP	LFP550832	GP-23	DON
LFF8038	PFF831 ⁴¹	LUF	LFP170516	G-566	DON	LFP3693F	GP-62	CHP	LFP550911	GP-53	DON
LFF8038	R 90 P ⁴²	LUF	LFP170570	GP-9586	DON	LFP3693F	GP-62	LUF	LFP550947	GP-43	DON
LFF8050	GPP-11	LUF	LFP170616	GP-69	DON	LFP3712	GP-54	BWS	LFP551014	G-5000	DON
LFF8060	GPP-1122	LUF	LFP170637	G-159	DON	LFP3712	GP-54 ¹²¹	LUF	LFP551613	G-613	DON
LFF8061	GPP-14 ⁰⁸	BWS	LFP170670	GP-53	DON	LFP3712	GP-66	LUF	LFP552290	GP-171	DON
LFF8061	GPP-14 ⁰⁸	LUF	LFP170680	GP-36	DON	LFP3729	GP-166 ⁶⁵	LUF	LFP5523	GP-171	LUF
LFF8062	GPP-1122	LUF	LFP170750	G-750	DON	LFP3729	GP-3937 ¹¹	LUF	LFP552518	GP-81 ³¹	DON

Referencia Cruzada por Numero de Parte

Cross Reference by Part Number



Numero	Gonher	Fabricante	Numero	Gonher	Fabricante	Numero	Gonher	Fabricante	Numero	Gonher	Fabricante
Number	Gonher	Manufacturer	Number	Gonher	Manufacturer	Number	Gonher	Manufacturer	Number	Gonher	Manufacturer
LFP52518	GP-9 ⁵⁸	DON	LFP816F	GP-27	CHP	LFR83330	GP-69	FLR	LFR83610	G-191	FLR
LFP52849	GP-3600	DON	LFP816F	GP-27	LUF	LFR83331	GP-36	FLR	LFR83614	GP-157	FLR
LFP553000	GP-3000	DON	LFP816FN	GP-27	LUF	LFR83333	GP-53	FLR	LFR83615	GP-156	FLR
LFP553335	G-335	DON	LFP8316G	GP-3766 ¹⁰⁰	CHP	LFR83333SC	GP-43	FLR	LFR83617	GP-3675	FLR
LFP553404	GP-50 ³⁰	DON	LFP8316G	GP-3766 ¹⁰⁰	LUF	LFR83334	GP-38	FLR	LFR83620	GP-193	FLR
LFP553634	GP-34	DON	LFP832	GP-23	LUF	LFR83335	GP-58	FLR	LFR83624	GP-3985	FLR
LFP553712	GP-69	DON	LFP8507	GP-68	LUF	LFR83336	GP-40	FLR	LFR83625	GP-54 ¹¹	FLR
LFP553746	GP-67	DON	LFP8509	GP-1	LUF	LFR83337	GP-3531	EXP	LFR83625	GP-66 ¹⁰	FLR
LFP553871	GP-88	DON	LFP8537	GP-9	LUF	LFR83338	GP-3816	FLR	LFR83630	GP-562	FLR
LFP553925	G-926	DON	LFP8538	GP-9	LUF	LFR83339	GP-3600	FLR	LFR-83632	GP-359	FLR
LFP554004	GP-51	DON	LFP8590	GP-77	BWS	LFR83340	G-133	FLR	LFR83635	GP-57	FLR
LFP554005	GP-52 ¹¹⁰	DON	LFP8590	GP-77	LUF	LFR83340	G-989	FLR	LFR83638	GP-3985	FLR
LFP554005	GP-69 ⁴⁸	DON	LFP8591	GP-51	BWS	LFR83341	GP-81 ¹¹	FLR	LFR83640	GP-152	FLR
LFP554403	GP-1	DON	LFP8591	GP-51	LUF	LFR83341	GP-9 ⁵⁸	FLR	LFR83641	GP-67	FLR
LFP554408	GP-3600	DON	LFP8642	GP-556	LUF	LFR83342	GP-9586	FLR	LFR83644	GP-149	FLR
LFP554731	G-333	DON	LFP880	GP-10	APOL	LFR83344	GP-3766	FLR	LFR83649	GP-40	FLR
LFP555088	G-139	DON	LFP880	GP-10	CAM2	LFR83345	GP-390	FLR	LFR83653	GP-36	FLR
LFP555240	GP-36	DON	LFP880	GP-10	CHP	LFR83349	GP-178	FLR	LFR83655	GP-68	FLR
LFP555570	GP-9586	DON	LFP880	GP-10	LUF	LFR83350	G-133	FLR	LFR83659	GP-1	FLR
LFP555616	GP-69	DON	LFP880	GP-10	MASE	LFR83350	G-989	FLR	LFR83665	GP-36	FLR
LFP555680	GP-36	DON	LFP880	GP-10	WARN	LFR83351	G-163	FLR	LFR83666	GP-36	FLR
LFP5570	GP-9586	BWS	LFP9000	GP-9000	CHP	LFR83353	GP-1	FLR	LFR83671	GP-193	FLR
LFP5570	GP-9586	CHP	LFP9000	GP-9000	LUF	LFR83357	G-31	FLR	LFR83675	GP-51	FLR
LFP5570	GP-9586	LUF	LFP9001	GP-9001	CHP	LFR83360	GP-77	FLR	LFR83679	GP-205	FLR
LFP557202	GP-10	DON	LFP9001	GP-9001	LUF	LFR83374	GP-52 ¹¹⁰	FLR	LFR83681	GP-68	FLR
LFP557207	GP-10	DON	LFP9007	GP-9000	LUF	LFR83374	GP-691 ⁴⁸	FLR	LFR83682	GP-171	FLR
LFP557624	GP-54 ¹¹	DON	LFP9008	GP-9001	LUF	LFR83376	GP-171	FLR	LFR83690	GP-2951	FLR
LFP557624	GP-66 ¹⁰	DON	LFP911	GP-53	BWS	LFR83377	GP-81	FLR	LFR83691	GP-149	FLR
LFP558329	GP-35	DON	LFP911	GP-53	CHP	LFR83378	GP-81	FLR	LFR83692	GP-91	FLR
LFP558615	GP-178	DON	LFP911	GP-53	LUF	LFR83382	GP-10	FLR	LFR83703	GP-754	FLR
LFP558616	GP-390	DON	LFP925F	GP-1107	CHP	LFR83390	GP-14	FLR	LFR83706	GP-171	FLR
LFP566	G-566	LUF	LFP925F	GP-1107	LUF	LFR83391	G-31	FLR	LFR83729	GP-166 ⁶⁵	FLR
LFP5757	GP-754	LUF	LFP928F	GP-93	CHP	LFR83393	GP-88	FLR	LFR83729	GP-3937 ¹¹	FLR
LFP5822	GP-406	LUF	LFP928F	GP-93	LUF	LFR83400	GP-81	FLR	LFR83730	GP-51	FLR
LFP5823	GP-56	LUF	LFP936F	GP-92	CHP	LFR83401	GP-1	FLR	LFR83746	GP-642	FLR
LFP5964	GP-359	LUF	LFP936F	GP-92	LUF	LFR83402	GP-1	FLR	LFR83758	GP-22	FLR
LFP6015	GP-737	LUF	LFP943F	GP-1122	APOL	LFR83403	GP-149	FLR	LFR83766	GP-3816	FLR
LFP6228	GP-67	LUF	LFP943F	GP-1122	BWS	LFR83406	GP-51	FLR	LFR83776	GP-462	FLR
LFP6240	GP-36	LUF	LFP943F	GP-1122	CAM2	LFR83407	GP-3985	FLR	LFR83805	GP-390	FLR
LFP6241	GP-69	LUF	LFP943F	GP-1122	CENE	LFR83410	GP-57	FLR	LFR83806	GP-178	FLR
LFP637	G-297	LUF	LFP943F	GP-1122	CHP	LFR83415	GP-36	FLR	LFR83812	GP-462	FLR
LFP637	G-297-B	LUF	LFP943F	GP-1122	GRAN	LFR83417	GP-36	FLR	LFR83827	G-3827	FLR
LFP637F	G-297	LUF	LFP943F	GP-1122	LUF	LFR83420	GP-69	FLR	LFR83855	GP-58 ⁹	FLR
LFP637F	G-297-B	LUF	LFP943F	GP-1122	MASE	LFR83421	GP-69	FLR	LFR83883	GP-152	FLR
LFP670	GP-53	BWS	LFP943F	GP-1122	WARN	LFR83433	GP-3985	FLR	LFR83885	GP-178	FLR
LFP670	GP-53	CHP	LFP944F	GP-92	AIRT	LFR83434	GP-3682	FLR	LFR83914	G-3754	FLR
LFP670	GP-53	LUF	LFP944F	GP-92	APOL	LFR83435	GP-171	FLR	LFR83918	GP-642	FLR
LFP680	GP-53	CHP	LFP944F	GP-92	BWS	LFR83435	GP-9	FLR	LFR83919	GP-69	FLR
LFP680	GP-53	LUF	LFP944F	GP-92	CAM2	LFR83436	GP-51	FLR	LFR83921	GP-178	FLR
LFP7	GP-5	LUF	LFP944F	GP-92	CENE	LFR83443	GP-54	FLR	LFR83922	GP-390	FLR
LFP725	GP-34	LUF	LFP944F	GP-92	CHP	LFR83443SC	GP-54 ⁹⁰	FLR	LFR83932	GP-66	FLR
LFP734	GP-43	LUF	LFP944F	GP-92	GRAN	LFR83451	GP-310	FLR	LFR83933	GP-171	FLR
LFP777	GP-57	CHP	LFP944F	GP-92	LUF	LFR-83451	GP-3569	FLR	LFR83935	GP-178	FLR
LFP777	GP-57	LUF	LFP944F	GP-92	MASE	LFR83455	GP-88	FLR	LFR83937	GP-3937	FLR
LFP777A	GP-57	CHP	LFP944F	GP-92	MIGH	LFR83460	GP-58	FLR	LFR83945	GP-3675	FLR
LFP777A	GP-57	LUF	LFP944F	GP-92	WARN	LFR83462	GP-149	FLR	LFR83948	GP-156	FLR
LFP777B	GP-57	BWS	LFP950	GP-54	LUF	LFR83466	GP-171 ¹⁵	FLR	LFR83959	GP-178	FLR
LFP777B	GP-57	CHP	LFP959F	GP-85 ⁹⁰	BWS	LFR83470	GP-43	FLR	LFR83970	GP-3937	FLR
LFP777B	GP-57	LUF	LFP959F	GP-85 ⁹⁰	CHP	LFR83473	GP-68	FLR	LFR83972	GP-178	FLR
LFP780	GP-178	BWS	LFP959F	GP-85 ⁹⁰	LUF	LFR83476	GP-51	FLR	LFR83973	GP-51	FLR
LFP780	GP-178	CAM2	LFP959F	GP-85 ⁹⁰	LYS	LFR83477	GP-51	FLR	LFR84014	GP-3816	FLR
LFP780	GP-178	CHP	LFP966	GP-58	LUF	LFR83480	GP-9	FLR	LFR84015	GP-81	FLR
LFP780	GP-178	GRAN	LFP9811F	GP-155	AUTE	LFR83481	GP-9	FLR	LFR84016	GP-81	FLR
LFP780	GP-178	LUF	LFP9811F	GP-155	LEEM	LFR83486	GP-3980	FLR	LFR84017	GP-54	FLR
LFP780	GP-178	PARP	LFP9943F	GP-1122	AUTE	LFR83490	GP-490	FLR	LFR84031	G-833	FLR
LFP780	GP-178	SECU	LFP9944F	GP-92	AUTE	LFR83494	GP-40	FLR	LFR84054	GP-54	FLR
LFP780	GP-178	TIRP	LFP9944F	GP-92	LEEM	LFR83495	GP-58	FLR	LFR84056	GP-36	FLR
LFP780	GP-178	TRUS	LFR38691	GP-149	FLR	LFR83497	GP-54 ⁹⁰	FLR	LFR84112	GP-77	FLR
LFP780	GP-178	WARN	LFR63639	GP-3000	FLR	LFR83501	GP-81 ¹¹	FLR	LFR84143	G-225	FLR
LFP781	GP-54	CHP	LFR73703	GP-754	FLR	LFR83501	GP-9 ⁵⁸	FLR	LFR84145	G-163	FLR
LFP781	GP-54	LUF	LFR73752	GP-36	FLR	LFR83503	GP-1 ⁹	FLR	LFR84154	GP-54	FLR
LFP784	GP-3766	APOL	LFR73795	GP-81	FLR	LFR83505	GP-81	FLR	LFR8500	G-500	FLR
LFP784	GP-3766	BWS	LFR816011	GP-58 ⁹	FLR	LFR83521	G-834	FLR	LFR8504	G-31	FLR
LFP784	GP-3766	CAM2	LFR816109	GP-408	FLR	LFR83529	G-33	FLR	LFR8509	G-33	FLR
LFP784	GP-3766	CHP	LFR816115	GP-58	FLR	LFR83530	GP-1	FLR	LFR8509AN	G-33	FLR
LFP784	GP-3766	GRAN	LFR82344	GP-3766	FLR	LFR83532	GP-36	FLR	LFR8511	G-33	FLR
LFP784	GP-3766	LUF	LFR83000	GP-3000	FLR	LFR83536	GP-462	FLR	LFR8512	G-6	FLR
LFP784	GP-3766	MASE	LFR83000TP	GP-3000	FLR	LFR83537	GP-149	FLR	LFR8516	G-566	FLR
LFP784	GP-3766	SECU	LFR83306	GP-1	FLR	LFR83542	GP-57	FLR	LFR8519	G-238	FLR
LFP784	GP-3766	WARN	LFR83307	GP-69	FLR	LFR83545	GP-57	FLR	LFR8522	G-333	FLR
LFP791	GP-36 ³⁰	LUF	LFR83308	GP-50	FLR	LFR83548	GP-3000 ¹¹	FLR	LFR8525	G-119	FLR
LFP791	GP-66 ⁹⁴	LUF	LFR83310	GP-3816	FLR	LFR83550	GP-3682	FLR	LFR8540	G-31	FLR
LFP811F	GP-155	AIRT	LFR83311	GP-81	FLR	LFR83552	GP-178	FLR	LFR8550	G-5000	FLR
LFP811F	GP-155	APOL	LFR83313	GP-1	FLR	LFR83553	GP-390	FLR	LFR8551	GP-1	FLR
LFP811F	GP-155	BWS	LFR83314	GP-310	FLR	LFR83554	GP-3980	FLR	LFR8551A	GP-1	FLR
LFP811F	GP-155	CAM2	LFR83315	GP-68	FLR	LFR83559	GP-69	FLR	LFR8552	G-330	FLR
LFP811F	GP-155	CENE	LFR83316	GP-69	FLR	LFR83560	GP-69	FLR	LFR8553	G-200	FLR
LFP811F	GP-155	CHP	LFR83317	GP-35	FLR	LFR83567	GP-35	FLR	LFR8555	G-152	FLR
LFP811F	GP-155	GRAN	LFR83318	GP-34	FLR	LFR83568	GP-28 ⁹	FLR	LFR8558	G-191	FLR
LFP811F	GP-155	LUF	LFR83320	G-163	FLR	LFR83568	GP-430 ⁸	FLR	LFR8560	G-236	FLR
LFP811F	GP-155	MASE	LFR83321	GP-51	FLR	LFR83571	GP-54	FLR	LFR8563	G-335	FLR
LFP811F	GP-155	MIGH	LFR83322	G-926	FLR	LFR83583	GP-9	FLR	LFR8566	G-870	FLR
LFP811F	GP-155	WARN	LFR83324	GP-1	FLR	LFR83589	GP-57	FLR	LFR8572	G-31	FLR
LFP815F	GP-26	CHP	LFR83325	GP-53	FLR	LFR83591	GP-149	FLR	LFR8580	GP-81	FLR
LFP815F	GP-26	LUF	LFR83326	GP-57	FLR	LFR83599	GP-38	FLR	LFR8581	GP-5	FLR
LFP815FN	GP-26	LUF	LFR83327	G-143	FLR	LFR83604	GP-81	FLR	LFR8583	GP-3	FLR

REFERENCIA CRUZADA

Numero	Gonher	Fabricante	Numero	Gonher	Fabricante	Numero	Gonher	Fabricante	Numero	Gonher	Fabricante	
Number	Gonher	Manufacturer	Number	Gonher	Manufacturer	Number	Gonher	Manufacturer	Number	Gonher	Manufacturer	
LFR8587		G-139	FLR	LFW2010	GP-2071W	LYS	LG6	GG-20	LEE	LH316	G-871	GIS
LFR8594		G-871	FLR	LFW2055	GP-1013Q	CHP	LG6	GG-20	LEEM	LH321	G-330	GIS
LFR8595		G-225	FLR	LFW2055	GP-1013Q	LUF	LG6	GG-20	LUF	LH334	G-5000	GIS
LFR8596		G-813	FLR	LFW2126	GP-2126Q	LUF	LG751	GG-76	LEE	LH3387A	GP-46	LONF
LFR8598		G-834	FLR	LFW2127	GP-2127W	LUF	LG751	GG-76	LEEM	LH3429	GP-3429	LONF
LFR8599		G-836	FLR	LFW4013	GP-1013Q	CHP	LG752	GG-203	LEE	LH3531	GP-3531	EXP
LFR8603		G-222	FLR	LFW4013	GP-1013Q	LUF	LG752	GG-203	LEEM	LH3535	GP-3980	LONF
LFR8607		GP-50	FLR	LFW4016	GP-1011Q	CHP	LG800	GG-47	LEE	LH3600	GP-3600	LONF
LFR8613		G-613	FLR	LFW4016	GP-1011Q	LUF	LG803	GG-208	LEEM	LH3639	GP-38	LONF
LFR8630		G-331	FLR	LFW4018	GP-1011Q	CHP	LG8145	GG-79	LEE	LH381-2	G-33	GIS
LFR8632B		GP-14	FLR	LFW4018	GP-1011Q	LUF	LG8145	GG-79	LEEM	LH414	G-834	GIS
LFR8634		G-169	FLR	LFW4022	GP-2022W	LUF	LG8246	GG-94	LEE	LH42	G-162H	GIS
LFR8637		G-159	FLR	LFW4070	GP-2071W	LUF	LG8246	GG-94	LEEM	LH43	GP-81 ²¹	LONF
LFR8647		GP-20	FLR	LFW4071	GP-2071W	LUF	LG-8303	GG-220	LEE	LH43	GP-9 ⁹⁸	LONF
LFR8651		GP-3	FLR	LFW4072	GP-1010Q	CHP	LG8304	GG-243	LEE	LH43623	GA-39	IHCO
LFR8652		GP-34	FLR	LFW4072	GP-1010Q	LUF	LG8304	GG-243	LEEM	LH44	G-870	GIS
LFR8653		GP-13	FLR	LFW4073	GP-1011Q	LUF	LG8324	GG-187	LEE	LH4635	G-153	LUF
LFR8654		GP-36	FLR	LFW4074	GP-1012Q	LUF	LG8324	GG-187	LEEM	LH4636	G-122	LUF
LFR8655		GP-3600 ⁹⁸	FLR	LFW4422	GP-2022W	CHP	LG8335	GG-63	LEE	LH4636	G-338	LUF
LFR8655		GP-38 ⁹⁹	FLR	LFW4422	GP-2022W	LUF	LG8346	GG-184	LEE	LH489	G-133	GIS
LFR8667		GP-51	FLR	LFW4740	GP-2071W	LUF	LG8346	GG-184	LEEM	LH489	G-989	GIS
LFR8670		GP-53	FLR	LFW4744	GP-2071W	CHP	LG8361	GG-7018 ⁹⁸	LEE	LH61	G-6	GIS
LFR8670SC		GP-53	FLR	LFW4744	GP-2071W	LUF	LG8361	GG-7019 ⁹⁷	LEE	LH66	G-191	GIS
LFR8671		G-122	FLR	LFW4860	GP-2015W	CHP	LG8361	GG-7020 ¹⁴	LEE	LH70	G-31	GIS
LFR8671		G-338	FLR	LFW4860	GP-2015W	LUF	LG8367	GG-1872	LEE	LH78	G-33	GIS
LFR8673		GP-10	FLR	LFW5870	GP-1013Q	LUF	LG8368	GG-185	LEE	LH8	G-871	GIS
LFR8678		GP-14	FLR	LFW5875	GP-2108W	LUF	LG8389	GG-84	LEE	LH81	G-813	GIS
LFR8680		GP-34	FLR	LG1	GG-5	LUF	LG840	GG-42	LEE	LH82	G-834	GIS
LFR8681		GP-66	FLR	LG111-1	GG-20	LEE	LG840	GG-42	LEEM	LH8504	G-162H	LUF
LFR8689		GP-81 ³¹	FLR	LG111-5	GG-20	LEE	LG8477	GG-264	AUTE	LH8546	G-191	LUF
LFR8689		GP-9 ⁹⁸	FLR	LG1116A	GG-19	AUTE	LG8477	GG-264	LEE	LH8A	GP-1	LONF
LFR8690		GP-10 ⁹⁷	FLR	LG1116A	GG-19	LEEM	LG8477	GG-264	LEEM	LH8-BR	G-871	GIS
LFR8691		GP-52 ¹⁰	FLR	LG111-6A	GG-19	LEE	LG8482	GG-67	LEE	LH91-B	G-836	GIS
LFR8691		GP-691 ⁴⁸	FLR	LG119	GG-6	LEE	LG8482	GG-67	LEEM	LH1444	G-222	GIS
LFR8691A		GP-52 ¹⁰	FLR	LG120	GG-7	LEE	LG8485	GG-61	LEE	L1	G-6	CHRY
LFR8691A		GP-691 ⁴⁸	FLR	LG14	GG-1	ALFI	LG8485	GG-61	LEEM	L1584	G-1121	FISP
LFR8692		GP-23	FLR	LG14	GG-4	ALFI	LG8486	GG-65	LEE	L1586	G-1123	FISP
LFR8694		GP-69	FLR	LG14	GG-5	LUF	LG8486	GG-65	LEEM	L1600	G-1121	FISP
LFR8695		GP-67	FLR	LG1-4	GG-1	LEE	LG8490	GG-142	LEE	L1830	GA-44	FISP
LFR8697		GP-31	FLR	LG1-4	GG-4	LEE	LG8496	GG-30	LEE	L1830	GA-44	PUR
LFR8699		GP-31	FLR	LG16	GG-19	LUF	LG8499	GG-190	LEE	L1877	G-1173 ¹⁰⁸	PUR
LFR8700		GP-3600	FLR	LG20	GG-20	LPM	LG8499	GG-190	LEEM	L1967	G-871	PUR
LFR8701		GP-1	FLR	LG22	GG-123	LUF	LG8501	GG-181	LEE	L1989	G-871	PUR
LFR8702		GP-88	FLR	LG242	GG-76	LEEM	LG8502	GG-148	LEE	L1989B	G-871	PUR
LFR8706		GP-66	FLR	LG243	GG-196	LEE	LG8511	GG-160	LEE	L1990	G-870	FISP
LFR8708		GP-36	FLR	LG243	GG-196	LEEM	LG-8562	GG-256	LEE	L12354	GA-7	FISP
LFR8711		GP-46	FLR	LG252	GG-1	LEEM	LG-8562	GG-256	LEEM	L1256	G-33	PERM
LFR8714		G-153	FLR	LG252	GG-4	LEEM	LG8572	GG-146	LEE	L12687	GP-1	PUR
LFR8716		GP-24 ²⁶	FLR	LG-2906	GG-194	LEE	LG8573	GG-580	LEEM	L12768	GP-50	FISP
LFR8716		GP-46 ²⁴	FLR	LG2954	GG-208	LEE	LG8580	GG-581	LEEM	L12768	GP-50	PUR
LFR8719		GP-69	FLR	LG2954	GG-208	LEEM	LG-8586	GG-65	LEE	L1278	G-834	PERM
LFR8721		G-331	FLR	LG2990	GG-76	LEEM	LG8800	GG-47	AUTE	L12840	GP-50	FISP
LFR8729		G-238	FLR	LG3/8	GG-5	L	LEE	LEE	LEE	L12840	GP-50	PUR
LFR8733		GP-51	FLR	LG3/8	GG-5	L	LUF	LEEM	LEEM	L12914	GA-71	FISP
LFR8734		GP-43	FLR	LG341	GG-203	AUTE	LG-8903	GG-220	LEE	L12915	GA-71	FISP
LFR8739		GP-390 ⁹³	FLR	LG341	GG-203	LEE	LG8908	GG-251	LEE	L1302	G-143	PERM
LFR8740		G-191	FLR	LG341	GG-203	LEEM	LG8908	GG-251	LEEM	L1306	G-163	PERM
LFR8747		GP-53	FLR	LG342	GG-208	LEE	LG8930	GG-63	LEE	L13177	G-225	FISP
LFR8750		G-750	FLR	LG342	GG-208	LEEM	LG8930	GG-63	LEEM	L13298	GA-230	PUR
LFR8750A		G-750	FLR	LG38	GG-5	L	LEEM	LEE	LEE	L13298	GP-81	PUR
LFR8750B		G-750	FLR	LG394018	GA-6	JOND	LG8934	GG-226	LEEM	L13350	GP-22	PUR
LFR8750C		G-750	FLR	LG4041	GG-123	LEEM	LG8946	GG-246	LEE	L13550	GP-81	PUR
LFR8750D		G-750	FLR	LG404-1	GG-123	LEE	LG8947	GG-246	LEE	L13554	GP-81	PUR
LFR8750S		G-750	FLR	LG427	GG-6	LEE	LG8947	GG-246	LEEM	L13615	GP-50	PUR
LFR8760		GP-36	FLR	LG427	GG-6	LEEM	LG-8947	GG-408	LEE	L13620	G-1123	FISP
LFR8764		GP-81	FLR	LG427	GG-6	LUF	LG8952	GG-246	LEE	L13620	G-1123	PUR
LFR8766		GP-9586	FLR	LG441	GG-7	LEE	LG8956	GG-181	LEE	L13621	GP-171	PUR
LFR8767		GP-3429	FLR	LG441	GG-7	LUF	LG8956	GG-181	LEEM	L13626	GP-31	PUR
LFR8777		GP-57	FLR	LG461	GG-1	LEE	LG8957	GG-217	LEE	L13786	G-296	FISP
LFR8778		GP-50 ³⁰	FLR	LG461	GG-4	LEE	LG8957	GG-217	LEEM	L13786	G-296-B	FISP
LFR8780		GP-46	FLR	LG461	GG-1	LEEM	LG-8963	GG-39	LEE	L13855	GP-1	PUR
LFR8781		GP-38	FLR	LG461	GG-4	LEEM	LG-8972	GG-213	LEE	L13970	GP-81	FISP
LFR8782		GP-3980	FLR	LG466	GG-45	AUTE	LG8974	GG-185	LEE	L13970	GP-81	PUR
LFR8783		GP-46	FLR	LG466	GG-45	LEE	LG8974	GG-185	LEEM	L13991	GA-230	PUR
LFR8785		GP-28 ⁸	FLR	LG466	GG-45	LEEM	LG8975	GG-214	LEE	L13997	G-1163	PUR
LFR8785		GP-430 ⁸	FLR	LG470	GG-16	AUTE	LG8985	GG-215	LEE	L14117	GP-81	PUR
LFR8786		GP-50	FLR	LG470	GG-16	LEE	LG8985	GG-215	LEEM	L14128	GP-81	PUR
LFR8787		GP-31	FLR	LG471	GG-17	AUTE	LG8991	GG-246	LEE	L1578	G-871	FISP
LFR8788		GP-50	FLR	LG471	GG-17	LEE	LG8991	GG-246	LEEM	L1579	G-871	FISP
LFR8793		G-6	FLR	LG474	GG-8 ¹⁰³	LEE	LGN14	GG-1	LEE	L1F200	G-1173	LEE
LFR8795		GP-42	FLR	LG474	GG-8	L ⁸⁰	LEE	LEE	LEE	LK1011	GP-3816	APL
LFR8796		GP-44	FLR	LG475	GG-87	AUTE	LGN38	GG-5	L	LK1013	GP-46	APL
LFR8797		GP-54 ¹¹	FLR	LG475	GG-87	LEE	LH13	G-238	GIS	LK1015	GP-46	APL
LFR8797		GP-66 ¹⁰	FLR	LG475	GG-87	LEEM	LH13	GP-13	LONF	LK1016	GP-40	APL
LFR8798		GP-3985	FLR	LG4760	GG-240	LEE	LH16	GP-81	LONF	LK1020	GP-3600 ⁹⁸	APL
LFR89000		GP-3000	FLR	LG4760	GG-240	LEEM	LH25	GP-20	LONF	LK1020	GP-38 ⁹⁹	APL
LFR89001		GP-9001	FLR	LG481	GG-46	AUTE	LH2849A	GP-24 ²⁶	LONF	LK1022	GP-28 ⁶	APL
LFR89009		GP-3001	FLR	LG481	GG-46	LEE	LH2849A	GP-462 ²⁴	LONF	LK1022	GP-430 ⁸	APL
LFR89011		GP-9001	FLR	LG481	GG-46	LEEM	LH2850	GP-310	LONF	LK1028	GP-1122	APL
LFR89333		GP-53	FLR	LG483	GG-3728	AUTE	LH2856	GP-40 ⁹⁴	LONF	LK1051	GP-3600	APL
LFR89620		GP-193	FLR	LG483	GG-3728	LEE	LH2856	GP-91 ⁷⁸	LONF	LK1080	GP-462	APL
LFR89691		GP-52 ¹⁰	FLR	LG483	GG-3728	LEEM	LH2865A	GP-42	LONF	LK1081	GP-1122	APL
LFR89691		GP-691 ⁴⁸	FLR	LG491056	GP-58	JOND	LH2870A	GP-28 ⁶	LONF	LK1090	GP-58 ¹⁵	APL
LFR89691A		GP-52 ¹⁰	FLR	LG5	GAD-1	NISS	LH2870A	GP-430 ⁹	LONF	LK1142	GP-5	APL
LFR89691A		GP-691 ⁴⁸	FLR	LG578	GG-66	LEE	LH2951	GP-58	LONF	LK1143	GP-50	APL
LFS706		GP-157	TOKY	LG578	GG-66	LEEM	LH30	GP-3	LONF	LK1146	GP-3985	APL

Referencia Cruzada por Numero de Parte

Cross Reference by Part Number



Numero	Gonher	Fabricante	Numero	Gonher	Fabricante	Numero	Gonher	Fabricante	Numero	Gonher	Fabricante
Number	Gonher	Manufacturer	Number	Gonher	Manufacturer	Number	Gonher	Manufacturer	Number	Gonher	Manufacturer
LK1161		GP-1 APL	LK3579		GG-246 APL	LL847-80		GAK-16 PETI	LP30		G-331 LEDR
LK1162		GP-36 APL	LK3582		G-133 APL	LLM20006		GAK-16 WORT	LP30		G-331 LEE
LK1163		GP-68 APL	LK3582		G-989 APL	LM114		G-5000 LUF	LP30		GP-3 LPM
LK1164		GP-1122 APL	LK3588		GA-27112 APL	LM30		G-31 LUF	LP30		G-31 LUF
LK1172		GP-54 APL	LK3608		GA-2194 APL	LM66		G-31 LUF	LP323		G-870 GIS
LK1190		GP-42 APL	LK3615		GP-55 APL	LM71		G-31 LUF	LP331		G-331 LUF
LK1191		GP-40 APL	LK3616		G-295 APL	LO101		G-870 WAKO	LP335		G-335 LUF
LK1192		GP-3531 EXP APL	LK3617		GAK-16 APL	LO-1206K		GP-359 WAKO	LP346		G-331 LUF
LK1700		GG-1 APL	LK3626		GP-166 ¹⁰⁰ APL	LO121K		GP-3985 WAKO	LP43		G-1143 LUF
LK1700		GG-4 APL	LK3627		GA-589 APL	LO124K		GP-3985 WAKO	LP487		G-169 BWS
LK219		G-836 APL	LK3628		GA-588 APL	LO125K		GP-3985 WAKO	LP487		G-169 CHP
LK219A		G-836 APL	LK3656		GAWW-2 APL	LO1753		GP-1010Q SAAB	LP487		G-169 LUF
LK221		G-834 APL	LK3663		GA-2122 APL	LO176		GA-33 ¹¹² WISC	LP49		G-330 LUF
LK221A1		G-834 APL	LK3669		GA-372 APL	LO177		GA-33 ¹¹² GRAY	LP5005		G-159 CHP
LK26		G-870 APL	LK3671		GP-43 APL	LO177		GA-33 ¹¹² WISC	LP5005		G-159 LUF
LK276		G-813 APL	LK3679		G-1121F APL	LO189		GAK-16 WISC	LP5008		G-122 LUF
LK284		G-833 APL	LK3684		GG-5 L APL	LO191		GAK-16 GRAY	LP5008		G-338 LUF
LK292		G-238 APL	LK3685		GA-9334 APL	LO191		GAK-16 WISC	LP5015		GP-67 LUF
LK3008		GA-1285 APL	LK3687		GA-9045 APL	LO201		G-870 WAKO	LP52		G-870 LUF
LK3015		GA-6127 APL	LK3688		GA-1287 APL	LO202K		GP-171 WAKO	LP560		G-222 BWS
LK3027		GA-2006 APL	LK3689		GA-7716 APL	LO202K		GP-9 WAKO	LP560		G-222 LUF
LK3028		GA-356 APL	LK3690		GA-7360 APL	LO203K		GP-3682 WAKO	LP5600		G-870 LUF
LK3035		GA-229 APL	LK3701		GA-483 APL	LO207K		GP-38 WAKO	LP566		G-566 BWS
LK3036		GA-8047 APL	LK3705		GA-1008 APL	LO219K		GP-38 WAKO	LP566		G-566 CHP
LK3041		GA-5648 APL	LK3735		GAK-1532 APL	LO230K		GP-3682 WAKO	LP566		G-566 LUF
LK3051		GA-2740 APL	LK3737		GP-57 APL	LO320K		GP-3985 WAKO	LP613		G-613 BWS
LK3064		GAD-3 APL	LK3738		GP-53 APL	LO323K		GP-40 WAKO	LP613		G-613 CHP
LK3066		G-331 APL	LK3744		GG-76 APL	LO420K		GP-38 WAKO	LP613		G-613 LUF
LK3080		GA-200 APL	LK3745		GG-203 APL	LO425K		GP-2951 ⁶² WAKO	LP70V		G-836 BWS
LK3080		GP-58 APL	LK3752		GPP-1122 APL	LO425K		GP-58 ⁸⁴ WAKO	LP70V		G-836 LUF
LK3112		G-750 APL	LK3764		G-297-B APL	LO502		GP-58 ¹⁵ WAKO	LP71		G-31 LUF
LK3160		G-1163 APL	LK3837		GP-40 APL	LO707K		GP-42 WAKO	LP72		G-870 GIS
LK3186		G-1143 APL	LK3840		GP-58 APL	LO708		G-834 WAKO	LP72		G-834 LUF
LK3193		GP-54 ¹⁰ APL	LK3867		GP-3682 APL	LO720K		GP-24 ²⁶ WAKO	LP74		G-222 LUF
LK3193		GP-66 ¹¹ APL	LK438		G-152 APL	LO720K		GP-462 ²⁴ WAKO	LP76		G-236 LUF
LK3201		GP-1122 APL	LK460		G-222 APL	LO802		GP-81 WAKO	LP769		G-871 LUF
LK3205		GP-36 APL	LK481		G-33 APL	LO823K		GP-54 ¹¹ WAKO	LP771		G-871 LUF
LK3212		GP-10 APL	LK547		G-191 APL	LO823K		GP-66 ¹⁰ WAKO	LP772		G-813 LUF
LK3224		G-1121 APL	LK548		G-238 APL	LO911K		GP-3531 EXP WAKO	LP78		G-33 LEE
LK3232		GP-66 APL	LK565		G-613 APL	LP02P000043		GA-853R KOBL	LP75		G-33 LEE
LK3239		GP-1108 APL	LK615		G-5000 APL	LP114		G-5000 LUF	LP8		GP-1 LPM
LK3241		GP-38 APL	LK617		GA-71 APL	LP118		G-335 LEDR	LP815		G-163 CHP
LK3242		GPP-18 APL	LK629		G-296 APL	LP118		G-335 LEE	LP815		G-163 LUF
LK3244		GP-78 APL	LK629		G-296-B APL	LP11P00004S002		GA-853R KOBL	LP8556		G-833 LUF
LK3245		GP-3 APL	LK629Y		G-296 APL	LP129		G-6 LUF	LP8700		G-3827 LUF
LK3250		GPP-18 APL	LK629Y		G-296-B APL	LP132		G-33 APOL	LP8741		G-3754 LUF
LK3254		GP-69 APL	LK651		GA-18 APL	LP132		G-33 BWS	LPW-000010		G-984 LAND
LK3255		GP-26 APL	LK688		GA-39 APL	LP132		G-33 CAM2	LPW-100160		GP-453 ROVE
LK3256		GP-27 APL	LK689		G-566 APL	LP132		G-33 CHP	LPW100230		GP-455 LAND
LK3271		G-31 APL	LK699		GA-8 APL	LP132		G-33 GRAN	LPW-100230		GP-455 ROVE
LK3276		G-1121 APL	LK700		GA-360 APL	LP132		G-33 LUF	LR001247		GP-341 LAND
LK3277		G-1123 APL	LK71700		GG-1 APL	LP132		G-33 WARN	LR11		G-191 LEE
LK3297		GA-49 APL	LK71700		GG-4 APL	LP135		G-333 LEDR	LR12		G-139 LEDR
LK3299		GA-50 APL	LK75		G-871 APL	LP135		G-333 LEE	LR12		G-139 LEE
LK3313		GAWW-2 APL	LK751		GA-730 APL	LP141		G-200 LUF	LR135		G-333 LEE
LK3316		GAWW-4 APL	LK75A5		G-871 APL	LP147		G-119 BWS	LR15036		G-1175 ¹⁰⁸ LEE
LK3321		GAD-1 APL	LK77501		GP-52 ¹¹⁰ APL	LP147		G-119 CHP	LR150-6		G-1175 ¹⁰⁸ LEE
LK3335		GA-436 APL	LK77501		GP-691 ⁴⁸ APL	LP147		G-119 LUF	LR151-6		G-1173 ¹⁰⁸ LEE
LK3342		GA-277 APL	LK782		GA-230 APL	LP151		G-33 BWS	LR30		G-331 LEE
LK3358		G-834 APL	LK783		G-297-B APL	LP151		G-33 CHP	LR500		G-500 LEE
LK3394		G-162H APL	LK795		GA-106 ⁴⁶ APL	LP151		G-33 LUF	LR5X9FF		G-238 ROLK
LK3405		G-1173 ¹⁰⁸ APL	LK795		GA-326 ⁷¹ APL	LP16		GP-81 ¹¹ LPM	LR750		G-750 LEE
LK3406		G-1121 APL	LK81300		GP-110 APL	LP16		GP-9 ⁹⁸ LPM	LRQ5X9FF		G-238 ROLK
LK3409A		G-238 APL	LK81301		GP-1101 APL	LP161		G-191 BWS	LS105		GP-462 PFX
LK3410		G-335 APL	LK81302		GP-14 APL	LP161		G-191 CHP	LS115		GP-28 ⁶ PFX
LK3411		GP-14 APL	LK839		GA-405 APL	LP161		G-191 LUF	LS115		GP-430 ⁸ PFX
LK3414		GP-34 APL	LK847		GA-6129 APL	LP163		G-238 BWS	LS1229		GA-153 KRA
LK3415		G-1174 ¹⁰⁸ APL	LK849		GAK-20 APL	LP163		G-238 CHP	LS127		GP-46 PFX
LK3422		GA-33 ¹¹² APL	LK853		GA-27112 APL	LP163		G-238 LUF	LS127-10		GP-46 PFX
LK3424		GP-78 APL	LK856		GAK-403 APL	LP164		G-152 BWS	LS1275		GP-46 PFX
LK3428		G-143 APL	LK872		GG-48 APL	LP164		G-152 LUF	LS130		GP-81 ¹¹ PFX
LK3429		G-163 APL	LK97403		GP-51 APL	LP166		G-34 LUF	LS130		GP-9 ⁹⁸ PFX
LK3443		GA-303 APL	LK97500		GP-52 ¹¹⁰ APL	LP189		G-139 LUF	LS144		GP-1 PFX
LK3463		GA-3425 APL	LK97500		GP-691 ⁴⁸ APL	LP19		GP-1 LPM	LS152		GP-46 PFX
LK3466		GA-3490 APL	LL12694		GA-230 FISP	LP2		G-6 LUF	LS152-A		GP-46 PFX
LK3476		GA-4365 APL	LL1356-2		G-33 PETI	LP2016		G-3752 CHP	LS152-B		GP-46 PFX
LK3495		GP-84 APL	LL13786		G-296 FISP	LP2016		G-3752 LUF	LS154A		GP-31 PFX
LK3496		GP-53 APL	LL13786		G-296-B FISP	LP2016		G-3752 PARP	LS155		GP-3816 PFX
LK3503		GA-26 APL	LL1578		G-871 FISP	LP2017		G-3752 CHP	LS162		GP-3600 PFX
LK3504		GA-361 APL	LL1579		G-871 FISP	LP2017		G-3752 LUF	LS165		GP-1 PFX
LK3507		GA-206 APL	LL1676-FN		GA-26 ¹¹² BLDW	LP2017		G-3752 PARP	LS168		GP-14 PFX
LK3511		GA-892 APL	LL1884		GA-360 AGCH	LP2017		G-3752 WARN	LS169		GP-22 PFX
LK3524		GAK-625 APL	LL1884		GA-360 BLDW	LP2210		G-31 LUF	LS169B		GP-22 PFX
LK3530		GAK-216 APL	LL2326		GA-885 BLDW	LP2212		G-225 LUF	LS171		GP-1 PFX
LK3531		GA-416 APL	LL2360FN		GAK-1532 BLDW	LP2218		G-133 LUF	LS174		GP-50 PFX
LK3532		GAK-458 APL	LL2363		GA-879 BLDW	LP2218		G-989 LUF	LS188		GP-38 PFX
LK3533		GA-459 APL	LL2642		GA-642 BLDW	LP2228		G-133 LUF	LS194		GP-81 PFX
LK3537		GP-390 ⁹³ APL	LL2685		GA-1095 BLDW	LP2228		G-989 LUF	LS206		GP-46 PFX
LK3539		GP-2071W APL	LL4790		GA-27112 PETI	LP2234		GP-54 LUF	LS384		GP-58 PFX
LK3550		GAK-216 APL	LL847-144		GA-106 ⁴⁶ PETI	LP2235		G-143 LUF	LS410A		GP-81 PFX
LK3551		GA-416 APL	LL847-144		GA-326 ⁷¹ PETI	LP2236		G-31 LUF	LS410C		GP-81 PFX
LK3559		GA-4303 APL	LL847-161		GA-26 PETI	LP2254		G-926 BWS	LS414		GP-54 ¹¹ PFX
LK3565		GA-2740 APL	LL847-161		GA-26 PETI	LP2254		G-926 LUF	LS414		GP-66 ¹⁰ PFX
LK3567		GP-40 APL	LL847-51		GA-27112 PETI	LP238		G-333 LUF	LS427		GP-36 PFX
LK3572		GA-2719B APL	LL847-57		GA-27112 PETI	LP238		G-6 LUF	LS427A		GP-36 PFX
LK3578		GP-1122 APL	LL847-78		GAK-16 PETI	LP2508		GP-9 SKOD	LS451		GP-38 PFX

REFERENCIA CRUZADA

Para números Gonher con Superíndice vea página 651
For Gonher with Superscript numbers see page 651

Numero	Gonher	Fabricante	Numero	Gonher	Fabricante	Numero	Gonher	Fabricante	Numero	Gonher	Fabricante
Number	Gonher	Manufacturer	Number	Gonher	Manufacturer	Number	Gonher	Manufacturer	Number	Gonher	Manufacturer
LS451A	GP-38	PFX	LT93	GA-390	AMS	LTH-273A	GA-273	LTH	LTH-6619A	GA-6619 ⁵	LTH
LS454	GP-3600	PFX	LT98	GA-7017	AMS	LTH-274A	GA-274	LTH	LTH-6619A	GA-6620 ⁵	LTH
LS462	GP-40	PFX	LTH-1	GP-1	LTH	LTH-275A	GA-275	LTH	LTH-662	GP-461	LTH
LS462-A	GP-40	PFX	LTH-1000D	GPP-1000	LTH	LTH-276A	GA-276	LTH	LTH-66G	GG-66	LTH
LS468	GP-3985	PFX	LTH1010H	GP-2071W	LTH	LTH-277A	GA-277	LTH	LTH-67G	GG-67	LTH
LS468-A	GP-3985	PFX	LTH-1010H	GP-1010Q	LTH	LTH-279A	GA-279	LTH	LTH-68	GP-68	LTH
LS4798	GP-54 ¹¹	PFX	LTH1011H	GP-1011Q	LTH	LTH27D	GP-27	LTH	LTH-6811	GP-6811	LTH
LS4798	GP-66 ¹⁰	PFX	LTH-10133	GG-986	LTH	LTH-28	GP-28	LTH	LTH-7018G	GG-7018	LTH
LS479A	GP-54 ¹¹	PFX	LTH-10133G	GG-986	LTH	LTH-280A	GA-280	LTH	LTH-7019G	GG-7019	LTH
LS479A	GP-66 ¹⁰	PFX	LTH-102G	GG-102	LTH	LTH-288A	GA-288R	LTH	LTH-70A	GA-70	LTH
LS488	GP-42	PFX	LTH-104G	GG-104	LTH	LTH-290G	GG-290	LTH	LTH-71A	GA-71	LTH
LS490	GP-24	PFX	LTH-1051-G	GG-1992	LTH	LTH-291	GP-291	LTH	LTH-723AR	GA-723R	LTH
LS491	GP-38	PFX	LTH-1053G	GG-111	LTH	LTH-294A	GAD-294	LTH	LTH-7248G	GG-72	LTH
LS492	GP-38	PFX	LTH107A	GA-107	LTH	LTH2968D	G-296	LTH	LTH-72G	GG-72	LTH
LS494	GP-1	PFX	LTH-1089G	GG-246	LTH	LTH2968D	G-296-B	LTH	LTH-734A	GA-734 ⁸¹	LTH
LS497B	GP-54 ¹¹	PFX	LTH109A	GA-109	LTH	LTH2978D	G-297-B	LTH	LTH-74A	GA-74	LTH
LS497B	GP-66 ¹⁰	PFX	LTH-1101D	GP-1101	LTH	LTH-298G	GG-298	LTH	LTH750	G-750	LTH
LS503	G-191	PFX	LTH-1107D	GP-1107	LTH	LTH-29A	GAD-29	LTH	LTH-75A	GA-75	LTH
LS507	GP-81	PFX	LTH1108D	GP-1108	LTH	LTH-3	GP-3	LTH	LTH-768AR	GA-768R	LTH
LS581	GP-36	PFX	LTH1121D	G-1121	LTH	LTH3000	GP-3000	LTH	LTH-7764A	GA-172	LTH
LS582	GP-310	PFX	LTH-1121D	G-1121F	LTH	LTH-300A	GA-300	LTH	LTH-77A	GA-77	LTH
LS583	GP-54	PFX	LTH1123D	G-1123	LTH	LTH-302A	GA-302	LTH	LTH-80A	GA-80	LTH
LS702	GP-28 ⁸	PFX	LTH-1133DC	GC-1133	LTH	LTH-30A	GAD-30	LTH	LTH-81	GP-81	LTH
LS702	GP-430 ⁸	PFX	LTH-1133DC	GS-1133	LTH	LTH31	GP-31	LTH	LTH-8141-A	GA-1614	LTH
LS712	GP-54 ¹¹	PFX	LTH-1133-DS	GC-1133	LTH	LTH-32G	GG-32	LTH	LTH-82G	GG-82	LTH
LS712	GP-66 ¹⁰	PFX	LTH-1133-DS	GS-1133	LTH	LTH33	GG-33	LTH	LTH-84G	GG-84	LTH
LS712C	GP-54 ¹¹	PFX	LTH-1173-D	G-1173	LTH	LTH-334A	GA-334	LTH	LTH-8747A	GA-258	LTH
LS712C	GP-66 ¹⁰	PFX	LTH-1174-D	G-1174	LTH	LTH-3359-A	GA-234	LTH	LTH-8805A	GA-278R	LTH
LS713	GP-3682	PFX	LTH-1174DC	G-1174	LTH	LTH-3395A	GA-163	LTH	LTH88M	GP-88	LTH
LS716	GP-171	PFX	LTH-1175-D	G-1175	LTH	LTH-345-A	GA-3425	LTH	LTH88N	GP-88	LTH
LS718	GP-3531	EXPI	LTH-1175DC	G-1175	LTH	LTH-348A	GA-348	LTH	LTH-890AR	GA-890R	LTH
LS731	GP-58	PFX	LTH-117A	GAD-117	LTH	LTH-3506	GP-44	LTH	LTH-8969A	GA-168	LTH
LS738	GP-9	PFX	LTH11D	GP-110	LTH	LTH3551A	GA-3551 ⁵⁸	LTH	LTH-8997A	GA-224	LTH
LS743	GP-15	PFX	LTH-11D	GP-11	LTH	LTH3551A	GA-3551	XT ⁶⁴	LTH-8G	GG-8	LTH
LS767	GP-36	PFX	LTH-1206-A	GA-2159	LTH	LTH-3588A	GA-3588	LTH	LTH-8GL	GG-8 L	LTH
LS775	GP-81	PFX	LTH-1212D	GPP-11	LTH	LTH-3600	GP-3600	LTH	LTH-8LP	GG-170	LTH
LS776	GP-34	PFX	LTH-121A	GAWW-121	LTH	LTH-362A	GA-362	LTH	LTH-9	GP-9	LTH
LS778	GP-51	PFX	LTH-127A	GA-127	LTH	LTH-3682	GP-3682	LTH	LTH-9000	GP-9000	LTH
LS783	GP-77	PFX	LTH-128A	GA-128	LTH	LTH-37	GP-37	LTH	LTH-9001	GP-9001	LTH
LS785A	GP-68	PFX	LTH-129A	GA-129	LTH	LTH371A	GA-371	LTH	LTH-9054A	GA-248	LTH
LS805	GP-3	PFX	LTH-13	GP-13	LTH	LTH-3728G	GG-3728	LTH	LTH-92G	GG-92	LTH
LS812	GP-171	PFX	LTH-130A	GA-130	LTH	LTH373A	GA-373	LTH	LTH-930AR	GA-930R	LTH
LS815	GP-53	PFX	LTH-132A	GA-132	LTH	LTH376A	GA-376	LTH	LTH-94G	GG-94	LTH
LS816	GP-3985	PFX	LTH-134A	GA-134	LTH	LTH-377A	GA-377	LTH	LTH-95G	GG-95	LTH
LS818	GP-3985	PFX	LTH-134G	GG-265	LTH	LTH-3781AR	GA-967R	LTH	LTH-9601A	GA-281	LTH
LS830	GP-3682	PFX	LTH-135G	GG-267	LTH	LTH-38	GP-38	LTH	LTH-9620-A	GA-285	LTH
LS841	GP-51	PFX	LTH-137G	GG-137	LTH	LTH-388A	GA-388	LTH	LTH-966AR	GA-966R	LTH
LS842	GP-57	PFX	LTH143	G-143	LTH	LTH-3901A	GA-3901	LTH	LTH-986G	GG-986	LTH
LS846	GP-52 ¹⁰	PFX	LTH-149	GP-149	LTH	LTH-3916A	GA-3916	LTH	LTH-99G	GG-99	LTH
LS846	GP-691 ⁴⁸	PFX	LTH-152	GP-152	LTH	LTH-391A	GA-391	LTH	LTH-VW10A	GAVW-10	LTH
LS848	GP-43	PFX	LTH-153A	GA-153	LTH	LTH-3980	GP-3980	LTH	LTH-VW120A	GAVW-120	LTH
LS867B	GP-461	PFX	LTH-156	GP-156	LTH	LTH-39G	GG-39	LTH	LTH-VW121A	GAVW-121	LTH
LSB5035	GP-67	COO	LTH-15A	GAD-15	LTH	LTH-3A	GAD-3	LTH	LTH-VW212A	GAVW-212	LTH
LSB5110	GP-1	COO	LTH-1603A	GA-186	LTH	LTH-3G	GG-3	LTH	LTH-VW2A	GAVW-2	LTH
LSB5145	GP-57	COO	LTH-160G	GG-160	LTH	LTH-40	GP-40	LTH	LTH-VW4A	GAVW-4	LTH
LSB5164	GP-57	COO	LTH-1615A	GA-1615	LTH	LTH-419G	GG-419	LTH	LTH-VW620A	GAVW-620	LTH
LSF5001	GP-310	COO	LTH-1616A	GA-1616	LTH	LTH-41G	GG-41	LTH	LTH-VW621A	GAVW-621	LTH
LSF5003	GP-171	COO	LTH-161G	GG-161	LTH	LTH-429A	GA-429	LTH	LTH-VW623A	GAVW-623	LTH
LSF5007	GP-390	COO	LTH-164A	GA-164	LTH	LTH-42G	GG-42	LTH	LTH-VW625A	GAVW-625	LTH
LSF5014	GP-9	COO	LTH-165A	GA-165	LTH	LTH43	GP-43	LTH	LTH-VW626A	GAVW-626	LTH
LSF5015	GP-9586	COO	LTH-168G	GG-106	LTH	LTH-44	GP-44	LTH	LU5	G-834	ROMA
LSF5022	GP-9	COO	LTH-169G	GG-169	LTH	LTH-4494A	GA-314	LTH	LU500	G-500	MICP
LSF5024	GP-9	COO	LTH-174A	GA-174	LTH	LTH-45G	GG-45	LTH	LU750	G-750	MICP
LSF5035	GP-67	COO	LTH-176A	GA-176	LTH	LTH-46	GP-46	LTH	LU519	GP-28 ⁸	ROMA
LSF5036	GP-35	COO	LTH-179A	GA-179	LTH	LTH-46G	GG-46	LTH	LU519	GP-430 ⁸	ROMA
LSF5037	GP-88	COO	LTH-182G	GG-182	LTH	LTH-47G	GG-47	LTH	LU54005	GP-52 ¹¹⁰	ROMA
LSF5048	GP-390 ³	COO	LTH-1836A	GA-183R	LTH	LTH-48	GP-3980 ⁴⁴	LTH	LU54005	GP-691 ⁴⁸	ROMA
LSF5049	GP-54	COO	LTH-1872G	GG-1872	LTH	LTH-48	GP-48 ¹¹⁷	LTH	LU562	GP-54 ¹¹	ROMA
LSF5050	GP-77	COO	LTH-190G	GG-190	LTH	LTH-49A	GA-49	LTH	LU562	GP-66 ¹⁰	ROMA
LSF5051	GP-43	COO	LTH193	GP-193	LTH	LTH-4G	GG-1	LTH	LU56714AA	GP-54	ROMA
LSF5055	GP-14	COO	LTH-195G	GG-195	LTH	LTH-4G	GG-4	LTH	LVA10419	GP-761H	JOND
LSF5065	GP-3000	COO	LTH-197AR	GA-197R	LTH	LTH-5	GP-5	LTH	LVM4111	GP-54	AVLY
LSF5092	GP-68	COO	LTH-19G	GG-19	LTH	LTH-5056A	GA-5056	LTH	LVM4112	GP-36	AVLY
LSF5093	GP-58	COO	LTH-1G	GG-1	LTH	LTH-5078D	GP-78	LTH	LVM4113	GP-68	AVLY
LSF5097	GP-3766	COO	LTH-1G	GG-4	LTH	LTH-50A	GA-50	LTH	LVM4114	GP-406	AVLY
LSF5102	GP-81	COO	LTH-20	GP-20	LTH	LTH53CD	GP-53	LTH	LVM4115	GP-1122	AVLY
LSF5104	GP-54	COO	LTH-205	GP-205	LTH	LTH53DD	GP-53	LTH	LVM4116	G-296	AVLY
LSF5105	GP-36	COO	LTH209A	GA-209	LTH	LTH-54A	GA-54	LTH	LVM4116	G-296-B	AVLY
LSF5106	GP-51	COO	LTH210A	GA-210	LTH	LTH-5626-A	GA-289	LTH	LW691	GP-52 ¹¹⁰	KENW
LSF5112	GP-38	COO	LTH-212-G	GG-915	LTH	LTH-566	G-566	LTH	LW691	GP-691 ⁴⁸	KENW
LSF5121	GP-166	COO	LTH-214G	GG-214	LTH	LTH57	GP-57	LTH	LX 1451	GA-2184	MAHL
LSF5122	GP-406	COO	LTH-216A	GA-216	LTH	LTH-5724A	GA-291	LTH	LX 1586	GA-27161	KNE
LSF5126	GP-171	COO	LTH-217A	GA-217	LTH	LTH-58	GP-58	LTH	LX 1586	GA-27161	MAHL
LSF5132	GP-3816	COO	LTH21A	GA-21	LTH	LTH-583-A	GA-196	LTH	LX 384	GA-2160	KNE
LSF5133	GP-3600	COO	LTH-22	GP-22	LTH	LTH-59A	GA-59	LTH	LX 384	GA-2160	MAHL
LSF5139	GP-36	COO	LTH-221AR	GA-221R	LTH	LTH-5G	GG-5	LTH	LX 882	GA-410	KNE
LSF5140	GP-51	COO	LTH-237G	GG-237	LTH	LTH-601A	GAVW-624	LTH	LX 882	GA-410	MAHL
LSF5144	GP-36	COO	LTH-2404A	GA-490	LTH	LTH60D	GP-1107	LTH	LX1	GAD-1	KNE
LSF5146	GP-54	COO	LTH-2510-A	GA-281	LTH	LTH613	G-613	LTH	LX1	GAD-1	MAHL
LSF5148	GP-9	COO	LTH-251G	GG-251	LTH	LTH-61G	GG-61	LTH	LX10	GA-55	MAHL
LT10	GA-2740	AMS	LTH-252G	GG-252	LTH	LTH-620A	GAVW-620	LTH	LX1005	GA-415	MAHL
LT53	GA-140	AMS	LTH-253A	GA-253	LTH	LTH-62G	GG-62	LTH	LX105	GA-2110	KNE
LT59	GA-3566	AMS	LTH-25G	GG-25	LTH	LTH-63G	GG-63	LTH	LX1069	GA-516R	LEVE
LT60	GA-3445	AMS	LTH26D	GP-26	LTH	LTH-64G	GG-64	LTH	LX1069	GA-516R	MAHL
LT653	G-33	ACD	LTH-271A	GA-271	LTH	LTH-6566G	GG-65	LTH	LX111	GAVW-2</	

Numero	Gonher	Fabricante	Numero	Gonher	Fabricante	Numero	Gonher	Fabricante	Numero	Gonher	Fabricante
Number	Gonher	Manufacturer	Number	Gonher	Manufacturer	Number	Gonher	Manufacturer	Number	Gonher	Manufacturer
M-45	GP-178	ATL	MA 1010	GA-322	MNH	MA16050-4	GG-196	MIT	MA3592	GA-273	MOB
M454	GP-408	MIGH	MA 1028	GA-248	MNH	MA160PL	GA-70	MAR	MA3597	GA-735	MILE
M-46	GP-28 ⁸	ATL	MA 1030	GA-604	MNH	MA164	GA-2740	CLEN	MA36	GA-3523	MEI
M-46	GP-430 ⁸	ATL	MA 1033	GA-414R	MNH	MA169	GA-277	CLEN	MA3647	GA-3647	MILE
M4612	GP-91	MIGH	MA 1037	GA-490	MNH	MA17	GA-192	MEI	MA3660	GA-277	MILE
M4619	GP-3985	MXLU	MA 1042	GA-194	MNH	MA171	GAD-3	CLEN	MA3681	GA-3681	MILE
M4620	GP-149	MXLU	MA 1045	GA-514	MNH	MA173	GP-3980 ⁴⁸	MOB	MA37	GA-3588	MILE
M4622	GP-91	MIGH	MA 1047	GA-386	MNH	MA173	GP-48 ¹¹⁷	MOB	MA3717	GA-274	MILE
M4622	GP-91	MXLU	MA 1055	GA-384	MNH	MA176PL	GA-56	MAR	MA373	GP-3682	MOB
M4651	GP-68	MIGH	MA 1056	GAD-294	MNH	MA179	GAVW-2	CLEN	MA38	GA-3647	MEI
M4670	GP-81	MIGH	MA 1058	GA-183R	MNH	MA18	GA-303	MEI	MA381	GAVW-2	CLEN
M4675	GP-81	MIGH	MA 1063	GA-2719B	MNH	MA184	GA-77	MILE	MA381	GA-74	MILE
M4757	G-971	MIGH	MA 1071	GA-488	MNH	MA189	GA-50	MILE	MA3814	GA-3814	MILE
M4757	G-971	MXLU	MA 1074	GA-491	MNH	MA189PL	GA-50	MAR	MA384	GA-360	CLEN
M-48	GP-406	MIGH	MA 1080	GA-244	MNH	MA19	GA-100	MAR	MA386	GA-3490	CLEN
M-48	GP-42	ATL	MA 1081	GA-381	MNH	MA19	GA-730	MEI	MA389	GA-106 ⁴⁶	CLEN
M4872	GP-562	MIGH	MA 1083	GA-415	MNH	MA192	GA-192	MAR	MA389	GA-326 ⁷¹	CLEN
M4875	GP-171	MIGH	MA 1089	GA-216	MNH	MA192	GA-192	MILE	MA39	GA-4303	MEI
M49	GP-3	MIGH	MA 1094	GA-432	MNH	MA193	GP-40	MOB	MA3901	GA-3901	MILE
M-49	GP-462	ATL	MA 1095	GA-304	MNH	MA194	GP-58	MOB	MA3902	GA-253	MILE
M495P	GP-3	MIGH	MA 1097	GA-249	MNH	MA195	GP-3600	MOB	MA3915	GA-3915	MILE
M5	GP-81 ³¹	MEI	MA 1105	GA-597	MNH	MA2	GA-113	MEI	MA3916	GA-3916	MILE
M5	GP-9 ⁵⁸	MEI	MA 1108	GA-362	MNH	MA20	GAD-1 ⁹⁷	MEI	MA3924	GA-153	MILE
M5	GP-5	MIGH	MA 1113	GA-596	MNH	MA21	GAD-3	MEI	MA397	GA-71	CLEN
M50	GP-50	MIGH	MA 1116	GA-145	MNH	MA23	GA-3300	MEI	MA4	GA-78	MEI
M-51	GP-3531	EXP	MA 1144	GA-606	MNH	MA24	GA-3424	MEI	MA4	GA-70	MOB
M517	GP-67	CYC	MA 1174	GA-410	MNH	MA25	GA-3425	MEI	MA420	GA-405	CLEN
M5230	GP-128	MIGH	MA 1306	GA-2184	CLEN	MA27	GA-54	MEI	MA4278	GAD-15	MOB
M5247	G-954	MXLU	MA 440	GA-2160	CLEN	MA2719B	GA-2719B	MILE	MA43	GA-101	MEI
M5274	G-765	MXLU	MA 6891	GA-2160	MFIL	MA2740	GA-2740	MILE	MA4303	GA-4303	MILE
M5280	G-984	MXLU	MA 727	GA-410	CLEN	MA2825	GP-38	MOB	MA4309	GAD-15	MILE
M5288	GP-3675	MXLU	MA1	GA-100	MEI	MA29	GA-735	MEI	MA431	GA-24	CLEN
M-53	GP-310	ATL	MA1	GP-1	MOB	MA299	GAVW-2	MAR	MA4341	GA-231	MOB
M-53	GP-3569	ATL	MA10	GA-50	MEI	MA30	GAVW-2	MEI	MA4342	GA-253	MOB
M5309	G-45	MXLU	MA1002	GAVW-121	CLEN	MA300	GA-277	MAR	MA4343	GA-5056	MOB
M5313	GP-408	MXLU	MA1003	GA-348	MNH	MA303	GA-303	MAR	MA4347	GA-153	MOB
M5317	GP-457	MXLU	MA101	GP-81	MOB	MA303	GA-303	MILE	MA435	GAVW-4	CLEN
M5335	GP-178	MXLU	MA1012	GA-133	CLEN	MA305	GA-730	MAR	MA4356	GA-390	MOB
M5386	G-49	MXLU	MA1015	GA-471	CLEN	MA305	GA-730	MILE	MA4356	GA-390	MXLU
M-54	GP-58	ATL	MA1017	GA-300	MNH	MA306	GA-3445	LETR	MA4356	GA-390	SERP
M5436	G-49	MXLU	MA1018	GA-2114	CLEN	MA306	GA-3445	MAR	MA4357	GA-216	MXLU
M-55	GP-40	ATL	MA103	GAD-1	MOB	MA3080	GA-3445	MOB	MA4361	GA-139	MOB
M553683	GA-31	WHIT	MA1030US	GP-81 ³¹	MOB	MA309	GA-200	CLEN	MA4361	GA-139	MXLU
M559940	GA-27	WHIT	MA1030US	GP-9 ⁵⁸	MOB	MA309	GP-58	CLEN	MA4372	GA-3901	MOB
M564004	GA-24	MIGH	MA1041	GA-477	MNH	MA30A4000100	GP-149	CUB	MA4375	GA-362	MOB
M-57	GP-171	ATL	MA-105	GA-105	MOTX	MA31	GA-271	MEI	MA4375	GA-362	MXLU
M570863	GA-31	WHIT	MA1052	GA-184	MNH	MA3138	GA-54	MOB	MA4375	GA-362	SERP
M577	G-870	SOPA	MA1061	GAVW-621	CLEN	MA3149	GA-3523	MOB	MA4378	GA-174	MOB
M6	G-1174 ⁰⁸	FIAT	MA1066	GA-258	MNH	MA3192	GA-271	MOB	MA4392	GA-253	MOB
M6	G-200	MEI	MA1072	GA-217	CLEN	MA3193	GA-734 ⁸¹	MOB	MA446	GAVW-2	CLEN
M6	G-6	MIGH	MA11	GA-85	MEI	MA3193	GA-735 ¹²⁴	MOB	MA4468	GA-362	ASAH
M600L4110	G-31	CONT	MA11	GP-13	MOB	MA3195	GA-3588	MOB	MA4468	GA-195	MOB
M600L5010	G-31	CONT	MA1104	GA-2174	CLEN	MA32	GA-3490	MEI	MA4468	GA-195	MXLU
M600L5101	G-31	CONT	MA110A	GAD-3	MOB	MA324A	GA-85	MAR	MA4468	GA-195	SERP
M605111	G-1174 ⁰⁸	ALCH	MA111	GP-46	MOB	MA324A	GA-85	MILE	MA4471	GA-471	MXLU
M6150533	GPP-11	TERE	MA1115	GA-324	MNH	MA325	GA-325	MAR	MA4479	GA-6479	MOB
M-62	GP-171	ATL	MA1124	GA-2106	CLEN	MA325	GA-325	MILE	MA448	GAVW-2	CLEN
M-63	GP-3985	ATL	MA1126	GA-7344	CLEN	MA326	GA-59	MAR	MA4487	GA-382	MOB
M6330	G-131	CONT	MA1128	GAD-117	MNH	MA326	GA-59	MILE	MA4487	GA-382	MXLU
M-65	GP-3682	ATL	MA1128	GAD-17	MNH	MA327	GA-57	MAR	MA4487	GA-382	SERP
M-65	GP-37	ATL	MA113	GAVW-22	MOB	MA327	GA-57	MILE	MA45	GA-274	MEI
M-67	GP-6811	ATL	MA1134	GA-4303	MNH	MA33	GA-277	MEI	MA45	GA-77	MOB
M7	GP-38	MEI	MA1138	GA-7142	CLEN	MA33	GP-20	MOB	MA455	GAVW-2	CLEN
M7	GP-81	MIGH	MA1141	GA-4325	MNH	MA3300	GA-3300	MILE	MA4613	GA-142	MOB
M71	G-31	CHP	MA1145	GA-595	CLEN	MA3373	GAVW-2	MILE	MA4613	GA-142	MXLU
M73	GP-24 ²⁶	MIGH	MA1149	GAVW-2	MOB	MA3380	GA-3647	MOB	MA4625	GA-2106	MOB
M73	GP-462 ⁹⁴	MIGH	MA1161	GA-5466	CLEN	MA3384	GA-89	MOB	MA4625	GA-2106	MXLU
M77	GP-178	ATL	MA1169	GA-386	CLEN	MA3398	GA-3566	MOB	MA4625	GA-2106	SERP
M7822	G-31	ZETT	MA1186	GA-384	CLEN	MA330S	GP-20	MOB	MA4626	GA-6619 ¹	MOB
M-79	G-112	ATL	MA12	GA-59	MEI	MA330S	GP-205	MOB	MA4626	GA-6620 ⁵	MOB
M8	GP-46	MEI	MA120	GA-74	MOB	MA340A	GA-86	MILE	MA4626	GA-6619 ¹	MXLU
M801002	GP-462	JOND	MA121	GA-250	MOB	MA3424	GA-3424	MILE	MA4626	GA-6620 ⁵	MXLU
M801209	GP-149	JOND	MA124	GA-3300	MOB	MA3425	GA-3425	MILE	MA4626	GA-6619 ¹	SERP
M806418	GP-91	JOND	MA129	GA-3424	MOB	MA3436	GA-4365	MXLU	MA4626	GA-6620 ⁵	SERP
M81	GP-81 ³¹	MIGH	MA13	GA-57	MEI	MA345	GA-71	CLEN	MA463	GAK-20	ASAH
M81	GP-9 ⁵⁸	MIGH	MA131	GA-3425	MOB	MA3465	GA-277	MOB	MA4632	GA-275	MOB
M-81	GP-6811	ATL	MA133	GA-78	MILE	MA3466	GA-4828	MOB	MA4645	GA-6690	MOB
M8153	G-180	MIGH	MA136	GA-55	MAR	MA3472	GA-357	MOB	MA4645	GA-6690	MXLU
M8170	G-954	MIGH	MA136	GA-55	MILE	MA3474	GA-3681	MOB	MA4648	GA-133	MOB
M8174	GA-6127 ⁰⁸	CMI	MA1405	GA-483	CLEN	MA3490	GA-3490	MILE	MA4650	GA-604	MOB
M8174	GA-6129 ⁰⁴	CMI	MA1407	GA-7360	CLEN	MA3497	GA-75	MILE	MA4650	GA-604	MXLU
M8198	G-984	MIGH	MA141	G-200	MOB	MA35	GA-89	MEI	MA4650	GA-604	SERP
M8198	GP-81 ³¹	MIGH	MA1412	GA-853R	CLEN	MA35	GP-22	MOB	MA4656	GA-7017	MXLU
M8198	GP-9 ⁵⁸	MIGH	MA14149-1	GG-1	MIT	MA351	GA-75	MAR	MA4656	GA-7017	MXLU
M837	G-72	MIGH	MA14149-1	GG-4	MIT	MA351	GA-75	MILE	MA4656	GA-7017	SERP
M8445	G-975	MIGH	MA143	GAD-3	CLEN	MA352	GAD-1	MILE	MA4669	GAD-294	MOB
M846	G-112	MIGH	MA146PL	GA-71	MAR	MA3523	GA-3523	MILE	MA468	GA-4325	ASAH
M8812	G-963	MIGH	MA148PL	GA-80	MAR	MA353	GAD-3	MILE	MA4680	GA-386	MOB
M8812	G-963	MXLU	MA15	GA-86	MEI	MA3537	GA-54	MILE	MA4680	GA-386	MXLU
M9	GP-3429	MEI	MA15	GA-3490	MOB	MA3549	GA-89	MILE	MA4680	GA-386	SERP
M939	GG-48	JCBM	MA156	GA-2740	CLEN	MA3558	GA-2110	MXLU	MA4690	GA-322	MOB
M960	G-70	MIGH	MA157	GA-2719B	CLEN	MA3559	GA-271	MILE	MA4690	GA-322	MXLU
M977	GP-31	MIGH	MA16	GA-75	MEI	MA3566	GA-3566	MILE	MA4690	GA-322	SERP
M9A	GP-46	MEI	MA16	GA-2740	MOB	MA3588	GA-3588	MILE	MA47	GA-4828	MEI
MA 1001	GA-475	MNH	MA160	GA-4365	CLEN	MA3590	GA-3916	MOB	MA4712	GA-217	MOB
MA 1002	GA-165 ¹¹³	MNH	MA160	GA-70	MILE	MA3591	GA-3814	MOB	MA4715	GA-7142	MOB

Referencia Cruzada por Numero de Parte

Cross Reference by Part Number



Numero	Gonher	Fabricante	Numero	Gonher	Fabricante	Numero	Gonher	Fabricante	Numero	Gonher	Fabricante
Number	Gonher	Manufacturer	Number	Gonher	Manufacturer	Number	Gonher	Manufacturer	Number	Gonher	Manufacturer
MA4715	GA-7142	MXLU	MA5365	GA-8606	MOB	MA6688	GA-3425	CLEN	MAA3472	GA-274	MOB
MA4720	GA-7344	MOB	MA537	GA-436	CLEN	MA6688	GA-372	MFIL	MAA3588	GA-3588	MOB
MA4721	GA-198	MOB	MA5378	GA-240	MOB	MA6690	GA-49	MFIL	MAA3592	GA-273	MOB
MA4722	GA-5466	MOB	MA5396	GA-248	MOB	MA6690	GA-6690	MILE	MAA3660	GA-277	MOB
MA4722	GA-5466	MXLU	MA5397	GA-194	MOB	MA67	GA-192	MOB	MAA3717	GA-274	MOB
MA4722	GA-5466	SERP	MA54	GA-3814	MEI	MA6709	GA-360	MFIL	MAA4	GA-70	MOB
MA4727	GA-300	MOB	MA540	GA-18	CLEN	MA6719	GA-4365	MFIL	MAA4282	GAD-30	MOB
MA4731	GA-165 ¹¹³	MOB	MA5400	GA-413R	MOB	MA68	GP-68	MOB	MAA4325	GA-4325	MOB
MA4731	GA-165	MXLU	MA541	GAK-20	CLEN	MA6807	GA-386	MILE	MAA4342	GA-253	MOB
MA4731	GA-165	SERP	MA5414	GA-477	MOB	MA682	GAD-1	CLEN	MAA45	GA-77	MOB
MA475	GA-78	ASAH	MA5418	GA-395	MOB	MA684	GA-405	MFIL	MAA50	GA-89	MOB
MA4799	GA-381	MOB	MA542	GAK-625	CLEN	MA698	GA-2740	MFIL	MAA5056	GA-5056	MOB
MA4799	GA-381	MXLU	MA543	GAK-403	CLEN	MA7	GA-70	MFIL	MAA5058	GA-273	MOB
MA48	G-6	MOB	MA5432	GA-264	MOB	MA70	GA-4303	MOB	MAA52	GA-71	MOB
MA4819	GA-141	MOB	MA5433	GA-414R	MOB	MA7017	GA-7017	MILE	MAA57	GA-80	MOB
MA4828	GA-4828	MILE	MA544	GAK-16	CLEN	MA707	GA-6127	CLEN	MAA59	GA-50	MOB
MA4831	GAD-118	MOB	MA5446	GA-780	MOB	MA7094	GA-604	MILE	MAA6491	GA-129	MOB
MA4831	GAD-118	MXLU	MA546	GA-892	CLEN	MA710	GA-18	CLEN	MAA6555	GA-275	MOB
MA4831	GAD-118	SERP	MA5462	GA-490	MOB	MA7142	GA-7142	MILE	MAA6576	GA-276	MOB
MA4832	GA-432	MOB	MA5463	GA-263	MOB	MA7174	GA-381	MILE	MAA67	GA-192	MOB
MA4852	GA-392	MOB	MA5466	GA-5466	MILE	MA722	GA-5648	CLEN	MAA68	GA-78	MOB
MA4858	GA-127	MOB	MA5489	GA-158	MOB	MA724	GA-27	CLEN	MAA6900	GAD-117	MOB
MA4873	GA-514	MOB	MA55	GA-5056	MEI	MA73	GP-37	MOB	MAA6900	GAD-17	MOB
MA4873	GA-514	MXLU	MA55	GA-55	MOTX	MA730	GA-6129	CLEN	MAA7007	GA-7007	MOB
MA4873	GA-514	SERP	MA5503	GA-138	MOB	MA7344	GA-7344	MILE	MAA71	GA-734 ¹²¹	MOB
MA4877	GA-175	MOB	MA5507	GA-269	MOB	MA735	GA-54	MAR	MAA71	GA-735 ¹²⁴	MOB
MA4878	GA-1615	MOB	MA5512	GA-488	MOB	MA7351	GA-322	MILE	MAA74	GA-55	MOB
MA4879	GA-1616	MOB	MA5528	GA-1617	MOB	MA7365	GA-217	MILE	MAA83	GA-85	MOB
MA4880	GA-1614	MOB	MA553	GA-416	CLEN	MA73R	GP-22	MOB	MAA84	GA-730	MOB
MA49	GP-3	MOB	MA554	GAK-216	CLEN	MA74	GA-55	MOB	MAA90	GA-303	MOB
MA4939	GA-139	MILE	MA555	GA-206	CLEN	MA7414	GA-141	MILE	MAA91	GA-59	MOB
MA495	GA-3490	ASAH	MA5556	GA-415	MOB	MA7420	GA-514	MILE	MAA92	GA-57	MOB
MA4995	GAVW-121	MOB	MA5560	GA-289	MOB	MA7421	GA-165	MILE	MAA99	GA-86	MOB
MA5	GA-55	MEI	MA5569	GA-1571	SERP	MA7426	GA-432	MILE	MAF 3566	GA-3566	MECC
MA5	GAK-403	MICF	MA557	GA-229	CLEN	MA7432	GA-132	MILE	MAF 3621	GA-140	MECC
MA501	GA-8047	CLEN	MA5578	GA-380	MOB	MA7440	GA-300	MILE	MAF 4958	GA-4958	MECC
MA502	GA-1285	CLEN	MA5595	GA-595	MILE	MA747	GA-517R	CLEN	MAF 6305	GA-390	MECC
MA503	GA-9334	CLEN	MA56	GA-174	MEI	MA753	GA-375	CLEN	MAF110	GA-349	MECC
MA504	GA-1286	CLEN	MA563	GAK-403	CLEN	MA7597	GA-164	MILE	MAF113	GA-75	MECC
MA5042	GA-442	MOB	MA5633	GA-1540	SERP	MA76	G-236	MOB	MAF113	GA-75	MOB
MA5042	GA-442	MXLU	MA5634	GA-492	SERP	MA7628	GAD-118	MILE	MAF113	GA-75	ROAD
MA5042	GA-442	SERP	MA5642	GA-437	SERP	MA7640	GA-240	MILE	MAF120	GA-74	MECC
MA5043	GAVW-620	MXLU	MA567	GA-467	CLEN	MA7730	GA-175	MILE	MAF120	GA-74	ROAD
MA5047	GA-240	MXLU	MA5670	GA-143	SERP	MA7774	GA-1616	MILE	MAF124	GA-3300	MECC
MA5048	GA-132	MOB	MA5671	GA-149	SERP	MA778	GA-467	CLEN	MAF124	GA-3300	MOB
MA5049	GA-595	MOB	MA568	GA-361	CLEN	MA8	GA-56	MEI	MAF124	GA-3300	ROAD
MA5049	GA-595	MXLU	MA569	GAK-403	CLEN	MA8	GA-26 ¹¹²	MICF	MAF129	GA-3424	MECC
MA505	GA-1287	CLEN	MA5699	GA-1542	SERP	MA80	GA-80	MOTX	MAF129	GA-3424	ROAD
MA5050	GA-605	MXLU	MA57	GA-6479	MEI	MA8038	GA-673R	MILE	MAF131	GA-3425	MECC
MA5056	GA-5056	MILE	MA5700	GA-1546	SERP	MA8039	GA-1615	MILE	MAF131	GA-3425	ROAD
MA5058	GA-273	MILE	MA5701	GA-1529	SERP	MA8040	GA-384	MILE	MAF133	GA-230	MECC
MA506	GA-9045	CLEN	MA5703	GA-1530	SERP	MA81	GP-9	MOB	MAF136	GA-55	MECC
MA507	GA-1008	CLEN	MA571	GAD-1	ASAH	MA8141	GA-1614	MILE	MAF148	GA-80	MECC
MA5076	GA-476	MXLU	MA572	GA-2740	ASAH	MA8142	GA-130	MILE	MAF160	GA-70	MECC
MA508	GA-1284	CLEN	MA573	GA-356	CLEN	MA8243	GA-158	MILE	MAF184	GA-77	MECC
MA5089	GA-301	MOB	MA575	GA-85	MOB	MA831	GA-85	MOB	MAF189	GA-50	MECC
MA5089	GA-301	MXLU	MA582	GAK-458	CLEN	MA84	GA-730	MOB	MAF192	GA-192	MECC
MA5089	GA-301	SERP	MA584	GA-3300	MAR	MA8609	GA-165 ¹¹³	MILE	MAF2318	GA-429	MECC
MA5090	GA-673R	MOB	MA588	GA-471	ASAH	MA88	GA-113	MAR	MAF2318	GA-429	ROAD
MA5091	GA-732R	MXLU	MA588	GA-33	CLEN	MA89	GP-28	MOB	MAF2719B	GA-2719B	MECC
MA51	GA-153	MEI	MA59	GA-50	MOB	MA8925	GA-780	MILE	MAF2740	GA-2740	MECC
MA510	GA-49	CLEN	MA595	GA-4303	CLEN	MA9	GA-77	MEI	MAF305	GA-730	MECC
MA5148	GA-384	MOB	MA596	GA-390	CLEN	MA90	GA-303	MOB	MAF-3080	GA-3445	MECC
MA5148	GA-384	MXLU	MA5US	GP-5	MOB	MA9054	GA-248	MILE	MAF31	GA-56	MOB
MA5148	GA-384	SERP	MA6	GA-71	MEI	MA91	GA-59	MOB	MAF3138	GA-54	MECC
MA5150	GA-172	MOB	MA601	GA-735	MAR	MA92	GA-57	MOB	MAF3138	GA-54	ROAD
MA5155	GA-130	MOB	MA602	GA-271	MAR	MA93	GA-325	MOB	MAF3149	GA-3523	MECC
MA516	GA-98 ¹¹²	CLEN	MA606	GAD-15	CLEN	MA991	GA-86	MOB	MAF3149	GA-3523	ROAD
MA5192	GA-158	MOB	MA6067	GA-1614	MOB	MAA-0031	GA-56	MOB	MAF3182	GA-55	MECC
MA52	GA-3916	MEI	MA6067	GA-1614	MXLU	MAA1	GA-71	MOB	MAF3182	GA-55	ROAD
MA52	GA-71	MOB	MA6067	GA-1614	SERP	MAA10	GA-73	MOB	MAF3192	GA-271	MECC
MA5219	GA-244	MOB	MA620	GAD-1	MFIL	MAA103	GA-50	MOB	MAF3192	GA-271	ROAD
MA5219	GA-244	MXLU	MA621	GA-3490	CLEN	MAA113	GA-75	MOB	MAF3193	GA-735	MECC
MA5227	GA-279	MOB	MA627	GA-71	MFIL	MAA1149	GAVW-2	MOB	MAF3193	GA-735	ROAD
MA5227	GA-279	MXLU	MA6305	GA-390	MILE	MAA1153	GAVW-4	MOB	MAF3195	GA-3588	MECC
MA5244	GA-607	MOB	MA633	GA-230	MFIL	MAA120	GA-74	MOB	MAF3195	GA-3588	ROAD
MA5244	GA-607	MXLU	MA6333	GA-382	MILE	MAA124	GA-2719B	MOB	MAF3197	GA-154	ROAD
MA5248	GA-163	MOB	MA6362	GA-362	MILE	MAA131	GA-3425	MOB	MAF3199	GA-70	ROAD
MA5249	GA-170	MOB	MA6366	GA-174	MILE	MAA16546	GAD-1	MOB	MAF324A	GA-85	MECC
MA5265	GA-8606	MOB	MA6376	GA-142	MILE	MAA16546C	GAD-3	MOB	MAF325	GA-325	MECC
MA5267	GAVW-621	MOB	MA6395	GA-195	MILE	MAA187	GA-90	MOB	MAF326	GA-59	MECC
MA5272	GA-472	MOB	MA640	GA-2194	CLEN	MAA2069	GA-6619 ⁵	MOB	MAF327	GA-57	MECC
MA5290	GA-1616	MOB	MA645	GAVW-120	CLEN	MAA2069	GA-6620 ⁵	MOB	MAF3300	GA-3300	MECC
MA5291	GA-780	MOB	MA646	GAD-15	CLEN	MAA2318	GA-429	MOB	MAF3357	GA-3681	ROAD
MA5291	GA-780	MXLU	MA6479	GA-679	MILE	MAA29R	GA-200	MOB	MAF3358	GA-3637	ROAD
MA52A	G-870	MOB	MA655	GA-166	CLEN	MAA3138	GA-54	MOB	MAF3373	GAVW-2	MECC
MA53	GA-273	MEI	MA655	GAD-3	MFIL	MAA3149	GA-153	MOB	MAF3380	GA-3647	ROAD
MA5301	GA-479	MOB	MA6555	GA-275	MILE	MAA3150	GA-253	MOB	MAF3384	GA-89	ROAD
MA5305	GA-286	MOB	MA6558	GA-2106	MILE	MAA3191	GA-272	MOB	MAF340A	GA-86	MECC
MA5306	GA-278R	MOB	MA657	GA-2110	CLEN	MAA3192	GA-271	MOB	MAF3424	GA-3424	MECC
MA5314	GA-348	MOB	MA6602	GA-200	MFIL	MAA3193	GA-735 ¹²⁴	MOB	MAF3425	GA-3425	MECC
MA5314	GA-348	SERP	MA6602	GP-58	MFIL	MAA3195	GA-3588	MOB	MAF3463	GA-230	ROAD
MA5323	GA-224	MOB	MA6618	GA-436	MFIL	MAA3195	GA-89	MOB	MAF3464	GA-77	ROAD
MA5324	GA-168	MOB	MA6670	GAD-3	MFIL	MAA3197	GA-154	MOB	MAF3467	GA-4325	ROAD
MA5330	GA-6479 ⁹⁰	MOB	MA6673	GAVW-2	MFIL	MAA3380	GA-3647	MOB	MAF3473	GA-85	ROAD
MA5352	GA-183	MXLU	MA6675	GA-3490	MFIL	MAA3463	GA-230	MOB	MAF3474	GA-3681	ROAD

REFERENCIA CRUZADA

Para números Gonher con Superíndice vea página 651
For Gonher with Superscript numbers see page 651

Numero	Gonher	Fabricante	Numero	Gonher	Fabricante	Numero	Gonher	Fabricante	Numero	Gonher	Fabricante
Number	Gonher	Manufacturer	Number	Gonher	Manufacturer	Number	Gonher	Manufacturer	Number	Gonher	Manufacturer
MAF3475		GAD-1 ⁸⁷ ROAD	MAP6817		GA-2194 MFIL	MC750		G-750 MOB	MD136790		GP-91 MITS
MAF3490		GA-3490 MECC	MAP6818		GA-277 MFIL	MC78		G-33 MOB	MD139		G-870 ALCO
MAF351		GA-75 MECC	MAR8502V		GA-595 MICF	MC78FM		G-33 MOB	MD141		G-1121 ALCO
MAF3523		GA-3523 MECC	MAT6632		GA-18 MFIL	MCA42DN		GA-21 MOB	MD141-1		G-1121F ALCO
MAF353		GAD-3 MECC	MAT6690		GA-49 MFIL	MCAAG602		GP-91 MZDA	MD145		GG-5 L ALCO
MAF3537		GA-54 MECC	MAT6709		GA-360 MFIL	MCC111-5		GG-20 MOB	MD152K		GA-33 ALCO
MAF3549		GA-89 MECC	MAT684		GA-405 MFIL	MCC-15		GP-1101 MOB	MD162326		GP-462 MITS
MAF3559		GA-271 MECC	MB001477-3301		GG-3 CHRY	MCC-150-3		GC-1133 MOB	MD168		GA-85 ALCO
MAF3588		GA-3588 MECC	MB001477-3301		GG-3 MITS	MCC150-3F		GC-1133 MOB	MD173		G-6 ALCO
MAF3597		GA-735 MECC	MB025679		GG-196 MITS	MCC-151-6		G-1173 MOB	MD175		G-143 ALCO
MAF3660		GA-277 MECC	MB052676		GG-196 CHRY	MCC2020		GS-2033 MOB	MD185		G-163 ALCO
MAF3681		GA-3681 MECC	MB052676		GG-196 MITS	MCC23-1		GP-11 MOB	MD192K		GAK-16 ALCO
MAF3717		GA-274 MECC	MB129591		GG-196 CHRY	MCC23-2		GPP-11 MOB	MD195		G-297 ALCO
MAF381		GA-74 MECC	MB129591		GG-196 MITS	MCC-59		G-1174 MOB	MD195		G-297-B ALCO
MAF3814		GA-3814 MECC	MB129591		GG-196 MOP	MCF0020		GP-1 CATP	MD204		GA-2740 ALCO
MAF3915		GA-3915 MECC	MB134953		GP-91 MITS	MCF19		GA-100 MECC	MD212		GA-27198 ALCO
MAF3916		GA-3916 MECC	MB1992366		GPP-18 BARH	MCF3642		GA-101 MECC	MD21490		G-6 MURY
MAF3924		GA-153 MECC	MB2		GG-45 CLEN	MCF41FM		G-566 MOB	MD215		G-162H ALCO
MAF4		GA-70 MEDC	MB220900		GPP-111 CHRY	MCOUGH378		GAK-16 SCHM	MD218K		GAK-20 ALCO
MAF4		GA-70 MOB	MB220900		GPP-524 CHRY	MD001		G-834 ALCO	MD220		GA-24 ALCO
MAF4		GA-70 ROAD	MB-348127		GG-114 MITS	MD001445		GP-3985 CHRY	MD222		GA-106 ⁶⁶ ALCO
MAF4303		GA-4303 MECC	MB3912		GP-1012Q MOB	MD001445		GP-3985 HYUN	MD222		GA-326 ⁷¹ ALCO
MAF4325		GA-4325 MECC	MB504738		GG-232 CHRY	MD001445		GP-3985 MITS	MD224		GA-360 ALCO
MAF45		GA-77 MEDC	MB504738		GG-232 MITS	MD003		G-801 ALCO	MD225		G-222 ALCO
MAF45		GA-77 MOB	MB504746		GG-185 CHRY	MD004049		GP-3985 MITS	MD2302		GA-8 ALCO
MAF45		GA-77 ROAD	MB504746		GG-185 MITS	MD005445		GP-3985 CHRY	MD23352		GA-26 MURY
MAF4828		GA-4828 MECC	MB504753		GG-185 CHRY	MD005445		GP-3985 MITS	MD23353		GA-27 MURY
MAF4830		GA-180 MECC	MB504753		GG-185 MITS	MD005450		GP-3985 CHRY	MD23693		GA-24 MURY
MAF50		GA-90 ROAD	MB504756		GG-185 CHRY	MD005450		GP-3985 CLRK	MD238		GA-405 ALCO
MAF5056		GA-5056 MECC	MB504758		GG-232 MITS	MD005450		GP-3985 MITS	MD23965		GA-26 MURY
MAF5058		GA-273 MECC	MB504759		GG-185 CHRY	MD007360		GP-40 MITS	MD24029		GA-26 MURY
MAF52		GA-71 MEDC	MB504759		GG-185 MITS	MD009		G-870 ALCO	MD253		G-238 ALCO
MAF52		GA-71 MOB	MB504760		GG-185 CHRY	MD011		G-833 ALCO	MD259		G-133 ALCO
MAF52		GA-71 ROAD	MB504760		GG-185 MITS	MD013		G-813 ALCO	MD259		G-989 ALCO
MAF526		GA-200 MASE	MB504761		GG-185 CHRY	MD014450		GP-3985 MITS	MD268		GA-3490 ALCO
MAF526		GP-58 MASE	MB504761		GG-185 MITS	MD017440		GP-91 CHRY	MD26814		GA-356 MURY
MAF527		GA-71 MASE	MB504762		GG-185 CHRY	MD017440		GP-91 MITS	MD290		GA-6129 ALCO
MAF564		GAVW-2 MASE	MB504762		GG-185 MITS	MD019		G-836 ALCO	MD3018055		GP-40 CHRY
MAF57		GA-80 MEDC	MB504764		GG-185 CHRY	MD024		GA-230 ALCO	MD302		GA-8 ALCO
MAF57		GA-80 MOB	MB504764		GG-185 MITS	MD027		G-225 ALCO	MD308302		GP-81 CHRY
MAF57		GA-80 ROAD	MB504766		GG-185 CHRY	MD027A		G-225 ALCO	MD308302		GP-81 MITS
MAF573		GAD-3 MASE	MB504766		GG-185 MITS	MD027B		G-225 ALCO	MD320K		GA-98 ¹¹² ALCO
MAF581		GA-230 MASE	MB554970		GG-1 MITS	MD027C		G-225 ALCO	MD321589		GP-145 MITS
MAF59		GA-50 MEDC	MB554970		GG-4 MITS	MD030795		GP-40 CHRY	MD325714		GP-149 MITS
MAF59		GA-50 MOB	MB620598		GP-81 MITS	MD030795		GP-40 MITS	MD352		GA-9045 ALCO
MAF59		GA-50 ROAD	MB658684		GG-185 CHRY	MD031805		GP-40 CHRY	MD352626		GP-6811 MITS
MAF615		GAD-1 MASE	MB658684		GG-185 MITS	MD031805		GP-40 MITS	MD352626		GP-91 MITS
MAF617		GA-3425 MASE	MB658689		GG-185 CHRY	MD039		G-613 ALCO	MD352627		GP-145 MITS
MAF619		GAVW-4 MASE	MB658689		GG-185 MITS	MD049		G-191 ALCO	MD356000		GP-91 MITS
MAF644		GA-277 MASE	MB6598903		GP-761H BARH	MD050		GA-70 ALCO	MD357		G-25 ALCO
MAF648		GA-2740 MASE	MB868451		GG-185 CHRY	MD052676		GG-196 MITS	MD360		GA-9334 ALCO
MAF67		GA-192 MEDC	MB868451		GG-185 MITS	MD053		G-801 ALCO	MD360935		GP-149 MITS
MAF67		GA-192 MOB	MB868452		GG-185 CHRY	MD061		G-870 ALCO	MD368		GA-78 ALCO
MAF67		GA-192 ROAD	MB868452		GG-185 MITS	MD0643446		GAK-16 MITS	MD372		GA-6127 ALCO
MAF68		GA-78 MOB	MB868457		GG-185 CHRY	MD071462		GP-40 MITS	MD38-15		GAK-20 MURY
MAF680		GAVW-2 MASE	MB868457		GG-185 MITS	MD071462A		GP-40 MITS	MD38-17		GA-27 MURY
MAF682		GA-2194 MASE	MB906051		GA-7344 CHRY	MD076		GA-200 ALCO	MD38-18		GAK-20 MURY
MAF74		GA-55 MEDC	MB906051		GA-7344 MITS	MD076		GP-58 ALCO	MD38-20		GA-27 MURY
MAF74		GA-55 MOB	MBE1254		GP-171 RANS	MD081		G-5000 ALCO	MD38-23		GA-24 MURY
MAF74		GA-55 ROAD	MBNA004		GG-203 CLEN	MD084693		GP-40 CHRY	MD38-37		GA-27 MURY
MAF749		GA-49 MASE	MBNA012		GG-196 CLEN	MD084693		GP-40 MITS	MD384		GA-2122 ALCO
MAF83		GA-85 MEDC	MBNA049		GG-187 CLEN	MD089		GP-81 ALCO	MD38-40		GA-27 MURY
MAF83		GA-85 MOB	MBNA055		GG-185 CLEN	MD093		G-296 ALCO	MD38-82		GA-360 MURY
MAF83		GA-85 ROAD	MBNA953		GG-246 CLEN	MD093		G-296-B ALCO	MD38-83		GA-361 MURY
MAF84		GA-730 MEDC	MBNA956		GG-189 CLEN	MD094		GA-71 ALCO	MD389		GA-37 MURY
MAF84		GA-730 MOB	MBNA957		GG-251 CLEN	MD097003		GP-91 CHRY	MD3HZ67318		GP-31 MTR
MAF84		GA-730 ROAD	MBNA958		GG-189 CLEN	MD097003		GP-91 MITS	MD4		GP-1 MURY
MAF90		GA-303 MEDC	MBNA959		GG-246 CLEN	MD098		GA-57 ALCO	MD400		GAVW-2 ALCO
MAF90		GA-303 MOB	MBNA970		GG-63 CLEN	MD099		GG-48 ALCO	MD-401		G-25 ALCO
MAF90		GA-303 ROAD	MBNA971		GG-94 CLEN	MD100		GAD-3 ALCO	MD409365		GP-91 MITS
MAF91		GA-59 MEDC	MBNA972		GG-185 CLEN	MD102		GAD-1 ALCO	MD418		GA-429 ALCO
MAF91		GA-59 MOB	MBNA975		GG-190 CLEN	MD103		G-801 ALCO	MD436		GA-277 ALCO
MAF91		GA-59 ROAD	MBNA976		GG-181 CLEN	MD105		G-1123 ALCO	MD43813		GP-3816 MURY
MAF92		GA-57 MEDC	MBNA984		GG-46 CLEN	MD105-1		G-1123F ALCO	MD438-14		GP-310 MURY
MAF92		GA-57 MOB	MBNA989		GG-351 CLEN	MD106		GAD-30 ALCO	MD-438-14		GP-3569 MURY
MAF92		GA-57 ROAD	MC 1003		GAC-1 MNH	MD107		GP-81 ³¹ ALCO	MD-438-14		GP-3569 MWM
MAF93		GA-325 MEDC	MC 1007		GAC-2 MNH	MD107		GP-9 ³⁸ ALCO	MD438-15		GP-1122 MURY
MAF93		GA-325 MOB	MC 1010-2		GAC-13 MNH	MD108063		GP-81 CHRY	MD448		GA-4365 ALCO
MAF93		GA-325 ROAD	MC 1018		GAC-7 MNH	MD108063		GP-22 MITS	MD484		GA-436 ALCO
MAF99		GA-86 MEDC	MC 1019		GAC-9 MNH	MD109		GP-81 ALCO	MD5002		GA-2156 ALCO
MAF99		GA-86 ROAD	MC031805		GP-40 MITS	MD113		G-801 ALCO	MD-5070		GA-2160 ALCO
MAF99-1		GA-86 MOB	MC1		GP-3 FORD	MD115		G-33 ALCO	MD532		GA-356 ALCO
MAK6652		GAK-403 MFIL	MC1006-2		GAC-6 MNH	MD116		GA-18 ALCO	MD534		GA-357 ALCO
MAK6666		GAK-16 MFIL	MC10863		GP-81 CHRY	MD120K		GAK-403 ALCO	MD542		GA-390 ALCO
MAK6667		GAK-20 MFIL	MC10863		GP-81 MITS	MD121		G-333 ALCO	MD550		GA-206 ALCO
MAK6693		GA-33 MFIL	MC115		G-34 MOB	MD129809		GP-58 CHRY	MD552K		GAK-216 ALCO
MAN631		GP-54 ¹¹ FCL	MC150-1		GS-1133 MOB	MD129809		GP-58 MITS	MD554K		GA-27 ALCO
MAN631		GP-66 ¹⁰ FCL	MC211		G-119 MOB	MD132		GA-71 ALCO	MD570		GA-3425 ALCO
MAN6501		GP-96 FCL	MC221		G-834 MOB	MD133737		GP-149 MITS	MD60330		GA-3490 MITS
MAN6555		GP-54 ¹¹ FCL	MC49		G-330 MOB	MD134953		GP-91 MITS	MD603330		GA-3490 CHRY
MAN6555		GP-66 ¹⁰ FCL	MC500		G-500 MOB	MD135735		GP-149 MITS	MD603330		GA-3490 MITS
MAO1065		G-834 COCT	MC50E		G-31 MOB	MD135737		GP-149 CHRY	MD603330		GA-3490 MOP
MAO1065		G-834 WHIT	MC613		G-613 MOB	MD135737		GP-149 MITS	MD603340		GA-4828 CHRY
MAP 60144		GA-2184 MFIL	MC622		GAC-2 MAIR	MD13661		GP-54 ¹¹ MITS	MD603340		GA-4828 MITS
MAP6696		GAVW-4 MFIL	MC74		G-833 MOB	MD13661		GP-66 ¹⁰ MITS	MD603340		GA-4828 MOP
MAP6742		GAVW-2 MFIL	MC74005KN4H		GP-3766 PAL	MD136790		GP-91 CHRY	MD603446		GAK-16 MITS

Referencia Cruzada por Numero de Parte

Cross Reference by Part Number



Numero	Gonher	Fabricante	Numero	Gonher	Fabricante	Numero	Gonher	Fabricante	Numero	Gonher	Fabricante
Number	Gonher	Manufacturer	Number	Gonher	Manufacturer	Number	Gonher	Manufacturer	Number	Gonher	Manufacturer
MD603800	GA-78	CHRY	MF1056	GG-92	MNH	MF43178	GG-63	MXLU	MF54638	GG-190	MXLU
MD603800	GA-78	MIT	MF1061	GG-220	MNH	MF4-3304	GP-1010Q	MOTF	MF54714	GG-66	MXLU
MD603932	GA-362	CHRY	MF1084	G-225	PUR	MF4-3318	GPP-18	MOTF	MF54794	GG-94	MXLU
MD603932	GA-362	MIT	MF1092	GG-45	MNH	MF4-3319	GPP-19	MOTF	MF551	GP-38	ASAH
MD604880	GA-4325	CHRY	MF1-11	GP-5	MOTF	MF4-3335	GP-52	MOTF	MF552A	G-870	PUR
MD604880	GA-4325	MIT	MF1-13	GP-13	MOTF	MF4-3340	GP-67	MOTF	MF554	GG-5 L	ASAH
MD604880	GA-4325	MOP	MF1-25	GP-20	MOTF	MF4-3375	GP-53	MOTF	MF55A	G-801	PUR
MD606K	GAK-1532	ALCO	MF1-2825	GP-38	MOTF	MF4-3376	GP-56	MOTF	MF5-6	G-6	MOTF
MD620472	GA-7142	CHRY	MF1-2870	GP-28	MOTF	MF4-3380	GP-1109	MOTF	MF565A	G-613	PUR
MD620472	GA-7142	MIT	MF1-30	GP-3	MOTF	MF4-3414	GP-1013Q	MOTF	MF5-8	GP-88	MOTF
MD620837	GA-605	MIT	MF1-3387	GP-46	MOTF	MF4-3416	GP-88	MOTF	MF5-801	G-871	MOTF
MD656	GA-467	ALCO	MF1-3535	GP-48	MOTF	MF4-3519	GP-9586	MOTF	MF5-813	G-813	MOTF
MD674	GA-55	ALCO	MF1-3600	GP-3600	MOTF	MF4-3528	GP-11	MOTF	MF5-816	G-816	MOTF
MD-694	GA-410	ALCO	MF1-3614	GP-58	MOTF	MF4-3555	GP-57	MOTF	MF5-824	G-870	MOTF
MD7030	GA-405	ALCO	MF1-3682	GP-3682	MOTF	MF4-3567	GP-34	MOTF	MF5-834	G-834	MOTF
MD7048	GA-229	ALCO	MF1-43	GP-9	MOTF	MF4-3594	GP-92	MOTF	MF5-856	G-294	MOTF
MD7076	GA-8047	ALCO	MF1-47	GP-34	MOTF	MF4-3595	GP-93	MOTF	MF59161	GG-79	MXLU
MD7078	GA-483	ALCO	MF149A	G-11816	PUR	MF4-36	GP-36	MOTF	MF5R26731B	GP-68	MTR
MD7080	GA-416	ALCO	MF1-8	GP-1	MOTF	MF4-3612	GP-53	MOTF	MF60900	GP-54	PUR
MD-8204	GA-323	SPLT	MF1-927	GP-22	MOTF	MF4-3757	GP-43	MOTF	MF60900A	GP-54	PUR
MD9130	GA-471	ALCO	MF1C29601A	GA-133	MTR	MF4-3773	GP-35	MOTF	MF615A	G-5000	PUR
MD9142	GA-180	ALCO	MF203A	G-33	PUR	MF4-4163	G-297	MOTF	MF6-174	G-500	MOTF
MD9198	GA-386	ALCO	MF2-146	GA-71	MOTF	MF4-42	GP-42	MOTF	MF6-175	G-750	MOTF
MD9212	GA-195	ALCO	MF2-148	GA-80	MOTF	MF4451	GG-196	ASAH	MF624A	G-236	PUR
MD-9430	GA-2174	ALCO	MF2-160	GA-70	MOTF	MF44705	GG-7018 ⁸⁸	MXLU	MF629A	G-296	PUR
MD9436	GA-477	ALCO	MF2-184	GA-77	MOTF	MF44705	GG-7019 ⁹⁷	MXLU	MF629A	G-296-B	PUR
MD9448	GA-4365	ALCO	MF2-189	GA-50	MOTF	MF44705	GG-7020 ¹¹⁴	MXLU	MF63000	GP-3816	PUR
MD9640	GAD-15	ALCO	MF21901	G-836	PUR	MF448	GG-5 L	ASAH	MF63000A	GP-3816	PUR
MD9642	GA-4303	ALCO	MF219A	G-836	PUR	MF4-49	GP-51	MOTF	MF63005A	GP-28 ⁹	PUR
MD9772	GA-2184	ALCO	MF221A	G-834	PUR	MF4-50	GP-50	MOTF	MF63005A	GP-430 ⁸	PUR
MD9828	GA-139	ALCO	MF221A-1	G-834	PUR	MF45700	GP-1	PUR	MF63169	GG-47	MXLU
MD9862	GA-362	ALCO	MF2-2662	GAVW-22	MOTF	MF45700A	GP-1	PUR	MF638	G-31	FIL
MD9872	GA-142	ALCO	MF2-2663	GA-200	MOTF	MF45700AB	GP-1	PUR	MF638BER	G-31	FIL
MD9874	GA-166	ALCO	MF2-305	GA-730	MOTF	MF45700B	GP-1	PUR	MF638	G-191	PUR
MD9880	GA-382	ALCO	MF2-3245	GAD-30	MOTF	MF45701A	GP-50	PUR	MF651A	GA-18	PUR
MD9890	GA-6619 ¹	ALCO	MF2-326	GA-59	MOTF	MF45702A	GP-5	PUR	MF65277	GG-986	MXLU
MD9890	GA-6620 ⁹	ALCO	MF2-3384	GAVW-2	MOTF	MF45800A	GP-81	PUR	MF662	G-143	FIL
MD9894	GA-133	ALCO	MF2-3399	GAVW-4	MOTF	MF45803A	GP-5	PUR	MF6-7500	GP-54 ¹¹	MOTF
MD9914	GA-7142	ALCO	MF2-3537	GA-54	MOTF	MF45804A	GP-1	PUR	MF6-7500	GP-66 ¹⁰	MOTF
MD9936	GA-322	ALCO	MF2-353A	GAD-1	MOTF	MF45805A	GP-50	PUR	MF67600A	GP-54	PUR
MD9938	GA-6690	ALCO	MF2-353A	GAD-3	MOTF	MF459	GG-1	ASAH	MF6D29601B	GA-217	MTR
MD9942	GA-7344	ALCO	MF2-3559	GA-271	MOTF	MF459	GG-4	ASAH	MF700A	GA-360	PUR
MDA38-22	GA-24	MURY	MF2-3559	GA-734	MOTF	MF473000A	GG-5 L	PUR	MF70A	G-870	PUR
MDA38-23	GA-24	MURY	MF2-3565	GA-108	MOTF	MF481	G-33	PUR	MF7-151	GA-101	MOTF
MDP1109	GP-83	MOB	MF2-3684	GA-231	MOTF	MF481A	G-33	PUR	MF7-1532	GAK-1532	MOTF
MDP3318	GPP-18	MOB	MF2-3705	GA-154	MOTF	MF4-977	GP-31	MOTF	MF7-1533	GA-425	MOTF
MDP3319	GPP-19	MOB	MF2-3784	GA-230	MOTF	MF4T26731A	GP-68	MTR	MF7-1533SY	GA-426	MOTF
MDP3401	GPP-18	MOB	MF2-381	GA-74	MOTF	MF500	G-500	FIL	MF7-1541	GA-329	MOTF
MDP3430	GP-55	MOB	MF2-3924	GA-153	MOTF	MF50274	GP-92	FACE	MF7-1541SY	GA-239	MOTF
MDS1108	GP-1107	MOB	MF2-5058	GA-273	MOTF	MF506	G-31	FIL	MF7-1543	GA-891	MOTF
MDS1110	GP-84	MOB	MF2-5350	GA-272	MOTF	MF5-1133C	GC-1133	MOTF	MF7-1543SY	GA-892	MOTF
MDS1131	GP-62	MOB	MF2600	G-870	PUR	MF5-1133CC	GC-1133	MOTF	MF7-1548	GA-483	MOTF
MDS3376	GP-56	MOB	MF2604	G-870	PUR	MF5-1133CS	GS-1133	MOTF	MF7-1548SY	GA-482	MOTF
MDS3380	GP-78	MOB	MF26A	G-870	PUR	MF5-1133S	GS-1133	MOTF	MF7-1553	GA-679	MOTF
MDS4102	GP-1122	MOB	MF26A1	G-870	PUR	MF5-1143	G-1143	MOTF	MF7-1553SY	GA-680	MOTF
ME004049	GP-3985	MIT	MF26A2	G-870	PUR	MF5-1163	G-1163	MOTF	MF7-1580	GA-109	MOTF
ME004099	GP-3985	MIT	MF26A3	G-870	PUR	MF5-1166	G-1166	MOTF	MF7-1581	GA-229	MOTF
ME014833D	GP-3985	MIT	MF26A4	G-870	PUR	MF5-1173	G-1173	MOTF	MF7-1596	GA-209	MOTF
ME033617	GA-280	MIT	MF26D	G-801	PUR	MF5-1174	G-1174	MOTF	MF7-1596SY	GA-210	MOTF
ME034879	GP-57	MIT	MF276A	G-813	PUR	MF5-1175	G-1175	MOTF	MF7-1599	GA-107	MOTF
ME035394	GP-1105	MIT	MF284A	G-833	PUR	MF5-11816	G-11816	MOTF	MF7-1696	GA-209	MOTF
ME035532	GP-1105	MIT	MF292A1	G-238	PUR	MF5-11860	G-1121	MOTF	MF7-190	GA-39	MOTF
ME053363	GA-24	MIT	MF297	GA-37	PUR	MF5-11861	G-1123	MOTF	MF7-2	GAP-379	MOTF
ME060219	GAK-20	MIT	MF297A	GA-37	PUR	MF5-119	G-119	MOTF	MF7-216	GA-1008	MOTF
ME063155	GA-206	MIT	MF3-1191	GG-298	MOTF	MF5-11941	GG-48	MOTF	MF7-223	GA-29	MOTF
ME063874	GA-106 ⁴⁶	MIT	MF314	GG-3	BARA	MF512A	G-613	PUR	MF7-224	GA-8047	MOTF
ME063874	GA-326 ⁷¹	MIT	MF31A	G-139	PUR	MF5-139	G-139	MOTF	MF7-226	GA-9334	MOTF
ME063876	GA-27	MIT	MF3-2	GG-5	MOTF	MF5-14	G-5000	MOTF	MF7-229	GA-18	MOTF
ME065322	GP-1010Q	MIT	MF3-20	GG-20	MOTF	MF5-155	G-152	MOTF	MF7-233	GA-9045	MOTF
ME9715512	GA-106 ⁴⁶	MIT	MF33144	GG-46	MXLU	MF5-1660	G-222	MOTF	MF7-234	GA-1287	MOTF
ME9715512	GA-326 ⁷¹	MIT	MF3-3388	GG-6	MOTF	MF5-1666	G-1166	MOTF	MF7-235	GA-1284	MOTF
ME9G26731A	GP-91	MTR	MF3-3499	GG-8	MOTF	MF5-1720	G-159	MOTF	MF7-236	GA-1286	MOTF
MEC9	GA-100	MOB	MF3-3559	GG-45	MOTF	MF5-1721	G-331	MOTF	MF7-237	GA-1285	MOTF
MECOHJ378-6	GA-5648	SCHM	MF343171M1	GP-490	MASY	MF5-1725	G-33	MOTF	MF7-239	GA-375	MOTF
MEFG6	GG-82	MTR	MF3-6	GG-4	MOTF	MF5-191	G-191	MOTF	MF7-240	GA-37	MOTF
MEFL600	GP-3600	MTR	MF36300A	GP-81	PUR	MF519A	G-162H	PUR	MF7-253	GA-16	MOTF
MF 1013	GG-308	MNH	MF36300M	GP-22	PUR	MF5-200	G-200	MOTF	MF7-254	GA-20	MOTF
MF 1016	GG-187	MNH	MF36304B	GP-81	PUR	MF5-211	G-566	MOTF	MF7-255	GA-24	MOTF
MF 1018	GG-137	MNH	MF-39-A	G-816	PUMX	MF5-218	G-34	MOTF	MF7-256	GA-33	MOTF
MF 1021	GG-187	MNH	MF3H26731C	GP-178	MTR	MF5-236	G-236	MOTF	MF7-257	GA-26	MOTF
MF 1031	GG-267	MNH	MF4-1101	GP-1101	MOTF	MF5-238	G-238	MOTF	MF7-2571	GAP-381	MOTF
MF 1032	GG-245	MNH	MF4-1103	GPP-11	MOTF	MF524A1	G-870	PUR	MF7-258	GA-403	MOTF
MF 1033	GG-239	MNH	MF4-1104	GP-110	MOTF	MF5-2821	G-613	MOTF	MF7-259	GA-27	MOTF
MF 1036	GG-243	MNH	MF4-1105	GP-114	MOTF	MF52A	G-870	PUR	MF7-2596SY	GA-210	MOTF
MF 1037	GG-220	MNH	MF4-1121	GP-1107	MOTF	MF52A	G-870	SPEC	MF7-268	GA-5648	MOTF
MF 1044	GG-256	MNH	MF4-1130	G-295	MOTF	MF-52-A	G-870	PUMX	MF7-287	GA-287	MOTF
MF 1045	GG-64	MNH	MF4-1131	GP-62	MOTF	MF5-31	G-31	MOTF	MF7-288	GA-1203	MOTF
MF 1046	GG-99	MNH	MF4-1145	GP-1122	MOTF	MF5-33	G-33	MOTF	MF7-3203	GA-21	MOTF
MF 1047	GG-84	MNH	MF4-1146	GP-26	MOTF	MF5-330	G-330	MOTF	MF7-329	GA-35	MOTF
MF 1068	GG-306	MNH	MF4-1147	GP-27	MOTF	MF5-331	G-331	MOTF	MF7-347	GA-429	MOTF
MF 1085	GG-3728	MNH	MF4-1191	G-296	MOTF	MF5-333	G-333	MOTF	MF7-3517	GA-377	MOTF
MF 1091	GG-39	MNH	MF4-1191	G-296-B	MOTF	MF5-335	G-335	MOTF	MF7-3603	GA-373	MOTF
MF02165059	GA-405	FIAT	MF4-20	GP-14	MOTF	MF534	G-31	FIL	MF7-3864	GA-1095	MOTF
MF1005</											

Numero	Gonher	Fabricante	Numero	Gonher	Fabricante	Numero	Gonher	Fabricante	Numero	Gonher	Fabricante
Number	Gonher	Manufacturer	Number	Gonher	Manufacturer	Number	Gonher	Manufacturer	Number	Gonher	Manufacturer
MF7-502SY	GA-6127	MOTF	MFA1105	GA-382	MTR	MFA215	GA-403	MTR	MFA719	GA-2740	MTR
MF7-507	GA-106	MOTF	MFA1108	GA-6619 ¹	MTR	MFA223	GA-7	MTR	MFA71R	GA-59	MTR
MF7-507SY	GA-206	MOTF	MFA1108	GA-6620 ²	MTR	MFA23	GA-78	MTR	MFA72	GA-730	MTR
MF7-523	GA-360	MOTF	MFA1112	GA-6690	MTR	MFA23R	GA-78	MTR	MFA721	GA-54	MTR
MF7-523SY	GA-360	MOTF	MFA1116	GA-529	MTR	MFA244	GA-12	MTR	MFA721R	GA-54	MTR
MF7-536	GA-356	MOTF	MFA1117	GA-217	MTR	MFA247	GA-18	MTR	MFA724	GA-89	MTR
MF7-536SY	GA-357	MOTF	MFA1118	GA-217	MTR	MFA250	GA-230	MTR	MFA727	GA-101	MTR
MF7-542	GA-31	MOTF	MFA1119	GA-197R	MTR	MFA273	GA-31	MTR	MFA728	GA-3637	MTR
MF7-592	GA-376	MOTF	MFA1120	GA-768R	MTR	MFA284	GA-29	MTR	MFA729	GA-3637	MTR
MF7-595	GA-378	MOTF	MFA1121	GAD-118	MTR	MFA289	GA-6127	MTR	MFA72R	GA-730	MTR
MF7-598	GA-7716	MOTF	MFA1127	GA-6479	MTR	MFA291	GA-135	MTR	MFA735	GA-1285	MTR
MF7-598SY	GA-7360	MOTF	MFA123	GA-11	MTR	MFA291FP	GA-135	MTR	MFA736	GA-1284	MTR
MF75A-1	G-871	PUR	MFA128	GAK-16	MTR	MFA3	GA-80	MTR	MFA738	GAK-625	MTR
MF75A-2	G-871	PUR	MFA129	GAK-20	MTR	MFA30	GA-153	MTR	MFA74	GA-86	MTR
MF75A-3	G-871	PUR	MFA130	GA-24	MTR	MFA31	GA-192	MTR	MFA740	GAP-379	MTR
MF75A-4	G-801	PUR	MFA131	GAK-403	MTR	MFA31R	GA-192	MTR	MFA746	GA-3501	MTR
MF75A-5	G-801	PUR	MFA132	GA-33	MTR	MFA32	GA-3588	MTR	MFA75	GA-57	MTR
MF7-6326	GA-371	MOTF	MFA1331	GA-139	MTR	MFA33	GA-70	MTR	MFA752	GA-277	MTR
MF7-74	GA-70	MOTF	MFA1338	GA-3901	MTR	MFA34	GA-3916	MTR	MFA753	GA-4303	MTR
MF7-76	GA-12	MOTF	MFA1348	GA-392	MTR	MFA35	GA-49	MTR	MFA75R	GA-57	MTR
MF7-77	GA-12	MOTF	MFA1352	GA-129	MTR	MFA352	GAVW-10	MTR	MFA768	GA-3588	MTR
MF79800	GA-388	CONT	MFA136	GA-9045	MTR	MFA36	GA-90	MTR	MFA773	GA-6128	MTR
MF7-9800	GA-388	MOTF	MFA1360	GA-276	MTR	MFA37	GAD-15	MTR	MFA7R	GA-50	MTR
MF80	GP-66	HYC	MFA1366	GA-142	MTR	MFA38	GAD-294	MTR	MFA8	GA-71	MTR
MF839A	GA-405	PUR	MFA137	GA-1287	MTR	MFA39	GA-55	MTR	MFA806	GA-209	MTR
MF84A	G-871	PUR	MFA138	GA-9334	MTR	MFA39-R	GA-55	MTR	MFA807	GA-210	MTR
MF8650	G-813	PUR	MFA1381	GA-253	MTR	MFA3-R	GA-80	MTR	MFA817	GA-251	MTR
MF8C26731AA	GP-68	MTR	MFA1386	GAVW-120	MTR	MFA50	GA-85	MTR	MFA822	GAK-1532	MTR
MF94A	G-31	PUR	MFA139	GA-1286	MTR	MFA501	GA-39	MTR	MFA828	GA-18	MTR
MFA1	GA-77	MTR	MFA140	GA-375	MTR	MFA504	GA-37	MTR	MFA836	GA-229	MTR
MFA10	GA-70	MTR	MFA1400	GAD-30	MTR	MFA52	GA-303	MTR	MFA837	GAK-216	MTR
MFA1000	GA-3637	MTR	MFA155	GAVW-2	MTR	MFA524	GA-8047	MTR	MFA838	GA-416	MTR
MFA1001	GA-3637	MTR	MFA156	GAD-3	MTR	MFA525	GA-1285	MTR	MFA840	GA-108	MTR
MFA1007	GA-734 ⁸¹	MTR	MFA158	GA-361	MTR	MFA52R	GA-303	MTR	MFA846	GA-31	MTR
MFA1007	GA-735 ¹²⁴	MTR	MFA160	GA-21	MTR	MFA536	GA-1008	MTR	MFA858	GA-826	MTR
MFA1015	GA-3501	MTR	MFA1603	GA-186	MTR	MFA537	GA-1284	MTR	MFA859	GA-827	MTR
MFA1017	GA-85	MTR	MFA161	GAD-1	MTR	MFA546	GA-5648	MTR	MFA860	GA-109	MTR
MFA1018	GA-74	MTR	MFA1611	GA-175	MTR	MFA547	GA-5648	MTR	MFA866	GA-75	MTR
MFA1019	GA-303	MTR	MFA1612	GA-127	MTR	MFA565	GA-360	MTR	MFA869	GA-3490	MTR
MFA1019R	GA-303	MTR	MFA1613	GA-128	MTR	MFA571	GA-26	MTR	MFA874	GAVW-4	MTR
MFA1020	GA-80	MTR	MFA1614	GA-300	MTR	MFA572	GA-27	MTR	MFA880	GAK-20	MTR
MFA1020R	GA-80	MTR	MFA1615	GA-1615	MTR	MFA574	GA-74	MTR	MFA89	GA-6129	MTR
MFA1021	GA-85	MTR	MFA1616	GA-1616	MTR	MFA574R	GA-74	MTR	MFA8R	GA-71	MTR
MFA1022	GA-75	MTR	MFA1617	GA-442	MTR	MFA579	GA-100	MTR	MFA90	GA-106 ⁴⁸	MTR
MFA1023	GA-300	MTR	MFA1618	GAVW-620	MTR	MFA579DP	GA-100	MTR	MFA90	GA-326 ¹	MTR
MFA1024	GA-3300	MTR	MFA161-R	GAD-1 ⁸⁷	MTR	MFA579R	GA-100	MTR	MFA903	GA-360	MTR
MFA1024R	GA-3300	MTR	MFA1632	GA-1615	MTR	MFA584	GA-27198 ¹²²	MTR	MFA904	GA-361	MTR
MFA1025	GA-75	MTR	MFA1634	GA-1615	MTR	MFA584	GA-3300 ⁹⁸	MTR	MFA92	GA-349	MTR
MFA1026	GA-3425	MTR	MFA1635	GA-930R	MTR	MFA584-R	GA-27198 ¹²²	MTR	MFA920	GA-373	MTR
MFA1027	GA-3425	MTR	MFA1641	GA-1614	MTR	MFA584-R	GA-3300 ⁹⁸	MTR	MFA934	GA-2984	MTR
MFA1027R	GA-3425	MTR	MFA1643	GA-130	MTR	MFA588	GA-429	MTR	MFA935	GA-135	MTR
MFA1029	GA-735 ¹²⁴	MTR	MFA1658	GA-158	MTR	MFA597	GA-376	MTR	MFA935FP	GA-135	MTR
MFA1029R	GA-735 ¹²⁴	MTR	MFA1668	GA-1615	MTR	MFA598	GA-378	MTR	MFA938	GAD-3	MTR
MFA1031	GA-277	MTR	MFA1669	GA-472	MTR	MFA600	GAVW-2	MTR	MFA939	GA-3300	MTR
MFA1032	GA-5056	MTR	MFA1673	GA-1616	MTR	MFA601	GA-229	MTR	MFA943	GAVW-22	MTR
MFA1033	GA-176	MTR	MFA1675	GA-472	MTR	MFA602	GA-7716	MTR	MFA949	GA-271	MTR
MFA1035	GA-230	MTR	MFA1679	GA-479	MTR	MFA603	GA-7360	MTR	MFA95	GA-77	MTR
MFA1036	GA-70	MTR	MFA1680	GA-780	MTR	MFA604	GA-50	MTR	MFA954	GA-33	MTR
MFA1037	GA-200	MTR	MFA1683	GA-224	MTR	MFA612	GA-85	MTR	MFA97	GA-75	MTR
MFA1037	GP-58	MTR	MFA1688	GA-168	MTR	MFA612-R	GA-85	MTR	MFA971	GA-274	MTR
MFA1038	GA-4828	MTR	MFA1695	GA-395	MTR	MFA613	GA-86	MTR	MFA979	GA-589	MTR
MFA1040	GA-89	MTR	MFA1696	GA-224	MTR	MFA613-R	GA-86	MTR	MFA97R	GA-75	MTR
MFA1041	GA-422	MTR	MFA1697	GA-1615	MTR	MFA617	GA-2740	MTR	MFA980	GA-588	MTR
MFA1043	GA-273	MTR	MFA170	GA-21	MTR	MFA620	GA-6880	MTR	MFA981	GA-730	MTR
MFA1045	GA-277	MTR	MFA1701	GA-132	MTR	MFA623	GA-483	MTR	MFA982	GA-3425	MTR
MFA1046	GA-174	MTR	MFA1702	GA-134	MTR	MFA624	GA-482	MTR	MFA987	GA-27198	MTR
MFA1047	GA-176	MTR	MFA1703	GA-165	MTR	MFA625	GA-329	MTR	MFA99	GA-325	MTR
MFA1050	GA-471	MTR	MFA1704	GAD-30	MTR	MFA626	GA-239	MTR	MFA992	GA-3647	MTR
MFA1051	GA-588	MTR	MFA1705	GAVW-621	MTR	MFA637	GA-3501	MTR	MFA993	GA-4325	MTR
MFA1052	GA-589	MTR	MFA1706	GAVW-620	MTR	MFA640	GA-3424	MTR	MFA994	GA-3681	MTR
MFA1057	GA-3501	MTR	MFA1707	GAVW-620	MTR	MFA640-R	GA-3424	MTR	MFA999	GA-277	MTR
MFA1061	GA-275	MTR	MFA1732	GA-134	MTR	MFA641	GA-3425	MTR	MFA99R	GA-325	MTR
MFA1071	GA-274	MTR	MFA1754	GA-1617	MTR	MFA641R	GA-3425	MTR	MFD-152	GP-11 ¹⁶	MTR
MFA1072	GA-133	MTR	MFA1760	GA-281	MTR	MFA649	GA-679	MTR	MFD-152	GP-1101 ⁴⁵	MTR
MFA1072R	GA-133	MTR	MFA1762	GA-172	MTR	MFA650	GA-680	MTR	MFD-810	G-297	MTR
MFA1073	GA-217	MTR	MFA1763	GA-172	MTR	MFA652	GA-425	MTR	MFD-810	G-297-B	MTR
MFA1076	GA-529	MTR	MFA1764	GA-172	MTR	MFA653	GA-426	MTR	MFD-85	GC-1133	MTR
MFA1077	GA-682R	MTR	MFA1765	GA-278R	MTR	MFA660	GA-679	MTR	MFE1006AK	GPP-419	LUF
MFA1081	GAD-30	MTR	MFA1766	GA-132	MTR	MFA661	GA-680	MTR	MFE10032	GP-34	HYC
MFA1082	GA-2194	MTR	MFA1768	GA-59	MTR	MFA662	GA-891	MTR	MFE160-10/2	GP-34	HYC
MFA1085	GA-3916	MTR	MFA1780	GA-1540	MTR	MFA663	GA-892	MTR	MFE16020BN2	GP-34	HYC
MFA1086	GA-3814	MTR	MFA1791	GAD-117	MTR	MFA665	GA-372	MTR	MFE160-25-2	GP-34	HYC
MFA1087	GAD-117	MTR	MFA1791	GAD-15	MTR	MFA666	GA-377	MTR	MFE80-10-2	GP-66	HYC
MFA1087	GAD-15	MTR	MFA1812	GA-8606	MTR	MFA672	GA-50	MTR	MFE801024	GP-66	HYC
MFA1089	GA-78	MTR	MFA1830	GA-164	MTR	MFA676	G-566	MTR	MFE80102U	GP-66	HYC
MFA1091	GA-3915	MTR	MFA1836	GA-392	MTR	MFA68	GA-3300	MTR	MFE801102	GP-66	HYC
MFA1092	GA-253	MTR	MFA1837	GA-279	MTR	MFA7	GA-50	MTR	MFE80252	GP-66	HYC
MFA1094	GA-153	MTR	MFA185	GA-206	MTR	MFA704	GA-80	MTR	MFE9003BN2	GP-3766	HYC
MFA1095	GA-390	MTR	MFA1850	GA-397	MTR	MFA706	GA-3523	MTR	MFE9005BN2	GP-3766	HYC
MFA1097	GA-139	MTR	MFA188	GA-360	MTR	MFA709	GA-107	MTR	MFF1000P	G-296	MASE
MFA1099	GA-3901	MTR	MFA1883	GA-437	MTR	MFA71	GA-59	MTR	MFF1000P	G-296-B	MASE
MFA110R	GA-70	MTR	MFA192	GA-356	MTR	MFA713	GA-734 ⁸¹	MTR	MFF1001P	GG-48	MASE
MFA11	GA-105	MTR	MFA196	GA-357	MTR	MFA713	GA-735 ¹²⁴	MTR	MFF1003P	GP-1122	MASE
MFA1100	GA-362	MTR	MFA19R	GA-77	MTR	MFA713R	GA-734 ⁸¹	MTR	MFF1005P	G-297	MASE
MFA1101	GA-195	MTR	MFA2	GA-56	MTR	MFA713R	GA-735 ¹²⁴	MTR	MFF1005P	G-297-B	MASE
			MFA208	GA-7	MTR	MFA717	GA-89	MTR	MFF130A	G-870	PUR

Referencia Cruzada por Numero de Parte

Cross Reference by Part Number



Numero	Gonher	Fabricante	Numero	Gonher	Fabricante	Numero	Gonher	Fabricante	Numero	Gonher	Fabricante
Number	Gonher	Manufacturer	Number	Gonher	Manufacturer	Number	Gonher	Manufacturer	Number	Gonher	Manufacturer
MFF299A	GG-48	PUR	MFL319	GP-53	MTR	MGA52	GA-71	MCG	ML1024	GP-3682	MNH
MFF299A-1	GG-48	PUR	MFL400	GP-3600	MTR	MGA57	GA-80	MCG	ML1170	GP-88	MOB
MFF300A-1	GG-48	PUR	MFL400A	GP-3600	MTR	MGA59	GA-50	MCG	ML13A	G-801	CLEN
MFF47300	GG-5 L	PUR	MFL401	GP-28 ^M	MTR	MGA68	GA-78	MCG	ML13B	G-801	CLEN
MFF516A	G-296	PUR	MFL401	GP-430 ^M	MTR	MGA83	GA-730	MCG	ML16810	GP-91	PUR
MFF516A	G-296-B	PUR	MFL402	GP-3980 ^M	MTR	MGA84	GA-85	MCG	ML16817	GP-91	PUR
MFF61901	GPP-14	PUR	MFL402	GP-48 ^M	MTR	MGA91	GA-59	MCG	ML16819	GP-91	PUR
MFF629	G-296	PUR	MFL406	GP-69	MTR	MGA92	GA-57	MCG	ML20	G-33	CLEN
MFF629	G-296-B	PUR	MFL504	GP-22	MTR	MGA93	GA-325	MCG	ML30015	GP-14	FACE
MFF629A	G-296	PUR	MFL505	GP-28	MTR	MGF11	GG-6	MECC	ML30137	GP-1	FACE
MFF629A	G-296-B	PUR	MFL505	GP-3600	MTR	MGF11	GG-5 L	MOB	ML31	G-870	CLEN
MFF629F	G-296	PUR	MFL600	GP-3600	MTR	MGF1115	GG-20	MOB	ML3335	GP-52 ¹⁰	MOB
MFF629F	G-296-B	PUR	MFL793	GP-46	MTR	MGF119	GG-6	MOB	ML3335	GP-69 ¹⁸	MOB
MFF64301B	GG-1	PUR	MFL793	GP-58	MTR	MGF12	GG-7	MECC	ML3375	GP-53	MOB
MFF64301B	GG-4	PUR	MFL797	GP-57	MTR	MGF120	GG-7	MOB	ML3442	GP-53	MOB
MFF783A	G-297	PUR	MFL797A	GP-57	MTR	MGF13	GG-123	MECC	ML3519	GP-9586	MOB
MFF783A	G-297-B	PUR	MFL801	GP-3682 ^M	MTR	MGF131	GG-19	MOB	ML3545	GP-52 ¹⁰	MOB
MFG 1036	GG-30	MTR	MFL801	GP-37 ^M	MTR	MGF20	GG-20	MECC	ML3545	GP-69 ¹⁸	MOB
MFG1	GG-20	MTR	MFL819	GP-3000	MTR	MGF21	GG-123	MOB	ML3612	GP-53	MOB
MFG10	GG-8 L	MTR	MFL820	GP-68	MTR	MGF22A	GG-19	MECC	ML3614	GP-58	ITAL
MFG100	GG-1	MTR	MFL9	GG-20	MTR	MGF3359	GG-45	MECC	ML36830	GP-3600	PUR
MFG100	GG-4	MTR	MFP617A	GA-71	PUR	MGF3596	GG-87	MECC	ML3757	GP-43	MOB
MFG101	GG-1	MTR	MFP624A	G-236	PUR	MGF3727	GG-46	MECC	ML39260	GP-54 ⁰	FACE
MFG101	GG-4	MTR	MFP699A	GA-8	PUR	MGF3802A	GG-47	MECC	ML3951	GP-166	MOB
MFG1012	GG-47	MTR	MFT42	GG-298	NIPP	MGF4191	GG-203	MECC	ML3951	GP-69	MOB
MFG1014	GG-195	MTR	MG007	G-1121	CLEN	MG0771105	GAK-403	AVEL	ML40048	GP-10	FACE
MFG1014	GG-95	MTR	MG010	G-1173	CLEN	MG0223	G-613	IHCO	ML40127	GP-54	FACE
MFG1015	GG-61	MTR	MG024	G-1174	CLEN	MG0771105	GAK-403	AVEL	ML402	G-238	CLEN
MFG1016	GG-251	MTR	MG07	G-1121	CLEN	MH1654	GP-66	MOB	ML406	G-836	CLEN
MFG1017	GG-195	MTR	MG086	G-1123	CLEN	MH302	GP-1	MFIL	ML410	G-335	CLEN
MFG1017	GG-95	MTR	MG088	G-1121F	CLEN	MH307	GP-13	MFIL	ML411	G-191	CLEN
MFG1018	GG-104	MTR	MG1	GP-1	MCG	MH310	GP-50	MFIL	ML413	G-222	CLEN
MFG1019	GG-265	MTR	MG1	GG-5 L	MEI	MH316P	GP-38	MFIL	ML418	G-31	CLEN
MFG1020	GG-111	MTR	MG1	GG-1	MOB	MH316X	GP-38	MFIL	ML451	G-6	CLEN
MFG1021	GG-98	MTR	MG1	GG-4	MOB	MH320	GP-171	MFIL	ML461	G-163	CLEN
MFG1022	GG-266	MTR	MG10	GG-8 ¹⁰³	MEI	MH321	GP-54	MFIL	ML462	G-143	CLEN
MFG1024	GG-94	MTR	MG10	GG-8 L ⁸⁰	MEI	MH325	GP-81	MFIL	ML47	GP-34	MOB
MFG1026	GG-290	MTR	MG10	GG-45	MOB	MH326	GP-36	MFIL	ML483	G-133	CLEN
MFG1028	GG-251	MTR	MG100	GG-5	MOB	MH3300	GP-51	MFIL	ML483	G-989	CLEN
MFG1032	GG-106	MTR	MG11	GG-196	MEI	MH3301	GP-51	MFIL	ML49	GP-51	MOB
MFG1039	GG-986	MTR	MG11	GG-5	MOB	MH3302	GP-77	MFIL	ML490	G-963	CLEN
MFG1060	GG-47	MTR	MG11M	GG-5 L	MOB	MH3305	GP-3985	MFIL	ML493	G-971	CLEN
MFG1069	GG-64	MTR	MG11W	GG-1	MOB	MH331	GP-46	MFIL	ML500	G-25	CLEN
MFG1070	GG-39	MTR	MG11W	GG-4	MOB	MH3310	GP-3682	MFIL	ML50300	GP-53	FACE
MFG1085	GG-160	MTR	MG12	GG-87	MEI	MH3310	GP-37	MFIL	ML52	GP-52 ¹⁰	MOB
MFG1086	GG-161	MTR	MG12	GG-8	MOB	MH332P	GP-462	MFIL	ML52	GP-69 ¹⁸	MOB
MFG11	GG-5 L	MTR	MG12M	GG-8 L	MOB	MH332X	GP-462	MFIL	ML61	G-834	CLEN
MFG12	GG-7019	MTR	MG13	GG-76	MEI	MH3330	GP-28 ⁸	MFIL	ML61B	G-834	CLEN
MFG157	GG-298	MTR	MG157	GG-6	MOB	MH3330	GP-430 ⁸	MFIL	ML7	GP-1	MOB
MFG2	GG-3	MTR	MG157A	GG-16	MOB	MH337	GP-1	MFIL	ML77	G-813	CLEN
MFG2	GG-5 L	MTR	MG158	GP-28 ⁸	MOB	MH350P	GP-28 ⁸	MFIL	MLD3340	GP-67	MOB
MFG3	GG-45	MTR	MG158A	GG-17	MOB	MH350P	GP-430 ⁸	MFIL	MLD3555	GP-57	MOB
MFG66	GG-32	MTR	MG1P	GP-1	MCG	MH352	GP-22	MFIL	MLS000127	GP-46	CITR
MFG77U	GG-29	MTR	MG2	GG-6	MEI	MH356	GP-22	MFIL	MLS000155	GP-3816	CITR
MFG800A	GG-47	MTR	MG20	GG-20	NEL	MH360	GP-3600	MFIL	MLS000169	GP-22	CITR
MFG840A	GG-42	MTR	MG20	GG-20	WIN	MH361	GP-171	MFIL	MLS000530	GP-46	CITR
MFG851	GG-3728	MTR	MG269212	GG-1	JOND	MH364	GP-42	MFIL	MLS000702	GP-28 ⁸	CITR
MFG862	GG-47	MTR	MG269212	GG-4	JOND	MH365	GP-54 ¹¹	MFIL	MLS000702	GP-430 ⁸	CITR
MFG862	GG-92	MTR	MG3	GG-7	MEI	MH365	GP-66 ¹⁰	MFIL	MM315200	GP-462	MITTS
MFG872	GG-1872	MTR	MG3169	GG-47	MOB	MH365P	GP-54 ¹¹	MFIL	MM409365	GP-91	MITTS
MFG881	GG-47	MTR	MG3171	GG-29	MOB	MH365P	GP-66 ¹⁰	MFIL	MM431599	GP-3985	MITTS
MFG881	GG-92	MTR	MG3178	GG-39	MOB	MH366P	GP-3985	MFIL	MM510001	GA-2740	MITTS
MFG883	GG-251	MTR	MG3728	GG-3728	MOB	MH369	GP-3	MFIL	MM510072	GA-33	MITTS
MFG887	GG-1992	MTR	MG3895	GG-67	MOB	MH371	GP-20	MFIL	MM510090	GA-12	MITTS
MFG89	GG-25	MTR	MG4	GG-123	MEI	MH376	GA-493 ¹⁰⁸	MFIL	MO 1194	G-25	MFIL
MFG986	GG-986	MTR	MG4194	GG-94	MOB	MH376X	GP-14	MFIL	MO10060	GP-406	MILE
MFG986B	GG-986	MTR	MG4777	GG-63	MOB	MH377	GP-81	MFIL	MO105	G-31	MFIL
MFG991	GG-986	MTR	MG481	GG-46	MOB	MH378	GP-31	MFIL	MO106	G-33	MFIL
MFH440A	G-152	PUR	MG5	GG-19	MEI	MH380	GP-3429	MFIL	MO107	G-801	MFIL
MFL1	GP-1	MTR	MG508129	GP-81	JOND	MH383	GP-3531	EXP	MO1102	G-801	MFIL
MFL10	GP-3	MTR	MG562	GP-41	MOB	MH383J	GP-3531	EXP	MO1106	G-870	MFIL
MFL12	GP-13	MTR	MG580	GG-580	MOB	MH389	GP-68	MFIL	MO111	GP-46	MOB
MFL147	GP-330	MTR	MG6	GG-16	MEI	MH392	GP-390 ³	MFIL	MO1114	G-191	MFIL
MFL173	GP-81 ³¹	MTR	MG636843	GP-34	JOND	MH398	GP-46	MFIL	MO1115	G-335	MFIL
MFL173	GP-9 ⁵⁸	MTR	MG6563	GG-61	MOB	MHK-6714-A	GP-1	MFIL	MO1115P	G-335	MFIL
MFL175	GP-14	MTR	MG6563	GG-62	MOB	MHK6714M	GP-1	FORD	MO1125	G-238	MFIL
MFL1995	GP-562	MTR	MG6566	GG-65	MOB	MKE2901	GAK-403	FLOM	MO1126	G-222	MFIL
MFL1A	GP-1	MTR	MG66	GG-32	MOB	ML 1002	GP-6811	MNH	MO1126	G-836	MFIL
MFL2	GP-5	MTR	MG7	GG-17	MEI	ML 1008	GP-149	MNH	MO1127	G-152	MFIL
MFL20	G-6	MTR	MG7018	GG-7018	MOB	ML 1012	GP-3682	MNH	MO1127P	G-152	MFIL
MFL2012	GP-44	MTR	MG7018	GG-7019	MOB	ML 1012	GP-38	MNH	MO1130	G-191	MFIL
MFL2013	GP-149	MTR	MG840	GG-42	MOB	ML 1019	G-70	MNH	MO1142	G-143	MFIL
MFL2014	GP-58	MTR	MG847368	GG-5 L	JOND	ML 1021	GP-457	MNH	MO1151	G-566	MFIL
MFL2018	GP-91	MTR	MG862	GG-30	MOB	ML 1026	GP-408	MNH	MO116	G-813	MFIL
MFL2020	GP-6811	MTR	MG86504145	GAK-16	JOND	ML 1030	GP-406	MNH	MO1164	G-133	MFIL
MFL2032	GP-3675	MTR	MG86512355	GA-459	JOND	ML 1031	G-912	MNH	MO1164	G-989	MFIL
MFL2033	GP-205	MTR	MG86512356	GAK-458	JOND	ML 1033	G-180	MNH	MO1179	G-25	MFIL
MFL2042	GP-291	MTR	MG872	GG-1872	MOB	ML 1036	GP-212	MNH	MO118	G-870	MFIL
MFL228	GP-81 ³¹	MTR	MG881	GG-92	MOB	ML1000	GP-46	MNH	MO118P	G-870	MFIL
MFL228	GP-9 ⁵⁸	MTR	MG89	GG-25	MOB	ML1001	GP-81	MNH	MO119	GP-1	MOB
MFL289	GP-28 ⁴⁵	MTR	MG9611973	GG-5 L	JOND	ML1004	GP-1	MNH	MO121P	G-870	MFIL
MFL289	GP-38 ⁷⁶	MTR	MG9800097	GP-34	JOND	ML1005	GP-3600	MNH	MO123	G-870	MFIL
MFL299	GP-31	MTR	MG9800633	GP-761H	JOND	ML1006	GP-68	MNH	MO123	GP-3429	MOB
MFL307	GP-51	MTR	MGA108	GA-55	MCG	ML1009	GP-157	MNH	MO123P	G-870	MFIL
MFL31	GP-46	MTR	MGA4	GA-70	MCG	ML1011	GP-205	MNH	MO124	G-834	MFIL
MFL313	GP-22	MTR	MGA45	GA-77	MCG	ML1014	GP-91	MNH	MO13	GP-13	MAR

REFERENCIA CRUZADA

Para números Gonher con Superíndice vea página 651
For Gonher with Superscript numbers see page 651

Numero	Gonher	Fabricante	Numero	Gonher	Fabricante	Numero	Gonher	Fabricante	Numero	Gonher	Fabricante
Number	Gonher	Manufacturer	Number	Gonher	Manufacturer	Number	Gonher	Manufacturer	Number	Gonher	Manufacturer
MO13.....	GP-13	MILE	MO5230.....	GP-128	MOB	MP12.....	GP-3980	MTRV	MPA70.....	GA-3647	KMA
MO130.....	G-801	MFIL	MO5250.....	G-112	MOB	MP14.....	GP-3600	KMA	MPA71.....	GA-274	KMA
MO132.....	G-833	MFIL	MO5274.....	G-765	MOB	MP15.....	GP-3600	MTRV	MPA77.....	GA-274	MTRV
MO16.....	GP-81	MILE	MO5288.....	GP-3675	MOB	MP15.....	GP-13	KMA	MPA76.....	GA-80	KMA
MO162.....	G-870	MFIL	MO5309.....	G-45	MOB	MP16.....	GP-13	MTRV	MPA78.....	GA-89	KMA
MO162P.....	G-870	MFIL	MO5313.....	GP-408	MOB	MP16.....	GP-2951	KMA	MPA79.....	GA-3588	KMA
MO17.....	GP-81	MOB	MO5315.....	G-72	MOB	MP20.....	GP-58	KMA	MPA79.....	GA-3588	MTRV
MO173.....	GP-3980	MOB	MO5320.....	G-963	MILE	MP20.....	GP-81	MTRV	MPA8.....	GA-70	KMA
MO18.....	GP-81	MOB	MO5335.....	GP-178	MOB	MP23.....	GP-24 ²⁶	KMA	MPA8.....	GA-70	MTRV
MO182.....	G-191	MFIL	MO5343.....	GP-149	MILE	MP23.....	GP-462 ²⁹	KMA	MPA81.....	GA-153	KMA
MO187.....	G-5000	MFIL	MO5436.....	G-49	MOB	MP25.....	GP-42	KMA	MPA82.....	GA-3916	KMA
MO192.....	G-613	MFIL	MO5505.....	G-70	MOB	MP26.....	GP-28 ⁸	KMA	MPA83.....	GA-4303	KMA
MO193.....	G-834	MFIL	MO5515.....	G-3752	MOB	MP26.....	GP-430 ⁹	KMA	MPA84.....	GA-4325	KMA
MO193.....	GP-40	MOB	MO5602.....	GA-133	ASAH	MP26.....	GP-28 ⁸	MTRV	MPA84.....	GA-4325	MTRV
MO195.....	GP-3600	MOB	MO561.....	GP-28 ⁸	MAR	MP26.....	GP-430 ⁹	MTRV	MPA85.....	GA-3814	KMA
MO1A.....	GP-1	MOB	MO561.....	GP-430 ⁹	MAR	MP27.....	GP-3531 EXP	KMA	MPA87.....	GA-277	KMA
MO2.....	GP-68	MILE	MO6607.....	GP-91	MILE	MP27.....	GP-3531 EXP	MTRV	MPA87.....	GA-277	MTRV
MO2167.....	GP-171	MOB	MO7317.....	GP-149	MILE	MP3.....	GP-3	KMA	MPA88.....	GA-5056	KMA
MO217F.....	G-870	MFIL	MO81.....	GP-81 ³¹	MOB	MP3.....	GP-3	MTRV	MPA88.....	GA-5056	MTRV
MO221F.....	G-870	MFIL	MO81.....	GP-9 ⁵⁸	MOB	MP31.....	GP-40	KMA	MPA89.....	GA-730	KMA
MO228.....	GP-81	MAR	MO8212.....	GP-212	MILE	MP32.....	GP-3682	KMA	MPA89.....	GA-730	MTRV
MO25.....	GP-20	MAR	MO8712.....	G-72	MILE	MP32.....	GP-37	KMA	MPA9.....	GA-74	KMA
MO25.....	GP-20	MILE	MO8765.....	G-765	MILE	MP32.....	GP-37	MTRV	MPA9.....	GA-74	MTRV
MO252.....	GP-28 ⁸	MOB	MO8806.....	G-45	MILE	MP32.....	GP-37	MTRV	MPA92.....	GA-140	KMA
MO252.....	GP-430 ⁸	MOB	MO8873.....	GP-408	MILE	MP33.....	GP-171	KMA	MPA93.....	GA-3901	KMA
MO256.....	GP-91	ASAH	MO8A.....	GP-171	KMA	MP38.....	GP-310	KMA	MPA93.....	GA-3901	MTRV
MO257.....	GP-310	MOB	MO9010.....	GP-457	MILE	MP38.....	GP-310	MTRV	MPA94.....	GA-174	KMA
MO257.....	GP-3569	MOB	MO9018.....	G-49	MILE	MP38.....	GP-3569	KMA	MPA94.....	GA-174	MTRV
MO2815.....	GP-3569	LETR	MOD5.....	G-31	GIS	MP404.....	G-1121	MFIL	MPL302.....	G-1175	MPL
MO2815.....	GP-3569	MAR	MOD5-DB.....	G-31	GIS	MP409.....	G-296	MFIL	MPL308.....	G-1166	MPL
MO2817.....	GP-3531 EXP	MAR	MODEL80.....	G-294	ROO	MP409.....	G-296-B	MFIL	MPL3120.....	G-1143 ³⁰	MPL
MO2821A.....	GP-58	MOB	MOF1.....	GP-1	MOB	MP41.....	GP-58	KMA	MPL3125.....	GS-2033	MPL
MO2856A.....	GP-40	MAR	MOF110X.....	GP-3985	MASE	MP411.....	GP-1123	MFIL	MPL3126.....	GS-2034	MPL
MO2865.....	GP-42	MAR	MOF116.....	GP-53	MOB	MP42.....	GP-3980	KMA	MPL339.....	G-1123	MPL
MO288.....	GP-3766	MOB	MOF128X.....	GP-3682	MASE	MP423.....	G-1175	MFIL	MPL359A.....	G-296	MPL
MO289.....	GP-3985	MOB	MOF13.....	GP-13	MECC	MP427.....	G-1173	MFIL	MPL359A.....	G-296-B	MPL
MO291.....	GP-3531 EXP	MOB	MOF130X.....	GP-3682	MASE	MP43.....	GP-3985	KMA	MPL377.....	GP-110	MPL
MO30.....	GP-3	MAR	MOF132X.....	GP-310	MASE	MP43.....	GP-3985	MTRV	MPL391.....	G-1173	MPL
MO30.....	GP-3	MILE	MOF133X.....	GP-28 ⁸	MASE	MP43.....	GP-3985	MTRV	MPL391.....	GP-1101	MPL
MO33.....	GP-20	MOB	MOF133X.....	GP-430 ⁸	MASE	MP432.....	G-297	MFIL	MPL397D.....	GPP-14	MPL
MO3387A.....	GP-46	MAR	MOF134X.....	GP-310	MASE	MP45.....	G-297-B	MFIL	MPL398.....	G-1174	MPL
MO3387A.....	GP-46	MILE	MOF136X.....	GP-91	MASE	MP45.....	GP-462	KMA	MPL403.....	GP-56	MPL
MO3429.....	GP-3429	MAR	MOF141.....	G-200	MOB	MP450.....	GP-1122	MFIL	MPL408.....	GP-26	MPL
MO3429.....	GP-3429	MILE	MOF250.....	GP-57	MOB	MP455.....	GP-110	MFIL	MPL498.....	GP-55	MPL
MO3506.....	GP-44	MILE	MOF2870A.....	GP-28 ⁸	MECC	MP459.....	G-1122	MFIL	MPL498.....	GP-27	MPL
MO3531.....	GP-3531 EXP	MILE	MOF2870A.....	GP-430 ⁸	MECC	MP477.....	GP-1107	MFIL	MPL499.....	GP-26	MPL
MO3535.....	GP-3980	MILE	MOF33.....	GP-20	MOB	MP5.....	GP-20	KMA	MPL499.....	GP-1011Q	MPL
MO3600.....	GP-3600	MILE	MOF3429.....	GP-3429	MECC	MP5.....	GP-20	MTRV	MPL5264.....	GP-390	MPL
MO3614.....	GP-58	MILE	MOF3531.....	GP-3531 EXP	MECC	MP505.....	G-1121	MFIL	MPL5268.....	GP-178	MPL
MO3651A.....	GP-171	MILE	MOF3600.....	GP-3600	MECC	MP505F.....	G-1121F	MFIL	MPL5295.....	GP-171	MPL
MO3675.....	GP-3675	MILE	MOF3682.....	GP-3682	MECC	MP519.....	G-1174	MFIL	MPL5539.....	GP-191	MPL
MO3682.....	GP-3682	MILE	MOF3682.....	GP-37	MECC	MP551.....	GP-38	ASAH	MPL5929.....	GP-3000	MPL
MO3682.....	GP-37	MILE	MOF373.....	GP-23	MECC	MP554.....	GG-5 L	ASAH	MPL680.....	GP-14	MPL
MO3766.....	GP-3766	MILE	MOF37X.....	GP-46	MASE	MP791181.....	GA-360	GMCC	MPL701.....	G-238	MPL
MO3786.....	GP-562	MILE	MOF39P.....	G-834	MASE	MP9.....	GP-9 ⁵⁸	KMA	MPL708.....	G-566	MPL
MO3976.....	GP-178	MILE	MOF43.....	GP-81 ³¹	MECC	MP9.....	GP-81 ³¹	MTRV	MPL740.....	G-191	MPL
MO3980.....	GP-3980	MILE	MOF43.....	GP-9 ⁵⁸	MECC	MPA10.....	GA-85	KMA	MPL791N.....	G-33	MPL
MO40.....	GP-13	MOB	MOF47P.....	G-836	MASE	MPA10.....	GA-85	MTRV	MPL792.....	G-500	MPL
MO400.....	GP-3600	MAR	MOF49.....	GP-3	MOB	MPA11.....	GA-4828	KMA	MPL7930.....	GP-26	MPL
MO4006.....	GP-44	MOB	MOF4967.....	GP-157	MECC	MPA11.....	GA-4828	MTRV	MPL7937.....	GP-1122	MPL
MO4007.....	GP-44	MOB	MOF5.....	GP-5	MOB	MPA12.....	GA-59	KMA	MPL796.....	G-31	MPL
MO4011.....	GP-3980	MOB	MOF59X.....	GP-28 ⁸	MASE	MPA12.....	GA-59	MTRV	MPL7971.....	GP-1122	MPL
MO422.....	GP-3985	ASAH	MOF59X.....	GP-430 ⁸	MASE	MPA13.....	GA-55	KMA	MPL846.....	GP-36	MPL
MO429.....	GP-91	ASAH	MOF64.....	GP-3600 ²⁷	MOB	MPA13.....	GA-55	MTRV	MPL862.....	GP-53	MPL
MO43.....	GP-81 ³¹	MILE	MOF64.....	GP-38 ⁸⁹	MOB	MPA14.....	GA-3681	KMA	MPL872.....	GP-34	MPL
MO43.....	GP-9 ⁵⁸	MILE	MOF65X.....	GP-40	MASE	MPA17.....	GA-303	KMA	MPL926.....	GP-43	MPL
MO432.....	GP-40	AMCO	MOF78X.....	GP-28 ⁸	MASE	MPA17.....	GA-303	MTRV	MPL942A.....	G-750	MPL
MO432.....	GP-40	ASAH	MOF78X.....	GP-430 ⁸	MASE	MPA19.....	GA-57	KMA	MPL942D.....	G-750	MPL
MO438.....	GP-91	ASAH	MOF80P.....	G-834	MASE	MPA19.....	GA-57	MTRV	MPL969.....	GP-57	MPL
MO4386.....	GP-156	MILE	MOF81.....	GP-81 ³¹	MOB	MPA2.....	GA-50	MTRV	MPO694.....	G-870	WHIT
MO4457.....	GP-3682	MOB	MOF81.....	GP-9 ⁵⁸	MOB	MPA20.....	GA-75	KMA	MPO695.....	G-801	COCT
MO4457.....	GP-37	MOB	MOF82X.....	GP-3531 EXP	MASE	MPA23.....	GA-192	KMA	MPO695.....	G-801	WHIT
MO4459.....	GP-91	MOB	MOF86X.....	GP-40	MASE	MPA23.....	GA-192	MTRV	MPO795.....	G-801	WHIT
MO4460.....	GP-91	MOB	MOF90X.....	GP-3816	MASE	MPA25.....	GA-54	KMA	MPO799.....	G-834	COCT
MO4466.....	GP-28 ⁸	MOB	MP-017.....	GAC-1	MAIR	MPA27.....	GA-3523	KMA	MPO799.....	G-834	WHIT
MO4466.....	GP-430 ⁸	MOB	MP-029.....	GAC-6	MAIR	MPA27.....	GA-3523	MTRV	MPO981.....	G-834	COCT
MO4477.....	GP-156	MOB	MP-033.....	GAC-4	MAIR	MPA29.....	GA-271	KMA	MPO981.....	G-834	WHIT
MO4484.....	GP-212	MOB	MP-041.....	GAC-7	MAIR	MPA3.....	GA-77	KMA	MR 127077.....	GA-283	MIITS
MO4610.....	GP-149	MOB	MP-044.....	GAC-10 ²⁸	MAIR	MPA3.....	GA-77	MTRV	MR 239024.....	GA-283	MIITS
MO4612.....	GP-91	MOB	MP-044.....	GAC-8	MAIR	MPA30.....	GA-735	KMA	MR1002P10.....	G-24	MPFI
MO4619.....	GP-3985	MOB	MP-057.....	GAC-5	MAIR	MPA30.....	GA-735	MTRV	MR188657.....	GA-607	MIITS
MO4620.....	GP-149	MOB	MP-060.....	GAC-3	MAIR	MPA32.....	GA-86	KMA	MR204132.....	GG-164	MIITS
MO4622.....	GP-91	MOB	MP-066-2.....	GAC-13	MAIR	MPA4.....	GA-3637	KMA	MR5.....	GP-66	ENGR
MO4631.....	GP-205	MOB	MP-076.....	GAC-9	MAIR	MPA4.....	GA-3637	MTRV	MR552951.....	GA-607	MIITS
MO4651.....	GP-68	MOB	MP0799.....	G-834	COCT	MPA50.....	GAD-1	KMA	MR571396.....	GA-606	MIITS
MO4670.....	GP-81	MOB	MP0904-000.....	GP-1	MARP	MPA51.....	GAD-3	KMA	MR571471.....	GA-7142	MIITS
MO4681.....	GP-38	MILE	MP0905-000.....	GP-3531 EXP	MARP	MPA53.....	GAVW-2	KMA	MR571473.....	GA-605	MIITS
MO4872.....	GP-562	MOB	MP-097.....	GAC-9	MAIR	MPA53.....	GAVW-2	MTRV	MS.....	G-31	UNI
MO49.....	GP-3	MOB	MP1.....	GP-1	KMA	MPA55.....	GA-3490	KMA	MS3.....	GP-34	SCHR
MO4967.....	GP-157	MILE	MP10.....	GP-1	MTRV	MPA6.....	GA-273	KMA	MS7.....	GP-34	SCHR
MO5.....	GP-205	MILE	MP10.....	GP-3429	KMA	MPA60.....	GA-2740	KMA	MSP.....	G-31	UNI
MO514.....	G-834	AEC	MP10.....	GP-3429	MTRV	MPA66.....	GA-3566	KMA	MT11.....	G-191	MOB
MO514.....	G-834	ASAH	MP11.....	GP-46	KMA	MPA7.....	GA-71	KMA	MT114.....	G-122	MOB
MO519.....	GP-462	AEC	MP11.....	GP-46	MTRV						
MO520.....	GP-91	ASAH	MP114.....	GAC-11	MAIR						
MO523.....	GP-462	ASAH	MP12.....	GP-3980	KMA						

Referencia Cruzada por Numero de Parte

Cross Reference by Part Number



Numero	Gonher	Fabricante	Numero	Gonher	Fabricante	Numero	Gonher	Fabricante	Numero	Gonher	Fabricante	
Number	Gonher	Manufacturer	Number	Gonher	Manufacturer	Number	Gonher	Manufacturer	Number	Gonher	Manufacturer	
MT114		G-338 MOB	N02206	.GA-33	BAUR	N1751	.GA-361	NUE	NA-1208C		.GA-164	PHOE
MT118		G-335 MOB	N0223	.GA-3523	NUE	N1752	.GA-107	NUE	NA-1267C		.GA-300	PHOE
MT126		G-836 MOB	N0225	.GA-77	NUE	N1760	.GA-6129	NUE	NA-1279C		.GA-279	PHOE
MT167		GP-149 BRAN	N0237	.GA-12	NUE	N1766	.GA-376	NUE	NA-1280C		.GA-300	PHOE
MT169		G-5000 MOB	N0238	.GA-78	NUE	N1783	.GA-885	NUE	NA-1284C		.GA-217	PHOE
MT17		GP-31 MOB	N0241	.GA-3647	NUE	N1788	.GA-251	NUE	NA-1285C		.GA-141	PHOE
MT179		G-813 MOB	N0242	.GA-4325	NUE	N1792	.GA-378	NUE	NA-1291C		GAVW-620	PHOE
MT189		G-139 MOB	N0243	.GA-230	NUE	N1798	.GA-6128	NUE	NA-1292C		.GA-175	PHOE
MT19L		G-871 MOB	N0245	.GA-3681	NUE	N1801	.GA-422	NUE	NA-1298C		.GA-132	PHOE
MT24050		GG-45 MIGH	N0247	.GA-3647	NUE	N19505-26	.GA-357	POCL	NA-1323C		GAD-118	PHOE
MT30		G-331 MOB	N0248	.GA-86	NUE	N2003	.GA-3501	NUE	NA-1341C		.GA-240	PHOE
MT40		G-238 MOB	N0249	.GA-57	NUE	N2008A	.GA-59	NUE	NA-1362R		.GA-200	PHOE
MT40FM		G-238 MOB	N0251	.GA-377	NUE	N2033	.GA-375	NUE	NA-1362R		GP-58	PHOE
MT48		GP-10 MOB	N0262	.GA-325	NUE	N2040	.GA-483	NUE	NA-1416C		.GA-128	PHOE
MT5-1		GP-14 MOB	N0268	.GA-39	NUE	N2051A	.GA-75	NUE	NA-141U		.GA-2719B	PHOE
MT61		GG-5 L MIGH	N0271	.GA-85	NUE	N2052A	.GA-429	NUE	NA-1509CT		.GA-1616	PHOE
MT61		G-1163 MOB	N0272	.GA-730	NUE	N2062	.GA-356	NUE	NA-1514C		.GA-2198 ⁹	PHOE
MT815		GP-26 MOB	N0279	.GA-3588	NUE	N2075	.GA-509 ¹⁴	NUE	NA-1514C		.GA-438 ¹¹	PHOE
MT816		GP-27 MOB	N0291	.GA-372	NUE	N2079	.GA-229	NUE	NA-1517CT		.GA-1615	PHOE
MTC149		G-296 MOB	N0300	.GA-105	NUE	N2091A	.GA-89	NUE	NA-1518C		.GA-348	PHOE
MTC149		G-296-B MOB	N0302	.GA-90	NUE	N2095	.GA-493 ¹⁰⁸	NUE	NA-152CR		.GA-80	PHOE
MTC149DV		G-297 MOB	N0303	.GA-55	NUE	N21611	.GP-92	GILB	NA-1547CT		.GA-130	PHOE
MTC149DV		G-297-B MOB	N0305	.GA-105	NUE	N223-1	.G-45	CITR	NA-1548C		.GA-301	PHOE
MTC15		GPP-14 MOB	N0306	.GA-56	NUE	N22601	.GP-92	GILB	NA-1604C		.GA-158	PHOE
MTC21-FM		G-1166 MOB	N0308	.GA-56	NUE	N231-23-802	.GP-91	MZDA	NA-1617C		.GA-164	PHOE
MTM00435		GP-34 MTM	N0325	.GA-80	NUE	N23580A	.G-31	DIAM	NA-1676		.GA-479	PHOE
MTM00436		GP-34 MTM	N0331	.GA-44	NUE	N2431	.GA-589	NUE	NA-174P		.GA-139	PHOE
MTW		GP-91 NIPP	N0381	.GA-389	NUE	N2475	.GA-405	NUE	NA-178CR		.GA-192	PHOE
MTW61		GP-91 NIPP	N0385	.GA-3551 ³⁵	NUE	N2581	.GA-378	NUE	NA-188P		.GA-6690	PHOE
MTY1		GP-1 MIGH	N0385	.GA-3551 XT ⁶⁴	NUE	N2585	.GA-608	NUE	NA-193P		.GA-5466	PHOE
MTY141		G-200 MIGH	N0395	.GA-694	NUE	N2587	.GA-879	NUE	NA-196P		.GA-322	PHOE
MTY33		GP-20 MIGH	N0481	.GA-389	NUE	N2595	.GA-6880	NUE	NA-2039C		.GA-224	PHOE
MTY49		GP-3 MIGH	N0581	.GA-371	NUE	N27	.G-1163	TNC	NA-2040C		.GA-168	PHOE
MTY5		GP-5 MIGH	N0601	.GA-253	NUE	N326-20-490	.GG-217	MZDA	NA-2055C		.GA-248	PHOE
MTY81		GP-81 ³¹ MIGH	N0615A	.GA-70	NUE	N326-20-490A	.GG-217	MZDA	NA-211		GAD-3	PHOE
MTY81		GP-9 ⁵⁸ MIGH	N0681	.GA-371	NUE	N35	.G-31	PUR	NA-212		GAD-1	PHOE
MU1179		G-25 MFIL	N07033	.GA-26	BAUR	N35580	.G-750	DIAM	NA-212CR		.GA-55	PHOE
MU1194		G-25 MFIL	N07033	.GA-26 ¹¹²	EAIR	N3Y6-14-302	.GP-91	MZDA	NA-218		GAD-30	PHOE
MU5074		GP-54 ¹¹ ZETT	N08109	.GAK-625	BAUR	N401267	.GA-106 ⁶⁶	CHIC	NA-218CR		.GA-78	PHOE
MU5074		GP-66 ¹⁰ ZETT	N08176	.GA-360	BAUR	N401267	.GA-326 ⁷¹	CHIC	NA-22051		.GA-476	PHOE
MU5345		GP-54 ¹¹ ZETT	N08177	.GA-361	BAUR	N403638	.GA-33	CHIC	NA-221		GAD-129	PHOE
MU5345		GP-66 ¹⁰ ZETT	N08463	.GA-106 ⁶⁶	BAUR	N404078	.GAK-403	CHIC	NA-22117		GAVW-4	PHOE
MU5380		GP-1122 ZETT	N08463	.GA-326 ⁷¹	BAUR	N404079	.GAK-16	CHIC	NA-2235-1R		.GA-50	PHOE
MU5635		GP-1122 ZETT	N08464	.GA-206	BAUR	N4050	.GP-1122	BOG	NA-2263R		.GA-71	PHOE
MU57120		GP-36 ZETT	N08505-29	.GA-6127	POCL	N4051	.GP-1122	BOG	NA2269		.GA-4303	ASAH
MU7512		GP-36 ZETT	N09505-59	.G-836	POCL	N4052	.GP-1122	BOG	NA2273		.GA-75	ASAH
MW2010		GP-1010Q MOB	N1010	.G-1121F	TNC	N4061	.GP-1122	BOG	NA2276		GAK-20	ASAH
MW3908		GP-2071W MOB	N1010FR	.G-1121	TNC	N4099	.GPP-1122	BOG	NA2282		.GA-27	ASAH
MW3910		GP-1011Q MOB	N1040	.GAK-625	NUE	N4105	.GPP-1122	BOG	NA-2290		GAVW-4	PHOE
MW-7MW		GP-34 SCHR	N1117	.G-296	TNC	N4106	.GPP-1122	BOG	NA-238AU		GAD-15	PHOE
MX85749		G-1173 JOND	N1117	.G-296-B	TNC	N4121	.GP-1122	BOG	NA-238U		.GA-4303	PHOE
MXS5X 9601 DA1		.GA-280 FORD	N1118	.G-297	TNC	N4150	.GP-1122	BOG	NA-240		.GA-75	PHOE
MXS5X9601DA		.GA-280 MTR	N1118	.G-297-B	TNC	N4153	.G-1121	BOG	NA-2443R		.GA-230	PHOE
MXW426731BA		GP-68 MTR	N1124	.G-1173	TNC	N4154	.GP-1122	BOG	NA-25114		.GA-2114	PHOE
MZ690072		GP-149 MITS	N1127	.GA-24	NUE	N4158	.GPP-1122	BOG	NA-26110-1		.GA-2110	PHOE
MZ690116		GP-6811 MITS	N1131	.GA-8047	NUE	N41580	.G-500	DIAM	NA-26126		.GA-2146	PHOE
MZT42-20-490		GG-150 KIA	N1138	.GA-109	NUE	N4159	.GPP-1122	BOG	NA-26144		GAVW-622	PHOE
			N1141	.G-1123	TNC	N4164	.GP-1122	BOG	NA-26151		GAVW-622	PHOE
			N1142	.G-1123	TNC	N4180	.GP-110	BOG	NA-26168		GAVW-622	PHOE
			N1144	.GA-360	NUE	N4200	.G-297	BOG	NA266		GAD-30	ASAH
			N1147	.G-1121	TNC	N4200	.G-297-B	BOG	NA-27154-1		GAVW-121	PHOE
			N1147SC	.G-1121F	TNC	N4201	.G-296	BOG	NA274		.GA-360	ASAH
			N1158	.G-1121F	BOG	N4201	.G-296-B	BOG	NA275		.GA-361	ASAH
			N1173	.GG-1173	TNC	N4205	.GG-189	BOG	NA-279		GAD-30	PHOE
			N1174	.G-1174	TNC	N44580	.GA-37	DIAM	NA281		.GA-106 ⁶⁶	ASAH
			N11846	.G-11816	TNC	N6660	.GA-361	CASE	NA281		.GA-326 ⁷¹	ASAH
			N11861	.G-1123	TNC	N6757	.GP-761H	CASE	NA282		.GA-206	ASAH
			N11881	.G-296	TNC	N6778	.GAK-1532	CASE	NA-2860		.GA-277	PHOE
			N11881	.G-296-B	TNC	N7028	.GAK-625	CASE	NA289		GAD-15	ASAH
			N1261	.G-1121	BOG	N7332	.GP-761H	CASE	NA290		.GA-6129	ASAH
			N1270	.G-1123	BOG	N9025	.GP-761H	CASE	NA291		GAD-1	ASAH
			N1325	.G-1121	BOG	N9030	.GA-37	NUE	NA293		GAD-1	ASAH
			N1326	.G-1123	BOG	N9354	.G-1123F	BOG	NA-2938R		.GA-3425	PHOE
			N1330	.GA-109	NUE	N9359	.G-1121F	BOG	NA294		GAD-1	ASAH
			N1366	.GA-209	NUE	N9675	.GP-1122	BOG	NA296		GAD-3	AMCO
			N1374	.GA-2984	NUE	N9960	.G-33	CASE	NA296		GAD-3	ASAH
			N1379	.GA-229	NUE	NA-1052CR	.GA-4325	PHOE	NA-2964		GAD-15	PHOE
			N14232	.GP-761H	CASE	NA-105N	.GA-264	PHOE	NA-301P		.GA-7142	PHOE
			N1529	.GA-27	NUE	NA-1089C	.GA-277	PHOE	NA-31152-1		GAVW-120	PHOE
			N152H1010	.GP-28 ⁸	MITTS	NA-1089N	.GA-278R	PHOE	NA-319P		.GA-7344	PHOE
			N152H1010	.GP-430 ⁸	MITTS	NA-1092CR	.GA-422	PHOE	NA-329CR		.GA-57	PHOE
			N1530	.GA-109	NUE	NA-1096C	.GA-6479	PHOE	NA-329P		.GA-607	PHOE
			N1532	.GA-26	NUE	NA-1097C	.GA-7007	PHOE	NA-332CR		.GA-325	PHOE
			N1533	.GA-9334	NUE	NA-1103CR	.GA-70	PHOE	NA-333CR		.GA-192	PHOE
			N1535	.GA-509 ¹⁴	NUE	NA-1113P	.GA-3814	PHOE	NA-3394		.GA-2194	PHOE
			N1549	.GA-37	NUE	NA-1115C	.GA-5056	PHOE	NA-34109		GAVW-2	PHOE
			N1555	.GA-9045	NUE	NA-1131C	.GA-273	PHOE	NA-3463		GAVW-2	PHOE
			N1556	.GA-9045	NUE	NA-1135C	.GA-7017	PHOE	NA-3474		GAVW-2	PHOE
			N1566	.GA-209	NUE	NA-1144C	.GA-471	PHOE	NA-3483-1		.GA-4365	PHOE
			N1572	.GA-106 ⁶⁶	NUE	NA-1146C	.GA-471	PHOE	NA-348CR		.GA-59	PHOE
			N1572	.GA-326 ⁷¹	NUE	NA-114CR	.GA-90	PHOE	NA-3521		.GA-853R	PHOE
			N1574	.GA-2984	NUE	NA-1163C	.GA-165	PHOE	NA-3526		.GA-712R	PHOE
			N1680A	.GA-192	NUE	NA-1166C	.GA-3901	PHOE	NA-3536		.GA-534R	PHOE
			N1720	.GA-31	NUE	NA-1172	.GA-3916	PHOE	NA-3537		.GA-539R	PHOE
			N1726	.GA-7716	NUE	NA-117CR	.GA-77	PHOE	NA-3540		.GA-930R	PHOE
			N1750	.GA-1095	NUE	NA-1195C	.GA-275	PHOE	NA-3540B		.GA-890R	PHOE

REFERENCIA CRUZADA

N

N00369		G-225	BAUR
N01128		GAK-403	BAUR
N0137		GA-135	NUE
N01371		GA-24	BAUR
N0150		GA-11	NUE
N0151		GA-373	NUE
N0175		GA-3424	NUE
N0178		GA-3425	NUE
N01817		GA-27	BAUR
N0187		GA-50	NUE
N0188		GAD-3	NUE
N01886		GAK-20	BAUR
N0191		GA-372	NUE
N0193		GA-7	NUE
N0200		GA-2719B	NUE
N0201		GA-74	NUE
N0204		GA-3490	NUE
N0209		GA-349	NUE
N0210		GA-3637	NUE
N0216		GA-3300	NUE
N0218		GA-2740	NUE
N0219		GA-303	NUE

Para números Gonher con Superíndice vea página 651
For Gonher with Superscript numbers see page 651

Numero	Gonher	Fabricante	Numero	Gonher	Fabricante	Numero	Gonher	Fabricante	Numero	Gonher	Fabricante
Number	Gonher	Manufacturer	Number	Gonher	Manufacturer	Number	Gonher	Manufacturer	Number	Gonher	Manufacturer
NA-354CR	GA-730	PHOE	NFF-007	GG-268	NAM	NOH-004	GP-42	NAM	NW3537	GA-54	NATW
NA-355CR	GA-85	PHOE	NFG-004	GG-240	NAM	NOMA-003	GP-149	NAM	NW3549	GA-89	NATW
NA-3560	GA-499R	PHOE	NFG-005	GG-46	NAM	NOMA-004	GP-149	NAM	NW3559	GA-271	NATW
NA-3566	GA-518R	PHOE	NFG-007	GG-66	NAM	NOMI-002	GP-149	NAM	NW3588	GA-3588	NATW
NA-3566	GA-518R	PUR	NFG-009	GG-580	NAM	NON-002	GP-3682	NAM	NW3597	GA-735	NATW
NA-3569	GA-197R	PHOE	NFG-010	GG-3728	NAM	NON-002	GP-37	NAM	NW3600	GP-3600	NATW
NA-3569B	GA-768R	PHOE	NFG-011	GG-581	NAM	NON-012	GP-149	NAM	NW3637	GA-3637	NATW
NA-3577R	GA-517R	PHOE	NFG-013	GG-146	NAM	NON-013	GP-3682	NAM	NW3647	GA-3647	NATW
NA-3577R	GA-303	PHOE	NFG-014	GG-146	NAM	NON-013	GP-37	NAM	NW3660	GA-277	NATW
NA-3595	GA-600R	PHOE	NFH-001	GG-190	NAM	NON-018	GP-38	NAM	NW3681	GA-3681	NATW
NA-3601	GA-682R	PHOE	NFH-003	GG-160	NAM	NON-019	GP-28 ⁵	NAM	NW3717	GA-274	NATW
NA-3601B	GA-683R	PHOE	NFH-005	GG-181	NAM	NON-019	GP-430 ⁸	NAM	NW381	GA-74	NATW
NA-3602	GA-221R	PHOE	NFH-006	GG-214	NAM	NOT-005	GP-157	NAM	NW3814	GA-3814	NATW
NA-3602B	GA-723R	PHOE	NFH-015	GG-215	NAM	NOT-008	GP-156	NAM	NW3902	GA-253	NATW
NA-3604	GA-435R	PHOE	NFH-017	GG-181	NAM	NPAC-001	GA-132	NAM	NW3915	GA-3915	NATW
NA-3605	GA-673R	PHOE	NFHY-005	GG-114	NAM	NPAC-002	GA-141	NAM	NW3916	GA-3916	NATW
NA-3611	GA-968R	PHOE	NFI-002	GG-260	NAM	NPAD-001	GA-3647	NAM	NW3924	GA-153	NATW
NA-3612	GA-413R	PHOE	NFI-005	GG-255	NAM	NPAH-001	GA-381	NAM	NW3980	GP-3980	NATW
NA-413	GA-2740	PHOE	NFM-016	GG-298	NAM	NPAH-002	GA-386	NAM	NW3985	GP-3985	NATW
NA-433CR	GA-86	PHOE	NFM-020	G-1123	NAM	NPAH-005	GA-382	NAM	NW400	GP-2071W	FLR
NA-467CR	GA-75	PHOE	NFM-026	GPP-1122	NAM	NPAH-009	GA-172	NAM	NW43	GP-81 ³¹	NATW
NA-477CR	GA-59	PHOE	NFMA-004	GG-1872	NAM	NPAH-010	GA-384	NAM	NW43	GP-9 ⁸	NATW
NA-479	GA-595	PHOE	NFMA-005	GG-150	NAM	NPAH-017	GA-170	NAM	NW4325	GA-4325	NATW
NA-479CR	GA-429	PHOE	NFMA-011	GG-268	NAM	NPAH-019	GA-163	NAM	NW4828	GA-4828	NATW
NA-494CR	GA-74	PHOE	NFMA-012	GG-142	NAM	NPAI-002	GA-139	NAM	NW5056	GA-5056	NATW
NA-49R	GA-70	PHOE	NFMA-013	GG-148	NAM	NPAM-002	GA-133	NAM	NW5058	GA-273	NATW
NA-592CR	GA-3300	PHOE	NFMA-015	GG-217	NAM	NPAM-005	GA-2106	NAM	NW6366	GA-174	NATW
NA-736CR	GA-3523	PHOE	NFME-001	GG-189	NAM	NPAM-007	GA-216	NAM	NW8A	GP-1	NATW
NA-742CR	GA-3425	PHOE	NFMI-003	GG-185	NAM	NPAM-015	GA-2740	NAM	NWA313	GA-170	NATW
NA-751C	GA-277	PHOE	NFMI-004	GG-185	NAM	NPAM-026	GA-595	NAM			
NA-753CR	GA-89	PHOE	NFMI-005	GG-185	NAM	NPAM-036	GA-471	NAM			
NA-773CR	GA-3588	PHOE	NFMI-008	GG-114	NAM	NPAN-002	GA-6619 ¹	NAM			
NA-785CR	GA-3647	PHOE	NFMI-015	GG-185	NAM	NPAN-002	GA-6620 ⁵	NAM			
NA-826CR	GA-381	PHOE	NFMI-016	GG-185	NAM	NPAN-003	GAD-294	NAM			
NA-847P	GA-381	PHOE	NFN-003	GG-63	NAM	NPAN-004	GAD-15	NAM			
NA-858C	GA-271	PHOE	NFN-006	GG-137	NAM	NPAN-005	GA-4303	NAM			
NA-867P	GA-163	PHOE	NFN-009	GG-298	NAM	NPAN-006	GAD-117	NAM			
NA-86CR	GA-56	PHOE	NFS-001	GG-146	NAM	NPAN-006	GAD-17	NAM			
NA-905CR	GA-153	PHOE	NFS-002	GG-146	NAM	NPAN-008	GAD-3	NAM			
NA-913CR	GA-3647	PHOE	NFT-001	GG-185	NAM	NPAN-010	GAD-1	NAM			
NA-918C	GA-3915	PHOE	NFT-004	GG-187	NAM	NPAN-013	GAD-30	NAM			
NA-921CR	GA-3637	PHOE	NFT-005	GG-298	NAM	NPAO-001	GA-277	NAM			
NA-925CR	GA-253	PHOE	NFT-012	GG-185	NAM	NPAS-009	GA-244	NAM			
NA-929C	GA-274	PHOE	NFT-013	GG-185	NAM	NPAT-008	GA-195	NAM			
NA-931CR	GA-370	PHOE	NFT-014	GG-185	NAM	NPAT-009	GA-322	NAM			
NA-933P	GA-166	PHOE	NFT-016	GG-185	NAM	NPAT-010	GA-6690	NAM			
NA-945P	GA-244	PHOE	NFT-017	GG-185	NAM	NPAT-012	GA-180	NAM			
NA-974C	GA-3916	PHOE	NFT-018	GG-45	NAM	NPAT-013	GA-139	NAM			
NA-987CR	GA-77	PHOE	NFT-024	GG-164	NAM	NPAT-015	GA-5466	NAM			
NC1024296	G-296	PHOE	NFV-002	GG-251	NAM	NPAT-017	GA-198	NAM			
NC1024296	G-296-B	PHOE	NFV-004	G-296	NAM	NPAT-023	GA-2719B	NAM			
NCM101	GA-33	COFA	NFV-005	G-296-B	NAM	NPMIA-004	GA-605	NAM			
ND10420201	G-296	SEAT	NFV-006	GG-226	NAM	NPMIA-008	GA-7344	NAM			
ND10420201	G-296-B	SEAT	NH111	G-1173	GIS	NPMIA-009	GA-7142	NAM			
ND14365	G-296	CITR	NH116	G-1123	GIS	NPMIA-020	GA-476	NAM			
ND14365	G-296-B	CITR	NH118	G-297	GIS	NPMIA-025	GA-3490	NAM			
ND14665	G-296	CITR	NH118	G-297	GIS	NPMIA-027	GA-607	NAM			
ND14665	G-296-B	CITR	NH118	G-297-B	GIS	NPMIA-031	GA-217	NAM			
ND2231	G-801	CITR	NH119-B	G-296	GIS	NTC1885	GG-251	LEYL			
ND223A1	G-834	CITR	NH119-B	G-296-B	GIS	NTC1885	GG-251	ROVE			
NE160	GP-3682	NEM	NH135	G-1121	GIS	NW11	GP-5	NATW			
NE165	G-870	NEM	NH-2129	G-765	PHOE	NW13	GP-13	NATW			
NE168	GP-38	NEM	NH528	G-1173	GIS	NW136	GA-55	NATW			
NE170	GP-54 ¹¹	NEM	NH529	G-1174	GIS	NW146	GA-71	NATW			
NE170	GP-66 ¹⁰	NEM	NH-69-1A	G-49	PHOE	NW148	GA-80	NATW			
NE210	GP-3985	NEM	NH-727-1X	G-971	PHOE	NW16	GP-81	NATW			
NE261M	GP-462	NEM	NH-925/3X	G-954	PHOE	NW160	GA-70	NATW			
NE266	G-834	NEM	NH-926-3X	G-963	PHOE	NW184	GA-77	NATW			
NE362247	GP-3816	PETT	NH-932-6N	G-112	PHOE	NW189	GA-50	NATW			
NF145	G-1123	GIS	NH-938/3X	G-984	PHOE	NW192	GA-192	NATW			
NF146	G-1121	GIS	NI16546-00H03	GA-33	NISS	NW25	GP-20	NATW			
NF147	G-1123	GIS	NI58396-47601	GP-36	TOTL	NW2709	GA-55	NATW			
NF200	GP-1101	FLR	NJA-3558-AA	GA-2130	JAGU	NW2719	GA-3300	NATW			
NF202	GP-27	FLR	NL300	GP-3000	FLR	NW2849	GP-24 ²⁶	NATW			
NF203	GP-26	FLR	NL3047	GP-53	FLR	NW2849	GP-462 ²⁴	NATW			
NF2251	GG-5 L	ASAH	NL309	GP-52 ¹¹⁰	FLR	NW2850	GP-310	NATW			
NF2255	GG-47	ASAH	NL309	GP-691 ⁴⁸	FLR	NW2870	GP-28 ⁵	NATW			
NF253	GG-76	ASAH	NL310	GP-57	FLR	NW2870	GP-430 ⁸	NATW			
NF257	GG-1	ASAH	NMD6091AB	GG-46	JAGU	NW30	GP-3	NATW			
NF257	GG-4	ASAH	NMD6091AC	GG-46	JAGU	NW303	GA-303	NATW			
NF258	GG-196	ASAH	NN10684	GP-157	WHEL	NW305	GA-730	NATW			
NF259	GG-45	ASAH	NO213	G-870	AEC	NW324A	GA-85	NATW			
NF3000	GP-2071W	NALC	NO213	G-870	ASAH	NW325	GA-325	NATW			
NFB-001	GG-251	NAM	NO214	GP-38	ASAH	NW326	GA-59	NATW			
NFC-001	GG-67	NAM	NO215	GP-38	ASAH	NW327	GA-57	NATW			
NFC-002	GG-264	NAM	NO223	GP-310	ASAH	NW3300	GA-3300	NATW			
NFC-003	GG-65	NAM	NO225	GP-10	ASAH	NW3387	GP-46	NATW			
NFC-004	GG-61	NAM	NO226	GP-310	ASAH	NW340A	GA-86	NATW			
NFC-005	GG-95	NAM	NO227	GP-38	ASAH	NO227	GA-3424	NATW			
NFC-006	GG-84	NAM	NO243	GP-38	ASAH	NW3425	GA-3425	NATW			
NFC-007	GG-243	NAM	NO244	GP-58	ASAH	NW3429	GP-3429	NATW			
NFC-008	GG-249	NAM	NO245	GP-36	ASAH	NW351	GA-75	NATW			
NFF-001	GG-94	NAM	NO248	GP-171	ASAH	NW352	GAD-1 ⁷	NATW			
NFF-003	GG-1872	NAM	NO249	GP-3682	ASAH	NW3523	GA-3523	NATW			
NFF-005	GG-30	NAM	NO249	GP-37	ASAH	NW353	GAD-3	NATW			
NFF-006	GG-92	NAM	NOH-002	GP-3531	EXP	NW3535	GP-3980	NATW			

Números Nuevos

O

O004	GP-157	BOG
O1	GP-1	SRS
O111	GP-1	SUN
O10	GP-310	SUN
O-10	GP-3569	SUN
O104X	GP-38	VIC
O113	G-143	TNC
O122	GP-46	SUN
O122	GP-46	BOG
O125	GP-3531	EXP
O126	GP-40	BOG
O13	GP-44	SUN
O133	GP-3816	BOG
O14	GP-3429	SUN
O15	GP-42	SUN
O1501	G-870	SAKU
O1511	GG-1	HEN
O1511	GG-4	HEN
O155-7	G-801	FIL
O16	GP-28 ⁶	SUN
O16	GP-430 ⁸	SUN
O1626	GP-38	NIPP
O17	GP-3980	SUN
O18	GP-3600	SUN
O1803	G-870	SAKU
O19	GP-40	SUN
O1901	G-836	SAKU
O1902	G-834	SAKU
O1903	G-5000	SAKU
O1904	G-836	SAKU
O1A	GP-1	SUN
O2	GP-20	SRS
O2	GP-20	SUN
O20	GP-3531	EXP
O201	G-870	UNN
O201X	GP-38	VIC
O205	G-25	VIC
O20A	GP-3531	EXP
O21	GP-58	SUN
O213	GP-3816	BOG
O219	GP-81 ³¹	BOG
O219	GP-9 ⁸	BOG
O22	GP-310	SUN
O-22	GP-3569	SUN
O222	GP-22	BOG
O227	GP-171	BOG
O231	GP-81 ³¹	BOG
O231	GP-9 ⁸	BOG
O232	GP-81	BOG
O23881	GA-33	AMHO

Referencia Cruzada por Numero de Parte

Cross Reference by Part Number



Numero	Gonher	Fabricante	Numero	Gonher	Fabricante	Numero	Gonher	Fabricante	Numero	Gonher	Fabricante
Number	Gonher	Manufacturer	Number	Gonher	Manufacturer	Number	Gonher	Manufacturer	Number	Gonher	Manufacturer
O24	GP-58	SUN	OC103	GP-14	MAHL	OC24	GP-22	KNE	OC61	GP-310	MAHL
O26	GP-3682	SUN	OC103	GP-14	PUR	OC24	GP-22	MAHL	OC62	GP-171	KNE
O2605	GP-37	SUN	OC105	GP-31	KNE	OC24	GP-22	TECF	OC62	GP-171	MAHL
O2609	G-31	SAKU	OC105	GP-31	MAHL	OC248	GP-9	KNE	OC62	GP-171	TECF
O2609	G-133	SAKU	OC105	GP-31	TECF	OC248	GP-9	MAHL	OC63	GP-171	KNE
O2609	G-989	SAKU	OC107	GP-20	KNE	OC248	GP-9	TECF	OC63	GP-171	MAHL
O2611	G-926	SAKU	OC107	GP-20	MAHL	OC25	GP-3816	KNE	OC63	GP-171	TECF
O2621	G-31	SAKU	OC107	GP-20	PUR	OC25	GP-3816	MAHL	OC67	GP-1	KNE
O2622	G-1143	SAKU	OC109	GP-3682	KNE	OC25	GP-3816	PUR	OC67	GP-1	MAHL
O2623	G-162H	SAKU	OC109	GP-37	KNE	OC25	GP-3816	TECF	OC69	GP-3429	MAHL
O-2624	G-971	SAKU	OC109	GP-3682	MAHL	OC26	GP-36	KNE	OC7	GP-46	KNE
O2627	G-31	SAKU	OC109	GP-37	MAHL	OC26	GP-36	MAHL	OC7	GP-46	MAHL
O29	GP-3980	SUN	OC109	GP-3682	PUR	OC27	GP-54	KNE	OC7	GP-46	PUR
O3	GP-3	SRS	OC109	GP-37	PUR	OC27	GP-54	MAHL	OC71	GP-3985	MAHL
O3	GP-3	SUN	OC11	GP-22	KNE	OC27	GP-54	PUR	OC74	GP-58	KNE
O30	GP-3985	SUN	OC11	GP-22	MAHL	OC28	GP-171	KNE	OC77	GP-3531	EXP
O301X	GP-3985	VIC	OC11	GP-22	PUR	OC29	GP-31	KNE	OC77	GP-3531	EXP
O31	GP-44	SUN	OC110	GP-38	KNE	OC30	GP-54	KNE	OC77	GP-3531	EXP
O3134	G-870	MICF	OC110	GP-38	MAHL	OC30	GP-54	PUR	OC78	GP-3816	KNE
O3134	G-870	NIPP	OC110	GP-38	TECF	OC304	GP-3000	MAHL	OC80	GP-171	KNE
O314	G-989	SAKU	OC113	GP-40	KNE	OC31	GP-81	KNE	OC80	GP-171	MAHL
O316	GP-40	BOG	OC113	GP-40	MAHL	OC31	GP-81	MAHL	OC80	GP-171	PUR
O317	GP-157	BOG	OC114	GP-3	KNE	OC31	GP-81	TECF	OC80	GP-171	TECF
O318	GP-3682	BOG	OC114	GP-13	MAHL	OC32	GP-54 ¹¹	KNE	OC81	GP-3980	KNE
O318	GP-37	BOG	OC116	GP-3682	KNE	OC32	GP-66 ¹⁰	KNE	OC81	GP-3980	MAHL
O32	GP-462	SUN	OC116	GP-37	KNE	OC32	GP-54 ¹¹	MAHL	OC81	GP-3980	TECF
O33	GP-149 ⁹⁹	SUN	OC116	GP-3682	MAHL	OC32	GP-66 ¹⁰	MAHL	OC83	GP-171	KNE
O33	GP-91 ⁷⁸	SUN	OC116	GP-37	MAHL	OC32	GP-54 ¹¹	PUR	OC83	GP-171	MAHL
O34	GP-156	SUN	OC116	GP-3682	TECF	OC32	GP-66 ¹⁰	PUR	OC83	GP-171	PUR
O35	GP-68	SUN	OC116	GP-37	TECF	OC33	GP-1	KNE	OC83	GP-171	TECF
O36	GP-81	SUN	OC117	GP-3	KNE	OC34	GP-3600	KNE	OC84	GP-3816	KNE
O37	GP-91	SUN	OC117	GP-3	MAHL	OC34	GP-3600	MAHL	OC84	GP-3816	MAHL
O3A	GP-205	SUN	OC117	GP-3	PUR	OC36	GP-81	KNE	OC85	GP-28 ⁶	KNE
O3L	GP-13	SUN	OC118	GP-5	KNE	OC37	GP-1	KNE	OC85	GP-430 ⁸	KNE
O4	GP-81 ³¹	SRS	OC118	GP-5	MAHL	OC37	GP-1	MAHL	OC85	GP-28 ⁶	MAHL
O4	GP-9 ⁵⁸	SRS	OC118	GP-5	PUR	OC37	GP-1	PUR	OC85	GP-430 ⁸	MAHL
O4	G-200	SUN	OC119	GP-36	KNE	OC38	GP-3600	KNE	OC86	GP-81	KNE
O401X	GP-462	VIC	OC119	GP-36	MAHL	OC38	GP-3600	MAHL	OC86	GP-81	MAHL
O43	G-1143	TNC	OC120	GP-38	KNE	OC38	GP-3600	PUR	OC86	GP-81	TECF
O5	GP-46	SRS	OC120	GP-38	MAHL	OC39	GP-42	KNE	OC87	GP-9586	KNE
O5	GP-3600 ¹⁰²	SUN	OC121	GP-51	KNE	OC39	GP-42	MAHL	OC87	GP-9586	MAHL
O5	GP-38 ⁹⁷	SUN	OC121	GP-51	MAHL	OC39	GP-42	PUR	OC87	GP-9586	TECF
O5001	G-813	SAKU	OC121	GP-51	PUR	OC4	GP-1	KNE	OC88	GP-68	KNE
O502	GP-28	BOG	OC122	GP-52 ¹¹⁰	MAHL	OC40	GP-77	KNE	OC88	GP-68	MAHL
O502A	G-870	TOKY	OC122	GP-69 ⁴⁸	MAHL	OC40	GP-77	MAHL	OC89	GP-157	KNE
O513	GP-38	BOG	OC123	GP-81 ³¹	KNE	OC40	GP-77	PUR	OC89	GP-157	MAHL
O516	GP-171	BOG	OC123	GP-9 ⁵⁸	KNE	OC41	GP-66	KNE	OC89	GP-157	TECF
O530	GP-28	BOG	OC123	GP-81 ³¹	MAHL	OC41	GP-66	MAHL	OC90	GP-46	KNE
O5302	G-143	SAKU	OC123	GP-9 ⁵⁸	MAHL	OC41	GP-66	TECF	OC90	GP-46	MAHL
O5303	G-163	SAKU	OC123	GP-81 ³¹	PUR	OC42	GP-31	KNE	OC90	GP-46	TECF
O5501	G-191	SAKU	OC123	GP-9 ⁵⁸	PUR	OC43	GP-54	TEC	OC93	GP-3980	MAHL
O-5502	G-191	SAKU	OC13	GP-50	KNE	OC44	GP-36	KNE	OC94	GP-28 ⁶	MAHL
O-5503	G-238	SAKU	OC13	G-236	LEM	OC44	GP-36	MAHL	OC94	GP-430 ⁸	MAHL
O5601	G-191	SAKU	OC13	GP-50	MAHL	OC44	GP-36	TECF	OC97	GP-81	KNE
O5602	G-191	SAKU	OC13	GP-50	PUR	OC47	GP-28 ⁵	KNE	OC97	GP-81	MAHL
O-5702	G-566	SAKU	OC131	GP-81	KNE	OC47	GP-430 ⁸	KNE	OC97	GP-81	TECF
O5703	G-613	SAKU	OC132	GP-1	KNE	OC47	GP-28 ⁵	MAHL	OC99	GP-40	KNE
O-5704	G-750	SAKU	OC133	GP-81	KNE	OC47	GP-430 ⁸	MAHL	OC99	GP-40	MAHL
O5705	G-500	SAKU	OC138	GP-40	KNE	OC47	GP-28 ⁵	PUR	OC99	GP-40	PUR
O-584	G-3753	VIC	OC138	GP-40	MAHL	OC47	GP-430 ⁸	PUR	OD11917	G-296	ROLS
O595-10N	G-871	MNH	OC138	GP-40	TECF	OC49	GP-28 ⁵	KNE	OD11917	G-296-B	ROLS
O595-10X	G-871	MNH	OC140	GP-171	KNE	OC49	GP-430 ⁸	KNE	OD11927	G-296	ROLS
O595-17X	G-870	MNH	OC140	GP-171	MAHL	OC49	GP-28 ⁵	MAHL	OD11927	G-296-B	ROLS
O6	GP-3429	SRS	OC140	GP-171	TECF	OC49	GP-430 ⁸	MAHL	OD3829	G-870	ROLS
O6	GP-81 ³¹	SUN	OC141	GP-81	KNE	OC49	GP-28 ⁵	PUR	OE 669	G-25	FTRO
O6	GP-9 ⁵⁸	SUN	OC141	GP-81	MAHL	OC49	GP-430 ⁸	PUR	OE24001	GA-37	ROLS
O626	GP-310	BOG	OC141	GP-81	TECF	OC50	GP-36	KNE	OE46263	GP-1013Q	ROLS
O628-00	G-801	MNH	OC145	GP-28 ⁵	MAHL	OC50	GP-36	MAHL	OE662	G-25	FTRO
O628-00	G-871	MNH	OC145	GP-430 ⁸	MAHL	OC50	GP-36	TECF	OF01	GP-1	CSP
O6501	G-31	SAKU	OC15	GP-171	KNE	OC51	GP-3600	KNE	OF02	GP-46	CSP
O6504	G-119	SAKU	OC15	GP-171	MAHL	OC53	GP-81	KNE	OF03	GP-3	CSP
O6506	G-34	SAKU	OC15	GP-171	TECF	OC53	GP-81	MAHL	OF04	GP-81 ³¹	CSP
O6601	G-833	SAKU	OC17	GP-81	KNE	OC53	GP-81	TECF	OF04	GP-9 ⁵⁸	CSP
O6718	G-870	NIPP	OC17	GP-81	MAHL	OC54	GP-36	KNE	OF05	GP-13	CSP
O6721	G-870	MICF	OC17	GP-81	PUR	OC54	GP-36	MAHL	OF06	GP-20	CSP
O7	GP-3980	SRS	OC171	GP-54 ¹¹	MAHL	OC55	GP-3600	MAHL	OF07	GP-3429	CSP
O7	GP-38	SUN	OC171	GP-66 ¹⁰	MAHL	OC56	GP-171	KNE	OF08	GP-3980	CSP
O7901	G-871	SAKU	OC195	GP-91	KNE	OC56	GP-81	MAHL	OF09	GP-28 ⁶	CSP
O7904	G-159	SAKU	OC195	GP-91	MAHL	OC57	GP-81 ³¹	KNE	OF09	GP-430 ⁸	CSP
O8	GP-5	SUN	OC195	GP-91	SOPA	OC57	GP-9 ⁵⁸	KNE	OF1	GP-1	CAC
O8207	G-834	MICF	OC198	GP-3816	KNE	OC57	GP-81 ³¹	MAHL	OF1	GP-157	IAPC
O8207	G-834	NIPP	OC198	GP-3816	MAHL	OC57	GP-9 ⁵⁸	MAHL	OF10	GP-58	CSP
O9	GP-58	SUN	OC198	GP-3816	TECF	OC57	GP-81 ³¹	TECF	OF100	GP-81	IAPC
O98100M1	G-225	KNE	OC202	GP-54	KNE	OC57	GP-9 ⁵⁸	TECF	OF101	GP-81	ROB
OAG2	GP-50	LEM	OC21	GP-58	KNE	OC59	GP-310	KNE	OF102	GP-1	BOG
OAG3	GP-5	LEM	OC21	GP-66	MAHL	OC59	GP-310	MAHL	OF102	GP-1	PRET
OB31-14-302	GP-91	KIA	OC216	GP-157	KNE	OC59	GP-310	TECF	OF102	GP-1	ROB
OB63-11-4302	GP-91	KIA	OC216	GP-157	MAHL	OC6	GP-46	KNE	OF103	GP-81	BOG
OB951	G-750	NODA	OC216	GP-157	TECF	OC6	GP-46	MAHL	OF103	GP-81	PRET
OBM01	G-984	WOW	OC217	GP-156	KNE	OC6	GP-46	PUR	OF103	GP-81	ROB
OBM02	G-954	WOW	OC217	GP-156	MAHL	OC60	GP-54 ¹¹	KNE	OF104	GP-81	BOG
OC100	GP-50	KNE	OC217	GP-156	TECF	OC60	GP-66 ¹⁰	KNE	OF104	GP-81 ³¹	PRET
OC100	GP-50	MAHL	OC22	GP-34	MAHL	OC60	GP-54 ¹¹	MAHL	OF104	GP-9 ⁵⁸	PRET
OC100	GP-50	PUR	OC23	GP-34	KNE	OC60	GP-66 ¹⁰	MAHL	OF104	GP-81	ROB
OC101	GP-53	KNE	OC23	GP-81 ³¹	KNE	OC60	GP-54 ¹¹	PUR	OF1042	GP-44	UNN
OC103	GP-14	KNE	OC23	GP-9 ⁵⁸	KNE	OC60	GP-66 ¹⁰	PUR	OF1049	GP-5	UNN

REFERENCIA CRUZADA

Para números Gonher con Superíndice vea página 651
For Gonher with Superscript numbers see page 651

Numero	Gonher	Fabricante	Numero	Gonher	Fabricante	Numero	Gonher	Fabricante	Numero	Gonher	Fabricante
Number	Gonher	Manufacturer	Number	Gonher	Manufacturer	Number	Gonher	Manufacturer	Number	Gonher	Manufacturer
OF105	GP-81 ³¹	IAPC	OF143	GP-3600	ROB	OF288	GP-3766	SERV	OF4457	GP-3682	SERC
OF105	GP-9 ⁵⁸	IAPC	OF144	GP-3980	BOG	OF289	GP-3985	PRET	OF4458	GP-37	SERV
OF1050	GP-50	UNN	OF144	GP-3980	PRET	OF29	GP-22	CSP	OF4458	GP-462	PRET
OF106	GP-13	PRET	OF144	GP-3980	ROB	OF291	GP-3531	EXP SERV	OF4459	GP-149 ⁹⁹	SERV
OF106	GP-3816	ROB	OF146	GP-40	BOG	OF2921	GP-3985 ⁶³	CAC	OF4459	GP-91 ⁷⁸	SERV
OF107	GP-40	PRET	OF146	GP-40	ROB	OF2931	GP-36	CAC	OF4460	GP-91	SERV
OF107	GP-58	ROB	OF1460	GP-58 ¹⁵	ARNO	OF2951	GP-58	CAC	OF4477	GP-156	SERV
OF1076	G-236	UNN	OF15	GP-3531	EXP CSP	OF2957	GP-28 ⁶	CAC	OF4484	GP-212	SERV
OF108	GP-38	BOG	OF150	GP-28 ⁸	ROB	OF2957	GP-430 ⁸	CAC	OF45	GP-3429	CAC
OF108	GP-3682	PRET	OF150	GP-430 ⁸	ROB	OF30	GP-3	CAC	OF45	GP-3429	FACE
OF108	GP-37	PRET	OF150	GG-48	WIPA	OF30	GP-44	CSP	OF-4558	GP-24	INTF
OF108	GP-38	ROB	OF151	GP-462	ROB	OF30	GP-3	FACE	OF456	G-813	WIPA
OF109	GP-42	CAC	OF152	GP-310	BOG	OF30	GP-42	IAPC	OF4619	GP-3985	SERC
OF109	GP-81	ROB	OF1522	GP-44	UNN	OF-30	GP-3	INTF	OF4619	GP-3985	SERV
OF109	GP-42	SERV	OF1523	GP-3985	UNN	OF31	GP-3816	CSP	OF4620	GP-149	SERV
OF1099	G-834	UNN	OF155	GP-24 ²⁶	ROB	OF316	GP-3569	SERV	OF4622	GP-91	SERC
OF11	GP-3600	CSP	OF155	GP-462 ²⁴	ROB	OF32	GP-3980	CSP	OF4622	GP-91	SERV
OF11	GP-5	FACE	OF159	GP-28 ⁸	ROB	OF33	GP-20	CAC	OF4631	GP-205	SERV
OF-11	GP-5	INTF	OF159	GP-430 ⁸	ROB	OF33	GP-462	IAPC	OF4651	GP-68	SERV
OF110	GP-24 ²⁶	PRET	OF16	GP-81	CAC	OF33	GP-20	SERV	OF4670	GP-81	SERV
OF110	GP-462 ²⁴	PRET	OF16	GP-24 ²⁶	CSP	OF330	G-330	CAC	OF47	GP-46	FACE
OF110	GP-24 ²⁶	ROB	OF16	GP-462 ²⁴	CSP	OF3306	GP-10	CAC	OF4731	GP-3985	CAC
OF110	GP-462 ²⁴	ROB	OF16	GP-81	FACE	OF3387	GP-46	CAC	OF48	GP-81 ³¹	CAC
OF111	GP-46	CAC	OF-16	GP-81	INTF	OF-3387	GP-46	INTF	OF48	GP-9 ⁵⁸	CAC
OF111	GP-1	ROB	OF160	GP-310	BOG	OF3387A	GP-46	CAC	OF480	G-225	WIPA
OF111	GP-46	SERV	OF161	GP-58	PRET	OF34	GP-462	IAPC	OF4872	GP-562	SERV
OF-111	GP-3569	PRET	OF162	GP-22	BOG	OF3429	GP-3429	CAC	OF4875	GP-171	SERV
OF112	GP-40	PRET	OF164	GP-40	BOG	OF35	GP-3531	EXP IAPC	OF49	GP-3	CAC
OF112	GP-462	ROB	OF164	GP-40	ROB	OF3506	GP-44	CAC	OF49	GP-3	SERV
OF1129	G-34	UNN	OF165	GP-462	ROB	OF-3506	GP-44	INTF	OF-4967	GP-157	INTF
OF113	GP-28 ⁸⁴	ROB	OF17	GP-81	CAC	OF3512	GP-22	CAC	OF5	GP-5	CAC
OF113	GP-3600 ⁹⁴	ROB	OF17	GP-3682	CSP	OF3531	GP-3531	EXP CAC	OF-5	GP-205	INTF
OF113	GP-430 ⁸⁵	ROB	OF17	GP-37	CSP	OF3531	GP-3531	EXP FACE	OF50	GP-50	CAC
OF1133	G-33	UNN	OF17	GP-81	SERV	OF3535	GP-3980 ⁴⁴	CAC	OF51	GP-3980	CAC
OF114	GP-20	BOG	OF173	GP-3980	SERC	OF3535	GP-48 ¹¹⁷	CAC	OF51	GP-3980	FACE
OF114	GP-20	PRET	OF173	GP-3980	SERV	OF-3535	GP-3980 ⁴⁴	INTF	OF510	GP-46	IAPC
OF114	GP-20	ROB	OF1742	GP-3766	UNN	OF-3535	GP-48 ¹¹⁷	INTF	OF513	GP-3985	IAPC
OF1145	G-971	UNN	OF1773	GP-31	UNN	OF3562	GP-46	CAC	OF52	GP-3980	PRET
OF115	GP-3	BOG	OF1794	GP-23	UNN	OF3569	GP-3569	CAC	OF5230	GP-128	WIPA
OF115	GP-310	IAPC	OF1797	GP-10	UNN	OF3569	GP-3569	FLT	OF5317	GP-457	SERC
OF115	GP-3569	IAPC	OF18	GP-81	CSP	OF3593	GP-462	CAC	OF5317HD	GP-457	SERC
OF115	GP-3	PRET	OF183	GP-3816	SERC	OF-3593	GP-149	INTF	OF547	G-801	WIPA
OF115	GP-3	ROB	OF183	GP-3816	SERV	OF-3593H	GP-6811	INTF	OF55	GP-171	IAPC
OF116	GP-36	BOG	OF19	GP-58	CSP	OF3600	GP-3600	CAC	OF552	G-870	WIPA
OF116	GP-36	ROB	OF193	GP-40	SERV	OF-3600	GP-3600	INTF	OF553	G-870	WIPA
OF1189	GP-81	UNN	OF195	GP-3600	SERV	OF3614	GP-2951 ⁶²	CAC	OF-5548D	GP-428	INTF
OF119	GP-42	BOG	OF1A	GP-1	SERV	OF3614	GP-58	CAC	OF60	GP-3682	IAPC
OF119	GP-42	PRET	OF2	GP-68	CAC	OF-3614	GP-58	INTF	OF60	GP-37	IAPC
OF119	GP-42	ROB	OF-2	GP-68	INTF	OF3651	GP-171	CAC	OF602	G-801	WIPA
OF-1170	GP-149	INTF	OF20	GP-91	CSP	OF3664	GP-3985	CAC	OF604	GP-40	CAC
OF-1170	GP-149	INTF	OF20	GP-58	IAPC	OF3669	GP-40	CAC	OF605	G-801	WIPA
OF12	GP-1	CSP	OF200	G-200	CAC	OF3675	GP-44	CAC	OF655	GP-212	CAC
OF120	GP-28 ⁸	ROB	OF21	GP-3985	CSP	OF-3675	GP-3675	INTF	OF6607	GP-91	CAC
OF120	GP-430 ⁸	ROB	OF213	GP-28 ⁸	CAC	OF3682	GP-3682	CAC	OF-6607	GP-91	INTF
OF12010	GP-2071W	OFS	OF213	GP-430 ⁸	CAC	OF3682	GP-37	CAC	OF6813	GP-452	CAC
OF121	G-834	BOG	OF214	GP-36	CAC	OF-3685	GP-3682	INTF	OF6848	G-971	CAC
OF121	G-834	ROB	OF2167	GP-171	SERV	OF37	GP-212	IAPC	OF7	GP-81	CAC
OF1218	GP-205	CAC	OF218	GP-34	CAC	OF373	GP-23	CAC	OF7	GP-81	SUN
OF123	GP-28 ⁸	PRET	OF22	GP-5	CSP	OF3766	GP-3766	CAC	OF71	GP-28 ⁸	IAPC
OF123	GP-430 ⁸	PRET	OF23	GP-3816	CSP	OF3786	GP-562	CAC	OF71	GP-430 ⁸	IAPC
OF123	GP-3429	SERV	OF236PL	G-236	CAC	OF3807A	GP-149 ⁹⁹	CAC	OF73	GP-24 ²⁶	CAC
OF124	GP-310	BOG	OF24	GP-42	CSP	OF3807A	GP-91 ⁷⁸	CAC	OF73	GP-462 ²⁴	CAC
OF125	GP-3531	EXP BOG	OF241	GP-2951 ⁶²	SERV	OF381	GP-36	SERV	OF7317	GP-149	CAC
OF125	GP-58	IAPC	OF241	GP-58	SERV	OF3816	GP-3816	CAC	OF75	GP-28 ⁸	IAPC
OF125	GP-3531	EXP PRET	OF25	GP-20	CAC	OF3976	GP-178	CAC	OF75	GP-430 ⁸	IAPC
OF125	GP-3531	EXP ROB	OF25	GP-3569	CHAM	OF3980	GP-3980	CAC	OF8	GP-1	CAC
OF1271	G-330	UNN	OF25	GP-310	CSP	OF-3980	GP-3980	INTF	OF-8	GP-1	INTF
OF1283	GP-36	UNN	OF25	GP-20	FACE	OF3985	GP-3985	CAC	OF81	GP-81 ³¹	CAC
OF129	GP-22	BOG	OF25	GP-40	IAPC	OF40	GP-13	CAC	OF81	GP-9 ⁵⁸	CAC
OF129	GP-22	ROB	OF-25	GP-20	INTF	OF40	GP-13	SERV	OF81	GP-81 ³¹	SERV
OF13	GP-13	CAC	OF-2500	GP-91	INTF	OF4006	GP-44	SERC	OF81	GP-9 ⁵⁸	SERV
OF13	GP-38	CSP	OF252	GP-28 ⁸	SERC	OF401	GP-46	CSP	OF-8158	G-112	INTF
OF13	GP-13	FACE	OF252	GP-430 ⁸	SERC	OF4011	GP-3980	SERC	OF82	GP-212	IAPC
OF-13	GP-36	SERV	OF255	GP-834	CSP	OF404	G-834	CSP	OF-8316	GP-128	INTF
OF130	GP-58	BOG	OF257	GP-310	SERC	OF407	GP-171 ¹⁵⁶	CSP	OF834	G-834	CAC
OF130	GP-58	ROB	OF257	GP-1	SERV	OF40A	GP-205	SERV	OF84	GP-23	SERV
OF131	GP-3429	BOG	OF257	GP-3569	SERV	OF412	GP-50	CSP	OF8765	G-765	CAC
OF131	GP-3429	PRET	OF26	GP-81	CSP	OF413	GP-3	CSP	OF-8776	G-910	INTF
OF131	GP-3429	ROB	OF260	GP-36	SERV	OF416	GP-23	CSP	OF8806	G-45	CAC
OF132	GP-46	BOG	OF27	GP-44	CSP	OF417	GP-3816	CSP	OF8873	GP-408	CAC
OF132	GP-46	PRET	OF28	GP-200	CSP	OF-4177	GP-291	INTF	OF8A	GP-1	FACE
OF132	GP-46	ROB	OF2825	GP-38	CAC	OF418	GP-3985 ⁶³	CSP	OF9018	G-49	CAC
OF1324	GP-3985 ⁶³	UNN	OF2825	GP-38	FACE	OF421	GP-3766	CSP	OF-9018	G-49	INTF
OF133	GP-3682	ROB	OF-2825	GP-38	INTF	OF422	GP-40	CSP	OF-927	GP-22	INTF
OF133	GP-37	ROB	OF2842	GP-36	CAC	OF423	GP-3985	CSP	OF-9301	G-918	INTF
OF133A	GP-3682	ROB	OF2846	GP-46	CAC	OF-4240	GP-112	INTF	OF-9461	G-466	INTF
OF133A	GP-37	ROB	OF2849	GP-24 ²⁶	CAC	OF43	GP-81 ³¹	CAC	OF-966	GP-37	INTF
OF134	GP-310	ROB	OF2849	GP-462 ²⁴	CAC	OF43	GP-9 ⁵⁸	CAC	OF977	GP-31	CAC
OF136	GP-37	ROB	OF2849	GP-24 ²⁶	FACE	OF43	GP-81 ³¹	FACE	OF99A	GP-42	ACD
OF14	GP-40	CSP	OF2849	GP-462 ²⁴	FACE	OF43	GP-9 ⁵⁸	FACE	OFAC1	GP-1	LEM
OF141	G-200	CAC	OF2859	GP-46	CAC	OF-43	GP-9	INTF	OF3R-14-302	GP-91	KIA
OF141	GP-38	ROB	OF2865	GP-42	CAC	OF433	G-236	CSP	OF-E5004	G-963	GFF
OF142	GP-40	BOG	OF2865	GP-42	FACE	OF4386	GP-156	CAC	OF-E5021	G-870	GFF
OF142	GP-40	ROB	OF2870	GP-28 ⁸	CAC	OF-4386	GP-156	INTF	OF-E5024	G-163	GFF
OF143	GP-3600	BOG	OF2870	GP-430 ⁸	CAC	OF44	GP-44	FACE	OF-E5027	G-31	GFF
OF143	GP-3600	PRET	OF-2870	GP-28	INTF	OF4422	GP-178	SERV	OF-E5054	G-191	GFF

Referencia Cruzada por Numero de Parte

Cross Reference by Part Number



Numero	Gonher	Fabricante	Numero	Gonher	Fabricante	Numero	Gonher	Fabricante	Numero	Gonher	Fabricante
Number	Gonher	Manufacturer	Number	Gonher	Manufacturer	Number	Gonher	Manufacturer	Number	Gonher	Manufacturer
OF-E5056		G-834 GFF	OMS225		GP-149 WOW	OP945		G-801 TNC	OPA92		GA-57 XSV
OF-E5068		G-238 GFF	ONS026		GP-10 WOW	OP949		G-133 TNC	OPA93		GA-325 XSV
OF-E5080		G-6 GFF	ONS033		GP-171 WOW	OP949		G-989 TNC	OPA99-1		GA-86 XSV
OF-E5093		G-801 GFF	ONS040		GP-3682 WOW	OP966		G-834 TNC	OPAP15		GA-3490 XSV
OF-E5101		G-833 GFF	ONS040		GP-37 WOW	OP993		G-801 TNC	OPAP16		GA-2740 XSV
OFK-1-E		GP-171 ¹⁶ ARRO	ONS043		GP-156 WOW	OPA103		GAD-1 XSV	OPF9		GA-100 XSV
OF-S4001		GP-51 GFF	ONS046		GP-51 WOW	OPA110		GA-349 XSV	OPG111		GG-5 L XSV
OF-S4001-1		GP-51 GFF	OP0238		G-238 TNC	OPA110A		GA-349 XSV	OPG111-1		GG-5 L XSV
OF-S4002-5		GP-171 GFF	OP1		GP-1 XSV	OPA113		GA-75 SPEC	OPG111-5		GG-20 XSV
OF-S4003		GP-58 GFF	OP109		GP-42 SPEC	OPA113		GA-75 XSV	OPG119		GG-6 XSV
OF-S4004		GP-54 GFF	OP111		GP-46 SPEC	OPA1149		GAVW-2 SPEC	OPG120		GG-7 XSV
OF-S4006		GP-3531 EXP GFF	OP111		GP-46 XSV	OPA1149		GAVW-2 XSV	OPG13-1		GG-19 XSV
OF-S4009		GP-149 GFF	OP123		GP-3429 SPEC	OPA120		GA-74 SPEC	OPG157		GG-16 XSV
OF-S4011		GP-1 GFF	OP123		GP-3429 XSV	OPA120		GA-74 XSV	OPG158		GG-17 XSV
OF-S4012		GP-53 GFF	OP124		GP-44 XSV	OPA124		GA-3300 XSV	OPG21		GG-123 XSV
OF-S4013		GP-53 GFF	OP141		G-200 XSV	OPA129		GA-3424 XSV	OPG3163		GG-8 XSV
OF-S4015		GP-81 ³¹ GFF	OP17		GP-81 SPEC	OPA131		GA-3425 XSV	OPG3169		GG-47 XSV
OF-S4015		GP-9 ⁵⁸ GFF	OP17		GP-81 XSV	OPA15		GA-3490 SPEC	OPG3173		GG-3728 XSV
OF-S4016		GP-3000 GFF	OP173		GP-3980 SPEC	OPA15		GA-3490 XSV	OPG3175		GG-196 XSV
OF-S4020		GP-171 GFF	OP173		GP-3980 XSV	OPA16		GA-2740 SPEC	OR530		GP-54 ¹¹ FAPO
OF-S4021		GP-157 GFF	OP191		G-191 TNC	OPA16		GA-2740 XSV	OR530		GP-66 ¹⁰ FAPO
OF-S4022		GP-149 GFF	OP193		GP-40 SPEC	OPA31		GA-56 XSV	OR531		GP-3600 FAPO
OF-S4023		GP-91 GFF	OP193		GP-40 XSV	OPA3138		GA-54 SPEC	OR573		GP-14 FAPO
OF-S4025		GP-3980 GFF	OP194		GP-3985 XSV	OPA3138		GA-54 XSV	OS13		GP-13 SIEG
OF-S4031		GP-66 GFF	OP195		GP-3600 SPEC	OPA3149		GA-3523 SPEC	OS16		GP-81 SIEG
OF-S4034		GP-52 ¹⁰ GFF	OP195		GP-3600 XSV	OPA3149		GA-3523 XSV	OS25		GP-20 SIEG
OF-S4034		GP-691 ⁴⁸ GFF	OP1A		GP-1 SPEC	OPA3192		GA-271 SPEC	OS2856		GP-40 SIEG
OF-S4035-5		GP-3985 GFF	OP1A		GP-1 XSV	OPA3192		GA-271 XSV	OS30		GP-3 SIEG
OF-S4036		GP-36 GFF	OP2167		GP-171 SPEC	OPA3193		GA-735 SPEC	OS3387		GP-46 SIEG
OF-S4040		GP-1 GFF	OP2167		GP-171 XSV	OPA3193		GA-735 XSV	OS3429		GP-3429 SIEG
OF-S4041		GP-36 GFF	OP221		G-25 TNC	OPA3195		GA-3588 SPEC	OS3531		GP-3531 EXP SIEG
OF-S4042		GP-3600 GFF	OP227		G-25 TNC	OPA3195		GA-3588 XSV	OS3535		GP-3980 SIEG
OF-S4043		GP-57 GFF	OP238		G-238 TNC	OPA3380		GA-3647 SPEC	OS3600		GP-3600 SIEG
OF-S4044		GP-156 GFF	OP241		GP-58 XSV	OPA3380		GA-3647 XSV	OS3682		GP-3682 SIEG
OF-S4045-5		GP-46 GFF	OP252		GP-28 ⁸ XSV	OPA3384		GA-89 SPEC	OS3682		GP-37 SIEG
OF-S4046		GP-3 GFF	OP252		GP-430 ⁸ XSV	OPA3384		GA-89 XSV	OS43		GP-81 ³¹ SIEG
OF-S4047		GP-13 GFF	OP253		GP-3985 ⁶³ XSV	OPA3463		GA-230 XSV	OS43		GP-9 ⁵⁸ SIEG
OF-S4048		GP-3429 GFF	OP257		GP-310 XSV	OPA3465		GA-277 SPEC	OS8A		GP-1 SIEG
OF-S4049		GP-390 GFF	OP262		G-33 TNC	OPA3465		GA-277 XSV	OS951		GP-2951 ²² SIEG
OF-S4049-L		GP-178 GFF	OP263		G-33 TNC	OPA3466		GA-4828 SPEC	OS951		GP-58 SIEG
OF-S4050		GP-38 GFF	OP264		G-33 TNC	OPA3466		GA-4828 XSV	OTT130		GP-81 ³¹ SIEG
OF-S4053		GP-157 GFF	OP270		G-222 TNC	OPA3467		GA-4325 SPEC	OTT130		GP-9 ⁵⁸ SIEG
OF-S4056		GP-3985 GFF	OP2821A		GP-58 XSV	OPA3467		GA-4325 XSV	OUHB378		GAK-20 SIEG
OF-S4058		GP-46 GFF	OP288		GP-3766 SPEC	OPA3468		GA-2740 XSV	OX 193D		G-141 KNE
OF-S4059		GP-46 GFF	OP288		GP-3766 XSV	OPA3472		GA-274 SPEC	OX104		G-971 KNE
OF-S4060		GP-54 ¹¹ GFF	OP291		GP-3531 EXP SPEC	OPA3472		GA-274 XSV	OX104		G-971 MAHL
OF-S4060		GP-66 ¹⁰ GFF	OP291		GP-3531 EXP XSV	OPA3474		GA-3681 SPEC	OX104		G-971 SOPA
OF-S4061		GP-22 GFF	OP31		G-31 TNC	OPA3474		GA-3681 XSV	OX105		G-971 KNE
OF-S4064		GP-81 GFF	OP33		GP-20 SPEC	OPA3590		GA-3916 SPEC	OX105		G-971 MAHL
OF-S4068		GP-58 GFF	OP33		G-33 TNC	OPA3590		GA-3916 XSV	OX105		G-971 SOPA
OF-S4073		GP-44 GFF	OP33		GP-20 XSV	OPA3591		GA-3814 SPEC	OX105D		G-971 KNE
OF-S4074		GP-31 GFF	OP330		G-330 TNC	OPA3591		GA-3814 XSV	OX105D		G-971 MAHL
OF-S4087		GP-36 GFF	OP340		G-31 TNC	OPA3592		GA-273 SPEC	OX105D		G-971 SOPA
OF-S4089		GP-152 GFF	OP354		G-834 TNC	OPA3592		GA-273 XSV	OX11		G-750 KNE
OG16		G-200 LEM	OP40		GP-13 SPEC	OPA4		GA-70 SPEC	OX11		G-750 MAHL
OG4		GP-3 LEM	OP40		GP-13 XSV	OPA4		GA-70 XSV	OX11		G-750 PUR
OG6		GP-20 LEM	OP4011		GP-3980 SPEC	OPA4299		GA-180 SPEC	OX12		G-801 KNE
OG8		GP-3 LEM	OP4011		GP-3980 XSV	OPA4299		GA-180 XSV	OX12		G-801 MAHL
OG9		G-6 LEM	OP42		GP-38 XSV	OPA4326		GA-78 XSV	OX12		G-801 PUR
OHF3787		GA-24 SCHM	OP4457		GP-3682 SPEC	OPA4339		GA-3915 SPEC	OX12		G-801 TECF
OIS017		GP-3985 WOW	OP4457		GP-37 SPEC	OPA4339		GA-3915 XSV	OX14		G-836 KNE
OK101		GP-40 TEHO	OP4457		GP-3682 XSV	OPA4342		GA-253 SPEC	OX14		G-836 MAHL
OK106		GP-3531 EXP TEHO	OP4457		GP-37 XSV	OPA4342		GA-253 XSV	OX14		G-836 PUR
OK109		GP-77 TEHO	OP4458		GP-462 XSV	OPA4343		GA-5056 SPEC	OX14		G-836 TECF
OK112		GP-46 TEHO	OP4459		GP-149 ⁶⁹ XSV	OPA4343		GA-5056 XSV	OX149		G-25 MAHL
OK12		GP-81 TEHO	OP4459		GP-91 ⁷⁸ XSV	OPA4347		GA-153 SPEC	OX149D		G-25 MAHL
OK126		GP-3682 TEHO	OP4477		GP-156 SPEC	OPA4347		GA-153 XSV	OX149DOEKO		G-25 MAHL
OK127		GP-40 TEHO	OP4477		GP-156 XSV	OPA4356		GA-390 SPEC	OX15		G-834 KNE
OK133		GP-56 TEHO	OP4619		GP-3985 SPEC	OPA4356		GA-390 XSV	OX15		G-834 MAHL
OK139		GP-390 ⁹³ TEHO	OP4619		GP-3985 XSV	OPA4372		GA-3901 SPEC	OX15		G-834 PUR
OK14		GP-1 TEHO	OP4651		GP-68 SPEC	OPA4372		GA-3901 XSV	OX15		G-834 TECF
OK145		GP-28 ⁸ TEHO	OP4651		GP-68 XSV	OPA4378		GA-174 SPEC	OX153		G-180 KNE
OK145		GP-430 ⁸ TEHO	OP4670		GP-81 SPEC	OPA4378		GA-174 XSV	OX153/7		G-180 MAHL
OK16		GP-38 TEHO	OP4670		GP-81 XSV	OPA4471		GA-471 SPEC	OX161D		G-3827 KNE
OK22		GP-38 TEHO	OP49		GP-3 SPEC	OPA4471		GA-471 XSV	OX17		G-870 KNE
OK31		GP-46 TEHO	OP49		GP-3 XSV	OPA45		GA-77 XSV	OX17		G-870 MAHL
OK48		GP-22 TEHO	OP5		GP-5 XSV	OPA4632		GA-275 SPEC	OX17		G-870 PUR
OK50		GP-36 TEHO	OP6		G-6 TNC	OPA4632		GA-275 XSV	OX17		G-870 TECF
OK54		GP-1122 TEHO	OP627		G-143 TNC	OPA52		GA-71 SPEC	OX17-174D		G-3754 MAHL
OK57		GP-54 ¹¹ TEHO	OP64		GP-3600 ²⁷ XSV	OPA52		GA-71 XSV	OX18		G-813 KNE
OK57		GP-66 ¹⁰ TEHO	OP64		GP-38 ⁸⁹ XSV	OPA57		GA-80 XSV	OX18		G-813 MAHL
OK6		GP-3816 TEHO	OP73		GP-24 ⁵⁸ DEL	OPA59		GA-50 SPEC	OX18		G-813 PUR
OK65		GP-1122 TEHO	OP73		GP-24 ²⁶ XSV	OPA59		GA-50 XSV	OX18		G-813 TECF
OK68		GP-144 TEHO	OP73		GP-462 ²⁴ XSV	OPA67		GA-192 SPEC	OX192D		G-25 KNE
OK7		GP-5 TEHO	OP801		G-801 TNC	OPA67		GA-192 XSV	OX192D		G-25 MAHL
OK71		GP-1 TEHO	OP803		G-225 TNC	OPA68		GA-78 XSV	OX2		G-238 KNE
OK72		GP-22 TEHO	OP81		GP-81 ³¹ SPEC	OPA74		GA-55 SPEC	OX2		G-238 MAHL
OK77		GP-3600 TEHO	OP81		GP-9 ⁵⁸ SPEC	OPA74		GA-55 XSV	OX2		G-238 PUR
OK8		GP-3 TEHO	OP81		GP-81 ³¹ XSV	OPA83		GA-85 SPEC	OX29		G-801 KNE
OK81		GP-50 TEHO	OP81		GP-9 ⁵⁸ XSV	OPA83-1		GA-85 XSV	OX29		G-801 MAHL
OK83		GP-3985 TEHO	OP813		G-813 TNC	OPA84		GA-730 XSV	OX29		G-801 TECF
OK87		GP-42 TEHO	OP820		G-870 TNC	OPA90		GA-303 SPEC	OX3		G-191 KNE
OK94		GP-51 TEHO	OP820SC		G-870 TNC	OPA90		GA-303 XSV	OX3		G-191 MAHL
OM639939		G-1123 MBNZ	OP834		G-834 TNC	OPA91		GA-59 SPEC	OX3		G-191 PUR
OMD173		GP-462 WOW	OP836		G-836 TNC	OPA91		GA-59 XSV	OX30		G-31 KNE
OMD180		GP-462 WOW	OP845		G-801 TNC	OPA92		GA-57 SPEC	OX30		G-31 MAHL

REFERENCIA CRUZADA

Para números Gonher con Superíndice vea página 651
For Gonher with Superscript numbers see page 651

Referencia Cruzada por Numero de Parte

Cross Reference by Part Number



Numero	Gonher	Fabricante	Numero	Gonher	Fabricante	Numero	Gonher	Fabricante	Numero	Gonher	Fabricante
Number	Gonher	Manufacturer	Number	Gonher	Manufacturer	Number	Gonher	Manufacturer	Number	Gonher	Manufacturer
P122154	GA-403	DON	P130049	GA-679	DON	P136840	GA-33 ¹²	DON	P145701	GA-6127	DON
P122156	GA-361	DON	P130050	GA-680	DON	P136847	GA-329	DON	P145702	GA-6128	DON
P122157	GA-206	DON	P130083	GA-357	DON	P136869	GA-616	DON	P145773	GA-425	DON
P122328	GA-20	DON	P130215	GA-329	DON	P136988	GA-563	DON	P145894	GA-357	DON
P122329	GA-360	DON	P130387	GA-891 ³⁰	DON	P137102	GA-16	DON	P145895	GA-625	DON
P122330	GA-106 ⁴⁶	DON	P130760	GA-216	DON	P137104	GA-20	DON	P145985	GA-625	DON
P122330	GA-326 ⁷¹	DON	P130761	GA-216	DON	P137178	GA-229	DON	P1462460	GP-761H	PHHR
P122370	GA-106 ⁴⁶	DON	P130765	GA-360	DON	P137296	GA-16	DON	P147	G-295	PUR
P122370	GA-326 ⁷¹	DON	P130766	GA-403	DON	P137352	GA-589	DON	P147	G-119	WES
P122393	GA-33 ¹²	DON	P130776	GA-416	DON	P137640	GA-210	DON	P148024	GA-879	DON
P122398	GA-33 ¹²	DON	P130959	GA-373	DON	P137641	GA-108	DON	P148043	GA-377	DON
P122404	GA-31	DON	P131283	GA-891	DON	P137652	GA-9334	DON	P148044	GA-372	DON
P122492	GA-403	DON	P131321	GA-357	DON	P137755	GA-398	DON	P148071	GA-758	DON
P122510	GA-33 ¹²	DON	P131322	GA-16	DON	P138	G-333	ACE	P148249	GA-885	DON
P122512	GA-33 ¹²	DON	P131332	GA-31	DON	P138	G-333	APOL	P148266	GA-16	DON
P122516	GA-16	DON	P131336	GA-239	DON	P138	G-333	BWS	P148380	GA-360	DON
P122517	GA-20	DON	P131340	GA-16	DON	P138	G-333	CAM2	P148383	GA-33 ¹²	DON
P122529	GA-27 ¹²	DON	P131346	GA-216	DON	P138	G-333	CHP	P148511	GA-107	DON
P122594	GA-16	DON	P131348	GA-329	DON	P138	G-333	LUF	P148586	GA-1532	DON
P122692	GA-16	DON	P131351	GA-361	DON	P138	GP-3600	PHI	P148727	GA-642	DON
P122695	GA-20	DON	P131352	GA-206	DON	P138	G-333	WARN	P148821	GA-360	DON
P122697	GA-403	DON	P131353	GA-891	DON	P138523	GA-376	DON	P148833	GA-459	DON
P122708	GA-6129	DON	P131377	GA-493 ¹⁰⁸	DON	P138627	GA-33 ¹²	DON	P148932	GA-1532	DON
P122794	GA-403	DON	P131399	GA-6127	DON	P138651	GA-403	MATB	P148966	GA-16	DON
P122836	GA-6129	DON	P131401	GA-16	DON	P138714	GA-377	DON	P148968	GA-403	DON
P122837	GA-6127	DON	P131406	GA-16	DON	P138748	GA-33 ¹²	DON	P149	G-296	PHI
P122854	GA-27 ¹²	DON	P132	G-33	CHP	P138750	GA-483	DON	P149	G-296-B	PHI
P122860	GA-216	DON	P132342	GA-372	DON	P138751	GA-8047	DON	P149287	GA-625	DON
P123370	GA-625	DON	P132566	GA-216	DON	P138752	GA-9334	DON	P149375	GA-209	DON
P1234	GS-2034	MNH	P132597	GA-106 ⁴⁶	DON	P138753	GA-9045	DON	P15	G-836	BLDW
P123412	GA-381	DON	P132597	GA-326 ⁷¹	DON	P138818	GA-7716	DON	P15	GP-14	PHI
P123567	GA-20	DON	P132598	GA-6127	DON	P138845	GA-1008	DON	P150061	GA-106 ⁴⁶	DON
P123568	GA-20	DON	P132601	GA-106 ⁴⁶	DON	P14	G-139	PHI	P150061	GA-326 ⁷¹	DON
P123569	GA-625	DON	P132601	GA-326 ⁷¹	DON	P1400	G-331	WES	P150135	GAP-381	DON
P123590	GA-20	DON	P132604	GA-360	DON	P140101	GA-467	DON	P150-3	G-1175	PHI
P123827	GA-360	DON	P132605	GA-361	DON	P140110	GA-405	DON	P150-3	G-1176	PHI
P124033	GA-98 ¹¹²	DON	P132609	GA-206	DON	P140122	GA-436	DON	P150561	GA-20	CASE
P124046	GA-398	DON	P132760	GA-377	DON	P140131	GA-49	DON	P150564	GP-1122	CASE
P124069	GA-361	DON	P132778	GA-33 ¹²	DON	P140426	GA-109	DON	P150611	GA-1532	DON
P124070	GA-360	DON	P132976	GA-403	DON	P140822	GA-372	DON	P150612	GA-625	DON
P124154	GA-403	DON	P132977	GA-33 ¹²	DON	P141	G-200	ACE	P150694	GA-694	DON
P124156	GA-33 ¹²	DON	P132978	GA-16	DON	P141	G-200	APOL	P150705	GA-16	DON
P124157	GA-16	DON	P132979	GA-20	DON	P141	G-200	BWS	P151	G-33	CHP
P124158	GA-16	DON	P132981	GA-27 ¹²	DON	P141	G-200	CAM2	P151	G-33	WES
P124159	GA-403	DON	P133104	GA-759 ¹⁰⁸	DON	P141	G-200	CHP	P151097	GA-377	DON
P124164	GA-458	DON	P133149	GA-6129	DON	P141	G-200	FRML	P151135	GA-563	DON
P124165	GA-459	DON	P133152	GA-6127	DON	P141	G-200	LUF	P151140	GA-251	DON
P124167	GA-6129	DON	P133179	GA-759 ¹⁰⁸	DON	P141	G-200	MICF	P151144	GA-1532	DON
P124177	GA-20	DON	P133298	GA-33 ¹²	DON	P141	G-200	MINL	P151146	GA-625	DON
P124178	GA-403	DON	P133320	GA-360	DON	P141	G-200	PUR	P151157	GA-106 ⁴⁶	DON
P124522	GA-251	DON	P133321	GA-106 ⁴⁶	DON	P141	G-200	REF	P151157	GA-326 ⁷¹	DON
P124731P	G-333	UNI	P133321	GA-326 ⁷¹	DON	P141	G-200	REX	P151158	GA-106 ⁴⁶	DON
P124851	GA-251	DON	P133322	GA-361	DON	P141	G-200	SECU	P151158	GA-326 ⁷¹	DON
P124861	GA-251	DON	P133323	GA-206	DON	P141	G-200	TRUS	P151179	GA-1532	DON
P125576	GA-106 ⁴⁶	DON	P133427	GA-239	DON	P141	G-200	WARN	P151323	GA-33 ¹²	DON
P125576	GA-326 ⁷¹	DON	P133443	GA-377	DON	P141	G-200	WES	P151325	GA-33 ¹²	DON
P125577	GA-6129	DON	P133525	GA-20	DON	P-141	G-200	PUMX	P151529	GA-356	DON
P126040	GA-403	DON	P133535	GA-20	DON	P141074	GA-372	DON	P151747	GA-892	DON
P126098	GA-20	DON	P133546	GA-33 ¹²	DON	P141317	GA-389	DON	P151757	GA-892	DON
P126310	GA-16	DON	P133653	GA-403	DON	P141319	GA-680	DON	P151768	GA-20	DON
P126343	GA-361	DON	P133655	GA-360	DON	P141628	GA-106 ⁴⁶	DON	P151770	GA-6129	DON
P126900	GA-879	DON	P133663	GA-106 ⁴⁶	DON	P141628	GA-326 ⁷¹	DON	P151771	GA-106 ⁴⁶	DON
P126984	GA-416	DON	P133663	GA-326 ⁷¹	DON	P141629	GA-206	DON	P151771	GA-326 ⁷¹	DON
P127	GP-69	PHI	P133675	GA-425	DON	P1419	G-971	BLDW	P151772	GA-616	DON
P127	G-613	PUR	P133694	GA-426	DON	P141M	G-200	PUR	P151775	GA-1532	DON
P-127	G-613	PUMX	P133711	GA-425	DON	P141P	G-200	CHP	P151777	GA-563	DON
P127128	GA-403	DON	P133765	GA-425	DON	P142100	GA-371	DON	P151903	GA-206	DON
P127164	GA-458	DON	P134	G-1123	PUR	P142367	GA-642	DON	P151906	GA-625	DON
P127312	GA-758	DON	P134009	GA-18	DON	P142730	GA-20	DON	P151913	GA-251	DON
P1275	GA-37	DIAM	P134273	GAP-379	DON	P142739	GA-20	DON	P151919	GA-16	DON
P127784	GA-458	DON	P134444	GA-482	DON	P142744	GA-360	DON	P151921	GA-106 ⁴⁶	DON
P127787	GA-459	DON	P134684	GA-892	DON	P142752	GA-6127	DON	P151921	GA-326 ⁷¹	DON
P12781	GS-2033	MNH	P134742	GA-376	DON	P142753	GA-361	DON	P151922	GA-403	DON
P128299	GA-6880	DON	P134743	GA-229	DON	P142756	GA-625	DON	P151967	GA-398	DON
P128355	GA-357	DON	P134744	GA-378	DON	P1428	G-152	PARK	P151968	GA-206	DON
P128356	GA-356	DON	P134745	GA-6880	DON	P143126	GA-6880	DON	P152346	GA-16	DON
P128407	GA-563	DON	P134866	GA-378	DON	P143141	GA-403	BRAY	P152577	GA-6129	DON
P128452	GA-892	DON	P134867	GA-229	DON	P143141	GA-403	MATB	P152582	GA-6129	DON
P128494	GA-493 ¹⁰⁸	DON	P134870	GA-373	DON	P1433	G-765	BLDW	P152583	GA-106 ⁴⁶	DON
P128515	GA-356	DON	P135	G-333	PHI	P143316	GA-360	DON	P152583	GA-326 ⁷¹	DON
P128518	GA-357	DON	P1350575	GP-54 ⁴¹	CASE	P143543	GA-892	DON	P152632	GA-403	DON
P128803	GA-891	DON	P1350575	GP-66 ¹⁰	CASE	P143649	GA-493 ¹⁰⁸	DON	P152634	GA-16	DON
P128952	GA-229	DON	P1350576	GP-36	CASE	P1439	G-49	BLDW	P152641	GA-329	DON
P129	G-6	CHP	P136	GG-48	HARM	P1440	G-45	BLDW	P152643	GA-33 ¹²	DON
P129313	GA-216	DON	P136253	GA-20	DON	P1443	G-180	BLDW	P152650	GA-20	DON
P129392	GA-892	DON	P136255	GA-679	DON	P1443	G-918	BLDW	P152652	GA-625	DON
P129396	GA-377	DON	P136257	GA-403	DON	P1445	G-49	BLDW	P152654	GA-1532	DON
P129472	GA-372	DON	P136259	GA-216	DON	P145140	GA-403	DON	P152658	GA-27 ¹²	DON
P129544	GA-107	DON	P136390	GA-18	DON	P145444	GA-33 ¹²	DON	P152659	GA-360	DON
P129545	GA-209	DON	P136401	GA-426	DON	P145522	GA-356	DON	P152709	GA-239	DON
P129600	GA-879	DON	P136492	GA-403	DON	P145536	GA-404	DON	P152716	GA-361	DON
P129648	GA-416	DON	P136646	GA-373	DON	P145600	GA-891 ³⁰	DON	P152830	GA-403	DON
P13	G-335	PHI	P136660	GA-6127	DON	P145649	GA-16	DON	P152859	GA-616	DON
P13</											

Numero	Gonher	Fabricante	Numero	Gonher	Fabricante	Numero	Gonher	Fabricante	Numero	Gonher	Fabricante
Number	Gonher	Manufacturer	Number	Gonher	Manufacturer	Number	Gonher	Manufacturer	Number	Gonher	Manufacturer
P153321	GA-16	DON	P1652	GP-66	FRM	P170433	G-1143	DON	P181188	GA-422	DON
P153336	GA-356	DON	P1653	GP-66	FRM	P170571	G-750	DON	P181189	GA-642	DON
P153338	GA-357	DON	P165332	GP-761H	DON	P170841	GG-5 L	DON	P181203	GA-827	DON
P153350	GAK-16	DON	P165338	GP-761H	DON	P170950	GP-761H	DON	P181204	GA-589	DON
P153352	GA-360	DON	P165344	GP-761H	DON	P171000	GP-3000	DON	P181207	GA-826	DON
P153353	GA-361	DON	P16534AGL	GP-66	FRM	P171089	GP-761H	DON	P181208	GA-588	DON
P153354	GA-106 ⁴⁶	DON	P16534AGR	GP-66	FRM	P171298	GP-761H	DON	P181337	GA-405	DON
P153354	GA-326 ⁷¹	DON	P165354	GP-761H	DON	P171421	GP-1109 ²¹	DON	P182000	GA-27 ¹²	DON
P153356	GA-206	DON	P1653A	GP-66	FRM	P171421	GP-62 ²⁹	DON	P182001	GA-26	DON
P153357	GAK-403	DON	P1653V15A	GP-66	FRM	P171802	G-24	DON	P182002	GA-6129	DON
P153359	GA-33 ¹²	DON	P1653V15A	GP-66	FRM	P171809	G-24	DON	P182006	GA-376	DON
P153360	GA-5648	DON	P1654	GP-66	FRM	P1720	G-1176	BWLA	P182007	GA-229	DON
P1535	G-1143	MNH	P1654A	GP-66	FRM	P172507	GP-54 ¹¹	DON	P182008	GA-378	DON
P1535-3N	G-1143	MNH	P1654V151A	GP-66	FRM	P172507	GP-66 ⁴⁹	DON	P182014	GA-209	DON
P153551	GA-3551 ⁵⁵	DON	P1654V152A	GP-66	FRM	P172535	GP-52 ¹¹⁰	DON	P182015	GA-107	DON
P153551	GA-3551 XT ⁶⁴	DON	P1654V52A	GP-66	FRM	P172535	GP-691 ⁴⁸	DON	P182019	GA-109	DON
P1535N	G-1143	MNH	P1654V53A	GP-66	FRM	P172538	G-834	DON	P182028	GA-209	DON
P1535X	G-1143	MNH	P1654V54A	GP-66	FRM	P172539	GP-28 ⁶	DON	P182034	GA-360	DON
P153960	GA-229	DON	P1655	GP-66	FRM	P172539	GP-430 ⁸	DON	P182038	GA-879	DON
P153970	GA-229	DON	P165623	G-339H	DON	P172540	GP-28 ⁶	DON	P182039	GA-356	DON
P154367	GA-1095	DON	P165733	GP-761H	DON	P172540	GP-430 ⁸	DON	P182043	GA-251	DON
P154513	GA-891 ⁹⁰	DON	P165877	GP-864H	DON	P172561	GP-54	DON	P182045	GAK-20	DON
P154517	GA-356	DON	P165879	GP-34	DON	P172563	G-133	DON	P182046	GA-106 ⁴⁶	DON
P154633	GA-892	DON	P166	G-34	ACE	P172653	G-1121F	DON	P182046	GA-326 ⁷¹	DON
P154711	GAK-403	DON	P166	G-34	APOL	P172681	G-1121F	DON	P182050	GA-33 ¹²	DON
P155	G-31	GLD	P166	G-34	BWS	P17276	GAK-403	LULL	P182052	GAK-16	DON
P1551	GP-66	COP	P166	G-34	CAM2	P172900	GP-34	DON	P182054	GAK-403	DON
P1551	GP-66	GLD	P166	G-34	CHP	P173	G-1163 ¹⁰⁸	HARM	P182062	GAK-1532	DON
P1553	GP-66	GLD	P166	G-34	GRAN	P173063	GAK-20	BRAY	P182063	GAK-625	DON
P155633	GA-119	DON	P166	G-34	LUF	P173063	GAK-20	MATB	P182073	GA-758	DON
P156	G-1173 ¹⁰⁸	WES	P166	G-34	SECU	P173736	GP-761H	DON	P182095	GA-1095	DON
P157	GG-16	FRML	P166	G-34	WARN	P173737	GP-761H	DON	P182099	GA-376	DON
P157	GG-16	PUR	P166086	GP-761H	DON	P173998	GP-193	DON	P182167	GA-20	DON
P157	G-33	WES	P166167	G-119	DON	P174	G-870	BLDW	P182173	GA-106 ⁴⁶	DON
P158	GG-17	FRML	P166173	GP-53	DON	P174	G-6	GLD	P182173	GA-326 ⁷¹	DON
P158	GG-17	PUR	P166174	GP-53	DON	P174	G-6	GUD	P182189	GA-642	DON
P15838	GA-37	DON	P166175	GP-52 ¹¹⁰	DON	P174	G-335	HARM	P18254	GA-37	DON
P15838	GA-37	NLSN	P166175	GP-691 ⁴⁸	DON	P174552	GP-761H	DON	P183051	GA-356	DON
P158661	GA-1285	DON	P166264	GP-34	DON	P176	G-816	BLDW	P183052	GA-106 ⁴⁶	DON
P158662	GA-1286	DON	P166375	G-33	DON	P176160	G-128	DON	P183052	GA-326 ⁷¹	DON
P158663	GA-1287	DON	P166376	G-33	DON	P177	G-871	BLDW	P183055	GA-6129	DON
P158664	GA-1284	DON	P166451	GP-53	DON	P17L	G-31	GLD	P183056	GA-360	DON
P158670	GA-7360	DON	P166481	G-238	DON	P17L-P	G-31	GLD	P183061	GA-229	DON
P158672	GA-482	DON	P166482	G-191	DON	P18	G-200	BLDW	P183067	GA-360	DON
P158675	GA-482	DON	P166483	G-566	DON	P180	G-1121	HARM	P183092	GA-329	DON
P158M	GP-17	PUR	P166507	GP-51	DON	P18065	GA-5648	DON	P183109	GA-1095	DON
P159	G-191	HARM	P166508	GP-9586	DON	P181000	GA-27 ¹²	DON	P183128	GA-33 ¹²	DON
P159040	GA-9334	DON	P166509	GP-36	DON	P181001	GA-26	DON	P183129	GAK-16	DON
P159046	GA-1008	DON	P166564	GP-13	DON	P181002	GA-6129	DON	P183135	GA-360	DON
P159548	GA-616	DON	P166613	GP-761H	DON	P181006	GA-376	DON	P183214	GAK-16	DON
P159701	GAK-625	DON	P166792	G-33	DON	P181007	GA-229	DON	P183215	GAK-403	DON
P159764	GAK-625	DON	P167	G-1174	GLD	P181008	GA-378	DON	P183219	GA-33 ¹²	DON
P15P	GP-1	WIX	P167	G-1174	WES	P181009	GA-6880	DON	P183224	GAK-1532	DON
P16	GPP-14	PHI	P167404	GP-51	DON	P181015	GA-107	DON	P183225	GA-360	DON
P1601	GPP-25	PHI	P167405	GP-52 ¹¹⁰	DON	P181016	GA-493 ¹⁰⁸	DON	P184	G-330	BLDW
P160558	GAK-403	DON	P167405	GP-691 ⁴⁸	DON	P181019	GA-109	DON	P184011	GA-27 ¹²	DON
P161	G-191	CHP	P167590	GP-761H	DON	P181028	GA-209	DON	P184012	GA-26	DON
P162033	G-153	DON	P167670	GP-53	DON	P181034	GA-360	DON	P184013	GA-6128 ²¹	DON
P162875	G-339H	DON	P167829	GP-3766	DON	P181035	GA-24 ¹¹²	DON	P184013	GA-6129	DON
P163	G-238	CHP	P167947	GP-359	DON	P181038	GA-879	DON	P184015	GA-378	DON
P163	G-238	HARM	P167947	GP-43	DON	P181039	GA-356	DON	P184034	GA-360	DON
P163068	GP-34	DON	P168004	GP-1	DON	P181042	GA-563	DON	P184039	GA-356	DON
P163299	GP-761H	DON	P168011	GP-46	DON	P181043	GA-251	DON	P184042	GA-563	DON
P163323	GP-761H	DON	P168062	GP-1011Q	DON	P181045	GA-20	DON	P184043	GA-251	DON
P163324	GP-761H	DON	P168090	GP-1	DON	P181045	GAK-20	DON	P184045	GAK-20	DON
P163412	GP-761H	DON	P168116	GP-58	DON	P181046	GA-106 ⁴⁶	DON	P184046	GA-106 ⁴⁶	DON
P163419	GP-761H	DON	P168176	GP-3000	DON	P181046	GA-326 ⁷¹	DON	P184046	GA-326 ⁷¹	DON
P163428	GP-761H	DON	P168230	GP-43	DON	P181050	GA-33 ¹¹²	DON	P184052	GA-106 ⁴⁶	DON
P163434	GP-761H	DON	P168279	G-1143 ³⁰	DON	P181052	GA-16	DON	P184052	GA-326 ⁷¹	DON
P163484	GP-761H	DON	P168727	GP-3	DON	P181052	GAK-16	DON	P184056	GA-360	DON
P163496	GP-761H	DON	P168729	GP-3980	DON	P181054	GAK-403	DON	P184059	GA-378	DON
P163542	GP-761H	DON	P169	G-5000	PHI	P181057	GA-885	DON	P184060	GA-493 ¹⁰⁸	DON
P163555	GP-761H	DON	P169	G-5000	PUR	P181062	GAK-1532	DON	P184061	GA-229	DON
P163721	GP-761H	DON	P-169	G-5000	PUMX	P181063	GAK-625	DON	P184092	GA-329	DON
P163868	GP-761H	DON	P169090	GP-1101	DON	P181073	GA-758	DON	P184109	GA-1095	DON
P163921	GP-761H	DON	P169091	GP-27	DON	P181095	GA-1095	DON	P184123	GA-360	DON
P163927	G-222	DON	P169092	GP-56	DON	P181099	GA-376	DON	P184142	GAK-625	DON
P163988	GP-761H	DON	P169093	GP-1101	DON	P181102	GA-9045	DON	P184144	GA-758	DON
P164	G-152	CHP	P169094	GP-55	DON	P181103	GA-8047	DON	P184146	GA-229	DON
P164002	GP-761H	DON	P169095	GP-93	DON	P181104	GA-9334	DON	P184148	GA-6880	DON
P164056	GP-761H	DON	P169096	GP-110	DON	P181105	GA-1008	DON	P184166	GAK-216	DON
P164091	GP-761H	DON	P169097	GP-84	DON	P181107	GA-29	DON	P184167	GA-403	DON
P164199	G-339H	DON	P169098	GP-85	DON	P181108	GA-375	DON	P184196	GAK-403	DON
P164200	G-152	DON	P169285	GP-761H	DON	P181109	GA-1203	DON	P184200	GA-403	DON
P164205	G-222	DON	P169745	GP-761H	DON	P181113	GA-287	DON	P185000	GA-27 ¹²	DON
P164207	G-153	DON	P1698	G-750	DIAM	P181118	GA-7716	DON	P185001	GA-26	DON
P164255	G-339H	DON	P1699	G-1175 ¹⁰⁸	DIAM	P181120	GA-483	DON	P185002	GA-6129	DON
P164375	GP-761H	DON	P169958	GP-761H	DON	P181137	GA-405	DON	P185007	GA-229	DON
P164378	GP-761H	DON	P17	GP-50	FRM	P181148	GA-509 ¹⁴	DON	P185008	GA-378	DON
P164381	GP-761H	DON	P17	G-31	GLD	P181163	GA-403	DON	P185014	GA-209	DON
P164384	GP-761H	DON	P17	GP-81	PHI	P181171	GA-360	DON	P185015	GA-107	DON
P164477	GP-761H	DON	P17	G-31	WES	P181173	GA-106 ⁴⁶	DON	P185019	GA-109	DON
P164500	G-152	DON	P170	G-870	BLDW	P181173	GA-326 ⁷¹	DON	P185025	GA-372	DON
P164904	G-339H	DON	P170064	G-222	DON	P181184	GA-405	DON	P185028	GA-209	DON
P165024	G-152	DON	P170212	GPP-11	DON	P181186	GA-608	DON	P185034	GA-360	DON
P165189	GP-34	DON	P170371	GP-761H	DON	P181187	GA-3501	DON	P185038	GA-879	DON

Referencia Cruzada por Numero de Parte

Cross Reference by Part Number



Numero	Gonher	Fabricante	Numero	Gonher	Fabricante	Numero	Gonher	Fabricante	Numero	Gonher	Fabricante
Number	Gonher	Manufacturer	Number	Gonher	Manufacturer	Number	Gonher	Manufacturer	Number	Gonher	Manufacturer
P185039	GA-356	DON	P219	G-1123	WES	P3	G-566	UNI	P333	GP-1101	GLD
P185043	GA-251	DON	P219	G-1123F	WES	P3	GP-50	UNN	P3331	G-836	WES
P185046	GA-106 ⁴⁶	DON	P221	G-225	COP	P30	G-31	CHP	P333D	GPP-14	GLD
P185046	GA-326 ⁷¹	DON	P221	G-225	GLD	P30	G-31	GLD	P3340	GP-67	FRM
P18505-01	GP-9586	DON	P2224	G-45	CHP	P30	G-31	WES	P335	G-31	ACD
P185053	GA-3551 ⁵⁵	DON	P2224	G-45	LUF	P3001	GP-31	BOG	P335	GP-335	BWS
P185053	GA-3551 XT ⁶⁴	DON	P2224	G-45	PARP	P3001-1	GP-77	BOG	P335	G-335	CHP
P185057	GA-885	DON	P2224	G-45	TIRP	P3002	GP-54	BOG	P335	G-335	LUF
P185067	GA-197R	DON	P2224	G-45	WARN	P3004	GP-58	BOG	P3375	GP-749	FRM
P185069	GA-682R	DON	P2225	G-49	CHP	P3005	GP-1	BOG	P3376	GP-56	FRM
P185093	GA-968R	DON	P2225	G-49	LUF	P3010	GP-31	BOG	P3380	GP-78	FRM
P185095	GA-1095	DON	P2225	G-49	PARP	P3010	G-6	GLD	P3380FP	GP-78	FRM
P185099	GA-376	DON	P2225	G-49	WARN	P3012	GP-310	BOG	P3384	GA-89	PHI
P185106	GA-518R	DON	P223	G-871	GLD	P3028	GP-171	BOG	P339	GP-14	GLD
P185107	GA-968R	DON	P224	GP-20	GLD	P3029	GP-81 ³¹	BOG	P340	GPP-14	GLD
P186	G-1173	GLD	P225	G-49	CHP	P3029	GP-9 ⁵⁸	BOG	P3401	GPP-18	FRM
P18662B	G-871	GLD	P225	GP-3	GLD	P3033	GP-28	BOG	P3404	GP-50 ²⁰	FRM
P18662B	G-871	WES	P225	G-49	LUF	P3038	GP-171	BOG	P3413	GP-50	FRM
P187	G-871	GLD	P226	GP-50	GLD	P3040	G-466	CHAM	P3430	GP-55	FRM
P18706	GA-9045	DON	P226	GP-50	GUD	P3040	G-466	LUF	P3430A	GP-55	FRM
P18709	GA-968R	DON	P228A	GG-20	COP	P3040	G-466	PARP	P3431	GP-85	FRM
P188	G-238	WES	P23	G-162H	PUR	P305	G-119	COP	P3431FP	GP-85	FRM
P189	G-139	BWS	P230	G-1143	PUR	P305	G-119	GLD	P3432	GP-20	FRM
P189	G-139	CHP	P-230	G-1143	PUMX	P3050	GP-3816	BOG	P3435	GP-1101	FRM
P189	G-139	LUF	P23-1	GP-1101	PHI	P3058	GP-81	BOG	P343MA	G-566	GLD
P19159	GA-9334	DON	P232	G-33	WES	P3059	GP-171 ¹⁹	BOG	P346	G-331	BWS
P19327	GA-29	DON	P235	G-200	GLD	P306	G-613	HARM	P346	G-331	CHP
P19476	GAK-20	LULL	P240X	G-871	MNH	P3062	GP-171	BOG	P346	G-296	GLD
P1950594L	GG-5 L	CASE	P2417	GP-50	BWLA	P3074	GP-3600	BOG	P346	G-296-B	GLD
P197	G-33	GLD	P242	G-163 ¹¹⁵	BLDW	P3077	GP-51	BOG	P346	G-331	LUF
P197	G-870	HARM	P2422	G-1175 ¹⁰⁸	BWLA	P3079	GP-46	BOG	P346A	G-296	GLD
P197MB	G-33	GLD	P2422	G-1175 ¹⁰⁸	LAPL	P308	G-750	HARM	P346A	G-296-B	GLD
P1999	G-500	DIAM	P245	G-330	GLD	P3081	GP-5	BOG	P349	G-870	COP
P19L	G-871	PUR	P245	G-330	GUD	P3084	GP-3816	BOG	P349	G-870	GLD
P-19-L	G-871	PUMX	P2470	G-816	LUF	P3086	GP-28	BOG	P35	G-31	PUR
P1H4115	G-1123	DUTZ	P248	G-613	GLD	P3087	GP-31	BOG	P350	G-34	GLD
P1H4115	G-1123F	DUTZ	P250	G-1173 ¹⁰⁸	GLD	P3089	GP-40	BOG	P350	G-122	HAS
P2	G-6	ACE	P250566	GA-892	CASE	P309	G-33	COP	P350	G-338	HAS
P2	G-6	APOL	P250599	GAK-625	CASE	P309	G-33	GLD	P3509	GP-66	FRM
P2	G-6	CAM2	P251	G-1175 ¹⁰⁸	GLD	P31	GP-78	PHI	P351	GP-14	GLD
P2	G-6	CHP	P251F	GP-1108	CHP	P3101	GP-3600	BOG	P3510	GP-66	FRM
P2	G-200	GLD	P25288	GP-3675	PUR	P311	GP-13	GLD	P3522	GPP-1122	FRM
P2	G-6	LUF	P256	G-1121	HARM	P311	GP-13	GUD	P3522A	GPP-1122	FRM
P2	G-6	WARN	P25F	G-11816	PUR	P3110	GP-3600	BOG	P3525A	GP-1101	FRM
P2	G-200	WHIT	P-25-F	G-11816	PUMX	P312	G-139	ACD	P3528	GP-1101	FRM
P20	GP-81	PHI	P2629	G-6	BWLA	P312	GP-3	GLD	P3528A	GP-11	FRM
P2000	GP-38	BOG	P2629	G-6	LAPL	P313	G-834	GLD	P3528AFP	GP-1101	FRM
P2001	GP-1	BOG	P265	G-834	TFIL	P3136	GP-81 ³¹	BOG	P3555	GP-57	FRM
P2002	GP-1	BOG	P2654403	GP-1	ERF	P3136	GP-9 ⁵⁸	BOG	P3555A	GP-57	FRM
P2003	GP-81 ³¹	BOG	P2654407	G-1121F	BRAY	P3140	GP-46	BOG	P3555PL	GP-57	FRM
P2003	GP-9 ⁵⁸	BOG	P26561117	G-296	ERF	P31409	GA-49	FRM	P356	G-833	BLDW
P2005	GP-1	BOG	P26561117	G-296-B	ERF	P3141	GP-22	BOG	P357	G-122	GLD
P2007	GP-91	BOG	P26562002	GP-78	PERK	P3142	GP-81	BOG	P357	G-338	GLD
P2008	GP-3985	BOG	P266	G-333	GLD	P3147	GP-40	BOG	P357433	G-295	WAUK
P2009	GP-42	BOG	P266	G-333	GUD	P3148	GP-40	BOG	P358	GP-1122	PHI
P201	G-566	HARM	P267	G-335	GLD	P31488	GA-405	FRM	P359	GP-92	FRM
P2015	GP-3531 EXP	BOG	P2677	G-31	BWLA	P3152	GP-171	BOG	P3594	GP-92	FRM
P2016	GP-40	BOG	P2677	G-31	DIAM	P3153	GP-1	BOG	P3595	GP-93	FRM
P2017	GP-58	BOG	P-2677	G-31	KENW	P3154	GP-81	BOG	P36	GS-2034	UNI
P202	GS-2033	TFIL	P268	G-5000	GLD	P316494	GA-712R	DON	P3610	GAC-9	BOG
P2020	GP-40	BOG	P268	GP-81 ³¹	HARM	P3166	GP-81 ³¹	BOG	P3620	GP-51	FRM
P2020S	GS-2033	PURF	P2688	G-5000	GLD	P3166	GP-9 ⁵⁸	BOG	P3645	GP-92	FRM
P2023	GP-3682	BOG	P2692	G-6	BWLA	P3167	GP-81 ³¹	BOG	P366	GP-1	GLD
P2024	GP-171	BOG	P2692	G-6	LAPL	P3167	GP-9 ⁵⁸	BOG	P366	GP-28 ⁹	TFIL
P2028	GP-157	BOG	P2700336	GA-251	DON	P317	GP-50	COP	P366	GP-430 ⁸	TFIL
P203	G-333	BLDW	P271	GP-31	ACD	P317	GP-50	GLD	P3671	GAC-7	BOG
P204	GS-2034	TFIL	P273	G-1175	GLD	P3171	GP-81	BOG	P37	GS-2033	UNI
P2044	GP-58	BOG	P275X	G-813	MNH	P3174	GP-40	BOG	P370	GP-36	GLD
P20505-09	GA-9334	POCL	P278	G-1173	GLD	P3178	GP-81	BOG	P370	G-295	PHI
P2056	GP-3816	BOG	P278A	G-1173	GLD	P3194	GP-1	BOG	P3711	GAC-6	BOG
P206	G-31	ACD	P279994	G-335	UNI	P321	GP-81 ³¹	COP	P3711	GP-1122	FRM
P206F	G-31	ACD	P279994P	G-335	UNI	P321	GP-9 ⁵⁸	COP	P3760	GP-66	FRM
P207	G-613	HARM	P280	G-225	WES	P321	GP-81 ³¹	GLD	P3761	GP-171	FRM
P20877	G-750	LETR	P2805	GP-50	FRM	P321	GP-9 ⁵⁸	GLD	P3767	GP-155	CAC
P20877	G-750	WABC	P2806	GP-50	FRM	P3220	GP-54	BOG	P3767	GP-155	FRM
P20-HD	G-33	BLDW	P2808	GP-50	FRM	P3224-1	GP-54	BOG	P3805	GP-85 ⁹⁰	FRM
P20L	G-871	PUR	P2810	GP-50	FRM	P3226	GP-54	BOG	P3815	G-270	FRM
P210-1	G-236	GLD	P2814	GP-22	FRM	P3228	GP-28	BOG	P3815A	G-270	FRM
P2113	GA-37	DIAM	P282	GP-1101	GLD	P3233	GP-40	BOG	P3823	GP-27	FRM
P2113	GA-37	WHIT	P285	GP-81	GLD	P324	G-1121	COP	P3853	GAC-10 ⁸⁸	BOG
P212	G-331	GLD	P286	G-613	HARM	P324	G-1121	GLD	P3853	GAC-8	BOG
P2129	G-765	CAMP	P2863349	GA-730	MOP	P3244	G-49	CHP	P3877	GAC-1	BOG
P2129	G-765	CHP	P289	G-297-B	HARM	P3244	G-49	LUF	P39	GP-44	GLD
P2129	G-765	LUF	P29	GP-34	PHI	P3244	G-49	PARP	P3940	G-294	FRM
P2129	G-765	PARP	P291	G-1174 ¹⁰⁸	GLD	P3244	G-49	WARN	P3940A	G-294	FRM
P2129	G-765	TRUS	P29130	GAK-16	FRM	P325	G-1123	COP	P3940AFP	G-294	FRM
P2129	G-765	WARN	P29195	GAK-403	FRM	P325	G-1123	GLD	P3940FP	G-294	FRM
P21366	G-33	KOEH	P291A	G-1174 ¹⁰⁸	GLD	P3252	GP-68	BOG	P3951	GP-166	FRM
P21366	G-33	LORA	P2950591	GPP-425	CASE	P3284H	G-159	HYST	P3952	GP-166	FRM
P214731	G-333	UNI	P2950591P	GPP-425	CASE	P3300	G-871	WES	P3961	GP-34	FRM
P2150	GP-1	GLD	P29748	GA-360	FRM	P3305	G-870	WES	P398	GP-10	GLD
P216	G-836	COP	P29870	GA-356	FRM	P331	G-331	CHP	P3986	G-313	LUF
P216	G-836	GLD	P2M3943	G-152	GLD	P3317	GP-50	FRM	P3H4120	G-31	DUTZ
P2172	G-500	DIAM	P3	GP-50	ACD	P3318	GPP-18	FRM	P3H4120	G-31	FAHR
P2175	GA-37	DIAM	P3	GP-20	GLD	P3319	GPP-19	FRM	P4	GP-3	GLD
P2182	GP-31	BOG	P3	GP-50	PHI	P333	GP-1101	COP	P4005	GP-14	BOG

REFERENCIA CRUZADA

Para números Gonher con Superíndice vea página 651
For Gonher with Superscript numbers see page 651

Numero	Gonher	Fabricante	Numero	Gonher	Fabricante	Numero	Gonher	Fabricante	Numero	Gonher	Fabricante
Number	Gonher	Manufacturer	Number	Gonher	Manufacturer	Number	Gonher	Manufacturer	Number	Gonher	Manufacturer
P4005		GPP-111 FRM	P4J6064		G-222 GLD	P524357		GA-85 DON	P536142		GA-930R DON
P4005		GPP-524 FRM	P4J6064-10		G-222 COP	P524358		GA-303 DON	P536425		GA-165 DON
P401229		GP-390 ATHY	P5		GP-81 ²¹ GLD	P524359		GA-3300 DON	P536429		GA-240 DON
P40123		GP-1122 ATHY	P5		GP-9 ⁹⁸ GLD	P524361		GA-75 DON	P536430		GA-2198 ⁷⁹ DON
P401230		GPP-18 ATHY	P5		GP-110 PBLT	P524362		GA-3501 DON	P536434		GA-438 ³¹ DON
P4063		GP-1 BOG	P5		GP-191 PHI	P524363		GA-2984 DON	P536431		GA-186 DON
P4064		GP-3 BOG	P50		G-31 PUR	P524366		GA-89 DON	P536433		GAUV-620 DON
P4065		GP-310 BOG	P-50		G-31 PUMX	P524368		GA-3501 DON	P536434		GA-442 DON
P4066		GP-36 BOG	P500005		GA-4325 DON	P524369		GA-89 DON	P536676		GAUV-2 DON
P41		G-566 PUR	P500008		GA-362 DON	P524370		GA-3424 DON	P536732		GA-732R DON
P-41		G-566 PUMX	P500028		GA-410 DON	P524371		GA-3425 DON	P536733		GA-673R DON
P4100A		GP-1122 FRM	P500063		GAD-15 DON	P524372		GA-3523 DON	P537369		GA-176 DON
P4102		GP-1122 FRM	P500074		GA-381 DON	P524374		GAD-1 DON	P538007		GA-712R DON
P4102A		GP-1122 FRM	P500082		GA-4303 DON	P524375		GAD-3 DON	P538456		GA-890R DON
P4102PL		GP-1122 FRM	P500083		GAD-30 DON	P524376		GA-74 DON	P538542		GA-967R DON
P4102RP		GP-1122 FRM	P500123		GAK-16 DON	P524377		GA-3490 DON	P539186		GA-930R DON
P411		GP-81 COP	P5005		G-159 CHP	P524378		GA-54 DON	P539460		GA-230 DON
P4157		GP-1122 FRM	P5008		G-122 CHP	P524380		GA-100 DON	P539463		GA-105 DON
P4159		G-1121 FRM	P5008		G-338 CHP	P524381		GA-734 ⁹¹ DON	P54		GP-36 PHI
P417		G-31 ACD	P502		GP-390 ⁹³ GLD	P524381		GA-735 ¹²⁴ DON	P540388		GA-435R DON
P4183		GPP-1122 FRM	P502007		GP-149 DON	P524382		GA-271 DON	P542101		GA-968R DON
P4186		GP-1122 FRM	P502009		GP-40 DON	P524384		GA-3588 DON	P542102		GA-968R DON
P42		G-31 BLDW	P502015		GP-157 DON	P524385		GA-3647 DON	P542345		GA-682R DON
P43		GPP-18 PHI	P502016		GP-58 DON	P524386		GA-3647 DON	P542909		GAUV-2 DON
P4349744		GP-58 CHRY	P502024		GP-58 ¹⁵ DON	P524388		GA-135 DON	P543614		GA-633R DON
P4349745		GP-58 CHRY	P502039		GP-3985 DON	P524389		GA-3681 DON	P544098		GA-413R DON
P436		GP-34 GLD	P502042		GP-359 DON	P524390		GA-71 DON	P544432		GA-702 ¹⁰⁸ DON
P4473		GP-1122 FRM	P502046		GP-359 DON	P524391		GA-70 DON	P5457		GP-1122 FRM
P4506		GP-1122 FRM	P502048		GP-3985 DON	P524392		GA-135 DON	P5465		GP-57 FRM
P4506PL		GP-1122 FRM	P502049		GP-91 DON	P524392		GA-35 DON	P546566		GAK-458 DON
P4516		GP-1122 FRM	P502051		GP-462 DON	P524393		GA-55 DON	P546596		GA-472 DON
P452		GP-1 GLD	P502057		GP-91 DON	P524394		GA-730 DON	P548070		GA-701 ¹⁰⁴ DON
P4520		GPP-1122 FRM	P502062		GP-91 DON	P524397		GA-2719B DON	P548963		GA-348 DON
P4529190		GP-171 ¹⁶ CHRY	P502063		GP-149 DON	P524398		GA-86 DON	P549644		GA-968R DON
P4529806		GP-171 ¹⁶ CHRY	P502067		GP-91 DON	P524401		GA-429 DON	P550003		GG-5 L DON
P454		GP-1 GLD	P502070		GP-156 DON	P525130		GA-174 DON	P550008		GP-1 DON
P455		GP-69 GLD	P502071		GP-91 DON	P525493		GA-3551 ²⁵ DON	P550012		GG-5 L DON
P4587		GPP-1122 FRM	P502072		GP-68 DON	P525493		GA-3551 XT ²⁴ DON	P550020		GP-14 DON
P459		GP-31 PHI	P502074		GP-46 DON	P526407		GA-827 DON	P550022		GG-123 DON
P459539		GA-694 DON	P502075		GP-46 DON	P526410		GA-826 DON	P550024		GP-5 DON
P46		GP-44 GLD	P502076		GP-40 DON	P526413		GA-39 DON	P550025		GP-3 DON
P460		GP-3816 COP	P502086		GP-38 DON	P526488		GA-21 DON	P550035		GP-13 DON
P460		GP-58 GLD	P502149		GPP-111 DON	P526660		GAK-1532 DON	P550041		G-143 DON
P463		GP-84 COP	P502149		GPP-524 DON	P526947		GA-682R DON	P550043		G-1143 DON
P463		GP-84 GLD	P502158		GPP-111 DON	P526966		GA-529 DON	P550045		GP-3429 DON
P4637		GP-166 FRM	P502158		GPP-524 DON	P527484		GA-197R DON	P550047		GP-46 DON
P4638		GP-166 FRM	P502169		GG-298 DON	P527680		GA-768R DON	P550050		GP-50 DON
P464		GP-83 COP	P503		GP-42 GLD	P527682		GA-682R DON	P550051		GP-3980 DON
P464		GP-83 GLD	P5067		GP-54 ¹¹ BOG	P527683		GA-683R DON	P550052		G-870 DON
P467		GPP-18 GLD	P5067		GP-66 ¹⁰ BOG	P527884		GA-197R DON	P550060		G-1121 DON
P47		G-5000 BLDW	P5068		GP-36 FRM	P528		G-159 BLDW	P550060		G-1121F DON
P476		G-34 BLDW	P507		G-926 BLDW	P528206		GA-12 DON	P550067		GP-3985 DON
P477		GP-62 COP	P50L		G-31 PUR	P528208		GA-2740 DON	P550078		GP-38 DON
P477		GP-62 GLD	P510		G-1175 ¹⁰⁸ WES	P528212		GA-3637 DON	P550088		GPP-14 DON
P47937		GAK-20 ATHY	P511		GP-1122 GLD	P528220		GA-44 DON	P550089		GP-92 DON
P48		G-6 PHI	P511		G-1173 ¹⁰⁸ WES	P528223		GA-119 DON	P550090		GG-5 L DON
P48		G-6 REF	P512		G-294 GLD	P528225		GA-277 DON	P550091		GG-19 DON
P-48		G-6 PUMX	P513		GP-1 GLD	P528226		GA-274 DON	P550093		GG-6 DON
P48-06		G-6 PUR	P514		GP-3600 GLD	P528227		GA-153 DON	P550094		GG-1 DON
P48068		GP-66 ATHY	P515		GP-46 GLD	P528231		GA-7 DON	P550094		GG-4 DON
P481		GP-51 COP	P5162		GP-38 FRM	P529104		GA-529 DON	P550095		GP-81 DON
P481		GP-51 GLD	P518		GP-52 ¹¹⁰ GLD	P529493		GA-197R DON	P550104		GP-1101 DON
P482		GP-78 GLD	P518		GP-69 ⁴⁸ GLD	P529494		GA-768R DON	P550105		GP-11 DON
P483		GP-69 GLD	P5188		GP-54 BOG	P53		GP-110 PHI	P550105		GP-1101 DON
P485		G-122 GLD	P5188		GP-66 BOG	P530079		GA-360 DON	P550106		GPP-11 DON
P485		G-338 GLD	P519		GP-53 GLD	P530276		GA-221R DON	P550106		GPP-14 DON
P486		GP-1107 GLD	P52		G-870 ACE	P530300		GA-197R DON	P550108		GPP-14 DON
P487		G-169 CHRY	P52		G-870 APOL	P530627		GA-6 DON	P550109		GP-1101 ⁵⁴ DON
P487		GP-23 GLD	P52		G-31 BLDW	P530628		GA-6 DON	P550110		GPP-19 DON
P488		GP-462 GLD	P52		G-870 BWS	P530630		GA-42 DON	P550115		GGP-25 DON
P4886		GPP-111 FRM	P52		G-870 CAM2	P530633		GA-11 DON	P550117		G-31 DON
P4886		GPP-524 FRM	P52		G-870 CHP	P530866		GA-371 DON	P550120		G-1121 DON
P48866		GAK-403 ATHY	P52		G-870 GRAN	P531026		GA-518R DON	P550120		G-1121F DON
P48874		GAK-20 ATHY	P52		G-870 LUF	P531751		GA-768R DON	P550126		GG-47 DON
P48M		G-6 REF	P52		G-870 MASE	P532499		GA-499R DON	P550132		G-33 DON
P49		G-330 ACE	P52		G-870 WARN	P532883		GA-435R DON	P550141		G-200 DON
P49		G-330 APOL	P520		GPP-19 GLD	P532966		GA-966R DON	P550147		G-119 DON
P49		G-330 CAM2	P521		GPP-18 GLD	P533235		GA-221R DON	P550152		GP-390 ⁹³ DON
P49		G-330 CHP	P521		G-31 PUR	P533354		GA-673R DON	P550154		GP-50 DON
P49		G-330 LUF	P521167		GA-7360 DON	P533355		GA-732R DON	P550155		G-163 DON
P49		G-330 PUR	P521445		GA-361 DON	P533655		GA-930R DON	P550157		GP-77 DON
P49		G-330 REX	P522		GP-3429 GLD	P533723		GA-723R DON	P550159		GP-14 DON
P49		G-330 SPEC	P522		G-1174 ¹⁰⁸ WES	P533781		GA-967R DON	P550162		GP-149 DON
P49		G-330 WARN	P522183		GA-616 DON	P533882		GA-600R DON	P550163		GP-3985 DON
P-49		G-330 PUMX	P522293		GA-377 DON	P533890		GA-890R DON	P550166		GP-68 DON
P492		GP-10 GLD	P522449		GAK-16 DON	P533930		GA-930R DON	P550168		GP-1 ⁹ DON
P493		GP-28 ⁸ GLD	P522606		GA-197R DON	P534095		GA-518R DON	P550173		GP-40 DON
P493		GP-430 ⁸ GLD	P524095		GA-682R DON	P534096		GA-518R DON	P550183		G-801 DON
P49360		GAK-403 ATHY	P524347		GA-77 DON	P534104		GA-273 DON	P550183		G-871 DON
P495		GP-66 GLD	P524349		GA-50 DON	P534105		GA-3901 DON	P550184		G-813 DON
P496		GP-26 GLD	P524350		GA-80 DON	P534816		GA-539R DON	P550185		G-834 DON
P497		GP-31 GLD	P524351		GA-192 DON	P534925		GA-534R DON	P550188		GP-14 DON
P498		GP-27 GLD	P524353		GA-78 DON	P535282		GA-853R DON	P550190		G-34 DON
P499		GP-69 GLD	P524354		GA-90 DON	P535717		GA-682R DON	P550196		GP-50 DON
P4H4120		G-1143 DUTZ	P524355		GA-59 DON	P535788		GA-518R DON	P550201		G-1163 DON
P4J6064		G-222 COP	P524356		GA-57 DON	P536036		GA-904R DON	P550202		GP-55 DON

Referencia Cruzada por Numero de Parte

Cross Reference by Part Number



Numero	Gonher	Fabricante	Numero	Gonher	Fabricante	Numero	Gonher	Fabricante	Numero	Gonher	Fabricante	
Number	Gonher	Manufacturer	Number	Gonher	Manufacturer	Number	Gonher	Manufacturer	Number	Gonher	Manufacturer	
P550208		GP-22	DON	P550522	G-1174 ¹⁰⁸	DON	P551039	GPP-1122	DON	P553634	GP-34	DON
P550209		GG-46	DON	P550527	G-1047	DON	P551040	GPP-10075	DON	P553693	GP-62	DON
P550214		GG-20	DON	P550528	G-3752	DON	P551042	GP-171	DON	P553712	GP-66	DON
P550215		GP-92	DON	P550534	GP-58	DON	P551049	G-294	DON	P553712	GP-69	DON
P550218		GP-84	DON	P550540	G-1175	DON	P551102	GP-77	DON	P553746	GP-67	DON
P550219		GP-83	DON	P550548	GPP-547	DON	P551130	G-295	DON	P553771	GP-54 ⁴¹	DON
P550222		GP-171 ¹⁶	DON	P550554	GPP-1291	DON	P551158	G-191	DON	P553771	GP-66 ¹⁰	DON
P550224		GP-20	DON	P550564	G-918	DON	P551167	G-11816	DON	P553825	G-143	DON
P550226		GP-9	DON	P550566	G-870	DON	P551178	GP-110	DON	P553854	GP-1105	DON
P550227		GP-3682	DON	P550580	GP-81	DON	P551195	GP-66	DON	P553855	GP-1107	DON
P550229		GP-66	DON	P550585	GP-2127W	DON	P551201	GP-171	DON	P553871	GP-88	DON
P550230		GP-66 ⁹⁰	DON	P550587	GPP-1122	DON	P551205	GP-54	DON	P553925	G-926	DON
P550237		GP-31	DON	P550588	GPP-1122	DON	P551205	GP-66	DON	P554004	GP-51	DON
P550239		GP-110	DON	P550589	GP-58	DON	P551241	GP-34	DON	P554005	GP-52 ¹¹⁰	DON
P550246		GP-1105	DON	P550594	G-871	DON	P551251	GP-81 ³¹	DON	P554005	GP-69 ⁴⁸	DON
P550248		GPP-1122	DON	P550595	G-225	DON	P551251	GP-9 ⁹⁸	DON	P554013	GP-1013Q	DON
P550249		GP-1232	DON	P550599	G-836	DON	P551258	GP-3000 ¹³	DON	P554016	GP-1011Q	DON
P550251		GP-34	DON	P550600	GP-212	DON	P551262	GP-69	DON	P554017	GP-54	DON
P550252		GP-34	DON	P550613	G-613	DON	P551268	GP-171	DON	P554018	GP-1011Q	DON
P550255		GP-66	DON	P550625	GP-749	DON	P551278	G-330	DON	P554019	GP-2108W	DON
P550256		GP-66 ²¹	DON	P550632	G-1046	DON	P551279	G-236	DON	P554071	GP-2071W	DON
P550272		GP-1122	DON	P550637	G-159	DON	P551285	G-836	DON	P554072	GP-1010Q	DON
P550299		GP-31	DON	P550656	GP-900	DON	P551291	G-816	DON	P554073	GP-1011Q	DON
P550300		G-31	DON	P550666	GPP-420	DON	P551297	GP-36	DON	P554074	GP-1012Q	DON
P550309		G-162H	DON	P550670	GP-53	DON	P551300	GP-171	DON	P554074	GP-1013Q	DON
P550316		G-1143 ⁹⁰	DON	P550671	GP-53	DON	P551303	GP-50	DON	P554075	GP-1013Q	DON
P550316		GS-557	DON	P550678	GP-1122	DON	P551307	GP-44	DON	P554105	GP-52 ¹¹⁰	DON
P550318		GP-171	DON	P550681	GPP-19	DON	P551311	GP-749	DON	P554105	GP-69 ⁴⁸	DON
P550319		GP-88	DON	P550683	GP-1101	DON	P551313	GP-110	DON	P554347	GP-26	DON
P550335		GP-58	DON	P550684	GP-1101	DON	P551314	GP-1109 ²²	DON	P554403	GP-1	DON
P550343		GP-9	DON	P550685	GC-1133	DON	P551314	GP-62 ⁹⁰	DON	P554407	GP-31	DON
P550345		GP-1122	DON	P550686	GS-1133	DON	P551315	GP-1109	DON	P554408	GP-3600	DON
P550349		G-1123F	DON	P550688	GPP-1122	DON	P551318	GP-78	DON	P554422	GP-2022W	DON
P550350		G-750	DON	P550690	GPP-1122	DON	P551323	GP-166	DON	P554620	GP-1122	DON
P550351		GPP-418	DON	P550691	GPP-14	DON	P551327	GP-171 ¹⁶	DON	P554636	G-122	DON
P550362		GP-54	DON	P550695	GP-36	DON	P551329	GPP-18	DON	P554636	GP-338	DON
P550364		GG-48	DON	P550710	GP-36	DON	P551348	GP-166	DON	P554680	GP-2015W	DON
P550367		GP-152	DON	P550711	GP-3682	DON	P551352	GP-754	DON	P554731	G-333	DON
P550371		GP-562	DON	P550715	GP-490	DON	P551381	GP-43	DON	P554744	GP-2071W	DON
P550372		GP-96	DON	P550716	GP-40	DON	P551551	GP-66	DON	P554770	GP-3600	DON
P550381		G-750	DON	P550718	GP-3985	DON	P551553	GP-66	DON	P554860	GP-2015W	DON
P550386		GP-34	DON	P550719	GP-36	DON	P551604	GP-88	DON	P555001	GPP-103 ⁹⁰	DON
P550387		GP-34	DON	P550726	GP-91	DON	P551670	GP-43 ⁹⁰	DON	P555001	GPP-11 ³⁹	DON
P550388		GP-864H	DON	P550729	GPP-547 ³⁹	DON	P551670	GP-53 ⁹⁶	DON	P555002	S 3202 ⁹⁰	DON
P550390		GPP-111	DON	P550729	PF831 ⁴¹	DON	P551712	GP-749	DON	P555003	GPP-11	DON
P550390		GPP-524	DON	P550729	R 60 P ⁴²	DON	P551723	GPP-424	DON	P555004	GPP-14	DON
P550393		GP-88	DON	P550730	GPP-1287 ³⁹	DON	P551740	GP-110	DON	P555005	GP-83	DON
P550396		G-162H	DON	P550730	PF831 ⁴¹	DON	P551743	GPP-11	DON	P555006	GP-57	DON
P550396		G-225	DON	P550730	R 60 P ⁴²	DON	P551749	G-1176	DON	P555007	GP-55	DON
P550397		GPP-419	DON	P550731	GP-54	DON	P551767	GPP-1291 ³⁹	DON	P555010	GPP-11	DON
P550398		GPP-419	DON	P550750	G-750	DON	P551767	PF831 ⁴¹	DON	P555011	GP-1101	DON
P550398		GPP-421	DON	P550751	G-750	DON	P551767	R 90 P ⁴²	DON	P555020	S 3202 ⁹⁰	DON
P550399		GPP-425	DON	P550752	G-559	DON	P551807	GP-51	DON	P555030	GPP-11	DON
P550400		GP-3600	DON	P550756	GPP-426	DON	P551808	GP-52 ¹¹⁰	DON	P555040	GP-14	DON
P550401		GPP-419	DON	P550761	G-3754	DON	P551808	GP-69 ⁴⁸	DON	P555088	G-139	DON
P550411		GP-36	DON	P550768	GP-3827	DON	P551915	GP-26	DON	P555095	GP-1122	DON
P550414		G-128	DON	P550774	GP-1109	DON	P552010	2010PM-OR ⁷	DON	P555110	GP-1101	DON
P550425		GP-556	DON	P550777	GP-57	DON	P552010	2010TM-OR ²	DON	P555240	GP-36	DON
P550428		GP-166 ⁹⁵	DON	P550780	GPP-612	DON	P552015	GP-2015W	DON	P555570	GP-9586	DON
P550428		GP-3937 ¹¹	DON	P550784	GP-3766	DON	P552020	GS-2033	DON	P555603	G-331	DON
P550430		GS-1261	DON	P550785	GS-1261	DON	P552022	GP-2022W	DON	P555616	GP-69	DON
P550431		GP-85	DON	P550811	GP-155	DON	P552040	GS-2034	DON	P555625	G-133	DON
P550433		GG-5 L	DON	P550832	GP-23	DON	P552055	GP-1013Q	DON	P555625	G-989	DON
P550434		GPP-425	DON	P550860	G-1121F	DON	P552070	GP-2071W	DON	P555627	GP-1108	DON
P550435		GPP-423	DON	P550861	G-1123	DON	P552071	GP-2071W	DON	P555680	GP-36	DON
P550436		GPP-1287 ³⁹	DON	P550861	G-1123F	DON	P552072	GP-1010Q	DON	P555823	GP-56	DON
P550436		PF831 ⁴¹	DON	P550868	GPP-18	DON	P552073	GP-1011Q	DON	P55591	GA-360	KOEH
P550436		S 3225 P ⁴²	DON	P550882	GP-81	DON	P552074	GP-1012Q	DON	P55591	GA-360	LORA
P550437		G-862	DON	P550911	GP-53	DON	P552076	GP-1013Q	DON	P55596	GA-360	KOEH
P550439		GPP-18	DON	P550915	GP-26	DON	P552096	GP-1013Q	DON	P55596	GA-360	LORA
P550440		GP-1122	DON	P550916	GP-27	DON	P552100	GP-193	DON	P556004	G-333	DON
P550448		GP-458	DON	P550916	GP-93	DON	P552106	GP-2071W	DON	P55602	GA-361	KOEH
P550451		G-3754	DON	P550928	GP-93	DON	P552126	GP-2126Q	DON	P55602	GA-361	LORA
P550455		GP-1224	DON	P550936	GP-92	DON	P552203	GP-1101	DON	P55605	GA-106 ⁹⁶	KOEH
P550463		G-128	DON	P550943	GP-1122	DON	P552250	GP-1101	DON	P55605	GA-326 ⁷¹	KOEH
P550470		GG-16	DON	P550944	GP-92	DON	P552251	GP-1101	DON	P55605	GA-106 ⁹⁶	LORA
P550471		GG-17	DON	P550947	GP-43	DON	P552253	GP-11	DON	P55605	GA-326 ⁷¹	LORA
P550474		GG-8 ¹⁰³	DON	P550951	G-33	DON	P552290	GP-171	DON	P55606	GA-206	LORA
P550474		GG-8 L ⁸⁰	DON	P550959	GP-85 ⁹⁰	DON	P552297	GP-66	DON	P556064	G-222	DON
P550475		GG-87	DON	P550962	GG-65	DON	P552347	GP-26	DON	P55613	GAK-20	KOEH
P550484		G-191	DON	P550963	GP-81	DON	P552411	GP-66	DON	P55613	GAK-20	LORA
P550485		G-238	DON	P550964	GP-205	DON	P552518	GP-81 ³¹	DON	P556245	G-296	DON
P550487		G-169	DON	P550965	GP-68	DON	P552518	GP-9 ⁹⁸	DON	P556245	G-296-B	DON
P550500		G-500	DON	P550966	G-178	DON	P552603	GP-78	DON	P556285	G-276	DON
P550502		GPP-424	DON	P550967	GG-1872	DON	P552819	GP-36	DON	P556286	G-277	DON
P550503		GPP-421	DON	P550969	G-128	DON	P552849	GP-462	DON	P556287	G-297	DON
P550504		GG-581	DON	P550971	GP-58	DON	P553000	GP-3000	DON	P556287	G-297-B	DON
P550505		GP-3675	DON	P550973	GP-359	DON	P553004	GP-1122	DON	P556700	G-153	DON
P550506		GPP-419	DON	P551000	GPP-1000	DON	P553025	G-926	DON	P556745	G-270	DON
P550507		GP-408	DON	P551001	GPP-11	DON	P553191	GP-51	DON	P556915	GP-26	DON
P550508		GP-266	DON	P551003	GPP-1003S	DON	P553261	G-1173 ¹⁰⁸	DON	P556916	GP-27	DON
P550509		G-1173	DON	P551006	GP-1109 ⁷⁶	DON	P553315	GP-68	DON	P556917	GP-27	DON
P550512		GP-152 ⁹⁰	DON	P551006	GP-62 ⁴⁵	DON	P553334	GP-34	DON	P557202	GP-10	DON
P550516		G-566	DON	P551014	G-5000	DON	P553335	G-335	DON	P557207	GP-10	DON
P550520		GP-737	DON	P551022	GPP-1003S	DON	P553404	GP-50 ²⁰	DON	P557207	GP-54	DON
P550521		G-971	DON	P551022	GPP-1022S	DON	P553548	GP-3000 ¹³	DON	P557264	G-278	DON

REFERENCIA CRUZADA

Para números Gonher con Superíndice vea página 651
For Gonher with Superscript numbers see page 651

Numero	Gonher	Fabricante	Numero	Gonher	Fabricante	Numero	Gonher	Fabricante	Numero	Gonher	Fabricante
Number	Gonher	Manufacturer	Number	Gonher	Manufacturer	Number	Gonher	Manufacturer	Number	Gonher	Manufacturer
P557382	GP-642	DON	P7052	G-133	BLDW	P770130	GA-361	DON	P779072	G-225	DON
P557440	GP-110	DON	P7052	G-989	BLDW	P770131	GA-106 ⁴⁶	DON	P779073	G-813	DON
P557440	GP-1105	DON	P7053	GP-54	FRM	P770131	GA-326 ⁷¹	DON	P779074	G-834	DON
P557624	GP-54 ¹¹	DON	P707	G-1121	MNH	P770132	GA-6129	DON	P779075	G-836	DON
P557624	GP-66 ¹⁰	DON	P7076	GP-317H	FRM	P770133	GA-6127	DON	P779080	G-613	DON
P557780	GP-310	DON	P7088	G-963	BLDW	P770135	GA-206	DON	P779091	G-331	DON
P558000	GPP-11	DON	P70V	G-836	CHP	P770136	GA-98 ¹¹²	DON	P779095	G-159	DON
P558010	S-3202 ⁴⁰	DON	P71	G-31	CHP	P770140	GA-892	DON	P779101	G-34	DON
P558020	GPP-11	DON	P71	GP-1108	GLD	P770145	GAK-216	DON	P779125	G-191	DON
P558030	GPP-11	DON	P71	G-31	LUF	P770148	GAK-625	DON	P779126	GP-1	DON
P558040	GP-83	DON	P71	G-1163	PUR	P770184	GA-6127	DON	P779127	GP-54 ¹¹	DON
P558050	GPP-11	DON	P-71	G-1163	PUMX	P770203	GA-360	DON	P779127	GP-66 ¹⁰	DON
P558250	GP-10	DON	P710	G-750	WES	P770344	GA-360	DON	P779128	GP-36	DON
P558250	GP-54	DON	P7136	G-112	BLDW	P770347	GAK-625	DON	P779130	GP-54	DON
P558329	GP-35	DON	P-7137	G-984	BLDW	P770371	GAK-16	DON	P779132	GP-81	DON
P558425	G-163	DON	P7138	G-954	BLDW	P770372	GAK-403	DON	P779135	GP-50	DON
P558615	GP-178	DON	P7145	G-3754	BLDW	P770373	GA-33 ¹¹²	DON	P779139	GP-3	DON
P558616	GP-390	DON	P7188	G-3754	BLDW	P770410	GAK-20	DON	P779143	GP-51	DON
P558712	GPP-18	DON	P7199	G-3827	BLDW	P770490	GA-106 ⁴⁶	DON	P779144	GP-53	DON
P558792	G-1166	DON	P72	G-834	APOL	P770490	GA-326 ⁷¹	DON	P779145	GP-10	DON
P559000	GP-9000	DON	P72	G-834	BWS	P770499	GA-892	DON	P779146	GP-14	DON
P559000	GP-9001	DON	P72	G-834	CAM2	P770537	GA-356	DON	P779147	GP-34	DON
P559306	GP-1122	DON	P72	G-834	CHP	P770538	GA-357	DON	P779150	GP-81 ¹¹	DON
P559418	GP-36	DON	P72	GP-11	GLD	P770616	GA-416	DON	P779150	GP-9 ⁹⁸	DON
P559430	GP-46	DON	P72	G-834	GRAN	P770618	GA-360	DON	P779152	GP-1	DON
P559740	G-152	DON	P72	G-834	LUF	P770709	GA-6129	DON	P779153	GP-23	DON
P559803	G-293	DON	P72	G-834	MASE	P770737	GA-357	DON	P779154	GP-69	DON
P560	G-222	CHP	P72	G-834	MIGH	P770738	GA-356	DON	P779155	GP-67	DON
P560	G-222	LUF	P72	G-834	SECU	P770739	GA-106 ⁴⁶	DON	P779157	GP-31	DON
P566	G-566	CHP	P72	G-834	WARN	P770739	GA-326 ⁷¹	DON	P779159	GP-3600	DON
P5694	GP-96	FRM	P7235	G-3752	BLDW	P771	G-871	ACE	P779160	GP-88	DON
P55484	G-191	CATP	P7251	GP-1105	FRM	P771	G-871	APOL	P779164	GP-462	DON
P55484	G-191	GLD	P7253	GP-864H	FRM	P771	G-871	CAM2	P779169	GP-51	DON
P55484A	G-191	GLD	P7257	GP-34	FRM	P771	G-871	CHP	P779171	GP-390 ⁹³	DON
P55485	G-238	CATP	P72711	GA-33 ¹¹²	BRAY	P771	G-871	LUF	P779173	GP-53	DON
P55485	G-238	COP	P72711	GA-33 ¹¹²	MATB	P771	G-871	MASE	P779176	GP-3429	DON
P55485	G-238	GLD	P73	GP-24 ²⁶	PHI	P771	G-871	WARN	P779177	GP-57	DON
P55485A	G-238	COP	P73	GP-462 ²⁴	PHI	P771009	GA-426	DON	P779178	GP-50 ¹⁰	DON
P55485A	G-238	GLD	P731	G-333	WES	P771507	GA-436	DON	P779180	GP-46	DON
P6	GP-38	GLD	P7313	G-70	BLDW	P771521	GA-6129	DON	P779182	GP-3980	DON
P602658	GA-780	DON	P7338	G-72	BLDW	P771533	GA-425	DON	P779183	GP-46	DON
P603232	GA-801R	DON	P739	G-122	HAS	P771538	GAK-403	DON	P779184	GP-28 ⁶	DON
P603233	GA-802R	DON	P739	G-338	HAS	P771541	GA-98 ¹¹²	DON	P779184	GP-430 ⁸	DON
P603577	GA-4999	DON	P7402	GP-110	FRM	P771543	GAK-403	DON	P779186	GP-31	DON
P605322	GA-518R	DON	P7412	GPP-419	FRM	P771546	GA-589	DON	P779187	GP-50	DON
P605551	GA-624R	DON	P7415	G-466	BLDW	P771547	GAK-16	DON	P779190	GP-42	DON
P606503	GA-799R	DON	P744	GP-1011Q	PBLT	P771558	GA-467	DON	P779191	GP-44	DON
P606720	GA-624R	DON	P75	G-6	WES	P771723	GPP-424	DON	P779192	GP-54 ¹¹	DON
P607955	GA-701 ¹⁰⁴	DON	P750	G-750	PHI	P771A	G-871	APOL	P779192	GP-66 ¹⁰	DON
P609239	GA-798R	DON	P7500	G-750	BLDW	P771A	G-871	CAM2	P779193	GP-3985	DON
P612826	GA-475	DON	P7500 POLY	G-750	BLDW	P771A	G-871	CHP	P779197	GP-81	DON
P613	G-613	CHP	P7510	GPP-1122	FRM	P771A	G-801	LUF	P779200	GP-69	DON
P613334	GA-770R	DON	P7511	GP-1122	FRM	P771A	G-871	LUF	P779201	GP-35	DON
P613336	GA-4862R	DON	P7512	GP-1122	FRM	P771A	G-871	MIGH	P779205	GP-53	DON
P613337	GA-4863	DON	P7513	GP-1122	FRM	P771A	G-871	WARN	P779211	GP-38	DON
P62	G-1143	PUR	P7524	GP-34	FRM	P772	G-813	ACE	P779212	GP-58	DON
P65	GG-20	WES	P7533	GP-66	FRM	P772	G-813	APOL	P779213	GP-40	DON
P6503	GP-1122	FRM	P7539	GP-761H	FRM	P772	G-813	CHP	P779214	GP-3531	EXP
P656	GS-1133	WES	P7542	GP-34	FRM	P772	G-813	LUF	P779215	GP-3816	DON
P657	GC-1133	WES	P7562	GP-864H	FRM	P772	G-813	WARN	P779216	GP-3600	DON
P66	G-236	WES	P76	G-236	ACE	P772507	GA-436	DON	P779218	GP-9586	DON
P67	G-1163	GLD	P76	G-236	APOL	P772533	GA-425	DON	P779219	GP-3816	DON
P67	GA-192	PHI	P76	G-236	BWS	P772564	GAK-458	DON	P779226	GP-77	DON
P67	G-1163	WES	P76	G-236	CAM2	P772580	GA-853R	DON	P779250	G-1123	DON
P6871	GP-761H	FRM	P76	G-236	CHP	P773520	GA-229	DON	P779252	G-1175 ¹⁰⁸	DON
P6873	GP-761H	FRM	P76	GP-1105	COP	P774502	GA-360	DON	P779253	G-1121	DON
P6874	GP-761H	FRM	P76	GP-1105	GLD	P774518	GA-106 ⁴⁶	DON	P779256	G-1143	DON
P6875	GP-761H	FRM	P76	G-236	GRAN	P774518	GA-326 ⁷¹	DON	P779257	G-1173	DON
P6876	GP-761H	FRM	P76	G-236	LUF	P774524	GA-106 ⁴⁶	DON	P779262	GP-20	DON
P6877	GP-761H	FRM	P76	G-236	PUR	P774524	GA-326 ⁷¹	DON	P779265	G-1175 ¹⁰⁸	DON
P6880	GP-761H	FRM	P76	GP-761H	FRM	P774583	GA-206	DON	P779276	G-1163 ¹⁰⁸	DON
P6881	GP-761H	FRM	P76	G-236	WARN	P775	GP-81	PHI	P779297	G-295	DON
P6882	GP-761H	FRM	P76-00	G-236	PUR	P775457	GA-459	DON	P779320	G-1121	DON
P6883	GP-761H	FRM	P761	G-236	REF	P776636	GAK-16	DON	P779328	G-296	DON
P6884	GP-761H	FRM	P76-1	G-236	PHI	P777045	GA-229	DON	P779328	G-296-B	DON
P6885	GP-761H	FRM	P76-1	G-236	PUR	P777483	GA-8	DON	P779330	G-297-B	DON
P6888	GP-761H	FRM	P-76-1	G-236	PUMX	P778214	GA-697R	DON	P779376	GP-1122	DON
P6892	GP-761H	FRM	P761-2	G-236	PUR	P778335	GA-517R	DON	P779379	GP-1122	DON
P6893	GP-761H	FRM	P76-2	G-236	PUR	P778361	GA-416	DON	P779380	GP-1101	DON
P6H5931	G-1166	COP	P7629	GAK-403	ATHY	P778613	GA-467	DON	P779392	GP-92	DON
P6H5931	G-1166	GLD	P766-38	G-1163 ¹⁰⁸	PUR	P779000	G-33	DON	P779393	GP-84	DON
P6H5932	G-1166	COP	P7666	G-1163	PUR	P779002	G-31	DON	P779394	GP-83	DON
P6H5932	G-1166	GLD	P766-62	G-1163 ¹⁰⁸	PUR	P779007	G-500	DON	P779396	GP-78	DON
P6H9999	G-238	GLD	P7678	G-276	FRM	P779014	G-566	DON	P779398	GP-155	DON
P6L7440	GP-110	GLD	P7678A	G-276	FRM	P779017	G-238	DON	P779400	GP-110	DON
P7	GP-81	GLD	P769	G-1163	PUR	P779020	G-333	DON	P779404	GPP-14	DON
P7	G-238	PHI	P76FF	G-236	ROLK	P779023	G-119	DON	P779405	GPP-18	DON
P70	GP-1	BWLA	P770051	GA-360	DON	P779034	G-31	DON	P779407	GP-55	DON
P700	G-1163	PUR	P770092	GA-106 ⁴⁶	DON	P779040	G-5000	DON	P779408	GP-62	DON
P701	G-1163	PUR	P770092	GA-326 ⁷¹	DON	P779042	G-200	DON	P779409	GP-27	DON
P7026	GP-864H ⁹⁰	FRM	P770110	GAK-625	DON	P779045	G-191	DON	P779410	GP-26	DON
P7037	GP-66	FRM	P770122	GAK-16	DON	P779047	G-236	DON	P779411	GP-1107	DON
P7038	GP-54	FRM	P770123	GAK-403	DON	P779050	G-335	DON	P779413	GP-56	DON
P7040	GP-34	FRM	P770124	GA-33 ¹¹²	DON	P779053	G-870	DON	P779416	GP-1122	DON
P7041	GP-66 ⁹⁰	FRM	P770125	GAK-20	DON	P779065	G-139	DON	P779418	GP-85	DON
P7046	GP-34	FRM	P770129	GA-360	DON	P779071	G-871	DON	P779419	GPP-19	DON

Referencia Cruzada por Numero de Parte

Cross Reference by Part Number



Numero	Gonher	Fabricante	Numero	Gonher	Fabricante	Numero	Gonher	Fabricante	Numero	Gonher	Fabricante
Number	Gonher	Manufacturer	Number	Gonher	Manufacturer	Number	Gonher	Manufacturer	Number	Gonher	Manufacturer
P779420		GPP-18 DON	P812405	GA-326 ⁷¹	DON	P85059	GAK-625	ATHY	P9F67003	G-191	GLD
P779425		GP-92 DON	P812408	GA-106 ⁴⁶	DON	P854	G-1174 ¹⁰⁸	TFIL	P9H1252	G-1166	COP
P779443		GP-78 DON	P812408	GA-326 ⁷¹	DON	P8576	GP-761H	FRM	P9H1252	G-1166	GLD
P779444		GP-1108 DON	P812503	GA-758	DON	P85842	GA-360	ATHY	P9H4729	G-1166	COP
P779445		GP-93 DON	P812504	GA-758	DON	P85843	GA-361	ATHY	P9H4729	G-1166	GLD
P779454		GP-85 ⁹⁰ DON	P812506	GA-33 ¹¹²	DON	P86	G-6	WES	P9M9740	G-152	COP
P779523		GP-34 DON	P812537	GA-880R	DON	P8604	GP-3766	FRM	P9M9740	G-152	GLD
P779544		G-122 DON	P812600	GA-6129	DON	P87	G-152	PUR	PA103	GAD-1	PHI
P779544		G-338 DON	P812601	GA-26 ¹¹²	DON	P-87	G-152	PUMX	PA110	GAD-3	PHI
P779556		G-331 DON	P812607	GAK-16	DON	P8732	GP-166 ⁶⁵	FRM	PA-110	GA-2740	PFMX
P779576		GP-171 ¹⁶ DON	P813	G-813	GLD	P8732	GP-3937 ¹¹	FRM	PA1112	GA-224	PRON
P779583		GP-166 DON	P814539	GA-361	DON	P88	GP-69	PHI	PA1127	GA-395	PRON
P779586		G-33 DON	P8153	G-180	CHAM	P88	G-119	PUR	PA1128	GA-477	PRON
P779587		GP-166 DON	P8153	G-180	LUF	P-88	G-119	PUMX	PA113	GA-75	PHI
P779589		GP-34 DON	P8153	G-918	LUF	P89	G-191	WES	PA1149	GAVV-2	PHI
P779596		GP-34 DON	P8153	G-180	WARN	P9	GP-13	GLD	PA-12	GA-55	PFMX
P779600		GP-34 DON	P815850	GA-33 ¹¹²	DON	P901502	GA-7360	DON	PA120	GA-74	PHI
P779601		GP-34 DON	P815861	GAK-16	DON	P901504	GA-7716	DON	PA124	GA-3300	PHI
P779604		GP-66 ⁹⁰ DON	P815870	GAK-403	DON	P901506	GA-482	DON	PA-124	GA-3566	PFMX
P779620		GP-34 DON	P8170	G-954	CHP	P901508	GA-483	DON	PA129	GA-3424	PHI
P779622		GP-36 DON	P8170	G-954	CIGO	P901510	GA-1284	DON	PA-130	GA-3501	PFMX
P779625		G-162H DON	P8170	G-954	FSN	P901512	GA-1285	DON	PA131	GA-3425	PHI
P779656		GP-66 DON	P8170	G-954	LUF	P901514	GA-1286	DON	PA-132	GA-140	PFMX
P779657		GP-66 DON	P8170	G-954	TIRP	P901516	GA-1287	DON	PA-132	GA-140	QKS
P779669		GP-66 DON	P8170	G-954	WARN	P901524	GA-8047	DON	PA136	GA-55	PRON
P779670		GP-66 DON	P817542	GA-398	DON	P901526	GA-9334	DON	PA-143	GA-4958	PFMX
P779671		GP-171 DON	P8191	GP-78	FRM	P901546	GA-9045	DON	PA148	GA-80	PRON
P779902		G-750 DON	P8198	G-984	CHP	P-91	G-1163	PUMX	PA-150	GA-3901	PFMX
P779925		GP-3766 DON	P8198	G-984	CIGO	P9105	G-225	BOG	PA-151	GA-390	PFMX
P779935		G-833 DON	P8198	G-984	LUF	P9117	G-813	BOG	PA-153	GAD-15	PFMX
P779960		G-143 DON	P8198	G-984	WARN	P9120	G-330	BOG	PA-154	GA-2194	PFMX
P779964		G-163 DON	P820	G-813	WES	P9122	G-971	BOG	PA-156	GA-471	PFMX
P779965		G-133 DON	P821575	GA-880R	DON	P915-50	G-296	MNH	PA-159	GA-382	PFMX
P779965		G-989 DON	P822	G-834	WES	P915-50	G-296-B	MNH	PA16	GA-2740	PHI
P78-1		G-33 PHI	P822144	GA-206	DON	P91610	G-296	MNH	PA160	GA-70	PRON
P781039		GA-697R DON	P823	G-870	WES	P91610	G-296-B	MNH	PA1615	GA-8047	BLDW
P783500		GA-781 DON	P82301	GA-33 ¹¹²	ATHY	P9161X	G-296	MNH	PA1616	GA-21	BLDW
P783870		GA-697R DON	P825-1V	G-1175 ¹⁰⁸	MNH	P9161X	G-296-B	MNH	PA1620	GA-29	BLDW
P7M3800		G-191 GLD	P825228	GA-5056	DON	P91650	G-296	MNH	PA1629-S	GA-375	BLDW
P7M38003		G-191 GLD	P8253X	G-1173 ¹⁰⁸	MNH	P91650	G-296-B	MNH	PA1631S	GA-1203	BLDW
P8		GP-3600 GLD	P8250	G-1173 ¹⁰⁸	MNH	P9165X	G-296	MNH	PA1634	GA-9334	BLDW
P80		G-6 BLDW	P825T	G-1173 ¹⁰⁸	MNH	P9165X	G-296-B	MNH	PA1636-FN	GA-20	BLDW
P800		G-871 WES	P825X	G-1173	MNH	P917X	G-296	MNH	PA1636-FN	GAK-20	BLDW
P801		G-871 GLD	P8264	GP-1109 ²²	FRM	P917X	G-296-B	MNH	PA1637FN	GA-27 ¹¹²	BLDW
P8020		GP-864H FRM	P8264	GP-62 ²⁰	FRM	P9180	G-31	BOG	PA1646	GA-24	BLDW
P802507		GA-6127 DON	P8270	G-871	MNH	P9181	G-31	BOG	PA1647	GA-1285	BLDW
P802509		GA-6129 DON	P828	G-870	MNH	P921-2X	G-1163	MNH	PA1648	GA-105	BLDW
P802781		GA-206 DON	P828633	GA-633R	DON	P922010	2010PM-OR ⁷	DON	PA1657	GAD-1	BLDW
P802821		GA-6128 DON	P828889	GA-853R	DON	P922010	2010TM-OR ²	DON	PA-166	GA-362	PFMX
P803		G-162H CHP	P8280	G-870	MNH	P922020	GS-2033	DON	PA1667-FN	GA-16	BLDW
P803912		GA-6129 DON	P829	GS-2034	DON	P922040	GS-2034	DON	PA1667-FN	GAK-16	BLDW
P803913		GA-6129 DON	P832X	G-1175 ¹⁰⁸	MNH	P9258	GP-1224	FRM	PA1669	GA-9045	BLDW
P803914		GA-106 ⁴⁶ DON	P8334	GP-110	FRM	P9258	GP-458	FRM	PA1670	GA-1287	BLDW
P803914		GA-326 ⁷¹ DON	P8335	GP-749	FRM	P9280	GP-171	FRM	PA1673	GA-1008	BLDW
P803915		GA-106 ⁴⁶ DON	P834	G-963	CHP	P9350	GP-1101	FRM	PA1674	GA-1284	BLDW
P803915		GA-326 ⁷¹ DON	P834	G-963	CIGO	P940	GP-57	ACD	PA1675	GA-1286	BLDW
P803919		GA-6129 DON	P834	G-963	GRAN	P94-0071	GA-388	DON	PA1676	GA-26	BLDW
P804205		GA-6129 DON	P834	G-963	LUF	P9407	GP-556	FRM	PA1676-FN	GA-26 ¹¹²	BLDW
P804215		GA-6127 DON	P834	G-963	SECU	P9441	G-836	BOG	PA-168	GA-195	PFMX
P8043		GP-1122 FRM	P834	G-963	TIRP	P945	G-297-B	MNH	PA1680	GA-192	BLDW
P804874		GA-206 DON	P834	G-963	WARN	P9451	G-297-B	MNH	PA1681-FN	GAK-403	BLDW
P805709		GA-6128 DON	P836	G-836	CHP	P945X	G-297-B	MNH	PA1683	GA-18	BLDW
P806251		GA-6127 DON	P837	G-72	CAMP	P9493	G-870	BOG	PA1690	GA-33	BLDW
P806426		GA-106 ⁴⁶ DON	P837	G-72	FSN	P9494	G-870	BOG	PA1690FN	GA-33 ¹¹²	BLDW
P806426		GA-326 ⁷¹ DON	P837	G-72	LUF	P9555	G-834	BOG	PA1704	GA-135	BLDW
P806427		GA-6128 DON	P837	G-72	PARP	P9559	G-834	BOG	PA1704	GA-35	BLDW
P806428		GA-6128 DON	P837	G-72	WARN	P9590	G-191	BOG	PA1708FN	GAK-16	BLDW
P806564		GA-6128 DON	P84-2	G-236	BLDW	P960	G-70	CAMP	PA1712	GA-12	BLDW
P806660		GA-6127 DON	P8427	GP-171 ¹⁶	FRM	P960	G-70	CHP	PA-172	GA-386	PFMX
P806766		GA-206 DON	P843	G-971	CHP	P960	G-70	LUF	PA-173	GA-7017	PFMX
P806767		GA-106 ⁴⁶ DON	P843	G-971	CIGO	P960	G-70	TIRP	PA1735	GA-78	BLDW
P806767		GA-326 ⁷¹ DON	P843	G-971	GRAN	P9600	G-133	BOG	PA-175	G-750	CNTM
P807219		GA-106 ⁴⁶ DON	P843	G-971	LUF	P9600	G-989	BOG	PA-175	GA-604	PFMX
P807219		GA-326 ⁷¹ DON	P843	GP-81 ³¹	FRM	P961PL	GP-81 ³¹	FRM	PA1753-FN	GA-98 ¹¹²	BLDW
P807628		GA-416 DON	P843	G-971	TIRP	P961PL	GP-9 ⁵⁸	FRM	PA1758	GA-55	BLDW
P807641		GAK-216 DON	P843	G-971	WARN	P9638	G-963	BOG	PA1765	GAP-379	BLDW
P809315		GA-106 ⁴⁶ DON	P8434	GP-1122	FRM	P9645	G-163	BOG	PA-179	GA-322	PFMX
P809315		GA-326 ⁷¹ DON	P8445	G-975	CHAM	P967	G-912	CAMP	PA1802	GA-3300	BLDW
P810		G-11816 MNH	P8445	G-975	LUF	P967	G-912	FSN	PA-181	GA-5466	PFMX
P810176		GA-6128 DON	P8445	G-975	MIGH	P967	G-912	LUF	PA1816	GA-287	BLDW
P810X		G-11816 MNH	P8445	G-975	WARN	P967	G-912	PARP	PA-182	GA-142	PFMX
P811		G-1123 MNH	P8451	GP-1109	FRM	P9735	G-163	BOG	PA-183	GA-2106	PFMX
P811		G-1123 TFIL	P8459	GP-761H	FRM	P9740	G-143	BOG	PA184	GA-77	PRON
P811		G-1123 TFIL	P846	G-112	CHP	P9741	G-143	BOG	PA1846	GA-6129	BLDW
P811000		GAK-20 DON	P846	G-112	CIGO	P9750	G-871	BOG	PA-185	GA-6619 ¹	PFMX
P811203		GA-360 DON	P846	G-112	FSN	P980	G-911	CAMP	PA-185	GA-6620 ⁵	PFMX
P811413		GA-106 ⁴⁶ DON	P846	G-112	LUF	P980	G-911	LUF	PA1863	GA-26	BLDW
P811413		GA-326 ⁷¹ DON	P846	G-112	TIRP	P9820	G-162H	BOG	PA-1866	GA-21	BLDW
P811500		GA-33 ¹¹² DON	P846	G-112	WARN	P9865	GGP-25	FRM	PA1880	GA-6127	BLDW
P812004		GAK-20 DON	P8480	GP-166	FRM	P99	G-834	PUR	PA1882	GA-403	BLDW
P812012		GA-616 DON	P8490	GP-1109 ²²	FRM	P-99	G-834	PUMX	PA1884	GA-360	BLDW
P812103		GA-616 DON	P8490	GP-62 ²⁰	FRM	P99162B	G-11816	WES	PA1885	GA-106 ⁴⁶	BLDW
P812111		GA-616 DON	P850529	GA-6127	CASE	P994	G-335	WES	PA1885	GA-326 ⁷¹	BLDW
P812179		GA-758 DON	P850561	GA-361	CASE	P998	G-613	BLDW	PA189	GA-50	PRON
P812204		GA-360 DON	P850562	GA-360	CASE	P999	G-566	BLDW	PA-189	GA-165	PFMX
P812405		GA-106 ⁴⁶ DON	P850589	GP-77	CASE						

Numero	Gonher	Fabricante	Numero	Gonher	Fabricante	Numero	Gonher	Fabricante	Numero	Gonher	Fabricante
Number	Gonher	Manufacturer	Number	Gonher	Manufacturer	Number	Gonher	Manufacturer	Number	Gonher	Manufacturer
PA1894	GA-356	BLDW	PA2208	GAVW-4	BLDW	PA-261	GA-2114	PFMX	PA-392	GA-434	QKS
PA1905	GA-357	BLDW	PA2210	GA-382	BLDW	PA-262	GA-183R	PFMX	PA3924	GA-153	PRON
PA1909	GA-135	BLDW	PA2211	GA-390	BLDW	PA2620	GA-616	BLDW	PA-394	GA-2193	PFMX
PA-191	GA-432	PFMX	PA2212	GA-2106	BLDW	PA2621	GA-398	BLDW	PA-394	GA-2193	QKS
PA1911	GA-361	BLDW	PA2213	GA-216	BLDW	PA-263	GA-264	PFMX	PA3951	GA-377	BLDW
PA192	GA-192	PRON	PA2214	GA-6690	BLDW	PA2631	GA-371	BLDW	PA4	GA-70	PHI
PA-192	GA-381	PFMX	PA2216	GA-142	BLDW	PA2642	GA-642	BLDW	PA-400	GA-2175	PFMX
PA1920	GA-31	BLDW	PA2217	GA-276	BLDW	PA-265	GA-479	PFMX	PA-400	GA-2175	QKS
PA-199	GA-514	PFMX	PA2218	GA-7017	BLDW	PA2657-FN	GAK-16	BLDW	PA40004	GA-70	PUR
PA2	GAP-379	FRM	PA2219	GA-139	BLDW	PA2660	GA-694	BLDW	PA4015	GA-7344	BLDW
PA2002	GA-85	BLDW	PA-222	GA-4365	PFMX	PA2669-FN	GAK-458	BLDW	PA4018	GA-7142	BLDW
PA2005	GA-303	BLDW	PA2220	GA-133	BLDW	PA-267	GA-293	PFMX	PA4018	GAD-117	BLDW
PA2006	GA-57	BLDW	PA2223	GA-42	BLDW	PA2670	GA-459	BLDW	PA4018	GAD-17	BLDW
PA2008	GA-59	BLDW	PA2226	GA-6	BLDW	PA2676	GA-758	BLDW	PA4023	GA-166	BLDW
PA2009	GA-325	BLDW	PA2227	GA-127	BLDW	PA-268	GA-395	PFMX	PA4028	GA-322	BLDW
PA-201	GA-442	PFMX	PA2229	GA-432	BLDW	PA2685	GA-1095	BLDW	PA403	GA-56	PER
PA2010	GA-730	BLDW	PA2230	GA-141	BLDW	PA-269	GA-414R	PFMX	PA-403	GA-2195	PFMX
PA-202	GAD-118	PFMX	PA2231	GA-164	BLDW	PA-270	GA-244	PFMX	PA4043	GA-476	BLDW
PA2024	GA-86	BLDW	PA2233	GA-442	BLDW	PA2703	GA-389	BLDW	PA4046	GA-300	BLDW
PA-203	GA-240	PFMX	PA2234	GA-2198 ⁷⁹	BLDW	PA2705	GA-3551 ⁵⁵	BLDW	PA4047	GA-2110	BLDW
PA2031	GAD-3	BLDW	PA2234	GA-438 ⁸¹	BLDW	PA2705	GA-3551 XT ⁶⁴	BLDW	PA4048	GA-2114	BLDW
PA2035	GA-349	BLDW	PA2236	GAVW-120	BLDW	PA2708	GA-759	BLDW	PA4049	GA-604	BLDW
PA-204	GA-732R	PFMX	PA2237	GAVW-620	BLDW	PA-271	GA-490	PFMX	PA-405	GA-2118	PFMX
PA2041	GA-195	BLDW	PA2240	GA-1616	BLDW	PA2719	GA-2719B	PHI	PA-405	GA-2118	QKS
PA2051	GA-75	BLDW	PA2241	GA-7007	BLDW	PA2719B	GA-2719B	PRON	PA4050	GA-381	BLDW
PA2052	GA-429	BLDW	PA2242	GAD-29	BLDW	PA-272	GA-477	PFMX	PA4054	GAD-129	BLDW
PA2055	GAD-1	BLDW	PA2243	GA-5466	BLDW	PA2732	GA-377	BLDW	PA4069	GA-217	BLDW
PA2057	GA-74	BLDW	PA2245	GA-5466	BLDW	PA2740	GA-2740	PRON	PA-407	GA-607	PFMX
PA2061	GA-3501	BLDW	PA-2246	GA-605	BLDW	PA2776	GA-467	BLDW	PA4070	GAD-294	BLDW
PA2065	GA-2719B	BLDW	PA2257	GA-165	BLDW	PA2792	GA-49	BLDW	PA4071	GA-175	BLDW
PA2066	GA-3424	BLDW	PA-227	GA-301	PFMX	PA2803	GA-2803T	BLDW	PA4074	GA-240	BLDW
PA2074	GA-3425	BLDW	PA-228	GA-595	PFMX	PA2803	GA-2803T	HAS	PA4075	GA-1615	BLDW
PA2075	GA-2740	BLDW	PA2312	GA-229	BLDW	PA2804	GA-2804 T	BLDW	PA4076	GAD-118	BLDW
PA2076	GA-54	BLDW	PA2314	GA-891	BLDW	PA2804 KIT	GA-2804 T	BLDW	PA4077	GA-514	BLDW
PA2077	GA-3523	BLDW	PA2317	GA-378	BLDW	PA-284	GA-3445	QKS	PA4081	GA-198	BLDW
PA2078	GA-55 ¹¹³	BLDW	PA2326	GA-885	BLDW	PA2846	GA-16	BLDW	PA4082	GAVW-121	BLDW
PA2083	GA-3445	BLDW	PA2332	GA-892	BLDW	PA2846-FN	GAK-16	BLDW	PA4084	GA-595	BLDW
PA2090	GA-3490	BLDW	PA2333	GA-376	BLDW	PA-290	GA-390	QKS	PA4085	GA-132	BLDW
PA2091	GA-89	BLDW	PA-234	GA-476	PFMX	PA-3	GA-80	PFMX	PA4086	GAC-13	BLDW
PA2092	GA-3501	BLDW	PA2357	GA-6880	BLDW	PA303	GA-303	PRON	PA4088	GA-130	BLDW
PA2096	GA-8	BLDW	PA2358	GA-7716	BLDW	PA31	GA-56	PHI	PA4089	GA-1614	BLDW
PA2096	GA-8	HAS	PA2359	GA-7360	BLDW	PA312	GA-192	PER	PA409	GA-50	PER
PA2099	GA-200	BLDW	PA2360-FN	GAK-1532	BLDW	PA314	GA-78	PER	PA4091	GAVW-622	BLDW
PA2099	GA-218	BLDW	PA2363	GA-879	BLDW	PA3149	GA-3523	PHI	PA4092	GA-301	BLDW
PA-210	GA-1614	PFMX	PA2369	GA-425	BLDW	PA3192	GA-271	PHI	PA4099	GA-172	BLDW
PA2101A	GAVW-2	BLDW	PA-237	GA-348	PFMX	PA3193	GA-735	PHI	PA4100	GA-384	BLDW
PA2103	GA-277	BLDW	PA2370	GA-426	BLDW	PA3195	GA-3588	PHI	PA4102	GA-158	BLDW
PA2104	GA-271	BLDW	PA2371	GA-329	BLDW	PA324A	GA-85	PRON	PA4103	GA-607	BLDW
PA2106	GA-3588	BLDW	PA2372	GA-239	BLDW	PA326	GA-59	PRON	PA4104	GA-163	BLDW
PA2107	GA-80 ¹¹³	BLDW	PA2380-FN	GAK-216	BLDW	PA-326	GA-2110	PFMX	PA4106	GA-170	BLDW
PA2108	GA-734 ⁸¹	BLDW	PA2381	GA-416	BLDW	PA327	GA-57	PRON	PA4107	GA-279	BLDW
PA2108	GA-735 ¹²⁴	BLDW	PA2382	GA-509 ¹⁴	BLDW	PA3300	GA-3300	PRON	PA4108	GA-244	BLDW
PA2109	GA-3647	BLDW	PA2384	GA-483	BLDW	PA-333	GA-2146	PFMX	PA4109	GA-8606	BLDW
PA-211	GA-7142	PFMX	PA2385	GA-482	BLDW	PA3373	GAVW-2	PRON	PA4110	GA-472	BLDW
PA2111	GA-390	BLDW	PA-240	GAVW-621	PFMX	PA3380	GA-3647	PHI	PA4111	GAVW-621	BLDW
PA2113	GA-3681	BLDW	PA2409	GA-6129	BLDW	PA3384	GA-89	PHI	PA4113	GA-348	BLDW
PA2114	GA-3637	BLDW	PA-241	GA-278R	PFMX	PA3398	GA-3566	PHI	PA4118	GA-278R	BLDW
PA2116	GA-422	BLDW	PA-242	GA-168	PFMX	PA3425	GA-3425	PRON	PA4120	GA-780	BLDW
PA2117	GA-4325	BLDW	PA2426-FN	GAK-625	BLDW	PA3441	GA-277	PRON	PA4122	GA-224	BLDW
PA2118	GA-154	BLDW	PA24278	GAD-15	PUR	PA3465	GA-277	PHI	PA4123	GA-168	BLDW
PA-212	GAVW-620	PFMX	PA2429	GA-2984	BLDW	PA3475	GA-529	BLDW	PA4124	GA-304	BLDW
PA2121	GA-4303	BLDW	PA-243	GA-6479 ⁹⁰	PFMX	PA3477	GA-436	BLDW	PA4125	GA-434	BLDW
PA2123	GA-140	BLDW	PA2431	GA-589	BLDW	PA3480	GA-108	BLDW	PA4126	GA-2146	BLDW
PA2124	GA-3566	BLDW	PA2432	GA-588	BLDW	PA351	GA-75	PRON	PA4127	GA-286	BLDW
PA2127	GA-274	BLDW	PA-2434	GA-826	BLDW	PA352	GAD-1	PRON	PA4129	GA-183	BLDW
PA2132	GA-3647	BLDW	PA2435	GA-827	BLDW	PA3523	GA-3523	PRON	PA4132	GA-248	BLDW
PA2134	GA-153	BLDW	PA-245	GA-472	PFMX	PA353	GAD-3	PRON	PA4133	GAC-1	BLDW
PA2135	GAD-15	BLDW	PA2475	GA-405	BLDW	PA3537	GA-54	PRON	PA4135	GA-3588 ¹¹³	BLDW
PA2136	GA-253	BLDW	PA2478	GA-6128	BLDW	PA3549	GA-89	PRON	PA4146	GA-6479 ⁹⁰	BLDW
PA-214	GA-384	PFMX	PA2493	GA-493 ¹⁰⁸	BLDW	PA3559	GA-271	PRON	PA4147	GA-395	BLDW
PA2142	GA-78	BLDW	PA-250	GA-286	PFMX	PA-3566	GA-3566	PRON	PA4148	GA-780	BLDW
PA2143	GA-3915	BLDW	PA2500	GA-372	BLDW	PA3580	GA-274	PRON	PA-415	GA-2106	PFMX
PA2147	GA-4958	BLDW	PA2501	GA-377	BLDW	PA3588	GA-3588	PRON	PA4150	GA-264	BLDW
PA2150	GA-273	BLDW	PA-251	GA-304	PFMX	PA3590	GA-3916	PHI	PA4151	GA-490	BLDW
PA2152	GA-5056	BLDW	PA2518	GA-251	BLDW	PA3591	GA-3814	PHI	PA4153	GAC-9	BLDW
PA2157	GA-4828	BLDW	PA2520	GA-109	BLDW	PA3592	GA-273	PHI	PA4157	GA-367	BLDW
PA2158	GA-3814	BLDW	PA2521	GA-209	BLDW	PA-3621	GA-140	PRON	PA4159	GAC-2	BLDW
PA2160	GA-3916	BLDW	PA2522	GA-210	BLDW	PA3647	GA-3647	PRON	PA4160	GA-158	BLDW
PA2162	GA-153	BLDW	PA2525	GA-107	BLDW	PA3681	GA-3681	PRON	PA4162	GA-488	BLDW
PA2163	GA-3901	BLDW	PA2526	GA-108	BLDW	PA-374	GAD-29	PFMX	PA4163	GA-224	BLDW
PA2164	GA-174	BLDW	PA-253	GA-183	PFMX	PA3763	GA-240	BLDW	PA4164	GA-448	BLDW
PA2168	GA-180	BLDW	PA2536	GAD-30	BLDW	PA3796	GA-781	BLDW	PA4165	GA-380	BLDW
PA-217	GA-279	PFMX	PA-254	GA-491	PFMX	PA3797	GA-782	BLDW	PA4167	GA-1617	BLDW
PA2171	GA-139	BLDW	PA2540	GA-373	BLDW	PA380	GA-70	PER	PA417	GA-55	PER
PA2178	GA-392	BLDW	PA2546	GA-679	BLDW	PA381	GA-74	PRON	PA-417	GA-2130	PFMX
PA2180	GA-471	BLDW	PA2547	GA-680	BLDW	PA3814	GA-3814	PRON	PA-417	GA-2130	QKS
PA2181	GA-4365	BLDW	PA-255	GA-413R	PFMX	PA3823	GA-240	BLDW	PA4170	GA-510	BLDW
PA2187	GA-6619 ¹	BLDW	PA2551	GA-891	BLDW	PA3823	GA-240	HAS	PA4172	GA-1571	BLDW
PA2187	GA-6620 ²	BLDW	PA2554	GAP-381	BLDW	PA383	GA-71	PER	PA4173	GA-415	BLDW
PA2189	GA-6479	BLDW	PA2562	GA-563	BLDW	PA-383	GA-2184	PFMX	PA4175	GA-1572	BLDW
PA2191	GA-275	BLDW	PA-257	GA-248	PFMX	PA-388	GA-605	PFMX	PA4177	GA-289	BLDW
PA2192	GA-129	BLDW	PA2571	GAP-381	FRM	PA3901	GA-3901	PRON	PA4179	GA-477	BLDW
PA2194	GA-362	BLDW	PA2586	GA-119	BLDW	PA3902	GA-253	PRON	PA4180	GA-263	BLDW
PA2200	GA-128	BLDW	PA-259	GA-194	PFMX	PA3914	GA-392	PRON	PA4180	GA-5466	BLDW
PA2204	GA-386	BLDW	PA-260	GA-780	PFMX	PA3916	GA-3916	PRON	PA4181	GA-479	BLDW
PA2206	GA-2194	BLDW	PA2608	GA-608	BLDW	PA-392	GA-434	PFMX	PA4182	GA-194	BLDW

Referencia Cruzada por Numero de Parte

Cross Reference by Part Number



Numero	Gonher	Fabricante	Numero	Gonher	Fabricante	Numero	Gonher	Fabricante	Numero	Gonher	Fabricante
Number	Gonher	Manufacturer	Number	Gonher	Manufacturer	Number	Gonher	Manufacturer	Number	Gonher	Manufacturer
PA4185	GA-1540	BLDW	PA570	GAK-20	PER	PA738	GA-6127	PER	PAF9155	GA-356	PURF
PA422	GA-2195	PFMX	PA573	GA-44	PER	PA74	GA-55	PHI	PAF9334	GA-9334	PURF
PA-422	GA-2195	QKS	PA576	GAK-16	PER	PA74	GA-55	PRON	PAF9472	GA-372	PURF
PA-423	GA-2198 ⁷⁹	PFMX	PA59	GA-50	PHI	PA7414	GA-141	PRON	PAF9544	GA-107	PURF
PA-423	GA-438 ³¹	PFMX	PA596	GA-1284	PER	PA7417	GA-198	PRON	PAK474	GAK-403	PER
PA-429	GA-364	PFMX	PA597	GA-1008	PER	PA7420	GA-514	PRON	PAK478	GAK-16	PER
PA-429	GA-364	QKS	PA598	GA-1285	PER	PA7421	GA-165	PRON	PAK480	GA-33 ¹²	PER
PA4303	GA-4303	PRON	PA599	GA-8047	PER	PA7432	GA-132	PRON	PAK493	GA-26	PER
PA4309	GAD-15	PRON	PA600	GA-1286	PER	PA7438	GA-442	PRON	PAK538	GA-27 ¹²	PER
PA4313	GA-491	BLDW	PA6017	GA-322	PHI	PA7440	GA-300	PRON	PAK545	GA-5648	PER
PA4319	GA-4319	BLDW	PA6035	GA-279	PHI	PA751	GA-891	PER	PAK576	GAK-16	PER
PA4320	GA-340	BLDW	PA6064	GA-386	PHI	PA7534	GA-27161	FIA	PAK651	GA-37	PER
PA4325	GA-4325	PRON	PA6077	GA-3901	PHI	PA7569A	G-278	FRM	PAK6570	GAK-20	PER
PA-433	GA-263	PFMX	PA6081	GA-301	PHI	PA7597	GA-164	PRON	PAK6880	GA-6880	PER
PA-433	GA-263	QKS	PA6117	GA-165	PHI	PA7614	GAVW-620	PRON	PAK703	GA-98 ¹²	PER
PA4331	GAC-10 ²⁸	BLDW	PA6132	GA-274	PHI	PA7628	GAD-118	PRON	PAK826	GA-416	PER
PA4331	GAC-8	BLDW	PA6134	GA-5056	PHI	PA7640	GA-240	PRON	PAK939	GAK-216	PER
PA4335	GA-248	BLDW	PA6140	GA-3915	PHI	PA7730	GA-175	PRON	PAK994	GA-509 ¹⁴	PER
PA4347	GA-153	PHI	PA615	GA-70	BLDW	PA7738	GA-127	PRON	PAK995	GA-376	PER
PA4356	GA-390	PRON	PA6153	GA-6479	PHI	PA7774	GA-1616	PRON	PAK996	GA-6880	PER
PA4361	GA-139	PRON	PA6158	GA-382	PHI	PA7851	GA-4365	SCHU	PAK999	GA-329	PER
PA4375	GA-362	PRON	PA616	GA-37	BLDW	PA7880	GA-2174	SCHU	PAT44377	GAK-403	JOND
PA4378	GA-174	PHI	PA6180	GA-253	PHI	PA7880	GA-2174	SFFI	PB0125	GA-6127 ⁹⁸	LETR
PA4419	GAVW-2	FRM	PA6234	GA-153	PHI	PA796	GA-403	PER	PB0125	GA-6129 ⁹⁸	LETR
PA442	GA-184	QKS	PA6236	GA-4828	PHI	PA803	GA-77	PER	PB0126	GA-360 ¹⁰⁴	LETR
PA-442	GA-184	PFMX	PA6244	GA-195	PHI	PA8038	GA-673R	PRON	PB0126	GA-361 ¹⁰⁸	LETR
PA-449	GA-145	QKS	PA6246	GA-7017	PHI	PA8039	GA-1615	PRON	PB0293	GA-356 ¹⁰⁴	LETR
PA45	GA-77	PHI	PA625	GA-56	BLDW	PA8040	GA-384	PRON	PB0293	GA-357 ¹⁰⁸	LETR
PA-450	GA-138	PFMX	PA6272	GA-240	PHI	PA8069	GA-244	PRON	PB0447	GP-2071W	LETR
PA-450	GA-138	QKS	PA6305	GA-390	PRON	PA809	GA-85	PER	PB0447	GP-2071W	WABC
PA-451	GA-269	PFMX	PA-6333	GA-382	PRON	PA812	GA-730	PER	PB0502	G-191	KOMA
PA-451	GA-269	QKS	PA634	GA-105	BLDW	PA813	GA-59	PER	PB0502	G-191	LETR
PA45314	GA-348	PUR	PA6362	GA-362	PRON	PA8133	GA-163	PRON	PB0502	G-191	WABC
PA-454	GA-488	PFMX	PA6366	GA-174	PRON	PA814	GA-57	PER	PB0704	GP-26	WABC
PA-454	GA-488	QKS	PA6376	GA-142	PRON	PA8141	GA-1614	PRON	PB104	GP-1101	PBLT
PA-455	GA-2114	PFMX	PA6395	GA-195	PRON	PA8142	GA-130	PRON	PB105	GP-1101	PBLT
PA4585	GA-3551 ⁵⁵	BLDW	PA6406	GA-130	PHI	PA816	GA-325	PER	PB110	G-1175	PBLT
PA4585	GA-3551	XT ⁶⁴	PA6417	GA-442	PHI	PA8162	GA-217	PRON	PB1525	GA-356 ¹⁰⁴	LETR
PA-459	GA-606	PFMX	PA642	GA-77	BLDW	PA817	GA-303	PER	PB1525	GA-357 ¹⁰⁸	LETR
PA460	GA-597	PFMX	PA643	GA-39	BLDW	PA818	GA-3300	PER	PB1612	GP-26	LETR
PA4600	GA-475	BLDW	PA645	GA-5648	BLDW	PA8208	GA-607	PRON	PB1612	GP-26	WABC
PA4601	GA-5876	BLDW	PA6479	GA-6479	PRON	PA821	GA-86	PER	PB1613	GP-27	LETR
PA-462	GA-1617	PFMX	PA648	GA-90	BLDW	PA8221	GA-279	PRON	PB1613	GP-27	WABC
PA4656	GA-7017	PRON	PA650	GA-71	BLDW	PA8243	GA-158	PRON	PB2007	GP-26	PBLT
PA-466	GA-2161	PFMX	PA6555	GA-275	PRON	PA825	GA-75	PER	PB206	GP-27	PBLT
PA-468	GA-249	PFMX	PA657	GA-80	BLDW	PA83	GA-85	PHI	PB3015	G-31	PUR
PA4680	GA-386	PRON	PA658	GA-50	BLDW	PA83-1	GA-85	PHI	PB3015D	G-31	PUR
PA-469	GA-415	PFMX	PA663	GA-44	BLDW	PA834	GA-229	PER	PB3016	G-143	PUR
PA4701	GA-702 ¹⁰⁸	BLDW	PA6690	GA-6690	PRON	PA835	GA-106 ⁹⁵	PER	PB5	GA-101	PEN
PA472	GA-2124	PFMX	PA67	GA-192	PHI	PA835	GA-326 ⁷¹	PER	PB50	GP-50	ACE
PA4722	GA-5466	PRON	PA675	GA-44	BLDW	PA836	GA-360	PER	PB50	GP-50	APOL
PA4731	GA-165	PRON	PA677	GA-11	BLDW	PA84	GA-730	PHI	PB50	GP-50	BWS
PA474	GAK-403	PER	PA678	GA-7	BLDW	PA842	GA-74	PER	PB50	GP-50	CAM2
PA478	GAK-16	PER	PA68	GA-100	PHI	PA859	GA-100	PER	PB50	GP-50	CHP
PA4785	GA-2156	BLDW	PA-6807	GA-386	PRON	PA8606	GA-8606	PRON	PB50	GP-50	FRM
PA4799	GA-381	PRON	PA6824	GA-2106	PRON	PA8754	GA-6479 ⁹⁰	PRON	PB50	GP-50	GRAN
PA480	GA-33 ¹²	PER	PA6828	GA-133	PRON	PA8756	GA-348	PRON	PB50	GP-50	LUF
PA4802	GA-888R	BLDW	PA6850	GAD-294	PRON	PA8805	GA-278R	PRON	PB50	GP-50	MASE
PA-481	GA-383	PFMX	PA691	GA-113	BLDW	PA887	GA-113	PER	PB50	GP-50	WARN
PA4817	GA-2122	BLDW	PA691	GA-231	BLDW	PA888	GA-113	PER	PB501	GP-50	FRM
PA4828	GA-4828	PRON	PA695	GA-18	PER	PA8925	GA-780	PRON	PB502	GP-50	FRM
PA4831	GAD-118	PRON	PA7000	GAVW-4	FIA	PA8969	GA-168	PRON	PB5038	G-33	LETR
PA-484	GA-324	PFMX	PA7001	GA-277	FIA	PA8997	GA-224	PRON	PB5038	G-33	WABC
PA485	GA-320	PFMX	PA7002	GAVW-2	FIA	PA90	GA-303	PHI	PB509N	G-33	PBLT
PA-486	GA-269	PFMX	PA7017	GAVW-4	FIA	PA9054	GA-248	PRON	PB516	G-566	PBLT
PA493	GA-26	PER	PA7017	GA-7017	PRON	PA91	GA-59	PHI	PB5556	GP-66	LETR
PA4939	GA-139	PRON	PA7020	GAVW-2	FIA	PA910	GA-153	PRON	PB6	GA-77	ACD
PA4941	GAVW-10	BLDW	PA7021	GAVW-2	FIA	PA9155	GA-356	PER	PB670	GP-53	PBLT
PA497	GA-9045	PER	PA703	GA-98 ¹²	PER	PA92	GA-57	PHI	PB750D	G-750	PBLT
PA498	GA-1287	PER	PA7030	GAVW-2	FIA	PA9269	GA-413R	PRON	PB777	GP-57	PBLT
PA499	GA-9334	PER	PA7031	GAVW-2	FIA	PA929	GA-18	PER	PB865	GA-6880	PBLT
PA5042	GA-442	PRON	PA7033	GA-2194	FIA	PA93	GA-325	PHI	PBA109	GAD-1 ⁹⁷	PROB
PA5043	GAVW-620	PRON	PA7034	GA-4365	FIA	PA9345	GA-414R	PRON	PBA110	GAD-3	PROB
PA5049	GA-595	PRON	PA7040	GA-2194	FIA	PA9360	GA-264	PRON	PBA113	GA-75	PROB
PA5056	GA-5056	PRON	PA7072	GA-2110	FIA	PA9400	GA-780	PRON	PBA120	GA-74	PROB
PA5058	GA-273	PRON	PA7084	GA-4303	FIA	PA9401	GA-490	PRON	PBA123	GA-2719B	PROB
PA512	GA-37	PER	PA7085	GAD-15	FIA	PA949	GA-425	PER	PBA124	GA-3300	PROB
PA514	GA-7	PER	PA7090	GAVW-622	FIA	PA952	GA-679	PER	PBA131	GA-3425	PROB
PA515	GA-39	PER	PA7094	GA-604	PRON	PA989	GA-378	PER	PBA148	GA-80	PROB
PA518	GA-80	PER	PA7096	GA-2156	FIA	PA99	GA-86	PHI	PA261	GA-3490	PROB
PA52	GA-71	PHI	PA7109	GAVW-120	FIA	PA99-1	GA-86	PHI	PA3138	GA-54	PROB
PA5248	GA-163	GRP	PA7119	GA-2114	FIA	PAF0015	GAP-381	PURF	PA3149	GA-3523	PROB
PA5306	GA-278R	PRON	PA7137	GAVW-121	FIA	PAF0694	GA-694	PURF	PA332	GA-325	PROB
PA5314	GA-348	PRON	PA7151	GA-6690	FIA	PAF2984	GA-2984	PURF	PBA4	GA-70	PROB
PA5330	GA-6479 ⁹⁰	PRON	PA7164	GA-172	PRON	PAF3186A	G-1143	APF	PBA45	GA-77	PROB
PA5333	GA-271	BLDW	PA7174	GA-381	PRON	PAF3551	GA-3551 ⁵⁵	PURF	PBA52	GA-71	PROB
PA5378	GA-240	PRON	PA7240	GA-2174	FIA	PAF3551	GA-3551	XT ⁶⁴	PBA59	GA-50	PROB
PA538	GA-27 ¹²	PER	PA731	GA-1203	PER	PAF4714	GAP-379	PURF	PBA602	GA-271	PROB
PA5396	GA-248	PRON	PA732	GA-135	PER	PAF-5069	GA-879	PURF	PBA67	GA-192	PROB
PA5418	GA-395	PRON	PA7344	GA-7344	PRON	PAF6880	GA-6880	PURF	PA74	GA-55	PROB
PA5446	GA-780	PRON	PA735	GA-378	PHI	PAF6918	GA-378	PURF	PA753	GA-89	PROB
PA545	GA-5648	PER	PA7351	GA-322	PRON	PAF7716	GA-7716	PURF	PA826	GA-3681	PROB
PA5466	GA-5466	PRON	PA7359	GA-2184	FIA	PAF7797	GA-229	PURF	PBA831	GA-85	PROB
PA5595	GA-595	PRON	PA736	GA-31	PER	PAF8047	GA-376	PURF	PBA84	GA-730	PROB
PA57	GA-80	PHI	PA7365	GA-217	PRON	PAF8483	GA-483	PURF	PBA90	GA-303	PROB
PA57	GA-80	PRON	PA737	GA-6129	PER	PAF9045	GA-9045	PURF	PBA91	GA-59	PROB

Para números Gonher con Superíndice vea página 651
For Gonher with Superscript numbers see page 651

REFERENCIA CRUZADA

Numero	Gonher	Fabricante	Numero	Gonher	Fabricante	Numero	Gonher	Fabricante	Numero	Gonher	Fabricante
Number	Gonher	Manufacturer	Number	Gonher	Manufacturer	Number	Gonher	Manufacturer	Number	Gonher	Manufacturer
PBA92	GA-57	PROB	PC187	GA-405	ACD	PC335	GA-8047	ACD	PCA-1532	GAK-1532	CNTM
PBA991	GA-86	PROB	PC-191	G-191	CNTM	PC337	GA-375	ACD	PCA-1543	GA-891	CNTM
PBC257001	GA-18	COVE	PC193	GA-39	ACD	PC338	GA-1285	ACD	PCA-15435Y	GA-892	CNTM
PBFJS116P16Z	G-1121	BOG	PC-1953	G-566	CNTM	PC-3387	GP-46	CNTM	PCA-1548	GA-483	CNTM
PBFJS116S16Z	G-1121	BOG	PC198	GPP-19	ACD	PC339	GA-1286	ACD	PCA-15485Y	GA-482	CNTM
PBFJS25P2Z	G-1121	BOG	PC-2	GAC-9	PFMX	PC34	GP-171 ¹⁶	PUR	PCA-1553	GA-679	CNTM
PBG131	GG-49	PROB	PC-2	GAC-9	QKS	PC34-1	GP-171 ¹⁶	PUR	PCA-15535Y	GA-680	CNTM
PBG157	GG-16	PROB	PC20	GP-81 ²¹	PUR	PC342	GA-71	ACD	PCA-1580	GA-109	CNTM
PBG158	GG-17	PROB	PC20	GP-9 ⁵⁸	PUR	PC343	GA-229	ACD	PCA-15805Y	GA-119	CNTM
PBG180	GG-45	PROB	PC200	GP-81	PUR	PC3535	GP-3980	CNTM	PCA-1581	GA-229	CNTM
PBG22	GG-123	PROB	PC-200	G-200	CNTM	PC358	GA-4365	ACD	PCA-1588	GA-589	CNTM
PBG427	GG-6	PROB	PC201	GP-3816	PUR	PC360	GA-277	ACD	PCA-15885Y	GA-588	CNTM
PBG441	GG-7	PROB	PC202	GP-36	PUR	PC-3600	GP-3600	CNTM	PCA-1596	GA-209	CNTM
PBO111	GP-46	PROB	PC-2020	GS-2033	CNTM	PC-3614	GP-58	CNTM	PCA-15965Y	GA-210	CNTM
PBO123	GP-3429	PROB	PC-2040	GS-2034	CNTM	PC-3682	GP-3682 ²³	CNTM	PCA-1599	GA-107	CNTM
PBO173	GP-3980	PROB	PC200F	GP-3816	PUR	PC-3682	GP-37 ⁵⁴	CNTM	PCA-160	GA-70	CNTM
PBO228	GP-81	PROB	PC21	GP-3816	PUR	PC37	GP-171	PUR	PCA-1621	GA-413R	CNTM
PBO2817	GP-3531	EXP	PC210	GP-31	PUR	PC-37	GAC-7	PFMX	PCA-1654	GAD-34	CNTM
PBO2821A	GP-58	PROB	PC211	GP-54	PUR	PC-37	GAC-7	QKS	PCA-1679	GA-479	CNTM
PBO2827	GP-3682	PROB	PC-211	G-613	CNTM	PC38	GP-81	PUR	PCA-1680	GA-780	CNTM
PBO2849	GP-24 ²⁶	PROB	PC213	GP-28 ⁸⁵	PUR	PC380	GAVW-4	ACD	PCA-1683	GA-224	CNTM
PBO2849	GP-462 ⁹⁴	PROB	PC213	GP-3816 ²⁵	PUR	PC39	GA-39	ACD	PCA-1688	GA-168	CNTM
PBO2856A	GP-40	PROB	PC213	GP-430 ⁸⁶	PUR	PC399	GA-3490	ACD	PCA-170	GA-73	CNTM
PBO2865	GP-42	PROB	PC213OF	GP-28 ⁸	PUR	PC-4163	G-297	CNTM	PCA-1732	GA-134	CNTM
PBO33	GP-20	PROB	PC213OF	GP-430 ⁸	PUR	PC-4163	G-297-B	CNTM	PCA-1780	GA-264	CNTM
PBO40	GP-13	PROB	PC214	GP-36	PUR	PC42	GP-1122	PUR	PCA-18	GA-219	CNTM
PBO400	GP-3600	PROB	PC215	GA-436	ACD	PC433	GA-3425	ACD	PCA-18	GP-58	CNTM
PBO49	GP-3	PROB	PC2-155	G-296	TFIL	PC435	GA-2194	ACD	PCA-184	GA-77	CNTM
PBO561	GP-28 ⁸	PROB	PC2-155	G-296-B	TFIL	PC436	GA-2122	ACD	PCA-187	GA-90	CNTM
PBO561	GP-430 ⁸	PROB	PC218	GP-81	PUR	PC46	GAVW-2	ACD	PCA-189	GA-50	CNTM
PBO81	GP-81 ³¹	PROB	PC-218	G-34	CNTM	PC48	GP-1122	PUR	PCA-192	GA-192	CNTM
PBO81	GP-9 ⁵⁸	PROB	PC22	GP-81	PUR	PC49	GP-1122	FLOM	PCA-2	GAP-379	CNTM
PBO832	GP-23	PROB	PC222	GP-36	PUR	PC-49	GAC-2	PFMX	PCA-216	GA-1008	CNTM
PC 2054 E	GA-410	ACD	PC224	GP-69	PUR	PC4F	G-6	WIX	PCA-223	GA-29	CNTM
PC 2054 E	GA-410	DPHI	PC225	GP-1	PUR	PC4FP	G-6	WIX	PCA-224	GA-8047	CNTM
PC 2060 E	GA-2160	ACD	PC2-255	G-297-B	TFIL	PC4H8792	G-1166	TFIL	PCA-226	GA-9334	CNTM
PC 2060 E	GA-2160	DPHI	PC228	GP-3600	PUR	PC500	G-31	WIX	PCA-229	GA-18	CNTM
PC 598	GA-2160	ACD	PC23	GP-81	PUR	PC500P	G-31	WIX	PCA-233	GA-9045	CNTM
PC 598	GA-2160	DPHI	PC230	GP-52 ¹¹⁰	PUR	PC507	GP-66 ⁹⁰	PUR	PCA-234	GA-1287	CNTM
PC10	GA-18	ACD	PC230	GP-691 ⁴⁸	PUR	PC509	G-1173 ¹⁰⁸	TFIL	PCA-235	GA-1284	CNTM
PC-1034	GP-31	CNTM	PC230MIC10	GP-52 ¹¹⁰	PUR	PC50P	GP-50	WIX	PCA-236	GA-1286	CNTM
PC-11	GP-5	CNTM	PC230MIC10	GP-691 ⁴⁸	PUR	PC511	GA-2110	ACD	PCA-237	GA-1285	CNTM
PC-1101	GP-1101	CNTM	PC230-MIC25	GP-52 ¹¹⁰	PUR	PC515	GAD-15	ACD	PCA-239	GA-375	CNTM
PC-1103	GP-111	CNTM	PC230-MIC25	GP-691 ⁴⁸	PUR	PC535	GA-4303	ACD	PCA-240	GA-37	CNTM
PC-1104	GP-110	CNTM	PC234	GAD-1	ACD	PC55	GP-5	WIX	PCA-24010	GA-272	CNTM
PC-1120	GP-26	CNTM	PC-236	G-236	CNTM	PC556	GAD-15	ACD	PCA-2465	GA-198	CNTM
PC-1121	GP-27	CNTM	PC237	GP-1	PUR	PC55P	GP-5	WIX	PCA-2523	GAK-625	CNTM
PC-1133C	GC-1133	CNTM	PC238	GP-3600	PUR	PC57P	GP-3	WIX	PCA-253	GA-16	CNTM
PC-11335	GS-1133	CNTM	PC-238	G-238	CNTM	PC58	GA-349	ACD	PCA-253	GAK-16	CNTM
PC-1163	G-1163	CNTM	PC24	GP-14	PUR	PC58P	GP-20	WIX	PCA2539	GA-493 ¹⁰⁸	CNT
PC-1166	G-1166	CNTM	PC240	GP-42	PUR	PC5F	G-31	WIX	PCA-254	GA-20	CNTM
PC-1173	G-1173	CNTM	PC244	GP-77	PUR	PC-6	G-6	CNTM	PCA-254	GAK-20	CNTM
PC-1174	G-1174	CNTM	PC246	GP-66 ⁹⁰	PUR	PC60	GP-13	WIX	PCA-2541	GA-251	CNTM
PC-1175	G-1175	CNTM	PC247	GP-31	PUR	PC601	GAVW-121	ACD	PCA-255	GA-24	CNTM
PC-1176	G-1176	CNTM	PC248	GP-54 ¹¹	PUR	PC60P	GP-13	WIX	PCA-256	GA-33	CNTM
PC-11860	G-1121	CNTM	PC248	GP-66 ¹⁰	PUR	PC63	GA-200	ACD	PCA-257	GA-26	CNTM
PC-11860A	G-1121F	CNTM	PC25	GP-1	PUR	PC63	GP-58	ACD	PCA-2571	GAP-381	CNTM
PC-11861	G-1123	CNTM	PC-25	GP-20	CNTM	PC64	GAD-1	ACD	PCA-258	GA-403	CNTM
PC-11861A	G-1123F	CNTM	PC252	GP-28 ⁸	PUR	PC65	GAD-1	ACD	PCA-258	GAK-403	CNTM
PC-119	G-119	CNTM	PC252	GP-430 ⁸	PUR	PC68	GA-230	ACD	PCA-259	GA-27	CNTM
PC-1191	G-296	CNTM	PC253	GP-28 ⁸	PUR	PC-7	GAC-13	PFMX	PCA2595	GA-563	CNT
PC-1191	G-296-B	CNTM	PC253	GP-430 ⁸	PUR	PC-7	GAC-13	QKS	PCA-2608	GA-284	CNTM
PC124	GAVW-2	ACD	PC255	GP-36	PUR	PC74	GA-44	ACD	PCA-2662	GAVW-22	CNTM
PC-13	GP-13	CNTM	PC257	GA-730	ACD	PC76N	G-236	WIX	PCA-268	GA-5648	CNTM
PC133K	GAK-20	ACD	PC257	GP-310	PUR	PC76NP	G-236	WIX	PCA-2755	GA-348	CNTM
PC134K	GA-24 ³⁴	ACD	PC260	GP-36	PUR	PC801	GAVW-2	ACD	PCA-2930	GA-373	CNTM
PC135	GA-106 ⁴⁶	ACD	PC260	GP-36	SPEC	PC-801	G-801	CNTM	PCA-2998	GAVW-623	CNTM
PC135	GA-326 ⁷¹	ACD	PC27	GP-81	PUR	PC809	GA-230	ACD	PCA-305	GA-730	CNTM
PC136	GA-403	ACD	PC-2836	GP-10	CNTM	PC812	G-1143	TFIL	PCA-3203	GA-21	CNTM
PC136K	GAK-403	ACD	PC29	GA-71	ACD	PC813	GA-2194	ACD	PCA-326	GA-59	CNTM
PC137	GA-16	ACD	PC297	GAVW-4	ACD	PC-813	G-813	CNTM	PCA-3425	GA-3425	CNTM
PC137K	GAK-16	ACD	PC-30	GP-3	CNTM	PC-816	G-816	CNTM	PCA-347	GA-429	CNTM
PC138	GA-33 ¹¹²	ACD	PC300	GA-2740	ACD	PC-820	GP-68	CNTM	PCA-351	GA-75	CNTM
PC138K	GA-33 ¹¹²	ACD	PC301	GP-50	PUR	PC-834	G-834	CNTM	PCA-3517	GA-377	CNTM
PC-139	G-139	CNTM	PC302	GAD-1	ACD	PC-848	G-833	CNTM	PCA-3518	GA-372	CNTM
PC-14	GP-5000	CNTM	PC302	GP-28 ⁸	PUR	PC86	GAD-3	ACD	PCA-3523	GA-3523	CNTM
PC141	G-200	WIX	PC302	GP-430 ⁸	PUR	PC-870	G-870	CNTM	PCA-3525	GA-734 ⁸¹	CNTM
PC144	GA-6129	ACD	PC302P	G-870	WIX	PC88	GA-360	ACD	PCA-3525	GA-735	CNTM
PC144	GA-27 ¹¹²	ACD	PC304	GAD-1	ACD	PC-8A	GP-1	CNTM	PCA-3537	GA-54	CNTM
PC144K	GA-27 ¹¹²	ACD	PC305P	G-836	WIX	PC-8C	GAC-10 ²⁸	PFMX	PCA-3538	GA-154	CNTM
PC1481E	GA-2184	ACD	PC307P	GP-81	WIX	PC-8C	GAC-8	PFMX	PCA-3588	GA-3588	CNTM
PC1481E	GA-2184	DPHI	PC31	GP-171 ¹⁹	PUR	PC-9	GP-81 ³¹	CNTM	PCA-3603	GA-373	CNTM
PC149	GG-298	CNTM	PC311P	GP-81	WIX	PC-9	GP-9 ⁵⁸	CNTM	PCA-3647	GA-3647	CNTM
PC15	GP-1	WIX	PC312P	GP-81	WIX	PC-927	GP-22	CNTM	PCA-3660	GA-277	CNTM
PC151P	G-335	WIX	PC314P	G-162H	WIX	PC945	G-1121	TFIL	PCA-3664	GA-234	CNTM
PC157	GA-18	ACD	PC316	GP-38 ⁷⁶	WIX	PC9660	GP-38 ⁷⁶	CNTM	PCA-3681	GA-3681	CNTM
PC15P	GP-1	WIX	PC317P	GP-38	WIX	PC-9661	GP-28	CNTM	PCA-3684	GA-231	CNTM
PC160	GAVW-22	ACD	PC318P	GP-3600	WIX	PC-9661A	GP-38	CNTM	PCA-3717	GA-274	CNTM
PC-1660	G-222	CNTM	PC32	GP-81	PUR	PC-9A	GP-9	CNTM	PCA-3784	GA-230	CNTM
PC170	GA-11	ACD	PC32-1	GP-3816	PUR	PCA-1047	GA-176	CNTM	PCA-381	GA-74	CNTM
PC172	GA-11	ACD	PC33	GP-54 ¹¹	PUR	PCA-1117	GA-217	CNTM	PCA-3819	GA-397	CNTM
PC-174	G-500	CNTM	PC33	GP-66 ¹⁰	PUR	PCA-12	GA-200	CNTM	PCA-3902	GA-253	CNTM
PC175	GA-5648	ACD	PC-33	G-33	CNTM	PCA1296	GAVW-624	CNTM	PCA-3914	GA-392	CNTM
PC-18	GAC-1	PFMX	PC-330	G-330	CNTM	PCA-133	GA-78	CNTM	PCA-3916	GA-3916	CNTM
PC-18	GAC-1	QKS	PC-333	G-333	CNTM	PCA-146	GA-71	CNTM	PCA-3924	GA-153	CNTM
PC180	GA-49	ACD	PC334	GAK-625	ACD	PCA-148	GA-80	CNTM	PCA-3990	GA-3551 ⁵⁵	CNTM

Referencia Cruzada por Numero de Parte

Cross Reference by Part Number



Numero	Gonher	Fabricante	Numero	Gonher	Fabricante	Numero	Gonher	Fabricante	Numero	Gonher	Fabricante
Number	Gonher	Manufacturer	Number	Gonher	Manufacturer	Number	Gonher	Manufacturer	Number	Gonher	Manufacturer
PCA-3990	GA-3551	XT ⁸⁴ CNTM	PCG-2	GG-5	CNTM	PER106	GP-54 ¹⁵	PUR	PER249F	GPP-1122	PUR
PCA-4061	GA-248	CNTM	PCG-2	GG-5 L	CNTM	PER106	GP-66 ¹⁰	PUR	PER250	GP-57	PUR
PCA-4116	GAVW-212	CNTM	PCG-20	GG-20	CNTM	PER109	GP-42	PUR	PER250-1	GP-57	PUR
PCA-4223	GA-6128	CNTM	PCG-3	GG-8	CNTM	PER1091	GP-46	PUR	PER252	GP-28 ⁹	PUR
PCA-4309	GAD-15	CNTM	PCG-3388	GG-16	CNTM	PER1091	GP-46	SPEC	PER252	GP-430 ⁸	PUR
PCA-4402	GA-280	CNTM	PCG-3389	GG-17	CNTM	PER11	GP-13	REF	PER253	GP-3985 ¹³	PUR
PCA-4677	GAD-294	CNTM	PCG-3587	GG-8	CNTM	PER110	GP-10	PUR	PER256	GP-455	PUR
PCA-502	GA-6129	CNTM	PCG-3596	GG-29	CNTM	PER11001	GP-10	PUR	PER257	GP-310	PUR
PCA-5025Y	GA-6127	CNTM	PCG-3727	GG-46	CNTM	PER111	GP-46	PUR	PER259	GP-53	PUR
PCA-5056	GA-5056	CNTM	PCG-3729	GG-25	CNTM	PER112	GP-46	PUR	PER26	GP-14	PUR
PCA-5058	GA-373	CNTM	PCG-3769	GG-42	CNTM	PER116	GP-53	PUR	PER260	GP-54 ²⁰	PUR
PCA-507	GA-106 ⁴⁶	CNTM	PCG-3770	GG-32	CNTM	PER116S	GP-53	PUR	PER264	GP-3980	PUR
PCA-510	GA-98 ¹²	CNTM	PCG-3802	GG-47	CNTM	PER1165C	GP-53	PUR	PER265F	GP-1122	PUR
PCA-523	GA-360	CNTM	PCG-3893	GG-7019	CNTM	PER119	GP-1	PUR	PER266F	GP-92	PUR
PCA-5235Y	GA-361	CNTM	PCG-3P	GG-3	CNTM	PER12	GP-3	PUR	PER267F	GPP-19	PUR
PCA-536	GA-356	CNTM	PCG-470	GG-41	CNTM	PER12	GP-3	REF	PER270	GP-40	PUR
PCA-5365Y	GA-357	CNTM	PCG-470	GG-6	CNTM	PER120	GP-14	PUR	PER274	GP-92	PUR
PCA-542	GA-31	CNTM	PCG-470A	GG-16	CNTM	PER121	GP-390 ¹³	PUR	PER274F	GP-92	PUR
PCA-580	GA-179	CNTM	PCG-471	GG-7	CNTM	PER123	GP-3429	PUR	PER276	GP-3816	PUR
PCA-583	GA-196	CNTM	PCG-471A	GG-17	CNTM	PER124	GP-44	PUR	PER277	GP-81	PUR
PCA-592	GA-376	CNTM	PCG-4777	GG-63	CNTM	PER127	GP-54	PUR	PER279	GP-43	PUR
PCA596	GA-6880	CONT	PCG-6313	GG-580	CNTM	PER128	GP-67	PUR	PER28	GP-3816	PUR
PCA-598	GA-7716	CNTM	PCG-6344	GG-39	CNTM	PER129	GP-88	PUR	PER2821A	GP-58	PUR
PCA-5985Y	GA-7360	CNTM	PCG-6563	GG-61	CNTM	PER131	GP-1101	PUR	PER283C	GP-2071W	PUR
PCA-620	GA-49	CNTM	PCG-682	GG-30	CNTM	PER131F	GP-1101	PUR	PER284F	GP-1122	PUR
PCA-6326	GA-371	CNTM	PCG-7018	GG-7018	CNTM	PER132	GP-1108	PUR	PER286	GP-40	PUR
PCA-6366	GA-174	CNTM	PCG-795	GG-87	CNTM	PER134	GP-55	PUR	PER286C	GP-2071W	PUR
PCA-6366A	GA-174	CNTM	PCG-862	GG-92	CNTM	PER137	GP-1	PUR	PER288	GP-3766	PUR
PCA-6479	GA-6479	CNTM	PCG-9009	GG-251	CNTM	PER138	GP-3600	PUR	PER289	GP-3985	PUR
PCA-6491	GA-129	CNTM	PCS1144	S 3202 ¹⁸	FRM	PER15	GP-1101	PUR	PER289F	GP-155	SPEC
PCA-6545	GAVW-120	CNTM	PCS5059	GPP-11	FRM	PER1503	G-1175	FRM	PER290	GP-3985	PUR
PCA-6545	GAVW-121	CNTM	PCS5059M	GPP-11	FRM	PER150F	GP-85	PUR	PER291	GP-3531 EXP	PUR
PCA-6546	GAD-30	CNTM	PCS5060	S 3202 ²⁰	FRM	PER151F	GP-1122	PUR	PER292	GP-149	PUR
PCA-6555	GA-275	CNTM	PCS5060G	S 3202 ²⁰	FRM	PER152	GPP-1122	PUR	PER298F	GP-155	PUR
PCA-6576	GA-276	CNTM	PCS5062	GPP-11	FRM	PER152F	GPP-1122	PUR	PER2992	GP-149	PUR
PCA-6619	GA-6619 ¹	CNTM	PCS5063	GPP-11	FRM	PER152FO	GPP-1122	PUR	PER3	GP-50	PUR
PCA-6619	GA-6620 ¹	CNTM	PD	G-296	ROO	PER167	GP-3531 EXP	PUR	PER3	GP-50	REF
PCA-6828	GA-133	CNTM	PD	G-296-B	ROO	PER168	GP-3816	PUR	PER30	GP-84	REF
PCA-6840	GA-278R	CNTM	PD1022	G-33	BAUD	PER168	GP-3816	SPEC	PER300	GP-53	PARK
PCA-6849	GAD-129	CNTM	PD14365	G-296	CITR	PER17	GP-81	PUR	PER300	GP-53	PUR
PCA-6850	GAD-294	CNTM	PD14365	G-296-B	CITR	PER171	GP-171	PUR	PER306	GP-14	PUR
PCA-6900	GAD-117	CNTM	PD14365A	G-296	CITR	PER173	GP-3980	PUR	PER307	GP-46	PUR
PCA-697	GAD-1	CNTM	PD14365A	G-296-B	CITR	PER179	GP-3816	PUR	PER31	GP-83	PUR
PCA-698	GAD-3	CNTM	PD19	GG-48	KELV	PER17K	GP-3816	PUR	PER311	GP-53	PUR
PCA-699	GAD-3	CNTM	PD3092	GA-2122	COO	PER17M	GP-81	PUR	PER313	GP-43	PUR
PCA-7006	GA-258	CNTM	PD50	G-31	PUR	PER18	GP-81	PUR	PER314	GP-35	PUR
PCA-7087	GA-271	CNTM	PD50-SERIES	G-31	PUR	PER182H	GP-66	PUR	PER318	GP-38	PUR
PCA73	GA-44	CONT	PE1182	GA-3490	PMC	PER183	GP-58	MINL	PER319	GP-54 ¹¹	PUR
PCA-7344	GA-744	CNTM	PE2014	G-870	PMC	PER183	GP-3816	PUR	PER319	GP-66 ¹⁰	PUR
PCA-74	GA-11	CNTM	PE2123	GAD-1 ⁸⁷	PMC	PER184	GP-40	PUR	PER321	GP-462	PUR
PCA-7414	GA-141	CNTM	PE3012	G-870	PMC	PER188	GP-28 ⁸⁴	PUR	PER323F	GPP-1122	PUR
PCA-7421	GA-165	CNTM	PE31130	GAD-1	PMC	PER188	GP-3600 ⁸⁸	PUR	PER33	GP-20	PUR
PCA-7432	GA-132	CNTM	PE313	GP-3682	PMC	PER188	GP-430 ⁸⁵	PUR	PER33	GP-20	REF
PCA-7440	GA-300	CNTM	PE318	GAD-1	PMC	PER190	GP-28 ⁸⁴	PUR	PER3300	GP-20	PUR
PCA-7597	GA-164	CNTM	PE3212	GP-1011Q	PMC	PER190	GP-3600 ⁸⁸	PUR	PER336F	GP-1122	PUR
PCA-76	GA-12	CNTM	PE352	GP-3985	PMC	PER190	GP-430 ⁸⁵	PUR	PER337	GP-3682	PUR
PCA-7628	GAD-118	CNTM	PE404	GP-38	PMC	PER194	GP-3985	PUR	PER338	GP-38	PUR
PCA-7688	GA-529	CNTM	PE502	GP-38	PMC	PER195	GP-3600	PUR	PER338	GP-38	PUR
PCA-77	GA-7	CNTM	PE504	GP-3985	PMC	PER195	GP-3600	PUR	PER33M	GP-20	PUR
PCA-7730	GA-175	CNTM	PE513	GP-38	PMC	PER1A	GP-1	PUR	PER349	GP-3985	PUR
PCA-7737	GA-128	CNTM	PE549	GP-462	PMC	PER1F	GP-1	PUR	PER35	GP-1101	PUR
PCA-7738	GA-127	CNTM	PE6113	GAD-3	PMC	PER20	GP-66	PARK	PER36	GP-110	PUR
PCA-7764	GA-172	CNTM	PE649	GP-149	PMC	PER20	GP-66	PUR	PER362	GP-28 ⁸⁴	PUR
PCA-7774	GA-1616	CNTM	PE68016093	GP-54	JOND	PER2001	GP-66	PUR	PER362	GP-3600 ⁸⁸	PUR
PCA-8038	GA-673R	CNTM	PE7121	GA-2719B	PMC	PER20-2	GGP-25	PUR	PER362	GP-430 ⁸⁵	PUR
PCA-8039	GA-1615	CNTM	PE739	GP-42	PMC	PER20-2	GP-26	PUR	PER367F	GP-1122	PUR
PCA-8080	GAVW-622	CNTM	PE8169	GA-2740	PMC	PER20-2	GP-92	PUR	PER37	GP-1105	PUR
PCA-8133	GA-163	CNTM	PE913	GP-10	PMC	PER20-25	GP-66	PUR	PER373	GP-3682	PUR
PCA-8142	GA-130	CNTM	PEA552	GA-71	PUR	PER204	GP-81	PUR	PER38	GP-11	PUR
PCA8169	GAVW-626	CNTM	PEA559	GA-361	PUR	PER20MIC10	GP-66	PUR	PER389F	GP-85 ¹⁰	PUR
PCA-8205	GA-301	CNTM	PEC16	GA-113	PHI	PER20MIC25	GP-66	PUR	PER39	GP-1108	PUR
PCA-8221	GA-279	CNTM	PEC17	GA-113	PHI	PER210	GP-50 ²⁰	PUR	PER393	GP-40	PUR
PCA-8243	GA-158	CNTM	PEC257001	G-834	KALM	PER211	GP-3816	PUR	PER40	GP-13	PUR
PCA-8606	GA-8606	CNTM	PEC3022	G-1046	TFIL	PER215	GP-9586	PUR	PER40	GP-13	REF
PCA-905	GA-153	CNTM	PEC9	GA-100	PHI	PER2167	GP-171	PUR	PER4000	GP-13	PUR
PCA-9082	GA-215	CNTM	PED109	G-1121	PUR	PER2168	GP-54	PUR	PER4001	GP-40	PUR
PCA-9129	GA-289	CNTM	PED116	G-296	PUR	PER217F	GP-1122	PUR	PER4007	GP-44	PUR
PCA-9200	GA-404	CNTM	PED116	G-296-B	PUR	PER218F	GP-1101 ⁸⁴	PUR	PER4011	GP-3980	PUR
PCA-9800	GA-388	CNTM	PED117	G-1123	PUR	PER224	GP-77	PUR	PER40M	GP-13	PUR
PCA-VV1	GAVW-2	CNTM	PEK502001	G-870	COVE	PER227F	GP-92	PUR	PER42	GP-38	PUR
PCA-VV2	GAVW-121	CNTM	PEK502002	G-836	COVE	PER228F	GP-93	PUR	PER42M	GP-38	PUR
PCA-VV3	GAVW-4	CNTM	PEK50201	G-870	KALM	PER23-1	GPP-14	PUR	PER43	GP-18	PUR
PCA-VV4	GAVW-10	CNTM	PEL200	G-162H	PUR	PER232	GP-43	PUR	PER4421	GP-390	PUR
PCA-VV5	GAVW-620	CNTM	PEL219	G-836	PUR	PER232	GP-53	PUR	PER4422	GP-178	PUR
PCA-VV6	GAVW-621	CNTM	PEL221	G-834	PUR	PER233	GP-26	PUR	PER4423F	GPP-18	PUR
PCG-10	GG-45	CNTM	PEL250	G-31	PUR	PER234	GP-27	PUR	PER4444	GP-34	PUR
PCG-1103	GP-11 ⁷⁶	CNTM	PEL260	G-870	PUR	PER234	GP-93	PUR	PER4459	GP-91	PUR
PCG-1103	GP-11 ⁷⁶	CNTM	PEL260	G-870	PUR	PER238	GP-68	PUR	PER4466	GP-28 ⁶	PUR
PCG-1103	GP-1101 ⁴⁵	CNTM	PEL261	G-870	PUR	PER24	GP-50	PUR	PER4466	GP-430 ⁸	PUR
PCG-1191	GG-298	CNTM	PEL312	G-871	PUR	PER240	GP-58	PUR	PER4466	GP-28 ⁹	SPEC
PCG-15	GG-5 L	CNTM	PEL353	G-870	PUR	PER241	GP-2951 ⁶²	PUR	PER4466	GP-430 ⁸	SPEC
PCG-1E	GG-1	CNTM	PER1	GP-1	PUR	PER241	GP-58	PUR	PER4476	GP-157	PUR
PCG-1E	GG-4	CNTM	PER1	GP-1	REF	PER244	GP-46	PUR	PER4477	GP-156	PUR
PCG-1P	GG-1	CNTM	PER100	GP-1	PUR	PER247F	GP-1122	PUR	PER4519	GP-3000	PUR
PCG-1P	GG-4	CNTM	PER100A	GP-1	PUR	PER247F	GPP-1122	PUR	PER4563	GP-77	PUR
PCG-1PW	GG-1	CNTM	PER101	GP-22	PUR	PER248F	GP-1122	PUR	PER46	GP-1107	PUR
PCG-1PW	GG-4	CNTM									

Numero	Gonher	Fabricante	Numero	Gonher	Fabricante	Numero	Gonher	Fabricante	Numero	Gonher	Fabricante
Number	Gonher	Manufacturer	Number	Gonher	Manufacturer	Number	Gonher	Manufacturer	Number	Gonher	Manufacturer
PER4620	GP-149	PUR	PF1080	GP-51	ACD	PF185	GP-110	FLL	PF231	G-1123	BLDW
PER4622	GP-91	PUR	PF1085	GP-81	UNN	PF19	GP-1	ACD	PF235	GP-92	AIR
PER4622	GP-91	SPEC	PF1090	GP-66 ⁹⁰	ACD	PF19226	G-500	MNH	PF235	GP-92	FLL
PER4631	GP-205	PUR	PF1092	G-133	ACD	PF19226X	G-500	MNH	PF24	GP-20	ACD
PER4631	GP-205	SPEC	PF1092	G-989	ACD	PF19326	G-750	MNH	PF24	GP-20	UNN
PER4651	GP-68	PUR	PF1093	GP-3569	ACD	PF19326X	G-750	MNH	PF244	G-1163 ¹⁰⁸	PER
PER4670	GP-81	PUR	PF1097	GP-34	ACD	PF19A	GP-171	UNN	PF25	GP-3	ACD
PER4757	G-971	SPEC	PF11	GP-13	ACD	PF1HC	GP-1	ACD	PF25	GP-3	UNN
PER48	GP-10	PHI	PF11	GP-3	ACD	PF2	GP-1	ACD	PF26	GP-66	ACD
PER48	GP-10	PUR	PF110	G-1175	AIR	PF2	GP-1	UNN	PF260	G-1175 ¹⁰⁸	PER
PER48	GP-10	SPEC	PF110	G-1175 ¹⁰⁸	FLL	PF20	GP-81 ³¹	ACD	PF27	GP-14	ACD
PER49	GP-3	PUR	PF1101	GP-43	ACD	PF20	GP-9 ⁹⁸	ACD	PF28	GP-14	ACD
PER49	GP-3	REF	PF111-5	GG-20	PHI	PF200	G-200	FSN	PF2812A	GP-22	UNN
PER4900	GP-3	PUR	PF1118	GP-88	ACD	PF202	GP-55	AIR	PF2817	GP-3531	EXP
PER49M	GP-3	PUR	PF1122	GP-14	ACD	PF202	GP-55	FLL	PF2821	GP-58	UNN
PER5	GP-5	PUR	PF1127	GP-91	ACD	PF2021	GP-34	ACD	PF283	GP-18	PER
PER5	GP-5	REF	PF1127	GP-91	UNN	PF2023	GP-34	ACD	PF2849	GP-24 ⁶	UCAL
PER500	GP-5	PUR	PF1128	GP-88	ACD	PF2027	GP-54	ACD	PF2849	GP-462 ⁹⁴	UNN
PER53	GP-110	PUR	PF1128	GP-3682	UNN	PF2035	G-191	ACD	PF2863	GP-3985	UNN
PER54	GP-36	PUR	PF1128	GP-88	ACD	PF2044	GP-36	ACD	PF2865	GP-42	UNN
PER5401	GP-36	PUR	PF1130	GP-36	ACD	PF2046	GP-36	ACD	PF2873	GP-3985	UNN
PER58	GP-81 ³¹	PUR	PF114	GG-20	AIR	PF2048	GP-66	ACD	PF2874	GP-157	UNN
PER58	GP-9 ⁵⁸	PUR	PF114	GG-20	FLL	PF205	G-1174 ¹⁰⁸	PER	PF2875	GP-156	UNN
PER59	GP-66	PUR	PF1150	GP-36	ACD	PF2051	GP-166 ¹⁰⁰	ACD	PF29	GP-13	ACD
PER5M	GP-5	PUR	PF116	G-1143	BLDW	PF2052	GP-156	ACD	PF292	G-5000	ACD
PER62	GPP-100	PUR	PF1164	GP-28 ⁴⁵	ACD	PF2057	GP-149	ACD	PF295	G-152	ACD
PER63	GPP-14	PUR	PF1164	GP-38 ⁷⁶	ACD	PF206	GP-27	AIR	PF2A	GP-1	UNN
PER64	GP-3600 ²⁷	PUR	PF1177	GP-40	ACD	PF206	GP-27	FLL	PF3	GP-50	UNN
PER64	GP-38 ⁹⁹	PUR	PF1180	GP-171	ACD	PF207	GP-26	AIR	PF30	GP-20	ACD
PER66	GP-50	PUR	PF119	GG-6	PHI	PF207	GP-26	FLL	PF30	GP-20	UNN
PER67	GP-51	PUR	PF1190	G-31	MNH	PF21	GG-123	PHI	PF3008	GS-2033	PUR
PER68	GP-51	PUR	PF1190X	G-31	MNH	PF210	G-330	ACD	PF-3008	GS-2033	PUMX
PER69	GP-52 ¹⁰	PUR	PF12	GP-3	ACD	PF210	G-6	ACD	PF3013D	G-1121	PUR
PER69	GP-691 ⁴⁸	PUR	PF120	GG-7	PHI	PF210	G-330	UNN	PF31	GP-5	ACD
PER70	GP-52 ¹⁰	PUR	PF1212	GP-2951	ACD	PF210	G-6	UNN	PF31	GP-5	UNN
PER70	GP-691 ⁴⁸	PUR	PF1217	GP-3000	ACD	PF2100	GP-193	ACD	PF3115	GG-5	L
PER73	GP-24 ²⁶	PUR	PF1218	GP-205	ACD	PF2101	GP-52 ¹¹⁰	ACD	PF3119	GS-2034	PUR
PER73	GP-462 ⁹⁴	PUR	PF1219	GP-157	ACD	PF2101	GP-691 ⁴⁸	ACD	PF-3119	GS-2034	PUMX
PER74	GP-462	PUR	PF1220	GP-156	ACD	PF211	GP-56	AIR	PF3121	GG-48	PUR
PER75	GP-42	PUR	PF1222	GP-462	ACD	PF211	GP-56	FLL	PF-3121	GG-48	PUMX
PER76	GPP-14	PUR	PF1224	GP-3985	ACD	PF211	G-1173 ¹⁰⁸	PER	PF3123	G-293	PUR
PER77	GPP-18	PUR	PF1225	GP-46	ACD	PF2111	GP-452	ACD	PF3125	G-293	PUR
PER78	GPP-19	PUR	PF1230	GP-462	ACD	PF2112	GP-91	ACD	PF-3125	GG-48	PUMX
PER81	GP-81 ³¹	PUR	PF1232	GP-3682 ⁵³	ACD	PF212	G-1173 ¹⁰⁸	PER	PF3128	GG-94	PUR
PER81	GP-9 ⁵⁸	PUR	PF1232	GP-37 ⁵⁴	ACD	PF2123	GP-3816	ACD	PF3131	G-297	PUR
PER8100	GP-81 ³¹	PUR	PF1233	GP-157	ACD	PF2129	G-765	ACD	PF3131	G-297-B	PUR
PER8100	GP-9 ⁵⁸	PUR	PF1234	GP-156	ACD	PF213	GP-1101	AIR	PF-3134	G-1123	PUMX
PER81M	GP-81 ³¹	PUR	PF1237	GP-91	ACD	PF213	GP-110	FLL	PF3135	G-297-B	PUR
PER81M	GP-9 ⁵⁸	PUR	PF1238	GP-3816	ACD	PF2135	GP-91	ACD	PF3144	GG-46	PHI
PER83	GP-1	PUR	PF1240	GP-212	ACD	PF2136	GP-171	ACD	PF3145D	G-1123F	PUR
PER84	GP-23	PUR	PF1248	GP-1 ⁹	ACD	PF2139	G-963	ACD	PF3148	2010PM-OR ⁷	PUR
PER85	GP-56	PUR	PF1250	GP-68	ACD	PF2144	GP-152	ACD	PF3148	2010TM-OR ²	PUR
PER86	GP-1122	PUR	PF1257	GP-88	ACD	PF2146	G-971	ACD	PF3157	G-1176	PUR
PER88	GP-69	PUR	PF13	GP-81 ³¹	ACD	PF2149	GP-1	ACD	PF316	G-1143 ⁹⁰	BLDW
PER8801	GP-69	PUR	PF13	GP-9 ⁵⁸	ACD	PF2152	GP-761H	ACD	PF3160	GG-5	L
PER89	GP-3600	PUR	PF13	GP-81 ³¹	UNN	PF2153	GP-761H	ACD	PF3160M	GG-5	L
PER92	GP-149	PUR	PF13	GP-9 ⁵⁸	UNN	PF2154	GP-54	ACD	PF3161	GG-196	PUR
PER96	GP-26	PUR	PF13-1	GG-19	PHI	PF2156	GP-68	ACD	PF3161M	GG-196	PUR
PER97	GP-27	PUR	PF132	GP-33	ACD	PF2158	GP-36	ACD	PF3163	GG-8	L
PERI208	GP-54 ¹¹	IRLE	PF132L	GP-33	ACD	PF2161	GP-57	ACD	PF3163M	GG-8	L
PERI208	GP-66 ¹⁰	IRLE	PF132W	GP-33	ACD	PF2174	GP-562	ACD	PF3169	GG-47	PHI
PERI2404A	GP-28 ⁶	IRLE	PF132W	GP-33	UNN	PF2175	GP-761H	ACD	PF3169	GG-47	PUR
PERI2404A	GP-430 ⁸	IRLE	PF132X	GP-33	ACD	PF2176	GP-761H	ACD	PF3170	GG-208	PUR
PERI2405B	GP-28 ⁸	IRLE	PF135	GP-33	ACD	PF2178	GP-864H	ACD	PF3170M	GG-208	PUR
PERI2405B	GP-430 ⁸	IRLE	PF1356	GP-149	UNN	PF2178	GP-864H	LUF	PF3171	GG-42	PUR
PERI260	GP-34	IRLE	PF1365	GP-91	UNN	PF2186	GP-46	ACD	PF3171M	GG-42	PUR
PERI315	GP-54	IRLE	PF141	G-200	ACD	PF2188	G-870	ACD	PF3172	GG-5	L
PF1	GP-1	ACD	PF141	G-200	UNN	PF2190	GP-171	ACD	PF3172M	GG-5	L
PF10	GP-5	ACD	PF1427	GG-6	APCO	PF2193	G-112	ACD	PF3173	GG-3728	PUR
PF1025	G-31	MNH	PF1441	GG-7	APCO	PF2194	GP-81	ACD	PF3173M	GG-3728	PUR
PF1025N	G-31	MNH	PF147	G-119	ACD	PF2195	GP-43	ACD	PF3175	GG-196	PUR
PF1026	GP-38	ACD	PF150	GP-33	ACD	PF2196	GP-77	ACD	PF3175M	GG-196	PUR
PF1027	GP-50	ACD	PF1506	G-1175 ¹⁰⁸	PUR	PF2197	GP-642	ACD	PF32	GP-171 ¹⁶	ACD
PF1028	GP-50	ACD	PF151	GP-33	ACD	PF2200	GP-36	ACD	PF328	GP-191	ACD
PF1030	GP-77	ACD	PF1535	G-1143	MNH	PF2201	GP-9	ACD	PF33	GP-66	ACD
PF1031	GP-54 ⁹⁰	ACD	PF1535N	G-1143	MNH	PF2202	GP-761H	ACD	PF3324	GG-65	PHI
PF1031A	GP-54 ⁹⁰	ACD	PF156	GP-33	ACD	PF2205	GP-3600	ACD	PF334	G-238	ACD
PF104	GP-1101	AIR	PF156X	GP-33	ACD	PF2209	GP-54	ACD	PF335	GP-58	UNN
PF104	GP-1101	FLL	PF157	GP-33	ACD	PF2211	GP-69	ACD	PF336	G-236	ACD
PF105	GP-1101	AIR	PF157	GG-16	PHI	PF222	GP-85	AIR	PF336	G-236	UNN
PF105	GP-1101	FLL	PF158	GG-17	PHI	PF222	GP-85	FLL	PF336-1	G-236	ACD
PF1051	GP-462	ACD	PF16	GP-66	ACD	PF2221	GP-128	ACD	PF338	G-331	ACD
PF1051	GP-462	UNN	PF163	GP-33	ACD	PF2227E	G-45	ACD	PF34	GP-38	ACD
PF1054	GP-3766	ACD	PF166	GP-34	ACD	PF2244G	G-49	ACD	PF340	GP-1101	PER
PF105C	GPP-14	AIR	PF167	G-296	AIR	PF2247G	G-180	ACD	PF343	GP-1101	PER
PF106	G-1174	AIR	PF167	G-296-B	AIR	PF2248G	G-954	ACD	PF344	G-330	ACD
PF106	G-1174 ¹⁰⁸	FLL	PF167	G-296	FLL	PF2249G	G-984	ACD	PF344	GPP-14	PER
PF1065	G-159	ACD	PF167	G-296-B	FLL	PF2250G	G-72	ACD	PF344	G-330	UNN
PF1066	GP-35	ACD	PF17	GP-14	ACD	PF2252G	G-975	ACD	PF345	GP-83	PER
PF1070	GP-178	ACD	PF1703	G-70	ACD	PF2254	GP-457	ACD	PF346	G-333	ACD
PF1070F	GP-178	ACD	PF1704	G-3752	ACD	PF227	G-296	PER	PF346	GP-84	PER
PF1071	GP-390	ACD	PF171	GP-84	AIR	PF227	G-296-B	PER	PF346	G-333	UNN
PF1078	GP-77	ACD	PF171	GP-84	FLL	PF227	GP-3600 ¹⁰²	UNN	PF3484	GG-581	PHI
PF108	G-1143	AIR	PF172	GP-83	AIR	PF227	GP-38 ⁹⁷	UNN	PF349	G-335	ACD
PF108	G-1143	FLL	PF172	GP-83	FLL	PF228	GP-81	UNN	PF35	GP-13	ACD
			PF185	GP-110	AIR	PF23	GP-20	ACD	PF35	GG-87	PHI

Referencia Cruzada por Numero de Parte

Cross Reference by Part Number



Numero	Gonher	Fabricante	Numero	Gonher	Fabricante	Numero	Gonher	Fabricante	Numero	Gonher	Fabricante
Number	Gonher	Manufacturer	Number	Gonher	Manufacturer	Number	Gonher	Manufacturer	Number	Gonher	Manufacturer
PF35		GP-13 UNN	PF7977		GS-1261 BLDW	PFA1047		GA-176 POFI	PFA8133		GA-163 POFI
PF351		G-6 ACD	PF8		GP-20 ACD	PFA1052		GA-391 POFI	PFA8142		GA-130 POFI
PF352		G-139 ACD	PF810		G-1176 BLDW	PFA1117		GA-217 POFI	PFA-8169		GAVW-626 POFI
PF352		GP-1108 PER	PF812		G-169 ACD	PFA12		GA-200 POFI	PFA8200		GA-292 POFI
PF353		GP-1107 PER	PF813		G-613 ACD	PFA-1232		GA-4319 POFI	PFA8205		GA-301 POFI
PF359		G-331 ACD	PF814		G-333 ACD	PFA133		GA-78 POFI	PFA8221		GA-279 POFI
PF37		GP-46 ACD	PF815		GP-26 PER	PFA1374		GA-231 POFI	PFA8243		GA-158 POFI
PF37		GP-46 UNN	PF816		G-11816 BLDW	PFA146		GA-71 POFI	PFA8602		GAVW-621 POFI
PF378		GP-212 UCAL	PF816		GP-27 PER	PFA148		GA-80 POFI	PFA8606		GA-8606 POFI
PF38		GP-10 ACD	PF816S		G-11816 BLDW	PFA-1586		GA-27161 POFI	PFA8755		GA-348 POFI
PF39		GP-44 ACD	PF820		GP-68 UNN	PFA160		GA-70 POFI	PFA905		GA-153 POFI
PF40		GP-46 ACD	PF823		G-1166 BLDW	PFA1603		GA-186 POFI	PFA9050		GA-780 POFI
PF40		GP-46 UNN	PF823E		G-1166 BLDW	PFA1654		GAD-34 POFI	PFA9053		GA-234 POFI
PF400		GP-3600 UNN	PF824		G-1166 BLDW	PFA1688		GA-168 POFI	PFA9082		GA-215 POFI
PF41		GP-3816 ACD	PF825		GP-38 UNN	PFA170		GA-73 POFI	PFA9129		GA-289 POFI
PF42		GP-1 ACD	PF827		GP-20 BLDW	PFA1732		GA-134 POFI	PFA9315		GA-2184 POFI
PF432		G-566 ACD	PF828		GP-34 ACD	PFA1780		GA-264 POFI	PFA9601		GA-280 POFI
PF432L		G-566 ACD	PF828		G-1163 BLDW	PFA184		GA-77 POFI	PFA9620		GAVW-121 POFI
PF44		GP-44 ACD	PF829		G-1166 BLDW	PFA1858		GA-291 POFI	PFA-VV5		GAVW-620 POFI
PF445		G-122 ACD	PF832		GP-23 ACD	PFA187		GA-90 POFI	PFA-VV6		GAVW-2 POFI
PF445		GP-338 ACD	PF834		G-1121 BLDW	PFA189		GA-50 POFI	PF1		GG-45 PUR
PF45		GP-3429 ACD	PF834		G-1121F BLDW	PFA192		GA-192 POFI	PF12		GP-2071W PER
PF45		GP-3429 UNN	PF839		G-5000 ACD	PFA2000		GA-278R POFI	PF12A		GP-1011Q PER
PF454		GP-408 ACD	PF847		GC-1133 ACD	PFA2465		GA-198 POFI	PF2		GG-3 PUR
PF454CL		GP-408 ACD	PF847		GG-48 BLDW	PFA2962		GAVW-624 POFI	PF155		GG-246 PUR
PF454FCL		GP-408 ACD	PF848		GS-1133 ACD	PFA2998		GAVW-623 POFI	PF156		GG-203 PUR
PF455		G-1143 PER	PF856		GP-69 ACD	PFA305		GA-730 POFI	PF157		GG-203 PUR
PF4560		GP-171 FRM	PF856L		GP-69 ACD	PFA3203		GA-21 POFI	PF157M		GG-203 PUR
PF4562		GP-14 PUR	PF857		GP-51 ACD	PFA3245		GAD-30 POFI	PF158		GG-196 PUR
PF456G		G-49 ACD	PF858		GP-1122 ACD	PFA326		GA-59 POFI	PF158M		GG-196 PUR
PF46		GP-44 ACD	PF859		GP-1122 ACD	PFA3384		GAVW-2 POFI	PF16		GP-2071W PER
PF46		GP-44 UNN	PF867		GP-24 ²⁴ ACD	PFA3399		GAVW-4 POFI	PF162		GG-203 PUR
PF47		GP-46 ACD	PF867		GP-462 ²⁴ ACD	PFA347		GA-429 POFI	PF162M		GG-203 PUR
PF47		GP-46 UNN	PF87		G-152 ACD	PFA351		GA-75 POFI	PF163		GG-208 PUR
PF48		GP-406 ACD	PF873		G-122 ACD	PFA3537		GA-54 POFI	PF163M		GG-208 PUR
PF492		G-222 ACD	PF873		G-338 ACD	PFA3559		GA-271 POFI	PF16A		GP-1011Q PUR
PF50		GP-42 ACD	PF879		GP-52 ¹¹⁰ ACD	PFA3588		GA-3588 POFI	PF18		GP-1011Q PUR
PF5018		GP-1122 AIR	PF879		GP-691 ⁴⁸ ACD	PFA3597		GA-734 POFI	PF1M		GG-45 PUR
PF5018		GP-1122 FLL	PF880		GP-10 ACD	PFA3660		GA-277 POFI	PF2		GG-76 PUR
PF5019		GP-78 AIR	PF881		GP-31 ACD	PFA3705		GA-154 POFI	PF22		GP-1011Q PER
PF5019		GP-78 FLL	PF893		GP-53 ACD	PFA3717		GA-274 POFI	PF246		GG-45 PUR
PF5021		GP-93 AIR	PF893		GG-6 BLDW	PFA381		GA-74 POFI	PF246M		GG-45 PUR
PF5021		GP-93 FLL	PF893-GR		GG-6 BLDW	PFA3818		GA-334 POFI	PF24A		GP-2071W PER
PF5037		GP-85 ⁹⁰ AIR	PF893-RV		GG-6 BLDW	PFA3880		GA-196 POFI	PF251		GG-76 PUR
PF5037		GP-85 ⁹⁰ FLL	PF894		GP-69 ACD	PFA3901		GA-3901 POFI	PF251M		GG-76 PUR
PF51		GP-3980 ACD	PF894		GG-7 BLDW	PFA3902		GA-253 POFI	PF257001		G-813 COVE
PF51		GP-3980 UNN	PF894-GR		GG-7 BLDW	PFA3914		GA-392 POFI	PF257004		GP-3600 COVE
PF52		GP-3980 ACD	PF894-RV		GG-17 BLDW	PFA3916		GA-3916 POFI	PF263		GG-185 PUR
PF52		GP-3980 CAC	PF895		GP-67 ACD	PFA3924		GA-153 POFI	PF263M		GG-185 PUR
PF53		GP-58 ACD	PF897		GP-9586 ACD	PFA3973		GA-397 POFI	PF265		GG-204 PUR
PF54		GP-58 ACD	PF898		GP-36 ACD	PFA4008		GA-219 POFI	PF265M		GG-204 PUR
PF56		GP-28 ACD	PF899		GP-53 ACD	PFA4010		GA-272 POFI	PF273		GG-226 PUR
PF56		GP-3600 ACD	PF9		GP-3985 ACD	PFA4061		GA-248 POFI	PF276		GG-251 PUR
PF561		GP-28 ⁰ UNN	PF9		GP-3985 UNN	PFA4116		GAVW-212 POFI	PF279		GG-215 PUR
PF561		GP-430 ⁰ UNN	PF902		GP-27 ACD	PFA4309		GAD-15 POFI	PF2M		GG-76 PUR
PF58		GP-3675 ACD	PF902		G-1175 BLDW	PFA4893		GA-230 POFI	PF30		GP-1013Q PUR
PF589		GS-2034 BLDW	PF902S		G-1175 BLDW	PFA5056		GA-5056 POFI	PF314		GP-2015W PUR
PF59		GP-3675 ACD	PF904		G-1176 BLDW	PFA5058		GA-273 POFI	PF3141		GG-240 PUR
PF590		GS-2033 BLDW	PF906		G-1173 BLDW	PFA5350		GA-2114 POFI	PF3141M		GG-240 PUR
PF598		2010PM-OR ⁷ BLDW	PF911		GP-53 ACD	PFA5729		GA-284 POFI	PF3144		GG-46 PUR
PF598		2010TM-OR ² BLDW	PF911D		GP-53 ACD	PFA580		GA-179 POFI	PF3144M		GG-46 PUR
PF598-10		2010TM-OR BLDW	PF911H		GP-53 ACD	PFA620		GA-49 POFI	PF3156		G-270 PUR
PF598-10		2010TM-OR HAS	PF912		GP-10 ACD	PFA6479		GA-6479 POFI	PF3161		GG-79 PUR
PF598-30		2010PM-OR BLDW	PF916		G-1174 BLDW	PFA6491		GA-129 POFI	PF3168		GG-189 PUR
PF6		GP-81 ACD	PF922		GP-390 ⁹³ ACD	PFA6545		GAVW-120 POFI	PF3177		GG-246 PUR
PF60		GP-28 ⁰ ACD	PF932		GP-23 ACD	PFA6555		GA-275 POFI	PF3178		GG-63 PUR
PF60		GP-430 ⁰ ACD	PF933		GP-66 ACD	PFA6576		GA-276 POFI	PF3178M		GG-63 PUR
PF60002		GAK-403 PERK	PF939		GP-1 ACD	PFA6619		GA-6619 ¹ POFI	PF318		GG-76 PUR
PF60011		GA-33 ¹² FENW	PF940		GP-57 ACD	PFA6619		GA-6620 ⁹ POFI	PF3182		GG-232 PUR
PF60011		GA-33 ¹² PERK	PF941		GP-34 ACD	PFA6636		GA-174 POFI	PF3182M		GG-232 PUR
PF60017		GAK-133 FENW	PF942		GC-1133 BLDW	PFA6828		GA-133 POFI	PF3185		GG-67 PUR
PF60017		GAK-16 PERK	PF943		GS-1133 BLDW	PFA6849		GAD-129 POFI	PF3187		GG-76 PUR
PF60052		GAK-20 PERK	PF947		GP-43 ACD	PFA6850		GAD-294 POFI	PF3187M		GG-76 PUR
PF61		GP-3675 ACD	PF947L		GP-359 ACD	PFA6900		GAD-117 POFI	PF3187M7		GG-76 PUR
PF63-1		G-1173 ⁰⁸ PUR	PF947L		GP-43 ACD	PFA697		GAD-1 POFI	PF3188		G-294 PUR
PF65		G-1174 ⁰⁸ PUR	PF950		G-1123 BLDW	PFA698		GAD-3 POFI	PF3190		GG-264 PUR
PF670		GP-53 ACD	PF951		G-33 ACD	PFA699		GAD-3 POFI	PF3191		GG-246 PUR
PF-7		GP-20 ACD	PF951L		G-33 ACD	PFA7006		GA-258 POFI	PF35		GG-87 PUR
PF712		GP-36 ACD	PF952		GP-22 ACD	PFA7344		GA-7344 POFI	PF35M		GG-87 PUR
PF7595		G-1120 BLDW	PF960		GP-310 ACD	PFA7414		GA-141 POFI	PF422		GP-2022W PER
PF7621		G-128 BLDW	PF960		GP-3569 ACD	PFA7421		GA-165 POFI	PF428		GP-2015W PER
PF7627		GG-111 BLDW	PF963		GP-3531 EXP ACD	PFA7432		GA-132 POFI	PF429		GP-2022W PER
PF7654		GS-1261 BLDW	PF964		GP-36 ACD	PFA7440		GA-300 POFI	PF4483		GG-246 PUR
PF7678		G-178 BLDW	PF966		GP-58 UNN	PFA7597		GA-164 POFI	PF4488		GG-214 PUR
PF7680		G-128 BLDW	PF967		GP-24 ²⁶ ACD	PFA7628		GAD-118 POFI	PF4489		GG-208 PUR
PF7698		G-862 BLDW	PF967		GP-462 ²⁴ ACD	PFA7730		GA-175 POFI	PF4492		GG-142 PUR
PF7718		G-559 BLDW	PF970		GP-3985 ACD	PFA7737		GA-128 POFI	PF4493		GG-217 PUR
PF7735		G-1046 BLDW	PF970C		GP-3985 ⁶³ ACD	PFA7738		GA-127 POFI	PF4495		GG-39 PUR
PF7744		G-128 BLDW	PF9715		GP-91 FRM	PFA7764		GA-172 POFI	PF4611		GG-61 PUR
PF7749		GS-557 BLDW	PF973		GP-46 ACD	PFA7774		GA-1616 POFI	PF4617		GG-67 PUR
PF7777		GS-1261 BLDW	PF976		GP-54 ACD	PFA7950		GA-114 POFI	PF4618		GG-65 PUR
PF7789		GS-2034 BLDW	PF980		GP-53 ACD	PFA8036		GA-413R POFI	PF4621		GG-30 PUR
PF7790		GS-2033 BLDW	PF986		G-926 ACD	PFA8038		GA-673R POFI	PF4637		GG-181 PUR
PF7812-KIT		G-1047 BLDW	PF996		G-153 ACD	PFA8039		GA-1615 POFI	PF4638		GG-190 PUR
PF7889		GS-2034 BLDW	PF998		G-339H ACD	PFA8043		GA-224 POFI	PF4658		GG-148 PUR
PF7890		GS-2033 BLDW	PF9A		GP-40 UNN	PFA8080		GAVW-622 POFI	PF4658M		GG-148 PUR

REFERENCIA CRUZADA

Para números Gonher con Superíndice vea página 651
For Gonher with Superscript numbers see page 651

Numero	Gonher	Fabricante	Numero	Gonher	Fabricante	Numero	Gonher	Fabricante	Numero	Gonher	Fabricante
Number	Gonher	Manufacturer	Number	Gonher	Manufacturer	Number	Gonher	Manufacturer	Number	Gonher	Manufacturer
PFC4662	GG-185	PUR	PGA4343	GA-5056	PROG	PH1	GP-1	ECOL	PH2167	GP-171	PRMT
PFC4662M	GG-185	PUR	PGA4347	GA-153	PROG	PH1	GP-1	MINL	PH226	GP-50	ACE
PFC4663	GG-137	PUR	PGA-4356	GA-390	PROG	PH10	GP-5	FRM	PH226	GP-50	APOL
PFC4663M	GG-137	PUR	PGA4361	GA-139	PROG	PH10060	GP-406	FRM	PH226	GP-50	BWS
PFC4665	GG-146	DEUS	PGA4372	GA-3901	PROG	PH10127	GP-112	FRM	PH226	GP-50	CAM2
PFC4665	GG-146	PUR	PGA4375	GA-362	PROG	PH11	GP-5	FRM	PH226	GP-50	CHP
PFC4673	GG-203	PUR	PGA4378	GA-174	PROG	PH11	GP-5	SAFE	PH226	GP-50	GRAN
PFC4685	GG-580	PUR	PGA4468	GA-195	PROG	PH1101FD	GP-1101	CHP	PH226	GP-50	LUF
PFC4689	GG-184	PUR	PGA4479	GA-6479	PROG	PH1111	GP-46	PRMT	PH226	GP-50	WARN
PFC4M	GG-1	PUR	PGA-4487	GA-382	PROG	PH1124	G-1173 ¹⁰⁸	MICP	PH227	GP-3600	CHP
PFC4M	GG-4	PUR	PGA45	GA-77	PROG	PH12	GP-3	ACE	PH227	GP-3682	CHP
PFC5	GG-45	PUR	PGA4613	GA-142	PROG	PH12	GP-3	APOL	PH227	GP-3600	LUF
PFC8	GP-2071W	PER	PGA4626	GA-6619 ¹	PROG	PH12	GP-3	BWS	PH227K	GP-3600	LUF
PFC8A	GP-2071W	PER	PGA4626	GA-6620 ²	PROG	PH12	GP-3	CAM2	PH227K	GP-3682	LUF
PFF105	GP-1101	PURF	PGA4632	GA-275	PROG	PH12	GP-3	CHP	PH227-K	GP-3600	CHP
PFF1101	GP-1101	PURF	PGA4645	GA-6690	PROG	PH12	GP-3	GRAN	PH227-K	GP-3682	CHP
PFF1108	GP-1108	PURF	PGA4648	GA-133	PROG	PH12	GP-3	LUF	PH228	GP-81	ACE
PFF1109	GP-78	PURF	PGA4650	GA-604	PROG	PH12	GP-3	MASE	PH228	GP-81	APOL
PFF216	GP-85	PURF	PGA4656	GA-7017	PROG	PH12	GP-3	WARN	PH228	GP-81	CHP
PFF218	GP-84	PURF	PGA4669	GAD-294	PROG	PH1218	GP-205	BWS	PH228	GP-81	ECOL
PFF219	GP-83	PURF	PGA-4680	GA-386	PROG	PH1218	GP-205	CAMP	PH228	GP-81	GRAN
PFF4604	G-1047	RAR	PGA4712	GA-217	PROG	PH1218	GP-205	CHP	PH228	GP-81	LUF
PFF5823	GP-56	PURF	PGA4731	GA-165	PROG	PH1218	GP-205	GRAN	PH228	GP-81	MASE
PFF831	PFF831	GONH	PGA4859	GA-128	PROG	PH1218	GP-205	LUF	PH228	GP-81	MINL
PFF831	PFF831	RAR	PGA50	GA-90	PROG	PH1218	GP-205	PARP	PH228	GP-81	PARP
PFF915	GP-26	PURF	PGA5048	GA-132	PROG	PH1218	GP-205	SECU	PH228	GP-81	TRUS
PFF916	GP-27	PURF	PGA52	GA-71	PROG	PH1218	GP-205	TRUS	PH228	GP-81	WARN
P-FG2313	GA-870	GLD	PGA57	GA-80	PROG	PH1218	GP-205	WARN	PH229	GP-31	CHP
PFG516K	GG-5 L	PAMO	PGA59	GA-50	PROG	PH1218B	GP-205	CHP	PH23	GP-20	FRM
PFL1A	GP-1	ACD	PGA67	GA-192	PROG	PH123	GP-3429	PRMT	PH232	GP-81 ³¹	CHP
PFL2016	G-3752	RAR	PGA68	GA-78	PROG	PH13	GP-13	FRM	PH232	GP-9 ⁹⁸	CHP
PFL400A	GP-3600	ACD	PGA7	GA-4303	PROG	PH13	GP-13	RKHL	PH232	GP-81 ³¹	PARP
PG01A	GP-1	PROG	PGA74	GA-55	PROG	PH13	GP-13	SAFE	PH232	GP-9 ⁹⁸	PARP
PG101	GG-5 L	PER	PGA831	GA-85	PROG	PH13A	GP-13	FRM	PH232	GP-81 ³¹	TRUS
PG13	GG-6	PER	PGA84	GA-730	PROG	PH13FP	GP-13	FRM	PH232	GP-9 ⁹⁸	TRUS
PG14	GG-7	PER	PGA90	GA-303	PROG	PH14	GP-3	FRM	PH24	GP-20	ACE
PG-15	GGP-25	FACE	PGA91	GA-59	PROG	PH1551	GP-66	CHP	PH24	GP-20	APOL
PG-15	GGP-25	MIGH	PGA92	GA-57	PROG	PH16	GP-81 ³¹	ACE	PH24	GP-20	BWS
PG17	GG-19	PER	PGA93	GA-325	PROG	PH16	GP-9 ⁹⁸	ACE	PH24	GP-20	CHP
PG18	GG-123	PER	PGA991	GA-86	PROG	PH16	GP-81 ³¹	APOL	PH24	GP-20	ECOL
PG227K	GP-38	CHP	PGF14731	G-500	CLRK	PH16	GP-9 ⁹⁸	APOL	PH24	GP-20	GRAN
PG25	GGP-25	FRM	PGF15898	G-33	AUSW	PH16	GP-81 ³¹	BWS	PH24	GP-20	LUF
PG25-1	GGP-25	FRM	PGF15898	G-33	CLRK	PH16	GP-9 ⁹⁸	BWS	PH24	GP-20	MASE
PG3334	GP-26	FRM	PGF19892	GA-5648	BLDW	PH16	GP-81 ³¹	CHP	PH24	GP-20	MINL
PG3334-1	GP-26	FRM	PGF19892	GA-5648	CLRK	PH16	GP-9 ⁹⁸	CHP	PH24	GP-20	PARP
PG3334-2	GP-26	FRM	PGO101	GP-22	PROG	PH16	GP-81 ³¹	ECOL	PH24	GP-20	TRUS
PG3349	GP-1101 ⁵⁴	FRM	PGO109	GP-42	PROG	PH16	GP-9 ⁹⁸	ECOL	PH24	GP-20	WARN
PG8	GG-20	PER	PGO111	GP-46	PROG	PH16	GP-81 ³¹	FRM	PH241	GP-2951	PRMT
PGA103	GAD-1 ⁹⁷	PROG	PGO119	GP-1	PROG	PH16	GP-81 ³¹	GRAN	PH25	GP-3	ACE
PGA110A	GAD-3	PROG	PGO123	GP-3429	PROG	PH16	GP-9 ⁹⁸	GRAN	PH25	GP-3	APOL
PGA113	GA-75	PROG	PGO167	GP-3531 EXP	PROG	PH16	GP-81 ³¹	LUF	PH25	GP-3	BWS
PGA1149	GAVW-2	PROG	PGO17	GP-81	PROG	PH16	GP-9 ⁹⁸	LUF	PH25	GP-3	CHP
PGA118	GAD-1 ⁸⁷	PROG	PGO173	GP-3980	PROG	PH16	GP-81 ³¹	MASE	PH25	GP-3	ECOL
PGA120	GA-74	PROG	PGO195	GP-3600	PROG	PH16	GP-9 ⁹⁸	MASE	PH25	GP-20	FRM
PGA124	GA-3300	PROG	PGO1A	GP-1	PROG	PH16	GP-81 ³¹	MINL	PH25	GP-3	GRAN
PGA124A	GA-3300	PROG	PGO2167	GP-171	PROG	PH16	GP-9 ⁹⁸	MINL	PH25	GP-3	LUF
PGA124B	GA-2719B	PROG	PGO241	GP-2951 ⁶²	PROG	PH16	GP-81 ³¹	PARP	PH25	GP-3	MASE
PGA129	GA-3424	PROG	PGO241	GP-58	PROG	PH16	GP-9 ⁹⁸	PARP	PH25	GP-3	MINL
PGA131	GA-3425	PROG	PGO252	GP-28 ⁸	PROG	PH16	GP-81 ³¹	TRUS	PH25	GP-3	PARP
PGA15	GP-92	FACE	PGO252	GP-430 ⁸	PROG	PH16	GP-9 ⁹⁸	TRUS	PH25	GP-20	RKHL
PGA15	GP-92	PHI	PGO-257	GP-3569	PROG	PH16	GP-81 ³¹	WARN	PH25	GP-20	SAFE
PGA15	GA-3490	PROG	PGO288	GP-3766	PROG	PH16	GP-9 ⁹⁸	WARN	PH25	GP-3	TRUS
PGA16	GA-2740	PROG	PGO291	GP-3531 EXP	PROG	PH-1615317-B7	G-813	FORD	PH25	GP-3	WARN
PGA1697	GA-277	PROG	PGO33	GP-20	PROG	PH16FP	GP-81	FRM	PH252	GP-28 ⁸	PRMT
PGA2318	GA-429	PROG	PGO3506	GP-44	PROG	PH17	GP-81	PRMT	PH252	GP-430 ⁸	PRMT
PGA231B	GA-429	PROG	PGO373	GP-3682	PROG	PH19	GP-1	FRM	PH253	GP-81	CHP
PGA24	GAD-3	PROG	PGO40	GP-13	PROG	PH190	GP-81	CHP	PH253	GP-81 ³¹	LUF
PGA2923	GA-3501	PROG	PGO4007	GP-44	PROG	PH190	GP-81	MASE	PH253	GP-9 ⁹⁸	LUF
PGA3	GA-75	PROG	PGO4011	GP-3980	PROG	PH193	GP-40	PRMT	PH253	GP-81	PARP
PGA-3080	GA-3445	PROG	PGO4457	GP-3682	PROG	PH195	GP-3600	PRMT	PH253	GP-81	TRUS
PGA3138	GA-345	PROG	PGO4459	GP-91	PROG	PH1960	G-152	TFIL	PH253	GP-81	WARN
PGA3149	GA-3523	PROG	PGO4466	GP-28 ⁸	PROG	PH19A	GP-1	FRM	PH257	GP-310	PRMT
PGA3192	GA-271	PROG	PGO4466	GP-430 ⁸	PROG	PH1A	GP-1	CHP	PH257	GP-3569	PRMT
PGA3193	GA-735	PROG	PGO4476	GP-157	PROG	PH1A	GP-1	GRAN	PH2571	GP-149	FRM
PGA3195	GA-3588	PROG	PGO-4484	GP-212	PROG	PH1A	GP-1	PARP	PH258	GP-3	CHP
PGA3357	GA-3637	PROG	PGO4619	GP-3985	PROG	PH1A	GP-1	PRMT	PH2671	GP-91	FRM
PGA3380	GA-3647	PROG	PGO4620	GP-149	PROG	PH1A	GP-1	TRUS	PH2700	GP-462	CHP
PGA-3382	GA-390	PROG	PGO4622	GP-91	PROG	PH1A	GP-1	WARN	PH2700	GP-462	LUF
PGA3384	GA-89	PROG	PGO4631	GP-205	PROG	PH2	GP-68	FRM	PH2700	GP-462	PARP
PGA-3398	GA-3566	PROG	PGO4651	GP-68	PROG	PH2	GP-68	RKHL	PH2700	GP-462	SECU
PGA3465	GA-277	PROG	PGO49	GP-3	PROG	PH20	GP-14	CHP	PH2700	GP-462	TRUS
PGA3466	GA-4828	PROG	PGO5	GP-5	PROG	PH20	GP-14	FRM	PH2700	GP-462	WARN
PGA3467	GA-4325	PROG	PGO73	GP-24 ²⁶	PROG	PH2005	GP-128	CHP	PH2701	GP-171	BWS
PGA3472	GA-274	PROG	PGO73	GP-462 ²⁴	PROG	PH2005	GP-128	LUF	PH2701	GP-171	CAM2
PGA3474	GA-3681	PROG	PGO81	GP-81 ³¹	PROG	PH2005	GP-128	PARP	PH2701	GP-171	CENE
PGA-3538	GA-140	PROG	PGO81	GP-9 ⁹⁸	PROG	PH2005	GP-128	TRUS	PH2701	GP-171	CHP
PGA3590	GA-3916	PROG	PGO84	GP-23	PROG	PH2005	GP-128	WARN	PH2701	GP-171	GRAN
PGA3591	GA-3814	PROG	PGO951	GP-58	PROG	PH2008	GP-455	CHP	PH2701	GP-171	LUF
PGA3592	GA-273	PROG	PGP16	GGP-25	PHI	PH2008	GP-457	CIGO	PH2701	GP-171	SECU
PGA4	GA-70	PROG	PGP17	GP-92	PHI	PH2008	GP-457	LUF	PH2701	GP-171	WARN
PGA4278	GAD-15	PROG	PGP8A	GP-1	PURF	PH2008	GP-457	PARM	PH2702	GP-212	CAMP
PGA4299	GA-180	PROG	PH 102.57 D	GA-2184	OTUR	PH2008	GP-457	WARN	PH2702	GP-212	LUF
PGA4326	GA-78	PROG	PH 140.165	GA-2160	OTUR	PH2009	GP-457	CHAM	PH2702	GP-212	PARP
PGA-4327	GA-4958	PROG	PH 2803-2	GP-1	FRM	PH2009	GP-457	CHP	PH2702	GP-212	WARN
PGA4339	GA-3915	PROG	PH1	GP-1	ACE	PH2009	GP-457	LUF	PH28	GP-3600	CHP
PGA4342	GA-253	PROG	PH1	GP-1	CHP	PH20A	GP-14	FRM	PH28	GP-3600	FRM

Referencia Cruzada por Numero de Parte

Cross Reference by Part Number



Numero	Gonher	Fabricante	Numero	Gonher	Fabricante	Numero	Gonher	Fabricante	Numero	Gonher	Fabricante
Number	Gonher	Manufacturer	Number	Gonher	Manufacturer	Number	Gonher	Manufacturer	Number	Gonher	Manufacturer
PH28	GP-3600	LUF	PH2816	GP-3816	GRAN	PH2832	GP-81 ³¹	LUF	PH2859	GP-2951	WARN
PH2801	GP-3985	CAM2	PH2816	GP-3816	LUF	PH2832	GP-9 ⁵⁸	LUF	PH2861	GP-28 ⁶	APOL
PH2801	GP-3985	CHP	PH2816	GP-3816	MASE	PH2832	GP-81 ³¹	PARP	PH2861	GP-430 ⁸	APOL
PH2801	GP-54 ¹¹	FRM	PH2816	GP-3816	PARP	PH2832	GP-9 ⁵⁸	PARP	PH2861	GP-28 ⁶	BWS
PH2801	GP-66 ¹⁰	FRM	PH2816	GP-3816	SECU	PH2832	GP-81 ³¹	TRUS	PH2861	GP-430 ⁸	BWS
PH2801	GP-3985	LUF	PH2816	GP-3816	TRUS	PH2832	GP-9 ⁵⁸	TRUS	PH2861	GP-28 ⁶	CAM2
PH2801	GP-3985	PARP	PH2816	GP-3816	WARN	PH2833	GP-171	FRM	PH2861	GP-430 ⁸	CAM2
PH2801	GP-3985	TRUS	PH2816S	GP-28 ⁶	FRM	PH2833	GP-68	LUF	PH2861	GP-28 ⁶	CHP
PH2801	GP-3985	WARN	PH2816S	GP-430 ⁸	FRM	PH2835	GP-58	APOL	PH2861	GP-430 ⁸	CHP
PH2801A	GP-54 ¹¹	FRM	PH2817	GP-3531 EXP	APOL	PH2835	GP-58	CHP	PH2861	GP-28 ⁶	GRAN
PH2801A	GP-66 ¹⁰	FRM	PH2817	GP-3531 EXP	BWS	PH2835	GP-58	GRAN	PH2861	GP-430 ⁸	GRAN
PH2801B	GP-54 ¹¹	FRM	PH2817	GP-3531 EXP	CHP	PH2835	GP-58	LUF	PH2861	GP-28 ⁶	LUF
PH2801B	GP-66 ¹⁰	FRM	PH2817	GP-3531 EXP	ECOL	PH2835	GP-58	MASE	PH2861	GP-430 ⁸	LUF
PH2802	GP-91	APOL	PH2817	GP-3531 EXP	GRAN	PH2835	GP-58	PARP	PH2861	GP-28 ⁶	MASE
PH2802	GP-91	CHP	PH2817	GP-3531 EXP	LUF	PH2835	GP-58	TRUS	PH2861	GP-430 ⁸	MASE
PH2802	GP-91	LUF	PH2817	GP-3531 EXP	MASE	PH2835	GP-58	WARN	PH2861	GP-28 ⁶	PARP
PH2803	GP-171 ¹⁶	FRM	PH2817	GP-3531 EXP	MINL	PH2836	GP-10	FRM	PH2861	GP-430 ⁸	PARP
PH2804	GP-171 ¹⁶	FRM	PH2817	GP-3531 EXP	PARP	PH2840	GP-157	BWS	PH2861	GP-28 ⁶	TRUS
PH2805	GP-462 ⁶⁶	CHP	PH2817	GP-3531 EXP	TRUS	PH2840	GP-157	CHP	PH2861	GP-430 ⁸	TRUS
PH2805	GP-91 ⁷⁸	CHP	PH2817	GP-3531 EXP	WARN	PH2840	GP-171 ¹⁶	FRM	PH2861	GP-28 ⁶	WARN
PH2805	GP-462 ⁶⁶	LUF	PH2818	GP-36	BWS	PH2840	GP-157	GRAN	PH2861	GP-430 ⁸	WARN
PH2805	GP-91 ⁷⁸	LUF	PH2818	GP-36	CAM2	PH2840	GP-157	LUF	PH2862	GP-36	LUF
PH2805	GP-462 ⁶⁶	PARP	PH2818	GP-36	CHP	PH2840	GP-157	PARP	PH2862	GP-36	WARN
PH2805	GP-91 ⁷⁸	PARP	PH2818	GP-36	GRAN	PH2840	GP-157	SECU	PH2863	GP-3985	CHP
PH2805	GP-462	TRUS	PH2818	GP-36	LUF	PH2840	GP-157	TRUS	PH2863	GP-3985	MINL
PH2805	GP-462 ⁶⁶	WARN	PH2818	GP-36	SECU	PH2840	GP-157	WARN	PH2863B	GP-3985	APOL
PH2805	GP-91 ⁷⁸	WARN	PH2819	GP-36	APOL	PH2840-1	GP-171 ¹⁶	FRM	PH2863B	GP-3985	BWS
PH2807	GP-81 ³¹	FRM	PH2819	GP-36	BWS	PH2841	GP-156	BWS	PH2863B	GP-3985	CAM2
PH2807	GP-9 ⁵⁸	FRM	PH2819	GP-36	CHP	PH2841	GP-156	CHP	PH2863B	GP-3985	CHP
PH28071	GP-81	FRM	PH2819	GP-36	GRAN	PH2841	GP-156	GRAN	PH2863B	GP-3985	CIGO
PH2808	GP-149 ⁶⁹	CHP	PH2819	GP-36	LUF	PH2841	GP-156	LUF	PH2863B	GP-3985	GRAN
PH2808	GP-91 ⁷⁸	CHP	PH2819	GP-36	MASE	PH2841	GP-156	MASE	PH2863B	GP-3985	LUF
PH2808	GP-149 ⁶⁹	LUF	PH2819	GP-36	MIGH	PH2841	GP-157	PARP	PH2863B	GP-3985	MIGH
PH2808	GP-91 ⁷⁸	LUF	PH2819	GP-36	SECU	PH2841	GP-156	TRUS	PH2863B	GP-3985	SECU
PH2808	GP-91	PARP	PH2819	GP-36	WARN	PH2841	GP-156	WARN	PH2863B	GP-3985	WARN
PH2808	GP-149 ⁶⁹	SECU	PH2820	GP-81	ECOL	PH2842	GP-54	FRM	PH2865	GP-42	APOL
PH2808	GP-91	SECU	PH2820	GP-81 ³¹	LUF	PH2844	GP-81	FRM	PH2865	GP-42	BWS
PH2808	GP-91	TRUS	PH2820	GP-9 ⁵⁸	LUF	PH2844	GP-3816	FRM	PH2865	GP-42	CAM2
PH2809	GP-40	APOL	PH2820A	GP-81 ³¹	LUF	PH2846	GP-46	CHP	PH2865	GP-42	CHP
PH2809	GP-40	CAM2	PH2820A	GP-9 ⁵⁸	LUF	PH2846	GP-46	FRM	PH2865	GP-42	ECOL
PH2809	GP-40	CHP	PH2820A	GP-81 ³¹	TRUS	PH2846	GP-46	LUF	PH2865	GP-42	FRM
PH2809	GP-58	FRM	PH2820A	GP-9 ⁵⁸	TRUS	PH2846A	GP-46	FRM	PH2865	GP-42	GRAN
PH2809	GP-40	GRAN	PH2821	GP-58	APOL	PH2846B	GP-46	FRM	PH2865	GP-42	LUF
PH2809	GP-40	LUF	PH2821	GP-58	CAM2	PH2849	GP-24 ²⁶	ACE	PH2865	GP-42	MASE
PH2809	GP-40	MASE	PH2821	GP-58	CHP	PH2849	GP-462 ²⁴	ACE	PH2865	GP-42	MIGH
PH2809	GP-40	PARP	PH2821	GP-58	LUF	PH2849	GP-24 ²⁶	APOL	PH2865	GP-42	MINL
PH2809	GP-40	SECU	PH2821	GP-58	MINL	PH2849	GP-462 ²⁴	APOL	PH2865	GP-42	SECU
PH2809	GP-40	TRUS	PH2821	GP-58	TRUS	PH2849	GP-24 ²⁶	CHP	PH2865	GP-42	TRUS
PH2809	GP-40	WARN	PH2821A	GP-58	APOL	PH2849	GP-462 ²⁴	CHP	PH2865	GP-42	WARN
PH2810	GP-3985	APOL	PH2821A	GP-1	FRM	PH2849	GP-24 ²⁶	FRM	PH2865A	GP-40	CHP
PH2810	GP-3985	CHP	PH2821A	GP-3816	LUF	PH2849	GP-462 ²⁴	FRM	PH2865A	GP-42	FRM
PH2811	GP-171	FRM	PH2821A	GP-58	PARP	PH2849	GP-24 ²⁶	LUF	PH2867	GP-149	CHP
PH2812	GP-22	CHP	PH2821A	GP-58	PRMT	PH2849	GP-462 ²⁴	LUF	PH2867	GP-149	LUF
PH2812	GP-22	ECOL	PH2821-A	GP-58	CHP	PH2849	GP-24 ²⁶	MASE	PH2867	GP-149	PARP
PH2812A	GP-22	APOL	PH2822	GP-38	APOL	PH2849	GP-462 ²⁴	MASE	PH2867	GP-149	TRUS
PH2812A	GP-22	BWS	PH2822	GP-38	CAM2	PH2849	GP-24 ²⁶	MINL	PH2867	GP-149	WARN
PH2812A	GP-22	CAM2	PH2822	GP-38	CHP	PH2849	GP-462 ²⁴	MINL	PH2868	GP-91	CHP
PH2812A	GP-22	CHP	PH2822	GP-38	GRAN	PH2849	GP-24 ²⁶	PARP	PH2868	GP-91	LUF
PH2812A	GP-22	GRAN	PH2822	GP-38	LUF	PH2849	GP-462 ²⁴	PARP	PH2868	GP-91	PARP
PH2812A	GP-22	LUF	PH2822	GP-38	SECU	PH2849	GP-24 ²⁶	PRMT	PH2868	GP-91	TRUS
PH2812A	GP-22	MASE	PH2822	GP-38	WARN	PH2849	GP-462 ²⁴	PRMT	PH2868	GP-91	WARN
PH2812A	GP-22	MIGH	PH2823	GP-156	BWS	PH2849	GP-462	TRUS	PH2869	GP-91	LUF
PH2812A	GP-22	SECU	PH2823	GP-156	CAM2	PH2849	GP-24 ²⁶	WARN	PH2869	GP-91	PARP
PH2812A	GP-22	WARN	PH2823	GP-156	CHP	PH2849	GP-462 ²⁴	WARN	PH2870	GP-28 ⁶	FRM
PH2814	GP-22	APOL	PH2823	GP-156	LUF	PH2849A	GP-24 ²⁶	FRM	PH2870	GP-430 ⁸	FRM
PH2814	GP-22	CAM2	PH2823	GP-156	WARN	PH2850	GP-310	APOL	PH2870A	GP-28 ⁶	FRM
PH2814	GP-22	CHP	PH2825	GP-38	BWS	PH2850	GP-1	CHP	PH2870A	GP-28 ⁶	RKHL
PH2814	GP-22	GRAN	PH2825	GP-38	CHP	PH2850	GP-1	FRM	PH2870A	GP-430 ⁸	RKHL
PH2814	GP-22	LUF	PH2825	GP-38	ECOL	PH2850	GP-1	LUF	PH2870B	GP-28 ⁶	FRM
PH2814	GP-22	MASE	PH2825	GP-38	FRM	PH2850	GP-310	MINL	PH2870B	GP-430 ⁸	FRM
PH2814	GP-22	MIGH	PH2825	GP-38	LUF	PH2850	GP-1	TRUS	PH2871	GP-462	FRM
PH2814	GP-22	MINL	PH2825	GP-38	MIGH	PH2854	GP-58	FRM	PH2871	GP-3985	CHP
PH2814	GP-22	SECU	PH2825	GP-38	MINL	PH2855	GP-81	FRM	PH2872	GP-3600	FRM
PH2814	GP-22	WARN	PH2825	GP-38	PARP	PH2855A	GP-81	FRM	PH2872	GP-3985	MINL
PH2815	GP-310	APOL	PH2825	GP-38	TRUS	PH2856	GP-3985	CHP	PH2872	GP-3985	WARN
PH2815	GP-310	BWS	PH2825	GP-38	WARN	PH2856	GP-40	ECOL	PH2872A	GP-3985 ⁵³	APOL
PH2815	GP-310	CAM2	PH2827	GP-3682	BWS	PH2856	GP-3985	FRM	PH2872A	GP-3985 ⁵³	CAM2
PH2815	GP-3569	CAMP	PH2827	GP-3682	CHP	PH2856	GP-3985	LUF	PH2872A	GP-3985	CHP
PH2815	GP-310	CHP	PH2827	GP-3682	ECOL	PH2856A	GP-40	CHP	PH2872A	GP-3985	ECOL
PH2815	GP-310	GRAN	PH2827	GP-3682	GRAN	PH2856A	GP-40	GRAN	PH2872A	GP-3985	LUF
PH2815	GP-3569	GRAN	PH2827	GP-3682	LUF	PH2856A	GP-40	LUF	PH2872A	GP-3985 ⁵³	SECU
PH2815	GP-310	LUF	PH2827	GP-3682	PARP	PH2856A	GP-40	MASE	PH2872A	GP-128	TRUS
PH2815	GP-3569	LUF	PH2827	GP-3682	TRUS	PH2856A	GP-3985	MIGH	PH2874	GP-46	BWS
PH2815	GP-310	MASE	PH2827	GP-3682	WARN	PH2856A	GP-40	MINL	PH2874	GP-46	CAM2
PH2815	GP-310	MINL	PH2829	GP-54	FRM	PH2856A	GP-40	PARP	PH2874	GP-46	CHP
PH2815	GP-3569	MINL	PH2830	GP-171	APOL	PH2856A	GP-40	TRUS	PH2874	GP-22	FRM
PH2815	GP-310	PARP	PH2830	GP-171	BWS	PH2856A	GP-40	WARN	PH2874	GP-46	GRAN
PH2815	GP-3569	PARP	PH2830	GP-171	CAM2	PH2858	GP-2951	CHP	PH2874	GP-46	LUF
PH2815	GP-310	TRUS	PH2830	GP-171	CHP	PH2858	GP-58	CHP	PH2874	GP-46	MIGH
PH2815	GP-3569	TRUS	PH2830	GP-3766	FRM	PH2858	GP-2951	LUF	PH2874	GP-46	WARN
PH2815	GP-310	WARN	PH2830	GP-171	LUF	PH2858	GP-2951	PARP	PH2874A	GP-58 ¹⁵	FRM
PH2815	GP-3569	WARN	PH2830	GP-171	PARP	PH2858	GP-2951	TRUS	PH2875	GP-58	FRM
PH-2815	GP-3569	MASE	PH2830	GP-171	TRUS	PH2858	GP-2951	WARN	PH2876	GP-91	BWS
PH2816	GP-3816	CAM2	PH2830	GP-171	WARN	PH2859	GP-2951	CHP	PH2876	GP-91	CHP
PH2816	GP-3816	CHP	PH2832	GP-81 ³¹	CHP	PH2859	GP-58	CHP	PH2876	GP-91	GRAN
PH2816	GP-3816	CIGO	PH2832	GP-9 ⁵⁸	CHP	PH2859	GP-2951	LUF	PH2876	GP-91	LUF

REFERENCIA CRUZADA

Para números Gonher con Superíndice vea página 651
For Gonher with Superscript numbers see page 651

Visite nuestro sitio en internet www.grupogonher.com
Visit our web site www.grupogonher.com

Numero	Gonher	Fabricante	Numero	Gonher	Fabricante	Numero	Gonher	Fabricante	Numero	Gonher	Fabricante
Number	Gonher	Manufacturer	Number	Gonher	Manufacturer	Number	Gonher	Manufacturer	Number	Gonher	Manufacturer
PH2876	GP-91	PARP	PH33	GP-20	PRMT	PH3786FP	GP-562	FRM	PH454	GP-408	CAMP
PH2876	GP-91	TRUS	PH3306	GP-10 ⁶⁷	FRM	PH3791	GP-14	FRM	PH454	GP-408	CHP
PH2876	GP-91	WARN	PH3306A	GP-10 ⁶⁷	FRM	PH38	GP-10	FRM	PH454	GP-408	LUF
PH2877	GP-36	FRM	PH3306A	GP-66	FRM	PH3804	GP-149	FRM	PH454	GP-408	PARP
PH2879	GP-81 ³¹	FRM	PH3335	GP-52 ¹¹⁰	FRM	PH3807A	GP-462	FRM	PH454	GP-408	WARN
PH2879	GP-9 ⁵⁸	FRM	PH3335	GP-691 ⁴⁸	FRM	PH3871	GP-88	CHP	PH4547	GP-40	FRM
PH288	GP-3766	PRMT	PH3335FP	GP-52 ¹¹⁰	FRM	PH39	GP-44	CHP	PH4550	GP-66 ⁹⁰	FRM
PH2880	GP-54	FRM	PH3335FP	GP-691 ⁴⁸	FRM	PH39	GP-69	FRM	PH4551	GP-66	FRM
PH2881	GP-171 ¹⁶	FRM	PH3353	GP-44	FRM	PH3900	GP-390	FRM	PH4553A	GP-68	FRM
PH2883	GP-88	FRM	PH3354	GP-46	FRM	PH3917	GP-462	FRM	PH4558	GP-24	FRM
PH2886	GP-38	FRM	PH3375	GP-53	FRM	PH3946	GP-3985	FRM	PH4560	GP-171	FRM
PH2887	GP-10	FRM	PH3381	GP-1	FRM	PH3950	GP-40	FRM	PH46	GP-44	CHP
PH289	GP-3985	MINL	PH3387	GP-46	FRM	PH3963	GP-171	FRM	PH46	GP-3816	FRM
PH2891	GP-28 ⁸	CAM2	PH3387	GP-46	SAFE	PH3976	GP-178	FRM	PH4610	GP-149	PRMT
PH2891	GP-430 ⁸	CAM2	PH3387A	GP-46	FRM	PH3976A	GP-178	FRM	PH4612	GP-91	PRMT
PH2891	GP-28 ⁸⁴	CHP	PH3387AFP	GP-46	FRM	PH3976FP	GP-178	FRM	PH4619	GP-3985	PRMT
PH2891	GP-3600 ⁵⁹	CHP	PH33PLOE	G-33	FRM	PH3980	GP-3980	FRM	PH4622	GP-91	MINL
PH2891	GP-430 ⁸⁵	CHP	PH3403	GP-54 ¹²¹	FRM	PH3980	GP-3980	RKHL	PH4622	GP-91	PRMT
PH2891	GP-28 ⁸	GRAN	PH3403	GP-66	FRM	PH3980FP	GP-3980	FRM	PH4631	GP-205	PRMT
PH2891	GP-430 ⁸	GRAN	PH3416	GP-88	FRM	PH3985	GP-3985	FRM	PH4651	GP-68	MINL
PH2891	GP-28 ⁸	LUF	PH3416A	GP-88	FRM	PH3985	GP-3985	RKHL	PH4651	GP-68	PRMT
PH2891	GP-430 ⁸	LUF	PH3429	GP-3429	FRM	PH39FP	GP-69	FRM	PH4670	GP-81	PRMT
PH2891	GP-28 ⁸	WARN	PH3429	GP-3429	RKHL	PH40	GP-46	CHP	PH4690	GP-54	ROMA
PH2891	GP-430 ⁸	WARN	PH3429A	GP-3429	FRM	PH40	GP-69	FRM	PH47	GP-46	APOL
PH2892	GP-452	CHAM	PH3432	GP-44	FRM	PH40	GP-13	PRMT	PH47	GP-46	BWS
PH2892	GP-452	DEUS	PH3442	GP-53	FRM	PH400	GP-3600	ACE	PH47	GP-46	CHP
PH2892	GP-452	GRAN	PH346	G-162H	TFIL	PH400	GP-3600	APOL	PH47	GP-46	ECOL
PH2892	GP-452	LUF	PH35	GP-22	FRM	PH400	GP-3600	BWS	PH47	GP-34	FRM
PH2892	GP-452	MIGH	PH3506	GP-44	FRM	PH400	GP-3600	CHP	PH47	GP-46	GRAN
PH2895	GP-3600	FRM	PH3508	GP-310	FRM	PH400	GP-3600	ECOL	PH47	GP-46	LUF
PH2899	GP-81 ³¹	FRM	PH3512	GP-22	FRM	PH400	GP-3600	GRAN	PH47	GP-46	MASE
PH2899	GP-9 ⁵⁸	FRM	PH3516	GP-462 ⁹⁴	FRM	PH400	GP-3600	LUF	PH47	GP-46	MINL
PH28A	GP-3600	FRM	PH3516	GP-91 ¹²⁶	FRM	PH400	GP-3600	MASE	PH47	GP-46	PARP
PH29	GP-13	ACE	PH3519	GP-9586	FRM	PH400	GP-3600	MINL	PH47	GP-46	TRUS
PH29	GP-13	APOL	PH3519A	GP-9586	FRM	PH400	GP-3600	PARP	PH47	GP-46	WARN
PH29	GP-13	BWS	PH3531	GP-3531 EXP	FRM	PH400	GP-3600	TRUS	PH4701	GP-46	FRM
PH29	GP-13	CHP	PH3531	GP-3531 EXP	RKHL	PH400	GP-3600	WARN	PH4703	GP-40	FRM
PH29	GP-13	ECOL	PH3531A	GP-3531 EXP	FRM	PH4005	GP-52 ¹¹⁰	CHP	PH4703A	GP-3985	FRM
PH29	GP-13	GRAN	PH3535	GP-48	FRM	PH4005	GP-691 ⁴⁸	CHP	PH4722	GP-46	FRM
PH29	GP-13	LUF	PH3535	GP-3980	RKHL	PH4006	GP-44	PRMT	PH4722A	GP-46	FRM
PH29	GP-13	MASE	PH3545FP	GP-52 ¹¹⁰	FRM	PH4007	GP-44	PRMT	PH4733	GP-3682	FRM
PH29	GP-13	MINL	PH3545FP	GP-691 ⁴⁸	FRM	PH4011	GP-3980	PRMT	PH4743	GP-1	FRM
PH29	GP-13	PARP	PH3551	GP-36	FRM	PH42	GP-54	FRM	PH4751	GP-455	FRM
PH29	GP-13	TRUS	PH3562	GP-40	FRM	PH42A	GP-10 ⁶⁷	FRM	PH48	GP-406	CHAM
PH29	GP-13	WARN	PH3567	GP-34	FRM	PH42A	GP-54	FRM	PH48	GP-406	CHP
PH2901	GP-31	CHP	PH3568	GP-58	FRM	PH43	GP-9 ⁵⁸	FRM	PH48	GP-81 ³¹	FRM
PH2903	GP-40	LUF	PH3569	GP-3569	FRM	PH43	GP-81 ³¹	RKHL	PH48	GP-9 ⁵⁸	FRM
PH2903	GP-40	MIGH	PH-3569	GP-3569	SECU	PH43	GP-9 ⁵⁸	RKHL	PH48	GP-406	FSN
PH2903	GP-40	PARP	PH3589	GP-9	FRM	PH43	GP-81 ³¹	RPRO	PH48	GP-406	LUF
PH2903	GP-40	TRUS	PH3592	GP-24	FRM	PH43	GP-9 ⁵⁸	RPRO	PH4824	GP-81	FRM
PH291	GP-3531 EXP	PRMT	PH3593	GP-149 ⁷⁴	FRM	PH43	GP-81 ³¹	SAFE	PH4853	GP-3985	FRM
PH2924	GP-54 ¹¹	FRM	PH3593	GP-91 ⁷⁸	FRM	PH43	GP-9 ⁵⁸	SAFE	PH4872	GP-562	PRMT
PH2924	GP-66 ¹⁰	FRM	PH3593AFP	GP-149	FRM	PH4386	GP-156	FRM	PH4883	GP-28 ⁶	FRM
PH2926	GP-3600	FRM	PH36	GP-36	FRM	PH43FP	GP-81 ³¹	FRM	PH4883	GP-430 ⁸	FRM
PH-2928	GP-455	FRM	PH3600	GP-3600	FRM	PH43FP	GP-9 ⁵⁸	FRM	PH49	GP-51	FRM
PH2931	GP-36	FRM	PH3600	GP-3600	RKHL	PH44	GP-44	APOL	PH49	GP-3	PRMT
PH2934	GP-3980	FRM	PH3600	GP-3600	RPRO	PH44	GP-44	BWS	PH4913	GP-462	FRM
PH2941	GP-81	FRM	PH3600A	GP-3600	RKHL	PH44	GP-44	CAM2	PH4952	GP-455	FRM
PH2950	GP-38	FRM	PH3600FP	GP-3600	FRM	PH44	GP-44	CHP	PH4967	GP-157	FRM
PH2951	GP-2951 ⁶²	FRM	PH3612	GP-43 ³⁰	FRM	PH44	GP-44	ECOL	PH4967	GP-157	RPRO
PH2951A	GP-2951 ⁶²	FRM	PH3612	GP-53 ⁴⁶	FRM	PH44	GP-44	GRAN	PH4998	GP-91	FRM
PH2951A	GP-58	FRM	PH3612FP	GP-43 ³⁰	FRM	PH44	GP-44	LUF	PH49A	GP-51	FRM
PH2954	GP-58	FRM	PH3612FP	GP-53 ⁴⁶	FRM	PH44	GP-44	PARP	PH49AFP	GP-51	FRM
PH2957	GP-28	FRM	PH3614	GP-58	FRM	PH44	GP-44	TRUS	PH5	GP-5	CHP
PH2960	GP-77	FRM	PH3614FP	GP-58	FRM	PH44	GP-44	WARN	PH5	GP-205	FRM
PH2964	GP-3816	FRM	PH3616	GP-68	FRM	PH4403	GP-1	BWS	PH51	GP-3980	APOL
PH2975	GP-68	FRM	PH3639	GP-38	FRM	PH4403	GP-1	CHP	PH51	GP-3980	CHP
PH2977A	GP-3985	FRM	PH3651A	GP-171	FRM	PH4403	GP-1	LUF	PH51	GP-3980	ECOL
PH2977B	GP-3985	FRM	PH3651A	GP-171	RPRO	PH4408	GP-3600	CHP	PH51	GP-3980	LUF
PH2978	GP-171	FRM	PH3656	GP-58 ¹⁵	LUF	PH4408	GP-3600	LUF	PH51	GP-3980	MINL
PH2985	GP-3682	FRM	PH3664	GP-3985	FRM	PH4457	GP-3682	PRMT	PH51	GP-3980	TRUS
PH299	GP-31	APOL	PH3675	GP-3675	FRM	PH4458	GP-462	ECOL	PH51	GP-3980	WARN
PH299	GP-31	CHP	PH3675	GP-44	MINL	PH4458	GP-462	MINL	PH5100	GP-9	FRM
PH299	GP-31	LUF	PH3682	GP-3682 ⁵³	FRM	PH4458	GP-462	PRMT	PH5102	GP-9	FRM
PH299	GP-31	WARN	PH3682	GP-3682	MINL	PH4459	GP-91	CHP	PH5114	GP-40	FRM
PH2991	GP-28 ⁸	FRM	PH3682	GP-3682	RKHL	PH4459	GP-91	MINL	PH5166	GP-156	FRM
PH2991	GP-430 ⁸	FRM	PH3682	GP-3682	RPRO	PH4459	GP-91	PRMT	PH5195	GP-462	FRM
PH2992	GP-455	CHP	PH3690	GP-43	FRM	PH4466	GP-28 ⁸	PRMT	PH5197	GP-291	FRM
PH2992	GP-455	CIGO	PH36A	GP-36	FRM	PH4466	GP-430 ⁸	PRMT	PH51A	GP-3980	BWS
PH2992	GP-40	FRM	PH37	GP-46	ACE	PH4477	GP-156	ECOL	PH51A	GP-3980	CHP
PH2992	GP-455	LUF	PH37	GP-46	CHP	PH4477	GP-156	MINL	PH51A	GP-3980	ECOL
PH2992A	GP-40	FRM	PH37	GP-14	FRM	PH4477	GP-156	PRMT	PH51A	GP-3980	GRAN
PH2995	GP-36	FRM	PH37	GP-46	LUF	PH4484	GP-212	PRMT	PH51A	GP-3980	LUF
PH2996A	GP-1	FRM	PH37	GP-46	WARN	PH45	GP-3429	APOL	PH51A	GP-3980	MASE
PH29A	GP-205	MINL	PH373	GP-23	FRM	PH45	GP-3429	BWS	PH51A	GP-3980	PARP
PH2FP	GP-3682	FRM	PH373	GP-3682	PRMT	PH45	GP-3429	CHP	PH51A	GP-3980	TRUS
PH2M	GP-1	REF	PH3735	GP-54 ¹¹	FRM	PH45	GP-3429	ECOL	PH51A	GP-3980	WARN
PH3	GP-1	FRM	PH3735	GP-66 ¹⁰	FRM	PH45	GP-3429	GRAN	PH52	GP-390 ⁹³	BWS
PH30	GP-20	CHP	PH3746	GP-67	CHP	PH45	GP-3429	LUF	PH52	GP-390 ⁹³	CHP
PH30	GP-3	FRM	PH3757	GP-43	FRM	PH45	GP-3429	MASE	PH52	GP-390 ⁹³	FRM
PH30	GP-3	RKHL	PH3766	GP-3766	FRM	PH45	GP-3429	MINL	PH52	GP-390 ⁹³	LUF
PH30	GP-3	SAFE	PH3766FP	GP-3766	FRM	PH45	GP-3429	PARP	PH52	GP-3980	MINL
PH30FP	GP-3	FRM	PH3773	GP-35	FRM	PH45	GP-3429	TRUS	PH5215	GP-88	FRM
PH31	GP-5	CHP	PH3776	GP-54 ¹¹	FRM	PH45	GP-3429	WARN	PH5230	GP-128	PRMT
PH3191	GP-51	CHP	PH3776	GP-66 ¹⁰	FRM	PH4510	GP-68	FRM	PH5250	GP-112	PRMT
PH32	GP-1	FRM	PH3786	GP-562	FRM	PH4511	GP-406	FRM	PH5274	GP-765	PRMT

Referencia Cruzada por Numero de Parte

Cross Reference by Part Number



Numero	Gonher	Fabricante	Numero	Gonher	Fabricante	Numero	Gonher	Fabricante	Numero	Gonher	Fabricante
Number	Gonher	Manufacturer	Number	Gonher	Manufacturer	Number	Gonher	Manufacturer	Number	Gonher	Manufacturer
PH5288	GP-3675	PRMT	PH7015	GP-91	LUF	PH922	GP-3675	LUF	PL14619	GP-3985	PUR
PH5309	G-45	PRMT	PH7015	GP-91	WARN	PH922	GP-44	PARP	PL14620	GP-149	PUR
PH5313	GP-408	PRMT	PH7017	GP-58	CHP	PH922	GP-44	TRUS	PL14622	GP-91	PUR
PH5317	GP-149	FRM	PH7017	GP-58	LUF	PH922	GP-3675	WARN	PL14670	GP-81	PUR
PH5335	GP-178	PRMT	PH7017	GP-58	WARN	PH922A1	GP-81	FRM	PL148	G-5000	COP
PH5394	GP-51	FRM	PH7028	GP-91	CHP	PH927	GP-58	FRM	PL15309	G-45	PUR
PH5436	G-49	PRMT	PH7028	GP-91	CIGO	PH933	GP-10	CHP	PL15436	G-49	PUR
PH5443	GP-432	FRM	PH7028	GP-91	LUF	PH933	GP-54	LUF	PL1553	GP-66	COP
PH5472	GP-54	FRM	PH7079	GP-51	FRM	PH9342	GP-490	FRM	PL1655	GP-66	COP
PH5505	G-70	PRMT	PH710	GP-9	CHP	PH9376FP	GP-51	FRM	PL166	G-34	COP
PH5515	G-3752	PRMT	PH7136	GP-88	FRM	PH9566	GP-58	FRM	PL170	GP-1	COP
PH5548	GP-428	FRM	PH7138	GP-152	FRM	PH9602	GP-91	FRM	PL175	G-238	PER
PH-5552	GP-430	FRM	PH7138FP	GP-152	FRM	PH961	GP-171	FRM	PL178	GP-50	PER
PH5566	GP-461	FRM	PH720	GP-35	BWS	PH9638	GP-3600 ¹⁰²	FRM	PL180	G-331	PER
PH5566	GP-462	FRM	PH720	GP-35	CHP	PH9638	GP-38 ⁸⁷	FRM	PL18662A	G-871	COP
PH561	GP-28 ⁸	ACE	PH720	GP-35	LUF	PH965	GP-81	FRM	PL188	G-5000	PER
PH561	GP-430 ⁸	ACE	PH7226	GP-171	FRM	PH966	GP-3816	CHP	PL1960	G-152	TFIL
PH561	GP-28 ⁸	APOL	PH725	GP-34	BWS	PH966811	GP-3816	FRM	PL20033	GP-20	PER
PH561	GP-430 ⁸	APOL	PH725	GP-34	CHP	PH968811	GP-6811	FRM	PL20033	GP-20	PUR
PH561	GP-28 ⁸	CHP	PH725	GP-34	LUF	PH9715	GP-91	FRM	PL20049	GP-3	PUR
PH561	GP-430 ⁸	CHP	PH7309	GP-36	FRM	PH9739	GP-291	FRM	PL20064	GP-3600 ⁸⁹	PUR
PH561	GP-28 ⁸	ECOL	PH7317	GP-149	FRM	PH977	GP-31	FRM	PL20064	GP-38 ²⁷	PUR
PH561	GP-430 ⁸	ECOL	PH7325	GP-3985	FRM	PH977A	GP-31	FRM	PL20081	GP-81 ³¹	PUR
PH561	GP-28 ⁸	GRAN	PH7405	GP-193	FRM	PH977AFP	GP-31	FRM	PL20081	GP-9 ⁹⁸	PUR
PH561	GP-430 ⁸	GRAN	PH7405A	GP-193	FRM	PH9837	GP-3675	FRM	PL20123	GP-3429	PUR
PH561	GP-28 ⁸	LUF	PH7497	GP-171 ¹⁶	FRM	PHE-100330	GA-2174	ROVE	PL20195	GP-3600	PUR
PH561	GP-430 ⁸	LUF	PH7498	GP-171	FRM	PHE-100460	GA-2135	ROVE	PL20252	GP-28 ⁶	PUR
PH561	GP-28 ⁸	MINL	PH7500	GP-54	FRM	PHM11	GP-5	MICP	PL20252	GP-430 ⁸	PUR
PH561	GP-430 ⁸	MINL	PH7575	GP-58	FRM	PHM1121	GP-27	MICP	PL2106	G-834	PUR
PH561	GP-28 ⁸	PARP	PH7576	GP-35	FRM	PHM1121P	GP-27	MICP	PL22167	GP-171	PUR
PH561	GP-430 ⁸	PARP	PH7650	GP-171 ¹⁶	FRM	PHM1191	G-296	MICP	PL2128	GP-81	COP
PH561	GP-28 ⁸	TRUS	PH7718	GP-54 ¹¹	FRM	PHM1191	G-296-B	MICP	PL22821	GP-58	PUR
PH561	GP-430 ⁸	TRUS	PH7718	GP-66 ¹⁰	FRM	PHM11C	GP-20	MICP	PL24	GP-20	COP
PH561	GP-28 ⁸	WARN	PH784	GP-3766	CHP	PHM117	GP-81 ³¹	MICP	PL24011	GP-3980	PUR
PH561	GP-430 ⁸	WARN	PH784	GP-3766	MINL	PHM17	GP-9 ⁹⁸	MICP	PL241	G-119	PER
PH-5618	GP-457	FRM	PH786	GP-3985 ⁶³	APOL	PHM20	GP-14	MICP	PL242	G-870	PER
PH5713	GP-128 ³	FRM	PH786	GP-3985 ⁶³	CAM2	PHM25	GP-20	MICP	PL24457	GP-3682 ³³	PUR
PH5713	GP-3600 ⁹	FRM	PH786	GP-3985 ⁶³	MINL	PHM3319	GPP-19	MICP	PL24457	GP-37 ⁴	PUR
PH5796	GP-291	FRM	PH791	GP-36	CHP	PHM3319P	GPP-19	MICP	PL24458	GP-462	PUR
PH5803	GP-3600	FRM	PH8	GP-1	CHP	PHM36	GP-36	MICP	PL24651	GP-68	PUR
PH-5882	GP-453	FRM	PH8	GP-171 ¹⁶	FRM	PHM43	GP-81 ³¹	MICP	PL25288	GP-3675	PUR
PH59	GP-3675	CHP	PH8	GP-1	SAFE	PHM43	GP-9 ⁹⁸	MICP	PL261	G-222	PER
PH59	GP-3675	LUF	PH81	GP-81 ³¹	PRMT	PHM50	GP-50	MICP	PL265	G-834	TFIL
PH59	GP-3675	PARP	PH81	GP-9 ⁹⁸	PRMT	PHM8	GP-1	MICP	PL268	G-566	PER
PH59	GP-3675	WARN	PH8170	GP-58 ¹⁵	FRM	PHM977	GP-31	MICP	PL271	G-613	PER
PH5FP	GP-205	FRM	PH820	GP-68	BWS	PI02673	GA-892	PERK	PL275	GP-51	PER
PH6010A	GP-91	FRM	PH820	GP-68	CHP	PILO3	GP-50	PUR	PL287	GP-38	PER
PH6011	GP-58	FRM	PH820	GP-68	GRAN	PILO5	GP-5	PUR	PL289	GP-10	PER
PH6016	GP-58	FRM	PH820	GP-68	LUF	PI15	GP-1101	PUR	PL292	GP-36	PER
PH6017	GP-91	FRM	PH820	GP-68	PARP	PJA305001	G-296	COVE	PL295	GP-24	COP
PH6017A	GP-91	FRM	PH820	GP-68	SECU	PJA305001	G-296-B	COVE	PL296	GP-310	PER
PH6018	GP-91	FRM	PH820	GP-68	TRUS	PJC257003	G-296	COVE	PL297	GP-66	PER
PH6022	GP-58	FRM	PH820	GP-68	WARN	PJC257003	G-296-B	COVE	PL299	GP-31	COP
PH61	GP-3980	LUF	PH8212	GP-212	FRM	PJC718004	G-297-B	COVE	PL299	G-122	PER
PH61A	GP-3980	LUF	PH-8212	GP-212	SECU	P-JD2	G-139	GLD	PL299	GP-338	PER
PH6349	GP-3000	FRM	PH8316	GP-128	FRM	P-JD2	G-139	WES	PL3	GP-3	PER
PH6349A	GP-3000	FRM	PH832	GP-23	ACE	PJK502001	G-297-B	COVE	PL3	GP-50	SPEC
PH64	G-222	TFIL	PH832	GP-23	APOL	PK15	G-1143	LETR	PL30001	GP-1	PUR
PH6607	GP-91	FRM	PH832	GP-23	BWS	PK15	G-1143	WABC	PL30001	GP-1	COP
PH6643	GP-77	FRM	PH832	GP-23	CAM2	PK2654403	GP-1	FAI	PL31	G-926	PUR
PH6682	GP-28 ⁸	FRM	PH832	GP-23	CHP	PL1	GP-1	PER	PL31313	GP-1	AIR
PH6682	GP-430 ⁸	FRM	PH832	GP-23	GRAN	PL100	G-333	PER	PL3313	GP-1	FLL
PH670	GP-43 ⁵⁰	CHP	PH832	GP-23	LUF	PL10017	GP-81 ³¹	PUR	PL3316	GP-69	AIR
PH670	GP-53 ⁴⁶	CHP	PH832	GP-23	MASE	PL10017	GP-9 ⁹⁸	PUR	PL3316	GP-69	FLL
PH670SC	GP-53	CHP	PH832	GP-23	SECU	PL10111	GP-46	PUR	PL3325	GP-53	AIR
PH6714	GP-77	CHP	PH832	GP-23	WARN	PL10193	GP-40	PUR	PL3326	GP-57	AIR
PH6714	GP-77	LUF	PH8476	GP-754	FRM	PL10241	GP-58 ¹⁵	PUR	PL3333	GP-53	AIR
PH6715	GP-54 ⁹⁰	BWS	PH8690	GP-9000	FRM	PL10291	GP-3531	EXP	PL3333	GP-53	FLL
PH6715	GP-54 ⁹⁰	LUF	PH8691	GP-9001	FRM	PL103	GP-5	PER	PL33335C	GP-43	AIR
PH675	GP-69	BWS	PH8873	GP-408	FRM	PL104A	GP-5	COP	PL33335C	GP-43	FLL
PH675	GP-69	CHP	PH8933	GP-642	FRM	PL106	G-330	PER	PL338	GP-28 ⁶	SPEC
PH675	GP-69	LUF	PH8942	GP-3937	FRM	PL107	G-169	PER	PL338	GP-430 ⁸	SPEC
PH6811	GP-6811	FRM	PH8994	GP-171	FRM	PL108	GP-81	PER	PL345	G-133	TFIL
PH6813	GP-452	FRM	PH8A	GP-1	ACE	PL114	G-122	COP	PL345	G-989	TFIL
PH6813	GP-452	SECU	PH8A	GP-1	APOL	PL114	G-338	COP	PL34631	GP-205	PUR
PH690	GP-10	CHP	PH8A	GP-1	BWS	PL114	G-871	PER	PL347	GP-34	PER
PH6923	GP-36	FRM	PH8A	GP-1	CHP	PL117	G-31	COP	PL366	GP-1	COP
PH7	GP-5	ACE	PH8A	GP-1	FRM	PL118A	G-335	COP	PL-38	G-1174	PUMX
PH7	GP-5	APOL	PH8A	GP-1	GRAN	PL12	G-139	COP	PL390	G-200	TFIL
PH7	GP-5	CAM2	PH8A	GP-1	LUF	PL120	G-813	PER	PL396	GP-81 ³¹	PER
PH7	GP-5	CHP	PH8A	GP-1	MASE	PL12222	GP-406	PUR	PL396	GP-9 ⁹⁸	PER
PH7	GP-81	FRM	PH8A	GP-1	VALU	PL125	G-836	PER	PL398	GP-54	COP
PH7	GP-5	GRAN	PH8A	GP-1	WARN	PL129	GP-3	PER	PL4017	GP-54	FLL
PH7	GP-5	LUF	PH8AFP	GP-1	FRM	PL13	GP-3600	COP	PL404	G-335	PER
PH7	GP-5	MASE	PH9	GP-171	FRM	PL132-1	G-33	TFIL	PL407	G-152	PER
PH7	GP-5	MINL	PH9010	GP-457	FRM	PL132MB	G-33	COP	PL40W	G-31	COP
PH7	GP-5	SECU	PH-9010	GP-457	SECU	PL14006	GP-44	PUR	PL42	GP-38	COP
PH7	GP-5	WARN	PH903	GP-212	CAMP	PL1400A	G-331	COP	PL436	GP-34	COP
PH7010	GP-149	CHP	PH903	GP-212	GRAN	PL141	G-200	COP	PL447	G-143	TFIL
PH7010	GP-149	LUF	PH903	GP-212	LUF	PL14159	GP-149	PUR	PL449	G-163	TFIL
PH7010	GP-149	WARN	PH903	GP-212	TRUS	PL14459	GP-149	PUR	PL45	G-500	PER
PH7014	GP-58	CHP	PH903	GP-212	WARN	PL14476	GP-157	PUR	PL451	GP-66	PER
PH7014	GP-58	LUF	PH922	GP-44	APOL	PL14477	GP-156	PUR	PL452	GP-1	COP
PH7014	GP-58	WARN	PH922	GP-44	CAM2	PL145	G-834	PER	PL453	GP-66	PER
PH7015	GP-91	CHP	PH922	GP-3675	CHP	PL14610	GP-149	PUR	PL45335	GP-178	PUR
PH7015	GP-54	FRM	PH922	GP-44	GRAN	PL14612	GP-91	PUR	PL48	G-6	COP

REFERENCIA CRUZADA

Numero	Gonher	Fabricante	Numero	Gonher	Fabricante	Numero	Gonher	Fabricante	Numero	Gonher	Fabricante
Number	Gonher	Manufacturer	Number	Gonher	Manufacturer	Number	Gonher	Manufacturer	Number	Gonher	Manufacturer
PL483		GP-69	PL99		G-200	PM226B		G-870	PM472		GP-11
PL485		G-122	PL9F6700		G-191	PM22-SERIES		G-33	PM476		GP-1105
PL485		G-338	PLA303		GA-39	PM238		G-238	PM477		GP-62
PL492		GP-10	PLA35330		GA-6479 ⁹⁰	PM2384		G-25	PM481		GP-51
PL495		GP-66	PLA45314		GA-348	PM2390		G-163	PM481		GP-51
PL50		G-33	PLF132		G-33	PM2429		G-143	PM482		GP-78
PL500		G-500	PLF4004		GP-51	PM2429D		G-143	PM483		GP-69
PL500		G-500	PLF484		G-191	PM2430		G-163	PM485		G-122
PL502		GP-390 ⁹³	PLF670		GP-53	PM2430D		G-163	PM485		G-338
PL503		GP-42	PLF690		GP-10	PM2447		G-133	PM486		GP-1107
PL509		G-33	PLF777		GP-57	PM2447		G-989	PM487		GP-23
PL509		G-33	PLJD15		GP-14	PM2447D		G-133	PM488		GP-462
PL513A		GP-81 ³¹	PLJD2L		G-139	PM2447D		G-989	PM492		GP-10
PL513A		GP-9 ⁵⁸	PLPF11		GP-13	PM245		G-330	PM493		GP-28 ⁹
PL514		GP-3600	PLPF12		GP-3	PM248		G-613	PM493		GP-430 ⁸
PL516		G-566	PLPF39		GP-44	PM24A		G-33	PM495		GP-66
PL516		G-566	PLPF46		GP-44	PM25		G-33	PM496		GP-26
PL516		G-566	PM1		GP-1	PM25-SERIES		G-33	PM497		GP-31
PL517		GP-67	PM10		GP-5	PM266		G-333	PM498		GP-27
PL519		G-238	PM1031		GA-7	PM266		G-870	PM499		GP-69
PL519		G-238	PM1033		GA-71	PM266B		G-870	PM46064		G-222
PL519		G-926	PM1034		GA-77	PM267		G-335	PM46064		G-222
PL52		GP-13	PM1058		GA-18	PM268B		G-5000	PM5		GP-81 ³¹
PL540X		G-1175 ¹⁰⁸	PM1096		GA-49	PM273A		G-1175 ¹⁰⁸	PM5		GP-9 ⁵⁸
PL553A		G-1174 ¹⁰⁸	PM1102		GA-361	PM278A		G-1173 ¹⁰⁸	PM500-SERIES		GP-20
PL556		G-566	PM1139		GA-892	PM282		GP-1101	PM502		GP-390 ⁹³
PL558		G-191	PM1143		G-1143	PM285		GP-81	PM503		GP-42
PL558		G-191	PM1148		GA-18	PM288		G-1163 ¹⁰⁸	PM511		GP-1122
PL58672		GP-69	PM1149		GAVW-2	PM291A		G-1174 ¹⁰⁸	PM512		GP-1122
PL58758		GP-1	PM1153		GAVW-4	PM294		G-139	PM5122		G-162H
PL607		GP-50	PM1173		G-1173 ¹⁰⁸	PM3		GP-20	PM513		GP-1
PL607		GP-50	PM1174		G-1174 ¹⁰⁸	PM30		G-34	PM514		GP-3600
PL613		G-613	PM1175		G-1175 ¹⁰⁸	PM30		G-31	PM515		GP-46
PL613		G-613	PM119		G-119	PM30		G-31	PM517		GP-67
PL613		G-613	PM13		G-33	PM301		G-6	PM518		GP-52 ¹¹⁰
PL618A		GP-31	PM1310		G-33	PM3015		G-31	PM518		GP-69 ¹⁴⁸
PL632		GP-14	PM13-15		GP-53	PM305		G-119	PM519		GP-53
PL64453		GP-5	PM13-16		GP-9586	PM305		G-119	PM520		GPP-19
PL651		GP-3	PM132		G-33	PM3054		G-1143	PM521		GPP-18
PL651		GP-3	PM135		G-33	PM309		G-33	PM522		GP-3429
PL653		GP-13	PM137		G-33	PM309		G-33	PM55484A		G-191
PL653		GP-13	PM138		G-33	PM31		G-34	PM55485A		G-238
PL654		GP-36	PM139		G-33	PM31		G-31	PM55485A		G-238
PL654		GP-36	PM139		G-139	PM313		G-834	PM55489A		G-191
PL667		GP-51	PM13A		G-33	PM317		GP-50	PM6		GP-38
PL667		GP-51	PM13-SERIES		G-33	PM321		GP-81 ³¹	PM-6006		G-222
PL670		GP-53	PM14		G-5000	PM321		GP-9 ⁵⁸	PM6025		G-159
PL670		GP-53	PM155		G-31	PM325		G-1123	PM6025		G-159
PL670SC		GP-53	PM155		G-152	PM325		G-1123	PM6041		G-169
PL670SC		GP-53	PM1553		GP-66	PM33		G-33	PM6049		G-339H
PL689		GP-81 ³¹	PM1556		GAD-1	PM331		G-331	PM613		G-613
PL689		GP-9 ⁵⁸	PM1587		GA-56	PM333		GP-1101	PM67		G-1163 ¹⁰⁸
PL689		GP-81 ³¹	PM1597		GA-2194	PM333		G-333	PM6H5931		G-1166
PL689		GP-9 ⁵⁸	PM16		G-200	PM333D		GPP-14	PM6H5931		G-1166
PL691		GP-52 ¹¹⁰	PM1600		GAVW-4	PM335		G-335	PM6L7440		GP-110
PL691		GP-691 ⁴⁸	PM16-1		G-200	PM339		GP-14	PM7		GP-81
PL691		GP-52 ¹¹⁰	PM1623		GA-436	PM340		GPP-14	PM700		GP-5
PL691		GP-691 ⁴⁸	PM1657		GAVW-2	PM343MA		G-566	PM700-SERIES		GP-20
PL692		GP-23	PM1697		GA-277	PM343MB		G-566	PM8		GP-3600
PL692		GP-23	PM174		G-6	PM346A		G-296	PM800		GP-20
PL697		GP-31	PM175		GA-405	PM346A		G-296-B	PM800-SERIES		GP-20
PL697		GP-31	PM1750		GA-405	PM349		G-870	PM801		G-871
PL699		GP-31	PM1760		GA-467	PM349		G-870	PM813		G-813
PL699		GP-31	PM1786		GA-3425	PM350		G-34	PM813		G-813
PL6F6700		G-191	PM1794		GAVW-2	PM351		GP-14	PM820		G-870
PL6H9999		G-238	PM1798		GAVW-2	PM356		G-31	PM834		G-834
PL6L7440		GP-110	PM17L		G-31	PM356D		G-31	PM870		G-870
PL6PL		G-6	PM17P		G-31	PM357		G-122	PM9		GP-13
PL7		GP-81	PM191		G-191	PM357		G-338	PM9H1252		G-1166
PL71		GP-88	PM19-1		G-119	PM366		GP-1	PM9H4729		G-1166
PL72A		G-834	PM197MB		G-33	PM370		GP-36	PM9M9740		G-152
PL731		G-333	PM2		G-200	PM39		GP-44	PM9M9740		G-152
PL734		GP-43	PM200		G-200	PM398		GP-10	PMA009		GA-135
PL734		GP-43	PM200		G-225	PM4		GP-3	PMA009		GA-135
PL74		G-31	PM2002		G-225	PM4020		G-296	PMA10		GA-86
PL750		G-750	PM2051		GP-2071W	PM4020		G-296-B	PMA1004		GA-86
PL750		G-750	PM2081		G-871	PM4175		G-1143	PMA101222K		GAK-16
PL750		G-750	PM2081B		G-871	PM4180		G-11816	PMA10-1222K		GAK-16
PL76-1		G-236	PM21		G-33	PM436		GP-34	PMA101234K		GAK-20
PL777		GP-57	PM210		G-6	PM452		GP-1	PMA10-1234K		GAK-20
PL777		GP-57	PM210-1		G-236	PM453		G-1121	PMA10-1237		GA-24
PL7M3800		G-191	PM2106		G-834	PM-453		G-1121	PMA10-1240		GA-27 ¹¹²
PL80		G-139	PM211		G-566	PM454		GP-1	PMA10-1240K		GA-27 ¹¹²
PL800		GP-871	PM212		G-331	PM454		G-1123	PMA10-1240K		GA-27 ¹¹²
PL801		G-871	PM2140		G-33	PM454		G-1123F	PM10-1243		GA-26
PL813		G-813	PM2151		G-191	PM455		GP-69	PMA101243K		GA-26
PL832		GP-23	PM216		G-836	PM46		GP-44	PM10-1243K		GA-26
PL86		G-6	PM216		G-836	PM460		GP-3816	PMA101246K		GAK-403
PL87		G-191	PM217		G-834	PM4600		G-122	PM4600		GAK-403
PL88		G-34	PM22		G-33	PM4600		G-338	PM4600		GA-33 ¹¹²
PL880		GP-10	PM221		G-225	PM463		GP-84	PM463		GA-33 ¹¹²
PL95		G-236	PM222		G-870	PM463		GP-84	PM463		GA-33 ¹¹²
PL957		G-813	PM2220		G-330	PM464		GP-83	PM464		GAK-16
PL96		GP-1	PM222B		G-870	PM464		GP-83	PM464		GAK-20
PL97		GP-50	PM223		G-871	PM467		GPP-18	PM467		GAK-20
PL98		G-33	PM226		GP-50	PM471		GP-1108	PM471		GAP-379

Referencia Cruzada por Numero de Parte
Cross Reference by Part Number



Numero	Gonher	Fabricante	Numero	Gonher	Fabricante	Numero	Gonher	Fabricante	Numero	Gonher	Fabricante
Number	Gonher	Manufacturer	Number	Gonher	Manufacturer	Number	Gonher	Manufacturer	Number	Gonher	Manufacturer
PMA10-3951	GA-379	CYC	PMA4M8048	GA-1285	COP	PMX750	G-750	COP	PO43	GP-98	PRON
PMA105043K	GA-98 ¹²	COP	PMA4M8048	GA-1285	CYC	PMX750	G-750	CYC	PO4459	GP-91	PHI
PMA10-5043K	GA-98 ¹²	CYC	PMA4M9334	GA-9334	COP	PMX750N	G-750	COP	PO4459	GP-91	PRON
PMA106	GA-11	COP	PMA4M9334	GA-9334	CYC	PMX750-N	G-750	CYC	PO445	GP-3429	PHI
PMA106	GA-11	CYC	PMA4M9335	GA-1286	COP	PMX750-S	G-750	CYC	PO46	GP-20	PHI
PMA106032	GA-403	COP	PMA4M9335	GA-1286	CYC	PN117	G-1121	SOPA	PO4610	GP-149	PRON
PMA10-6032	GA-403	CYC	PMA4M9378	GA-1008	COP	PO1	GP-1	PHI	PO4612	GP-91	PRON
PMA106587	GA-360	COP	PMA4M9378	GA-1008	CYC	PO1085	GP-81	PHI	PO4619	GP-3985	PRON
PMA10-6587	GA-360	CYC	PMA4M9379	GA-1284	COP	PO1088	GP-28 ⁶	PHI	PO4670	GP-81	PRON
PMA106632	GA-6129	COP	PMA4M9379	GA-1284	CYC	PO1088	GP-430 ⁸	PHI	PO-47	GP-178	PFMX
PMA10-6632	GA-6129	CYC	PMA50	GA-37	COP	PO109	GP-42	PHI	PO-48	GP-44	PFMX
PMA106641	GA-6127	COP	PMA50	GA-37	CYC	PO-109	GP-149	PFMX	PO487	GP-3675	PRON
PMA10-6641	GA-6127	CYC	PMA52	GA-71	CYC	PO1-1	GP-1	PHI	PO49	GP-3	PHI
PMA106769	GA-106 ⁴⁶	COP	PMA57	GA-80	CYC	PO111	GP-46	PHI	PO494	GP-58	PRON
PMA106769	GA-326 ⁷¹	COP	PMA58	GA-105	CYC	PO113	GP-28 ⁸⁴	PHI	PO4967	GP-157	PRON
PMA10-6769	GA-106 ⁴⁶	CYC	PMA59	GA-50	CYC	PO113	GP-3600 ⁸⁴	PHI	PO5	GP-5	PHI
PMA10-6769	GA-326 ⁷¹	CYC	PMA67	GA-192	CYC	PO113	GP-38 ⁸⁷	PHI	PO5	GP-205	PRON
PMA10-6775	GA-206	CYC	PMA68	GA-78	CYC	PO113	GP-430 ⁸⁵	PHI	PO510	GP-457	PRON
PMA10-6834	GA-361	MICP	PMA698	GAD-3	MICP	PO1338	GP-462	PHI	PO512	G-45	PRON
PMA107	GA-12	COP	PMA7	GA-3424	CYC	PO1356	GP-149	PHI	PO-52	GP-408	PFMX
PMA107	GA-12	CYC	PMA71	GA-135	MICP	PO1357	GP-91	PHI	PO5274	GP-765	PRON
PMA108	GA-55	CYC	PMA725HD	GA-425	COP	PO-136	G-963	PFMX	PO5288	GP-3675	PRON
PMA109155	GA-356	COP	PMA725HD	GA-425	CYC	PO1361	GP-3682	PHI	PO-53	GP-971	PFMX
PMA10-9155	GA-356	CYC	PMA7360HD	GA-7360	CYC	PO1365	GP-91	PHI	PO5335	GP-178	PRON
PMA10-9159	GA-357	CYC	PMA77	GA-7	COP	PO1372	GP-68	PHI	PO5436	G-49	PRON
PMA10-9726	GA-31	CYC	PMA77	GA-7	CYC	PO1394	GP-157	PHI	PO-55	GP-765	PFMX
PMA116345	GA-891	COP	PMA7716HD	GA-7716	CYC	PO141	G-200	PHI	PO55591	GA-360	KOEH
PMA11-6345	GA-891	CYC	PMA7M9045	GA-9045	COP	PO-141	GP-452	PFMX	PO55591	GA-360	LORA
PMA11-6880	GA-6880	CYC	PMA7M9045	GA-9045	CYC	PO-141	GP-452	QKS	PO55613	GAK-20	KOEH
PMA116918	GA-378	COP	PMA7M9046	GA-1287	COP	PO-149	G-984	PFMX	PO-56	G-45	PFMX
PMA11-6918	GA-378	CYC	PMA7M9046	GA-1287	CYC	PO1521	GP-171	PHI	PO-58	GP-49	PFMX
PMA1169180	GA-378	COP	PMA83	GA-85	CYC	PO1522	GP-44	PHI	PO-60	G-180	PFMX
PMA11-6918-0	GA-378	CYC	PMA84	GA-730	CYC	PO-154	G-466	PFMX	PO-61	G-112	PFMX
PMA117797	GA-229	COP	PMA8482HD	GA-482	CYC	PO-156	G-3752	PFMX	PO-62	G-72	PFMX
PMA11-7797	GA-229	CYC	PMA8483HD	GA-483	CYC	PO-159	G-70	PFMX	PO-63	G-954	PFMX
PMA11-8047	GA-376	CYC	PMA91	GA-59	CYC	PO-160	G-975	PFMX	PO64	GP-3600	PHI
PMA118829	GA-891	COP	PMA92	GA-57	CYC	PO1607	GP-178	PHI	PO6607	GP-91	PRON
PMA11-8829	GA-891	CYC	PMA926HD	GA-679	COP	PO-161	G-912	PFMX	PO73	GP-24 ⁶	PHI
PMA11-9587	GA-509 ¹⁴	CYC	PMA926HD	GA-679	CYC	PO-167	GP-406	PFMX	PO73	GP-462 ²⁴	PHI
PMA119649	GA-416	COP	PMA93	GA-325	CYC	PO173	GP-3980	PHI	PO74	GP-3985	PHI
PMA11-9649	GA-416	CYC	PMA94	GA-3300	CYC	PO18	GP-81	PHI	PO741	GP-91 ⁷⁸	PHI
PMA12	GA-85	CYC	PMA956	GA-21	CYC	PO-19	GP-3600	PFMX	PO81	GP-81 ³¹	PHI
PMA12-0215	GA-329	CYC	PMD13	G-33	ACD	PO194	GP-3531	EXP	PO81	GP-98 ⁸	PHI
PMA12-0219	GA-239	CYC	PMD21	G-33	ACD	PO195	GP-3600	PHI	PO8158	G-112	PRON
PMA122	GA-39	COP	PMD22	G-33	ACD	PO2	GP-68	PRON	PO83	GP-1	PHI
PMA122	GA-39	CYC	PMD25	G-33	ACD	PO-21	GP-58	PFMX	PO83	GP-3569	PHI
PMA1220HD	GA-135	COP	PMD27	G-33	ACD	PO213	GP-28 ⁶	PHI	PO8316	GP-128	PRON
PMA12-20HD	GA-135	CYC	PMF26F	G-870	ROLK	PO213	GP-430 ⁸	PHI	PO84	GP-23	PHI
PMA133	GA-78	MICP	PMF900BP	GP-50	ROLK	PO-22	GP-310	PFMX	PO8765	GP-765	PRON
PMA142	GA-349	CYC	PMFA256	GA-200	POWT	PO-22	GP-3569	PFMX	PO8873	GP-408	PRON
PMA1424HD	GA-360	CYC	PMFA256	GA-256	POWT	PO241	GP-58	PHI	PO8873	GP-1	PRON
PMA144	GA-75	CYC	PMFA353	GA-230	POWT	PO25	GP-20	PRON	PO9018	G-49	PRON
PMA145	GA-429	CYC	PMFA355	GAD-3	POWT	PO252	GP-28 ⁶	PRON	PO-9A	GP-46	PFMX
PMA146	GA-74	CYC	PMFA363	GAD-1	POWT	PO252	GP-430 ⁸	PRON	PP137	GP-1	PHI
PMA146R	GA-71	MICP	PMFA375	GA-2740	POWT	PO258	GP-58	PHI	PP15	GP-1101	PHI
PMA147	GA-86	CYC	PMFA380	GA-3425	POWT	PO-27	GP-3682	PFMX	PP49	GP-330	PHI
PMA148	GA-3300	CYC	PMFF5066	GG-1	JOND	PO28	GP-3816	PHI	PLL14610	GP-149	PROL
PMA148	GA-80	MICP	PMFF5066	GG-4	JOND	PO-28	GP-3675	PFMX	PLL14612	GP-91	PROL
PMA160	GA-70	MICP	PMFF903	G-296	POWT	PO2856A	GP-40	PRON	PLL24011	GP-3980	PROL
PMA18065	GA-5648	CYC	PMFF903	G-296	POWT	PO2870A	GP-28 ⁶	PRON	PLL24457	GP-3682	PROL
PMA18065K	GA-5648	COP	PMFF908	GP-1123	POWT	PO2870A	GP-430 ⁸	PRON	PLL25288	GP-3675	PROL
PMA18065K	GA-5648	CYC	PMFG2313	G-870	CYC	PO289	GP-3985	PHI	PPP128299	GA-6880	DON
PMA184	GA-77	MICP	PMFL15	GP-22	POWT	PO-29	GP-3980 ¹⁴	PFMX	PPP524347	GA-77	DON
PMA187	GA-90	COP	PMFL27	GP-46	POWT	PO292	GP-462	PHI	PPP524349	GA-50	DON
PMA187	GA-90	CYC	PMFL31	GP-28 ⁶	POWT	PO2951A	GP-2951	PRON	PPP524350	GA-80	DON
PMA189	GA-50	MICP	PMFL31	GP-430 ⁸	POWT	PO30	GP-3	PRON	PPP524351	GA-192	DON
PMA21	GA-105	CYC	PMFL57	GP-36	POWT	PO33	GP-20	PHI	PPP524353	GA-78	DON
PMA239	GA-7716	MICP	PMFM127FF	G-870	ROLK	PO3387A	GP-46	PRON	PPP524354	GA-90	DON
PMA250C55	GA-18	COP	PMFQ26FF	G-870	ROLK	PO-34	GP-81	PFMX	PPP524355	GA-59	DON
PMA250C55	GA-18	CYC	PMFQ984FF	G-813	ROLK	PO3429	GP-3429	PRON	PPP524356	GA-57	DON
PMA257K	GA-26	MICP	PMG13	GG-123	CYC	PO3506	GP-44	PRON	PPP524357	GA-85	DON
PMA26	GAD-1	CYC	PMG13P	GG-123	CYC	PO3531	GP-3531	EXP	PPP524358	GA-303	DON
PMA288	GA-1203	MICP	PMG17	GG-19	CYC	PO-3569	GP-3569	PRON	PPP524359	GA-3300	DON
PMA3	GA-3425	CYC	PMG20	GG-20	MICP	PO3593A	GP-149	PRON	PPP524361	GA-75	DON
PMA305	GA-730	MICP	PMG228A	GG-20	CYC	PO3600	GP-3600	PRON	PPP524362	GA-3501	DON
PMA31	GA-56	CYC	PMG4-16K	GG-1	CYC	PO3614	GP-58	PRON	PPP524368	GA-3501	DON
PMA313HD	GA-426	COP	PMG4-16K	GG-4	CYC	PO3651A	GP-171	PRON	PPP524369	GA-89	DON
PMA313HD	GA-426	CYC	PMG427	GG-6	CYC	PO3682	GP-3682	PRON	PPP524370	GA-3424	DON
PMA326	GA-59	MICP	PMG441	GG-7	CYC	PO-37	GP-91	PFMX	PPP524371	GA-3425	DON
PMA37HD	GA-44	CYC	PMG470	GG-16	CYC	PO373	GP-3682	PHI	PPP524372	GA-3523	DON
PMA38	GAD-3	CYC	PMG471	GG-17	CYC	PO3766	GP-3766	PRON	PPP524374	GAD-1	DON
PMA381	GA-74	MICP	PMG5-16	GG-5	L	PO3786	GP-562	PRON	PPP524375	GAD-3	DON
PMA388HD	GA-3501	CYC	PMG6-16	GG-5	L	PO-38	GP-156	PFMX	PPP524376	GA-74	DON
PMA4	GA-70	CYC	PMG6-16K	GG-5	L	PO3807	GP-462	PRON	PPP524377	GA-3490	DON
PMA414HD	GA-880	COP	PMJD2	G-139	CYC	PO-39	GP-157	PFMX	PPP524378	GA-54	DON
PMA414HD	GA-680	CYC	PMK1076	GAUV-22	PUR	PO3976A	GP-178	PRON	PPP524380	GA-100	DON
PMA45	GA-77	CYC	PMP322	GP-81	PUR	PO3980	GP-3980	PRON	PPP524381	GA-735	DON
PMA49839	GA-679	COP	PMS328	G-1174 ¹⁰⁸	CYC	PO3985	GP-3985	PRON	PPP524382	GA-271	DON
PMA49839	GA-679	CYC	PMX17LN	G-31	CYC	PO40	GP-13	PHI	PPP524384	GA-3588	DON
PMA49840	GA-680	CYC	PMX18LN	G-31	CYC	PO4006	GP-44	PRON	PPP524386	GA-3647	DON
PMA4L4718	GA-375	COP	PMX30N	G-31	CYC	PO4011	GP-3980	PHI	PPP524388	GA-135	DON
PMA4L4718	GA-375	CYC	PMX400510	GP-52 ¹¹⁰	PAL	PO4011	GP-3980	PRON	PPP524389	GA-3681	DON
PMA4L4719	GA-1203	COP	PMX400510	GP-691 ⁴⁸	PAL	PO41	GP-205	PHI	PPP524390	GA-71	DON
PMA4L4719	GA-1203	CYC	PMX500N	GP-500	COP	PO-41A	GP-212	PFMX	PPP524391	GA-70	DON
PMA4M8047	GA-8047	COP	PMX500N	G-500	CYC	PO42	GP-38	PHI	PPP524392	GA-135	DON
PMA4M8047	GA-8047	CYC	PMX500S	G-500							

Numero	Gonher	Fabricante	Numero	Gonher	Fabricante	Numero	Gonher	Fabricante	Numero	Gonher	Fabricante
Number	Gonher	Manufacturer	Number	Gonher	Manufacturer	Number	Gonher	Manufacturer	Number	Gonher	Manufacturer
PPP524394	GA-730	DON	PS8487	GPP-424	FRM	PT159E	G-33	BLDW	PZ28	GP-44	PEN
PPP524397	GA-2719B	DON	PS8488	GPP-10075	FRM	PT185	G-335	BLDW	PZ-29	GP-3980	PEN
PPP524398	GA-86	DON	PS8533	GPP-421	FRM	PT189	G-152	BLDW	PZ3	GP-3	PEN
PPP524401	GA-429	DON	PS8605FP	GPP-426	FRM	PT189MPG	G-152	BLDW	PZ30	GP-3985	PEN
PQ76FF	G-236	ROLK	PS8622	GPP-419	FRM	PT268	G-122	BLDW	PZ32	GP-462	PEN
PR	GP-50	ACD	PS8687	GPP-10225	FRM	PT268	G-338	BLDW	PZ33	GP-91	PEN
PR150-3	G-1175 ¹⁰⁸	PUR	PS8688	GPP-10075	FRM	PT269	G-330	BLDW	PZ34	GP-81	PEN
PR-150-3	G-1175	PUMX	PS8689	GPP-10035	FRM	PT29	G-801	BLDW	PZ35	GP-28 ⁶	PEN
PR1506	G-1175 ¹⁰⁸	PUR	PS8689	GPP-10225	FRM	PT29	G-870	BLDW	PZ35	GP-430 ⁸	PEN
PR151	G-1173 ¹⁰⁸	PUR	PS903640	GP-1122	TFIL	PT294	G-139	GLD	PZ36	GP-149	PEN
PR151-6	G-1173 ¹⁰⁸	PUR	PS9127	GPP-425	FRM	PT385	G-33	BLDW	PZ37	GP-91	PEN
PR-151-6	G-1173	PUMX	PS9268	GPP-419	FRM	PT390	G-339H	BLDW	PZ38	GP-156	PEN
PR1517	G-1173	PUR	PS962	GP-54 ¹¹	TFIL	PT390MPG	G-339H	BLDW	PZ39	GP-157	PEN
PR3304	GP-2017W	FRM	PS962	GP-66 ¹⁰	TFIL	PT500	G-500	PUR	PZ4	GP-5	PEN
PR3414	GP-1011Q	FRM	PS9794	GPP-1287 ³⁹	FRM	PT63-1	G-139	BLDW	PZ41A	GP-212	PEN
PR3433	GP-2022W	FRM	PS9794	S 3226 P ⁴⁰	FRM	PT670	G-191	BLDW	PZ42	GP-68	PEN
PR3753	GP-1013Q	FRM	PSA272	GP-1010Q	TFIL	PT750	G-750	PUR	PZ45	GP-205	PEN
PR3758	GP-1011Q	FRM	PSA273	GP-1011Q	TFIL	PT87-5	G-331	BLDW	PZ453	G-1121	PUR
PR3907	GP-2071W	FRM	PSA276	GP-1013Q	TFIL	PT88-HD	G-238	BLDW	PZ454	G-1123	PUR
PR3908	GP-2071W	FRM	PSA299	GP-2071W	TFIL	PT88-HD	G-238	GLD	PZ47	GP-178	PEN
PR3909	GP-1010Q	FRM	PSA331	GP-2071W	TFIL	PT90	G-222	BLDW	PZ48	GP-44	PEN
PR3910	GP-1011Q	FRM	PSC138	GP-26	TFIL	PT90-10	G-222	BLDW	PZ49	GP-562	PEN
PR3911	GP-1012Q	FRM	PSC139	GP-27	TFIL	PT903	G-169	BLDW	PZ5	GP-13	PEN
PR393	GP-2015W	FRM	PSC172	GPP-14	TFIL	PT9186	G-24	BLDW	PZ51	GP-128	PEN
PR64	GP-22	PUR	PSC3132	GP-26	TFIL	PT9334	GA-42	JOND	PZ-52	GP-408	PEN
PR7308	GP-1011Q	FRM	PSC410	GPP-18	TFIL	PT94	G-222	BLDW	PZ-53	GP-971	PEN
PR7570	GP-1013Q	FRM	PSC496	GPP-1122	TFIL	PT951	G-169	BLDW	PZ-55	G-765	PEN
PR8289	GP-2015W	FRM	PSC72-2	GP-1122	TFIL	PT98-10	G-153	BLDW	PZ56	GP-45	PEN
PR8591	GP-2108W	FRM	PSC73	GP-1122	TFIL	PU 1046/1X	G-1046	MNH	PZ-57	GP-457	PEN
PR8693	GP-2126Q	FRM	PSC73-1	GP-1122	TFIL	PU1046X	G-1046	MNH	PZ-58	G-49	PEN
PR8694	GP-2127W	FRM	PSC744	GP-110	TFIL	PV444	G-836	VOLV	PZ6	GP-200	PEN
PS10451	GPP-111	FRM	PSC771	GPP-1122	TFIL	PW2010	GP-2071W	PARK	PZ-60	G-180	PEN
PS10451	GPP-524	FRM	PSH140	GP-66	TFIL	PW2010	GP-2071W	PUR	PZ-61	G-112	PEN
PS211H	GP-34	TFIL	PSH211	GP-34	TFIL	PW2016	GP-1011Q	PARK	PZ-62	G-72	PEN
PS2206	GP-27	TFIL	PSH211H	GP-34	TFIL	PW2016	GP-1011Q	PUR	PZ-63	G-954	PEN
PS2207	GP-26	TFIL	PSH26056	GP-66	TFIL	PW2022	GP-2022W	PUR	PZ7	GP-81 ¹¹	PEN
PS26056	GP-66	TFIL	PSH486	GP-166 ¹⁰⁰	TFIL	PW2072	GP-1010Q	PARK	PZ7	GP-9 ⁸	PEN
PS270	GP-53	TFIL	PSH962	GP-66 ⁹⁰	TFIL	PW283	GP-2071W	PUR	PZ8	GP-38	PEN
PS277	GP-57	TFIL	PSH962H	GP-54	TFIL	PW2901	GP-2071W	CHP	PZ9	GP-46	PEN
PS284	GP-24	TFIL	PSH96H	GP-166 ¹⁰⁰	TFIL	PW320	GP-1011Q	PUR	PZ9A	GP-46	PEN
PS3607	G-293	FRM	PSI10	GP-3429	PEN	PW330	GP-1010Q	PUR	PZA1	GA-77	PEN
PS3607A	G-293	FRM	PSJ154Z	G-1123	BOG	PW4013	GP-1013Q	CHP	PZA10	GA-85	PEN
PS3712	GPP-11	FRM	PSJ182	G-1121	BOG	PW4016	GP-1011Q	CHP	PZA101	GA-429	PEN
PS405	GP-52 ¹¹⁰	TFIL	PSJ183	G-1121	BOG	PW4018	GP-1011Q	CHP	PZA101	GA-6690	PEN
PS405	GP-69 ¹⁴⁸	TFIL	PSJ183Z	G-1121	BOG	PW4022	GP-2022W	CHP	PZA102	GA-3424	PEN
PS48	GP-3985	TFIL	PSL083	GP-3985	TFIL	PW4452	GP-2071W	PUR	PZA103	GA-3425	PEN
PS4886	GPP-111	FRM	PSL123	GP-36	TFIL	PW4453	GP-1011Q	PUR	PZA104	GA-735	PEN
PS4886	GPP-524	FRM	PSL124	GP-36	TFIL	PW4454	GP-1011Q	PUR	PZA105	GA-3523	PEN
PS569	GP-54	TFIL	PSL130	GP-40	TFIL	PW4455	GP-1013Q	PUR	PZA106	GA-89	PEN
PS570	GP-54 ⁹⁰	TFIL	PSL131	GP-91	TFIL	PW475	GP-2015W	PUR	PZA108	GA-3588	PEN
PS6628	GP-1232	FRM	PSL132	GP-58	TFIL	PW4860	GP-2015W	CHP	PZA109	GA-3647	PEN
PS6829	GPP-1000	FRM	PSL133	GP-3682	TFIL	PX102	GA-360	PIPE	PZA11	GA-59	PEN
PS6830	S 3202 ⁴⁰	FRM	PSL134	GP-58	TFIL	PX109	GA-106 ⁴⁶	PIPE	PZA110	GA-2740	PEN
PS6831	GPP-11	FRM	PSL135	GP-91	TFIL	PX109	GA-326 ⁴¹	PIPE	PZA113	GA-2719B	PEN
PS6832	GPP-14	FRM	PSL136	GP-462	TFIL	PX119	GA-49	PIPE	PZA114	GA-3300	PEN
PS7170	GPP-547 ³⁹	FRM	PSL138	GP-3985	TFIL	PX123	GA-405	PIPE	PZA115	GAVW-2	PEN
PS7170	PFF831 ⁴¹	FRM	PSL141	GP-81 ³¹	TFIL	PX134	GA-436	PIPE	PZA117	GA-277	PEN
PS7170	R 60 P ⁴²	FRM	PSL141	GP-9 ⁵⁸	TFIL	PX152	GA-356	PIPE	PZA119	GA-3490	PEN
PS7171	GPP-1287 ³⁹	FRM	PSL171	GP-171	TFIL	PX153	GA-26 ¹¹²	PIPE	PZA12	GA-55	PEN
PS7171	PFF831 ⁴¹	FRM	PSL270	GP-53	TFIL	PX164C	GA-372	PIPE	PZA123	GA-271	PEN
PS7171	R 60 P ⁴²	FRM	PSL277	GP-57	TFIL	PX956	GA-616	PIPE	PZA-124	GA-3566	PEN
PS7407	GPP-418	FRM	PSL280	GP-178	TFIL	PZ1	GP-1	PEN	PZA125	GAD-3	PEN
PS7407A	GPP-418	FRM	PSL281	GP-43	TFIL	PZ10	GP-3429	PEN	PZA126	GA-274	PEN
PS7407A	GPP-420	FRM	PSL300	GP-3000	TFIL	PZ102	GP-58	PEN	PZA128	GA-74	PEN
PS7408	GPP-419	FRM	PSL3443	GP-54	TFIL	PZ103	GP-23	PEN	PZA130	GA-3501	PEN
PS7408A	GPP-419	FRM	PSL3443SC	GP-54 ⁹⁰	TFIL	PZ105	GP-3766	PEN	PZA131	GA-3681	PEN
PS7409	GPP-421	FRM	PSL400	GP-51	TFIL	PZ106	GP-40	PEN	PZA-132	GA-140	PEN
PS7409A	GPP-421	FRM	PSL405	GP-52 ¹¹⁰	TFIL	PZ108	GP-149	PEN	PZA133	GA-4828	PEN
PS7411	GPP-425	FRM	PSL405	GP-691 ⁴⁸	TFIL	PZ109	GP-149	PEN	PZA134	GA-3814	PEN
PS7569	G-278	FRM	PSL408	GP-3600	TFIL	PZ12	GP-28 ⁶	PEN	PZA135	GA-153	PEN
PS7569A	G-278	FRM	PSL417	GP-51	TFIL	PZ12	GP-430 ⁸	PEN	PZA137	GA-3916	PEN
PS7576	G-278	FRM	PSL418	GP-54	TFIL	PZ13	GP-81	PEN	PZA138	GA-273	PEN
PS7677	G-277	FRM	PSL47	GP-81	TFIL	PZ14	GP-462 ⁴¹	PEN	PZA139	GA-5056	PEN
PS7713	GPP-1287 ³⁹	FRM	PSL48	GP-3985	TFIL	PZ-14	GP-24 ²⁶	PEN	PZA140	GA-4303	PEN
PS7713	PFF831 ⁴¹	FRM	PSL50	GP-40	TFIL	PZ-15	GP-3980	PEN	PZA141	GA-78	PEN
PS7713	S 3225 P ⁴²	FRM	PSL561	GP-28	TFIL	PZ-156	GP-3752	PEN	PZA142	GA-174	PEN
PS7714	GPP-1291 ³⁹	FRM	PSL562	GP-28 ⁹	TFIL	PZ-159	G-70	PEN	PZA-143	GA-4958	PEN
PS7714	S 3226 P ⁴⁰	FRM	PSL562	GP-430 ⁸	TFIL	PZ16	GP-3985	PEN	PZA144	GA-4325	PEN
PS7716	GPP-1291 ³⁹	FRM	PSL567	GP-77	TFIL	PZ-161	G-912	PEN	PZA148	GA-253	PEN
PS7716	PFF831 ⁴¹	FRM	PSL568	GP-77	TFIL	PZ-167	GP-406	PEN	PZA149	GA-3915	PEN
PS7716	R 90 P ⁴²	FRM	PSL569	GP-54	TFIL	PZ17	GP-42	PEN	PZA15	GA-57	PEN
PS8047	GPP-11	FRM	PSL570	GP-54 ⁹⁰	TFIL	PZ18	GP-3531	EXP	PZA150	GA-3901	PEN
PS8048	GPP-1000	FRM	PSL619	GP-46	TFIL	PZ18A	GP-3531	EXP	PZA-151	GA-390	PEN
PS8186	GPP-547 ³⁹	FRM	PSL63	GP-46	TFIL	PZ19	GP-3600	PEN	PZA153	GAD-15	PEN
PS8186	PFF831 ⁴¹	FRM	PSL675	GP-31	TFIL	PZ2	GP-20	PEN	PZA-154	GA-2194	PEN
PS8186	R 60 P ⁴²	FRM	PSL714	GP-1	TFIL	PZ20	GP-40	PEN	PZA-156	GA-471	PEN
PS8187	GPP-1287 ³⁹	FRM	PSL818	GP-149	TFIL	PZ208	GP-128	PEN	PZA-159	GA-382	PEN
PS8187	PFF831 ⁴¹	FRM	PSL900	GP-1	TFIL	PZ21	GP-58	PEN	PZA16	GA-75	PEN
PS8187	R 60 P ⁴²	FRM	PSL959	GP-13	TFIL	PZ-22	GP-310	PEN	PZA162	GA-6479	PEN
PS8239	GPP-423	FRM	PSL962	GP-54 ¹¹	TFIL	PZ-22	GP-3569	PEN	PZA163	GA-275	PEN
PS825	GP-38	TFIL	PSL962	GP-66 ¹⁰	TFIL	PZ23	GP-91	PEN	PZA164	GAVW-120	PEN
PS8322	GPP-424	FRM	PSL966	GP-3816	TFIL	PZ24	GP-3985	PEN	PZA166	GA-362	PEN
PS8428	GPP-1122	FRM	PT108	G-813	BLDW	PZ25	GP-40	PEN	PZA167	GA-180	PEN
PS8486	GPP-1291 ³⁹	FRM	PT108HD	G-813	BLDW	PZ26	GP-58	PEN	PZA-168	GA-195	PEN
PS8486	PFF831 ⁴¹	FRM	PT-11	G-119	BLDW	PZ264	GA-258	PFMX	PZA169	GA-139	PEN
PS8486	R 90 P ⁴²	FRM	PT12	G-834	BLDW	PZ-27	GP-3682	PEN	PZA17	GA-303	PEN

Referencia Cruzada por Numero de Parte

Cross Reference by Part Number



Numero	Gonher	Fabricante	Numero	Gonher	Fabricante	Numero	Gonher	Fabricante	Numero	Gonher	Fabricante
Number	Gonher	Manufacturer	Number	Gonher	Manufacturer	Number	Gonher	Manufacturer	Number	Gonher	Manufacturer
PZA-172	GA-386	PEN	PZA4	GA-50	PEN	Q15H4117	GP-1122	DUTZ	QA24378	GA-174	QAP
PZA-173	GA-7017	PEN	PZA-407	GA-607	PEN	Q15H4117	GP-1122	KHDF	QA24468	GA-195	QAP
PZA-175	GA-604	PEN	PZA-433	GA-263	PEN	Q15H4123	GP-54 ¹³	DUTZ	QA24471	GA-471	QAP
PZA-177	GA-6690	PEN	PZA-442	GA-184	PEN	Q15H4123	GP-66 ¹⁰	DUTZ	QA24680	GA-386	QAP
PZA178	GA-133	PEN	PZA-450	GA-138	PEN	Q166	G-34	FLL	QA2856A	GP-46	QKS
PZA-179	GA-322	PEN	PZA-451	GA-269	PEN	Q193	GP-40	PROF	QA2923	GA-3501	PROF
PZA18	GA-730	PEN	PZA-454	GA-488	PEN	Q195	GP-3600	PROF	QA30045	GA-77	QAP
PZA180	GA-217	PEN	PZA-462	GA-1617	PEN	Q1A	GP-1	PROF	QA30052	GA-71	QAP
PZA-181	GA-5466	PEN	PZA-468	GA-249	PEN	Q1H4115	G-1123	AHLM	QA30057	GA-80	QAP
PZA-182	GA-142	PEN	PZA-469	GA-415	PEN	Q1H4115	G-1123	DUTZ	QA30059	GA-50	QAP
PZA-183	GA-2106	PEN	PZA5	GA-78	PEN	Q1H4115	G-1123	FAHR	QA30067	GA-192	QAP
PZA-185	GA-6619 ¹	PEN	PZA7	GA-70	PEN	Q1H4115	G-1123	FAUN	QA3138	GA-54	PROF
PZA-185	GA-6620 ⁰	PEN	PZA8	GA-56	PEN	Q1H4115	G-1123	KHDF	QA3149	GA-3523	PROF
PZA186	GA-300	PEN	PZB1	GA-100	PEN	Q1H4115	G-1123	KRAM	QA3192	GA-271	PROF
PZA187	GA-175	PEN	PZB2	GA-113	PEN	Q1H4117	GP-1122	AHLM	QA3195	GA-3588	PROF
PZA188	GA-1616	PEN	PZB5	GA-101	PEN	Q1H4117	GP-1122	ATCO	QA3306A	GP-10	QKS
PZA189	GA-165	PEN	PZB7	GA-176	PEN	Q1H4117	GP-1122	DUTZ	QA33193	GA-735	QAP
PZA19	GA-192	PEN	PZ11	GP-1	PEN	Q1H4117	GP-1122	FAHR	QA33380	GA-3647	QAP
PZA190	GA-141	PEN	PZ1104	GP-81	PEN	Q1H4117	GP-1122	KHDF	QA33466	GA-4828	QAP
PZA-191	GA-432	PEN	PZ1105	GP-3766	PEN	Q1H4117	GP-1122	KRAM	QA33472	GA-274	QAP
PZA-192	GA-381	PEN	PZ1-109	GP-149	PEN	Q1H4119	G-1123	FAHR	QA3357	GA-3637	PROF
PZA193	GAD-294	PEN	PZ112	GP-28 ⁹	PEN	Q1H4119	G-1123	FAUN	QA33590	GA-3916	QAP
PZA-195	GA-4365	PEN	PZ112	GP-430 ⁸	PEN	Q2167	GP-171	PROF	QA33591	GA-3814	QAP
PZA196	GA-392	PEN	PZ113	GP-81	PEN	Q252	GP-28 ⁹	PROF	QA3380	GA-3647	PROF
PZA198	GA-198	PEN	PZ1-137	GP-91	PEN	Q252	GP-430 ⁸	PROF	QA3384	GA-89	PROF
PZA199	GAD-118	PEN	PZ1-147	GP-178	PEN	Q288	GP-3766	PROF	QA3387A	GP-46	QKS
PZA-199	GA-514	PEN	PZ118A	GP-3531 EXP	PEN	Q291	GP-3531 EXP	PROF	QA34356	GA-390	QAP
PZA2	GA-71	PEN	PZ119	GP-3600	PEN	Q31	G-31	FLL	QA34361	GA-139	QAP
PZA200	GA-164	PEN	PZ12	GP-20	PEN	Q33	GP-20	PROF	QA34479	GA-6479	QAP
PZA-201	GA-442	PEN	PZ1-21	GP-58 ¹⁵	PEN	Q330	G-330	FLL	QA34487	GA-382	QAP
PZA-202	GAD-118	PEN	PZ1-22	GP-310	PEN	Q333	G-333	FLL	QA34613	GA-142	QAP
PZA-203	GA-240	PEN	PZ1228	GP-3675	PEN	Q335	G-335	AIR	QA3465	GA-277	PROF
PZA204	GA-732R	PEN	PZ1248	GP-44	PEN	Q335	G-335	FLL	QA3467	GA-4325	PROF
PZA205	GA-166	PEN	PZ125	GP-44	PEN	Q4006	GP-44	PROF	QA3472	GA-274	PROF
PZA206	GA-1615	PEN	PZ126	GP-58	PEN	Q4011	GP-3980	PROF	QA3474	GA-3681	PROF
PZA207	GA-130	PEN	PZ1-27	GP-3682	PEN	Q4244	G-296	GEC	QA3490	GA-3916	PROF
PZA208	GA-158	PEN	PZ128	GP-44	PEN	Q4244	G-296-B	GEC	QA3491	GA-3814	PROF
PZA209	GA-277	PEN	PZ1-29	GP-3980	PEN	Q4244	G-296	GENE	QA3592	GA-273	PROF
PZA21	GA-54	PEN	PZ13	GP-3	PEN	Q4244	G-296-B	GENE	QA3807A	GP-462	QKS
PZA-210	GA-1614	PEN	PZ130	GP-3985	PEN	Q424-4	G-296	DORM	QA39	GP-69	QKS
PZA-211	GA-7142	PEN	PZ133	GP-91	PEN	Q424-4	G-296-B	DORM	QA3950	GP-40	QKS
PZA212	GAVW-620	PEN	PZ134	GP-81	PEN	Q4457	GP-3682	PROF	QA4	GA-70	PROF
PZA-214	GA-384	PEN	PZ135	GP-28 ⁹	PEN	Q4460	GP-91	PROF	QA40004	GA-70	QAP
PZA217	GA-279	PEN	PZ135	GP-430 ⁸	PEN	Q4476	GP-157	PROF	QA40015	GA-3490	QAP
PZA218	GA-127	PEN	PZ136	GP-149	PEN	Q4477	GP-156	PROF	QA40016	GA-2740	QAP
PZA219	GA-172	PEN	PZ137	GP-91	PEN	Q4612	GP-91	PROF	QA40090	GA-303	QAP
PZA22	GA-325	PEN	PZ138	GP-157	PEN	Q4619	GP-3985	PROF	QA40113	GA-75	QAP
PZA220	GA-198	PEN	PZ139	GP-157	PEN	Q4620	GP-149	PROF	QA40120	GA-74	QAP
PZA2200	GA-132	PEN	PZ142	GP-68	PEN	Q4622	GP-91	PROF	QA40129	GA-3424	QAP
PZA2203	GA-240	PEN	PZ145	GP-205	PEN	Q4631	GP-205	PROF	QA40131	GA-3425	QAP
PZA2204	GA-732R	PEN	PZ146	GP-91	PEN	Q4651	GP-68	PROF	QA4278	GAD-15	PROF
PZA-222	GA-4365	PEN	PZ147	GP-178	PEN	Q4670	GP-81	PROF	QA43138	GA-54	QAP
PZA224	GA-128	PEN	PZ148	GP-562	PEN	Q4872	GP-562	PROF	QA43149	GA-3523	QAP
PZA225	GA-166	PEN	PZ15	GP-13	PEN	Q49	GP-3	PROF	QA43195	GA-3588	QAP
PZA227	GA-301	PEN	PZ151	GP-128	PEN	Q500	G-500	FLL	QA43357	GA-3637	QAP
PZA228	GA-595	PEN	PZ1-52	GP-408	PEN	Q511	G-1173	FLL	QA4342	GA-253	PROF
PZA23	GA-86	PEN	PZ17	GP-81 ³¹	PEN	Q512	G-1175	FLL	QA4343	GA-5056	PROF
PZA-232	GA-2198 ²⁹	PEN	PZ17	GP-9 ⁵⁸	PEN	Q522	G-1174	FLL	QA43467	GA-4325	QAP
PZA-232	GA-438 ³¹	PEN	PZ19A	GP-46	PEN	Q5230	GP-128	PROF	QA4347	GA-153	PROF
PZA233	GA-163	PEN				Q5274	G-765	PROF	QA43474	GA-3681	QAP
PZA-234	GA-476	PEN				Q5288	GP-3675	PROF	QA4356	GA-390	PROF
PZA235	GA-170	PEN				Q5335	GP-178	PROF	QA4361	GA-139	PROF
PZA236	GA-8606	PEN				Q566	G-566	FLL	QA4372	GA-3901	PROF
PZA237	GA-348	PEN				Q5L7564	G-1166	FLL	QA4375	GA-362	PROF
PZA238	GAVW-121	PEN				Q6H5931	G-1166	FLL	QA4378	GA-174	PROF
PZA24	GAD-1	PEN				Q6H5932	G-1166	FLL	QA44632	GA-275	QAP
PZA240	GAVW-621	PEN				Q6H9999	G-238	FLL	QA4468	GA-195	PROF
PZA241	GA-278R	PEN				Q6PL	G-6	FLL	QA4479	GA-6479	PROF
PZA242	GA-168	PEN				Q71	G-1163	FLL	QA4487	GA-382	PROF
PZA243	GA-6479	PEN				Q750	G-750	FLL	QA45	GA-77	PROF
PZA244	GA-224	PEN				Q751211	GP-34	CRSS	QA46	GP-3816	QKS
PZA245	GA-472	PEN				Q7M3800	G-191	FLL	QA4613	GA-142	PROF
PZA25	GAD-3	PEN				Q806	G-836	FLL	QA4632	GA-275	PROF
PZA-250	GA-286	PEN				Q81	GP-81 ³¹	PROF	QA4645	GA-6690	PROF
PZA-251	GA-304	PEN				Q81	GP-9 ⁵⁸	PROF	QA4650	GA-604	PROF
PZA253	GA-183	PEN				Q815F	GP-26	FLL	QA4656	GA-7017	PROF
PZA-254	GA-491	PEN				Q816F	GP-27	FLL	QA4680	GA-386	PROF
PZA-255	GA-413R	PEN	Q0250299	GAK-625	DERR	Q834	G-834	FLL	QA4690	GA-322	PROF
PZA257	GA-248	PEN	Q0250299	GAK-625	DUTZ	Q9F6700	G-191	FLL	QA4712	GA-217	PROF
PZA-259	GA-194	PEN	Q02505-99	GAK-625	POCL	Q9H1252	G-1166	FLL	QA4715	GA-7142	PROF
PZA26	GA-164	PEN	Q05H4115	G-1121F	DUTZ	Q9H4729	G-1166	FLL	QA4720	GA-7344	PROF
PZA-260	GA-780	PEN	Q05H4115	G-1121F	DUTZ	QA110A	GAD-3	PROF	QA4721	GA-198	PROF
PZA-261	GA-2114	PEN	Q05H4115	G-1121	FAUN	QA11149	GAVW-2	QAP	QA4722	GA-5466	PROF
PZA-262	GA-183R	PEN	Q05H4115	G-1121	KHDF	QA113	GA-75	PROF	QA4727	GA-300	PROF
PZA-263	GA-264	PEN	Q05H4115	G-1121	KRAM	QA1149	GAVW-2	PROF	QA4731	GA-165	PROF
PZA-264	GA-258	PEN	Q05H4117	GP-1122	DUTZ	QA120	GA-74	PROF	QA4799	GA-381	PROF
PZA-265	GA-479	PEN	Q05H4117	GP-1122	KHDF	QA124	GA-27198 ¹²²	PROF	QA4819	GA-141	PROF
PZA-265	GA-479	PEN	Q09505-58	GP-1	POCL	QA124	GA-3300 ⁹⁸	PROF	QA4831	GAD-118	PROF
PZA-267	GA-293	PEN	Q1101	GP-1101	FLL	QA131	GA-3425	PROF	QA4852	GA-392	PROF
PZA268	GA-395	PEN	Q1103	GP-1101	FLL	QA16	GA-2740	PROF	QA4858	GA-127	PROF
PZA-269	GA-414R	PEN	Q111	GP-46	PROF	QA24299	GA-180	QAP	QA4873	GA-514	PROF
PZA270	GA-244	PEN	Q123	GP-3429	PROF	QA24339	GA-3915	QAP	QA4877	GA-175	PROF
PZA271	GA-490	PEN	Q132	G-33	FLL	QA24342	GA-253	QAP	QA4878	GA-1615	PROF
PZA-272	GA-477	PEN	Q132-HD	G-33	FLL	QA24343	GA-5056	QAP	QA4879	GA-1616	PROF
PZA28	GA-673R	PEN	Q132-S	G-33	FLL	QA24372	GA-3901	QAP	QA4880	GA-164	PROF
PZA3	GA-80	PEN	Q141	G-200	FLL	QA24375	GA-362	QAP	QA50084	GA-730	QAP
PZA326	GA-8606	PEN	Q147	G-119	FLL						

Números Nuevos

Q

Numero	Gonher	Fabricante	Numero	Gonher	Fabricante	Numero	Gonher	Fabricante	Numero	Gonher	Fabricante
Number	Gonher	Manufacturer	Number	Gonher	Manufacturer	Number	Gonher	Manufacturer	Number	Gonher	Manufacturer
QA50091	GA-59	QAP	QS2825	GP-38	QKS	QS5618	GP-457	QKS	QSA34878	GA-1615	QKS
QA50092	GA-57	QAP	QS2842	GP-36	QKS	QS6552	GP-212	QKS	QSA34879	GA-1616	QKS
QA50093	GA-325	QAP	QS2844	GP-81 ²¹	QKS	QS6607	GP-91	QKS	QSA3490	GA-3490	QKS
QA5042	GA-442	PROF	QS2844	GP-9 ³⁸	QKS	QS6811	GP-149 ⁹⁹	QKS	QSA3497	GA-75	QKS
QA5048	GA-132	PROF	QS2846B	GP-46	QKS	QS6811	GP-91 ⁹⁴	QKS	QSA3501	GA-3501	QKS
QA50831	GA-85	QAP	QS2849	GP-24 ²⁶	QKS	QS6848	G-971	QKS	QSA351	GA-75	QKS
QA5090	GA-673R	PROF	QS2849	GP-462 ²⁴	QKS	QS7	GP-81	QKS	QSA35155	GA-130	QKS
QA5148	GA-384	PROF	QS2849A	GP-24 ²⁶	QKS	QS7317	GP-149	QKS	QSA35192	GA-158	QKS
QA5150	GA-172	PROF	QS2849A	GP-462 ²⁴	QKS	QS7328	GP-81	QKS	QSA352	GAD-1	QKS
QA5155	GA-130	PROF	QS2850	GP-1	QKS	QS8	GP-1	QKS	QSA3523	GA-3523	QKS
QA5192	GA-158	PROF	QS2856	GP-3985	QKS	QS8081	G-954	QKS	QSA35244	GA-607	QKS
QA5227	GA-279	PROF	QS2856A	GP-46	QKS	QS8158	G-112	QKS	QSA353	GAD-3	QKS
QA5248	GA-163	PROF	QS2865A	GP-42	QKS	QS8481	G-180	QKS	QSA3537	GA-54	QKS
QA5265	GA-8606	PROF	QS2870	GP-28 ⁸⁴	QKS	QS8712	G-72	QKS	QSA3549	GA-89	QKS
QA52923	GA-3501	QAP	QS2870	GP-3600 ⁸⁴	QKS	QS8765	G-765	QKS	QSA35528	GA-1617	QKS
QA5314	GA-348	PROF	QS2870	GP-38 ⁸⁷	QKS	QS8806	G-45	QKS	QSA3559	GA-271	QKS
QA5323	GA-224	PROF	QS2870	GP-43 ⁸⁵	QKS	QS8873	GP-408	QKS	QSA3566	GA-3566	QKS
QA5324	GA-168	PROF	QS2870A	GP-28 ⁸⁴	QKS	QS8A	GP-1	QKS	QSA3588	GA-3588	QKS
QA5330	GA-6479 ⁹⁰	PROF	QS2870A	GP-3600 ⁸⁴	QKS	QS9018	G-49	QKS	QSA3597	GA-735	QKS
QA53384	GA-89	QAP	QS2870A	GP-38 ⁸⁷	QKS	QS966B	GP-3816	QKS	QSA362	GA-2984	QKS
QA5378	GA-240	PROF	QS2870A	GP-43 ⁸⁵	QKS	QS977A	GP-31	QKS	QSA3621	GA-140	QKS
QA57	GA-80	PROF	QS2951	GP-58	QKS	QSA133	GA-78	QKS	QSA3637	GA-3637	QKS
QA59	GA-50	PROF	QS2977A	GP-3985	QKS	QSA136	GA-55	QKS	QSA3642	GA-101	QKS
QA60074	GA-55	QAP	QS30	GP-3	QKS	QSA146	GA-71	QKS	QSA3647	GA-3647	QKS
QA6067	GA-1614	PROF	QS3304	GP-2071W	QKS	QSA148	GA-80	QKS	QSA3660	GA-277	QKS
QA67	GA-192	PROF	QS3306	GP-10	QKS	QSA1513	GA-135	QKS	QSA3681	GA-3681	QKS
QA74	GA-55	PROF	QS3306A	GP-10	QKS	QSA1517	GA-679	QKS	QSA3717	GA-274	QKS
QA831	GA-85	PROF	QS3335	GP-52 ¹¹⁰	QKS	QSA1517SY	GA-680	QKS	QSA381	GA-74	QKS
QA90	GA-303	PROF	QS3335	GP-691 ⁴⁸	QKS	QSA1520	GA-21	QKS	QSA3814	GA-3814	QKS
QA91	GA-59	PROF	QS3375	GP-53	QKS	QSA1533	GA-425	QKS	QSA3901	GA-3901	QKS
QA92	GA-57	PROF	QS3387	GP-46	QKS	QSA1533SY	GA-426	QKS	QSA3902	GA-253	QKS
QA93	GA-325	PROF	QS3387A	GP-46	QKS	QSA1541	GA-329	QKS	QSA3914	GA-392	QKS
QA991	GA-86	PROF	QS3429	GP-3429	QKS	QSA1541SY	GA-239	QKS	QSA3915	GA-3915	QKS
QB13131	GA-101	QAP	QS3431	GP-85	QKS	QSA1543	GA-891	QKS	QSA3916	GA-3916	QKS
QB20009	GA-100	QAP	QS3432	GP-44	QKS	QSA1543SY	GA-892	QKS	QSA3924	GA-153	QKS
QB20161	GA-113	QAP	QS34875	GP-171	QKS	QSA1548	GA-483	QKS	QSA3997	GA-216	QKS
QB43160	GA-176	QAP	QS3506	GP-44	QKS	QSA1548SY	GA-482	QKS	QSA4303	GA-4303	QKS
QC30	G-31	FLL	QS3512	GP-22	QKS	QSA1553	GA-679	QKS	QSA4309	GAD-15	QKS
QF10021	GG-123	QAP	QS3519	GP-9586	QKS	QSA1553SY	GA-680	QKS	QSA4325	GA-4325	QKS
QF10035	GG-87	QAP	QS3522	GPP-1122	QKS	QSA1581	GA-229	QKS	QSA4365	GA-4365	QKS
QF10119	GG-6	QAP	QS3528	GP-1101	QKS	QSA1588	GA-589	QKS	QSA4383	GA-471	QKS
QF10120	GG-7	QAP	QS3531	GP-3531 EXP	QKS	QSA1588SY	GA-588	QKS	QSA45047	GA-240	QKS
QF10131	GG-19	QAP	QS3535	GP-3980	QKS	QSA160	GA-70	QKS	QSA45090	GA-673R	QKS
QF10157	GG-16	QAP	QS3555	GP-57	QKS	QSA176	GA-56	QKS	QSA4521	GA-2194	QKS
QF20005	GG-45	QAP	QS3555A	GP-57	QKS	QSA184	GA-77	QKS	QSA4828	GA-4828	QKS
QF33144	GG-46	QAP	QS3562	GP-40	QKS	QSA187	GA-90	QKS	QSA4830	GA-180	QKS
QF54611	GG-61	QAP	QS3569	GP-310	QKS	QSA189	GA-50	QKS	QSA4939	GA-139	QKS
QF63169	GG-47	QAP	QS3569	GP-3569	QKS	QSA19	GA-100	QKS	QSA4958	GA-4958	QKS
QFP1	GP-1	FLL	QS3593	GP-91	QKS	QSA192	GA-192	QKS	QSA502	GA-6129	QKS
QFP11	GP-3	FLL	QS3593A	GP-91	QKS	QSA216	GA-1008	QKS	QSA5025Y	GA-6127	QKS
QFP7	GP-20	FLL	QS3594	GP-92	QKS	QSA224	GA-8047	QKS	QSA5056	GA-5056	QKS
QL10017	GP-81	QAP	QS3595	GP-93	QKS	QSA226	GA-9334	QKS	QSA5058	GA-273	QKS
QL10111	GP-46	QAP	QS36	GP-36	QKS	QSA229	GA-18	QKS	QSA507	GA-106 ⁴⁶	QKS
QL10291	GP-3531 EXP	QAP	QS3600	GP-3600	QKS	QSA233	GA-9045	QKS	QSA507	GA-326 ⁷¹	QKS
QL14619	GP-3985	QAP	QS3612	GP-43 ³⁰	QKS	QSA234	GA-1287	QKS	QSA5075Y	GA-206	QKS
QL20033	GP-20	QAP	QS3612	GP-53 ⁴⁶	QKS	QSA235	GA-1284	QKS	QSA523	GA-360	QKS
QL20049	GP-3	QAP	QS3614	GP-58	QKS	QSA236	GA-1286	QKS	QSA523SY	GA-361	QKS
QL20081	GP-81 ²¹	QAP	QS3651A	GP-171	QKS	QSA237	GA-1285	QKS	QSA5350	GA-2114	QKS
QL20081	GP-9 ³⁸	QAP	QS3664	GP-3985	QKS	QSA239	GA-375	QKS	QSA536	GA-356	QKS
QL20123	GP-3429	QAP	QS3675	GP-44	QKS	QSA24	GA-113	QKS	QSA5365Y	GA-357	QKS
QL20195	GP-3600	QAP	QS3675A	GP-3675	QKS	QSA240	GA-37	QKS	QSA542	GA-31	QKS
QL22167	GP-171	QAP	QS3682	GP-3682	QKS	QSA24720	GA-7344	QKS	QSA5466	GA-5466	QKS
QL24011	GP-3980	QAP	QS3710	GP-92	QKS	QSA248	GA-29	QKS	QSA5595	GA-595	QKS
QL24457	GP-3682	QAP	QS3711	GP-1122	QKS	QSA24831	GAD-118	QKS	QSA595	GA-378	QKS
QL24651	GP-68	QAP	QS373	GP-23	QKS	QSA24858	GA-127	QKS	QSA596	GA-6880	QKS
QL30001	GP-1	QAP	QS3766	GP-3766	QKS	QSA24859	GA-128	QKS	QSA597	GA-229	QKS
QL30040	GP-13	QAP	QS3767	GP-155	QKS	QSA25042	GA-442	QKS	QSA598	GA-7716	QKS
QL30257	GP-310	QAP	QS3807	GP-462	QKS	QSA25048	GA-132	QKS	QSA598SY	GA-7360	QKS
QO5H4115	G-1121	DUTZ	QS3807A	GP-462	QKS	QSA25148	GA-384	QKS	QSA6305	GA-390	QKS
QO5H4115	G-1121	FAHR	QS3816	GP-3816	QKS	QSA25456	GA-184	QKS	QSA6333	GA-382	QKS
QO5H4115	G-1121	KRAM	QS39	GA-263	QKS	QSA25463	GA-263	QKS	QSA6362	GA-362	QKS
QO5H4115	G-1121	KRAM	QS393	GP-2015W	QKS	QSA26067	GA-1614	QKS	QSA6366	GA-174	QKS
QS11	GP-5	QKS	QS3950	GP-40	QKS	QSA268	GA-5648	QKS	QSA6376	GA-142	QKS
QS1101	GP-1101	QKS	QS3963	GP-171	QKS	QSA2709A	GAD-1 ⁹⁷	QKS	QSA6395	GA-195	QKS
QS1103	GP-114	QKS	QS3976	GP-178	QKS	QSA2719	GA-2719B	QKS	QSA6479	GA-6479	QKS
QS1104	GP-110	QKS	QS3980	GP-3980	QKS	QSA2719B	GA-2719B	QKS	QSA6491	GA-129	QKS
QS1109	GP-83	QKS	QS3985	GP-3985	QKS	QSA2740	GA-2740	QKS	QSA6545	GAUV-120	QKS
QS1110	GP-84	QKS	QS40	GP-69	QKS	QSA288	GA-1203	QKS	QSA6555	GA-275	QKS
QS1130	G-295	QKS	QS42	GP-10 ⁶⁷	QKS	QSA292	GA-37	QKS	QSA6558	GA-2106	QKS
QS1146	GP-26	QKS	QS42	GP-69 ²⁹	QKS	QSA303	GA-303	QKS	QSA6619	GA-6619 ¹	QKS
QS1147	GP-27	QKS	QS43	GP-81 ²¹	QKS	QSA305	GA-730	QKS	QSA6619	GA-6620 ⁵	QKS
QS1147A	GP-27	QKS	QS43	GP-9 ³⁸	QKS	QSA324	GA-85	QKS	QSA6664	GA-166	QKS
QS13	GP-13	QKS	QS4386	GP-156	QKS	QSA324A	GA-85	QKS	QSA6690	GA-6690	QKS
QS14006	GP-44	QKS	QS44872	GP-562	QKS	QSA325	GA-325	QKS	QSA6807	GA-386	QKS
QS14610	GP-149	QKS	QS45335	GP-178	QKS	QSA326	GA-59	QKS	QSA6828	GA-133	QKS
QS14612	GP-91	QKS	QS45515	G-3752	QKS	QSA327	GA-57	QKS	QSA6850	GAD-294	QKS
QS16	GP-81	QKS	QS46	GP-3816	QKS	QSA329	GA-135	QKS	QSA7017	GA-7017	QKS
QS1653	GP-66	QKS	QS4681	GP-28 ⁸⁴	QKS	QSA3300	GA-3300	QKS	QSA7071	GA-7071	QKS
QS1654	GP-66	QKS	QS4681	GP-430 ⁸⁷	QKS	QSA3373	GAUV-2	QKS	QSA7094	GA-604	QKS
QS1654A	GP-66	QKS	QS47	GP-34	QKS	QSA340	GA-86	QKS	QSA7142	GA-7142	QKS
QS19	GP-1	QKS	QS4731	GP-3985	QKS	QSA340A	GA-86	QKS	QSA7174	GA-381	QKS
QS2	GP-68	QKS	QS4967	GP-157	QKS	QSA3424	GA-3424	QKS	QSA7351	GA-322	QKS
QS20	GP-14	QKS	QS49A	GP-51	QKS	QSA3425	GA-3425	QKS	QSA7365	GA-217	QKS
QS200	G-200	QKS	QS5	GP-205	QKS	QSA3441	GA-277	QKS	QSA7414	GA-141	QKS
QS25	GP-20	QKS	QS50	GP-50	QKS	QSA347	GA-429	QKS	QSA7417	GA-198	QKS
QS25230	GP-128	QKS	QS5320	G-963	QKS	QSA34877	GA-175	QKS	QSA7420	GA-514	QKS

Referencia Cruzada por Numero de Parte

Cross Reference by Part Number



Numero	Gonher	Fabricante	Numero	Gonher	Fabricante	Numero	Gonher	Fabricante	Numero	Gonher	Fabricante
Number	Gonher	Manufacturer	Number	Gonher	Manufacturer	Number	Gonher	Manufacturer	Number	Gonher	Manufacturer
QSA7421	GA-165 ¹³	QKS	QSG3727	GG-46	QKS	R1Y	G-200	FORD	R27207	GAK-20	CASE
QSA7426	GA-432	QKS	QSG3802	GG-47	QKS	R2	GP-5	RPS	R27R34Z	G-296	COM
QSA7431	GAVW-121	QKS	QSG3802A	GG-47	QKS	R20	GP-81	PUR	R27R34Z	G-296-B	COM
QSA7440	GA-300	QKS	QSG4191	GG-203	QKS	R20	GP-81 ³¹	RPS	R29	GP-34	PUR
QSA7597	GA-164	QKS				R20	GP-9 ⁵⁸	RPS	R294P	G-33	RYCO
QSA7614	GAVW-620	QKS				R2001P	G-871	RYCO	R294PB	G-33	RYCO
QSA7620	GA-2198 ⁷⁹	QKS				R2002P	G-871	RYCO	R294V	G-33	RYCO
QSA7620	GA-438 ³¹	QKS				R2006P	G-6	RYCO	R3	G-200	RPS
QSA7640	GA-240	QKS				R2006PB	G-6	RYCO	R30	G-31	RYCO
QSA7651	GAVW-622	QKS				R2007P	G-870	RYCO	R3019	GG-123	STAM
QSA77	GA-7	QKS				R2008P	G-162H	RYCO	R302	GP-28 ⁶	TNC
QSA7764	GA-172	QKS				R2008P	G-225	RYCO	R302	GP-430 ⁸	TNC
QSA7774	GA-1616	QKS				R2022V	G-870	RYCO	R3020	GG-6	STAM
QSA7775	GA-476	QKS				R2034P	G-871	RYCO	R3021	GG-7	STAM
QSA8037	GA-732R	QKS				R2037P	G-1173 ¹⁰⁸	RYCO	R3022	GG-16	STAM
QSA8133	GA-163	QKS				R2045P	GG-48	RYCO	R3023	GG-17	STAM
QSA8141	GA-1614	QKS				R2047P	G-1123	RYCO	R307	GP-40	TNC
QSA8205	GA-301	QKS				R205P	G-871	RYCO	R309	GP-77	TNC
QSA8221	GA-279	QKS				R205PB	G-871	RYCO	R31	GP-78	PUR
QSA8269	GA-472	QKS				R205PD	G-871	RYCO	R31	G-178	RAR
QSA8475	GA-170	QKS				R205VA	G-871	RYCO	R310	GP-40	TNC
QSA8548	GA-304	QKS				R205VB	G-871	RYCO	R317	GP-46	TNC
QSA8602	GAVW-621	QKS	R006	G-870	LUC	R205VC	G-871	RYCO	R32112-R	GPP-14	JOND
QSA8606	GA-8606	QKS	R0250508	GG-1	POCL	R2061P	G-813	RYCO	R327	GP-455	TNC
QSA8747	GA-258	QKS	R05H4115	G-1121F	DUTZ	R2066P	G-331	RYCO	R34	GP-68	TNC
QSA8754	GA-6479 ⁹⁰	QKS	R05H4115	G-1121F	KHDF	R2066PB	G-331	RYCO	R34736	GPP-14	JOND
QSA8755	GA-348	QKS	R0747	GAVW-2	TECF	R2068P	G-836	RYCO	R34736-R	GPP-14	JOND
QSA8760	GA-183	QKS	R0868	GAD-1	TECF	R2069P	G-834	RYCO	R34762	GAK-1532	CASE
QSA8766	GA-491	QKS	R09505-59	GP-36	POCL	R206VB	G-870	RYCO	R35736-R	GPP-14	JOND
QSA8805	GA-278R	QKS	R0964	GA-230	TECF	R2071P	G-833	RYCO	R4	GP-3816	RPS
QSA8817	GA-477	QKS	R0996	GAK-20	TECF	R2071PA	G-833	RYCO	R406	GP-1	TNC
QSA8911	GA-194	QKS	R1	GP-1	RPS	R2072P	G-238	RYCO	R408P	G-191	RYCO
QSA8918	GA-286	QKS	R10	GP-22	TNC	R2091P	G-236	RYCO	R408PA	G-191	RYCO
QSA8925	GA-780	QKS	R102A	GP-31	RYCO	R2106	G-1174 ¹⁰⁸	RYCO	R413	G-1174 ¹⁰⁸	RYCO
QSA8956	GA-479	QKS	R102C	GP-31	RYCO	R2106P	G-1174	RYCO	R414P	G-1173 ¹⁰⁸	RYCO
QSA8969	GA-168	QKS	R102P	G-31	RYCO	R2112P	G-335	RYCO	R42	G-1143	RYCO
QSA8997	GA-224	QKS	R10R6	G-1174	COM	R2115P	G-1173 ¹⁰⁸	RYCO	R42	GP-462	TNC
QSA9053	GA-183R	QKS	R11	GP-3816	TNC	R2121P	G-870	RYCO	R424	GP-40	TNC
QSA9054	GA-248	QKS	R1161	GP-66 ⁹⁰	ROTO	R2123P	G-330	RYCO	R428	GP-3531 EXP	TNC
QSA9269	GA-413R	QKS	R120P	R120P	GONH	R2124P	G-200	RYCO	R42P	G-1143	RYCO
QSA9332	GA-395	QKS	R120P	R120P	RAR	R2132P	G-296	RYCO	R43	GPP-547 ³⁹	RAR
QSA9345	GA-414R	QKS	R13	G-335	PUR	R2132P	G-296-B	RYCO	R43	PPF831 ⁴⁰	RAR
QSA9359	GA-293	QKS	R13	GP-46	TNC	R2151P	G-238	RYCO	R43	R 60 P ⁴⁰	RAR
QSA9360	GA-264	QKS	R-13	G-335	PUMX	R2152P	GG-20	RYCO	R432	G-1143	RYCO
QSA9400	GA-780	QKS	R132	GP-13	TNC	R2154P	G-870	RYCO	R44	GPP-1287 ³⁹	RAR
QSA9401	GA-490	QKS	R134	GP-3	TNC	R2155P	G-152	RYCO	R44	PPF831 ⁴⁰	RAR
QSAK1563	GA-33 ¹¹²	QKS	R1350575	GP-54 ¹¹	CASE	R2165P	G-139	RYCO	R44	R 60 P ⁴⁰	RAR
QSAK253	GAK-16	QKS	R1350575	GP-66 ¹⁰	CASE	R2176P	G-834	RYCO	R443	GP-40	TNC
QSAK254	GAK-20	QKS	R13505-75	GP-54 ¹¹	POCL	R2211P	G-870	RYCO	R458	GP-3816	TNC
QSAK256	GA-33 ¹¹²	QKS	R13505-75	GP-66 ¹⁰	POCL	R2221P	G-222	RYCO	R462	GP-58	TNC
QSAK257	GA-26	QKS	R13R6	G-1174 ¹⁰⁸	COM	R2228P	G-5000	RYCO	R468	GP-390 ³³	TNC
QSAK258	GAK-403	QKS	R14	G-139	PUR	R224	GP-28 ⁶	TNC	R48	GP-171	TNC
QSAK259	GA-27 ¹¹²	QKS	R14	GP-46	TNC	R224	GP-430 ⁸	TNC	R49	GP-1	TNC
QSAK5052S	GA-33 ¹¹²	QKS	R-14	G-139	PUMX	R2243P	GP-81	RYCO	R5	G-191	PUR
QSAK510	GA-98 ¹¹²	QKS	R14458	G-33	CASE	R2245P	G-330	RYCO	R-5	G-191	PUMX
QSC1114	G-297	QKS	R15	GP-14	PUR	R226	GP-42	TNC	R50	GP-50	TNC
QSC1114	G-297-B	QKS	R16	GPP-14	PUR	R2263P	G-871	RYCO	R51	GP-50	TNC
QSC1173	G-1173	QKS	R16	GP-20	RPS	R2279P	G-613	RYCO	R52	GP-50	TNC
QSC1175	G-1175	QKS	R169	GP-500	RYCO	R2281P	G-870	RYCO	R54	GP-3816	TNC
QSC1191A	G-296	QKS	R169	GP-171	TNC	R2294P	G-1121	RYCO	R57	GP-28 ⁶	TNC
QSC1191A	G-296-B	QKS	R16943	GP-34	JOND	R2294V	G-1121	GUD	R57	GP-430 ⁸	TNC
QSC127	G-1173	QKS	R16951	G-295	JOND	R2294V	G-1121F	RYCO	R6	GP-38	RPS
QSC14	G-5000	QKS	R17	GP-31	PUR	R2309	G-122	RYCO	R600L422	G-31	CONT
QSC175E	G-750	QKS	R17	GP-13	RPS	R2309	G-338	RYCO	R600L424	G-31	CONT
QSC175T	G-750	QKS	R171	GP-171	TNC	R2309P	G-122	RYCO	R600L4242	G-31	CONT
QSC191	G-191	QKS	R171P	G-1163	RYCO	R2309P	G-338	RYCO	R600L4242	G-31	CORB
QSC191A	G-191	QKS	R171PA	G-1163	RYCO	R2309PA	G-122	RYCO	R600L444	G-31	CONT
QSC211	G-566	QKS	R172P	G-1121	RYCO	R2309PA	G-338	RYCO	R600L444	G-31	CORB
QSC211A	G-566	QKS	R175	GP-81	TNC	R2312P	G-33	RYCO	R60P	GPP-1287 ³⁹	RAR
QSC218	G-34	QKS	R176	G-750	RYCO	R2317P	G-870	RYCO	R60P	PPF831 ⁴⁰	RAR
QSC236	G-236	QKS	R18	GP-3	RPS	R2317P	G-870	RYCO	R60P	R 60 P ⁴⁰	RAR
QSC236A	G-236	QKS	R1818910	GPP-125	GILB	R2323P	G-222	RYCO	R60S	GPP-1287 ³⁹	RAR
QSC238	G-238	QKS	R182	G-1173 ¹⁰⁸	RYCO	R2327P	G-191	RYCO	R60S	PPF831 ⁴⁰	RAR
QSC238A	G-238	QKS	R18505-49	G-293	POCL	R2328P	G-33	RYCO	R60S	R 60 P ⁴⁰	RAR
QSC330	G-330	QKS	R186	G-1123	RYCO	R2332P	GG-48	RYCO	R60T	GPP-1287 ³⁹	RAR
QSC333	G-333	QKS	R186	G-1123F	RYCO	R2340	G-834	RYCO	R60T	PPF831 ⁴⁰	RAR
QSC335	G-335	QKS	R19	GP-3600	RPS	R2340P	G-834	RYCO	R60T	R 60 P ⁴⁰	RAR
QSC33A	G-33	QKS	R19	GP-38	RPS	R2355	GG-6	RYCO	R61	GP-81	TNC
QSC6	G-6	QKS	R198	G-1176	RYCO	R2355P	GG-6	RYCO	R64	GP-81	TNC
QSCG11	GG-6	QKS	R1A	GP-1	FORD	R2356	GG-123	RYCO	R65	GP-1	TNC
QSCG12	GG-7	QKS	R1AB	G-236	FORD	R2361P	G-34	RYCO	R67	GP-36	TNC
QSCG13	GG-123	QKS	R1B	G-6	FORD	R2367P	G-834	RYCO	R68	GP-54 ¹¹	TNC
QSCG20	GG-20	QKS	R1C	G-330	FORD	R236P	G-870	RYCO	R68	GP-66 ¹⁰	TNC
QSCG3388	GG-16	QKS	R1E	G-5000	FORD	R2381PA	G-163	RYCO	R7	G-238	PUR
QSCG3389	GG-17	QKS	R1F	G-6	FORD	R2388P	G-297-B	RYCO	R-7	G-238	PUMX
QSG1	GG-1	QKS	R1H4155	G-1123	DUTZ	R240	GP-31	TNC	R70	GP-171	TNC
QSG1	GG-4	QKS	R1H4155	G-1123F	DUTZ	R2413P	G-133	RYCO	R75	GP-81	TNC
QSG12	GG-5 L	QKS	R1H4155H	G-1123	DUTZ	R2413P	G-989	RYCO	R78	GP-14	TNC
QSG15	GG-5 L	QKS	R1H4155H	G-1123F	DUTZ	R2442	GP-38	TNC	R8	GP-31	ROLK
QSG20	GG-20	QKS	R1K	G-200	FORD	R2444P	GG-298	RYCO	R800937	GA-398	DON
QSG22	GG-19	QKS	R1M	G-236	FORD	R24926	G-191	CATP	R800969	GA-206	DON
QSG3	GG-5 L	QKS	R1N	G-750	FORD	R25511	GP-34	CASE	R801	G-31	ROLK
QSG3359	GG-45	QKS	R1R	GP-5	FORD	R25844	GP-34	CASE	R802598	GA-398	DON
QSG3499	GG-8 ¹⁰³	QKS	R1T	GP-13	FORD	R26	GPP-14	RAR	R804201	GA-106 ⁴⁰	DON
QSG3499	GG-8 L ⁸⁰	QKS	R1U	GP-5	FORD	R26P	GPP-14	RAR	R804201	GA-326 ¹	DON
QSG3596	GG-87	QKS	R1V	GP-3	FORD	R27091	G-270	JOND	R804203	GA-6129	DON

R

REFERENCIA CRUZADA

Para números Gonher con Superíndice vea página 651
For Gonher with Superscript numbers see page 651

Referencia Cruzada por Numero de Parte

Cross Reference by Part Number



Numero	Gonher	Fabricante	Numero	Gonher	Fabricante	Numero	Gonher	Fabricante	Numero	Gonher	Fabricante
Number	Gonher	Manufacturer	Number	Gonher	Manufacturer	Number	Gonher	Manufacturer	Number	Gonher	Manufacturer
S101CP	G-5000	WGB	S1810NR	GPP-1122	SOFM	S30262A	G-222	CATP	S-58	GP-91	SHE
S1026	G-1175 ¹⁰⁸	GLD	S181CP	G-1173 ¹⁰⁸	WGB	S30621	G-1175 ¹⁰⁸	AUTC	S58CP	G-1173 ¹⁰⁸	WGB
S102CP	G-1174 ¹⁰⁸	WGB	S1834	GA-7344	AMS	S3062-1	G-1175 ¹⁰⁸	CUMM	S59	GP-34	AMBA
S103CP	G-1175 ¹⁰⁸	WGB	S1864	GA-390	AMS	S3062-1A	G-1175 ¹⁰⁸	CUMM	S59	GP-34	CRSS
S104CP	G-1176	WGB	S1881	GAP-379	AMS	S3062A	G-1175 ¹⁰⁸	ALCH	S59	GP-34	FLUI
S1050	GA-12	AMS	S1886	GA-128	AMS	S3062A	G-1175 ¹⁰⁸	AUTC	S59	GP-34	MIFP
S1059	GA-230	AMS	S188CP	G-836	WGB	S3062A	G-1175 ¹⁰⁸	CASE	S-60	GP-28 ⁶	SHE
S106338	G-31	AERO	S189CP	G-152	WGB	S3062A	G-1175 ¹⁰⁸	CORB	S-60	GP-430 ⁸	SHE
S1074	GA-105	AMS	S1901	GA-3445	AMS	S3062A	G-1175 ¹⁰⁸	CUMM	S60427	G-870	LNCR
S1099	GA-44	AMS	S1910	GA-514	AMS	S3062A	G-1175 ¹⁰⁸	DAVI	S-61	GP-462	SHE
S11023	GA-26	GMCX	S1919	GA-217	AMS	S3062A	G-1175 ¹⁰⁸	DIAM	S62427	GP-66	CASE
S1132	GA-8047	NUE	S1919	GA-224 ¹¹⁰	AMS	S3062A	G-1175 ¹⁰⁸	EUCL	S-63	GP-205	SHE
S1144	GA-360	NUE	S1925	GA-301	AMS	S3062A	G-1175 ¹⁰⁸	FIAT	S-65	GP-171	SHE
S11465	GA-31	GMCX	S1941	GA-476	AMS	S3062A	G-1175 ¹⁰⁸	FLXI	S-66	GP-44	SHE
S114CP	GP-5	WGB	S1953	GA-253	AMS	S3062A	G-1175 ¹⁰⁸	FWDX	S6607	GP-91	STP
S115	G-34	HUT	S1967	GA-595	AMS	S3062A	G-1175 ¹⁰⁸	LETR	S-67	GP-178	SHE
S1157	GA-200	AMS	S196CP	G-566	WGB	S3062A	G-1175 ¹⁰⁸	LORA	S6800NR	GP-1122	SOFM
S1157	GP-58	AMS	S1980	GA-183	AMS	S3062-A	G-1175 ¹⁰⁸	WHIT	S-69	GP-128	SHE
S115CP	G-333	WGB	S1983	GAVW-621	AMS	S306CP	GP-85	WGB	S-70	GP-765	SHE
S1166	GP-81	BUSH	S1987	GA-163	AMS	S-31	GP-1	SHE	S-71	GP-562	SHE
S117745	GAK-625	CASE	S1996	GA-286	AMS	S311CP	GP-46	WGB	S7111NC	G-296	SOFM
S118	G-335	HUT	S1999	GA-244	AMS	S-32	GP-28 ⁶	SHE	S7111NC	G-296-B	SOFM
S119CP	GP-1101	WGB	S2	G-31	ACD	S-32	GP-430 ⁸	SHE	S71CP	G-238	WGB
S118-C	G-750	WGB	S201CP	G-33	WGB	S320	GP-2071W	PER	S72	GP-1	SUN
S1231	GA-694	NUE	S2050512	GP-310	ALBA	S320	GP-2071W	WGB	S-73	GP-58	SHE
S1246	GG-48	JCBM	S2062	GA-356	NUE	S3200	GA-33 ¹¹²	BOG	S73840	G-200	CASE
S1258	GA-154	AMS	S207-23-603	GA-49	MZDA	S3201	GPP-11	RAR	S-74	GP-156	SHE
S12634	GP-50	LINC	S2079	GA-229	NUE	S3202	GA-361	BOG	S74CP	G-33	WGB
S127C	G-870	WGB	S2095	GA-493 ¹⁰⁸	NUE	S3202	S 3202 ⁴⁰	RAR	S75	GP-750	ACD
S127CP	G-870	WGB	S-21	GP-171	SHE	S3203	GA-206	BOG	S-75	GP-3985	SHE
S128CP	G-871	WGB	S2100	GA-71	BOG	S3203	GPP-11	RAR	S750C	GP-750	WGB
S13	G-139	HUT	S2106	GA-200	BOG	S3204	GPP-14	RAR	S751	GP-750	ACD
S1322	GA-329	NUE	S2106	GP-58	BOG	S3225P	GPP-1287 ³⁹	RAR	S75CP	G-139	WGB
S1330	GA-109	NUE	S211CP	G-225	WGB	S3225P	S 3225 P ⁴⁰	RAR	S-76	GP-3675	SHE
S133CP	GA-39	WGB	S214CP	G-222	WGB	S3226FLO2	GPP-1291 ³⁹	ALNC	S-77	GP-81	SHE
S13505-53	GP-53	POCL	S2193	GAK-625	BOG	S3226FLO2	S 3226 P ⁴⁰	ALNC	S806	GP-3816	HARM
S1350576	GP-36	CASE	S21CP	G-1163	WGB	S3226P	GPP-1291 ³⁹	RAR	S807	GP-50	HARM
S13505-76	GP-36	POCL	S-22	GP-38	SHE	S3226P	PF831 ⁴⁰	RAR	S808	GP-81 ³¹	HARM
S1351	GA-2984	NUE	S221106	GAK-20	CASE	S3226P	S 3226 P ⁴⁰	RAR	S808	GP-9 ³⁸	HARM
S1379	GA-229	NUE	S221347	GA-27 ¹¹²	CASE	S3226T	GPP-1000	RAR	S8111NC	G-297-B	SOFM
S140CP	GG-20	WGB	S221CP	G-169	WGB	S3230	GPP-11	RAR	S821	GP-50	HARM
S1466	GA-216	AMS	S224636	GA-357	CASE	S3230P	GPP-11	RAR	S8212	GP-212	STP
S147CP	G-1166	WGB	S224636	GA-357	DROT	S326	G-1174 ¹⁰⁸	GLD	S826	GP-54	HARM
S148CP	G-1166	WGB	S224637	GA-356	CASE	S328	G-1174 ¹⁰⁸	GLD	S833	GP-38	HARM
S149CP	G-1166	WGB	S224637	GA-356	DROT	S330	GP-2071W	PER	S836	GP-46	HARM
S1501	GA-2110	AMS	S226CP	GP-20	WGB	S330	GP-2071W	WGB	S83CP-A	GP-1	WGB
S150CP	G-1166	WGB	S-23	GP-81 ³¹	SHE	S331	GP-2071W	PER	S843	GP-81	HARM
S151CP	GP-13	WGB	S-23	GP-9 ³⁸	SHE	S331	GP-2071W	WGB	S8481	G-180	STP
S1529	GA-27 ¹¹²	NUE	S230CP	GP-84	WGB	S3315A	GAVW-617	SOFM	S850	GP-462	HARM
S152CP	G-1143	WGB	S231996	GA-360	CASE	S-34	GP-40	SHE	S85142	GA-2804 T	PUR
S1530	GA-109	NUE	S234CP	GP-83	WGB	S35	G-31	HUT	S854	GP-14	HARM
S1534	GA-9334	NUE	S238647	GA-398	CASE	S-35	GP-3600	SHE	S859	GP-28 ⁶	HARM
S154CP	G-335	WGB	S238CP	G-34	WGB	S3506	GP-44	STP	S859	GP-430 ⁸	HARM
S1556	GA-9045	NUE	S239CP	G-296	WGB	S3569	GP-310	STP	S863	GP-1122	HARM
S156	G-1173 ¹⁰⁸	GLD	S239CP	G-296-B	WGB	S3569	GP-3569	STP	S869	GP-54 ¹¹	HARM
S1565	GA-276	AMS	S2450	GA-563	NUE	S-36	GP-3531 EXP	SHE	S869	GP-66 ¹⁰	HARM
S1566	GA-209	NUE	S252CP	G-613	WGB	S3675	GP-3675	STP	S871	GP-3985	HARM
S15672	GA-106 ⁴⁶	NUE	S253CP	GP-1101	WGB	S-37	GP-58	SHE	S8712	G-72	STP
S15672	GA-326 ⁷¹	NUE	S254CP	GP-114	WGB	S373	GP-2071W	PER	S8765	G-765	STP
S15691	GAD-117	AMS	S2581	GA-378	NUE	S37975	GAK-403	CASE	S879	GP-1122	HARM
S15691	GAD-17	AMS	S2587	GA-879	NUE	S37975	GAK-403	DROT	S87CP	GP-50	WGB
S156CP	GP-3	WGB	S2595	GA-6880	NUE	S3816	GP-3816	STP	S880	GP-58 ¹⁵	HARM
S1591	GA-384	AMS	S-26	GP-46	SHE	S3976	GP-178	STP	S8873	GP-408	STP
S15C	G-31	WGB	S265CP	GP-14	WGB	S3980	GP-3980	STP	S9002	GA-403	NUE
S-16	GP-20	SHE	S266CP	GP-3	WGB	S3C	G-31	WGB	S9012	GA-7716	NUE
S1605	GA-604	AMS	S267CP	G-159	WGB	S4021	GA-483	NUE	S9033	GAK-403	BOG
S160CP	G-119	WGB	S269CP	GP-110	WGB	S41CP	G-6	WGB	S9035	GA-436	BOG
S161CP	G-834	WGB	S-27	GP-44	SHE	S422	GP-2022W	WGB	S9042	GA-3425	BOG
S166CP	GP-81	WGB	S273	GP-2071W	PER	S-43	GP-3980	SHE	S9051	GAD-15	BOG
S169	G-5000	HUT	S273CP	GP-36	WGB	S-45	GP-3985	SHE	S9053	GA-50	BOG
S1694	GA-166	AMS	S2750563	G-1121F	POCL	S453	GP-2071W	WGB	S9057	GA-3300	BOG
S1694	GAVW-622	AMS	S279CP	GP-51	WGB	S473	GP-2071W	PER	S9061	GAVW-4	BOG
S-17	GP-13	SHE	S28	GP-66	AMBA	S475	GP-1011Q	PER	S9063	GA-303	BOG
S1701	GA-6880	NUE	S28	GP-66	CRSS	S475	GP-1011Q	WGB	S9071	GAVW-2	BOG
S17016	GA-2740	SEFA	S28	GP-66	FLUI	S47CP	G-1175 ¹⁰⁸	WGB	S9076	GAVW-2	BOG
S1703	GAD-118	AMS	S28	GP-66	MIFP	S-48	GP-3682	SHE	S9085	GA-4365	BOG
S17080	GA-3445	SEFA	S28	GP-66	NORT	S48052	GA-7	SIMC	S90CP	G-236	WGB
S171CP	G-813	WGB	S-28	GP-3429	SHE	S48B-C	G-500	WGB	S9117	GAD-30	BOG
S1720	GA-31	NUE	S2808	GP-91	STP	S49	GP-3	HUT	S9121	GA-78	BOG
S1727	GA-7716	NUE	S285CP	GP-81	WGB	S5	GP-205	STP	S913	GP-171 ¹⁶	TIKO
S1728	GA-376	AMS	S2870A	GP-28 ⁸	STP	S50	G-31	HUT	S9131	GP-171 ¹⁶	TIKO
S1731	GA-7142	AMS	S2870A	GP-430 ⁸	STP	S-50	GP-157	SHE	S9132	GA-4303	BOG
S17378	GA-3566	SEFA	S29	GP-66	AMBA	S500C	G-500	WGB	S93CP	G-200	WGB
S174CP	G-331	WGB	S29	GP-66	CRSS	S-51	GP-6811	SHE	S9461	G-466	STP
S1750	GAD-129	AMS	S29	GP-66	FLUI	S-51	GP-91	SHE	S9800	GAD-1	BOG
S1752	GA-107	NUE	S29	GP-66	MIFP	S512146	G-296	LNCR	S9801	GAD-3	BOG
S17538	GA-140	SEFA	S29	GP-66	NORT	S512146	G-296-B	LNCR	S9806	GA-2740	BOG
S1760	GA-6129	NUE	S293CP	GP-81 ³¹	WGB	S51CP	G-191	WGB	S9807	GAD-3	BOG
S1766	GA-376	NUE	S293CP	GP-9 ³⁸	WGB	S-52	GP-81	SHE	S9810	GA-3490	BOG
S177CP	G-1175 ¹⁰⁸	WGB	S295CP	GP-26	WGB	S-53	GP-149	SHE	S9899	GA-467	BOG
S1788	GA-251	NUE	S296CP	GP-27	WGB	S5320	G-963	STP	S99	GP-834	HUT
S1792	GA-378	NUE	S3	GP-50	HUT	S-54	GP-68	SHE	S9928	GA-2194	BOG
S1798	GA-6128	NUE	S30	GP-331	HUT	S-55	GP-171	SHE	S9932	GA-49	BOG
S17N	G-31	GLD	S30	GP-462	SHE	S-56	GP-3766	SHE	S9933	GAK-16	BOG
S-18	GP-3	SHE	S3004	GA-2114	BOG	S-57-S-76	GP-3675	SHE	S9957	GA-277	BOG
S1810	GA-127	AMS	S3023	GAVW-121	BOG	S58	GP-34	MIFP	S9964	GA-2110	BOG

REFERENCIA CRUZADA

Para números Gonher con Superíndice

Numero	Gonher	Fabricante	Numero	Gonher	Fabricante	Numero	Gonher	Fabricante	Numero	Gonher	Fabricante
Number	Gonher	Manufacturer	Number	Gonher	Manufacturer	Number	Gonher	Manufacturer	Number	Gonher	Manufacturer
S9969	GA-467	BOG	SA-24339	GA-3915	POWF	SA-30067	GA-192	POWF	SA35396	GA-248	POWF
S9975	GA-405	BOG	SA24342	GA-253	EVGR	SA301	GA-3300	WGB	SA35414	GA-477	POWF
S9994	GAVW-2	BOG	SA-24342	GA-253	POWF	SA30110	GA-349	EVGR	SA35432	GA-264	POWF
SA 873	GA-2160	SAVA	SA24343	GA-5056	EVGR	SA-30110	GA-349	POWF	SA35433	GA-414R	POWF
SA026	GA-8047	SAVA	SA-24343	GA-5056	POWF	SA311	GAVW-2	SAVA	SA35462	GA-490	POWF
SA1	GA-71	WGB	SA24372	GA-3901	EVGR	SA3138	GA-54	SECU	SA3549	GA-89	SERP
SA100	GA-33 ¹¹²	WGB	SA-24372	GA-3901	POWF	SA3149	GA-3523	SECU	SA35528	GA-1617	POWF
SA-100	GA-673R	SHE	SA24375	GA-362	EVGR	SA315	GAVW-4	SAVA	SA35556	GA-415	POWF
SA100A	GA-33 ¹¹²	WGB	SA24375	GA-362	PUR	SA3192	GA-271	SECU	SA3559	GA-271	SERP
SA-101	GA-153	SHE	SA-24375	GA-362	POWF	SA3193	GA-735	SECU	SA3566	GA-3566	SERP
SA10165	GA-340	STP	SA24378	GA-174	EVGR	SA3195	GA-3588	SECU	SA3566	GA-3566	STP
SA1032A	GA-5056	SECU	SA-24378	GA-174	POWF	SA-32	GA-75	SHE	SA3590	GA-3916	SECU
SA10349	GA-1530	STP	SA24468	GA-195	EVGR	SA322	GA-277	SAVA	SA3591	GA-3814	SECU
SA103A	GA-27 ¹¹²	WGB	SA24468	GA-195	POWF	SA324A	GA-85	SERP	SA3592	GA-273	SECU
SA1046	GA-174	SECU	SA24468	GA-195	PUR	SA325	GA-356	WGB	SA36	GA-37	WGB
SA10468	GA-171	STP	SA24471	GA-471	POWF	SA326	GA-59	SERP	SA-36	GA-3300	SHE
SA105	GA-26	WGB	SA24645	GA-6690	EVGR	SA326	GA-6129	WGB	SA362	GA-6880	WGB
SA105A	GA-26	WGB	SA24645	GA-6690	PUR	SA327	GA-57	SERP	SA3621	GA-140	STP
SA1061	GA-275	SECU	SA-24645	GA-6690	POWF	SA-33	GA-303	SHE	SA3647	GA-3647	SERP
SA1096	GA-6479	SECU	SA24648	GA-133	EVGR	SA330	GAP-379	WGB	SA3649	GA-390	STP
SA110	GA-1285	WGB	SA24648	GA-133	PUR	SA3300	GA-3300	SERP	SA3660	GA-277	SERP
SA110A	GAD-3	SECU	SA-24648	GA-133	POWF	SA33193	GA-735	EVGR	SA368	GA-229	WGB
SA11149	GAVW-2	EVGR	SA24680	GA-386	EVGR	SA-33193	GA-735	POWF	SA3681	GA-3681	SERP
SA11149	GAVW-2	MIDS	SA24680	GA-386	POWF	SA33380	GA-3647	EVGR	SA-37	GAD-1	SHE
SA-11149	GAVW-2	POWF	SA24690	GA-322	EVGR	SA-33380	GA-3647	POWF	SA3717	GA-274	SERP
SA113	GA-75	SECU	SA24690	GA-322	POWF	SA334	GA-361	WGB	SA375	GA-75	WGB
SA113	GA-9334	WGB	SA24690	GA-322	PUR	SA33466	GA-4828	EVGR	SA376	GA-429	WGB
SA1135	GA-7017	SECU	SA24712	GA-217	EVGR	SA-33466	GA-4828	POWF	SA379	GA-86	WGB
SA114	GA-55	WGB	SA-24712	GA-217	POWF	SA33472	GA-274	EVGR	SA381	GA-74	SERP
SA119	GA-7	WGB	SA24720	GA-7344	EVGR	SA-33472	GA-274	POWF	SA381	GA-349	WGB
SA120	GA-74	SECU	SA24720	GA-7142	POWF	SA33590	GA-3916	EVGR	SA3814	GA-3814	SERP
SA120	GA-11	WGB	SA24722	GA-5466	EVGR	SA-33590	GA-3916	POWF	SA389	GAD-3	WGB
SA122	GA-29	WGB	SA24722	GA-5466	POWF	SA33591	GA-3814	EVGR	SA390	GAD-1	WGB
SA124	GA-3200	SECU	SA24731	GA-165	EVGR	SA-33591	GA-3814	POWF	SA3901	GA-3901	SERP
SA125	GA-375	WGB	SA24731	GA-165	POWF	SA337	GA-378	WGB	SA3916	GA-3916	SERP
SA126	GA-1203	WGB	SA24819	GA-141	EVGR	SA3373	GAVW-2	SERP	SA3924	GA-153	SERP
SA128	GA-8047	WGB	SA-24819	GA-141	POWF	SA338	GA-376	WGB	SA4	GA-70	SECU
SA12800	G-31	MIC	SA24831	GAD-118	EVGR	SA3380	GA-3647	SECU	SA40004	GA-70	EVGR
SA130	GA-1286	WGB	SA-24831	GAD-118	POWF	SA34356	GA-390	EVGR	SA-40004	GA-70	POWF
SA131	GA-1008	WGB	SA24858	GA-127	EVGR	SA34356	GA-390	POWF	SA40015	GA-3490	EVGR
SA13192	GA-271	EVGR	SA-24858	GA-127	POWF	SA34361	GA-139	EVGR	SA-40015	GA-3490	POWF
SA-13192	GA-271	POWF	SA24873	GA-514	EVGR	SA34361	GA-139	POWF	SA40016	GA-2740	EVGR
SA132	GA-1284	WGB	SA24873	GA-514	POWF	SA34479	GA-6479	EVGR	SA-40016	GA-2740	POWF
SA133	GA-9045	WGB	SA24880	GA-164	EVGR	SA34479	GA-6479	PUR	SA40090	GA-303	EVGR
SA133CP	GA-39	WGB	SA24880	GA-164	PUR	SA-34479	GA-6479	POWF	SA-40090	GA-303	POWF
SA134	GA-187	WGB	SA-24880	GA-164	POWF	SA34487	GA-382	EVGR	SA40113	GA-75	EVGR
SA136	GA-55	SERP	SA-25042	GA-442	POWF	SA34487	GA-382	POWF	SA-40113	GA-75	POWF
SA137	GA-135	WGB	SA25048	GA-132	EVGR	SA34613	GA-142	EVGR	SA40120	GA-74	EVGR
SA14347	GA-153	EVGR	SA-25048	GA-132	POWF	SA34613	GA-142	POWF	SA-40120	GA-74	POWF
SA-14347	GA-153	POWF	SA-25049	GA-595	POWF	SA34613	GA-142	PUR	SA40124	GA-3300	EVGR
SA146	GA-18	WGB	SA25089	GA-301	POWF	SA34625	GA-2106	POWF	SA40124	GA-3300	POWF
SA14650	GA-604	EVGR	SA25148	GA-384	EVGR	SA3465	GA-277	SECU	SA40131	GA-3425	EVGR
SA14650	GA-604	POWF	SA25148	GA-384	POWF	SA3466	GA-4828	SECU	SA-40131	GA-3425	POWF
SA14656	GA-7017	EVGR	SA252	GA-362	SECU	SA34715	GA-7142	POWF	SA404	GA-405	SAVA
SA14656	GA-7017	POWF	SA25248	GA-163	EVGR	SA3472	GA-274	SECU	SA408	GA-135	WGB
SA149	GA-7	WGB	SA-25248	GA-163	POWF	SA34721	GA-198	EVGR	SA412	GA-49	SAVA
SA150	GA-12	WGB	SA25301	GA-479	POWF	SA-34721	GA-198	POWF	SA415	GA-142	SECU
SA153	GAK-403	WGB	SA25306	GA-278R	POWF	SA34799	GA-381	EVGR	SA4303	GA-4303	SERP
SA153A	GAK-403	WGB	SA-25324	GA-168	POWF	SA34799	GA-381	POWF	SA4309	GAD-15	SERP
SA156	GAK-16	WGB	SA25418	GA-395	POWF	SA34852	GA-392	EVGR	SA43138	GA-54	EVGR
SA156A	GAK-16	WGB	SA25446	GA-780	POWF	SA-34852	GA-392	POWF	SA-43138	GA-54	POWF
SA16	GA-2740	SECU	SA25463	GA-263	POWF	SA34877	GA-175	EVGR	SA43149	GA-3523	EVGR
SA160	GA-70	SERP	SA-26	GA-59	SHE	SA34877	GA-382	POWF	SA-43149	GA-3523	POWF
SA17	G-31	MIC	SA26067	GA-1614	POWF	SA34877	GA-175	PUR	SA43195	GA-3588	EVGR
SA182	GAK-20	WGB	SA263	GA-360	WGB	SA-34877	GA-175	POWF	SA-43195	GA-3588	POWF
SA183	GAK-20	WGB	SA27	G-31	MIC	SA34878	GA-1615	EVGR	SA43398	GA-3566	POWF
SA184	GA-77	SERP	SA-27	GA-57	SHE	SA-34878	GA-1615	POWF	SA43467	GA-4325	EVGR
SA-19	GA-55	SHE	SA270	GA-206	WGB	SA34879	GA-1616	EVGR	SA-43467	GA-4325	POWF
SA192	GA-192	SERP	SA271	GA-85	WGB	SA34879	GA-1616	PUR	SA4347	GA-153	SECU
SA193	GA-5648	WGB	SA2719B	GA-2719B	SERP	SA-34879	GA-1616	POWF	SA43474	GA-3681	EVGR
SA2	GA-170	WGB	SA273	GA-325	WGB	SA34995	GAVW-121	EVGR	SA-43474	GA-3681	POWF
SA20	G-31	MIC	SA2740	GA-2740	SERP	SA34995	GAVW-121	POWF	SA44326	GA-78	EVGR
SA20070	GA-4303	EVGR	SA2740	GA-2740	STP	SA350	G-31	MIC	SA-44326	GA-78	POWF
SA-20070	GA-4303	POWF	SA275	GA-57	WGB	SA351	GA-195	SECU	SA44327	GA-4958	POWF
SA2027	GA-100	BLDW	SA276	GA-59	WGB	SA35150	GA-172	EVGR	SA44632	GA-275	EVGR
SA2039	GA-113	BLDW	SA277	GA-730	WGB	SA-35150	GA-172	POWF	SA-44632	GA-275	POWF
SA2047	GA-186	BLDW	SA278	GA-98 ¹¹²	WGB	SA35155	GA-130	EVGR	SA44727	GA-300	EVGR
SA208	GA-230	WGB	SA283	GA-106 ⁴⁶	WGB	SA-35155	GA-130	POWF	SA44727	GA-300	PUR
SA2087	GA-101	BLDW	SA283	GA-326 ⁷¹	WGB	SA35192	GA-158	EVGR	SA-44727	GA-300	POWF
SA209	GA-71	SAVA	SA285	GA-303	WGB	SA-35192	GA-158	POWF	SA45	GA-77	SECU
SA2159	GA-176	BLDW	SA29	GA-105	WGB	SA352	GAD-1	SERP	SA-45	GA-54	SHE
SA219	GA-44	WGB	SA292	GA-31	WGB	SA35207	GA-217	POWF	SA45090	GA-673R	EVGR
SA225	GA-71	WGB	SA293	GAD-15	SECU	SA35219	GA-244	POWF	SA-45090	GA-673R	POWF
SA2281	GA-230	SAVA	SA293	GAK-403	WGB	SA35227	GA-279	EVGR	SA453	GA-3501	WGB
SA234	GA-382	SECU	SA299	GAVW-2	SECU	SA-35227	GA-279	POWF	SA-45314	GA-348	POWF
SA23465	GA-277	EVGR	SA-30	GA-192	SHE	SA3523	GA-3523	SERP	SA456	GAK-16	SAVA
SA-23465	GA-277	POWF	SA300	GA-277	SECU	SA35244	GA-607	POWF	SA46	GA-77	WGB
SA23538	GA-140	POWF	SA30045	GA-77	EVGR	SA35265	GA-8606	EVGR	SA466	GAK-16	WGB
SA23592	GA-273	EVGR	SA-30045	GA-77	POWF	SA-35265	GA-8606	POWF	SA467	GA-6127	WGB
SA-23592	GA-273	POWF	SA30052	GA-71	EVGR	SA35267	GAVW-621	POWF	SA-47	GA-735	SHE
SA24	GA-56	WGB	SA-30052	GA-71	POWF	SA353	GA-3901	SECU	SA-48	GA-271	SHE
SA24278	GAD-15	EVGR	SA30057	GA-80	EVGR	SA353	GAD-3	SERP	SA-49	GA-3523	SHE
SA-24278	GAD-15	POWF	SA-30057	GA-80	POWF	SA35305	GA-286	POWF	SA4958	GA-4958	STP
SA24299	GA-180	EVGR	SA30059	GA-50	EVGR	SA-35323	GA-224	POWF	SA-50	GA-3647	SHE
SA-24299	GA-180	POWF	SA-30059	GA-50	POWF	SA35330	GA-6479 ⁹⁰	POWF	SA50091	GA-59	EVGR
SA24339	GA-3915	EVGR	SA30067	GA-192	EVGR	SA3537	GA-54	SERP	SA-50091	GA-59	POWF

Referencia Cruzada por Numero de Parte

Cross Reference by Part Number



Numero	Gonher	Fabricante	Numero	Gonher	Fabricante	Numero	Gonher	Fabricante	Numero	Gonher	Fabricante
Number	Gonher	Manufacturer	Number	Gonher	Manufacturer	Number	Gonher	Manufacturer	Number	Gonher	Manufacturer
SA50092	GA-57	EVGR	SA8141	GA-1614	STP	SAF50	GA-85	STP	SDA140666	GA-5648	DON
SA-50092	GA-57	POWF	SA-82	GA-6479	SHE	SAF500A	GA-85	STP	SDA146071	GA-5648	DON
SA50093	GA-325	EVGR	SA8269	GA-472	STP	SAF52	GA-303	STP	SDA146090	GA-5648	DON
SA50093	GA-325	POWF	SA-83	GA-7017	SHE	SAF54	GA-3300	STP	SDA146091	GA-5648	DON
SA5056	GA-5056	SERP	SA84	GA-5648	WGB	SAF574	GA-74	STP	SDA146094	GA-5648	DON
SA5058	GA-273	SERP	SA-84	GAD-15	SHE	SAF58	GP-34	MIFP	SDA146095	GA-5648	DON
SA50831	GA-85	EVGR	SA840	GA-2110	SAVA	SAF584	GA-3300	STP	SDA146100	GA-5648	DON
SA-50831	GA-85	POWF	SA85	GA-386	SHE	SAF59	GP-34	MIFP	SDA146130	GA-5648	DON
SA50991	GA-86	EVGR	SA8548	GA-304	STP	SAF600	GA-4828	STP	SDF10	GP-156	AMS
SA-50991	GA-86	POWF	SA-87	GA-3901	SHE	SAF601	GA-735	STP	SDF10	GP-157	AMS
SA-51	GA-3588	SHE	SA8747	GA-258	STP	SAF602	GA-271	STP	SDF11	GP-68	AMS
SA-52	GA-89	SHE	SA8766	GA-491	STP	SAF604	GA-4325	STP	SDF13	GP-149	AMS
SA530	GAVW-2	SAVA	SA8767	GA-2195	STP	SAF611	GA-3814	STP	SDF13	GP-91	AMS
SA53384	GA-89	WGB	SA88	GA-192	WGB	SAF640	GA-3424	STP	SDF15	GP-1	AMS
SA-53384	GA-89	POWF	SA-88	GA-6690	SHE	SAF641	GA-3425	STP	SDF15	GP-171	AMS
SA54	GA-300	STP	SA8817	GA-390	STP	SAF665	GA-390	STP	SDF20	GP-91	AMS
SA541	GA-3425	SAVA	SA-89	GA-158	SHE	SAF735	GA-54	STP	SDF22	GP-14	AMS
SA542	GA-2194	SAVA	SA8911	GAK-403	SAVA	SAF736	GA-3523	STP	SDF22	GP-20	AMS
SA54669	GAD-294	EVGR	SA8911	GA-194	STP	SAF74	GA-86	STP	SDF22	GP-5	AMS
SA54669	GAD-294	PUR	SA89254CS	G-31	HERC	SAF74A	GA-86	STP	SDF23	GP-3980	AMS
SA-54669	GA-273	POWF	SA8956	GA-479	STP	SAF753	GA-75	STP	SDF24	GP-13	AMS
SA55	GA-90	WGB	SA-9	GA-70	SHE	SAF773	GA-3588	STP	SDF24	GP-205	AMS
SA551	GA-71	SAVA	SA90	GA-303	SECU	SAF7816	GA-6690	STP	SDF25	GP-3	AMS
SA-55378	GA-240	POWF	SA-90	GA-322	SHE	SAF7826	GA-133	STP	SDF26	GP-31	AMS
SA55400	GA-413R	POWF	SA9031	GA-206	SAVA	SAF7828	GA-386	STP	SDF29	GP-46	AMS
SA-56	GA-2719B	SHE	SA9053	GA-183R	STP	SAF785	GA-3647	STP	SDF30	GP-3429	AMS
SA57	GA-80	WGB	SA9061	GA-106 ⁴⁶	SAVA	SAF7862	GA-141	STP	SDF32	GP-44	AMS
SA58	GA-50	WGB	SA9061	GA-326 ⁷¹	SAVA	SAF7863	GA-165	STP	SDF34	GP-28	AMS
SA-58	GA-74	SHE	SA91	GA-59	SECU	SAF7872	GA-164	STP	SDF34	GP-3600	AMS
SA5876	GA-475 ¹³	STP	SA-91	GA-300	SHE	SAF826	GA-3681	STP	SDF34	GP-38	AMS
SA5876	GA-5876 ³⁵	STP	SA9115	GA-364	STP	SAF905	GA-153	STP	SDF36	GP-24	AMS
SA60	G-31	MIC	SA92	GA-57	SECU	SAF918	GA-3915	STP	SDF36	GP-462	AMS
SA60	GA-44	WGB	SA92	GA-78	WGB	SAF92	GA-349	STP	SDF41	GP-3766	AMS
SA-60	GA-4303	SHE	SA-92	GA-165	SHE	SAF925	GA-253	STP	SDF42	GP-171	AMS
SA60074	GA-55	EVGR	SA-93	GA-164	SHE	SAF97	GA-75	STP	SDF42	GP-22	AMS
SA-60074	GA-55	POWF	SA9359	GA-293	STP	SAF971	GA-274	STP	SDF42	GP-81	AMS
SA61	GA-105	WGB	SA94	GA-5648	WGB	SAF974	GA-3916	STP	SDF42	GP-9	AMS
SA-61	GA-4828	SHE	SA9441	GA-33 ¹¹²	SAVA	SAK301	G-1121	SCHL	SDF44	GP-3985 ⁸⁶	AMS
SA614	GA-200	SAVA	SA9482	GA-263	STP	SAK700	GP-54 ¹¹	SCHL	SDF45	GP-3531 EXP	AMS
SA614	GP-58	SAVA	SA9493	GA-184	STP	SAK700	GP-66 ¹⁰	SCHL	SDF57	GP-3816	AMS
SA-63	GA-3814	SHE	SA-95	GA-1616	SHE	SAK701	G-162H	SCHL	SDF57	GP-58	AMS
SA6305	GA-390	STP	SA9501	GA-360	SAVA	SAK702	GP-310	SCHL	SDF59	GP-408	AMS
SA6333	GA-382	STP	SA9564	GA-138	STP	SB	GP-58	ACD	SDF64	GP-3675	AMS
SA6366	GA-174	SERP	SA9589	GA-488	STP	SB 018	GA-410	SCT	SDF70	GP-51	AMS
SA6376	GA-142	STP	SA96	GA-21	WGB	SB 2132	GA-2184	SCT	SDF71	GP-43	AMS
SA6395	GA-195	SERP	SA9600	GA-269	STP	SB2268	GG-6	SCHU	SDF72	GP-53	AMS
SA-64	GA-274	SHE	SA97	GA-24	WGB	SB2279	GG-47	SCHU	SDF73	GP-52 ¹¹⁰	AMS
SA646	GA-200	SAVA	SA-97	GA-141	SHE	SB2298	GG-46	SCHU	SDF73	GP-691 ¹⁸	AMS
SA646	GP-58	SAVA	SA9762	GG-1	SCHU	SB2773	GG-1	SCHU	SDF74	GP-3000	AMS
SA6479	GA-6479	SERP	SA-98	GA-130	SHE	SB2773	GG-4	SCHU	SDF75	GP-57	AMS
SA-65	GA-5056	SHE	SAB140516090	GP-38	FORD	SBA130336070	G-296	SHIB	SDF76	GP-23	AMS
SA-66	GA-273	SHE	SAB-2	GA-113	SHE	SBA130336070	G-296-B	SHIB	SDF77	GP-193	AMS
SA665	GA-390	SECU	SAB-3	GA-100	SHE	SBA140516010	GP-38	SHIB	SDF80	GP-178	AMS
SA67	GA-192	SECU	SAC07-2020	GG-1	SUBA	SBA140516030	GP-42	SHIB	SDF84	GP-2951	AMS
SA-67	GA-3916	SHE	SAC07-2020	GG-4	SUBA	SBA140516040	GP-38	SHIB	SDF96	GP-171	AMS
SA673	GA-229	SAVA	SAF1031	GA-277	STP	SBA140516060	GP-28 ⁸	SHIB	SDF96	GP-81 ³¹	AMS
SA-68	GA-153	SHE	SAF1032A	GA-5056	STP	SBA140516060	GP-430 ⁸	SHIB	SDF96	GP-9 ⁸	AMS
SA6807	GA-386	SERP	SAF1046	GA-174	STP	SBA140516090	GP-38	FORD	SDF99	GP-562	AMS
SA6807	GA-386	STP	SAF106	GA-77	STP	SBA140516090	GP-38	SHIB	SE	GP-58	ACD
SA689	GA-892	SAVA	SAF1061	GA-275	STP	SBA140516110	GP-38	SHIB	SE021030288A	GP-28 ⁶	SEAT
SA-69	GA-174	SHE	SAF109	GP-42	STP	SBA140516120	GP-42	FORD	SE021030288A	GP-430 ⁸	SEAT
SA7	GA-105	WGB	SAF1096	GA-6479	STP	SBA140516120	GP-42	SHIB	SE021104653A	GG-251	SEAT
SA-7	GA-80	SHE	SAF110	GAD-3	STP	SBA140516170	GP-171	FORD	SE022119900B	G-296	SEAT
SA7017	GA-7017	SERP	SAF117	GAD-1	STP	SBA140516170	GP-171	SHIB	SE022119900B	G-296-B	SEAT
SA7017	GA-7017	STP	SAF123	GA-2719B	STP	SBA140516180	GP-3600	FORD	SE10	GP-34	ZING
SA7094	GA-604	STP	SAF132	GA-50	STP	SBA140516180	GP-3600	SHIB	SE25	GP-34	ZING
SA714	GA-3490	SAVA	SAF133	GA-78	STP	SBA140516190	GP-38	SHIB	SE25P	GP-34	ZING
SA7174	GA-381	STP	SAF146	GA-71	STP	SBA140517020	GP-58 ⁹	FORD	SE3	GP-34	ZING
SA72	GA-77	WGB	SAF148	GA-80	STP	SBA314531072	GA-33 ¹¹²	FORD	SEC	GP-31	WGB
SA727	GA-240	SAVA	SAF178	GA-192	STP	SBA314531072	GA-33 ¹¹²	SHIB	Senior	G-31	MIL
SA7351	GA-322	STP	SAF184	GA-77	STP	SBA340500920	GP-51	FORD	SF	GP-58	ACD
SA74	GA-55	SECU	SAF20	GP-66	MIFP	SBI041	GG-246	SAVA	SF109	GP-42	HUT
SA-74	GA-277	SHE	SAF212	GA-55	STP	SBI104	GG-251	SAVA	SF111	GP-46	HUT
SA7420	GA-514	STP	SAF234	GA-382	STP	SC	GP-1	ACD	SF111	GP-46	TARG
SA7426	GA-432	STP	SAF252	GA-362	STP	SC250	G-31	ACD	SF112	GP-20	HUT
SA753	GA-89	SECU	SAF261	GA-3490	STP	SC259	G-31	ACD	SF119	GP-1	HUT
SA7640	GA-240	STP	SAF28	GP-66	MIFP	SC260	G-31	ACD	SF123	GP-3429	HUT
SA7669	GA-434	STP	SAF29	GP-66	MIFP	SC8626	G-1163 ¹⁰⁸	LETR	SF123	GP-3429	TARG
SA7816	GA-6690	SECU	SAF293	GAD-15	STP	SC8626	G-1163	WABC	SF135	GP-333	HUT
SA7826	GA-133	SECU	SAF295	GAVW-4	STP	SC8628	G-1163	LETR	SF141	GP-200	HUT
SA7828	GA-386	SECU	SAF296	GAVW-2	STP	SCL500	G-500	HUT	SF15	GP-1101	HUT
SA7836	GA-604	SECU	SAF298	GAVW-4	STP	SCL750	G-750	HUT	SF17	GP-81	HUT
SA7841	GA-322	SECU	SAF299	GAVW-2	STP	SD	GP-3816	ACD	SF173	GP-3980	HUT
SA7842	GA-381	SECU	SAF300	GA-277	STP	SD1311	G-750	KOMA	SF18	GP-31	HUT
SA7854	GA-217	SECU	SAF302	GA-4303	STP	SD1311	G-750	LETR	SF19	GP-14	HUT
SA7858	GA-432	SECU	SAF305	GA-730	STP	SD1311	G-750	WABC	SF1A	GP-1	HUT
SA7862	GA-141	SECU	SAF307	GA-2740	STP	SD2	G-31	ACD	SF1A	GP-1	TARG
SA7863	GA-165	SECU	SAF31	GA-56	STP	SD3	GP-58	ACD	SF21	GP-14	HUT
SA7872	GA-164	SECU	SAF329	GA-57	STP	SD3	GP-58	CHP	SF213	GP-28 ⁸⁴	HUT
SA7877	GA-3901	SECU	SAF332	GA-325	STP	SD3	GP-58	LUF	SF213	GP-3600 ⁸⁴	HUT
SA7880	GA-514	SECU	SAF340	GA-2719B	STP	SD3	GP-3816	WARN	SF213	GP-38 ⁸⁹	HUT
SA-80	GA-275	SHE	SAF348	GA-59	STP	SD304-53	G-31	CONT	SF213	GP-430 ⁸⁵	HUT
SA8040	GA-384	STP	SAF351	GA-195	STP	SDA140001	GA-5648	DON	SF23-1	GP-1101	HUT
SA8099	GA-2118	STP	SAF353	GA-3901	STP	SDA140138	GA-5648	DON	SF2817	GP-3531 EXP	TARG
SA-81	GA-253	SHE	SAF4	GA-70	STP	SDA140161	GA-5648	DON	SF2827	GP-3682	TARG
SA811	GAD-15	SAVA	SAF409	GA-429	STP	SDA140164	GA-5648	DON	SF2835	GP-58	TARG

Numero	Gonher	Fabricante	Numero	Gonher	Fabricante	Numero	Gonher	Fabricante	Numero	Gonher	Fabricante
Number	Gonher	Manufacturer	Number	Gonher	Manufacturer	Number	Gonher	Manufacturer	Number	Gonher	Manufacturer
SF2856A	GP-40	TARG	SFA2499SET	GA-499R	SURE	SFA9334SET	GA-9334 ¹⁰⁴	SURE	SF00009	GP-3001	SURE
SF3	GP-50	HUT	SFA2858SET	GA-880R ¹⁰⁴	SURE	SFA9335S	GA-1286	SURE	SF00070	G-836	SURE
SF33	GP-20	HUT	SFA3087	GA-2194	SURE	SFA9372S	GA-6127	SURE	SF00072	G-834	SURE
SF33	GP-20	TARG	SFA3192	GA-271	SURE	SFA9373S	GA-206	SURE	SF00074	G-833	SURE
SF40	GP-13	HUT	SFA3436	GA-4365	SURE	SFA9378P	GA-1008	SURE	SF00079	GP-91	SURE
SF40	GP-13	TARG	SFA3465	GA-277	SURE	SFA9379S	GA-1284	SURE	SF00082	GP-3816	SURE
SF400	GP-3600	TARG	SFA3472	GA-274	SURE	SFA9472PK	GA-372	SURE	SF00117	G-31	SURE
SF48	G-6	HUT	SFA3558	GA-2110	SURE	SFA9668	GA-230	SURE	SF00132	G-33	SURE
SF49	G-330	HUT	SFA3592	GA-273	SURE	SFA9853	GA-375	SURE	SF00139	GP-310	SURE
SF49	GP-3	TARG	SFA3776S	GA-416	SURE	SFC-1306	GPP-1287 ³⁹	SAKU	SF00163	GP-57	SURE
SF5	GP-5	HUT	SFA3800SET	GA-106 ⁶⁷	SURE	SFC-1306	PPF831 ⁴¹	SAKU	SF00252	GP-68	SURE
SF51A	GP-3980	TARG	SFA3800SET	GA-206 ¹⁰⁸	SURE	SFC-1306	R 60 P ⁶²	SAKU	SF0041	GP-58	SURE
SF6298	G-33	LETR	SFA3800SET	GA-326 ⁷²	SURE	SFC2055	GP-1013Q	SURE	SF00484	G-191	SURE
SF64	GP-3600 ²⁷	HUT	SFA4	GA-70	SURE	SFC2073	GP-1011Q	SURE	SF00485	G-238	SURE
SF64	GP-38 ⁸⁹	HUT	SFA4046S	GA-398	SURE	SFC2076	GP-1013Q	SURE	SF00499	GP-68	SURE
SF6510	GP-66	STAU	SFA4282	GAD-30	SURE	SFC-7924	GPP-1122	SAKU	SF00516	G-566	SURE
SF6520	GP-66	STAU	SFA4299	GA-180	SURE	SFD012187	GP-53	STEI	SF00667	GP-51	SURE
SF6711	GP-34	STAU	SFA4343	GA-5056	SURE	SFD01-2187	GP-53	FORD	SF00678	GP-14	SURE
SF6720	GP-34	STAU	SFA4356	GA-390	SURE	SFD01-5585	G-500	FORD	SF00777	GP-57	SURE
SF6721	GP-34	STAU	SFA4357	GA-216	SURE	SFD18-498	GP-34	FORD	SF00911	GP-53	SURE
SF7	GP-81	HUT	SFA4361	GA-139	SURE	SFD18-502	GP-66	FORD	SF00947	GP-43	SURE
SF73	GP-24 ²⁶	HUT	SFA4372	GA-3901	SURE	SFD187-502	GP-66	FORD	SF00950	GP-54	SURE
SF73	GP-462 ⁹⁴	HUT	SFA4375	GA-362	SURE	SFD28-028	G-750	FORD	SF01001	GP-157	SURE
SF76	G-236	HUT	SFA4378	GA-174	SURE	SFD28-031	GP-2071W	FORD	SF01072	GP-5	SURE
SF78	G-33	HUT	SFA4468	GA-195	SURE	SFD28035	GP-1101	STEI	SF01076	G-133	SURE
SF801	G-871	HUT	SFA4471	GA-471	SURE	SFD28-035	GPP-14	FORD	SF01076	G-989	SURE
SF803	G-225	HUT	SFA4479	GA-6479	SURE	SFD45-252	GA-356	FORD	SF0109	GP-42	SURE
SF81	GP-81 ³¹	HUT	SFA4487	GA-382	SURE	SFD45253	GA-357	STEI	SF01090	GP-81	SURE
SF81	GP-9 ⁵⁸	HUT	SFA45	GA-77	SURE	SFD45-253	GA-357	FORD	SF0111	GP-46	SURE
SF81	GP-81 ³¹	TARG	SFA4626	GA-6619 ¹	SURE	SFD90-1158T	GP-57	FORD	SF01230	GP-53	SURE
SF81	GP-9 ⁵⁸	TARG	SFA4626	GA-6620 ²	SURE	SFF0060	GG-48	SURE	SF01440	GP-57	SURE
SF813	G-813	HUT	SFA4632	GA-275	SURE	SFF0108	G-1143	SURE	SF0152A	GP-46	SURE
SF820	G-870	HUT	SFA4643	GA-166	SURE	SFF0167	G-296	SURE	SF0152B	GP-46	SURE
SF834	G-834	HUT	SFA4648	GA-133	SURE	SFF0167	G-296-B	SURE	SF01622	GP-91	SURE
SF898	GG-123	BLDW	SFA4680	GA-386	SURE	SFF0173	G-296	SURE	SF01670	GP-53	SURE
SFA0015	GAP-381	SURE	SFA4690	GA-322	SURE	SFF0173	G-296-B	SURE	SF02110	G-163	SURE
SFA0017	GAD-3	SURE	SFA4712	GA-217	SURE	SFF0202	GP-55	SURE	SF02111	G-926	SURE
SFA0013P	GA-49	SURE	SFA4720	GA-7344	SURE	SFF0215	GP-1122	SURE	SF02430	GP-171	SURE
SFA0215P	GA-329	SURE	SFA4722	GA-5466	SURE	SFF0218	GP-84	SURE	SF02430	GP-3766	SURE
SFA0219S	GA-239	SURE	SFA4727	GA-300	SURE	SFF0219	GP-83	SURE	SF03000	GP-3000	SURE
SFA0266	GA-240	SURE	SFA4731	GA-165	SURE	SFF0293	GP-1109 ²²	SURE	SF03171	GP-171	SURE
SFA0418P	GA-360	SURE	SFA4819	GA-141	SURE	SFF0293	GP-62 ²⁰	SURE	SF03327	G-143	SURE
SFA0490S	GA-361	SURE	SFA4831	GAD-118	SURE	SFF0540	G-1175	SURE	SF03345	GP-390	SURE
SFA0694PK	GA-694	SURE	SFA4852	GA-392	SURE	SFF0707	G-1121	SURE	SF03349	GP-178	SURE
SFA0760PF	GAK-216	SURE	SFA4878	GA-2740	SURE	SFF0712	GP-749 ⁹⁰	SURE	SF03548	GP-3000 ¹³	SURE
SFA0851P	GA-356	SURE	SFA4879	GA-1616	SURE	SFF0721	GP-1122	SURE	SF03620	GP-193	SURE
SFA0881	GA-3647	SURE	SFA4880	GA-164	SURE	SFF0723	GP-1122	SURE	SF03628	GP-9	SURE
SFA0883S	GA-357	SURE	SFA5043	GAVVW-620	SURE	SFF0796	G-297-B	SURE	SF03883	GP-152	SURE
SFA1002P	GA-6129	SURE	SFA5048	GA-132	SURE	SFF0799	GP-96	SURE	SF04004	GP-51	SURE
SFA1007	GA-229	SURE	SFA5049	GA-595	SURE	SFF0862	GPP-19	SURE	SF04005	GP-52 ¹⁰⁰	SURE
SFA1008	GA-378	SURE	SFA5089	GA-301	SURE	SFF0863	GPP-18	SURE	SF04005	GP-691 ¹⁸	SURE
SFA1009	GA-6880	SURE	SFA5090	GA-673R	SURE	SFF0928	GP-93	SURE	SF04018	GP-36	SURE
SFA1015P	GA-107	SURE	SFA5091	GA-732R	SURE	SFF0936	GP-92	SURE	SF04054	GP-54 ⁴¹	SURE
SFA1016	GA-493 ¹⁰⁸	SURE	SFA5105	GA-2114	SURE	SFF1000	GPP-1000	SURE	SF04054	GP-66 ⁹⁰	SURE
SFA1019P	GA-109	SURE	SFA5106	GAVVW-622	SURE	SFF105DN	GP-14	SURE	SF04302	GP-149	SURE
SFA1028P	GA-209	SURE	SFA52	GA-71	SURE	SFF105N	GP-1101	SURE	SF04403	GP-1	SURE
SFA1042P	GA-563	SURE	SFA5265	GA-8606	SURE	SFF1090	GP-458	SURE	SF04407	GP-31	SURE
SFA10425SET	GA-563 ¹⁰⁴	SURE	SFA5290	GA-1616	SURE	SFF1201	G-1143 ⁹⁰	SURE	SF04408	GP-3600	SURE
SFA1045F	GAK-20	SURE	SFA5306	GA-278R	SURE	SFF1206	GS-2033	SURE	SF04422	GP-178	SURE
SFA1046P	GA-106 ⁶⁶	SURE	SFA5313P	GA-483	SURE	SFF1207	GS-2034	SURE	SF04457	GP-3682	SURE
SFA1046P	GA-326 ⁷¹	SURE	SFA5324	GA-168	SURE	SFF1212	GPP-11	SURE	SF04478	GP-156	SURE
SFA1050PF	GA-33 ¹¹²	SURE	SFA5702P	GA-6128	SURE	SFF1251	GPP-1122	SURE	SF04623	GP-91	SURE
SFA1052PF	GAK-16	SURE	SFA5838	GA-37	SURE	SFF1280	GPP-18	SURE	SF04670	GP-81	SURE
SFA1054PF	GAK-403	SURE	SFA59	GA-50	SURE	SFF1313	GP-110	SURE	SF04872	GP-562	SURE
SFA1073P	GA-758	SURE	SFA6029SET	GA-360	SURE	SFF1369	GP-62	SURE	SF05050	G-750	SURE
SFA1073SET	GA-758	SURE	SFA6050SET	GA-361	SURE	SFF1371	GP-1101	SURE	SF05230	GP-128	SURE
SFA1095	GA-1095	SURE	SFA6067	GA-1614	SURE	SFF1440	GPP-1287 ³⁹	SURE	SF05240	GP-36	SURE
SFA1099	GA-376	SURE	SFA6444SET	GA-483	SURE	SFF1440	PPF831 ⁴¹	SURE	SF05680	GP-36	SURE
SFA110	GAD-3	SURE	SFA6501P	GA-405	SURE	SFF1440	R 60 P ⁶²	SURE	SF06634	GP-51	SURE
SFA1102P	GA-9045	SURE	SFA6501SET	GA-405 ¹⁰⁴	SURE	SFF1596	GG-298	SURE	SF07126	GP-3816	SURE
SFA113	GA-75	SURE	SFA70	GA-4303	SURE	SFF1707	G-1121F	SURE	SF07222	GP-3985	SURE
SFA1149	GAVVW-2	SURE	SFA7033SET	GA-6127 ¹⁰⁸	SURE	SFF2299	GP-1122	SURE	SF07394	GP-35	SURE
SFA1163P	GA-403	SURE	SFA7033SET	GA-6129 ¹⁰⁴	SURE	SFF2631	G-277	SURE	SF07502	GP-38	SURE
SFA1186P	GA-608	SURE	SFA7360S	GA-7360	SURE	SFF4347	GP-26	SURE	SF08916	GP-3682	SURE
SFA1203	GA-1203	SURE	SFA7550	GA-39	SURE	SFF5052	GP-1122	SURE	SF09003	GP-51	SURE
SFA1204P	GA-589	SURE	SFA7640S	GA-210	SURE	SFF6506	GP-85 ⁹⁰	SURE	SF09005	GP-54 ⁴¹	SURE
SFA1208S	GA-588	SURE	SFA7701	GAD-3	SURE	SFF6915	GP-26	SURE	SF09005	GP-66 ¹⁰	SURE
SFA124	GA-3300	SURE	SFA7716P	GA-7716	SURE	SFF6916	GP-27	SURE	SF09214	GP-77	SURE
SFA1240F	GA-27 ¹¹²	SURE	SFA7716SET	GA-7360 ¹⁰⁸	SURE	SFF7122	GP-1122	SURE	SF09263	G-963	SURE
SFA1243PF	GA-26	SURE	SFA7716SET	GA-7716 ¹⁰⁴	SURE	SFF7352	GPP-1122	SURE	SF09501	GP-54	SURE
SFA1283P	GA-891	SURE	SFA8047P	GA-8047	SURE	SFF7587	GP-749	SURE	SF09586	GP-9586	SURE
SFA1445	GA-2146	SURE	SFA8047SET	GA-1285 ¹⁰⁸	SURE	SFF8070	GPP-1291 ³⁹	SURE	SFA020	GP-91	SURE
SFA15	GA-3490	SURE	SFA8047SET	GA-8047 ¹⁰⁴	SURE	SFF8070	PPF831 ⁴¹	SURE	SF0FL90	GP-81 ³¹	SURE
SFA1575P	GA-880R	SURE	SFA8048S	GA-1285	SURE	SFF8070	R 90 P ⁶²	SURE	SF0FL90	GP-9 ⁹⁸	SURE
SFA16	GA-2740	SURE	SFA83	GA-85	SURE	SFF9405	GP-1122	SURE	SF0S020	GG-187	SURE
SFA1606PF	GAK-1532	SURE	SFA8422	GPP-1122	SURE	SFG103	G-296	MTR	SF51680	GG-251	SURE
SFA1696	GA-482	SURE	SFA8482S	GA-482	SURE	SFG103	G-296-B	MTR	SF52020	GG-94	SURE
SFA1735PF	GAK-625	SURE	SFA8600SET	GA-398 ¹⁰⁴	SURE	SFH0251	GP-34	SURE	SF53031	GG-1	SURE
SFA1735SET	GAK-625 ¹⁰⁴	SURE	SFA8603	GA-517R	SURE	SFH0950	GP-66	SURE	SF53031	GG-4	SURE
SFA1802P	GA-467	SURE	SFA8889P	GA-853R	SURE	SFH0962	GP-66 ⁹⁰	SURE	SF53033	GG-5 L	SURE
SFA1829P	GA-251	SURE	SFA8889SET	GA-853R ¹⁰⁴	SURE	SFH2630	GP-66	SURE	SF55357	GG-5 L	SURE
SFA2411SET	GA-239 ¹⁰⁸	SURE	SFA9046S	GA-1287	SURE	SFH6014	G-162H	SURE	SG-10	GG-6	SURE
SFA2411SET	GA-329 ¹⁰⁴	SURE	SFA91	GA-59	SURE	SFL203	GP-13	MTR	SG-11	GG-123	SHE
SFA2465	GA-436	SURE	SFA92	GA-57	SURE	SFL206	GP-3	MTR	SG-12	GG-7	SHE

Referencia Cruzada por Numero de Parte

Cross Reference by Part Number



Numero	Gonher	Fabricante	Numero	Gonher	Fabricante	Numero	Gonher	Fabricante	Numero	Gonher	Fabricante
Number	Gonher	Manufacturer	Number	Gonher	Manufacturer	Number	Gonher	Manufacturer	Number	Gonher	Manufacturer
SG-14	GG-16	SHE	SHA145	GA-130	SHE	SL	GP-50	ACD	SL603007	G-296	AVEL
SG-15	GG-17	SHE	SHA146	GA-279	SHE	SL 6704	GA-410	SCHU	SL603007	G-296-B	AVEL
SG-21	GG-87	SHE	SHA147	GA-392	SHE	SL 6704	GA-410	SFFI	SL603049	G-750	AVEL
SG-22	GG-204	SHE	SHA148	GA-163	SHE	SL 8688	GA-2160	SCHU	SL603053	G-566	AVEL
SG-25	GG-46	SHE	SHA150	GA-1614	SHE	SL 8688	GA-2160	SFFI	SL6081	GA-8	SCHU
SG-26	GG-47	SHE	SHA151	GA-732R	SHE	SL01-23-802	GP-36	MZDA	SL6135	GA-2122	SCHU
SG-27	GG-66	SHE	SHA152	GA-348	SHE	SL02-23-802	GP-36	MZDA	SL6222	GA-16 ¹²	SCHU
SG-28	GG-581	SHE	SHA153	GA-8606	SHE	SL07-23-570	GG-298	MZDA	SL6222	GAK-16 ¹⁴	SCHU
SG-29	GG-1872	SHE	SHA154	GA-170	SHE	SL-10017	GP-81	POWF	SL8344	GA-853R	SCHU
SG-3	GG-5 L	SHE	SHA156	GA-472	SHE	SL10111	GP-46	EVGR	SL8843	GA-357	SCHU
SG516	GG-5	CHP	SHA157	GA-780	SHE	SL-10111	GP-46	POWF	SL8866	GA-616	SCHU
SG9	GG-19	SHE	SHA158	GAVW-620	SHE	SL-10193	GP-40	EVGR	SL8939	GA-26 ¹²	SCHU
SGL3644	GP-149	WOOG	SHA159	GA-168	SHE	SL-10193	GP-40	POWF	SL8977	GA-563	SCHU
SH	GP-58	ACD	SHA160	GA-6479 ⁹⁰	SHE	SL-10241	GP-58	EVGR	SL8989	GA-499R	SCHU
SH 132.279	GA-410	OTUR	SHA161	GA-224	SHE	SL-10241	GP-58	POWF	SL8991	GA-499R	SCHU
SH1	GP-1	SHE	SHA162	GA-240	SHE	SL10291	GP-3531 EXP	EVGR	SL9331	G-500	LETR
SH16	GP-20	SHE	SHA163	GA-301	SHE	SL-10291	GP-3531 EXP	POWF	SL9349	G-500	LETR
SH18	GP-3	SHE	SHA164	GA-278R	SHE	SL12935	GA-2804 T	SCHU	SLT603007	G-296	AVEL
SH20	GP-81 ³¹	SHE	SHA166	GAVW-121	SHE	SL14006	GP-44	EVGR	SLT603007	G-296-B	AVEL
SH20	GP-9 ⁵⁸	SHE	SHA167	GAVW-621	SHE	SL14006	GP-44	PUR	SMP181000	GA-27 ¹²	DON
SH23	GP-3429	SHE	SHA168	GA-1616	SHE	SL-14006	GP-44	POWF	SMP181001	GA-26	DON
SH27	GP-3980	SHE	SHA169	GA-286	SHE	SL14459	GP-91	EVGR	SMP181002	GA-6129	DON
SH28	GP-3600	SHE	SHA171	GA-248	SHE	SL-14459	GP-91	POWF	SMP181002	GA-9045	DON
SH29	GP-58	SHE	SHA172	GA-194	SHE	SL14477	GP-156	EVGR	SMP181004	GA-9334	DON
SH33	GP-3985	SHE	SHA173	GA-595	SHE	SL-14477	GP-156	POWF	SMP181006	GA-376	DON
SH35	GP-81	SHE	SHA175	GA-258	SHE	SL14610	GP-149	EVGR	SMP181007	GA-229	DON
SH36	GP-68	SHE	SHA176	GA-491	SHE	SL14610	GP-149	POWF	SMP181008	GA-378	DON
SH37	GP-3766	SHE	SHA178	GA-293	SHE	SL14612	GP-91	EVGR	SMP181015	GA-107	DON
SH38	GP-2005	SHE	SHA179	GA-183R	SHE	SL-14612	GP-91	POWF	SMP181016	GA-493 ¹⁰⁸	DON
SH39	GP-562	SHE	SHA180	GA-395	SHE	SL14619	GP-3985	EVGR	SMP181019	GA-109	DON
SH41	GP-44	SHE	SHA181	GA-780	SHE	SL14619	GP-3985	POWF	SMP181028	GA-209	DON
SH42	GP-128	SHE	SHA182	GA-244	SHE	SL14620	GP-149	EVGR	SMP181034	GA-360	DON
SH43	GP-3675	SHE	SHA183	GA-304	SHE	SL14620	GP-149	POWF	SMP181039	GA-356	DON
SH44	G-765	SHE	SHA184	GA-477	SHE	SL14622	GP-91	EVGR	SMP181042	GA-563	DON
SH45	GP-408	SHE	SHA186	GA-264	SHE	SL-14622	GP-91	POWF	SMP181043	GA-251	DON
SH46	G-45	SHE	SHA187	GA-414R	SHE	SL15309	G-45	POWF	SMP181045	GAK-20	DON
SH47	GP-178	SHE	SHA188	GA-490	SHE	SL15313	GP-408	POWF	SMP181046	GA-106 ⁶	DON
SH48	GP-149	SHE	SHA19	GAD-15	SHE	SL15436	G-49	POWF	SMP181046	GA-326 ²¹	DON
SH50	G-72	SHE	SHA191	GA-263	SHE	SL15505	G-70	POWF	SMP181050	GA-33 ¹²	DON
SH502	GP-310	SHE	SHA2	GA-77	SHE	SL1675	GA-42	SFFI	SMP181052	GAK-16	DON
SH502	GP-3569	SHE	SHA26	GA-59	SHE	SL1676	GA-6	SFFI	SMP181054	GAK-403	DON
SH504	GP-171	SHE	SHA27	GA-57	SHE	SL1694	GA-44	SCHU	SMP181062	GAK-1532	DON
SH51	G-49	SHE	SHA31	GA-75	SHE	SL20033	GP-20	EVGR	SMP181063	GAK-625	DON
SH516	GP-3531 EXP	SHE	SHA33	GA-2719B ¹²²	SHE	SL-20033	GP-20	POWF	SMP181073	GA-758	DON
SH517	GP-40	SHE	SHA33	GA-3300 ⁵⁸	SHE	SL20049	GP-3	EVGR	SMP181095	GA-1095	DON
SH518	GP-28 ⁸	SHE	SHA38	GA-192	SHE	SL-20049	GP-3	POWF	SMP181099	GA-376	DON
SH518	GP-430 ⁸	SHE	SHA46	GA-271	SHE	SL-20064	GP-38	POWF	SMP181108	GA-375	DON
SH519	GP-3816	SHE	SHA48	GA-3647	SHE	SL20123	GP-3429	EVGR	SMP181109	GA-1203	DON
SH52	G-954	SHE	SHA49	GA-3588	SHE	SL-20123	GP-3429	POWF	SMP181118	GA-7716	DON
SH520	GP-91	SHE	SHA50	GA-89	SHE	SL20195	GP-3600	EVGR	SMP181120	GA-483	DON
SH524	GP-3682	SHE	SHA51	GA-274	SHE	SL-20195	GP-3600	POWF	SMP181137	GA-405	DON
SH525	GP-157	SHE	SHA63	GA-3814	SHE	SL20252	GP-28 ⁵	EVGR	SMP181148	GA-509 ¹⁴	DON
SH528	GP-212	SHE	SHA65	GA-3916	SHE	SL20252	GP-430 ⁸	EVGR	SMP181163	GA-403	DON
SH529	GP-462	SHE	SHA66	GA-153	SHE	SL20252	GP-28 ⁹	POWF	SMP181184	GA-405	DON
SH53	G-112	SHE	SHA67	GA-273	SHE	SL20252	GP-430 ⁸	POWF	SMP181186	GA-608	DON
SH531	GP-91	SHE	SHA71	GA-253	SHE	SL22167	GP-171	EVGR	SMP181187	GA-3501	DON
SH533	GP-28 ⁸	SHE	SHA72	GA-174	SHE	SL22167	GP-171	POWF	SMP181188	GA-422	DON
SH533	GP-430 ⁸	SHE	SHA75	GA-7017	SHE	SL22821	GP-58	EVGR	SMP181203	GA-827	DON
SH534	GP-91	SHE	SHA76	GA-4303	SHE	SL-22821	GP-58	POWF	SMP181204	GA-589	DON
SH538	GP-91	SHE	SHA77	GA-5056	SHE	SL24011	GP-3980	EVGR	SMP181207	GA-826	DON
SH54	G-180	SHE	SHA78	GA-6479	SHE	SL24011	GP-3980	POWF	SMP181208	GA-588	DON
SH55	GP-457	SHE	SHA79	GA-3901	SHE	SL24457	GP-3682	EVGR	SMP183109	GA-1095	DON
SH57	G-3752	SHE	SHA80	GA-275	SHE	SL24457	GP-3682	POWF	SMP771507	GA-436	DON
SH66378	GP-761H	HIFI	SHA82	GA-195	SHE	SL24466	GP-28 ⁹	EVGR	SMP771538	GAK-403	DON
SH7796	G-500	LETR	SHA83	GA-386	SHE	SL24466	GP-430 ⁸	EVGR	SMP771541	GA-98 ¹²	DON
SH7797	G-500	LETR	SHA84	GA-362	SHE	SL24466	GP-28 ⁹	POWF	SMP771543	GAK-403	DON
SH8986	G-500	LETR	SHA85	GA-6690	SHE	SL24466	GP-430 ⁸	POWF	SMP771546	GA-589	DON
SH8986	G-500	WABC	SHA86	GA-139	SHE	SL24466	GP-28 ⁹	PUR	SMP773520	GA-229	DON
SHA10	GA-277	SHE	SHA87	GA-165 ¹¹³	SHE	SL24466	GP-430 ⁸	PUR	SN	GP-50	ACD
SHA107	GA-142	SHE	SHA88	GA-300	SHE	SL24651	GP-68	EVGR	SN001	G-296	SAVA
SHA109	GAD-294	SHE	SHA9	GA-70	SHE	SL-24651	GP-68	POWF	SN001	G-296-B	SAVA
SHA110	GA-133	SHE	SHA97	GA-2106	SHE	SL25230	GP-128	EVGR	SN039	GP-1122	SAVA
SHA111	GA-604	SHE	SHA99	GA-382	SHE	SL-25230	GP-128	POWF	SN063	G-1123	SAVA
SHA113	GA-141	SHE	SI1023	GA-26	GMCX	SL25250	G-112	POWF	SN506	G-1163	SAVA
SHA114	GA-7344	SHE	SI1198	GA-26	GMCX	SL25274	G-765	EVGR	SN509	GP-1122	SAVA
SHA115	GA-7142	SHE	SI1227	GA-26	GMCX	SL25274	G-765	POWF	SN565	G-297-B	SAVA
SHA116	GA-432	SHE	SI1465	GA-31	GMCX	SL25288	GP-3675	EVGR	SN88	G-1121	SAVA
SHA118	GA-322	SHE	SI	GP-58	ACD	SL-25288	GP-3675	POWF	SO008	GP-81	SAVA
SHA119	GA-381	SHE	SK	GP-58	ACD	SL25545	G-112	POWF	SO014	GP-14	SAVA
SHA120	GA-217	SHE	SK3429	GPP-421	SCHU	SL30001	GP-1	EVGR	SO022	GP-81	SAVA
SHA123	GAVW-2	SHE	SK3446	GPP-425	SCHU	SL-30001	GP-1	POWF	SO040	GP-54 ¹¹	SAVA
SHA125	GAD-118	SHE	SK3473	GPP-423	SCHU	SL-30040	GP-13	POWF	SO040	GP-66 ¹⁰	SAVA
SHA127	GA-164	SHE	SK3517	G-1143 ⁹⁰	SCHU	SL30288	GP-3766	POWF	SO0401	G-870	SAVA
SHA128	GA-5466	SHE	SK3518	GPP-25	SCHU	SL34631	GP-205	EVGR	SO051	G-225	SAVA
SHA129	GA-514	SHE	SK3553	GP-1107	SCHU	SL-34631	GP-205	POWF	SO055	G-871	SAVA
SHA131	GA-175	SHE	SK3633	GPP-425	SCHU	SL44872	GP-562	EVGR	SO071	GP-50	SAVA
SHA132	GA-1616	SHE	SK3831	G-1121F	SCHU	SL-44872	GP-562	POWF	SO-10060	GP-406	SECU
SHA133	GA-198	SHE	SK3920	2010PM-OR ⁷	SCHU	SL45335	GP-178	EVGR	SO102	G-238	SAVA
SHA134	GA-673R	SHE	SK3920	2010TM-OR ⁷	SCHU	SL-45335	GP-178	POWF	SO111	GP-46	SECU
SHA135	GA-132	SHE	SK3925	GS-2033	SCHU	SL45515	G-3752	POWF	SO115	GP-36	SAVA
SHA136	GA-1615	SHE	SK3928	GS-2034	SCHU	SL5530	GA-8	SCHU	SO1204	G-870	SCHU
SHA137	GA-442	SHE	SK3993	GPP-1122	SCHU	SL5628	GA-98 ¹¹²	SCHU	SO123	GP-3429	SECU
SHA140	GA-127	SHE	SKS17573	GAK-16	HYST	SL5671	GA-880R	SCHU	SO1297	G-335	SCHU
SHA141	GA-384	SHE	SKS17575	GAK-16	HYST	SL5712	GA-80	SCHU	SO13	GP-13	SERP
SHA143	GA-172	SHE	SKS41373	GA-33 ¹¹²	HYST	SL5734	GA-55	SCHU	SO130	GP-46	SAVA
SHA144	GA-158	SHE	SKS413732	GA-33 ¹¹²	HYST	SL5840	GA-1095	SCHU	SO141	G-200	STP

REFERENCIA CRUZADA

Para números Gonher con Superíndice vea página 651
For Gonher with Superscript numbers see page 651

Numero	Gonher	Fabricante	Numero	Gonher	Fabricante	Numero	Gonher	Fabricante	Numero	Gonher	Fabricante
Number	Gonher	Manufacturer	Number	Gonher	Manufacturer	Number	Gonher	Manufacturer	Number	Gonher	Manufacturer
SO16	GP-81	SERP	SOA51-65100	GP-3682	SUBA	SP844	GP-20	ALCO	SRP-106	G-6	STR
SO17	GP-81	SECU	SOA51-65101	GA-4303	SUBA	SP845	GP-58 ⁷⁷	ALCO	SRP-1101	GP-1101	STR
SO173	GP-3980	SECU	SOA5165102	GAD-3	PUR	SP846	GP-81 ³¹	ALCO	SRP-1101L	GP-1101	STR
SO178	G-222	SAVA	SOA51-65102	GAD-3	SUBA	SP846	GP-9 ⁹⁸	ALCO	SRP-1101L-FFSD	GPP-14	STR
SO180	GP-51	SAVA	SOA51-65104	GG-203	SUBA	SP847	GP-50	ALCO	SRP-1112	G-1174 ¹⁰⁸	STR
SO195	GP-3600	SECU	SOA51-65105	GG-203	SUBA	SP848	GP-1101	ALCO	SRP-1124	G-1173 ¹⁰⁸	STR
SO1A	GP-1	SECU	SOP117	G-1121	SOPA	SP852	GP-3985	ALCO	SRP-1127	G-1176	STR
SO2	GP-68	SERP	SOP125	G-1121	SOPA	SP853	GP-1	ALCO	SRP-1127E	G-1175	STR
SO215	GP-171	SAVA	SOP25	G-870	SOPA	SP854	GP-1	ALCO	SRP-11360	G-1175 ¹⁰⁸	STR
SO216	GP-54	SAVA	SOP58	G-813	SOPA	SP856	GP-36	ALCO	SRP-1163	G-1163	STR
SO2167	GP-171	SECU	SOP8	G-871	SOPA	SP861	GP-1122	ALCO	SRP-1166-2F	G-1166	STR
SO226	GP-42	SAVA	SOP9	G-870	SOPA	SP865	GP-178	ALCO	SRP-1166-3F(2)	G-1166	STR
SO228	GP-28 ⁸	HIFI	SP1001	GP-91	ALCO	SP866	GP-1 ¹⁰⁷	ALCO	SRP-1166-4F(2)	G-1166	STR
SO228	GP-430 ⁸	HIFI	SP1002	GP-91	ALCO	SP868	GPP-19	ALCO	SRP-1172	G-1175 ¹⁰⁸	STR
SO228	GP-28 ⁸	SAVA	SP1004	GP-156	ALCO	SP870	GP-10	ALCO	SRP-1173	G-1173 ¹⁰⁸	STR
SO228	GP-430 ⁸	SAVA	SP1008	GP-157 ⁸⁹	ALCO	SP871	GP-1122	ALCO	SRP-1174	G-1174 ¹⁰⁸	STR
SO228	GP-81	STP	SP1010	GP-51	ALCO	SP873	GP-462	ALCO	SRP-1175	G-1175 ¹⁰⁸	STR
SO236	G-836	SAVA	SP1011	GP-57	ALCO	SP874	GP-69 ¹²¹	ALCO	SRP-1175E	G-1175	STR
SO-241	GP-58	SECU	SP1014	GP-77	ALCO	SP875	GP-1105	ALCO	SRP-1176	G-1176	STR
SO25	GP-20	SERP	SP2001	GG-5 L	ALCO	SP876	GP-62	ALCO	SRP-1179	G-1176	STR
SO252	GP-28 ⁸	SECU	SP2002	GG-246	ALCO	SP882	GP-51	ALCO	SRP-1184	G-1173 ¹⁰⁸	STR
SO252	GP-430 ⁸	SECU	SP2007	GG-226	ALCO	SP884	GP-26	ALCO	SRP-1190	G-296	STR
SO2527	GP-28 ⁸	SECU	SP2010	GG-215	ALCO	SP885	GP-27	ALCO	SRP-1190	G-296-B	STR
SO2527	GP-430 ⁸	SECU	SP2015	GG-142	ALCO	SP888	GP-81 ³¹	ALCO	SRP-1191	G-296	STR
SO253	GP-81	SECU	SP2032	GG-185	ALCO	SP888	GP-9 ⁹⁸	ALCO	SRP-1191	G-296-B	STR
SO2801	GP-3985	STP	SP2037	GG-190	ALCO	SP892	GP-3816	ALCO	SRP-132	G-33	STR
SO2802	GP-91	STP	SP2038	GG-181	ALCO	SP893	GP-46	ALCO	SRP-141	G-200	STR
SO2814	GP-22	STP	SP2041	GG-63	ALCO	SP894	GP-38	ALCO	SRP-147	G-119	STR
SO2815	GP-310	STP	SP2044	GG-148	ALCO	SP896	GP-20	ALCO	SRP-15561-8A	GP-31	STR
SO2817	GP-3531	EXP	SP2055	GG-94	ALCO	SP898	GP-58 ¹⁵	ALCO	SRP-1H20	G-871	STR
SO2821	GP-58	STP	SP2058	GG-63	ALCO	SP900	GP-3980	ALCO	SRP-1H3	G-333	STR
SO2825	GP-38	SERP	SP2069	GG-185	ALCO	SP901	GP-1	ALCO	SRP-1H4	G-335	STR
SO2825	GP-38	STP	SP2079	GG-187	ALCO	SP904	GP-3531	EXP	SRP-20	G-871	STR
SO2835	GP-58	STP	SP2083	GG-46	ALCO	SP905	GP-1122	ALCO	SRP-30	G-31	STR
SO2840	GP-157	SECU	SP2139	GG-369	ALCO	SP906	GP-81	ALCO	SRP-49	G-330	STR
SO2850	GP-1	STP	SP30	GP-3	SERP	SP907	GP-81	ALCO	SRP-499	GP-14	STR
SO2856A	GP-3985	STP	SP3251	G-750	LETR	SP909	GP-455	ALCO	SRP-50	GP-50	STR
SO2861	GP-28 ⁸	SECU	SP3891	GA-31	GMCX	SP911	GP-40	ALCO	SRP-500	G-500	STR
SO2861	GP-430 ⁸	SECU	SP4040	GP-149	SCHU	SP914	GP-3985	ALCO	SRP-7365	GG-20	STR
SO2865	GP-42	STP	SP4052	GP-38	SCHU	SP916	GP-1	ALCO	SRP-7366	GG-20	STR
SO2870A	GP-28 ⁸	SERP	SP4060	GP-3985	SCHU	SP918	GP-3985	ALCO	SRP-750	G-750	STR
SO2870A	GP-430 ⁸	SERP	SP4300	GP-54 ¹¹	SCHU	SP919	GP-462	ALCO	SRP-76-1	G-236	STR
SO2872	GP-3985	STP	SP4300	GP-66 ¹⁰	SCHU	SP920	GP-1 ¹²²	ALCO	SRP-800	GP-50	STR
SO2876	GP-91	SECU	SP4371	GP-28 ⁸	SCHU	SP926	GP-58	ALCO	SRP-801	G-871	STR
SO289	GP-3985	SECU	SP4371	GP-430 ⁸	SCHU	SP929	GP-3682	ALCO	SRP-803	G-870	STR
SO291	GP-3531	EXP	SP4379	GP-462	SCHU	SP930	GP-28 ⁸	ALCO	SRP-805	G-11816	STR
SO295	G-834	SAVA	SP4397	GP-3816	SCHU	SP930	GP-430 ⁸	ALCO	SRP-806	G-836	STR
SO2951	GP-58	SERP	SP4459	GP-52 ¹¹⁰	SCHU	SP931	GP-68	ALCO	SRP-810	G-11816	STR
SO30	GP-3	SERP	SP4459	GP-691 ⁴⁸	SCHU	SP932	GP-38 ¹¹⁹	ALCO	SRP-812	GP-58	STR
SO325	GP-81	SAVA	SP4480	GP-3980	SCHU	SP934	GP-91	ALCO	SRP-820	G-813	STR
SO33	GP-20	SECU	SP4484	GP-44	SCHU	SP935	GP-46	ALCO	SRP-821	G-225	STR
SO3387A	GP-46	SERP	SP4508	GP-50 ²⁰	SCHU	SP936	GP-171	ALCO	SRP-826	G-834	STR
SO3429	GP-3429	SERP	SP4515	GP-3000 ¹³	SCHU	SP937	GP-462	ALCO	SRP-A10-1234	GAK-20	STR
SO3531	GP-3531	EXP	SP4519	GP-54	SCHU	SP947	GP-46	ALCO	SRP-A10-1240	GA-27 ¹¹²	STR
SO3593A	GP-149	SERP	SP4525	GP-54 ⁹⁰	SCHU	SP948	GP-3985 ¹⁰¹	ALCO	SRP-A10-1246	GAK-403	STR
SO3600	GP-3600	SERP	SP4542	GP-390 ⁹³	SCHU	SP950	GP-36	ALCO	SRP-A10-1275	GA-33 ¹¹²	STR
SO3614	GP-58	SERP	SP4554	GP-91	SCHU	SP951	GP-2951	ALCO	SRP-A10-4873	GAK-16	STR
SO3682	GP-3682	SERP	SP5162	GP-58 ¹⁵	SCHU	SP952	GP-3985 ¹⁰⁵	ALCO	SRP-A1113	GA-9334	STR
SO373	GP-3682	SECU	SP6289	G-33	WABC	SP959	GP-462	ALCO	SRP-A1116	GA-9045	STR
SO3950	GP-40	SERP	SP6292	G-33	LETR	SP960	GP-406	ALCO	SRP-A1211	GA-5648	STR
SO3980	GP-3980	SERP	SP6292	G-33	WABC	SP961	GP-149	ALCO	SRP-A14125	GA-375	STR
SO3985	GP-40	SERP	SP6298	G-33	GMCX	SP963	GP-3429	ALCO	SRP-A14185	GA-1203	STR
SO40	GP-13	SECU	SP6298	G-33	LETR	SP966	GP-1122	ALCO	SRP-A18065	GA-5648	STR
SO400	GP-3600	STP	SP6298	G-33	WABC	SP967	GPP-1122	ALCO	SRPA21	GA-105	STR
SO411	GP-9	SAVA	SP801	GP-1 ⁵⁸	ALCO	SP970	GPP-111	ALCO	SRPA212	GA-55	STR
SO416	GP-9	SAVA	SP802	GP-1	ALCO	SP970	GPP-524	ALCO	SRP-A251287	GA-1287	STR
SO43	GP-171	SERP	SP803	GP-20	ALCO	SP989	GP-149	ALCO	SRP-A31	GA-56	STR
SO432	GP-46	SAVA	SP804	GP-13	ALCO	SP990	GP-9	ALCO	SRP-A37	GA-44	STR
SO4335	G-834	SCHU	SP805	GP-3	ALCO	SP991	GP-157 ¹²²	ALCO	SRP-A4	GA-70	STR
SO449	GP-40	SAVA	SP808	GP-14	ALCO	SP999	GP-69 ⁸⁷	ALCO	SRP-A45	GA-77	STR
SO4615	G-25	SCHU	SP810	GP-46	ALCO	SPE15-10	GP-66	LHA	SRPA50	GA-90	STR
SO4615	G-25	SFFI	SP811	GP-26	ALCO	SPE15-25	GP-66	LHA	SRPA51	GA-37	STR
SO49	GP-3	SECU	SP812	GP-28 ⁸	ALCO	SPE25-10	GP-66	LHA	SRPA52	GA-71	STP
SO4967	GP-157	SERP	SP812	GP-430 ⁸	ALCO	SPE25-25	GP-66 ²¹	LHA	SRP-A52	GA-71	STR
SO5	GP-205	SERP	SP814	GP-42	ALCO	SPE50-10	GP-34	LHA	SRP-A57	GA-80	STR
SO51	GP-3980	STP	SP816	GP-81 ³¹	ALCO	SPE50-25	GP-34	LHA	SRPA59	GA-50	STP
SO522	GP-40	SAVA	SP816	GP-9 ⁵⁸	ALCO	SPE60-25	GP-34	LHA	SRP-A59	GA-50	STR
SO523	GP-3531	EXP	SP819	GP-3985 ⁸²	ALCO	SPH12504	GP-761H	SCHU	SRP-A67	GA-192	STR
SO561	GP-28 ⁸	STP	SP820	GP-3816	ALCO	SPH12507	GP-761H	SCHU	SRP-A68	GA-105	STR
SO561	GP-430 ⁸	STP	SP821	GP-1122	ALCO	SPH12509	GP-761H	SCHU	SRP-A68	GA-78	STR
SO603	G-834	SAVA	SP822	GP-54	ALCO	SPH12512	GP-761H	SCHU	SRP-A712	GA-1285	STR
SO6607	GP-91	SERP	SP823	GP-36	ALCO	SPH12514	GP-761H	SCHU	SRP-A713	GA-1286	STR
SO7317	GP-149 ⁸²	SERP	SP824	GP-81	ALCO	SPH18071	GP-66	SCHU	SRP-A76	GA-12	STR
SO7317	GP-91 ⁷⁸	SERP	SP825	GP-3600	ALCO	SPH18072	GP-66	SCHU	SRP-A912	GA-8047	STR
SO81	GP-81 ³¹	SECU	SP826	GP-31	ALCO	SPH20052	GP-3766	SCHU	SRP-A956	GA-21	STR
SO81	GP-9 ⁵⁸	SECU	SP827	GP-31	ALCO	SPH20106	GP-864H	SCHU	SRP-AM1113	GA-9334	STR
SO820	GP-68	SECU	SP829	GP-81	ALCO	SPH9470	GP-166 ⁶⁵	SCHU	SRP-AM1116	GA-9045	STR
SO-8873	GP-408	SECU	SP831	GPP-1122	ALCO	SPH9470	GP-3937 ³¹	SCHU	SRP-AM1211	GA-5648	STR
SO8A	GP-1	SERP	SP832	GP-54 ¹¹	ALCO	SPH9608	GP-317H	SCHU	SRP-AM1211K	GA-5648	STR
SO928	G-143	SAVA	SP832	GP-66 ¹⁰	ALCO	SPH9615	GP-317H	SCHU	SRP-AM18065	GA-5648	STR
SOA25-0000	GP-38	SUBA	SP836	GP-81	ALCO	SPH9737	GP-34	SCHU	SRP-AM31	GA-39	STR
SOA25-0010	GP-38 ⁹⁴	SUBA	SP836	GP-9	ALCO	SPH9820	GP-171 ¹⁶	SCHU	SRP-AM50	GA-37	STR
SOA260000	GAD-3	PUR	SP837	GP-1	ALCO	SR	GP-58	ACD	SRP-AM510	GA-18	STR
SOA26-0000	GA-349	SUBA	SP840	GP-50	ALCO	SR-817215	GP-454	JAGU	SRP-AM712	GA-1285	STR
SOA28-0000	GP-3682	SUBA	SP842	GP-38 ⁸⁷	ALCO	SRP-1	GP-1	STR	SRP-AM812	GA-1008	STR
SOA29-0100	GAD-3	SUBA	SP843	GP-50	ALCO	SRP-105	G-31	STR	SRP-AM912	GA-8047	STR

Referencia Cruzada por Numero de Parte

Cross Reference by Part Number



Numero	Gonher	Fabricante	Numero	Gonher	Fabricante	Numero	Gonher	Fabricante	Numero	Gonher	Fabricante
Number	Gonher	Manufacturer	Number	Gonher	Manufacturer	Number	Gonher	Manufacturer	Number	Gonher	Manufacturer
SRP-ARI09	GA-135	STR	STG160126	GA-357 ¹⁰⁸	DON	T0191	GA-372	NUE	T12-1018	GP-27	UNVC
SRPCAT11	G-152	STR	STG160127	GA-356 ¹⁰⁴	DON	T0242504	GA-86	MOP	T12-1019	GP-26	UNVC
SRP-CAT3800	G-191	STR	STG160127	GA-357 ¹⁰⁸	DON	T0291	GA-372	MOP	T12-1022	GA-371	UNVC
SRP-CAT40	G-238	STR	STG160134	GA-356 ¹⁰⁴	DON	T0544588	GG-1	CHRY	T12-1072	GA-229	UNVC
SRP-CAT40H	G-222	STR	STG160134	GA-357 ¹⁰⁸	DON	T0544588	GG-4	CHRY	T12-1076	GA-373	UNVC
SRP-CAT6700	G-191	STR	STG160135	GA-356 ¹⁰⁴	DON	T0544588	GG-1	MOP	T12-1081	GP-11	UNVC
SRP-F30	G-31	STR	STG160135	GA-357 ¹⁰⁸	DON	T0544588	GG-4	MOP	T12-1082	GPP-1122	UNVC
SRP-F31	G-31	STR	STG160136	GA-356 ¹⁰⁴	DON	T0581	GA-371	NUE	T12-1083	GP-78	UNVC
SRP-F31-E	G-31	STR	STG160136	GA-357 ¹⁰⁸	DON	T06-1012	GP-2071W	UNVC	T12-1084	GP-78	UNVC
SRP-F43	G-1143	STR	STG160158	GA-356 ¹⁰⁴	DON	T06-1013	GP-2071W	UNVC	T12-1085	GP-110	UNVC
SRP-F6	G-6	STR	STG160158	GA-357 ¹⁰⁸	DON	T06-1038	GP-1011Q	UNVC	T12-1086	GP-92	UNVC
SRP-F7	G-5000	STR	STG160165	GA-356 ¹⁰⁴	DON	T06-1039	GP-1012Q	UNVC	T12-1087	GP-155	UNVC
SRP-FL566	G-566	STR	STG160165	GA-357 ¹⁰⁸	DON	T06-1041	GP-1011Q	UNVC	T12-1088	GP-1122	UNVC
SRP-GB218	GP-84	STR	STG160168	GA-356 ¹⁰⁴	DON	T06-1042	GP-1013Q	UNVC	T12-1089	G-296	UNVC
SRP-GB219	GP-83	STR	STG160168	GA-357 ¹⁰⁸	DON	T06-1066	GP-1011Q	UNVC	T12-1090	GP-1101	UNVC
SRP-IH16	G-122	STR	STG160175	GA-356 ¹⁰⁴	DON	T0680167	GG-251	CHRY	T12-1091	GP-1108	UNVC
SRP-IH16	G-338	STR	STG160175	GA-357 ¹⁰⁸	DON	T0680167	GG-251	MOP	T12-1092	G-1121	UNVC
SRP-IH20	G-871	STR	STG160182	GA-356 ¹⁰⁴	DON	T0700092	GPP-1122	CHRY	T12-1094	G-1175 ¹⁰⁸	UNVC
SRP-IH3	G-333	STR	STG160182	GA-357 ¹⁰⁸	DON	T0720978	GP-3985	CHRY	T12-1095	GA-109	UNVC
SRP-IH4	G-335	STR	STG160198	GA-356 ¹⁰⁴	DON	T0730077	GP-3985	CHRY	T1286	GA-1286	TRU
SRP-JD2	G-139	STR	STG160198	GA-357 ¹⁰⁸	DON	T08-1007	GP-53	UNVC	T1287	GA-1287	TRU
SRP-JD2-2L	G-139	STR	STG160443	GA-356 ¹⁰⁴	DON	T08-1008	GP-53	UNVC	T1330	GA-109	NUE
SRP-JD2L	G-139	STR	STG160443	GA-357 ¹⁰⁸	DON	T08-1009	GP-54	UNVC	T1348025	GA-71	CHRY
SRP-JD3	G-331	STR	STG160445	GA-356 ¹⁰⁴	DON	T08-1010	GP-57	UNVC	T1348025	GA-71	MOP
SRP-JD4	G-331	STR	STG160445	GA-357 ¹⁰⁸	DON	T08-1012	GP-53	UNVC	T13481	GAK-16	LINC
SRP-MM1	GP-81	STR	STG160588	GA-356 ¹⁰⁴	DON	T08-1043	GP-193	UNVC	T1348115	GA-200	CHRY
SRP-P1652	GP-66	STR	STG160588	GA-357 ¹⁰⁸	DON	T08-1044	GP-3000	UNVC	T1349332	GG-1	CHRY
SRP-PF10	GP-5	STR	STG161000	GA-563	DON	T08-1060	GP-3766	UNVC	T1349332	GG-4	CHRY
SRP-PF11	GP-13	STR	STG161006	GA-563 ¹⁰⁴	DON	T08-1061	GP-10	UNVC	T1349452	GP-40	CHRY
SRP-PF12	GP-3	STR	STG161010	GA-563 ¹⁰⁴	DON	T08-1062	GP-53	UNVC	T13505-54	G-750	POCL
SRP-PF150	G-33	STR	STG161020	GA-563	DON	T08-1063	GP-1	UNVC	T13505-54	G-750	POCL
SRP-PF157	G-33	STR	STM3690	GPP-1122	VETU	T08-1064	GP-43	UNVC	T1365661	GP-81	CHRY
SRP-PF16	GP-58	STR	STP1	GP-1	STP	T08-1065	GP-81 ³¹	STP	T1365661	GP-81	MOP
SRP-PF166	G-34	STR	STP16	GP-81 ³¹	STP	T08-1065	GP-9 ⁵⁸	UNVC	T1379	GA-229	NUE
SRP-PF20	GP-14	STR	STP16	GP-9 ⁵⁸	STP	T08-1066	GP-171 ¹⁶	UNVC	T14	GA-735	SRS
SRP-PF24	GP-20	STR	STP228	GP-81	STP	T08-1067	GP-88	UNVC	T14	G-333	TEX
SRP-PF25	GP-3	STR	STP24	GP-20	STP	T08-1068	GP-69	UNVC	T-140	G-222	PUMX
SRP-PF29	GP-13	STR	STP25	GP-3	STP	T08-1068	GP-69	UNVC	T14542BP	G-1173 ¹⁰⁸	PHHR
SRP-PF7	GP-5	STR	STP2801	GP-3985	STP	T08-1069	GP-88	UNVC	T14542PB	G-1173 ¹⁰⁸	PHHR
SRP-PH20	GP-14	STR	STP2802	GP-91	STP	T08-1070	GP-13	UNVC	T149	G-296	PUR
SRP-W40	G-31	STR	STP2815	GP-310	STP	T08-1071	GP-23	UNVC	T149	G-296-B	PUR
SRS3414	GA-516R	IPEC	STP2817	GP-3531	EXP	T08-1072	GP-152	UNVC	T149	G-296	WHIT
SRS7802	GA-864R	IPEC	STP2820	GP-81	STP	T08-1073	GP-53	UNVC	T149	G-296-B	WHIT
SS001	GA-1285	NUE	STP2821	GP-58	STP	T08-1073	GP-53	UNVC	T15	GA-192	SRS
SS002	GA-361	NUE	STP2825	GP-38	STP	T08-1075	GP-52 ¹¹⁰	UNVC	T15	G-330	TEX
SS004	GA-119	NUE	STP2827	GP-3682	STP	T08-1075	GP-691 ⁴⁸	UNVC	T1529	GA-27 ¹¹²	NUE
SS005	GA-1286	NUE	STP2830	GP-171	STP	T08-1076	G-750	UNVC	T1532	GA-26	NUE
SS007	GA-1287	NUE	STP2840	GP-157	STP	T08-1077	G-33	UNVC	T1556	GA-9045	NUE
SS008	GA-206	NUE	STP2841	GP-156	STP	T08-1078	G-613	UNVC	T15834	GA-853R	THWA
SS009	GA-210	NUE	STP2849	GP-24 ²⁶	STP	T08-1079	G-566	UNVC	T16	GP-20	HAVO
SS010	GA-7360	NUE	STP2849	GP-462 ²⁴	STP	T08-1153	GP-53	UNVC	T16	GA-3523	SRS
SS011	GA-108	NUE	STP2850	GP-1	STP	T1	GA-59	SRS	T16	GP-20	TEX
SS017	GA-482	NUE	STP2856	GP-3985	STP	T10	GA-3300	SRS	T16024	GP-9	THWA
SS018	GA-357	NUE	STP2856A	GP-3985	STP	T10-1222	GAK-16	TRU	T1623	GP-1	MICF
SS027	GA-416	NUE	STP2865	GP-42	STP	T10-1234	GAK-20	TRU	T1623	GP-1	MICP
SS033	GA-892	NUE	STP29	GP-13	STP	T10-1240	GA-27 ¹¹²	TRU	T1624	GP-3682	MICF
SS042	GA-239	NUE	STP400	GP-3600	STP	T10-1243	GA-26	TRU	T1627	GP-38	MICF
SS049	GA-588	NUE	STP44	GP-44	STP	T10-1246	GAK-403	TRU	T1627	GP-38	MICP
SS073	GA-426	NUE	STP45	GP-3429	STP	T10-1246	GAK-403	TRU	T1627	GP-38	MICP
SS089	GA-680	NUE	STP47	GP-46	STP	T10-1246	GAK-403	TRU	T1631	GP-9	MICP
SSB-AN150Z	GA-608	VOR	STP51	GP-3980	STP	T10-1246	GAK-403	TRU	T1632	GP-58	MICP
ST	GP-3816	ACD	STP51	GP-3980	STP	T10-1246	GAK-403	TRU	T16B	GP-20	TEX
ST10060	GP-406	STECH	STP561	GP-28 ⁴	STP	T10-1246	GAK-403	TRU	T17	GP-13	TEX
ST3506	GP-44	STECH	STP7	GP-5	STP	T10-1222	GAK-16	TRU	T17-1053	GP-9586	UNVC
ST3614	GP-58	STECH	STRCNH378	GAK-403	SCHM	T10-1234	GAK-20	TRU	T17-1054	GP-31	UNVC
ST3980	GP-3980	STECH	STRCOHN378	GAK-403	SCHM	T10-1240	GA-27 ¹¹²	TRU	T17-1055	GP-69	UNVC
ST6711	GP-34	STEC	STRCONH378	GAK-403	SCHM	T10-1243	GA-26	TRU	T17-1056	GP-178	UNVC
ST8873	GP-408	STECH	STRCOUH3	GAK-403	SCHM	T10-1246	GAK-403	TRU	T17-1057	GP-390	UNVC
ST9641	G-70	STECH	STRONH378	GAK-403	SCHM	T10-1246	GAK-403	TRU	T17-1058	GP-66	UNVC
STB160071	GA-356 ¹⁰⁴	DON	STS1	GP-46	GUP	T10-3951	GAP-379	TRU	T17-1059	G-169	UNVC
STB160071	GA-357 ¹⁰⁸	DON	SU6468	G-33	WABC	T10-5043	GA-98 ¹¹²	TRU	T1750	GA-1095	NUE
STG160077	GA-356 ¹⁰⁴	DON	SU6848	G-33	LETR	T10-5255	GA-26	TRU	T175002	GP-761H	JOND
STG160077	GA-357 ¹⁰⁸	DON	SV1282	G-1174 ¹⁰⁸	LETR	T10-6587	GA-360	TRU	T1760	GA-6129	NUE
STG160092	GA-356 ¹⁰⁴	DON	SV1282	G-1174 ¹⁰⁸	WABC	T10-6632	GA-6129	TRU	T1766	GA-376	NUE
STG160092	GA-357 ¹⁰⁸	DON	SV1349	G-1173 ¹⁰⁸	LETR	T10-6641	GA-6127	TRU	T179	GA-71	LUC
STG160098	GA-356 ¹⁰⁴	DON	SV1349	G-1173 ¹⁰⁸	WABC	T10-6769	GA-106 ⁴⁶	TRU	T18	GP-3	HAVO
STG160098	GA-357 ¹⁰⁸	DON	SV4731	G-1175 ¹⁰⁸	LETR	T10-6769	GA-326 ⁷¹	TRU	T18	GP-3	TEX
STG160101	GA-356 ¹⁰⁴	DON	SV6848	G-33	LETR	T1068	GPP-18	ACD	T18728	G-1163 ¹⁰⁸	COX
STG160101	GA-357 ¹⁰⁸	DON	SV6848	G-33	WABC	T10-6834	GA-361	TRU	T18728	G-1163 ¹⁰⁸	WHIT
STG160102	GA-356 ¹⁰⁴	DON	SW1622	GP-2022W	SCHU	T10-7672	GA-106 ⁴⁶	TRU	T188	GP-3	TEX
STG160102	GA-357 ¹⁰⁸	DON	SW2854	GP-66	VERS	T10-7672	GA-326 ⁷¹	TRU	T19	GA-325	SRS
STG160103	GA-356 ¹⁰⁴	DON	SW6920	GP-1	VERS	T10-9086	GA-360	TRU	T19	GP-3600 ¹⁰²	TEX
STG160103	GA-357 ¹⁰⁸	DON	SWT603043	GP-52 ¹¹⁰	AVEL	T10-9155	GA-356	TRU	T19	GP-387 ⁷	TEX
STG160105	GA-356 ¹⁰⁴	DON	SWT603043	GP-69 ⁴⁸	AVEL	T10-9159	GA-357	TRU	T19044	GP-14	JOND
STG160105	GA-357 ¹⁰⁸	DON	SWT603046	G-33	AVEL	T10-9726	GA-31	TRU	T19044D	GP-14	JOND
STG160109	GA-356 ¹⁰⁴	DON	SWT603049	G-750	AVEL	T11	GA-71	SRS	T19044T	GP-14	JOND
STG160109	GA-357 ¹⁰⁸	DON	SWT603052	GP-1013Q	AVEL	T11-4747	GA-98 ¹¹²	TRU	T19044TH	GP-14	JOND
STG160111	GA-356 ¹⁰⁴	DON	SWT603101	GP-26	AVEL	T115438	GAK-16	JOND	T19044TL	GP-14	JOND
STG160111	GA-357 ¹⁰⁸	DON	SX	GP-31	ACD	T11-6880-0	GA-6880	TRU	T19044TL	GP-14	LANZ
STG160114	GA-356 ¹⁰⁴	DON	SY	GP-38</							

Numero	Gonher	Fabricante	Numero	Gonher	Fabricante	Numero	Gonher	Fabricante	Numero	Gonher	Fabricante
Number	Gonher	Manufacturer	Number	Gonher	Manufacturer	Number	Gonher	Manufacturer	Number	Gonher	Manufacturer
T20.....	GP-81 ³¹	HAVO	T4.....	GA-70	SRS	T9010.....	GAK-403	NUE	TA19.....	GA-55	TEX
T20.....	GP-9 ⁵⁸	HAVO	T4.....	GP-13	TEX	T9045.....	GA-9045	TRU	TA193.....	GA-158	HAVO
T20.....	GA-54	SRS	T40.....	GP-178	HAVO	T915.....	GP-26	ACD	TA195.....	GA-448	HAVO
T20.....	GP-81 ³¹	TEX	T40.....	GA-4828	SRS	T92.....	GP-92	ACD	TA198.....	GA-55	TEX
T20.....	GP-9 ⁵⁸	TEX	T40.....	GP-178	TEX	T921.....	GP-26	ACD	TA2.....	GA-77	HAVO
T20-1.....	G-5000	KNE	T40348.....	GA-33 ¹¹²	CASE	T93.....	GP-27	ACD	TA2.....	GA-77	TEX
T206.....	G-163	KNE	T40348.....	GA-33 ¹¹²	DAVY	T933.....	GP-93	ACD	TA-200.....	GA-263	HAVO
T2079.....	GA-229	NUE	T40349.....	GA-33 ¹¹²	CASE	T9334.....	GA-9334	TRU	TA-201.....	GA-479	HAVO
T208.....	G-143	KNE	T41.....	GP-44	HAVO	T936.....	GP-92	ACD	TA22.....	GA-85	TEX
T20B.....	GP-81 ³¹	TEX	T42.....	GP-128	HAVO	T937.....	GP-92	ACD	TA23.....	GA-730	TEX
T20B.....	GP-9 ⁵⁸	TEX	T42.....	GA-277	SRS	T944.....	GP-92	ACD	TA23B.....	GA-730	TEX
T21.....	GAD-3	SRS	T42420.....	G-6	PHHR	T944.....	GP-92	MIGH	TA25.....	GA-325	TEX
T22.....	GA-86	SRS	T427L303.....	G-31	CONT	T95.....	GP-27	ACD	TA25B.....	GA-325	TEX
T22.....	GP-46	TEX	T427L403.....	G-31	CONT	T95.....	GP-93	ACD	TA26.....	GA-59	HAVO
T23.....	GP-3429	HAVO	T427L5000.....	G-31	CONT	T96.....	GP-55 ⁹⁰	ACD	TA26.....	GA-59	TEX
T23.....	GA-3424	SRS	T43.....	GA-4303	SRS	T97.....	GP-85 ⁹⁰	ACD	TA26B.....	GA-59	TEX
T23.....	GP-3429	TEX	T-43.....	GP-3675	HAVO	TA040-93230.....	GA-880R	KUBO	TA27.....	GA-57	HAVO
T231.....	GP-3429	TEX	T-44.....	G-765	HAVO	TA1.....	GA-56	TEX	TA27.....	GA-57	TEX
T24.....	GP-44	HAVO	T-45.....	GP-408	HAVO	TA104.....	GA-3501	HAVO	TA27B.....	GA-57	TEX
T24.....	GAD-1	SRS	T-46.....	G-45	HAVO	TA106.....	GA-139	HAVO	TA2B.....	GA-77	TEX
T24.....	GP-44	TEX	T-47.....	GP-178	HAVO	TA106.....	GA-139	TEX	TA3.....	GA-50	HAVO
T25.....	GP-28 ⁶	TEX	T-48.....	GP-149	HAVO	TA107.....	GA-142	HAVO	TA3.....	GA-50	TEX
T25.....	GP-430 ⁸	TEX	T4807999.....	GP-50	MOP	TA108.....	GA-6619 ¹	TEX	TA30.....	GA-303	HAVO
T2595.....	GA-6880	NUE	T4897991.....	GP-81	MOP	TA108.....	GA-6620 ⁹	TEX	TA30.....	GA-303	TEX
T26.....	GP-46	HAVO	T4897999.....	GP-81	MOP	TA-108.....	GA-6619 ¹	HAVO	TA30B.....	GA-303	TEX
T26.....	GA-80	SRS	T4906199.....	GA-71	CHRY	TA-108.....	GA-6620 ⁹	HAVO	TA31.....	GA-75	HAVO
T26.....	GP-46	TEX	T4906199.....	GA-71	MOP	TA109.....	GAD-294	HAVO	TA31.....	GA-75	TEX
T26B.....	GP-46	TEX	T4907999.....	GP-50	MOP	TA110.....	GA-133	HAVO	TA31B.....	GA-75	TEX
T27.....	GA-3647	SRS	T5.....	GA-55	SRS	TA-111.....	GA-604	HAVO	TA32.....	GA-86	TEX
T27.....	GP-3980	TEX	T51.....	GA-4365	SRS	TA113.....	GA-141	HAVO	TA33.....	GA-3300	HAVO
T-27.....	GP-3980	HAVO	T-51.....	G-49	HAVO	TA114.....	GA-7344	HAVO	TA33.....	GA-3300	TEX
T27B.....	GP-3980	TEX	T5120.....	GP-51	NIPP	TA115.....	GA-7142	HAVO	TA33B.....	GA-3300	TEX
T28.....	GP-3600	HAVO	T-52.....	G-954	HAVO	TA-116.....	GA-432	HAVO	TA35.....	GA-349	TEX
T28.....	GA-3490	SRS	T52566.....	GA-853R	THWA	TA1170.....	GA-139	ASAH	TA36.....	GA-85	HAVO
T28.....	GP-3600	TEX	T53.....	GAVW-2	SRS	TA-118.....	GA-322	HAVO	TA36.....	GA-85	TEX
T28B.....	GP-3600	TEX	T-53.....	G-112	HAVO	TA-119.....	GA-381	HAVO	TA36B.....	GA-85	TEX
T29.....	GP-58	HAVO	T54.....	GA-273	SRS	TA-1198.....	GA-410	AMCO	TA37.....	GA-86	TEX
T29.....	GA-2740	SRS	T55.....	GP-3531	EXP	TA120.....	GA-217	HAVO	TA37B.....	GA-86	TEX
T29.....	GP-58	TEX	T55.....	GA-274	SRS	TA123.....	GAVW-2	HAVO	TA38.....	GA-192	HAVO
T2DU879.....	GAK-20	INGR	T-55.....	GP-457	HAVO	TA123.....	GAVW-2	TEX	TA38.....	GA-192	TEX
T3.....	G-200	HAVO	T553.....	G-1174	ACD	TA125.....	GAD-118	HAVO	TA38B.....	GA-192	TEX
T3.....	GA-57	SRS	T553.....	G-1174 ¹⁰⁸	REF	TA127.....	GA-164	HAVO	TA39.....	GA-3424	TEX
T3.....	G-200	TEX	T567143.....	GAK-403	HYST	TA-128.....	GA-5466	HAVO	TA39B.....	GA-3424	TEX
T30.....	GA-3637	SRS	T57.....	GP-462	MICF	TA129.....	GA-514	HAVO	TA3B.....	GA-50	TEX
T30.....	GP-13	TEX	T-57.....	G-3752	HAVO	TA131.....	GA-175	HAVO	TA40.....	GA-3425	TEX
T3006174.....	GP-761H	HYST	T58.....	G-1173 ¹⁰⁸	ACD	TA132.....	GA-1616	HAVO	TA40B.....	GA-3425	TEX
T301.....	GP-42	MICF	T59.....	G-1175 ¹⁰⁸	ACD	TA132.....	GA-1616	TEX	TA43.....	GA-54	HAVO
T304.....	GP-91	MICF	T59.....	GP-91	NIPP	TA133.....	GA-198	HAVO	TA43.....	GA-54	TEX
T30B.....	GP-13	TEX	T59.....	G-1174	PUR	TA134.....	GA-673R	HAVO	TA43B.....	GA-54	TEX
T31.....	GP-44	HAVO	T-59.....	G-70	HAVO	TA135.....	GA-132	HAVO	TA44.....	GA-3523	HAVO
T31.....	GA-3681	SRS	T6.....	GA-50	SRS	TA136.....	GA-1615	HAVO	TA44.....	GA-3523	TEX
T31.....	GP-44	TEX	T60.....	G-1174	ACD	TA137.....	GA-442	HAVO	TA44B.....	GA-3523	TEX
T3131.....	GP-28 ⁸	MICF	T600.....	GP-91	MICF	TA140.....	GA-127	HAVO	TA45.....	GA-735	HAVO
T3131.....	GP-430 ⁸	MICF	T62.....	GP-149	MICF	TA-141.....	GA-384	HAVO	TA45.....	GA-735	TEX
T3132.....	GP-91	MICF	T628.....	G-1173 ¹⁰⁸	ACD	TA143.....	GA-172	HAVO	TA45B.....	GA-735	TEX
T3135.....	GP-38	MICF	T65.....	G-1175 ¹⁰⁸	ACD	TA144.....	GA-158	HAVO	TA46.....	GA-271	HAVO
T3135.....	GP-38	NIPP	T65MS.....	G-1175 ¹⁰⁸	ACD	TA145.....	GA-130	HAVO	TA46.....	GA-271	TEX
T3136.....	GP-310	MICP	T6646.....	GP-66	TIMB	TA146.....	GA-279	HAVO	TA46B.....	GA-271	TEX
T3140.....	GP-382	MICF	T67206.....	GP-38	MICF	TA147.....	GA-392	HAVO	TA48.....	GA-3647	HAVO
T3141.....	GP-38	MICF	T6720G.....	GP-38	NIPP	TA148.....	GA-163	HAVO	TA48.....	GA-3647	TEX
T3142.....	GP-3682	MICF	T6730.....	GP-3985	MICF	TA149.....	GA-240	HAVO	TA48B.....	GA-3647	TEX
T3142.....	GP-38	MICP	T6734.....	GP-3985	MICF	TA150.....	GA-1614	HAVO	TA49.....	GA-3588	HAVO
T3142.....	GP-3682	NIPP	T6736.....	GP-42	MICF	TA-151.....	GA-732R	HAVO	TA49.....	GA-3588	TEX
T3143.....	GP-171	MICF	T6757.....	GP-359	DENS	TA-152.....	GA-348	HAVO	TA49B.....	GA-3588	TEX
T3144.....	GP-54 ¹¹	MICF	T68010001.....	G-33	HENL	TA-153.....	GA-8606	HAVO	TA50.....	GA-89	HAVO
T3144.....	GP-66 ¹⁰	MICF	T7.....	GA-85	SRS	TA-154.....	GA-170	HAVO	TA50.....	GA-89	TEX
T3148.....	GP-3682	MICF	T7.....	GP-50	TEX	TA-156.....	GA-472	HAVO	TA50B.....	GA-89	TEX
T3148.....	GP-3682	MICP	T72.....	G-1174 ¹⁰⁸	ACD	TA-157.....	GA-780	HAVO	TA51.....	GA-274	HAVO
T3148.....	GP-3682	NIPP	T73.....	G-1175 ¹⁰⁸	ACD	TA-158.....	GAVW-620	HAVO	TA51.....	GA-274	TEX
T3149.....	GP-171	MICF	T7311.....	GP-3985	MICF	TA-159.....	GA-168	HAVO	TA51B.....	GA-274	TEX
T3155.....	GP-149	MICF	T7311G.....	GP-3985	NIPP	TA-160.....	GA-6479 ⁹⁰	HAVO	TA53.....	GA-78	TEX
T33.....	GP-3985	HAVO	T7314.....	GP-40	MICF	TA-161.....	GA-224	HAVO	TA53B.....	GA-78	TEX
T33.....	GP-3985	TEX	T7314.....	GP-40	NIPP	TA-162.....	GA-240	HAVO	TA54.....	GA-80	HAVO
T33B.....	GP-3985	TEX	T7316.....	GP-149	MICF	TA-163.....	GA-301	HAVO	TA54.....	GA-80	TEX
T34.....	GP-462	TEX	T750.....	G-750	PUR	TA-164.....	GA-278R	HAVO	TA54B.....	GA-80	TEX
T34B.....	GP-462	TEX	T77.....	G-1174	ACD	TA165.....	GA-180	ASAH	TA55.....	GA-90	TEX
T35.....	GP-81	HAVO	T7716.....	GA-7716	TRU	TA-166.....	GAVW-121	HAVO	TA55B.....	GA-90	TEX
T35.....	GP-81	TEX	T7919.....	GP-91	THWA	TA-167.....	GAVW-621	HAVO	TA56.....	GA-429	TEX
T35B.....	GP-81	TEX	T8.....	GA-303	SRS	TA-168.....	GA-1616	HAVO	TA56B.....	GA-429	TEX
T36.....	GP-68	HAVO	T8.....	G-6	TEX	TA-169.....	GA-286	HAVO	TA57.....	GA-74	HAVO
T36.....	GA-271	SRS	T8047.....	GA-8047	TRU	TA-171.....	GA-248	HAVO	TA57.....	GA-74	TEX
T36.....	GP-68	TEX	T815.....	GP-26	ACD	TA173.....	GA-595	HAVO	TA57B.....	GA-74	TEX
T36B.....	GP-68	TEX	T8204.....	GP-462	MICP	TA-174.....	GA-410	AMCO	TA6.....	GA-71	HAVO
T37.....	GP-3766	HAVO	T8204.....	GP-462	NIPP	TA-179.....	GA-183R	HAVO	TA6.....	GA-71	TEX
T37.....	GP-3766	TEX	T8206.....	GP-462	MICP	TA18.....	GA-78	TEX	TA60.....	GA-3681	HAVO
T371L5000.....	G-31	CONT	T821.....	GP-26	ACD	TA-180.....	GA-395	HAVO	TA60.....	GA-3681	TEX
T37B.....	GP-3766	TEX	T8211.....	GP-36	NIPP	TA181.....	GAD-1 ⁸⁷	ASAH	TA60B.....	GA-3681	TEX
T38.....	GP-205	HAVO	T829.....	GPP-18	ACD	TA-181.....	GA-780	HAVO	TA62.....	GA-4325	HAVO
T38.....	GA-74	SRS	T8301.....	GP-42	MICF	TA182.....	GA-27198	ASAH	TA62.....	GA-4325	TEX
T38.....	GP-205	TEX	T8304.....	GP-91	MICF	TA-182.....	GA-244	HAVO	TA63.....	GA-3814	HAVO
T38B.....	GP-205	TEX	T8304G.....	GP-91	MICF	TA-184.....	GA-477	HAVO	TA63.....	GA-3814	TEX
T39.....	GP-562	HAVO	T8305.....	GP-91	MICF	TA-186.....	GA-264	HAVO	TA63B.....	GA-3814	TEX
T39.....	GA-3588	SRS	T8306.....	GP-91	MICF	TA-187.....	GA-414R	HAVO	TA65.....	GA-3916	HAVO
T39.....	GP-562	TEX	T8307.....	GP-149	MICF	TA-188.....	GA-490	HAVO	TA65.....	GA-3916	TEX
T39B.....	GP-562	TEX	T9.....	GA-77	SRS	TA-189.....	GAVW-622	HAVO	TA65B.....	GA-3916	TEX
T3B.....	G-200	TEX	T9.....	G-236	TEX	TA19.....	GA-55	HAVO	TA66.....	GA-153	HAVO

Referencia Cruzada por Numero de Parte

Cross Reference by Part Number



Numero	Gonher	Fabricante	Numero	Gonher	Fabricante	Numero	Gonher	Fabricante	Numero	Gonher	Fabricante
Number	Gonher	Manufacturer	Number	Gonher	Manufacturer	Number	Gonher	Manufacturer	Number	Gonher	Manufacturer
TA66	GA-153	TEX	TA84B	GA-362	TEX	TF2224	G-45	FSN	TF500	GP-38	TEX
TA66B	GA-153	TEX	TA85	GA-6690	HAVO	TF2224	G-45	TIRP	TF501	GP-58	TEX
TA67	GA-273	HAVO	TA85	GA-6690	TEX	TF25	GP-20	FSN	TF502	GP-310	HAVO
TA67	GA-273	TEX	TA86	GA-139	HAVO	TF25288	GP-3675	FSN	TF502	GP-3569	HAVO
TA67B	GA-273	TEX	TA86	GA-139	TEX	TF2702	GP-212	FSN	TF502B	GP-310	TEX
TA6B	GA-71	TEX	TA87	GA-165	HAVO	TF2825	GP-38	FSN	TF503	GP-24 ²⁶	TEX
TA7	GA-80	TEX	TA87	GA-165	TEX	TF2844	GP-81	FSN	TF503	GP-462 ²⁴	TEX
TA70	GA-277	HAVO	TA88	GA-300	HAVO	TF2849	GP-24 ²⁶	FSN	TF504	GP-81	TEX
TA70	GA-277	TEX	TA88	GA-300	TEX	TF2849	GP-462 ²⁴	FSN	TF504	GP-171	HAVO
TA70B	GA-277	TEX	TA89	GA-78	HAVO	TF2850	GP-1	FSN	TF504B	GP-171	TEX
TA71	GA-1253	HAVO	TA9	GA-70	HAVO	TF2856A	GP-40	FSN	TF505	GP-81	TEX
TA71	GA-253	TEX	TA9	GA-70	TEX	TF2865	GP-42	FSN	TF505B	GP-81	TEX
TA71B	GA-253	TEX	TA90	GA-3915	HAVO	TF2870	GP-28 ⁸⁴	FSN	TF506	GP-81 ²¹	TEX
TA72	GA-174	HAVO	TA-93	GA-4958	HAVO	TF2870	GP-3600 ⁸⁴	FSN	TF506	GP-9 ²⁸	TEX
TA72	GA-174	TEX	TA94	GA-180	HAVO	TF2870	GP-38 ⁸⁷	FSN	TF507	GP-28 ⁸⁴	TEX
TA7302	GA-135	TRU	TA94	GA-180	TEX	TF2870	GP-430 ⁸⁵	FSN	TF507	GP-3600 ⁸⁴	TEX
TA7337	GA-135	TRU	TA95	GA-390	TEX	TF2876	GP-91	TIRP	TF507	GP-38 ⁸⁷	TEX
TA7360	GA-375	TRU	TA-95	GA-390	HAVO	TF2884	GP-81	FSN	TF507	GP-430 ⁸⁵	TEX
TA7361	GA-1203	TRU	TA96	GA-471	HAVO	TF289	GP-3985	FSN	TF508	GP-3985	TEX
TA7364	GA-8047	TRU	TA96	GA-471	TEX	TF289	GP-3985	TIRP	TF510	GP-81	TEX
TA7365	GA-1285	TRU	TA97	GA-2106	TEX	TF2951	GP-58	FSN	TF510B	GP-81	TEX
TA7366	GA-9334	TRU	TA-97	GA-2106	HAVO	TF30	GP-3	FSN	TF511	G-870	TEX
TA7367	GA-1286	TRU	TA99	GA-382	TEX	TF3244	G-49	TIRP	TF514	G-225	TEX
TA7368	GA-1008	TRU	TA-99	GA-382	HAVO	TF338	GP-3766	ACD	TF515	GP-42	TEX
TA7369	GA-1284	TRU	TA9B	GA-70	TEX	TF3387	GP-46	FSN	TF516	GP-3531	EXP HAVO
TA7374	GA-9045	TRU	TA82	GA-113	TEX	TF3432	GP-44	FSN	TF518	GP-3531	EXP TEX
TA7375	GA-1287	TRU	TA58	GP-34	MIFP	TF3531	GP-3531	EXP FSN	TF516B	GP-3531	EXP TEX
TA7381	GAK-16	TRU	TA59	GP-34	MIFP	TF3531-A	GP-3531	EXP FSN	TF517	GP-40	HAVO
TA7382	GAK-20	TRU	TAX33N	GAK-625	JOY	TF355	GP-58	FSN	TF517	GP-40	TEX
TA7384	GA-27 ¹¹²	TRU	TB01	GP-1	PUR	TF3593	GP-462	FSN	TF517B	GP-40	TEX
TA7385	GA-26	TRU	TB0111	GP-46	PUR	TF3682	GP-3682	FSN	TF518	GP-28 ⁶	TEX
TA7386	GAK-403	TRU	TB033	GP-20	PUR	TF3850	GP-310	FSN	TF518	GP-430 ⁸	TEX
TA7387	GA-33 ¹¹²	TRU	TB040	GP-13	PUR	TF3850	GP-3569	FSN	TF518	GP-28 ⁶	HAVO
TA7396	GAK-16	TRU	TB049	GP-3	PUR	TF3850	GP-310	TIRP	TF518	GP-430 ⁸	HAVO
TA7399	GAP-379	TRU	TB0816	GP-81 ³¹	PUR	TF3870	GP-28 ⁶	FSN	TF519	GP-3816	HAVO
TA7401	GA-98 ¹¹²	TRU	TB0816	GP-9 ⁵⁸	PUR	TF3870	GP-430 ⁸	FSN	TF519	GP-2951 ⁹²	TEX
TA7405	GA-403	TRU	TB93407505	GP-36	ZETO	TF3870	GP-28 ⁶	TIRP	TF519	GP-58	TEX
TA7410	GA-360	TRU	TB98	GA-70	TEX	TF3870	GP-430 ⁸	TIRP	TF519B	GP-2951 ⁹²	TEX
TA7411	GA-6129	TRU	TBO1	GP-1	PUR	TF400	G-31	DEL	TF519B	GP-58	TEX
TA7412	GA-6127	TRU	TBO111	GP-46	PUR	TF4006	GP-44	TIRP	TF520	GP-91	HAVO
TA7413	GA-106 ⁸⁶	TRU	TBO17	GP-46	PUR	TF43	GP-81 ³¹	FSN	TF520	GP-91	TEX
TA7413	GA-326 ⁷¹	TRU	TBO18	GP-46	PUR	TF43	GP-9 ⁵⁸	FSN	TF521	GP-58	TEX
TA7414	GA-206	TRU	TBO193	GP-40	PUR	TF4458	GP-462	FSN	TF521B	GP-58	TEX
TA7415	GA-33 ¹¹²	TRU	TBO33	GP-20	PUR	TF4459	GP-149 ⁹⁹	FSN	TF524	GP-3682	HAVO
TA7419	GA-356	TRU	TBO373	GP-38	PUR	TF4459	GP-91	FSN	TF524	GP-3682	TEX
TA7427	GA-892	TRU	TBO40	GP-13	PUR	TF4460	GP-91	FSN	TF524B	GP-3682	TEX
TA7434	GA-891	TRU	TBO49	GP-3	PUR	TF4466	GP-28 ⁶	FSN	TF525	GP-157	HAVO
TA7435	GA-378	TRU	TBO81	GP-81 ³¹	PUR	TF4466	GP-430 ⁸	FSN	TF525	GP-157	TEX
TA7436	GA-378	TRU	TBO81	GP-9 ⁵⁸	PUR	TF4477	GP-156	FSN	TF525B	GP-157	TEX
TA7437	GA-229	TRU	TC7838	G-1175 ¹⁰⁸	LETR	TF-4484	GP-212	FSN	TF526	GP-156	TEX
TA7439	GA-891	TRU	TC7844	G-31	LETR	TF45	GP-3429	FSN	TF526B	GP-156	TEX
TA7445	GA-18	TRU	TC7844	G-31	WABC	TF454	GP-408	FSN	TF527	GP-462	HAVO
TA7450	GA-18	TRU	TCA136	GA-55	FRM	TF454	GP-408	TIRP	TF527	GP-462	TEX
TA7462	GA-5648	TRU	TCA146PL	GA-71	FRM	TF4620	GP-149	FSN	TF527B	GP-462	TEX
TA7487	GA-71	TRU	TCA160PL	GA-70	FRM	TF4622	GP-91	FSN	TF528	GP-212	HAVO
TA7488	GA-80	TRU	TCA189PL	GA-50	FRM	TF4631	GP-205	FSN	TF529	GP-149	HAVO
TA7489	GA-55	TRU	TCA305	GA-730	FRM	TF4651	GP-68	FSN	TF531	GP-91	TEX
TA7492	GA-85	TRU	TCA324A	GA-85	FRM	TF4670	GP-81	FSN	TF533	GP-28 ⁶	HAVO
TA7493	GA-325	TRU	TCA326	GA-59	FRM	TF47	GP-46	FSN	TF533	GP-430 ⁸	HAVO
TA7494	GA-59	TRU	TCA340A	GA-86	FRM	TF51	GP-3980	FSN	TF534	GP-91	TEX
TA7495	GA-57	TRU	TCA351	GA-75	FRM	TF52	GP-3980	FSN	TF537	GP-81	HAVO
TA7496	GA-50	TRU	TD427F432	GAK-403	CONT	TF52	GP-3980	TIRP	TF538	GP-91	HAVO
TA7497	GA-71	TRU	TD500L5000	G-31	CONT	TF5288	GP-3675	TIRP	TF538	GP-91	HAVO
TA7499	GA-730	TRU	TD600L301	G-31	CONT	TF7	GP-81	FSN	TF538	GP-91	HAVO
TA75	GA-7017	TEX	TD600L302	G-1143	CONT	TF8A	GP-1	FSN	TF538	GP-91	HAVO
TA-75	GA-7017	HAVO	TD600L342	G-1143	CONT	TF9939	G-1174 ¹⁰⁸	WHIT	TF538	GP-91	HAVO
TA7500	GA-70	TRU	TD600L400	G-31	CONT	TFA1	GAD-1	HAVO	TF538	GP-91	HAVO
TA7502	GA-12	TRU	TD600L4000	G-31	AERO	TFA1	GAD-1	TEX	TF538	GP-91	HAVO
TA7503	GA-55	TRU	TD600L4000	G-31	CLRK	TFA10	GA-277	HAVO	TF538	GP-91	HAVO
TA7505	GA-56	TRU	TD600L4000	G-31	CONT	TFA10	GA-277	TEX	TF538	GP-91	HAVO
TA7507	GA-105	TRU	TD600L4010	G-1143	CONT	TFA10B	GA-277	TEX	TF538	GP-91	HAVO
TA7509	GA-75	TRU	TD600L5000	G-31	CONT	TFA11	GAVW-2	HAVO	TF538	GP-91	HAVO
TA750C	G-750	HARV	TD600L5010	G-1143	CONT	TFA11	GAVW-2	TEX	TF538	GP-91	HAVO
TA76	GA-4303	HAVO	TD6776	GP-1101	LETR	TFA11B	GAVW-2	TEX	TF538	GP-91	HAVO
TA76	GA-4303	TEX	TD6776	GP-1101	WABC	TFA15	GAD-1	TEX	TF538	GP-91	HAVO
TA76B	GA-4303	TEX	TD7196	G-6	LETR	TFA15B	GAD-1	TEX	TF538	GP-91	HAVO
TA77	GA-5056	HAVO	TD7196	G-6	WABC	TFA16	GA-2719B	TEX	TF538	GP-91	HAVO
TA77	GA-5056	TEX	TDX27493	GA-33 ¹¹²	MASY	TFA16B	GA-2719B	TEX	TF538	GP-91	HAVO
TA77B	GA-5056	TEX	TEC700	GA-100	TEX	TFA-17	GA-3566	HAVO	TH06446	GA-892	JOND
TA78	GA-6479	HAVO	TEC701	GA-113	TEX	TFA19	GAD-15	HAVO	TH109435	GA-398	JOND
TA78B	GA-6479	TEX	TEC702	GA-113	TEX	TFA19	GAD-15	TEX	TH1376	G-1173 ¹⁰⁸	LETR
TA79	GA-3901	HAVO	TEC706	GA-176	HAVO	TFA19B	GAD-15	TEX	TH227L5010	G-31	CONT
TA79	GA-3901	TEX	TEC706	GA-176	TEX	TFA1B	GAD-1	TEX	TH4276330	G-31	CONT
TA79B	GA-3901	TEX	TECXLF75000	GP-3001	CUMM	TFA2	GA-349 ⁹⁸	HAVO	TH427L202	G-31	CONT
TA8	GA-105	TEX	TF05126	G-1174 ¹⁰⁸	COCT	TFA2	GAD-3	HAVO	TH427L330	G-31	CONT
TA80	GA-275	HAVO	TF11	GP-5	FSN	TFA2	GAD-3	TEX	TH427L5010	G-31	CONT
TA80	GA-275	TEX	TF1158	GG-76	ASAH	TFA-2159	GA-323	TNFI	TH42L330	G-31	CONT
TA80B	GA-275	TEX	TF1252	GG-45	ASAH	TFA2B	GAD-3	TEX	TH4723	GA-5648	LETR
TA82	GA-195	HAVO	TF13	GP-13	FSN	TFA3	GP-75	HAVO	TH6776	GP-1101	LETR
TA82	GA-195	TEX	TF1353	GG-203	ASAH	TFA3	GA-75	TEX	TH6776	GP-1101	WABC
TA82B	GA-195	TEX	TF1354	GG-203	ASAH	TFA3B	GA-75	TEX	TH9177	GA-5648	LETR
TA83	GA-386	TEX	TF1357	GG-204	ASAH	TFA5	GA-3490	TEX	TH9177	GA-5648	WABC
TA-83	GA-386	HAVO	TF1376	G-1173 ¹⁰⁸	LETR	TFA5B	GA-3490	TEX	TJ1560196001	GP-81	KOMA
TA83B	GA-386	TEX	TF200	G-200	FSN	TFA9	GA-2740	HAVO	TJ1780141100	GAD-1	KOMA
TA84	GA-362	HAVO	TF2129	G-765	FSN	TFA9	GA-2740	TEX	TKC6055	GG-251	LEVL
TA84	GA-362	TEX	TF2129	G-765	TIRP	TFA9B	GA-2740	TEX	TL-2CSO	GP-52 ¹¹⁰	CLRK

Numero	Gonher	Fabricante	Numero	Gonher	Fabricante	Numero	Gonher	Fabricante	Numero	Gonher	Fabricante
Number	Gonher	Manufacturer	Number	Gonher	Manufacturer	Number	Gonher	Manufacturer	Number	Gonher	Manufacturer
TL-2CSO	GP-691 ⁴⁸	CLRK	TP25	GP-149 ⁶⁹	SRS	TP993	GPP-11	ACD	TS12	GA-50	AMS
TL6209	G-33	GMCX	TP25	GP-91 ⁷⁸	SRS	TP994	GP-78	ACD	TS12	GA-77	AMS
TL6209	G-33	LETR	TP26	GP-157	SRS	TP995	2010PM-OR ⁷	ACD	TS120	GA-172	AMS
TL6209	G-33	WABC	TP27	GP-3985	SRS	TP995	2010TM-OR ²	ACD	TS120	GA-381	AMS
TL6698	G-33	LETR	TP28	GP-149	SRS	TPA1	GA-59	SRS	TS122	GA-158	AMS
TL-SFSO	GP-52 ¹⁰	CLRK	TP3	GP-3	SRS	TPA10	GA-3300	SRS	TS123	GA-348	AMS
TL-SFSO	GP-691 ⁴⁸	CLRK	TP4	GP-81 ³¹	SRS	TPA11	GA-71	SRS	TS124	GA-2114	AMS
TM27L3100	GP-81	CONT	TP4	GP-9 ⁵⁸	SRS	TPA12	GA-730	SRS	TS124	GA-217	AMS
TME1243	GA-26	HDA	TP5	GP-46	SRS	TPA14	GA-735	SRS	TS125	GA-132	AMS
TME6587	GA-360	HDA	TP509	G-1173 ¹⁰⁸	ACD	TPA15	GA-192	SRS	TS126	GA-VVW-620	AMS
TME6632	GA-6129	HDA	TP509L	G-1173 ¹⁰⁸	ACD	TPA1758	GA-373	TRCP	TS127	GA-8606	AMS
TME6918	GA-378	HDA	TP510	G-1175 ¹⁰⁸	ACD	TPA19	GA-325	SRS	TS128	GA-279	AMS
TME7797	GA-229	HDA	TP511	G-1173 ¹⁰⁸	ACD	TPA1968	GA-3551 ³⁵	TRCP	TS13	GA-3300	AMS
TME8047	GA-376	HDA	TP511M	G-1173 ¹⁰⁸	REF	TPA1968	GA-3551 XT ⁶⁴	TRCP	TS13	GP-3531 EXP	SRS
TME8299	GA-6880	HDA	TP512	G-1175 ¹⁰⁸	ACD	TPA2	GA-75	SRS	TS14	GA-4325	AMS
TME8494	GA-493 ¹⁰⁸	HDA	TP512M	G-1175 ¹⁰⁸	REF	TPA20	GA-54	SRS	TS14	GA-78	AMS
TME9155	GA-356	HDA	TP513	G-1173 ¹⁰⁸	ACD	TPA21	GAD-3	SRS	TS14	GAD-1	AMS
TME9544	GA-107	HDA	TP514	G-1175 ¹⁰⁸	ACD	TPA22	GA-86	SRS	TS14	GP-3600	SRS
TME9545	GA-209	HDA	TP516	G-1173 ¹⁰⁸	ACD	TPA23	GA-3424	SRS	TS15	GA-471	AMS
TN01160024	GP-36	KHDF	TP518	G-1176	ACD	TPA24	GAD-1	SRS	TS152	GA-7344	AMS
TN01160243	GP-1122	DUTZ	TP522	G-1174 ¹⁰⁸	ACD	TPA26	GA-80	SRS	TS154	GA-217	AMS
TN1173765	GP-77	KHDF	TP522M	G-1174 ¹⁰⁸	ACD	TPA28	GA-3490	SRS	TS155	GA-301	AMS
TO118	GP-1	ASAH	TP523	G-1176	ACD	TPA29	GA-2740	SRS	TS16	GA-57	AMS
TO124	GP-38	ASAH	TP524	G-1173 ¹⁰⁸	ACD	TPA3	GA-57	SRS	TS16	GA-75	AMS
TO127	GP-38	ASAH	TP530	G-1175 ¹⁰⁸	ACD	TPA30	GA-3637	SRS	TS16	GP-28 ⁶	SRS
TO130	GP-38	ASAH	TP531	G-1163 ¹⁰⁸	ACD	TPA31	GA-3647	SRS	TS16	GP-430 ⁸	SRS
TO131	GP-38	ASAH	TP533	G-1175 ¹⁰⁸	ACD	TPA32	GA-3681	SRS	TS160	GA-VVW-621	AMS
TO134	GP-58	ASAH	TP540M	G-1175 ¹⁰⁸	REF	TPA36	GA-271	SRS	TS162	GA-286	AMS
TO137	GP-157	ASAH	TP540X	G-1175 ¹⁰⁸	ACD	TPA38	GA-74	SRS	TS17	GA-3523	AMS
TO138	GP-58	ASAH	TP540X	G-1175 ¹⁰⁸	UNN	TPA39	GA-3588	SRS	TS170	GA-248	AMS
TO17503	G-1163 ¹⁰⁸	COCT	TP542	G-1166	ACD	TPA4	GA-70	SRS	TS18	GA-75	AMS
TO17503	G-1163 ¹⁰⁸	WHIT	TP555	G-1174 ¹⁰⁸	ACD	TPA42	GA-277	SRS	TS18663	G-870	MASY
TO202	GP-38	TOYO	TP560	G-1173 ¹⁰⁸	ACD	TPA424	GA-106 ⁴⁶	SRS	TS19	GP-13	SRS
TO250	GP-38	NISS	TP567	GP-1101	ACD	TPA424	GA-326 ⁹¹	SRS	TS191	GA-1615	AMS
TO5639	G-1173 ¹⁰⁸	COCT	TP567	GP-1101	UNN	TPA43	GA-4303	SRS	TS2	GP-20	SRS
TO5639	G-1173 ¹⁰⁸	WHIT	TP574	G-1123	ACD	TPA5	GA-55	SRS	TS20	GA-325	AMS
TP1	GP-1	SRS	TP6	GP-3429	SRS	TPA51	GA-4365	SRS	TS20	GA-86	AMS
TP1001	GPP-11	ACD	TP614	G-1143	ACD	TPA52	GA-55	SRS	TS21	GA-2194	AMS
TP1002	GPP-11	ACD	TP617	GA-VVW-2	ACD	TPA53	GA-VVW-2	SRS	TS21	GP-3682	SRS
TP1003	GPP-11	ACD	TP623	GPP-14	ACD	TPA54	GA-273	SRS	TS2135	G-222	LETR
TP1006	G-294	ACD	TP628	G-1173	ACD	TPA55	GA-274	SRS	TS22	GA-730	SRS
TP1006	G-294	CAC	TP629	GP-11 ⁷⁶	ACD	TPA58	GA-3425	SRS	TS22	GA-85	AMS
TP1006	G-294	GKIN	TP629	GP-1101 ⁴⁵	ACD	TPA59	GA-89	SRS	TS23	GA-3588	AMS
TP1006	G-294	MIGH	TP629	GP-1101	UNN	TPA6	GA-50	SRS	TS23	GA-70	AMS
TP1045	GS-2033	ACD	TP630	GPP-14	ACD	TPA60	GA-75	SRS	TS23	GA-90	AMS
TP1049	G-293	ACD	TP634	GP-84	ACD	TPA62	GA-3814	SRS	TS24	GA-174	AMS
TP1055	GP-155	ACD	TP635	GP-83	ACD	TPA63	GA-4828	SRS	TS27	GA-71	AMS
TP1057	S-3202 ⁴⁰	ACD	TP7	GP-3980	SRS	TPA64	GA-3916	SRS	TS27	GA-80	AMS
TP1058	GPP-19	ACD	TP8	GP-310	SRS	TPA65	GA-5056	SRS	TS29	GA-3901	AMS
TP1067	GP-1122	ACD	TP807	GP-1101	ACD	TPA66	GA-174	SRS	TS3	GP-3	SRS
TP1068	GPP-18	ACD	TP808	GP-110	ACD	TPA67	GA-153	SRS	TS31	GA-59	SRS
TP1069	GPP-1122	ACD	TP809	GP-1105	ACD	TPA7	GA-85	SRS	TS32	GA-192	AMS
TP11	GP-40	SRS	TP810	GP-11	ACD	TPA8	GA-303	SRS	TS33	GA-VVW-2	AMS
TP1125	GP-62	ACD	TP811	GP-1108	ACD	TPA9	GA-77	SRS	TS35	GA-54	AMS
TP12	GP-42	SRS	TP815	GP-26	ACD	TPA979	GA-209	TRCP	TS37	GA-12	AMS
TP1204	G-1121	ACD	TP816	GP-27	ACD	TPA987	GA-210	TRCP	TS38	GA-3501	AMS
TP1226	G-294	ACD	TP816	GP-27	UNN	TPF213	GP-110	TRCP	TS4	GP-81 ³¹	SRS
TP1227	GP-1122	ACD	TP831	GP-1107	ACD	TPL3000	GP-3000	TRCP	TS4	GP-9 ⁵⁸	SRS
TP1228	G-296	ACD	TP847	GC-1133	ACD	TPL670	GP-53	TRCP	TS40	GA-3814	AMS
TP1228	G-296-B	ACD	TP848	GS-1133	ACD	TPL777	GP-57	TRCP	TS41	GA-3647	AMS
TP1241	GP-1122	ACD	TP859	GA-27 ¹¹²	ACD	TR4922	GA-27 ¹¹²	LETR	TS43	GA-4365	AMS
TP1246	GP-78	ACD	TP860	GPP-1000	ACD	TR49224	GA-27 ¹¹²	WABC	TS45	GA-4828	AMS
TP1247	GP-1122	ACD	TP862	GP-78	ACD	TR4922-4	GA-27 ¹¹²	LETR	TS47	GA-271	AMS
TP125	GP-62	ACD	TP865	GP-1105	ACD	TR7297	GA-27 ¹¹²	LETR	TS49	GA-5056	AMS
TP1261	GP-1101	ACD	TP866	GP-62	ACD	TR7297	GA-27 ¹¹²	WABC	TS5	GP-46	SRS
TP1262	S-3202 ⁴⁰	ACD	TP876	G-295	ACD	TRC7244	GP-1	FUNK	TS51	GA-89	AMS
TP1263	GPP-419	ACD	TP877	GP-110	ACD	TRC7244	GP-1	HUBR	TS52	GA-55	AMS
TP1263	GPP-419	ATL	TP887	GP-1107	ACD	TS04	GA-165	AMS	TS53	GA-140	AMS
TP1264	GP-1122	ACD	TP9	GP-58	SRS	TS06	GA-275	AMS	TS54	GA-4303	AMS
TP1274	GPP-111	ACD	TP915	GP-26	ACD	TS07	GA-195	AMS	TS57	GA-735	AMS
TP1274	GPP-524	ACD	TP915D	GP-26	ACD	TS08	GA-6479	AMS	TS58	GA-3915	AMS
TP1280	GPP-547 ³⁹	ACD	TP916	GP-27	ACD	TS09	GA-322	AMS	TS59	GA-3566	AMS
TP1280	PFF831 ⁴¹	ACD	TP916D	GP-27	ACD	TS09	GA-VVW-120	AMS	TS6	GP-3429	SRS
TP1280	R 60 P ⁴²	ACD	TP916L	GP-27	ACD	TS1	GP-1	SRS	TS61	GA-429	AMS
TP1282	GP-1122	ACD	TP917	GP-55	ACD	TS10	GP-156	SRS	TS63	GA-253	AMS
TP1285	GPP-1287 ³⁹	ACD	TP918	GA-287 ³⁹	ACD	TS101	GA-164	AMS	TS67	GA-349	AMS
TP1285	PFF831 ⁴¹	ACD	TP919	GPP-18	ACD	TS102	GA-141	AMS	TS67	GA-390	AMS
TP1285	R 60 P ⁴²	ACD	TP920	GP-56	ACD	TS103	GA-442	AMS	TS67	GAD-3	AMS
TP1287	GP-1105	LUF	TP927	GP-85	ACD	TS104	GA-300	AMS	TS68	GA-180	AMS
TP1292	GPP-1000	ACD	TP928	GP-93	ACD	TS105	GA-432	AMS	TS7	GP-3980	SRS
TP1296	GP-96	ACD	TP928L	GP-93	ACD	TS106	GA-240	AMS	TS72	GA-27198	AMS
TP13	GP-3531 EXP	SRS	TP931	GP-78	ACD	TS108	GA-198	AMS	TS72	GA-3424	AMS
TP14	GP-3600	SRS	TP934	GP-84	ACD	TS109	GA-2198 ³⁹	AMS	TS72	GA-3425	AMS
TP15	G-1173 ¹⁰⁸	ACD	TP935	GP-83	ACD	TS109	GA-438 ⁹¹	AMS	TS74	GAD-15	AMS
TP16	GP-28 ⁶	SRS	TP936	GP-92	ACD	TS11	GA-2740	AMS	TS77	GA-7	AMS
TP16	GP-430 ⁸	SRS	TP936	GA-303	GKIN	TS11	GA-303	AMS	TS78	GA-153	AMS
TP17	GP-24 ²⁶	SRS	TP942	G-297	ACD	TS11	GA-74	AMS	TS79	GA-274	AMS
TP17	GP-462 ⁹⁴	SRS	TP942	G-297-B	ACD	TS11	GP-40	SRS	TS79	GA-381	AMS
TP19	GP-13	SRS	TP943	GP-1122	ACD	TS111	GA-673R	AMS	TS80	GA-VVW-4	AMS
TP2	GP-20	SRS	TP943	GP-1122	GKIN	TS113	GA-5466	AMS	TS81	GA-277	AMS
TP21	GP-3980	SRS	TP943	GP-1122	MIGH	TS114	GA-604	AMS	TS83	GA-392	AMS
TP22	GP-1	INTM	TP944	GP-92	GKIN	TS116	GA-VVW-121	AMS	TS87	GA-3916	AMS
TP22	GP-3682	SRS	TP959	GP-85 ⁹⁰	ACD	TS117	GA-6690	AMS	TS88	GA-273	AMS
TP23	GP-44	SRS	TP961	GP-1122	ACD	TS118	GA-780	AMS	TS9	GP-58	SRS
TP24	GP-58	INTM	TP972	GP-1108	ACD	TS12	GA-3490	AMS	TS90	GA-382	AMS
TP24	GP-81	SRS	TP985	GS-2034	ACD	TS12	GA-3637	AMS	TS92	GA-7007	AMS

Numero	Gonher	Fabricante	Numero	Gonher	Fabricante	Numero	Gonher	Fabricante	Numero	Gonher	Fabricante
Number	Gonher	Manufacturer	Number	Gonher	Manufacturer	Number	Gonher	Manufacturer	Number	Gonher	Manufacturer
V15801	GP-34	VERS	V40	GP-13	GRP	V9A89	G-1174 ¹⁰⁸	EMCO	VA2318	GA-429	GRP
V16	GP-81	VCRA	V4006	GP-44	GRP	V9A90	G-1173 ¹⁰⁸	EMCO	VA2318	GA-429	SPEC
V160	GP-3985	GRP	V4007	GP-44	GRP	V9A99	G-33	EMCO	VA24	GA-85	VALV
V167	GP-3531	EXP	V4011	GP-3980	GRP	VA1	GA-85	VALV	VA25	GA-86	VALV
V1695007	G-500	VOLV	V4011BP	GP-3980	GRP	VA10	GA-71	VALV	VA26	GA-325	VALV
V17	GP-81	GRP	V4013	GA-735	VALU	VA101	GA-604	VALV	VA27	GAD-3	VALV
V173	GP-3980	GRP	V4020	GA-271	VALU	VA102	GA-322	VALV	VA28	GA-3424	VALV
V18	GP-81	GRP	V4036	GA-3647	VALU	VA103	GAD-1	GRP	VA29	GA-3425	VALV
V183	GP-3816	GRP	V4040	GA-3588	VALU	VA103	GA-381	VALV	VA2923	GA-3501	GRP
V183	GP-3816	SPEC	V4046	GA-3681	VALU	VA104	GA-7344	VALV	VA3	GA-75	GRP
V193	GP-40	GRP	V42	GP-38	GRP	VA105	GA-300	VALV	VA3	GA-75	SPEC
V194	GP-3985	GRP	V42	GP-38	SPEC	VA106	GA-432	VALV	VA3	GA-50	VALV
V195	GP-3600	GRP	V4422	GP-178	SPEC	VA107	GA-141	VALV	VA3080	GA-3445	GRP
V19567	G-750	FORD	V4457	GP-3682	GRP	VA108	GA-165 ¹¹³	VALV	VA3087	GA-2194	SPEC
V195BP	GP-3600	GRP	V4457BP	GP-3682	GRP	VA108	GA-165 ¹¹³	WARN	VA31	GA-56	GRP
V1A	GP-1	GRP	V4458	GP-462	GRP	VA109	GA-164	VALV	VA31	GA-54	VALV
V1ABP	GP-1	GRP	V4459	GP-91	GRP	VA11	GA-56	VALV	VA3138	GA-54	GRP
V2036	GP-3980	VALU	V4459BP	GP-91	GRP	VA110	GA-349	GRP	VA3138	GA-54	TVI
V2040	GP-46	VALU	V4466	GP-28 ⁸	GRP	VA110A	GAD-3 ⁹⁴	GRP	VA3149	GA-3523	GRP
V2042	GP-44	VALU	V4466	GP-430 ⁸	GRP	VA110A	GA-349 ⁹⁸	TVI	VA3192	GA-271	GRP
V2045	GP-3429	VALU	V4466	GP-28 ⁸	SPEC	VA110A	GAD-3	TVI	VA3192	GA-271	TVI
V2061	GP-13	VALU	V4466	GP-430 ⁸	SPEC	VA111	GA-240	VALV	VA3193	GA-735	GRP
V2068	GP-81 ³¹	VALU	V4476	GP-157	GRP	VA1118	GA-12	CURT	VA3195	GA-3588	GRP
V2068	GP-9 ⁵⁸	VALU	V4477	GP-156	GRP	VA112	GA-132	VALV	VA3195	GA-3588	TVI
V2069	GP-3	VALU	V4477BP	GP-156	GRP	VA113	GA-75	GRP	VA3197	GA-154	GRP
V2167	GP-171	GRP	V4484	GP-212	GRP	VA113	GA-75	TVI	VA3357	GA-3637	GRP
V2222	GP-406	GRP	V4610	GP-149	GRP	VA113	GA-514	VALV	VA3357	GA-3637	SPEC
V2307	GP-81	VALU	V4610BP	GP-149	GRP	VA114	GA-1616	VALV	VA3358	GA-3637	GRP
V231	GP-3531	EXP	V4612	GP-91	GRP	VA1149	GAVW-2	GRP	VA3380	GA-3647	GRP
V2342	GP-28 ⁸	VALU	V4619	GP-3985	GRP	VA115	GA-348	VALV	VA3380	GA-3647	TVI
V2342	GP-430 ⁸	VALU	V4620	GP-149	GRP	VA117	GA-163	VALV	VA3384	GA-89	GRP
V2348	GP-58	VALU	V4620BP	GP-149	GRP	VA118	GA-170	VALV	VA3398	GA-3566	GRP
V2390	GP-42	VALU	V4621	GP-68	GRP	VA12	GA-730	VALV	VA3436	GA-4365	GRP
V2392	GP-3531	EXP	V4621BP	GP-68	GRP	VA120	GA-74	GRP	VA3463	GA-230	GRP
V241	GP-58	GRP	V4622	GP-91	GRP	VA120	GAVW-620	VALV	VA3463	GA-230	SPEC
V241BP	GP-58	GRP	V4631	GP-205	GRP	VA121	GA-472	VALV	VA3465	GA-277	GRP
V250CX522A	GA-588	UAC	V4631BP	GP-205	GRP	VA122	GA-780	VALV	VA3465	GA-277	TVI
V2-50CX522A	GA-588	UNI	V4651	GP-68	GRP	VA124	GA-3300	GRP	VA3466	GA-4828	GRP
V250DX216A	GA-589	UAC	V466987	GP-1122	VOLV	VA124	GA-3300	TVI	VA3467	GA-4325	GRP
V2-50DX216A	GA-589	UNI	V4670	GP-81	GRP	VA124	GAVW-121	VALV	VA3468	GA-2740	GRP
V2515	GP-1	VALU	V4670BP	GP-81	GRP	VA126	GA-322	VALV	VA3472	GA-274	GRP
V2516	GP-3600	VALU	V4757	G-971	GRP	VA128	GA-605	VALV	VA3472	GA-274	TVI
V252	GP-28 ⁸	GRP	V478736	GP-51	VOLV	VA129	GA-3424	GRP	VA3473	GA-85	GRP
V252	GP-430 ⁸	GRP	V4872	GP-562	GRP	VA129	GA-3424	SPEC	VA3474	GA-3681	GRP
V252	GP-28 ⁸	SPEC	V49	GP-3	GRP	VA129	GA-301	VALV	VA35	GA-429	VALV
V252	GP-430 ⁸	SPEC	V49BP	GP-3	GRP	VA13	GA-75	VALV	VA3538	GA-140	GRP
V253	GP-3985 ⁸³	GRP	V5	GP-5	GRP	VA131	GA-3425	GRP	VA3590	GA-3916	GRP
V2558	GP-20	VALU	V5	GP-5	SPEC	VA131	GA-3425	SPEC	VA3590	GA-3916	TVI
V257	GP-310	GRP	V5	G-200	VALV	VA132	GA-2198 ⁹⁹	VALV	VA3591	GA-3814	GRP
V257	GP-3569	GRP	V5044	GG-6	VALU	VA132	GA-438 ³¹	VALV	VA3592	GA-273	GRP
V26199	GP-2015W	NEWH	V5046	GG-19	VALU	VA133	GA-476	VALV	VA3592	GA-273	TVI
V26199	GP-2015W	VRS	V5048	GG-7	VALU	VA135	GA-172	VALV	VA36	GAVW-2	VALV
V2808	GP-149	VCRA	V5051	GG-16	VALU	VA137	GA-278R	VALV	VA37	GA-3523	VALV
V2808	GP-91	VCRA	V5052	GG-17	VALU	VA138	GAVW-621	VALV	VA38	GA-3588	VALV
V2821A	GP-2951 ⁶²	GRP	V5081	GG-87	VALU	VA14	GA-78	VALV	VA39	GA-735	VALV
V2821A	GP-58 ⁹⁴	GRP	V5087	GG-196	VALU	VA140	GA-168	VALV	VA4	GA-70	GRP
V2876465	GP-58	OPEL	V5230	GP-128	GRP	VA141	GA-224	VALV	VA4	GA-70	TVI
V288	GP-3766	GRP	V5247	G-954	GRP	VA142	GA-479	VALV	VA4	GA-55	VALV
V289	GP-3985	GRP	V5250	G-112	GRP	VA144	GA-244	VALV	VA40	GA-271	VALV
V290	GP-3985	GRP	V5271	GG-20	VALU	VA145	GA-183	VALV	VA41	GA-74	VALV
V290	GP-3985	SPEC	V5274	G-765	GRP	VA146	GA-286	VALV	VA4278	GAD-15	GRP
V291	GP-3531	EXP	V5288	GP-3675	GRP	VA149	GA-224	VALV	VA4278	GAD-15	SPEC
V3011	GA-71	VALU	V5309	G-45	GRP	VA15	GA-3490	GRP	VA4278	GAD-15	TVI
V3020	GA-70	VALU	V5313	GP-408	GRP	VA15	GA-100	VALV	VA4299	GA-180	GRP
V3039	GA-54	VALU	V5315	G-72	GRP	VA152	GA-491	VALV	VA4314	GA-3501	GRP
V3044	GA-730	VALU	V5335	GP-178	GRP	VA153	GA-607	VALV	VA4326	GA-78	GRP
V3054	GA-77	VALU	V5436	G-49	GRP	VA154	GA-248	VALV	VA4327	GA-4958	GRP
V3055	GA-80	VALU	V5505	G-70	GRP	VA155	GA-183R	VALV	VA4339	GA-3915	GRP
V3057	GA-74	VALU	V5515	G-3752	GRP	VA156	GA-258	VALV	VA4342	GA-253	GRP
V3067	GA-303	VALU	V5545	G-112	GRP	VA16	GA-2740	GRP	VA4343	GA-5056	GRP
V3073	GA-75	VALU	V57124	GP-57	FORD	VA160	GA-490	VALV	VA4343	GA-5056	TVI
V3083	GA-50	VALU	V57124	GP-57	NEWH	VA161	GA-414R	VALV	VA4347	GA-153	GRP
V3088	GA-192	VALU	V58125	GP-43	FORD	VA162	GA-395	VALV	VA4347	GA-153	TVI
V3095	GA-55	VALU	V602T121	G-613	FORD	VA163	GA-264	VALV	VA4349	GAVW-2	SPEC
V3098	GA-59	VALU	V608T118	GPP-14	NEWH	VA164	GA-477	VALV	VA4356	GA-390	GRP
V3101	GA-57	VALU	V61559	GP-55	NEWH	VA165	GA-194	VALV	VA4361	GA-139	GRP
V3103	GA-3523	VALU	V64	GP-3600 ⁷⁷	GRP	VA167	GA-780	VALV	VA4371	GA-165	GRP
V3113	GA-86	VALU	V64	GP-38 ⁸⁹	GRP	VA169	GA-413R	VALV	VA4372	GA-3901	GRP
V3116	GA-85	VALU	V711T106	G-500	FORD	VA1697	GA-277	GRP	VA4372	GA-3901	TVI
V3140	GA-3424	VALU	V73	GP-24 ²⁶	GRP	VA17	GAD-3	GRP	VA4375	GA-362	GRP
V3170	GAVW-2	VALU	V73	GP-462 ²⁴	GRP	VA17	GA-80	VALV	VA4378	GA-174	GRP
V321	GP-462	GRP	V79080	GPP-11	FORD	VA170	GA-293	VALV	VA4378	GA-174	TVI
V33	GP-20	GRP	V79080	GPP-11	NEWH	VA171	GA-263	VALV	VA44	GA-3647	VALV
V3349	GA-2740	VALU	V79446	GP-761H	VERS	VA176	GA-367	VALV	VA4468	GA-195	GRP
V34778	GP-1	FORD	V81	GP-81 ³¹	GRP	VA177	GA-488	VALV	VA4468	GA-195	TVI
V349619	G-162H	VOLV	V81	GA-304	VALV	VA178	GA-304	VALV	VA4471	GA-471	GRP
V373	GP-3682	GRP	V84	GP-23	GRP	VA18	GA-113	VALV	VA4479	GA-6479	GRP
V37545	GP-1122	CASE	V88833	GPP-18	FORD	VA181	GA-415	VALV	VA4479	GA-6479	TVI
V37546	GP-36	CASE	V88834	GP-1122	FORD	VA182	GA-1617	VALV	VA4487	GA-382	GRP
V37624	GP-54 ¹¹	CASE	V88834	GP-1122	NEWH	VA189	GA-510	VALV	VA45	GA-77	GRP
V37624	GP-66 ¹⁰	CASE	V88835	GP-390	FORD	VA19	GA-86	VALV	VA45	GA-77	SPEC
V3912	GA-3490	VALU	V88835	GP-390	NEWH	VA195	GA-380	VALV	VA46	GA-3490	VALV
V3980	GP-3980	VCRA	V95611	GA-758	NEWH	VA2	GA-59	VALV	VA4613	GA-142	GRP
V3991	GA-113	VALU	V95611	GA-758	VERS	VA20	GAD-1	VALV	VA4625	GA-2106	GRP
V3995	GA-100	VALU	V95612	GA-759 ¹⁰⁸	EMCO	VA22	GA-3300	VALV	VA4629	GA-139	GRP
V4	GP-5	VALV	V9703112	GP-3000	EMCO	VA23	GA-192	VALV	VA4645	GA-6690	GRP

Referencia Cruzada por Numero de Parte

Cross Reference by Part Number



Numero	Gonher	Fabricante	Numero	Gonher	Fabricante	Numero	Gonher	Fabricante	Numero	Gonher	Fabricante
Number	Gonher	Manufacturer	Number	Gonher	Manufacturer	Number	Gonher	Manufacturer	Number	Gonher	Manufacturer
VA4648	GA-133	GRP	VA66	GA-273	VALV	VF9034	GA-27 ¹¹²	WABC	VFL205	GP-46	MOTA
VA4650	GA-604	GRP	VA67	GA-192	GRP	VF9084	GA-27 ¹¹²	LETR	VFL212	GP-3985	MOTA
VA4656	GA-7017	GRP	VA67	GA-3814	VALV	VF9084	GA-27 ¹¹²	WABC	VFL214	GP-28 ⁶	MOTA
VA4656	GA-7017	TVI	VA68	GA-78	GRP	VFA 5	GA-410	MOTA	VFL214	GP-430 ⁸	MOTA
VA4669	GAD-294	GRP	VA69	GA-277	VALV	VFA 566	GA-2160	MOTA	VFL216	G-870	MOTA
VA4680	GA-386	GRP	VA7	GA-4303	GRP	VFA106	G-1175 ¹⁰⁸	EMCO	VFL219	GP-3985	MOTA
VA4690	GA-322	GRP	VA7	GA-4303	SPEC	VFA107	GA-8	MOTA	VFL223	GP-40	MOTA
VA47	GA-3445	VALV	VA7	GA-4303	TVI	VFA134	GA-200	MOTA	VFL224	GP-3985	MOTA
VA4712	GA-217	GRP	VA7	GA-70	VALV	VFA134	GP-58	MOTA	VFL227	GP-46	MOTA
VA4715	GA-7142	GRP	VA70	GA-174	VALV	VFA137	GA-230	MOTA	VFL232	GP-1	MOTA
VA4720	GA-7344	GRP	VA72	GA-4828	VALV	VFA144	GAD-1	MOTA	VFL244	GP-3985	MOTA
VA4721	GA-198	GRP	VA74	GA-55	GRP	VFA145	GAD-3	MOTA	VFL245	GP-3682	MOTA
VA4722	GA-5466	GRP	VA74	GA-5056	VALV	VFA194	GAVW-2	MOTA	VFL269	GP-40	MOTA
VA4727	GA-300	GRP	VA75	GA-3915	VALV	VFA195	GAVW-2	MOTA	VFL272	GP-28 ⁶	MOTA
VA4731	GA-165 ¹¹³	GRP	VA76	GA-3901	VALV	VFA200	GA-2122	MOTA	VFL272	GP-430 ⁸	MOTA
VA4731	GA-165	TVI	VA78	GA-6479	VALV	VFA204	GA-2740	MOTA	VFL283	GP-455	MOTA
VA4799	GA-381	GRP	VA8	GA-77	VALV	VFA225	GA-3425	MOTA	VFL295	GP-462	MOTA
VA4819	GA-141	GRP	VA83	GA-85	GRP	VFA227	GA-2740	MOTA	VFL315	GP-3531 EXP	MOTA
VA4831	GAD-118	GRP	VA83	GA-386	VALV	VFA236	GA-71	MOTA	VFL322	GP-28 ⁶	MOTA
VA4832	GA-432	GRP	VA83	GA-386	WARN	VFA240	GA-71	MOTA	VFL322	GP-430 ⁸	MOTA
VA4852	GA-392	GRP	VA83-1	GA-85	GRP	VFA241	GAVW-2	MOTA	VFL324	GP-28 ⁶	MOTA
VA4858	GA-127	GRP	VA84	GA-730	GRP	VFA275	GA-2194	MOTA	VFL324	GP-430 ⁸	MOTA
VA4873	GA-514	GRP	VA84	GA-730	SPEC	VFA279	GA-277	MOTA	VFL330	GP-68	MOTA
VA4877	GA-175	GRP	VA84	GA-195	VALV	VFA280	GA-4365	MOTA	VFN36	G-500	EMCO
VA4878	GA-1615	GRP	VA85	GA-253	VALV	VFA289	GAVW-2	MOTA	VG10	GG-45	VALV
VA4878	GA-1615	TVI	VA86	GAD-15	VALV	VFA290	GAVW-2	MOTA	VG11	GG-87	MOTA
VA4879	GA-1616	GRP	VA87	GA-362	VALV	VFA302	GA-49	MOTA	VG111-5	GG-20	GRP
VA4880	GA-164	GRP	VA88	GA-275	VALV	VFA303	GA-2156	MOTA	VG119	GG-6	GRP
VA49	GA-274	VALV	VA89	GA-175	VALV	VFA319	GAVW-2	MOTA	VG120	GG-7	GRP
VA4955	GAVW-121	GRP	VA9	GA-303	VALV	VFA321	GAVW-4	MOTA	VG13	GG-8 ¹⁰³	VALV
VA5	GA-57	VALV	VA90	GA-303	GRP	VFA326	GAVW-2	MOTA	VG13	GG-8 L ⁸⁰	VALV
VA50	GA-90	GRP	VA90	GA-3901	VALV	VFA378	GAVW-4	MOTA	VG13-1	GG-19	GRP
VA50	GA-89	VALV	VA91	GA-59	GRP	VFA489	GAD-15	MOTA	VG14	GG-46	VALV
VA5042	GA-442	GRP	VA91	GA-59	TVI	VFA519	GA-2114	MOTA	VG15	GG-3728	VALV
VA5048	GA-132	GRP	VA91	GA-279	VALV	VFA538	GA-362	MOTA	VG157	GG-16	GRP
VA5049	GA-595	GRP	VA92	GA-57	GRP	VFA56	GA-4303	MOTA	VG158	GG-17	GRP
VA5089	GA-301	GRP	VA92	GA-57	TVI	VFA568	GA-2110	MOTA	VG16	GG-47	VALV
VA5090	GA-673R	GRP	VA92	GA-673R	VALV	VFA703	GAVW-2	MOTA	VG17	GG-203	VALV
VA51	GA-75	VALV	VA93	GA-325	GRP	VFA724	GA-2146	MOTA	VG2	GG-19	VALV
VA5148	GA-384	GRP	VA93	GA-325	SPEC	VFA89	G-1174 ¹⁰⁸	MOTA	VG21	GG-123	GRP
VA5150	GA-172	GRP	VA93	GA-442	VALV	VFA90	G-1173 ¹⁰⁸	MOTA	VG21	GG-208	VALV
VA5155	GA-130	GRP	VA94	GA-3300	GRP	VFA99	G-33	MOTA	VG22	GG-196	VALV
VA5192	GA-158	GRP	VA94	GA-1615	VALV	VFE646	GG-7	LSTR	VG24	GG-94	VALV
VA52	GA-71	GRP	VA96	GA-6690	VALV	VFE646	GG-7	PETT	VG25	GG-76	VALV
VA52	GA-2440	VALV	VA97	GAD-294	VALV	VFF102	G-296	MOTA	VG26	GG-20	VALV
VA5219	GA-274	GRP	VA99	GA-86	GRP	VFF102	G-296-B	MOTA	VG27	GG-264	VALV
VA5227	GA-279	GRP	VA99	GA-7142	VALV	VFF104	G-297-B	MOTA	VG28	GG-61	VALV
VA5244	GA-607	GRP	VA99-1	GA-86	GRP	VFF105	GP-1122	MOTA	VG29	GG-65	VALV
VA5248	GA-163	GRP	VC0046	GP-55 ⁹⁰	KOMA	VFF106	GG-48	MOTA	VG3	GG-6	VALV
VA5249	GA-170	GRP	VC0046	GP-55 ⁹⁰	LETR	VFF107	G-1121F	MOTA	VG30	GG-177 ⁴³	VALV
VA5265	GA-8606	GRP	VC0046	GP-55 ⁹⁰	WABC	VFF109	G-296	MOTA	VG30	GG-581 ¹¹⁶	VALV
VA5267	GAVW-621	GRP	VC0047	GP-85 ⁹⁰	KOMA	VFF109	G-296-B	MOTA	VG31	GG-63	VALV
VA5290	GA-1616	GRP	VC0047	GP-85 ⁹⁰	LETR	VFF110	GPP-1122	MOTA	VG3163	GG-8 L	GRP
VA53	GA-3681	VALV	VC0047	GP-85 ⁹⁰	WABC	VFF113	G-296	MOTA	VG3169	GG-47	GRP
VA5301	GA-479	GRP	VC8812	G-1143	LETR	VFF113	G-296-B	MOTA	VG3170	GG-208	GRP
VA5305	GA-286	GRP	VC8812	G-1143	WABC	VFF114	G-297-B	MOTA	VG3173	GG-3728	GRP
VA5306	GA-278R	GRP	VC8813	GP-14	LETR	VFF133	GG-246	MOTA	VG3175	GG-196	GRP
VA5314	GA-348	GRP	VC9484	GA-26	LETR	VFF154	GG-5 L	MOTA	VG32	GG-1872	VALV
VA5323	GA-224	GRP	VC9485	GA-26	LETR	VFF156	GG-251	MOTA	VG33	GG-66	VALV
VA5324	GA-168	GRP	VC9485	GA-26	WABC	VFF516	GG-5 L	MOTA	VG35	GG-87	GRP
VA5330	GA-6479 ⁹⁰	GRP	VDP7023	GAK-403	VAPM	VFL102	G-834	MOTA	VG4	GG-123	VALV
VA5372	GA-258	GRP	VDP7027	GAK-16	VAPM	VFL108	GP-3682	MOTA	VG4175	GG-196	GRP
VA5378	GA-240	GRP	VE1062	GA-563	WABC	VFL112	GP-81	MOTA	VG5	GG-7	VALV
VA5396	GA-248	GRP	VE233	GP-20	COP	VFL113	GP-42	MOTA	VG6	GG-16	VALV
VA5397	GA-194	GRP	VE3625	GP-1013Q	KOMA	VFL114	GP-58 ¹⁵	MOTA	VG7	GG-17	VALV
VA54	GA-277	VALV	VE36885	GP-1013Q	KOMA	VFL117	GP-28 ⁶	MOTA	VG9485	GA-26	LETR
VA5400	GA-413R	GRP	VER110	GP-10	COP	VFL117	GP-430 ⁸	MOTA	VG9485	GA-26	WABC
VA5405	GA-183R	GRP	VER111	GP-46	COP	VFL121	GP-46	MOTA	VJ0560	GA-360	LETR
VA5414	GA-477	GRP	VER1A	GP-1	COP	VFL123	GP-3816	MOTA	VJ0560	GA-360	WABC
VA5418	GA-395	GRP	VER40	GP-13	COP	VFL135	GP-9	MOTA	VJ0561	GA-361	LETR
VA5432	GA-264	GRP	VER49	GP-3	COP	VFL142	G-870	MOTA	VJ0561	GA-361	WABC
VA5433	GA-414R	GRP	VER5	GP-5	COP	VFL143	G-836	MOTA	VJ1709	GA-6129	LETR
VA5446	GA-780	GRP	VER84	GP-23	COP	VFL150	GP-81	MOTA	VJ1880	GA-6129	LETR
VA5456	GA-184	GRP	VF106	G-1173	EMCO	VFL153	GP-3980	MOTA	VJ1880	GA-6129	WABC
VA5462	GA-490	GRP	VF1546	G-750	LETR	VFL154	GP-20	MOTA	VJ1881	GA-106 ⁶⁶	LETR
VA5463	GA-263	GRP	VF1546	G-750	WABC	VFL156	GP-3531 EXP	MOTA	VJ1881	GA-326 ⁷¹	LETR
VA5489	GA-158	GRP	VF1576	G-750	LETR	VFL158	GP-9	MOTA	VJ1881	GA-106 ⁶⁶	WABC
VA5503	GA-138	GRP	VF1576	G-750	WABC	VFL162	GP-455	MOTA	VJ1881	GA-326 ⁷¹	WABC
VA5507	GA-269	GRP	VF16	GA-113	GRP	VFL163	GP-91	MOTA	VJ1882	GA-360	LETR
VA5512	GA-488	GRP	VF160R	GA-608	AIR	VFL165	GP-50	MOTA	VJ1882	GA-360	WABC
VA5528	GA-1617	GRP	VF-160R	GA-608	VOR	VFL172	GP-40	MOTA	VJ1883	GA-6127	LETR
VA5556	GA-415	GRP	VF2048	GP-1101	LETR	VFL175	GP-81	MOTA	VJ1883	GA-6127	WABC
VA5560	GA-289	GRP	VF2048	GP-1101	WABC	VFL176	GP-91	MOTA	VJ1884	GA-206	LETR
VA5578	GA-380	GRP	VF2049	GA-39	LETR	VFL177	GP-22	MOTA	VJ1884	GA-206	WABC
VA56	GAD-3	VALV	VF2049	GA-39	WABC	VFL181	GP-46	MOTA	VJ1885	GA-361	LETR
VA57	GA-80	GRP	VF3277	GA-26	LETR	VFL184	GP-38	MOTA	VJ1885	GA-361	WABC
VA57	GA-80	SPEC	VF3277	GA-26	WABC	VFL190	GP-3816	MOTA	VJ2437	GA-357	KOMA
VA57	GA-101	VALV	VF32771	GA-26 ¹¹²	WABC	VFL191	GP-3682	MOTA	VJ2437	GA-357	LETR
VA59	GA-50	GRP	VF3277-2	GA-26	LETR	VFL192	GP-38	MOTA	VJ2437	GA-357	WABC
VA59	GA-4303	VALV	VF3675	GP-3675	MXLI	VFL194	GP-3816	MOTA	VJ5139	GA-356	KOMA
VA6067	GA-1614	GRP	VF3682	GP-3682	MXLI	VFL197	GP-3816	MOTA	VJ5139	GA-356	LETR
VA61	GA-2719B	VALV	VF3980	GP-3980	MXLI	VFL198	GP-28 ⁶	MOTA	VJ5139	GA-356	WABC
VA62	GA-3566	VALV	VF7317	GP-149	MXLI	VFL198	GP-430 ⁸	MOTA	VJ7034	GP-2071W	LETR
VA63	GA-140	VALV	VF7401	G-566	LETR	VFL200	GP-3682	MOTA	VJ7034	GP-2071W	WABC
VA64	GA-153	VALV	VF7401	G-566	WABC	VFL201	GP-3980	MOTA	VJ8003	GP-53	LETR
VA65	GA-3916	VALV	VF9	GA-100	GRP	VFL203	GP-3816	MOTA	VJ8003	GP-53	WABC

REFERENCIA CRUZADA

Numero	Gonher	Fabricante	Numero	Gonher	Fabricante	Numero	Gonher	Fabricante	Numero	Gonher	Fabricante
Number	Gonher	Manufacturer	Number	Gonher	Manufacturer	Number	Gonher	Manufacturer	Number	Gonher	Manufacturer
VJ8004	GP-55	LETR	VP4712	GA-106 ⁶⁵	LETR	VQA3474	GA-3681	VALQ	VY9166	GA-6129 ¹⁰⁴	LETR
VJ8004	GP-55	WABC	VP4712	GA-326 ⁷¹	LETR	VQA3590	GA-3916	VALQ	VY9198	GA-356 ¹⁰⁴	LETR
VL4530	G-222	LETR	VP4713	GA-6129	LETR	VQA3591	GA-3814	VALQ	VY9198	GA-357 ¹⁰⁸	LETR
VL4530	G-222	WABC	VP4713	GA-6129	WABC	VQA3592	GA-273	VALQ	VY9209	GA-106 ⁶⁵	LETR
VN1709	GA-6129	LETR	VP6987	GA-360 ¹⁰⁴	LETR	VQA4	GA-70	VALQ	VY9209	GA-326 ⁷¹	LETR
VN1709	GA-6129	WABC	VP6987	GA-361 ¹⁰⁸	LETR	VQA4278	GAD-15	VALQ	VY9209	GA-106 ⁶⁵	WABC
VN4933	GA-27 ¹¹²	LETR	VP7011	GA-206 ¹⁰⁸	LETR	VQA4299	GA-180	VALQ	VY9209	GA-326 ⁷¹	WABC
VN4933	GA-27 ¹¹²	WABC	VP70130	GA-206 ¹⁰⁸	LETR	VQA4314	GA-3501	VALQ	VY9210	GA-206	LETR
VN4939	GA-6129	LETR	VPD5001	G-870	VAPM	VQA4339	GA-3915	VALQ	VY9210	GA-206	WABC
VN4939	GA-6129	WABC	VPD5003	GP-3600	VAPM	VQA4342	GA-253	VALQ	VZ2854	G-33	KOMA
VN5588	GA-26	LETR	VPD5013	G-834	VAPM	VQA4343	GA-5056	VALQ	VZ2854	G-33	LETR
VN5588	GA-26	WABC	VPD5015	GP-14	VAPM	VQA45	GA-77	VALQ	VZ2854	G-33	WABC
VN5888	GA-26	LETR	VPD5020	GP-66	VAPM	VQA52	GA-71	VALQ	Números Nuevos		
VN5888	GA-26	WABC	VPD5021	GP-166	VAPM	VQA57	GA-80	VALQ			
VO1	GP-1	VALV	VPD5022	G-834	VAPM	VQA59	GA-50	VALQ			
VO10	GP-1	VALV	VPD5025	GP-81	VAPM	VQA67	GA-192	VALQ			
VO11	GP-28 ⁸	VALV	VPD5027	GP-77	VAPM	VQA68	GA-78	VALQ			
VO11	GP-430 ⁸	VALV	VPD5028	G-5000	VAPM	VQA7	GA-4303	VALQ			
VO12	GP-13	VALV	VPD5029	GP-54 ⁹⁰	VAPM	VQA74	GA-55	VALQ			
VO13	GP-44	VALV	VPD5032	GP-54 ³¹	VAPM	VQA831	GA-85	VALQ			
VO14	GP-3429	VALV	VPD5032	GP-66 ¹⁰	VAPM	VQA84	GA-730	VALQ			
VO15	GP-28 ⁸	VALV	VPD5109	GP-754	VAPM	VQA90	GA-303	VALQ			
VO15	GP-430 ⁸	VALV	VPD6003	G-296	VAPM	VQA91	GA-59	VALQ			
VO16	GP-46	VALV	VPD6003	G-296-B	VAPM	VQA92	GA-57	VALQ			
VO17	GP-3816	VALV	VPD6004	G-297-B	VAPM	VQA93	GA-325	VALQ			
VO18	GP-462	VALV	VPD6006	G-295	VAPM	VQA991	GA-86	VALQ			
VO19	GP-40	VALV	VPD6008	GPP-1122	VAPM	VR465D	GP-1	VERM	W		
VO2	GP-3	VALV	VPD6013	GP-1122	VAPM	VS0048	GA-6129	LETR			
VO20	GP-42	VALV	VPD6022	G-297-B	VAPM	VS0048	GA-6129	WABC	W0132071	G-500	AMBO
VO21	GP-3980 ⁴⁴	VALV	VPD6028	GPP-419	VAPM	VS1352	GA-357	LETR	W01432-87	G-296	POCL
VO21	GP-48 ¹¹⁷	VALV	VPD6085	GPP-418	VAPM	VS1352	GA-357	WABC	W01432-87	G-296-B	POCL
VO22	GP-3531 EXP	VALV	VPD6095	G-296	VAPM	VS1353	GA-356	LETR	W0150555	GAK-403	DERR
VO23	GP-3600	VALV	VPD6095	G-296-B	VAPM	VS1353	GA-356	WABC	W0150555	GAK-403	DUTZ
VO24	GP-310	VALV	VPD7003	GA-18	VAPM	VS1384	GA-6127 ¹⁰⁸	LETR	W015055-55	GAK-403	POCL
VO24	GP-3569	VALV	VPD7007	GA-589	VAPM	VS1384	GA-6129 ¹⁰⁴	LETR	W05H4115	G-1121	DUTZ
VO25	GP-58	VALV	VPD7008	GA-588	VAPM	VS1764	GA-6127	LETR	W05H4115	G-1121	KHDF
VO26	GP-3816	VALV	VPD7022	GA-18	VAPM	VS1764	GA-6127	WABC	W103	GA-50	CHAM
VO27	GP-3531 EXP	VALV	VPD7026	GAK-216	VAPM	VS1968	GA-360	LETR	W104397A	GP-50	WHIT
VO29	GP-3985	VALV	VPD7041	GA-827	VAPM	VS1968	GA-360	WABC	W105	GAD-1	CHAM
VO3	GP-20	VALV	VPD7042	GA-18	VAPM	VS1969	G-613	LETR	W10505-45	G-33	POCL
VO30	GP-462	VALV	VPD7043	GA-398	VAPM	VS1969	G-613	WABC	W106	GA-230	CHAM
VO31	GP-3675	VALV	VPD7044	GA-616	VAPM	VS2033	GP-20	LETR	W108	GAD-3	CHAM
VO32	GP-58	VALV	VPD7107	GA-853R	VAPM	VS2033	GP-20	WABC	W109	GA-200	CHAM
VO33	GP-3682	VALV	VPJ4515	GP-761H	VAPM	VS-2186	GA-879	LETR	W109	GP-58	CHAM
VO34	GP-3980	VALV	VPK1504	G-331	VAPM	VS2200	GAK-16	LETR	W109	GP-13	WIN
VO35	GP-3985	VALV	VPK1532	GP-761H	VAPM	VS2275	GAK-16	LETR	W11 102/18	GP-51	MNH
VO36	GP-81	VALV	VPK1545	GP-761H	VAPM	VS2275	GAK-16	WABC	W-1104	GP-110	WEB
VO39	GP-91	VALV	VPK1557	GP-28 ⁸	VAPM	VS2437	GA-357	LETR	W-1109	GP-83	WEB
VO40	GP-157	VALV	VPK1557	GP-430 ⁸	VAPM	VS2437	GA-357	WABC	W-1110	GP-84	WEB
VO41	GP-156	VALV	VPK816	G-870	LSTR	VS3493	G-1173 ¹⁰⁸	LETR	W1102	GP-77	MNH
VO42	GP-462	VALV	VPX0042	GPP-1122	VAPM	VS3493	G-1173 ¹⁰⁸	WABC	W11102-11	GP-51	MNH
VO43	GP-28 ⁸	VALV	VQ101	GP-22	VALQ	VS48	GA-6129	LETR	W11102-15	GP-88	MNH
VO43	GP-430 ⁸	VALV	VQ109	GP-42	VALQ	VS48	GA-6129	WABC	W11102-4	GP-81	MNH
VO44	GP-171	VALV	VQ111	GP-46	VALQ	VS48	GA-6129	WABC	W1126	GP-81	MNH
VO45	GP-81	VALV	VQ119	GP-1	VALQ	VS603012	G-834	AVEL	W1130	GP-81	MNH
VO46	GP-3766	VALV	VQ123	GP-3429	VALQ	VS7035	GP-57	KOMA	W1140-1	GP-310	MNH
VO47	GP-68	VALV	VQ17	GP-81	VALQ	VS7035	GP-57	LETR	W1167	GP-54	MNH
VO48	GP-2951	VALV	VQ173	GP-3980	VALQ	VS7035	GP-57	WABC	W1168/5	GP-88	MNH
VO49	GP-91	VALV	VQ193	GP-40	VALQ	VS7283	GP-53	KOMA	W11703	GP-54 ⁴¹	MNH
VO50	GP-149	VALV	VQ195	GP-3600	VALQ	VS7283	GP-53	LETR	W11703	GP-66 ¹⁰	MNH
VO51	GP-212	VALV	VQ1A	GP-1	VALQ	VS7283	GP-53	WABC	W119	GA-303	CHAM
VO52	GP-91	VALV	VQ2167	GP-171	VALQ	VS7331	GP-93	WABC	W115CRP	GP-5	WIN
VO54	GP-91	VALV	VQ252	GP-28 ⁸	VALQ	VS7351	GP-85 ⁹⁰	LETR	W12 102	GP-193	MNH
VO55	GP-3980	VALV	VQ252	GP-430 ⁸	VALQ	VS7382	GP-2071W	LETR	W120	GA-2740	CHAM
VO56	GP-205	VALV	VQ257	GP-310	VALQ	VS7382	GP-2071W	WABC	W12505-99	GP-51	POCL
VO57	GP-81 ³¹	VALV	VQ288	GP-3766	VALQ	VS7692	GP-53	KOMA	W127	GA-349	CHAM
VO57	GP-9 ⁵⁸	VALV	VQ291	GP-3531 EXP	VALQ	VS7692	GP-53	WABC	W12901	GP-34	MNH
VO58	GP-44	VALV	VQ33	GP-20	VALQ	VST603012	G-834	AVEL	W-13	GP-13	WEB
VO59	GP-128	VALV	VQ40	GP-13	VALQ	VT603012	G-834	AVEL	W13 150	GP-152	MNH
VO6	GP-81 ³¹	VALV	VQ4011	GP-3980	VALQ	VW077-115-561-F	G-932	VOLK	W131452	GP-52 ¹¹⁰	MNH
VO6	GP-9 ⁵⁸	VALV	VQ4457	GP-3682	VALQ	VW110	GPP-1122	GKIN	W131452	GP-691 ⁸⁸	MNH
VO60	GP-212	VALV	VQ4619	GP-3985	VALQ	VW-441-201-511-C	GG-408	VOLK	W137	GA-71	CHAM
VO61	GP-91	VALV	VQ49	GP-3	VALQ	VW4492	GA-356 ¹⁰⁴	LETR	W140	GA-3490	CHAM
VO62	GP-971	VALV	VQ81	GP-81 ³¹	VALQ	VW4492	GA-357 ¹⁰⁸	LETR	W15254	GA-27 ¹¹²	CASE
VO63	GP-562	VALV	VQ81	GP-9 ⁵⁸	VALQ	VW9357	GA-356 ¹⁰⁴	LETR	W154	GA-3425	CHAM
VO64	GP-178	VALV	VQA113	GA-75	VALQ	VW9357	GA-357 ¹⁰⁸	LETR	W15H4117	GP-1122	DUTZ
VO65	GP-408	VALV	VQA1149	GAVW-2	VALQ	VX1300	GA-27 ¹¹²	LETR	W15H4117	GP-1122	KHDF
VO66	G-72	VALV	VQA120	GA-74	VALQ	VX1300	GA-27 ¹¹²	WABC	W-2	GP-68	WEB
VO67	G-765	VALV	VQA129	GA-3424	VALQ	VX1917	GA-27 ¹¹²	LETR	W-20	GP-14	WEB
VO68	GP-457	VALV	VQA131	GA-3425	VALQ	VY1709	GA-6129	LETR	W21	GA-105	WIN
VO69	G-180	VALV	VQA15	GA-3490	VALQ	VY1709	GA-6129	WABC	W2198147	GA-880R	RANS
VO7	GP-38	VALV	VQA16	GA-2740	VALQ	VY1917	GA-27 ¹¹²	LETR	W-25	GP-20	WEB
VO72	G-49	VALV	VQA3	GA-75	VALQ	VY2195	G-222	LETR	W27-100	GG-196	WPT
VO73	G-45	VALV	VQA3149	GA-3523	VALQ	VY2195	G-222	WABC	W2710837	GAK-16	AGCO
VO74	G-984	VALV	VQA3192	GA-271	VALQ	VY2820	GA-6127 ¹⁰⁸	LETR	W2710837	GAK-16	WHIT
VO76	G-49	VALV	VQA3193	GA-735	VALQ	VY2820	GA-6129 ¹⁰⁴	LETR	W27109	GG-45	WPT
VO77	G-466	VALV	VQA3195	GA-3588	VALQ	VY3801	GAK-20	LETR			
VO79	G-3752	VALV	VQA3357	GA-3637	VALQ	VY5281	GA-106 ⁶⁵	LETR			
VO8	GP-46	VALV	VQA3380	GA-3647	VALQ	VY5281	GA-326 ⁷¹	LETR			
VO80	G-70	VALV	VQA3384	GA-89	VALQ	VY6734	GA-6127	LETR			
VO81	G-3752	VALV	VQA3436	GA-4365	VALQ	VY6734	GA-6127	WABC			
VO88	GP-406	VALV	VQA3463	GA-230	VALQ	VY7503	GA-356 ¹⁰⁴	LETR			
VO9	GP-81	VALV	VQA3465	GA-277	VALQ	VY7503	GA-357 ¹⁰⁸	LETR			
VP0357	GA-360	LETR	VQA3466	GA-4828	VALQ	VY8321	GA-356 ¹⁰⁴	LETR			
VP0357	GA-360	WABC	VQA3467	GA-4325	VALQ	VY8321	GA-357 ¹⁰⁸	LETR			
VP4365	GA-360	LETR	VQA3472	GA-274	VALQ	VY9166	GA-6127 ¹⁰⁸	LETR			

Referencia Cruzada por Numero de Parte

Cross Reference by Part Number



Numero	Gonher	Fabricante	Numero	Gonher	Fabricante	Numero	Gonher	Fabricante	Numero	Gonher	Fabricante
Number	Gonher	Manufacturer	Number	Gonher	Manufacturer	Number	Gonher	Manufacturer	Number	Gonher	Manufacturer
W27-109-K	GG-45	WPT	W27-331	GP-3816	WPT	W27-651	GAD-15	WPT	W55484	G-191	WIN
W27-110	GG-45	WPT	W27-333	GP-81	WPT	W27-654	GA-4325	WPT	W55484P	G-191	NEL
W27-111	GG-196	WPT	W27-335	G-870	WPT	W27-665	GA-230	WPT	W55484-P	G-191	WIN
W27-112	GG-11	WPT	W27-344	GP-81 ³¹	WPT	W27-666	GAVW-2	WPT	W55485P	G-238	WIN
W27-112	GG-4	WPT	W27-344	GP-9 ⁵⁸	WPT	W27-676	GA-277	WPT	W610-80	GP-156	MNH
W27-113	GG-5 L	WPT	W27-346	GP-38	WPT	W27-678	GA-78	WPT	W610-81	GP-91	MNH
W27-114	GG-1	WPT	W27-347	GP-28 ⁸⁴	WPT	W27-686	GA-200	WPT	W610-82	GP-149	MNH
W27-114	GG-4	WPT	W27-347	GP-3600 ²⁷	WPT	W27-686	GP-58	WPT	W61083	GAD-315	MNH
W27-114K	GG-1	WPT	W27-347	GP-430 ⁸⁵	WPT	W27-691	GA-139	WPT	W61083	GP-156	MNH
W27-114K	GG-4	WPT	W27-348	GP-3816	WPT	W27-698	GA-216	WPT	W-6349	GP-3000	WEB
W27-115	GG-5 L	WPT	W27-352	GP-171 ¹²²	WPT	W27-699	GA-471	WPT	W64453	GP-1013Q	PUR
W27-115-K	GG-5 L	WPT	W27-352	GP-81 ³¹	WPT	W27-700	GA-3588	WPT	W64455	GP-1013Q	PUR
W27-116	GG-19	WPT	W27-352	GP-9 ⁵⁸	WPT	W27-701	GA-390	WPT	W-6607	GP-91	WEB
W27-117	GG-1	WPT	W27-353	GP-28 ⁸	WPT	W27-703	GAVW-4	WPT	W67	GA-192	WIN
W27-117	GG-4	WPT	W27-353	GP-430 ⁸⁴	WPT	W27-704	GA-2110	WPT	W67-80	GP-149	MNH
W27-119	GG-1	WPT	W27-355	GP-28 ⁸⁴	WPT	W27-713	GA-142	WPT	W67-81	GP-157 ⁴⁹	MNH
W27-119	GG-4	WPT	W27-355	GP-3600 ⁵⁸	WPT	W27-714	GA-195	WPT	W67-81	GP-58 ¹¹⁹	MNH
W27-119-K	GG-1	WPT	W27-355	GP-430 ⁸⁵	WPT	W27-717	GAD-3	WPT	W68/1	GP-157	MNH
W27-119-K	GG-4	WPT	W27-357	GP-42	WPT	W-2825	GP-38	WEB	W68-80	GP-157	MNH
W27-122	GG-5 L	WPT	W27-358	GP-24 ²⁶	WPT	W-2849A	GP-24	WEB	W6H5931	G-1166	WIN
W27-124	GG-204	WPT	W27-358	GP-462 ²⁴	WPT	W-2865A	GP-42	WEB	W6H5932	G-1166	NEL
W27-124K	GG-204	WPT	W27-359	GP-81	WPT	W-2870A	GP-28	WEB	W6H5932	G-1166	WIN
W27-125	GG-76	WPT	W27-360	GP-81 ³¹	WPT	W-2951	GP-2951	WEB	W6H5932P	G-1166	WIN
W27-125-K	GG-76	WPT	W27-360	GP-9 ⁵⁸	WPT	W2M3943	G-152	NEL	W6H999	G-238	NEL
W27-126	GG-45	WPT	W27-362	GP-28 ⁸	WPT	W2M3943	G-152	WIN	W6H9999	G-238	NEL
W27-126-K	GG-45	WPT	W27-362	GP-430 ⁸	WPT	W-30	GP-3	WEB	W6H9999	G-238	WIN
W27-127	GG-76	WPT	W27-364	GP-462	WPT	W300	GP-1013Q	KRA	W6H9999P	G-238	WIN
W27-135	GG-196	WPT	W27-365	G-834	WPT	W31	GA-56	WIN	W6L4714	GAP-379	NEL
W27-135-K	GG-196	WPT	W27-366	GP-3531	EXP	W312	GG-1	BARA	W6L4714	GAP-379	WIN
W27-136	GG-5 L	WPT	W27-368	GP-36	WPT	W312	GG-4	BARA	W711	GP-3816	MNH
W27-137	GG-5 L	WPT	W27-369	GP-40	WPT	W312	GG-1	MNH	W711-80	GP-58	MNH
W27-138	GG-5 L	WPT	W27-370	G-834	WPT	W312	GG-4	MNH	W712	GP-3816	MNH
W27-140	GG-45	WPT	W27-371	GP-3600	WPT	W31480	GP-149	MNH	W712/22	GP-46	MNH
W27-142	GG-1121	WPT	W27-372	GP-38	WPT	W320	GP-2071W	KRA	W712/43	GP-58	MNH
W27-143	GG-251	WPT	W27-374	GP-3985	WPT	W-3335	GP-52	WEB	W712/53	GP-428	MNH
W27-147	GG-11	WPT	W27-375	GP-58	WPT	W-3387A	GP-46	WEB	W712/8	GP-461	MNH
W27-147	GG-4	WPT	W27-376	GP-81	WPT	W-3429	GP-3429	WEB	W7120	GP-58	MNH
W27-149	GG-94	WPT	W27-378	GP-46	WPT	W-3506	GP-44	WEB	W71218	GP-91	MNH
W27-151	GG-203	WPT	W27-379	GP-46	WPT	W-3531	GP-3531	EXP	W712-19	GP-58	MNH
W27-151-K	GG-203	WPT	W27-380	GP-3682	WPT	W-3535	GP-48	WEB	W712-2	GP-58	MNH
W27-152	GG-203	WPT	W27-386	GP-28 ⁸	WPT	W3555CRP	GP-1	WIN	W712-21	GP-58	MNH
W27-154	GPP-1122	WPT	W27-386	GP-430 ⁸	WPT	W-3569	GP-3569	WEB	W712-4	GP-3816	MNH
W27-155	GG-246	WPT	W27-389	GP-28 ⁸	WPT	W-36	GP-36	WEB	W712-6	GP-3816	MNH
W27-156	GG-246	WPT	W27-389	GP-430 ⁸	WPT	W-3600	GP-3600	WEB	W713	GP-3816	MNH
W27-164	GG-203	WPT	W27-391	GP-40	WPT	W-3614	GP-58	WEB	W713/14	GP-28 ⁶	MNH
W27-164K	GG-203	WPT	W27-394	GP-81 ³¹	WPT	W-3675	GP-3675	WEB	W713/14	GP-430 ⁸	MNH
W27-168	GG-251	WPT	W27-394	GP-9 ⁵⁸	WPT	W-3682	GP-3682	WEB	W713/15	GP-455	MNH
W27-169	GG-246	WPT	W27-396	GP-40	WPT	W373	GP-2071W	KRA	W713-1	GP-38	MNH
W27-174	GG-6	WPT	W27-399	GP-81 ³¹	WPT	W-373	GP-23	WEB	W713-4	GP-3816	MNH
W27-175	GG-76	WPT	W27-399	GP-9 ⁵⁸	WPT	W-3766	GP-3766	WEB	W-716-1	GP-461	MNH
W27-177	GG-208	WPT	W27-404	GP-58	WPT	W-3786	GP-562	WEB	W717	GP-455	MNH
W27-179	GG-5 L	WPT	W27-407	GP-462	WPT	W-3950	GP-40	WEB	W718	GP-3600	MNH
W27-179-K	GG-5 L	WPT	W27-502	GAD-1	WPT	W-3976	GP-178	WEB	W719/11	GP-28 ⁶	MNH
W27-181	G-296	WPT	W27-506	GAD-1	WPT	W-3980	GP-3980	WEB	W719/11	GP-430 ⁸	MNH
W27-181	G-296-B	WPT	W27-507	GAD-1	WPT	W-3985	GP-3985	WEB	W719/15	GP-28 ⁶	MNH
W27-183	GG-87	WPT	W27-508	GAD-3	WPT	W4	GA-70	WIN	W719/15	GP-430 ⁸	MNH
W27-184	GG-246	WPT	W27-509	GAD-3	WPT	W-42	GP-54	WEB	W719/25	GP-28 ⁶	MNH
W2719	GA-2719B	WALM	W27-510	GAD-1	WPT	W422	GP-2022W	KRA	W719/25	GP-430 ⁸	MNH
W27-197	GG-185	WPT	W27-517	GP-9	WPT	W-43	GP-9	WEB	W719/30	GP-28 ⁶	MNH
W27-202	GG-63	WPT	W27-520	GA-71	WPT	W431002	G-238	WAOUK	W719/30	GP-3569	MNH
W27-204	GG-79	WPT	W27-543	GA-303	WPT	W43-100-2	G-238	LRAI	W719/30	GP-430 ⁸	MNH
W27-207	GG-208	WPT	W27-550	GA-200	WPT	W-4386	GP-156	WEB	W719/4	GP-28 ⁶	MNH
W27-210	GG-47	WPT	W27-550	GP-58	WPT	W44644	G-6	INGR	W719/4	GP-430 ⁸	MNH
W27-212	GG-246	WPT	W27-551	GA-77	WPT	W45	GA-77	WIN	W719/5	GP-28 ⁶	MNH
W27-216	GG-1121	WPT	W27-563	GAD-1	WPT	W453	GP-2071W	KRA	W719/5	GP-430 ⁸	MNH
W27-221	GG-215	WPT	W27-565	GA-349	WPT	W473	GP-2071W	COP	W719/7	GP-457	MNH
W27-225	GG-203	WPT	W27-574	GAVW-2	WPT	W473	GP-2071W	CYC	W719/9	GP-24 ⁵⁶	MNH
W27-229	GG-217	WPT	W27-577	GA-113	WPT	W473	GP-2071W	KRA	W719/9	GP-462 ⁸⁴	MNH
W27-236	GG-181	WPT	W27-580	GAVW-2	WPT	W475	GP-2015W	COP	W719-12	GP-3600	MNH
W27-257	GG-214	WPT	W27-583	GA-2719B	WPT	W475	GP-2015W	CYC	W-719-33	GP-453	MNH
W27-258	GG-185	WPT	W27-587	GA-277	WPT	W475	GP-2015W	KRA	W-719-36	GP-454	MNH
W27-259	GG-251	WPT	W27-588	GAVW-4	WPT	W-4967	GP-157	WEB	W719-99	GP-3816	MNH
W273	GP-2071W	KRA	W27-589	GA-4303	WPT	W-49A	GP-51	WEB	W7233	GP-3600	MNH
W27-303	GP-1	WPT	W27-590	GAVW-2	WPT	W4H8792	G-1166	WIN	W-7317	GP-149	WEB
W27-306	GP-81 ³¹	WPT	W27-593	GA-3300	WPT	W4H87922	G-1166	WIN	W735/1	GP-452	MNH
W27-306	GP-9 ⁵⁸	WPT	W27-597	GA-303	WPT	W4H8792P	G-1166	WIN	W735/2	GP-452	MNH
W27-307	GP-81 ³¹	WPT	W27-601	GA-75	WPT	W455368P	G-1166	WIN	W74	GA-55	NEL
W27-307	GP-9 ⁵⁸	WPT	W27-603	GAVW-2	WPT	W-5	GP-205	WEB	W74	GA-55	WIN
W27-308	G-870	WPT	W27-607	GA-50	WPT	W50475	GP-2015W	PUR	W75/3	GP-291	MNH
W27-310	GP-171	WPT	W27-608	GAVW-2	WPT	W52	GA-71	WIN	W752	GP-291	MNH
W27-311	GP-58	WPT	W27-609	GA-3490	WPT	W52022	GP-2022W	PUR	W76118	G-33	INGR
W27-312	GP-3985 ⁸³	WPT	W27-612	GA-3425	WPT	W54450	GP-2071W	PUR	W77	GP-58 ¹⁵	MNH
W27-313	GP-24 ²⁶	WPT	W27-613	GAD-3	WPT	W54452	GP-2071W	PUR	W79	GP-291	MNH
W27-313	GP-462 ⁹⁴	WPT	W27-614	GA-4365	WPT	W54453	GP-1010Q	PUR	W7M3800	G-191	NEL
W27-314	GP-81	WPT	W27-625	GA-2740	WPT	W54453	GP-1011Q	PUR	W7M3800	G-191	WIN
W27-315	GP-1	WPT	W27-626	GAD-3	WPT	W54454	GP-1011Q	PUR	W7M3800B	G-191	NEL
W27-316	GP-81 ³¹	WPT	W27-633	GAVW-2	WPT	W54454	GP-1012Q	PUR	W7M3800B	G-191	WIN
W27-316	GP-9 ⁵⁸	WPT	W27-634	GAD-30	WPT	W55072	GP-2071W	PUR	W7M3800G	G-191	NEL
W27-318	GP-22	WPT	W27-635	GA-50	WPT	W-5618	GP-457	WEB	W7M3800G	G-191	WIN
W27-319	GP-3816	WPT	W27-636	GA-271	WPT	W57	GA-80	NEL	W7M3800P	G-191	NEL
W27-320	GP-58	WPT	W27-640	GA-735	WPT	W57	GA-80	WIN	W7M3800P	G-191	WIN
W27-322	GP-171 ¹⁶	WPT	W27-641	GA-3490	WPT	W58	GA-105	WIN	W7M3800PG	G-191	NEL
W27-323	GP-81	WPT	W27-647	GA-2194	WPT	W59	GA-50	WIN	W7M3800PG	G-191	WIN
W27-325	GP-28 ⁸	WPT	W27-648	GAD-1	WPT	W5L7564	G-1166	WIN	W75CRP	GP-5	WIN
W27-325	GP-430 ⁸	WPT	W27-650	GA-180	WPT	W5L7564P	G-1166	WIN	W812-99	GP-91	MNH
W27-327	GP-36	WPT	W27-651	GA-230	WPT	W55484	G-191	NEL	W81383	GP-462	MNH

REFERENCIA CRUZADA

Para números Gonher con Superíndice vea página 651
For Gonher with Superscript numbers see page 651

Visite nuestro sitio en internet www.grupogonher.com
Visit our web site www.grupogonher.com

Numero	Gonher	Fabricante	Numero	Gonher	Fabricante	Numero	Gonher	Fabricante	Numero	Gonher	Fabricante
Number	Gonher	Manufacturer	Number	Gonher	Manufacturer	Number	Gonher	Manufacturer	Number	Gonher	Manufacturer
W8130		GP-58	W940-23		GP-1	WA-1754		GA-1617	WA-3245-1		GAD-29
W814/80		GP-462	W940-24		GP-1	WA-1754		GA-1617	WA-324A		GA-85
W814-81		GP-58	W940-25		GP-310	WA-176		GA-56	WA325		GA-325
W814-99		GP-3682	W94027		GP-1	WA183		GAD-1	WA-325		GA-325
W815		GP-40	W940-37		GP-68	WA184		GA-77	WA326		GA-59
W815/82		GP-212	W940-5		GP-36	WA-184		GA-77	WA-326		GA-59
W81580		GP-40	W9407X		GP-110	WA-1858		GA-291	WA-327		GA-57
W815-81		GP-3531 EXP	W940-81		GP-1	WA1858P		GA-291	WA-327		GA-57
W816-80		GP-40	W9409		GP-171	WA-187		GA-90	WA329		GA-135
W817/80		GP-462	W940-99		GP-1	WA189		GA-50	WA-329		GA-35
W8182		GP-3600	W950		GP-54	WA-189		GA-50	WA3300		GA-3300
W818-4		GP-38	W950/16		GP-178	WA192		GA-192	WA-3300		GA-3300
W818-81		GP-38	W950/26		GP-737	WA-192		GA-192	WA-3373		GAVW-2
W818-82		GP-3682	W950/4		GP-310	WA196		GA-3300	WA-3373		GAVW-2
W818-84		GP-2951	W950-1		GP-54	WA-2		GAD-34	WA-3384		GAVW-2
W81899		GP-24 ²⁶	W950-13		GP-54	WA2004		GA-39	WA-3399		GAVW-4
W81899		GP-462 ²⁴	W950-17		GP-54	WA-2005		GA-288R	WA340		GA-86
W-8212		GP-212	W950-18		GP-178	WA2009		GA-37	WA-340A		GA-86
W83		GA-85	W9504		GP-31	WA2014		GA-29	WA-340A		GA-86
W-8316		GP-128	W950-5		GP-31	WA20340PC		GA-5648	WA3424		GA-3424
W84		GA-730	W950-7		GP-31	WA2036		GA-3445	WA-3424		GA-3424
W8800470		GP-44	W9508		GP-166	WA2038		GA-8047	WA3425		GA-3425
W-8873		GP-408	W962		GP-54 ¹¹	WA2039		GA-1285	WA-3425		GA-3425
W-8A		GP-1	W962		GP-66 ¹⁰	WA2042		GA-375	WA-3441		GAVW-10
W8M5388P		G-1166	W962/28		GP-54 ¹¹	WA2043		GA-1203	WA-3445		GA-3445
W8M9641P		G-1166	W962/28		GP-66 ¹⁰	WA2047		GA-21	WA347		GA-429
W90		GA-303	W962/8		GP-54 ¹¹	WA2054K		GA-27 ¹¹²	WA-3486P		GA-2156
W90		GA-303	W962/8		GP-66 ¹⁰	WA2058		GA-1008	WA-3490		GA-3490
W91		GA-59	W962-11		GP-10	WA2059		GA-1284	WA-3490		GA-3490
W91		GA-59	W962-14		GP-54	WA2060		GA-9334	WA-3497		GA-75
W910-1		GP-22	W962-6		GP-54 ¹¹	WA2061		GA-1286	WA-3501		GA-3501
W9103		GP-40	W962-6		GP-66 ¹⁰	WA2062		GA-9045	WA-3501		GA-3501
W914-13		GP-40	W96260		GP-54 ¹¹	WA2063		GA-1287	WA-351		GA-75
W914-14		GP-3531 EXP	W96260		GP-66 ¹⁰	WA2066K		GAK-16	WA-351		GA-75
W914-2		GP-81 ³¹	W-9688		GP-6811	WA2067K		GAK-20	WA-352		GAD-1
W914-2		GP-9 ⁵⁸	W9F6700		G-191	WA2068		GA-24	WA-352		GAD-1
W9143		GP-40	W9F6700		G-191	WA2074K		GA-33 ¹¹²	WA-3523		GA-3523
W9146		GP-46	W9F6700G		G-191	WA2078K		GAK-403	WA-3523		GA-3523
W914-7		GP-46	W9F6700G		G-191	WA2087		GA-18	WA353		GAD-3
W914-8		GP-42	W9F6700PG		G-191	WA2093		GA-90	WA-353		GAD-3
W914-80		GP-42	W9H1252		G-1166	WA-2096		GA-6619 ¹	WA-3536		GA-3536
W916-1		GP-81 ³¹	W9H1252-P		G-1166	WA-2096		GA-6620 ⁵	WA-3537		GA-54
W916-1		GP-9 ⁵⁸	W9H4729		G-1166	WA21		GA-105	WA-3537A		GA-54
W917-97		GP-3985	WA-001		GA-49	WA2112		GA-135	WA-3549		GA-89
W917-98		GP-3531 EXP	WA1		GA-49	WA2119K		GAK-16	WA-3549		GA-89
W917-99		GP-42	WA1003G		GA-234	WA2122		GA-26	WA355140		GAK-16
W9182X		GP-46	WA-1004		GA-179	WA2122K		GA-26	WA3559		GA-271
W92		GA-57	WA-1004-1		GA-179	WA2136		GA-4303	WA-3559		GA-271
W92		GA-57	WA-10088		GA-363	WA2137K		GA-98 ¹¹²	WA-3565		GA-218
W920		GP-171	WA-10118		GA-489	WA2140K		GAK-20	WA-3566		GA-3566
W920/48		GP-171	WA-10193		GA-328	WA2160		GA-230	WA3588		GA-3588
W920-12		GP-81	WA10346		GA-1529	WA2172		GA-56 ⁹⁰	WA-3588		GA-3588
W920-17		GP-3816	WA1040940104		GA-2179	WA2181		GA-206	WA3593		GP-149
W92021		GP-81	WA1040940104		GA-2179	WA2183		GAP-379	WA-3597		GA-735 ¹²⁴
W920210		GP-81	WA-1052P		GA-391	WA2216		GA-6129	WA-3597		GA-734
W92023		GP-81	WA108		GA-7	WA2218		GA-390	WA-3597A		GA-735
W920-25		GP-3985	WA109		GA-78	WA2224		GA-106 ⁴⁶	WA-3597E		GA-735
W92026		GP-81	WA-1110		GA-259	WA2224		GA-326 ⁷¹	WA3597N		GA-734
W920-20		GP-58	WA-1117T		GA-16	WA2226		GA-26	WA-3621		GA-140
W920-32		GP-68	WA114		GA-55	WA2229		GA-21	WA-3637		GA-3637
W9205		GP-3985	WA1144		GP-2022W	WA2242		GA-6127	WA-3647		GA-3647
W920-7		GP-171	WA1162		GP-1013Q	WA2252		GA-356	WA-3647		GA-3647
W920-70		GP-81	WA12		GA-200	WA2254		GA-360	WA3660		GA-277
W920700		GP-81	WA12		GA-7	WA2257		GA-403	WA-3660		GA-277
W92070		GP-81	WA1216		GA-139	WA2258		GA-106 ⁴⁶	WA3681		GA-3681
W920-80		GP-81 ³¹	WA129		GA-244	WA2258		GA-326 ⁷¹	WA-3681		GA-3681
W920-80		GP-9 ⁵⁸	WA1296P		GA-285	WA2265		GA-357	WA-3684		GA-219
W92099		GP-81 ³¹	WA1306		GA-2719B	WA2267		GA-135	WA-3686		GA-422
W92099		GP-9 ⁵⁸	WA133		GA-78	WA2275K		GAK-16	WA37		GA-44
W92709		GA-356	WA-133		GA-78	WA2277		GA-31	WA-3705		GA-154
W93		GA-325	WA134		GA-44	WA2289		GA-37	WA3711		GAD-3
W93		GA-325	WA136		GA-55	WA2333		GA-139	WA3717		GA-274
W930/20		GP-432	WA-136		GA-55	WA-2510H		GA-281	WA-3717		GA-274
W930/26		GP-112	WA1383		GA-5466	WA2662		GAVW-22	WA3729		GAD-1
W930-7		GP-171	WA1411		GA-263	WA-2662A		GAVW-22	WA3781		GA-74
W931		GP-50	WA-1444P		GA-2159	WA-2663A		GA-200	WA-3784		GA-231
W93280		GP-1	WA146		GA-71	WA-2719		GA-2719B	WA-3784A		GA-230
W932-81		GP-1	WA-146		GA-71	WA-2719		GA-2719B	WA-381		GA-74
W935-99		GP-81 ³¹	WA148		GA-80	WA-2740		GA-2740	WA-381		GA-74
W935-99		GP-9 ⁵⁸	WA-148		GA-80	WA-2750		GA-302	WA-3814		GA-3814
W936		GP-1	WA1485		GA-323	WA-2849A		GP-24	WA-3814		GA-3814
W936-2		GP-5	WA1513		GA-135	WA-2962P		GAVW-624	WA-3901		GA-3901
W93640		GP-14	WA-1519C		GA-348	WA-2998		GAVW-623	WA-3901		GA-3901
W936-5		GP-3	WA160		GA-70	WA3		GA-71	WA3902		GA-253
W9396-4		GP-14	WA160		GA-85	WA-3012		GA-289	WA-3902		GA-253
W940		GP-1	WA-160		GA-70	WA303		GA-303	WA3914		GA-392
W940/13		GP-3569	WA161		GA-730	WA-303		GA-303	WA-3914		GA-392
W940/15N		GP-171 ¹⁹	WA-1675M		GA-472	WA-305		GA-730	WA-3915		GA-3915
W940/25		GP-3569	WA168		GA-303	WA-305		GA-730	WA-3915		GA-3915
W940/34		GP-390	WA169		GA-59	WA31		GA-56	WA-3916		GA-3916
W940/44		GP-3569	WA170		GA-325	WA-3102		GAVW-625	WA-3916		GA-3916
W940-1		GP-1	WA-170		GA-73	WA313		GA-170	WA3924		GA-153
W94010		GP-1	WA171		GA-57	WA316		GA-183	WA-3924		GA-153
W94017X		GP-1101	WA1718		GP-1011Q	WA324		GA-85	WA-3973P		GA-397
W940-18		GP-36	WA1718		GP-1011Q	WA-3245		GAD-30	WA-3997		GA-216
W940-21		GP-1	WA-1732		GA-134	WA-3245		GAD-30	WA4		GA-70

Referencia Cruzada por Numero de Parte

Cross Reference by Part Number



Numero	Gonher	Fabricante	Numero	Gonher	Fabricante	Numero	Gonher	Fabricante	Numero	Gonher	Fabricante
Number	Gonher	Manufacturer	Number	Gonher	Manufacturer	Number	Gonher	Manufacturer	Number	Gonher	Manufacturer
WA4008	GA-230	WALM	WA6485	GA-2160	WEUR	WA-7774	GA-1616	WEB	WA9589	GA-488	WALM
WA-4010	GA-272	WALM	WA6491	GA-129	WALM	WA-7775	GA-476	WALM	WA-9601	GA-284	WEB
WA-4116V	GAVW-212	WALM	WA65	GA-11	WES	WA78	GA-230	WES	WA-9662	GA-510	WALM
WA-4237-1	GA-280	WALM	WA6545	GAVW-120	WALM	WA-8004	GA-1615	WEB	WA-9681	GA-606	WALM
WA-4303	GA-4303	WALM	WA-6545	GAVW-120	WEB	WA-8037	GA-732R	WALM	WA-9683	GA-380	WALM
WA-4303	GA-4303	WEB	WA-6546	GAD-315	WALM	WA-8037	GA-732R	WEB	WA-9778	GA-415	WALM
WA4309	GAD-15	WALM	WA6555	GA-275	WALM	WA-8038	GA-673R	WALM	WA98	GA-192	WES
WA-4309	GAD-15	WEB	WA-6555	GA-275	WEB	WA-8038	GA-673R	WEB	WA-9838	GA-289	WALM
WA4325	GA-4325	WALM	WA-6558	GA-2106	WALM	WA-8039	GA-1615	WALM	WAC20	G-813	WIN
WA-4325	GA-4325	WEB	WA-6576	GA-276	WALM	WA-8040	GA-384	WALM	WAC20P	G-813	NEL
WA-4383	GA-471	WALM	WA-6576	GA-276	WEB	WA-8040	GA-384	WEB	WAC20-P	G-813	WIN
WA-4383	GA-471	WEB	WA-6591	GA-176	WALM	WA-8060	GA-49	WEB	WAC70	G-836	NEL
WA-4494	GA-314	WALM	WA-6591	GA-176	WEB	WA-8067	GA-198	WEB	WAC70	G-836	WIN
WA-4576	GA-2110	WALM	WA-6619	GA-6619	WALM	WA-8069	GA-244	WALM	WAC70-P	G-836	WIN
WA48	GA-71	WES	WA-6619	GA-6620	WALM	WA-8069	GA-244	WEB	WAC72	G-834	NEL
WA-4828	GA-4828	WALM	WA-6619	GA-6619	WEB	WA-8080	GAVW-622	WALM	WAC72	G-834	WIN
WA-4828	GA-4828	WEB	WA-6664	GA-166	WALM	WA-8133	GA-163	WALM	WAF1	GA-55	WLM
WA-4830	GA-180	WALM	WA-6664	GA-166	WEB	WA-8133	GA-163	WEB	WAF10	GA-303	WLM
WA-4830	GA-180	WEB	WA-6690	GA-6690	WALM	WA-8141	GA-1614	WEB	WAF1001	GA-360	JONA
WA-4893	GA-231	WALM	WA-6690	GA-6690	WEB	WA-8142	GA-130	WALM	WAF1005	GA-106 ⁶	JONA
WA49	GA-77	WES	WA6807	GA-386	WALM	WA-8142	GA-130	WEB	WAF1005	GA-326 ⁷¹	JONA
WA-4924	GAD-117	WEB	WA6807	GA-386	WEB	WA81497	GP-462	MFI	WAF11	GA-77	WLM
WA-4939	GA-139	WALM	WA-6828	GA-133	WALM	WA81498	GP-58	MFI	WAF1135	GA-7017	WARN
WA-4939	GA-139	WEB	WA-6828	GA-133	WEB	WA-8169	GAVW-626	WALM	WAF116	GP-58	WARN
WA-4958	GA-4958	WEB	WA-6849	GAD-129	WALM	WA81899	GP-24 ²⁶	MFI	WAF12	GA-78	WLM
WA5056	GA-5056	WALM	WA-6850	GAD-294	WALM	WA81899	GP-462 ²⁴	MFI	WAF1279	GA-279	WARN
WA-5056	GA-5056	WEB	WA-6850	GAD-294	WEB	WA-8205	GA-301	WALM	WAF13	GA-730	WLM
WA5058	GA-273	WALM	WA-6900	GAD-117	WALM	WA-8205	GA-301	WEB	WAF1301	GA-732R	WARN
WA-5058	GA-273	WEB	WA-6900	GAD-17	WALM	WA-8208	GA-607	WALM	WAF14	GA-70	WLM
WA51	GA-105	WES	WA697	GAD-1	WALM	WA-8221	GA-279	WALM	WAF148	GA-80	WARN
WA52	GA-50	WES	WA7007	GA-7007	WALM	WA-8221	GA-279	WEB	WAF15	GA-71	WLM
WA53	GA-80	WES	WA-7017	GA-7017	WALM	WA-8243	GA-158	WALM	WAF1519	GA-348	WARN
WA54	GA-90	WES	WA-7017	GA-7017	WEB	WA-8243	GA-158	WEB	WAF16	GA-80	WLM
WA5466	GA-5466	WALM	WA-7094	GA-604	WEB	WA825	GP-38	MFI	WAF1617	GA-442	WARN
WA-5466	GA-5466	WEB	WA71299	GP-3816	MFI	WA84	GAD-1	WES	WAF1618	GAVW-620	WARN
WA-5496	GA-134	WEB	WA-7142	GA-7142	WALM	WA-8475	GA-170	WALM	WAF1624	GA-415	WARN
WA5513	GAVW-620	WALM	WA-7142	GA-7142	WEB	WA-8475	GA-170	WEB	WAF1641	GA-1614	WARN
WA-5595	GA-595	WEB	WA-7174	GA-381	WEB	WA8503	GA-5466	MICF	WAF1679	GA-479	WARN
WA-5777	GA-475	WALM	WA7195	GP-28 ⁸	MFI	WA8539	GAD-3	MICF	WAF1680	GA-780	WARN
WA-583	GA-196	WALM	WA7195	GP-430 ⁸	MFI	WA8561	GA-2740	MICF	WAF1688	GA-168	WARN
WA-5970	GA-334	WALM	WA71998	GP-28 ⁸	MFI	WA-8602	GAVW-621	WALM	WAF1695	GA-395	WARN
WA6017	GA-322	PHI	WA71998	GP-430 ⁸	MFI	WA-8602	GAVW-621	WEB	WAF1696	GA-224	WARN
WA6026	GA-381	PHI	WA71999	GP-58	MFI	WA-8606	GA-8606	WALM	WAF17	GA-192	WLM
WA6027	GAD-294	PHI	WA72	G-834	WIN	WA-8606	GA-8606	WEB	WAF1754	GA-1617	WARN
WA6028	GA-7344	PHI	WA-73	GA-44	WALM	WA-8747	GA-258	WALM	WAF18	GAD-1	WLM
WA6041	GA-390	PHI	WA-7344	GA-7344	WALM	WA-8747	GA-258	WEB	WAF19	GA-100	WLM
WA6051	GA-217	PHI	WA-7344	GA-7344	WEB	WA-8756	GA-348	WEB	WAF2	GA-59	WLM
WA6057	GA-7142	PHI	WA-7351	GA-322	WEB	WA-8760	GA-183	WALM	WAF2014	GA-414R	WARN
WA6061	GA-230	PHI	WA-7365	GA-217	WALM	WA-8805	GA-278R	WALM	WAF212	GA-55	WARN
WA6064	GA-386	PHI	WA-7365	GA-217	WEB	WA-8805	GA-278R	WEB	WAF22	GA-3300	WLM
WA6080	GA-141	PHI	WA74	GA-11	WALM	WA-8817	GA-477	WALM	WAF222	GA-55 ¹¹³	WLM
WA6082	GA-166	PHI	WA-7414	GA-141	WALM	WA-8911	GA-194	WALM	WAF234	GA-382	WARN
WA6089	GA-4958	PHI	WA-7414	GA-141	WEB	WA-8911	GA-194	WEB	WAF24	GA-113	WLM
WA6093	GA-275	PHI	WA7417	GA-198	WALM	WA-8918	GA-286	WALM	WAF252	GA-362	WARN
WA6095	GAD-118	PHI	WA-7420	GA-514	WALM	WA-8918	GA-286	WEB	WAF254	GA-2194	WARN
WA6097	GA-133	PHI	WA-7420	GA-514	WEB	WA-8925	GA-780	WEB	WAF2548	GA-448	WARN
WA6098	GA-432	PHI	WA-7421	GA-165	WALM	WA-8956	GA-479	WALM	WAF279	GA-216	WARN
WA6108	GA-604	PHI	WA-7421	GA-165	WEB	WA-8969	GA-168	WALM	WAF280	GA-471	WARN
WA6116	GAD-15	PHI	WA-7426	GA-432	WALM	WA-8969	GA-168	WEB	WAF289	GA-6619 ¹	WARN
WA6117	GA-165	PHI	WA-7426	GA-432	WEB	WA-8970	GA-216	WEB	WAF289	GA-6620 ⁵	WARN
WA6123	GAVW-2	PHI	WA-7431	GAVW-121	WALM	WA-8997	GA-224	WALM	WAF297	GA-4365	WARN
WA6134	GA-410	WEUR	WA-7431	GAVW-121	WEB	WA-8997	GA-224	WEB	WAF3	GA-57	WLM
WA6144	GA-392	PHI	WA-7432	GA-132	WALM	WA-9053	GA-183R	WALM	WAF351	GA-195	WARN
WA6146	GA-180	PHI	WA-7432	GA-132	WEB	WA-9054	GA-248	WALM	WAF355	GA-2110	WARN
WA6158	GA-382	PHI	WA-7438	GA-442	WEB	WA-9054	GA-248	WEB	WAF3588	GA-477	WARN
WA6162	GA-6690	PHI	WA-7440	GA-300	WALM	WA9101	GP-22	MFI	WAF359	GA-139	WARN
WA6186	GA-142	PHI	WA-7440	GA-300	WEB	WA-9115	GA-364	WALM	WAF3590	GA-490	WARN
WA6186	GA-142	POWF	WA7583	G-33	LETR	WA9142	GP-22	MFI	WAF3594	GA-367	WARN
WA6190	GA-6619	PHI	WA7583	G-33	WABC	WA91499	GP-40 ²⁴	MFI	WAF388	GA-3501	WARN
WA6190	GA-6620 ⁵	PHI	WA-7597	GA-164	WALM	WA91499	GP-91 ²⁸	MFI	WAF3933	GAVW-616	WARN
WA6213	GA-300	PHI	WA-7597	GA-164	WEB	WA91798	GP-3531	EXP	WAF3936	GAVW-618	WARN
WA6221	GA-2110	PHI	WA76	GA-12	WALM	WA91799	GP-42	MFI	WAF3959	GA-380	WARN
WA6240	GAVW-120	PHI	WA7605	GA-3490	MICF	WA92017	GP-171	MFI	WAF3997	GA-1546	WARN
WA6244	GA-195	PHI	WA-7605	GA-605	WALM	WA92096	GP-171	MFI	WAF4027	GA-341	WARN
WA6246	GA-7017	PHI	WA-7614	GAVW-620	WALM	WA92098	GP-81 ³¹	MFI	WAF4030	GA-1530	WARN
WA6255	GA-3501	PHI	WA-7614	GAVW-620	WEB	WA92098	GP-9 ³⁸	MFI	WAF415	GA-142	WARN
WA6264	GA-362	PHI	WA-7614-2	GAVW-620	WALM	WA-9269	GA-413R	WALM	WAF5	GA-50	WLM
WA6289	GA-175	PHI	WA7619	GA-362	MICF	WA9332	GA-395	WALM	WAF5191	GA-510	WARN
WA6302	GA-164	PHI	WA-7620	GA-438	WEB	WA-9332	GA-395	WEB	WAF545	GA-2106	WARN
WA6303	GA-514	PHI	WA-7626	GA-6	WALM	WA-9345	GA-414R	WALM	WAF5858	GA-2146	WARN
WA-6305	GA-390	WEB	WA-7626	GA-6	WEB	WA-9345	GA-414R	WEB	WAF6	GA-56 ⁹⁰	WLM
WA-6333	GA-382	WEB	WA-7628	GAD-118	WALM	WA-9359	GA-293	WALM	WAF601	GA-735	WLM
WA6339	GA-128	PHI	WA-7628	GAD-118	WEB	WA93595	GP-3985 ⁵³	MFI	WAF602	GA-271	WLM
WA6349	GA-127	PHI	WA7638	GA-607	MICF	WA93596	GP-3985 ⁵³	MFI	WAF665	GA-390	WARN
WA-6362	GA-362	WALM	WA-7640	GA-240	WALM	WA-9360	GA-264	WALM	WAF7	GA-85	WLM
WA-6362	GA-362	WEB	WA-7640	GA-240	WEB	WA-9360	GA-264	WEB	WAF735	GA-54	WLM
WA6366	GA-174	WALM	WA-77	GA-7	WALM	WA94	GA-12	WES	WAF753	GA-89	WLM
WA-6366	GA-174	WEB	WA-7730	GA-175	WALM	WA940	GP-1	MFI	WAF7816	GA-6690	WARN
WA-6376	GA-142	WEB	WA-7730	GA-175	WEB	WA940/12	GP-2108W	MNH	WAF7828	GA-386	WARN
WA-6395	GA-195	WEB	WA-7737	GA-128	WALM	WA-9401	GA-490	WALM	WAF7833	GA-7142	WARN
WA6416	GA-1616	PHI	WA-7737	GA-128	WEB	WA-9401	GA-490	WEB	WAF7836	GA-604	WARN
WA6418	GA-1615	PHI	WA-7738	GA-127	WALM	WA-9482	GA-263	WALM	WAF7841	GA-322	WARN
WA6425	GA-132	PHI	WA-7738	GA-127	WEB	WA-9482	GA-5466	WALM	WAF7842	GA-381	WARN
WA6469	GA-139	MICF	WA-7764	GA-172	WALM	WA-9492	GA-367	WALM	WAF785	GA-3647	WLM
WA6479	GA-6479	WALM	WA-7764	GA-172	WEB	WA-9493	GA-184	WALM	WAF7857	GAD-118	WARN
WA-6479	GA-6479	WEB	WA-7774	GA-1616	WALM	WA-9564	GA-138	WALM	WAF7863	GA-165	WARN

REFERENCIA CRUZADA

Para números Gonher con Superíndice vea página 651
For Gonher with Superscript numbers see page 651

Visite nuestro sitio en internet www.grupogonher.com
Visit our web site www.grupogonher.com

Numero	Gonher	Fabricante	Numero	Gonher	Fabricante	Numero	Gonher	Fabricante	Numero	Gonher	Fabricante
Number	Gonher	Manufacturer	Number	Gonher	Manufacturer	Number	Gonher	Manufacturer	Number	Gonher	Manufacturer
WAF7876	GA-605	WARN	WCF-8046	GAC-9	WALM	WD429	GP-24 ⁸⁸	DEL	WEC-236	G-236	WALM
WAF7878	GA-240	WARN	WCF-8631	GAC-1	WALM	WD429	GP-462 ²⁴	DEL	WEC-238	G-238	WALM
WAF7880	GA-514	WARN	WCF-8644	GAC-10 ²⁸	WALM	WD431	GP-31	DEL	WEC-2821	G-613	WALM
WAF7885	GA-2114	WARN	WCF-8644	GAC-8	WALM	WD434	GP-52 ¹¹⁰	DEL	WEC31	G-31	WALM
WAF7892	GA-5466	WARN	WCF-8644	GAC-8 ²⁸	WALM	WD434	GP-691 ⁴⁸	DEL	WEC-33	G-33	WALM
WAF7893	GA-476	WARN	WCF-9118	GAC-7	WALM	WD435	GP-390 ⁹³	DEL	WEC-330	G-330	WALM
WAF7905	GA-217	WARN	WCH33PL	G-33	NEL	WD437	GP-42	DEL	WEC331	G-331	WALM
WAF7906	GA-2198 ⁷⁹	WARN	WC-H33PL	G-33	WIN	WD442	GP-1	DEL	WEC-333	G-333	WALM
WAF7906	GA-438 ³¹	WARN	WCH6PL	G-6	WIN	WD444	GP-46	DEL	WEC-6	G-6	WALM
WAF7908	GA-384	WARN	WC-JD7-01	G-139	WIN	WD445	GP-46	DEL	WEC-612	G-141	WALM
WAF7909	GA-500	WARN	WC-L500	G-500	WIN	WD446	GP-20	DEL	WEC-813	G-813	WALM
WAF7910	GA-301	WARN	WC-LJD7-01P	G-139	WIN	WD451	GP-66	DEL	WEC-8158	G-112	WALM
WAF7911	GA-244	WARN	WC-P117	G-31	WIN	WD453	GP-66	DEL	WEC834	G-834	WALM
WAF7914	GA-607	WARN	WC-S1133PL	GS-1133	WIN	WD455	G-1143	DEL	WEC-848	G-833	WALM
WAF7935	GA-621	WARN	WD 13 145	GP-52	MNH	WD458	GP-1122	DEL	WEC-8806	G-45	WALM
WAF7938	GA-286	WARN	WD 13 145	GP-691	MNH	WD458	GPP-1122	DEL	WEC-9018	G-49	WALM
WAF7946	GA-278R	WARN	WD100	G-333	DEL	WD459	GP-1122	DEL	WF1	GP-2071W	MAHL
WAF7958	GA-183	WARN	WD103	GP-5	DEL	WD459	GPP-1122	DEL	WF1	GP-1	WLM
WAF7984	GA-248	WARN	WD106	G-330	DEL	WD461	GP-11	DEL	WF100	GP-2071W	ACD
WAF7996	GA-413R	WARN	WD107	G-169	DEL	WD462	GPP-1000	DEL	WF101	GP-1011Q	ACD
WAF8	GA-86	WLM	WD108	GP-81	DEL	WD496	GP-81 ³¹	DEL	WF1010	GP-2071W	FLG
WAF9	GA-75	WLM	WD1096	GP-1	DEL	WD496	GP-9 ⁸⁸	DEL	WF1011	GP-2071W	FLG
WAF9096	GA-780	WARN	WD129	GP-3	DEL	WD51	GP-20	DEL	WF1012	GP-1011Q	FLG
WARI1400R	G-331	WIN	WD1342	GP-38 ⁸⁹	DEL	WD52	GP-13	DEL	WF102	GP-1013Q	ACD
WAR28110R	G-139	WIN	WD1392	GP-23	DEL	WD54	GP-3	DEL	WF103	GP-1011Q	ACD
WB1	G-500	WGB	WD16	GPP-25	DEL	WD601	GP-31	DEL	WF104	GP-1013Q	ACD
WB2	G-750	WGB	WD180M	G-331	DEL	WD602	GP-1	DEL	WF109	GP-2022W	ACD
WB-50	GP-50	WEB	WD198	GP-14	DEL	WD603	GP-3600	DEL	WF111	GP-2071W	ACD
WC10	GP-1011Q	HAS	WD1996	GP-1	DEL	WD607	GP-56	DEL	WF112	GP-1011Q	ACD
WC11	GP-2126Q	HAS	WD227	G-296	DEL	WD618	GP-92	DEL	WF113	GP-2071W	ACD
WC1170C	G-500	WIN	WD227	G-296-B	DEL	WD619	GP-93	DEL	WF114	GP-1011Q	ACD
WC-11860P	G-1121	WEB	WD241	G-119	DEL	WD620	GP-34	DEL	WF1143PB	G-1143	WIN
WC-11860Z	G-1121F	WEB	WD242	G-870	DEL	WD621	GP-26	DEL	WF115	GP-1012Q	ACD
WC-1191A	G-296-B	WEB	WD261	G-222	DEL	WD625	GP-85	DEL	WF12	GP-2015W	ACD
WC12	GP-2071W	HAS	WD268	G-566	DEL	WD630	GP-9586	DEL	WF141	G-200	WLM
WC14	GP-2108W	HAS	WD270	GP-110	DEL	WD70	G-33	DEL	WF20	GP-81 ³¹	WLM
WC15	GP-2071W	HAS	WD271	G-613	DEL	WD7010	GP-2071W	DEL	WF20	GP-9 ⁸⁸	WLM
WC16	GP-2071W	HAS	WD273	GPP-18	DEL	WD7015	GP-2015W	DEL	WF201	GP-2015W	CSP
WC16670T	G-750	WIN	WD274	GPP-19	DEL	WD7016	GP-1011Q	DEL	WF2010	GP-2071W	FLG
WC17	GP-1010Q	HAS	WD276	G-122	DEL	WD7022	GP-2022W	DEL	WF2010	GP-2071W	LBFI
WC18	GP-1011Q	HAS	WD276	G-338	DEL	WD7023	GP-2071W	DEL	WF2011	GP-2071W	FLG
WC2	GP-2071W	HAS	WD277	GP-66	DEL	WD7320	GP-2071W	DEL	WF2012	GP-1011Q	FLG
WC20	GP-1013Q	HAS	WD278	GP-66	DEL	WD7330	GP-1011Q	DEL	WF2014	GP-1013Q	FLG
WC3	GP-2015W	HAS	WD281	GP-81	DEL	WD7331	GP-1011Q	DEL	WF2015	GP-2015W	FLG
WC4	GP-1013Q	HAS	WD282	GP-69	DEL	WD7360	GP-1011Q	DEL	WF2016	GP-1011Q	FLG
WC4200	G-1173 ¹⁰⁸	WIN	WD283	GPP-18	DEL	WD7361	GP-1011Q	DEL	WF2016	GP-1011Q	LBFI
WC5	GP-2022W	HAS	WD288	GP-54	DEL	WD7373	GP-1011Q	DEL	WF2017	GP-1011Q	FLG
WC-5703	GP-1013Q	SAKU	WD289	GP-10	DEL	WD74	G-31	DEL	WF2018	GP-1011Q	FLG
WC5705	GP-2071W	SAKU	WD292	GP-36	DEL	WD7453	GP-2071W	DEL	WF202	GP-2071W	CSP
WC5707	GP-1011Q	SAKU	WD293	G-566	DEL	WD7473	GP-2071W	DEL	WF2022	GP-2022W	FLG
WC5709	GP-2071W	SAKU	WD295	GP-31	DEL	WD7475	GP-2015W	DEL	WF2023	GP-2071W	FLG
WC5710	GP-1010Q	SAKU	WD296	GP-1	DEL	WD750	G-750	DEL	WF2024	GP-2071W	FLG
WC-5711	GP-1011Q	SAKU	WD297	GP-66	DEL	WD80	G-139	DEL	WF2025	GP-1011Q	FLG
WC6	GP-1010Q	HAS	WD299	G-122	DEL	WD86	G-6	DEL	WF203	GP-1011Q	CSP
WC6	GP-2071W	HAS	WD299	G-338	DEL	WD87	G-191	DEL	WF204	GP-2022W	CSP
WC6901	GP-1013Q	SAKU	WD309	GP-3429	DEL	WD88	G-34	DEL	WF2050	GP-2071W	FLG
WC7	GP-1012Q	HAS	WD310	GP-44	DEL	WD89	G-6	DEL	WF2051	GP-2071W	FLG
WC7101	GP-1013Q	SAKU	WD342	GP-38 ⁸⁹	DEL	WD90	GPP-25	DEL	WF2051A	GP-2071W	FLG
WC7901	GP-1011Q	SAKU	WD345	GP-83	DEL	WD940-2	GP-36	MNH	WF2052	GP-1011Q	FLG
WC9	GP-1011Q	HAS	WD346	GP-84	DEL	WD95	G-236	DEL	WF2053	GP-1011Q	FLG
WC9320	G-1176	WIN	WD347	GP-34	DEL	WD950	GP-66	MNH	WF2053A	GP-1011Q	FLG
WCC1133PL	GC-1133	NEL	WD352	GP-1108	DEL	WD950-2	GP-66	MNH	WF2054	GP-1013Q	FLG
WCC1133PL	GC-1133	WIN	WD353	GP-78	DEL	WD9503	GP-66	MNH	WF2055	GP-1013Q	FLG
WC-F30	G-31	WIN	WD357	GPP-14	DEL	WD96	GP-1	DEL	WF2056	GP-1013Q	FLG
WC-F31	G-31	WIN	WD362	GP-1101	DEL	WD962	GP-66 ⁹⁰	MNH	WF2059	GP-2071W	FLG
WCF-35494	GAC-2	WALM	WD363	GP-78	DEL	WD97	GP-50	DEL	WF2060	GP-1011Q	FLG
WCF-45384	GAC-1	WALM	WD369	G-297	DEL	WD98	G-33	DEL	WF2061	GP-1011Q	FLG
WCF550	GG-94	COBR	WD369	G-297-B	DEL	WD99	G-200	DEL	WF2065	GP-1012Q	FLG
WCF559	GG-76	COBR	WD371	GP-69	DEL	WD996	GP-1	DEL	WF2066	GP-1013Q	FLG
WCF595	GG-79	COBR	WD372	GP-69	DEL	WD998	G-33	DEL	WF2067	GP-2071W	FLG
WCF600	GG-215	COBR	WD373	GP-51	DEL	WDK 725	GPP-1122	MNH	WF2069	GP-1011Q	FLG
WCF601	GG-214	COBR	WD374	GP-66	DEL	WDK724	GP-1122	MNH	WF2070	GP-2071W	FLG
WCF604	GG-196	COBR	WD382	GP-66	DEL	WDX109	G-870	DEL	WF2071	GP-2071W	FLG
WCF608	GG-246	COBR	WD387	GP-10	DEL	WDX109	G-871	DEL	WF2072	GP-1010Q	FLG
WCF610	GG-251	COBR	WD388	GP-50	DEL	WDX114	G-871	DEL	WF2073	GP-1011Q	FLG
WCF612	GG-63	COBR	WD391	G-295	DEL	WDX117	G-225	DEL	WF2074	GP-1012Q	FLG
WCF613	GG-194	COBR	WD392	GP-23	DEL	WDX120	G-813	DEL	WF2076	GP-1013Q	FLG
WCF616	GG-208	COBR	WD394	GP-26	DEL	WDX125	G-836	DEL	WF2078	GP-2015W	FLG
WCF617	GG-181	COBR	WD395	GP-27	DEL	WDX144	G-11816	DEL	WF2079	GP-2022W	FLG
WCF618	GG-208	COBR	WD396	GP-81 ³¹	DEL	WDX145	G-834	DEL	WF2081	GP-1011Q	FLG
WCF622	GG-217	COBR	WD396	GP-9 ⁸⁸	DEL	WDX177	GP-81	DEL	WF2088	GP-2071W	FLG
WCF623	GG-261	COBR	WD397	GP-34	DEL	WDX178	GP-50	DEL	WF2089	GP-1011Q	FLG
WCF624	GG-185	COBR	WD399	GP-53	DEL	WE750CBP	G-750	ROLK	WF2093	GP-1010Q	FLG
WCF627	GG-220	COBR	WD3995C	GP-53	DEL	WEC-11	GG-6	WALM	WF2098	GP-1013Q	FLG
WCF632	GG-76	COBR	WD404	G-335	DEL	WEC-1133C	GC-1133	WALM	WF2104	GP-1012Q	FLG
WCF633	GG-76	COBR	WD407	G-152	DEL	WEC-1133S	GS-1133	WALM	WF2106	GP-2071W	FLG
WCF634	GG-213	COBR	WD414	GP-28 ⁸⁴	DEL	WEC-1173	G-1173	WALM	WF2108	GP-2108W	FLG
WCF635	GG-203	COBR	WD414	GP-3600 ⁸⁴	DEL	WEC-1174	G-1174	WALM	WF2125	GP-2126Q	FLG
WCF660	GG-226	COBR	WD414	GP-430 ⁸⁵	DEL	WEC1175	G-1175	WALM	WF2126	GP-2126Q	FLG
WCF661	GG-246	COBR	WD42	G-31	DEL	WEC-11860	G-1121	WALM	WF2127	GP-2127W	FLG
WCF661	GG-408	COBR	WD423	GP-14	DEL	WEC-119	G-119	WALM	WF2142	GP-1011Q	FLG
WCF663	GG-39	COBR	WD424	GP-50	DEL	WEC-14	G-5000	WALM	WF2144	GP-1011Q	FLG
WCF664	GG-190	COBR	WD425	GP-3985	DEL	WEC191	G-191	WALM	WF2144	GP-2071W	FLG
WCF665	GG-220	COBR	WD426	GP-462	DEL	WEC-200	G-200	WALM	WF24	GP-20	WLM
WCF666	GG-146	COBR	WD427	GP-3816	DEL	WEC-211	G-566	WALM	WF25	GP-3	WLM
WCF667	GG-151	COBR	WD428	GP-1101 ⁸⁴	DEL	WEC-218	G-34	WALM	WF30	G-31	WIN

Referencia Cruzada por Numero de Parte

Cross Reference by Part Number



Numero	Gonher	Fabricante	Numero	Gonher	Fabricante	Numero	Gonher	Fabricante	Numero	Gonher	Fabricante
Number	Gonher	Manufacturer	Number	Gonher	Manufacturer	Number	Gonher	Manufacturer	Number	Gonher	Manufacturer
WF30P		G-31 WIN	WG-1101	GP-1101	WALM	WG-7019M	GG-7019 ⁹⁷	WALM	WGA319	GA-1008	WOOG
WF31		G-31 NEL	WG-1103	GP-11	WALM	WG-7019M	GG-7020 ¹¹⁴	WALM	WGA320	GA-7716	WOOG
WF31		G-31 WIN	WG-1146	GP-26	WALM	WG-7092	GG-30	WALM	WGA320S	GA-7360	WOOG
WF31		GG-1 WIX	WG-1147	GP-27	WALM	WG-7099	GG-82	WALM	WGA325	GA-467	WOOG
WF31		GG-4 WIX	WG-1191	G-296	WALM	WG-7143	GG-167	WALM	WGA333	GA-375	WOOG
WF31G		G-31 NEL	WG-1191	G-296-B	WALM	WG-7143	GG-64	WEB	WGA338K	GA-98 ¹¹²	WOOG
WF31G		G-31 WIN	WG-1191	GG-298	WALM	WG-7248	GG-72	WALM	WGA338KE	GA-98 ¹¹²	WOOG
WF33		GG-5 L WIX	WG-1191	GG-298	WEB	WG-7315	GG-66	WALM	WGA339KE	GAK-625	WOOG
WF35		GP-13 WLM	WG11CH	GG-16	WALM	WG-7315	GG-66	WEB	WGA340KE	GAK-458	WOOG
WF-3C		GP-1011Q ACD	WG-12	GG-7	WALM	WG-7333	GG-581	WALM	WGA340S	GA-459	WOOG
WF4		GP-2071W ACD	WG12CH	GG-17	WALM	WG-7399	GG-99	WALM	WGA343	GA-1285	WOOG
WF41-1		GG-196 MNH	WG-15	GG-5 L	WEB	WG-7404	GG-1992	WALM	WGA344	GA-1287	WOOG
WF4200		G-1173 ¹⁰⁸ WIN	WG-1562	GG-256	WALM	WG-7416	GG-84	WALM	WGA345	GA-1286	WOOG
WF4300		G-1173 ¹⁰⁸ WIN	WG-16400-N9600	GG-94	WEB	WG-7596	GG-92	WALM	WGA346	GA-1284	WOOG
WF4320		G-1173 ¹⁰⁸ WIN	WG-16900-SEO-A31	GG-181	WEB	WG-7599	GG-160	WALM	WGA359	GA-1203	WOOG
WF4330		G-1173 ¹⁰⁸ WIN	WG-17M	GG-32	WALM	WG-7609	GG-267	WALM	WGA364	GA-329	WOOG
WF44		GG-6 WIX	WG-1M	GG-29	WALM	WG-7610	GG-265	WALM	WGA364S	GA-239	WOOG
WF45		GP-3429 WLM	WG-1M	GG-5 L	WALM	WG-7740	GG-290	WALM	WGA367	GA-483	WOOG
WF47		GP-46 WLM	WG2	GG-1	WALM	WG-7760	GG-104	WALM	WGA367S	GA-482	WOOG
WF49140		GP-81 MNH	WG2	GG-4	WALM	WG-8	GG-8	WALM	WGA374	GA-372	WOOG
WF51		GP-3980 WLM	WG2	GG-19	WLM	WG-8018	GG-986	WALM	WGA375	GA-378	WOOG
WF69		GG-76 MNH	WG-2	GG-124	WEB	WG-8018	GG-986	WEB	WGA382K	GAK-216	WOOG
WF8300		G-1175 WIN	WG20	GG-20	WALM	WG-8097C	GG-195	WALM	WGA382S	GA-416	WOOG
WF8330		G-1175 ¹⁰⁸ WIN	WG-22	GG-19	WALM	WG-8190	GG-95	WALM	WGA386	GA-2984	WOOG
WF8330		G-1176 ¹⁰⁸ WIN	WG-22	GG-19	WEB	WG-8219	GG-266	WALM	WGA388	GA-403	WOOG
WF9142		GP-81 MNH	WG3	GG-6	WLM	WG-8425C	GG-111	WALM	WGA389	GA-425	WOOG
WF9160		GP-81 MNH	WG-3	GG-1	WALM	WG-8M	GG-170	WALM	WGA389S	GA-426	WOOG
WF9161		GP-81 MNH	WG-3	GG-4	WALM	WGA100	GA-9334	WOOG	WGA390	GA-26	WOOG
WF91610		GP-81 MNH	WG-3	GG-5	WEB	WGA1010S	GA-759	WOOG	WGA391K	GAK-16	WOOG
WF916-10		GP-58 MNH	WG-3359	GG-45	WEB	WGA1017K	GAK-16	WOOG	WGA399	GA-209	WOOG
WF920-20		GP-58 MNH	WG-3499	GG-8 L	WALM	WGA1019	GAD-30	WOOG	WGA399S	GA-210	WOOG
WF9H4729		G-1166 WIN	WG-3499	GG-8 L	WEB	WGA1034	GA-33 ¹¹²	WOOG	WGA401	GA-135	WOOG
WFC1143PB		G-1143 NEL	WG-3596	GG-87	WALM	WGA1046	GA-6129	WOOG	WGA403	GA-6128	WOOG
WFC1143PB		G-1143 WIN	WG-3606	GG-5 L	WALM	WGA1057	GA-6129	WOOG	WGA403S	GA-6127	WOOG
WFC1143-PL		G-1143 WIN	WG-3641	GG-79	WALM	WGA106	GA-49	WOOG	WGA413	GA-6880	WOOG
WFC50		GP-1 WLM	WG-3692	GG-240	WALM	WGA1080	GA-853R	WOOG	WGA420	GA-679	WOOG
WFC60		GP-38 WLM	WG-3727	GG-46	WALM	WGA1098	GA-499R	WOOG	WGA420S	GA-680	WOOG
WFC70		GP-28 ⁸⁴ WLM	WG-3727	GG-46	WEB	WGA1106	GA-966R	WOOG	WGA432	GA-251	WOOG
WFC70		GP-3600 ⁹⁴ WLM	WG-3728	GG-3728	WALM	WGA1106S	GA-967R	WOOG	WGA434	GAP-379	WOOG
WFC70		GP-430 ⁸⁵ WLM	WG-3747	GG-246	WALM	WGA1107S	GA-890R	WOOG	WGA446	GAP-381	WOOG
WF-CS1133PL		GS-1133 WLM	WG-3769	GG-42	WALM	WGA1108	GA-682R	WOOG	WGA468	GA-8	WOOG
WF-F104		GP-1101 WIN	WG-3802	GG-47	WALM	WGA1108S	GA-683R	WOOG	WGA477	GA-563	WOOG
WFF104P		GP-1101 NEL	WG-3802A	GG-47	WEB	WGA110K	GA-27 ¹¹²	WOOG	WGA495	GA-39	WOOG
WFF-F104P		GP-1101 WIN	WG3829	GG-251	WALM	WGA110KE	GA-27 ¹¹²	WOOG	WGA503	GA-77	WOOG
WFF105P		GP-1101 NEL	WG-3829	GG-251	WEB	WGA1110	GA-197R	WOOG	WGA513	GA-105	WOOG
WF-F105P		GP-1101 WIN	WG-3850	GG-1872	WALM	WGA1110S	GA-768R	WOOG	WGA514	GA-105	WOOG
WFF132		G-33 NEL	WG-3850	GG-1872	WEB	WGA1111	GA-197R	WOOG	WGA520	GA-56	WOOG
WFR82010		GP-2071W FLR	WG-3895	GG-264	WALM	WGA1118	GA-221R	WOOG	WGA521	GA-71	WOOG
WFR82014		GP-1013Q FLR	WG-3M	GG-25	WALM	WGA1123	GP-3985	WOOG	WGA522	GA-70	WOOG
WFR82015		GP-2015W FLR	WG4	GG-7	WLM	WGA1129	GA-2804 T	WOOG	WGA524	GA-80	WOOG
WFR82016		GP-1011Q FLR	WG-4163	G-297	WALM	WGA1164	GA-42	WOOG	WGA535	GA-192	WOOG
WFR82018		GP-1011Q FLR	WG-4163	G-297-B	WALM	WGA1202	GA-712R	WOOG	WGA536	GA-44	WOOG
WFR82022		GP-2022W FLR	WG-4164	GG-116	WEB	WGA1203	GA-600R	WOOG	WGA539	GA-21	WOOG
WFR82023		GP-2071W FLR	WG-4194	GG-94	WALM	WGA122	GA-8047	WOOG	WGA54	GA-6129	WOOG
WFR82050		GP-2071W FLR	WG-455	GG-123	WALM	WGA124	GA-5648	WOOG	WGA541	GA-78	WOOG
WFR82051		GP-2071W FLR	WG-4715	GG-204	WEB	WGA1246	GA-880R	WOOG	WGA542	GA-55	WOOG
WFR82052		GP-1011Q FLR	WG475	GG-87	WLM	WGA124E	GA-5648	WOOG	WGA543	GA-325	WOOG
WFR82053		GP-1011Q FLR	WG-4777	GG-63	WEB	WGA1250	GA-517R	WOOG	WGA544	GA-59	WOOG
WFR82054		GP-1013Q FLR	WG-4777M	GG-63	WALM	WGA126	GA-436	WOOG	WGA545	GA-57	WOOG
WFR82055		GP-1013Q FLR	WG-481	GG-46	WALM	WGA12K	GAK-16	WOOG	WGA546	GA-730	WOOG
WFR82056		GP-1013Q FLR	WG-4894	GG-986	WALM	WGA12KE	GAK-16	WOOG	WGA547	GA-85	WOOG
WFR82059		GP-2071W FLR	WG5	GG-123	WLM	WGA130	GA-229	WOOG	WGA54E	GA-6129	WOOG
WFR82060		GP-1011Q FLR	WG-5	GG-5	WALM	WGA134	GA-37	WOOG	WGA545	GA-6127	WOOG
WFR82061		GP-1011Q FLR	WG-5237	GG-137	WALM	WGA13K	GAK-20	WOOG	WGA552	GA-303	WOOG
WFR82066		GP-1013Q FLR	WG-5237	GG-137	WEB	WGA13KE	GAK-20	WOOG	WGA553	GA-3300	WOOG
WFR82067		GP-2071W FLR	WG-5511V	GG-252	WALM	WGA155	GA-18	WOOG	WGA569	GA-349	WOOG
WFR82069		GP-1011Q FLR	WG-5870	GG-102	WALM	WGA1554	GA-2146	WOOG	WGA578	GA-2719R	WOOG
WFR82070		GP-2071W FLR	WG6	GG-16	WLM	WGA1582	GA-6	WOOG	WGA580	GA-75	WOOG
WFR82071		GP-2071W FLR	WG-6	GG-1	WALM	WGA15K	GA-33 ¹¹²	WOOG	WGA584	GA-230	WOOG
WFR82072		GP-1010Q FLR	WG-6	GG-4	WALM	WGA15KE	GA-33 ¹¹²	WOOG	WGA597	GA-29	WOOG
WFR82073		GP-1011Q FLR	WG-6	GG-4	WEB	WGA161K	GAK-216	WOOG	WGA601	GA-7	WOOG
WFR82074		GP-1012Q FLR	WG-61	GG-5	WALM	WGA161S	GA-416	WOOG	WGA608	GA-509 ¹⁴	WOOG
WFR82076		GP-1013Q FLR	WG-618A	GG-64	WALM	WGA162K	GAK-1532	WOOG	WGA616	GA-3501	WOOG
WFR82078		GP-2015W FLR	WG-61M	GG-5 L	WALM	WGA166	GA-826	WOOG	WGA619	GA-376	WOOG
WFR82079		GP-2022W FLR	WG-6344	GG-39	WALM	WGA167	GA-6129	WOOG	WGA633	GA-86	WOOG
WFR82081		GP-1011Q FLR	WG-6348	GG-41	WALM	WGA16K	GAK-403	WOOG	WGA649	GA-109	WOOG
WFR82088		GP-2071W FLR	WG-6348M	GG-256	WALM	WGA16KE	GAK-403	WOOG	WGA650S	GA-357	WOOG
WFR82093		GP-1010Q FLR	WG-6563	GG-61	WALM	WGA1749	GA-2156	WOOG	WGA653	GA-429	WOOG
WFR82104		GP-1012Q FLR	WG-6566	GG-65	WALM	WGA1785	GA-2156	WOOG	WGA665	GA-107	WOOG
WFR82106		GP-2071W FLR	WG-6567	GG-67	WALM	WGA18	GA-360	WOOG	WGA665S	GA-108	WOOG
WFR82108		GP-2108W FLR	WG-6569	GG-62	WALM	WGA181	GA-589	WOOG	WGA666	GA-180	WOOG
WFR82126		GP-2126Q FLR	WG-6613	GG-580	WALM	WGA1869	GA-888R	WOOG	WGA670	GA-608	WOOG
WFR82127		GP-2127W FLR	WG-6678	GG-151	WALM	WGA18E	GA-360	WOOG	WGA675K	GAK-1532	WOOG
WFR82144		GP-1011Q FLR	WG-6680	GG-187	WALM	WGA18S	GA-361	WOOG	WGA678	GA-493 ¹⁰⁸	WOOG
WF-TP511		G-1173 WIN	WG-6826	GG-184	WALM	WGA1906	GA-4365	WOOG	WGA679	GA-3424	WOOG
WF-TP512		G-1175 WIN	WG7	GG-17	WLM	WGA193	GA-588	WOOG	WGA680	GA-3425	WOOG
WF-TP540X		G-1175 WIN	WG-7018M	GG-7018 ³⁸	WALM	WGA207	GA-356	WOOG	WGA684	GA-3523	WOOG
WF-X9320		G-1176 WIN	WG-7018M	GG-7019 ⁹⁷	WALM	WGA207E	GA-356	WOOG	WGA694	GAD-1	WOOG
WFX-CC1133PL		GC-1133 WIN	WG-7018M	GG-7020 ¹¹⁴	WALM	WGA207S	GA-357	WOOG	WGA696	GA-12	WOOG
WG01061		GG-106 WALM	WG-7018S	GG-7018 ³⁸	WALM	WGA30	GA-106 ⁴⁶	WOOG	WGA701	GA-679	WOOG
WG-1		GG-3 WALM	WG-7018S	GG-7019 ⁹⁷	WALM	WGA30	GA-326 ⁹¹	WOOG	WGA704	GAD-3	WOOG
WG10		GG-45 WALM	WG-7018S	GG-7020 ¹¹⁴	WALM	WGA309S	GA-892	WOOG	WGA706	GA-11	WOOG
WG1											

Numero	Gonher	Fabricante	Numero	Gonher	Fabricante	Numero	Gonher	Fabricante	Numero	Gonher	Fabricante
Number	Gonher	Manufacturer	Number	Gonher	Manufacturer	Number	Gonher	Manufacturer	Number	Gonher	Manufacturer
WGA7215	GA-827	WOOG	WGF157	GG-5 L	WOOG	WGFS1206	GS-2033	WOOG	WGL1275	G-163	WOOG
WGA733	GA-3490	WOOG	WGF171	GP-84	WOOG	WGFS1207	GS-2034	WOOG	WGL2821	GP-1	WOOG
WGA734	GA-113	WOOG	WGF172	GP-83	WOOG	WGFS1208	2010PM-OR ⁷	WOOG	WGL2895	GP-3600	WOOG
WGA740	GA-3501	WOOG	WGF178	G-1143	WOOG	WGFS1208	2010TM-OR ²	WOOG	WGL3000	GP-3000	WOOG
WGA747	GA-389	WOOG	WGF179	GG-19	WOOG	WGFS1208-30	2010PM-OR	WOOG	WGL3307	GP-69	WOOG
WGA749	GA-54	WOOG	WGF180	GG-6	WOOG	WGFS1209	G-294	WOOG	WGL3308	GP-50	WOOG
WGA758	GA-89	WOOG	WGF181	GG-7	WOOG	WGFS1212	GPP-11	WOOG	WGL3310	GP-3816	WOOG
WGA761	GA-735	WOOG	WGF182	GP-78	WOOG	WGFS1214	GPP-11	WOOG	WGL3311	GP-81	WOOG
WGA762	GA-271	WOOG	WGF184	GP-1108	WOOG	WGFS1221	GPP-1122	WOOG	WGL3313	GP-1	WOOG
WGA763	GA-VW-2	WOOG	WGF185	GP-110	WOOG	WGFS1223	GPP-1287 ³⁹	WOOG	WGL3314	GP-1	WOOG
WGA766	GA-3588	WOOG	WGF192	GP-11	WOOG	WGFS1223	PF831 ⁴¹	WOOG	WGL3315	GP-68	WOOG
WGA769	GA-3647	WOOG	WGF194	GPP-1000	WOOG	WGFS1223	R 60 P ⁴²	WOOG	WGL3316	GP-69	WOOG
WGA771	GA-154	WOOG	WGF198	GPP-14	WOOG	WGFS1225	GPP-11	WOOG	WGL3317	GP-35	WOOG
WGA782	GA-371	WOOG	WGF200	GP-18	WOOG	WGFS1226	GPP-1122	WOOG	WGL3322	G-926	WOOG
WGA786	GA-D-30	WOOG	WGF202	GP-55	WOOG	WGFS1235	GPP-1122	WOOG	WGL3324	GP-1	WOOG
WGA787	GA-135	WOOG	WGF202R	GP-55	WOOG	WGFS1242	GPP-103 ⁴⁰	WOOG	WGL3325	GP-53	WOOG
WGA790	GA-376	WOOG	WGF203	G-295	WOOG	WGFS1242	GPP-11 ³⁹	WOOG	WGL3326	GP-57	WOOG
WGA793	GA-694	WOOG	WGF204	GP-62	WOOG	WGFS1251	GPP-1122	WOOG	WGL3330	GP-81	WOOG
WGA803	GA-222	WOOG	WGF206	GP-27	WOOG	WGFS1276	GPP-1122	WOOG	WGL3333	GP-53	WOOG
WGA811	GA-1095	WOOG	WGF207	GP-26	WOOG	WGFS1277	GP-92	WOOG	WGL3333SC	GP-43	WOOG
WGA812	GA-891 ⁹⁰	WOOG	WGF209	GP-1107	WOOG	WGFS1280	GPP-18	WOOG	WGL3334	GP-38	WOOG
WGA813	GA-3637	WOOG	WGF210	GP-1101 ⁵⁴	WOOG	WGFS1281	R120P	WOOG	WGL3335	GP-3816	WOOG
WGA816	GA-616	WOOG	WGF211	GP-56	WOOG	WGFS1500	GPP-425	WOOG	WGL3336	GP-40	WOOG
WGA8165	GA-398	WOOG	WGF213	GP-110	WOOG	WGFS1913	S 3202 ⁴⁰	WOOG	WGL3337	GP-3531 EXP	WOOG
WGA829	GA-3551 XT ⁶⁴	WOOG	WGF216	GP-26	WOOG	WGFS1925	GPP-423	WOOG	WGL3338	GP-3816	WOOG
WGA829	GA-3551 ⁵⁵	WOOG	WGF219	GG-17	WOOG	WGFS1925	GPP-425	WOOG	WGL3339	GP-3600	WOOG
WGA836	GA-3501	WOOG	WGF220	GG-16	WOOG	WGFS1930	GPP-425	WOOG	WGL3341	GP-81 ³¹	WOOG
WGA842	GA-2129	WOOG	WGF222	GP-85	WOOG	WGFS1931	GPP-419	WOOG	WGL3341	GP-9 ⁵⁸	WOOG
WGA861K	GAK-16	WOOG	WGF223	GPP-19	WOOG	WGFS1932	GPP-1291 ³⁹	WOOG	WGL3342	GP-9586	WOOG
WGA864	GA-101	WOOG	WGF224	GP-18	WOOG	WGFS1932	PF831 ⁴¹	WOOG	WGL3344	GP-3766	WOOG
WGA868	GA-119	WOOG	WGF231	GP-1122	WOOG	WGFS1932	R 90 P ⁴²	WOOG	WGL3345	GP-390	WOOG
WGA870	GA-377	WOOG	WGF232	G-277	WOOG	WGFS1951	GPP-1291 ³⁹	WOOG	WGL3349	GP-178	WOOG
WGA874	GA-3916	WOOG	WGF235	GP-92	WOOG	WGFS1951	PF831 ⁴¹	WOOG	WGL3353	GP-9	WOOG
WGA875	GA-273	WOOG	WGF239	GG-8 ¹⁸⁰	WOOG	WGFS1951	R 90 T ⁴²	WOOG	WGL3357	G-31	WOOG
WGA878	GA-277	WOOG	WGF239	GG-8 ¹⁰³	WOOG	WGFS2916	GPP-418	WOOG	WGL3360	GP-77	WOOG
WGA879	GA-403	WOOG	WGF249	GG-123	WOOG	WGFS2925	GPP-423	WOOG	WGL3375	GP-171	WOOG
WGA881	GA-4828	WOOG	WGF296	G-296	WOOG	WGFS2930	GPP-425	WOOG	WGL3382	GP-10	WOOG
WGA882	GA-274	WOOG	WGF296	G-296-B	WOOG	WGFS2931	GPP-419	WOOG	WGL3390	GP-14	WOOG
WGA883	GA-153	WOOG	WGF4012	GG-48	WOOG	WGFS2954	GPP-421	WOOG	WGL3391	G-31	WOOG
WGA884	GA-90	WOOG	WGF4783	GP-1109 ²⁷	WOOG	WGFS6021	GPP-420	WOOG	WGL3393	GP-88	WOOG
WGA890	GA-D-15	WOOG	WGF4783	GP-62 ²⁰	WOOG	WGH1866	GP-761H	WOOG	WGL3402	GP-1	WOOG
WGA893	GA-5056	WOOG	WGF5002	G-297	WOOG	WGH1878	GP-91	WOOG	WGL3403	GP-149	WOOG
WGA894	GA-174	WOOG	WGF5002	G-297-B	WOOG	WGH1919	GP-58 ⁹	WOOG	WGL3406	GP-51	WOOG
WGA896	GA-329	WOOG	WGF5011	GP-26	WOOG	WGH6054	G-122	WOOG	WGL3407	GP-3985	WOOG
WGA899	GA-403	WOOG	WGF5012	GGP-25	WOOG	WGH6054	G-338	WOOG	WGL3415	GP-36	WOOG
WGA89K	GA-26	WOOG	WGF5017	GP-1108	WOOG	WGH6055	GP-66	WOOG	WGL3420	GP-69	WOOG
WGA89KE	GA-26	WOOG	WGF5018	GP-1122	WOOG	WGH6056	GP-66	WOOG	WGL3434	GP-3682	WOOG
WGA907	GA-758	WOOG	WGF5019	GP-78	WOOG	WGH6057	GP-66	WOOG	WGL3435	GP-81	WOOG
WGA907S	GA-759 ⁰⁸	WOOG	WGF5020	GP-1108	WOOG	WGH6072	G-191	WOOG	WGL3436	GP-51	WOOG
WGA923	GA-2122	WOOG	WGF5021	GP-93	WOOG	WGH6079	G-331	WOOG	WGL3443	GP-54	WOOG
WGA96	GA-405	WOOG	WGF5026	GG-46	WOOG	WGH6080	GP-66	WOOG	WGL3449	GP-1	WOOG
WGA972	GA-8	WOOG	WGF5027	GG-87	WOOG	WGH6083	G-153	WOOG	WGL3451	GP-1	WOOG
WGA994	GA-18	WOOG	WGF5033	GP-1122	WOOG	WGH6096	GP-81	WOOG	WGL3460	GP-58	WOOG
WGC3003	GA-589	WOOG	WGF5034	GP-92	WOOG	WGH6097	G-152	WOOG	WGL3462	GP-149	WOOG
WGC3004	GA-425	WOOG	WGF5035	GP-155	WOOG	WGH6098	G-222	WOOG	WGL3473	GP-68	WOOG
WGC3006	GA-679	WOOG	WGF5037	GP-85 ⁹⁰	WOOG	WGH6107	GP-171 ¹⁵	WOOG	WGL3480	GP-9	WOOG
WGC400	GA-33 ¹¹²	WOOG	WGF5038	GP-18	WOOG	WGH6115	GP-166	WOOG	WGL3481	GP-9	WOOG
WGC410	GAK-16	WOOG	WGF5040	GP-1122	WOOG	WGH6121	GP-66	WOOG	WGL3486	GP-3980	WOOG
WGC411	GAK-16	WOOG	WGF5045	G-270	WOOG	WGH6122	GP-54	WOOG	WGL3497	GP-54 ⁹⁰	WOOG
WGC420	GAK-403	WOOG	WGF5046	GPP-1122	WOOG	WGH6123	GP-166	WOOG	WGL3503	GP-1 ⁹	WOOG
WGC421	GAK-403	WOOG	WGF5049	G-296	WOOG	WGH6125	GP-34	WOOG	WGL3505	GP-81	WOOG
WGC510	GAK-1532	WOOG	WGF5049	G-296-B	WOOG	WGH6133	GP-34	WOOG	WGL3548	GP-3000 ¹³	WOOG
WGC511	GAK-1532	WOOG	WGF5052	GP-1122	WOOG	WGH6138	GP-34	WOOG	WGL3644	GP-149	WOOG
WGC53003	GA-588 ⁰⁸	WOOG	WGF5066	GG-1	WOOG	WGH6141	GP-66 ⁹⁰	WOOG	WGL3703	GP-754	WOOG
WGC53003	GA-589 ⁰⁴	WOOG	WGF5066	GG-4	WOOG	WGH6159	GP-36	WOOG	WGL3935	GP-178	WOOG
WGC53004	GA-425 ⁰⁴	WOOG	WGF5067	GP-1107	WOOG	WGH6162	G-162H	WOOG	WGL3970	GP-3937	WOOG
WGC53004	GA-426 ⁰⁸	WOOG	WGF5078	GP-78	WOOG	WGH6164	GP-81	WOOG	WGL4017	GP-54	WOOG
WGC53005	GA-680 ⁰⁸	WOOG	WGF5095	GP-1122	WOOG	WGH6184	G-339H	WOOG	WGL4031	G-833	WOOG
WGC53006	GA-679 ⁰⁴	WOOG	WGF5097	GG-47	WOOG	WGH6188	GP-166	WOOG	WGL4112	GP-77	WOOG
WGC53006	GA-680 ⁰⁸	WOOG	WGF5100	G-1121F	WOOG	WGH6197	G-191	WOOG	WGL5000	G-500	WOOG
WGC5410	GAK-16 ⁰⁴	WOOG	WGF5109	GPP-19	WOOG	WGH6279	GP-66	WOOG	WGL504	G-31	WOOG
WGC5411	GAK-16 ⁰⁴	WOOG	WGF5113	GP-1122	WOOG	WGH6352	GP-9	WOOG	WGL509	G-33	WOOG
WGC5420	GAK-403 ⁰⁴	WOOG	WGF5136	GG-3728	WOOG	WGH6510	GP-66	WOOG	WGL512	G-6	WOOG
WGC5421	GAK-403 ⁰⁴	WOOG	WGF5176	GG-94	WOOG	WGH6551	GP-761H	WOOG	WGL519	G-238	WOOG
WGC5510	GAK-1532	WOOG	WGF5245	GP-110	WOOG	WGH6552	GP-761H	WOOG	WGL522	G-333	WOOG
WGC5511	GAK-1532	WOOG	WGF5264	GP-749	WOOG	WGH6553	GP-761H	WOOG	WGL525	G-119	WOOG
WGF004	G-1123	WOOG	WGF5272	GP-96	WOOG	WGH6554	GP-761H	WOOG	WGL550	G-5000	WOOG
WGF008	G-1121F	WOOG	WGF5275	G-278	WOOG	WGH6555	GP-761H	WOOG	WGL552	G-330	WOOG
WGF009	G-1123	WOOG	WGF5458	GP-458	WOOG	WGH6561	GP-761H	WOOG	WGL553	G-200	WOOG
WGF058	G-1121	WOOG	WGF700X	G-1121F	WOOG	WGH6565	GP-761H	WOOG	WGL558	G-191	WOOG
WGF100	GG-5 L	WGB	WGF7587	GP-749	WOOG	WGH6566	GP-761H	WOOG	WGL560	G-236	WOOG
WGF100-1	GG-5 L	WGB	WGF796	G-297-B	WOOG	WGH6572	GP-761H	WOOG	WGL563	G-335	WOOG
WGF100-2	GG-4	WGB	WGF9059	GP-1122	WOOG	WGH6573	GP-761H	WOOG	WGL566	G-870	WOOG
WGF103	G-1175 ⁰⁸	WOOG	WGF9066	G-11816	WOOG	WGH6711	GP-34	WOOG	WGL572	G-31	WOOG
WGF104	GP-1101	WOOG	WGF9205	GPP-418	WOOG	WGH6720	GP-34	WOOG	WGL580	GP-1	WOOG
WGF105	GP-1101	WOOG	WGF9205	GPP-166 ⁶⁵	WOOG	WGH7936	GP-166 ⁶⁵	WOOG	WGL581	GP-5	WOOG
WGF106	GP-1101	WOOG	WGF9207	GPP-421	WOOG	WGH7936	GP-3937 ¹¹	WOOG	WGL587	G-139	WOOG
WGF106	G-1174 ⁰⁸	WOOG	WGF9213	GPP-421	WOOG	WGH9098	G-238	WOOG	WGL594	G-871	WOOG
WGF108	G-1143	WOOG	WGF9222	GPP-424	WOOG	WGH9107	GP-171 ¹⁵	WOOG	WGL595	G-162H	WOOG
WGF109	G-1173	WOOG	WGF9350	GP-255	WOOG	WGH9111	GP-81	WOOG	WGL596	G-813	WOOG
WGF110	G-1175 ⁰⁸	WOOG	WGF9366	GPP-1122	WOOG	WGH9117	GP-317H	WOOG	WGL598	G-834	WOOG
WGF112	GG-5 L	WGB	WGF962-14	GP-54	WOOG	WGH9142	GP-761H	WOOG	WGL599	G-836	WOOG
WGF114	GG-20	WOOG	WGF962-14	GP-54	WOOG	WGH962-14	GP-54	WOOG	WGL607	GP-50	WOOG
WGF115	G-1176	WOOG	WGF962-14	GP-54	WOOG	WGH962-14	GP-54	WOOG	WGL632	GP-14	WOOG
WGF134	G-1163	WOOG	WGF962-14	GP-54	WOOG	WGH962-14	GP-54	WOOG	WGL634	G-169	WOOG
WGF149PL	GG-124	WOOG	WGF1203	GS-1133	WOOG	WGL12109	G-143	WOOG	WGL637	G-159	WOOG
			WGF1205	GG-1133	WOOG	WGL12110-2	G-143	WOOG			

Referencia Cruzada por Numero de Parte

Cross Reference by Part Number



Numero	Gonher	Fabricante	Numero	Gonher	Fabricante	Numero	Gonher	Fabricante	Numero	Gonher	Fabricante
Number	Gonher	Manufacturer	Number	Gonher	Manufacturer	Number	Gonher	Manufacturer	Number	Gonher	Manufacturer
WGL647	GP-20	WOOG	WGW9096	GP-1013Q	WOOG	WK614/8	GG-151	MNH	WP160A	GA-70	WMP
WGL651	GP-3	WOOG	WGW9097	GP-1013Q	WOOG	WK614/9	GG-150	MNH	WP176A	GA-56 ⁹⁰	WMP
WGL652	GP-34	WOOG	WH-5320	G-963	WEB	WK618	GG-246	MNH	WP184A	GA-77	WMP
WGL653	GP-13	WOOG	WH-8158	G-112	WEB	WK68/81	GG-220	MNH	WP189A	GA-50	WMP
WGL654	GP-36	WOOG	WH-820	G-870	WEB	WK710/2	GG-146	MNH	WP192A	GA-192	WMP
WGL655	GP-38	WOOG	WH-834	G-834	WEB	WK-711-1	GG-411	MNH	WP200A	G-200	WMP
WGL667	GP-51	WOOG	WH-8481	G-180	WEB	WK712-2	GP-1122	MNH	WP25	GP-20	WMP
WGL670	GP-53	WOOG	WH-8712	G-72	WEB	WK7123	GP-1122	MNH	WP2825	GP-38	WMP
WGL670R	GP-53	WOOG	WH-8765	G-765	WEB	WK719	GP-1122	MNH	WP2850	GP-1	WMP
WGL670SC	GP-53	WOOG	WH-8806	G-45	WEB	WK-720	GG-420	MNH	WP2870	GP-28 ⁶	WMP
WGL673	GP-10	WOOG	WH-9018	G-49	WEB	WK721	GP-1122	MNH	WP2870	GP-430 ⁸	WMP
WGL678	GP-14	WOOG	WHA-1533	GA-416	WALM	WK723	GP-1122	MNH	WP2870A	GP-28 ⁸⁵	WMP
WGL680	GP-34	WOOG	WHA-1533SY	GA-425	WALM	WK723-1	GP-1122	MNH	WP2870A	GP-3600 ⁸⁴	WMP
WGL689	GP-81	WOOG	WHA-1548SY	GA-482	WALM	WK724	GP-1122	MNH	WP2870A	GP-38 ⁸⁷	WMP
WGL690	GP-10	WOOG	WHA-1553	GA-679	WALM	WK-725	GG-408	MNH	WP2870A	GP-430 ⁸⁵	WMP
WGL691	GP-52 ¹⁰	WOOG	WHA-1553SY	GA-680	WALM	WK727	GP-1122	MNH	WP30	GP-3	WMP
WGL691	GP-69 ⁴⁸	WOOG	WHA-1580	GA-109	WALM	WK730/5	GG-915	MNH	WP303A	GA-303	WMP
WGL691R	GP-52 ¹⁰	WOOG	WHA-1580SY	GA-119	WALM	WK731	GP-1122	MNH	WP305A	GA-730	WMP
WGL691R	GP-69 ⁴⁸	WOOG	WHA-1581	GA-229	WALM	WK733	GP-1122	MNH	WP324AA	GA-85	WMP
WGL692	GP-23	WOOG	WHA-1596	GA-209	WALM	WK7380	GG-94	MNH	WP325A	GA-325	WMP
WGL694	GP-69	WOOG	WHA-1596SY	GA-210	WALM	WK76	GG-146	MNH	WP326A	GA-59	WMP
WGL695	GP-67	WOOG	WHA-1599	GA-107	WALM	WK8145	GPP-423	MNH	WP327A	GA-57	WMP
WGL697	GP-31	WOOG	WHA-224	GA-7716	WALM	WK830	GG-251	MNH	WP3387	GP-46	WMP
WGL702	GP-88	WOOG	WHA-226	GA-9334	WALM	WK830/6	GG-408	MNH	WP340AA	GA-86	WMP
WGL708	GP-54	WOOG	WHA-233	GA-9045	WALM	WK8301	GG-189	MNH	WP351A	GA-75	WMP
WGL716	GP-462	WOOG	WHA-235	GA-1284	WALM	WK8303	GG-189	MNH	WP352A	GAD-1	WMP
WGL733	GP-51	WOOG	WHA-236	GA-1286	WALM	WK8304	GG-189	MNH	WP3870	GP-28 ⁶	WMP
WGL734	GP-43	WOOG	WHA-237	GA-1285	WALM	WK-831	GG-431	MNH	WP3870	GP-430 ⁸	WMP
WGL739	GP-390 ⁹³	WOOG	WHA-240	GA-37	WALM	WK832	GPP-1122	MNH	WP400	GP-3600	WMP
WGL740	G-191	WOOG	WHA-253	GA-16	WALM	WK842	GPP-1122	MNH	WP-4102	GP-1122	WEB
WGL750	G-750	WOOG	WHA-255	GA-24	WALM	WK842-1	GP-1122	MNH	WP43	GP-81 ³¹	WMP
WGL764	GP-81	WOOG	WHA-258	GA-403	WALM	WK842-1	GPP-1122	MNH	WP43	GP-9 ⁸⁸	WMP
WGL767	GP-3429	WOOG	WHA-294	GA-8047	WALM	WK842-2	GPP-1122	MNH	WP45	GP-3429	WMP
WGL777	GP-57	WOOG	WHA-3203	GA-21	WALM	WK842-5	GP-1122	MNH	WP47	GP-46	WMP
WGL777R	GP-57	WOOG	WHA-3517	GA-377	WALM	WK8426	GPP-1122	MNH	WP51	GP-3980	WMP
WGL778	GP-50 ³⁰	WOOG	WHA-3518	GA-372	WALM	WK853	GG-261	MNH	WP71	G-1163	NEL
WGL780	GP-46	WOOG	WHA-3603	GA-373	WALM	WK8531	GG-226	MNH	WP71	G-1163	WIN
WGL781	GP-38	WOOG	WHA-3990	GA-3551 XT ⁶⁴	WALM	WK940/11	GPP-111	MNH	WP7270	GP-38	MNH
WGL782	GP-3980	WOOG	WHA-3990	GA-3551 ³⁵	WALM	WK940/11	GPP-524	MNH	WP735A	GA-54	WMP
WGL785	GP-28 ⁶	WOOG	WHA-4223	GA-6127	WALM	WK940-5	GP-1122	MNH	WP76	G-236	WIN
WGL785	GP-430 ⁸	WOOG	WHA-502	GA-6128	WALM	WK9472	GPP-103 ⁴⁰	LBHR	WP76-2	G-236	WIN
WGL786	GP-50	WOOG	WHA-507	GA-106 ⁴⁶	WALM	WK9472	GPP-11 ³⁹	LBHR	WP76P	G-236	WIN
WGL787	GP-31	WOOG	WHA-507SY	GA-206	WALM	WK9472	GPP-103 ⁴⁰	MNH	WP8A	GP-1	WMP
WGL788	GP-50	WOOG	WHA-523	GA-360	WALM	WK9472	GPP-11 ³⁹	MNH	WP926-3X	GP-1101	MNH
WGL793	G-6	WOOG	WHA-523SY	GA-361	WALM	WK950/21	GP-548	MNH	WP931	GP-50	MNH
WGL795	GP-42	WOOG	WHA-536	GA-356	WALM	WK950-3	GP-110	MNH	WP93110	GP-50	MNH
WGL796	GP-44	WOOG	WHA-536SY	GA-357	WALM	WK962/7	GP-96	MNH	WP93110	GP-50	MNH
WGL797	GP-54 ¹¹	WOOG	WHA-542	GA-31	WALM	WK96217	GP-1107	MNH	WP940	GP-1	MNH
WGL797	GP-66 ¹⁰	WOOG	WHA-592	GA-376	WALM	WK96218	GP-1108	MNH	WP940/3	GP-54 ¹¹	MNH
WGL798	GP-3985	WOOG	WHA-595	GA-378	WALM	WL500	G-500	NEL	WP940/3	GP-66 ¹⁰	MNH
WGL9014	GP-400	WOOG	WHA-598	GA-6129	WALM	WL500	G-500	WIN	WP962-3X	GP-1101	MNH
WGL9022	GP-81	WOOG	WHA-598	GA-7360	WALM	WL72	GP-1	NEL	WP980	G-911	WARN
WGL9028	GP-642	WOOG	WHA-6326	GA-371	WALM	WL72	GP-1	WIN	WPF132	G-33	NEL
WGL9033	GP-58 ¹⁵	WOOG	WHA-9489	GA-436	WALM	WL7302	G-25	WEUR	WPF132	G-33	WIN
WGL9042	G-3827	WOOG	WIH540	G-333	NEL	WL750	G-750	NEL	WPF132P	G-33	NEL
WGL9056	GP-91	WOOG	WI-H540P	G-333	WIN	WL750	G-750	WIN	WPF132-P	G-33	WIN
WGL9101	GP-3816	WOOG	WK 1060/1	GPP-1061	MNH	WLAF1646	GA-4999	WARN	WPF141	G-200	NEL
WGL9105	GP-91	WOOG	WK 512	GG-106	MNH	WLAF8996	GA-475 ¹¹³	WARN	WPF141	G-200	NEL
WGL9130	GP-291	WOOG	WK 59 X	GG-355	MNH	WLAF8996	GA-5876 ⁹⁵	WARN	WPF141-P	G-200	WIN
WGL9135	GP-171	WOOG	WK 612	GG-291	MNH	WLAF9096	GA-780	WARN	WPF147	G-119	NEL
WGL9137	GP-52 ¹⁰	WOOG	WK 612/1	G-566	NEL	WLF516	G-566	NEL	WPF147	G-119	WIN
WGL9137	GP-69 ⁴⁸	WOOG	WK 613/3	GG-252	MNH	WL-F516	G-566	WIN	WPF150	G-33	WIN
WGL9139	GP-38	WOOG	WK 614/35	GG-220	MNH	WL-F516P	G-566	WIN	WPF151	G-33	WIN
WGL9142	GP-28 ⁶	WOOG	WK 68/1	GG-160	MNH	WM101-P	G-870	WIN	WPF157	G-33	WIN
WGL9142	GP-430 ⁸	WOOG	WK 932/2	GP-1101	MNH	WM117-P	G-31	WIN	WPF157P	G-33	NEL
WGL9144	GP-28 ⁶	WOOG	WK 962/11	GP-26	MNH	WM912A	GA-8047	NEL	WPF166	G-34	NEL
WGL9144	GP-430 ⁸	WOOG	WK 962/11	S 3202	MNH	WO1042	GP-44	PHI	WPF166	G-34	WIN
WGL9150	GP-310	WOOG	WK 965	GPP-1000	MNH	WO1365	GP-91	PHI	WPF2	GP-1	NEL
WGL9152	GP-3985	WOOG	WK 966/2	GP-78	MNH	WO1378	GP-212	PHI	WPF2	GP-1	WIN
WGL9165	GP-455	WOOG	WK 980/1	GP-749	MNH	WO1607	GP-178	PHI	WPF20	GP-81 ³¹	WIN
WGL9177	GP-406	WOOG	WK-1060	GPP-1060	MNH	WO1734	GP-562	PHI	WPF20	GP-9 ⁸⁸	WIN
WGL9197	GP-91	WOOG	WK1060/3X	GPP-1291 ³⁹	MNH	WO1742	GP-3766	PHI	WPF24	GP-20	NEL
WGL9199	GP-3001	WOOG	WK1060/3X	PPF831 ⁴¹	MNH	WO1773	GP-31	PHI	WPF24	GP-20	WIN
WGL920-7	GP-81	WOOG	WK1060/3X	R 90 P ⁸²	MNH	W05H4115	G-1121	DUTZ	WPF24-P	GP-20	WIN
WGL940	GP-1	WOOG	WK1102/5	GP-749	MNH	WP 11 102	GP-556	MNH	WPF25	GP-3	NEL
WGL950	GP-54	WOOG	WK11102/5	GP-749	MNH	WP 12 120	GP-9001	MNH	WPF25	GP-3	WIN
WGL962	GP-54 ¹¹	WOOG	WK295	GG-5 L	MNH	WP 12 121	GP-3001	MNH	WPF25-P	GP-3	WIN
WGL962	GP-66 ¹⁰	WOOG	WK31-2	GG-1	MNH	WP 12 300	GP-3000	MNH	WPF31	GP-5	NEL
WGL977	GP-31	WOOG	WK31-2	GG-4	MNH	WP 1240	GP-359	MNH	WPF31	GP-5	WIN
WGN7404	GP-3766	WOOG	WK31-3	GG-1	MNH	WP 928/81	GP-112	MNH	WPF35	GP-13	WIN
WGNP7404	GP-3766	WOOG	WK31-3	GG-4	MNH	WP101	G-870	NEL	WPH48	GP-406	WARN
WGNP7504	GP-864H	WOOG	WK31-4	GG-3	MNH	WP101	G-870	WIN	WRC40	G-31	WIN
WGTX310	GP-24	WOOG	WK32/4	GG-194	MNH	WP101P	G-870	NEL	WS10060	GP-406	WALM
WGW2015	GP-2015W	WOOG	WK42/13	GG-188	MNH	WP11	GP-5	WMP	WS11	GP-5	WALM
WGW2022	GP-2022W	WOOG	WK42-5	GG-204	MNH	WP-1101A	GP-1101	WEB	WS13	GP-13	WALM
WGW2051	GP-2071W	WOOG	WK47	GP-39	MNH	WP-1121	GP-78	WEB	WS-16	GP-81	WALM
WGW2070	GP-2071W	WOOG	WK-504	GG-409	MNH	WP1144	GP-9	MNH	WS2	GP-68	WALM
WGW2071	GP-2071W	WOOG	WK-516-1	GG-351	MNH	WP1168	GP-9	MNH	WS20	GP-14	WALM
WGW2073	GP-1011Q	WOOG	WK612-2	GG-46	MNH	WP117	G-31	NEL	WS2022	GP-2022W	MIGH
WGW2073R	GP-1011Q	WOOG	WK613	GG-5 L	MNH	WP117	G-31	WIN	WS25	GP-20	WALM
WGW2074	GP-1012Q	WOOG	WK614/14	GG-142	MNH	WP12308	GP-3000 ¹³	MNH	WS-2825	GP-38	WALM
WGW2076	GP-1013Q	WOOG	WK614/15	GG-136	MNH	WP1295	GP-57	MNH	WS-2830	GP-22	WALM
WGW2076R	GP-1013Q	WOOG	WK614/24								

Numero	Gonher	Fabricante	Numero	Gonher	Fabricante	Numero	Gonher	Fabricante	Numero	Gonher	Fabricante
Number	Gonher	Manufacturer	Number	Gonher	Manufacturer	Number	Gonher	Manufacturer	Number	Gonher	Manufacturer
WS-3306	GP-10	WALM	X13	GP-22	ACD	X810190140	GP-1122	FEND	XLP774524	GA-326 ⁷¹	DON
WS3387	GP-46	WALM	X13200-02	GP-1	ISUZ	X810270073	GA-49	FEND	XN-750928	GP-54 ⁹⁰	FORD
WS-3387A	GP-46	WALM	X13201-001	GP-171	ISUZ	X84	GP-3531	EXP	XR 127077	GA-283	MITS
WS3429	GP-3429	WALM	X13201-002	GP-1	ISUZ	X871096	GP-52 ¹¹⁰	CLRK	XR4941	GAK-403	OLIV
WS-3506	GP-44	WALM	X13201-009	GP-3682	ISUZ	X871096	GP-691 ⁴⁸	CLRK	XR4941	GAK-403	WHIT
WS3512	GP-22	WALM	X13201-011	GP-57	ISUZ	X871191	GP-52 ¹¹⁰	CLRK	XR5137	GAK-403	OLIV
WS-3531	GP-3531	EXP	X13240-001	2010PM-OR ³	ISUZ	X871191	GP-691 ⁴⁸	CLRK	XR5137	GAK-403	WHIT
WS-3535	GP-3980 ⁴⁴	WALM	X13240-001	2010TM-OR ³	ISUZ	X8714	G-31	SEAG	XR817215	GP-3600	JAGU
WS-3535	GP-48 ¹¹⁷	WALM	X13240-021	G-277	ISUZ	X8790	G-31	SEAG	XR81775	GG-986	JAGU
WS-3562	GP-3562	WALM	X13372	G-31	SEAG	X88	GP-40	ACD	XR823395	GP-3600	JAGU
WS-3593	GP-149	WALM	X13373	G-31	SEAG	X89	GP-68	ACD	XR-823395	GP-454	JAGU
WS36	GP-36	WALM	X13505-58	GP-1013Q	POCL	X9	GP-3816	ACD	XR82766	GA-479	JAGU
WS3600	GP-3600	WALM	X14	GP-1	ACD	X93	GP-46	ACD	XR83332	GP-3600	JAGU
WS3614	GP-58	WALM	X15	GP-3816	ACD	X95	GP-40	ACD	XR-83332	GP-454	JAGU
WS-3675	GP-3675	WALM	X16	GP-3600	ACD	XA14747C	GAK-403	CASE	XR88237	GA-479	JAGU
WS-3682	GP-3682	WALM	X17	GP-361	ACD	XA67019	GAK-16	CASE	XR8E-6714-AA	GP-3600	FORD
WS-373	GP-23	WALM	X17	G-31	WES	XA70704	GAK-16	CASE	XR-8E6714-AB	GP-454	JAGU
WS-38	GP-10	WALM	X175N	G-31	GLD	XA74015	GAK-403	CASE	XR8E-6714-AB	GP-3600	FORD
WS3950	GP-40	WALM	X17LN	G-31	GLD	XA76507	GA-33 ¹¹²	CASE	XS42-19N619-CA	GAC-7	FORD
WS3980	GP-3980	WALM	X17N	G-31	GLD	XB10702	GAK-403	CASE	XSSX 9601 DA	GA-280	FORD
WS-3985	GP-3985	WALM	X18	GP-3816	ACD	XB14747C	GAK-403	CASE	XVP4712	GA-106 ⁶⁶	LETR
WS43	GP-81 ³¹	WALM	X1K	GP-81	ACD	XB39303	GA-33 ¹¹²	CASE	XVP4712	GA-326 ⁷¹	LETR
WS43	GP-9 ⁵⁸	WALM	X2	GP-36	ACD	XB41440	GAK-20	CASE	XVP4713	GA-6129	LETR
WS-4386	GP-156	WALM	X20	GP-3816	ACD	XB47447C	GAK-403	CASE	XW4Z-6731-BA	GP-457	FORD
WS475	GP-2015W	MIGH	X21	GP-28 ⁹⁵	ACD	XB8567	GAK-20	CASE	XW4Z-6A642-AA	GP-457	FORD
WS-4840R	GP-291	WALM	X21	GP-3600 ⁶⁰	ACD	XB8597	GAK-20	CASE	XW4Z-9601-AC	GA-479	FORD
WS-4967	GP-157	WALM	X21	GP-430 ⁹⁶	ACD	XC14747C	GAK-403	CASE	XWA335140	GAK-16	CASE
WS-5	GP-205	WALM	X22	GP-54 ¹¹	ACD	XC1474C	GAK-403	CASE	XWA355140	GAK-16	CASE
WS50	GP-50	WALM	X22	GP-66 ¹⁰	ACD	XC-370491	GA-26	FORD	XZ988972	GAK-403	HITA
WS5618	GP-457	WALM	X2409-001	GA-33 ¹¹²	TRAN	XC3U-9601-AA	GA-780	FORD			
WS-6607	GP-91	WALM	X24351	GA-26	GMCCX	XC3Z-9601-AA	GA-780	FORD			
WS-7317	GP-91	WALM	X250	G-31	WES	XD25	GP-1122	ACD			
WS8	GP-1	WALM	X27780	GAP-379	WHIT	XD63	GP-1122	ACD			
WS-8316	GP-128	WALM	X28	GP-3980	ACD	XD67	GP-1122	ACD			
WS927	GP-22	WALM	X2950576	GA-853R	CASE	XD701	GPP-1122	ACD			
WS938101	GAK-20	WELL	X30	G-31	WES	XD71616714554	GP-54 ⁹⁰	FORD			
WS-966	GP-37	WALM	X30N	G-31	GLD	XD77	GP-1122	ACD			
WS-966A	GP-37	WALM	X3549957	GP-81 ³¹	CHRY	XD77	GPP-1122	ACD			
WS-977	GP-31	WALM	X3549957	GP-9 ⁵⁸	CHRY	XD79	GPP-111	ACD			
WS-977	GP-310	WALM	X4011	GP-3980	XSV	XD79	GPP-524	ACD			
WTL12	G-1175	WIN	X4055040	GA-27 ¹¹²	HITA	XD91927	GAK-1532	CASE			
WTP511	G-1173 ¹⁰⁸	NEL	X4059818	GA-361	HITA	XE511	G-25	CHAM			
WTP511	G-1173	WIN	X4085787	GA-106 ⁴⁶	HITA	XF22-9601-AC	GA-1616	FORD			
WTP511-P	G-1173	WIN	X4085787	GA-326 ⁷¹	HITA	XF52-6731-AA	GP-149	FORD			
WTP512	G-1175 ¹⁰⁸	NEL	X4085788	GA-206	HITA	XJ017C	GP-24	BENG			
WTP512	G-1175	WIN	X4090408	GA-360	HITA	XJ0810H	GP-171 ¹⁵	SHAN			
WTP512P	G-1175	NEL	X4090409	GA-361	HITA	XJ-22065	GAK-20	FORD			
WTP512-P	G-1175	WIN	X4100806	GA-360	HITA	XJD2N	G-139	GLD			
WTP522	G-1174 ¹⁰⁸	NEL	X4122937	GAK-403	HITA	XL21350	GAK-20	CASE			
WTP522	G-1174 ¹⁰⁸	WIN	X43	G-1143	WES	XL21351	GAK-20	CASE			
WTP540X	G-1175	NEL	X43485	GAK-20	LETR	XL22027	GA-27 ¹¹²	CASE			
WTP540X	G-1175	WIN	X43-485	GAK-20	LROI	XL3Z-9601-AA	GA-433	FORD			
WXP5132	G-1173	WIN	X43501	GA-27 ¹¹²	WABC	XL5Z-9155AB	GG-210	FORD			
WY2195	G-222	LETR	X43561	GA-27 ¹¹²	LETR	XL750	G-750	AIR			
WY2195	G-222	WABC	X43562	GA-26	LETR	XL750	G-750	FLL			
			X43628	GA-27 ¹¹²	LETR	XL750	G-750	PER			
			X43628	GA-27 ¹¹²	WABC	XLP182000	GA-27 ¹¹²	DON			
			X44	GP-42	ACD	XLP182001	GA-26	DON			
			X4509010	GAK-20	HITA	XLP182002	GA-6129	DON			
			X46	GP-462	ACD	XLP182006	GA-376	DON			
			X4610	GP-149	XSV	XLP182007	GA-229	DON			
			X47	GP-36	ACD	XLP182008	GA-378	DON			
			X48A	GP-46	ACD	XLP182014	GA-209	DON			
			X49	GP-171	ACD	XLP182015	GA-107	DON			
			X500C	G-500	WES	XLP182019	GA-109	DON			
			X500N	G-500	COP	XLP182028	GA-209	DON			
			X500N	G-500	GLD	XLP182034	GA-360	DON			
			X500S	G-500	GLD	XLP182038	GA-879	DON			
			X503	GP-81	ACD	XLP182039	GA-356	DON			
			X504	GP-28 ⁸	ACD	XLP182043	GA-251	DON			
			X504	GP-430 ⁸	ACD	XLP182045	GAK-20	DON			
			X51	GP-3600	ACD	XLP182046	GA-106 ⁴⁶	DON			
			X513	GP-28 ⁸	ACD	XLP182046	GA-326 ⁷¹	DON			
			X513	GP-430 ⁸	ACD	XLP182050	GA-33 ¹¹²	DON			
			X522	GP-3682	COO	XLP182052	GAK-16	DON			
			X5288	GP-3675	XSV	XLP182054	GAK-403	DON			
			X53	GP-171	ACD	XLP182057	GA-885	DON			
			X56	GP-24	ACD	XLP182062	GAK-1532	DON			
			X6	GP-46	ACD	XLP182063	GAK-625	DON			
			X600-211-1230	GP-53	KOMA	XLP182095	GA-1095	DON			
			X600-211-1231	GP-53	KOMA	XLP182099	GA-376	DON			
			X6350505	G-152	PPM	XLP184011	GA-27 ¹¹²	DON			
			X66	GP-81	ACD	XLP184012	GA-26	DON			
			X6A	GP-46	ACD	XLP184013	GA-6129	DON			
			X7	GP-22	ACD	XLP184015	GA-378	DON			
			X71	GP-28 ⁸	ACD	XLP184034	GA-360	DON			
			X71	GP-430 ⁸	ACD	XLP184039	GA-356	DON			
			X724693	GP-761H	CASE	XLP184043	GA-251	DON			
			X750	G-750	COP	XLP184045	GAK-20	DON			
			X750	G-750	GLD	XLP184046	GA-106 ⁴⁶	DON			
			X750C	G-750	WES	XLP184046	GA-326 ⁷¹	DON			
			X750N	G-750	COP	XLP184109	GA-1095	DON			
			X750N	G-750	GLD	XLP184142	GAK-625	DON			
			X750S	G-750	GLD	XLP184144	GA-758	DON			
			X75497	GA-356	HOUQ	XLP772564	GAK-458	DON			
			X80201	GAK-403	HOUQ	XLP774524	GA-106 ⁴⁶	DON			

Números Nuevos

Y

Y0002284	GG-48	DORM
Y0002284	GG-48	GENE
Y0002285	G-836	DORM
Y00-02285	G-834	GENE
Y0002286	G-834	DORM
Y00-02286	G-834	GENE
Y002264502	GA-5648	FODN
Y01336609	G-296	FODN
Y01336609	G-296-B	FODN
Y02111703	GP-1101	FODN
Y02120202	G-566	FODN
Y02120509	GAK-403	FODN
Y02120607	GAK-20	FODN
Y02128407	G-1143	FODN
Y02160711	G-750	FODN
Y02178911	GP-1101	FODN
Y02194400	G-750	FODN
Y02264502	GA-5648	FODN
Y02274510	G-33	FODN
Y02520504	GA-360	FODN
Y02729105	GP-1013Q	FODN
Y02729203	GP-2071W	FODN
Y02926604	GP-53	FODN
Y02942403		

Referencia Cruzada por Numero de Parte

Cross Reference by Part Number



Numero	Gonher	Fabricante	Numero	Gonher	Fabricante	Numero	Gonher	Fabricante	Numero	Gonher	Fabricante
Number	Gonher	Manufacturer	Number	Gonher	Manufacturer	Number	Gonher	Manufacturer	Number	Gonher	Manufacturer
Y05017412	GP-691 ⁴⁸	PCAR	Z08505-62	GA-360	POCL	Z15	GG-4	RYCO	Z324	GG-190	RYCO
Y07709101	G-296	FODN	Z100	GP-81 ²¹	GUD	Z151	GP-92	GUD	Z33	GP-14	COO
Y07709101	G-296-B	FODN	Z100	GP-9 ⁵⁸	GUD	Z152	GP-93	GUD	Z33	GPP-14	GUD
Y07709102	G-296	FODN	Z1007	GP-46	COO	Z153	GP-171	GUD	Z33	GPP-14	RYCO
Y07709102	G-296-B	FODN	Z101	GP-38	GUD	Z154	GP-46	RYCO	Z337	GG-208	RYCO
Y08552602	GP-57	FODN	Z1013	GP-171	COO	Z155	GP-3531	EXP	Z35	GP-81	GUD
Y104271	G-6	INGR	Z103	GP-3600	GUD	Z156	GP-46	GUD	Z35	GP-81	RYCO
Y104271	G-6	INGR	Z103	GP-3600	RYCO	Z156	GPP-1122	RYCO	Z37	GP-38	GUD
Y535740	GA-27 ¹¹²	WHIT	Z1039	GP-91	COO	Z157	GPP-1122	RYCO	Z37	GP-38	RYCO
Y535760	GA-5648	WHIT	Z104	GG-45	COO	Z158	GP-58	GUD	Z38	GP-1	GUD
Y535763	GA-5648	WHIT	Z104	GP-34	GUD	Z158	GP-58	RYCO	Z38	GP-1	RYCO
Y538142	GA-26	WHIT	Z104	GP-34	RYCO	Z159	GP-1101	GUD	Z389	GG-146	GUD
Y538691	GA-27 ¹¹²	WHIT	Z1042	GP-156	COO	Z15A	GP-20	COO	Z40	GP-3	RYCO
Y541511	GA-26	WHIT	Z105	GP-26	RYCO	Z15K	GG-1	GUD	Z40	GP-3	RYCO
Y541972	GA-27 ¹¹²	WHIT	Z105A	GP-26	GUD	Z15K	GG-4	GUD	Z419	GP-36	RYCO
Y541978	GA-27 ¹¹²	WHIT	Z106	GP-27	RYCO	Z15K	GG-1	RYCO	Z42	GP-66	GUD
Y551925	GA-27 ¹¹²	WHIT	Z106A	GP-27	GUD	Z15K	GG-4	RYCO	Z42	GP-66	RYCO
Y556122	GA-27 ¹¹²	WHIT	Z106A	GP-27	RYCO	Z160	GP-3985	COO	Z43	GP-9	COO
Y564285	GA-31	WHIT	Z107	GP-22 ²⁵	COO	Z160	GP-40	GUD	Z44	GP-3	GUD
Y566121	GA-27 ¹¹²	WHIT	Z108	GPP-1122	GUD	Z160	GP-44	RYCO	Z44	GP-462	RYCO
Y7111-296	G-296	CAV	Z111	GP-34	GUD	Z162	GP-3985	GUD	Z46	GP-9	COO
Y7111-296	G-296-B	CAV	Z111	GPP-18	RYCO	Z162	GP-3985	RYCO	Z46	GP-83	GUD
YC3U-9600-AD	GA-966R	FORD	Z112	GP-69	GUD	Z164	GP-462	GUD	Z46	GP-83	RYCO
YC3X-9601-AA	GA-1615	FORD	Z1128	GP-149	COO	Z165	GG-45	RYCO	Z47	GP-84	GUD
YC3Z-9601-FA	GA-966R	FORD	Z1129	GP-149	COO	Z166	GP-3816	GUD	Z47	GP-84	RYCO
YE136750	G-256	KAWA	Z114	GP-78	GUD	Z166	GP-3816	RYCO	Z478	GP-40	COO
YE3313281	GP-43	KAWA	Z1142	GP-91	COO	Z167	GP-1122	GUD	Z48	GP-3600	GUD
YE3903410	GPP-18	KAWA	Z115	GP-1	GUD	Z167	GP-1122	RYCO	Z48	GPP-14	COO
YE3903640	GP-1122	KAWA	Z115	GG-251	RYCO	Z168	GG-251	RYCO	Z494	GP-28 ⁹	COO
YE404060	GP-1101	KAWA	Z116	GP-1101 ⁵⁴	GUD	Z170	GP-171	GUD	Z494	GP-430 ⁸	COO
YF09-13-Z40	GA-224	MZDA	Z116	GP-1101 ⁵⁴	RYCO	Z170	GP-171	RYCO	Z500A	GP-3816	GUD
YF09-14-302	GP-128	MZDA	Z117	GP-66	GUD	Z171	GP-3985	GUD	Z501	GP-81	COO
YF12-9155-AA	GG-47	FORD	Z117	GP-1107	RYCO	Z171	GP-28	RYCO	Z501-20-490	GG-150	MZDA
YF12-9155-CA	GG-47	FORD	Z118	GP-1122	GUD	Z173	GP-58	GUD	Z502	GP-3980	GUD
YF12-9601-AA	GA-224	FORD	Z118	GPP-1122	GUD	Z175	GP-36	RYCO	Z505	GP-46	COO
YL8Z-9601-AA	GA-224	FORD	Z118	GP-1122	RYCO	Z178	GP-3985	GUD	Z505	GP-46	GUD
YM11966035-150	GP-149	KOMA	Z118	GPP-1122	RYCO	Z179	GP-36	RYCO	Z51	GP-110	RYCO
YM1198081250	GA-880R	KOMA	Z119	GP-3600	COO	Z181	GP-77	GUD	Z510A	GP-310	COO
YM12112012901	GA-33 ¹¹²	KOMA	Z119	GP-1122	GUD	Z184	GP-52 ¹¹⁰	GUD	Z510	GG-3	COO
YM12915035150	GP-91	KOMA	Z119	GPP-1122	GUD	Z184	GP-691 ⁴⁸	GUD	Z513	GG-5 L	COO
YM1966035150	GP-91	KOMA	Z119	GP-1122	RYCO	Z184	GP-3985	RYCO	Z517	GP-455	COO
YN02PU1004S002	GPP-103 ⁹⁰	KOBL	Z119	GPP-1122	RYCO	Z185K	GG-1	GUD	Z518	GP-28 ⁹	GUD
YN02PU1004S002	GPP-11 ³⁹	KOBL	Z121	GP-3816	COO	Z185K	GG-4	GUD	Z518	GP-430 ⁸	GUD
YN02PU1010P1	GPP-103 ⁹⁰	KOBL	Z123	GP-81	GUD	Z189	GP-390 ⁹³	GUD	Z520	GP-46	COO
YN02PU1010P1	GPP-11 ³⁹	KOBL	Z1232	GP-28 ⁹	COO	Z189	GP-390 ⁹³	RYCO	Z522	GP-3682	COO
YN148	GP-6811	BRAN	Z1232	GP-430 ⁸	COO	Z191	GP-157	RYCO	Z525	GP-58	COO
YN21PU1001P1	GPP-103 ⁹⁰	KOBL	Z124A	GP-69	GUD	Z193	GP-462	RYCO	Z527	GP-40	COO
YN21PU1001P1	GPP-11 ³⁹	KOBL	Z124A	GP-69	RYCO	Z196	GG-208	RYCO	Z53	GP-54	GUD
YN21PU1001S01	GPP-103 ⁹⁰	KOBL	Z125	GP-58	RYCO	Z197	GP-3682	GUD	Z53	GP-66	RYCO
YN21PU1001S01	GPP-11 ³⁹	KOBL	Z128	GP-26	GUD	Z197	GG-203	RYCO	Z54A	GP-31	GUD
Y0002286	G-834	DORM	Z129	GP-27	GUD	Z198	GG-208	RYCO	Z54A	GP-31	RYCO
YS4Z-19N619-AA	GAC-7	FORD	Z130	GP-3531	EXP	Z200	GP-171 ¹⁶	ACD	Z55	GP-1122	GUD
YS4Z-19N619-DB	GAC-7	FORD	Z130A	GP-3531	EXP	Z200	GG-63	RYCO	Z56	GP-9	COO
YS4Z-9601-CC	GA-168	FORD	Z131	GP-171	GUD	Z201	GG-63	RYCO	Z56B	GP-3985	GUD
YSC-10231-20-0C	GP-408	YAMH	Z1319	GP-58	COO	Z202	GG-94	RYCO	Z56B	GP-3985	RYCO
YSC13231200C	GP-3	YAMH	Z131A	GP-171	RYCO	Z205	GG-203	RYCO	Z577	GPP-1122	COO
YTO152	GP-310	VALM	Z1322	GG-45	COO	Z217	GP-1107	RYCO	Z57A	GP-42	RYCO
YUT-026	GA-410	YUIL	Z133	G-1121	COO	Z219	GP-38	GUD	Z59	GP-26	GUD
YUT-057	GA-410	YUIL	Z133	GP-36	RYCO	Z22	GP-1101	GUD	Z60	GP-81	COO
YUT-061	GA-410	YUIL	Z134	GP-38	RYCO	Z22	GP-1101	RYCO	Z60	GP-81	GUD
YY9101234	GAK-20	KAWA	Z1344	GP-149	COO	Z222	GP-91	GUD	Z62	GP-3600	GUD
YYP101240	GA-27 ¹¹²	KAWA	Z135	GP-171	GUD	Z226	GP-462	GUD	Z62	GP-3600	RYCO
YYP104972	GAK-403	KAWA	Z135	GP-171	RYCO	Z23	GP-50	COO	Z63	GP-28 ⁹	GUD
YYP106587	GA-360	KAWA	Z13505-59	GP-1011Q	POCL	Z236	GP-53	GUD	Z63	GP-430 ⁸	GUD
YYP106632	GA-6129	KAWA	Z136	GP-66	GUD	Z237	GP-55	GUD	Z63	GP-28 ⁹	RYCO
YYP106641	GA-6127	KAWA	Z136	GP-66	RYCO	Z238	GP-57	GUD	Z63	GP-430 ⁸	RYCO
YYP106769	GA-106 ⁴⁶	KAWA	Z138	GP-66	RYCO	Z239	GP-3000	GUD	Z64	GP-171	GUD
YYP106769	GA-326 ⁷¹	KAWA	Z139	GP-310	GUD	Z24	GP-13	COO	Z645	GP-196	COO
YYP106775	GA-206	KAWA	Z139	GP-310	RYCO	Z24	GP-13	GUD	Z653	GG-203	COO
YYP106834	GA-361	KAWA	Z1402OF201	GP-3682	KOMA	Z24	GP-13	RYCO	Z66	GP-36	COO
YYP117437	GA-106 ⁴⁶	KAWA	Z1402OF301	GP-81	KOMA	Z240	GP-2071W	GUD	Z66	GP-36	GUD
YYP117437	GA-326 ⁷¹	KAWA	Z141	GP-68	GUD	Z241	GP-1013Q	GUD	Z68	GP-462	GUD
YYP118160	GAK-403	KAWA	Z1415208W1103	GP-171	KOMA	Z242	GP-1011Q	GUD	Z68	GP-28 ⁹	RYCO
YYP119373	GA-206	KAWA	Z142	GP-38	GUD	Z25	GP-3600	COO	Z68	GP-430 ⁸	RYCO
YYP119775	GAK-16	KAWA	Z142	GP-40	RYCO	Z25A	GP-3682	GUD	Z68A	GP-462	GUD
YYP124046	GA-398	KAWA	Z142A	GP-40	RYCO	Z27	GP-81	GUD	Z69	GP-46	GUD
YYP128355	GA-357	KAWA	Z143	GP-390 ⁹³	GUD	Z27	GP-50	RYCO	Z69	GP-46	RYCO
YYP128356	GA-356	KAWA	Z143	GP-390	RYCO	Z27A	GP-81	COO	Z7	GP-1	COO
			Z145	GP-62	GUD	Z27A	GP-50	GUD	Z7	GP-1	GUD
			Z145	GP-3682	RYCO	Z27A	GP-50	RYCO	Z70	GG-1	FIA
			Z145A	GP-3682	GUD	Z2910	GG-5 L	GUD	Z70	GG-4	FIA
			Z145A	GP-3682	RYCO	Z294	GG-124	COO	Z71	GP-54 ¹¹	COO
			Z146	GP-68	GUD	Z294	GG-1	GUD	Z71	GP-66 ¹⁰	COO
			Z148	GP-462	GUD	Z294	GG-4	GUD	Z71	GP-54 ¹¹	GUD
			Z149	GP-54 ¹¹	GUD	Z297	GG-76	GUD	Z71	GP-66 ¹⁰	GUD
			Z149	GP-66 ¹⁰	GUD	Z29A	GG-1	COO	Z72	GP-36	GUD
			Z149	GP-69	RYCO	Z29A	GG-4	COO	Z72	GP-36	RYCO
			Z149091503004	GP-156	KOMA	Z30	GP-110	COO	Z73	GP-3985	COO
			Z14FF-10044	G-296	KUBO	Z30	GP-5	RYCO	Z73	GP-3985	GUD
			Z14FF-10044	G-296-B	KUBO	Z307	GG-148	RYCO	Z73	GP-1	RYCO
			Z14OF-10044	GP-1	KUBO	Z308	GG-142	RYCO	Z74	GP-10 ⁸⁸	GUD
			Z14OF-10422	GP-171	KUBO	Z310	GG-217	RYCO	Z74	GP-54 ¹¹	GUD
			Z15	GP-5	COO	Z314	GP-22	RYCO	Z74	GP-66 ¹⁰	GUD
			Z15	GG-1	GUD	Z316	GG-185	RYCO	Z74	GP-10 ⁸⁸	RYCO
			Z15	GG-4	GUD	Z318	GG-204	RYCO	Z74	GP-54 ¹¹	RYCO
			Z15	GG-1	RYCO	Z32	GP-14	GUD	Z74	GP-66 ¹⁰	RYCO
Z08505-39	GA-357	POCL									

REFERENCIA CRUZADA

Para números Gonher con Superíndice vea página 651
For Gonher with Superscript numbers see page 651

Visite nuestro sitio en internet www.grupogonher.com
Visit our web site www.grupogonher.com

Numero	Gonher	Fabricante	Numero	Gonher	Fabricante	Numero	Gonher	Fabricante	Numero	Gonher	Fabricante
Number	Gonher	Manufacturer	Number	Gonher	Manufacturer	Number	Gonher	Manufacturer	Number	Gonher	Manufacturer
Z74B	GP-46	COO	ZFA129033	GA-174	ABHN						
Z75	GP-1122	GUD	ZFA129101	GAD-3	ABHN						
Z75	GP-1122	RYCO	ZFA129102	GA-2719B	ABHN						
Z76	GP-42	COO	ZFA129106	GA-2194	ABHN						
Z76	GP-42	GUD	ZFA129107	GA-471	ABHN						
Z760238730	GA-880R	KOMA	ZFA129108	GAD-15	ABHN						
Z77	GP-3600	COO	ZFA129109	GA-4365	ABHN						
Z78	GG-19	GUD	ZFA129110	GA-2740	ABHN						
Z78	GG-19	RYCO	ZFA129117	GA-2110	ABHN						
Z782	GP-3816	COO	ZFA129118	GA-3425	ABHN						
Z789A	GP-68	COO	ZFA129121	GA-390	ABHN						
Z79A	GP-149	RYCO	ZFA129122	GA-3588	ABHN						
Z79X	GP-91	GUD	ZFA129124	GA-2106	ABHN						
Z8	GP-50	COO	ZFA129125	GA-4303	ABHN						
Z8	GP-50	GUD	ZFA129126	GA-362	ABHN						
Z8	GP-50	RYCO	ZFL115002	GP-1	ABHN						
Z80	GP-20	RYCO	ZFL115003	GP-81 ³¹	ABHN						
Z803	GP-58	COO	ZFL115003	GP-9 ⁵⁸	ABHN						
Z81	GPP-18	GUD	ZFL115004	GP-20	ABHN						
Z81	GPP-18	RYCO	ZFL115005	GP-3	ABHN						
Z819	GP-149	COO	ZFL115006	GP-13	ABHN						
Z82	GP-3816	GUD	ZFL115007	GP-3429	ABHN						
Z82	GP-3816	RYCO	ZFL115008	GP-46	ABHN						
Z83	GPP-11	GUD	ZFL115009	GP-3980	ABHN						
Z84	GP-38	COO	ZFL115011	GP-3600	ABHN						
Z84	GP-81	RYCO	ZFL115016	GP-22	ABHN						
Z844	GP-1	COO	ZFL115103	GP-462	ABHN						
Z85	GP-3816	GUD	ZFL115105	GP-3816	ABHN						
Z858	GP-38	COO	ZFL115106	GP-3531 EXP	ABHN						
Z860	GP-81	COO	ZFL115109	GP-3682	ABHN						
Z87	GP-22	COO	ZFL115111	GP-157	ABHN						
Z87	GP-22	GUD	ZFL115112	GP-156	ABHN						
Z876	GP-3682	COO	ZFL115116	GP-36	ABHN						
Z877	GP-1	COO	ZME16	GP-761H	ZING						
Z87A	GP-58	GUD	ZME16L	GP-761H	ZING						
Z87A	GP-58	RYCO	ZME16LP	GP-761H	ZING						
Z88	GP-28 ⁸	COO	ZME16P	GP-761H	ZING						
Z88	GP-430 ⁸	COO	ZME22	GP-761H	ZING						
Z88	GP-3816	GUD	ZME22L	GP-761H	ZING						
Z88A	GP-3816	RYCO	ZME5	GP-761H	ZING						
Z88G	GP-28 ⁸	GUD	ZME5L	GP-761H	ZING						
Z88G	GP-430 ⁸	GUD	ZSE25	GP-864H	ZING						
Z89A	GP-81	GUD	ZZL0-13-470	GG-1872	MZDA						
Z89A	GP-81	RYCO	ZZL0-13-470A	GG-1872	MZDA						
Z9	GP-1	GUD	ZZL0-13-240	GA-273	MZDA						
Z9	GP-1	RYCO	ZZL0-14-302	GP-1	MZDA						
Z903	GP-9	COO	ZZL2252	G-31	LEYL						
Z903A	GP-9	COO	ZZM0-13-470	GG-47	MZDA						
Z91	GP-149	COO	ZZM1-23-802	GP-3600	MZDA						
Z91	GG-45	GUD	ZZM1-23-802A	GP-3600	MZDA						
Z91	GG-45	RYCO	ZZM2-23-603	GA-1616	MZDA						
Z916	GP-462	COO	ZZP0-23-602	GA-158	MZDA						
Z917	GP-455	COO	ZZP0-23-603	GA-158	MZDA						
Z91B	GP-91	GUD	ZZP171298	GP-761H	KAWA						
Z92	GG-196	GUD									
Z92	GG-196	RYCO									
Z920	GP-462	COO									
Z94	GP-110	COO									
Z94	G-277	GUD									
Z946	GG-203	COO									
Z957	GP-38	COO									
Z958	GP-3	COO									
Z959	GP-46	COO									
Z96	GP-81	GUD									
Z962	GP-3985	COO									
Z963	GP-157	COO									
Z97	GP-81	GUD									
Z973	GG-5 L	COO									
Z97A	GP-20	GUD									
Z97A	GP-20	RYCO									
ZFA129001	GA-70	ABHN									
ZFA129002	GA-85	ABHN									
ZFA129003	GA-303	ABHN									
ZFA129004	GA-75	ABHN									
ZFA129005	GA-50	ABHN									
ZFA129006	GA-80	ABHN									
ZFA129007	GA-192	ABHN									
ZFA129009	GA-55	ABHN									
ZFA129010	GA-730	ABHN									
ZFA129011	GA-57	ABHN									
ZFA129012	GA-59	ABHN									
ZFA129013	GA-3300	ABHN									
ZFA129014	GA-735	ABHN									
ZFA129015	GA-271	ABHN									
ZFA129016	GA-3814	ABHN									
ZFA129018	GA-3424	ABHN									
ZFA129021	GA-54	ABHN									
ZFA129022	GA-3523	ABHN									
ZFA129023	GA-89	ABHN									
ZFA129024	GA-3647	ABHN									
ZFA129025	GA-3681	ABHN									
ZFA129027	GA-153	ABHN									
ZFA129028	GA-274	ABHN									
ZFA129029	GA-3916	ABHN									
ZFA129031	GA-5056	ABHN									
ZFA129032	GA-273	ABHN									

Filtros Tipo Sellado

Spin-On Filters

GP-1 FILTRO P/ACEITE



Código: 2001
Rosca: 3/4-16
Diámetro Ext.: (3 5/8 in) (3.625 in) (92.0 mm)
Altura Total: (5 13/32 in) (5.406 in) (137.3 mm)
Diámetro Ext. Empaque: (2.844 in) (2 27/32 in) (72.2 mm)
Diámetro Int. Empaque: (2.484 in) (2 31/64 in) (63.1 mm)
Altura Empaque: (0.203 in) (13/64 in) (5.2 mm)
Válvula de alivio: 8-11 PSI
Válvula anti drenaje: SI
Principales aplicaciones: Ford, Allis chalmers, Case, Toyota, Perkins, Wisconsin
Principales equivalencias: Ford C9NN-6714-A, Allis chalmers 70237000, Case A146696

GP-10 FILTRO P/ACEITE



Código: 2009
Rosca: 1-12
Diámetro Ext.: (3 5/8 in) (3.625 in) (92.0 mm)
Altura Total: (7 17/32 in) (7.531 in) (191.2 mm)
Diámetro Ext. Empaque: (2.844 in) (2 27/32 in) (72.2 mm)
Diámetro Int. Empaque: (2.484 in) (2 31/64 in) (63.1 mm)
Altura Empaque: (0.203 in) (13/64 in) (5.2 mm)
Válvula de alivio: 18-22 PSI
Válvula anti drenaje: SI
Principales aplicaciones: Motores, Excavadoras y Tractores IHC
Principales equivalencias: IHC 3181-045-R93, Fleetguard LF673

GP-1 GOLD FILTRO P/ACEITE

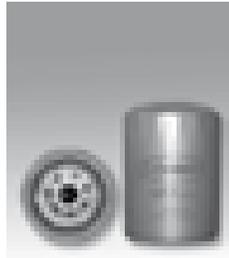

Código: 2148
Rosca: 3/4-16
Diámetro Ext.: (3 5/8 in) (3.625 in) (92.0 mm)
Altura Total: (5 13/32 in) (5.406 in) (137.3 mm)
Diámetro Ext. Empaque: (2.844 in) (2 27/32 in) (72.2 mm)
Diámetro Int. Empaque: (2.484 in) (2 31/64 in) (63.1 mm)
Altura Empaque: (0.203 in) (13/64 in) (5.2 mm)
Válvula de alivio: 8-11 PSI
Válvula anti drenaje: SI
Principales aplicaciones: Ford, Allis chalmers, Case, Toyota, Perkins, Wisconsin, modelos recientes que utilicen aceite sintético
Principales equivalencias: Ford C9NN-6714-A, Allis chalmers 70237000, Case A146696

GP-11 FILTRO P/COMB.

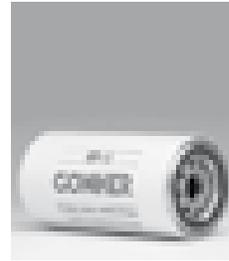

Código: 2010
Rosca: 1-14
Diámetro Ext.: (3 5/8 in) (3.625 in) (92.0 mm)
Altura Total: (7 17/32 in) (7.531 in) (191.2 mm)
Diámetro Ext. Empaque: (2.844 in) (2 27/32 in) (72.2 mm)
Diámetro Int. Empaque: (2.484 in) (2 31/64 in) (63.1 mm)
Altura Empaque: (0.203 in) (13/64 in) (5.2 mm)
Principales aplicaciones: Tractores Kenworth, Dina, Mercedes Benz, Motores Cummins
Principales equivalencias: Cummins 3300901, Fleetguard FF213
Observaciones: Filtro primario, utilice GPP-11 o GPP-14 como secundario

GP-3 FILTRO P/ACEITE



Código: 2003
Rosca: 13/16-16
Diámetro Ext.: (3 5/8 in) (3.625 in) (92.0 mm)
Altura Total: (3 45/64 in) (3.703 in) (94.0 mm)
Diámetro Ext. Empaque: (2.844 in) (2 27/32 in) (72.2 mm)
Diámetro Int. Empaque: (2.484 in) (2 31/64 in) (63.1 mm)
Altura Empaque: (0.203 in) (13/64 in) (5.2 mm)
Principales aplicaciones: Automóviles y Camionetas Chevrolet
Principales equivalencias: General Motors 5578052

GPP-11 FILTRO P/COMB.



Código: 2127
Rosca: 1-14
Diámetro Ext.: (3 5/8 in) (3.625 in) (92.0 mm)
Altura Total: (7 7/32 in) (7.218 in) (183.3 mm)
Diámetro Ext. Empaque: (2.844 in) (2 27/32 in) (72.2 mm)
Diámetro Int. Empaque: (2.484 in) (2 31/64 in) (63.1 mm)
Altura Empaque: (0.203 in) (13/64 in) (5.2 mm)
Principales aplicaciones: Tractores Kenworth, Dina, Mack, Mercedes Benz, Motores Cummins
Principales equivalencias: Cummins 156172, Fleetguard FF105D

GP-5 FILTRO P/ACEITE



Código: 2005
Rosca: 13/16-16
Diámetro Ext.: (3 5/8 in) (3.625 in) (92.0 mm)
Altura Total: (5 13/32 in) (5.406 in) (137.3 mm)
Diámetro Ext. Empaque: (3.422 in) (3 27/64 in) (86.9 mm)
Diámetro Int. Empaque: (3.047 in) (3 3/64 in) (77.4 mm)
Altura Empaque: (0.266 in) (17/64 in) (6.7 mm)
Válvula anti drenaje: SI
Principales aplicaciones: Automóviles Van-Rambler, Camionetas Dina, Motores Cummins y Allis chalmers
Principales equivalencias: OMC 8991072, Fram PH11

GP-13 FILTRO P/ACEITE



Código: 2013
Rosca: 13/16-16
Diámetro Ext.: (3 5/8 in) (3.625 in) (92.0 mm)
Altura Total: (5 13/32 in) (5.406 in) (137.3 mm)
Diámetro Ext. Empaque: (3.422 in) (3 27/64 in) (86.9 mm)
Diámetro Int. Empaque: (3.047 in) (3 3/64 in) (77.4 mm)
Altura Empaque: (0.266 in) (17/64 in) (6.7 mm)
Principales aplicaciones: Automóviles y Camionetas Chevrolet
Principales equivalencias: General Motors 6438384, Fram PH13

GP-9 FILTRO P/ACEITE



Código: 2008
Rosca: 3/4-16
Diámetro Ext.: (3 5/8 in) (3.625 in) (92.0 mm)
Altura Total: (3 45/64 in) (3.703 in) (94.0 mm)
Diámetro Ext. Empaque: (2.844 in) (2 27/32 in) (72.2 mm)
Diámetro Int. Empaque: (2.484 in) (2 31/64 in) (63.1 mm)
Altura Empaque: (0.203 in) (13/64 in) (5.2 mm)
Válvula de alivio: 8-11 PSI
Válvula anti drenaje: SI
Principales aplicaciones: Automóviles y Camionetas Chrysler, Dodge, Ford,
Principales equivalencias: Chrysler 3549957, Ford D4ZZ-6731-B

GP-14 FILTRO P/ACEITE



Código: 2015
Rosca: 13/16-16
Diámetro Ext.: (3 5/8 in) (3.625 in) (92.0 mm)
Altura Total: (5 13/32 in) (5.406 in) (137.3 mm)
Diámetro Ext. Empaque: (2.844 in) (2 27/32 in) (72.2 mm)
Diámetro Int. Empaque: (2.484 in) (2 31/64 in) (63.1 mm)
Altura Empaque: (0.203 in) (13/64 in) (5.2 mm)
Válvula de alivio: 18-22 PSI
Principales aplicaciones: Tractores, Combinadas, Niveladores, Excavadoras y Cargadoras John Deere
Principales equivalencias: John Deere T19044, Fleetguard LF678

GPP-14 FILTRO P/COMB.



Código: 2017
Rosca: 1-14
Diámetro Ext.: (3 5/8 in) (3.625 in) (92.0 mm)
Altura Total: (5 3/4 in) (5.75 in) (146.0 mm)
Diámetro Ext. Empaque: (2.844 in) (2 27/32 in) (72.2 mm)
Diámetro Int. Empaque: (2.484 in) (2 31/64 in) (63.1 mm)
Altura Empaque: (0.203 in) (13/64 in) (5.2 mm)
Principales aplicaciones: Tractores, Cargadoras y Motores John Deere
Principales equivalencias: John Deere AP-28990, AR-31627-R

GPP-18 FILTRO P/COMB.



Código: 2363
Rosca: 13/16-18
Diámetro Ext.: (3 5/8 in) (3.625 in) (92.0 mm)
Altura Total: (4 19/32 in) (4.593 in) (116.6 mm)
Diámetro Ext. Empaque: (2.844 in) (2 27/32 in) (72.2 mm)
Diámetro Int. Empaque: (2.484 in) (2 31/64 in) (63.1 mm)
Altura Empaque: (0.203 in) (13/64 in) (5.2 mm)
Principales aplicaciones: Bomag, Carrier, Case, Cummins, Fiat-Allis, Freightliner, Hyster, Hyundai, IHC, Ingersoll-Rand, Kenworth, Komatsu, Peterbilt, Volvo, White,
Principales equivalencias: Case J925274, Caterpillar 9Y4441, Cummins 3935274
Observaciones: Filtro primario, utilice GPP-19 como secundario

GPP-19 FILTRO P/COMB.



Código: 2389
Rosca: 15/16-16
Diámetro Ext.: (3 5/8 in) (3.625 in) (92.0 mm)
Altura Total: (4 19/32 in) (4.593 in) (116.6 mm)
Diámetro Ext. Empaque: (2.844 in) (2 27/32 in) (72.2 mm)
Diámetro Int. Empaque: (2.484 in) (2 31/64 in) (63.1 mm)
Altura Empaque: (0.203 in) (13/64 in) (5.2 mm)
Principales aplicaciones: Allis Chalmers, Case, Fiat-Allis, Ford
Principales equivalencias: Case A39867, Fiat 74321716, Ford 9613325
Observaciones: Filtro secundario, utilice GPP-18 como primario

GP-20 FILTRO P/ACEITE



Código: 2024
Rosca: 13/16-16
Diámetro Ext.: (3 5/8 in) (3.625 in) (92.0 mm)
Altura Total: (3 45/64 in) (3.703 in) (94.0 mm)
Diámetro Ext. Empaque: (2.844 in) (2 27/32 in) (72.2 mm)
Diámetro Int. Empaque: (2.484 in) (2 31/64 in) (63.1 mm)
Altura Empaque: (0.203 in) (13/64 in) (5.2 mm)
Válvula anti drenaje: SI
Principales aplicaciones: Automóviles y Camionetas Cadillac, VAM, Camiones Dina, General Motors
Principales equivalencias: American Motors 3222897, General Motors 6437461, 8993146

GP-22 FILTRO P/ACEITE



Código: 2139
Rosca: 3/4-16
Diámetro Ext.: (3 5/8 in) (3.625 in) (92.0 mm)
Altura Total: (2 21/64 in) (2.328 in) (59.1 mm)
Diámetro Ext. Empaque: (2.844 in) (2 27/32 in) (72.2 mm)
Diámetro Int. Empaque: (2.484 in) (2 31/64 in) (63.1 mm)
Altura Empaque: (0.203 in) (13/64 in) (5.2 mm)
Válvula de alivio: 8-11 PSI
Válvula anti drenaje: SI
Principales aplicaciones: Automóviles y Camionetas Renault
Principales equivalencias: Renault 7701265435, 8983501080

GP-23 FILTRO P/ACEITE



Código: 2027
Rosca: 13/16-16
Diámetro Ext.: (3 5/8 in) (3.625 in) (92.0 mm)
Altura Total: (8 1/2 in) (8.5 in) (215.9 mm)
Diámetro Ext. Empaque: (3.422 in) (3 27/64 in) (86.9 mm)
Diámetro Int. Empaque: (3.047 in) (3 3/64 in) (77.4 mm)
Altura Empaque: (0.266 in) (17/64 in) (6.7 mm)
Principales aplicaciones: Camiones General Motors
Principales equivalencias: General Motors 6439031, 25010754

GP-24 FILTRO P/ACEITE



Código: 2145
Rosca: M20X1.5
Diámetro Ext.: (3 5/64 in) (3.078 in) (78.1 mm)
Altura Total: (4 45/64 in) (4.703 in) (119.4 mm)
Diámetro Ext. Empaque: (2.844 in) (2 27/32 in) (72.2 mm)
Diámetro Int. Empaque: (2.484 in) (2 31/64 in) (63.1 mm)
Altura Empaque: (0.203 in) (13/64 in) (5.2 mm)
Válvula de alivio: 8-12 PSI
Válvula anti drenaje: SI
Principales aplicaciones: Automóviles Mazda, Equipos Case, Clark, John Deere, Komatsu, Thermo king
Principales equivalencias: Mazda RF03-23-802, Thermo King 11-4928

GP-26 FILTRO P/COMB.



Código: 2029
Rosca: 1-12
Diámetro Ext.: (3 5/8 in) (3.625 in) (92.0 mm)
Altura Total: (7 17/32 in) (7.531 in) (191.2 mm)
Diámetro Ext. Empaque: (3.422 in) (3 27/64 in) (86.9 mm)
Diámetro Int. Empaque: (3.047 in) (3 3/64 in) (77.4 mm)
Altura Empaque: (0.266 in) (17/64 in) (6.7 mm)
Principales aplicaciones: Bomag, Detroit Diesel, Ford, Freightliner, General Motors, IHC, Kenworth
Principales equivalencias: Detroit Diesel 23518481, IHC 469441-C1, 465680-C91
Observaciones: Filtro primario, utilice GP-27 como secundario

GP-27 FILTRO P/COMB.



Código: 2030
Rosca: 13/16-12
Diámetro Ext.: (3 5/8 in) (3.625 in) (92.0 mm)
Altura Total: (7 17/32 in) (7.531 in) (191.2 mm)
Diámetro Ext. Empaque: (3.422 in) (3 27/64 in) (86.9 mm)
Diámetro Int. Empaque: (3.047 in) (3 3/64 in) (77.4 mm)
Altura Empaque: (0.266 in) (17/64 in) (6.7 mm)
Principales aplicaciones: Bomag, Detroit Diesel, Ford, Freightliner, General Motors, IHC, Kenworth
Principales equivalencias: Detroit Diesel 23518482, IHC 469442-C1
Observaciones: Filtro secundario, utilice GP-26 como primario

GP-28 FILTRO P/ACEITE



Código: 2048
Rosca: 3/4-16
Diámetro Ext.: (3 5/64 in) (3.078 in) (78.1 mm)
Altura Total: (4 45/64 in) (4.703 in) (119.4 mm)
Diámetro Ext. Empaque: (2.844 in) (2 27/32 in) (72.2 mm)
Diámetro Int. Empaque: (2.484 in) (2 31/64 in) (63.1 mm)
Altura Empaque: (0.203 in) (13/64 in) (5.2 mm)
Válvula de alivio: 27-36 PSI
Válvula anti drenaje: SI
Principales aplicaciones: Automóviles y Camionetas Volkswagen, Audi, BMW, Seat, Porsche
Principales equivalencias: Volkswagen 059115561C

GP-28 GOLD FILTRO P/ACEITE



Código: 2150
Rosca: 3/4-16
Diámetro Ext.: (3 5/64 in) (3.078 in) (78.1 mm)
Altura Total: (4 45/64 in) (4.703 in) (119.4 mm)
Diámetro Ext. Empaque: (2.844 in) (2 27/32 in) (72.2 mm)
Diámetro Int. Empaque: (2.484 in) (2 31/64 in) (63.1 mm)
Altura Empaque: (0.203 in) (13/64 in) (5.2 mm)
Válvula de alivio: 27-36 PSI
Válvula anti drenaje: SI
Principales aplicaciones: Automóviles y Camionetas Volkswagen, Audi, BMW, Seat, Porsche, modelos recientes que utilizen aceite sintético
Principales equivalencias: Volkswagen 059115561C

GP-31 FILTRO P/ACEITE



Código: 2033
Rosca: 3/4-16
Diámetro Ext.: (3 5/8 in) (3.625 in) (92.0 mm)
Altura Total: (7 17/32 in) (7.531 in) (191.2 mm)
Diámetro Ext. Empaque: (2.844 in) (2 27/32 in) (72.2 mm)
Diámetro Int. Empaque: (2.484 in) (2 31/64 in) (63.1 mm)
Altura Empaque: (0.203 in) (13/64 in) (5.2 mm)
Válvula de alivio: 8-12 PSI
Válvula anti drenaje: SI
Principales aplicaciones: Carrier, Case, Caterpillar, Dina, Ford, Hyster, JCB, Massey Ferguson, Perkins, Volvo, White
Principales equivalencias: Caterpillar 7W2326, Ford F5RZ-6731-B, Massey Ferguson 1447031M91

GP-34 FILTRO P/ACEITE



Código: 2063
Rosca: 1 1/2-16
Diámetro Ext.: (5 5/64 in) (5.078 in) (128.9 mm)
Altura Total: (6 27/32 in) (6.843 in) (173.8 mm)
Diámetro Ext. Empaque: (5.141 in) (5 9/64 in) (130.6 mm)
Diámetro Int. Empaque: (4.75 in) (4 3/4 in) (120.7 mm)
Altura Empaque: (0.188 in) (3/16 in) (4.8 mm)
Principales aplicaciones: Case, Caterpillar, Ford, Hyster, IHC, Ingersoll-Rand, John Deere, New Holland
Principales equivalencias: Caterpillar 9Y4475, IHC 123085-C2, John Deere AR43634

GP-35 FILTRO P/ACEITE



Código: 2113
Rosca: 1 1/2-12
Diámetro Ext.: (5 5/64 in) (5.078 in) (128.9 mm)
Altura Total: (6 27/32 in) (6.843 in) (173.8 mm)
Diámetro Ext. Empaque: (5.141 in) (5 9/64 in) (130.6 mm)
Diámetro Int. Empaque: (4.75 in) (4 3/4 in) (120.7 mm)
Altura Empaque: (0.188 in) (3/16 in) (4.8 mm)
Principales aplicaciones: Equipo John Deere
Principales equivalencias: John Deere AR98329, RE57394

GP-36 FILTRO P/ACEITE



Código: 2043
Rosca: 1-12
Diámetro Ext.: (3 5/8 in) (3.625 in) (92.0 mm)
Altura Total: (5 13/32 in) (5.406 in) (137.3 mm)
Diámetro Ext. Empaque: (2.844 in) (2 27/32 in) (72.2 mm)
Diámetro Int. Empaque: (2.484 in) (2 31/64 in) (63.1 mm)
Altura Empaque: (0.203 in) (13/64 in) (5.2 mm)
Válvula de alivio: 18-22 PSI
Principales aplicaciones: Automóviles Jaguar, Equipo Pesado Bomag, Case, Caterpillar, Deutz Ford, IHC, Komatsu, Nissan, White
Principales equivalencias: Caterpillar 311332, Deutz A1H14123, IHC 3136046-R91

GP-37 FILTRO P/ACEITE



Código: 2124
Rosca: 3/4-16
Diámetro Ext.: (3 19/64 in) (3.296 in) (83.7 mm)
Altura Total: (3 59/64 in) (3.921 in) (99.6 mm)
Diámetro Ext. Empaque: (2.484 in) (2 31/64 in) (63.1 mm)
Diámetro Int. Empaque: (1.813 in) (1 13/16 in) (46 mm)
Altura Empaque: (0.125 in) (1/8 in) (3.2 mm)
Válvula anti drenaje: SI
Principales aplicaciones: Automóviles y Camionetas Infiniti, Nissan
Principales equivalencias: Nissan 15208-F4300, 35622-90002

GP-37 GOLD FILTRO P/ACEITE

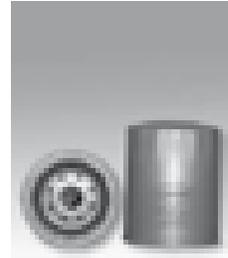

Código: 2149
Rosca: 3/4-16
Diámetro Ext.: (3 19/64 in) (3.296 in) (83.7 mm)
Altura Total: (3 59/64 in) (3.921 in) (99.6 mm)
Diámetro Ext. Empaque: (2.484 in) (2 31/64 in) (63.1 mm)
Diámetro Int. Empaque: (1.813 in) (1 13/16 in) (46 mm)
Altura Empaque: (0.125 in) (1/8 in) (3.2 mm)
Válvula anti drenaje: SI
Principales aplicaciones: Automóviles y Camionetas Infiniti, Nissan, modelos recientes que utilizen aceite sintético
Principales equivalencias: Nissan 15208-F4300, 35622-90002

GP-38 FILTRO P/ACEITE



Código: 2062
Rosca: 3/4-16
Diámetro Ext.: (3 5/64 in) (3.078 in) (78.1 mm)
Altura Total: (4 45/64 in) (4.703 in) (119.4 mm)
Diámetro Ext. Empaque: (2.844 in) (2 27/32 in) (72.2 mm)
Diámetro Int. Empaque: (2.484 in) (2 31/64 in) (63.1 mm)
Altura Empaque: (0.203 in) (13/64 in) (5.2 mm)
Válvula anti drenaje: SI
Principales aplicaciones: Automóviles y Camionetas Nissan, Subaru, Toyota, Equipo Pesado Ford, Komatsu, Nissan, Toyota
Principales equivalencias: Nissan 65012-65014, Toyota 15601-33021

GP-40 FILTRO P/ACEITE



Código: 2146
Rosca: M20X1.5
Diámetro Ext.: (3 5/8 in) (3.625 in) (92.0 mm)
Altura Total: (3 3/16 in) (3.187 in) (80.9 mm)
Diámetro Ext. Empaque: (2.844 in) (2 27/32 in) (72.2 mm)
Diámetro Int. Empaque: (2.484 in) (2 31/64 in) (63.1 mm)
Altura Empaque: (0.203 in) (13/64 in) (5.2 mm)
Válvula de alivio: 8-12 PSI
Válvula anti drenaje: SI
Principales aplicaciones: Automóviles y Camionetas Dodge, Hyundai, Isuzu, Mazda, Equipo Pesado Clark, IHC, John Deere, Komatsu
Principales equivalencias: Chrysler 8983501900, IHC 1962769-C1, Mazda 0813-23-802B

GP-42 FILTRO P/ACEITE



Código: 2147
Rosca: M20X1.5
Diámetro Ext.: (3 5/8 in) (3.625 in) (92.0 mm)
Altura Total: (3 3/16 in) (3.187 in) (80.9 mm)
Diámetro Ext. Empaque: (3.422 in) (3 27/64 in) (86.9 mm)
Diámetro Int. Empaque: (3.047 in) (3 3/64 in) (77.4 mm)
Altura Empaque: (0.266 in) (17/64 in) (6.7 mm)
Válvula de alivio: 8-12 PSI
Principales aplicaciones: Tractores Ford, IHC
Principales equivalencias: Ford E1NN-6714-AB, IHC 1014308C1

GP-43 FILTRO P/ACEITE



Código: 2144
Rosca: 1 1/2-12
Diámetro Ext.: (4 61/64 in) (4.953 in) (125.8 mm)
Altura Total: (8 5/64 in) (8.078 in) (205.1 mm)
Diámetro Ext. Empaque: (4.281 in) (4 9/32 in) (108.7 mm)
Diámetro Int. Empaque: (3.781 in) (3 25/32 in) (96 mm)
Altura Empaque: (0.375 in) (3/8 in) (9.5 mm)
Principales aplicaciones: Bomag, Case, Clark, Cummins, Detroit Diesel, Hino, IHC, Kenworth, Komatsu, Peterbilt, White
Principales equivalencias: Cummins 3313281, Detroit Diesel 23530407, IHC 1240892-H1, White 30-3436861

GP-50 FILTRO P/ACEITE



Código: 2034
Rosca: 5/8-18
Diámetro Ext.: (3 5/8 in) (3.625 in) (92.0 mm)
Altura Total: (5 13/32 in) (5.406 in) (137.3 mm)
Diámetro Ext. Empaque: (2.844 in) (2 27/32 in) (72.2 mm)
Diámetro Int. Empaque: (2.484 in) (2 31/64 in) (63.1 mm)
Altura Empaque: (0.203 in) (13/64 in) (5.2 mm)
Principales aplicaciones: Automóviles Renault, VAM, Equipo Pesado Allis Chalmers, Case, Caterpillar, Clark, Hyster, IHC, Oliver
Principales equivalencias: American Motors 3165818, Allis Chalmers 7451220-7, Caterpillar 311598

GP-44 FILTRO P/ACEITE



Código: 2643
Rosca: 13/16-16
Diámetro Ext.: (3 5/64 in) (3.078 in) (78.1 mm)
Altura Total: (3 25/64 in) (3.390 in) (86.1 mm)
Diámetro Ext. Empaque: (2.844 in) (2 27/32 in) (72.2 mm)
Diámetro Int. Empaque: (2.484 in) (2 31/64 in) (63.1 mm)
Altura Empaque: (0.203 in) (13/64 in) (5.2 mm)
Válvula anti drenaje: SI
Principales aplicaciones: Automóviles y Camionetas Cadillac, Chevrolet, Hummer, Pontiac
Principales equivalencias: General Motors 25010633, 88984215

GP-51 FILTRO P/ACEITE



Código: 2064
Rosca: 1 1/8-16
Diámetro Ext.: (4 17/64 in) (4.265 in) (108.3 mm)
Altura Total: (10 3/8 in) (10.375 in) (263.5 mm)
Diámetro Ext. Empaque: (3.969 in) (3 31/32 in) (100.8 mm)
Diámetro Int. Empaque: (3.547 in) (3 35/64 in) (90.1 mm)
Altura Empaque: (0.297 in) (19/64 in) (7.5 mm)
Principales aplicaciones: Allis Chalmers, Caterpillar, Freightliner, General Motors, Kenworth, Mack, Nissan, Volvo
Principales equivalencias: Caterpillar 311283, General Motors 25012408, Volvo 478736

GP-46 FILTRO P/ACEITE



Código: 2211
Rosca: M18X1.5
Diámetro Ext.: (3 5/64 in) (3.078 in) (78.1 mm)
Altura Total: (3 25/64 in) (3.390 in) (86.1 mm)
Diámetro Ext. Empaque: (2.844 in) (2 27/32 in) (72.2 mm)
Diámetro Int. Empaque: (2.484 in) (2 31/64 in) (63.1 mm)
Altura Empaque: (0.203 in) (13/64 in) (5.2 mm)
Válvula anti drenaje: SI
Principales aplicaciones: Automóviles y Camionetas Cadillac, Chevrolet, Chrysler, Isuzu, Jeep, Peugeot, Pontiac, Saab
Principales equivalencias: Chrysler 8132313, General Motors 93156298

GP-52 FILTRO P/ACEITE



Código: 2065
Rosca: 1 1/2-16
Diámetro Ext.: (4 61/64 in) (4.953 in) (125.8 mm)
Altura Total: (11 23/64 in) (11.359 in) (288.5 mm)
Diámetro Ext. Empaque: (4.281 in) (4 9/32 in) (108.7 mm)
Diámetro Int. Empaque: (3.781 in) (3 25/32 in) (96 mm)
Altura Empaque: (0.375 in) (3/8 in) (9.5 mm)
Principales aplicaciones: Case, Caterpillar, Ford, Freightliner, General Motors, IHC, Kenworth, Mack, Peterbilt, Sterling
Principales equivalencias: Caterpillar 311284, General Motors 25014777, IHC 684206-C2

GP-46 GOLD FILTRO P/ACEITE

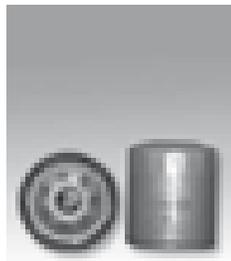

Código: 2153
Rosca: M18X1.5
Diámetro Ext.: (3 5/64 in) (3.078 in) (78.1 mm)
Altura Total: (3 25/64 in) (3.390 in) (86.1 mm)
Diámetro Ext. Empaque: (2.844 in) (2 27/32 in) (72.2 mm)
Diámetro Int. Empaque: (2.484 in) (2 31/64 in) (63.1 mm)
Altura Empaque: (0.203 in) (13/64 in) (5.2 mm)
Válvula anti drenaje: SI
Principales aplicaciones: Automóviles y Camionetas Cadillac, Chevrolet, Chrysler, Isuzu, Jeep, Peugeot, Pontiac, Saab, modelos recientes que utilicen aceite sintético
Principales equivalencias: Chrysler 8132313, General Motors 93156298

GP-53 FILTRO P/ACEITE



Código: 2066
Rosca: 1 1/2-12
Diámetro Ext.: (4 61/64 in) (4.953 in) (125.8 mm)
Altura Total: (10 21/64 in) (10.328 in) (262.3 mm)
Diámetro Ext. Empaque: (4.281 in) (4 9/32 in) (108.7 mm)
Diámetro Int. Empaque: (3.781 in) (3 25/32 in) (96 mm)
Altura Empaque: (0.375 in) (3/8 in) (9.5 mm)
Principales aplicaciones: Motores Cummins, Detroit Diesel, Komatsu
Principales equivalencias: Cummins 3889310, Detroit Diesel 25014214, Komatsu CU3307885

GP-48 FILTRO P/ACEITE



Código: 2089
Rosca: M18X1.5
Diámetro Ext.: (3 5/64 in) (3.078 in) (78.1 mm)
Altura Total: (4 45/64 in) (4.703 in) (119.4 mm)
Diámetro Ext. Empaque: (2.844 in) (2 27/32 in) (72.2 mm)
Diámetro Int. Empaque: (2.484 in) (2 31/64 in) (63.1 mm)
Altura Empaque: (0.203 in) (13/64 in) (5.2 mm)
Principales aplicaciones: Automóviles Chevrolet Cutlass
Principales equivalencias: General Motors 25012757

GP-54 FILTRO P/ACEITE



Código: 2077
Rosca: 1-12
Diámetro Ext.: (3 5/8 in) (3.625 in) (92.0 mm)
Altura Total: (7 17/32 in) (7.531 in) (191.2 mm)
Diámetro Ext. Empaque: (2.844 in) (2 27/32 in) (72.2 mm)
Diámetro Int. Empaque: (2.484 in) (2 31/64 in) (63.1 mm)
Altura Empaque: (0.203 in) (13/64 in) (5.2 mm)
Válvula de alivio: 18-22 PSI
Válvula anti drenaje: SI
Principales aplicaciones: Bomag, Case, Caterpillar, Deutz, Komatsu, Thermo King, Volvo
Principales equivalencias: Case 3136460R91, Caterpillar 5W6017, Volvo 6211489-7

GP-55 FILTRO P/COMB.



Código: 2091
Rosca: 1 1/4-12
Diámetro Ext.: (5 5/64 in) (5.078 in) (128.9 mm)
Altura Total: (11 15/32 in) (11.468 in) (291.3 mm)
Diámetro Ext. Empaque: (4.156 in) (4 5/32 in) (105.6 mm)
Diámetro Int. Empaque: (3.625 in) (3 5/8 in) (92.1 mm)
Altura Empaque: (0.313 in) (5/16 in) (7.9 mm)
Principales aplicaciones: Allis Chalmers, Cummins, Euclid, Peterbilt, Wabco
Principales equivalencias: Cummins 3375404, Euclid 4084262, Wabco VJ8004

GP-56 FILTRO P/COMB.



Código: 2112
Rosca: 1-14
Diámetro Ext.: (4 17/64 in) (4.265 in) (108.3 mm)
Altura Total: (10 3/8 in) (10.375 in) (263.5 mm)
Diámetro Ext. Empaque: (2.844 in) (2 27/32 in) (72.2 mm)
Diámetro Int. Empaque: (2.484 in) (2 31/64 in) (63.1 mm)
Altura Empaque: (0.203 in) (13/64 in) (5.2 mm)
Principales aplicaciones: Equipo Case, Caterpillar
Principales equivalencias: Caterpillar 3R2253, Donaldson P779413

GP-57 FILTRO P/ACEITE



Código: 2121
Rosca: 1 3/8-16
Diámetro Ext.: (4 61/64 in) (4.953 in) (125.8 mm)
Altura Total: (10 21/64 in) (10.328 in) (262.3 mm)
Diámetro Ext. Empaque: (4.281 in) (4 9/32 in) (108.7 mm)
Diámetro Int. Empaque: (3.781 in) (3 25/32 in) (96 mm)
Altura Empaque: (0.375 in) (3/8 in) (9.5 mm)
Principales aplicaciones: Allis Chalmers, Bomag, Caterpillar, Cummins, Euclid, Ford, Freightliner, IHC, Kenworth, Komatsu, Mack, Peterbilt
Principales equivalencias: Caterpillar 9Y4524, Cummins 3313289, Ford E4HS-6714-AA

GP-58 FILTRO P/ACEITE



Código: 2098
Rosca: 3/4-16
Diámetro Ext.: (3 5/64 in) (3.078 in) (78.1 mm)
Altura Total: (3 25/64 in) (3.390 in) (86.1 mm)
Diámetro Ext. Empaque: (2.844 in) (2 27/32 in) (72.2 mm)
Diámetro Int. Empaque: (2.484 in) (2 31/64 in) (63.1 mm)
Altura Empaque: (0.203 in) (13/64 in) (5.2 mm)
Válvula de alivio: 8-12 PSI
Válvula anti drenaje: SI
Principales aplicaciones: Automóviles y Camionetas Chevrolet, Chrysler, Dodge, Ford, Jeep, Plymouth, Renault, Saab, Toyota
Principales equivalencias: Chrysler 4273810, General Motors 25011520, Toyota 90915-20005

GP-58 GOLD FILTRO P/ACEITE



Código: 2152
Rosca: 3/4-16
Diámetro Ext.: (3 5/64 in) (3.078 in) (78.1 mm)
Altura Total: (3 25/64 in) (3.390 in) (86.1 mm)
Diámetro Ext. Empaque: (2.844 in) (2 27/32 in) (72.2 mm)
Diámetro Int. Empaque: (2.484 in) (2 31/64 in) (63.1 mm)
Altura Empaque: (0.203 in) (13/64 in) (5.2 mm)
Válvula de alivio: 8-12 PSI
Válvula anti drenaje: SI
Principales aplicaciones: Automóviles y Camionetas Chevrolet, Chrysler, Dodge, Ford, Jeep, Plymouth, Renault, Saab, Toyota, modelos recientes que utilizen aceite sintético
Principales equivalencias: Chrysler 4273810, General Motors 25011520, Toyota 90915-20005

GP-62 FILTRO P/COMB.



Código: 2086
Rosca: 7/8-14
Diámetro Ext.: (3 5/8 in) (3.625 in) (92.0 mm)
Altura Total: (5 13/32 in) (5.406 in) (137.3 mm)
Diámetro Ext. Empaque: (2.844 in) (2 27/32 in) (72.2 mm)
Diámetro Int. Empaque: (2.484 in) (2 31/64 in) (63.1 mm)
Altura Empaque: (0.203 in) (13/64 in) (5.2 mm)
Principales aplicaciones: Caterpillar, Freightliner, General Motors, IHC, Thermo King
Principales equivalencias: Caterpillar 6I4783, General Motors 25012681, IHC 1820479-C1

GP-66 FILTRO P/ACEITE



Código: 2099
Rosca: 1-12
Diámetro Ext.: (3 5/8 in) (3.625 in) (92.0 mm)
Altura Total: (6 43/64 in) (6.671 in) (169.4 mm)
Diámetro Ext. Empaque: (2.844 in) (2 27/32 in) (72.2 mm)
Diámetro Int. Empaque: (2.484 in) (2 31/64 in) (63.1 mm)
Altura Empaque: (0.203 in) (13/64 in) (5.2 mm)
Válvula de alivio: 18-22 PSI
Principales aplicaciones: Bomag, Case, Caterpillar, Ford, Hyster, IHC, John Deere, Volvo
Principales equivalencias: Case 1276810C1, Caterpillar 9Y4496, IHC 3136406-R91, John Deere RE34040

GP-67 FILTRO P/ACEITE



Código: 2303
Rosca: 3/4-20
Diámetro Ext.: (4 17/64 in) (4.265 in) (108.3 mm)
Altura Total: (7 15/64 in) (7.234 in) (183.7 mm)
Diámetro Ext. Empaque: (2.813 in) (2 13/16 in) (71.4 mm)
Diámetro Int. Empaque: (2.453 in) (2 29/64 in) (62.3 mm)
Altura Empaque: (0.234 in) (15/64 in) (6 mm)
Principales aplicaciones: Unidades de Refrigeración Thermo-King
Principales equivalencias: Thermo-King 12-5703A, Fleetguard FF695

GP-68 FILTRO P/ACEITE



Código: 2335
Rosca: M22X1.5
Diámetro Ext.: (3 5/8 in) (3.625 in) (92.0 mm)
Altura Total: (3 45/64 in) (3.703 in) (94.0 mm)
Diámetro Ext. Empaque: (2.844 in) (2 27/32 in) (72.2 mm)
Diámetro Int. Empaque: (2.484 in) (2 31/64 in) (63.1 mm)
Altura Empaque: (0.203 in) (13/64 in) (5.2 mm)
Válvula de alivio: 11-14 PSI
Válvula anti drenaje: SI
Principales aplicaciones: Automóviles y Camionetas Ford, Lincoln, Mercury
Principales equivalencias: Ford F1AE-6714-BC, 78SF-6714-AA3A

GP-69 FILTRO P/ACEITE



Código: 2101
Rosca: 1-12
Diámetro Ext.: (3 5/8 in) (3.625 in) (92.0 mm)
Altura Total: (7 17/32 in) (7.531 in) (191.2 mm)
Diámetro Ext. Empaque: (2.844 in) (2 27/32 in) (72.2 mm)
Diámetro Int. Empaque: (2.484 in) (2 31/64 in) (63.1 mm)
Altura Empaque: (0.203 in) (13/64 in) (5.2 mm)
Válvula anti drenaje: SI
Principales aplicaciones: Case, Gallon, Hough, IHC, Navistar
Principales equivalencias: Case A184775, Gallon D120303, IHC 675617-C91

GP-77 FILTRO P/ACEITE



Código: 2186
Rosca: 1 1/8-16
Diámetro Ext.: (5 45/64 in) (5.703 in) (144.8 mm)
Altura Total: (6 1/16 in) (6.062 in) (153.9 mm)
Diámetro Ext. Empaque: (4.766 in) (4 49/64 in) (121 mm)
Diámetro Int. Empaque: (3.672 in) (3 43/64 in) (93.3 mm)
Altura Empaque: (0.5 in) (1/2 in) (12.7 mm)
Válvula de alivio: 18-22 PSI
Válvula anti drenaje: SI
Principales aplicaciones: Bomag, Deutz, Ford, P&H
Principales equivalencias: Bomag 5710633, Deutz A22H4123, Ford E0NN-6714-AAS

GP-78 FILTRO P/COMB.



Código: 2427
Rosca: 7/8-14
Diámetro Ext.: (4 17/64 in) (4.265 in) (108.3 mm)
Altura Total: (7 7/64 in) (7.109 in) (180.5 mm)
Diámetro Ext. Empaque: (2.844 in) (2 27/32 in) (72.2 mm)
Diámetro Int. Empaque: (2.484 in) (2 31/64 in) (63.1 mm)
Altura Empaque: (0.203 in) (13/64 in) (5.2 mm)
Principales aplicaciones: Case, Dina, IHC, Navistar
Principales equivalencias: Case 672603C3, IHC 672603-C3, 674293-C91
Observaciones: Filtro secundario, utilice GP-1105 o GP-1108 como primario

GP-81 FILTRO P/ACEITE



Código: 2519
Rosca: 3/4-16
Diámetro Ext.: (3 5/8 in) (3.625 in) (92.0 mm)
Altura Total: (3 45/64 in) (3.703 in) (94.0 mm)
Diámetro Ext. Empaque: (2.844 in) (2 27/32 in) (72.2 mm)
Diámetro Int. Empaque: (2.484 in) (2 31/64 in) (63.1 mm)
Altura Empaque: (0.203 in) (13/64 in) (5.2 mm)
Válvula de alivio: 8-11 PSI
Válvula anti drenaje: SI
Principales aplicaciones: Automóviles y Camionetas Chrysler, Dodge, Jeep, Land Rover, Plymouth
Principales equivalencias: Chrysler 5281090, T1365661

GP-83 FILTRO P/COMB.



Código: 2200
Rosca: 13/16-18
Diámetro Ext.: (4 3/8 in) (4.375 in) (111.1 mm)
Altura Total: (7 29/32 in) (7.906 in) (200.8 mm)
Diámetro Ext. Empaque: (2.828 in) (2 53/64 in) (71.8 mm)
Diámetro Int. Empaque: (2.469 in) (2 15/32 in) (62.7 mm)
Altura Empaque: (0.219 in) (7/32 in) (5.6 mm)
Principales aplicaciones: Camiones Mack
Principales equivalencias: Mack 483GB444, 483GB219B
Observaciones: Filtro primario, utilice GP-84 o GP-85 como secundario

GP-84 FILTRO P/COMB.



Código: 2201
Rosca: 7/8-16
Diámetro Ext.: (4 3/8 in) (4.375 in) (111.1 mm)
Altura: (7 7/8 in) (7.875 in) (200.0 mm)
Diámetro Ext. Empaque: (2.828 in) (2 53/64 in) (71.8 mm)
Diámetro Int. Empaque: (2.469 in) (2 15/32 in) (62.7 mm)
Altura Empaque: (0.219 in) (7/32 in) (5.6 mm)
Principales aplicaciones: Camiones Mack
Principales equivalencias: Mack 483GB441, 483GB218B
Observaciones: Filtro secundario, utilice GP-83 como primario

GP-85 FILTRO P/COMB.



Código: 2202
Rosca: 1 1/16-16
Diámetro Ext.: (4 1/4 in) (4.25 in) (107.9 mm)
Altura Total: (10 5/16 in) (10.312 in) (261.9 mm)
Diámetro Ext. Empaque: (3.969 in) (3 31/32 in) (100.8 mm)
Diámetro Int. Empaque: (3.547 in) (3 35/64 in) (90.1 mm)
Altura Empaque: (0.25 in) (1/4 in) (6.4 mm)
Principales aplicaciones: Camiones Mack, Motores Detroit Diesel
Principales equivalencias: Detroit Diesel 23518532, Mack 483GB431, 483GB446
Observaciones: Filtro secundario, utilice GP-83 como primario

GP-88 FILTRO P/ACEITE



Código: 2195
Rosca: 1-12
Diámetro Ext.: (4 17/64 in) (4.265 in) (108.3 mm)
Altura Total: (8 49/64 in) (8.765 in) (222.6 mm)
Diámetro Ext. Empaque: (2.828 in) (2 53/64 in) (71.8 mm)
Diámetro Int. Empaque: (2.469 in) (2 15/32 in) (62.7 mm)
Altura Empaque: (0.203 in) (13/64 in) (5.2 mm)
Principales aplicaciones: Case, IHC, Mercedes Benz, Thermo King
Principales equivalencias: IHC 1811953C1, Mercedes Benz 00341841701, Thermo king 12-5702A

GP-91 FILTRO P/ACEITE



Código: 2689
Rosca: M20X1.5
Diámetro Ext.: (2 11/16 in) (2.687 in) (68.2 mm)
Altura Total: (2 35/64 in) (2.546 in) (64.6 mm)
Diámetro Ext. Empaque: (2.422 in) (2 27/64 in) (61.5 mm)
Diámetro Int. Empaque: (1.969 in) (1 31/32 in) (50 mm)
Altura Empaque: (0.172 in) (11/64 in) (4.4 mm)
Válvula de alivio: 11-17 PSI
Válvula Anti drenaje: si
Principales aplicaciones: Automóviles y Camionetas Acura, Dodge, Ford, Honda, Mazda, Mitsubishi, Nissan, Subaru
Principales equivalencias: Ford E7GZ-6731-A, Honda 15400-PFB-004, Nissan 15208-65F01

GP-92 FILTRO P/COMB.



Código: 2094
Rosca: 1-12
Diámetro Ext.: (3 5/8 in) (3.625 in) (92.0 mm)
Altura Total: (5 13/32 in) (5.406 in) (137.3 mm)
Diámetro Ext. Empaque: (3.422 in) (3 27/64 in) (86.9 mm)
Diámetro Int. Empaque: (3.047 in) (3 3/64 in) (77.4 mm)
Altura Empaque: (0.266 in) (17/64 in) (6.7 mm)
Principales aplicaciones: Clark, Detroit Diesel, General Motors, IHC
Principales equivalencias: Detroit Diesel 23518527, General Motors 25014371
Observaciones: Filtro primario, utilice GP-93 como secundario

GP-93 FILTRO P/COMB.



Código: 2095
Rosca: 13/16-12
Diámetro Ext.: (3 5/8 in) (3.625 in) (92.0 mm)
Altura Total: (4 15/64 in) (4.234 in) (107.5 mm)
Diámetro Ext. Empaque: (3.422 in) (3 27/64 in) (86.9 mm)
Diámetro Int. Empaque: (3.047 in) (3 3/64 in) (77.4 mm)
Altura Empaque: (0.266 in) (17/64 in) (6.7 mm)
Principales aplicaciones: Clark, Detroit Diesel, General Motors, IHC
Principales equivalencias: Detroit Diesel 23518526, General Motors 25013273
Observaciones: Filtro secundario, utilice GP-92 como primario

GP-96 FILTRO P/COMB.



Código: 2038
Rosca: M18X1.5
Diámetro Ext.: (3 11/16 in) (3.687 in) (93.6 mm)
Altura Total: (8 1/8 in) (8.125 in) (206.3 mm)
Diámetro Ext. Empaque: (2.813 in) (2 13/16 in) (71.4 mm)
Diámetro Int. Empaque: (2.453 in) (2 29/64 in) (62.3 mm)
Altura Empaque: (0.203 in) (13/64 in) (5.2 mm)
Principales aplicaciones: Camiones y Autobuses Volvo con motor D12-A, D16-A, VED12
Principales equivalencias: Volvo 420799-9, 8193841, Fleetguard FF5272

GPP-103 FILTRO P/COMB.



Código: 2544
Rosca: 1-14
Diámetro Ext.: (3 5/8 in) (3.625 in) (92.0 mm)
Altura Total: (6 21/32 in) (6.656 in) (169.0 mm)
Diámetro Ext. Empaque: (2.844 in) (2 27/32 in) (72.2 mm)
Diámetro Int. Empaque: (2.484 in) (2 31/64 in) (63.1 mm)
Altura Empaque: (0.203 in) (13/64 in) (5.2 mm)
Principales aplicaciones: Motores Cummins, Camiones Dina
Principales equivalencias: Cummins 3355903
Observaciones: Filtro secundario, utilice GP-11, GP-1105 o GP-1108 como primario

GP-110 FILTRO P/COMB.



Código: 2140
Rosca: 1-14
Diámetro Ext.: (3 5/8 in) (3.625 in) (92.0 mm)
Altura Total: (7 1/8 in) (7.125 in) (180.9 mm)
Diámetro Ext. Empaque: (2.844 in) (2 27/32 in) (72.2 mm)
Diámetro Int. Empaque: (2.484 in) (2 31/64 in) (63.1 mm)
Altura Empaque: (0.25 in) (1/4 in) (6.4 mm)
Principales aplicaciones: Carrier, Caterpillar, Ford, General Motors, Hough, IHC, Kenworth, Mack, New Holland, Nissan, White
Principales equivalencias: Caterpillar 7S1220, General Motors 6439676, IHC 702253-C1, Nissan 16444-99525

GPP-111 FILTRO P/COMB.



Código: 2132
Rosca: M20X1.5
Diámetro Ext.: (3 7/8 in) (3.875 in) (98.4 mm)
Altura Total: (5 3/8 in) (5.375 in) (136.5 mm)
Rosca del puerto: M36X1.5
Principales aplicaciones: Camionetas H100 Diesel y camiones Isuzu ELF 400/450
Principales equivalencias: Hyundai 31973-44001, 31973-44100, Isuzu 8-94483-850-0, 8-98037-481-0

GP-112 FILTRO P/ACEITE



Código: 2122
Rosca: M26X1.5
Diámetro Ext.: (3 25/32 in) (3.781 in) (96.0 mm)
Altura Total: (4 13/32 in) (4.406 in) (111.9 mm)
Válvula de alivio: 14 PSI
Principales aplicaciones: Camionetas H100 Diesel
Principales equivalencias: Hyundai 26300-42040

GP-128 FILTRO P/ACEITE



Código: 2983
Rosca: 3/4-16
Diámetro Ext.: (3 5/64 in) (3.078 in) (78.1 mm)
Altura Total: (4 45/64 in) (4.703 in) (119.4 mm)
Diámetro Ext. Empaque: (2.844 in) (2 27/32 in) (72.2 mm)
Diámetro Int. Empaque: (2.484 in) (2 31/64 in) (63.1 mm)
Altura Empaque: (0.203 in) (13/64 in) (5.2 mm)
Válvula de alivio: 11-17 PSI
Válvula anti drenaje: SI
Principales aplicaciones: Automóviles y Camionetas Ford
Principales equivalencias: Ford F8CZ-6731-AA

GP-145 FILTRO P/ACEITE



Código: 2041
Rosca: M20X1.5
Diámetro Ext.: (2 53/64 in) (2.828 in) (71.8 mm)
Altura Total: (3 31/32 in) (3.968 in) (100.8 mm)
Diámetro Ext. Empaque: (2.484 in) (2 31/64 in) (63.1 mm)
Diámetro Int. Empaque: (2.172 in) (2 11/64 in) (55.2 mm)
Altura Empaque: (0.234 in) (15/64 in) (6 mm)
Válvula de alivio: 12-16 PSI
Válvula anti drenaje: SI
Principales aplicaciones: Automóviles y Camionetas Mitsubishi
Principales equivalencias: Mitsubishi AW343979, MD352627

GP-149 FILTRO P/ACEITE



Código: 2462
Rosca: M20X1.5
Diámetro Ext.: (3 3/64 in) (3.046 in) (77.3 mm)
Altura Total: (3 11/32 in) (3.343 in) (84.9 mm)
Diámetro Ext. Empaque: (2.422 in) (2 27/64 in) (61.5 mm)
Diámetro Int. Empaque: (1.969 in) (1 31/32 in) (50 mm)
Altura Empaque: (0.172 in) (1/64 in) (4.4 mm)
Válvula de alivio: 8-12 PSI
Válvula anti drenaje: SI
Principales aplicaciones: Automóviles y Camionetas Acura, Ford, Honda, Nissan
Principales equivalencias: Ford F32Z-6731-A, Honda 15400-PLM-A01PE, Nissan 15208-F4600

GP-152 FILTRO P/ACEITE



Código: 2543
Rosca: M36X1.5
Diámetro Ext.: (4 59/64 in) (4.921 in) (125.0 mm)
Altura Total: (12 3/16 in) (12.187 in) (309.5 mm)
Diámetro Ext. Empaque: (4.563 in) (4 9/16 in) (115.9 mm)
Diámetro Int. Empaque: (3.906 in) (3 29/32 in) (99.2 mm)
Altura Empaque: (0.359 in) (23/64 in) (9.1 mm)
Válvula de alivio: 32-34 PSI
Principales aplicaciones: Camiones y Motores IHC
Principales equivalencias: IHC 1819452-C1, 1833121-C1

GP-155 FILTRO P/COMB.



Código: 2426
Rosca: 7/8-14
Diámetro Ext.: (4 17/64 in) (4.265 in) (108.3 mm)
Altura Total: (4 41/64 in) (4.640 in) (117.8 mm)
Diámetro Ext. Empaque: (2.844 in) (2 27/32 in) (72.2 mm)
Diámetro Int. Empaque: (2.484 in) (2 31/64 in) (63.1 mm)
Altura Empaque: (0.203 in) (13/64 in) (5.2 mm)
Principales aplicaciones: Camiones y Camionetas Ford, IHC
Principales equivalencias: Ford E3TZ-9155-A, IHC 1804459-C1

GP-156 FILTRO P/ACEITE



Código: 2341
Rosca: 3/4-16
Diámetro Ext.: (2 23/32 in) (2.718 in) (69.0 mm)
Altura Total: (3 39/64 in) (3.609 in) (91.6 mm)
Diámetro Ext. Empaque: (2.422 in) (2 27/64 in) (61.5 mm)
Diámetro Int. Empaque: (1.969 in) (1 31/32 in) (50 mm)
Altura Empaque: (0.172 in) (11/64 in) (4.4 mm)
Válvula de alivio: 11-17 PSI
Válvula anti drenaje: SI
Principales aplicaciones: Automóviles y Camionetas Chevrolet, Nissan, Suzuki, Toyota
Principales equivalencias: General Motors 94851858, Nissan 16546-53J00, Toyota 90915-10004

GP-157 FILTRO P/ACEITE



Código: 2342
Rosca: 3/4-16
Diámetro Ext.: (2 23/32 in) (2.718 in) (69.0 mm)
Altura Total: (2 15/16 in) (2.937 in) (74.6 mm)
Diámetro Ext. Empaque: (2.422 in) (2 27/64 in) (61.5 mm)
Diámetro Int. Empaque: (1.969 in) (1 31/32 in) (50 mm)
Altura Empaque: (0.172 in) (11/64 in) (4.4 mm)
Válvula de alivio: 11-17 PSI
Válvula anti drenaje: SI
Principales aplicaciones: Automóviles y Camionetas Pontiac, Toyota, Tractores Pequeños John Deere, Montacargas Toyota
Principales equivalencias: General Motors 94858995, Toyota 90915-10003, John Deere AM105555

GP-166 FILTRO P/ACEITE



Código: 2558
Rosca: 1 1/8-16
Diámetro Ext.: (3 5/8 in) (3.625 in) (92.0 mm)
Altura Total: (6 43/64 in) (6.671 in) (169.4 mm)
Diámetro Ext. Empaque: (2.844 in) (2 27/32 in) (72.2 mm)
Diámetro Int. Empaque: (2.469 in) (2 15/32 in) (62.7 mm)
Altura Empaque: (0.281 in) (9/32 in) (7.1 mm)
Válvula de alivio: 8-12 PSI
Principales aplicaciones: Equipo Caterpillar, Ford
Principales equivalencias: Caterpillar 4T6915, Ford D8NN-B486-EA

GP-171 FILTRO P/ACEITE



Código: 2339
Rosca: 3/4-16
Diámetro Ext.: (3 5/8 in) (3.625 in) (92.0 mm)
Altura Total: (3 47/64 in) (3.734 in) (94.8 mm)
Diámetro Ext. Empaque: (2.844 in) (2 27/32 in) (72.2 mm)
Diámetro Int. Empaque: (2.484 in) (2 31/64 in) (63.1 mm)
Altura Empaque: (0.203 in) (13/64 in) (5.2 mm)
Válvula de alivio: 18-22 PSI
Válvula anti drenaje: SI
Principales aplicaciones: Automóviles Audi, Equipo Pesado Case, Clark, Hyster, IHC, JCB, Scania, Volvo
Principales equivalencias: Case 47128196, Hyster 297865-12, Volvo 79078234

GP-178 FILTRO P/ACEITE



Código: 2541
Rosca: 1-16
Diámetro Ext.: (3 5/8 in) (3.625 in) (92.0 mm)
Altura Total: (7 9/64 in) (7.140 in) (181.3 mm)
Diámetro Ext. Empaque: (2.844 in) (2 27/32 in) (72.2 mm)
Diámetro Int. Empaque: (2.484 in) (2 31/64 in) (63.1 mm)
Altura Empaque: (0.203 in) (13/64 in) (5.2 mm)
Principales aplicaciones: Camionetas Dodge, Equipo Pesado Case, Cummins, Ford, Freightliner, Komatsu, Volvo, White
Principales equivalencias: Chrysler 5093092AA, Cummins 4063262, Ford F3HZ-6731-C

GP-193 FILTRO P/ACEITE



Código: 2340
Rosca: 1 5/8-12
Diámetro Ext.: (4 41/64 in) (4.640 in) (117.8 mm)
Altura Total: (10 11/32 in) (10.343 in) (262.7 mm)
Diámetro Ext. Empaque: (4.281 in) (4 9/32 in) (108.7 mm)
Diámetro Int. Empaque: (3.781 in) (3 25/32 in) (96 mm)
Altura Empaque: (0.375 in) (3/8 in) (9.5 mm)
Principales aplicaciones: Detroit Diesel, Ford, Freightliner, IHC, Sterling, Volvo
Principales equivalencias: Detroit Diesel 23530573, 23527033

GP-205 FILTRO P/ACEITE



Código: 2690
Rosca: 13/16-16
Diámetro Ext.: (3 5/8 in) (3.625 in) (92.0 mm)
Altura Total: (5 13/32 in) (5.406 in) (137.3 mm)
Diámetro Ext. Empaque: (3.422 in) (3 27/64 in) (86.9 mm)
Diámetro Int. Empaque: (3.047 in) (3 3/64 in) (77.4 mm)
Altura Empaque: (0.266 in) (17/64 in) (6.7 mm)
Válvula anti drenaje: SI
Principales aplicaciones: Camionetas y Motores General Motors
Principales equivalencias: General Motors 25013977, 25160561

GP-212 FILTRO P/ACEITE



Código: 2244
Rosca: M22X1.5
Diámetro Ext.: (3 9/32 in) (3.281 in) (83.3 mm)
Altura Total: (3 1/8 in) (3.125 in) (79.4 mm)
Válvula de alivio:
Válvula anti drenaje: si
Principales aplicaciones: Automóviles Acura, camionetas Sterling
Principales equivalencias: Honda 15400-PL2-004, 15400-PL2-305, Sterling 126 126000 97

GP-291 FILTRO P/ACEITE



Código: 2985
Rosca: M20X1.5
Diámetro Ext.: (3 1/32 in) (3.031 in) (76.9 mm)
Altura Total: (2 7/64 in) (2.109 in) (53.5 mm)
Diámetro Ext. Empaque: (2.844 in) (2 27/32 in) (72.2 mm)
Diámetro Int. Empaque: (2.484 in) (2 31/64 in) (63.1 mm)
Altura Empaque: (0.203 in) (13/64 in) (5.2 mm)
Válvula de alivio: 11-17 PSI
Válvula anti drenaje: si
Principales aplicaciones: Automóviles y Camionetas Nissan, Renault
Principales equivalencias: Fram PH5197, Mann & Hummel W753

GP-310 FILTRO P/ACEITE



Código: 2986
Rosca: 3/4-16
Diámetro Ext.: (3 49/64 in) (3.765 in) (95.6 mm)
Altura Total: (7 21/64 in) (7.328 in) (186.1 mm)
Diámetro Ext. Empaque: (2.281 in) (2 9/32 in) (57.9 mm)
Diámetro Int. Empaque: (2.406 in) (2 13/32 in) (61.1 mm)
Altura Empaque: (0.328 in) (21/64 in) (8.3 mm)
Válvula de alivio: 26-30 PSI
Válvula anti drenaje: SI
Principales aplicaciones: Automóviles y Camionetas Volkswagen, Audi
Principales equivalencias: Volkswagen 69115561, 76115651

GP-317H FILTRO P/ACEITE HIDRÁULICO



Código: 2131
Rosca: 1 1/8-16
Diámetro Ext.: (3 11/16 in) (3.687 in) (93.6 mm)
Altura Total: (5 21/32 in) (5.656 in) (143.6 mm)
Diámetro Ext. Empaque: (2.813 in) (2 13/16 in) (71.4 mm)
Diámetro Int. Empaque: (2.469 in) (2 15/32 in) (62.7 mm)
Altura Empaque: (0.203 in) (13/64 in) (5.2 mm)
Principales aplicaciones: Camiones Volvo, Excavadoras Kubota
Principales equivalencias: Volvo 3177754, Kubota 6813-16-2130

GP-359 FILTRO P/ACEITE



Código: 2207
Rosca: 1 1/2-12
Diámetro Ext.: (4 21/32 in) (4.656 in) (118.2 mm)
Altura Total: (4 15/16 in) (4.937 in) (125.3 mm)
Diámetro Ext. Empaque: (4.281 in) (4 9/32 in) (108.7 mm)
Diámetro Int. Empaque: (3.781 in) (3 25/32 in) (96 mm)
Válvula de alivio: 19 PSI
Válvula anti drenaje: NO
Principales aplicaciones: Camiones Isuzu ELF 400/450
Principales equivalencias: Isuzu 8-97148-280-0, 8-97046-464-1

GP-390 FILTRO P/ACEITE



Código: 2559
Rosca: 1-16
Diámetro Ext.: (3 5/8 in) (3.625 in) (92.0 mm)
Altura Total: (5 13/32 in) (5.406 in) (137.3 mm)
Diámetro Ext. Empaque: (2.844 in) (2 27/32 in) (72.2 mm)
Diámetro Int. Empaque: (2.484 in) (2 31/64 in) (63.1 mm)
Altura Empaque: (0.203 in) (13/64 in) (5.2 mm)
Principales aplicaciones: Allis Chalmers, Bomag, Case, Cummins, Fiat-Allis, Ingersoll-Rand, Komatsu
Principales equivalencias: Allis Chalmers 4035556-2, Case J934429, Ingersoll-Rand 59728170

GP-406 FILTRO P/ACEITE



Código: 2193
Rosca: M22X1.5
Diámetro Ext.: (2 15/16 in) (2.937 in) (74.5 mm)
Altura Total: (3 1/16 in) (3.062 in) (77.7 mm)
Diámetro Ext. Empaque: (2.750 in) (2 3/4 in) (69.8 mm)
Diámetro Int. Empaque: (2.375 in) (2 3/8 in) (60.3 mm)
Altura Empaque: (0.250 in) (1/4 in) (6.3 mm)
Válvula de alivio: 8-12 PSI
Válvula anti drenaje: SI
Principales aplicaciones: Automóviles y Camionetas Buick, Cadillac, Chevrolet, Chrysler, Dodge, Ford, GMC, Hummer, Jeep, Pontiac, Suzuki, Volkswagen
Principales equivalencias: Ac delco PF48, Fram PH10060, Baldwin B160

GP-408 FILTRO P/ACEITE



Código: 2245
Rosca:
Diámetro Ext.: (in) (in) (mm)
Altura Total: (in) (in) (mm)
Diámetro Ext. Empaque: (in) (in) (mm)
Diámetro Int. Empaque: (in) (in) (mm)
Altura Empaque: (in) (in) (mm)
Válvula de alivio:
Válvula anti drenaje:
Principales aplicaciones: Camionetas Chevrolet, GMC
Principales equivalencias: General Motors 25324052, 89060467, 89060499

GPP-418 FILTRO P/COMB.



Código: 2930
Diámetro Ext.: (3 9/32 in) (3.281 in) (83.3 mm)
Altura Total: (5 3/16 in) (5.187 in) (131.7 mm)
Principales aplicaciones: Tractores John Deere
Principales equivalencias: John Deere RE62418, RE58367, RE50455
Observaciones: Filtro Secundario, utilice GPP-421 como primario

GPP-419 FILTRO P/COMB.



Código: 2931
Diámetro Ext.: (3 9/32 in) (3.281 in) (83.3 mm)
Altura Total: (5 15/16 in) (5.937 in) (150.8 mm)
Principales aplicaciones: Tractores John Deere
Principales equivalencias: John Deere RE60019
Observaciones: Filtro Secundario, utilice GPP-421 o GPP-425 como primario

GPP-420 FILTRO P/COMB.



Código: 2932
Diámetro Ext.: (3 9/32 in) (3.281 in) (83.3 mm)
Altura Total: (4 7/16 in) (4.437 in) (112.7 mm)
Principales aplicaciones: Tractores John Deere
Principales equivalencias: John Deere RE60021

GPP-421 FILTRO P/COMB.



Código: 2129
Diámetro Ext.: (3 9/32 in) (3.281 in) (83.3 mm)
Diámetro Int.: (21/32 in) (0.656 in) (16.6 mm)
Altura: (5 31/32 in) (5.968 in) (151.6 mm)
Principales aplicaciones: Tractores John Deere
Principales equivalencias: John Deere RE53729
Observaciones: Filtro Primario, utilice GPP-418 o GPP-419 como secundario

GPP-423 FILTRO P/COMB.



Código: 2076
Diámetro Ext.: (3 9/32 in) (3.281 in) (83.3 mm)
Diámetro Int.: (21/32 in) (0.656 in) (16.6 mm)
Altura: (7 5/8 in) (7.625 in) (193.6 mm)
Principales aplicaciones: Tractores John Deere, New Holland
Principales equivalencias: John Deere RE62420, New Holland 87801285, 87840590
Observaciones: Filtro Secundario

GPP-424 FILTRO P/COMB.



Código: 2128
Diámetro Ext.: (3 9/32 in) (3.281 in) (83.3 mm)
Diámetro Int.: (21/32 in) (0.656 in) (16.6 mm)
Altura: (5 31/32 in) (5.968 in) (151.6 mm)
Principales aplicaciones: Tractores Caterpillar, John Deere
Principales equivalencias: Caterpillar 117-4089, John Deere RE62424
Observaciones: Filtro Primario

GPP-425 FILTRO P/COMB.



Código: 2130
Diámetro Ext.: (3 9/32 in) (3.281 in) (83.3 mm)
Diámetro Int.: (21/32 in) (0.656 in) (16.6 mm)
Altura Total: (5 7/32 in) (5.218 in) (132.5 mm)
Principales aplicaciones: Tractores Caterpillar, Ford, New Holland, Motores Perkins
Principales equivalencias: Caterpillar 100-6374, 138-3100, New Holland 87801341, 87840591
Observaciones: Filtro Primario, utilice GPP-419 como secundario

GPP-426 FILTRO P/COMB.



Código: 2080
Diámetro Ext.: (3 9/32 in) (3.281 in) (83.3 mm)
Diámetro Int.: (21/32 in) (0.656 in) (16.6 mm)
Altura Total: (7 5/8 in) (7.625 in) (193.6 mm)
Principales aplicaciones: Tractores John Deere, Timberjack
Principales equivalencias: John Deere RE62423, RE 65431, Timberjack 431892, A431892
Observaciones: Filtro Primario

GP-428 FILTRO P/ACEITE



Código: 2057
Rosca: 3/4-16
Diámetro Ext.: (3 3/32 in) (3.093 in) (78.5 mm)
Altura Total: (3 51/64 in) (3.796 in) (96.4 mm)
Diámetro Ext. Empaque: (2.75 in) (2 3/4 in) (69.9 mm)
Diámetro Int. Empaque: (2.375 in) (2 3/8 in) (60.3 mm)
Altura Empaque: (0.375 in) (3/8 in) (9.5 mm)
Principales aplicaciones: Automóviles Seat, Volkswagen
Principales equivalencias: Volkswagen 030-115-561T

GP-430 FILTRO P/ACEITE



Código: 2002
Rosca: 3/4-16
Diámetro Ext.: (3 5/64 in) (3.078 in) (78.1 mm)
Altura Total: (4 27/32 in) (4.843 in) (123.0 mm)
Diámetro Ext. Empaque: (2.797 in) (2 51/64 in) (71 mm)
Diámetro Int. Empaque: (2.438 in) (2 7/16 in) (61.9 mm)
Altura Empaque: (0.281 in) (9/32 in) (7.1 mm)
Válvula de alivio: 34-38 PSI
Válvula anti drenaje: SI
Principales aplicaciones: Automóviles y Camionetas Audi, Seat, Volkswagen
Principales equivalencias: VAG 034115561A, 078115561K

GP-432 FILTRO P/ACEITE



Código: 2991
Rosca: 3/4-16
Diámetro Ext.: (3 3/4 in) (3.75 in) (95.2 mm)
Altura Total: (4 31/64 in) (4.484 in) (113.9 mm)
Diámetro Ext. Empaque: (2.797 in) (2 51/64 in) (71 mm)
Diámetro Int. Empaque: (2.438 in) (2 7/16 in) (61.9 mm)
Altura Empaque: (0.203 in) (13/64 in) (5.2 mm)
Válvula de alivio: 12-16 PSI
Válvula anti drenaje: SI
Principales aplicaciones: Camionetas Land Rover
Principales equivalencias: Rover ERR3340, Chrysler 2471400

GP-452 FILTRO P/ACEITE



Código: 2998
Rosca: M24X2
Diámetro Ext.: (3 5/64 in) (3.078 in) (78.1 mm)
Altura Total: (7 31/64 in) (7.484 in) (190.1 mm)
Diámetro Ext. Empaque: (2.813 in) (2 13/16 in) (71.4 mm)
Diámetro Int. Empaque: (2.469 in) (2 15/32 in) (62.7 mm)
Altura Empaque: (0.203 in) (13/64 in) (5.2 mm)
Válvula de alivio: 36-38 PSI
Válvula anti drenaje: SI
Principales aplicaciones: Automóviles y Camionetas Audi
Principales equivalencias: Volkswagen 077-115-561G

GP-453 FILTRO P/ACEITE



Código: 2992
Rosca: 13/16-16
Diámetro Ext.: (3 5/64 in) (3.078 in) (78.1 mm)
Altura Total: (4 27/32 in) (4.843 in) (123.0 mm)
Diámetro Ext. Empaque: (2.797 in) (2 51/64 in) (71 mm)
Diámetro Int. Empaque: (2.438 in) (2 7/16 in) (61.9 mm)
Altura Empaque: (0.203 in) (13/64 in) (5.2 mm)
Válvula de alivio: 12-16 PSI
Principales aplicaciones: Automóviles y Camionetas Land Rover
Principales equivalencias: Rover GFE378, LPW100160

GP-454 FILTRO P/ACEITE



Código: 2993
Rosca: 3/4-16
Diámetro Ext.: (3 5/64 in) (3.078 in) (78.1 mm)
Altura Total: (4 27/32 in) (4.843 in) (123.0 mm)
Diámetro Ext. Empaque: (2.797 in) (2 51/64 in) (71 mm)
Diámetro Int. Empaque: (2.438 in) (2 7/16 in) (61.9 mm)
Altura Empaque: (0.266 in) (17/64 in) (6.7 mm)
Válvula anti drenaje: SI
Principales aplicaciones: Automóviles Jaguar
Principales equivalencias: Jaguar XR8E6714AB, XR83332

GP-455 FILTRO P/ACEITE



Código: 2994
Rosca: 13/16-16
Diámetro Ext.: (3 5/64 in) (3.078 in) (78.1 mm)
Altura Total: (3 15/16 in) (3.937 in) (100.0 mm)
Diámetro Ext. Empaque: (2.797 in) (2 51/64 in) (71 mm)
Diámetro Int. Empaque: (2.438 in) (2 7/16 in) (61.9 mm)
Altura Empaque: (0.25 in) (1/4 in) (6.4 mm)
Válvula de alivio: 12-16 PSI
Válvula anti drenaje: SI
Principales aplicaciones: Automóviles y Camionetas Land Rover
Principales equivalencias: Rover AHU2880, LPW100230

GP-457 FILTRO P/ACEITE



Código: 2995
Rosca: 1-12
Diámetro Ext.: (3 5/64 in) (3.078 in) (78.1 mm)
Altura Total: (4 11/16 in) (4.687 in) (119.0 mm)
Diámetro Ext. Empaque: (2.797 in) (2 51/64 in) (71 mm)
Diámetro Int. Empaque: (2.438 in) (2 7/16 in) (61.9 mm)
Altura Empaque: (0.234 in) (15/64 in) (6 mm)
Válvula de alivio: 12-14 PSI
Válvula anti drenaje: SI
Principales aplicaciones: Automóviles Jaguar
Principales equivalencias: Jaguar EAZ1354, 96JV6714AA

GP-458 FILTRO P/COMB.



Código: 2937
Rosca: 1-14
Diámetro Ext.: (4 3/8 in) (4.375 in) (111.1 mm)
Altura Total: (5 15/16 in) (5.937 in) (150.8 mm)
Diámetro Ext. Empaque: (3.547 in) (3 35/64 in) (90.1 mm)
Diámetro Int. Empaque: (3.156 in) (3 5/32 in) (80.2 mm)
Altura Empaque: (0.219 in) (7/32 in) (5.6 mm)
Principales aplicaciones: Unidades de refrigeración Carrier
Principales equivalencias: Carrier 30-01090-01

GP-461 FILTRO P/ACEITE



Código: 2990
Rosca: M20X1.5
Diámetro Ext.: (3 5/64 in) (3.078 in) (78.1 mm)
Altura Total: (3 1/2 in) (3.5 in) (88.9 mm)
Diámetro Ext. Empaque: (2.797 in) (2 51/64 in) (71 mm)
Diámetro Int. Empaque: (2.438 in) (2 7/16 in) (61.9 mm)
Altura Empaque: (0.203 in) (13/64 in) (5.2 mm)
Válvula de alivio: 18-22 PSI
Válvula anti drenaje: SI
Principales aplicaciones: Automóviles y Camionetas Peugeot
Principales equivalencias: Peugeot 1109-RO, 1109-TO

GP-462 FILTRO P/ACEITE



Código: 2004
Rosca: M20X1.5
Diámetro Ext.: (3 7/64 in) (3.109 in) (78.9 mm)
Altura Total: (3 27/32 in) (3.843 in) (97.6 mm)
Diámetro Ext. Empaque: (2.797 in) (2 51/64 in) (71 mm)
Diámetro Int. Empaque: (2.438 in) (2 7/16 in) (61.9 mm)
Altura Empaque: (0.203 in) (13/64 in) (5.2 mm)
Válvula de alivio: 18-22 PSI
Válvula anti drenaje: SI
Principales aplicaciones: Automóviles y Camionetas Acura, Honda, Mazda, Peugeot
Principales equivalencias: Honda 15220-PC6-004, 15400-PH1-F02, Mazda 8173-23-802

GP-490 FILTRO P/ACEITE



Código: 2933
Rosca: 3/4-16
Diámetro Ext.: (3 1/32 in) (3.031 in) (76.9 mm)
Altura Total: (4 3/64 in) (4.046 in) (102.7 mm)
Diámetro Ext. Empaque: (2.484 in) (2 31/64 in) (63.1 mm)
Diámetro Int. Empaque: (2.172 in) (2 11/64 in) (55.2 mm)
Altura Empaque: (0.234 in) (15/64 in) (6 mm)
Principales aplicaciones: Unidades de refrigeración Carrier, King Bird y Tractores Massey Ferguson
Principales equivalencias: Massey Ferguson MF343171M1, Carrier 941172

GPP-523 FILTRO P/COMB.



Código: 2297
Rosca: 3/4-16
Diámetro Ext.: (3 9/32 in) (3.285 in) (83.4 mm)
Altura Total: (6 13/16 in) (6.815 in) (173.1 mm)
Rosca del puerto: M36X1.5
Principales aplicaciones: Camionetas Nissan D22 (Frontier) a diesel
Principales equivalencias: Nissan 165546-01T0A

GPP-524 FILTRO P/COMB.



Código: 2209
Rosca: M20X1.5
Diámetro Ext.: (3 7/8 in) (3.875 in) (98.4 mm)
Altura Total: (5 3/8 in) (5.375 in) (136.5 mm)
Rosca del puerto: M36X1.5
Principales aplicaciones: Camionetas H100 Diesel y camiones Isuzu ELF 400/450
Principales equivalencias: Hyundai 31973-44001, 31973-44100, Isuzu 8-94483-850-0, 8-98037-481-0

GPP-547 FILTRO P/COMB.



Código: 2073
Rosca: 1-14
Diámetro Ext.: (4 1/4 in) (4.25 in) (107.9 mm)
Altura Total: (6 21/32 in) (6.656 in) (169.0 mm)
Diámetro Ext. Empaque: (3.969 in) (3 31/32 in) (100.8 mm)
Diámetro Int. Empaque: (3.594 in) (3 19/32 in) (91.3 mm)
Altura Empaque: (0.25 in) (1/4 in) (6.4 mm)
Principales aplicaciones: Motores IHC, Navistar
Principales equivalencias: IHC 677004-C91, Fleetguard FS19547

GP-548 FILTRO P/COMB.



Código: 2133
Rosca: M20X1.5
Diámetro Ext.: (3 11/16 in) (3.687 in) (93.6 mm)
Altura Total: (7 1/8 in) (7.125 in) (180.9 mm)
Diámetro Ext. Empaque: (2.813 in) (2 13/16 in) (71.4 mm)
Diámetro Int. Empaque: (2.469 in) (2 15/32 in) (62.7 mm)
Altura Empaque: (0.203 in) (13/64 in) (5.2 mm)
Principales aplicaciones: Camiones Volkswagen, Motores Cummins
Principales equivalencias: Cummins 4897833, Fleetguard FF5420, FF5485

GP-556 FILTRO P/ACEITE



Código: 2989
Rosca: 1 3/8-16
Diámetro Ext.: (5 17/64 in) (5.265 in) (133.7 mm)
Altura Total: (9 1/8 in) (9.125 in) (231.7 mm)
Diámetro Ext. Empaque: (3.969 in) (3 31/32 in) (100.8 mm)
Diámetro Int. Empaque: (3.594 in) (3 19/32 in) (91.2 mm)
Altura Empaque: (0.250 in) (1/4 in) (6.4 mm)
Válvula anti drenaje: SI
Principales aplicaciones: Camiones Volvo
Principales equivalencias: Volvo 477556

GP-562 FILTRO P/ACEITE



Código: 2988
Rosca: 1 1/2-16
Diámetro Ext.: (4 17/64 in) (4.265 in) (108.3 mm)
Altura Total: (8 1/8 in) (8.125 in) (206.3 mm)
Diámetro Ext. Empaque: (3.969 in) (3 31/32 in) (100.8 mm)
Diámetro Int. Empaque: (3.469 in) (3 15/32 in) (88.1 mm)
Altura Empaque: (0.25 in) (1/4 in) (6.4 mm)
Principales aplicaciones: Camionetas Ford a diesel
Principales equivalencias: Ford F4TZ-6731A

GP-749 FILTRO P/COMB.



Código: 2012
Rosca: 1-14
Diámetro Ext.: (3 11/16 in) (3.687 in) (93.6 mm)
Altura Total: (10 1/2 in) (10.5 in) (266.7 mm)
Diámetro Ext. Empaque: (2.813 in) (2 13/16 in) (71.4 mm)
Diámetro Int. Empaque: (2.453 in) (2 29/64 in) (62.3 mm)
Altura Empaque: (0.203 in) (13/64 in) (5.2 mm)
Principales aplicaciones: Motores Caterpillar, Ford, Freightliner, IHC, Kenworth, Peterbilt, Sterling
Principales equivalencias: Caterpillar 1R0749, Fleetguard FF5319

GPP-612 FILTRO P/COMB.



Código: 2194
Diámetro Ext.: (3 19/32 in) (3.593 in) (91.3 mm)
Diámetro Int.: (15/32 in) (0.469 in) (11.9 mm)
Altura Total: (4 23/32 in) (4.719 in) (119.9 mm)
Principales aplicaciones: Camionetas Sprinter con motor OM611 y OM612
Principales equivalencias: Mercedes Benz A6120920001, Mann & Hummel WK 842/20

GP-754 FILTRO P/ACEITE



Código: 2938
Rosca: 1 1/2-16
Diámetro Ext.: (3 3/4 in) (3.75 in) (95.2 mm)
Altura Total: (5 3/4 in) (5.75 in) (146.0 mm)
Diámetro Ext. Empaque: (3.766 in) (3 49/64 in) (95.6 mm)
Diámetro Int. Empaque: (3.172 in) (3 11/64 in) (80.6 mm)
Altura Empaque: (0.469 in) (15/32 in) (11.9 mm)
Válvula de alivio: 18-22 PSI
Principales aplicaciones: Tractores y Motores John Deere
Principales equivalencias: John Deere RE59754

GP-642 FILTRO P/ACEITE



Código: 2934
Rosca: M26X1.5
Diámetro Ext.: (3 11/16 in) (3.687 in) (93.6 mm)
Altura Total: (7 1/8 in) (7.125 in) (180.9 mm)
Diámetro Ext. Empaque: (2.797 in) (2 51/64 in) (71 mm)
Diámetro Int. Empaque: (2.438 in) (2 7/16 in) (61.9 mm)
Altura Empaque: (0.203 in) (13/64 in) (5.2 mm)
Válvula anti drenaje: SI
Principales aplicaciones: Unidades de Refrigeración Thermo-King
Principales equivalencias: Thermo-King 11-7382, Fleetguard LF3642

GP-761H FILTRO P/ACEITE



Código: 2929
Rosca: 1 3/8-12
Diámetro Ext.: (3 13/16 in) (3.812 in) (96.8 mm)
Altura Total: (6 in) (6.000 in) (152.4 mm)
Diámetro Ext. Empaque: (2.766 in) (2 49/64 in) (70.2 mm)
Diámetro Int. Empaque: (2.484 in) (2 31/64 in) (63.1 mm)
Altura Empaque: (0.281 in) (9/32 in) (7.1 mm)
Principales aplicaciones: Tractores y Motores John Deere
Principales equivalencias: John Deere AL77061

GP-691 FILTRO P/ACEITE



Código: 2014
Rosca: 1 1/2-16
Diámetro Ext.: (5 3/8 in) (5.375 in) (136.5 mm)
Altura Total: (12 3/32 in) (12.093 in) (307.1 mm)
Diámetro Ext. Empaque: (4.328 in) (4 21/64 in) (109.9 mm)
Diámetro Int. Empaque: (3.813 in) (3 13/16 in) (96.8 mm)
Altura Empaque: (0.375 in) (3/8 in) (9.5 mm)
Principales aplicaciones: Tractores y Motores Caterpillar
Principales equivalencias: Caterpillar 1R0716, 2P4005

GP-864H FILTRO P/ACEITE



Código: 2928
Rosca: 1 1/2-16
Diámetro Ext.: (5 1/16 in) (5.062 in) (128.5 mm)
Altura Total: (6 31/32 in) (6.968 in) (177.0 mm)
Diámetro Ext. Empaque: (4.828 in) (4 53/64 in) (122.6 mm)
Diámetro Int. Empaque: (2.484 in) (2 31/64 in) (63.1 mm)
Altura Empaque: (0.188 in) (3/16 in) (4.8 mm)
Principales aplicaciones: Tractores y Motores John Deere
Principales equivalencias: John Deere RE45864

GP-737 FILTRO P/ACEITE



Código: 2134
Rosca: M27X2.0
Diámetro Ext.: (3 21/32 in) (3.656 in) (92.8 mm)
Altura Total: (6 13/16 in) (6.812 in) (173.0 mm)
Diámetro Ext. Empaque: (2.75 in) (2 3/4 in) (69.9 mm)
Diámetro Int. Empaque: (2.438 in) (2 7/16 in) (61.9 mm)
Altura Empaque: (0.203 in) (13/64 in) (5.2 mm)
Principales aplicaciones: Camiones Volkswagen, Motores Cummins
Principales equivalencias: Fleetguard LF3886, Wix 57037, Baldwin BT7237

GPP-1000 FILTRO P/COMB.



Código: 2925
Rosca: 1-14
Diámetro Ext.: (3 11/16 in) (3.687 in) (93.6 mm)
Altura Total: (9 17/32 in) (9.531 in) (242.0 mm)
Diámetro Ext. Empaque: (2.813 in) (2 13/16 in) (71.4 mm)
Diámetro Int. Empaque: (2.453 in) (2 29/64 in) (62.3 mm)
Altura Empaque: (0.203 in) (13/64 in) (5.2 mm)
Principales aplicaciones: Motores Cummins
Principales equivalencias: Cummins 3329289, Donaldson P551000

GPP-1003 FILTRO P/COMB.



Código: 2949
Rosca: 1-14
Diámetro Ext.: (3 11/16 in) (3.687 in) (93.6 mm)
Altura Total: (9 13/16 in) (9.812 in) (249.2 mm)
Diámetro Ext. Empaque: (2.813 in) (2 13/16 in) (71.4 mm)
Diámetro Int. Empaque: (2.453 in) (2 29/64 in) (62.3 mm)
Altura Empaque: (0.203 in) (13/64 in) (5.2 mm)
Principales aplicaciones: Motores Cummins
Principales equivalencias: Cummins 3406889, Fleetguard FS1003
Observaciones: Separador de agua con purgador y sensor

GPP-1007S FILTRO P/COMB.



Código: 2950
Rosca: M85X2.0
Diámetro Ext.: (4 21/32 in) (4.656 in) (118.2 mm)
Altura Total: (11 1/2 in) (11.5 in) (292.1 mm)
Diámetro Ext. Empaque: (4.672 in) (4 43/64 in) (118.7 mm)
Diámetro Int. Empaque: (4 in) (4 in) (101.6 mm)
Altura Empaque: (0.563 in) (9/16 in) (14.3 mm)
Principales aplicaciones: Motores Cummins, Mack, Volvo
Principales equivalencias: Cummins 3331096, Fleetguard FS1007
Observaciones: Separador de agua con purgador y sensor

GP-1010Q FILTRO P/AGUA



Código: 2037
Rosca: 11/16-16
Diámetro Ext.: (3 5/8 in) (3.625 in) (92.0 mm)
Altura Total: (5 13/32 in) (5.406 in) (137.3 mm)
Cantidad de unidades: 6
Diámetro Ext. Empaque: (2.844 in) (2 27/32 in) (72.2 mm)
Diámetro Int. Empaque: (2.484 in) (2 31/64 in) (63.1 mm)
Altura Empaque: (0.203 in) (13/64 in) (5.2 mm)
Principales aplicaciones: Allis Chalmers, Case, Ford, Komatsu
Principales equivalencias: Allis Chalmers 4029089-2, Ford E8NN-8A424-BB

GP-1011Q FILTRO P/AGUA



Código: 2141
Rosca: 11/16-16
Diámetro Ext.: (3 5/8 in) (3.625 in) (92.0 mm)
Altura Total: (5 13/32 in) (5.406 in) (137.3 mm)
Cantidad de unidades: 8
Diámetro Ext. Empaque: (2.844 in) (2 27/32 in) (72.2 mm)
Diámetro Int. Empaque: (2.484 in) (2 31/64 in) (63.1 mm)
Altura Empaque: (0.203 in) (13/64 in) (5.2 mm)
Principales aplicaciones: Allis Chalmers, Caterpillar, Cummins, Fiat-Allis, Hino, Komatsu, Nissan, Scania, Volvo, Wabco
Principales equivalencias: Allis Chalmers 4393504-8, Caterpillar 9Y4532, Komatsu 6710-61-8131

GP-1012Q FILTRO P/AGUA



Código: 2518
Rosca: 11/16-16
Diámetro Ext.: (3 5/8 in) (3.625 in) (92.0 mm)
Altura Total: (5 13/32 in) (5.406 in) (137.3 mm)
Cantidad de unidades: 12
Diámetro Ext. Empaque: (2.844 in) (2 27/32 in) (72.2 mm)
Diámetro Int. Empaque: (2.484 in) (2 31/64 in) (63.1 mm)
Altura Empaque: (0.203 in) (13/64 in) (5.2 mm)
Principales aplicaciones: Ford, Komatsu, New Holland
Principales equivalencias: New Holland 861361, 80861361

GP-1013Q FILTRO P/AGUA



Código: 2088
Rosca: 11/16-16
Diámetro Ext.: (3 5/8 in) (3.625 in) (92.0 mm)
Altura Total: (7 17/32 in) (7.531 in) (191.2 mm)
Cantidad de unidades: 16
Diámetro Ext. Empaque: (2.844 in) (2 27/32 in) (72.2 mm)
Diámetro Int. Empaque: (2.484 in) (2 31/64 in) (63.1 mm)
Altura Empaque: (0.203 in) (13/64 in) (5.2 mm)
Principales aplicaciones: Allis Chalmers, Caterpillar, Euclid, John Deere, Komatsu, Volvo
Principales equivalencias: Caterpillar 311292, John Deere AR94652, Volvo 207015007

GPP-1022S FILTRO P/COMB.



Código: 2951
Rosca: 1-14
Diámetro Ext.: (3 11/16 in) (3.687 in) (93.6 mm)
Altura Total: (9 3/4 in) (9.75 in) (247.6 mm)
Diámetro Ext. Empaque: (2.813 in) (2 13/16 in) (71.4 mm)
Diámetro Int. Empaque: (2.453 in) (2 29/64 in) (62.3 mm)
Altura Empaque: (0.203 in) (13/64 in) (5.2 mm)
Principales aplicaciones: Motores Cummins
Principales equivalencias: Cummins 3800394, Fleetguard FS1022
Observaciones: Separador de agua con purgador y sensor

GPP-1060 FILTRO P/COMB.



Código: 2111
Rosca: 1-12
Diámetro Ext.: (4 5/16 in) (4.312 in) (109.5 mm)
Altura del Elemento: (6 3/4 in) (6.75 in) (171.4 mm)
Altura Total: (9 1/2 in) (9.5 in) (241.3 mm)
Diámetro Ext. Empaque: (4.063 in) (4 1/16 in) (103.2 mm)
Diámetro Int. Empaque: (3.625 in) (3 5/8 in) (92.1 mm)
Altura Empaque: (0.063 in) (1/16 in) (1.6 mm)
Principales aplicaciones: Camiones y Autobuses Mercedes Benz, Volvo
Principales equivalencias: Mercedes Benz 9794770007, Mann & Hummel WK 1060

GPP-1061 FILTRO P/COMB.

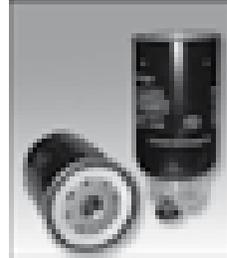

Código: 2191
Rosca: 1-14
Diámetro Ext.: (4 1/4 in) (4.250 in) (107.9 mm)
Altura Total: (10 27/32 in) (10.843 in) (275.4 mm)
Diámetro Ext. Empaque: (4.093 in) (4 3/32 in) (103.9 mm)
Diámetro Int. Empaque: (3.578 in) (3 37/64 in) (90.8 mm)
Altura Empaque: (0.063 in) (1/16 in) (1.6 mm)
Principales aplicaciones: Camiones y Autobuses Mercedes Benz, Scania, Volvo
Principales equivalencias: Scania 139 3640, Volvo 8129975, 8159975, Mann & Hummel WK 1060/1

GP-1101 FILTRO P/COMB.



Código: 2039
Rosca: 1-14
Diámetro Ext.: (3 5/8 in) (3.625 in) (92.0 mm)
Altura Total: (5 17/32 in) (5.531 in) (140.4 mm)
Diámetro Ext. Empaque: (2.844 in) (2 27/32 in) (72.2 mm)
Diámetro Int. Empaque: (2.484 in) (2 31/64 in) (63.1 mm)
Altura Empaque: (0.203 in) (13/64 in) (5.2 mm)
Principales aplicaciones: Motores Cummins, IHC
Principales equivalencias: Cummins 3315846, 4010476

GP-1105 FILTRO P/COMB.



Código: 2105
Rosca: 1-14
Diámetro Ext.: (3 5/8 in) (3.625 in) (92.0 mm)
Altura Total: (6 43/64 in) (6.671 in) (169.4 mm)
Diámetro Ext. Empaque: (2.844 in) (2 27/32 in) (72.2 mm)
Diámetro Int. Empaque: (2.484 in) (2 31/64 in) (63.1 mm)
Altura Empaque: (0.203 in) (13/64 in) (5.2 mm)
Principales aplicaciones: Galion, Hough, IHC, Navistar, Thermo king
Principales equivalencias: Galion 120302, IHC 625626-C1, 702143-C1, Thermo king 12-3692A
Observaciones: Filtro primario, utilice GP-78, GP-1107 o GP-1109 como secundario

GP-1107 FILTRO P/COMB.



Código: 2106
Rosca: 7/8-14
Diámetro Ext.: (3 5/8 in) (3.625 in) (92.0 mm)
Altura Total: (7 17/32 in) (7.531 in) (191.2 mm)
Diámetro Ext. Empaque: (2.844 in) (2 27/32 in) (72.2 mm)
Diámetro Int. Empaque: (2.484 in) (2 31/64 in) (63.1 mm)
Altura Empaque: (0.203 in) (13/64 in) (5.2 mm)
Principales aplicaciones: Galion, Hough, IHC, Navistar, Thermo king
Principales equivalencias: Galion 120301, IHC 359251-C1, 674293-C1, Thermo king 12-3855A
Observaciones: Filtro secundario, utilice GP-1105 o GP-1108 como primario

GP-1108 FILTRO P/COMB.



Código: 2117
Rosca: 1-14
Diámetro Ext.: (3 5/8 in) (3.625 in) (92.0 mm)
Altura Total: (7 17/32 in) (7.531 in) (191.2 mm)
Diámetro Ext. Empaque: (2.844 in) (2 27/32 in) (72.2 mm)
Diámetro Int. Empaque: (2.484 in) (2 31/64 in) (63.1 mm)
Altura Empaque: (0.203 in) (13/64 in) (5.2 mm)
Principales aplicaciones: Case, Caterpillar, Ford, Hough, IHC, Navistar, Sterling, Thermo king
Principales equivalencias: Caterpillar 9Y4429, IHC 625627-C1, Thermo king 12-5704A
Observaciones: Filtro primario, utilice GP-78, GP-1107 o GP-1109 como secundario

GP-1109 FILTRO P/COMB.



Código: 2119
Rosca: 7/8-14
Diámetro Ext.: (3 5/8 in) (3.625 in) (92.0 mm)
Altura Total: (7 17/32 in) (7.531 in) (191.2 mm)
Diámetro Ext. Empaque: (2.844 in) (2 27/32 in) (72.2 mm)
Diámetro Int. Empaque: (2.484 in) (2 31/64 in) (63.1 mm)
Altura Empaque: (0.203 in) (13/64 in) (5.2 mm)
Principales aplicaciones: Caterpillar, Freightliner, Sterling
Principales equivalencias: Caterpillar 1R0751, 1R0759, 6I4783
Observaciones: Filtro secundario, utilice GP-1108 o GP-1105 como primario

GP-1122 FILTRO P/COMB.



Código: 2096
Rosca: M16X1.5
Diámetro Ext.: (2 31/32 in) (2.968 in) (75.4 mm)
Altura Total: (4 41/64 in) (4.640 in) (117.8 mm)
Diámetro Ext. Empaque: (2.734 in) (2 47/64 in) (69.5 mm)
Diámetro Int. Empaque: (2.406 in) (2 13/32 in) (61.1 mm)
Altura Empaque: (0.234 in) (15/64 in) (6 mm)
Principales aplicaciones: Bomag, Case, Caterpillar, Cummins, Deutz, Fiat, Ford, IHC, M.A.N., Scania, Volvo, White
Principales equivalencias: Case J903640, Caterpillar 9Y4516, Cummins 3931063, IHC 3218794-R91
Observaciones: Filtro primario, utilice GPP-1122 como secundario

GPP-1122 FILTRO P/COMB.



Código: 2100
Rosca: M16X1.5
Diámetro Ext.: (2 15/16 in) (2.937 in) (74.6 mm)
Altura Total: (5 1/32 in) (5.031 in) (127.7 mm)
Diámetro Ext. Empaque: (2.734 in) (2 47/64 in) (69.5 mm)
Diámetro Int. Empaque: (2.406 in) (2 13/32 in) (61.1 mm)
Altura Empaque: (0.234 in) (15/64 in) (6 mm)
Principales aplicaciones: Bomag, Case, Cummins, Deutz, Fiat-allis, Ford, Hyster, IHC, Ingersoll-Rand, JCB, Komatsu, New Holland, Volvo
Principales equivalencias: Case 87039679, Cummins 3931062, IHC 3218793-R91, New Holland 87840509
Observaciones: Filtro secundario, utilice GP-1122 como primario

GP-1224 FILTRO P/COMB.



Código: 2197
Rosca: 1-14
Diámetro Ext.: (4 1/4 in) (4.250 in) (107.9 mm)
Altura Total: (5 29/32 in) (5.906 in) (150.0 mm)
Diámetro Ext. Empaque: (3.968 in) (3 31/32 in) (100.7 mm)
Diámetro Int. Empaque: (3.593 in) (3 19/32 in) (91.2 mm)
Altura Empaque: (0.250 in) (1/4 in) (6.3 mm)
Principales aplicaciones: Unidades de refrigeración Carrier
Principales equivalencias: Carrier 30-01090-00, 30-01090-04, 30-0109005

GP-1232 FILTRO P/COMB.



Código: 2007
Rosca: M16X2.5
Diámetro Ext.: (3 1/16 in) (3.062 in) (77.7 mm)
Altura Total: (4 13/16 in) (4.812 in) (122.2 mm)
Diámetro Ext. Empaque: (2.797 in) (2 51/64 in) (71 mm)
Diámetro Int. Empaque: (2.469 in) (2 15/32 in) (62.7 mm)
Altura Empaque: (0.25 in) (1/4 in) (6.4 mm)
Principales aplicaciones: Camiones y Camionetas Dodge con motor a diesel
Principales equivalencias: Chrysler 4429107, Fleetguard FS1232

GPP-1287 FILTRO P/COMB.



Código: 2953
Rosca: 1-14
Diámetro Ext.: (4 1/4 in) (4.25 in) (107.9 mm)
Altura Total: (7 1/16 in) (7.062 in) (179.3 mm)
Diámetro Ext. Empaque: (3.969 in) (3 31/32 in) (100.8 mm)
Diámetro Int. Empaque: (3.594 in) (3 19/32 in) (91.3 mm)
Altura Empaque: (0.25 in) (1/4 in) (6.4 mm)
Principales aplicaciones: Motores Ford 401 a diesel, Unidades de Refrigeración Carrier
Principales equivalencias: Ford F1HZ-9365A, Carrier 30-01079

GPP-1291 FILTRO P/COMB.



Código: 2926
Rosca: 1-14
Diámetro Ext.: (4 1/4 in) (4.25 in) (107.9 mm)
Altura Total: (8 9/16 in) (8.562 in) (217.4 mm)
Diámetro Ext. Empaque: (3.969 in) (3 31/32 in) (100.8 mm)
Diámetro Int. Empaque: (3.594 in) (3 19/32 in) (91.3 mm)
Altura Empaque: (0.25 in) (1/4 in) (6.4 mm)
Principales aplicaciones: Camiones IHC (1992-97), Motores Caterpillar, Cummins, Detroit Diesel
Principales equivalencias: IHC 1685159-C91, Fleetguard FS1291

GP-2015W FILTRO P/AGUA



Código: 2304
Rosca: 3/4-20
Diámetro Ext.: (3 5/8 in) (3.625 in) (92.0 mm)
Altura Total: (5 13/32 in) (5.406 in) (137.3 mm)
Cantidad de unidades: 8
Diámetro Ext. Empaque: (2.844 in) (2 27/32 in) (72.2 mm)
Diámetro Int. Empaque: (2.484 in) (2 31/64 in) (63.1 mm)
Altura Empaque: (0.203 in) (13/64 in) (5.2 mm)
Principales aplicaciones: Camiones y Motores Mack
Principales equivalencias: Mack 25MF435, 25MF435B

GP-2022W FILTRO P/AGUA



Código: 2318
Rosca: 1-16
Diámetro Ext.: (4 17/64 in) (4.265 in) (108.3 mm)
Altura Total: (5 33/64 in) (5.515 in) (140.0 mm)
Cantidad de unidades: 12
Diámetro Ext. Empaque: (3.969 in) (3 31/32 in) (100.8 mm)
Diámetro Int. Empaque: (3.547 in) (3 35/64 in) (90.1 mm)
Altura Empaque: (0.297 in) (19/64 in) (7.5 mm)
Principales aplicaciones: Camiones y Motores Mack
Principales equivalencias: Mack 25MF422, 25MF436B

GP-2071W FILTRO P/AGUA



Código: 2320
Rosca: 1 1/16-16
Diámetro Ext.: (3 5/8 in) (3.625 in) (92.0 mm)
Altura Total: (4 15/64 in) (4.234 in) (107.5 mm)
Cantidad de unidades: 4
Diámetro Ext. Empaque: (2.844 in) (2 27/32 in) (72.2 mm)
Diámetro Int. Empaque: (2.484 in) (2 31/64 in) (63.1 mm)
Altura Empaque: (0.203 in) (13/64 in) (5.2 mm)
Principales aplicaciones: Allis Chalmers, Case, Caterpillar, Cummins, Fiat-Allis, Ford, Freightliner, General Motors, IHC, John Deere, Kenworth, Komatsu
Principales equivalencias: Caterpillar 9N3717, Cummins 3318157, John Deere RE42052

GP-2108W FILTRO P/AGUA



Código: 2058
Rosca: M16X1.5
Diámetro Ext.: (3 11/16 in) (3.687 in) (93.6 mm)
Altura Total: (5 7/16 in) (5.437 in) (138.1 mm)
Cantidad de unidades: 8
Diámetro Ext. Empaque: (2.328 in) (2 21/64 in) (59.1 mm)
Diámetro Int. Empaque: (2.328 in) (2 21/64 in) (59.1 mm)
Altura Empaque: (0.25 in) (1/4 in) (6.4 mm)
Principales aplicaciones: Camiones, Autobuses y Motores Volvo
Principales equivalencias: Volvo 3945411, Fleetguard WF2108

GP-2126Q FILTRO P/AGUA



Código: 2927
Rosca: M36X2.0
Diámetro Ext.: (3 3/4 in) (3.75 in) (95.2 mm)
Altura Total: (5 15/32 in) (5.468 in) (138.9 mm)
Cantidad de unidades: 11.5
Diámetro Ext. Empaque: (3.719 in) (3 23/32 in) (94.5 mm)
Diámetro Int. Empaque: (3.172 in) (3 11/64 in) (80.6 mm)
Altura Empaque: (0.188 in) (3/16 in) (4.8 mm)
Principales aplicaciones: Motores Cummins, Volvo, Mack
Principales equivalencias: Cummins 3680433, Fleetguard WF2126
Cantidad de unidades: 11 1/2

GP-2127W FILTRO P/AGUA



Código: 2011
Rosca: M36X2.0
Diámetro Ext.: (3 3/4 in) (3.75 in) (95.2 mm)
Altura Total: (5 15/32 in) (5.468 in) (138.9 mm)
Cantidad de unidades: 0
Diámetro Ext. Empaque: (3.719 in) (3 23/32 in) (94.5 mm)
Diámetro Int. Empaque: (3.172 in) (3 11/64 in) (80.6 mm)
Altura Empaque: (0.188 in) (3/16 in) (4.8 mm)
Principales aplicaciones: Motores Cummins
Principales equivalencias: Cummins 3680434, Fleetguard WF2127
Cantidad de unidades: 0

GP-2951 FILTRO P/ACEITE



Código: 2176
Rosca: 3/4-16
Diámetro Ext.: (3 19/64 in) (3.296 in) (83.7 mm)
Altura Total: (3 15/16 in) (3.937 in) (100.0 mm)
Diámetro Ext. Empaque: (2.5 in) (2 1/2 in) (63.5 mm)
Diámetro Int. Empaque: (1.813 in) (1 13/16 in) (46 mm)
Altura Empaque: (0.125 in) (1/8 in) (3.2 mm)
Válvula de alivio: 8-12 PSI
Válvula anti drenaje: SI
Principales aplicaciones: Automóviles y Camionetas Chevrolet, Suzuki
Principales equivalencias: General Motors 96058042, Suzuki 16510-85FA0

GP-3000 FILTRO P/ACEITE



Código: 2277
Rosca: 2 1/4-12
Diámetro Ext.: (4 61/64 in) (4.953 in) (125.8 mm)
Altura Total: (11 23/64 in) (11.359 in) (288.5 mm)
Diámetro Ext. Empaque: (4.625 in) (4 5/8 in) (117.5 mm)
Diámetro Int. Empaque: (3.953 in) (3 61/64 in) (100.4 mm)
Altura Empaque: (0.469 in) (15/32 in) (11.9 mm)
Principales aplicaciones: Case, Cummins, Fiat-Allis, Ford, Freightliner, Ingersoll-Rand, John Deere, Kenworth, Komatsu, New Holland, Volvo
Principales equivalencias: Ford E9PJ-6714-AA, John Deere RE44647, Volvo 991218853

GP-3001 FILTRO P/ACEITE



Código: 2006
Rosca: 2 1/4-12
Diámetro Ext.: (4 19/32 in) (4.593 in) (116.6 mm)
Altura Total: (11 13/32 in) (11.406 in) (289.7 mm)
Diámetro Ext. Empaque: (4.625 in) (4 5/8 in) (117.5 mm)
Diámetro Int. Empaque: (3.953 in) (3 61/64 in) (100.4 mm)
Altura Empaque: (0.234 in) (15/64 in) (6 mm)
Principales aplicaciones: Motores Cummins
Principales equivalencias: Cummins 3401544, John Deere AT193242

GP-3429 FILTRO P/ACEITE



Código: 2167
Rosca: 13/16-16
Diámetro Ext.: (3 5/64 in) (3.078 in) (78.1 mm)
Altura Total: (4 45/64 in) (4.703 in) (119.4 mm)
Diámetro Ext. Empaque: (2.844 in) (2 27/32 in) (72.2 mm)
Diámetro Int. Empaque: (2.484 in) (2 31/64 in) (63.1 mm)
Altura Empaque: (0.203 in) (13/64 in) (5.2 mm)
Principales aplicaciones: Automóviles Cadillac
Principales equivalencias: General Motors 25010276, 25010324

GP-3531 EXP FILTRO P/ACEITE



Código: 2168
Rosca: M22X1.5
Diámetro Ext.: (3 5/8 in) (3.625 in) (92.0 mm)
Altura Total: (3 3/16 in) (3.187 in) (80.9 mm)
Diámetro Ext. Empaque: (2.844 in) (2 27/32 in) (72.2 mm)
Diámetro Int. Empaque: (2.484 in) (2 31/64 in) (63.1 mm)
Altura Empaque: (0.203 in) (13/64 in) (5.2 mm)
Válvula de alivio: 8-12 PSI
Válvula anti drenaje: SI
Principales aplicaciones: Automóviles Honda Civic (1982-1987)
Principales equivalencias: Honda 15400-689-004, 15400-PA6-305

GP-3675 FILTRO P/ACEITE



Código: 2333
Rosca: 13/16-16
Diámetro Ext.: (3 5/64 in) (3.078 in) (78.1 mm)
Altura Total: (4 7/64 in) (4.109 in) (104.3 mm)
Diámetro Ext. Empaque: (2.844 in) (2 27/32 in) (72.2 mm)
Diámetro Int. Empaque: (2.484 in) (2 31/64 in) (63.1 mm)
Altura Empaque: (0.203 in) (13/64 in) (5.2 mm)
Válvula anti drenaje: SI
Principales aplicaciones: Automóviles y Camionetas Cadillac, Chevrolet, GMC, Hummer, Pontiac
Principales equivalencias: General Motors 88925275, 89017342

GP-3562 FILTRO P/ACEITE



Código: 2170
Rosca: M20X1.5
Diámetro Ext.: (3 5/8 in) (3.625 in) (92.0 mm)
Altura Total: (3 3/16 in) (3.187 in) (80.9 mm)
Diámetro Ext. Empaque: (2.844 in) (2 27/32 in) (72.2 mm)
Diámetro Int. Empaque: (2.484 in) (2 31/64 in) (63.1 mm)
Altura Empaque: (0.203 in) (13/64 in) (5.2 mm)
Válvula de alivio: 8-12 PSI
Válvula anti drenaje: SI
Principales aplicaciones: Automóviles Renault Laguna (2001)
Principales equivalencias: Walmi WS-3562

GP-3682 FILTRO P/ACEITE



Código: 2174
Rosca: 3/4-16
Diámetro Ext.: (3 5/64 in) (3.078 in) (78.1 mm)
Altura Total: (4 7/64 in) (4.109 in) (104.3 mm)
Diámetro Ext. Empaque: (2.844 in) (2 27/32 in) (72.2 mm)
Diámetro Int. Empaque: (2.484 in) (2 31/64 in) (63.1 mm)
Altura Empaque: (0.203 in) (13/64 in) (5.2 mm)
Válvula anti drenaje: SI
Principales aplicaciones: Automóviles y Camionetas, Infiniti, Mini, Nissan, Subaru
Principales equivalencias: Nissan 15208-H8904, 32622-90002

GP-3569 FILTRO P/ACEITE



Código: 2331
Rosca: 3/4-16
Diámetro Ext.: (5 3/8 in) (5.375 in) (136.5 mm)
Altura Total: (3 5/8 in) (3.625 in) (92.1 mm)
Diámetro Ext. Empaque: (in) (in) (mm)
Diámetro Int. Empaque: (in) (in) (mm)
Altura Empaque: (in) (in) (mm)
Válvula de alivio: 27.5-36.2 PSI
Válvula anti drenaje:
Principales aplicaciones: Automóviles y Camionetas Audi, Volkswagen
Principales equivalencias: Volkswagen 068 115 561B, 068 115 561E

GP-3766 FILTRO P/ACEITE



Código: 2178
Rosca: 1 1/2-16
Diámetro Ext.: (4 17/64 in) (4.265 in) (108.3 mm)
Altura Total: (5 41/64 in) (5.640 in) (143.2 mm)
Diámetro Ext. Empaque: (3.969 in) (3 31/32 in) (100.8 mm)
Diámetro Int. Empaque: (3.547 in) (3 35/64 in) (90.1 mm)
Altura Empaque: (0.297 in) (19/64 in) (7.5 mm)
Principales aplicaciones: Vans y Camionetas Ford con motor a diesel
Principales equivalencias: Ford E3TZ-6731-A, IHC 1804442-C1

GP-3600 FILTRO P/ACEITE



Código: 2212
Rosca: 3/4-16
Diámetro Ext.: (3 5/64 in) (3.078 in) (78.1 mm)
Altura Total: (4 45/64 in) (4.703 in) (119.4 mm)
Diámetro Ext. Empaque: (2.844 in) (2 27/32 in) (72.2 mm)
Diámetro Int. Empaque: (2.484 in) (2 31/64 in) (63.1 mm)
Altura Empaque: (0.203 in) (13/64 in) (5.2 mm)
Válvula de alivio: 8-12 PSI
Válvula anti drenaje: SI
Principales aplicaciones: Automóviles y Camionetas Dodge, Ford, Jaguar, Jeep, Lincoln, Mazda, Mercury, Toyota
Principales equivalencias: Chrysler 4781452AA, Ford E4FZ-6731-A

GP-3816 FILTRO P/ACEITE

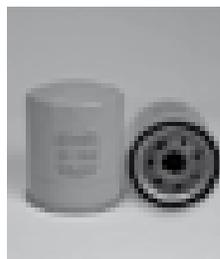

Código: 2330
Rosca: 3/4-16
Diámetro Ext.: (3 3/64 in) (3.046 in) (77.3 mm)
Altura Total: (3 11/32 in) (3.343 in) (84.9 mm)
Válvula de alivio: 28-32 PSI
Diámetro Ext. Empaque: (2.844 in) (2 27/32 in) (72.2 mm)
Diámetro Int. Empaque: (2.484 in) (2 31/64 in) (63.1 mm)
Altura Empaque: (0.203 in) (13/64 in) (5.2 mm)
Principales aplicaciones: Automóviles Audi, Motores Deutz, Tractores Pequeños John Deere
Principales equivalencias: Deutz 1174416, John Deere HE122-0338, Volkswagen 035-115-591

GP-3600 GOLD FILTRO P/ACEITE

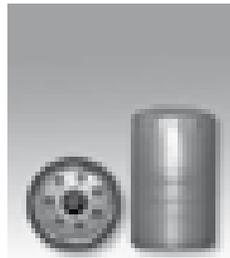

Código: 2151
Rosca: 3/4-16
Diámetro Ext.: (3 5/64 in) (3.078 in) (78.1 mm)
Altura Total: (4 45/64 in) (4.703 in) (119.4 mm)
Diámetro Ext. Empaque: (2.844 in) (2 27/32 in) (72.2 mm)
Diámetro Int. Empaque: (2.484 in) (2 31/64 in) (63.1 mm)
Altura Empaque: (0.203 in) (13/64 in) (5.2 mm)
Válvula de alivio: 8-12 PSI
Válvula anti drenaje: SI
Principales aplicaciones: Automóviles y Camionetas Dodge, Ford, Jaguar, Jeep, Lincoln, Mazda, Mercury, Toyota, modelos recientes que utilicen aceite sintético
Principales equivalencias: Chrysler 4781452AA, Ford E4FZ-6731-A

GP-3937 FILTRO P/ACEITE



Código: 2948
Rosca: 1 1/8-16
Diámetro Ext.: (3 11/16 in) (3.687 in) (93.6 mm)
Altura Total: (7 3/16 in) (7.187 in) (182.5 mm)
Diámetro Ext. Empaque: (2.844 in) (2 27/32 in) (72.2 mm)
Diámetro Int. Empaque: (2.547 in) (2 35/64 in) (64.7 mm)
Altura Empaque: (0.281 in) (9/32 in) (7.1 mm)
Principales aplicaciones: Motores Cummins
Principales equivalencias: Cummins 3937144, Fleetguard LF3937

GP-3980 FILTRO P/ACEITE



Código: 2322
Rosca: M18X1.5
Diámetro Ext.: (3 5/64 in) (3.078 in) (78.1 mm)
Altura Total: (4 45/64 in) (4.703 in) (119.4 mm)
Diámetro Ext. Empaque: (2.844 in) (2 27/32 in) (72.2 mm)
Diámetro Int. Empaque: (2.484 in) (2 31/64 in) (63.1 mm)
Altura Empaque: (0.203 in) (13/64 in) (5.2 mm)
Válvula anti drenaje: SI
Principales aplicaciones: Automóviles y Camionetas Chevrolet, Isuzu, Pontiac
Principales equivalencias: General Motors 25012757, 91066585

GP-9586 FILTRO P/ACEITE



Código: 2216
Rosca: 1 1/8-16
Diámetro Ext.: (3 5/8 in) (3.625 in) (92.0 mm)
Altura Total: (5 13/32 in) (5.406 in) (137.3 mm)
Diámetro Ext. Empaque: (2.844 in) (2 27/32 in) (72.2 mm)
Diámetro Int. Empaque: (2.484 in) (2 31/64 in) (63.1 mm)
Altura Empaque: (0.203 in) (13/64 in) (5.2 mm)
Principales aplicaciones: Caterpillar, Ford, General Motors, Hino, IHC, Isuzu, Mack, White
Principales equivalencias: Caterpillar 8T7427, General Motors 25312506

GP-3985 FILTRO P/ACEITE



Código: 2319
Rosca: M20X1.5
Diámetro Ext.: (3 5/8 in) (3.625 in) (92.0 mm)
Altura Total: (3 45/64 in) (3.703 in) (94.0 mm)
Diámetro Ext. Empaque: (2.844 in) (2 27/32 in) (72.2 mm)
Diámetro Int. Empaque: (2.484 in) (2 31/64 in) (63.1 mm)
Altura Empaque: (0.203 in) (13/64 in) (5.2 mm)
Válvula de alivio: 8-12 PSI
Válvula anti drenaje: SI
Principales aplicaciones: Automóviles y Camionetas Dodge, Jeep, Peugeot, Equipo Pesado Caterpillar, Hyster, Komatsu, Perkins
Principales equivalencias: Chrysler 33004195, Caterpillar 311128, Komatsu 372020F104

GP-6811 FILTRO P/ACEITE



Código: 2332
Rosca: M20X1.5
Diámetro Ext.: (3 19/64 in) (3.296 in) (83.7 mm)
Altura Total: (2 61/64 in) (2.953 in) (75.0 mm)
Diámetro Ext. Empaque: (2.484 in) (2 31/64 in) (63.1 mm)
Diámetro Int. Empaque: (1.813 in) (1 13/16 in) (46 mm)
Altura Empaque: (0.125 in) (1/8 in) (3.2 mm)
Válvula de alivio: 8-12 PSI
Válvula anti drenaje: SI
Principales aplicaciones: Automóviles y Camionetas Chrysler, Dodge, Honda, Hyundai, Mitsubishi, Equipo Pesado IHC, Komatsu
Principales equivalencias: Honda 15400-PT7-005, Hyundai 26300-35501

GP-9000 FILTRO P/ACEITE



Código: 2924
Rosca: M95X2.5
Diámetro Ext.: (4 21/32 in) (4.656 in) (118.2 mm)
Altura Total: (13 7/8 in) (13.875 in) (352.4 mm)
Diámetro Ext. Empaque: (4.656 in) (4 21/32 in) (118.3 mm)
Diámetro Int. Empaque: (3.953 in) (3 61/64 in) (100.4 mm)
Altura Empaque: (0.594 in) (19/32 in) (15.1 mm)
Principales aplicaciones: Motores Cummins, Mack, Volvo
Principales equivalencias: Cummins 3406810, Fleetguard LF9000

GP-9001 FILTRO P/ACEITE



Código: 2947
Rosca: M95X2.5
Diámetro Ext.: (4 21/32 in) (4.656 in) (118.2 mm)
Altura Total: (11 23/32 in) (11.718 in) (297.6 mm)
Diámetro Ext. Empaque: (4.656 in) (4 21/32 in) (118.3 mm)
Diámetro Int. Empaque: (3.953 in) (3 61/64 in) (100.4 mm)
Altura Empaque: (0.594 in) (19/32 in) (15.1 mm)
Principales aplicaciones: Motores Cummins, Mack, Volvo
Principales equivalencias: Cummins 3406809, Fleetguard LF9001

Filtros Tipo Cartucho

Cartridge Filters

G-6 FILTRO P/ACEITE



Código: 1006
Diámetro Ext.: (3 27/32 in) (3.843 in) (97.6 mm)
Diámetro Int.: (13/16 in) (0.812 in) (20.6 mm)
Altura Total: (4 53/64 in) (4.828 in) (122.6 mm)
Principales aplicaciones: Ford, Allis chalmers, Case, Clark, Fuller
Principales equivalencias: Allis chalmers 4372517, Fleetguard LF512

G-34 FILTRO P/ACEITE



Código: 1015
Diámetro Ext.: (3 17/32 in) (3.531 in) (89.6 mm)
Diámetro Int.: (1 1/4 in) (1.25 in) (31.7 mm)
Altura Total: (8 9/16 in) (8.562 in) (217.4 mm)
Principales aplicaciones: Camiones y Motores General Motors
Principales equivalencias: General Motors 6437562, 6439977

G-24 FILTRO P/ACEITE



Código: 1183
Diámetro Ext.: (2 13/16 in) (2.812 in) (71.4 mm)
Diámetro Int.: (1 29/32 in) (1.906 in) (48.4 mm)
Altura Total: (5 31/32 in) (5.968 in) (151.6 mm)
Principales aplicaciones: Sistemas Hidraulicos de las gruas Hiab-Foco
Principales equivalencias: Hiab 9961941, Fleetguard HF6306

G-45 FILTRO P/ACEITE



Código: 1341
Diámetro Ext.: (2 31/64 in) (2.484 in) (63.1 mm)
Diámetro Int.: (57/64 in) (0.890 in) (22.6 mm)
Altura Total: (3 1/32 in) (3.031 in) (76.9 mm)
Principales aplicaciones: Automóviles Chevrolet
Principales equivalencias: General Motors 21018826, 90536362

G-25 FILTRO P/ACEITE



Código: 1399
Diámetro Ext.: (3 3/64 in) (3.047 in) (77.4 mm)
Diámetro Int.: (61/64 in) (0.953 in) (24.2 mm)
Altura Total: (2 61/64 in) (2.953 in) (75.0 mm)
Principales aplicaciones: Camionetas Nissan D22 (Frontier) a diesel
Principales equivalencias: Nissan 15208-AD300, 15208-5M300

G-49 FILTRO P/ACEITE

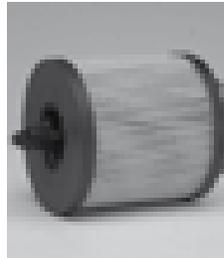

Código: 1358
Diámetro Ext.: (2 17/32 in) (2.531 in) (64.2 mm)
Diámetro Int.: (1 1/4 in) (1.25 in) (31.7 mm)
Altura Total: (3 1/2 in) (3.5 in) (88.9 mm)
Principales aplicaciones: Automóviles Chevrolet, Pontiac, Saab
Principales equivalencias: General Motors 24460713, 93175493

G-31 FILTRO P/ACEITE



Código: 1011
Diámetro Ext.: (4 19/64 in) (4.296 in) (109.1 mm)
Diámetro Int.: (43/64 in) (0.671 in) (17.0 mm)
Altura Total: (7 13/16 in) (7.812 in) (198.4 mm)
Principales aplicaciones: Carrier, Case, Caterpillar, Chicago Pneumatic, Chrysler, Clark, Continental Teledyne, Detroit Diesel, Deutz, Euclid, IHC, Mercedes Benz, P&H
Principales equivalencias: Caterpillar 9Y4497, General Motors 557009297, IHC 422547-C1

G-70 FILTRO P/ACEITE



Código: 1342
Diámetro Ext.: (2 9/16 in) (2.562 in) (65.0 mm)
Diámetro Int.: (1 in) (1.000 in) (25.4 mm)
Altura Total: (2 61/64 in) (2.953 in) (75.0 mm)
Principales aplicaciones: Automóviles y Camionetas Ford, Mazda, Mercury
Principales equivalencias: Ford 3M4Z-6744-AC, Mazda L321-14-302-9U

G-33 FILTRO P/ACEITE



Código: 1013
Diámetro Ext.: (4 19/64 in) (4.296 in) (109.1 mm)
Diámetro Int.: (1 25/64 in) (1.390 in) (35.3 mm)
Altura Total: (9 in) (9.000 in) (228.6 mm)
Principales aplicaciones: Allis Chalmers, Case, Clark, Detroit Diesel, Euclid, General Motors, Hough, Kenworth, Mack, Michigan
Principales equivalencias: Allis Chalmers 4369988-0, General Motors 25011193

G-72 FILTRO P/ACEITE



Código: 1402
Diámetro Ext.: (3 in) (3.000 in) (76.2 mm)
Diámetro Int.: (59/64 in) (0.922 in) (23.4 mm)
Altura Total: (4 45/64 in) (4.703 in) (119.5 mm)
Principales aplicaciones: Automóviles y Camionetas Volvo
Principales equivalencias: Volvo 1275810, 1275811, 1275811-6

G-112 FILTRO P/ACEITE



Código: 1335
Diámetro Ext.: (3 17/64 in) (3.265 in) (82.9 mm)
Diámetro Int.: (1 1/2 in) (1.5 in) (38.1 mm)
Diámetro Int.: (7/8 in) (0.875 in) (22.2 mm)
Altura Total: (4 3/8 in) (4.375 in) (111.1 mm)
Principales aplicaciones: Automóviles Volkswagen
Principales equivalencias: Volkswagen 021-115-561B

G-139 FILTRO P/ACEITE



Código: 1035
Diámetro Ext.: (3 13/64 in) (3.203 in) (81.3 mm)
Diámetro Int.: (1 5/8 in) (1.625 in) (41.2 mm)
Altura Total: (6 29/64 in) (6.453 in) (163.9 mm)
Principales aplicaciones: Tractores John Deere
Principales equivalencias: John Deere AR26350, AT15088

G-119 FILTRO P/ACEITE



Código: 1024
Diámetro Ext.: (4 19/64 in) (4.296 in) (109.1 mm)
Diámetro Int.: (1 27/64 in) (1.421 in) (36.1 mm)
Altura Total: (5 9/16 in) (5.562 in) (141.2 mm)
Principales aplicaciones: Clark, Cleveland, General Motors, IHC, Ingersoll-Rand, Michigan
Principales equivalencias: Clark 946008, General Motors 5574978

G-141 FILTRO P/ACEITE



Código: 1346
Diámetro Ext.: (2 5/16 in) (2.312 in) (58.7 mm)
Diámetro Int.: (7/8 in) (0.875 in) (22.2 mm)
Altura del Elemento: (3 31/32 in) (3.968 in) (100.8 mm)
Altura Total: (5 19/32 in) (5.593 in) (142.0 mm)
Principales aplicaciones: Automóviles y Camionetas Peugeot
Principales equivalencias: Peugeot 1109R6

G-122 FILTRO P/ACEITE



Código: 1025
Diámetro Ext.: (4 61/64 in) (4.953 in) (125.8 mm)
Diámetro Int.: (3 19/64 in) (3.296 in) (83.7 mm)
Altura Total: (6 1/16 in) (6.062 in) (153.9 mm)
Principales aplicaciones: Tractores IHC
Principales equivalencias: IHC 385683-R1, 70432-C91

G-143 FILTRO P/ACEITE



Código: 1209
Diámetro Ext.: (4 37/64 in) (4.578 in) (116.2 mm)
Diámetro Int.: (2 1/4 in) (2.25 in) (57.1 mm)
Altura Total: (9 49/64 in) (9.765 in) (248.0 mm)
Principales aplicaciones: Camiones y Autobuses M.A.N., Mercedes Benz
Principales equivalencias: M.A.N. 81-05504-0041, Mercedes Benz 4031840025

G-128 FILTRO P/COMB.



Código: 1300
Diámetro Ext.: (3 59/64 in) (3.921 in) (99.6 mm)
Diámetro Int.: (43/64 in) (0.671 in) (17.0 mm)
Altura Total: (4 13/64 in) (4.203 in) (106.7 mm)
Principales aplicaciones: Motores Detroit Diesel Serie 60 (con sistema Fuel-Pro)
Principales equivalencias: General Motors 23514049, Fleetguard FS1029

G-152 FILTRO P/ACEITE



Código: 1152
Diámetro Ext.: (3 27/32 in) (3.843 in) (97.6 mm)
Diámetro Int.: (2 7/32 in) (2.218 in) (56.3 mm)
Altura Total: (9 7/32 in) (9.218 in) (234.1 mm)
Principales aplicaciones: Caterpillar, Kenworth, Komatsu, Navistar
Principales equivalencias: Caterpillar 2M9156, 9W6427

G-133 FILTRO P/ACEITE



Código: 1203
Diámetro Ext.: (4 19/64 in) (4.296 in) (109.1 mm)
Diámetro Int.: (35/64 in) (0.546 in) (13.8 mm)
Altura Total: (9 33/64 in) (9.515 in) (241.6 mm)
Principales aplicaciones: Motores Mercedes Benz
Principales equivalencias: Mercedes Benz 11843325, Fleetguard LF3340

G-153 FILTRO P/ACEITE



Código: 1185
Diámetro Ext.: (6 55/64 in) (6.859 in) (174.2 mm)
Diámetro Int.: (3 15/16 in) (3.937 in) (100.0 mm)
Altura Total: (9 1/64 in) (9.015 in) (228.9 mm)
Principales aplicaciones: Equipo Caterpillar
Principales equivalencias: Caterpillar 3I0592, 9Y4521

G-159 FILTRO P/ACEITE

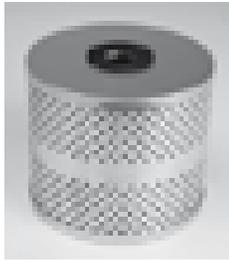

Código: 1210
Diámetro Ext.: (4 3/4 in) (4.75 in) (120.6 mm)
Diámetro Int.: (7/8 in) (0.875 in) (22.2 mm)
Altura Total: (4 1/32 in) (4.031 in) (102.3 mm)
Principales aplicaciones: Camiones Freightliner, IHC, Kenworth, Volvo
Principales equivalencias: IHC 598698-C1, Kenworth KW-637

G-179 FILTRO P/COMB.



Código: 1400
Diámetro Ext. del Elemento: (3 53/64 in) (3.828 in) (97.2 mm)
Diámetro Int.: (59/64 in) (0.922 in) (23.4 mm)
Altura Total: (4 31/64 in) (4.484 in) (113.9 mm)
Principales aplicaciones: Camiones Isuzu ELF 300
Principales equivalencias: Isuzu 8-98037-011-0

G-162H FILTRO P/ACEITE HIDRÁULICO



Código: 1288
Diámetro Ext.: (2 9/32 in) (2.281 in) (57.9 mm)
Diámetro Int.: (45/64 in) (0.703 in) (17.8 mm)
Altura Total: (3 15/16 in) (3.937 in) (100.0 mm)
Principales aplicaciones: Camiones y Autobuses IHC, M.A.N., Mercedes Benz, Scania, Volvo
Principales equivalencias: IHC 1691121-C1, Mercedes Benz 11842225, Volvo 4110239

G-180 FILTRO P/ACEITE



Código: 1345
Diámetro Ext.: (2 35/64 in) (2.546 in) (64.6 mm)
Diámetro Int.: (1 9/64 in) (1.140 in) (28.9 mm)
Altura Total: (4 35/64 in) (4.546 in) (115.4 mm)
Principales aplicaciones: Automóviles y Camionetas Mercedes Benz
Principales equivalencias: Mercedes Benz 112 180 0009, 611 180 09 67

G-163 FILTRO P/ACEITE



Código: 1283
Diámetro Ext.: (4 37/64 in) (4.578 in) (116.2 mm)
Diámetro Int.: (2 1/4 in) (2.25 in) (57.1 mm)
Altura Total: (6 49/64 in) (6.765 in) (171.8 mm)
Principales aplicaciones: Motores Mercedes Benz
Principales equivalencias: Mercedes Benz 4011840025

G-191 FILTRO P/ACEITE



Código: 1037
Diámetro Ext.: (3 27/32 in) (3.843 in) (97.6 mm)
Diámetro Int.: (1 5/8 in) (1.625 in) (41.2 mm)
Altura Total: (9 9/64 in) (9.140 in) (232.1 mm)
Principales aplicaciones: Caterpillar, Clark, Gardner-Denver, Komatsu, P&H
Principales equivalencias: Caterpillar 1W7399, 8N4301

G-169 FILTRO P/ACEITE



Código: 1289
Diámetro Ext.: (3 17/32 in) (3.531 in) (89.6 mm)
Diámetro Int.: (7/8 in) (0.875 in) (22.2 mm)
Altura Total: (2 53/64 in) (2.828 in) (71.8 mm)
Principales aplicaciones: Camiones Freightliner, IHC
Principales equivalencias: IHC 279294-C91, 754145-C91

G-200 FILTRO P/ACEITE



Código: 1040
Diámetro Ext.: (3 17/32 in) (3.531 in) (89.6 mm)
Diámetro Int.: (1 1/4 in) (1.25 in) (31.7 mm)
Altura Total: (5 9/16 in) (5.562 in) (141.2 mm)
Principales aplicaciones: Camiones General Motors
Principales equivalencias: General Motors 5574540, 6435674

G-178 FILTRO P/COMB.



Código: 1356
Diámetro Ext. del Elemento: (3 17/32 in) (3.531 in) (89.6 mm)
Diámetro Ext. Total: (4 7/8 in) (4.875 in) (123.8 mm)
Diámetro Int.: (9/16 in) (0.562 in) (14.2 mm)
Altura Total: (4 17/32 in) (4.531 in) (115.0 mm)
Principales aplicaciones: Vans y camionetas Ford, IHC con motor 7.3L 1994-98
Principales equivalencias: Ford F47Z-9N184AB, Fleetguard FS1298

G-222 FILTRO P/ACEITE



Código: 1153
Diámetro Ext.: (4 63/64 in) (4.984 in) (126.6 mm)
Diámetro Int.: (3 19/64 in) (3.296 in) (83.7 mm)
Altura Total: (9 1/62 in) (9.016 in) (229.0 mm)
Principales aplicaciones: Allis Chalmers, Caterpillar, Fiat-Allis, Komatsu, Wabco
Principales equivalencias: Allis Chalmers 7066642-1, Caterpillar 7S8701, Komatsu 1316-04-8210

G-225 FILTRO P/ACEITE



Código: 1205
Diámetro Ext.: (2 9/32 in) (2.281 in) (57.9 mm)
Diámetro Int.: (45/64 in) (0.703 in) (17.8 mm)
Altura Total: (3 7/8 in) (3.875 in) (98.4 mm)
Principales aplicaciones: Camiones y Motores Mercedes Benz
Principales equivalencias: Mercedes Benz 0001842325, 0004660404

G-277 FILTRO P/COMB.



Código: 2935
Ancho: (2 5/8 in) (2.625 in) (66.6 mm)
Largo: (4 5/8 in) (4.625 in) (117.4 mm)
Altura Total: (2 15/32 in) (2.468 in) (62.7 mm)
Principales aplicaciones: Unidades de refrigeración Thermo-King
Principales equivalencias: Thermo-King 11-6286

G-236 FILTRO P/ACEITE



Código: 1045
Diámetro Ext.: (3 3/16 in) (3.187 in) (80.9 mm)
Diámetro Int.: (49/64 in) (0.765 in) (19.4 mm)
Altura Total: (4 5/64 in) (4.078 in) (103.5 mm)
Principales aplicaciones: Camiones y Motores Chrysler, Dodge
Principales equivalencias: Chrysler 2128548, 2716017

G-278 FILTRO P/COMB.



Código: 1391
Ancho: (2 29/32 in) (2.906 in) (73.8 mm)
Largo: (4 19/32 in) (4.594 in) (116.7 mm)
Altura Total: (2 15/32 in) (2.469 in) (62.7 mm)
Principales aplicaciones: Unidades de refrigeración Thermo-King
Principales equivalencias: Thermo-King 117264

G-238 FILTRO P/ACEITE



Código: 1047
Diámetro Ext.: (4 61/64 in) (4.953 in) (125.8 mm)
Diámetro Int.: (3 19/64 in) (3.296 in) (83.7 mm)
Altura Total: (8 15/16 in) (8.937 in) (227.0 mm)
Principales aplicaciones: Caterpillar, Hyster, Kenworth, Komatsu, P&H
Principales equivalencias: Caterpillar 1R0721, Komatsu 6128-51-5091

G-293 FILTRO P/COMB.



Código: 2059
Ancho: (3 23/32 in) (3.718 in) (94.4 mm)
Largo: (4 31/32 in) (4.968 in) (126.2 mm)
Altura Total: (3 5/16 in) (3.312 in) (84.1 mm)
Principales aplicaciones: Motores Allis chalmers, Caterpillar, Dynapac, John Deere, New Holland, Ford, GMC, IHC, White
Principales equivalencias: Caterpillar 6N7617, Luber Finer LFF1131, Fleetguard FS1205

G-270 FILTRO P/COMB.

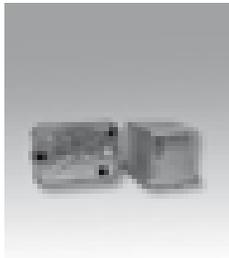

Código: 2977
Ancho: (3 11/16 in) (3.687 in) (93.6 mm)
Largo: (5 3/32 in) (5.093 in) (129.3 mm)
Altura Total: (3 3/8 in) (3.375 in) (85.7 mm)
Principales aplicaciones: Tractores Allis Chalmers, John Deere
Principales equivalencias: Allis chalmers 4036432, John Deere RE27091

G-294 FILTRO P/COMB.

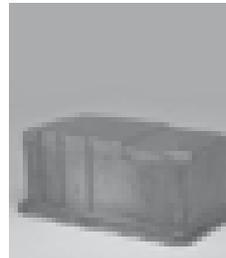

Código: 2877
Ancho: (2 13/16 in) (2.812 in) (71.4 mm)
Largo: (6 5/16 in) (6.312 in) (160.3 mm)
Altura Total: (2 5/8 in) (2.625 in) (66.6 mm)
Principales aplicaciones: Motores GMC 1984-94, John Deere, Ford 1985-87
Principales equivalencias: Ford F572-9N327, Fleetguard Fs1209, Donaldson P551049

G-276 FILTRO P/COMB.



Código: 2936
Ancho: (2 5/8 in) (2.625 in) (66.6 mm)
Largo: (4 5/8 in) (4.625 in) (117.4 mm)
Altura Total: (2 15/32 in) (2.468 in) (62.7 mm)
Principales aplicaciones: Unidades de refrigeración Thermo-King
Principales equivalencias: Thermo-King 11-6285

G-295 FILTRO P/COMB.



Código: 2067
Ancho: (3 23/32 in) (3.718 in) (94.4 mm)
Largo: (4 31/32 in) (4.968 in) (126.2 mm)
Altura Total: (3 5/16 in) (3.312 in) (84.1 mm)
Principales aplicaciones: Allis Chalmers, Case, Caterpillar, Ingersoll Rand, John Deere, Kohler, Minneapolis-Moline, Oliver, White
Principales equivalencias: Allis Chalmers 4024232-3, Caterpillar 9Y4423, John Deere AR50041

G-296 FILTRO P/COMB.



Código: 2046
Rosca: 3/4 ORIFICIO
Diámetro Ext.: (3 29/64 in) (3.453 in) (87.7 mm)
Altura Total: (2 49/64 in) (2.765 in) (70.2 mm)
Principales aplicaciones: Motores con Sistema C.A.V. a diesel
Principales equivalencias: C.A.V. 7111-296, Y7111-296

G-330 FILTRO P/ACEITE



Código: 1050
Diámetro Ext.: (3 3/16 in) (3.187 in) (80.9 mm)
Diámetro Int.: (49/64 in) (0.765 in) (19.4 mm)
Altura Total: (4 53/64 in) (4.828 in) (122.6 mm)
Principales aplicaciones: Camiones y Motores Ford, Deutz
Principales equivalencias: Ford COTE-6731-A, CCITZ-6731-D

G-296-B FILTRO P/COMB.



Código: 2327
Rosca: 3/4 ORIFICIO
Diámetro Ext.: (3 29/64 in) (3.453 in) (87.7 mm)
Altura Total: (2 49/64 in) (2.765 in) (70.2 mm)
Principales aplicaciones: Motores con Sistema C.A.V. a diesel
Principales equivalencias: C.A.V. 7111-296, Y7111-296

G-331 FILTRO P/ACEITE



Código: 1051
Diámetro Ext.: (4 37/64 in) (4.578 in) (116.2 mm)
Diámetro Int.: (2 13/64 in) (2.203 in) (55.9 mm)
Altura Total: (5 5/16 in) (5.312 in) (134.9 mm)
Principales aplicaciones: Equipo John Deere
Principales equivalencias: John Deere AR75601, AT75603

G-297 FILTRO P/COMB.



Código: 2102
Rosca: 3/4 ORIFICIO
Diámetro Ext.: (3 29/64 in) (3.453 in) (87.7 mm)
Altura Total: (4 25/64 in) (4.390 in) (111.5 mm)
Principales aplicaciones: Motores con Sistema C.A.V. a diesel
Principales equivalencias: C.A.V. 7111-796

G-333 FILTRO P/ACEITE

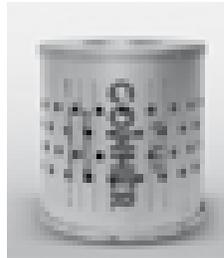

Código: 1053
Diámetro Ext.: (4 37/64 in) (4.578 in) (116.2 mm)
Diámetro Int. Mayor: (2 3/16 in) (2.187 in) (55.5 mm)
Diámetro Int. Menor: (1/2 in) (0.5 in) (12.7 mm)
Altura Total: (4 27/32 in) (4.843 in) (123.0 mm)
Principales aplicaciones: Motores IHC, Navistar
Principales equivalencias: IHC 213383-R91, 223960-R92

G-297-B FILTRO P/COMB.



Código: 2328
Rosca: 3/4 ORIFICIO
Diámetro Ext.: (3 29/64 in) (3.453 in) (87.7 mm)
Altura Total: (4 25/64 in) (4.390 in) (111.5 mm)
Principales aplicaciones: Motores con Sistema C.A.V. a diesel
Principales equivalencias: C.A.V. 7111-796

G-335 FILTRO P/ACEITE



Código: 1055
Diámetro Ext.: (3 27/32 in) (3.843 in) (97.6 mm)
Diámetro Int.: (1 5/8 in) (1.625 in) (41.2 mm)
Altura Total: (5 9/16 in) (5.562 in) (141.2 mm)
Principales aplicaciones: Motores IHC, Navistar
Principales equivalencias: IHC 325827-R91, 785896-R91

G-313 FILTRO P/ACEITE



Código: 1383
Diámetro Ext.: (2 5/8 in) (2.625 in) (66.6 mm)
Diámetro Int.: (1 7/32 in) (1.218 in) (30.9 mm)
Altura Total: (4 15/16 in) (4.937 in) (125.4 mm)
Principales aplicaciones: Automóviles Audi, Volkswagen
Principales equivalencias: Volkswagen 06D-115-562

G-338 FILTRO P/ACEITE



Código: 1165
Diámetro Ext.: (5 5/64 in) (5.078 in) (128.9 mm)
Diámetro Int.: (2 29/32 in) (2.906 in) (73.8 mm)
Altura Total: (6 5/64 in) (6.078 in) (154.3 mm)
Principales aplicaciones: Tractores IHC
Principales equivalencias: IHC 385683-R1, 70432-C91

G-339H FILTRO P/ACEITE HIDRAULICO



Código: 1330
Diámetro Ext.: (4 9/16 in) (4.562 in) (115.8 mm)
Diámetro Int.: (2 7/32 in) (2.218 in) (56.3 mm)
Altura Total: (7 31/32 in) (7.968 in) (202.4 mm)
Principales aplicaciones: Tractores John Deere
Principales equivalencias: John Deere AR94510, Fleetguard HF6184

GS-557 FILTRO P/COMB.



Código: 1392
Diámetro Ext.: (4 23/32 in) (4.718 in) (119.9 mm)
Diámetro Int.: (21/32 in) (0.656 in) (16.7 mm)
Altura Total: (6 15/32 in) (6.469 in) (164.3 mm)
Principales aplicaciones: Camiones Freightliner con motor cummins ISX
Principales equivalencias: Fleetguard FS19557, Baldwin PF7749

G-341 FILTRO P/ACEITE



Código: 1385
Diámetro Ext.: (2 33/64 in) (2.515 in) (63.8 mm)
Diámetro Int.: (1 9/64 in) (1.140 in) (28.9 mm)
Altura Total: (2 23/32 in) (2.718 in) (69.0 mm)
Principales aplicaciones: Automóviles Peugeot 206 (2005-06), Mini Cooper (2007)
Principales equivalencias: BMW 11 42 7 557 012, Peugeot 1109-Z1

G-559 FILTRO P/COMB.



Código: 1370
Diámetro Ext.: (4 11/32 in) (4.343 in) (110.3 mm)
Diámetro Int.: (21/32 in) (0.656 in) (16.6 mm)
Altura Total: (6 1/2 in) (6.5 in) (165.1 mm)
Principales aplicaciones: Motores Cummins
Principales equivalencias: Fleetguard FS19559, Luber Finer L9559F

G-409 FILTRO P/ACEITE



Código: 5028
Diámetro Ext.: (3 3/4 in) (3.75 in) (95.2 mm)
Diámetro Int.: (2 1/2 in) (2.5 in) (63.5 mm)
Altura Total: (9 in) (9.000 in) (228.6 mm)
Principales aplicaciones: Motores marinos cerca de la ciudad de Mazatlan, Sinaloa, Mexico
Observaciones: Centro de Laminacion cuerpo exterior forrado con estopa

G-566 FILTRO P/ACEITE



Código: 1063
Diámetro Ext.: (4 3/4 in) (4.75 in) (120.6 mm)
Diámetro Int.: (1 1/2 in) (1.5 in) (38.1 mm)
Altura Total: (9 1/2 in) (9.5 in) (241.3 mm)
Principales aplicaciones: Allis Chalmers, Cummins, Euclid, General Motors, Hough, IHC, Kenworth, Michigan, P&H, Wabco
Principales equivalencias: Cummins 402700, General Motors 25013195, IHC 244523-R91

G-466 FILTRO P/ACEITE



Código: 1376
Diámetro Ext.: (2 13/16 in) (2.812 in) (71.4 mm)
Diámetro Int. superior: cerrado
Diámetro Int. inferior: (1 9/64 in) (1.140 in) (28.9 mm)
Altura: (5 37/64 in) (5.578 in) (141.6 mm)
Principales aplicaciones: Camionetas Volkswagen Eurovan Diesel 2005-06
Principales equivalencias: Volkswagen 045-115-446A, 071-115-582A

G-613 FILTRO P/ACEITE



Código: 1065
Diámetro Ext.: (4 3/4 in) (4.75 in) (120.6 mm)
Diámetro Int.: (1 1/2 in) (1.5 in) (38.1 mm)
Altura Total: (7 3/8 in) (7.375 in) (187.3 mm)
Principales aplicaciones: Motores Cummins
Principales equivalencias: Cummins 721305, AR60253

G-500 FILTRO P/ACEITE



Código: 5029
Diámetro Ext.: (7 39/64 in) (7.609 in) (193.2 mm)
Diámetro Int.: (7/8 in) (0.875 in) (22.2 mm)
Altura Total: (10 1/16 in) (10.062 in) (255.5 mm)
Principales aplicaciones: Allis Chalmers, Cummins, Ford, Mack, Michigan
Principales equivalencias: Allis Chalmers 70091540, Cummins 256839, Ford DOTZ-6731-C

G-638 FILTRO P/ACEITE

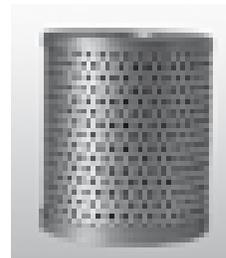

Código: 1381
Diámetro Ext.: (3 3/8 in) (3.375 in) (85.7 mm)
Diámetro Int.: (1 3/8 in) (1.375 in) (34.9 mm)
Altura Total: (3 7/8 in) (3.875 in) (98.4 mm)
Principales aplicaciones: Camiones Ford, IHC
Principales equivalencias: IHC 2586638C1

G-750 FILTRO P/ACEITE



Código: 5031
Diámetro Ext.: (7 39/64 in) (7.609 in) (193.2 mm)
Diámetro Int.: (7/8 in) (0.875 in) (22.2 mm)
Altura Total: (14 13/16 in) (14.812 in) (376.2 mm)
Principales aplicaciones: Allis Chalmers, Cummins, Euclid, Ford, General Motors, Hough, IHC, Kenworth, Komatsu, Mack, Volvo
Principales equivalencias: Cummins 257886, Ford D5PZ-6731-D, General Motors 90228696

G-833 FILTRO P/ACEITE



Código: 1071
Diámetro Ext.: (3 27/32 in) (3.843 in) (97.6 mm)
Diámetro Int.: (1 13/32 in) (1.406 in) (35.7 mm)
Altura Total: (6 3/16 in) (6.187 in) (157.1 mm)
Principales aplicaciones: Equipo J.C. Bamford, Motores Perkins
Principales equivalencias: Perkins 26560076

G-765 FILTRO P/ACEITE



Código: 1403
Diámetro Ext.: (2 5/64 in) (2.078 in) (52.8 mm)
Diámetro Int.: (45/64 in) (0.703 in) (17.9 mm)
Altura Total: (7 41/64 in) (7.641 in) (194.1 mm)
Principales aplicaciones: Automóviles y Camionetas Cadillac, Chevrolet, Oldsmobile, Pontiac, Saab
Principales equivalencias: General motors 12593333, 25177917

G-834 FILTRO P/ACEITE



Código: 1072
Diámetro Ext.: (3 27/32 in) (3.843 in) (97.6 mm)
Diámetro Int.: (1 13/32 in) (1.406 in) (35.7 mm)
Altura Total: (4 11/16 in) (4.687 in) (119.0 mm)
Principales aplicaciones: Ford, Hyster, J.C. Bamford, M.A.N., Massey Ferguson, Perkins
Principales equivalencias: Ford A700X-6744-DA, Massey ferguson 1883288-M91

G-801 FILTRO P/ACEITE



Código: 1066
Diámetro Ext.: (2 33/64 in) (2.515 in) (63.8 mm)
Diámetro Int.: (3/4 in) (0.75 in) (19.0 mm)
Altura Total: (5 3/8 in) (5.375 in) (136.5 mm)
Principales aplicaciones: Automóviles Alfa Romeo y Jaguar (1957-62), Equipo Pesado Hyster, Massey Ferguson
Principales equivalencias: Hyster 990325, Massey Ferguson 1882916-M91

G-836 FILTRO P/ACEITE



Código: 1074
Diámetro Ext.: (3 27/32 in) (3.843 in) (97.6 mm)
Diámetro Int.: (1 13/32 in) (1.406 in) (35.7 mm)
Altura Total: (3 15/16 in) (3.937 in) (100.0 mm)
Principales aplicaciones: Carrier, Ford, Kohler, Perkins
Principales equivalencias: Ford 753F-6731-AA1A, Perkins 3654344

G-813 FILTRO P/ACEITE



Código: 1069
Diámetro Ext.: (2 13/16 in) (2.812 in) (71.4 mm)
Diámetro Int.: (51/64 in) (0.796 in) (20.2 mm)
Altura Total: (4 7/16 in) (4.437 in) (112.7 mm)
Principales aplicaciones: Allis Chalmers, Caterpillar, Hyster, Komatsu, Massey Ferguson, Perkins,
Principales equivalencias: Caterpillar 311614, Massey Ferguson 1852251-M91

G-862 FILTRO P/COMB.



Código: 1344
Diámetro Ext. Mayor: (4 53/64 in) (4.828 in) (122.6 mm)
Diámetro Ext. Menor: (3 1/2 in) (3.5 in) (88.9 mm)
Diámetro Int.: (35/64 in) (0.546 in) (13.8 mm)
Altura Total: (3 3/8 in) (3.375 in) (85.7 mm)
Principales aplicaciones: Camionetas Ford a diesel
Principales equivalencias: Ford F81Z-9N184AA

G-816 FILTRO P/ACEITE



Código: 1070
Diámetro Ext.: (2 13/16 in) (2.812 in) (71.4 mm)
Diámetro Int.: (1 21/64 in) (1.328 in) (33.7 mm)
Altura Total: (3 3/8 in) (3.375 in) (85.7 mm)
Principales aplicaciones: Motores Lister
Principales equivalencias: Lister 4193038, 20126020

G-862T FILTRO P/COMB.



Código: 1413
Diámetro Ext. Mayor: (4 53/64 in) (4.828 in) (122.6 mm)
Diámetro Ext. Menor: (3 1/2 in) (3.5 in) (88.9 mm)
Diámetro Int.: (35/64 in) (0.546 in) (13.8 mm)
Altura Total: (3 3/8 in) (3.375 in) (85.7 mm)
Principales aplicaciones: Camionetas Ford a diesel
Principales equivalencias: Ford F81Z-9N184AA

G-870 FILTRO P/ACEITE



Código: 1080
Diámetro Ext.: (2 13/16 in) (2.812 in) (71.4 mm)
Diámetro Int.: (1 21/64 in) (1.328 in) (33.7 mm)
Altura Total: (5 3/8 in) (5.375 in) (136.5 mm)
Principales aplicaciones: Hyster, IHC, J.C. Bamford, Lister, Massey Ferguson, Nuffields
Principales equivalencias: Allis Chalmers 99100224, Lister 240-15890

G-918 FILTRO P/ACEITE



Código: 1348
Diámetro Ext.: (2 3/8 in) (2.375 in) (60.3 mm)
Diámetro Int.: (1 3/16 in) (1.187 in) (30.1 mm)
Altura Total: (4 9/16 in) (4.562 in) (115.8 mm)
Principales aplicaciones: Automóviles y Camionetas Mercedes Benz
Principales equivalencias: Mercedes Benz A112-184-0025, Fleet-guard LF3997

G-871 FILTRO P/ACEITE



Código: 1081
Diámetro Ext.: (2 13/16 in) (2.812 in) (71.4 mm)
Diámetro Int.: (1 21/64 in) (1.328 in) (33.7 mm)
Altura Total: (6 in) (6.000 in) (152.4 mm)
Principales aplicaciones: Automóviles Alfa Romeo y Jaguar (1957-62), Equipo Pesado J.C. Bamford, Massey Ferguson, Perkins
Principales equivalencias: Massey Ferguson 835995-M93, Perkins 26540077

G-926 FILTRO P/ACEITE



Código: 1299
Diámetro Ext.: (4 37/64 in) (4.578 in) (116.2 mm)
Diámetro Int.: (51/64 in) (0.796 in) (20.2 mm)
Altura Total: (9 in) (9.000 in) (228.6 mm)
Principales aplicaciones: Camiones y Motores Mercedes Benz
Principales equivalencias: Mercedes Benz 3441800109, A0000910840

G-910 FILTRO P/ACEITE



Código: 1351
Diámetro Ext.: (2 1/16 in) (2.062 in) (52.3 mm)
Diámetro Int.: (7/8 in) (0.875 in) (22.2 mm)
Altura Total: (3 5/64 in) (3.078 in) (78.1 mm)
Principales aplicaciones: Automóviles Mercedes Benz
Principales equivalencias: Chrysler 1661800009

G-932 FILTRO P/ACEITE



Código: 1353
Diámetro Ext.: (3 35/64 in) (3.546 in) (90.0 mm)
Diámetro Int.: (31/32 in) (0.968 in) (24.6 mm)
Altura Total: (3 25/64 in) (3.390 in) (86.1 mm)
Principales aplicaciones: Automóviles Audi
Principales equivalencias: VAG 077115561F, 077198563

G-911 FILTRO P/ACEITE



Código: 1410
Diámetro Ext.: (2 11/32 in) (2.340 in) (59.4 mm)
Diámetro Int.: (1 3/32 in) (1.090 in) (27.6 mm)
Altura Total: (2 1/4 in) (2.250 in) (57.1 mm)
Principales aplicaciones: Automóviles Pontiac, Scion, Toyota
Principales equivalencias: General motors 19185485, Toyota 4152-37010, 4152-YZZA6

G-954 FILTRO P/ACEITE

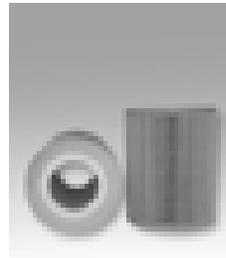

Código: 1347
Diámetro Ext.: (3 1/4 in) (3.25 in) (82.5 mm)
Diámetro Int.: (1 9/16 in) (1.562 in) (39.6 mm)
Altura Total: (4 1/8 in) (4.125 in) (104.7 mm)
Principales aplicaciones: Automóviles y Camionetas BMW
Principales equivalencias: BMW 11421740534, 11427512300

G-912 FILTRO P/ACEITE



Código: 1411
Diámetro Ext.: (2 49/64 in) (2.760 in) (70.1 mm)
Diámetro Int.: (1 7/64 in) (1.100 in) (27.9 mm)
Altura Total: (2 41/64 in) (2.645 in) (67.1 mm)
Principales aplicaciones: Automóviles Lexus, Toyota
Principales equivalencias: General motors 19185485, Toyota 4152-31090, 4152-YZZA1

G-963 FILTRO P/ACEITE



Código: 1354
Diámetro Ext.: (3 3/16 in) (3.187 in) (80.9 mm)
Diámetro Int.: (1 3/32 in) (1.093 in) (27.7 mm)
Altura Total: (4 15/32 in) (4.468 in) (113.5 mm)
Principales aplicaciones: Automóviles y Camionetas BMW
Principales equivalencias: BMW 11421711568, 11421730389

G-971 FILTRO P/ACEITE

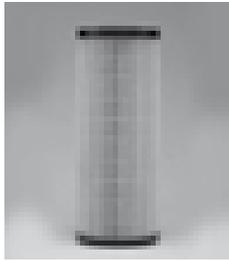

Código: 1349
Diámetro Ext.: (2 7/16 in) (2.437 in) (61.9 mm)
Diámetro Int.: (29/32 in) (0.906 in) (23.0 mm)
Altura Total: (6 1/4 in) (6.25 in) (158.7 mm)
Principales aplicaciones: Automóviles y Camionetas Mercedes Benz
Principales equivalencias: Chrysler 1041800109, 1041840825

G-975 FILTRO P/ACEITE



Código: 1352
Diámetro Ext.: (2 33/64 in) (2.515 in) (63.8 mm)
Diámetro Int.: (63/64 in) (0.984 in) (25.0 mm)
Altura Total: (4 1/32 in) (4.031 in) (102.3 mm)
Principales aplicaciones: Automóviles BMW
Principales equivalencias: BMW 11421432097, 11421743398

G-984 FILTRO P/ACEITE



Código: 1350
Diámetro Ext.: (3 1/8 in) (3.125 in) (79.3 mm)
Diámetro Int.: (63/64 in) (0.984 in) (25.0 mm)
Altura Total: (6 5/16 in) (6.312 in) (160.3 mm)
Principales aplicaciones: Automóviles y Camionetas BMW
Principales equivalencias: BMW 11421745390, 11427510717

G-989 FILTRO P/ACEITE



Código: 1298
Diámetro Ext.: (4 19/64 in) (4.296 in) (109.1 mm)
Diámetro Int.: (35/64 in) (0.546 in) (13.8 mm)
Altura Total: (9 43/64 in) (9.671 in) (245.6 mm)
Principales aplicaciones: Camiones y Autobuses Mercedes Benz
Principales equivalencias: Mercedes Benz 3455867290, 3551800109

G-1046 FILTRO P/COMB.



Código: 1355
Diámetro Ext.: (3 39/64 in) (3.609 in) (91.6 mm)
Diámetro Int.: (33/64 in) (0.515 in) (13.0 mm)
Altura Total: (4 5/64 in) (4.078 in) (103.5 mm)
Principales aplicaciones: Camiones y Autobuses Mercedes Benz
Principales equivalencias: Mercedes Benz A0000901551, A9060920305

G-1047 KIT FILTRO P/COMB.

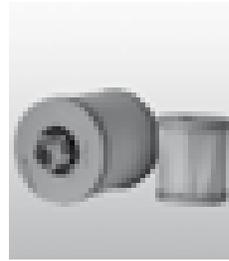

Código: 1382
PRIMER Elemento
Diámetro Ext.: (3 11/32 in) (3.343 in) (84.9 mm)
Diámetro Int.: (1 9/16 in) (1.562 in) (39.6 mm)
Altura: (4 3/16 in) (4.187 in) (106.3 mm)
SEGUNDO Elemento
Diámetro Ext.: (2 5/16 in) (2.312 in) (58.7 mm)
Diámetro Int.: (15/16 in) (0.937 in) (22.3 mm)
Altura: (2 19/32 in) (2.593 in) (65.8 mm)
Principales aplicaciones: Camiones Ford, IHC
Principales equivalencias: Ford 3C3Z-9N-184CA, IHC 18471710C92

G-1120 FILTRO P/COMB.



Código: 1172
Diámetro Ext.: (2 1/16 in) (2.062 in) (52.3 mm)
Diámetro Int.: (7/16 in) (0.437 in) (11.1 mm)
Altura Total: (4 3/4 in) (4.75 in) (120.6 mm)
Principales aplicaciones: Tractores Síderna

G-1121 FILTRO P/COMB.



Código: 1195
Diámetro Ext.: (2 21/32 in) (2.656 in) (67.4 mm)
Diámetro Int.: (17/64 in) (0.265 in) (6.7 mm)
Altura Total: (4 17/32 in) (4.531 in) (115.0 mm)
Principales aplicaciones: Motores Deutz, Camiones y Autobuses M.A.N., Mercedes Benz, Volvo
Principales equivalencias: Deutz W05H4115, Mercedes Benz 3440927005, Volvo 66058603

G-1121F FILTRO P/COMB.



Código: 1286
Diámetro Ext.: (2 21/32 in) (2.656 in) (67.4 mm)
Diámetro Int.: (17/64 in) (0.265 in) (6.7 mm)
Altura Total: (4 17/32 in) (4.531 in) (115.0 mm)
Principales aplicaciones: Motores Deutz, Camiones y Autobuses M.A.N., Mercedes Benz, Volvo
Principales equivalencias: Deutz W05H4115, Mercedes Benz 3440927005, Volvo 66058603

G-1123 FILTRO P/COMB.



Código: 1204
Diámetro Ext.: (3 5/64 in) (3.078 in) (78.1 mm)
Diámetro Int.: (17/64 in) (0.265 in) (6.7 mm)
Altura Total: (5 49/64 in) (5.765 in) (146.4 mm)
Principales aplicaciones: Clark, Daewoo, Deutz, IHC, Komatsu, M.A.N., Mercedes Benz, Scania, Volvo
Principales equivalencias: Deutz R1H4155, Mercedes Benz 4220900051, Volvo 7233897

G-1123F FILTRO P/COMB.



Código: 1287
Diámetro Ext.: (3 5/64 in) (3.078 in) (78.1 mm)
Diámetro Int.: (17/64 in) (0.265 in) (6.7 mm)
Altura Total: (5 49/64 in) (5.765 in) (146.4 mm)
Principales aplicaciones: Clark, Daewoo, Deutz, IHC, Komatsu, M.A.N., Mercedes Benz, Scania, Volvo
Principales equivalencias: Deutz R1H4155, Mercedes Benz 4220900051, Volvo 7233897

G-1166 FILTRO P/COMB.



Código: 1105
Diámetro Ext.: (3 17/32 in) (3.531 in) (89.6 mm)
Diámetro Int.: (1 1/4 in) (1.25 in) (31.7 mm)
Altura Total: (6 21/64 in) (6.328 in) (160.7 mm)
Principales aplicaciones: Caterpillar, Gardner Denver, P&H, Peterbilt
Principales equivalencias: Caterpillar 5M0473, 9H8792

GC-1133 FILTRO P/COMB.



Código: 1091
Diámetro Ext.: (3 3/16 in) (3.187 in) (80.9 mm)
Diámetro Int.: (49/64 in) (0.765 in) (19.4 mm)
Altura Total: (7 5/8 in) (7.625 in) (193.6 mm)
Principales aplicaciones: Camiones Dina, Motores Cummins, Perkins
Principales equivalencias: Cummins 146823, 3001825
Observaciones: Filtro primario, utilice GS-1133 como secundario

G-1173 FILTRO P/COMB.



Código: 1108
Diámetro Ext.: (2 31/32 in) (2.968 in) (75.4 mm)
Diámetro Int.: (1 7/64 in) (1.109 in) (28.1 mm)
Altura Total: (3 1/4 in) (3.25 in) (82.5 mm)
Principales aplicaciones: Allis Chalmers, Case, Clark, Continental Teledyne, Euclid, General Motors, Ingersoll Rand, White
Principales equivalencias: Allis Chalmers 4348149-8, General Motors 9045748

GS-1133 FILTRO P/COMB.



Código: 1092
Diámetro Ext.: (3 3/16 in) (3.187 in) (80.9 mm)
Diámetro Int.: (49/64 in) (0.765 in) (19.4 mm)
Altura Total: (4 13/16 in) (4.812 in) (122.2 mm)
Principales aplicaciones: Camiones Dina, Motores Cummins, Perkins
Principales equivalencias: Cummins 136197, 3001825
Observaciones: Filtro secundario, utilice GC-1133 como primario

G-1174 FILTRO P/COMB.



Código: 1109
Diámetro Ext.: (2 31/32 in) (2.968 in) (75.4 mm)
Diámetro Int.: (1 7/64 in) (1.109 in) (28.1 mm)
Altura Total: (5 3/16 in) (5.187 in) (131.7 mm)
Principales aplicaciones: Allis Chalmers, Detroit Diesel, General Motors, Thermo King
Principales equivalencias: General Motors 9021029, Thermo King 11-2230

G-1143 FILTRO P/COMB.



Código: 1096
Diámetro Ext.: (6 1/16 in) (6.062 in) (153.9 mm)
Diámetro Int.: (31/32 in) (0.968 in) (24.6 mm)
Altura Total: (9 49/64 in) (9.765 in) (248.0 mm)
Principales aplicaciones: Caterpillar, Cummins, Hough, Michigan, Wabco
Principales equivalencias: Caterpillar 311169, Cummins 256835

G-1175 FILTRO P/COMB.



Código: 1110
Diámetro Ext.: (2 31/32 in) (2.968 in) (75.4 mm)
Diámetro Int.: (1 7/64 in) (1.109 in) (28.1 mm)
Altura Total: (7 3/8 in) (7.375 in) (187.3 mm)
Principales aplicaciones: Detroit Diesel, Euclid, Case, General Motors, Hough
Principales equivalencias: General Motors 5199838, 5574533

G-1163 FILTRO P/COMB.



Código: 1103
Diámetro Ext.: (3 17/32 in) (3.531 in) (89.6 mm)
Diámetro Int.: (1 1/4 in) (1.25 in) (31.7 mm)
Altura Total: (4 5/16 in) (4.312 in) (109.5 mm)
Principales aplicaciones: Motores IHC, Navistar
Principales equivalencias: IHC 610309-C91, 701096-C91

G-1176 FILTRO P/COMB.



Código: 1111
Diámetro Ext.: (2 31/32 in) (2.968 in) (75.4 mm)
Diámetro Int.: (1 7/64 in) (1.109 in) (28.1 mm)
Altura Total: (7 3/4 in) (7.75 in) (196.8 mm)
Principales aplicaciones: Allis Chalmers, Clark, Detroit Diesel, Hyster, Kenworth
Principales equivalencias: Allis Chalmers 4371165-0, Clark 944475

GS-1261 FILTRO P/COMB.



Código: 2952
Diámetro Ext.: (3 3/8 in) (3.375 in) (85.7 mm)
Diámetro Int.: (13/16 in) (0.812 in) (20.6 mm)
Altura Total: (4 3/32 in) (4.093 in) (103.9 mm)
Principales aplicaciones: Camiones y Camionetas Chrysler, Dodge, Ford, Freightliner, Kenworth, Peterbilt, Motores Cummins
Principales equivalencias: Cummins 3942470, Fleetguard FS1261

G-3754 FILTRO P/ACEITE

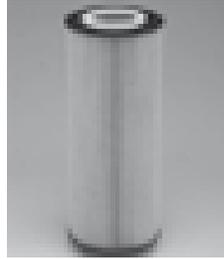

Código: 1332
Diámetro Ext.: (3 17/64 in) (3.265 in) (82.9 mm)
Diámetro Int.: (3/8 in) (0.375 in) (9.5 mm)
Altura Total: (8 11/32 in) (8.343 in) (211.9 mm)
Principales aplicaciones: Tractores y Motores Deutz
Principales equivalencias: Fleetguard LF3754, Baldwin P7145

GS-2033 FILTRO P/COMB.



Código: 1169
Diámetro Ext.: (4 21/64 in) (4.328 in) (109.9 mm)
Diámetro Int.: (21/32 in) (0.656 in) (16.6 mm)
Altura Total: (9 29/32 in) (9.906 in) (251.6 mm)
Principales aplicaciones: Housings Racor 1000FH Series
Principales equivalencias: Racor 2020SM

G-3827 FILTRO P/ACEITE



Código: 1331
Diámetro Ext.: (3 17/64 in) (3.265 in) (82.9 mm)
Diámetro Int.: (3/8 in) (0.375 in) (9.5 mm)
Altura Total: (5 61/64 in) (5.953 in) (151.2 mm)
Principales aplicaciones: Motores Mercedes Benz
Principales equivalencias: Mercedes Benz 1801609, 9041800210

GS-2034 FILTRO P/COMB.



Código: 1170
Diámetro Ext.: (4 21/64 in) (4.328 in) (109.9 mm)
Diámetro Int.: (21/32 in) (0.656 in) (16.6 mm)
Altura Total: (4 29/32 in) (4.906 in) (124.6 mm)
Principales aplicaciones: Housings Racor 900 Series
Principales equivalencias: Racor 2040 Series

G-5000 FILTRO P/ACEITE



Código: 1116
Diámetro Ext.: (4 37/64 in) (4.578 in) (116.2 mm)
Diámetro Int.: (49/64 in) (0.765 in) (19.4 mm)
Altura Total: (4 27/32 in) (4.843 in) (123.0 mm)
Principales aplicaciones: Tractores Ford, New Holland
Principales equivalencias: Ford D6NN-6744-A, DGPN-6731-A

G-3752 FILTRO P/ACEITE



Código: 1387
Diámetro Ext.: (3 9/32 in) (3.281 in) (83.3 mm)
Diámetro Int.: (3/8 in) (0.375 in) (9.5 mm)
Altura Total: (6 11/16 in) (6.687 in) (169.8 mm)
Principales aplicaciones: Camiones y Camionetas Ford, IHC
Principales equivalencias: Ford 3C3Z-6731-AA, IHC 1844588-C91

G-11816 FILTRO P/COMB.



Código: 1117
Diámetro Ext.: (2 13/16 in) (2.812 in) (71.4 mm)
Diámetro Int.: (1 1/32 in) (1.031 in) (26.1 mm)
Altura Total: (3 1/4 in) (3.25 in) (82.5 mm)
Principales aplicaciones: Carrier, Ford, Fordson, Hyster, Kohler, Lister, Massey Ferguson, Perkins
Principales equivalencias: Ford EPN-99162-B, Perkins 32327

G-3753 FILTRO P/ACEITE



Código: 1401
Diámetro Ext.: (2 43/64 in) (2.672 in) (67.9 mm)
Diámetro Int.: (21/32 in) (0.656 in) (16.7 mm)
Altura Total: (6 3/16 in) (6.188 in) (157.2 mm)
Principales aplicaciones: Camiones Isuzu ELF 300
Principales equivalencias: Isuzu 8-98018-858-0

Filtros Para Aire Automotriz

Automotive Air Filters

GAC-1 FILTRO P/AIRE DE CABINA



Código: 13991
 Largo: (13 21/32 in) (13.656 in) (346.9 mm)
 Ancho: (5 11/16 in) (5.687 in) (144.4 mm)
 Altura Total: (1 1/16 in) (1.063 in) (27.0 mm)
 Principales aplicaciones: Automóviles y Camionetas Ford, Lincoln y Mercury
 Principales equivalencias: Ford F65Z-19N619-AB

GAD-3 FILTRO P/AIRE



Código: 3003
 Diámetro Ext.: (8 27/32 in) (8.843 in) (224.6 mm)
 Diámetro Int.: (6 61/64 in) (6.953 in) (176.6 mm)
 Altura Total: (2 1/32 in) (2.031 in) (51.5 mm)
 Principales aplicaciones: Automóviles Datsun, Nissan 1973-1991
 Principales equivalencias: Nissan 16546-18000

GAD-1 FILTRO P/AIRE

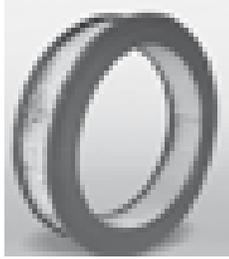

Código: 3001
 Diámetro Ext.: (10 27/64 in) (10.421 in) (264.7 mm)
 Diámetro Int.: (7 15/16 in) (7.937 in) (201.6 mm)
 Altura Total: (2 13/32 in) (2.406 in) (61.1 mm)
 Principales aplicaciones: Automóviles Datsun 1966-1972, Isuzu, Opel, Toyota
 Principales equivalencias: Nissan 16546-16800

GAC-4 FILTRO P/AIRE DE CABINA

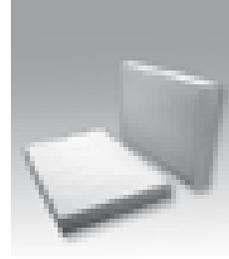

Código: 13994
 Largo: (9 1/64 in) (9.016 in) (229.0 mm)
 Ancho: (6 17/64 in) (6.266 in) (159.1 mm)
 Altura Total: (1 3/16 in) (1.188 in) (30.2 mm)
 Principales aplicaciones: Automóviles Renault
 Principales equivalencias: Renault 77-00-424-098

GAC-2 FILTRO P/AIRE DE CABINA

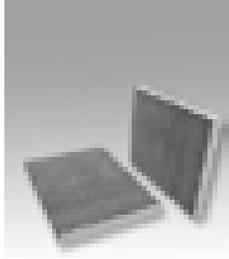

Código: 13992
 Largo: (12 13/64 in) (12.203 in) (310.0 mm)
 Ancho: (9 19/64 in) (9.297 in) (236.1 mm)
 Altura Total: (59/64 in) (0.922 in) (23.4 mm)
 Principales aplicaciones: Camionetas Chrysler, Dodge y Plymouth
 Principales equivalencias: Chrysler 82205905, 4885955AA

GAVW-4 FILTRO P/AIRE



Código: 3004
 Largo: (8 9/64 in) (8.140 in) (206.7 mm)
 Ancho: (8 3/8 in) (8.375 in) (212.7 mm)
 Altura Total: (2 13/64 in) (2.203 in) (55.9 mm)
 Principales aplicaciones: Automóviles Volkswagen, Audi, Volvo, Jaguar, Porsche 1972-1990
 Principales equivalencias: Volkswagen 021-129-620

GAVW-2 FILTRO P/AIRE



Código: 3002
 Largo: (13 3/16 in) (13.187 in) (334.9 mm)
 Ancho: (5 9/32 in) (5.281 in) (134.1 mm)
 Altura Total: (1 9/16 in) (1.562 in) (39.6 mm)
 Principales aplicaciones: Automóviles Volkswagen Sedan 1970-2003
 Principales equivalencias: Volkswagen 113129620

GAC-5 FILTRO P/AIRE DE CABINA

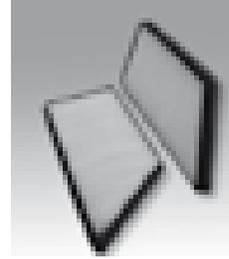

Código: 13995
 Largo: (13 19/32 in) (13.594 in) (345.3 mm)
 Ancho: (6 55/64 in) (6.859 in) (174.2 mm)
 Altura Total: (1 9/64 in) (1.141 in) (29.0 mm)
 Principales aplicaciones: Automóviles Peugeot
 Principales equivalencias: Peugeot 6447-AZ

GAC-3 FILTRO P/AIRE DE CABINA



Código: 13993
 Largo: (9 7/8 in) (9.875 in) (250.8 mm)
 Ancho: (8 15/32 in) (8.469 in) (215.1 mm)
 Altura Total: (1 17/64 in) (1.266 in) (32.1 mm)
 Principales aplicaciones: Automóviles Seat y Volkswagen
 Principales equivalencias: Volkswagen 6Q0820367, 620-820-367, 620-820-367B

GA-6 FILTRO P/AIRE



Código: 3161
 Diámetro Ext.: (7 1/8 in) (7.125 in) (180.9 mm)
 Diámetro Int.: (5 1/2 in) (5.5 in) (139.7 mm)
 Altura Total: (2 5/32 in) (2.156 in) (54.7 mm)
 Principales aplicaciones: Motores Briggs & Stratton 18cc SERIE 21-16HP.
 Principales equivalencias: Briggs & Stratton 394018, Wix 42359

GAC-6 FILTRO P/AIRE DE CABINA

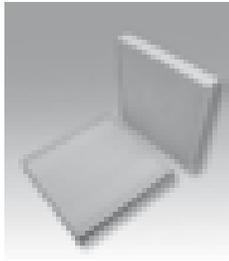

Código: 13996
Largo: (8 11/32 in) (8.344 in) (211.9 mm)
Ancho: (8 17/64 in) (8.266 in) (209.9 mm)
Altura Total: (1 3/16 in) (1.188 in) (30.2 mm)
Principales aplicaciones: Automóviles Acura y Honda
Principales equivalencias: Honda 80292-S5A-003, 80292-S5D-A01, 80292-SCV-A01

GAC-9 FILTRO P/AIRE DE CABINA

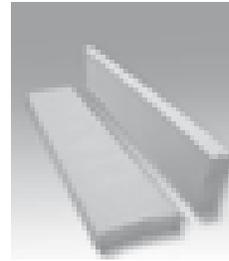

Código: 13999
Largo: (20 3/64 in) (20.047 in) (509.2 mm)
Ancho: (3 15/16 in) (3.937 in) (100.0 mm)
Altura Total: (1 3/16 in) (1.188 in) (30.2 mm)
Principales aplicaciones: Automóviles Ford y Mercury
Principales equivalencias: Ford F5RZ-19N619-A, F5RZ-19N619-BA

GA-7 FILTRO P/AIRE

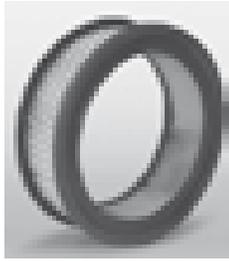

Código: 3006
Diámetro Ext.: (6 3/64 in) (6.046 in) (153.5 mm)
Diámetro Int.: (4 21/32 in) (4.656 in) (118.2 mm)
Altura Total: (2 1/16 in) (2.062 in) (52.3 mm)
Principales aplicaciones: Compresores Kohler, Briggs & Stratton
Principales equivalencias: Kohler 235116, Fram CA77

GAC-10 FILTRO P/AIRE DE CABINA

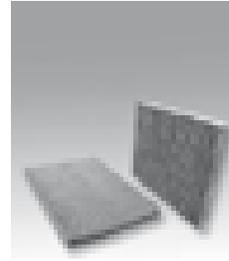

Código: 13300
Largo: (11 7/64 in) (11.109 in) (282.2 mm)
Ancho: (8 1/8 in) (8.125 in) (206.4 mm)
Altura Total: (1 3/16 in) (1.188 in) (30.2 mm)
Principales aplicaciones: Automóviles Audi, Seat y Volkswagen
Principales equivalencias: Volkswagen 1J0 819 644, 1H0 819 638 A

GAC-7 FILTRO P/AIRE DE CABINA



Código: 13997
Largo: () (in) (in) (mm)
Ancho: () (in) (in) (mm)
Altura Total: () (in) (in) (mm)
Principales aplicaciones: Automóviles Ford
Principales equivalencias: Ford XS4Z-19N619-CA, YS4Z-19N619-AA, YS4Z-19N619-DB

GAVW-10 FILTRO P/AIRE

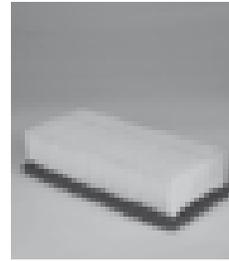

Código: 3092
Largo: (7 7/32 in) (7.218 in) (183.3 mm)
Ancho: (3 45/64 in) (3.703 in) (94.0 mm)
Altura Total: (1 15/16 in) (1.937 in) (49.2 mm)
Principales aplicaciones: Automóviles Volkswagen Atlantic, Golf, Jetta y Caribe a gasolina
Principales equivalencias: Volkswagen 055129620AZ

GA-8 FILTRO P/AIRE



Código: 3088
Diámetro Ext.: (5 3/4 in) (5.75 in) (146.0 mm)
Diámetro Int.: (4 5/64 in) (4.078 in) (103.5 mm)
Altura Total: (2 29/64 in) (2.453 in) (62.3 mm)
Principales aplicaciones: Motores Lister
Principales equivalencias: Lister 366-06227A

GA-11 FILTRO P/AIRE



Código: 3007
Diámetro Ext.: (4 23/64 in) (4.359 in) (110.7 mm)
Diámetro Int.: (2 63/64 in) (2.984 in) (75.8 mm)
Altura Total: (1 39/64 in) (1.609 in) (40.8 mm)
Principales aplicaciones: Briggs & Stratton, Jacobsen, Kohler, Tecumseh, John Deere, Lawn boy
Principales equivalencias: Kohler 236840, Fram CA74

GAC-8 FILTRO P/AIRE DE CABINA

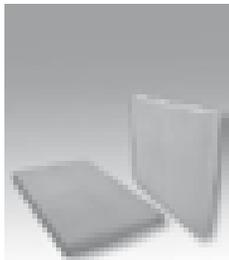

Código: 13998
Largo: (10 63/64 in) (10.984 in) (279.0 mm)
Ancho: (8 7/64 in) (8.109 in) (206.0 mm)
Altura Total: (63/64 in) (0.984 in) (25.0 mm)
Principales aplicaciones: Automóviles Audi, Seat y Volkswagen
Principales equivalencias: Volkswagen 1J0 819 644, 1H0 819 638 A

GAC-11 FILTRO P/AIRE DE CABINA



Código: 13301
Largo: (9 29/64 in) (9.453 in) (240.1 mm)
Ancho: (7 7/16 in) (7.438 in) (188.9 mm)
Altura Total: (1 3/8 in) (1.375 in) (34.9 mm)
Principales aplicaciones: Automóviles Ford Fiesta
Principales equivalencias: Ford 1-204-459, Mann & Hummel CU2433

GA-12 FILTRO P/AIRE



Código: 3008
Diámetro Ext.: (4 23/64 in) (4.359 in) (110.7 mm)
Diámetro Int.: (2 63/64 in) (2.984 in) (75.8 mm)
Altura Total: (2 19/64 in) (2.296 in) (58.3 mm)
Principales aplicaciones: Jacobsen, John Deere, Kohler, Lauson, Lawn boy, Onan, Tecumseh
Principales equivalencias: Kohler 231847, Wix 42374

GAVW-22 FILTRO P/AIRE



Código: 3115
Diámetro Ext.: (11 in) (11.000 in) (279.4 mm)
Diámetro Int.: (8 7/8 in) (8.875 in) (225.4 mm)
Altura Total: (2 11/32 in) (2.343 in) (59.5 mm)
Principales aplicaciones: Automóviles Volkswagen Corsar (1983-89)
Principales equivalencias: Fram CA2662, Motorcraft MFA943

GAC-12 FILTRO P/AIRE DE CABINA



Código: 13302
Largo: (in) (in) (mm)
Ancho: (in) (in) (mm)
Altura Total: (in) (in) (mm)
Principales aplicaciones:
Principales equivalencias:

GAD-29 FILTRO P/AIRE



Código: 13644
Diámetro Ext.: (4 31/32 in) (4.968 in) (126.2 mm)
Diámetro Int.: (2 3/4 in) (2.75 in) (69.8 mm)
Altura Total: (7 3/32 in) (7.093 in) (180.1 mm)
Principales aplicaciones: Camionetas Nissan Urvan (2002-04)
Principales equivalencias: Nissan 16546-14C11, 16546-17C11

GAC-13 FILTRO P/AIRE DE CABINA

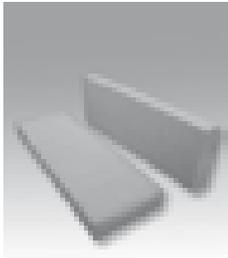

Código: 13303
Largo: (8 55/64 in) (8.859 in) (225.0 mm)
Ancho: (4 3/8 in) (4.375 in) (111.1 mm)
Altura Total: (1 3/16 in) (1.188 in) (30.2 mm)
Principales aplicaciones: Automóviles Acura y Honda
Principales equivalencias: Honda 80291-S84-A01

GAD-30 FILTRO P/AIRE



Código: 3204
Diámetro Ext.: (4 31/32 in) (4.968 in) (126.2 mm)
Diámetro Int. del Elemento: (2 57/64 in) (2.890 in) (73.4 mm)
Diámetro Int. Para la Guía: (3/8 in) (0.375 in) (9.5 mm)
Altura Total: (6 11/32 in) (6.343 in) (161.1 mm)
Principales aplicaciones: Camionetas Nissan Ichi van y Montacargas Nissan
Principales equivalencias: Nissan 16546-76000, 16546-76016

GAD-15 FILTRO P/AIRE



Código: 3272
Largo: (11 1/16 in) (11.062 in) (280.9 mm)
Ancho: (6 39/64 in) (6.609 in) (167.8 mm)
Altura Total: (1 7/32 in) (1.218 in) (30.9 mm)
Principales aplicaciones: Automóviles y Camionetas Nissan
Principales equivalencias: Nissan 16546-V0100

GAD-34 FILTRO P/AIRE



Código: 13650
Diámetro Ext.: (5 1/4 in) (5.25 in) (133.3 mm)
Diámetro Int.: (2 3/8 in) (2.375 in) (60.3 mm)
Altura Total: (11 3/32 in) (11.093 in) (281.7 mm)
Principales aplicaciones: Camionetas Nissan Urvan
Principales equivalencias: Nissan 16546-VW-600

GAD-17 FILTRO P/AIRE

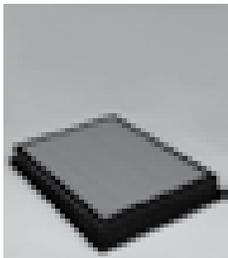

Código: 3554
Largo: (8 63/64 in) (8.984 in) (228.2 mm)
Ancho: (6 39/64 in) (6.609 in) (167.8 mm)
Altura Total: (1 7/32 in) (1.218 in) (30.9 mm)
Principales aplicaciones: Automóviles Nissan 300ZX V6 3.0L
Principales equivalencias: Nissan 16546-30P00

GA-42 FILTRO P/AIRE

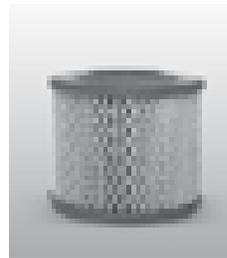

Código: 3160
Diámetro Ext.: (4 1/4 in) (4.25 in) (107.9 mm)
Diámetro Int.: (2 1/32 in) (2.031 in) (51.5 mm)
Altura Total: (3 3/4 in) (3.75 in) (95.2 mm)
Principales aplicaciones: Motores Briggs & Stratton
Principales equivalencias: Briggs & Stratton 390930, 393957

GA-44 FILTRO P/AIRE

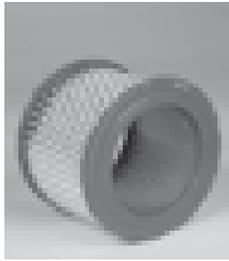

Código: 3018
Diámetro Ext.: (4 11/32 in) (4.343 in) (110.3 mm)
Diámetro Int.: (2 63/64 in) (2.984 in) (75.8 mm)
Altura Total: (3 21/64 in) (3.328 in) (84.5 mm)
Principales aplicaciones: Montacargas Clark
Principales equivalencias: Clark 1804277, 1614059

GA-56 FILTRO P/AIRE



Código: 3026
Diámetro Ext.: (11 5/64 in) (11.078 in) (281.3 mm)
Diámetro Int.: (8 9/16 in) (8.562 in) (217.4 mm)
Altura Total: (2 55/64 in) (2.859 in) (72.6 mm)
Principales aplicaciones: Camiones Chevrolet
Principales equivalencias: General Motors 1554864, 5766164

GA-49 FILTRO P/AIRE



Código: 4195
Diámetro Ext.: (4 61/64 in) (4.953 in) (125.8 mm)
Diámetro Int. del Elemento: (2 15/32 in) (2.468 in) (62.7 mm)
Diámetro Int. Para la Guía: (3/8 in) (0.375 in) (9.5 mm)
Altura Total: (11 31/64 in) (11.484 in) (291.7 mm)
Principales aplicaciones: Volkswagen Combi (1988-2002)
Principales equivalencias: Volkswagen 060-129-620, 060-999-620

GA-57 FILTRO P/AIRE



Código: 3027
Diámetro Ext.: (12 3/64 in) (12.046 in) (305.9 mm)
Diámetro Int.: (9 13/16 in) (9.812 in) (249.2 mm)
Altura Total: (2 15/32 in) (2.468 in) (62.7 mm)
Principales aplicaciones: Automóviles y Camiones Cadillac, Chevrolet
Principales equivalencias: General Motors 6485108, 6487314

GA-50 FILTRO P/AIRE



Código: 3021
Diámetro Ext.: (9 43/64 in) (9.671 in) (245.6 mm)
Diámetro Int.: (8 7/64 in) (8.109 in) (205.9 mm)
Altura Total: (1 61/64 in) (1.953 in) (49.6 mm)
Principales aplicaciones: Automóviles y Camionetas Chevrolet
Principales equivalencias: General Motors 5648036, 8995350

GA-59 FILTRO P/AIRE



Código: 3028
Diámetro Ext.: (12 3/64 in) (12.046 in) (305.9 mm)
Diámetro Int.: (9 13/16 in) (9.812 in) (249.2 mm)
Altura Total: (3 7/16 in) (3.437 in) (87.3 mm)
Principales aplicaciones: Automóviles y Camionetas Chevrolet
Principales equivalencias: General Motors 8995524, 8996712

GA-54 FILTRO P/AIRE



Código: 3096
Diámetro Ext. Mayor: (10 43/64 in) (10.671 in) (271.0 mm)
Diámetro Ext. Menor: (9 5/32 in) (9.156 in) (232.5 mm)
Diámetro Int. Mayor: (9 5/32 in) (9.156 in) (232.5 mm)
Diámetro Int. Menor: (7 61/64 in) (7.953 in) (202.0 mm)
Altura Total: (2 5/64 in) (2.078 in) (52.7 mm)
Principales aplicaciones: Automóviles Chevrolet Citation, Century, Cutlass
Principales equivalencias: General Motors 8996292, 8996555

GA-70 FILTRO P/AIRE



Código: 3032
Diámetro Ext.: (9 63/64 in) (9.984 in) (253.6 mm)
Diámetro Int.: (7 35/64 in) (7.546 in) (191.6 mm)
Altura Total: (2 49/64 in) (2.765 in) (70.2 mm)
Principales aplicaciones: Automóviles y Camionetas Chrysler, Dodge, Jeep, Plymouth
Principales equivalencias: Chrysler 4201103, 8992661

GA-55 FILTRO P/AIRE

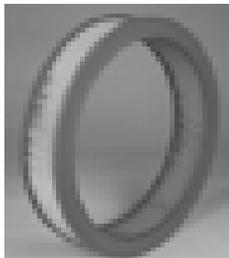

Código: 3025
Diámetro Ext.: (13 3/4 in) (13.75 in) (349.2 mm)
Diámetro Int.: (11 9/16 in) (11.562 in) (293.6 mm)
Altura Total: (3 1/16 in) (3.062 in) (77.7 mm)
Principales aplicaciones: Automóviles Cadillac Eldorado (1979), Camiones Chevrolet
Principales equivalencias: Genral Motors 6424140, 6424613

GA-71 FILTRO P/AIRE



Código: 3034
Diámetro Ext.: (8 in) (8.000 in) (203.2 mm)
Diámetro Int.: (6 7/16 in) (6.437 in) (163.5 mm)
Altura Total: (3 1/64 in) (3.015 in) (76.5 mm)
Principales aplicaciones: Automóviles y Camionetas Crysler, Dodge, Plymouth, Renault
Principales equivalencias: Chrysler 2402704, 3769010

GA-73 FILTRO P/AIRE



Código: 3036
Diámetro Ext.: (12 47/64 in) (12.734 in) (323.4 mm)
Diámetro Int.: (11 1/32 in) (11.031 in) (280.1 mm)
Altura Total: (2 7/64 in) (2.109 in) (53.5 mm)
Principales aplicaciones: Automóviles Ford (1957-64)
Principales equivalencias: Ford ECJ9601, Fram CA170

GA-80 FILTRO P/AIRE



Código: 3044
Diámetro Ext.: (8 13/32 in) (8.406 in) (213.5 mm)
Diámetro Int.: (6 37/64 in) (6.578 in) (167.0 mm)
Altura Total: (3 9/32 in) (3.281 in) (83.3 mm)
Principales aplicaciones: Automóviles y Camionetas Ford
Principales equivalencias: Ford C40Z-9601-A, E4UE-9601-AA

GA-74 FILTRO P/AIRE

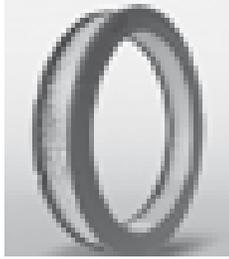

Código: 3037
Diámetro Ext.: (11 13/64 in) (11.203 in) (284.5 mm)
Diámetro Int.: (9 3/32 in) (9.093 in) (230.9 mm)
Altura Total: (1 63/64 in) (1.984 in) (50.4 mm)
Principales aplicaciones: Automóviles y Camionetas Ford, Mercury
Principales equivalencias: Ford D3ZZ-9601-A, D3ZZ-9601-AR

GA-85 FILTRO P/AIRE



Código: 3047
Diámetro Ext.: (13 1/4 in) (13.25 in) (336.5 mm)
Diámetro Int.: (11 3/8 in) (11.375 in) (288.9 mm)
Altura Total: (2 51/64 in) (2.796 in) (71.0 mm)
Principales aplicaciones: Automóviles, Camiones y Camionetas Ford
Principales equivalencias: Ford C8AZ-9601-A, D7AF-9601-AA

GA-75 FILTRO P/AIRE



Código: 3038
Diámetro Ext.: (11 13/64 in) (11.203 in) (284.5 mm)
Diámetro Int.: (9 3/32 in) (9.093 in) (230.9 mm)
Altura Total: (2 39/64 in) (2.609 in) (66.2 mm)
Principales aplicaciones: Automóviles y Camionetas Ford, Mercury
Principales equivalencias: Ford D2AZ-9600-A, D2AZ-9601-AA

GA-86 FILTRO P/AIRE



Código: 3099
Diámetro Ext.: (13 1/4 in) (13.25 in) (336.5 mm)
Diámetro Int.: (11 3/8 in) (11.375 in) (288.9 mm)
Altura Total: (2 1/2 in) (2.5 in) (63.5 mm)
Principales aplicaciones: Automóviles Ford (1970-77)
Principales equivalencias: Ford D3ZZ-9600-C, D7AZ-9601-BR

GA-77 FILTRO P/AIRE

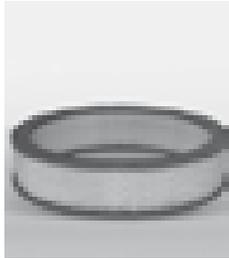

Código: 3040
Diámetro Ext.: (9 43/64 in) (9.671 in) (245.6 mm)
Diámetro Int.: (8 7/64 in) (8.109 in) (205.9 mm)
Altura Total: (2 17/64 in) (2.265 in) (57.5 mm)
Principales aplicaciones: Automóviles y Camionetas Dodge, Ford, Jeep, Plymouth, VAM
Principales equivalencias: Chrysler 8991386, Ford 2735E-9601-A

GA-89 FILTRO P/AIRE



Código: 3095
Diámetro Ext.: (12 3/64 in) (12.046 in) (305.9 mm)
Diámetro Int.: (9 13/16 in) (9.812 in) (249.2 mm)
Altura Total: (5 7/16 in) (5.437 in) (138.1 mm)
Principales aplicaciones: Camiones y Camionetas Chevrolet, Ford
Principales equivalencias: Ford E5HZ-9601-A, General Motors 8997890

GA-78 FILTRO P/AIRE



Código: 3042
Diámetro Ext.: (9 7/8 in) (9.875 in) (250.8 mm)
Diámetro Int.: (7 3/4 in) (7.75 in) (196.8 mm)
Altura Total: (2 11/32 in) (2.343 in) (59.5 mm)
Principales aplicaciones: Automóviles y Camiones Chrysler, Dodge, Ford
Principales equivalencias: Chrysler 8992873, Ford C4ZF-9601-B2

GA-90 FILTRO P/AIRE



Código: 3203
Diámetro Ext.: (9 43/64 in) (9.671 in) (245.6 mm)
Diámetro Int.: (8 7/64 in) (8.109 in) (205.9 mm)
Altura Total: (3 5/64 in) (3.078 in) (78.1 mm)
Principales aplicaciones: Camiones Chevrolet
Principales equivalencias: General Motors 3973287, 6486785

GA-100 FILTRO P/AIRE



Código: 13630
Largo: (3 29/32 in) (3.906 in) (99.2 mm)
Ancho: (1 25/32 in) (1.781 in) (45.2 mm)
Altura Total: (1 5/8 in) (1.625 in) (41.2 mm)
Principales aplicaciones: Automóviles y Camionetas Chevrolet
Principales equivalencias: General Motors 6484966, 6486700

GA-114 FILTRO P/AIRE



Código: 13799
Largo: (7 29/64 in) (7.453 in) (189.3 mm)
Ancho: (6 43/64 in) (6.671 in) (169.4 mm)
Altura Total: (2 25/32 in) (2.781 in) (70.6 mm)
Principales aplicaciones: Camionetas Peugeot Partner (2003-06)
Principales equivalencias: Peugeot 1444.V2

GA-101 FILTRO P/AIRE



Código: 13631
Largo: (1 31/32 in) (1.968 in) (50.0 mm)
Ancho: (1 37/64 in) (1.578 in) (40.0 mm)
Altura Total: (1 29/32 in) (1.906 in) (48.4 mm)
Principales aplicaciones: Automóviles y Camionetas Chevrolet
Principales equivalencias: General Motors 8996724, 25096399

GAD-116 FILTRO P/AIRE

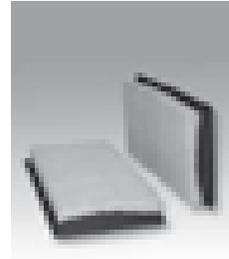

Código: 13471
Largo: (9 5/32 in) (9.156 in) (232.5 mm)
Ancho: (5 23/64 in) (5.359 in) (136.1 mm)
Altura Total: (1 11/32 in) (1.343 in) (34.1 mm)
Principales aplicaciones: Automóviles y Camionetas Nissan
Principales equivalencias: Nissan 16546-ED000

GA-105 FILTRO P/AIRE



Código: 3055
Diámetro Ext. Mayor: (6 19/32 in) (6.593 in) (167.4 mm)
Diámetro Ext. Menor: (6 21/64 in) (6.328 in) (160.7 mm)
Diámetro Int.: (5 in) (5.000 in) (127.0 mm)
Altura Total: (3 in) (3.000 in) (76.2 mm)
Principales aplicaciones: Automóviles VAM (1958-64), Montacargas Allis Chalmers, Caterpillar
Principales equivalencias: American Motors 8991012, Allis Chalmers 4997568-8

GAD-117 FILTRO P/AIRE



Código: 3854
Largo: (8 63/64 in) (8.984 in) (228.2 mm)
Ancho: (6 39/64 in) (6.609 in) (167.8 mm)
Altura Total: (1 7/32 in) (1.218 in) (30.9 mm)
Principales aplicaciones: Automóviles Nissan
Principales equivalencias: Nissan 16546-30P00, 16546-F4100

GA-110 FILTRO P/AIRE



Código: 13987
Largo: (5 33/64 in) (5.516 in) (140.1 mm)
Ancho: (10 1/8 in) (10.125 in) (257.2 mm)
Altura Total: (5 3/8 in) (5.374 in) (136.5 mm)
Principales aplicaciones: Camionetas H100 a diesel
Principales equivalencias: Hyundai 28113-4F000

GAD-118 FILTRO P/AIRE

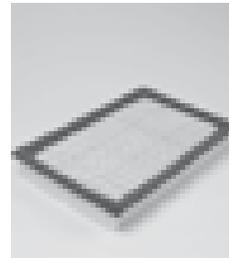

Código: 3429
Largo: (10 13/16 in) (10.812 in) (274.6 mm)
Ancho: (7 1/16 in) (7.062 in) (179.3 mm)
Altura Total: (1 19/32 in) (1.593 in) (40.4 mm)
Principales aplicaciones: Camionetas Nissan Quest (1997-2003)
Principales equivalencias: Nissan 16546-7B000, 16546-TB000

GA-113 FILTRO P/AIRE



Código: 13632
Largo: (4 in) (4.000 in) (101.6 mm)
Ancho: (1 3/4 in) (1.75 in) (44.4 mm)
Altura Total: (1 7/32 in) (1.218 in) (30.9 mm)
Principales aplicaciones: Automóviles y Camionetas Ford
Principales equivalencias: Ford D1AZ-6D695-A, D1AF-6D695-AA

GAVW-120 FILTRO P/AIRE

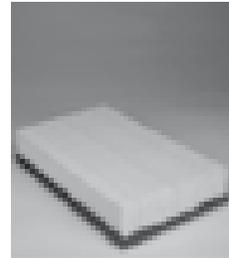

Código: 3480
Largo: (12 3/16 in) (12.187 in) (309.5 mm)
Ancho: (7 9/32 in) (7.281 in) (184.9 mm)
Altura Total: (2 1/4 in) (2.25 in) (57.1 mm)
Principales aplicaciones: Automóviles Audi, Volkswagen
Principales equivalencias: Volkswagen 859129620

GAVW-121 FILTRO P/AIRE

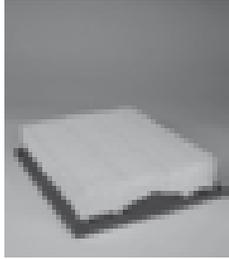

Código: 3463
Largo: (10 9/64 in) (10.140 in) (257.5 mm)
Ancho: (8 63/65 in) (8.969 in) (227.8 mm)
Altura Total: (2 1/4 in) (2.25 in) (57.1 mm)
Principales aplicaciones: Automóviles Volkswagen
Principales equivalencias: Volkswagen 1H0129620

GA-130 FILTRO P/AIRE



Código: 3935
Diámetro Ext.: (6 13/16 in) (6.812 in) (173.0 mm)
Diámetro Int.: (3 5/32 in) (3.156 in) (80.1 mm)
Altura Total: (7 7/8 in) (7.875 in) (200.0 mm)
Principales aplicaciones: Automóviles Ford Escort (1994-2002)
Principales equivalencias: Ford F7CZ-9601-A, F7CX-9601-AA

GA-127 FILTRO P/AIRE

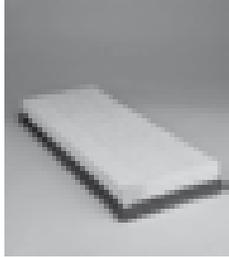

Código: 3611
Largo: (15 5/8 in) (15.625 in) (396.8 mm)
Ancho: (5 29/32 in) (5.906 in) (150.0 mm)
Altura Total: (1 39/64 in) (1.609 in) (40.8 mm)
Principales aplicaciones: Automóviles Ford Contour (1995-2002) 4 cil.
Principales equivalencias: Ford F5RZ-9601-C

GA-132 FILTRO P/AIRE



Código: 3484
Largo: (8 7/8 in) (8.875 in) (225.4 mm)
Ancho: (7 7/16 in) (7.437 in) (188.9 mm)
Altura Total: (1 1/2 in) (1.5 in) (38.1 mm)
Principales aplicaciones: Automóviles Chrysler Cirrus, Dodge Stratus
Principales equivalencias: Chrysler 4874153, 4882141

GA-128 FILTRO P/AIRE

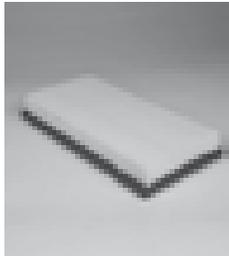

Código: 3486
Largo: (12 5/8 in) (12.625 in) (320.6 mm)
Ancho: (5 29/32 in) (5.906 in) (150.0 mm)
Altura Total: (1 21/32 in) (1.656 in) (42.0 mm)
Principales aplicaciones: Automóviles Ford Contour, Mystique (1995-2002) 6 cil.
Principales equivalencias: Ford F5RZ-9601-C

GA-133 FILTRO P/AIRE

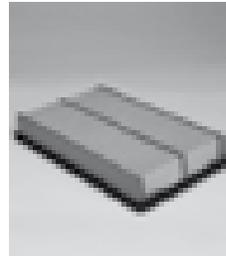

Código: 3584
Largo: (9 55/64 in) (9.859 in) (250.4 mm)
Ancho: (5 31/32 in) (5.968 in) (151.6 mm)
Altura Total: (1 9/16 in) (1.562 in) (39.6 mm)
Principales aplicaciones: Automóviles y Camionetas Ford, Mazda
Principales equivalencias: Ford F1CZ-9601-A, Mazda B6S7-13-Z40

GA-129 FILTRO P/AIRE



Código: 3336
Diámetro Ext. Mayor: (13 5/8 in) (13.625 in) (346.0 mm)
Diámetro Ext. Menor: (10 1/32 in) (10.031 in) (254.7 mm)
Diámetro Int. Mayor: (9 23/32 in) (9.718 in) (246.8 mm)
Diámetro Int. Menor: (6 1/8 in) (6.125 in) (155.5 mm)
Altura Total: (3 3/32 in) (3.093 in) (78.5 mm)
Principales aplicaciones: Camionetas Chrysler, Dodge
Principales equivalencias: Chrysler 4307868

GA-134 FILTRO P/AIRE

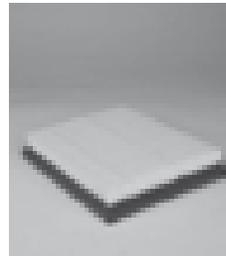

Código: 3473
Largo: (8 5/16 in) (8.312 in) (211.1 mm)
Ancho: (6 17/32 in) (6.531 in) (165.8 mm)
Altura Total: (1 13/32 in) (1.406 in) (35.7 mm)
Principales aplicaciones: Automóviles Chevrolet Chevy
Principales equivalencias: General Motors 90411732, 90486296

GAD-129 FILTRO P/AIRE

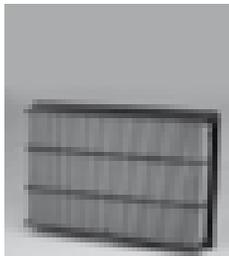

Código: 3465
Largo: (11 5/32 in) (11.156 in) (283.3 mm)
Ancho: (7 31/64 in) (7.484 in) (190.1 mm)
Altura Total: (1 23/32 in) (1.718 in) (43.6 mm)
Principales aplicaciones: Automóviles y Camionetas Infiniti, Nissan
Principales equivalencias: Nissan 16546-1P100, 16546-60U00

GA-138 FILTRO P/AIRE



Código: 13805
Largo: (13 7/16 in) (13.437 in) (341.3 mm)
Ancho: (5 15/32 in) (5.468 in) (138.9 mm)
Altura Total: (1 49/64 in) (1.765 in) (44.8 mm)
Principales aplicaciones: Automóviles Acura TLX, Honda Accord
Principales equivalencias: Honda 17220-RAA-A00, 17220-RAA-Y00

GA-139 FILTRO P/AIRE



Código: 3466
Diámetro Ext.: (8 27/32 in) (8.843 in) (224.6 mm)
Altura Total: (2 27/32 in) (2.843 in) (72.2 mm)
Principales aplicaciones: Camionetas Chevrolet LUV
Principales equivalencias: General Motors 25099343, 25099409

GA-145 FILTRO P/AIRE



Código: 13442
Largo: (10 15/64 in) (10.234 in) (260.0 mm)
Ancho: (9 23/32 in) (9.719 in) (246.9 mm)
Altura Total: (1 31/32 in) (1.969 in) (50.0 mm)
Principales aplicaciones: Automóviles Cadillac Catera
Principales equivalencias: General motors 90509318

GA-140 FILTRO P/AIRE



Código: 3270
Diámetro Ext. Menor: (6 21/32 in) (6.656 in) (169.0 mm)
Diámetro Ext. Mayor: (14 21/32 in) (14.656 in) (372.2 mm)
Diámetro Int. Menor: (4 3/8 in) (4.375 in) (111.1 mm)
Diámetro Int. Mayor: (11 7/32 in) (11.218 in) (284.9 mm)
Principales aplicaciones: Automóviles y Camionetas Subaru (1980-89)
Principales equivalencias: Subaru 42145-7000, 82145-7000

GA-147 FILTRO P/AIRE



Código: 3696
Largo: (8 55/64 in) (8.859 in) (225.0 mm)
Ancho: (6 39/64 in) (6.609 in) (167.8 mm)
Altura Total: (2 3/64 in) (2.046 in) (51.9 mm)
Principales aplicaciones: Automóviles Toyota
Principales equivalencias: Toyota 17700-74010, 17801-74010

GA-141 FILTRO P/AIRE



Código: 3483
Largo: (12 17/32 in) (12.531 in) (318.2 mm)
Ancho: (7 1/16 in) (7.062 in) (179.3 mm)
Altura Total: (1 1/2 in) (1.5 in) (38.1 mm)
Principales aplicaciones: Automóviles Chrysler, Dodge (1993-99)
Principales equivalencias: Chrysler 4573031

GA-149 FILTRO P/AIRE



Código: 13461
Largo: (in) (in) (mm)
Ancho: (in) (in) (mm)
Altura Total: (in) (in) (mm)
Principales aplicaciones: Automóviles Kia
Principales equivalencias: Kia 28113-2G000

GA-142 FILTRO P/AIRE



Código: 13440
Largo: (10 5/64 in) (10.078 in) (256.0 mm)
Ancho: (8 in) (8.000 in) (203.2 mm)
Altura Total: (1 49/64 in) (1.766 in) (44.8 mm)
Principales aplicaciones: Automóviles Chevrolet, Geo, Pontiac y Suzuki
Principales equivalencias: General Motors 25099249, 96055471

GA-153 FILTRO P/AIRE

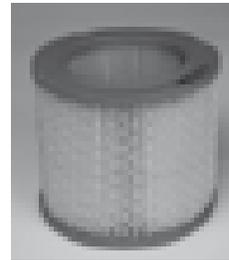

Código: 3156
Diámetro Ext.: (5 41/64 in) (5.640 in) (143.2 mm)
Diámetro Int.: (3 21/32 in) (3.656 in) (92.8 mm)
Altura Total: (4 29/32 in) (4.906 in) (124.6 mm)
Principales aplicaciones: Automóviles Chevrolet
Principales equivalencias: General Motors 25096829, 25098632

GA-143 FILTRO P/AIRE



Código: 13441
Largo: (11 1/2 in) (11.500 in) (292.1 mm)
Ancho: (9 5/64 in) (9.078 in) (230.6 mm)
Altura Total: (2 9/32 in) (2.281 in) (57.9 mm)
Principales aplicaciones: Camionetas Dodge y Jeep
Principales equivalencias: Chrysler 5189933AA

GA-154 FILTRO P/AIRE

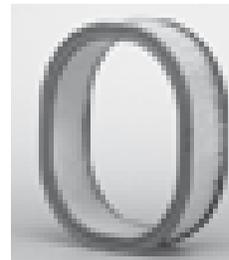

Código: 3100
Diámetro Ext. Mayor: (10 43/64 in) (10.671 in) (271.0 mm)
Diámetro Ext. Menor: (9 5/32 in) (9.156 in) (232.5 mm)
Diámetro Int. Mayor: (9 5/32 in) (9.156 in) (232.5 mm)
Diámetro Int. Menor: (7 61/64 in) (7.953 in) (202.0 mm)
Altura Total: (3 7/8 in) (3.875 in) (98.4 mm)
Principales aplicaciones: Automóviles Chevrolet Citation (1981-84)
Principales equivalencias: General Motors 25040556, 25040934

GA-155 FILTRO P/AIRE

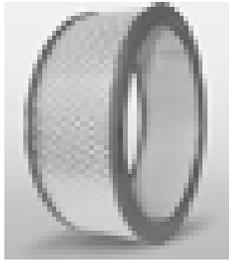

Código: 3391
Diámetro Ext.: (14 3/16 in) (14.187 in) (360.3 mm)
Diámetro Int.: (11 1/16 in) (11.062 in) (280.9 mm)
Altura Total: (5 1/16 in) (5.062 in) (128.5 mm)
Principales aplicaciones: Compresores Mattei
Principales equivalencias: Mattei 13011, Baldwin PA4894

GA-165 FILTRO P/AIRE

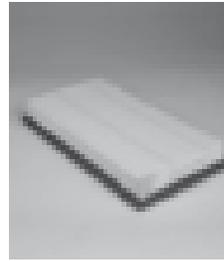

Código: 3485
Largo: (11 9/16 in) (11.562 in) (293.6 mm)
Ancho: (6 1/32 in) (6.031 in) (153.1 mm)
Altura Total: (1 5/8 in) (1.625 in) (41.2 mm)
Principales aplicaciones: Automóviles y Camionetas Chevrolet, Isuzu, Pontiac
Principales equivalencias: General Motors 25098463, Isuzu 8-25098-463-0

GA-158 FILTRO P/AIRE

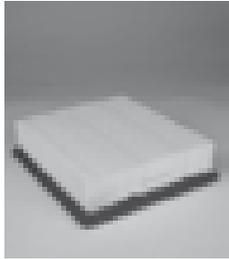

Código: 3342
Largo: (7 37/64 in) (7.578 in) (192.4 mm)
Ancho: (8 25/32 in) (8.781 in) (223.0 mm)
Altura Total: (2 11/64 in) (2.171 in) (55.1 mm)
Principales aplicaciones: Automóviles y Camionetas Ford, Mazda
Principales equivalencias: Ford F77Z-9601-AA, Mazda ZZPO-23-603

GA-166 FILTRO P/AIRE



Código: 3583
Largo: (10 11/64 in) (10.171 in) (258.3 mm)
Ancho: (8 9/32 in) (8.281 in) (210.3 mm)
Altura Total: (1 11/16 in) (1.687 in) (42.8 mm)
Principales aplicaciones: Automóviles y Camionetas Chevrolet, Suzuki
Principales equivalencias: General Motors 96057994, 96064348, Suzuki 13780-61A00

GA-162 EXP FILTRO P/AIRE



Código: 3422
Largo: (8 13/32 in) (8.406 in) (213.5 mm)
Ancho: (5 27/32 in) (5.843 in) (148.4 mm)
Altura Total: (1 9/16 in) (1.562 in) (39.6 mm)
Principales aplicaciones: Automóviles Chevrolet Bretta, Corsica, Pontiac Tempest
Principales equivalencias: General Motors 25097359

GA-168 FILTRO P/AIRE



Código: 3339
Largo: (10 15/32 in) (10.468 in) (265.9 mm)
Ancho: (5 3/4 in) (5.75 in) (146.0 mm)
Altura Total: (2 1/16 in) (2.062 in) (52.3 mm)
Principales aplicaciones: Automóviles Ford Focus (2000-05)
Principales equivalencias: Ford YS4Z-9601-CC

GA-163 FILTRO P/AIRE



Código: 3137
Largo: (10 49/64 in) (10.765 in) (273.4 mm)
Ancho: (6 5/8 in) (6.625 in) (168.2 mm)
Altura Total: (1 3/4 in) (1.75 in) (44.4 mm)
Principales aplicaciones: Automóviles Honda
Principales equivalencias: Honda 17220-PAA-000, 17220-PAA-A00

GA-170 FILTRO P/AIRE

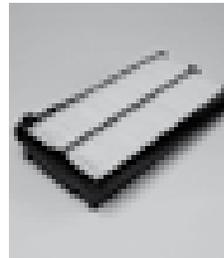

Código: 3110
Largo: (12 9/16 in) (12.562 in) (319.0 mm)
Ancho: (6 5/16 in) (6.312 in) (160.3 mm)
Altura Total: (2 15/16 in) (2.937 in) (74.6 mm)
Principales aplicaciones: Automóviles Honda
Principales equivalencias: Honda 17220-P8C-A00

GA-164 FILTRO P/AIRE

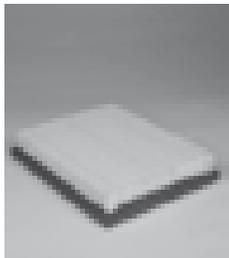

Código: 3481
Largo: (9 13/32 in) (9.406 in) (238.9 mm)
Ancho: (7 5/32 in) (7.156 in) (181.7 mm)
Altura Total: (1 19/32 in) (1.593 in) (40.4 mm)
Principales aplicaciones: Automóviles y Camionetas Cadillac, Chevrolet, Pontiac
Principales equivalencias: General Motors 12482805, General Motors 25099149

GA-171 FILTRO P/AIRE



Código: 13398
Largo: (in) (in) (mm)
Ancho: (in) (in) (mm)
Altura Total: (in) (in) (mm)
Principales aplicaciones: Automóviles Acura y Honda
Principales equivalencias: Honda 17220-R70-A00

GA-172 FILTRO P/AIRE

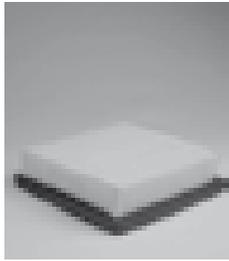

Código: 3069
Largo: (7 9/16 in) (7.562 in) (192.0 mm)
Ancho: (7 13/16 in) (7.812 in) (198.4 mm)
Altura Total: (2 in) (2.000 in) (50.8 mm)
Principales aplicaciones: Automóviles Honda Civic 1.6L (1999-2000)
Principales equivalencias: Honda 17220-P2N-A01

GA-180 FILTRO P/AIRE



Código: 3695
Largo: (1 15/64 in) (1.234 in) (31.3 mm)
Ancho: (6 39/64 in) (6.609 in) (167.8 mm)
Altura Total: (2 13/16 in) (2.812 in) (71.4 mm)
Principales aplicaciones: Automóviles y Camionetas Toyota
Principales equivalencias: Toyota 17801-70010

GA-174 FILTRO P/AIRE



Código: 3335
Largo: (12 29/32 in) (12.906 in) (327.8 mm)
Ancho: (5 53/64 in) (5.828 in) (148.0 mm)
Altura Total: (1 11/32 in) (1.343 in) (34.1 mm)
Principales aplicaciones: Camionetas y Camiones Ford
Principales equivalencias: Ford E77Z-9601-B, E7TE-9601-AC

GA-183 FILTRO P/AIRE



Código: 3464
Largo: (11 7/32 in) (11.218 in) (284.9 mm)
Ancho: (6 9/32 in) (6.281 in) (159.5 mm)
Altura Total: (2 17/32 in) (2.531 in) (64.2 mm)
Principales aplicaciones: Automóviles y Camionetas Honda, Mazda
Principales equivalencias: Honda 17220-P8F-A00

GA-175 FILTRO P/AIRE

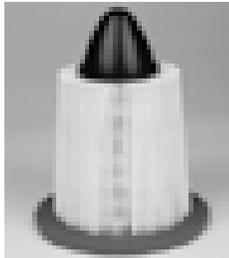

Código: 3609
Diámetro Ext.: (6 15/32 in) (6.468 in) (164.3 mm)
Diámetro Int.: (3 5/32 in) (3.156 in) (80.1 mm)
Altura Total: (7 29/32 in) (7.906 in) (200.8 mm)
Principales aplicaciones: Automóviles Ford Mustang (1994-96)
Principales equivalencias: Ford F4ZZ-9601-A, F4ZZ-9601-AC

GA-183R FILTRO P/AIRE



Código: 4430
Diámetro Ext.: (5 in) (5.000 in) (127.0 mm)
Diámetro Int.: (3 5/32 in) (3.156 in) (80.1 mm)
Altura entre tapas: (6 17/64 in) (6.265 in) (159.1 mm)
Altura Total: (6 17/64 in) (6.265 in) (159.1 mm)
Principales aplicaciones: Automóviles Chrysler Cirrus, Dodge Stratus
Principales equivalencias: Chrysler 5011836AA

GA-176 FILTRO P/AIRE

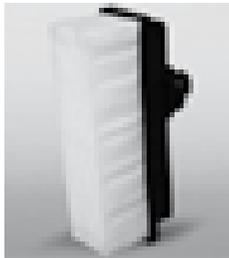

Código: 3488
Largo: (4 15/32 in) (4.468 in) (113.5 mm)
Ancho: (1 19/64 in) (1.296 in) (32.9 mm)
Altura Total: (2 1/2 in) (2.5 in) (63.5 mm)
Principales aplicaciones: Automóviles y Camionetas Ford
Principales equivalencias: Ford E5TZ-9D695-A, E7TE-9D695-BA

GA-184 FILTRO P/AIRE

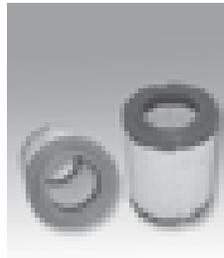

Código: 13639
Diámetro Ext.: (5 15/32 in) (5.468 in) (138.9 mm)
Diámetro Int.: (3 15/64 in) (3.234 in) (82.1 mm)
Altura Total: (6 27/32 in) (6.843 in) (173.8 mm)
Principales aplicaciones: Automóviles y Camionetas Acura, Honda
Principales equivalencias: Honda 17220-PNA-003, 17220-PZD-A01

GA-179 FILTRO P/AIRE

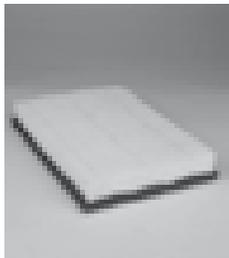

Código: 3986
Largo: (10 1/32 in) (10.031 in) (254.7 mm)
Ancho: (7 in) (7.000 in) (177.8 mm)
Altura Total: (1 17/32 in) (1.531 in) (38.8 mm)
Principales aplicaciones: Automóviles Ford Fiesta, Camionetas Ford Courier
Principales equivalencias: Ford 2N1U 9601 BD

GA-186 FILTRO P/AIRE

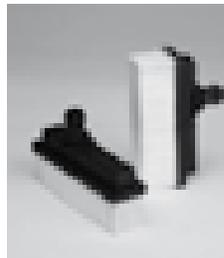

Código: 3993
Largo: (4 15/32 in) (4.468 in) (113.5 mm)
Ancho: (1 19/64 in) (1.296 in) (32.9 mm)
Altura Total: (7 3/4 in) (7.75 in) (196.8 mm)
Principales aplicaciones: Automóviles y Camionetas Ford
Principales equivalencias: Ford F4TZ-9D695-A, F4TE-9D695-AA

GA-192 FILTRO P/AIRE



Código: 3168
Diámetro Ext.: (9 43/64 in) (9.671 in) (245.6 mm)
Diámetro Int.: (8 7/64 in) (8.109 in) (205.9 mm)
Altura Total: (3 35/64 in) (3.546 in) (90.0 mm)
Principales aplicaciones: Automóviles y Camionetas Cadillac, Chevrolet
Principales equivalencias: General Motors 6483864, 8996711

GA-198 FILTRO P/AIRE



Código: 3673
Largo: (12 17/64 in) (12.265 in) (311.5 mm)
Ancho: (7 7/8 in) (7.875 in) (200.0 mm)
Altura Total: (2 3/64 in) (2.046 in) (51.9 mm)
Principales aplicaciones: Automóviles y Camionetas Chevrolet, Isuzu
Principales equivalencias: Isuzu 8-97035-303-0, 8-97111-423-0

GA-193 FILTRO P/AIRE



Código: 13397
Largo: (in) (in) (mm)
Ancho: (in) (in) (mm)
Altura Total: (in) (in) (mm)
Principales aplicaciones: Automóviles Honda Accord (2008-2010)
Principales equivalencias: Honda 17220-R40-A00

GA-200 FILTRO P/AIRE



Código: 3059
Diámetro Ext.: (5 1/16 in) (5.062 in) (128.5 mm)
Diámetro Int.: (3 13/64 in) (3.203 in) (81.3 mm)
Altura Total: (6 21/32 in) (6.656 in) (169.0 mm)
Principales aplicaciones: Automóviles y Camionetas Renault (1960-84)
Principales equivalencias: Renault 7701001499, 7701348115

GA-194 FILTRO P/AIRE



Código: 3672
Largo: (12 23/64 in) (12.359 in) (313.9 mm)
Ancho: (7 63/64 in) (7.984 in) (202.8 mm)
Altura Total: (2 61/64 in) (2.953 in) (75.0 mm)
Principales aplicaciones: Automóviles Honda Civic
Principales equivalencias: Honda 17220-PLC-000

GAVW-212 FILTRO P/AIRE



Código: 3479
Largo: (10 7/8 in) (10.875 in) (276.2 mm)
Ancho: (7 9/32 in) (7.281 in) (184.9 mm)
Altura Total: (2 1/4 in) (2.25 in) (57.1 mm)
Principales aplicaciones: Automóviles Volkswagen Derby (1995-2006)
Principales equivalencias: Volkswagen 110-129-620A

GA-195 FILTRO P/AIRE



Código: 3697
Largo: (12 13/64 in) (12.203 in) (309.9 mm)
Ancho: (6 9/64 in) (6.140 in) (155.9 mm)
Altura Total: (1 43/64 in) (1.671 in) (42.4 mm)
Principales aplicaciones: Automóviles y Camionetas Toyota
Principales equivalencias: Toyota 17801-02020, 17801-74020-83

GA-215 FILTRO P/AIRE

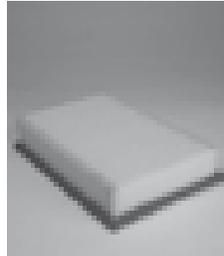

Código: 13646
Largo: (9 5/8 in) (9.625 in) (244.4 mm)
Ancho: (6 5/8 in) (6.625 in) (168.2 mm)
Altura Total: (1 29/32 in) (1.906 in) (48.4 mm)
Principales aplicaciones: Automóviles Peugeot
Principales equivalencias: Peugeot 1444W2

GA-196 FILTRO P/AIRE



Código: 13637
Largo: (13 15/32 in) (13.468 in) (342.1 mm)
Ancho: (5 9/16 in) (5.562 in) (141.2 mm)
Altura Total: (1 59/64 in) (1.921 in) (48.8 mm)
Principales aplicaciones: Automóviles Ford
Principales equivalencias: Ford CO. 1571-9601-AA

GA-216 FILTRO P/AIRE



Código: 13773
Largo: (9 47/64 in) (9.734 in) (247.2 mm)
Ancho: (6 39/64 in) (6.609 in) (167.8 mm)
Altura Total: (1 35/64 in) (1.546 in) (39.2 mm)
Principales aplicaciones: Automóviles Hyundai, Dodge Verna
Principales equivalencias: Hyundai 2811322600

GA-217 FILTRO P/AIRE

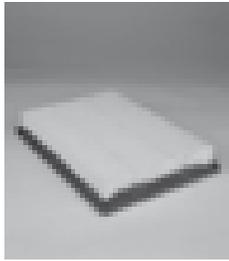

Código: 3340
Largo: (10 1/64 in) (10.015 in) (254.3 mm)
Ancho: (7 1/8 in) (7.125 in) (180.9 mm)
Altura Total: (1 1/2 in) (1.5 in) (38.1 mm)
Principales aplicaciones: Automóviles Ford Sable, Topaz
Principales equivalencias: Ford F23Z-9601-B, F23E-9601-BB

GA-231 FILTRO P/AIRE



Código: 3154
Diámetro Ext.: (10 1/8 in) (10.125 in) (257.1 mm)
Diámetro Int.: (7 3/4 in) (7.75 in) (196.8 mm)
Altura Total: (2 1/8 in) (2.125 in) (53.9 mm)
Principales aplicaciones: Automóviles Renault (1984-86)
Principales equivalencias: Renault 7702184008

GA-218 FILTRO P/AIRE



Código: 3098
Diámetro Ext.: (5 in) (5.000 in) (127.0 mm)
Diámetro Int.: (3 3/8 in) (3.375 in) (85.7 mm)
Altura Total: (6 13/16 in) (6.812 in) (173.0 mm)
Principales aplicaciones: Automóviles Renault R18 (1980-86)
Principales equivalencias: Renault 7701001499, 7701348115

GA-234 FILTRO P/AIRE



Código: 13635
Largo: (11 39/64 in) (11.609 in) (294.8 mm)
Ancho: (9 1/4 in) (9.25 in) (234.9 mm)
Altura Total: (1 7/16 in) (1.437 in) (36.5 mm)
Principales aplicaciones: Automóviles y Camionetas Chevrolet
Principales equivalencias: General Motors 9117557, 89001934

GA-219 FILTRO P/AIRE



Código: 3112
Diámetro Ext.: (5 in) (5.000 in) (127.0 mm)
Diámetro Int.: (3 3/8 in) (3.375 in) (85.7 mm)
Altura Total: (8 1/2 in) (8.5 in) (215.9 mm)
Principales aplicaciones: Automóviles Renault R12 (1972-84)
Principales equivalencias: Renault 77013-48175

GA-240 FILTRO P/AIRE



Código: 13726
Largo: (11 25/32 in) (11.781 in) (299.2 mm)
Ancho: (10 3/4 in) (10.75 in) (273.0 mm)
Altura Total: (2 1/4 in) (2.25 in) (57.1 mm)
Principales aplicaciones: Camionetas Dodge Ram (1994-2002)
Principales equivalencias: Chrysler 4728406, 4864442AB

GA-224 FILTRO P/AIRE



Código: 3706
Largo: (9 in) (9.000 in) (228.6 mm)
Ancho: (7 5/64 in) (7.078 in) (179.7 mm)
Altura Total: (2 19/64 in) (2.296 in) (58.3 mm)
Principales aplicaciones: Automóviles y Camionetas Ford, Mercury
Principales equivalencias: Ford YF1Z-9601-AA, YL8Z-9601-AA

GA-241 FILTRO P/AIRE



Código: 13443
Largo: (in) (in) (mm)
Ancho: (in) (in) (mm)
Altura Total: (in) (in) (mm)
Principales aplicaciones: Automóviles Bmw y Rolls Royce
Principales equivalencias: Bmw 13717505007, 13717526008

GA-230 FILTRO P/AIRE

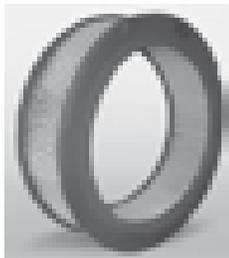

Código: 3114
Diámetro Ext.: (9 23/32 in) (9.718 in) (246.8 mm)
Diámetro Int.: (7 23/32 in) (7.718 in) (196.0 mm)
Altura Total: (2 31/64 in) (2.484 in) (63.1 mm)
Principales aplicaciones: Automóviles Renault Alliance (1985-86)
Principales equivalencias: Renault 7700711477, 8983500079

GA-244 FILTRO P/AIRE



Código: 3467
Largo: (9 in) (9.000 in) (228.6 mm)
Ancho: (7 5/64 in) (7.078 in) (179.7 mm)
Altura Total: (2 9/32 in) (2.281 in) (57.9 mm)
Principales aplicaciones: Automóviles y Camionetas Chevrolet, Suzuki
Principales equivalencias: General Motors 91174457, Suzuki 13780-77E00

GA-248 FILTRO P/AIRE

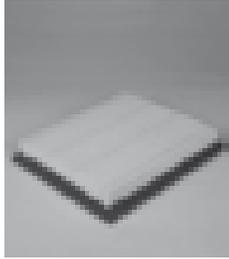

Código: 3171
Largo: (9 21/64 in) (9.328 in) (236.9 mm)
Ancho: (8 7/16 in) (8.437 in) (214.3 mm)
Altura Total: (1 35/64 in) (1.546 in) (39.2 mm)
Principales aplicaciones: Mini Vans Chrysler
Principales equivalencias: Chrysler 4861480AA

GA-259 FILTRO P/AIRE



Código: 3104
Diámetro Ext.: (6 19/32 in) (6.593 in) (167.4 mm)
Diámetro Int.: (5 in) (5.000 in) (127.0 mm)
Altura Total: (6 43/64 in) (6.671 in) (169.4 mm)
Principales aplicaciones: Motores Chevrolet 3500 con conversion a gas
Principales equivalencias: Walmi WA1110

GA-249 FILTRO P/AIRE

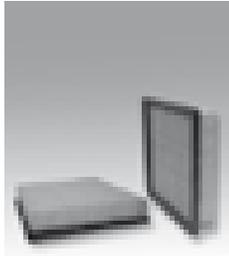

Código: 23282
Largo: (8 57/64 in) (8.890 in) (225.8 mm)
Ancho: (8 39/64 in) (8.610 in) (218.6 mm)
Altura Total: (1 13/16 in) (1.810 in) (45.9 mm)
Principales aplicaciones: Camionetas Chrysler, Dodge
Principales equivalencias: Chrysler 53032527AA, 53032527AB

GA-263 FILTRO P/AIRE



Código: 13640
Largo: (11 27/64 in) (11.421 in) (290.1 mm)
Ancho: (5 29/32 in) (5.906 in) (150.0 mm)
Altura Total: (2 3/64 in) (2.046 in) (51.9 mm)
Principales aplicaciones: Automóviles Toyota
Principales equivalencias: Toyota 17801-0D020, 17801-22020

GA-250 FILTRO P/AIRE



Código: 3105
Diámetro Ext.: (6 21/64 in) (6.328 in) (160.7 mm)
Diámetro Int.: (5 in) (5.000 in) (127.0 mm)
Altura Total: (5 15/32 in) (5.468 in) (138.9 mm)
Principales aplicaciones: Motores Chevrolet 3500 con conversion a gas
Principales equivalencias: Mobil MA121

GA-264 FILTRO P/AIRE

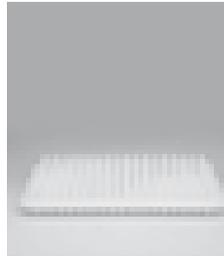

Código: 13641
Largo: (12 35/64 in) (12.546 in) (318.6 mm)
Ancho: (7 37/64 in) (7.578 in) (192.4 mm)
Altura Total: (1 21/32 in) (1.656 in) (42.0 mm)
Principales aplicaciones: Automóviles y Camionetas Toyota
Principales equivalencias: Toyota 17801-0H020, 17801-20040

GA-253 FILTRO P/AIRE



Código: 3286
Diámetro Ext.: (5 41/64 in) (5.640 in) (143.2 mm)
Diámetro Int.: (3 21/32 in) (3.656 in) (92.8 mm)
Altura Total: (5 31/32 in) (5.968 in) (151.6 mm)
Principales aplicaciones: Automóviles Chevrolet (1990-97)
Principales equivalencias: General Motors 25043504

GA-265 FILTRO P/AIRE



Código: 23291
Largo: () () (mm)
Ancho: () () (mm)
Altura Total: () () (mm)
Principales aplicaciones: Automóviles Pontiac, Scion y Toyota
Principales equivalencias: Toyota 178010D060, 178010T030, 1780121050

GA-258 FILTRO P/AIRE

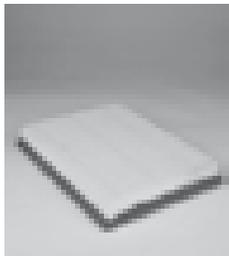

Código: 3707
Largo: (10 5/64 in) (10.078 in) (255.9 mm)
Ancho: (7 15/32 in) (7.468 in) (189.7 mm)
Altura Total: (1 1/2 in) (1.5 in) (38.1 mm)
Principales aplicaciones: Automóviles Chrysler PT Cruiser
Principales equivalencias: Chrysler 4891176AA

GA-269 FILTRO P/AIRE



Código: 13804
Largo: (12 29/32 in) (12.906 in) (327.8 mm)
Ancho: (5 53/64 in) (5.828 in) (148.0 mm)
Altura Total: (1 45/64 in) (1.703 in) (43.2 mm)
Principales aplicaciones: Automóviles Acura, Honda
Principales equivalencias: Honda 17220-RCA-A00, 17220-RDA-A00

GA-271 FILTRO P/AIRE



Código: 3097
Largo: (8 5/64 in) (8.078 in) (205.1 mm)
Ancho: (5 17/64 in) (5.265 in) (133.7 mm)
Altura Total: (1 39/64 in) (1.609 in) (40.8 mm)
Principales aplicaciones: Automóviles y Camionetas Chrysler, Dodge, Plymouth, Cargadoras New Holland
Principales equivalencias: Chrysler 4342801, New Holland 86504784

GA-276 FILTRO P/AIRE



Código: 3277
Largo: (11 9/64 in) (11.140 in) (282.9 mm)
Ancho: (4 19/64 in) (4.296 in) (109.1 mm)
Altura Total: (1 41/64 in) (1.640 in) (41.6 mm)
Principales aplicaciones: Automóviles Chrysler, Dodge
Principales equivalencias: Chrysler 4268981

GA-272 FILTRO P/AIRE

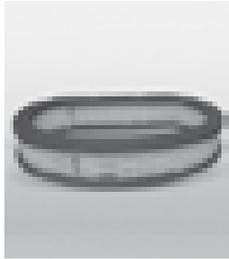

Código: 3155
Diámetro Ext. Mayor: (13 1/8 in) (13.125 in) (333.3 mm)
Diámetro Ext. Menor: (7 5/16 in) (7.312 in) (185.7 mm)
Diámetro Int. Mayor: (11 13/64 in) (11.203 in) (284.5 mm)
Diámetro Int. Menor: (5 25/64 in) (5.390 in) (136.9 mm)
Altura Total: (1 55/64 in) (1.859 in) (47.2 mm)
Principales aplicaciones: Automóviles y Camionetas Chrysler, Dodge, Ford, Plymouth, Volkswagen
Principales equivalencias: Chrysler 4342800, Ford E59E-9601-AA

GA-277 FILTRO P/AIRE



Código: 3285
Largo: (10 53/64 in) (10.828 in) (275.0 mm)
Ancho: (5 15/64 in) (5.234 in) (132.9 mm)
Altura Total: (1 19/32 in) (1.593 in) (40.4 mm)
Principales aplicaciones: Automóviles y Camionetas, Chrysler, Dodge, Ford, Plymouth, Volkswagen
Principales equivalencias: Chrysler 4241042, Ford E59E-9601-AA

GA-273 FILTRO P/AIRE



Código: 3205
Largo: (11 7/32 in) (11.218 in) (284.9 mm)
Ancho: (6 11/64 in) (6.171 in) (156.7 mm)
Altura Total: (1 13/64 in) (1.203 in) (30.5 mm)
Principales aplicaciones: Automóviles y Camionetas Ford, Mazda, Mercury
Principales equivalencias: Ford E6AE-9601-BC, E6AZ-9601-B

GA-278R FILTRO P/AIRE



Código: 4406
Diámetro Ext.: (5 21/32 in) (5.656 in) (143.6 mm)
Diámetro Int.: (2 11/32 in) (2.343 in) (59.5 mm)
Altura Total: (6 37/64 in) (6.578 in) (167.0 mm)
Principales aplicaciones: Automóviles Dodge Neon
Principales equivalencias: Chrysler 4891097AA

GA-274 FILTRO P/AIRE



Código: 3260
Largo: (7 57/64 in) (7.890 in) (200.4 mm)
Ancho: (6 31/32 in) (6.968 in) (177.0 mm)
Altura Total: (1 37/64 in) (1.578 in) (40.0 mm)
Principales aplicaciones: Automóviles Ford Topaz
Principales equivalencias: Ford E43A-9601-CA, E43E-9601-CB

GA-279 FILTRO P/AIRE

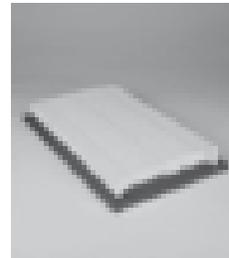

Código: 3715
Largo: (12 25/64 in) (12.390 in) (314.7 mm)
Ancho: (7 41/64 in) (7.640 in) (194.0 mm)
Altura Total: (1 35/64 in) (1.546 in) (39.2 mm)
Principales aplicaciones: Automóviles y Camionetas Chevrolet, Pontiac
Principales equivalencias: General Motors 25161977

GA-275 FILTRO P/AIRE

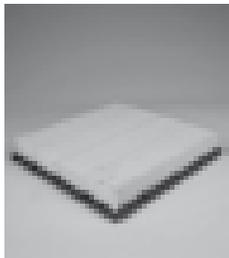

Código: 3261
Largo: (9 5/8 in) (9.625 in) (244.4 mm)
Ancho: (9 5/8 in) (9.625 in) (244.4 mm)
Altura Total: (1 37/64 in) (1.578 in) (40.0 mm)
Principales aplicaciones: Automóviles Ford, Mercury
Principales equivalencias: Ford E9FE-9601-AB, E9SE-9601-AB

GA-280 FILTRO P/AIRE



Código: 13634
Largo: (10 1/64 in) (10.015 in) (254.3 mm)
Ancho: (8 21/32 in) (8.656 in) (219.8 mm)
Altura Total: (1 45/64 in) (1.703 in) (43.2 mm)
Principales aplicaciones: Automóviles Ford
Principales equivalencias: Fram CA8736, Interfil F87A36

GA-281 FILTRO P/AIRE



Código: 3671
Largo: (10 37/64 in) (10.578 in) (268.6 mm)
Ancho: (5 13/32 in) (5.406 in) (137.3 mm)
Altura Total: (1 7/64 in) (1.109 in) (28.1 mm)
Principales aplicaciones: Automóviles Hyundai, Dodge Atos
Principales equivalencias: Hyundai 28113-02510

GA-288R FILTRO P/AIRE

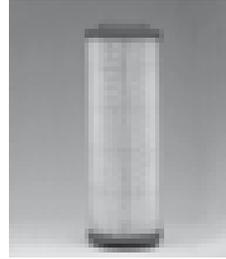

Código: 13806
Diámetro Ext.: (4 9/64 in) (4.140 in) (105.1 mm)
Diámetro Int.: (2 3/64 in) (2.046 in) (51.9 mm)
Altura Total: (12 1/4 in) (12.25 in) (311.1 mm)
Principales aplicaciones: Automóviles Ford Escort (2003-07)
Principales equivalencias: Ford 2-NIV-9601-BD

GA-283 FILTRO P/AIRE

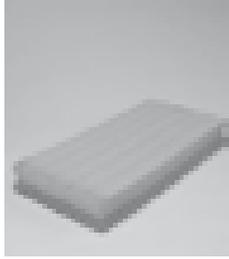

Código: 13731
Largo: (13 1/2 in) (13.5 in) (342.9 mm)
Ancho: (6 21/32 in) (6.656 in) (169.0 mm)
Altura Total: (1 13/16 in) (1.812 in) (46.0 mm)
Principales aplicaciones: Automóviles y Camionetas Mitsubishi
Principales equivalencias: Mitsubishi MR 127077, MR 239024, XR 127077

GA-289 FILTRO P/AIRE



Código: 13704
Largo: (11 25/64 in) (11.390 in) (289.3 mm)
Ancho: (8 15/64 in) (8.234 in) (209.1 mm)
Altura Total: (1 29/64 in) (1.453 in) (36.9 mm)
Principales aplicaciones: Automóviles y Camionetas Chevrolet, Chrysler, Dodge
Principales equivalencias: Chrysler 5019002AA, 5037615AA, General Motors 9129747

GA-284 FILTRO P/AIRE

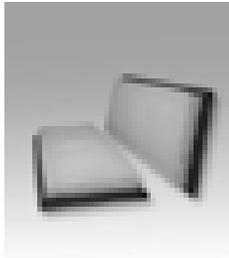

Código: 13796
Largo: (16 1/4 in) (16.25 in) (412.7 mm)
Ancho: (5 3/32 in) (5.093 in) (129.3 mm)
Altura Total: (1 3/16 in) (1.187 in) (30.1 mm)
Principales aplicaciones: Automóviles Ford Fiesta (2003-05)
Principales equivalencias: Interfil F-96A01

GA-291 FILTRO P/AIRE



Código: 13642
Largo: (6 15/16 in) (6.937 in) (176.2 mm)
Ancho Mayor: (5 7/16 in) (5.437 in) (138.1 mm)
Ancho Menor: (3 27/32 in) (3.843 in) (97.6 mm)
Altura Total: (2 15/16 in) (2.937 in) (74.6 mm)
Principales aplicaciones: Automóviles y Camionetas Nissan, Renault
Principales equivalencias: Nissan 1654600AA

GA-285 FILTRO P/AIRE

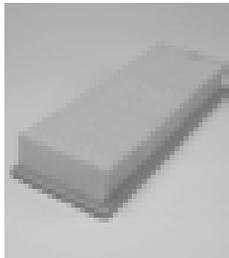

Código: 13702
Largo: (14 9/16 in) (14.562 in) (369.8 mm)
Ancho: (5 19/64 in) (5.296 in) (134.5 mm)
Altura Total: (2 9/32 in) (2.281 in) (57.9 mm)
Principales aplicaciones: Automóviles Seat
Principales equivalencias: VAG 6K0-129-620B

GA-292 FILTRO P/AIRE



Código: 13797
Largo: (9 19/32 in) (9.593 in) (243.6 mm)
Ancho: (7 29/64 in) (7.453 in) (189.3 mm)
Altura Total: (2 in) (2.000 in) (50.8 mm)
Principales aplicaciones: Automóviles Renault Megane (2003-06)
Principales equivalencias: Renault 8200261781, 8200378889

GA-286 FILTRO P/AIRE



Código: 13772
Largo: (12 5/32 in) (12.156 in) (308.7 mm)
Ancho: (9 1/16 in) (9.062 in) (230.1 mm)
Altura Total: (2 3/64 in) (2.046 in) (51.9 mm)
Principales aplicaciones: Camionetas Toyota
Principales equivalencias: Toyota 17801-07010, 17801-50040

GA-293 FILTRO P/AIRE



Código: 13807
Largo: (14 27/32 in) (14.843 in) (377.0 mm)
Ancho: (5 11/32 in) (5.343 in) (135.7 mm)
Altura Total: (2 3/64 in) (2.046 in) (51.9 mm)
Principales aplicaciones: Camionetas Toyota RAV4
Principales equivalencias: Toyota 17801-28010

GAD-294 FILTRO P/AIRE

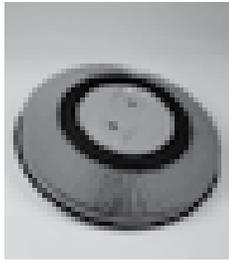

Código: 3475
Diámetro Ext.: (13 3/64 in) (13.046 in) (331.3 mm)
Diámetro Int.: (1/2 in) (0.5 in) (12.7 mm)
Altura Total: (2 11/32 in) (2.343 in) (59.5 mm)
Principales aplicaciones: Camionetas Nissan
Principales equivalencias: Nissan 16546-86G00

GA-304 FILTRO P/AIRE



Código: 13444
Diámetro Ext.: (13 3/8 in) (13.375 in) (339.7 mm)
Diámetro Int.: (6 47/64 in) (6.734 in) (171.1 mm)
Altura Total: (1 19/32 in) (1.594 in) (40.5 mm)
Principales aplicaciones: Automóviles Kia
Principales equivalencias: Kia K2A5-13-240A

GA-300 FILTRO P/AIRE

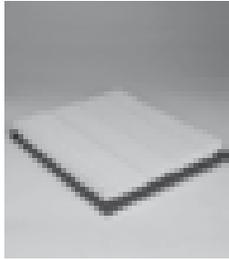

Código: 3487
Largo: (11 3/8 in) (11.375 in) (288.9 mm)
Ancho: (9 41/64 in) (9.640 in) (244.8 mm)
Altura Total: (1 29/64 in) (1.453 in) (36.9 mm)
Principales aplicaciones: Camionetas Jeep, Nissan
Principales equivalencias: Chrysler 53007386

GA-305 FILTRO P/AIRE



Código: 13445
Diámetro Ext.: (in) (in) (mm)
Diámetro Int.: (in) (in) (mm)
Altura Total: (in) (in) (mm)
Principales aplicaciones: Automóviles y Camionetas Volvo
Principales equivalencias: Volvo 9454647, 9454647-0

GA-301 FILTRO P/AIRE



Código: 3987
Largo: (13 29/64 in) (13.453 in) (341.7 mm)
Ancho: (6 15/64 in) (6.234 in) (158.3 mm)
Altura Total: (1 13/16 in) (1.812 in) (46.0 mm)
Principales aplicaciones: Camionetas Jeep Grand Cherokee, Rubicon
Principales equivalencias: Chrysler 4797777AB

GA-314 FILTRO P/AIRE



Código: 13730
Largo: (8 1/32 in) (8.031 in) (203.9 mm)
Ancho: (7 51/64 in) (7.796 in) (198.0 mm)
Altura Total: (1 3/8 in) (1.375 in) (34.9 mm)
Principales aplicaciones: Automóviles Pontiac Matiz
Principales equivalencias: Daewoo 96314494

GA-302 FILTRO P/AIRE

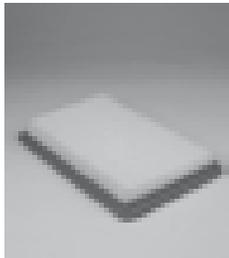

Código: 13850
Largo: (10 41/64 in) (10.640 in) (270.2 mm)
Ancho: (6 1/2 in) (6.5 in) (165.1 mm)
Altura Total: (1 19/64 in) (1.296 in) (32.9 mm)
Principales aplicaciones: Automóviles Hyundai, Dodge Atos (2005-07)
Principales equivalencias: Hyundai 28113-02750

GAD-315 FILTRO P/AIRE

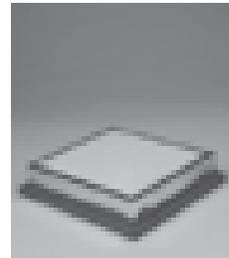

Código: 13849
Largo: (6 43/64 in) (6.671 in) (169.4 mm)
Ancho: (6 11/64 in) (6.171 in) (156.7 mm)
Altura Total: (1 3/8 in) (1.375 in) (34.9 mm)
Principales aplicaciones: Automóviles Nissan Micra
Principales equivalencias: Nissan 1654641B01, 16546-0U800

GA-303 FILTRO P/AIRE



Código: 3169
Diámetro Ext.: (11 13/64 in) (11.203 in) (284.5 mm)
Diámetro Int.: (9 3/32 in) (9.093 in) (230.9 mm)
Altura Total: (2 3/16 in) (2.187 in) (55.5 mm)
Principales aplicaciones: Automóviles y Camionetas Ford
Principales equivalencias: Ford C8TF-9600-A, E4ZZ-9601-AR

GA-320 FILTRO P/AIRE



Código: 13969
Largo: (9 15/16 in) (9.937 in) (252.4 mm)
Ancho: (9 15/16 in) (9.937 in) (252.4 mm)
Altura Total: (2 11/64 in) (2.172 in) (55.2 mm)
Principales aplicaciones: Automóviles Lexus, Pontiac, Scion, Toyota
Principales equivalencias: Toyota 17801-31120, 17801-AD010

GA-322 FILTRO P/AIRE



Código: 13456
Largo: (12 3/16 in) (12.188 in) (309.6 mm)
Ancho: (7 1/4 in) (7.250 in) (184.2 mm)
Altura Total: (1 11/16 in) (1.688 in) (42.9 mm)
Principales aplicaciones: Automóviles y Camionetas Lexus y Toyota
Principales equivalencias: Toyota 17801-03010, 17801-74060

GA-334 FILTRO P/AIRE

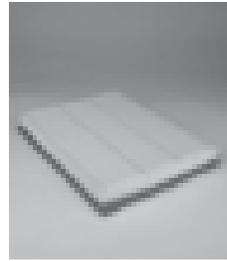

Código: 13638
Largo: (12 3/64 in) (12.046 in) (305.9 mm)
Ancho: (8 55/64 in) (8.859 in) (225.0 mm)
Altura Total: (1 7/16 in) (1.437 in) (36.5 mm)
Principales aplicaciones: Automóviles Chevrolet
Principales equivalencias: General Motors 9194405, 9202382

GA-323 FILTRO P/AIRE

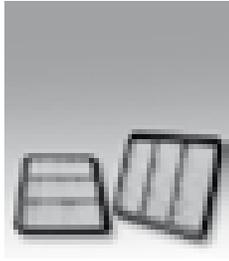

Código: 13967
Largo: (8 7/8 in) (8.875 in) (225.4 mm)
Ancho: (7 5/8 in) (7.625 in) (193.6 mm)
Altura Total: (1 in) (1.00 in) (25.4 mm)
Principales aplicaciones: Automóviles Pontiac Matiz G2
Principales equivalencias: General motors 96591485

GA-340 FILTRO P/AIRE

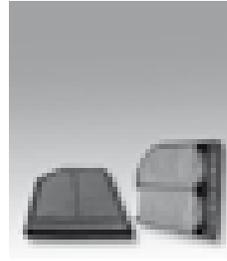

Código: 13971
Largo del Elemento: (7 5/32 in) (7.156 in) (181.7 mm)
Ancho del Elemento: (6 31/32 in) (6.968 in) (176.9 mm)
Largo Total: (8 55/64 in) (8.859 in) (225.0 mm)
Ancho Total: (7 3/4 in) (7.750 in) (196.8 mm)
Altura Total: (1 37/64 in) (1.578 in) (40.0 mm)
Principales aplicaciones: Automóviles Honda Civic
Principales equivalencias: Honda 17220-RNA-A00

GA-324 FILTRO P/AIRE



Código: 13968
Largo: (8.812 in) (8 13/16 in) (223.8 mm)
Ancho: (7.359 in) (7 23/64 in) (186.9 mm)
Altura Total: (1.812 in) (1 13/16 in) (46.0 mm)
Principales aplicaciones: Automóviles Chevrolet, Pontiac y Suzuki
Principales equivalencias: General motors 96 536 696, 96 536 697

GA-341 FILTRO P/AIRE



Código: 13970
Largo: (10.468 in) (10 15/32 in) (265.8 mm)
Ancho: (6.734 in) (6 47/64 in) (171.0 mm)
Altura Total: (1.921 in) (1 59/64 in) (48.7 mm)
Principales aplicaciones: Camionetas Honca CR-V
Principales equivalencias: Honda 17220-RZA-000

GA-325 FILTRO P/AIRE



Código: 3172
Diámetro Ext.: (12 11/32 in) (12.343 in) (313.5 mm)
Diámetro Int.: (10 27/32 in) (10.843 in) (275.4 mm)
Altura Total: (2 5/8 in) (2.625 in) (66.6 mm)
Principales aplicaciones: Automóviles Cadillac Deville, Eldorado
Principales equivalencias: General Motors 6483644

GA-348 FILTRO P/AIRE



Código: 3207
Largo: (12 1/4 in) (12.25 in) (311.1 mm)
Ancho: (9 11/16 in) (9.687 in) (246.0 mm)
Altura Total: (2 19/64 in) (2.296 in) (58.3 mm)
Principales aplicaciones: Camionetas Cadillac, Chevrolet, GMC
Principales equivalencias: General Motors 25313348, 25313349

GA-328 FILTRO P/AIRE

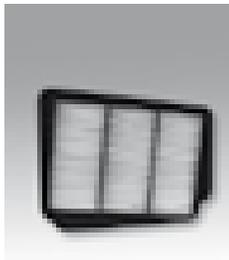

Código: 13966
Largo Elemento: (9 5/8 in) (9.625 in) (244.4 mm)
Largo Total: (11 1/4 in) (11.250 in) (285.7 mm)
Ancho Elemento: (7 1/4 in) (7.250 in) (184.1 mm)
Ancho Total: (8 5/8 in) (8.625 in) (219.0 mm)
Altura Total: (1 1/2 in) (1.500 in) (38.1 mm)
Principales aplicaciones: Automóviles Chevrolet y Suzuki
Principales equivalencias: General motors 96553450

GA-349 FILTRO P/AIRE



Código: 3176
Diámetro Ext.: (9 3/16 in) (9.187 in) (233.3 mm)
Diámetro Int.: (9 31/32 in) (9.968 in) (253.2 mm)
Altura Total: (2 3/16 in) (2.187 in) (55.5 mm)
Principales aplicaciones: Automóviles Ford (1989-92), Motores Cummins
Principales equivalencias: Ford D12F-9601-BA

GA-362 FILTRO P/AIRE



Código: 3353
Diámetro Ext. Mayor: (8 5/64 in) (8.078 in) (205.1 mm)
Diámetro Ext. Menor: (7 27/32 in) (7.843 in) (199.2 mm)
Diámetro Int. Mayor: (5 19/64 in) (5.296 in) (134.5 mm)
Diámetro Int. Menor: (4 11/32 in) (4.343 in) (110.3 mm)
Altura Total: (6 55/64 in) (6.859 in) (174.2 mm)
Principales aplicaciones: Automóviles y Camionetas Hyundai, Dodge
Principales equivalencias: Chrysler MD603932, Hyundai 28113-32510, 28177-32520

GA-381 FILTRO P/AIRE



Código: 13458
Largo: (8 11/64 in) (8.172 in) (207.6 mm)
Ancho: (7 9/32 in) (7.281 in) (184.9 mm)
Altura Total: (1 11/16 in) (1.688 in) (42.9 mm)
Principales aplicaciones: Automóviles Honda
Principales equivalencias: Honda 17220-P07-000

GA-363 FILTRO P/AIRE



Código: 3108
Largo: (10 11/32 in) (10.343 in) (262.7 mm)
Ancho: (5 5/16 in) (5.312 in) (134.9 mm)
Altura Total: (2 7/32 in) (2.218 in) (56.3 mm)
Principales aplicaciones: Automóviles Chevrolet Astra, Dodge Attitude
Principales equivalencias: Hyundai 28113-1G000, Fram CA10088

GA-382 FILTRO P/AIRE



Código: 13457
Largo: (7 15/16 in) (7.938 in) (201.6 mm)
Ancho: (6 53/64 in) (6.828 in) (173.4 mm)
Altura Total: (1 15/32 in) (1.469 in) (37.3 mm)
Principales aplicaciones: Automóviles Honda
Principales equivalencias: Honda 17220-PM7-000, 17220-PM7-F00

GA-364 FILTRO P/AIRE INY.

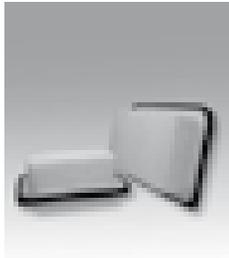

Código: 13915
Largo: (9 13/16 in) (9.812 in) (249.2 mm)
Ancho: (4 23/32 in) (4.718 in) (119.8 mm)
Altura Total: (2 7/64 in) (2.109 in) (53.5 mm)
Principales aplicaciones: Automóviles Toyota Yaris
Principales equivalencias: Toyota 17801-21030

GA-383 FILTRO P/AIRE INY.

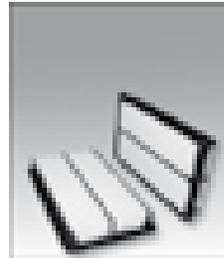

Código: 13917
Largo: (11 63/64 in) (11.984 in) (304.4 mm)
Ancho: (6 29/32 in) (6.906 in) (175.4 mm)
Altura Total: (1 37/64 in) (1.578 in) (40.0 mm)
Principales aplicaciones: Mini Vans Honda Odyssey
Principales equivalencias: Honda 17220-RD5-A00, 17220-RGL-A10

GA-367 FILTRO P/AIRE



Código: 13899
Largo: (10 15/16 in) (10.937 in) (277.8 mm)
Ancho: (9 11/32 in) (9.343 in) (237.3 mm)
Altura: (1 15/32 in) (1.468 in) (37.3 mm)
Principales aplicaciones: Camionetas Chevrolet Equinox
Principales equivalencias: General Motors 22676970

GA-384 FILTRO P/AIRE



Código: 13454
Largo: (8 55/64 in) (8.859 in) (225.0 mm)
Ancho: (6 5/8 in) (6.625 in) (168.3 mm)
Altura Total: (1 9/64 in) (1.141 in) (29.0 mm)
Principales aplicaciones: Automóviles Honda
Principales equivalencias: Honda 17220-P2A-005, 17220-P2F-A01

GA-380 FILTRO P/AIRE INY.



Código: 13916
Largo: (13 31/32 in) (13.968 in) (354.8 mm)
Ancho Mayor: (6 17/32 in) (6.531 in) (165.8 mm)
Ancho Menor: (3 1/8 in) (3.125 in) (79.3 mm)
Altura Total: (2 7/16 in) (2.437 in) (61.9 mm)
Principales aplicaciones: Camionetas Toyota
Principales equivalencias: Toyota 17801-0P010, 17801-31090

GA-386 FILTRO P/AIRE



Código: 13455
Largo: (in) (in) (mm)
Ancho: (in) (in) (mm)
Altura Total: (in) (in) (mm)
Principales aplicaciones: Automóviles Honda
Principales equivalencias: Honda 17220-PT2-000

GA-390 FILTRO P/AIRE



Código: 13459
Largo: (in) (in) (mm)
Ancho: (in) (in) (mm)
Altura Total: (in) (in) (mm)
Principales aplicaciones: Automóviles Honda
Principales equivalencias: Honda 17220-PH4-305, 17232-PH4-661

GA-410 FILTRO P/AIRE



Código: 13322
Largo: (5 17/64 in) (5.266 in) (133.7 mm)
Ancho: (3 1/64 in) (3.016 in) (76.6 mm)
Altura Total: (11 1/16 in) (11.062 in) (281.0 mm)
Principales aplicaciones: Camionetas Toyota Hiace
Principales equivalencias: Toyota 17801-54100, 17801-75010

GA-391 FILTRO P/AIRE



Código: 13636
Largo: (10 63/64 in) (10.984 in) (279.0 mm)
Ancho Mayor: (8 3/64 in) (8.046 in) (204.3 mm)
Ancho Menor: (4 3/64 in) (4.046 in) (102.7 mm)
Altura Total: (2 7/32 in) (2.218 in) (56.3 mm)
Principales aplicaciones: Automóviles Renault
Principales equivalencias: Renault 7701052082

GA-413R FILTRO P/AIRE



Código: 4431
Diámetro Ext.: (5 11/32 in) (5.343 in) (135.7 mm)
Diámetro Int.: (3 5/32 in) (3.156 in) (80.1 mm)
Altura Total: (13 3/64 in) (13.046 in) (331.3 mm)
Principales aplicaciones: Vans Chevrolet
Principales equivalencias: Genreal Motors 15153904

GA-392 FILTRO P/AIRE



Código: 3048
Largo: (15 15/16 in) (15.937 in) (404.8 mm)
Ancho: (7 15/16 in) (7.937 in) (201.6 mm)
Altura Total: (1 41/64 in) (1.640 in) (41.6 mm)
Principales aplicaciones: Automóviles Chevrolet, Pontiac
Principales equivalencias: General Motors 25042562

GA-414R FILTRO P/AIRE

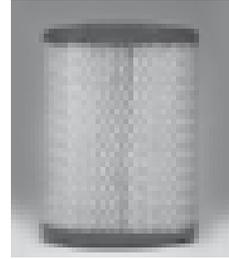

Código: 13714
Diámetro Ext.: (5 63/64 in) (5.984 in) (152.0 mm)
Diámetro Int.: (3 5/32 in) (3.156 in) (80.1 mm)
Altura Total: (8 1/32 in) (8.031 in) (203.9 mm)
Principales aplicaciones: Camionetas Chevrolet
Principales equivalencias: General Motors 15036141C

GA-395 FILTRO P/AIRE



Código: 13725
Largo: (11 1/2 in) (11.5 in) (292.1 mm)
Ancho: (7 3/32 in) (7.093 in) (180.1 mm)
Altura Total: (2 1/4 in) (2.25 in) (57.1 mm)
Principales aplicaciones: Camionetas Ford, Lincoln
Principales equivalencias: Ford 1L2Z-9601-AA

GA-415 FILTRO P/AIRE



Código: 13972
Diámetro Ext.: (5 53/64 in) (5.828 in) (148.0 mm)
Diámetro Int.: (3 3/32 in) (3.093 in) (78.5 mm)
Altura Total: (8 27/64 in) (8.421 in) (213.8 mm)
Principales aplicaciones: Camionetas Chevrolet, GMC, Hummer, Isuzu
Principales equivalencias: General motors 15123627, 15202408

GA-397 FILTRO P/AIRE



Código: 13648
Largo: (12 53/64 in) (12.828 in) (325.8 mm)
Ancho: (9 29/32 in) (9.906 in) (251.6 mm)
Altura Total: (1 15/16 in) (1.937 in) (49.2 mm)
Principales aplicaciones: Automóviles Chevrolet
Principales equivalencias: General Motors 9177267, 93172461

GA-429 FILTRO P/AIRE



Código: 3066
Diámetro Ext.: (10 57/64 in) (10.890 in) (276.6 mm)
Diámetro Int.: (8 15/16 in) (8.937 in) (227.0 mm)
Altura Total: (3 1/2 in) (3.5 in) (88.9 mm)
Principales aplicaciones: Camionetas y Camiones Chrysler, Dodge
Principales equivalencias: Chrysler 3614353

GA-432 FILTRO P/AIRE



Código: 13728
Largo: (10 3/8 in) (10.375 in) (263.5 mm)
Ancho: (6 29/64 in) (6.453 in) (163.9 mm)
Altura Total: (1 17/32 in) (1.531 in) (38.8 mm)
Principales aplicaciones: Automóviles Ford, Mazda
Principales equivalencias: Ford F32Z-9601-A

GA-442 FILTRO P/AIRE



Código: 13729
Diámetro Ext. Mayor: (12 9/16 in) (12.562 in) (319.0 mm)
Diámetro Ext. Menor: (6 3/8 in) (6.375 in) (161.9 mm)
Diámetro Int. Mayor: (9 23/64 in) (9.359 in) (237.7 mm)
Diámetro Int. Menor: (3 11/64 in) (3.171 in) (80.5 mm)
Altura Total: (6 7/64 in) (6.109 in) (155.1 mm)
Principales aplicaciones: Vans y Camionetas Ford con motor diesel 7.3L 1994-98
Principales equivalencias: Ford F5TZ9601A

GA-433 FILTRO P/AIRE



Código: 13446
Largo: (in) (in) (mm)
Ancho: (in) (in) (mm)
Altura Total: (in) (in) (mm)
Principales aplicaciones: Camionetas Ford
Principales equivalencias: Ford XL3Z-9601-AA, Motorcraft FA 1682

GA-448 FILTRO P/AIRE

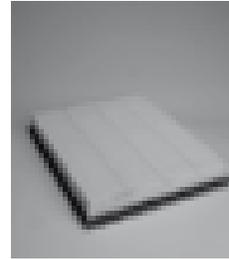

Código: 13716
Largo: (10 45/64 in) (10.703 in) (271.8 mm)
Ancho: (9 43/64 in) (9.671 in) (245.6 mm)
Altura Total: (1 37/64 in) (1.578 in) (40.0 mm)
Principales aplicaciones: Camionetas Jeep Grand Cherokee
Principales equivalencias: Chrysler 5015610AA

GA-434 FILTRO P/AIRE



Código: 13447
Largo: (10 5/32 in) (10.156 in) (258.0 mm)
Ancho: (6 7/32 in) (6.219 in) (158.0 mm)
Altura Total: (1 9/16 in) (1.562 in) (39.7 mm)
Principales aplicaciones: Automóviles Kia Sephia
Principales equivalencias: Kia K201-13-Z00

GA-464 FILTRO P/AIRE



Código: 13313
Largo: (11 1/2 in) (11.500 in) (292.1 mm)
Ancho: (7 29/32 in) (7.906 in) (200.8 mm)
Altura Total: (1 45/64 in) (1.703 in) (43.2 mm)
Principales aplicaciones: Automóviles Toyota
Principales equivalencias: Toyota 17801-0H050, 17801-28030

GA-437 FILTRO P/AIRE

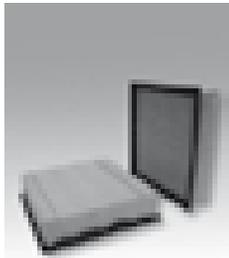

Código: 13448
Largo: (10 31/64 in) (10.484 in) (266.3 mm)
Ancho: (9 15/16 in) (9.937 in) (252.4 mm)
Altura Total: (2 41/64 in) (2.641 in) (67.1 mm)
Principales aplicaciones: Camionetas Ford y Lincoln
Principales equivalencias: Ford 7C3Z-9601-A

GA-471 FILTRO P/AIRE



Código: 13717
Largo: (9 1/2 in) (9.5 in) (241.3 mm)
Ancho: (7 3/4 in) (7.75 in) (196.8 mm)
Altura Total: (1 57/64 in) (1.890 in) (48.0 mm)
Principales aplicaciones: Automóviles Mazda (1986-89)
Principales equivalencias: Mazda E5D3-23-603A

GA-438 FILTRO P/AIRE



Código: 13715
Largo: (13 7/8 in) (13.875 in) (352.4 mm)
Ancho: (5 1/4 in) (5.25 in) (133.3 mm)
Altura Total: (1 23/32 in) (1.718 in) (43.6 mm)
Principales aplicaciones: Camionetas Dodge Ram (1994-2002) 10 Cil.
Principales equivalencias: Chrysler 112-094-06-04

GA-472 FILTRO P/AIRE



Código: 13724
Largo: (13 1/2 in) (13.5 in) (342.9 mm)
Ancho: (7 1/16 in) (7.062 in) (179.3 mm)
Altura Total: (2 3/32 in) (2.093 in) (53.1 mm)
Principales aplicaciones: Camiones Ford V8 7.3L Turbo Diesel
Principales equivalencias: Ford F81A-9601-AA, F81Z-9601-AB

GA-475 FILTRO P/AIRE



Código: 13832
 Largo: (12 29/64 in) (12.453 in) (316.3 mm)
 Ancho: (10 29/32 in) (10.906 in) (277.0 mm)
 Altura Total: (2 49/64 in) (2.765 in) (70.2 mm)
 Principales aplicaciones: Vans Mercedes Benz, Volkswagen, Freightliner
 Principales equivalencias: Mercedes Benz A0030947504, Chrysler 5103-555AA, Volkswagen 2D0129-620

GA-488 FILTRO P/AIRE

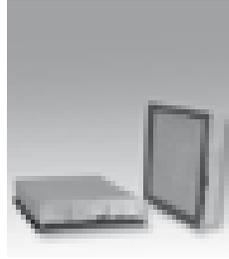

Código: 23283
 Largo: (10 31/32 in) (10.968 in) (278.5 mm)
 Ancho: (9 15/16 in) (9.937 in) (252.3 mm)
 Altura Total: (2 19/32 in) (2.593 in) (65.8 mm)
 Principales aplicaciones: Camionetas Dodge Ram a diesel
 Principales equivalencias: Chrysler 5029703AA, 53032700AB

GA-476 FILTRO P/AIRE



Código: 13718
 Largo: (9 61/64 in) (9.953 in) (252.8 mm)
 Ancho: (6 3/8 in) (6.375 in) (161.9 mm)
 Altura Total: (1 1/2 in) (1.5 in) (38.1 mm)
 Principales aplicaciones: Automóviles Hyundai Accent
 Principales equivalencias: Hyundai 28113-22051

GA-489 FILTRO P/AIRE

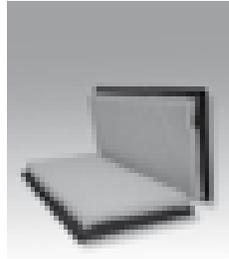

Código: 13376
 Largo: () () (mm)
 Ancho: () () (mm)
 Altura Total: () () (mm)
 Principales aplicaciones: Automóviles y Camionetas Dodge y Jeep
 Principales equivalencias: Chrysler 4891694AA

GA-477 FILTRO P/AIRE

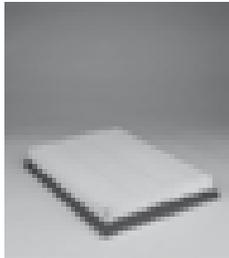

Código: 13719
 Largo: (11 31/64 in) (11.484 in) (291.7 mm)
 Ancho: (8 21/64 in) (8.328 in) (211.5 mm)
 Altura Total: (1 9/16 in) (1.562 in) (39.6 mm)
 Principales aplicaciones: Camionetas Jeep Commander, Grand Cherokee, Liberty
 Principales equivalencias: Chrysler 5018777AB

GA-490 FILTRO P/AIRE



Código: 13721
 Largo: (13 3/4 in) (13.75 in) (349.2 mm)
 Ancho: (9 3/8 in) (9.375 in) (238.1 mm)
 Altura Total: (2 3/64 in) (2.046 in) (51.9 mm)
 Principales aplicaciones: Camionetas Chrysler, Dodge
 Principales equivalencias: Chrysler 53032404AA

GA-479 FILTRO P/AIRE



Código: 13720
 Largo: (12 13/64 in) (12.203 in) (309.9 mm)
 Ancho: (6 33/64 in) (6.515 in) (165.4 mm)
 Altura Total: (1 23/32 in) (1.718 in) (43.6 mm)
 Principales aplicaciones: Automóviles y Camionetas Ford, Jaguar, Lincoln
 Principales equivalencias: Ford XW4Z-9601-AC, Jaguar XR88237

GA-491 FILTRO P/AIRE



Código: 13433
 Largo: (9 3/8 in) (9.375 in) (238.1 mm)
 Ancho: (7 7/16 in) (7.437 in) (188.9 mm)
 Altura Total: (1 21/32 in) (1.656 in) (42.1 mm)
 Principales aplicaciones: Automóviles Hyundai y Kia
 Principales equivalencias: Hyundai 28113-37101, Kia 28113-37010, 28113-37101

GA-486 FILTRO P/AIRE



Código: 13431
 Largo: (11 31/32 in) (11.969 in) (304.0 mm)
 Ancho: (7 49/64 in) (7.766 in) (197.2 mm)
 Altura Total: (1 25/64 in) (1.391 in) (35.3 mm)
 Principales aplicaciones: Automóviles Saturn
 Principales equivalencias: General motors 15800986

GA-492 FILTRO P/AIRE



Código: 13432
 Largo: (10 1/8 in) (10.125 in) (257.2 mm)
 Ancho: (6 3/8 in) (6.375 in) (161.9 mm)
 Altura Total: (1 11/16 in) (1.687 in) (42.8 mm)
 Principales aplicaciones: Automóviles Chrysler PT Cruiser
 Principales equivalencias: Chrysler 4891691AA

GA-510 FILTRO P/AIRE



Código: 13645
Largo: (11 63/64 in) (11.984 in) (304.4 mm)
Ancho: (12 19/32 in) (12.593 in) (319.8 mm)
Altura Total: (1 5/16 in) (1.312 in) (33.3 mm)
Principales aplicaciones: Automóviles y Camionetas Chrysler
Principales equivalencias: Chrysler 5510026AA

GA-604 FILTRO P/AIRE



Código: 13451
Largo: (9 27/32 in) (9.844 in) (250.0 mm)
Ancho: (5 35/64 in) (5.547 in) (140.9 mm)
Altura Total: (2 3/64 in) (2.047 in) (52.0 mm)
Principales aplicaciones: Automóviles y Camionetas Saturn
Principales equivalencias: General motors 21000938, 25166243

GA-514 FILTRO P/AIRE



Código: 13452
Largo: (12 1/8 in) (12.125 in) (308.0 mm)
Ancho: (7 1/4 in) (7.250 in) (184.2 mm)
Altura Total: (2 3/16 in) (2.187 in) (55.5 mm)
Principales aplicaciones: Automóviles y Camionetas Acura, Honda e Isuzu
Principales equivalencias: Honda 17220-POA-A00, Isuzu 5-86202-255-0

GA-605 FILTRO P/AIRE



Código: 13801
Largo: (9 27/32 in) (9.843 in) (250.0 mm)
Ancho: (8 55/64 in) (8.859 in) (225.0 mm)
Altura Total: (1 15/16 in) (1.937 in) (49.2 mm)
Principales aplicaciones: Camionetas Mitsubishi Montero (2003-06)
Principales equivalencias: Mitsubishi MD620837, MR571473

GA-595 FILTRO P/AIRE

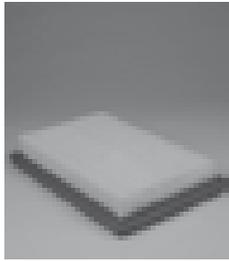

Código: 13723
Largo: (9 39/64 in) (9.609 in) (244.0 mm)
Ancho: (6 3/16 in) (6.187 in) (157.1 mm)
Altura Total: (1 17/32 in) (1.531 in) (38.8 mm)
Principales aplicaciones: Automóviles Mazda Protege (1995-2003)
Principales equivalencias: Mazda B595-13-Z40

GA-606 FILTRO P/AIRE



Código: 13800
Largo: (9 9/64 in) (9.140 in) (232.1 mm)
Ancho: (8 39/64 in) (8.609 in) (218.6 mm)
Altura Total: (1 31/32 in) (1.968 in) (50.0 mm)
Principales aplicaciones: Automóviles y Camionetas Mitsubishi
Principales equivalencias: Mitsubishi MR571396

GA-596 FILTRO P/AIRE

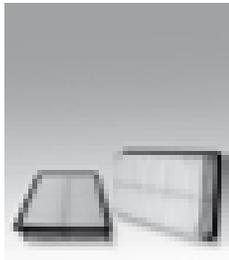

Código: 13314
Largo: (10 51/64 in) (10.796 in) (274.2 mm)
Ancho: (7 13/32 in) (7.406 in) (188.1 mm)
Altura Total: (2 39/64 in) (2.609 in) (66.2 mm)
Principales aplicaciones: Automóviles Mazda
Principales equivalencias: Mazda LF50-13-Z40A, LF50-13-Z40-9U

GA-607 FILTRO P/AIRE INY.



Código: 13906
Largo: (8 3/8 in) (8.375 in) (212.7 mm)
Ancho: (8 1/16 in) (8.062 in) (204.7 mm)
Altura Total: (1 31/32 in) (1.968 in) (50.0 mm)
Principales aplicaciones: Automóviles y Camionetas Mitsubishi
Principales equivalencias: Mitsubishi MR188657, MR552951

GA-597 FILTRO P/AIRE

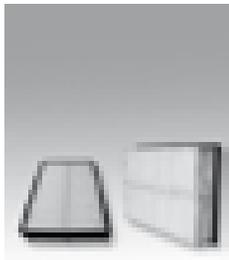

Código: 13315
Largo: (12 1/4 in) (12.250 in) (311.1 mm)
Ancho: (6 61/64 in) (6.953 in) (176.6 mm)
Altura Total: (1 15/16 in) (1.937 in) (49.1 mm)
Principales aplicaciones: Automóviles y Camionetas Mazda
Principales equivalencias: Mazda AJ57-13-Z40

GAVW-616 FILTRO P/AIRE



Código: 13429
Largo: (in) (in) (mm)
Ancho: (in) (in) (mm)
Altura Total: (in) (in) (mm)
Principales aplicaciones: Automóviles y Camionetas Audi, Porsche y Volkswagen
Principales equivalencias: Volkswagen 7L0-129-620, 955 110 131 00

GAVW-617 FILTRO P/AIRE

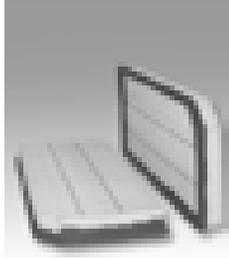

Código: 13428
Largo: (15 63/64 in) (15.984 in) (406.0 mm)
Ancho: (6 27/32 in) (6.844 in) (173.8 mm)
Altura Total: (1 15/32 in) (1.469 in) (37.3 mm)
Principales aplicaciones: Automóviles Audi y Volkswagen
Principales equivalencias: Volkswagen 6F 133 843A

GAVW-622 FILTRO P/AIRE



Código: 13649
Largo: (10 in) (10.000 in) (254.0 mm)
Ancho: (8 3/8 in) (8.375 in) (212.7 mm)
Altura Total: (2 17/64 in) (2.265 in) (57.5 mm)
Principales aplicaciones: Automóviles y Camionetas Audi, BMW, Volkswagen
Principales equivalencias: BMW 13711736675, VAG 58133843

GAVW-618 FILTRO P/AIRE

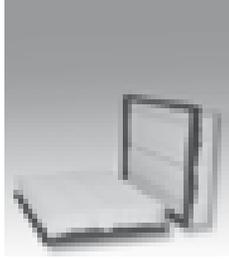

Código: 13430
Largo: (in) (in) (mm)
Ancho: (in) (in) (mm)
Altura Total: (in) (in) (mm)
Principales aplicaciones: Automóviles Audi y Volkswagen
Principales equivalencias: Volkswagen 1K0 129 620, 1K0 129 620B

GAVW-623 FILTRO P/AIRE

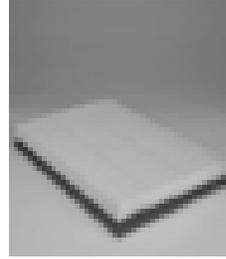

Código: 13647
Largo: (11 5/32 in) (11.156 in) (283.3 mm)
Ancho: (7 13/32 in) (7.406 in) (188.1 mm)
Altura Total: (1 1/2 in) (1.5 in) (38.1 mm)
Principales aplicaciones: Automóviles Seat, Volkswagen
Principales equivalencias: Volkswagen 6Q0129620B

GAVW-619 FILTRO P/AIRE



Código: 13427
Largo: (in) (in) (mm)
Ancho: (in) (in) (mm)
Altura Total: (in) (in) (mm)
Principales aplicaciones: Automóviles Audi y Volkswagen
Principales equivalencias: Volkswagen 1K0129620D, 1K0129620E, 1K0129620G, 1L0129620E

GAVW-624 FILTRO P/AIRE

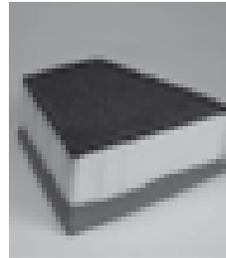

Código: 13798
Largo: (8 9/64 in) (8.140 in) (206.7 mm)
Ancho: (8 11/32 in) (8.343 in) (211.9 mm)
Altura Total: (3 13/64 in) (3.203 in) (81.3 mm)
Principales aplicaciones: Automóviles Seat, Volkswagen
Principales equivalencias: Volkswagen 6Q0-129-620B

GAVW-620 FILTRO P/AIRE

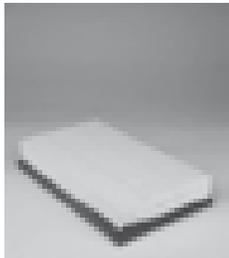

Código: 3936
Largo: (11 1/4 in) (11.25 in) (285.7 mm)
Ancho: (6 7/16 in) (6.437 in) (163.5 mm)
Altura Total: (1 15/16 in) (1.937 in) (49.2 mm)
Principales aplicaciones: Automóviles Volkswagen Pointer
Principales equivalencias: Volkswagen 377-129-620

GAVW-625 FILTRO P/AIRE



Código: 13863
Largo: (16 15/16 in) (16.937 in) (430.2 mm)
Ancho: (5 3/32 in) (5.093 in) (129.3 mm)
Altura Total: (1 23/64 in) (1.359 in) (34.5 mm)
Principales aplicaciones: Automóviles Volkswagen
Principales equivalencias: Volkswagen 07K-129-620

GAVW-621 FILTRO P/AIRE



Código: 3102
Largo: (14 11/32 in) (14.343 in) (364.3 mm)
Ancho: (7 1/4 in) (7.25 in) (184.1 mm)
Altura Total: (2 1/64 in) (2.015 in) (51.1 mm)
Principales aplicaciones: Automóviles Audi, Seat, Volkswagen
Principales equivalencias: Volkswagen 1J0126620, 1J0129620

GAVW-626 FILTRO P/AIRE

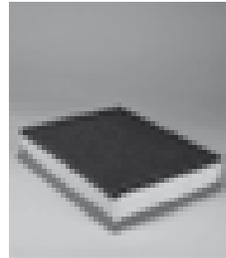

Código: 3705
Largo: (10 29/64 in) (10.453 in) (265.5 mm)
Ancho: (8 35/64 in) (8.546 in) (217.0 mm)
Altura Total: (2 7/32 in) (2.218 in) (56.3 mm)
Principales aplicaciones: Camionetas Volkswagen Eurovan
Principales equivalencias: Volkswagen 74-129-620

GAVW-627 FILTRO P/AIRE

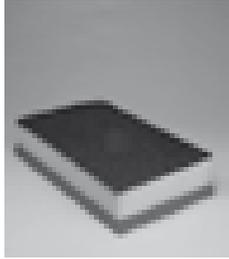

Código: 13890
Largo: (12 13/64 in) (12.203 in) (309.9 mm)
Ancho: (6 11/32 in) (6.343 in) (161.1 mm)
Altura del Elemento: (2 29/64 in) (2.453 in) (62.3 mm)
Altura Total: (2 41/64 in) (2.640 in) (67.0 mm)
Principales aplicaciones: Camionetas Volkswagen Eurovan L4 1.9L TDI (2006-07)
Principales equivalencias: Volkswagen 7H0129620A

GA-780 FILTRO P/AIRE

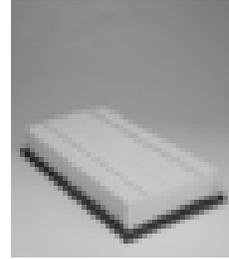

Código: 13727
Largo: (13 19/32 in) (13.593 in) (345.2 mm)
Ancho: (7 7/64 in) (7.109 in) (180.5 mm)
Altura Total: (2 15/16 in) (2.937 in) (74.6 mm)
Principales aplicaciones: Camionetas Ford a diesel
Principales equivalencias: Ford XC3U-9601-AA, XC3Z-9601-AA

GA-646 FILTRO P/AIRE



Código: 13449
Largo: (11 11/16 in) (11.687 in) (296.8 mm)
Ancho: (9 3/16 in) (9.187 in) (233.3 mm)
Altura Total: (1 in) (1.000 in) (25.4 mm)
Principales aplicaciones: Automóviles Saab
Principales equivalencias: General motors 12 78 6800

GA-1529 FILTRO P/AIRE



Código: 13435
Largo: (9 9/16 in) (9.562 in) (242.9 mm)
Ancho: (7 3/4 in) (7.750 in) (196.9 mm)
Altura Total: (2 9/32 in) (2.281 in) (57.9 mm)
Principales aplicaciones: Automóviles Nissan Sentra
Principales equivalencias: Nissan 16546-ET000

GA-730 FILTRO P/AIRE

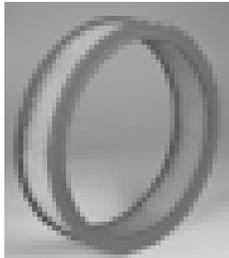

Código: 3068
Diámetro Ext.: (12 47/64 in) (12.734 in) (323.4 mm)
Diámetro Int.: (11 1/32 in) (11.031 in) (280.1 mm)
Altura Total: (2 51/64 in) (2.796 in) (71.0 mm)
Principales aplicaciones: Automóviles y Camionetas Chrysler, Dodge, Plymouth
Principales equivalencias: Chrysler 3769002, 3769688

GA-1530 FILTRO P/AIRE



Código: 13437
Largo: () (in) (mm)
Ancho: () (in) (mm)
Altura Total: () (in) (mm)
Principales aplicaciones: Automóviles Nissan
Principales equivalencias: Nissan 16546-JA00A

GA-734 FILTRO P/AIRE



Código: 3101
Diámetro Ext. Mayor: (14 9/16 in) (14.562 in) (369.8 mm)
Diámetro Ext. Menor: (7 63/64 in) (7.984 in) (202.8 mm)
Diámetro Int. Mayor: (12 25/32 in) (12.781 in) (324.6 mm)
Diámetro Int. Menor: (6 1/32 in) (6.031 in) (153.1 mm)
Altura Total: (2 23/64 in) (2.359 in) (59.9 mm)
Principales aplicaciones: Automóviles Ford Topaz (1989)
Principales equivalencias: Ford E1FZ-9601-A, E1EE-9601-AB

GA-1540 FILTRO P/AIRE

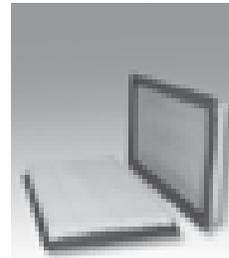

Código: 13426
Largo: () (in) (mm)
Ancho: () (in) (mm)
Altura Total: () (in) (mm)
Principales aplicaciones: Camionetas Ford
Principales equivalencias: Ford 6L2Z-9601-AA

GA-735 FILTRO P/AIRE



Código: 3221
Diámetro Ext. Mayor: (14 9/16 in) (14.562 in) (369.8 mm)
Diámetro Ext. Menor: (7 63/64 in) (7.984 in) (202.8 mm)
Diámetro Int. Mayor: (12 25/32 in) (12.781 in) (324.6 mm)
Diámetro Int. Menor: (6 1/32 in) (6.031 in) (153.1 mm)
Altura Total: (1 61/64 in) (1.953 in) (49.6 mm)
Principales aplicaciones: Automóviles Ford Topaz (1984-88)
Principales equivalencias: Ford E1EE-9601-AB, E4EE-9601-CA

GA-1542 FILTRO P/AIRE

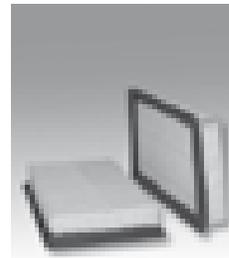

Código: 13438
Largo: (12 1/16 in) (12.062 in) (306.3 mm)
Ancho: (6 23/32 in) (6.718 in) (170.6 mm)
Altura Total: (1 25/32 in) (1.781 in) (45.2 mm)
Principales aplicaciones: Automóviles y Camionetas Ford, Lincoln, Mazda y Mercury
Principales equivalencias: Ford 7T4Z-9601-A

GA-1545 FILTRO P/AIRE



Código: 13439
Largo: (in) (in) (mm)
Ancho: (in) (in) (mm)
Altura Total: (in) (in) (mm)
Principales aplicaciones: Automóviles y Camionetas Cadillac
Principales equivalencias: General motors 25351142

GA-1615 FILTRO P/AIRE



Código: 3957
Diámetro Ext.: (8 5/32 in) (8.156 in) (207.1 mm)
Diámetro Int.: (4 23/64 in) (4.359 in) (110.7 mm)
Altura Total: (7 59/64 in) (7.921 in) (201.2 mm)
Principales aplicaciones: Automóviles y Camionetas Ford, Lincoln
Principales equivalencias: Ford F6ZZ-9601-A, F8AZ-9601-AA

GA-1546 FILTRO P/AIRE



Código: 13436
Largo: (15 3/16 in) (15.187 in) (385.7 mm)
Ancho: (7 11/32 in) (7.343 in) (186.5 mm)
Altura Total: (1 11/32 in) (1.343 in) (34.1 mm)
Principales aplicaciones: Camionetas Nissan y Suzuki
Principales equivalencias: Nissan 16546-EA000

GA-1616 FILTRO P/AIRE



Código: 3756
Diámetro Ext.: (6 55/64 in) (6.859 in) (174.2 mm)
Diámetro Int.: (3 9/64 in) (3.140 in) (79.7 mm)
Altura Total: (7 29/32 in) (7.906 in) (200.8 mm)
Principales aplicaciones: Automóviles y Camionetas Ford, Mazda
Principales equivalencias: Ford XF2Z-9601-AC, Mazda ZMZ2-23-603

GA-1571 FILTRO P/AIRE



Código: 13434
Largo: (14 23/32 in) (14.719 in) (373.9 mm)
Ancho: (6 13/16 in) (6.812 in) (173.0 mm)
Altura Total: (2 3/4 in) (2.750 in) (69.9 mm)
Principales aplicaciones: Camionetas Ford
Principales equivalencias: Ford 5C3Z-9601-AA

GA-1617 FILTRO P/AIRE

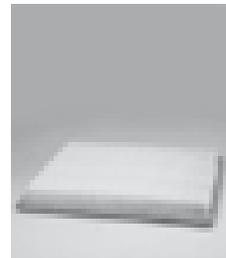

Código: 13795
Largo: (11 19/64 in) (11.296 in) (286.9 mm)
Ancho: (8 15/32 in) (8.468 in) (215.1 mm)
Altura Total: (1 5/16 in) (1.312 in) (33.3 mm)
Principales aplicaciones: Camionetas Ford, Lincoln
Principales equivalencias: Ford 4L3Z-9601-BA

GA-1572 FILTRO P/AIRE



Código: 23284
Largo: (10 5/8 in) (10.625 in) (269.8 mm)
Ancho: (6 5/16 in) (6.312 in) (160.3 mm)
Alto: (1 61/64 in) (1.960 in) (49.7 mm)
Principales aplicaciones: Automóviles y Camionetas Ford, Mazda y Mercury
Principales equivalencias: Ford 6E52-9601-AE, 6E5Z-9601-EA

GA-2104 FILTRO P/AIRE



Código: 13756
Largo: (13 13/64 in) (13.203 in) (335.3 mm)
Ancho: (7 31/64 in) (7.484 in) (190.1 mm)
Altura Total: (1 15/32 in) (1.468 in) (37.3 mm)
Principales aplicaciones: Automóviles Mercedes Benz
Principales equivalencias: AMG 1040940104

GA-1614 FILTRO P/AIRE



Código: 13453
Diámetro Ext.: (6 7/8 in) (6.875 in) (174.6 mm)
Diámetro Int.: (3 13/64 in) (3.203 in) (81.4 mm)
Altura Total: (5 59/64 in) (5.922 in) (150.4 mm)
Principales aplicaciones: Camionetas Ford Explorer
Principales equivalencias: Ford F67X-9601-AA, F67Z-9601-AA

GA-2105 FILTRO P/AIRE



Código: 13760
Largo: (11 15/32 in) (11.468 in) (291.3 mm)
Ancho: (5 57/64 in) (5.890 in) (149.6 mm)
Altura Total: (2 1/4 in) (2.25 in) (57.1 mm)
Principales aplicaciones: Automóviles BMW
Principales equivalencias: BMW 13721702907, 13721742201

GA-2106 FILTRO P/AIRE

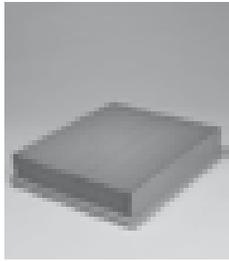

Código: 13754
Largo: (9 1/4 in) (9.25 in) (234.9 mm)
Ancho: (7 29/32 in) (7.906 in) (200.8 mm)
Altura Total: (1 13/16 in) (1.812 in) (46.0 mm)
Principales aplicaciones: Automóviles Mercedes Benz
Principales equivalencias: Chrysler 6040940904, 6040941004

GA-2121 FILTRO P/AIRE

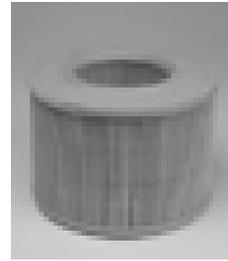

Código: 13758
Diámetro Ext.: (6 15/16 in) (6.937 in) (176.2 mm)
Diámetro Int.: (3 35/64 in) (3.546 in) (90.0 mm)
Altura Total: (6 in) (6.000 in) (152.4 mm)
Principales aplicaciones: Automóviles Renault Megane (2001)
Principales equivalencias: Renault 7700957336

GA-2109 FILTRO P/AIRE

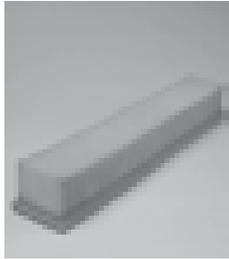

Código: 13751
Largo: (18 3/16 in) (18.187 in) (461.9 mm)
Ancho: (3 25/64 in) (3.390 in) (86.1 mm)
Altura Total: (2 3/4 in) (2.75 in) (69.8 mm)
Principales aplicaciones: Automóviles Mercedes Benz
Principales equivalencias: Chrysler 1110940204

GA-2122 FILTRO P/AIRE

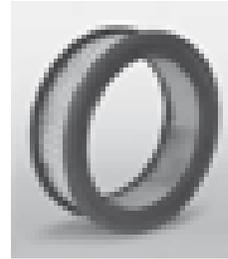

Código: 13766
Diámetro Ext.: (7 41/64 in) (7.640 in) (194.0 mm)
Diámetro Int.: (6 1/16 in) (6.062 in) (153.9 mm)
Altura Total: (2 13/64 in) (2.203 in) (55.9 mm)
Principales aplicaciones: Automóviles Mini Cooper
Principales equivalencias: General Motors 93152736, Fram CA4894

GA-2110 FILTRO P/AIRE

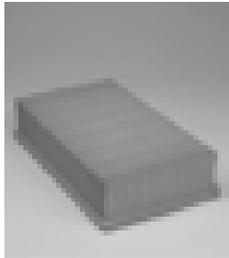

Código: 13757
Largo: (10 5/64 in) (10.078 in) (255.9 mm)
Ancho: (5 57/64 in) (5.890 in) (149.6 mm)
Altura Total: (2 1/4 in) (2.25 in) (57.1 mm)
Principales aplicaciones: Automóviles BMW
Principales equivalencias: BMW 13711247465, 13721247465

GA-2123 FILTRO P/AIRE

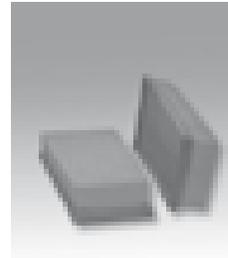

Código: 13732
Largo: (12 33/64 in) (12.515 in) (317.8 mm)
Ancho: (6 57/64 in) (6.890 in) (175.0 mm)
Altura Total: (2 9/32 in) (2.281 in) (57.9 mm)
Principales aplicaciones: Automóviles Peugeot 306 (1998-2001)
Principales equivalencias: Peugeot 1444-F6

GA-2114 FILTRO P/AIRE

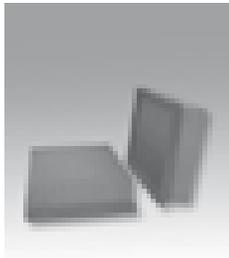

Código: 13764
Largo: (9 9/16 in) (9.562 in) (242.8 mm)
Ancho: (7 in) (7.000 in) (177.8 mm)
Altura Total: (2 17/64 in) (2.265 in) (57.5 mm)
Principales aplicaciones: Automóviles y Camionetas BMW
Principales equivalencias: BMW 13-72-1-730-946

GA-2124 FILTRO P/AIRE



Código: 13761
Diámetro Ext.: (6 59/64 in) (6.921 in) (175.8 mm)
Diámetro Int.: (6 59/64 in) (6.921 in) (175.8 mm)
Altura Total: (5 1/8 in) (5.125 in) (130.1 mm)
Principales aplicaciones: Automóviles Audi
Principales equivalencias: Volkswagen 06C133843

GA-2118 FILTRO P/AIRE

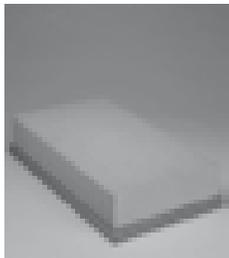

Código: 13755
Largo: (11 5/64 in) (11.078 in) (281.3 mm)
Ancho: (6 17/64 in) (6.265 in) (159.1 mm)
Altura Total: (2 1/4 in) (2.25 in) (57.1 mm)
Principales aplicaciones: Automóviles Saab
Principales equivalencias: Saab 4236030

GA-2130 FILTRO P/AIRE



Código: 13745
Largo: (12 1/8 in) (12.125 in) (307.9 mm)
Ancho: (7 1/4 in) (7.25 in) (184.1 mm)
Altura Total: (1 59/64 in) (1.921 in) (48.8 mm)
Principales aplicaciones: Automóviles y Camionetas Chevrolet
Principales equivalencias: Mann & Hummel C31 130, Fram CA5970

GA-2135 FILTRO P/AIRE

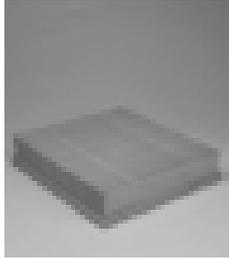

Código: 13767
 Largo: (9 51/64 in) (9.796 in) (248.8 mm)
 Ancho: (8 63/64 in) (8.984 in) (228.2 mm)
 Altura Total: (1 31/32 in) (1.968 in) (50.0 mm)
 Principales aplicaciones: Camionetas Land Rover
 Principales equivalencias: Rover GFE2412, Fram CA9102

GA-2156 FILTRO P/AIRE

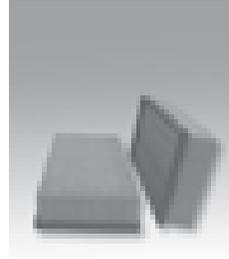

Código: 13738
 Largo: (12 51/64 in) (12.796 in) (325.0 mm)
 Ancho: (6 9/64 in) (6.140 in) (155.9 mm)
 Altura Total: (2 17/64 in) (2.265 in) (57.5 mm)
 Principales aplicaciones: Automóviles Peugeot
 Principales equivalencias: Peugeot 1444-A9

GA-2136 FILTRO P/AIRE



Código: 13762
 Diámetro Ext.: (3 37/64 in) (3.578 in) (90.8 mm)
 Diámetro Int.: (3 37/64 in) (3.578 in) (90.8 mm)
 Altura Total: (5 5/16 in) (5.312 in) (134.9 mm)
 Principales aplicaciones: Automóviles Mercedes Benz SMART (2001)
 Principales equivalencias: SMART 0001024V001

GA-2158 FILTRO P/AIRE



Código: 13765
 Largo: (6 59/64 in) (6.921 in) (175.8 mm)
 Ancho: (5 19/32 in) (5.593 in) (142.0 mm)
 Altura Total: (3 5/64 in) (3.078 in) (78.1 mm)
 Principales aplicaciones: Automóviles y Camionetas Renault
 Principales equivalencias: Renault 7701-045724

GA-2141 FILTRO P/AIRE

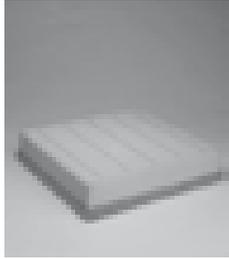

Código: 13744
 Largo: (11 19/64 in) (11.296 in) (286.9 mm)
 Ancho: (10 5/32 in) (10.156 in) (257.9 mm)
 Altura Total: (2 9/32 in) (2.281 in) (57.9 mm)
 Principales aplicaciones: Automóviles Audi
 Principales equivalencias: VAG 077129620B, 07712962D

GA-2159 FILTRO P/AIRE

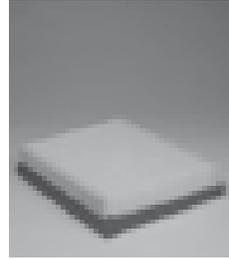

Código: 13733
 Largo: (8 7/64 in) (8.109 in) (205.9 mm)
 Ancho: (6 43/64 in) (6.671 in) (169.4 mm)
 Altura Total: (1 21/32 in) (1.656 in) (42.0 mm)
 Principales aplicaciones: Automóviles Peugeot 206 (2000-02)
 Principales equivalencias: Peugeot 1444G9, Fram Ca8674

GA-2146 FILTRO P/AIRE



Código: 13752
 Largo: (9 11/16 in) (9.687 in) (246.0 mm)
 Ancho: (8 1/8 in) (8.125 in) (206.3 mm)
 Altura Total: (2 9/32 in) (2.281 in) (57.9 mm)
 Principales aplicaciones: Camionetas Land Rover
 Principales equivalencias: Rover ESR-4238

GA-2160 FILTRO P/AIRE



Código: 13736
 Diámetro Ext.: (5 31/64 in) (5.484 in) (139.3 mm)
 Diámetro Int.: (4 35/64 in) (4.546 in) (115.4 mm)
 Altura Total: (6 1/2 in) (6.5 in) (165.1 mm)
 Principales aplicaciones: Automóviles Peugeot 306 (1997)
 Principales equivalencias: Citroen 1444-A7

GA-2147 FILTRO P/AIRE

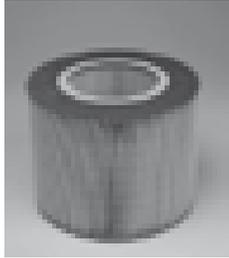

Código: 13743
 Diámetro Ext.: (6 59/64 in) (6.921 in) (175.8 mm)
 Diámetro Int.: (3 23/32 in) (3.718 in) (94.4 mm)
 Altura Total: (5 29/64 in) (5.453 in) (138.5 mm)
 Principales aplicaciones: Automóviles Saab
 Principales equivalencias: Saab 4572491, 5173166

GA-2161 FILTRO P/AIRE



Código: 13740
 Largo: (10 45/64 in) (10.703 in) (271.8 mm)
 Ancho: (4 41/64 in) (4.640 in) (117.8 mm)
 Altura Total: (1 61/64 in) (1.953 in) (49.6 mm)
 Principales aplicaciones: Automóviles Mercedes Benz
 Principales equivalencias: Chrysler 05098424AA, 1120940304

GA-2164 FILTRO P/AIRE

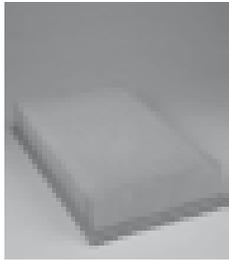

Código: 13742
Largo: (12 27/64 in) (12.421 in) (315.5 mm)
Ancho: (7 31/64 in) (7.484 in) (190.1 mm)
Altura Total: (2 13/64 in) (2.203 in) (55.9 mm)
Principales aplicaciones: Automóviles Mercedes Benz
Principales equivalencias: Chrysler 112-094-0104, 112-094-0204

GA-2179 FILTRO P/AIRE

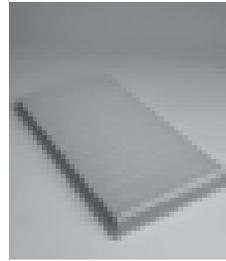

Código: 13746
Largo: (13 13/64 in) (13.203 in) (335.3 mm)
Ancho: (7 4/47 in) (7.085 in) (179.9 mm)
Altura Total: (1 5/32 in) (1.156 in) (29.3 mm)
Principales aplicaciones: Automóviles Mercedes Benz
Principales equivalencias: Chrysler 0440941604

GA-2170 FILTRO P/AIRE



Código: 13741
Largo: (12 3/32 in) (12.093 in) (307.1 mm)
Ancho: (4 23/32 in) (4.718 in) (119.8 mm)
Altura Total: (1 41/64 in) (1.640 in) (41.6 mm)
Principales aplicaciones: Automóviles Mercedes Benz
Principales equivalencias: Chrysler 1120940404

GA-2181 FILTRO P/AIRE



Código: 13763
Diámetro Ext.: (4 7/8 in) (4.875 in) (123.8 mm)
Diámetro Int.: (4 7/8 in) (4.875 in) (123.8 mm)
Altura Total: (5 29/32 in) (5.906 in) (150.0 mm)
Principales aplicaciones: Automóviles Mercedes Benz
Principales equivalencias: Mercedes Benz 1960940024, 1660940004

GA-2173 FILTRO P/AIRE



Código: 13734
Largo: (11 45/64 in) (11.703 in) (297.2 mm)
Ancho: (3 in) (3.000 in) (76.2 mm)
Altura Total: (1 59/64 in) (1.921 in) (48.8 mm)
Principales aplicaciones: Automóviles Peugeot, Renault
Principales equivalencias: Peugeot 1444-86, Renault 7 701 042 841

GA-2182 FILTRO P/AIRE



Código: 13759
Largo: (8 27/64 in) (8.421 in) (213.9 mm)
Ancho: (5 17/32 in) (5.531 in) (140.4 mm)
Altura Total: (2 9/32 in) (2.281 in) (57.9 mm)
Principales aplicaciones: Automóviles Renault Laguna (2001)
Principales equivalencias: Renault 7701040285

GA-2174 FILTRO P/AIRE

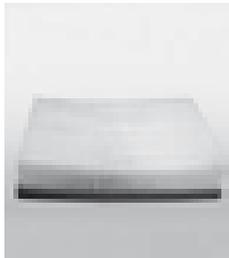

Código: 13753
Largo: (10 11/16 in) (10.687 in) (271.4 mm)
Ancho: (4 41/64 in) (4.640 in) (117.8 mm)
Altura Total: (2 1/2 in) (2.5 in) (63.5 mm)
Principales aplicaciones: Camionetas Land Rover
Principales equivalencias: Rover C40749, ESR4103

GA-2184 FILTRO P/AIRE

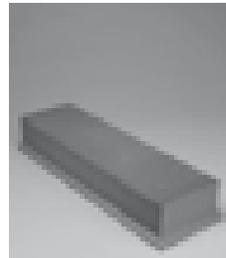

Código: 13735
Largo: (13 25/64 in) (13.390 in) (340.1 mm)
Ancho: (3 61/64 in) (3.953 in) (100.4 mm)
Altura Total: (2 17/64 in) (2.265 in) (57.5 mm)
Principales aplicaciones: Automóviles Mercedes Benz SL600
Principales equivalencias: Chrysler 033-094-68-04

GA-2175 FILTRO P/AIRE



Código: 13748
Largo: (13 13/64 in) (13.203 in) (335.3 mm)
Ancho: (7 31/64 in) (7.484 in) (190.1 mm)
Altura Total: (2 17/64 in) (2.265 in) (57.5 mm)
Principales aplicaciones: Automóviles y Camionetas Mercedes Benz
Principales equivalencias: Chrysler 6040940504, 6040940604

GA-2192 FILTRO P/AIRE



Código: 13747
Largo: (10 1/8 in) (10.125 in) (257.1 mm)
Ancho: (8 5/32 in) (8.156 in) (207.1 mm)
Altura Total: (1 1/2 in) (1.5 in) (38.1 mm)
Principales aplicaciones: Automóviles Mercedes Benz
Principales equivalencias: Chrysler 1370940004, 1370940104

GA-2193 FILTRO P/AIRE

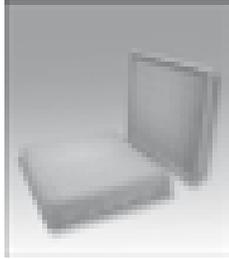

Código: 13749
Largo: (9 19/64 in) (9.296 in) (236.1 mm)
Ancho: (9 1/4 in) (9.25 in) (234.9 mm)
Altura Total: (1 21/32 in) (1.656 in) (42.0 mm)
Principales aplicaciones: Automóviles BMW
Principales equivalencias: BMW 13711247405, 13721247405

GA-2740 FILTRO P/AIRE



Código: 3318
Diámetro Ext.: (11 in) (11.000 in) (279.4 mm)
Diámetro Int.: (8 15/32 in) (8.468 in) (215.1 mm)
Altura Total: (2 3/16 in) (2.187 in) (55.5 mm)
Principales aplicaciones: Automóviles Mazda (1979-84)
Principales equivalencias: Mazda 8172-23-603, 8173-26-603

GA-2194 FILTRO P/AIRE



Código: 13750
Largo: (12 39/64 in) (12.609 in) (320.2 mm)
Ancho: (7 13/64 in) (7.203 in) (182.9 mm)
Altura Total: (1 1/2 in) (1.5 in) (38.1 mm)
Principales aplicaciones: Camionetas BMW
Principales equivalencias: BMW 13712960105, 13721261012

GA-3300 FILTRO P/AIRE



Código: 3181
Diámetro Ext.: (11 23/32 in) (11.718 in) (297.6 mm)
Diámetro Int.: (9 35/64 in) (9.546 in) (242.4 mm)
Altura Total: (2 3/32 in) (2.093 in) (53.1 mm)
Principales aplicaciones: Automóviles y Camionetas Ford, Mercury
Principales equivalencias: Ford D3DZ-9600-B, D4ZZ-9601-AA

GA-2195 FILTRO P/AIRE



Código: 13739
Largo: (11 37/64 in) (11.578 in) (294.0 mm)
Ancho: (8 31/32 in) (8.968 in) (227.8 mm)
Altura Total: (2 17/64 in) (2.265 in) (57.5 mm)
Principales aplicaciones: Automóviles y Camionetas Mercedes Benz
Principales equivalencias: Chrysler 6040940004, 640940304

GA-3424 FILTRO P/AIRE



Código: 3182
Diámetro Ext.: (11 11/64 in) (11.171 in) (283.7 mm)
Diámetro Int.: (9 7/16 in) (9.437 in) (239.7 mm)
Altura Total: (1 3/4 in) (1.75 in) (44.4 mm)
Principales aplicaciones: Automóviles Ford (1976-82)
Principales equivalencias: Ford D7ZF-9601-AA, D7ZZ-9601-AR

GA-2198 FILTRO P/AIRE



Código: 13737
Largo: (13 63/64 in) (13.984 in) (355.2 mm)
Ancho: (5 19/64 in) (5.296 in) (134.5 mm)
Altura Total: (1 31/32 in) (1.968 in) (50.0 mm)
Principales aplicaciones: Automóviles Mercedes Benz
Principales equivalencias: Chrysler 1120940004

GA-3425 FILTRO P/AIRE



Código: 3183
Diámetro Ext.: (11 11/64 in) (11.171 in) (283.7 mm)
Diámetro Int.: (9 7/16 in) (9.437 in) (239.7 mm)
Altura Total: (1 23/32 in) (1.718 in) (43.6 mm)
Principales aplicaciones: Camionetas Ford (1983-86)
Principales equivalencias: Ford D7FZ-9601-A, E47E-9601-BA

GA-2719B FILTRO P/AIRE



Código: 3180
Diámetro Ext.: (12 1/16 in) (12.062 in) (306.3 mm)
Diámetro Int.: (9 13/32 in) (9.406 in) (238.9 mm)
Altura Total: (2 in) (2.000 in) (50.8 mm)
Principales aplicaciones: Camionetas Toyota (1981-90)
Principales equivalencias: Toyota 17801-37010, 17801-41090

GA-3445 FILTRO P/AIRE



Código: 3319
Diámetro Ext.: (4 13/32 in) (4.406 in) (111.9 mm)
Diámetro Int.: (2 15/16 in) (2.937 in) (74.6 mm)
Altura Total: (5 3/4 in) (5.75 in) (146.0 mm)
Principales aplicaciones: Automóviles Dodge, Tractores Pequeños John Deere, Minneapolis-Moline
Principales equivalencias: Chrysler 5240668, John Deere AM31000

GA-3490 FILTRO P/AIRE



Código: 3313
Diámetro Ext.: (9 7/8 in) (9.875 in) (250.8 mm)
Diámetro Int.: (7 3/4 in) (7.75 in) (196.8 mm)
Altura Total: (2 in) (2.000 in) (50.8 mm)
Principales aplicaciones: Automóviles Honda (1976-83)
Principales equivalencias: Honda 17200-671-000, 17220-PA6-661

GA-3588 FILTRO P/AIRE



Código: 3293
Diámetro Ext.: (9 43/64 in) (9.671 in) (245.6 mm)
Diámetro Int.: (8 7/64 in) (8.109 in) (205.9 mm)
Altura Total: (2 55/64 in) (2.859 in) (72.6 mm)
Principales aplicaciones: Automóviles y Camionetas Cadillac, Chevrolet, Isuzu, Nissan, Pontiac
Principales equivalencias: General Motors 25098766, Isuzu 8-25040-929-0

GA-3501 FILTRO P/AIRE



Código: 3337
Diámetro Ext.: (11 1/2 in) (11.5 in) (292.1 mm)
Diámetro Int.: (8 19/64 in) (8.296 in) (210.7 mm)
Altura Total: (5 in) (5.000 in) (127.0 mm)
Principales aplicaciones: Camionetas y Camiones Dodge, Ford, IHC
Principales equivalencias: Ford E8TZ-9600-C, IHC 1700712-C92

GA-3622 FILTRO P/AIRE



Código: 3323
Diámetro Ext. Menor: (8 7/16 in) (8.437 in) (214.3 mm)
Diámetro Ext. Mayor: (10 7/16 in) (10.437 in) (265.1 mm)
Diámetro Int. Menor: (6 15/16 in) (6.937 in) (176.2 mm)
Diámetro Int. Mayor: (8 15/16 in) (8.937 in) (227.0 mm)
Altura Total: (2 5/16 in) (2.312 in) (58.7 mm)
Principales aplicaciones: Automóviles Cadillac, Chevrolet (1982)
Principales equivalencias: General Motors 25040470, 25040489

GA-3523 FILTRO P/AIRE



Código: 3184
Diámetro Ext.: (10 in) (10.000 in) (254.0 mm)
Diámetro Int.: (8 21/32 in) (8.656 in) (219.8 mm)
Altura Total: (2 9/32 in) (2.281 in) (57.9 mm)
Principales aplicaciones: Automóviles y Camionetas Chevrolet (1981-84)
Principales equivalencias: General Motors 8996356, 8996587

GA-3637 FILTRO P/AIRE



Código: 3322
Diámetro Ext.: (9 43/64 in) (9.671 in) (245.6 mm)
Diámetro Int.: (8 3/32 in) (8.093 in) (205.5 mm)
Altura Total: (2 9/64 in) (2.140 in) (54.3 mm)
Principales aplicaciones: Camionetas Ford Ranger (1982-84)
Principales equivalencias: Ford E3TZ-9601-A, E37E-9601-CB

GA-3536 FILTRO P/AIRE



Código: 3324
Diámetro Ext. Mayor: (10 7/16 in) (10.437 in) (265.1 mm)
Diámetro Ext. Menor: (8 7/16 in) (8.437 in) (214.3 mm)
Diámetro Int. Mayor: (8 15/16 in) (8.937 in) (227.0 mm)
Diámetro Int. Menor: (6 15/16 in) (6.937 in) (176.2 mm)
Altura Total: (1 7/8 in) (1.875 in) (47.6 mm)
Principales aplicaciones: Automóviles Chevrolet Citation
Principales equivalencias: General Motors 8996333, 8996528

GA-3647 FILTRO P/AIRE



Código: 3187
Diámetro Ext.: (8 1/2 in) (8.5 in) (215.9 mm)
Diámetro Int.: (6 59/64 in) (6.921 in) (175.8 mm)
Altura Total: (2 31/64 in) (2.484 in) (63.1 mm)
Principales aplicaciones: Automóviles y Camionetas Chevrolet
Principales equivalencias: General Motors 25040881, 25043317

GA-3566 FILTRO P/AIRE



Código: 3320
Diámetro Ext.: (11 19/32 in) (11.593 in) (294.4 mm)
Diámetro Int.: (8 25/32 in) (8.781 in) (223.0 mm)
Altura Total: (1 19/32 in) (1.593 in) (40.4 mm)
Principales aplicaciones: Automóviles Chevrolet, Toyota (1980-88)
Principales equivalencias: General Motors 94840272, Toyota 17801-15010

GA-3681 FILTRO P/AIRE



Código: 3188
Diámetro Ext.: (10 1/64 in) (10.015 in) (254.3 mm)
Diámetro Int.: (8 5/8 in) (8.625 in) (219.0 mm)
Altura Total: (2 1/2 in) (2.5 in) (63.5 mm)
Principales aplicaciones: Camionetas Chevrolet, GMC (1982-85)
Principales equivalencias: General Motors 25041541, 25041542

GA-3814 FILTRO P/AIRE

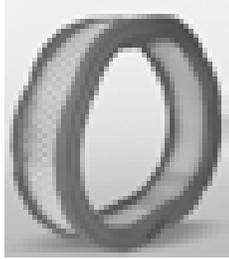

Código: 3332
 Diámetro Ext.: (7 9/32 in) (7.281 in) (184.9 mm)
 Diámetro Ext.: (8 25/32 in) (8.781 in) (223.0 mm)
 Diámetro Int.: (5 25/32 in) (5.781 in) (146.8 mm)
 Diámetro Int.: (7 9/32 in) (7.281 in) (184.9 mm)
 Altura Total: (2 1/4 in) (2.25 in) (57.1 mm)
 Principales aplicaciones: Automóviles Chrysler, Dodge
 Principales equivalencias: Mopar F00AF611

GA-4319 FILTRO P/AIRE



Código: 13399
 Largo: (in) (in) (mm)
 Ancho: (in) (in) (mm)
 Altura Total: (in) (in) (mm)
 Principales aplicaciones: Camionetas Renault Trafic
 Principales equivalencias: Renault 77 01 047 285, 77 01 476 258, 82 00 457 286

GA-3901 FILTRO P/AIRE

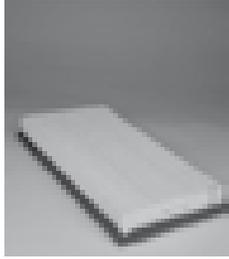

Código: 3338
 Largo: (13 37/64 in) (13.578 in) (344.8 mm)
 Ancho: (6 45/64 in) (6.703 in) (170.2 mm)
 Altura Total: (1 39/64 in) (1.609 in) (40.8 mm)
 Principales aplicaciones: Camionetas Dodge, Jeep
 Principales equivalencias: Chrysler 8953004383

GA-4325 FILTRO P/AIRE

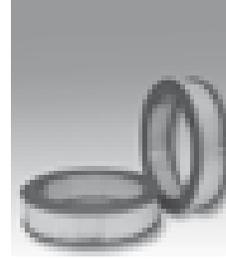

Código: 3321
 Diámetro Ext.: (10 1/8 in) (10.125 in) (257.1 mm)
 Diámetro Int.: (7 29/32 in) (7.906 in) (200.8 mm)
 Altura Total: (2 1/2 in) (2.5 in) (63.5 mm)
 Principales aplicaciones: Camionetas Dodge, Mazda, Nissan (1983-92)
 Principales equivalencias: Chrysler MD604880, Mazda AM15-13-Z00

GA-3915 FILTRO P/AIRE

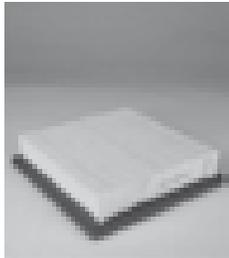

Código: 3330d
 Largo: (7 13/32 in) (7.406 in) (188.1 mm)
 Ancho: (6 45/64 in) (6.703 in) (170.2 mm)
 Altura Total: (1 19/32 in) (1.593 in) (40.4 mm)
 Principales aplicaciones: Automóviles Chevrolet Camaro, Corvette
 Principales equivalencias: General Motors 25043246

GA-4365 FILTRO P/AIRE

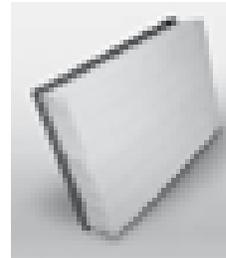

Código: 3334
 Largo: (13 3/16 in) (13.187 in) (334.9 mm)
 Ancho: (6 13/32 in) (6.406 in) (162.7 mm)
 Altura Total: (1 15/32 in) (1.468 in) (37.3 mm)
 Principales aplicaciones: Automóviles Volvo (1975-93)
 Principales equivalencias: Volvo 13263520, 47714758

GA-3916 FILTRO P/AIRE

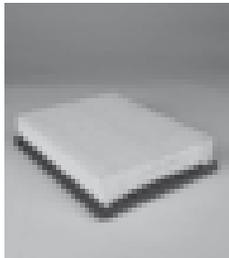

Código: 3331
 Largo: (7 5/8 in) (7.625 in) (193.6 mm)
 Ancho: (6 1/16 in) (6.062 in) (153.9 mm)
 Altura Total: (1 5/8 in) (1.625 in) (41.2 mm)
 Principales aplicaciones: Automóviles y Camionetas Chevrolet, Chrysler, Pontiac
 Principales equivalencias: General Motors 24577608, 25098845

GA-4828 FILTRO P/AIRE



Código: 3333
 Diámetro Ext. Mayor: (6 15/32 in) (6.468 in) (164.3 mm)
 Diámetro Ext. Menor: (4 53/64 in) (4.828 in) (122.6 mm)
 Diámetro Int. Mayor: (5 1/8 in) (5.125 in) (130.1 mm)
 Diámetro Int. Menor: (3 29/64 in) (3.453 in) (87.7 mm)
 Altura Total: (8 3/8 in) (8.375 in) (212.7 mm)
 Principales aplicaciones: Automóviles y Vans Chrysler, Dodge (1982-85)
 Principales equivalencias: Chrysler MD603340

GA-4303 FILTRO P/AIRE



Código: 3792
 Largo: (10 23/32 in) (10.718 in) (272.2 mm)
 Ancho: (6 17/64 in) (6.265 in) (159.1 mm)
 Altura Total: (1 19/64 in) (1.296 in) (32.9 mm)
 Principales aplicaciones: Automóviles Subaru (1982-89)
 Principales equivalencias: Nissan 16546-AA010, 16546-N4294

GA-4958 FILTRO P/AIRE



Código: 3314
 Diámetro Ext.: (9 7/8 in) (9.875 in) (250.8 mm)
 Diámetro Int.: (7 3/4 in) (7.75 in) (196.8 mm)
 Altura Total: (1 23/32 in) (1.718 in) (43.6 mm)
 Principales aplicaciones: Automóviles Honda Civic (1984-87)
 Principales equivalencias: Honda 17220-PE0-003, 17220-PE0-661

GA-5056 FILTRO P/AIRE

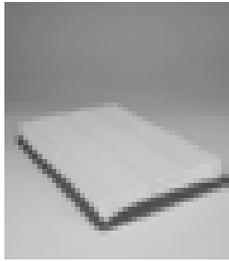

Código: 3328
Largo: (11 9/32 in) (11.281 in) (286.5 mm)
Ancho: (7 9/16 in) (7.562 in) (192.0 mm)
Altura Total: (1 37/64 in) (1.578 in) (40.0 mm)
Principales aplicaciones: Automóviles y Camionetas Ford, Lincoln, Mercury
Principales equivalencias: Ford E5TZ-9601-B, E5TE-9601-ABM

GA-6619 FILTRO P/AIRE



Código: 3298
Diámetro Ext.: (11 5/64 in) (11.078 in) (281.3 mm)
Diámetro Int.: (33/64 in) (0.515 in) (13.0 mm)
Altura Total: (1 11/16 in) (1.687 in) (42.8 mm)
Principales aplicaciones: Automóviles y Camionetas Nissan
Principales equivalencias: Nissan 16546-77A10, 16546-84A10

GA-5057 FILTRO P/AIRE



Código: 3329
Largo: (11 9/32 in) (11.281 in) (286.5 mm)
Ancho: (7 57/64 in) (7.890 in) (200.4 mm)
Altura Total: (1 1/2 in) (1.5 in) (38.1 mm)
Principales aplicaciones: Automóviles y Camionetas Ford, Lincoln, Mercury
Principales equivalencias: Ford E6SZ-9601-B, E6SE-9601-BA

GA-6620 FILTRO P/AIRE



Código: 3133
Diámetro Ext.: (11 in) (11.000 in) (279.4 mm)
Diámetro Int.: (5/8 in) (0.625 in) (15.8 mm)
Altura Total: (2 17/64 in) (2.265 in) (57.5 mm)
Principales aplicaciones: Automóviles y Camionetas Nissan
Principales equivalencias: Nissan 16546-77A10, 16546-84A10

GA-5466 FILTRO P/AIRE



Código: 23312
Largo: (6 43/64 in) (6.672 in) (169.5 mm)
Ancho: (10 1/2 in) (10.500 in) (266.7 mm)
Altura Total: (1 21/32 in) (1.656 in) (42.1 mm)
Principales aplicaciones: Automóviles y Camionetas Chevrolet, Mazda y Toyota
Principales equivalencias: General motors 94856888, KJ01-13-Z40, 17801-15070

GA-6690 FILTRO P/AIRE



Código: 13857
Largo: (9 51/64 in) (9.796 in) (248.8 mm)
Ancho: (6 21/32 in) (6.656 in) (169.0 mm)
Altura Total: (2 1/64 in) (2.015 in) (51.1 mm)
Principales aplicaciones: Automóviles Mazda
Principales equivalencias: Mazda JE48-13-Z40

GA-5876 FILTRO P/AIRE



Código: 13342
Largo: (12 13/32 in) (12.406 in) (315.1 mm)
Ancho: (10 7/8 in) (10.875 in) (276.2 mm)
Altura Total: (3 3/16 in) (3.187 in) (80.9 mm)
Principales aplicaciones: Camionetas Sprinter con motor OM611, OM612 y OM647
Principales equivalencias: Mercedes Benz A003094830467, A0030948304

GA-7007 FILTRO P/AIRE

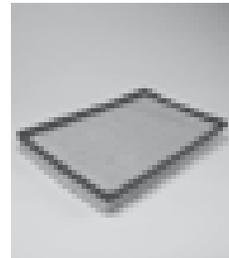

Código: 3553
Largo: (17 17/64 in) (17.265 in) (438.5 mm)
Ancho: (10 37/64 in) (10.578 in) (268.6 mm)
Altura Total: (1 39/64 in) (1.609 in) (40.8 mm)
Principales aplicaciones: Automóviles Chevrolet Corvette
Principales equivalencias: General Motors 25096933

GA-6479 FILTRO P/AIRE

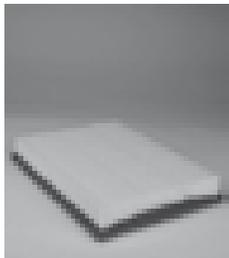

Código: 3352
Largo: (10 21/32 in) (10.656 in) (270.6 mm)
Ancho: (7 15/16 in) (7.937 in) (201.6 mm)
Altura Total: (1 19/32 in) (1.593 in) (40.4 mm)
Principales aplicaciones: Automóviles y Camionetas Cadillac, Chevrolet, Pontiac
Principales equivalencias: General Motors 10351258, 24508572

GA-7017 FILTRO P/AIRE

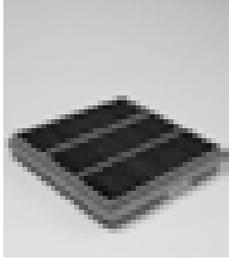

Código: 3790
Largo: (13 47/64 in) (13.734 in) (348.8 mm)
Ancho: (4 1/8 in) (4.125 in) (104.7 mm)
Altura Total: (1 39/64 in) (1.609 in) (40.8 mm)
Principales aplicaciones: Automóviles Chevrolet Caprice (1991-93)
Principales equivalencias: General Motors 25097917, 25097917

GA-7142 FILTRO P/AIRE

Código: 13768
Largo: (8 7/8 in) (8.875 in) (225.4 mm)
Ancho: (8 7/8 in) (8.875 in) (225.4 mm)
Altura Total: (1 13/32 in) (1.406 in) (35.7 mm)
Principales aplicaciones: Automóviles y Camionetas Dodge, Mitsubishi
Principales equivalencias: Mitsubishi MD620472, MR571471

GA-7344 FILTRO P/AIRE

Código: 3430
Largo: (9 in) (9.000 in) (228.6 mm)
Ancho: (7 5/16 in) (7.312 in) (185.7 mm)
Altura Total: (2 1/16 in) (2.062 in) (52.3 mm)
Principales aplicaciones: Automóviles y Camionetas Chrysler, Dodge, Mazda, Mitsubishi
Principales equivalencias: Chrysler MB906051, Mazda KL47-13-Z40A, Mitsubishi MB906051

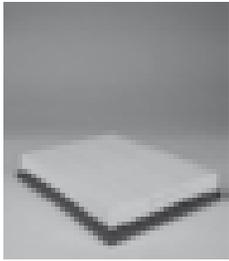
GA-8606 FILTRO P/AIRE

Código: 3453
Largo: (9 1/2 in) (9.5 in) (241.3 mm)
Ancho: (7 1/16 in) (7.062 in) (179.3 mm)
Altura Total: (1 1/2 in) (1.5 in) (38.1 mm)
Principales aplicaciones: Automóviles Chrysler, Dodge
Principales equivalencias: Chrysler 4591100AB, 4591100AC

GA-27161 FILTRO P/AIRE

Código: 13400
Largo: (in) (in) (mm)
Ancho: (in) (in) (mm)
Altura Total: (in) (in) (mm)
Principales aplicaciones: Camionetas Ford Transit
Principales equivalencias: Ford 1373 667, 6C 1196 01 BC

Filtros Para Aire Servicio Pesado

Heavy Duty Air Filters

GA-16 FILTRO P/AIRE



Código: 4003
Diámetro Ext.: (5 19/64 in) (5.296 in) (134.5 mm)
Diámetro Int.: (2 5/8 in) (2.625 in) (66.6 mm)
Altura entre tapas: (11 in) (11.000 in) (279.4 mm)
Altura Total: (11 3/8 in) (11.375 in) (288.9 mm)
Principales aplicaciones: Filtro individual sin aspas, use GAK-16 con aspas
Principales equivalencias: Donaldson P119775

GA-21 FILTRO P/AIRE



Código: 3009
Diámetro Ext.: (9 37/64 in) (9.578 in) (243.2 mm)
Diámetro Int.: (5 in) (5.000 in) (127.0 mm)
Altura Total: (6 17/64 in) (6.265 in) (159.1 mm)
Principales aplicaciones: Camiones y Autobuses Dina, Motores Cummins
Principales equivalencias: Cummins 621222, 721322

GAK-16 FILTRO P/AIRE



Código: 4054
Diámetro Ext.: (5 19/64 in) (5.296 in) (134.5 mm)
Diámetro Int.: (2 5/8 in) (2.625 in) (66.6 mm)
Altura entre tapas: (10 59/64 in) (10.921 in) (277.4 mm)
Altura Total: (11 19/64 in) (11.296 in) (286.9 mm)
Principales aplicaciones: Allis chalmers, Case, Hough, John Deere, Minneapolis-Moline, Yale & Towne, Clark, IHC, Massey Ferguson
Principales equivalencias: John Deere AT20728, Donaldson P113986
Observaciones: Para filtro sin aspas utilice GA-16

GA-24 FILTRO P/AIRE



Código: 4009
Diámetro Ext.: (9 3/16 in) (9.187 in) (233.3 mm)
Diámetro Int.: (4 7/8 in) (4.875 in) (123.8 mm)
Altura entre tapas: (10 in) (10.000 in) (254.0 mm)
Altura Total: (10 1/2 in) (10.5 in) (266.7 mm)
Principales aplicaciones: Case, Caterpillar, Ford, Galion, Hyster, Ingersoll-Rand, Michigan
Principales equivalencias: Caterpillar 310916, Ingersoll-Rand 92266485

GA-18 FILTRO P/AIRE



Código: 4005
Diámetro Ext.: (4 1/2 in) (4.5 in) (114.3 mm)
Diámetro Int.: (2 1/4 in) (2.25 in) (57.1 mm)
Altura Total: (10 11/64 in) (10.171 in) (258.3 mm)
Principales aplicaciones: Allis chalmers, Tractores Ford, Massey-Ferguson, IHC
Principales equivalencias: Ford C7NN-94641-A, Donaldson P113986
Observaciones: Filtro primario, Use GA-118 como secundario

GA-26 FILTRO P/AIRE



Código: 4010
Diámetro Ext.: (12 3/32 in) (12.093 in) (307.1 mm)
Diámetro Int.: (7 23/32 in) (7.718 in) (196.0 mm)
Altura entre tapas: (14 in) (14.000 in) (355.6 mm)
Altura Total: (14 1/2 in) (14.5 in) (368.3 mm)
Principales aplicaciones: Hough, IHC, Kenworth
Principales equivalencias: IHC 884044-C91, Kenworth 80165690

GA-20 FILTRO P/AIRE



Código: 4007
Diámetro Ext.: (7 29/32 in) (7.906 in) (200.8 mm)
Diámetro Int.: (3 1/2 in) (3.5 in) (88.9 mm)
Altura entre tapas: (10 in) (10.000 in) (254.0 mm)
Altura Total: (10 13/32 in) (10.406 in) (264.3 mm)
Principales aplicaciones: Case, Clark, Galion, Hough, Hyster, Ingersoll-Rand, Lister
Principales equivalencias: Clark 1644729, Hyster 179961
Observaciones: Para filtro con aspas utilice GAK-20

GA-27 FILTRO P/AIRE



Código: 4012
Diámetro Ext.: (11 3/32 in) (11.093 in) (281.7 mm)
Diámetro Int.: (6 23/32 in) (6.718 in) (170.6 mm)
Altura entre tapas: (12 in) (12.000 in) (304.8 mm)
Altura Total: (12 1/2 in) (12.5 in) (317.5 mm)
Principales aplicaciones: Allis Chalmers, Hino, Hough, Hyster, IHC, Kenworth, Michigan, Terex
Principales equivalencias: Allis Chalmers 4062434, IHC 878945-C92

GAK-20 FILTRO P/AIRE



Código: 4087
Diámetro Ext.: (7 29/32 in) (7.906 in) (200.8 mm)
Diámetro Int.: (3 1/2 in) (3.5 in) (88.9 mm)
Altura entre tapas: (10 in) (10.000 in) (254.0 mm)
Altura Total: (10 3/8 in) (10.375 in) (263.5 mm)
Principales aplicaciones: Allis Chalmers, Case, Caterpillar, Hyster, Ingersoll-Rand, John Deere, Michigan
Principales equivalencias: Allis Chalmers 7024462-2, Caterpillar 310926, John Deere AR36414
Observaciones: Para filtro sin aspas utilice GA-20

GA-29 FILTRO P/AIRE



Código: 4014
Diámetro Ext.: (10 13/32 in) (10.406 in) (264.3 mm)
Diámetro Int.: (6 1/32 in) (6.031 in) (153.1 mm)
Altura entre tapas: (8 in) (8.000 in) (203.2 mm)
Altura Total: (8 1/4 in) (8.25 in) (209.5 mm)
Principales aplicaciones: Cargadoras Case, Equipo Caterpillar, Clark, Hyster
Principales equivalencias: Case 9301361, Caterpillar 5L7687

GA-31 FILTRO P/AIRE



Código: 4016
Diámetro Ext.: (12 3/32 in) (12.093 in) (307.1 mm)
Diámetro Int.: (7 23/32 in) (7.718 in) (196.0 mm)
Altura entre tapas: (13 in) (13.000 in) (330.2 mm)
Altura Total: (13 1/2 in) (13.5 in) (342.9 mm)
Principales aplicaciones: Dina, Hough, IHC
Principales equivalencias: Cummins 150584, IHC 672019C91

GA-39 FILTRO P/AIRE

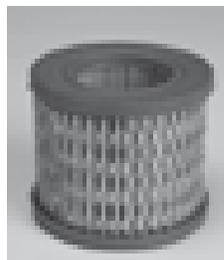

Código: 3014
Diámetro Ext.: (3 in) (3.000 in) (76.2 mm)
Diámetro Int.: (1 11/16 in) (1.687 in) (42.8 mm)
Altura Total: (2 35/64 in) (2.546 in) (64.6 mm)
Principales aplicaciones: Allis Chalmers, Bomag, Cummins, Euclid, Ford, IHC, Kenworth, Kohler, Komatsu, Mack, Michigan, P&H, Peterbilt
Principales equivalencias: Cummins 257014, IHC 998458-R91, Komatsu 6620-21-7550

GA-33 FILTRO P/AIRE



Código: 4017
Diámetro Ext.: (4 1/16 in) (4.062 in) (103.1 mm)
Diámetro Int.: (2 15/32 in) (2.468 in) (62.7 mm)
Altura entre tapas: (10 in) (10.000 in) (254.0 mm)
Altura Total: (10 1/4 in) (10.25 in) (260.3 mm)
Principales aplicaciones: Allis Chalmers, Carrier, Case, Clark, Hyster, IHC, John Deere, Komatsu, Lister, Massey-Ferguson, Michigan, New Holland, White
Principales equivalencias: IHC 3066498-R93, John Deere AT31825

GA-98 FILTRO P/AIRE



Código: 4023
Diámetro Ext.: (6 1/16 in) (6.062 in) (153.9 mm)
Diámetro Int.: (3 1/2 in) (3.5 in) (88.9 mm)
Altura entre tapas: (10 in) (10.000 in) (254.0 mm)
Altura Total: (10 3/8 in) (10.375 in) (263.5 mm)
Principales aplicaciones: Equipo John Deere
Principales equivalencias: John Deere AR21424, AR46181
Observaciones: Para filtro con aspas utilice GAK-98

GA-35 FILTRO P/AIRE



Código: 3012
Diámetro Ext.: (3 3/64 in) (3.046 in) (77.3 mm)
Diámetro Int.: (1 25/64 in) (1.390 in) (35.3 mm)
Altura Total: (1 3/8 in) (1.375 in) (34.9 mm)
Principales aplicaciones: Compresores de Aire Bendix-Westinghouse
Principales equivalencias: Fleetguard AF365, Luber Finer LAF488

GA-106 FILTRO P/AIRE



Código: 4060
Diámetro Ext.: (11 3/32 in) (11.093 in) (281.7 mm)
Diámetro Int.: (6 23/32 in) (6.718 in) (170.6 mm)
Altura entre tapas: (16 in) (16.000 in) (406.4 mm)
Altura Total: (16 1/2 in) (16.5 in) (419.1 mm)
Principales aplicaciones: Allis Chalmers, Caterpillar, Cummins, Fiat-Allis, Ford, IHC, Michigan, Nuffields, Scania
Principales equivalencias: Allis chalmers 70659533, Caterpillar 9Y7811, Cummins 3909821
Observaciones: Filtro primario, utilice GA-206 como secundario

GAD-36 FILTRO P/AIRE



Código: 4560
Diámetro Ext.: (5 17/64 in) (5.260 in) (133.6 mm)
Diámetro Int.: (2 7/16 in) (2.430 in) (61.7 mm)
Altura Total: (8 49/64 in) (8.760 in) (222.5 mm)
Principales aplicaciones: Camionetas Nissan a diesel
Principales equivalencias: Nissan 16546-9S001

GA-107 FILTRO P/AIRE



Código: 4081
Diámetro Ext.: (12 3/32 in) (12.093 in) (307.1 mm)
Diámetro Int.: (7 23/32 in) (7.718 in) (196.0 mm)
Altura entre tapas: (18 in) (18.000 in) (457.2 mm)
Altura Total: (18 1/2 in) (18.5 in) (469.9 mm)
Principales aplicaciones: Camiones IHC, Motores Cummins, GMC, Caterpillar
Principales equivalencias: General Motors 25040873, IHC 470186-C91
Observaciones: Filtro primario, utilice GA-108 como secundario

GA-37 FILTRO P/AIRE



Código: 4019
Diámetro Ext.: (10 5/16 in) (10.312 in) (261.9 mm)
Diámetro Int.: (7 29/32 in) (7.906 in) (200.8 mm)
Altura entre tapas: (12 in) (12.000 in) (304.8 mm)
Altura Total: (12 in) (12.000 in) (304.8 mm)
Principales aplicaciones: Allis Chalmers, Chrysler, Cummins, Hyster
Principales equivalencias: Allis Chalmers 4052677, Cummins 405067

GA-108 FILTRO P/AIRE



Código: 4371
Diámetro Ext.: (7 39/64 in) (7.609 in) (193.2 mm)
Diámetro Int.: (6 1/32 in) (6.031 in) (153.1 mm)
Altura entre tapas: (15 25/64 in) (15.390 in) (390.9 mm)
Altura Total: (15 49/64 in) (15.765 in) (400.4 mm)
Principales aplicaciones: Camiones IHC, Motores Cummins, GMC, Caterpillar
Principales equivalencias: General Motors 25096113, IHC 482646-C91
Observaciones: Filtro secundario, utilice GA-107 como primario

GA-109 FILTRO P/AIRE



Código: 4084
 Diámetro Ext.: (10 13/32 in) (10.406 in) (264.3 mm)
 Diámetro Int.: (6 1/32 in) (6.031 in) (153.1 mm)
 Altura entre tapas: (12 in) (12.000 in) (304.8 mm)
 Altura Total: (12 1/2 in) (12.5 in) (317.5 mm)
 Principales aplicaciones: Camiones Dina, General Motors, IHC
 Principales equivalencias: General Motors 25041707, IHC 479461-C91
 Observaciones: Filtro primario, utilice GA-119 como secundario

GA-209 FILTRO P/AIRE



Código: 4135
 Diámetro Ext.: (10 13/32 in) (10.406 in) (264.3 mm)
 Diámetro Int.: (6 1/32 in) (6.031 in) (153.1 mm)
 Altura entre tapas: (15 63/64 in) (15.984 in) (406.0 mm)
 Altura Total: (16 31/64 in) (16.484 in) (418.7 mm)
 Principales aplicaciones: Camiones Dina, IHC, Kenworth, Navistar, Peterbilt
 Principales equivalencias: IHC 470185-C92, 998055-C91
 Observaciones: Filtro primario, utilice GA-210 como secundario

GA-119 FILTRO P/AIRE



Código: 4357
 Diámetro Ext.: (5 15/16 in) (5.937 in) (150.8 mm)
 Diámetro Int.: (4 53/64 in) (4.828 in) (122.6 mm)
 Altura entre tapas: (9 7/32 in) (9.218 in) (234.1 mm)
 Altura Total: (9 23/32 in) (9.718 in) (246.8 mm)
 Principales aplicaciones: Caterpillar, IHC, Navistar
 Principales equivalencias: Caterpillar 8V5006, IHC 530776-C1, 530778-C1
 Observaciones: Filtro secundario, utilice GA-109 como primario

GA-210 FILTRO P/AIRE



Código: 4155
 Diámetro Ext.: (5 15/16 in) (5.937 in) (150.8 mm)
 Diámetro Int.: (4 53/64 in) (4.828 in) (122.6 mm)
 Altura entre tapas: (13 7/16 in) (13.437 in) (341.3 mm)
 Altura Total: (13 15/16 in) (13.937 in) (354.0 mm)
 Principales aplicaciones: Camiones Dina, IHC, Navistar
 Principales equivalencias: IHC 482664-C1, 482647-C91
 Observaciones: Filtro secundario, utilice GA-209 como primario

GA-135 FILTRO P/AIRE



Código: 3158
 Diámetro Ext.: (2 47/64 in) (2.734 in) (69.4 mm)
 Diámetro Int.: (1 5/32 in) (1.156 in) (29.3 mm)
 Altura Total: (1 3/16 in) (1.187 in) (30.1 mm)
 Principales aplicaciones: Camiones con compresor de aire Bendix-Westinghouse
 Principales equivalencias: Bendix-Westinghouse 100783, 278500

GAK-216 FILTRO P/AIRE



Código: 4162
 Diámetro Ext.: (5 19/64 in) (5.296 in) (134.5 mm)
 Diámetro Int.: (3 1/4 in) (3.25 in) (82.5 mm)
 Altura entre tapas: (12 in) (12.000 in) (304.8 mm)
 Altura Total: (12 3/8 in) (12.375 in) (314.3 mm)
 Principales aplicaciones: Allis Chalmers, Case, IHC, JCB, John Deere, Massey Ferguson
 Principales equivalencias: IHC 924779-C2, John Deere AR81913, Massey Ferguson 1070329M91
 Observaciones: Filtro primario, utilice GA-416 como secundario

GA-197R FILTRO P/AIRE



Código: 4389
 Diámetro Ext.: (9 25/64 in) (9.390 in) (238.5 mm)
 Diámetro Int.: (5 3/16 in) (5.187 in) (131.7 mm)
 Altura entre tapas: (12 3/4 in) (12.75 in) (323.8 mm)
 Altura Total: (12 3/4 in) (12.75 in) (323.8 mm)
 Principales aplicaciones: Camiones Chevrolet Kodiak, Ford, Motores Caterpillar, Cummins
 Principales equivalencias: General Motors 15696245, Ford F3HZ-9601-A
 Observaciones: Filtro Primario, utilice GA-768R como secundario

GA-221R FILTRO P/AIRE



Código: 4392
 Diámetro Ext.: (13 3/32 in) (13.093 in) (332.5 mm)
 Diámetro Int.: (6 25/32 in) (6.781 in) (172.2 mm)
 Altura entre tapas: (18 21/32 in) (18.656 in) (473.8 mm)
 Altura Total: (18 21/32 in) (18.656 in) (473.8 mm)
 Principales aplicaciones: Camiones y Autobuses IHC, Navistar
 Principales equivalencias: IHC 2005895C1, Donaldson P533235
 Observaciones: Filtro Primario, utilice GA-723R como secundario

GA-206 FILTRO P/AIRE



Código: 4116
 Diámetro Ext.: (7 17/32 in) (7.531 in) (191.2 mm)
 Diámetro Int.: (5 1/4 in) (5.25 in) (133.3 mm)
 Altura entre tapas: (15 15/16 in) (15.937 in) (404.8 mm)
 Altura Total: (15 15/16 in) (15.937 in) (404.8 mm)
 Principales aplicaciones: Allis Chalmers, IHC, Komatsu, Michigan, Scania
 Principales equivalencias: Allis Chalmers 7066247-7, IHC 702323-C91, Komatsu 6125-81-7032
 Observaciones: Filtro secundario, utilice GA-106 como primario

GA-229 FILTRO P/AIRE



Código: 4128
 Diámetro Ext.: (10 13/32 in) (10.406 in) (264.3 mm)
 Diámetro Int.: (6 1/32 in) (6.031 in) (153.1 mm)
 Altura entre tapas: (21 3/4 in) (21.75 in) (552.4 mm)
 Altura Total: (22 3/4 in) (22.75 in) (577.8 mm)
 Principales aplicaciones: Camiones y Tractocamiones Kenworth, Mack
 Principales equivalencias: Kenworth KW-853M, Mack 2MD29350

GA-239 FILTRO P/AIRE



Código: 4359
Diámetro Ext.: (5 15/16 in) (5.937 in) (150.8 mm)
Diámetro Int.: (4 53/64 in) (4.828 in) (122.6 mm)
Altura entre tapas: (10 in) (10.000 in) (254.0 mm)
Altura Total: (10 3/8 in) (10.375 in) (263.5 mm)
Principales aplicaciones: Case, IHC, Komatsu
Principales equivalencias: Case A47146, IHC 642688-C91, Komatsu 3816-27-9351
Observaciones: Filtro secundario, utilice GA-329 como primario

GA-326 FILTRO P/AIRE



Código: 4104
Diámetro Ext.: (11 3/32 in) (11.093 in) (281.7 mm)
Diámetro Int.: (6 23/32 in) (6.718 in) (170.6 mm)
Altura entre tapas: (16 in) (16.000 in) (406.4 mm)
Altura Total: (16 1/2 in) (16.5 in) (419.1 mm)
Principales aplicaciones: Allis Chalmers, Fiat-Allis, Ford, Komatsu, Scania, Terex, Volvo
Principales equivalencias: Allis Chalmers 70659533, Ford D4HA-9600-BA, Komatsu 6125-81-7032

GA-251 FILTRO P/AIRE



Código: 4219
Diámetro Ext.: (12 3/32 in) (12.093 in) (307.1 mm)
Diámetro Int.: (7 23/32 in) (7.718 in) (196.0 mm)
Altura entre tapas: (19 13/16 in) (19.812 in) (503.2 mm)
Altura Total: (20 1/2 in) (20.5 in) (520.7 mm)
Principales aplicaciones: Compresores Ingersoll-Rand, Sullair
Principales equivalencias: Ingersoll-Rand 35355395, Sullair

GA-329 FILTRO P/AIRE



Código: 4358
Diámetro Ext.: (10 13/32 in) (10.406 in) (264.3 mm)
Diámetro Int.: (6 1/32 in) (6.031 in) (153.1 mm)
Altura entre tapas: (12 in) (12.000 in) (304.8 mm)
Altura Total: (12 1/2 in) (12.5 in) (317.5 mm)
Principales aplicaciones: Case, Hough, IHC, Komatsu
Principales equivalencias: Case A147020, IHC 674433-C91, Komatsu 3816-27-9341
Observaciones: Filtro primario, utilice GA-239 como secundario

GA-287 FILTRO P/AIRE



Código: 4146
Diámetro Ext.: (12 3/4 in) (12.75 in) (323.8 mm)
Diámetro Ext. Total: (14 17/32 in) (14.531 in) (369.0 mm)
Diámetro Int.: (8 12/35 in) (8.343 in) (211.9 mm)
Altura Total: (9 13/16 in) (9.812 in) (249.2 mm)
Principales aplicaciones: Instaladores de Turbos, Niveladoras Caterpillar
Principales equivalencias: Caterpillar 4S8833

GA-356 FILTRO P/AIRE



Código: 4093
Diámetro Ext.: (13 7/8 in) (13.875 in) (352.4 mm)
Diámetro Int.: (9 7/16 in) (9.437 in) (239.7 mm)
Altura entre tapas: (17 63/64 in) (17.984 in) (456.8 mm)
Altura Total: (18 15/64 in) (18.234 in) (463.1 mm)
Principales aplicaciones: Caterpillar, Euclid, Ford, Ingersoll-Rand, Michigan, Terex, Volvo, Wabco
Principales equivalencias: Caterpillar 6N6071, Euclid 9038900, IHC 942626-C1
Observaciones: Filtro primario, utilice GA-357 como secundario

GA-299 FILTRO P/AIRE



Código: 4394
Filtración Invertida
Diámetro Ext.: (8 7/8 in) (8.875 in) (225.4 mm)
Diámetro Int.: (5 5/8 in) (5.625 in) (142.8 mm)
Altura del Elemento: (13 5/16 in) (13.312 in) (338.1 mm)
Altura Total: (14 3/8 in) (14.375 in) (365.1 mm)
Principales aplicaciones: Camiones Dina Cab-Over con motor Cummins
Principales equivalencias: IHC 2991015C1

GA-357 FILTRO P/AIRE



Código: 4136
Diámetro Ext.: (8 5/8 in) (8.625 in) (219.0 mm)
Diámetro Int.: (7 1/16 in) (7.062 in) (179.3 mm)
Altura entre tapas: (16 1/2 in) (16.5 in) (419.1 mm)
Altura Total: (17 in) (17.000 in) (431.8 mm)
Principales aplicaciones: Caterpillar, Euclid, Ford, Ingersoll-Rand, Michigan, Terex, Volvo, Wabco
Principales equivalencias: Caterpillar 6N6072, Euclid 9049488, IHC 942625-C1
Observaciones: Filtro secundario, utilice GA-356 como primario

GA-319 FILTRO P/AIRE



Código: 4351
Diámetro Ext.: (10 13/32 in) (10.406 in) (264.3 mm)
Diámetro Int.: (6 1/32 in) (6.031 in) (153.1 mm)
Altura entre tapas: (12 in) (12.000 in) (304.8 mm)
Altura Total: (12 1/2 in) (12.5 in) (317.5 mm)
Principales aplicaciones: Camiones Dodge con motor Perkins Fase 4 (1994)
Principales equivalencias: Perkins 414020

GA-360 FILTRO P/AIRE



Código: 4094
Diámetro Ext.: (9 7/32 in) (9.218 in) (234.1 mm)
Diámetro Int.: (4 27/32 in) (4.843 in) (123.0 mm)
Altura entre tapas: (13 in) (13.000 in) (330.2 mm)
Altura Total: (13 1/2 in) (13.5 in) (342.9 mm)
Principales aplicaciones: Allis Chalmers, Case, Clark, JCB, New Holland, Nuffields, Volvo
Principales equivalencias: Allis Chalmers 7068473-3, Case 5231996, Volvo 70684733
Observaciones: Filtro primario, utilice GA-361 como secundario

GA-361 FILTRO P/AIRE



Código: 4206
 Diámetro Ext.: (4 37/64 in) (4.578 in) (116.2 mm)
 Diámetro Int.: (3 15/32 in) (3.468 in) (88.1 mm)
 Altura entre tapas: (12 31/32 in) (12.968 in) (329.4 mm)
 Altura Total: (12 31/32 in) (12.968 in) (329.4 mm)
 Principales aplicaciones: Allis Chalmers, Case, Clark, JCB, New Holland, Nuffields, Volvo
 Principales equivalencias: Allis Chalmers 7208376-8, New Holland 2510998, Volvo 74751918
 Observaciones: Filtro secundario, utilice GA-360 como primario

GA-376 FILTRO P/AIRE



Código: 4029
 Diámetro Ext.: (13 7/8 in) (13.875 in) (352.4 mm)
 Diámetro Int.: (9 7/16 in) (9.437 in) (239.7 mm)
 Altura entre tapas: (18 in) (18.000 in) (457.2 mm)
 Altura Total: (18 1/2 in) (18.5 in) (469.9 mm)
 Principales aplicaciones: Camiones Freightliner, General Motors, IHC, Peterbilt, Thermo king
 Principales equivalencias: General Motors 25096450, IHC 1669437-C1

GA-371 FILTRO P/AIRE



Código: 4129
 Diámetro Ext.: (12 3/4 in) (12.75 in) (323.8 mm)
 Diámetro Int.: (8 3/8 in) (8.375 in) (212.7 mm)
 Altura entre tapas: (24 in) (24.000 in) (609.6 mm)
 Altura Total: (25 in) (25.000 in) (635.0 mm)
 Principales aplicaciones: Camiones Dina equipados con motor Cummins
 Principales equivalencias: Donaldson P530866, Fram CA6326

GA-377 FILTRO P/AIRE



Código: 4080
 Diámetro Ext.: (10 3/8 in) (10.375 in) (263.5 mm)
 Diámetro Int.: (6 27/32 in) (6.843 in) (173.8 mm)
 Altura entre tapas: (28 in) (28.000 in) (711.2 mm)
 Altura Total: (29 in) (29.000 in) (736.6 mm)
 Principales aplicaciones: Camiones Ford, Freightliner, General Motors, IHC, Peterbilt
 Principales equivalencias: General Motors 8997222, IHC 587426C1

GA-372 FILTRO P/AIRE



Código: 4097
 Diámetro Ext.: (8 43/64 in) (8.671 in) (220.2 mm)
 Diámetro Int.: (5 11/64 in) (5.171 in) (131.3 mm)
 Altura entre tapas: (28 1/32 in) (28.031 in) (711.9 mm)
 Altura Total: (29 1/32 in) (29.031 in) (737.3 mm)
 Principales aplicaciones: Camiones Ford, General Motors, IHC, White
 Principales equivalencias: Ford D8HZ-9601-A, General Motors 8997221, IHC 503634-C91

GA-378 FILTRO P/AIRE



Código: 4082
 Diámetro Ext.: (12 3/4 in) (12.75 in) (323.8 mm)
 Diámetro Int.: (8 3/8 in) (8.375 in) (212.7 mm)
 Altura entre tapas: (22 in) (22.000 in) (558.8 mm)
 Altura Total: (23 in) (23.000 in) (584.2 mm)
 Principales aplicaciones: Camiones Freightliner, General Motors, Kenworth, Mack, Peterbilt
 Principales equivalencias: General Motors 15588698, Kenworth KW-852M, Mack 2MD2143P2

GA-373 FILTRO P/AIRE



Código: 4085
 Diámetro Ext.: (8 43/64 in) (8.671 in) (220.2 mm)
 Diámetro Int.: (5 11/64 in) (5.171 in) (131.3 mm)
 Altura entre tapas: (15 in) (15.000 in) (381.0 mm)
 Altura Total: (15 7/8 in) (15.875 in) (403.2 mm)
 Principales aplicaciones: Camiones General Motors, IHC, Mack
 Principales equivalencias: General Motors 25040529, Mack 57MD27

GAP-379 FILTRO P/AIRE

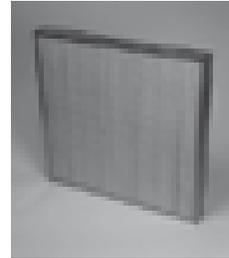

Código: 4102
 Largo: (23 7/8 in) (23.875 in) (606.4 mm)
 Ancho: (23 7/8 in) (23.875 in) (606.4 mm)
 Altura Total: (2 in) (2.000 in) (50.8 mm)
 Principales aplicaciones: Motores Caterpillar
 Principales equivalencias: Caterpillar 310038, 310038

GA-375 FILTRO P/AIRE



Código: 4028
 Diámetro Ext.: (13 7/8 in) (13.875 in) (352.4 mm)
 Diámetro Int.: (9 7/16 in) (9.437 in) (239.7 mm)
 Altura entre tapas: (12 in) (12.000 in) (304.8 mm)
 Altura Total: (12 1/4 in) (12.25 in) (311.1 mm)
 Principales aplicaciones: Motores Caterpillar
 Principales equivalencias: Caterpillar 4L4721, 9L1695

GAP-381 FILTRO P/AIRE

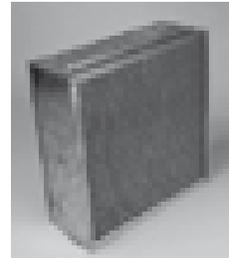

Código: 4131
 Largo: (14 7/8 in) (14.875 in) (377.8 mm)
 Ancho: (14 7/8 in) (14.875 in) (377.8 mm)
 Altura Total: (5 1/8 in) (5.125 in) (130.1 mm)
 Principales aplicaciones: Motores Caterpillar
 Principales equivalencias: Caterpillar 310399, 4N0015

GA-388 FILTRO P/AIRE

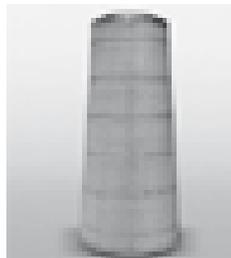

Código: 4179
Diámetro Ext.: (8 1/8 in) (8.125 in) (206.3 mm)
Diámetro Int.: (3 15/16 in) (3.937 in) (100.0 mm)
Altura entre tapas: (23 11/32 in) (23.343 in) (592.9 mm)
Altura Total: (24 3/32 in) (24.093 in) (611.9 mm)
Principales aplicaciones: Tractocamiones Kenworth T800 con motor Cummins 450 (1988-90)
Principales equivalencias: Fram CA2800, Fleetguard AF25092

GA-404 FILTRO P/AIRE



Código: 4098
Diámetro Ext.: (5 19/64 in) (5.296 in) (134.5 mm)
Diámetro Int.: (2 13/16 in) (2.812 in) (71.4 mm)
Altura entre tapas: (14 3/32 in) (14.093 in) (357.9 mm)
Altura Total: (15 3/32 in) (15.093 in) (383.3 mm)
Principales aplicaciones: Camionetas Dina 3200 Modelos 81-82
Principales equivalencias: Donaldson P145536, Continental PCA-9200

GA-389 FILTRO P/AIRE



Código: 4458
Diámetro Ext. Mayor: (10 13/32 in) (10.406 in) (264.3 mm)
Diámetro Ext. Menor: (7 13/32 in) (7.406 in) (188.1 mm)
Diámetro Int.: (6 15/16 in) (6.937 in) (176.2 mm)
Altura Total: (23 in) (23.000 in) (584.2 mm)
Principales aplicaciones: Camiones y Autobuses Navistar y Detroit Diesel
Principales equivalencias: IHC 574844C1, Donaldson P141317
Observaciones: Filtración Invertida

GA-405 FILTRO P/AIRE



Código: 4212
Diámetro Ext.: (9 1/2 in) (9.5 in) (241.3 mm)
Diámetro Int.: (5 13/64 in) (5.203 in) (132.1 mm)
Altura entre tapas: (19 1/32 in) (19.031 in) (483.3 mm)
Altura Total: (19 31/64 in) (19.484 in) (494.9 mm)
Principales aplicaciones: Camiones M.A.N., Mercedes Benz, New Holland, Scania, Volvo
Principales equivalencias: Mercedes Benz 120948702, New Holland 753486, Volvo 6640289

GA-398 FILTRO P/AIRE



Código: 4366
Diámetro Ext.: (5 11/16 in) (5.687 in) (144.4 mm)
Diámetro Int.: (4 37/64 in) (4.578 in) (116.2 mm)
Altura entre tapas: (17 1/8 in) (17.125 in) (434.9 mm)
Altura Total: (17 1/2 in) (17.5 in) (444.5 mm)
Principales aplicaciones: Case, Caterpillar, Ford, Hino, John Deere, Komatsu, Volvo
Principales equivalencias: Case S238647, Caterpillar 9Y6808, John Deere AT81019, Volvo 2528681
Observaciones: Filtro secundario, utilice GA-309 o GA-616 como primario

GA-412R FILTRO P/AIRE RADIAL



Código: 4527
Diámetro Ext.: (in) (in) (mm)
Diámetro Int.: (in) (in) (mm)
Altura Total: (in) (in) (mm)
Principales aplicaciones: Camionetas Toyota Hilux
Principales equivalencias: Toyota 17801-0C010, 17801-0C010

GA-403 FILTRO P/AIRE



Código: 4030
Diámetro Ext.: (6 1/16 in) (6.062 in) (153.9 mm)
Diámetro Int.: (3 1/2 in) (3.5 in) (88.9 mm)
Altura entre tapas: (12 in) (12.000 in) (304.8 mm)
Altura Total: (12 3/8 in) (12.375 in) (314.3 mm)
Principales aplicaciones: Case, Clark, Cummins, Galion, Hough, Hyster, IHC, J.C. Bamford, John Deere, Massey Ferguson
Principales equivalencias: Galion 114360, IHC 389363R91, John Deere RE24619
Observaciones: Para filtro con aspas utilice GAK-403

GA-416 FILTRO P/AIRE

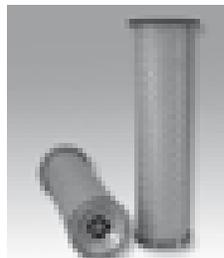

Código: 4178
Diámetro Ext.: (3 5/8 in) (3.625 in) (92.0 mm)
Diámetro Int.: (2 13/32 in) (2.406 in) (61.1 mm)
Altura entre tapas: (11 5/64 in) (11.078 in) (281.3 mm)
Altura Total: (11 5/32 in) (11.156 in) (283.3 mm)
Principales aplicaciones: Case, Fiat-Allis, Hough, JCB, John Deere
Principales equivalencias: Fiat 79081328, JCB 32-203703, John Deere AR71365
Observaciones: Filtro secundario, utilice GAK-216 como primario

GAK-403 FILTRO P/AIRE



Código: 4069
Diámetro Ext.: (6 1/16 in) (6.062 in) (153.9 mm)
Diámetro Int.: (3 1/2 in) (3.5 in) (88.9 mm)
Altura entre tapas: (12 in) (12.000 in) (304.8 mm)
Altura Total: (12 3/8 in) (12.375 in) (314.3 mm)
Principales aplicaciones: Allis Chalmers, Case, Caterpillar, Galion, Hough, Hyster, IHC, J.C. Bamford, John Deere, Mack, New Holland, Nissan, Toyota
Principales equivalencias: Caterpillar 9Y6841, IHC 3130920-R91, John Deere AT44377
Observaciones: Para filtro sin aspas utilice GA-403

GA-422 FILTRO P/AIRE



Código: 3144
Diámetro Ext.: (11 1/2 in) (11.5 in) (292.1 mm)
Diámetro Int.: (8 19/64 in) (8.296 in) (210.7 mm)
Altura Total: (7 3/64 in) (7.046 in) (178.9 mm)
Principales aplicaciones: Camiones Ford, IHC
Principales equivalencias: IHC 573465-C91, 588201-C91

GA-425 FILTRO P/AIRE



Código: 4198
Diámetro Ext.: (7 5/16 in) (7.312 in) (185.7 mm)
Diámetro Int.: (3 15/16 in) (3.937 in) (100.0 mm)
Altura entre tapas: (14 7/8 in) (14.875 in) (377.8 mm)
Altura Total: (15 1/4 in) (15.25 in) (387.3 mm)
Principales aplicaciones: Tractores John Deere
Principales equivalencias: John Deere AR54336, AR79941
Observaciones: Filtro primario, utilice GA-426 como secundario

GA-459 FILTRO P/AIRE



Código: 4429
Diámetro Ext. del Elemento: (3 3/8 in) (3.375 in) (85.7 mm)
Diámetro Ext. con Borde: (3 25/32 in) (3.781 in) (96.0 mm)
Diámetro Int. del Elemento: (2 15/16 in) (2.937 in) (74.6 mm)
Diámetro Int. para la Guía: (11/16 in) (0.687 in) (17.4 mm)
Altura Total: (12 1/16 in) (12.062 in) (306.3 mm)
Principales aplicaciones: Tractores New Holland, John Deere, Deutz
Principales equivalencias: Deutz 4319256, Donaldson P124165
Observaciones: Filtro Secundario, utilice GAK-458 como primario

GA-426 FILTRO P/AIRE



Código: 4194
Diámetro Ext.: (3 7/8 in) (3.875 in) (98.4 mm)
Diámetro Int.: (3 9/64 in) (3.140 in) (79.7 mm)
Altura entre tapas: (12 15/16 in) (12.937 in) (328.6 mm)
Altura Total: (13 1/8 in) (13.125 in) (333.3 mm)
Principales aplicaciones: Tractores John Deere
Principales equivalencias: John Deere AR54337, AR79942
Observaciones: Filtro secundario, utilice GA-425 como primario

GA-465R FILTRO P/AIRE RADIAL



Código: 4484
Diámetro Ext.: (9 3/4 in) (9.750 in) (247.7 mm)
Diámetro Int.: (6 19/64 in) (6.297 in) (159.9 mm)
Altura Total: (15 5/8 in) (15.625 in) (396.9 mm)
Principales aplicaciones: Camiones DAF
Principales equivalencias: DAF 1672465

GA-435R FILTRO P/AIRE



Código: 4405
Diámetro Ext.: (13 in) (13.000 in) (330.2 mm)
Diámetro Int.: (7 23/32 in) (7.718 in) (196.0 mm)
Altura entre tapas: (16 13/32 in) (16.406 in) (416.7 mm)
Altura Total: (16 13/32 in) (16.406 in) (416.7 mm)
Principales aplicaciones: Camiones Volvo, Motores Cummins, Detroit Diesel
Principales equivalencias: Volvo 8076195, Donaldson P532883

GA-467 FILTRO P/AIRE



Código: 4360
Diámetro Ext.: (11 7/8 in) (11.875 in) (301.6 mm)
Diámetro Int.: (7 1/2 in) (7.5 in) (190.5 mm)
Altura entre tapas: (18 1/8 in) (18.125 in) (460.3 mm)
Altura Total: (18 5/8 in) (18.625 in) (473.0 mm)
Principales aplicaciones: Camiones M.A.N., Mercedes Benz
Principales equivalencias: M.A.N. 81-08304-0044, Mercedes Benz 86909400203

GA-436 FILTRO P/AIRE



Código: 4215
Diámetro Ext.: (9 1/2 in) (9.5 in) (241.3 mm)
Diámetro Int.: (5 13/64 in) (5.203 in) (132.1 mm)
Altura entre tapas: (19 3/32 in) (19.093 in) (484.9 mm)
Altura Total: (19 35/64 in) (19.546 in) (496.4 mm)
Principales aplicaciones: Camiones y Autobuses Scania, Volvo
Principales equivalencias: Scania 365727, 211811

GA-482 FILTRO P/AIRE



Código: 4147
Diámetro Ext.: (11 7/16 in) (11.437 in) (290.5 mm)
Diámetro Int.: (7 in) (7.000 in) (177.8 mm)
Altura entre tapas: (15 23/64 in) (15.359 in) (390.1 mm)
Altura Total: (15 23/64 in) (15.359 in) (390.1 mm)
Principales aplicaciones: Equipos Caterpillar
Principales equivalencias: Caterpillar 612506, 7N4048
Observaciones: Filtro secundario, utilice GA-483 como primario

GAK-458 FILTRO P/AIRE



Código: 4428
Diámetro Ext. del Elemento: (6 3/32 in) (6.093 in) (154.7 mm)
Diámetro Ext. Incluyendo Aspas: (7 13/16 in) (7.812 in) (198.4 mm)
Diámetro Int. del Elemento: (3 15/32 in) (3.468 in) (88.1 mm)
Diámetro Int. para la Guía: (3/4 in) (0.75 in) (19.0 mm)
Altura Total: (13 1/2 in) (13.5 in) (342.9 mm)
Principales aplicaciones: Tractores Ford, Deutz, Allis chalmers,
Principales equivalencias: Deutz 4319257, Donaldson P127164
Observaciones: Filtro Primario, utilice GA-459 como secundario

GA-483 FILTRO P/AIRE



Código: 4140
Diámetro Ext.: (12 1/2 in) (12.5 in) (317.5 mm)
Diámetro Int.: (9 1/8 in) (9.125 in) (231.7 mm)
Altura Total: (15 in) (15.000 in) (381.0 mm)
Principales aplicaciones: Equipos Caterpillar
Principales equivalencias: Caterpillar 612505, 8N4150
Observaciones: Filtro primario, utilice GA-482 como secundario

GA-493 FILTRO P/AIRE



Código: 4541
Diámetro Ext.: (in) (in) (mm)
Diámetro Int.: (in) (in) (mm)
Altura Total: (in) (in) (mm)
Principales aplicaciones: Camiones Western Star
Principales equivalencias: Baldwin PA2493, Fleetguard AF1616

GA-517R FILTRO P/AIRE RADIAL SECUNDARIO



Código: 4492
Diámetro Ext.: (11 29/32 in) (11.906 in) (302.4 mm)
Diámetro Int.: (6 5/8 in) (6.625 in) (168.2 mm)
Altura Total: (17 19/32 in) (17.593 in) (446.8 mm)
Principales aplicaciones: Camiones Scania
Principales equivalencias: Scania 1335679, 1421022

GA-498 FILTRO P/AIRE



Código: 4545
Diámetro Ext.: (5 29/32 in) (5.906 in) (150.0 mm)
Diámetro Int.: (3 9/64 in) (3.140 in) (79.7 mm)
Altura Total: (7 31/64 in) (7.484 in) (190.0 mm)
Principales aplicaciones: Camiones Changan SC1040D
Principales equivalencias: Changan KL1519, KL1519A1

GA-518R FILTRO P/AIRE RADIAL



Código: 4530
Diámetro Ext.: (9 21/64 in) (9.328 in) (236.9 mm)
Diámetro Int.: (5 61/64 in) (5.953 in) (151.2 mm)
Altura Total: (23 17/32 in) (23.531 in) (597.6 mm)
Principales aplicaciones: Camiones Freightliner y Peterbilt
Principales equivalencias: Baldwin RS3516, Fleetguard AF25219, AF25525

GA-499R FILTRO P/AIRE RADIAL



Código: 4456
Diámetro Ext.: (9 5/32 in) (9.156 in) (232.5 mm)
Diámetro Int.: (4 5/8 in) (4.625 in) (117.4 mm)
Altura Total: (12 1/2 in) (12.5 in) (317.5 mm)
Principales aplicaciones: Motores Caterpillar
Principales equivalencias: Caterpillar 6I2499, Donaldson P532499

GA-529 FILTRO P/AIRE



Código: 4399
Diámetro Ext.: (7 11/32 in) (7.343 in) (186.5 mm)
Diámetro Int. del Elemento: (5 3/8 in) (5.375 in) (136.5 mm)
Diámetro Int. para la Guía: (7/16 in) (0.437 in) (11.0 mm)
Altura Total: (13 7/8 in) (13.875 in) (352.4 mm)
Principales aplicaciones: Camiones Ford
Principales equivalencias: Ford F1HZ-9601-C

GA-509 FILTRO P/AIRE



Código: 4356
Diámetro Ext.: (10 13/32 in) (10.406 in) (264.3 mm)
Diámetro Int.: (6 1/32 in) (6.031 in) (153.1 mm)
Altura Total: (18 1/32 in) (18.031 in) (457.9 mm)
Principales aplicaciones: Tractocamiones Kenworth (1993)
Principales equivalencias: Engine Life ELA8876

GA-534R FILTRO P/AIRE RADIAL



Código: 4460
Diámetro Ext.: (13 3/32 in) (13.093 in) (332.5 mm)
Diámetro Int.: (7 3/8 in) (7.375 in) (187.3 mm)
Altura Total: (25 23/32 in) (25.718 in) (653.2 mm)
Principales aplicaciones: Camiones y Tractocamiones Kenworth, Peterbilt
Principales equivalencias: Donaldson P534925, Fleetguard AF25248

GA-516R FILTRO P/AIRE RADIAL



Código: 4493
Diámetro Ext.: (12 21/64 in) (12.328 in) (313.1 mm)
Diámetro Int.: (7 1/4 in) (7.250 in) (184.1 mm)
Altura Total: (21 1/32 in) (21.031 in) (534.1 mm)
Principales aplicaciones: Camiones Scania con motor DSC12 02 y DSC12 03
Principales equivalencias: Scania 1423414

GA-539R FILTRO P/AIRE RADIAL



Código: 4459
Diámetro Ext.: (11 3/8 in) (11.375 in) (288.9 mm)
Diámetro Int.: (6 13/16 in) (6.812 in) (173.0 mm)
Altura Total: (23 23/32 in) (23.718 in) (602.4 mm)
Principales aplicaciones: Camiones y Tractocamiones Kenworth, Peterbilt
Principales equivalencias: Donaldson P534816, Fleetguard AF26163

GA-563 FILTRO P/AIRE



Código: 4531
Diámetro Ext.: (14 45/64 in) (14.703 in) (373.5 mm)
Diámetro Int.: (10 9/32 in) (10.281 in) (261.1 mm)
Altura Total: (24 in) (24.000 in) (609.6 mm)
Principales aplicaciones: Bell, Dynapac, Hitachi, Hogzilla, Ingersoll-Rand, Volvo, Wabco
Principales equivalencias: Baldwin PA2562, Fram CA259, Wix 42258

GA-616 FILTRO P/AIRE



Código: 4369
Diámetro Ext.: (9 1/8 in) (9.125 in) (231.7 mm)
Diámetro Int.: (5 13/16 in) (5.812 in) (147.6 mm)
Altura entre tapas: (18 in) (18.000 in) (457.2 mm)
Altura Total: (18 11/16 in) (18.687 in) (474.6 mm)
Principales aplicaciones: Tractores Ford
Principales equivalencias: Ford D8NN-9618-AA
Observaciones: Filtro primario, utilice GA-398 como secundario

GA-588 FILTRO P/AIRE



Código: 4367
Diámetro Ext.: (3 5/8 in) (3.625 in) (92.0 mm)
Diámetro Int.: (2 15/16 in) (2.937 in) (74.6 mm)
Altura entre tapas: (13 3/4 in) (13.75 in) (349.2 mm)
Altura Total: (13 27/32 in) (13.843 in) (351.6 mm)
Principales aplicaciones: Equipo Ford, New Holland
Principales equivalencias: Ford D1NN-9R500-A, E0NN-9R500-AA
Observaciones: Filtro secundario, utilice GA-589 como primario

GA-624R FILTRO P/AIRE RADIAL



Código: 4455
Diámetro Ext.: (13 in) (13.000 in) (330.2 mm)
Diámetro Int.: (8 1/4 in) (8.25 in) (209.5 mm)
Altura Total: (19 1/2 in) (19.5 in) (495.3 mm)
Principales aplicaciones: Motores Cummins, Volvo
Principales equivalencias: Volvo 20411-815, Fleetguard AF26163

GA-589 FILTRO P/AIRE



Código: 4368
Diámetro Ext.: (6 21/32 in) (6.656 in) (169.0 mm)
Diámetro Int.: (3 3/4 in) (3.75 in) (95.2 mm)
Altura entre tapas: (15 in) (15.000 in) (381.0 mm)
Altura Total: (15 7/16 in) (15.437 in) (392.1 mm)
Principales aplicaciones: Equipo Ford, New Holland
Principales equivalencias: Ford D1NN-9600-A, E9NN-9601-AA
Observaciones: Filtro primario, utilice GA-588 como secundario

GAK-625 FILTRO P/AIRE



Código: 4120
Diámetro Ext.: (6 27/32 in) (6.843 in) (173.8 mm)
Diámetro Int.: (4 7/32 in) (4.218 in) (107.1 mm)
Altura entre tapas: (16 1/16 in) (16.062 in) (407.9 mm)
Altura Total: (16 7/16 in) (16.437 in) (417.5 mm)
Principales aplicaciones: Allis Chalmers, Clark, Ingersoll-Rand, Massey-Ferguson, Michigan, New Holland, White
Principales equivalencias: Allis Chalmers 7026678-7, Ingersoll Rand 50748078, New Holland 9809615

GA-600R FILTRO P/AIRE RADIAL



Código: 4532
Diámetro Ext.: (14 1/4 in) (14.250 in) (361.9 mm)
Diámetro Int.: (8 63/64 in) (8.984 in) (228.1 mm)
Altura Total: (18 1/8 in) (18.125 in) (460.3 mm)
Principales aplicaciones: Maquinaria Caterpillar
Principales equivalencias: Caterpillar 106-3969, Baldwin RS3700, Fleetguard AF25262

GA-633R FILTRO P/AIRE RADIAL



Código: 4494
Diámetro Ext.: (9 1/4 in) (9.25 in) (234.9 mm)
Diámetro Int.: (5 5/16 in) (5.312 in) (134.9 mm)
Altura Total: (11 1/2 in) (11.5 in) (292.1 mm)
Principales aplicaciones: Camiones General Motors, Isuzu
Principales equivalencias: Isuzu 8970622940, Donaldson P828633

GA-608 FILTRO P/AIRE



Código: 4457
Diámetro Ext.: (12 3/4 in) (12.75 in) (323.8 mm)
Diámetro Int. del Elemento: (8 11/32 in) (8.343 in) (211.9 mm)
Diámetro Int. para la Guía: (21/32 in) (0.656 in) (16.6 mm)
Altura Total: (27 in) (27.000 in) (685.8 mm)
Principales aplicaciones: Camiones Peterbilt
Principales equivalencias: Donaldson P181186, Fleetguard AF996M

GA-642 FILTRO P/AIRE



Código: 4539
Diámetro Ext.: (13 53/64 in) (13.828 in) (351.2 mm)
Diámetro Int.: (7 29/64 in) (7.453 in) (189.3 mm)
Altura Total: (10 19/32 in) (10.594 in) (269.1 mm)
Principales aplicaciones: Camiones Ford con motor Cummins
Principales equivalencias: Ford E2HZ-9601-B, Baldwin PA2642, Fleetguard AF1886M

GA-673R FILTRO P/AIRE



Código: 4391
Diámetro Ext.: (6 15/32 in) (6.468 in) (164.3 mm)
Diámetro Int.: (3 37/64 in) (3.578 in) (90.8 mm)
Altura entre tapas: (11 1/8 in) (11.125 in) (282.5 mm)
Altura Total: (11 1/8 in) (11.125 in) (282.5 mm)
Principales aplicaciones: Camionetas Chevrolet, GMC
Principales equivalencias: GMC 15998574, 25168081

GA-694 FILTRO P/AIRE



Código: 4196
Diámetro Ext.: (10 3/8 in) (10.375 in) (263.5 mm)
Diámetro Int.: (6 27/32 in) (6.843 in) (173.8 mm)
Altura entre tapas: (28 in) (28.000 in) (711.2 mm)
Altura Total: (29 in) (29.000 in) (736.6 mm)
Principales aplicaciones: Camiones IHC, Kenworth, Peterbilt
Principales equivalencias: IHC 573138-C91, 57368-C1

GA-679 FILTRO P/AIRE



Código: 4091
Diámetro Ext.: (9 3/32 in) (9.093 in) (230.9 mm)
Diámetro Int.: (4 13/16 in) (4.812 in) (122.2 mm)
Altura entre tapas: (16 25/32 in) (16.781 in) (426.2 mm)
Altura Total: (17 7/32 in) (17.218 in) (437.3 mm)
Principales aplicaciones: Equipo John Deere
Principales equivalencias: John Deere AR49839, AR79679
Observaciones: Filtro primario, utilice GA-680 como secundario

GA-697R FILTRO P/AIRE RADIAL



Código: 4485
Diámetro Ext.: (8 3/8 in) (8.375 in) (212.7 mm)
Diámetro Int.: (4 11/16 in) (4.687 in) (119.0 mm)
Altura Total: (16 7/16 in) (16.437 in) (417.5 mm)
Principales aplicaciones: Camiones DAF
Principales equivalencias: DAF 1433697, Fleetguard AF25873

GA-680 FILTRO P/AIRE



Código: 4138
Diámetro Ext.: (4 11/16 in) (4.687 in) (119.0 mm)
Diámetro Int.: (3 61/64 in) (3.953 in) (100.4 mm)
Altura entre tapas: (14 3/16 in) (14.187 in) (360.3 mm)
Altura Total: (14 3/16 in) (14.187 in) (360.3 mm)
Principales aplicaciones: Equipo John Deere
Principales equivalencias: John Deere AR49840, AR79680
Observaciones: Filtro secundario, utilice GA-679 como primario

GA-701 FILTRO P/AIRE PRIM.



Código: 4468
Diámetro Ext. del Elemento: (9 29/32 in) (9.906 in) (251.6 mm)
Diámetro Ext. Total: (12 25/32 in) (12.781 in) (324.6 mm)
Altura Total: (8 1/32 in) (8.031 in) (203.9 mm)
Tipo: primario
Use el filtro GA-702 como secundario
Principales aplicaciones: Camiones Freightliner
Principales equivalencias: Donaldson P548070, Fleetguard AF26154, Baldwin CA4700
Observaciones: Filtro primario, utilice GA-702 como secundario

GA-682R FILTRO P/AIRE



Código: 4402
Diámetro Ext.: (13 1/32 in) (13.031 in) (330.9 mm)
Diámetro Int.: (6 27/32 in) (6.843 in) (173.8 mm)
Altura del Elemento: (14 3/4 in) (14.75 in) (374.6 mm)
Altura Total: (15 15/32 in) (15.468 in) (392.9 mm)
Principales aplicaciones: Camiones Ford, White, GMC, Detroit Diesel, Volvo
Principales equivalencias: Volvo 1117576, Donaldson P527682
Observaciones: Filtro primario, utilice GA-683R como secundario

GA-702 FILTRO P/AIRE SEC.

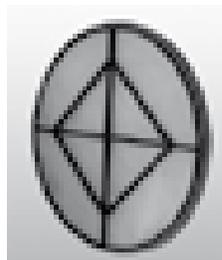

Código: 4469
Diámetro Ext.: (9 13/32 in) (9.406 in) (238.9 mm)
Altura Total: (31/32 in) (0.968 in) (24.6 mm)
Tipo: secundario
Use el filtro GA-701 como primario
Principales aplicaciones: Camiones Freightliner
Principales equivalencias: Donaldson P544432, Fleetguard AF26153, Baldwin PA4701
Observaciones: Filtro secundario, utilice GA-701 como primario

GA-683R FILTRO P/AIRE



Código: 4404
Diámetro Ext.: (6 13/16 in) (6.812 in) (173.0 mm)
Diámetro Int.: (5 13/64 in) (5.203 in) (132.1 mm)
Altura entre tapas: (14 29/64 in) (14.453 in) (367.1 mm)
Altura Total: (14 29/64 in) (14.453 in) (367.1 mm)
Principales aplicaciones: Camiones Ford, White, GMC, Detroit Diesel, Volvo
Principales equivalencias: Donaldson P527683, Fleetguard AF25345
Observaciones: Filtro secundario, utilice GA-682R como primario

GA-712R FILTRO P/AIRE RADIAL



Código: 4533
Diámetro Ext.: (14 1/4 in) (14.250 in) (361.9 mm)
Diámetro Int.: (8 63/64 in) (8.984 in) (228.1 mm)
Altura Total: (15 1/2 in) (15.500 in) (393.7 mm)
Principales aplicaciones: Maquinaria Caterpillar
Principales equivalencias: Caterpillar 123-6855, Baldwin RS3712, Fleetguard AF25338

GA-723R FILTRO P/AIRE



Código: 4393
Diámetro Ext.: (6 27/32 in) (6.843 in) (173.8 mm)
Diámetro Int.: (5 27/32 in) (5.843 in) (148.4 mm)
Altura entre tapas: (17 33/64 in) (17.515 in) (444.8 mm)
Altura Total: (17 3/4 in) (17.75 in) (450.8 mm)
Principales aplicaciones: Camiones y Autobuses IHC, Navistar
Principales equivalencias: IHC 2022289C1
Observaciones: Filtro secundario, utilice GA-221R como primario

GA-770R FILTRO P/AIRE RADIAL



Código: 4495
Diámetro Ext.: (8.843 in) (8 27/32 in) (224.6 mm)
Diámetro Int.: (7.125 in) (7 1/8 in) (180.9 mm)
Altura Total: (16.718 in) (16 23/32 in) (424.6 mm)
Principales aplicaciones: Camiones International CF-500 y CF-600
Principales equivalencias: International 3587702C1, Baldwin RS4992, Fleetguard AF25962

GA-732R FILTRO P/AIRE



Código: 4403
Diámetro Ext.: (7 7/32 in) (7.218 in) (183.3 mm)
Diámetro Int.: (3 35/64 in) (3.546 in) (90.0 mm)
Altura entre tapas: (11 11/64 in) (11.171 in) (283.7 mm)
Altura Total: (11 11/64 in) (11.171 in) (283.7 mm)
Principales aplicaciones: Camionetas Chevrolet, GMC
Principales equivalencias: GMC 15986275, 25168082

GA-781 FILTRO P/AIRE



Código: 4424
Diámetro Ext. del Elemento: (7 9/32 in) (7.281 in) (184.9 mm)
Diámetro Ext. con Borde: (9 9/32 in) (9.281 in) (235.7 mm)
Diámetro Int.: (3 5/8 in) (3.625 in) (92.0 mm)
Altura Total: (12 11/32 in) (12.343 in) (313.5 mm)
Principales aplicaciones: Tractores John Deere
Principales equivalencias: John Deere AL78223, Fleetguard AF25300
Observaciones: Filtro primario, utilice GA-782 como secundario

GA-758 FILTRO P/AIRE



Código: 4426
Diámetro Ext.: (12 1/8 in) (12.125 in) (307.9 mm)
Diámetro Int. del Elemento: (7 11/16 in) (7.687 in) (195.2 mm)
Diámetro Int. para la Guía: (29/32 in) (0.906 in) (23.0 mm)
Altura Total: (19 1/2 in) (19.5 in) (495.3 mm)
Principales aplicaciones: Tractores Ford, Tractores y Excavadoras John Deere
Principales equivalencias: New Holland V95611, John Deere AR95758
Observaciones: Filtro primario, utilice GA-759 como secundario

GA-782 FILTRO P/AIRE



Código: 4425
Diámetro Ext. del Elemento: (5 1/32 in) (5.031 in) (127.7 mm)
Diámetro Ext. con Borde: (7 13/16 in) (7.812 in) (198.4 mm)
Diámetro Int.: (3 5/8 in) (3.625 in) (92.0 mm)
Altura Total: (5 3/16 in) (5.187 in) (131.7 mm)
Principales aplicaciones: Tractores John Deere
Principales equivalencias: John Deere AL78224, Fleetguard AF25301
Observaciones: Filtro secundario, utilice GA-781 como primario

GA-759 FILTRO P/AIRE



Código: 4427
Diámetro Ext.: (7 5/8 in) (7.625 in) (193.6 mm)
Diámetro Int. del Elemento: (6 1/16 in) (6.062 in) (153.9 mm)
Diámetro Int. para la Guía: (21/32 in) (0.656 in) (16.6 mm)
Altura Total: (18 3/8 in) (18.375 in) (466.7 mm)
Principales aplicaciones: Tractores Ford, Tractores y Excavadoras John Deere
Principales equivalencias: John Deere AR95759
Observaciones: Filtro secundario, utilice GA-758 como primario

GA-798R FILTRO P/AIRE



Código: 4447
Diámetro Ext. Mayor: (8 1/32 in) (8.031 in) (203.9 mm)
Diámetro Ext. Menor: (3 1/32 in) (3.031 in) (76.9 mm)
Diámetro Int.: (5 3/64 in) (5.046 in) (128.1 mm)
Altura Total: (14 13/16 in) (14.812 in) (376.2 mm)
Principales aplicaciones: Camiones IHC
Principales equivalencias: IHC 3532800C91
Observaciones: Filtro secundario, utilice GA-799R como primario

GA-768R FILTRO P/AIRE



Código: 4390
Diámetro Ext.: (5 5/16 in) (5.312 in) (134.9 mm)
Diámetro Int.: (3 45/64 in) (3.703 in) (94.0 mm)
Altura entre tapas: (11 13/16 in) (11.812 in) (300.0 mm)
Altura Total: (12 3/64 in) (12.046 in) (305.9 mm)
Principales aplicaciones: Camiones Chevrolet Kodiak, Ford, Motores Caterpillar, Cummins
Principales equivalencias: Caterpillar 311455, Ford F3HZ-9602-A, General Motors 12544543
Observaciones: Filtro secundario, utilice GA-197R como primario

GA-799R FILTRO P/AIRE



Código: 4442
Diámetro Ext.: (10 1/4 in) (10.25 in) (260.3 mm)
Diámetro Int.: (6 3/4 in) (6.75 in) (171.4 mm)
Altura Total: (15 31/32 in) (15.968 in) (405.6 mm)
Principales aplicaciones: Camiones IHC
Principales equivalencias: IHC 3532799C91
Observaciones: Filtro primario, utilice GA-798R como secundario

GA-801R FILTRO P/AIRE



Código: 4446
Diámetro Ext.: (9 15/32 in) (9.468 in) (240.5 mm)
Diámetro Int.: (5 37/64 in) (5.578 in) (141.6 mm)
Altura Total: (16 1/2 in) (16.5 in) (419.1 mm)
Principales aplicaciones: Motores Mercedes Benz DN904
Principales equivalencias: Inducontrol AA1235, Reytor IT2002
Observaciones: Filtro primario, utilice GA-802R como secundario

GA-809R FILTRO P/AIRE



Código: 4444
Diámetro Ext.: (5 in) (5.000 in) (127.0 mm)
Diámetro Int.: (4 11/64 in) (4.171 in) (105.9 mm)
Altura Total: (14 63/64 in) (14.984 in) (380.6 mm)
Principales aplicaciones: Nueva versión Premium
Principales equivalencias: Reytor IT2001S
Observaciones: Filtro secundario, utilice GA-808R como primario

GA-802R FILTRO P/AIRE



Código: 4443
Diámetro Ext.: (5 5/8 in) (5.625 in) (142.8 mm)
Diámetro Int.: (4 43/64 in) (4.671 in) (118.6 mm)
Altura Total: (15 11/16 in) (15.687 in) (398.4 mm)
Principales aplicaciones: Motores Mercedes Benz DN904
Principales equivalencias: Inducontrol AA1236, Reytor IT2002S
Observaciones: Filtro secundario, utilice GA-801R como primario

GA-826 FILTRO P/AIRE



Código: 4103
Diámetro Ext.: (9 1/32 in) (9.031 in) (229.3 mm)
Diámetro Int.: (5 45/64 in) (5.703 in) (144.8 mm)
Altura entre tapas: (16 in) (16.000 in) (406.4 mm)
Altura Total: (16 1/2 in) (16.5 in) (419.1 mm)
Principales aplicaciones: Case, IHC, John Deere
Principales equivalencias: IHC 67974-C4, John Deere AT44631
Observaciones: Filtro primario, utilice GA-827 como secundario

GA-803R FILTRO P/AIRE



Código: 4448
Diámetro Ext.: (10 63/64 in) (10.984 in) (279.0 mm)
Diámetro Int.: (5 53/64 in) (5.828 in) (148.0 mm)
Altura Total: (18 13/32 in) (18.406 in) (467.5 mm)
Principales aplicaciones: Nueva versión Premium
Principales equivalencias: Reytor IT2057
Observaciones: Filtro primario, utilice GA-804R como secundario

GA-827 FILTRO P/AIRE



Código: 4132
Diámetro Ext.: (5 37/64 in) (5.578 in) (141.6 mm)
Diámetro Int.: (4 27/64 in) (4.421 in) (112.3 mm)
Altura entre tapas: (15 37/64 in) (15.578 in) (395.6 mm)
Altura Total: (15 37/64 in) (15.578 in) (395.6 mm)
Principales aplicaciones: Case, Ford, IHC, John Deere
Principales equivalencias: Ford E6NN-9R500-FA, IHC 67685-C92, John Deere AT44632
Observaciones: Filtro secundario, utilice GA-826 como primario

GA-804R FILTRO P/AIRE



Código: 4445
Diámetro Ext.: (5 5/8 in) (5.625 in) (142.8 mm)
Diámetro Int.: (5 1/32 in) (5.031 in) (127.7 mm)
Altura Total: (17 15/64 in) (17.234 in) (437.7 mm)
Principales aplicaciones: Nueva versión Premium
Principales equivalencias: Reytor IT2057S
Observaciones: Filtro secundario, utilice GA-803R como primario

GA-853R FILTRO P/AIRE RADIAL



Código: 4481
Diámetro Ext.: (6 1/2 in) (6.5 in) (165.1 mm)
Diámetro Int.: (3 9/16 in) (3.562 in) (90.4 mm)
Altura Total: (14 1/32 in) (14.031 in) (356.3 mm)
Principales aplicaciones: Case, Caterpillar, John Deere, New Holland, Terex, Volvo
Principales equivalencias: Case 87438248, John Deere AT169911, Volvo 11883618

GA-808R FILTRO P/AIRE



Código: 4449
Diámetro Ext.: (10 in) (10.000 in) (254.0 mm)
Diámetro Int.: (5 1/64 in) (5.015 in) (127.3 mm)
Altura Total: (16 21/32 in) (16.656 in) (423.0 mm)
Principales aplicaciones: Nueva versión Premium
Principales equivalencias: Reytor IT2001
Observaciones: Filtro primario, utilice GA-809R como secundario

GA-864R FILTRO P/AIRE RADIAL



Código: 4496
Diámetro Ext.: (11 5/64 in) (11.078 in) (281.3 mm)
Diámetro Int.: (5 55/64 in) (5.859 in) (148.8 mm)
Altura Total: (18 1/2 in) (18.5 in) (469.9 mm)
Principales aplicaciones: Camiones Mercedes Benz
Principales equivalencias: Mann & Hummel C28 1053, Luber Finer LAF3864

GA-879 FILTRO P/AIRE



Código: 4538
Diámetro Ext.: (17 21/32 in) (17.656 in) (448.5 mm)
Diámetro Int.: (11 11/64 in) (11.172 in) (283.8 mm)
Altura Total: (23 in) (23.000 in) (584.2 mm)
Principales aplicaciones: Caterpillar, Euclid, Hitachi, Terex, Wabco
Principales equivalencias: Baldwin PA2363, Fleetguard AF879

GA-891 FILTRO P/AIRE



Código: 4077
Diámetro Ext.: (6 1/16 in) (6.062 in) (153.9 mm)
Diámetro Int.: (3 1/2 in) (3.5 in) (88.9 mm)
Altura entre tapas: (15 in) (15.000 in) (381.0 mm)
Altura Total: (15 3/8 in) (15.375 in) (390.5 mm)
Principales aplicaciones: Case, Hough, IHC
Principales equivalencias: IHC 529851-R1, 683238-C91
Observaciones: Filtro primario, utilice GA-892 como secundario

GA-880R FILTRO P/AIRE RADIAL



Código: 4483
Diámetro Ext.: (4 9/64 in) (4.140 in) (105.1 mm)
Diámetro Int.: (3 in) (3.000 in) (76.2 mm)
Altura Total: (10 53/64 in) (10.828 in) (275.0 mm)
Principales aplicaciones: Carrier, Case, Caterpillar, John Deere, Komatsu, New Holland
Principales equivalencias: Caterpillar 3I2147, Komatsu Z760238730, New Holland 86549700

GA-892 FILTRO P/AIRE



Código: 4076
Diámetro Ext.: (3 27/32 in) (3.843 in) (97.6 mm)
Diámetro Int.: (2 59/64 in) (2.921 in) (74.2 mm)
Altura entre tapas: (14 1/32 in) (14.031 in) (356.3 mm)
Altura Total: (14 1/32 in) (14.031 in) (356.3 mm)
Principales aplicaciones: Case, Hough, IHC, Komatsu, Massey Ferguson, New Holland
Principales equivalencias: IHC 683238-C91, Komatsu 529852-R4, Massey Ferguson 258522-M91
Observaciones: Filtro secundario, utilice GA-891 como primario

GA-885 FILTRO P/AIRE



Código: 4542
Diámetro Ext.: (12 23/32 in) (12.718 in) (323.0 mm)
Diámetro Int.: (8 1/2 in) (8.500 in) (215.9 mm)
Diámetro Int. para la guía: (25/32 in) (0.781 in) (19.8 mm)
Altura entre tapas: (17 5/64 in) (17.078 in) (433.7 mm)
Altura Total: (17 39/64 in) (17.609 in) (447.2 mm)
Principales aplicaciones: Camiones Peterbilt
Principales equivalencias: Baldwin PA2326, Fleetguard AF888M, Fram CA1503

GA-904R FILTRO P/AIRE



Código: 4411
Diámetro Ext.: (9 29/32 in) (9.906 in) (251.6 mm)
Diámetro Int.: (5 in) (5.000 in) (127.0 mm)
Altura entre tapas: (16 21/32 in) (16.656 in) (423.0 mm)
Altura Total: (16 21/32 in) (16.656 in) (423.0 mm)
Principales aplicaciones: Camiones "Boxer" Mercedes Benz con Housing Reytor y motor OM904LA
Principales equivalencias: Inducontrol AA1167, Reytor IT2000
Observaciones: Filtro primario, utilice GA-905R como secundario

GA-888R FILTRO P/AIRE RADIAL



Código: 4482
Diámetro Ext.: (4 1/8 in) (4.125 in) (104.7 mm)
Diámetro Int.: (2 21/32 in) (2.656 in) (67.4 mm)
Altura Total: (10 5/32 in) (10.156 in) (257.9 mm)
Principales aplicaciones: Unidades de Refrigeración Carrier
Principales equivalencias: Carrier 30-00430-22, 30-00430-23

GA-905R FILTRO P/AIRE



Código: 4410
Diámetro Ext.: (5 3/32 in) (5.093 in) (129.3 mm)
Diámetro Int.: (4 11/64 in) (4.171 in) (105.9 mm)
Altura entre tapas: (15 19/64 in) (15.296 in) (388.5 mm)
Altura Total: (15 19/64 in) (15.296 in) (388.5 mm)
Principales aplicaciones: Camiones "Boxer" Mercedes Benz con Housing Reytor y motor OM904LA
Principales equivalencias: Inducontrol AA1175, Reytor IT2000SY
Observaciones: Filtro secundario, utilice GA-904R como primario

GA-890R FILTRO P/AIRE



Código: 4397
Diámetro Ext.: (5 7/8 in) (5.875 in) (149.2 mm)
Diámetro Int.: (4 51/64 in) (4.796 in) (121.8 mm)
Altura entre tapas: (14 43/64 in) (14.671 in) (372.6 mm)
Altura Total: (14 7/8 in) (14.875 in) (377.8 mm)
Principales aplicaciones: Camiones Dina con motor Navistar, Tractores John Deere
Principales equivalencias: John Deere RE51630, Donaldson P533890
Observaciones: Filtro secundario, utilice GA-930R como primario

GA-906R FILTRO P/AIRE



Código: 4409
Diámetro Ext.: (11 1/4 in) (11.25 in) (285.7 mm)
Diámetro Int.: (5 31/32 in) (5.968 in) (151.6 mm)
Altura entre tapas: (18 1/2 in) (18.5 in) (469.9 mm)
Altura Total: (18 1/2 in) (18.5 in) (469.9 mm)
Principales aplicaciones: Camiones "Marcopolo", "Torino", "Andare", "Allegro" de Mercedes Benz con Housing Reytor y motor OM906LA
Principales equivalencias: Inducontrol AA1212, Reytor IT2056
Observaciones: Filtro primario, utilice GA-907R como secundario

GA-907R FILTRO P/AIRE



Código: 4408
Diámetro Ext.: (5 63/64 in) (5.984 in) (152.0 mm)
Diámetro Int.: (4 13/16 in) (4.812 in) (122.2 mm)
Altura entre tapas: (17 3/8 in) (17.375 in) (441.3 mm)
Altura Total: (17 3/8 in) (17.375 in) (441.3 mm)
Principales aplicaciones: Camiones "Marcopolo", "Torino", "Andare", "Allegro" de Mercedes Benz con Housing Reytor y motor OM906LA
Principales equivalencias: Inducontrol AA1213, Reytor IT2056SY
Observaciones: Filtro secundario, utilice GA-906R como primario

GA-967R FILTRO P/AIRE



Código: 4451
Diámetro Ext.: (5 1/4 in) (5.25 in) (133.3 mm)
Diámetro Int.: (4 15/64 in) (4.234 in) (107.5 mm)
Altura Total: (17 1/2 in) (17.5 in) (444.5 mm)
Principales aplicaciones: Tractocamiones Freightliner, Motores Cummins, Detroit Diesel
Principales equivalencias: Donaldson P533781, Luber Finer LAF3781
Observaciones: Filtro secundario, utilice GA-966R como primario

GA-908R FILTRO P/AIRE



Código: 4450
Diámetro Ext.: (6 3/64 in) (6.046 in) (153.5 mm)
Diámetro Int.: (5 1/32 in) (5.031 in) (127.7 mm)
Altura Total: (16 1/32 in) (16.031 in) (407.1 mm)
Principales aplicaciones: Camiones y Autobuses Volvo con motor Cummins ISB
Principales equivalencias: Inducontrol AA1220, Reytor IT2015SY
Observaciones: Filtro secundario, utilice GA-909R como primario

GA-968R FILTRO P/AIRE RADIAL



Código: 4461
Diámetro Ext.: (10 29/32 in) (10.906 in) (277.0 mm)
Diámetro Int.: (6 25/32 in) (6.781 in) (172.2 mm)
Altura Total: (15 21/32 in) (15.656 in) (397.6 mm)
Principales aplicaciones: Tractocamiones Kenworth, Peterbilt, Motores Cummins
Principales equivalencias: Donaldson P532101, Fleetguard AF25598

GA-909R FILTRO P/AIRE RADIAL



Código: 4506
Diámetro Ext.: (11 1/32 in) (11.031 in) (280.1 mm)
Diámetro Int.: (5 45/64 in) (5.703 in) (144.8 mm)
Altura Total: (17 51/64 in) (17.796 in) (452.0 mm)
Principales aplicaciones: Camiones y Autobuses Volvo con motor Cummins ISB
Principales equivalencias: Inducontrol AA-1219, Fleetguard AF26111, Reytor IT 2015
Observaciones: Filtro primario, utilice GA-908R como secundario

GA-1008 FILTRO P/AIRE



Código: 4037
Diámetro Ext.: (8 13/32 in) (8.406 in) (213.5 mm)
Diámetro Int.: (4 1/32 in) (4.031 in) (102.3 mm)
Altura entre tapas: (10 in) (10.000 in) (254.0 mm)
Altura Total: (10 1/2 in) (10.5 in) (266.7 mm)
Principales aplicaciones: Equipo Caterpillar
Principales equivalencias: Caterpillar 4M9387, 9M1885
Observaciones: Filtro primario, utilice GA-1284 como secundario

GA-930R FILTRO P/AIRE



Código: 4396
Diámetro Ext.: (11 5/64 in) (11.078 in) (281.3 mm)
Diámetro Int.: (5 51/64 in) (5.796 in) (147.2 mm)
Altura entre tapas: (15 5/8 in) (15.625 in) (396.8 mm)
Altura Total: (15 5/8 in) (15.625 in) (396.8 mm)
Principales aplicaciones: Camiones Dina con motor Navistar, Tractores John Deere
Principales equivalencias: John Deere RE51629, Donaldson P533930
Observaciones: Filtro primario, utilice GA-890R como secundario

GA-1095 FILTRO P/AIRE



Código: 4323
Diámetro Ext.: (13 13/16 in) (13.812 in) (350.8 mm)
Diámetro Int.: (9 1/2 in) (9.5 in) (241.3 mm)
Altura Total: (16 in) (16.000 in) (406.4 mm)
Principales aplicaciones: Camiones y Autobuses Autocar, White, GMC, Volvo
Principales equivalencias: White 220053201, Donaldson P181095

GA-966R FILTRO P/AIRE



Código: 4401
Diámetro Ext.: (9 25/64 in) (9.390 in) (238.5 mm)
Diámetro Int.: (5 3/16 in) (5.187 in) (131.7 mm)
Altura entre tapas: (18 63/64 in) (18.984 in) (482.2 mm)
Altura Total: (18 63/64 in) (18.984 in) (482.2 mm)
Principales aplicaciones: Tractocamiones Freightliner, Motores Cummins, Detroit Diesel
Principales equivalencias: Donaldson P532966, Luber Finer LAF4498
Observaciones: Filtro primario, utilice GA-967R como secundario

GA-1203 FILTRO P/AIRE



Código: 4039
Diámetro Ext.: (13 7/8 in) (13.875 in) (352.4 mm)
Diámetro Int.: (9 7/16 in) (9.437 in) (239.7 mm)
Altura entre tapas: (17 31/32 in) (17.968 in) (456.4 mm)
Altura Total: (18 7/32 in) (18.218 in) (462.7 mm)
Principales aplicaciones: Motores Caterpillar
Principales equivalencias: Caterpillar 4L4720, 7L5628

GA-1284 FILTRO P/AIRE



Código: 4040
Diámetro Ext.: (3 25/32 in) (3.781 in) (96.0 mm)
Diámetro Int.: (2 21/32 in) (2.656 in) (67.4 mm)
Altura entre tapas: (10 1/8 in) (10.125 in) (257.1 mm)
Altura Total: (11 3/8 in) (11.375 in) (288.9 mm)
Principales aplicaciones: Equipo Caterpillar
Principales equivalencias: Caterpillar 4M9379, 9M1829
Observaciones: Filtro secundario, utilice GA-1008 como primario

GA-1285 FILTRO P/AIRE



Código: 4041
Diámetro Ext.: (4 25/32 in) (4.781 in) (121.4 mm)
Diámetro Int.: (3 21/32 in) (3.656 in) (92.8 mm)
Altura entre tapas: (12 1/8 in) (12.125 in) (307.9 mm)
Altura Total: (13 3/8 in) (13.375 in) (339.7 mm)
Principales aplicaciones: Equipo Caterpillar
Principales equivalencias: Caterpillar 3P0085, 9M1884
Observaciones: Filtro secundario, utilice GA-8047 como primario

GA-1286 FILTRO P/AIRE



Código: 4042
Diámetro Ext.: (6 9/32 in) (6.281 in) (159.5 mm)
Diámetro Int.: (4 21/32 in) (4.656 in) (118.2 mm)
Altura entre tapas: (13 1/8 in) (13.125 in) (333.3 mm)
Altura Total: (14 3/8 in) (14.375 in) (365.1 mm)
Principales aplicaciones: Equipo Caterpillar
Principales equivalencias: Caterpillar 1P7958, 9S0664
Observaciones: Filtro secundario, utilice GA-9334 como primario

GA-1287 FILTRO P/AIRE



Código: 4043
Diámetro Ext.: (6 9/32 in) (6.281 in) (159.5 mm)
Diámetro Int.: (4 21/32 in) (4.656 in) (118.2 mm)
Altura entre tapas: (16 17/64 in) (16.265 in) (413.1 mm)
Altura Total: (17 33/64 in) (17.515 in) (444.8 mm)
Principales aplicaciones: Equipo Caterpillar
Principales equivalencias: Caterpillar 3I0427, 9M4798
Observaciones: Filtro secundario, utilice GA-9045 como primario

GAK-1532 FILTRO P/AIRE



Código: 4210
Diámetro Ext.: (6 25/64 in) (6.390 in) (162.3 mm)
Diámetro Int.: (3 1/4 in) (3.25 in) (82.5 mm)
Altura entre tapas: (15 in) (15.000 in) (381.0 mm)
Altura Total: (15 1/2 in) (15.5 in) (393.7 mm)
Principales aplicaciones: Case, Hyster, Ingersoll-Rand, J.C. Bamford, Massey Ferguson, New Holland
Principales equivalencias: Case A189348, Ingersoll-Rand 92147453, New Holland 266221

GA-2803T FILTRO P/AIRE



Código: 13329
Diámetro Ext.: (6 5/8 in) (6.625 in) (168.3 mm)
Diámetro Int.: (2 in) (2.000 in) (50.8 mm)
Altura Total: (10 11/32 in) (10.344 in) (262.7 mm)
Principales aplicaciones: Unidades de Refrigeración Carrier
Principales equivalencias: Carrier 30-01077-01, Baldwin PA2803

GA-2804 T FILTRO P/AIRE

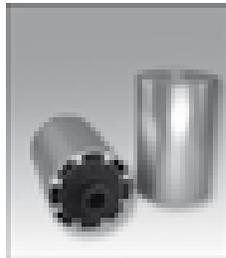

Código: 13330
Diámetro Ext.: (6 5/8 in) (6.625 in) (168.3 mm)
Diámetro Int.: (1 13/32 in) (1.406 in) (35.7 mm)
Altura Total: (11 11/32 in) (11.344 in) (288.1 mm)
Principales aplicaciones: Unidades de Refrigeración Thermo king
Principales equivalencias: Thermo king 115978, 117400, Baldwin PA2804

GA-2984 FILTRO P/AIRE



Código: 4322
Diámetro Ext.: (12 1/16 in) (12.062 in) (306.3 mm)
Diámetro Int. del Elemento: (5 11/16 in) (5.687 in) (144.4 mm)
Diámetro Int. para la Guía: (5/8 in) (0.625 in) (15.8 mm)
Altura Total: (15 11/16 in) (15.687 in) (398.4 mm)
Principales aplicaciones: Motores IHC, Camiones White
Principales equivalencias: IHC 472088-C91, White 22-0050002

GA-3095R FILTRO P/AIRE RADIAL



Código: 4536
Diámetro Ext. Abierto: (10 11/16 in) (10.687 in) (271.4 mm)
Diámetro Ext. Cerrado: (10 11/16 in) (10.687 in) (271.4 mm)
Diámetro Int.: (6 55/64 in) (6.859 in) (174.2 mm)
Altura Total: (16 37/64 in) (16.578 in) (421.0 mm)
Principales aplicaciones: Camiones Mercedes Benz con motor OM904LA
Principales equivalencias: Reytor IT3095, Fram CA10389
Observaciones: Filtro primario, utilice GA-3096R como secundario

GA-3096R FILTRO P/AIRE RADIAL



Código: 4537
Diámetro Ext. Abierto: (6 21/64 in) (6.328 in) (160.7 mm)
Diámetro Ext. Cerrado: (6 1/64 in) (6.015 in) (152.7 mm)
Diámetro Int.: (5 in) (5.000 in) (127 mm)
Altura Total: (15 31/64 in) (15.484 in) (393.2 mm)
Principales aplicaciones: Camiones Mercedes Benz con motor OM904LA
Principales equivalencias: Reytor IT3095SY, Fram CA10389S
Observaciones: Filtro secundario, utilice GA-3095R como primario

GA-3551 FILTRO P/AIRE



Código: 4200
Diámetro Ext.: (10 39/64 in) (10.609 in) (269.4 mm)
Diámetro Int.: (6 23/32 in) (6.718 in) (170.6 mm)
Altura entre tapas: (22 1/32 in) (22.031 in) (559.5 mm)
Altura Total: (22 17/32 in) (22.531 in) (572.2 mm)
Observaciones: Filtro estándar, para uso Heavy Duty o larga duración utilice GA-3551 XT
Principales aplicaciones: Camiones Freightliner, IHC, Kenworth, Mack
Principales equivalencias: Donaldson P525493, Fletguard AF1968
Observaciones: Filtro estándar, para uso Heavy duty o larga duración utilice GA-3551 XT

GA-3551 XT FILTRO P/AIRE



Código: 4505
Diámetro Ext.: (10 39/64 in) (10.609 in) (269.4 mm)
Diámetro Int.: (6 23/32 in) (6.718 in) (170.6 mm)
Altura entre tapas: (22 1/32 in) (22.031 in) (559.5 mm)
Altura Total: (22 17/32 in) (22.531 in) (572.2 mm)
Observaciones: Filtro de larga duración o uso Heavy Duty, para uso estándar utilice GA-3551
Principales aplicaciones: Camiones Freightliner, IHC, Kenworth, Mack
Principales equivalencias: Donaldson P525493, Fletguard AF1968
Observaciones: Filtro de larga duración o uso Heavy duty, para uso estándar utilice GA-3551

GA-4862R FILTRO P/AIRE RADIAL



Código: 4502
Diámetro Ext.: (12 1/16 in) (12.062 in) (306.4 mm)
Diámetro Int.: (9 7/8 in) (9.875 in) (250.8 mm)
Altura Total: (16 3/32 in) (16.094 in) (408.8 mm)
Principales aplicaciones: Camiones International
Principales equivalencias: Baldwin RS4862, Donaldson P613336, Fleetguard AF26103
Observaciones: Filtro primario, utilice GA-4863 como secundario

GA-4863 FILTRO P/AIRE



Código: 4503
Diámetro Ext.: (9 61/64 in) (9.953 in) (252.8 mm)
Diámetro Int.: (5 25/64 in) (5.391 in) (136.9 mm)
Altura Total: (15 29/64 in) (15.453 in) (392.5 mm)
Principales aplicaciones: Camiones International
Principales equivalencias: Baldwin RS4863, Donaldson P613337, Fleetguard AF26268
Observaciones: Filtro secundario, utilice GA-4862R como primario

GA-4999 FILTRO P/AIRE

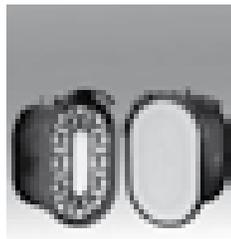

Código: 4529
Largo: (12 3/4 in) (12.750 in) (323.9 mm)
Ancho: (8 in) (8.000 in) (203.2 mm)
Altura Total: (9 5/16 in) (9.312 in) (236.5 mm)
Principales aplicaciones: Camionetas Ford con motor V8 6.0L a diesel
Principales equivalencias: Ford 3C3U-9601-BC, 3C3Z-9601-BA, 4C2Z-9601-AA, 4C3Z-9601-AA

GA-5648 FILTRO P/AIRE

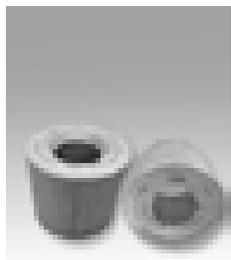

Código: 4046
Diámetro Ext.: (12 3/4 in) (12.75 in) (323.8 mm)
Diámetro Int.: (8 3/8 in) (8.375 in) (212.7 mm)
Altura entre tapas: (10 63/64 in) (10.984 in) (279.0 mm)
Altura Total: (11 31/64 in) (11.484 in) (291.7 mm)
Principales aplicaciones: Allis Chalmers, Caterpillar, Galion, Gardner-Denver, IHC, Michigan
Principales equivalencias: Allis Chalmers 7062071-7, Caterpillar 9M6379

GA-6127 FILTRO P/AIRE



Código: 4072
Diámetro Ext.: (8 15/32 in) (8.468 in) (215.1 mm)
Diámetro Int.: (6 11/64 in) (6.171 in) (156.7 mm)
Altura entre tapas: (17 41/64 in) (17.640 in) (448.0 mm)
Altura Total: (17 41/64 in) (17.640 in) (448.0 mm)
Principales aplicaciones: Allis Chalmers, Cummins, Euclid, Fiat-Allis, Ingersoll-Rand, Komatsu, Michigan, Nissan, Scania, Terex
Principales equivalencias: Allis Chalmers 197588-8, Cummins 3013207, Ingersoll-Rand 91634337
Observaciones: Filtro secundario, utilice GA-6129 como primario

GA-6128 FILTRO P/AIRE



Código: 4075
Diámetro Ext.: (12 3/32 in) (12.093 in) (307.1 mm)
Diámetro Int.: (7 23/32 in) (7.718 in) (196.0 mm)
Altura entre tapas: (18 in) (18.000 in) (457.2 mm)
Altura Total: (18 1/2 in) (18.5 in) (469.9 mm)
Principales aplicaciones: Equipo Komatsu
Principales equivalencias: Komatsu 6128-81-4400, 6128-81-7330
Observaciones: Filtro primario, utilice GA-6127 como secundario

GA-6129 FILTRO P/AIRE



Código: 4099
Diámetro Ext.: (12 3/32 in) (12.093 in) (307.1 mm)
Diámetro Int.: (7 23/32 in) (7.718 in) (196.0 mm)
Altura entre tapas: (18 in) (18.000 in) (457.2 mm)
Altura Total: (18 1/2 in) (18.5 in) (469.9 mm)
Principales aplicaciones: Allis Chalmers, Cummins, Euclid, Fiat-Allis, Ford, General Motors, Ingersoll-Rand, Komatsu, Michigan, Nissan, Scania, Terex
Principales equivalencias: Allis Chalmers 70659387, 3013206, Ingersoll-Rand 91634345
Observaciones: Filtro primario, utilice GA-6127 como secundario

GA-6880 FILTRO P/AIRE



Código: 4203
Diámetro Ext.: (12 3/4 in) (12.75 in) (323.8 mm)
Diámetro Int.: (8 3/8 in) (8.375 in) (212.7 mm)
Altura Total: (27 in) (27.000 in) (685.8 mm)
Principales aplicaciones: Tractocamiones IHC, Kenworth, Peterbilt
Principales equivalencias: IHC 422714-C92, Kenworth 21401091

GA-7360 FILTRO P/AIRE



Código: 4142
 Diámetro Ext.: (10 9/64 in) (10.140 in) (257.5 mm)
 Diámetro Int.: (6 1/32 in) (6.031 in) (153.1 mm)
 Altura entre tapas: (13 1/2 in) (13.5 in) (342.9 mm)
 Altura Total: (13 1/2 in) (13.5 in) (342.9 mm)
 Principales aplicaciones: Equipo Caterpillar, Hough
 Principales equivalencias: Caterpillar 4N6275, 7W7510
 Observaciones: Filtro secundario, utilice GA-7716 como primario

GA-9334 FILTRO P/AIRE



Código: 4049
 Diámetro Ext.: (11 3/32 in) (11.093 in) (281.7 mm)
 Diámetro Int.: (6 23/32 in) (6.718 in) (170.6 mm)
 Altura entre tapas: (13 in) (13.000 in) (330.2 mm)
 Altura Total: (13 1/2 in) (13.5 in) (342.9 mm)
 Principales aplicaciones: Equipo Caterpillar, Peterbilt
 Principales equivalencias: Caterpillar 1P7958, 9M1827
 Observaciones: Filtro primario, utilice GA-1286 como secundario

GA-7716 FILTRO P/AIRE



Código: 4058
 Diámetro Ext.: (11 1/2 in) (11.5 in) (292.1 mm)
 Diámetro Int.: (8 3/32 in) (8.093 in) (205.5 mm)
 Altura entre tapas: (13 in) (13.000 in) (330.2 mm)
 Altura Total: (13 1/2 in) (13.5 in) (342.9 mm)
 Principales aplicaciones: Equipo Caterpillar, Hough
 Principales equivalencias: Caterpillar 4N6274, 7W5495
 Observaciones: Filtro primario, utilice GA-7360 como secundario

GA-8047 FILTRO P/AIRE



Código: 4047
 Diámetro Ext.: (9 7/32 in) (9.218 in) (234.1 mm)
 Diámetro Int.: (4 27/32 in) (4.843 in) (123.0 mm)
 Altura entre tapas: (12 in) (12.000 in) (304.8 mm)
 Altura Total: (12 1/2 in) (12.5 in) (317.5 mm)
 Principales aplicaciones: Equipo Caterpillar
 Principales equivalencias: Caterpillar 3I0849, 8N5389
 Observaciones: Filtro primario, utilice GA-1285 como secundario

GA-8150 FILTRO P/AIRE



Código: 4550
 Diámetro Ext.: (6 19/32 in) (6.595 in) (167.5 mm)
 Diámetro Int.: (4 3/16 in) (4.187 in) (106.3 mm)
 Altura entre tapas: (15 17/64 in) (15.264 in) (387.7 mm)
 Altura Total: (15 41/64 in) (15.639 in) (397.2 mm)
 Diámetro Ext. Empaque: (5 57/64 in) (5.891 in) (149.6 mm)
 Diámetro Int. Empaque: (4 57/64 in) (4.891 in) (124.2 mm)
 Altura Empaque: (3/8 in) (0.375 in) (9.5 mm)
 Principales aplicaciones: Camiones Volkswagen Worker 8-150
 Principales equivalencias: Volkswagen 2RD 129 620, 2VC 129 619

GA-9045 FILTRO P/AIRE



Código: 4048
 Diámetro Ext.: (11 3/32 in) (11.093 in) (281.7 mm)
 Diámetro Int.: (6 23/32 in) (6.718 in) (170.6 mm)
 Altura entre tapas: (16 1/32 in) (16.031 in) (407.1 mm)
 Altura Total: (16 17/32 in) (16.531 in) (419.8 mm)
 Principales aplicaciones: Equipo Caterpillar
 Principales equivalencias: Caterpillar 1W3894, 9M5511
 Observaciones: Filtro primario, utilice GA-1287 como secundario

Filtros Para Gasolina

Filters for Gasoline

GG-1 FILTRO P/GASOLINA



Código: 7018
Diámetro Ext.: (1 9/64 in) (1.140 in) (28.9 mm)
Altura Total: (3 3/16 in) (3.187 in) (80.9 mm)
Entrada: (1/4 in) (0.25 in) (6.3 mm)
Salida: (1/4 in) (0.25 in) (6.3 mm)
Principales aplicaciones: Automóviles Volkswagen Sedan, Brasília, Safari hasta 1992
Principales equivalencias: Volkswagen ZVW262101

GG-6 FILTRO P/GASOLINA



Código: 7020
Diámetro Ext.: (47/64 in) (0.734 in) (18.6 mm)
Altura Total: (1 3/64 in) (1.046 in) (26.5 mm)
Principales aplicaciones: Chevrolet, Buick, Plymouth, Oldsmobile
Principales equivalencias: General Motors 5651393
Observaciones: Salida sin válvula check

GG-3 FILTRO P/GASOLINA

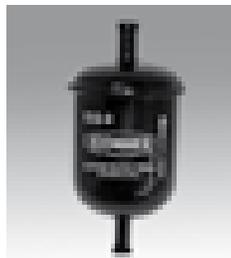

Código: 7028
Diámetro Ext.: (2 9/64 in) (2.140 in) (54.3 mm)
Altura Total: (4 5/32 in) (4.156 in) (105.5 mm)
Entrada: (3/8 in) (0.375 in) (9.5 mm)
Salida: (3/8 in) (0.375 in) (9.5 mm)
Principales aplicaciones: Ford Mustang V8 302
Principales equivalencias: Ford C2RZ9155B

GG-7 FILTRO P/GASOLINA

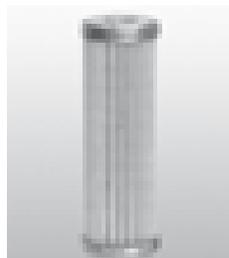

Código: 7022
Diámetro Ext.: (47/64 in) (0.734 in) (18.6 mm)
Altura Total: (2 1/16 in) (2.062 in) (52.3 mm)
Principales aplicaciones: Chevrolet, Buick, GMK, Oldsmobile, Pontiac
Principales equivalencias: General Motors 5651536
Observaciones: Salida sin válvula check

GG-4 FILTRO P/GASOLINA



Código: 7002
Diámetro Ext.: (2 5/32 in) (2.156 in) (54.7 mm)
Altura Total: (4 5/32 in) (4.156 in) (105.5 mm)
Entrada: (1/4 in) (0.25 in) (6.3 mm)
Salida: (1/4 in) (0.25 in) (6.3 mm)
Principales aplicaciones: Renault 1960-86, Volkswagen 1970-94
Principales equivalencias: Renault M7702030304

GG-8 FILTRO P/GASOLINA

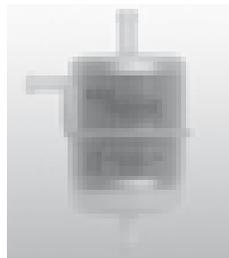

Código: 7026
Diámetro Ext.: (2 15/16 in) (2.937 in) (74.6 mm)
Altura Total: (6 5/32 in) (6.156 in) (156.3 mm)
Entrada: (5/16 in) (0.312 in) (7.9 mm)
Salida: (5/16 in) (0.312 in) (7.9 mm)
Retorno de vapores: (5/16 in) (0.312 in) (7.9 mm)
Principales aplicaciones: Automóviles y Camionetas Chrysler, Dodge y Plymouth
Principales equivalencias: Chrysler 4041540

GG-5 FILTRO P/GASOLINA



Código: 7003
Diámetro Ext.: (2 5/32 in) (2.156 in) (54.7 mm)
Altura Total: (4 25/32 in) (4.781 in) (121.4 mm)
Entrada: (3/8 in) (0.375 in) (9.5 mm)
Salida: (3/8 in) (0.375 in) (9.5 mm)
Principales aplicaciones: Universal para motores a gasolina (Adaptable)
Principales equivalencias: Chrysler 2465703, Fram G2

GG-8 L FILTRO P/GASOLINA



Código: 7031
Diámetro Ext.: (1 21/32 in) (1.656 in) (42.0 mm)
Altura Total: (4 1/64 in) (4.015 in) (101.9 mm)
Entrada: (5/16 in) (0.312 in) (7.9 mm)
Salida: (5/16 in) (0.312 in) (7.9 mm)
Retorno de vapores: (1/4 in) (0.25 in) (6.3 mm)
Principales aplicaciones: Automóviles y Camionetas Chrysler, Dodge y Plymouth
Principales equivalencias: Chrysler 4041540

GG-5 L FILTRO P/GASOLINA



Código: 7029
Diámetro Ext.: (1 29/32 in) (1.906 in) (48.4 mm)
Altura Total: (3 61/64 in) (3.953 in) (100.4 mm)
Entrada: (5/16 in) (0.312 in) (7.9 mm)
Salida: (5/16 in) (0.312 in) (7.9 mm)
Principales aplicaciones: Universal para motores a gasolina (Adaptable)
Principales equivalencias: Chrysler 2465703, Fram G15

GG-16 FILTRO P/GASOLINA



Código: 7048
Diámetro Ext.: (47/64 in) (0.734 in) (18.6 mm)
Altura Total: (1 3/64 in) (1.046 in) (26.5 mm)
Principales aplicaciones: Chevrolet, Buick, AMC, GMC, Dodge
Principales equivalencias: General Motors 5651802
Observaciones: Con válvula Check

GG-17 FILTRO P/GASOLINA



Código: 7049
Diámetro Ext.: (47/64 in) (0.734 in) (18.6 mm)
Altura Total: (2 1/16 in) (2.062 in) (52.3 mm)
Principales aplicaciones: AMC, Buick, Chevrolet, Pontiac, Oldsmobile
Principales equivalencias: General Motors 5651803
Observaciones: Con válvula Check

GG-29 FILTRO P/GASOLINA



Código: 7050
Diámetro Ext.: (1 1/2 in) (1.5 in) (38.1 mm)
Altura Total: (3 19/64 in) (3.296 in) (83.7 mm)
Entrada: 1/2-20
Salida: 1/2-20
Principales aplicaciones: Automóviles Ford (1985-93)
Principales equivalencias: Motorcraft FG77U

GG-19 FILTRO P/GASOLINA



Código: 7085
Diámetro Ext.: (31/32 in) (0.968 in) (24.6 mm)
Altura Total: (2 25/32 in) (2.781 in) (70.6 mm)
Entrada: (5/16 in) (0.312 in) (7.9 mm)
Salida: 1/8-27 NPT
Principales aplicaciones: Automóviles y Camionetas Ford, Lincoln y Mercury (1968-78)
Principales equivalencias: Ford CSUZ-9155A

GG-30 FILTRO P/GASOLINA



Código: 7056
Diámetro Ext.: (2 17/64 in) (2.265 in) (57.5 mm)
Altura Total: (5 55/64 in) (5.859 in) (148.8 mm)
Entrada: (5/16 in) (0.312 in) (7.9 mm)
Salida: (5/16 in) (0.312 in) (7.9 mm)
Principales aplicaciones: Automóviles Ford (1989-2001)
Principales equivalencias: Ford E9SE-9155AA, Motorcraft FG862

GG-20 FILTRO P/GASOLINA

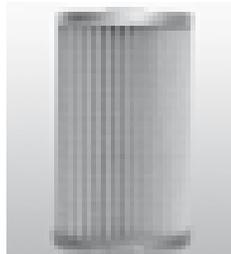

Código: 7006
Diámetro Ext.: (2 5/64 in) (2.078 in) (52.7 mm)
Altura Total: (3 33/64 in) (3.515 in) (89.2 mm)
Entrada: (7/16 in) (0.437 in) (11.1 mm)
Principales aplicaciones: Automóviles y Camionetas Cadillac, Dodge, Ford. Equipo pesado Caterpillar, Case, Fairbanks, Hyster, IHC, Minneapolis, Navistar, New Holland
Principales equivalencias: Ford C5AZ-9365-A, Caterpillar 9Y4405

GG-32 FILTRO P/GASOLINA



Código: 7055
Diámetro Ext.: (1 31/32 in) (1.968 in) (50.0 mm)
Altura Total: (3 13/64 in) (3.203 in) (81.3 mm)
Entrada: 1/2-20
Salida: 1/2-20
Retorno de vapores: 7/16-24
Principales aplicaciones: Camionetas Ford (1989-92)
Principales equivalencias: Ford 89TY-9155AA, Motorcraft MFG66

GG-25 FILTRO P/GASOLINA



Código: 7054
Diámetro Ext.: (2 in) (2.000 in) (50.8 mm)
Altura Total: (3 3/16 in) (3.187 in) (80.9 mm)
Entrada: 1/2-20
Salida: 1/2-20
Principales aplicaciones: Automóviles y Camionetas Ford (1986-90)
Principales equivalencias: Motorcraft MFG89

GG-39 FILTRO P/GASOLINA



Código: 7051
Diámetro Ext.: (2 3/4 in) (2.75 in) (69.8 mm)
Altura Total: (5 1/32 in) (5.031 in) (127.7 mm)
Entrada: (9/32 in) (0.281 in) (7.1 mm)
Salida: (9/32 in) (0.281 in) (7.1 mm)
Principales aplicaciones: Automóviles Nissan
Principales equivalencias: Nissan 16400-59A00

GGP-25 FILTRO P/GASOLINA



Código: 2542
Rosca: 1-12
Diámetro Ext.: (3 5/8 in) (3.625 in) (92.0 mm)
Altura Total: (5 23/64 in) (5.359 in) (136.1 mm)
Principales aplicaciones: Bombas despachadoras de gasolina con sistema para filtro Wyne
Principales equivalencias: Donaldson P550115, Fleetguard FF5012

GG-41 FILTRO P/GASOLINA



Código: 7047
Diámetro Ext.: (2 3/16 in) (2.187 in) (55.5 mm)
Altura Total: (17 7/16 in) (17.437 in) (442.9 mm)
Entrada: (3/8 in) (0.375 in) (9.5 mm)
Salida: (3/8 in) (0.375 in) (9.5 mm)
Principales aplicaciones: Automóviles Chevrolet
Principales equivalencias: Interfil FGI-30

GG-42 FILTRO P/GASOLINA



Código: 7046
Diámetro Ext.: (1 3/8 in) (1.375 in) (34.9 mm)
Altura Total: (2 15/16 in) (2.937 in) (74.6 mm)
Entrada: 1/2-20
Salida: 1/2-20
Retorno de vapores: 7/16-24
Principales aplicaciones: Automóviles Ford (1983-92)
Principales equivalencias: Ford E43Z-9155C, Motorcraft FG840A

GG-50 FILTRO P/GASOLINA



Código: 7030
Diámetro Ext.: (1 9/32 in) (1.281 in) (32.5 mm)
Diámetro Int.: (1/4 in) (0.25 in) (6.3 mm)
Altura Total: (2 3/32 in) (2.093 in) (53.1 mm)
Principales aplicaciones: Rambler, Jeep, Wagoneer, Javelin (1970-86)
Principales equivalencias: Interfil FGI-125

GG-45 FILTRO P/GASOLINA



Código: 7027
Diámetro Ext.: (1 49/64 in) (1.765 in) (44.8 mm)
Altura Total: (3 1/4 in) (3.25 in) (82.5 mm)
Entrada: (9/32 in) (0.281 in) (7.1 mm)
Salida: (9/32 in) (0.281 in) (7.1 mm)
Principales aplicaciones: Automóviles y Camionetas Nissan
Principales equivalencias: Nissan 16400-H8594, 16400-W1110

GG-61 FILTRO P/GASOLINA



Código: 7045
Diámetro Ext.: (2 11/64 in) (2.171 in) (55.1 mm)
Altura Total: (3 53/64 in) (3.828 in) (97.2 mm)
Entrada: (5/16 in) (0.312 in) (7.9 mm)
Salida: (5/16 in) (0.312 in) (7.9 mm)
Principales aplicaciones: Automóviles Chrysler, Dodge (1987-93)
Principales equivalencias: Chrysler 4443461

GG-46 FILTRO P/GASOLINA



Código: 7044
Diámetro Ext.: (2 11/64 in) (2.171 in) (55.1 mm)
Altura Total: (4 5/16 in) (4.312 in) (109.5 mm)
Entrada: M16X1.5
Salida: M16X1.5
Principales aplicaciones: Automóviles y Camionetas Chevrolet
Principales equivalencias: General Motors 25055480

GG-62 FILTRO P/GASOLINA

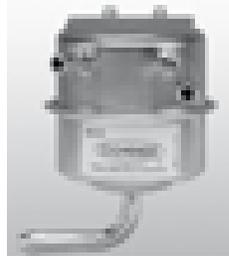

Código: 7052
Diámetro Ext.: (2 3/4 in) (2.75 in) (69.8 mm)
Altura Total: (3 35/64 in) (3.546 in) (90.0 mm)
Entrada: (5/16 in) (0.312 in) (7.9 mm)
Salida: (5/16 in) (0.312 in) (7.9 mm)
Retorno de vapores: (5/16 in) (0.312 in) (7.9 mm)
Principales aplicaciones: Chrysler Spirit (1990-92)
Principales equivalencias: Chrysler 4306285

GG-47 FILTRO P/GASOLINA



Código: 7053
Diámetro Ext.: (3 9/64 in) (3.140 in) (79.7 mm)
Altura Total: (5 47/64 in) (5.734 in) (145.6 mm)
Entrada: (5/16 in) (0.312 in) (7.9 mm)
Salida: (5/16 in) (0.312 in) (7.9 mm)
Principales aplicaciones: Automóviles y Camionetas Ford
Principales equivalencias: Ford E7DZ9155A

GG-63 FILTRO P/GASOLINA



Código: 7063
Diámetro Ext.: (2 23/32 in) (2.718 in) (69.0 mm)
Altura Total: (4 47/64 in) (4.734 in) (120.2 mm)
Entrada: (5/16 in) (0.312 in) (7.9 mm)
Salida: (5/16 in) (0.312 in) (7.9 mm)
Principales aplicaciones: Automóviles y Camionetas Nissan
Principales equivalencias: Nissan 16400-F5100

GG-48 FILTRO P/GASOLINA



Código: 7007
Diámetro Ext.: (2 9/32 in) (2.281 in) (57.9 mm)
Diámetro Int.: (55/64 in) (0.859 in) (21.8 mm)
Altura Total: (1 41/64 in) (1.640 in) (41.6 mm)
Principales aplicaciones: JCB (J.C. Bamford), Motores Lister
Principales equivalencias: JCB S1246, Lister 201-13118

GG-64 FILTRO P/GASOLINA



Código: 7072
Diámetro Ext.: (2 11/64 in) (2.171 in) (55.1 mm)
Altura Total: (6 3/8 in) (6.375 in) (161.9 mm)
Entrada: (5/16 in) (0.312 in) (7.9 mm)
Salida: (5/16 in) (0.312 in) (7.9 mm)
Principales aplicaciones: Automóviles y Camionetas Chevrolet
Principales equivalencias: General Motors 25121074

GG-65 FILTRO P/GASOLINA



Código: 7067
Diámetro Ext.: (2 11/64 in) (2.171 in) (55.1 mm)
Altura Total: (5 15/32 in) (5.468 in) (138.9 mm)
Entrada: (5/16 in) (0.312 in) (7.9 mm)
Salida: (5/16 in) (0.312 in) (7.9 mm)
Principales aplicaciones: Camionetas Chrysler, Dodge
Principales equivalencias: Chrysler 4418090

GG-79 FILTRO P/GASOLINA

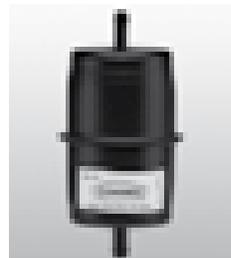

Código: 7070
Diámetro Ext.: (2 15/16 in) (2.937 in) (74.6 mm)
Altura Total: (6 in) (6.000 in) (152.4 mm)
Entrada: (5/16 in) (0.312 in) (7.9 mm)
Salida: (5/16 in) (0.312 in) (7.9 mm)
Principales aplicaciones: Camionetas Chrysler, Dodge y Jeep
Principales equivalencias: Chrysler 33000076

GG-66 FILTRO P/GASOLINA



Código: 7064
Diámetro Ext.: (2 11/64 in) (2.171 in) (55.1 mm)
Altura Total: (5 21/64 in) (5.328 in) (135.3 mm)
Entrada: (3/8 in) (0.375 in) (9.5 mm)
Salida: M16X1.5
Principales aplicaciones: Automóviles y Camionetas Chevrolet, Cadillac, Pontiac, Buick
Principales equivalencias: General Motors 25121293

GG-82 FILTRO P/GASOLINA



Código: 7105
Diámetro Ext.: (3 5/32 in) (3.156 in) (80.1 mm)
Altura Total: (5 31/64 in) (5.484 in) (139.3 mm)
Entrada: (5/16 in) (0.312 in) (7.9 mm)
Salida: (5/16 in) (0.312 in) (7.9 mm)
Principales aplicaciones: Automóviles Ford Fiesta (1998-01)
Principales equivalencias: Interfil FGI-132, Motorcraft MEF6G

GG-67 FILTRO P/GASOLINA

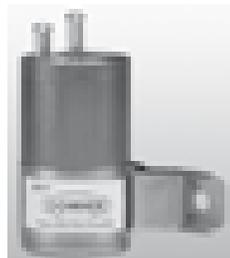

Código: 7068
Diámetro Ext.: (2 11/64 in) (2.171 in) (55.1 mm)
Altura Total: (3 49/64 in) (3.765 in) (95.6 mm)
Entrada: (5/16 in) (0.312 in) (7.9 mm)
Salida: (5/16 in) (0.312 in) (7.9 mm)
Principales aplicaciones: Camionetas Chrysler, Dodge
Principales equivalencias: Chrysler 4443452, 4443453, 4443454

GG-84 FILTRO P/GASOLINA



Código: 7075
Diámetro Ext.: (2 11/64 in) (2.171 in) (55.1 mm)
Altura Total: (6 23/64 in) (6.359 in) (161.5 mm)
Entrada: (3/8 in) (0.375 in) (9.5 mm)
Salida: (5/16 in) (0.312 in) (7.9 mm)
Principales aplicaciones: Automóviles Chrysler
Principales equivalencias: Interfil FGI-38A, Fram G7416

GG-72 FILTRO P/GASOLINA



Código: 7069
Diámetro Ext.: (2 11/64 in) (2.171 in) (55.1 mm)
Altura Total: (5 49/64 in) (5.765 in) (146.4 mm)
Entrada: (5/16 in) (0.312 in) (7.9 mm)
Salida: (5/16 in) (0.312 in) (7.9 mm)
Principales aplicaciones: Camionetas Chrysler, Dodge
Principales equivalencias: Chrysler 4637101

GG-87 FILTRO P/GASOLINA



Código: 7191
Diámetro Ext.: (1 7/64 in) (1.109 in) (28.1 mm)
Altura Total: (1 15/16 in) (1.937 in) (49.2 mm)
Entrada: 1/2-20
Salida: 1/8-27 NPT
Principales aplicaciones: Automóviles y Camionetas Ford (1982-86)
Principales equivalencias: Ford E02Z-9155A

GG-76 FILTRO P/GASOLINA



Código: 7186
Diámetro Ext.: (3 27/64 in) (3.421 in) (86.9 mm)
Altura Total: (2 5/64 in) (2.078 in) (52.7 mm)
Entrada: (1/4 in) (0.25 in) (6.3 mm)
Salida: (1/4 in) (0.25 in) (6.3 mm)
Principales aplicaciones: Automóviles y Camionetas Toyota
Principales equivalencias: Toyota 23300-24020, 23300-25050

GG-92 FILTRO P/GASOLINA



Código: 7065
Diámetro Ext.: (2 17/64 in) (2.265 in) (57.5 mm)
Altura Total: (6 29/64 in) (6.453 in) (163.9 mm)
Entrada: (5/16 in) (0.312 in) (7.9 mm)
Salida: (3/8 in) (0.375 in) (9.5 mm)
Principales aplicaciones: Automóviles Ford, Lincoln
Principales equivalencias: Ford F15E-9155AA

GG-94 FILTRO P/GASOLINA

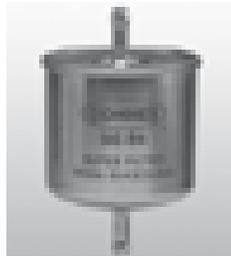

Código: 7066
Diámetro Ext.: (3 5/32 in) (3.156 in) (80.1 mm)
Altura Total: (5 3/8 in) (5.375 in) (136.5 mm)
Entrada: (5/16 in) (0.312 in) (7.9 mm)
Salida: (5/16 in) (0.312 in) (7.9 mm)
Principales aplicaciones: Automóviles y Camionetas Nissan
Principales equivalencias: Nissan 16400-N9600

GG-101 FILTRO P/GASOLINA

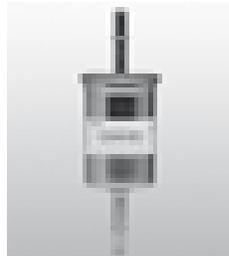

Código: 7269
Diámetro Ext.: (2 17/64 in) (2.265 in) (57.5 mm)
Altura Total: (6 63/64 in) (6.984 in) (177.4 mm)
Entrada: (3/8 in) (0.375 in) (9.5 mm)
Salida: (3/8 in) (0.375 in) (9.5 mm)
Principales aplicaciones: Automóviles y Camionetas Ford, Lincoln
Principales equivalencias: Ford 2C5Z9155A

GG-95 FILTRO P/GASOLINA



Código: 7073
Diámetro Ext.: (2 11/64 in) (2.171 in) (55.1 mm)
Altura Total: (8 13/64 in) (8.203 in) (208.3 mm)
Entrada: (3/8 in) (0.375 in) (9.5 mm)
Salida: (5/16 in) (0.312 in) (7.9 mm)
Retorno de vapores: (5/16 in) (0.312 in) (7.9 mm)
Principales aplicaciones: Dodge Neon (1994-98)
Principales equivalencias: Chrysler 4495950

GG-102 FILTRO P/GASOLINA



Código: 7106
Diámetro Ext.: (3 5/64 in) (3.078 in) (78.1 mm)
Altura Total: (6 15/16 in) (6.937 in) (176.2 mm)
Entrada: (5/16 in) (0.312 in) (7.9 mm)
Salida: (5/16 in) (0.312 in) (7.9 mm)
Principales aplicaciones: Automóviles Audi, Seat, Volkswagen
Principales equivalencias: Volkswagen 1J201511A

GG-97 FILTRO P/GASOLINA



Código: 7271
Diámetro Ext.: (2 7/64 in) (2.109 in) (53.5 mm)
Altura Total: (3 1/2 in) (3.5 in) (88.9 mm)
Entrada: (3/8 in) (0.375 in) (9.5 mm)
Salida: (5/16 in) (0.312 in) (7.9 mm)
Retorno de vapores: (5/16 in) (0.312 in) (7.9 mm)
Principales aplicaciones: Camionetas Jeep Liberty
Principales equivalencias: Chrysler 52100-402-AE

GG-104 FILTRO P/GASOLINA



Código: 7100
Diámetro Ext.: (2 11/64 in) (2.171 in) (55.1 mm)
Altura Total: (5 13/64 in) (5.203 in) (132.1 mm)
Entrada: (3/8 in) (0.375 in) (9.5 mm)
Salida: (5/16 in) (0.312 in) (7.9 mm)
Principales aplicaciones: Automóviles Chrysler, Dodge
Principales equivalencias: Chrysler 4695049

GG-98 FILTRO P/GASOLINA



Código: 7187
Diámetro Ext.: (2 33/64 in) (2.515 in) (63.8 mm)
Altura Total: (4 41/64 in) (4.640 in) (117.8 mm)
Entrada: (1/4 in) (0.25 in) (6.3 mm)
Salida: (1/4 in) (0.25 in) (6.3 mm)
Principales aplicaciones: Automóviles Nissan
Principales equivalencias: Interfil FGI-29, Fram G4894

GG-106 FILTRO P/GASOLINA



Código: 7161
Diámetro Ext.: (2 11/64 in) (2.171 in) (55.1 mm)
Altura Total: (6 5/32 in) (6.156 in) (156.3 mm)
Entrada: (5/16 in) (0.312 in) (7.9 mm)
Salida: (5/16 in) (0.312 in) (7.9 mm)
Principales aplicaciones: Automóviles Volkswagen Derby (1999-2005)
Principales equivalencias: Volkswagen 6X0201511B

GG-99 FILTRO P/GASOLINA

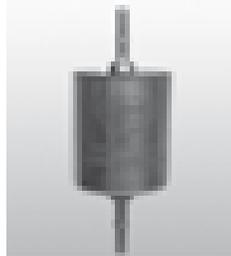

Código: 7078
Diámetro Ext.: (2 5/8 in) (2.625 in) (66.6 mm)
Altura Total: (6 15/16 in) (6.937 in) (176.2 mm)
Entrada: (3/8 in) (0.375 in) (9.5 mm)
Salida: (5/16 in) (0.312 in) (7.9 mm)
Principales aplicaciones: Camionetas Jeep
Principales equivalencias: Chrysler 33003007

GG-111 FILTRO P/GASOLINA



Código: 7201
Diámetro Ext.: (5 1/64 in) (5.015 in) (127.3 mm)
Altura Total: (1 3/4 in) (1.75 in) (44.4 mm)
Principales aplicaciones: Camionetas Chrysler, Dodge
Principales equivalencias: Chrysler 4864307

GG-114 FILTRO P/GASOLINA



Código: 7259
Diámetro Ext.: (2 25/32 in) (2.781 in) (70.6 mm)
Altura Total: (4 35/64 in) (4.546 in) (115.4 mm)
Entrada: M14X1.5
Salida: M12X1.25
Principales aplicaciones: Automóviles Hyundai
Principales equivalencias: Hyundai 31911-22000

GG-124 FILTRO P/GASOLINA



Código: 7210
Diámetro Ext.: (2 19/32 in) (2.593 in) (65.8 mm)
Altura Total: (3 59/64 in) (3.921 in) (99.6 mm)
Entrada: (5/16 in) (0.312 in) (7.9 mm)
Salida: (5/16 in) (0.312 in) (7.9 mm)
Principales aplicaciones: Universal para Automóviles y Camionetas carburados
Principales equivalencias: Interfil FGI-148

GG-115 FILTRO P/GASOLINA



Código: 7206
Diámetro Ext.: (2 51/64 in) (2.796 in) (71.0 mm)
Altura Total: (5 11/16 in) (5.687 in) (144.4 mm)
Entrada: (5/16 in) (0.312 in) (7.9 mm)
Salida: (5/16 in) (0.312 in) (7.9 mm)
Retorno de vapores: (5/16 in) (0.312 in) (7.9 mm)
Principales aplicaciones: Automóviles Mazda
Principales equivalencias: Mazda G607-20-490A, G607-20-490B

GGP-125 FILTRO P/GASOLINA



Código: 2954
Rosca: 1 1/2-16
Diámetro Ext.: (3 3/4 in) (3.75 in) (95.2 mm)
Altura Total: (5 9/16 in) (5.562 in) (141.2 mm)
Principales aplicaciones: Bombas despachadoras de gasolina con sistema para filtro Gilbarco
Principales equivalencias: Gilbarco R18189-10, Baldwin BF7645, Wix 24029

GG-116 FILTRO P/GASOLINA



Código: 7208
Diámetro Ext.: (1 39/64 in) (1.609 in) (40.8 mm)
Altura Total: (4 1/2 in) (4.5 in) (114.3 mm)
Entrada: (1/4 in) (0.25 in) (6.3 mm)
Salida: (1/4 in) (0.25 in) (6.3 mm)
Principales aplicaciones: Universal para Automóviles y Camionetas carburados (1960-92)
Principales equivalencias: Fram G4164, Interfil FGI-146

GG-126 FILTRO P/GASOLINA



Código: 7211
Diámetro Ext.: (2 13/64 in) (2.203 in) (55.9 mm)
Altura Total: (4 11/16 in) (4.687 in) (119.0 mm)
Entrada: (1/4 in) (0.25 in) (6.3 mm)
Salida: (1/4 in) (0.25 in) (6.3 mm)
Observaciones: Universal para automóviles y camionetas carburados
Principales aplicaciones: Universal para Automóviles y Camionetas carburados
Principales equivalencias: Interfil FGI-149

GG-117 FILTRO P/GASOLINA



Código: 7209
Diámetro Ext.: (1 57/64 in) (1.890 in) (48.0 mm)
Altura Total: (4 5/8 in) (4.625 in) (117.4 mm)
Entrada: (1/4 in) (0.25 in) (6.3 mm)
Salida: (1/4 in) (0.25 in) (6.3 mm)
Observaciones: Universal para automóviles y camionetas carburados
Principales aplicaciones: Universal para Automóviles y Camionetas carburados
Principales equivalencias: Interfil FGI-147

GG-131 FILTRO P/GASOLINA



Código: 7212
Diámetro Ext.: (2 1/8 in) (2.125 in) (53.9 mm)
Altura Total: (4 3/64 in) (4.046 in) (102.7 mm)
Entrada: (5/16 in) (0.312 in) (7.9 mm)
Salida: (5/16 in) (0.312 in) (7.9 mm)
Observaciones: universal para automóviles y camionetas carburados
Principales aplicaciones: Universal para Automóviles y Camionetas carburados
Principales equivalencias: Interfil FGI-150

GG-123 FILTRO P/GASOLINA



Código: 7205
Diámetro Ext.: (45/64 in) (0.703 in) (17.8 mm)
Altura Total: (51/64 in) (0.796 in) (20.2 mm)
Principales aplicaciones: Automóviles y Camionetas Chevrolet, Ford (1965-1981)
Principales equivalencias: Ford D9PZ-9155-A, General Motors 7013404

GG-136 FILTRO P/GASOLINA



Código: 7218
Diámetro Ext.: (2 25/32 in) (2.781 in) (70.6 mm)
Altura Total: (5 9/64 in) (5.140 in) (130.5 mm)
Entrada: (5/16 in) (0.312 in) (7.9 mm)
Salida: (5/16 in) (0.312 in) (7.9 mm)
Principales aplicaciones: Automóviles Mazda
Principales equivalencias: Mazda JE48-20-490, JE49-20-490

GG-137 FILTRO P/GASOLINA



Código: 7077
Diámetro Ext.: (2 9/32 in) (2.281 in) (57.9 mm)
Altura Total: (5 5/64 in) (5.078 in) (128.9 mm)
Entrada: (5/16 in) (0.312 in) (7.9 mm)
Salida: (5/16 in) (0.312 in) (7.9 mm)
Principales aplicaciones: Automóviles y Camionetas Nissan
Principales equivalencias: Nissan 16400-9E000, 16400-72L00

GG-151 FILTRO P/GASOLINA



Código: 7076
Diámetro Ext.: (5 1/8 in) (5.125 in) (130.1 mm)
Altura Total: (2 25/32 in) (2.781 in) (70.6 mm)
Entrada: M12X1.25
Salida: M12X1.25
Principales aplicaciones: Automóviles y Camionetas Chevrolet, Geo
Principales equivalencias: General Motors 25121587

GG-142 FILTRO P/GASOLINA



Código: 7214
Diámetro Ext.: (2 25/32 in) (2.781 in) (70.6 mm)
Altura Total: (6 49/64 in) (6.765 in) (171.8 mm)
Entrada: (5/16 in) (0.312 in) (7.9 mm)
Salida: (5/16 in) (0.312 in) (7.9 mm)
Principales aplicaciones: Automóviles Mazda
Principales equivalencias: Mazda F201-20-490A

GG-160 FILTRO P/GASOLINA



Código: 7114
Diámetro Ext.: (2 25/64 in) (2.390 in) (60.7 mm)
Altura Total: (4 19/64 in) (4.296 in) (109.1 mm)
Entrada: M14X1.5
Salida: M12X1.5
Principales aplicaciones: Automóviles y Camionetas Honda
Principales equivalencias: Honda 16010-S01-A32, 16010-ST5-933

GG-146 FILTRO P/GASOLINA



Código: 7215
Diámetro Ext.: (3 25/64 in) (3.390 in) (86.1 mm)
Altura Total: (3 61/64 in) (3.953 in) (100.4 mm)
Entrada: (5/16 in) (0.312 in) (7.9 mm)
Salida: (5/16 in) (0.312 in) (7.9 mm)
Principales aplicaciones: Automóviles Chevrolet, Geo, Pontiac, Suzuki
Principales equivalencias: General Motors 96064225, Suzuki 15430-50G00

GG-161 FILTRO P/GASOLINA



Código: 7163
Altura Total: (6 53/64 in) (6.828 in) (173.4 mm)
Entrada: (3/8 in) (0.375 in) (9.5 mm)
Salida: (5/16 in) (0.312 in) (7.9 mm)
Principales aplicaciones: Automóviles Honda
Principales equivalencias: Honda 16900-584-G01, Interfil FGI-186A

GG-148 FILTRO P/GASOLINA



Código: 7216
Diámetro Ext.: (2 25/32 in) (2.781 in) (70.6 mm)
Altura Total: (5 5/16 in) (5.312 in) (134.9 mm)
Entrada: (5/16 in) (0.312 in) (7.9 mm)
Salida: (5/16 in) (0.312 in) (7.9 mm)
Principales aplicaciones: Automóviles Mazda
Principales equivalencias: Mazda JE01-20-490A

GG-164 FILTRO P/GASOLINA

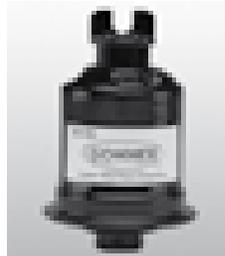

Código: 7213
Diámetro Ext.: (2 17/32 in) (2.531 in) (64.2 mm)
Altura Total: (3 27/32 in) (3.843 in) (97.6 mm)
Entrada: M14X1.5
Salida: M12X1.25
Principales aplicaciones: Camionetas Toyota RAV4
Principales equivalencias: Toyota 2330-79495

GG-150 FILTRO P/GASOLINA



Código: 7217
Diámetro Ext.: (2 25/32 in) (2.781 in) (70.6 mm)
Altura Total: (6 25/64 in) (6.390 in) (162.3 mm)
Entrada: (5/16 in) (0.312 in) (7.9 mm)
Salida: (5/16 in) (0.312 in) (7.9 mm)
Principales aplicaciones: Automóviles Mazda
Principales equivalencias: Mazda B6BF-20-490A, BP01-20-490A

GG-167 FILTRO P/GASOLINA



Código: 7219
Diámetro Ext.: (2 11/64 in) (2.171 in) (55.1 mm)
Altura Total: (5 57/64 in) (5.890 in) (149.6 mm)
Entrada: (5/16 in) (0.312 in) (7.9 mm)
Salida: (5/16 in) (0.312 in) (7.9 mm)
Principales aplicaciones: Camionetas Chevrolet
Principales equivalencias: Interfil FGI-165, Walmi WG-7143

GG-169 FILTRO P/GASOLINA



Código: 7195
Diámetro Ext.: (2 47/64 in) (2.734 in) (69.4 mm)
Altura Total: (4 13/16 in) (4.812 in) (122.2 mm)
Entrada: M14X1.5
Salida: M14X1.5
Principales aplicaciones: Automóviles Hyundai, Dodge Atos (1999-2004)
Principales equivalencias: Hyundai 31911-02100

GG-184 FILTRO P/GASOLINA



Código: 7260
Diámetro Ext.: (3 25/64 in) (3.390 in) (86.1 mm)
Altura Total: (3 13/16 in) (3.812 in) (96.8 mm)
Entrada: M14X1.5
Salida: M12X1.25
Principales aplicaciones: Automóviles Honda
Principales equivalencias: Honda 16010-SM4-931

GG-170 FILTRO P/GASOLINA



Código: 7119
Diámetro Ext.: (1 3/4 in) (1.75 in) (44.4 mm)
Altura Total: (4 13/32 in) (4.406 in) (111.9 mm)
Entrada: 3/8 flare
Salida: 1/4 NPT
Observaciones: universal para autos, camionetas y motores, incluyendo Perkins con sistema de gas LP
Principales aplicaciones: Universal para Automóviles, Camionetas y Motores con sistema de Gas LP, Incluyendo Perkins con sistema de Gas LP
Principales equivalencias: FGI-08

GG-185 FILTRO P/GASOLINA



Código: 7221
Diámetro Ext.: (2 3/4 in) (2.75 in) (69.8 mm)
Altura Total: (4 19/32 in) (4.593 in) (116.6 mm)
Entrada: M12X1.25
Salida: M14X1.5
Principales aplicaciones: Automóviles Toyota
Principales equivalencias: Toyota 23300-29045

GG-177 FILTRO P/GASOLINA

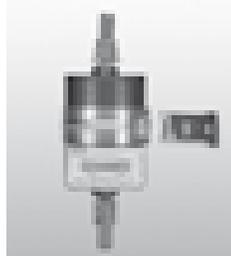

Código: 7220
Diámetro Ext.: (2 11/64 in) (2.171 in) (55.1 mm)
Altura Total: (6 7/16 in) (6.437 in) (163.5 mm)
Entrada: (3/8 in) (0.375 in) (9.5 mm)
Salida: (3/8 in) (0.375 in) (9.5 mm)
Principales aplicaciones: Automóviles y Camionetas Chevrolet
Principales equivalencias: General motors 10093250

GG-187 FILTRO P/GASOLINA



Código: 7261
Diámetro Ext.: (2 25/32 in) (2.781 in) (70.6 mm)
Altura Total: (4 1/8 in) (4.125 in) (104.7 mm)
Entrada: M14X1.5
Salida: M14X1.5
Principales aplicaciones: Automóviles y Camionetas Toyota
Principales equivalencias: Toyota 23300-65010

GG-181 FILTRO P/GASOLINA



Código: 7188
Diámetro Ext.: (3 13/32 in) (3.406 in) (86.5 mm)
Altura Total: (3 59/64 in) (3.921 in) (99.6 mm)
Entrada: M12X1.25
Salida: M12X1.25
Principales aplicaciones: Automóviles Honda Accord
Principales equivalencias: Honda 16900-SF1-A32

GG-188 FILTRO P/GASOLINA



Código: 7222
Diámetro Ext.: (2 9/32 in) (2.281 in) (57.9 mm)
Altura Total: (2 23/64 in) (2.359 in) (59.9 mm)
Entrada: (1/4 in) (0.25 in) (6.3 mm)
Salida: (1/4 in) (0.25 in) (6.3 mm)
Principales aplicaciones: Automóviles Subaru (1980-81)
Principales equivalencias: Subaru 7420-23000

GG-182 FILTRO P/GASOLINA



Código: 7283
Diámetro Ext.: (2 9/16 in) (2.562 in) (65.0 mm)
Altura Total: (4 51/64 in) (4.796 in) (121.8 mm)
Entrada: (5/16 in) (0.312 in) (7.9 mm)
Salida: (5/16 in) (0.312 in) (7.9 mm)
Principales aplicaciones: Automóviles Hyundai, Dodge Verna (2000-05)
Principales equivalencias: Hyundai 31911-25000

GG-189 FILTRO P/GASOLINA



Código: 7223
Diámetro Ext.: (3 13/64 in) (3.203 in) (81.3 mm)
Altura Total: (5 23/32 in) (5.718 in) (145.2 mm)
Entrada: M12X1.25
Salida: M14X1.5
Principales aplicaciones: Automóviles Mercedes Benz
Principales equivalencias: Mercedes Benz 001-477-8901

GG-190 FILTRO P/GASOLINA



Código: 7224
Diámetro Ext.: (3 23/64 in) (3.359 in) (85.3 mm)
Altura Total: (3 39/64 in) (3.609 in) (91.6 mm)
Entrada: M12X1.25
Salida: M12X1.25
Principales aplicaciones: Automóviles Honda
Principales equivalencias: Honda 16900-SH3-A30

GG-202 FILTRO P/GASOLINA



Código: 7227
Diámetro Ext.: (2 1/4 in) (2.25 in) (57.1 mm)
Altura Total: (2 19/64 in) (2.296 in) (58.3 mm)
Entrada: (1/4 in) (0.25 in) (6.3 mm)
Salida: (1/4 in) (0.25 in) (6.3 mm)
Principales aplicaciones: Automóviles Subaru (1982-89)
Principales equivalencias: Subaru 74202-3020

GG-194 FILTRO P/GASOLINA



Código: 7189
Diámetro Ext.: (1 61/64 in) (1.953 in) (49.6 mm)
Altura Total: (2 33/64 in) (2.515 in) (63.8 mm)
Entrada: (1/4 in) (0.25 in) (6.3 mm)
Salida: (1/4 in) (0.25 in) (6.3 mm)
Principales aplicaciones: Camionetas Nissan (1981-84)
Principales equivalencias: Nissan 16400-06W00

GG-203 FILTRO P/GASOLINA



Código: 7228
Diámetro Ext.: (2 1/4 in) (2.25 in) (57.1 mm)
Altura Total: (2 19/64 in) (2.296 in) (58.3 mm)
Entrada: (1/4 in) (0.25 in) (6.3 mm)
Salida: (1/4 in) (0.25 in) (6.3 mm)
Principales aplicaciones: Automóviles Subaru (1987-92)
Principales equivalencias: Subaru 74207-2170, 74202-3010

GG-195 FILTRO P/GASOLINA



Código: 7102
Diámetro Ext.: (2 7/32 in) (2.218 in) (56.3 mm)
Altura Total: (7 9/16 in) (7.562 in) (192.0 mm)
Entrada: (3/8 in) (0.375 in) (9.5 mm)
Salida: (5/16 in) (0.312 in) (7.9 mm)
Principales aplicaciones: Automóviles Dodge Neon (198-99)
Principales equivalencias: Chrysler 5278097AB

GG-204 FILTRO P/GASOLINA



Código: 7229
Diámetro Ext.: (2 7/32 in) (2.218 in) (56.3 mm)
Altura Total: (2 19/64 in) (2.296 in) (58.3 mm)
Entrada: (1/4 in) (0.25 in) (6.3 mm)
Salida: (1/4 in) (0.25 in) (6.3 mm)
Principales aplicaciones: Automóviles Chevrolet, Toyota (1982-89)
Principales equivalencias: General Motors 25055188, Toyota 23300-15010

GG-196 FILTRO P/GASOLINA



Código: 7225
Diámetro Ext.: (1 49/64 in) (1.765 in) (44.8 mm)
Altura Total: (3 35/64 in) (3.546 in) (90.0 mm)
Entrada: (1/4 in) (0.25 in) (6.3 mm)
Salida: (1/4 in) (0.25 in) (6.3 mm)
Principales aplicaciones: Camionetas Dodge
Principales equivalencias: Chrysler MB052676, MB129591

GG-206 FILTRO P/GASOLINA



Código: 7267
Diámetro Ext.: (2 63/64 in) (2.984 in) (75.8 mm)
Altura Total: (5 5/64 in) (5.078 in) (128.9 mm)
Entrada: (5/16 in) (0.312 in) (7.9 mm)
Salida: (5/16 in) (0.312 in) (7.9 mm)
Principales aplicaciones: Camionetas Chevrolet Tracker
Principales equivalencias: General Motors 30020673, 15410-65D00

GG-199 FILTRO P/GASOLINA



Código: 7226
Diámetro Ext.: (2 7/32 in) (2.218 in) (56.3 mm)
Altura Total: (3 13/32 in) (3.406 in) (86.5 mm)
Entrada: (1/4 in) (0.25 in) (6.3 mm)
Salida: (1/4 in) (0.25 in) (6.3 mm)
Principales aplicaciones: Automóviles Toyota
Principales equivalencias: Interfil FGI-67

GG-207 FILTRO P/GASOLINA



Código: 7230
Diámetro Ext.: (1 61/64 in) (1.953 in) (49.6 mm)
Altura Total: (2 31/64 in) (2.484 in) (63.1 mm)
Entrada: (1/4 in) (0.25 in) (6.3 mm)
Salida: (1/4 in) (0.25 in) (6.3 mm)
Principales aplicaciones: Automóviles Honda
Principales equivalencias: Interfil FGI-73, Fram G4773

GG-208 FILTRO P/GASOLINA



Código: 7231
Diámetro Ext.: (1 31/32 in) (1.968 in) (50.0 mm)
Altura Total: (2 33/64 in) (2.515 in) (63.8 mm)
Entrada: (5/16 in) (0.312 in) (7.9 mm)
Salida: (5/16 in) (0.312 in) (7.9 mm)
Principales aplicaciones: Automóviles Honda, Mazda
Principales equivalencias: Honda 16900-SE0-004, Mazda F508-13-470

GG-215 FILTRO P/GASOLINA

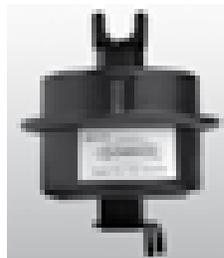

Código: 7234
Diámetro Ext.: (2 49/64 in) (2.765 in) (70.2 mm)
Altura Total: (3 63/64 in) (3.984 in) (101.2 mm)
Entrada: M12X1.25
Salida: M12X1.25
Principales aplicaciones: Automóviles Acura
Principales equivalencias: Acura 16900-SB2-685

GG-209 FILTRO P/GASOLINA



Código: 7263
Diámetro Ext.: (2 5/32 in) (2.156 in) (54.7 mm)
Altura Total: (4 53/64 in) (4.828 in) (122.6 mm)
Entrada: (3/8 in) (0.375 in) (9.5 mm)
Salida: (3/8 in) (0.375 in) (9.5 mm)
Principales aplicaciones: Camionetas Chevrolet Trail Blazer
Principales equivalencias: General Motors 15015509

GG-217 FILTRO P/GASOLINA

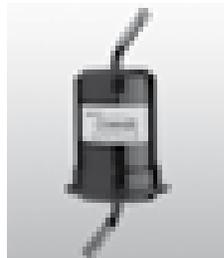

Código: 7235
Diámetro Ext.: (2 51/64 in) (2.796 in) (71.0 mm)
Altura Total: (6 11/16 in) (6.687 in) (169.8 mm)
Entrada: (21/64 in) (0.328 in) (8.3 mm)
Salida: (21/64 in) (0.328 in) (8.3 mm)
Principales aplicaciones: Automóviles Mazda
Principales equivalencias: Mazda N326-20490

GG-210 FILTRO P/GASOLINA

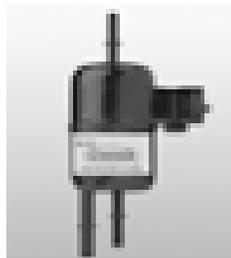

Código: 7265
Diámetro Ext.: (2 3/16 in) (2.187 in) (55.5 mm)
Altura Total: (6 1/4 in) (6.25 in) (158.7 mm)
Entrada: (3/8 in) (0.375 in) (9.5 mm)
Salida: (5/16 in) (0.312 in) (7.9 mm)
Retorno de vapores: (5/16 in) (0.312 in) (7.9 mm)
Principales aplicaciones: Camionetas Ford
Principales equivalencias: Ford XL5Z-9155AB

GG-220 FILTRO P/GASOLINA



Código: 7262
Diámetro Ext.: (2 51/64 in) (2.796 in) (71.0 mm)
Altura Total: (4 45/64 in) (4.703 in) (119.4 mm)
Entrada: M12X1.25
Salida: M12X1.25
Principales aplicaciones: Automóviles y Camionetas Toyota
Principales equivalencias: Toyota 23300-19295

GG-213 FILTRO P/GASOLINA



Código: 7232
Diámetro Ext.: (2 1/4 in) (2.25 in) (57.1 mm)
Altura Total: (3 29/64 in) (3.453 in) (87.7 mm)
Entrada: (1/4 in) (0.25 in) (6.3 mm)
Salida: (1/4 in) (0.25 in) (6.3 mm)
Retorno de vapores: (1/4 in) (0.25 in) (6.3 mm)
Principales aplicaciones: Automóviles Subaru
Principales equivalencias: Subaru 7420-72020, 7420-72021

GG-223 FILTRO P/GASOLINA

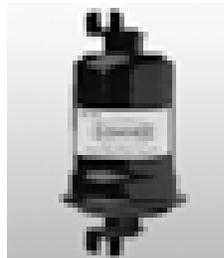

Código: 7236
Diámetro Ext.: (2 25/32 in) (2.781 in) (70.6 mm)
Altura Total: (5 17/64 in) (5.265 in) (133.7 mm)
Entrada: M12X1.25
Salida: M12X1.25
Principales aplicaciones: Automóviles Hyundai
Principales equivalencias: Hyundai 31911-33301, Fram G7616

GG-214 FILTRO P/GASOLINA



Código: 7233
Diámetro Ext.: (3 3/8 in) (3.375 in) (85.7 mm)
Altura Total: (4 21/64 in) (4.328 in) (109.9 mm)
Entrada: M14X1.5
Salida: M12X1.25
Principales aplicaciones: Automóviles Acura
Principales equivalencias: Acura 16900-SDA-671

GG-226 FILTRO P/GASOLINA



Código: 7237
Diámetro Ext.: (3 13/64 in) (3.203 in) (81.3 mm)
Altura Total: (5 1/8 in) (5.125 in) (130.1 mm)
Entrada: M14X1.5
Salida: M14X1.5
Principales aplicaciones: Automóviles Audi, Volkswagen
Principales equivalencias: Volkswagen 811133511A, 811133511D

GG-227 FILTRO P/GASOLINA



Código: 7238
Diámetro Ext.: (2 25/32 in) (2.781 in) (70.6 mm)
Altura Total: (5 5/64 in) (5.078 in) (128.9 mm)
Entrada: M12X1.25
Salida: M12X1.25
Principales aplicaciones: Automóviles y Camionetas Toyota
Principales equivalencias: Toyota 23300-19295

GG-240 FILTRO P/GASOLINA



Código: 7244
Diámetro Ext.: (2 11/64 in) (2.171 in) (55.1 mm)
Altura Total: (4 53/64 in) (4.828 in) (122.6 mm)
Entrada: 5/8-18
Salida: (3/8 in) (0.375 in) (9.5 mm)
Principales aplicaciones: Automóviles Cadillac
Principales equivalencias: General Motors 25055001

GG-232 FILTRO P/GASOLINA



Código: 7239
Diámetro Ext.: (2 25/32 in) (2.781 in) (70.6 mm)
Altura Total: (5 19/64 in) (5.296 in) (134.5 mm)
Entrada: M12X1.25
Salida: M12X1.25
Principales aplicaciones: Camionetas Mitsubishi
Principales equivalencias: Mitsubishi MB504758, Fram G7356

GG-242 FILTRO P/GASOLINA



Código: 7245
Diámetro Ext.: (2 11/64 in) (2.171 in) (55.1 mm)
Altura Total: (5 25/64 in) (5.390 in) (136.9 mm)
Entrada: (3/8 in) (0.375 in) (9.5 mm)
Salida: (3/8 in) (0.375 in) (9.5 mm)
Principales aplicaciones: Automóviles Chevrolet Corvette (1982-84)
Principales equivalencias: General Motors 25055065, 25055066

GG-234 FILTRO P/GASOLINA



Código: 7240
Diámetro Ext.: (3 25/64 in) (3.390 in) (86.1 mm)
Altura Total: (3 29/32 in) (3.906 in) (99.2 mm)
Entrada: M12X1.25
Salida: M12X1.25
Principales aplicaciones: Automóviles Acura, Honda
Principales equivalencias: Honda 16010-SK7-A60

GG-243 FILTRO P/GASOLINA



Código: 7246
Diámetro Ext.: (2 41/64 in) (2.640 in) (67.0 mm)
Altura Total: (6 19/32 in) (6.593 in) (167.4 mm)
Entrada: (3/8 in) (0.375 in) (9.5 mm)
Salida: (5/16 in) (0.312 in) (7.9 mm)
Principales aplicaciones: Automóviles y Camionetas Chrysler, Dodge, Jeep
Principales equivalencias: Chrysler 33003007

GG-237 FILTRO P/GASOLINA



Código: 7242
Diámetro Ext.: (2 25/32 in) (2.781 in) (70.6 mm)
Altura Total: (5 17/64 in) (5.265 in) (133.7 mm)
Entrada: M12X1.25
Salida: M12X1.25
Principales aplicaciones: Hyundai, Dodge H100 a gasolina
Principales equivalencias: Hyundai 31976-43670, Interfil FGI-98

GG-245 FILTRO P/GASOLINA



Código: 7247
Diámetro Ext.: (2 11/64 in) (2.171 in) (55.1 mm)
Altura Total: (5 49/64 in) (5.765 in) (146.4 mm)
Entrada: (5/16 in) (0.312 in) (7.9 mm)
Salida: (5/16 in) (0.312 in) (7.9 mm)
Principales aplicaciones: Camionetas Dodge, Plymouth
Principales equivalencias: Chrysler 4418521

GG-239 FILTRO P/GASOLINA

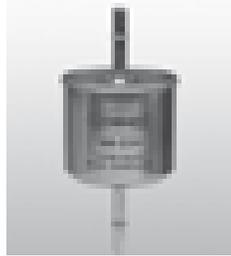

Código: 7243
Diámetro Ext.: (3 5/32 in) (3.156 in) (80.1 mm)
Altura Total: (6 47/64 in) (6.734 in) (171.0 mm)
Entrada: (5/16 in) (0.312 in) (7.9 mm)
Salida: (3/8 in) (0.375 in) (9.5 mm)
Principales aplicaciones: Automóviles Ford, Volkswagen
Principales equivalencias: Ford F3TZ-9155-AFFV

GG-246 FILTRO P/GASOLINA



Código: 7103
Diámetro Ext.: (2 7/16 in) (2.437 in) (61.9 mm)
Altura Total: (5 3/16 in) (5.187 in) (131.7 mm)
Entrada: M14X1.5
Salida: M12X1.25
Principales aplicaciones: Automóviles y Camionetas Audi, Cadillac, Saab, Volkswagen
Principales equivalencias: General Motors 25176764, Volkswagen 441201511C

GG-247 FILTRO P/GASOLINA

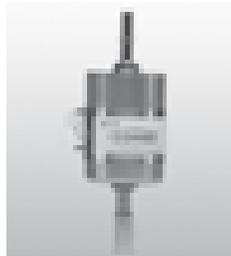

Código: 7248
Diámetro Ext.: (2 11/64 in) (2.171 in) (55.1 mm)
Altura Total: (6 27/64 in) (6.421 in) (163.1 mm)
Entrada: (3/8 in) (0.375 in) (9.5 mm)
Salida: (5/16 in) (0.312 in) (7.9 mm)
Principales aplicaciones: Automóviles Dodge Monaco
Principales equivalencias: Chrysler 4554038

GG-256 FILTRO P/GASOLINA



Código: 7251
Diámetro Ext.: (2 11/64 in) (2.171 in) (55.1 mm)
Altura Total: (6 29/64 in) (6.453 in) (163.9 mm)
Entrada: (3/8 in) (0.375 in) (9.5 mm)
Salida: (3/8 in) (0.375 in) (9.5 mm)
Principales aplicaciones: Automóviles Buick, Chevrolet, Oldsmobile, Pontiac
Principales equivalencias: General Motors 25121656, 25121970

GG-249 FILTRO P/GASOLINA

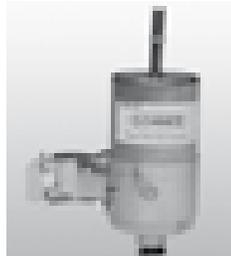

Código: 7249
Diámetro Ext.: (2 11/64 in) (2.171 in) (55.1 mm)
Altura Total: (6 5/32 in) (6.156 in) (156.3 mm)
Entrada: (5/16 in) (0.312 in) (7.9 mm)
Salida: (5/16 in) (0.312 in) (7.9 mm)
Principales aplicaciones: Automóviles y Camionetas Dodge
Principales equivalencias: Chrysler 52019023

GG-260 FILTRO P/GASOLINA



Código: 7253
Diámetro Ext.: (2 11/64 in) (2.171 in) (55.1 mm)
Altura Total: (4 5/16 in) (4.312 in) (109.5 mm)
Entrada: M14X1.5
Salida: M14X1.5
Principales aplicaciones: Automóviles y Camionetas Geo, Isuzu
Principales equivalencias: General Motors 25121160, Isuzu 8-25121-160-0

GG-251 FILTRO P/GASOLINA



Código: 7062
Diámetro Ext.: (3 7/32 in) (3.218 in) (81.7 mm)
Altura Total: (6 11/64 in) (6.171 in) (156.7 mm)
Entrada: (5/16 in) (0.312 in) (7.9 mm)
Salida: (5/16 in) (0.312 in) (7.9 mm)
Principales aplicaciones: Automóviles Audi, Mercedes Benz, Peugeot, Seat, Volkswagen
Principales equivalencias: Volkswagen 1H0201511A, 251201511A

GG-261 FILTRO P/GASOLINA



Código: 7204
Diámetro Ext.: (3 7/16 in) (3.437 in) (87.3 mm)
Altura Total: (6 1/64 in) (6.015 in) (152.7 mm)
Entrada: M14X1.5
Salida: M12X1.5
Principales aplicaciones: Automóviles Audi, Ferrari, Rolls royce, Saab, Volkswagen, Volvo
Principales equivalencias: Saab 93 33 790, Volvo 1389562-8, Volkswagen-Audi-Porsche 893 133 511

GG-252 FILTRO P/GASOLINA



Código: 7097
Diámetro Ext.: (3 1/16 in) (3.062 in) (77.7 mm)
Altura Total: (6 31/32 in) (6.968 in) (177.0 mm)
Entrada: (3/8 in) (0.375 in) (9.5 mm)
Salida: (3/8 in) (0.375 in) (9.5 mm)
Principales aplicaciones: Automóviles Volkswagen
Principales equivalencias: Volkswagen 377-133-511A

GG-262 FILTRO P/GASOLINA



Código: 7203
Diámetro Ext.: (2 39/64 in) (2.609 in) (66.2 mm)
Altura Total: (3 31/64 in) (3.484 in) (88.5 mm)
Entrada: (1/4 in) (0.25 in) (6.3 mm)
Salida: (1/4 in) (0.25 in) (6.3 mm)
Retorno de vapores: (1/4 in) (0.25 in) (6.3 mm)
Principales aplicaciones: Automóviles Volkswagen
Principales equivalencias: Volkswagen 026-127-177B

GG-255 FILTRO P/GASOLINA



Código: 7250
Diámetro Ext.: (2 11/64 in) (2.171 in) (55.1 mm)
Altura Total: (5 31/64 in) (5.484 in) (139.3 mm)
Entrada: (5/16 in) (0.312 in) (7.9 mm)
Salida: (5/16 in) (0.312 in) (7.9 mm)
Principales aplicaciones: Automóviles y Camionetas Chevrolet, Isuzu
Principales equivalencias: General Motors 25121778, Isuzu 8-25121-778-0

GG-263 FILTRO P/GASOLINA

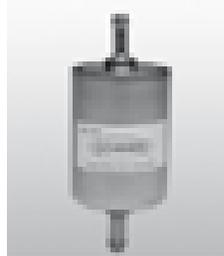

Código: 7255
Diámetro Ext.: (2 11/64 in) (2.171 in) (55.1 mm)
Altura Total: (5 23/64 in) (5.359 in) (136.1 mm)
Entrada: (3/8 in) (0.375 in) (9.5 mm)
Salida: (5/16 in) (0.312 in) (7.9 mm)
Principales aplicaciones: Automóviles Chevrolet, GMC, Opel
Principales equivalencias: Interfil FGI-97A

GG-264 FILTRO P/GASOLINA

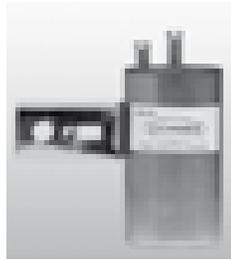

Código: 7254
Diámetro Ext.: (2 11/64 in) (2.171 in) (55.1 mm)
Altura Total: (4 35/64 in) (4.546 in) (115.4 mm)
Entrada: (5/16 in) (0.312 in) (7.9 mm)
Salida: (5/16 in) (0.312 in) (7.9 mm)
Principales aplicaciones: Automóviles y Camionetas Chrysler, Dodge, Plymouth
Principales equivalencias: Chrysler 4279987, 4279995

GG-283 FILTRO P/GASOLINA

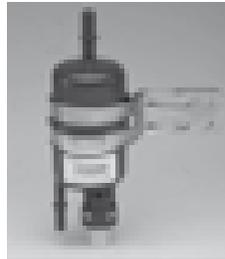

Código: 7266
Diámetro Ext.: (2 13/64 in) (2.203 in) (55.9 mm)
Altura Total: (6 17/32 in) (6.531 in) (165.8 mm)
Entrada: (5/16 in) (0.312 in) (7.9 mm)
Salida: (3/8 in) (0.375 in) (9.5 mm)
Retorno de vapores: (3/8 in) (0.375 in) (9.5 mm)
Principales aplicaciones: Camionetas Jeep
Principales equivalencias: Chrysler 52100283AD

GG-265 FILTRO P/GASOLINA



Código: 7190
Diámetro Ext.: (2 7/64 in) (2.109 in) (53.5 mm)
Altura Total: (6 23/64 in) (6.359 in) (161.5 mm)
Entrada: (3/8 in) (0.375 in) (9.5 mm)
Salida: (5/16 in) (0.312 in) (7.9 mm)
Retorno de vapores: (5/16 in) (0.312 in) (7.9 mm)
Principales aplicaciones: Automóviles y Camionetas Chrysler, Dodge, Plymouth
Principales equivalencias: Chrysler 4682569, 4809118AD

GG-290 FILTRO P/GASOLINA



Código: 7162
Altura Total: (5 29/32 in) (5.906 in) (150.0 mm)
Entrada: (3/8 in) (0.375 in) (9.5 mm)
Salida: (3/8 in) (0.375 in) (9.5 mm)
Principales aplicaciones: Automóviles y Camionetas Chevrolet, Pontiac
Principales equivalencias: General Motors 10290491

GG-266 FILTRO P/GASOLINA



Código: 7104
Diámetro Ext.: (2 13/64 in) (2.203 in) (55.9 mm)
Altura Total: (5 7/16 in) (5.437 in) (138.1 mm)
Entrada: M16X1.5
Salida: (3/8 in) (0.375 in) (9.5 mm)
Principales aplicaciones: Camionetas Chevrolet
Principales equivalencias: General Motors 25168594, 89028789
Observaciones: Filtración invertida al filtro GG-3728

GG-291 FILTRO P/GASOLINA



Código: 7273
Diámetro Ext.: (2 27/64 in) (2.421 in) (61.5 mm)
Altura Total: (5 3/8 in) (5.375 in) (136.5 mm)
Entrada: (5/16 in) (0.312 in) (7.9 mm)
Salida: (5/16 in) (0.312 in) (7.9 mm)
Principales aplicaciones: Automóviles Nissan, Peugeot, Renault, Smart
Principales equivalencias: Nissan 16400-00-Q-AA, Peugeot 1567-87

GG-267 FILTRO P/GASOLINA



Código: 7192
Diámetro Ext.: (2 7/64 in) (2.109 in) (53.5 mm)
Altura Total: (6 23/64 in) (6.359 in) (161.5 mm)
Entrada: (3/8 in) (0.375 in) (9.5 mm)
Salida: (5/16 in) (0.312 in) (7.9 mm)
Retorno de vapores: (5/16 in) (0.312 in) (7.9 mm)
Principales aplicaciones: Automóviles y Camionetas Chrysler, Dodge, Plymouth
Principales equivalencias: Chrysler 4809118AB

GG-298 FILTRO P/GASOLINA



Código: 7032
Diámetro Ext.: (3 13/64 in) (3.203 in) (81.3 mm)
Diámetro Int.: (23/32 in) (0.718 in) (18.2 mm)
Altura Total: (2 13/16 in) (2.812 in) (71.4 mm)
Principales aplicaciones: Motores Volkswagen con sistema C.A.V.
Principales equivalencias: C.A.V. 7111-596

GG-268 FILTRO P/GASOLINA



Código: 7207
Diámetro Ext.: (3 9/64 in) (3.140 in) (79.7 mm)
Altura Total: (5 35/64 in) (5.546 in) (140.8 mm)
Entrada: (5/16 in) (0.312 in) (7.9 mm)
Salida: (5/16 in) (0.312 in) (7.9 mm)
Principales aplicaciones: Automóviles y Camionetas Ford, Mazda
Principales equivalencias: Ford F32Z-9155-A, Mazda FS11-20-490B

GG-299 FILTRO P/GASOLINA

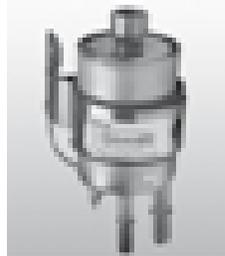

Código: 7268
Diámetro Ext.: (2 13/64 in) (2.203 in) (55.9 mm)
Altura Total: (5 5/8 in) (5.625 in) (142.8 mm)
Entrada: (3/8 in) (0.375 in) (9.5 mm)
Salida: (3/8 in) (0.375 in) (9.5 mm)
Retorno de vapores: (5/16 in) (0.312 in) (7.9 mm)
Principales aplicaciones: Automóviles Chevrolet Corvette
Principales equivalencias: General Motors 10299146

GG-307 FILTRO P/GASOLINA



Código: 7264
Diámetro Ext.: (5 17/64 in) (5.265 in) (133.7 mm)
Altura Total: (6 41/64 in) (6.640 in) (168.6 mm)
Entrada: (3/8 in) (0.375 in) (9.5 mm)
Salida: (5/16 in) (0.312 in) (7.9 mm)
Retorno de vapores: (5/16 in) (0.312 in) (7.9 mm)
Principales aplicaciones: Automóviles Ford, Mercury
Principales equivalencias: Ford 1F1Z-9155-AD, 1F1Z-9155-CA

GG-408 FILTRO P/GASOLINA



Código: 7278
Diámetro Ext.: (2 15/16 in) (2.937 in) (74.6 mm)
Altura Total: (4 59/64 in) (4.921 in) (125.0 mm)
Entrada: M14X1.5
Salida: M12X1.5
Principales aplicaciones: Automóviles Audi
Principales equivalencias: VAG 441-201-511-C, Volkswagen 441-201-511-C

GG-308 FILTRO P/COMBUSTIBLE



Código: 7316
Diámetro Ext.: (2 1/4 in) (2.250 in) (57.1 mm)
Altura Total: (7 3/64 in) (7.046 in) (178.9 mm)
Entrada: (3/8 in) (0.375 in) (9.5 mm)
Salida: (3/8 in) (0.375 in) (9.5 mm)
Retorno de vapores: (5/16 in) (0.312 in) (7.9 mm)
Principales aplicaciones: Camionetas Ford, Lincoln, Mazda y Mercury
Principales equivalencias: Ford 2L2Z-9155-AB, Motorcraft MFG 1036

GG-409 FILTRO P/GASOLINA



Código: 7279
Diámetro Ext.: (2 11/64 in) (2.171 in) (55.1 mm)
Altura Total: (13 25/64 in) (13.390 in) (340.1 mm)
Entrada: (5/16 in) (0.312 in) (7.9 mm)
Salida: (5/16 in) (0.312 in) (7.9 mm)
Principales aplicaciones: Automóviles y Camionetas BMW
Principales equivalencias: BMW 13-32-1-405-092, Mann & Hummel WK504

GG-351 FILTRO P/GASOLINA

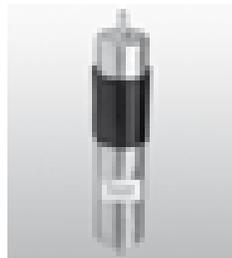

Código: 7274
Diámetro Ext.: (2 13/32 in) (2.406 in) (61.1 mm)
Altura Total: (11 13/16 in) (11.812 in) (300.0 mm)
Entrada: (5/16 in) (0.312 in) (7.9 mm)
Salida: (5/16 in) (0.312 in) (7.9 mm)
Principales aplicaciones: Automóviles BMW
Principales equivalencias: BMW 13-32-1-702-635, 13-32-1-740-986

GG-411 FILTRO P/GASOLINA



Código: 7277
Diámetro Ext.: (2 15/16 in) (2.937 in) (74.6 mm)
Altura Total: (5 5/32 in) (5.156 in) (130.9 mm)
Entrada: (5/16 in) (0.312 in) (7.9 mm)
Salida: (5/16 in) (0.312 in) (7.9 mm)
Principales aplicaciones: Automóviles Mercedes Benz
Principales equivalencias: Mercedes Benz 002-477-39-01, 168-470-02-90

GG-355 FILTRO P/GASOLINA



Código: 7284
Diámetro Ext.: (2 27/64 in) (2.421 in) (61.5 mm)
Altura Total: (5 53/64 in) (5.828 in) (148.0 mm)
Entrada: (5/16 in) (0.312 in) (7.9 mm)
Salida: (5/16 in) (0.312 in) (7.9 mm)
Principales aplicaciones: Automóviles Seat, Volkswagen
Principales equivalencias: Seat 6Q0201511

GG-419 FILTRO P/GASOLINA



Código: 7272
Diámetro Ext.: (2 15/16 in) (2.937 in) (74.6 mm)
Altura Total: (5 5/32 in) (5.156 in) (130.9 mm)
Entrada: (5/16 in) (0.312 in) (7.9 mm)
Salida: (5/16 in) (0.312 in) (7.9 mm)
Principales aplicaciones: Automóviles Daewoo, Pontiac Matiz
Principales equivalencias: Daewoo 96335719

GG-369 FILTRO P/GASOLINA



Código: 7302
Salida: M14X1.5
Entrada: (5/16 in) (0.312 in) (7.9 mm)
Altura Total: (4 9/16 in) (4.562 in) (115.8 mm)
Principales aplicaciones: Automóviles Hyundai, Dodge Atos (2005-07)
Principales equivalencias: Hyundai 31911-0500

GG-420 FILTRO P/GASOLINA

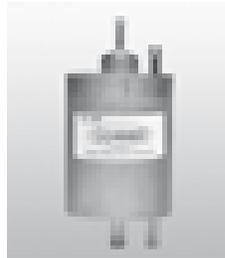

Código: 7275
Diámetro Ext.: (2 15/16 in) (2.937 in) (74.6 mm)
Altura Total: (6 21/64 in) (6.328 in) (160.7 mm)
Entrada: (25/64 in) (0.390 in) (9.9 mm)
Salida: (5/64 in) (0.078 in) (1.9 mm)
Principales aplicaciones: Automóviles y Camionetas Mercedes Benz
Principales equivalencias: Mercedes Benz 002-477-31-01

GG-431 FILTRO P/GASOLINA



Código: 7276
Diámetro Ext.: (2 61/64 in) (2.953 in) (75.0 mm)
Altura Total: (6 7/64 in) (6.109 in) (155.1 mm)
Entrada: (5/16 in) (0.312 in) (7.9 mm)
Salida: (5/16 in) (0.312 in) (7.9 mm)
Principales aplicaciones: Automóviles y Camionetas Mercedes Benz
Principales equivalencias: Mercedes Benz 002-477-28-01, Mann & Hummel WK-831

GG-1872 FILTRO P/GASOLINA



Código: 7060
Diámetro Ext.: (3 9/64 in) (3.140 in) (79.7 mm)
Altura Total: (6 23/32 in) (6.718 in) (170.6 mm)
Entrada: (5/16 in) (0.312 in) (7.9 mm)
Salida: (5/16 in) (0.312 in) (7.9 mm)
Principales aplicaciones: Automóviles y Camionetas Ford, Mazda
Principales equivalencias: Ford F0TZ-9155-B, Mazda Z2L0-13-470A

GG-580 FILTRO P/GASOLINA

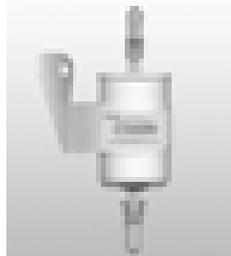

Código: 7071
Diámetro Ext.: (2 11/64 in) (2.171 in) (55.1 mm)
Altura Total: (6 27/64 in) (6.421 in) (163.1 mm)
Entrada: (3/8 in) (0.375 in) (9.5 mm)
Salida: (3/8 in) (0.375 in) (9.5 mm)
Principales aplicaciones: Automóviles Chevrolet, GMC
Principales equivalencias: General Motors 25121656, 25121970

GG-1992 FILTRO P/GASOLINA



Código: 7059
Diámetro Ext.: (2 3/8 in) (2.375 in) (60.3 mm)
Altura Total: (5 7/32 in) (5.218 in) (132.5 mm)
Entrada: (5/16 in) (0.312 in) (7.9 mm)
Salida: (5/16 in) (0.312 in) (7.9 mm)
Principales aplicaciones: Automóviles y Camionetas Nissan
Principales equivalencias: Nissan 16400-P31G00

GG-581 FILTRO P/GASOLINA



Código: 7096
Diámetro Ext.: (2 11/64 in) (2.171 in) (55.1 mm)
Altura Total: (6 29/64 in) (6.453 in) (163.9 mm)
Entrada: (3/8 in) (0.375 in) (9.5 mm)
Salida: (3/8 in) (0.375 in) (9.5 mm)
Principales aplicaciones: Automóviles y Camionetas Cadillac, Chevrolet, GMC, Pontiac
Principales equivalencias: General Motors 25319686, 89028790

GG-3728 FILTRO P/GASOLINA



Código: 7058
Diámetro Ext.: (2 5/32 in) (2.156 in) (54.7 mm)
Altura Total: (4 51/64 in) (4.796 in) (121.8 mm)
Entrada: (3/8 in) (0.375 in) (9.5 mm)
Salida: M16X1.5
Principales aplicaciones: Automóviles y Camionetas Chevrolet
Principales equivalencias: General Motors 25055075, 25055083

GG-915 FILTRO P/GASOLINA



Código: 7282
Diámetro Ext.: (2 7/8 in) (2.875 in) (73.0 mm)
Altura Total: (6 47/64 in) (6.734 in) (171.0 mm)
Entrada: (5/16 in) (0.312 in) (7.9 mm)
Salida: (5/16 in) (0.312 in) (7.9 mm)
Principales aplicaciones: Automóviles Ford
Principales equivalencias: Ford 1S719155BA

GG-7018 FILTRO P/GASOLINA

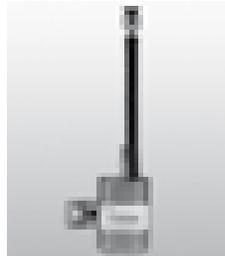

Código: 7057
Diámetro Ext.: (2 11/64 in) (2.171 in) (55.1 mm)
Altura Total: (10 in) (10.000 in) (254.0 mm)
Entrada: (5/16 in) (0.312 in) (7.9 mm)
Salida: (5/16 in) (0.312 in) (7.9 mm)
Principales aplicaciones: Automóviles Chrysler
Principales equivalencias: Chrysler 4682004

GG-986 FILTRO P/GASOLINA



Código: 7164
Diámetro Ext.: (2 7/64 in) (2.109 in) (53.5 mm)
Altura Total: (7 13/64 in) (7.203 in) (182.9 mm)
Entrada: (5/16 in) (0.312 in) (7.9 mm)
Salida: (5/16 in) (0.312 in) (7.9 mm)
Principales aplicaciones: Automóviles y Camionetas Ford, Jaguar, Lincoln, Mercury
Principales equivalencias: Ford 3S4Z-9155-BA, F89Z-9155-A

GG-7019 FILTRO P/GASOLINA



Código: 7061
Diámetro Ext.: (2 11/64 in) (2.171 in) (55.1 mm)
Altura Total: (8 29/32 in) (8.906 in) (226.2 mm)
Entrada: (5/16 in) (0.312 in) (7.9 mm)
Salida: (5/16 in) (0.312 in) (7.9 mm)
Principales aplicaciones: Automóviles Chrysler
Principales equivalencias: Chrysler 4495662, 4682003

GG-7020 FILTRO P/GASOLINA

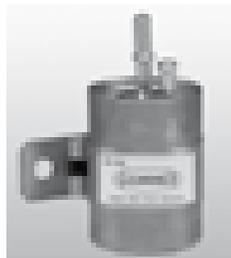

Código: 7107

Diámetro Ext.: (2 11/64 in) (2.171 in) (55.1 mm)

Altura Total: (4 1/2 in) (4.5 in) (114.3 mm)

Entrada: (5/16 in) (0.312 in) (7.9 mm)

Salida: (5/16 in) (0.312 in) (7.9 mm)

Principales aplicaciones: Automóviles Chrysler, Dodge

Principales equivalencias: Chrysler 4443462

Filtros Racor

Racor Filters

R 60 P FILTRO P/COMB.



Código: 38015
Rosca central:
Diámetro Ext.: (in) (in) (mm)
Altura Total:
Con tazón: (in) (in) (mm)
Sin tazón: (in) (in) (mm)
Caudal máximo:
Presión máxima de trabajo:
Micraje típico: 30
Principales aplicaciones:
Principales equivalencias:

R 60 T FILTRO P/COMB.



Código: 38016
Rosca central:
Diámetro Ext.: (in) (in) (mm)
Altura Total:
Con tazón: (in) (in) (mm)
Sin tazón: (in) (in) (mm)
Caudal máximo:
Presión máxima de trabajo:
Micraje típico: 10
Principales aplicaciones:
Principales equivalencias:

R 90 P FILTRO P/COMB.



Código: 38017
Rosca central:
Diámetro Ext.: (in) (in) (mm)
Altura Total:
Con tazón: (in) (in) (mm)
Sin tazón: (in) (in) (mm)
Caudal máximo:
Presión máxima de trabajo:
Micraje típico: 30
Principales aplicaciones:
Principales equivalencias:

R 90 T FILTRO P/COMB.



Código: 38018
Rosca central:
Diámetro Ext.: (in) (in) (mm)
Altura Total:
Con tazón: (in) (in) (mm)
Sin tazón: (in) (in) (mm)
Caudal máximo:
Presión máxima de trabajo:
Micraje típico: 10
Principales aplicaciones:
Principales equivalencias:

R120P FILTRO P/COMB.



Código: 38046
Rosca central: 1-14
Diámetro Ext.: (4 3/8 in) (4.375 in) (111.1 mm)
Altura Total:
Con tazón: (12 in) (12.000 in) (304.8 mm)
Sin tazón: (8 1/2 in) (8.500 in) (215.9 mm)
Caudal máximo:
Presión máxima de trabajo:
Micraje típico: 30
Principales aplicaciones:
Principales equivalencias:

PFF831 FILTRO P/COMB.



Código: 38063
Rosca central: 1-14
Diámetro Ext.: (4 19/64 in) (4.296 in) (109.1 mm)
Altura Total:
Con tazón: (5 1/2 in) (5.5 in) (139.7 mm)
Sin tazón: (4 in) (4.000 in) (101.6 mm)
Caudal máximo: 30 GPH
Presión máxima de trabajo: 30 PSI
Micraje típico: 40
Principales aplicaciones: Navistar 6400 Series con Motores a Diesel
Principales equivalencias: Fleetguard FS1287, FS19532, FS19551, FS1291

2010PM-OR FILTRO P/COMB.



Código: 38005
Diámetro Ext.: (in) (in) (mm)
Diámetro Int.: (in) (in) (mm)
Altura Total: (in) (in) (mm)
Micraje típico: 30
Principales aplicaciones:
Principales equivalencias:

2010TM-OR FILTRO P/COMB.



Código: 38006
Diámetro Ext.: (in) (in) (mm)
Diámetro Int.: (in) (in) (mm)
Altura Total: (in) (in) (mm)
Micraje típico: 10
Principales aplicaciones:
Principales equivalencias:

S 3202 FILTRO P/COMB.



Código: 38034
Rosca central: 1-12
Diámetro Ext.: (3 53/64 in) (3.828 in) (97.2 mm)
Altura Total:
Con tazón: (10 1/2 in) (10.500 in) (266.7 mm)
Sin tazón: (7 13/32 in) (7.406 in) (188.1 mm)
Caudal máximo: 90 GPH
Presión máxima de trabajo:
Micraje típico: 30
Principales aplicaciones:
Principales equivalencias:

S 3225 P FILTRO P/COMB.



Código: 38039
Rosca central: 1-14
Diámetro Ext.: (in) (in) (in)
Altura Total:
Con tazón: (in) (in) (in)
Sin tazón: (in) (in) (in)
Caudal máximo:
Presión máxima de trabajo:
Micraje típico: 30
Principales aplicaciones:
Principales equivalencias:

S 3225 T FILTRO P/COMB.



Código: 38040
Rosca central: 1-14
Diámetro Ext.: (in) (in) (in)
Altura Total:
Con tazón: (in) (in) (in)
Sin tazón: (in) (in) (in)
Caudal máximo:
Presión máxima de trabajo:
Micraje típico: 10
Principales aplicaciones:
Principales equivalencias:

S 3226 P FILTRO P/COMB.



Código: 38030
Rosca central: 1-14
Diámetro Ext.: (in) (in) (in)
Altura Total:
Con tazón: (in) (in) (in)
Sin tazón: (in) (in) (in)
Caudal máximo:
Presión máxima de trabajo:
Micraje típico: 30
Principales aplicaciones:
Principales equivalencias:

S 3226 T FILTRO P/COMB.



Código: 38041
Rosca central: 1-14
Diámetro Ext.: (in) (in) (in)
Altura Total:
Con tazón: (in) (in) (in)
Sin tazón: (in) (in) (in)
Caudal máximo:
Presión máxima de trabajo:
Micraje típico: 10
Principales aplicaciones:
Principales equivalencias:

Especificaciones de Filtros Sellados para Aceite (Roscas Estándar y Milimétricas)
 Specifications for Spin-On Oil Filters (Standard threads and Millimeter)



Código	Filtro	Rosca	Diámetro Exterior	Altura	Válvula de Alívio	Anti-Retorno	Diámetro Exterior de Empaque	Diámetro Interior de Empaque	Altura de Empaque
2034	GP-50	5/8-18	(3 5/8 in) (92.0 mm)	(5 13/32 in) (137.3 mm)			(2 27/32 in) (72.2 mm)	(2 31/64 in) (63.1 mm)	(13/64 in) (5.2 mm)
2342	GP-157	3/4-16	(2 23/32 in) (69.0 mm)	(2 15/16 in) (74.6 mm)	11-17 PSI	SI	(2 27/64 in) (61.5 mm)	(1 31/32 in) (50 mm)	(11/64 in) (4.4 mm)
2341	GP-156	3/4-16	(2 23/32 in) (69.0 mm)	(3 39/64 in) (91.6 mm)	11-17 PSI	SI	(2 27/64 in) (61.5 mm)	(1 31/32 in) (50 mm)	(11/64 in) (4.4 mm)
2933	GP-490	3/4-16	(3 1/32 in) (76.9 mm)	(4 3/64 in) (102.7 mm)			(2 31/64 in) (63.1 mm)	(2 11/64 in) (55.2 mm)	(15/64 in) (6 mm)
2330	GP-3816	3/4-16	(3 3/64 in) (77.3 mm)	(3 11/32 in) (84.9 mm)	28-32 PSI	NO	(2 27/32 in) (72.2 mm)	(2 31/64 in) (63.1 mm)	(13/64 in) (5.2 mm)
2098	GP-58	3/4-16	(3 5/64 in) (78.1 mm)	(3 25/64 in) (86.1 mm)	8-12 PSI	SI	(2 27/32 in) (72.2 mm)	(2 31/64 in) (63.1 mm)	(13/64 in) (5.2 mm)
2174	GP-3682	3/4-16	(3 5/64 in) (78.1 mm)	(4 7/64 in) (104.3 mm)	N/D	SI	(2 27/32 in) (72.2 mm)	(2 31/64 in) (63.1 mm)	(13/64 in) (5.2 mm)
2983	GP-128	3/4-16	(3 5/64 in) (78.1 mm)	(4 45/64 in) (119.4 mm)	11-17 PSI	SI	(2 27/32 in) (72.2 mm)	(2 31/64 in) (63.1 mm)	(13/64 in) (5.2 mm)
2048	GP-28	3/4-16	(3 5/64 in) (78.1 mm)	(4 45/64 in) (119.4 mm)	27-36 PSI	SI	(2 27/32 in) (72.2 mm)	(2 31/64 in) (63.1 mm)	(13/64 in) (5.2 mm)
2212	GP-3600	3/4-16	(3 5/64 in) (78.1 mm)	(4 45/64 in) (119.4 mm)	8-12 PSI	SI	(2 27/32 in) (72.2 mm)	(2 31/64 in) (63.1 mm)	(13/64 in) (5.2 mm)
2062	GP-38	3/4-16	(3 5/64 in) (78.1 mm)	(4 45/64 in) (119.4 mm)	N/D	SI	(2 27/32 in) (72.2 mm)	(2 31/64 in) (63.1 mm)	(13/64 in) (5.2 mm)
2002	GP-430	3/4-16	(3 5/64 in) (78.1 mm)	(4 27/32 in) (123.0 mm)	34-38 PSI	SI	(2 51/64 in) (71 mm)	(2 7/16 in) (61.9 mm)	(9/32 in) (7.1 mm)
2993	GP-454	3/4-16	(3 5/64 in) (78.1 mm)	(4 27/32 in) (123.0 mm)	N/D	SI	(2 51/64 in) (71 mm)	(2 7/16 in) (61.9 mm)	(17/64 in) (6.7 mm)
2057	GP-428	3/4-16	(3 3/32 in) (78.5 mm)	(3 51/64 in) (96.4 mm)	8-12 PSI	SI	(2 3/4 in) (69.8 mm)	(2 3/8 in) (60.3 mm)	(3/8 in) (9.5 mm)
2124	GP-37	3/4-16	(3 19/64 in) (83.7 mm)	(3 59/64 in) (99.6 mm)	N/D	SI	(2 31/64 in) (63.1 mm)	(1 13/16 in) (46 mm)	(1/8 in) (3.2 mm)
2176	GP-2951	3/4-16	(3 19/64 in) (83.7 mm)	(3 15/16 in) (100.0 mm)	8-12 PSI	SI	(2 1/2 in) (63.5 mm)	(1 13/16 in) (46 mm)	(1/8 in) (3.2 mm)
2139	GP-22	3/4-16	(3 5/8 in) (92.0 mm)	(2 21/64 in) (59.1 mm)	8-11 PSI	SI	(2 27/32 in) (72.2 mm)	(2 31/64 in) (63.1 mm)	(13/64 in) (5.2 mm)
2519	GP-81	3/4-16	(3 5/8 in) (92.0 mm)	(3 45/64 in) (94.0 mm)	8-11 PSI	SI	(2 27/32 in) (72.2 mm)	(2 31/64 in) (63.1 mm)	(13/64 in) (5.2 mm)
2008	GP-9	3/4-16	(3 5/8 in) (92.0 mm)	(3 45/64 in) (94.0 mm)	8-11 PSI	SI	(2 27/32 in) (72.2 mm)	(2 31/64 in) (63.1 mm)	(13/64 in) (5.2 mm)
2339	GP-171	3/4-16	(3 5/8 in) (92.0 mm)	(3 47/64 in) (94.8 mm)	18-22 PSI	SI	(2 27/32 in) (72.2 mm)	(2 31/64 in) (63.1 mm)	(13/64 in) (5.2 mm)
2001	GP-1	3/4-16	(3 5/8 in) (92.0 mm)	(5 13/32 in) (137.3 mm)	8-11 PSI	SI	(2 27/32 in) (72.2 mm)	(2 31/64 in) (63.1 mm)	(13/64 in) (5.2 mm)
2033	GP-31	3/4-16	(3 5/8 in) (92.0 mm)	(7 17/32 in) (191.2 mm)	8-12 PSI	SI	(2 27/32 in) (72.2 mm)	(2 31/64 in) (63.1 mm)	(13/64 in) (5.2 mm)
2991	GP-432	3/4-16	(3 3/4 in) (95.2 mm)	(4 31/64 in) (113.9 mm)	12-16 PSI	SI	(2 51/64 in) (71 mm)	(2 7/16 in) (61.9 mm)	(13/64 in) (5.2 mm)
2986	GP-310	3/4-16	(3 49/64 in) (95.6 mm)	(7 21/64 in) (186.1 mm)	26-30 PSI	SI	(2 9/32 in) (57.9 mm)	(2 13/32 in) (61.1 mm)	(21/64 in) (8.3 mm)
2303	GP-67	3/4-20	(4 17/64 in) (108.3 mm)	(7 15/64 in) (183.7 mm)	N/D	NO	(2 13/16 in) (71.4 mm)	(2 29/64 in) (62.3 mm)	(15/64 in) (5.9 mm)
2643	GP-44	13/16-16	(3 5/64 in) (78.1 mm)	(3 25/64 in) (86.1 mm)	N/D	SI	(2 27/32 in) (72.2 mm)	(2 31/64 in) (63.1 mm)	(13/64 in) (5.2 mm)
2994	GP-455	13/16-16	(3 5/64 in) (78.1 mm)	(3 15/16 in) (100.0 mm)	12-16 PSI	SI	(2 51/64 in) (71 mm)	(2 7/16 in) (61.9 mm)	(1/4 in) (6.3 mm)
2333	GP-3675	13/16-16	(3 5/64 in) (78.1 mm)	(4 7/64 in) (104.3 mm)	N/D	SI	(2 27/32 in) (72.2 mm)	(2 31/64 in) (63.1 mm)	(13/64 in) (5.2 mm)
2167	GP-3429	13/16-16	(3 5/64 in) (78.1 mm)	(4 45/64 in) (119.4 mm)			(2 27/32 in) (72.2 mm)	(2 31/64 in) (63.1 mm)	(13/64 in) (5.2 mm)
2992	GP-453	13/16-16	(3 5/64 in) (78.1 mm)	(4 27/32 in) (123.0 mm)	12-16 PSI	NO	(2 51/64 in) (71 mm)	(2 7/16 in) (61.9 mm)	(13/64 in) (5.2 mm)
2024	GP-20	13/16-16	(3 5/8 in) (92.0 mm)	(3 45/64 in) (94.0 mm)	N/D	SI	(2 27/32 in) (72.2 mm)	(2 31/64 in) (63.1 mm)	(13/64 in) (5.2 mm)
2003	GP-3	13/16-16	(3 5/8 in) (92.0 mm)	(3 45/64 in) (94.0 mm)			(2 27/32 in) (72.2 mm)	(2 31/64 in) (63.1 mm)	(13/64 in) (5.2 mm)
2015	GP-14	13/16-16	(3 5/8 in) (92.0 mm)	(5 13/32 in) (137.3 mm)	18-22 PSI	NO	(2 27/32 in) (72.2 mm)	(2 31/64 in) (63.1 mm)	(13/64 in) (5.2 mm)
2690	GP-205	13/16-16	(3 5/8 in) (92.0 mm)	(5 13/32 in) (137.3 mm)	N/D	SI	(3 27/64 in) (86.9 mm)	(3 3/64 in) (77.4 mm)	(17/64 in) (6.7 mm)
2005	GP-5	13/16-16	(3 5/8 in) (92.0 mm)	(5 13/32 in) (137.3 mm)	N/D	SI	(3 27/64 in) (86.9 mm)	(3 3/64 in) (77.4 mm)	(17/64 in) (6.7 mm)
2013	GP-13	13/16-16	(3 5/8 in) (92.0 mm)	(5 13/32 in) (137.3 mm)			(3 27/64 in) (86.9 mm)	(3 3/64 in) (77.4 mm)	(17/64 in) (6.7 mm)
2027	GP-23	13/16-16	(3 5/8 in) (92.0 mm)	(8 1/2 in) (215.9 mm)			(3 27/64 in) (86.9 mm)	(3 3/64 in) (77.4 mm)	(17/64 in) (6.7 mm)
2995	GP-457	1-12	(3 5/64 in) (78.1 mm)	(4 11/16 in) (119.0 mm)	12-14 PSI	SI	(2 51/64 in) (71 mm)	(2 7/16 in) (61.9 mm)	(15/64 in) (6 mm)
2043	GP-36	1-12	(3 5/8 in) (92.0 mm)	(5 13/32 in) (137.3 mm)	18-22 PSI	NO	(2 27/32 in) (72.2 mm)	(2 31/64 in) (63.1 mm)	(13/64 in) (5.2 mm)
2099	GP-66	1-12	(3 5/8 in) (92.0 mm)	(6 43/64 in) (169.4 mm)	18-22 PSI	NO	(2 27/32 in) (72.2 mm)	(2 31/64 in) (63.1 mm)	(13/64 in) (5.2 mm)
2009	GP-10	1-12	(3 5/8 in) (92.0 mm)	(7 17/32 in) (191.2 mm)	18-22 PSI	SI	(2 27/32 in) (72.2 mm)	(2 31/64 in) (63.1 mm)	(13/64 in) (5.2 mm)
2077	GP-54	1-12	(3 5/8 in) (92.0 mm)	(7 17/32 in) (191.2 mm)	18-22 PSI	SI	(2 27/32 in) (72.2 mm)	(2 31/64 in) (63.1 mm)	(13/64 in) (5.2 mm)
2101	GP-69	1-12	(3 5/8 in) (92.0 mm)	(7 17/32 in) (191.2 mm)	N/D	SI	(2 27/32 in) (72.2 mm)	(2 31/64 in) (63.1 mm)	(13/64 in) (5.2 mm)
2195	GP-88	1-12	(4 17/64 in) (108.3 mm)	(8 49/64 in) (222.6 mm)			(2 53/64 in) (71.8 mm)	(2 15/32 in) (62.7 mm)	(13/64 in) (5.2 mm)
2559	GP-390	1-16	(3 5/8 in) (92.0 mm)	(5 13/32 in) (137.3 mm)			(2 27/32 in) (72.2 mm)	(2 31/64 in) (63.1 mm)	(13/64 in) (5.2 mm)
2541	GP-178	1-16	(3 5/8 in) (92.0 mm)	(7 9/64 in) (181.3 mm)			(2 27/32 in) (72.2 mm)	(2 31/64 in) (63.1 mm)	(13/64 in) (5.2 mm)
2216	GP-9586	1 1/8-16	(3 5/8 in) (92.0 mm)	(5 13/32 in) (137.3 mm)			(2 27/32 in) (72.2 mm)	(2 31/64 in) (63.1 mm)	(13/64 in) (5.2 mm)
2558	GP-166	1 1/8-16	(3 5/8 in) (92.0 mm)	(6 43/64 in) (169.4 mm)	8-12 PSI	NO	(2 27/32 in) (72.2 mm)	(2 15/32 in) (62.7 mm)	(9/32 in) (7.1 mm)
2131	GP-317H	1 1/8-16	(3 11/16 in) (93.6 mm)	(5 21/32 in) (143.6 mm)			(2 13/16 in) (71.4 mm)	(2 15/32 in) (62.7 mm)	(13/64 in) (5.2 mm)
2948	GP-3937	1 1/8-16	(3 11/16 in) (93.6 mm)	(7 3/16 in) (182.5 mm)			(2 27/32 in) (72.2 mm)	(2 35/64 in) (64.7 mm)	(9/32 in) (7.1 mm)
2064	GP-51	1 1/8-16	(4 17/64 in) (108.3 mm)	(10 3/8 in) (263.5 mm)			(3 31/32 in) (100.8 mm)	(3 35/64 in) (90.1 mm)	(19/64 in) (7.5 mm)
2186	GP-77	1 1/8-16	(5 45/64 in) (144.8 mm)	(6 1/16 in) (153.9 mm)	18-22 PSI	SI	(4 49/64 in) (121 mm)	(3 43/64 in) (93.3 mm)	(1/2 in) (12.7 mm)
2929	GP-761H	1 3/8-12	(3 13/16 in) (96.8 mm)	(6 in) (152.4 mm)			(2 49/64 in) (70.2 mm)	(2 31/64 in) (63.1 mm)	(9/32 in) (7.1 mm)
2989	GP-556	1 3/8-16	(4 1/4 in) (107.9 mm)	(10 1/16 in) (255.5 mm)			(3 31/32 in) (100.8 mm)	(3 19/32 in) (91.2 mm)	(1/4 in) (6.3 mm)
2121	GP-57	1 3/8-16	(4 61/64 in) (125.8 mm)	(10 21/64 in) (262.3 mm)			(4 9/32 in) (108.7 mm)	(3 25/32 in) (96 mm)	(3/8 in) (9.5 mm)
2207	GP-359	1 1/2-12	(4 21/32 in) (118.2 mm)	(4 15/16 in) (125.3 mm)	19 PSI	NO	(4 9/32 in) (108.7 mm)	(3 25/32 in) (96 mm)	
2144	GP-43	1 1/2-12	(4 61/64 in) (125.8 mm)	(8 5/64 in) (205.1 mm)			(4 9/32 in) (108.7 mm)	(3 25/32 in) (96 mm)	(3/8 in) (9.5 mm)
2066	GP-53	1 1/2-12	(4 61/64 in) (125.8 mm)	(10 21/64 in) (262.3 mm)			(4 9/32 in) (108.7 mm)	(3 25/32 in) (96 mm)	(3/8 in) (9.5 mm)
2113	GP-35	1 1/2-12	(5 5/64 in) (128.9 mm)	(6 27/32 in) (173.8 mm)			(5 9/64 in) (130.6 mm)	(4 3/4 in) (120.7 mm)	(3/16 in) (4.8 mm)
2938	GP-754	1 1/2-16	(3 3/4 in) (95.2 mm)	(5 3/4 in) (146.0 mm)	18-22 PSI	NO	(3 49/64 in) (95.6 mm)	(3 11/64 in) (80.6 mm)	(15/32 in) (11.9 mm)
2178	GP-3766	1 1/2-16	(4 17/64 in) (108.3 mm)	(5 41/64 in) (143.2 mm)			(3 31/32 in) (100.8 mm)	(3 35/64 in) (90.1 mm)	(19/64 in) (7.5 mm)
2988	GP-562	1 1/2-16	(4 17/64 in) (108.3 mm)	(8 1/8 in) (206.3 mm)			(3 31/32 in) (100.8 mm)	(3 15/32 in) (88.1 mm)	(1/4 in) (6.3 mm)
2065	GP-52	1 1/2-16	(4 61/64 in) (125.8 mm)	(11 23/64 in) (288.5 mm)			(4 9/32 in) (108.7 mm)	(3 25/32 in) (96 mm)	(3/8 in) (9.5 mm)
2928	GP-864H	1 1/2-16	(5 1/16 in) (128.5 mm)	(6 31/32 in) (177.0 mm)			(4 53/64 in) (122.6 mm)	(2 31/64 in) (63.1 mm)	(3/16 in) (4.8 mm)
2063	GP-34	1 1/2-16	(5 5/64 in) (128.9 mm)	(6 27/32 in) (173.8 mm)			(5 9/64 in) (130.6 mm)	(4 3/4 in) (120.7 mm)	(3/16 in) (4.8 mm)
2014	GP-691	1 1/2-16	(5 3/8 in) (136.5 mm)	(12 3/32 in) (307.1 mm)			(4 21/64 in) (109.9 mm)	(3 13/16 in) (96.8 mm)	(3/8 in) (9.5 mm)

Código	Filtro	Rosca	Diámetro Exterior	Altura	Válvula de Alivio	Anti-Retorno	Diámetro Exterior de Empaque	Diámetro Interior de Empaque	Altura de Empaque
2340	GP-193	1 5/8-12	(4 41/64 in) (117.8 mm)	(10 11/32 in) (262.7 mm)			(4 9/32 in) (108.7 mm)	(3 25/32 in) (96 mm)	(3/8 in) (9.5 mm)
2006	GP-3001	2 1/4-12	(4 19/32 in) (116.6 mm)	(11 13/32 in) (289.7 mm)			(4 5/8 in) (117.5 mm)	(3 61/64 in) (100.4 mm)	(15/64 in) (6 mm)
2277	GP-3000	2 1/4-12	(4 61/64 in) (125.8 mm)	(11 23/64 in) (288.5 mm)			(4 5/8 in) (117.5 mm)	(3 61/64 in) (100.4 mm)	(15/32 in) (11.9 mm)
2211	GP-46	M18X1.5	(3 5/64 in) (78.1 mm)	(3 25/64 in) (86.1 mm)	N/D	SI	(2 27/32 in) (72.2 mm)	(2 31/64 in) (63.1 mm)	(13/64 in) (5.2 mm)
2322	GP-3980	M18X1.5	(3 5/64 in) (78.1 mm)	(4 45/64 in) (119.4 mm)	N/D	SI	(2 27/32 in) (72.2 mm)	(2 31/64 in) (63.1 mm)	(13/64 in) (5.2 mm)
2089	GP-48	M18X1.5	(3 5/64 in) (78.1 mm)	(4 45/64 in) (119.4 mm)			(2 27/32 in) (72.2 mm)	(2 31/64 in) (63.1 mm)	(13/64 in) (5.2 mm)
2689	GP-91	M20X1.5	(2 11/16 in) (68.2 mm)	(2 35/64 in) (64.6 mm)	11-17 PSI	SI	(2 27/64 in) (61.5 mm)	(1 31/32 in) (50 mm)	(11/64 in) (4.4 mm)
2462	GP-149	M20X1.5	(2 23/32 in) (69.0 mm)	(3 25/64 in) (86.1 mm)	11-17 PSI	SI	(2 29/64 in) (62.3 mm)	(2 9/64 in) (54.3 mm)	(13/64 in) (5.1 mm)
2041	GP-145	M20X1.5	(2 53/64 in) (71.8 mm)	(3 31/32 in) (100.8 mm)	12-16 PSI	SI	(2 31/64 in) (63.1 mm)	(2 11/64 in) (55.2 mm)	(15/64 in) (6 mm)
2985	GP-291	M20X1.5	(3 1/32 in) (76.9 mm)	(2 7/64 in) (53.5 mm)	11-17 PSI	SI	(2 27/32 in) (72.2 mm)	(2 31/64 in) (63.1 mm)	(13/64 in) (5.2 mm)
2990	GP-461	M20X1.5	(3 5/64 in) (78.1 mm)	(3 1/2 in) (88.9 mm)	18-22 PSI	SI	(2 51/64 in) (71 mm)	(2 7/16 in) (61.9 mm)	(13/64 in) (5.2 mm)
2145	GP-24	M20X1.5	(3 5/64 in) (78.1 mm)	(4 45/64 in) (119.4 mm)	8-12 PSI	SI	(2 27/32 in) (72.2 mm)	(2 31/64 in) (63.1 mm)	(13/64 in) (5.2 mm)
2004	GP-462	M20X1.5	(3 7/64 in) (78.9 mm)	(3 27/32 in) (97.6 mm)	18-22 PSI	SI	(2 51/64 in) (71 mm)	(2 7/16 in) (61.9 mm)	(13/64 in) (5.2 mm)
2332	GP-6811	M20X1.5	(3 19/64 in) (83.7 mm)	(2 61/64 in) (75.0 mm)	8-12 PSI	SI	(2 31/64 in) (63.1 mm)	(1 13/16 in) (46 mm)	(1/8 in) (3.2 mm)
2147	GP-42	M20X1.5	(3 5/8 in) (92.0 mm)	(3 3/16 in) (80.9 mm)	8-12 PSI	NO	(3 27/64 in) (86.9 mm)	(3 3/64 in) (77.4 mm)	(17/64 in) (6.7 mm)
2170	GP-3562	M20X1.5	(3 5/8 in) (92.0 mm)	(3 3/16 in) (80.9 mm)	8-12 PSI	SI	(2 27/32 in) (72.2 mm)	(2 31/64 in) (63.1 mm)	(13/64 in) (5.2 mm)
2146	GP-40	M20X1.5	(3 5/8 in) (92.0 mm)	(3 3/16 in) (80.9 mm)	8-12 PSI	SI	(2 27/32 in) (72.2 mm)	(2 31/64 in) (63.1 mm)	(13/64 in) (5.2 mm)
2319	GP-3985	M20X1.5	(3 5/8 in) (92.0 mm)	(3 45/64 in) (94.0 mm)	8-12 PSI	SI	(2 27/32 in) (72.2 mm)	(2 31/64 in) (63.1 mm)	(13/64 in) (5.2 mm)
2193	GP-406	M22X1.5	(2 15/16 in) (74.5 mm)	(3 1/16 in) (77.7 mm)	8-12 PSI	SI	(2 3/4 in) (69.8 mm)	(2 3/8 in) (60.3 mm)	(1/4 in) (6.3 mm)
2168	GP-3531 EXP	M22X1.5	(3 5/8 in) (92.0 mm)	(3 3/16 in) (80.9 mm)	8-12 PSI	SI	(2 27/32 in) (72.2 mm)	(2 31/64 in) (63.1 mm)	(13/64 in) (5.2 mm)
2335	GP-68	M22X1.5	(3 5/8 in) (92.0 mm)	(3 45/64 in) (94.0 mm)	11-14 PSI	SI	(2 27/32 in) (72.2 mm)	(2 31/64 in) (63.1 mm)	(13/64 in) (5.2 mm)
2998	GP-452	M24X2	(3 5/64 in) (78.1 mm)	(7 31/64 in) (190.1 mm)	36-38 PSI	SI	(2 13/16 in) (71.4 mm)	(2 15/32 in) (62.7 mm)	(13/64 in) (5.2 mm)
2934	GP-642	M26X1.5	(3 11/16 in) (93.6 mm)	(7 1/8 in) (180.9 mm)	N/D	SI	(2 51/64 in) (71 mm)	(2 7/16 in) (61.9 mm)	(13/64 in) (5.2 mm)
2122	GP-112	M26x1.5	(3 25/32 in) (96.0 mm)	(4 13/32 in) (111.9 mm)	14 PSI				
2134	GP-737	M27X2.0	(3 21/32 in) (92.8 mm)	(6 13/16 in) (173.0 mm)			(2 3/4 in) (69.8 mm)	(2 7/16 in) (61.9 mm)	(13/64 in) (5.2 mm)
2543	GP-152	M36X1.5	(4 59/64 in) (125.0 mm)	(12 3/16 in) (309.5 mm)	32-34 PSI	NO	(4 9/16 in) (115.9 mm)	(3 29/32 in) (99.2 mm)	(23/64 in) (9.1 mm)
2947	GP-9001	M95X2.5	(4 21/32 in) (118.2 mm)	(11 23/32 in) (297.6 mm)			(4 21/32 in) (118.3 mm)	(3 61/64 in) (100.4 mm)	(19/32 in) (15.1 mm)
2924	GP-9000	M95X2.5	(4 21/32 in) (118.2 mm)	(13 7/8 in) (352.4 mm)			(4 21/32 in) (118.3 mm)	(3 61/64 in) (100.4 mm)	(19/32 in) (15.1 mm)

Especificaciones de Filtros Sellados Para Agua (Sistema de Enfriamiento) Roscas Estándar y Milimétricas
Specifications For Water Spin-On Filters (Cooling System) Standard threads and Millimeter

Código	Filtro	Rosca	Diámetro Exterior	Altura	N° Unidades	Diámetro Exterior de Empaque	Diámetro Interior de Empaque	Altura de Empaque
2320	GP-2071W	11/16-16	(3 5/8 in) (92.0 mm)	(4 15/64 in) (107.5 mm)	4	(2 27/32 in) (72.2 mm)	(2 31/64 in) (63.1 mm)	(13/64 in) (5.2 mm)
2518	GP-1012Q	11/16-16	(3 5/8 in) (92.0 mm)	(5 13/32 in) (137.3 mm)	12	(2 27/32 in) (72.2 mm)	(2 31/64 in) (63.1 mm)	(13/64 in) (5.2 mm)
2037	GP-1010Q	11/16-16	(3 5/8 in) (92.0 mm)	(5 13/32 in) (137.3 mm)	6	(2 27/32 in) (72.2 mm)	(2 31/64 in) (63.1 mm)	(13/64 in) (5.2 mm)
2141	GP-1011Q	11/16-16	(3 5/8 in) (92.0 mm)	(5 13/32 in) (137.3 mm)	8	(2 27/32 in) (72.2 mm)	(2 31/64 in) (63.1 mm)	(13/64 in) (5.2 mm)
2088	GP-1013Q	11/16-16	(3 5/8 in) (92.0 mm)	(7 17/32 in) (191.2 mm)	16	(2 27/32 in) (72.2 mm)	(2 31/64 in) (63.1 mm)	(13/64 in) (5.2 mm)
2272	GP-2077W	11/16-16	(3 25/32 in) (96.0 mm)	(5 13/32 in) (137.3 mm)	0	(2 53/64 in) (71.8 mm)	(2 15/32 in) (62.7 mm)	(7/32 in) (5.6 mm)
2304	GP-2015W	3/4-20	(3 5/8 in) (92.0 mm)	(5 13/32 in) (137.3 mm)	8	(2 27/32 in) (72.2 mm)	(2 31/64 in) (63.1 mm)	(13/64 in) (5.2 mm)
2318	GP-2022W	1-16	(4 17/64 in) (108.3 mm)	(5 33/64 in) (140.0 mm)	12	(3 31/32 in) (100.8 mm)	(3 35/64 in) (90.1 mm)	(19/64 in) (7.5 mm)
2058	GP-2108W	M16X1.5	(3 11/16 in) (93.6 mm)	(5 7/16 in) (138.1 mm)	8	(2 21/64 in) (59.1 mm)	(2 21/64 in) (59.1 mm)	(1/4 in) (6.4 mm)
2011	GP-2127W	M36X2.0	(3 3/4 in) (95.2 mm)	(5 15/32 in) (138.9 mm)	0	(3 23/32 in) (94.5 mm)	(3 11/64 in) (80.6 mm)	(3/16 in) (4.8 mm)
2927	GP-2126Q	M36X2.0	(3 3/4 in) (95.2 mm)	(5 15/32 in) (138.9 mm)	11	(3 23/32 in) (94.5 mm)	(3 11/64 in) (80.6 mm)	(3/16 in) (4.8 mm)

Especificaciones de Filtros Sellados para Diesel (Roscas Estándar y Milimétricas)
 Specification for Diesel Spin-On Filters (Standard threads and Millimeter)



Código	Filtro	Rosca	Diámetro Exterior	Altura	Posición	Purgador	Diámetro Exterior de Empaque	Diámetro Interior de Empaque	Altura de Empaque
2297	GPP-523	3/4-16	(3 9/32 in) (83.4 mm)	(6 13/16 in) (173.1 mm)	Individual	SI			
2095	GP-93	13/16-12	(3 5/8 in) (92.0 mm)	(4 15/64 in) (107.5 mm)	Secundario	NO	(3 27/64 in) (86.9 mm)	(3 3/64 in) (77.4 mm)	(17/64 in) (6.7 mm)
2030	GP-27	13/16-12	(3 5/8 in) (92.0 mm)	(7 17/32 in) (191.2 mm)	Secundario	NO	(3 27/64 in) (86.9 mm)	(3 3/64 in) (77.4 mm)	(17/64 in) (6.7 mm)
2363	GPP-18	13/16-18	(3 5/8 in) (92.0 mm)	(4 19/32 in) (116.6 mm)	Primario	SI	(2 27/32 in) (72.2 mm)	(2 31/64 in) (63.1 mm)	(13/64 in) (5.2 mm)
2200	GP-83	13/16-18	(4 3/8 in) (111.1 mm)	(7 29/32 in) (200.8 mm)	Primario	NO	(2 53/64 in) (71.8 mm)	(2 15/32 in) (62.7 mm)	(7/32 in) (5.6 mm)
2086	GP-62	7/8-14	(3 5/8 in) (92.0 mm)	(5 13/32 in) (137.3 mm)	Secundario	NO	(2 27/32 in) (72.2 mm)	(2 31/64 in) (63.1 mm)	(13/64 in) (5.2 mm)
2119	GP-1109	7/8-14	(3 5/8 in) (92.0 mm)	(7 17/32 in) (191.2 mm)	Primario	NO	(2 27/32 in) (72.2 mm)	(2 31/64 in) (63.1 mm)	(13/64 in) (5.2 mm)
2106	GP-1107	7/8-14	(3 5/8 in) (92.0 mm)	(7 17/32 in) (191.2 mm)	Secundario	NO	(2 27/32 in) (72.2 mm)	(2 31/64 in) (63.1 mm)	(13/64 in) (5.2 mm)
2426	GP-155	7/8-14	(4 17/64 in) (108.3 mm)	(4 41/64 in) (117.8 mm)	Individual	NO	(2 27/32 in) (72.2 mm)	(2 31/64 in) (63.1 mm)	(13/64 in) (5.2 mm)
2427	GP-78	7/8-14	(4 17/64 in) (108.3 mm)	(7 7/64 in) (180.5 mm)	Secundario	NO	(2 27/32 in) (72.2 mm)	(2 31/64 in) (63.1 mm)	(13/64 in) (5.2 mm)
2201	GP-84	7/8-16	(4 3/8 in) (111.1 mm)	(7 7/8 in) (200.0 mm)	Secundario	NO	(2 53/64 in) (71.8 mm)	(2 15/32 in) (62.7 mm)	(7/32 in) (5.6 mm)
2389	GPP-19	15/16-16	(3 5/8 in) (92.0 mm)	(4 19/32 in) (116.6 mm)	Secundario	SI	(2 27/32 in) (72.2 mm)	(2 31/64 in) (63.1 mm)	(13/64 in) (5.2 mm)
2094	GP-92	1-12	(3 5/8 in) (92.0 mm)	(5 13/32 in) (137.3 mm)	Primario	NO	(3 27/64 in) (86.9 mm)	(3 3/64 in) (77.4 mm)	(17/64 in) (6.7 mm)
2029	GP-26	1-12	(3 5/8 in) (92.0 mm)	(7 17/32 in) (191.2 mm)	Primario	NO	(3 27/64 in) (86.9 mm)	(3 3/64 in) (77.4 mm)	(17/64 in) (6.7 mm)
38034	S 3202	1-12	(3 53/64 in) (97.2 mm)	(7 13/32 in) (188.1 mm)	Individual	NO			
2111	GPP-1060	1-12	(4 5/16 in) (109.5 mm)	(9 1/2 in) (241.3 mm)	Individual	SI	(4 1/16 in) (103.2 mm)	(3 5/8 in) (92.1 mm)	(1/16 in) (1.6 mm)
2039	GP-1101	1-14	(3 5/8 in) (92.0 mm)	(5 17/32 in) (140.4 mm)	Individual	NO	(2 27/32 in) (72.2 mm)	(2 31/64 in) (63.1 mm)	(13/64 in) (5.2 mm)
2017	GPP-14	1-14	(3 5/8 in) (92.0 mm)	(5 3/4 in) (146.0 mm)	Individual	SI	(2 27/32 in) (72.2 mm)	(2 31/64 in) (63.1 mm)	(13/64 in) (5.2 mm)
2544	GPP-103	1-14	(3 5/8 in) (92.0 mm)	(6 21/32 in) (169.0 mm)	Secundario	SI	(2 27/32 in) (72.2 mm)	(2 31/64 in) (63.1 mm)	(13/64 in) (5.2 mm)
2105	GP-1105	1-14	(3 5/8 in) (92.0 mm)	(6 43/64 in) (169.4 mm)	Primario	NO	(2 27/32 in) (72.2 mm)	(2 31/64 in) (63.1 mm)	(13/64 in) (5.2 mm)
2140	GP-110	1-14	(3 5/8 in) (92.0 mm)	(7 1/8 in) (180.9 mm)	Individual	NO	(2 27/32 in) (72.2 mm)	(2 31/64 in) (63.1 mm)	(1/4 in) (6.4 mm)
2127	GPP-11	1-14	(3 5/8 in) (92.0 mm)	(7 7/32 in) (183.3 mm)	Primario	SI	(2 27/32 in) (72.2 mm)	(2 31/64 in) (63.1 mm)	(13/64 in) (5.2 mm)
2010	GP-11	1-14	(3 5/8 in) (92.0 mm)	(7 17/32 in) (191.2 mm)	Primario	NO	(2 27/32 in) (72.2 mm)	(2 31/64 in) (63.1 mm)	(13/64 in) (5.2 mm)
2117	GP-1108	1-14	(3 5/8 in) (92.0 mm)	(7 17/32 in) (191.2 mm)	Primario	NO	(2 27/32 in) (72.2 mm)	(2 31/64 in) (63.1 mm)	(13/64 in) (5.2 mm)
2925	GPP-1000	1-14	(3 11/16 in) (93.6 mm)	(9 17/32 in) (242.0 mm)	Individual	SI	(2 13/16 in) (71.4 mm)	(2 29/64 in) (62.3 mm)	(13/64 in) (5.2 mm)
2951	GPP-1022S	1-14	(3 11/16 in) (93.6 mm)	(9 3/4 in) (247.6 mm)	Individual	SI	(2 13/16 in) (71.4 mm)	(2 29/64 in) (62.3 mm)	(13/64 in) (5.2 mm)
2949	GPP-1003S	1-14	(3 11/16 in) (93.6 mm)	(9 13/16 in) (249.2 mm)	Individual	SI	(2 13/16 in) (71.4 mm)	(2 29/64 in) (62.3 mm)	(13/64 in) (5.2 mm)
2012	GP-749	1-14	(3 11/16 in) (93.6 mm)	(10 1/2 in) (266.7 mm)	Individual	NO	(2 13/16 in) (71.4 mm)	(2 29/64 in) (62.3 mm)	(13/64 in) (5.2 mm)
2197	GP-1224	1-14	(4 1/4 in) (107.9 mm)	(5 29/32 in) (150.0 mm)	Individual	NO	(3 31/32 in) (100.7 mm)	(3 19/32 in) (91.2 mm)	(1/4 in) (6.3 mm)
2073	GPP-547	1-14	(4 1/4 in) (107.9 mm)	(6 21/32 in) (169.0 mm)	Individual	SI	(3 31/32 in) (100.8 mm)	(3 19/32 in) (91.3 mm)	(1/4 in) (6.3 mm)
2953	GPP-1287	1-14	(4 1/4 in) (107.9 mm)	(7 1/16 in) (179.3 mm)	Individual	SI	(3 31/32 in) (100.8 mm)	(3 19/32 in) (91.3 mm)	(1/4 in) (6.3 mm)
2926	GPP-1291	1-14	(4 1/4 in) (107.9 mm)	(8 9/16 in) (217.4 mm)	Individual	SI	(3 31/32 in) (100.8 mm)	(3 19/32 in) (91.3 mm)	(1/4 in) (6.3 mm)
2191	GP-1061	1-14	(4 1/4 in) (107.9 mm)	(10 27/32 in) (275.4 mm)	Individual	SI	(4 3/32 in) (103.9 mm)	(3 37/64 in) (90.8 mm)	(1/16 in) (1.6 mm)
2112	GP-56	1-14	(4 17/64 in) (108.3 mm)	(10 3/8 in) (263.5 mm)	Individual	NO	(2 27/32 in) (72.2 mm)	(2 31/64 in) (63.1 mm)	(13/64 in) (5.2 mm)
38046	R120P	1-14	(4 9/32 in) (108.7 mm)	(8 45/64 in) (221.0 mm)	Individual	NO			
38063	PFF831	1-14	(4 19/64 in) (109.1 mm)	(5 1/2 in) (139.7 mm)	Individual	NO			
2937	GP-458	1-14	(4 3/8 in) (111.1 mm)	(5 15/16 in) (150.8 mm)	Individual	NO	(3 35/64 in) (90.1 mm)	(3 5/32 in) (80.2 mm)	(7/32 in) (5.6 mm)
2202	GP-85	1 1/16-16	(4 1/4 in) (107.9 mm)	(10 5/16 in) (261.9 mm)	Secundario	NO	(3 31/32 in) (100.8 mm)	(3 35/64 in) (90.1 mm)	(1/4 in) (6.3 mm)
2091	GP-55	1 1/4-12	(5 5/64 in) (128.9 mm)	(11 15/32 in) (291.3 mm)	Individual	NO	(4 5/32 in) (105.6 mm)	(3 5/8 in) (92.1 mm)	(5/16 in) (7.9 mm)
2100	GPP-1122	M16X1.5	(2 15/16 in) (74.6 mm)	(5 1/32 in) (127.7 mm)	Secundario	SI	(2 47/64 in) (69.5 mm)	(2 13/32 in) (61.1 mm)	(15/64 in) (6 mm)
2096	GP-1122	M16X1.5	(2 31/32 in) (75.4 mm)	(4 41/64 in) (117.8 mm)	Primario	NO	(2 47/64 in) (69.5 mm)	(2 13/32 in) (61.1 mm)	(15/64 in) (6 mm)
2007	GP-1232	M16X2.5	(3 1/16 in) (77.7 mm)	(4 13/16 in) (122.2 mm)	Individual	NO	(2 51/64 in) (71 mm)	(2 15/32 in) (62.7 mm)	(1/4 in) (6.3 mm)
2038	GP-96	M18X1.5	(3 11/16 in) (93.6 mm)	(8 1/8 in) (206.3 mm)	Individual	NO	(2 13/16 in) (71.4 mm)	(2 29/64 in) (62.3 mm)	(13/64 in) (5.2 mm)
2133	GP-548	M20X1.5	(3 11/16 in) (93.6 mm)	(7 1/8 in) (180.9 mm)	Individual	NO	(2 13/16 in) (71.4 mm)	(2 15/32 in) (62.7 mm)	(13/64 in) (5.2 mm)
2209	GPP-524	M20X1.5	(3 9/16 in) (90.4 mm)	(5 7/16 in) (138.0 mm)	Individual	SI			
2132	GPP-111	M20X1.5	(3 7/8 in) (98.4 mm)	(5 3/8 in) (136.5 mm)	Individual	SI			
2950	GPP-1007S	M85X2.0	(4 21/32 in) (118.2 mm)	(11 1/2 in) (292.1 mm)	Individual	SI	(4 43/64 in) (118.7 mm)	(4 in) (101.6 mm)	(9/16 in) (14.3 mm)
2932	GPP-420	NO APLICA	(3 9/32 in) (83.3 mm)	(4 7/16 in) (112.7 mm)	Secundario	SI	NO APLICA	NO APLICA	NO APLICA
2930	GPP-418	NO APLICA	(3 9/32 in) (83.3 mm)	(5 3/16 in) (131.7 mm)	Secundario	SI	NO APLICA	NO APLICA	NO APLICA
2130	GPP-425	NO APLICA	(3 9/32 in) (83.3 mm)	(5 7/32 in) (132.5 mm)	Primario	SI	NO APLICA	NO APLICA	NO APLICA
2931	GPP-419	NO APLICA	(3 9/32 in) (83.3 mm)	(5 15/16 in) (150.8 mm)	Secundario	SI	NO APLICA	NO APLICA	NO APLICA
2128	GPP-424	NO APLICA	(3 9/32 in) (83.3 mm)	(5 31/32 in) (151.6 mm)	Primario	SI	NO APLICA	NO APLICA	NO APLICA
2129	GPP-421	NO APLICA	(3 9/32 in) (83.3 mm)	(5 31/32 in) (151.6 mm)	Primario	SI	NO APLICA	NO APLICA	NO APLICA
2080	GPP-426	NO APLICA	(3 9/32 in) (83.3 mm)	(7 5/8 in) (193.6 mm)	Primario	SI	NO APLICA	NO APLICA	NO APLICA
2076	GPP-423	NO APLICA	(3 9/32 in) (83.3 mm)	(7 5/8 in) (193.6 mm)	Secundario	SI	NO APLICA	NO APLICA	NO APLICA

Especificaciones de Filtros tipo Cartucho para Aceite

Specifications of cartridge type oil filters

Diámetro Exterior		Diámetro Interior		Altura		Filtro	Diámetro Exterior		Diámetro Interior		Altura		Filtro
in	mm	in	mm	in	mm	GONHER	in	mm	in	mm	in	mm	GONHER
2 1/16	52.3	7/8	22.2	3 5/64	78.1	G-910	3 17/32	89.6	1 1/4	31.7	5 9/16	141.2	G-200
2 9/32	57.9	45/64	17.8	3 7/8	98.4	G-225	3 17/32	89.6	1 1/4	31.7	8 9/16	217.4	G-34
2 9/32	57.9	45/64	17.8	3 15/16	100.0	G-162H	3 35/64	90.0	31/32	24.6	3 25/64	86.1	G-932
2 5/16	58.7	7/8	22.2	5 19/32	142.0	G-141	3 3/4	95.2	2 1/2	63.5	9	228.6	G-409
2 7/16	61.9	29/32	23.0	6 1/4	158.7	G-971	3 27/32	97.6	13/16	20.6	4 53/64	122.6	G-6
2 1/4	63.5	57/64	22.6	3 1/32	76.9	G-45	3 27/32	97.6	1 13/32	35.7	3 15/16	100.0	G-836
2 1/2	63.5	1 7/32	30.9	4 17/32	115.0	G-918	3 27/32	97.6	1 13/32	35.7	4 11/16	119.0	G-834
2 33/64	63.8	3/4	19.0	5 3/8	136.5	G-801	3 27/32	97.6	1 13/32	35.7	6 3/16	157.1	G-833
2 33/64	63.8	63/64	25.0	4 1/32	102.3	G-975	3 27/32	97.6	1 5/8	41.2	5 9/16	141.2	G-335
2 33/64	63.8	1 9/64	28.9	2 23/32	69.0	G-341	3 27/32	97.6	1 5/8	41.2	9 9/64	232.1	G-191
2 17/32	64.2	1 1/4	31.7	3 1/2	88.9	G-49	3 27/32	97.6	2 7/32	56.3	9 7/32	234.1	G-152
2 35/64	64.6	1 9/64	28.9	4 35/64	115.4	G-180	4 19/64	109.1	35/64	13.8	9 33/64	241.6	G-133
2 9/16	65.0	1	25.4	2 61/64	75.0	G-70	4 19/64	109.1	35/64	13.8	9 43/64	245.6	G-989
2 5/8	66.6	1 7/32	30.9	4 15/16	125.4	G-313	4 19/64	109.1	43/64	17.0	7 13/16	198.4	G-31
2 43/64	67.9	21/32	16.7	6 3/16	157.2	G-3753	4 19/64	109.1	1 25/64	35.3	9	228.6	G-33
2 13/16	71.4	51/64	20.2	4 7/16	112.7	G-813	4 19/64	109.1	1 27/64	36.1	5 9/16	141.2	G-119
2 13/16	71.4	1 9/64	28.9	5 37/64	141.6	G-466	4 9/16	115.8	2 7/32	56.3	7 31/32	202.4	G-339H
2 13/16	71.4	1 21/64	33.7	3 3/8	85.7	G-816	4 37/64	116.2	49/64	19.4	4 27/32	123.0	G-5000
2 13/16	71.4	1 21/64	33.7	5 3/8	136.5	G-870	4 37/64	116.2	51/64	20.2	9	228.6	G-926
2 13/16	71.4	1 21/64	33.7	6	152.4	G-871	4 37/64	116.2	2 3/16	55.5	4 27/32	123.0	G-333
2 13/16	71.4	1 29/32	48.4	5 31/32	151.6	G-24	4 37/64	116.2	2 13/64	55.9	5 5/16	134.9	G-331
3 3/64	77.4	61/64	24.2	2 61/64	75.0	G-25	4 37/64	116.2	2 1/4	57.1	6 49/64	171.8	G-163
3 1/8	79.3	63/64	25.0	6 5/16	160.3	G-984	4 37/64	116.2	2 1/4	57.1	9 49/64	248.0	G-143
3 3/16	80.9	49/64	19.4	4 5/64	103.5	G-236	4 3/4	120.6	7/8	22.2	4 1/32	102.3	G-159
3 3/16	80.9	49/64	19.4	4 53/64	122.6	G-330	4 3/4	120.6	1 1/2	38.1	7 3/8	187.3	G-613
3 3/16	80.9	1 3/32	27.7	4 15/32	113.5	G-963	4 3/4	120.6	1 1/2	38.1	9 1/2	241.3	G-566
3 13/64	81.3	1 5/8	41.2	6 29/64	163.9	G-139	4 61/64	125.8	3 19/64	83.7	6 1/16	153.9	G-122
3 1/4	82.5	1 9/16	39.6	4 1/8	104.7	G-954	4 61/64	125.8	3 19/64	83.7	8 15/16	227.0	G-238
3 17/64	82.9	3/8	9.5	5 61/64	151.2	G-3827	4 63/64	126.6	3 19/64	83.7	9 1/62	229.0	G-222
3 17/64	82.9	3/8	9.5	8 11/32	211.9	G-3754	5 5/64	128.9	2 29/32	73.8	6 5/64	154.3	G-338
3 17/64	82.9	1 1/2	38.1	4 3/8	111.1	G-112	6 55/64	174.2	3 15/16	100.0	9 1/64	228.9	G-153
3 9/32	83.3	3/8	9.5	6 11/16	169.8	G-3752	7 39/64	193.2	7/8	22.2	10 1/16	255.5	G-500
3 3/8	85.7	1 3/8	34.9	3 7/8	98.4	G-638	7 39/64	193.2	7/8	22.2	14 13/16	376.2	G-750
3 17/32	89.6	7/8	22.2	2 53/64	71.8	G-169							

Especificaciones de Filtros tipo Cartucho para Diesel

Specifications of cartridge type filters for Diesel

Diámetro Exterior		Diámetro Interior		Altura		Filtro	Diámetro Exterior		Diámetro Interior		Altura		Filtro
in	mm	in	mm	in	mm	GONHER	in	mm	in	mm	in	mm	GONHER
2 1/16	52.3	7/16	11.1	4 3/4	120.6	G-1120	3 3/8	85.7	13/16	20.6	4 3/32	103.9	GS-1261
2 5/16	58.7	15/16	22.3	2 19/32	65.8	G-1047 (secundario)	3 17/32	89.6	1 1/4	31.7	4 5/16	109.5	G-1163
2 21/32	67.4	17/64	6.7	4 17/32	115.0	G-1121	3 17/32	89.6	1 1/4	31.7	6 21/64	160.7	G-1166
2 21/32	67.4	17/64	6.7	4 17/32	115.0	G-1121F	3 39/64	91.6	33/64	13.0	4 5/64	103.5	G-1046
2 13/16	71.4	1 11/32	26.1	3 1/4	82.5	G-11816	3 3/4	95.2	21/32	16.6	6 29/32	175.4	G-128
2 31/32	75.4	1 7/64	28.1	3 1/4	82.5	G-1173	3 53/64	97.2	59/64	23.4	4 31/64	113.9	G-179
2 31/32	75.4	1 7/64	28.1	5 3/16	131.7	G-1174	4 21/64	109.9	21/32	16.6	4 29/32	124.6	GS-2034
2 31/32	75.4	1 7/64	28.1	7 3/8	187.3	G-1175	4 21/64	109.9	21/32	16.6	9 29/32	251.6	GS-2033
2 31/32	75.4	1 7/64	28.1	7 3/4	196.8	G-1176	4 11/32	110.3	21/32	16.6	6 1/2	165.1	G-559
3 5/64	78.1	17/64	6.7	5 49/64	146.4	G-1123	4 23/32	119.9	21/32	16.7	6 15/32	164.3	GS-557
3 5/64	78.1	17/64	6.7	5 49/64	146.4	G-1123F	4 53/64	122.6	35/64	13.8	3 3/8	85.7	G-862
3 3/16	80.9	49/64	19.4	4 13/16	122.2	GS-1133	4 7/8	123.8	9/16	14.2	4 17/32	115.0	G-178
3 3/16	80.9	49/64	19.4	7 5/8	193.6	GC-1133	6 1/16	153.9	31/32	24.6	9 49/64	248.0	G-1143
3 11/32	84.9	1 9/16	39.6	4 3/16	106.3	G-1047 (primario)							

Especificaciones de Filtros tipo Circulares para Aire

Specifications for Air Filters Circular type



Diámetro Exterior		Diámetro Interior		Altura		Filtro	Diámetro Exterior		Diámetro Interior		Altura		Filtro
in	mm	in	mm	in	mm	GONHER	in	mm	in	mm	in	mm	GONHER
2 47/64	69.4	1 5/32	29.3	1 3/16	30.1	GA-135	7 39/64	193.2	6 1/32	153.1	15 49/64	400.4	GA-108
3	76.2	1 11/16	42.8	2 35/64	64.6	GA-39	7 5/8	193.6	6 1/16	153.9	18 3/8	466.7	GA-759
3 3/64	77.3	1 25/64	35.3	1 3/8	34.9	GA-35	7 41/64	194.0	6 1/16	153.9	2 13/64	55.9	GA-2122
3 37/64	90.8	1 31/32	49.9	5 5/16	134.9	GA-2136	7 13/16	198.4	3 15/32	88.1	13 1/2	342.9	GAK-458
3 5/8	92.0	2 13/32	61.1	11 5/32	283.3	GA-416	7 13/16	198.4	3 5/8	92.0	5 3/16	131.7	GA-782
3 5/8	92.0	2 15/16	74.6	13 27/32	351.6	GA-588	7 29/32	200.8	3 1/2	88.9	10 3/8	263.5	GAK-20
3 25/32	96.0	2 21/32	67.4	11 3/8	288.9	GA-1284	7 29/32	200.8	3 1/2	88.9	10 13/32	264.3	GA-20
3 25/32	96.0	2 15/16	74.6	12 1/16	306.3	GA-459	8	203.2	6 7/16	163.5	3 1/64	76.5	GA-71
3 27/32	97.6	2 59/64	74.2	14 1/32	356.3	GA-892	8 1/32	203.9	5 3/64	128.1	14 13/16	376.2	GA-798R
3 7/8	98.4	3 9/64	79.7	13 1/8	333.3	GA-426	8 5/64	205.1	5 19/64	134.5	6 55/64	174.2	GA-362
4 1/16	103.1	2 15/32	62.7	10 1/4	260.3	GA-33	8 1/8	206.3	3 15/16	100.0	24 3/32	611.9	GA-388
4 1/8	104.7	2 21/32	67.4	10 5/32	257.9	GA-888R	8 5/32	207.1	4 23/64	110.7	7 59/64	201.2	GA-1615
4 9/64	105.1	2 3/64	51.9	12 1/4	311.1	GA-288R	8 3/8	212.7	4 11/16	119.0	16 7/16	417.5	GA-697R
4 9/64	105.1	3	76.2	10 53/64	275.0	GA-880R	8 13/32	213.5	4 1/32	102.3	10 1/2	266.7	GA-1008
4 1/4	107.9	2 1/32	51.5	3 3/4	95.2	GA-42	8 13/32	213.5	6 37/64	167.0	3 9/32	83.3	GA-80
4 11/32	110.3	2 63/64	75.8	3 21/64	84.5	GA-44	8 15/32	215.1	6 11/64	156.7	17 41/64	448.0	GA-6127
4 23/64	110.7	2 63/64	75.8	1 39/64	40.8	GA-11	8 1/2	215.9	6 59/64	175.8	2 31/64	63.1	GA-3647
4 23/64	110.7	2 63/64	75.8	2 19/64	58.3	GA-12	8 5/8	219.0	7 1/16	179.3	17	431.8	GA-357
4 13/32	111.9	2 15/16	74.6	5 3/4	146.0	GA-3445	8 43/64	220.2	5 11/64	131.3	15 7/8	403.2	GA-373
4 1/2	114.3	2 1/4	57.1	10 11/64	258.3	GA-18	8 43/64	220.2	5 11/64	131.3	29 1/32	737.3	GA-372
4 37/64	116.2	3 15/32	88.1	12 31/32	329.4	GA-361	8 25/32	223.0	7 9/32	184.9	2 1/4	57.1	GA-3814
4 11/16	119.0	3 61/64	100.4	14 3/16	360.3	GA-680	8 27/32	224.6	6 61/64	176.6	2 1/32	51.5	GAD-3
4 25/32	121.4	3 21/32	92.8	13 3/8	339.7	GA-1285	8 843	224.6	7 125	180.9	16 7/16	424.6	GA-770R
4 7/8	123.8	4 7/8	123.8	5 29/32	150.0	GA-2181	8 7/8	225.4	5 5/8	142.8	14 3/8	365.1	GA-299
4 61/64	125.8	2 15/32	62.7	11 31/64	291.7	GA-49	9 1/32	229.3	5 45/64	144.8	16 1/2	419.1	GA-826
4 31/32	126.2	2 3/4	69.8	7 3/32	180.1	GAD-29	9 3/32	230.9	4 13/16	122.2	17 7/32	437.3	GA-679
4 31/32	126.2	2 57/64	73.4	6 11/32	161.1	GAD-30	9 1/8	231.7	5 13/16	147.6	18 11/16	474.6	GA-616
5	127.0	3 5/32	80.1	6 17/64	159.1	GA-183R	9 5/32	232.5	4 5/8	117.4	12 1/2	317.5	GA-499R
5	127.0	3 3/8	85.7	6 13/16	173.0	GA-218	9 3/16	233.3	4 7/8	123.8	10 1/2	266.7	GA-24
5	127.0	3 3/8	85.7	8 1/2	215.9	GA-219	9 3/16	233.3	9 31/32	253.2	2 3/16	55.5	GA-349
5	127.0	4 11/64	105.9	14 63/64	380.6	GA-809R	9 7/32	234.1	4 27/32	123.0	12 1/4	317.5	GA-8047
5 1/16	128.5	3 13/64	81.3	6 21/32	169.0	GA-200	9 7/32	234.1	4 27/32	123.0	13 1/2	342.9	GA-360
5 3/32	129.3	4 11/64	105.9	15 19/64	388.5	GA-905R	9 1/4	234.9	5 5/16	134.9	11 1/2	292.1	GA-633R
5 1/4	133.3	2 3/8	60.3	11 3/32	281.7	GAD-34	9 9/32	235.7	3 5/8	92.0	12 11/32	313.5	GA-781
5 1/4	133.3	4 15/64	107.5	17 1/2	444.5	GA-967R	9 21/64	236.9	5 61/64	151.2	23 17/32	597.6	GA-518R
5 19/64	134.5	11 19/64	286.9	11 19/64	286.9	GAK-16	9 25/64	238.5	5 3/16	131.7	12 3/4	323.8	GA-197R
5 19/64	134.5	2 5/8	66.6	11 3/8	288.9	GA-16	9 25/64	238.5	5 3/16	131.7	18 63/64	482.2	GA-966R
5 19/64	134.5	12 13/16	71.4	15 3/32	383.3	GA-404	9 15/32	240.5	5 37/64	141.6	16 1/2	419.1	GA-801R
5 19/64	134.5	3 1/4	82.5	12 3/8	314.3	GAK-216	9 1/2	241.3	5 13/64	132.1	19 31/64	494.9	GA-405
5 5/16	134.9	3 45/64	94.0	12 3/64	305.9	GA-768R	9 1/2	241.3	5 13/64	132.1	19 35/64	496.4	GA-436
5 11/32	135.7	3 5/32	80.1	13 3/64	331.3	GA-413R	9 37/64	243.2	5	127.0	6 17/64	159.1	GA-21
5 15/32	138.9	3 15/64	82.1	6 27/32	173.8	GA-184	9 43/64	245.6	8 3/32	205.5	2 9/64	54.3	GA-3637
5 31/64	139.3	4 35/64	115.4	6 1/2	165.1	GA-2160	9 43/64	245.6	8 7/64	205.9	1 61/64	49.6	GA-50
5 37/64	141.6	4 27/64	112.3	15 37/64	395.6	GA-827	9 43/64	245.6	8 7/64	205.9	2 17/64	57.5	GA-77
5 5/8	142.8	4 43/64	118.6	15 11/16	398.4	GA-802R	9 43/64	245.6	8 7/64	205.9	2 55/64	72.6	GA-3588
5 5/8	142.8	5 1/32	127.7	17 15/64	437.7	GA-804R	9 43/64	245.6	8 7/64	205.9	3 5/64	78.1	GA-90
5 41/64	143.2	3 21/32	92.8	4 29/32	124.6	GA-153	9 43/64	245.6	8 7/64	205.9	3 35/64	90.0	GA-192
5 41/64	143.2	3 21/32	92.8	5 31/32	151.6	GA-253	9 23/32	246.8	7 23/32	196.0	2 31/64	63.1	GA-230
5 21/32	143.6	2 11/32	59.5	6 37/64	167.0	GA-278R	9 7/8	250.8	7 3/4	196.8	1 23/32	43.6	GA-4958
5 11/16	144.4	4 37/64	116.2	17 1/2	444.5	GA-398	9 7/8	250.8	7 3/4	196.8	2	50.8	GA-3490
5 3/4	146.0	4 5/64	103.5	2 29/64	62.3	GA-8	9 7/8	250.8	7 3/4	196.8	2 11/32	59.5	GA-780
5 53/64	148.0	3 3/32	78.5	8 27/64	213.8	GA-415	9 29/32	251.6	5	127.0	16 21/32	423.0	GA-904R
5 7/8	149.2	4 51/64	121.8	14 7/8	377.8	GA-890R	9 29/32	251.6	12 25/32	324.6	8 1/32	203.9	GA-701
5 29/32	150.0	3 9/64	79.7	7 31/64	190.0	GA-498	9 15/16	252.4	9 15/16	252.4	2 11/64	55.2	GA-320
5 15/16	150.8	4 53/64	122.6	9 23/32	246.8	GA-119	9 61/64	252.8	5 25/64	136.9	15 29/64	392.5	GA-4863
5 15/16	150.8	4 53/64	122.6	10 3/8	263.5	GA-239	9 63/64	253.6	7 35/64	191.6	2 49/64	70.2	GA-70
5 15/16	150.8	4 53/64	122.6	13 15/16	354.0	GA-210	10	254.0	5 1/64	127.3	16 21/32	423.0	GA-808R
5 63/64	152.0	3 13/64	81.3	8 1/32	203.9	GA-414R	10	254.0	8 21/32	219.8	2 9/32	57.9	GA-3523
5 63/64	152.0	4 13/16	122.2	17 3/8	441.3	GA-907R	10 1/64	254.3	8 5/8	219.0	2 1/2	63.5	GA-3681
6 3/64	153.5	4 21/32	118.2	2 1/16	52.3	GA-7	10 1/8	257.1	7 3/4	196.8	2 1/8	53.9	GA-4321
6 3/64	153.5	5 1/32	127.7	16 1/32	407.1	GA-908R	10 1/8	257.1	7 29/32	200.8	2 1/2	63.5	GA-235
6 1/16	153.9	3 1/2	88.9	10 3/8	263.5	GA-98	10 9/64	257.5	6 1/32	153.1	13 1/2	342.9	GA-7360
6 1/16	153.9	3 1/2	88.9	12 3/8	314.3	GA-403	10 1/4	260.3	6 3/4	171.4	15 31/32	405.6	GA-799R
6 1/16	153.9	3 1/2	88.9	12 3/8	314.3	GAK-403	10 5/16	261.9	7 29/32	200.8	12	304.8	GA-37
6 1/16	153.9	3 1/2	88.9	15 3/8	390.5	GA-891	10 3/8	263.5	5 7/8	149.2	16 1/16	407.9	GA-864R
6 9/32	159.5	4 21/32	118.2	14 3/8	365.1	GA-1286	10 3/8	263.5	6 27/32	173.8	29	736.6	GA-377
6 9/32	159.5	4 21/32	118.2	17 33/64	444.8	GA-1287	10 3/8	263.5	6 27/32	173.8	29	736.6	GA-694
6 21/64	160.7	5	127.0	5 15/32	138.9	GA-250	10 13/32	264.3	6 1/32	153.1	8 1/4	209.5	GA-29
6 21/64	160.7	5	127.0	15 31/64	393.2	GA-3096R	10 13/32	264.3	6 1/32	153.1	12 1/2	317.5	GA-109
6 25/64	162.3	3 1/4	82.5	15 1/2	393.7	GAK-1532	10 13/32	264.3	6 1/32	153.1	12 1/2	317.5	GA-329
6 15/32	164.3	3 5/32	80.1	7 29/32	200.8	GA-175	10 13/32	264.3	6 1/32	153.1	16 31/64	418.7	GA-209
6 15/32	164.3	3 37/64	90.8	11 1/8	282.5	GA-673R	10 13/32	264.3	6 1/32	153.1	18 1/32	457.9	GA-509
6 15/32	164.3	5 1/8	130.1	8 3/8	212.7	GA-4828	10 13/32	264.3	6 1/32	153.1	22 3/4	577.8	GA-229
6 1/2	165.1	3 9/16	90.4	14 1/32	356.3	GA-853R	10 13/32	264.3	6 1/32	153.1	12 1/2	317.5g	GA-319
6 19/32	167.5	4 3/16	106.3	15 41/64	397.2	GA-8105	10 13/32	264.3	6 15/16	176.2	23	584.2	GA-389
6 19/32	167.5	5	127.0	3	76.2	GA-105	10 27/64	264.7	7 15/16	201.6	2 13/32	61.1	GAD-1
6 19/32	167.5	5	127.0	6 43/64	169.4	GA-259	10 7/16	265.1	8 15/16	227.0	1 7/8	47.6	GA-3536
6 5/8	168.3	1 13/32	35.7	11 11/32	288.1	GA-2804 T	10 7/16	265.1	8 15/16	227.0	2 5/16	58.7	GA-3622
6 5/8	168.3	2	50.8	10 11/32	262.7	GA-2803T	10 39/64	269.4	6 23/32	170.6	22 17/32	572.2	GA-3551
6 21/32	169.0	3 3/4	95.2										

Especificaciones de Filtros tipo Circulares para Aire

Specifications for Air Filters Circular type

Diámetro Exterior		Diámetro Interior		Altura		Filtro	Diámetro Exterior		Diámetro Interior		Altura		Filtro
in	mm	in	mm	in	mm	GONHER	in	mm	in	mm	in	mm	GONHER
11 3/32	281.7	6 23/32	170.6	12 1/2	317.5	GA-27	12 9/16	319.0	9 23/64	237.7	6 7/64	155.1	GA-442
11 3/32	281.7	6 23/32	170.6	13 1/2	342.9	GA-9334	12 23/32	323.0	8 1/2	215.9	17 39/64	447.2	GA-885
11 3/32	281.7	6 23/32	170.6	16 1/2	419.1	GA-106	12 47/64	323.4	11 1/32	280.1	2 7/64	53.5	GA-73
11 3/32	281.7	6 23/32	170.6	16 1/2	419.1	GA-326	12 47/64	323.4	11 1/32	280.1	2 51/64	71.0	GA-730
11 3/32	281.7	6 23/32	170.6	16 17/32	419.8	GA-9045	12 3/4	323.8	8 11/32	211.9	27	685.8	GA-608
11 11/64	283.7	9 7/16	239.7	1 23/32	43.6	GA-3425	12 3/4	323.8	8 3/8	212.7	11 31/64	291.7	GA-5648
11 11/64	283.7	9 7/16	239.7	1 3/4	44.4	GA-3424	12 3/4	323.8	8 3/8	212.7	23	584.2	GA-378
11 13/64	284.5	9 3/32	230.9	1 63/64	50.4	GA-74	12 3/4	323.8	8 3/8	212.7	25	635.0	GA-371
11 13/64	284.5	9 3/32	230.9	2 3/16	55.5	GA-303	12 3/4	323.8	8 3/8	212.7	27	685.8	GA-6880
11 13/64	284.5	9 3/32	230.9	2 39/64	66.2	GA-75	13	330.2	7 23/32	196.0	16 13/32	416.7	GA-435R
11 1/4	285.7	5 31/32	151.6	18 1/2	469.9	GA-906R	13	330.2	8 1/4	209.5	19 1/2	495.3	GA-624R
11 3/8	288.9	6 13/16	173.0	23 23/32	602.4	GA-539R	13 1/32	330.9	6 27/32	173.8	15 15/32	392.9	GA-682R
11 7/16	290.5	7	177.8	15 23/64	390.1	GA-482	13 3/64	331.3	1/2	12.7	2 11/32	59.5	GAD-294
11 1/2	292.1	8 3/32	205.5	13 1/2	342.9	GA-7716	13 3/32	332.5	6 25/32	172.2	18 21/32	473.8	GA-221R
11 1/2	292.1	8 19/64	210.7	5	127.0	GA-3501	13 3/32	332.5	7 3/8	187.3	25 23/32	653.2	GA-534R
11 1/2	292.1	8 19/64	210.7	7 3/64	178.9	GA-422	13 1/8	333.3	11 13/64	284.5	1 55/64	47.2	GA-272
11 19/32	294.4	8 25/32	223.0	1 19/32	40.4	GA-3566	13 1/4	336.5	11 3/8	288.9	2 1/2	63.5	GA-86
11 23/32	297.6	9 35/64	242.4	2 3/32	53.1	GA-3300	13 1/4	336.5	11 3/8	288.9	2 51/64	71.0	GA-85
11 7/8	301.6	7 1/2	190.5	18 5/8	473.0	GA-467	13 5/8	346.0	9 23/32	246.8	3 3/32	78.5	GA-129
11 29/32	302.4	6 5/8	168.2	17 19/32	446.8	GA-517R	13 3/4	349.2	11 9/16	293.6	3 1/16	77.7	GA-55
12 3/64	305.9	9 13/16	249.2	2 15/32	62.7	GA-57	13 13/16	350.8	9 1/2	241.3	16	406.4	GA-1095
12 3/64	305.9	9 13/16	249.2	3 7/16	87.3	GA-59	13 53/64	351.2	7 29/64	189.3	10 19/32	269.1	GA-642
12 3/64	305.9	9 13/16	249.2	5 7/16	138.1	GA-89	13 7/8	352.4	9 7/16	239.7	12 1/4	311.1	GA-375
12 1/16	306.3	5 11/16	144.4	15 11/16	398.4	GA-2984	13 7/8	352.4	9 7/16	239.7	18 7/32	462.7	GA-1203
12 1/16	306.3	9 13/32	238.9	2	50.8	GA-2719B	13 7/8	352.4	9 7/16	239.7	18 15/64	463.1	GA-356
12 1/16	306.4	9 7/8	250.8	16 3/32	408.8	GA-4862R	13 7/8	352.4	9 7/16	239.7	18 1/2	469.9	GA-376
12 3/32	307.1	7 23/32	196.0	13 1/2	342.9	GA-31	14 3/16	360.3	11 1/16	280.9	5 1/16	128.5	GA-155
12 3/32	307.1	7 23/32	196.0	14 1/2	368.3	GA-26	14 1/4	361.9	8 63/64	228.1	15 1/2	393.7	GA-712R
12 3/32	307.1	7 23/32	196.0	18 1/2	469.9	GA-107	14 1/4	361.9	8 63/64	228.1	18 1/8	460.3	GA-600R
12 3/32	307.1	7 23/32	196.0	18 1/2	469.9	GA-6128	14 17/32	369.0	8 12/35	211.9	9 13/16	249.2	GA-287
12 3/32	307.1	7 23/32	196.0	18 1/2	469.9	GA-6129	14 9/16	369.8	12 25/32	324.6	1 61/64	49.6	GA-735
12 3/32	307.1	7 23/32	196.0	20 1/2	520.7	GA-251	14 9/16	369.8	12 25/32	324.6	2 23/64	59.9	GA-734
12 1/8	307.9	7 11/16	195.2	19 1/2	495.3	GA-758	14 21/32	372.2	11 7/32	284.9	1 55/64	47.2	GA-140
12 21/64	313.1	7 1/4	184.1	21 1/32	534.1	GA-516R	14 45/64	373.5	10 9/32	261.1	24	609.6	GA-563
12 11/32	313.5	10 27/32	275.4	2 5/8	66.6	GA-325	17 21/32	448.5	11 11/64	283.8	23	584.2	GA-879
12 1/2	317.5	9 1/8	231.7	15	381.0	GA-483							

Especificaciones de Filtros Cuadrados y Rectangulares para Aire

Specifications Square & Rectangular Filters for Air

Largo		Ancho		Alto		Filtro	Largo		Ancho		Alto		Filtro
in	mm	in	mm	in	mm	GONHER	in	mm	in	mm	in	mm	GONHER
3 29/32	99.2	1 25/32	45.2	1 5/8	41.2	GA-100	8 63/64	228.2	6 39/64	167.8	1 7/32	30.9	GAD-17
4	101.6	1 3/4	44.4	1 7/32	30.9	GA-113	9	228.6	7 5/64	179.7	2 9/32	57.9	GA-244
4 15/32	113.5	1 19/64	32.9	2 1/2	63.5	GA-176	9	228.6	7 5/64	179.7	2 19/64	58.3	GA-224
4 15/32	113.5	1 19/64	32.9	7 3/4	196.8	GA-186	9	228.6	7 5/16	185.7	2 1/16	52.3	GA-7344
5 17/64	133.7	3 1/64	76.6	11 1/16	281.0	GA-410	9 1/64	229.0	6 17/64	159.1	1 3/16	30.2	GAC-4
5 33/64	140.1	10 1/8	257.2	5 3/8	136.5	GA-110	9 9/64	232.1	8 39/64	218.6	1 31/32	50.0	GA-606
6 43/64	169.4	6 11/64	156.7	1 3/8	34.9	GAD-315	9 5/32	232.5	5 23/64	136.1	1 11/32	34.1	GAD-116
6 59/64	175.8	5 19/32	142.0	3 5/64	78.1	GA-2158	9 1/4	234.9	7 29/32	200.8	1 13/16	46.0	GA-2106
6 15/16	176.2	5 7/16	138.1	2 15/16	74.6	GA-291	9 19/64	236.1	9 1/4	234.9	1 21/32	42.0	GA-2193
7 7/32	183.3	3 45/64	94.0	1 15/16	49.2	GAVV-10	9 21/64	236.9	8 7/16	214.3	1 35/64	39.2	GA-248
7 13/32	188.1	6 45/64	170.2	1 19/32	40.4	GA-3915	9 3/8	238.1	7 7/16	188.9	1 21/32	42.1	GA-491
7 29/64	189.3	6 43/64	169.4	2 25/32	70.6	GA-114	9 13/32	238.9	7 5/32	181.7	1 19/32	40.4	GA-164
7 9/16	192.0	7 13/16	198.4	2	50.8	GA-172	9 29/64	240.1	7 7/16	188.9	1 3/8	34.9	GAC-11
7 37/64	192.4	8 25/32	223.0	2 11/64	55.1	GA-158	9 1/2	241.3	7 1/16	179.3	1 1/2	38.1	GA-8606
7 5/8	193.6	6 1/16	153.9	1 5/8	41.2	GA-3916	9 1/2	241.3	7 3/4	196.8	1 57/64	48.0	GA-471
7 57/64	200.4	6 31/32	177.0	1 37/64	40.0	GA-274	9 9/16	242.8	7	177.8	2 17/64	57.5	GA-2114
8 1/32	203.9	7 51/64	198.0	1 3/8	34.9	GA-314	9 9/16	242.9	7 3/4	196.9	2 9/32	57.9	GA-1529
8 5/64	205.1	5 17/64	133.7	1 39/64	40.8	GA-271	9 19/32	243.6	7 29/64	189.3	2	50.8	GA-292
8 7/64	205.9	6 43/64	169.4	1 21/32	42.0	GA-2159	9 39/64	244.0	6 3/16	157.1	1 17/32	38.8	GA-595
8 9/64	206.7	8 11/32	211.9	3 13/64	81.3	GAVV-624	9 5/8	244.4	6 5/8	168.2	1 29/32	48.4	GA-215
8 9/64	206.7	8 3/8	212.7	2 13/64	55.9	GAVV-4	9 5/8	244.4	9 5/8	244.4	1 37/64	40.0	GA-275
8 11/64	207.6	7 9/32	184.9	1 11/16	42.9	GA-381	9 11/16	246.0	8 1/8	206.3	2 9/32	57.9	GA-2146
8 5/16	211.1	6 17/32	165.8	1 13/32	35.7	GA-134	9 47/64	247.2	6 39/64	167.8	1 35/64	39.2	GA-216
8 11/32	211.9	8 17/64	209.9	1 3/16	30.2	GAC-6	9 3/4	247.7	6 19/64	159.9	1 5/8	396.9	GA-465R
8 3/8	212.7	8 1/16	204.7	1 31/32	50.0	GA-607	9 51/64	248.8	6 21/32	169.0	2 1/64	51.1	GA-6690
8 13/32	213.5	5 27/32	148.4	1 9/16	39.6	GA-162 EXP	9 51/64	248.8	8 63/64	228.2	1 31/32	50.0	GA-2135
8 27/64	213.9	5 17/32	140.4	2 9/32	57.9	GA-2182	9 13/16	249.2	4 23/32	119.8	2 7/64	53.5	GA-364
8 13/16	223.8	7 23/64	186.9	1 13/16	46.0	GA-324	9 27/32	250.0	5 35/64	140.9	2 3/64	52.0	GA-604
8 55/64	225.0	4 3/8	111.1	1 3/16	30.2	GAC-13	9 27/32	250.0	8 55/64	225.0	1 15/16	49.2	GA-605
8 55/64	225.0	6 5/8	168.3	1 9/64	29.0	GA-384	9 55/64	250.4	5 31/32	151.6	1 9/16	39.6	GA-133
8 55/64	225.0	7 3/4	196.8	1 37/64	40.0	GA-340	9 7/8	250.8	8 15/32	215.1	1 17/64	32.1	GAC-3
8 7/8	225.4	7 7/16	188.9	1 1/2	38.1	GA-132	9 61/64	252.8	6 3/8	161.9	1 1/2	38.1	GA-476
8 7/8	225.4	1 5/8	193.6	1	25.4	GA-323	10	254.0	8 3/8	212.7	2 17/64	57.5	GAVV-622
8 7/8	225.4	8 7/8	225.4	1 13/32	35.7	GA-7142	10 1/64	254.3	7 1/8	180.9	1 1/2	38.1	GA-217
8 63/64	228.2	6 39/64	167.8	1 7/32	30.9	GAD-117	10 1/64	254.3	8 21/32	219.8	1 45/64	43.2	GA-280

Especificaciones de Filtros Cuadrados y Rectangulares para Aire

Specifications Square & Rectangular Filters for Air



Largo		Ancho		Alto		Filtro	Largo		Ancho		Alto		Filtro
in	mm	in	mm	in	mm	GONHER	in	mm	in	mm	in	mm	GONHER
10 1/32	254.7	7	177.8	1 17/32	38.8	GA-179	12 29/32	327.8	5 53/64	148.0	1 45/64	43.2	GA-269
10 5/64	255.9	5 57/64	149.6	2 1/4	57.1	GA-2110	13 3/16	334.9	5 9/32	134.1	1 9/16	39.6	GAVW-2
10 5/64	255.9	7 15/32	189.7	1 1/2	38.1	GA-258	13 3/16	334.9	6 13/32	162.7	1 15/32	37.3	GA-4365
10 5/64	256.0	8	203.2	1 49/64	44.8	GA-142	13 13/64	335.3	7 4/47	179.9	1 5/32	29.3	GA-2179
10 1/8	257.1	8 5/32	207.1	1 1/2	38.1	GA-2192	13 13/64	335.3	7 31/64	190.1	1 15/32	37.3	GA-2104
10 1/8	257.2	6 3/8	161.9	1 11/16	42.8	GA-492	13 13/64	335.3	7 31/64	190.1	2 17/64	57.5	GA-2175
10 9/64	257.5	8 63/65	227.8	2 1/4	57.1	GAVW-121	13 25/64	340.1	3 61/64	100.4	2 17/64	57.5	GA-2184
10 5/32	258.0	6 7/32	158.0	1 9/16	39.7	GA-434	13 7/16	341.3	5 15/32	138.9	1 49/64	44.8	GA-138
10 11/64	258.3	8 9/32	210.3	1 11/16	42.8	GA-166	13 29/64	341.7	6 15/64	158.3	1 13/16	46.0	GA-301
10 15/64	259.9	6 39/64	167.8	2 13/16	71.4	GA-180	13 15/32	342.1	5 9/16	141.2	1 59/64	48.8	GA-196
10 15/64	260.0	9 23/32	246.9	1 31/32	50.0	GA-145	13 12/32	342.9	6 21/32	169.0	1 13/16	46.0	GA-283
10 11/32	262.7	5 5/16	134.9	2 7/32	56.3	GA-363	13 1/2	342.9	7 1/16	179.3	2 3/32	53.1	GA-472
10 3/8	263.5	6 29/64	163.9	1 17/32	38.8	GA-432	13 37/64	344.8	6 45/64	170.2	1 39/64	40.8	GA-3901
10 29/64	265.5	8 35/64	217.0	2 7/32	56.3	GAVW-626	13 19/32	345.2	7 7/64	180.5	2 15/16	74.5	GA-780
10 15/32	265.8	6 47/64	171.0	1 59/64	48.7	GA-341	13 19/32	345.3	6 55/64	174.2	1 9/64	29.0	GAC-5
10 15/32	265.9	5 3/4	146.0	2 1/16	52.3	GA-168	13 21/32	346.9	5 11/16	144.4	1 1/16	27.0	GAC-1
10 31/64	266.3	9 15/16	252.4	2 41/64	67.1	GA-1542	13 47/64	348.8	4 1/8	104.7	1 39/64	40.8	GA-7017
10 31/64	266.3	9 15/16	252.4	2 41/64	67.1	GA-437	13 3/4	349.2	9 3/8	238.1	2 3/64	51.9	GA-490
10 1/2	266.7	8 23/64	212.3	2 3/4	69.8	GA-2124	13 7/8	352.4	5 1/4	133.3	1 23/32	43.6	GA-438
10 37/64	268.6	5 13/32	137.3	1 7/64	28.1	GA-281	13 31/32	354.8	6 17/32	165.8	2 7/16	61.9	GA-380
10 41/64	270.2	6 1/2	165.1	1 19/64	32.9	GA-302	13 63/64	355.2	5 19/64	134.5	1 31/32	50.0	GA-2198
10 21/32	270.6	7 15/16	201.6	1 19/32	40.4	GA-6479	14 11/32	364.3	7 1/4	184.1	2 1/64	51.1	GAVW-621
10 11/16	271.4	4 41/64	117.8	2 1/2	63.5	GA-2174	14 9/16	369.8	5 19/64	134.5	2 9/32	57.9	GA-285
10 45/64	271.8	4 41/64	117.8	1 61/64	49.6	GA-2161	14 23/32	373.9	6 13/16	173.0	2 3/4	69.9	GA-1571
10 45/64	271.8	9 43/64	245.6	1 37/64	40.0	GA-448	14 27/32	377.0	5 11/32	135.7	2 3/64	51.9	GA-293
10 23/32	272.2	6 17/64	159.1	1 19/64	32.9	GA-4303	14 7/8	377.8	14 7/8	377.8	5 1/8	130.1	GAP-381
10 49/64	273.4	6 5/8	168.2	1 3/4	44.4	GA-163	15 3/16	385.7	7 11/32	186.5	1 11/32	34.1	GA-1546
10 51/64	274.2	7 13/32	188.1	2 39/64	66.2	GA-596	15 5/8	396.8	5 29/32	150.0	1 39/64	40.8	GA-127
10 13/16	274.6	7 11/16	179.3	1 19/32	40.4	GAD-118	15 15/16	404.8	7 15/16	201.6	1 41/64	41.6	GA-392
10 53/64	275.0	5 15/64	132.9	1 19/32	40.4	GA-277	15 63/64	406.0	6 27/32	173.8	1 15/32	37.3	GAVW-617
10 7/8	276.2	7 9/32	184.9	2 1/4	57.1	GAVW-212	16 1/4	412.7	5 3/32	129.3	1 3/16	30.1	GA-284
10 15/16	277.8	9 11/32	237.3	1 15/32	37.3	GA-367	16 15/16	430.2	5 3/32	129.3	1 23/64	34.5	GAVW-625
10 63/64	279.0	8 3/64	204.3	2 7/32	56.3	GA-391	17 17/64	438.5	10 37/64	268.6	1 39/64	40.8	GA-7007
10 63/64	279.0	8 7/64	206.0	63/64	25.0	GAC-8	18 3/16	461.9	3 25/64	86.1	2 3/4	69.8	GA-2109
11 1/16	280.9	6 39/64	167.8	1 7/32	30.9	GAD-15	20 3/64	509.2	3 15/16	100.0	1 3/16	30.2	GAC-9
11 5/64	281.3	6 17/64	159.1	2 1/4	57.1	GA-2118	23 7/8	606.4	23 7/8	606.4	2	50.8	GAC-379
11 7/64	282.2	8 1/8	206.4	1 3/16	30.2	GAC-10							
11 9/64	282.9	4 19/64	109.1	1 41/64	41.6	GA-276							
11 5/32	283.3	7 13/32	188.1	1 1/2	38.1	GAVW-623							
11 5/32	283.3	7 31/64	190.1	1 23/32	43.6	GAD-129							
11 7/32	284.9	6 11/64	156.7	1 13/64	30.5	GA-273							
11 7/32	284.9	6 9/32	159.5	2 17/32	64.2	GA-183							
11 1/4	285.7	6 7/16	163.5	1 15/16	49.2	GAVW-620							
11 1/4	285.7	8 5/8	219.0	1 1/2	38.1	GA-328							
11 9/32	286.5	7 9/16	192.0	1 37/64	40.0	GA-5056							
11 9/32	286.5	7 57/64	200.4	1 1/2	38.1	GA-5057							
11 19/64	286.9	10 5/32	257.9	2 9/32	57.9	GA-2141							
11 5/16	287.3	8 15/32	215.1	1 5/16	33.3	GA-1617							
11 3/8	288.9	9 41/64	244.8	1 29/64	36.9	GA-300							
11 25/64	289.3	8 15/64	209.1	1 29/64	36.9	GA-289							
11 27/64	290.1	5 29/32	150.0	2 3/64	51.9	GA-263							
11 15/32	291.3	5 57/64	149.6	2 1/4	57.1	GA-2105							
11 31/64	291.7	8 21/64	211.5	1 9/16	39.6	GA-477							
11 1/2	292.1	7 13/32	178.5	1 21/32	42.0	GA-6626							
11 1/2	292.1	7 3/32	180.1	2 1/4	57.1	GA-395							
11 1/2	292.1	7 29/32	200.8	1 45/64	43.2	GA-464							
11 1/2	292.1	9 5/64	230.6	2 9/32	57.9	GA-143							
11 9/16	293.6	6 1/32	153.1	1 5/8	41.2	GA-165							
11 37/64	294.0	8 31/32	227.8	2 17/64	57.5	GA-2195							
11 39/64	294.8	9 1/4	234.9	1 7/16	36.5	GA-234							
11 11/16	296.8	9 3/16	233.3	1	25.4	GA-646							
11 45/64	297.2	3	76.2	1 59/64	48.8	GA-2173							
11 25/32	299.2	10 3/4	273.0	2 1/4	57.1	GA-240							
11 63/64	304.4	6 29/32	175.4	1 37/64	40.0	GA-383							
11 63/64	304.4	12 19/32	319.8	1 5/16	33.3	GA-510							
12 3/64	305.9	8 55/64	225.0	1 7/16	36.5	GA-334							
12 3/32	307.1	4 23/32	119.8	1 41/64	41.6	GA-2170							
12 1/8	307.9	7 1/4	184.1	1 59/64	48.8	GA-2130							
12 1/8	308.0	7 1/4	184.2	2 3/16	55.5	GA-514							
12 5/32	308.7	9 1/16	230.1	2 3/64	51.9	GA-286							
12 3/16	309.5	7 9/32	184.9	2 1/4	57.1	GAVW-120							
12 13/64	309.9	6 9/64	155.9	1 43/64	42.4	GA-195							
12 13/64	309.9	6 11/32	161.1	2 41/64	67.0	GAVW-627							
12 13/64	309.9	6 33/64	165.4	1 23/32	43.6	GA-479							
12 13/64	310.0	9 19/64	236.1	59/64	23.4	GAC-2							
12 1/4	311.1	6 61/64	176.6	1 15/16	49.1	GA-597							
12 1/4	311.1	9 11/16	246.0	2 19/64	58.3	GA-348							
12 17/64	311.5	7 7/8	200.0	2 3/64	51.9	GA-198							
12 23/64	313.9	7 63/64	202.8	1 47/64	44.0	GA-194							
12 25/64	314.7	7 41/64	194.0	1 35/64	39.2	GA-279							
12 13/32	315.1	10 7/8	276.2	3 3/16	80.9	GA-5876							
12 27/64	315.5	7 31/64	190.1	2 13/64	55.9	GA-2164							
12 29/64	316.3	10 29/32	277.0	2 49/64	70.2	GA-475							
12 33/64	317.8	6 57/64	175.0	2 9/32	57.9	GA-2123							
12 17/32	318.2	7 1/16	179.3	1 1/2	38.1	GA-141							
12 35/64	318.6	7 37/64	192.4	1 21/32	42.0	GA-264							
12 9/16	319.0	6 5/16	160.3	2 15/16	74.6	GA-170							
12 39/64	320.2	7 13/64	182.9	1 1/2	38.1	GA-2194							
12 5/8	320.6	5 29/32	150.0	1 21/32	42.0	GA-128							
12 3/4	323.9	8	203.2	9 5/16	236.5	GA-4999							
12 51/64	325.0	6 9/64	155.9	2 17/64	57.5	GA-2156							
12 53/64	325.8	9 29/32	251.6	1 15/16	49.2	GA-397							
12 29/32	327.8	5 53/64	148.0	1 11/32	34.1	GA-174							

Especificaciones de Filtros para Gasolina

Gasoline Filters Specifications

Código	Número GONHER	Entrada	Salida	Vapores	Diámetro Exterior	Largo
7232	GG-213	1/4 in	1/4 in	1/4 in	(2 1/4 in) (57.1 mm)	(3 29/64 in) (87.7 mm)
7203	GG-262	1/4 in	1/4 in	1/4 in	(2 39/64 in) (66.2 mm)	(3 31/64 in) (88.5 mm)
7018	GG-1	1/4 in	1/4 in		(1 9/64 in) (28.9 mm)	(3 3/16 in) (80.9 mm)
7208	GG-116	1/4 in	1/4 in		(1 39/64 in) (40.8 mm)	(4 1/2 in) (114.3 mm)
7225	GG-196	1/4 in	1/4 in		(1 49/64 in) (44.8 mm)	(3 35/64 in) (90.0 mm)
7209	GG-117	1/4 in	1/4 in		(1 57/64 in) (48.0 mm)	(4 5/8 in) (117.4 mm)
7230	GG-207	1/4 in	1/4 in		(1 61/64 in) (49.6 mm)	(2 31/64 in) (63.1 mm)
7189	GG-194	1/4 in	1/4 in		(1 61/64 in) (49.6 mm)	(2 33/64 in) (63.8 mm)
7002	GG-4	1/4 in	1/4 in		(2 5/32 in) (54.7 mm)	(4 5/32 in) (105.5 mm)
7211	GG-126	1/4 in	1/4 in		(2 13/64 in) (55.9 mm)	(4 11/16 in) (119.0 mm)
7229	GG-204	1/4 in	1/4 in		(2 7/32 in) (56.3 mm)	(2 19/64 in) (58.3 mm)
7226	GG-199	1/4 in	1/4 in		(2 7/32 in) (56.3 mm)	(3 13/32 in) (86.5 mm)
7227	GG-202	1/4 in	1/4 in		(2 1/4 in) (57.1 mm)	(2 19/64 in) (58.3 mm)
7228	GG-203	1/4 in	1/4 in		(2 1/4 in) (57.1 mm)	(2 19/64 in) (58.3 mm)
7222	GG-188	1/4 in	1/4 in		(2 9/32 in) (57.9 mm)	(2 23/64 in) (59.9 mm)
7187	GG-98	1/4 in	1/4 in		(2 33/64 in) (63.8 mm)	(4 41/64 in) (117.8 mm)
7186	GG-76	1/4 in	1/4 in		(3 27/64 in) (86.9 mm)	(2 5/64 in) (52.7 mm)
7027	GG-45	9/32 in	9/32 in		(1 49/64 in) (44.8 mm)	(3 1/4 in) (82.5 mm)
7051	GG-39	9/32 in	9/32 in		(2 3/4 in) (69.8 mm)	(5 1/32 in) (127.7 mm)
7085	GG-19	5/16 in	1/8-27 NPT		(31/32 in) (24.6 mm)	(2 25/32 in) (70.6 mm)
7031	GG-8 L	5/16 in	5/16 in	1/4 in	(1 21/32 in) (42.0 mm)	(4 1/64 in) (101.9 mm)
7052	GG-62	5/16 in	5/16 in	5/16 in	(2 3/4 in) (69.8 mm)	(3 35/64 in) (90.0 mm)
7206	GG-115	5/16 in	5/16 in	5/16 in	(2 51/64 in) (71.0 mm)	(5 11/16 in) (144.4 mm)
7026	GG-8	5/16 in	5/16 in	5/16 in	(2 15/16 in) (74.6 mm)	(6 5/32 in) (156.3 mm)
7029	GG-5 L	5/16 in	5/16 in		(1 29/32 in) (48.4 mm)	(3 61/64 in) (100.4 mm)
7231	GG-208	5/16 in	5/16 in		(1 31/32 in) (50.0 mm)	(2 33/64 in) (63.8 mm)
7164	GG-986	5/16 in	5/16 in		(2 7/64 in) (53.5 mm)	(7 13/64 in) (182.9 mm)
7212	GG-131	5/16 in	5/16 in		(2 1/8 in) (53.9 mm)	(4 3/64 in) (102.7 mm)
7028	GG-3	5/16 in	5/16 in		(2 9/64 in) (54.3 mm)	(4 5/32 in) (105.5 mm)
7107	GG-7020	5/16 in	5/16 in		(2 11/64 in) (55.1 mm)	(4 1/2 in) (114.3 mm)
7254	GG-264	5/16 in	5/16 in		(2 11/64 in) (55.1 mm)	(4 35/64 in) (115.4 mm)
7067	GG-65	5/16 in	5/16 in		(2 11/64 in) (55.1 mm)	(5 15/32 in) (138.9 mm)
7250	GG-255	5/16 in	5/16 in		(2 11/64 in) (55.1 mm)	(5 31/64 in) (139.3 mm)
7069	GG-72	5/16 in	5/16 in		(2 11/64 in) (55.1 mm)	(5 49/64 in) (146.4 mm)
7247	GG-245	5/16 in	5/16 in		(2 11/64 in) (55.1 mm)	(5 49/64 in) (146.4 mm)
7219	GG-167	5/16 in	5/16 in		(2 11/64 in) (55.1 mm)	(5 57/64 in) (149.6 mm)
7161	GG-106	5/16 in	5/16 in		(2 11/64 in) (55.1 mm)	(6 5/32 in) (156.3 mm)
7249	GG-249	5/16 in	5/16 in		(2 11/64 in) (55.1 mm)	(6 5/32 in) (156.3 mm)
7072	GG-64	5/16 in	5/16 in		(2 11/64 in) (55.1 mm)	(6 3/8 in) (161.9 mm)
7061	GG-7019	5/16 in	5/16 in		(2 11/64 in) (55.1 mm)	(8 29/32 in) (226.2 mm)
7057	GG-7018	5/16 in	5/16 in		(2 11/64 in) (55.1 mm)	(10 in) (254.0 mm)
7279	GG-409	5/16 in	5/16 in		(2 11/64 in) (55.1 mm)	(13 25/64 in) (340.1 mm)
7068	GG-67	5/16 in	5/16 in		(2 11/64 in) (55.1 mm)	(3 49/64 in) (95.6 mm)
7045	GG-61	5/16 in	5/16 in		(2 11/64 in) (55.1 mm)	(3 53/64 in) (97.2 mm)
7056	GG-30	5/16 in	5/16 in		(2 17/64 in) (57.5 mm)	(5 55/64 in) (148.8 mm)
7077	GG-137	5/16 in	5/16 in		(2 9/32 in) (57.9 mm)	(5 5/64 in) (128.9 mm)
7059	GG-1992	5/16 in	5/16 in		(2 3/8 in) (60.3 mm)	(5 7/32 in) (132.5 mm)
7274	GG-351	5/16 in	5/16 in		(2 13/32 in) (61.1 mm)	(11 13/16 in) (300.0 mm)
7273	GG-291	5/16 in	5/16 in		(2 27/64 in) (61.5 mm)	(5 3/8 in) (136.5 mm)
7284	GG-355	5/16 in	5/16 in		(2 27/64 in) (61.5 mm)	(5 53/64 in) (148.0 mm)
7283	GG-182	5/16 in	5/16 in		(2 9/16 in) (65.0 mm)	(4 51/64 in) (121.8 mm)
7210	GG-124	5/16 in	5/16 in		(2 19/32 in) (65.8 mm)	(3 59/64 in) (99.6 mm)
7063	GG-63	5/16 in	5/16 in		(2 23/32 in) (69.0 mm)	(4 47/64 in) (120.2 mm)
7218	GG-136	5/16 in	5/16 in		(2 25/32 in) (70.6 mm)	(5 9/64 in) (130.5 mm)
7216	GG-148	5/16 in	5/16 in		(2 25/32 in) (70.6 mm)	(5 5/16 in) (134.9 mm)
7217	GG-150	5/16 in	5/16 in		(2 25/32 in) (70.6 mm)	(6 25/64 in) (162.3 mm)
7214	GG-142	5/16 in	5/16 in		(2 25/32 in) (70.6 mm)	(6 49/64 in) (171.8 mm)
7282	GG-915	5/16 in	5/16 in		(2 7/8 in) (73.0 mm)	(6 47/64 in) (171.0 mm)
7272	GG-419	5/16 in	5/16 in		(2 15/16 in) (74.6 mm)	(5 5/32 in) (130.9 mm)
7277	GG-411	5/16 in	5/16 in		(2 15/16 in) (74.6 mm)	(5 5/32 in) (130.9 mm)
7070	GG-79	5/16 in	5/16 in		(2 15/16 in) (74.6 mm)	(6 in) (152.4 mm)
7276	GG-431	5/16 in	5/16 in		(2 61/64 in) (75.0 mm)	(6 7/64 in) (155.1 mm)
7267	GG-206	5/16 in	5/16 in		(2 63/64 in) (75.8 mm)	(5 5/64 in) (128.9 mm)
7106	GG-102	5/16 in	5/16 in		(3 5/64 in) (78.1 mm)	(6 15/16 in) (176.2 mm)
7207	GG-268	5/16 in	5/16 in		(3 9/64 in) (79.7 mm)	(5 35/64 in) (140.8 mm)
7053	GG-47	5/16 in	5/16 in		(3 9/64 in) (79.7 mm)	(5 47/64 in) (145.6 mm)
7060	GG-1872	5/16 in	5/16 in		(3 9/64 in) (79.7 mm)	(6 23/32 in) (170.6 mm)

Especificaciones de Filtros para Gasolina
Gasoline Filters Specifications



Código	Número GONHER	Entrada	Salida	Vapores	Diámetro Exterior	Largo
7066	GG-94	5/16 in	5/16 in		(3 5/32 in) (80.1 mm)	(5 3/8 in) (136.5 mm)
7105	GG-82	5/16 in	5/16 in		(3 5/32 in) (80.1 mm)	(5 31/64 in) (139.3 mm)
7062	GG-251	5/16 in	5/16 in		(3 7/32 in) (81.7 mm)	(6 11/64 in) (156.7 mm)
7215	GG-146	5/16 in	5/16 in		(3 25/64 in) (86.1 mm)	(3 61/64 in) (100.4 mm)
7266	GG-283	5/16 in	3/8 in	3/8 in	(2 13/64 in) (55.9 mm)	(6 17/32 in) (165.8 mm)
7065	GG-92	5/16 in	3/8 in		(2 17/64 in) (57.5 mm)	(6 29/64 in) (163.9 mm)
7243	GG-239	5/16 in	3/8 in		(3 5/32 in) (80.1 mm)	(6 47/64 in) (171.0 mm)
7302	GG-369	5/16 in	M14X1.5		(2 5/32 in) (54.7 mm)	(4 9/16 in) (115.8 mm)
7235	GG-217	21/64 in	21/64 in		(2 51/64 in) (71.0 mm)	(6 11/16 in) (169.8 mm)
7119	GG-170	3/8 flare	1/4 NPT		(1 3/4 in) (44.4 mm)	(4 13/32 in) (111.9 mm)
7264	GG-307	3/8 in	5/16 in	5/16 in	(5 17/64 in) (133.7 mm)	(6 41/64 in) (168.6 mm)
7190	GG-265	3/8 in	5/16 in	5/16 in	(2 7/64 in) (53.5 mm)	(6 23/64 in) (161.5 mm)
7192	GG-267	3/8 in	5/16 in	5/16 in	(2 7/64 in) (53.5 mm)	(6 23/64 in) (161.5 mm)
7271	GG-97	3/8 in	5/16 in	5/16 in	(2 7/64 in) (53.5 mm)	(3 1/2 in) (88.9 mm)
7073	GG-95	3/8 in	5/16 in	5/16 in	(2 11/64 in) (55.1 mm)	(8 13/64 in) (208.3 mm)
7265	GG-210	3/8 in	5/16 in	5/16 in	(2 3/16 in) (55.5 mm)	(6 1/4 in) (158.7 mm)
7163	GG-161	3/8 in	5/16 in		(2 1/32 in) (51.5 mm)	(6 53/64 in) (173.4 mm)
7100	GG-104	3/8 in	5/16 in		(2 11/64 in) (55.1 mm)	(5 13/64 in) (132.1 mm)
7255	GG-263	3/8 in	5/16 in		(2 11/64 in) (55.1 mm)	(5 23/64 in) (136.1 mm)
7075	GG-84	3/8 in	5/16 in		(2 11/64 in) (55.1 mm)	(6 23/64 in) (161.5 mm)
7248	GG-247	3/8 in	5/16 in		(2 11/64 in) (55.1 mm)	(6 27/64 in) (163.1 mm)
7102	GG-195	3/8 in	5/16 in		(2 7/32 in) (56.3 mm)	(7 9/16 in) (192.0 mm)
7078	GG-99	3/8 in	5/16 in		(2 5/8 in) (66.6 mm)	(6 15/16 in) (176.2 mm)
7246	GG-243	3/8 in	5/16 in		(2 41/64 in) (67.0 mm)	(6 19/32 in) (167.4 mm)
7268	GG-299	3/8 in	3/8 in	5/16 in	(2 13/64 in) (55.9 mm)	(5 5/8 in) (142.8 mm)
7162	GG-290	3/8 in	3/8 in		(1 31/32 in) (49.9 mm)	(5 29/32 in) (150.0 mm)
7003	GG-5	3/8 in	3/8 in		(2 5/32 in) (54.7 mm)	(4 25/32 in) (121.4 mm)
7263	GG-209	3/8 in	3/8 in		(2 5/32 in) (54.7 mm)	(4 53/64 in) (122.6 mm)
7245	GG-242	3/8 in	3/8 in		(2 11/64 in) (55.1 mm)	(5 25/64 in) (136.9 mm)
7071	GG-580	3/8 in	3/8 in		(2 11/64 in) (55.1 mm)	(6 27/64 in) (163.1 mm)
7220	GG-177	3/8 in	3/8 in		(2 11/64 in) (55.1 mm)	(6 7/16 in) (163.5 mm)
7096	GG-581	3/8 in	3/8 in		(2 11/64 in) (55.1 mm)	(6 29/64 in) (163.9 mm)
7251	GG-256	3/8 in	3/8 in		(2 11/64 in) (55.1 mm)	(6 29/64 in) (163.9 mm)
7047	GG-41	3/8 in	3/8 in		(2 3/16 in) (55.5 mm)	(17 7/16 in) (442.9 mm)
7269	GG-101	3/8 in	3/8 in		(2 17/64 in) (57.5 mm)	(6 63/64 in) (177.4 mm)
7097	GG-252	3/8 in	3/8 in		(3 1/16 in) (77.7 mm)	(6 31/32 in) (177.0 mm)
7058	GG-3728	3/8 in	M16X1.5		(2 5/32 in) (54.7 mm)	(4 51/64 in) (121.8 mm)
7064	GG-66	3/8 in	M16X1.5		(2 11/64 in) (55.1 mm)	(5 21/64 in) (135.3 mm)
7275	GG-420	25/64 in	5/64 in		(2 15/16 in) (74.6 mm)	(6 21/64 in) (160.7 mm)
7191	GG-87	1/2-20	1/8-27 NPT		(1 7/64 in) (28.1 mm)	(1 15/16 in) (49.2 mm)
7046	GG-42	1/2-20	1/2-20	7/16-24	(1 3/8 in) (34.9 mm)	(2 15/16 in) (74.6 mm)
7055	GG-32	1/2-20	1/2-20	7/16-24	(1 31/32 in) (50.0 mm)	(3 13/64 in) (81.3 mm)
7050	GG-29	1/2-20	1/2-20		(1 1/2 in) (38.1 mm)	(3 19/64 in) (83.7 mm)
7054	GG-25	1/2-20	1/2-20		(2 in) (50.8 mm)	(3 3/16 in) (80.9 mm)
7244	GG-240	5/8-18	3/8 in		(2 11/64 in) (55.1 mm)	(4 53/64 in) (122.6 mm)
7076	GG-151	M12X1.25	M12X1.25		(5 1/8 in) (130.1 mm)	(2 25/32 in) (70.6 mm)
7234	GG-215	M12X1.25	M12X1.25		(2 49/64 in) (70.2 mm)	(3 63/64 in) (101.2 mm)
7238	GG-227	M12X1.25	M12X1.25		(2 25/32 in) (70.6 mm)	(5 5/64 in) (128.9 mm)
7236	GG-223	M12X1.25	M12X1.25		(2 25/32 in) (70.6 mm)	(5 17/64 in) (133.7 mm)
7242	GG-237	M12X1.25	M12X1.25		(2 25/32 in) (70.6 mm)	(5 17/64 in) (133.7 mm)
7239	GG-232	M12X1.25	M12X1.25		(2 25/32 in) (70.6 mm)	(5 19/64 in) (134.5 mm)
7224	GG-190	M12X1.25	M12X1.25		(3 23/64 in) (85.3 mm)	(3 39/64 in) (91.6 mm)
7240	GG-234	M12X1.25	M12X1.25		(3 25/64 in) (86.1 mm)	(3 53/64 in) (97.2 mm)
7188	GG-181	M12X1.25	M12X1.25		(3 13/32 in) (86.5 mm)	(3 59/64 in) (99.6 mm)
7221	GG-185	M12X1.25	M14X1.5		(2 3/4 in) (69.8 mm)	(4 19/32 in) (116.6 mm)
7223	GG-189	M12X1.25	M14X1.5		(3 13/64 in) (81.3 mm)	(5 23/32 in) (145.2 mm)
7262	GG-220	M14X1.25	M12X1.25		(2 51/64 in) (71.0 mm)	(4 41/64 in) (117.8 mm)
7103	GG-246	M14X1.5	M12X1.25		(2 7/16 in) (61.9 mm)	(5 3/16 in) (131.7 mm)
7213	GG-164	M14X1.5	M12X1.25		(2 17/32 in) (64.2 mm)	(3 27/32 in) (97.6 mm)
7259	GG-114	M14X1.5	M12X1.25		(2 25/32 in) (70.6 mm)	(4 35/64 in) (115.4 mm)
7233	GG-214	M14X1.5	M12X1.25		(3 3/8 in) (85.7 mm)	(4 21/64 in) (109.9 mm)
7260	GG-184	M14X1.5	M12X1.25		(3 25/64 in) (86.1 mm)	(3 13/16 in) (96.8 mm)
7114	GG-160	M14X1.5	M12X1.5		(2 25/64 in) (60.7 mm)	(4 19/64 in) (109.1 mm)
7278	GG-408	M14X1.5	M12X1.5		(2 15/16 in) (74.6 mm)	(4 59/64 in) (125.0 mm)
7204	GG-261	M14X1.5	M12X1.5		(3 7/16 in) (87.3 mm)	(6 1/64 in) (152.7 mm)
7253	GG-260	M14X1.5	M14X1.5		(2 11/64 in) (55.1 mm)	(4 5/16 in) (109.5 mm)
7195	GG-169	M14X1.5	M14X1.5		(2 47/64 in) (69.4 mm)	(4 13/16 in) (122.2 mm)

Especificaciones de Filtros para Gasolina Gasoline Filters Specifications

Código	Número GONHER	Entrada	Salida	Vapores	Diámetro Exterior	Largo
7261	GG-187	M14X1.5	M14X1.5		(2 25/32 in) (70.6 mm)	(4 1/8 in) (104.7 mm)
7237	GG-226	M14X1.5	M14X1.5		(3 13/64 in) (81.3 mm)	(5 1/8 in) (130.1 mm)
7104	GG-266	M16X1.5	3/8 in		(2 13/64 in) (55.9 mm)	(5 7/16 in) (138.1 mm)
7044	GG-46	M16X1.5	M16X1.5		(2 11/64 in) (55.1 mm)	(4 5/16 in) (109.5 mm)

Tabla de Conversión de Pulgadas a Milímetros
Conversion Table Inches to Millimeters

Fracciones (Pulg.) In.....	Decimal (Pulg.) In.....	Métrico (Milímetros) mm.
1/64	0.015625	0.3969
1/32	0.031250	0.7937
3/64	0.046975	1.1906
1/16	0.062500	1.5875
5/64	0.078125	1.9844
3/32	0.093750	2.3812
7/64	0.109375	2.7781
1/8	0.125000	3.1750
9/64	0.140625	3.5719
5/32	0.156250	3.9687
11/64	0.171875	4.3656
3/16	0.187500	4.7625
13/64	0.203125	5.1594
7/32	0.218750	5.5562
5/64	0.234375	5.9531
1/4	0.250000	6.3500
17/64	0.265250	6.7469
9/32	0.281250	7.1437
19/64	0.296875	7.5406
5/16	0.312500	7.9375
21/64	0.328125	8.3344
11/32	0.343750	8.7312
23/64	0.359375	9.1281
3/8	0.375000	9.5250
25/64	0.390625	9.9219
13/32	0.406260	10.3187
27/64	0.421875	10.7156
7/16	0.437500	11.1125
29/64	0.453125	11.5094
15/32	0.468750	11.9062
31/64	0.484375	12.3031
1/2	0.500000	12.7000
33/64	0.515621	13.0969
17/63	0.531250	13.4937
35/64	0.546875	13.8906
9/16	0.562500	14.2875
37/64	0.578125	14.6844
19/32	0.593750	15.0812
39/64	0.609375	15.4781
5/8	0.625000	15.8750
41/64	0.640625	16.2719
21/32	0.656250	16.6687
43/64	0.671875	17.0656
11/16	0.687500	17.4625
45/64	0.703125	17.8594
23/32	0.718750	18.2562
47/64	0.734375	18.6531
3/4	0.750000	19.0500
49/64	0.765625	19.4469
25/32	0.781250	19.8437
51/64	0.796875	20.2406
13/16	0.812500	20.6375
53/64	0.828125	21.0344
27/32	0.843750	21.4312
55/64	0.859375	21.8281
7/8	0.875000	22.2250
57/64	0.896250	22.6219
29/32	0.906250	23.0187
59/64	0.921875	23.4156
15/16	0.937500	23.8125
61/64	0.953125	24.2094
31/32	0.968750	24.6062
63/64	0.984375	25.0031
1	1.000000	25.3999

Instrucciones para una correcta Instalación de filtros sellados.

Los filtros son las piezas que más seguido se sustituyen de su vehículo. Para asegurar el rendimiento normal del filtro, prevenir costosos daños a su motor y facilitar los próximos servicios, al reemplazar un filtro, siga los pasos que a continuación se describen:

El motor debe estar tibio, levante el cofre del motor de su vehículo y remueva el tapón de admisión de aceite.

Levante el vehículo tomando las medidas de seguridad apropiadas y desatornille el tapón del cárter o depósito, permita que escurra todo el aceite, vuelva a instalar el tapón del cárter no sin antes inspeccionar el estado de las juntas o empaques, reemplácelas si es necesario.

Remueva el filtro usado utilizando la herramienta apropiada, en algunos casos y dada la incomodidad de la instalación, se requerirá del uso de herramientas especiales que evitarán que el filtro se dañe, haciendo difícil su remoción.



Limpie con un trapo limpio la base del motor y asegúrese de que el empaque o junta anterior no se quede pegada a la base; no use estopa, aplique una película de aceite limpio al nuevo empaque. **Nota: Nunca use grasa lubricante en el empaque u otro material.**

Instale el nuevo filtro cuidando de no trasroscarlo. En las unidades grandes puede ser necesario llenar el filtro con aceite limpio antes de instalarlo, verifique las recomendaciones del manual del propietario, después de que el empaque del filtro tope con la base del motor, apriételo a mano de acuerdo a las instrucciones que se encuentran en el filtro o en el empaque del mismo producto

No sobre apriete, ni utilice herramientas para apretar.

Importante: Antes de efectuar cualquier cambio de aceite o filtros verifique que tenga las herramientas y conocimientos apropiados, de no tenerla visite a su centro de servicio o mecánico de confianza. Así evitará daños y demoras.

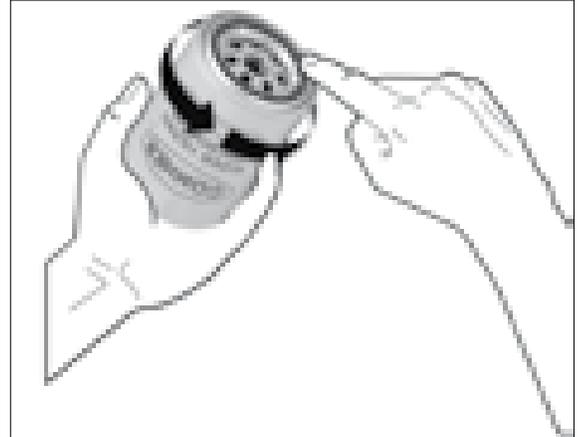

Baje el vehículo a nivel del suelo y llene el cárter o depósito con aceite limpio hasta el nivel recomendado, vuelva a instalar el tapón de admisión de aceite. Encienda el motor y espere unos segundos a que la presión se normalice. *Si el indicador de presión no indica la normalización o la luz de advertencia en el tablero no se apaga, apague el motor y revise la instalación*

Apague el motor y cheque el nivel de aceite, rellene si es necesario.

Encienda el motor por 5 minutos y verifique que no haya fugas alrededor del filtro, el tapón del cárter o depósito y las conexiones existentes.

Apague el motor y cierre el cofre.

No tire el filtro usado y aceite sucio en el drenaje o en la tierra, observe las disposiciones ecológicas aplicables en su región.

Nunca deje encendida la unidad sin Vigilancia después de hacer un cambio De aceite o filtros, pueden presentarse fugas de lubricante sin percatarse de ellas, llegando a ser de resultados catastróficos.



Instructions for proper installation of spin-on filters

The filters are more often the parts are replaced in your vehicle. To ensure performance normal filter, prevent costly damage to your engine and provide the following services, to replace a filter, follow the steps described below:

The engine should be warm, lift the hood of your car engine and remove the oil cap admission.

Raise the vehicle taking appropriate security measures and unscrew the cap or shell casing, allow to drain all the oil, reinstall the cap of the housing but not before inspecting the condition of the seals or gaskets, replace if necessary.

Remove the used filter using the appropriate tool in some cases and given the inconvenience of the installation will require the use of special tools that will prevent damage to the filter, making removal difficult.



Wipe clean the motor base and make sure the previous meeting gasket or will not remain attached to the base, do not use burlap, apply a film of clean oil to the new gasket

Note: Never use grease on the gasket or other material.

Install the new filter being careful not trasroscarlo. In large units may be necessary to fill the filter with clean oil before installing it, check the owner's manual recommendations, after the packing of the filter cap with the base engine, tighten it by hand according to the instructions found in the filter or on the packaging of the product

Do not over tighten or use tools to tighten

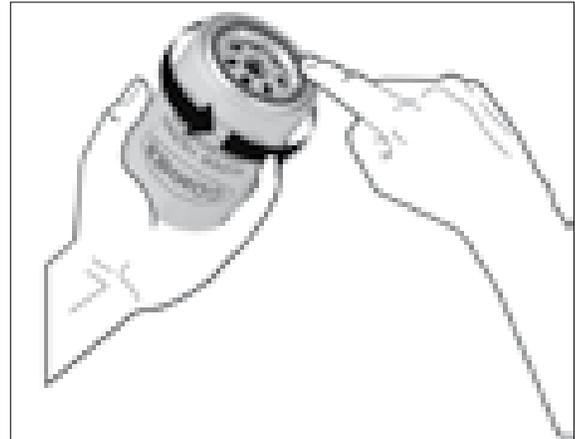

Lower the vehicle at ground level and fill the crankcase with clean oil or deposit to the recommended level, then reinstall the oil inlet cap. Start the engine and wait a few seconds for the pressure to normal. *If the pressure gauge indicates no standardization or the warning light on the dash does not turn off, turn off the engine and check the installation*

Turn off the engine and check the oil level, fill if necessary.

Start the engine for 5 minutes and check for leaks around the filter, sump or tank cap and existing connections.

Turn off the engine and close the hood

Do not throw the used filter and the drain dirty oil or land, observe the applicable environmental provisions in their region.

Never leave burning unattended unit after a change of oil or filters, lubricant leaks can occur without noticing them, becoming catastrophic results.

Important: Before you make any changes or oil filters verify you have the proper tools and knowledge, not to have her visit your service center or trusted mechanic. This will prevent damage and delay.



Problemas con la luz de aviso para la presión de aceite.

La mayor parte de los automotores actuales utilizan una luz de aviso, montada en el panel de instrumentos para brindar al conductor una señal visual de la baja presión de aceite. La baja presión es importante, dado que el aceite “bajo presión” es necesario para separar adecuadamente las partes muy cargadas del motor y evitar un desgaste excesivo.

La luz de aviso está conectada en serie con un interruptor de presión de aceite, como se ilustra en la figura 1. El interruptor de presión contiene contactos eléctricos que están en posición cerrada cuando la presión de aceite es inferior a 5 lbs/pulg². Cuando el motor no está funcionando y el encendido está conectado a la luz de aviso queda conectada.

Cuando el motor es puesto en marcha, la presión de aceite comprime el diafragma en el interruptor de presión, abriendo los contactos y haciendo que la luz se apague.

Si la luz de aviso permanece conectada durante más de 5 segundos, después de que el motor ha sido puesto en marcha, apáguelo inmediatamente; el nivel de aceite deberá ser controlado y puesto en situación normal. Si la luz de aviso continua conectada cuando el nivel de aceite es normal, entonces podrá existir una serie de posibles problemas.

- 1.- El interruptor de presión puede haber fallado.
- 2.- El cableado entre el interruptor de presión y la luz de aviso puede estar conectado a tierra.
- 3.- La bomba puede estar descebada debido a una falla o a un filtro (o malla) de succión saturado.
- 4.- La válvula reguladora de presión puede estar abierta y retornar el aceite nuevamente al cárter.

En algunos motores, el filtro está montado en una posición que permite que el aceite drene nuevamente al cárter cuando el motor es detenido. Este sería el caso del filtro ilustrado en la figura 2, donde está en posición horizontal situado sobre el nivel de aceite en el cárter. Dado que el filtro acumula hasta 0.94 litros de aceite, toma aproximadamente cinco segundos para que la bomba lo llene después de que el motor ha sido puesto en marcha, durante cuyo lapso la luz de aviso queda conectada.

Para evitar que el motor funcione sin presión de aceite durante ese período, los filtros diseñados para esas posiciones contienen una válvula antidrenaje. Esta válvula tiene actualmente la forma de una empaquetadura de neopreno que permite el libre flujo de aceite a través del filtro en la dirección normal, pero cuando el motor está “parado” evita que el aceite se descargue en el cárter. Si la luz de aviso permanece conectada durante periodos más prolongados, después de que el filtro ha estado usándose en el automotor durante algún tiempo, se recomienda su reemplazo.

Bajo algunas condiciones, la luz de aviso puede parpadear cuando el motor está funcionando. Esto sucede generalmente cuando el vehículo está doblando o situado sobre una cuesta relativamente empinada. Si se produjese un parpadeo bajo estas condiciones, se debe a que el nivel de aceite es bajo, y el filtro (malla) de la bomba ya no está totalmente sumergido. El nivel de aceite debe ser inmediatamente llenado a la situación normal.

En síntesis, la luz de aviso de la presión de aceite brinda una Información vital al conductor. Si la luz permanece conectada o aún parpadea cuando el motor está funcionando, debe ser desconectada inmediatamente e Investigada la causa.

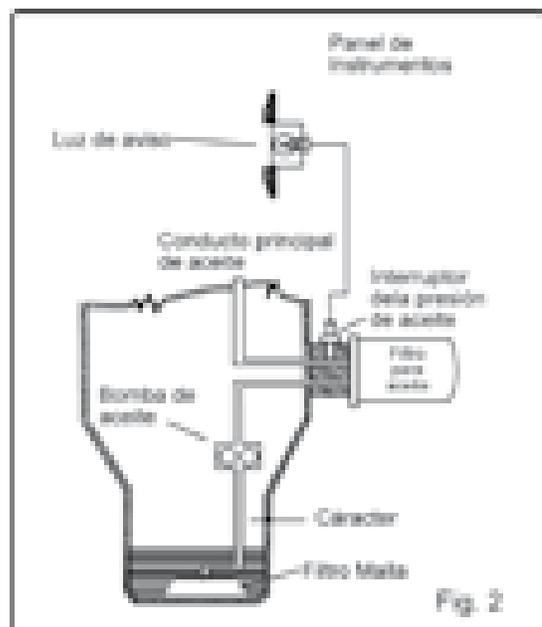
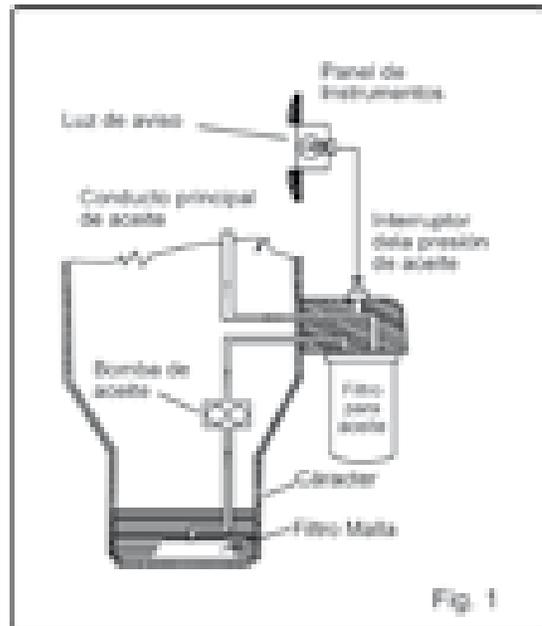

Problems with the warning light for oil pressure.

Most of the vehicles today use a warning light mounted on the instrument panel to give the driver a visual sign of low oil pressure. The low pressure is important, since the oil "under pressure" is necessary to accurately separate high-loaded parts of the engine and prevent excessive wear.

The warning light is connected in series with an oil pressure switch, as illustrated in Figure 1. The pressure switch contains electrical contacts that are in the closed position when the oil pressure is below 5 lbs/pulg2. When the motor is running and connected to the ignition warning light is connected.

When the engine is started, oil pressure deflects the diaphragm in the pressure switch, opening the contacts and making the light turns off.

If the warning light stays connected for more than 5 seconds after the engine has been started, shut down immediately, the oil level must be monitored and placed in a normal situation. If the warning light continuously connected when the oil level is normal, then it may be a number of potential problems.

- 1.- The pressure switch may have failed.
- 2.- The wiring between the pressure switch and the warning light can be grounded
- 3.- The pump could have lost its prime due to either a faulty pump or clogged suction strainer.
- 4.- The pressure regulating valve can be open and return the oil back into the crankcase.

In some engines, the filter is mounted in a position that allows oil to drain back into the crankcase when the engine is stopped. This is the case of the filter illustrated in Figure 2, which is flat above the level of oil in the crankcase. As the filter accumulates to 0.94 liters of oil, it takes about five seconds for the fill pump after the engine has been launched, during which time the warning light is connected.

To prevent the engine run without oil pressure during that period, the filters designed for these positions contain an anti-drain valve. This valve now has the form of a neoprene gasket that allows the free flow of oil through the filter in the normal direction, but when the engine is idle prevents oil discharged into the crankcase. If the warning light stays connected for longer periods after the filter has been in use in the vehicle for some time, we recommend replacement.

Under some conditions, the warning light may flicker when the engine is running. This usually happens when the vehicle is turning or standing on a relatively steep slope. When there is a flicker under these conditions is that the oil level is low and the filter (mesh) of the pump is not fully submerged. The oil level should be immediately filled by the normal situation.

In summary, the warning light for oil pressure provides vital information to the driver. If the light still stays connected and flashes when the engine is running, must be disconnected immediately and investigate the cause.

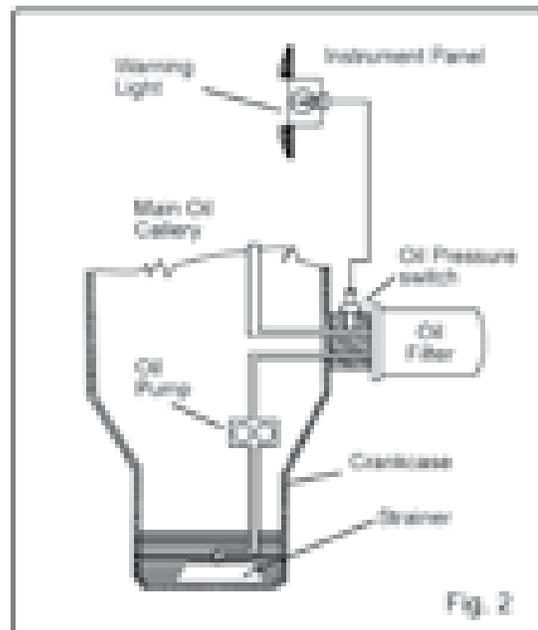
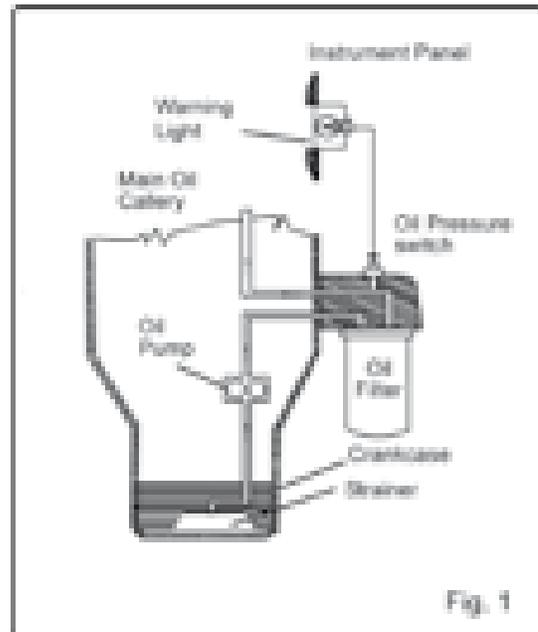

Pérdida de alimentación en la bomba de aceite.

Inmediatamente después de un cambio de aceite, uno de los asuntos que más confusión enfrentan los mecánicos profesionales o personas interesadas en hacer sus propias reparaciones, es la dificultad de recuperar la presión del aceite en la bomba a su nivel normal de operación.

Aunque no ocurre con frecuencia, es muy posible que la bomba de aceite pueda perder su alimentación o ceba durante el cambio de aceite.

Cuando se drena el aceite usado del motor (Fig. 1) puede también vaciarse el aceite del tubo de succión de la bomba de aceite y posiblemente de la bomba de aceite misma. Cuando se agrega el aceite nuevo al cárter, se ahoga de nuevo la entrada del tubo de succión, de la bomba de aceite sin lograr desplazar el aire atrapado en el tubo. El aire atrapado causará cavitación en la bomba, e impedirá el flujo de aceite y no habrá presión de aceite en el motor y sus indicadores.

Muchos instaladores al ver esto culpan de esta situación al filtro de aceite (Fig. 2) y suponen que el filtro está tapado a la vez bloqueando el flujo del aceite. Como el instalador sospecha del filtro, instalará un segundo filtro. A veces se resuelve así el problema porque el aire atrapado fue descargado cuando se retiró el primer filtro. Por lo tanto, se fortalece la sospecha del instalador de que el filtro era el causante de la falla argumentada.

El punto de todo esto es que el filtro de aceite no era problema y en muchos casos hay una solución sencilla.

Si después del cambio del filtro y de aceite, la luz roja o el indicador de presión baja del aceite continúa por diez segundos, apagar el motor, retirar el filtro de aceite (Fig. 3), y usando una pistola de aceite cargada con aceite de motor, inyectar aceite varias veces en la salida de la base del filtro de aceite en el motor (Esta será la abertura al lado del perno roscado; no ayudará en nada inyectar aceite en el perno roscado). Luego llenar el filtro con aceite de motor nuevo y reinstalar. Encender el motor y verificar si la presión de aceite se normaliza. En la mayoría de los casos el problema estará solucionado, sin embargo si la falla persiste, por ningún motivo se deberá permitir que el motor funcione por más de 10 segundos sin presión de aceite. Usar un reloj para cronometrar los diez segundos y estar seguro del lapso del tiempo. En ciertos casos, la bomba utilizará cada uno de los diez segundos para recuperar el flujo de aceite. Si esto falla de nuevo, retirar el filtro y encender el motor hasta que se derrame el aceite de la bancada del motor. No continúe encendiendo el motor por más de diez segundos a la vez. Cuando el aceite se derrame, reinstalar el filtro de aceite (Fig. 4), corregir el nivel del aceite y volver a encender el motor. La presión del aceite deberá volver a su nivel normal.

Nota: A veces se puede evitar este problema reduciendo el tiempo que drena el aceite.

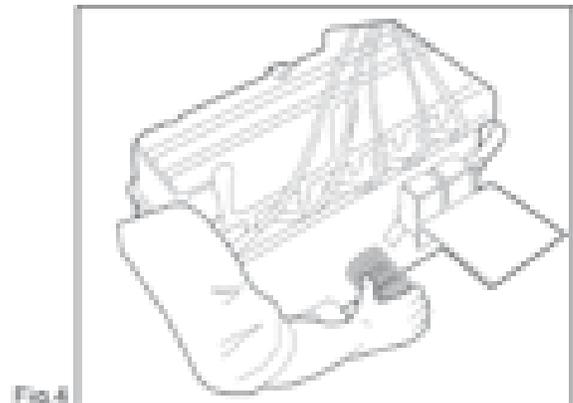
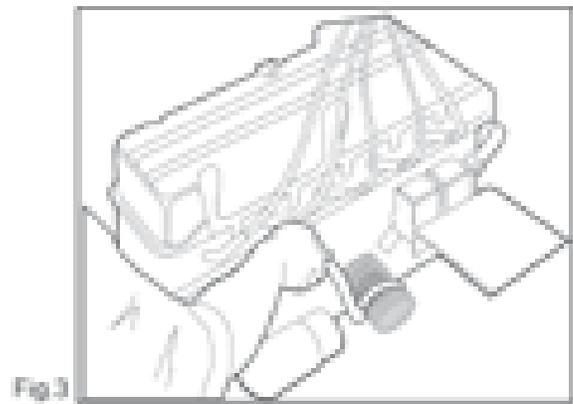
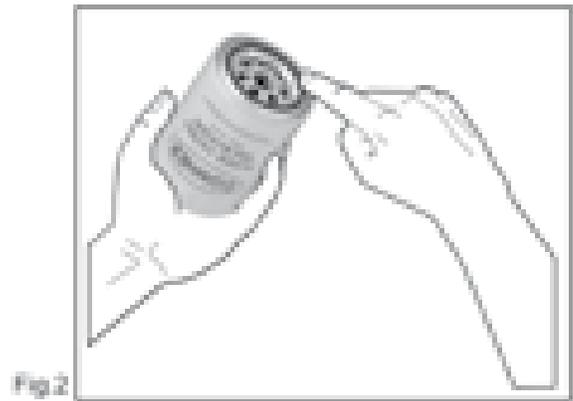
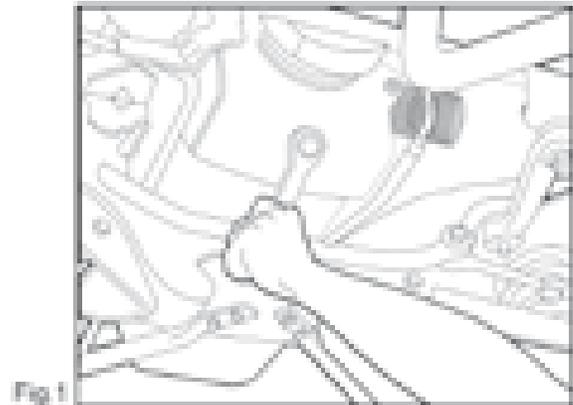

Loss of power in the oil pump.

Immediately after an oil change, one of the most confusing issues facing the professional mechanics or people interested in making their own repairs, is the difficulty of recovering the oil pressure in the pump to normal operation.

Although it occurs frequently, it is possible that the oil pump may lose his or fattening food during the oil change.

When used oil is drained from the engine (Fig. 1) could also empty the oil suction tube of the oil pump and possibly the oil pump itself. When you add new oil to the crankcase, chokes back the suction inlet of the oil pump without moving the air get trapped in the tube. The trapped air will cause cavitation at the pump, and impede the flow of oil and no oil pressure in the engine and its indicators.

Many installers to see this blame for this situation, oil filter (Fig. 2) and assume that the filter is clogged at the same time blocking the flow of oil. Suspicion and installer of the filter, install a second filter. Sometimes it thus solves the problem because the trapped air was discharged when he retired the first filter. Therefore, it strengthens the suspicion of the installer that the filter was the cause of the failure arguments.

The point of all this is that the oil filter was not a problem and in many cases a simple solution.

If after changing the oil filter, red light or indicator of low oil pressure continues for ten seconds, turn off the engine, remove the oil filter (Fig. 3), and using a gun loaded with olive oil motor, oil injected several times in the output of the filter base engine oil (This is the opening next to the threaded bolt, will not help anything inject oil into the threaded bolt). Then fill the filter with fresh engine oil and reinstall. Start the engine and check the oil pressure is normalized. In most cases the problem will be solved, however if the fault persists, for any reason you should let the engine run for more than 10 seconds without oil pressure. Use a timing clock for ten seconds and be sure the lapse of time. In some cases, the pump will use every ten seconds to recover the oil flow. If this fails again, remove the filter and start the engine until the oil spill from the engine bench. Do not continue turning the engine for more than ten seconds at a time. When the oil spill, reinstall the oil filter (Fig. 4), correcting oil level and restarting the engine. The oil pressure should return to normal.

Note: Sometimes you can avoid this problem by reducing the time to drain the oil.

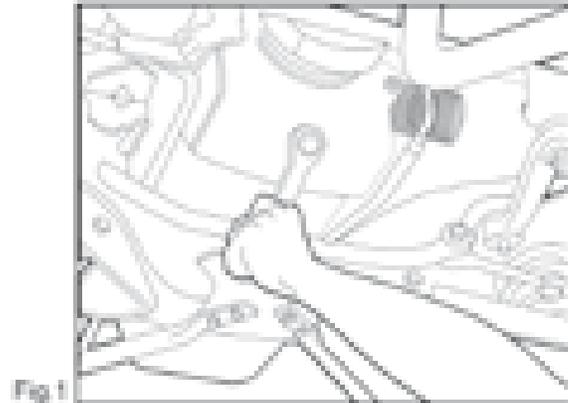

Fig 1

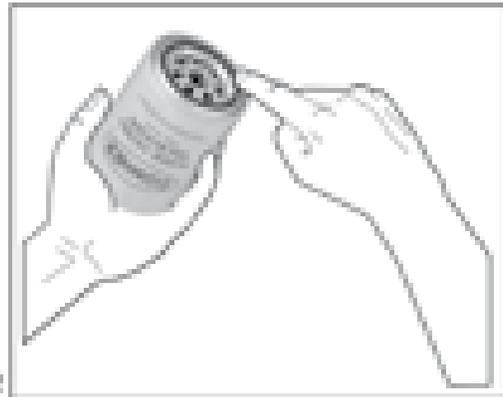

Fig 2

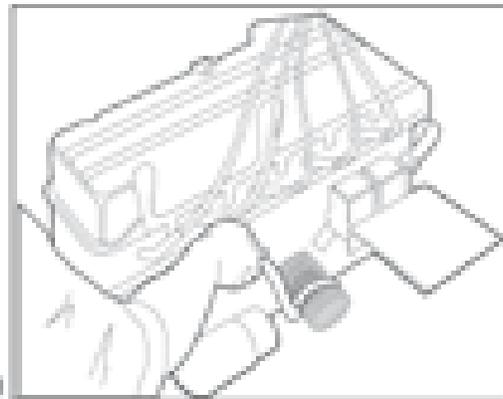

Fig 3

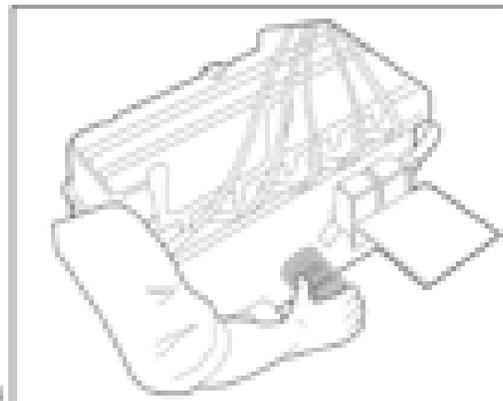

Fig 4

Deficiencias mas usuales provocadas por la válvula reguladora de presión.

Filtros para aceite lubricante con presión excesiva

Todos los fabricantes de filtros han recibido alguna vez un filtro devuelto por un cliente con una sobrepresión excesiva. Con frecuencia, el filtro deformado es la única indicación que tiene el dueño del automóvil para saber que se presentó un problema en su sistema de aceite lubricante.

Es posible que el filtro dañado no se haya advertido hasta que se quitó durante el siguiente cambio de aceite programado. Sin embargo, si la presión fue suficiente como para romper la junta o desenrollar la costura engargolada, el dueño del automóvil habrá experimentado problemas inmediatos y costosos.

Con la "evidencia" en sus manos, tiende a echarle la culpa al filtro dañado. No es sorprendente que él esté un poco más que molesto cuando el fabricante del filtro niega cualquier responsabilidad por el daño. Entonces, ¿Qué fue lo que causó la presión excesiva?. El echar una mirada a la forma como funciona el sistema de aceite lubricante, mostrará que la presión del aceite es creada por la bomba de aceite. El límite superior de esta presión está controlado por una válvula reguladora de presión que generalmente es una parte integral de la bomba.

La figura 1 es un diagrama simplificado del sistema de aceite lubricante, mostrando ésta bomba, válvula reguladora, filtro y rodamientos. La bomba suministra suficiente flujo para lubricar los rodamientos y otras partes móviles del motor. Este aceite debe estar bajo presión para separar adecuadamente las partes fuertemente cargadas del motor y evitar el desgaste excesivo. El objeto de la válvula reguladora es proporcionar esta presión que en la mayoría de los automóviles de pasajeros se encuentran entre los 40 y 60 PSI (libras por pulgada cuadrada).

La válvula reguladora está formada por una bola o émbolo que regula la presión con la ayuda de un resorte. El resorte está calibrado de tal forma que el émbolo se levante de su asiento cuando la presión de aceite llega al nivel deseado. Una vez que la válvula está abierta, la presión permanece bastante constante con sólo cambios ligeros que se presentan cuando varía la velocidad del motor.

El filtro y los otros componentes en el sistema de lubricación están sujetos a la presión establecida por la válvula reguladora. Si ésta presión es excesiva, se presentará el daño del filtro. Esto es lo que no comprenden las personas que no están familiarizadas con los sistemas de lubricación.

¿Qué es lo que puede hacer que la presión en el sistema exceda el ajuste de la válvula reguladora? La pregunta es que la válvula puede estar pegada en la posición cerrada o esta lenta para moverse a la posición abierta después de haber arrancado al motor. La figura 2 muestra el sistema funcionando con la válvula reguladora pegada en la posición de cierre. Bajo estas condiciones, la presión se acumula igualmente en todos los componentes en el sistema hasta que algo suceda para aliviar la presión. Si la válvula reguladora se despegas, la presión regresará a normal. Si permanece pegada, algo se tiene que romper.

La presión de operación normal no origina deformación permanente en el cuerpo del filtro. Cuando la presión del sistema llega a 150 PSI debido a una válvula reguladora defectuosa, la mayoría de los filtros se deforman permanentemente. A esta presión, la junta generalmente no se romperá y la costura engargolada permanecerá intacta.

Si la válvula reguladora continúa pegada, la presión se incrementará más y la junta entre el filtro y la base puede romperse. Esto probablemente hará que se pierda todo el aceite en el sistema. Si el filtro se ha instalado de manera demasiado apretada, la junta no se romperá y la costura

engargolada se desenrollará conforme la presión continúa aumentando. Si el cliente está alerta y para el motor a la primera indicación de problema (lámpara roja en o reducción en la presión de aceite) él puede limitar su pérdida a un trabajo de arrastre, cambio de aceite y filtro nuevo.

Si conduce hasta el taller más próximo, probablemente quemará el motor debido a la falta de aceite. El punto principal es que el filtro deformado no es la causa de esta presión excesiva, sino que es la víctima de una válvula reguladora defectuosa.

Todos los fabricantes de filtros han recibido alguna vez un filtro El cliente preguntará si un filtro que haya estado completamente tapado podría haber causado las condiciones de sobrepresión en el sistema. La respuesta es no. Si la válvula reguladora está funcionando correctamente mantendrá la presión en el filtro a 40 o 60 PSI incluso si el filtro está tapado.

Resumiendo, si un filtro se deforma debido a sobre presión en el sistema, la falla reside en la válvula reguladora y no en el filtro.

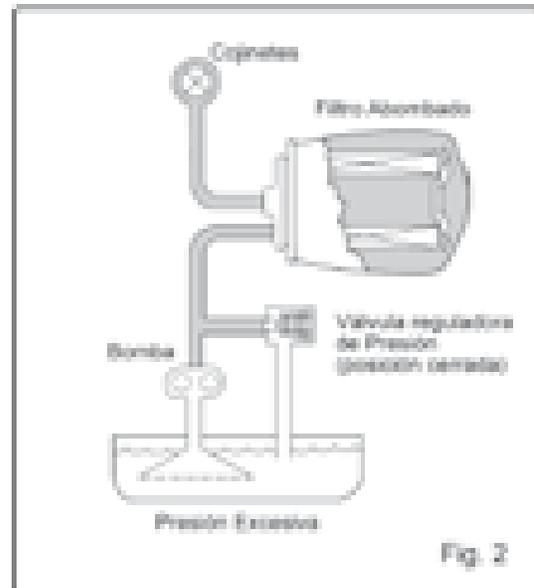
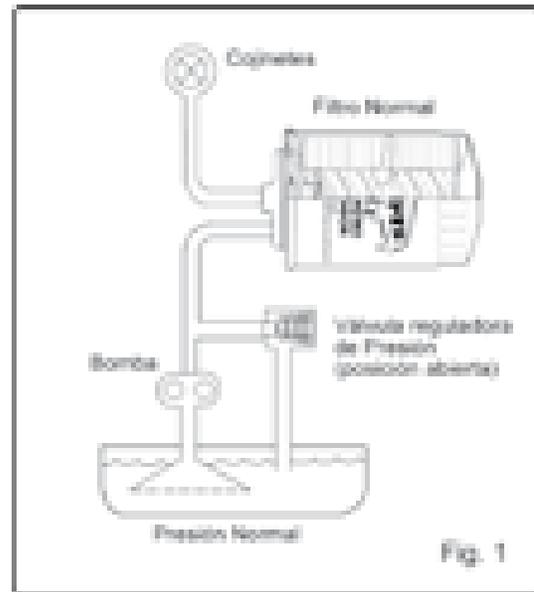

Most common deficiencies caused by the pressure regulating valve.

Lubricating oil filters with excessive pressure

All filter manufacturers have ever received a filter is returned by a customer with excessive overpressure. Often the deformed filter is the only indication that the car owner has to know that there was a problem in lubricating oil system.

It is possible that the damaged filter is not realized before that was removed during the next oil change schedule. However, if the pressure was enough to break the seal or seam stitching unwind, the owner of the car will have experienced immediate problems and costly.

With the "evidence" in hand, tends to blame the damaged filter. Not surprisingly, he is a little more than annoyed when filter manufacturer denies any responsibility for the damage. So what was causing too much pressure?. A look at how the system works lubricating oil show that oil pressure is created by the oil pump. The upper limit of this pressure is controlled by a pressure regulating valve which is usually an integral part of the pump.

Figure 1 is a simplified diagram of the lube oil system, showing this pump, control valve, filters and bearings. The pump provides sufficient flow to lubricate the bearings and other moving engine parts. This oil must be under pressure to accurately separate the heavily loaded engine parts and prevent excessive wear. The purpose of the throttle is to provide this pressure than most passenger cars are between 40 and 60 PSI (pounds per square inch).

The throttle is formed by a ball or piston that controls the pressure with the aid of a spring. The spring is calibrated so that the plunger is lifted from his seat when the oil pressure reaches the desired level. Once the valve is open, the pressure remains fairly constant with only slight changes that occur when the engine speed varies.

The filter and the other components in the lubrication system are subject to the pressure established by the throttle. If this pressure is excessive, damage the filter. This is what I do not understand people who are not familiar with lubrication systems.

What you can do that the system pressure exceeds the setting of the throttle? The question is that the valve may be stuck in the closed position or is slow to move to the open position after the engine started. Figure 2 shows the system running with the throttle stuck in the closed position. Under these conditions, pressure builds up equally on all components in the system until something happens to relieve the pressure. If the throttle is off, the pressure returns to normal. If you stay stuck, something has to break.

The normal operating pressure does not cause permanent deformation in the body of the filter. When the system pressure reaches 150 PSI due to a defective throttle, most filters are permanently deformed. At this pressure, the board generally will not be broken seam and the seam will remain intact.

If still stuck throttle, the pressure will increase further and the seal between the filter and the base can be changed. This will probably miss all

the oil in the system. If the filter is installed so too tight, the board will not break the seam and seam it will scroll as the pressure continues to increase. If the client is alert and for the engine at the first sign of trouble (red lamp or a reduction in oil pressure) it can limit your loss to a towing job, oil change and new filter. If you drive to the nearest workshop, probably burn the motor due to lack of oil. The main point is that the deformed filter is not the cause of this excessive pressure, but is the victim of a faulty throttle.

All filter manufacturers have ever received a filter The client asks if a filter has been completely blocked out the conditions could have caused overpressure in the system. The answer is no. If the throttle is working properly maintain the pressure in the filter at 40 or 60 PSI even if the filter is clogged. In short, if a filter is deformed due to over pressure in the system, the fault lies with the throttle and not in the filter.

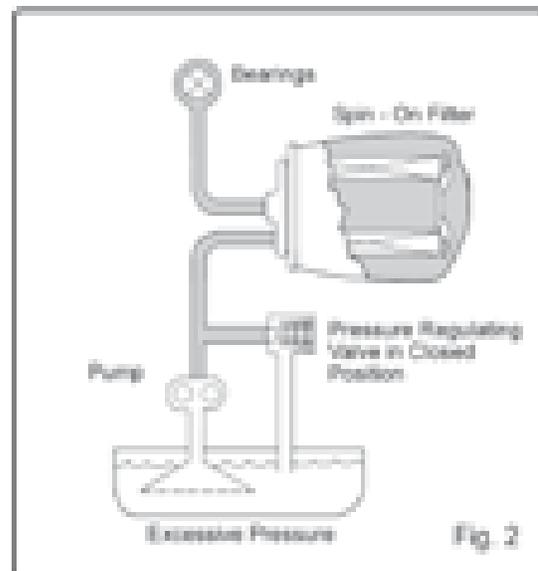
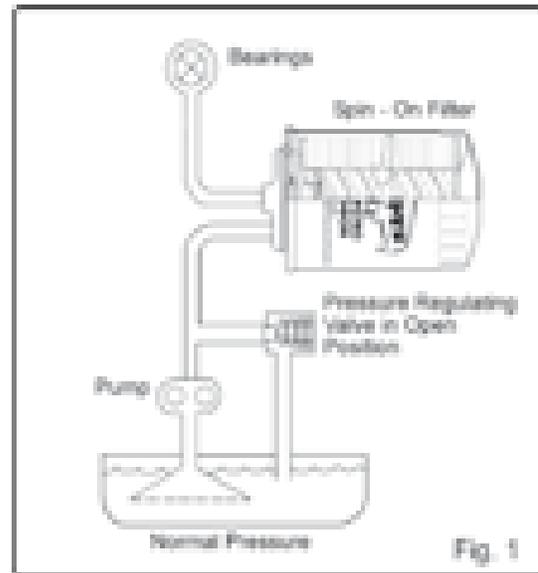

Filtros con soporte central o elemento colapsado.

COLAPSO:

Término usado para describir el daño ocasionado a un filtro en cuya apariencia se observa un aplastamiento del soporte central para el medio filtrante (figura 1).

Cuando encontramos un elemento filtrante donde ha ocurrido un colapso, la tendencia natural, es pensar que algo dentro del filtro no funcionó de manera correcta, siendo éste, el causante de los daños ocasionados. Generalmente esta no es la causa de los daños, sino el síntoma de un problema dentro del motor.

Los motores automotrices incorporan una válvula check o válvula de alivio entre la entrada y salida del flujo total de aceite, esta válvula permite la continuidad de la lubricación creando un by-pass por donde el aceite circula sin pasar por el filtro directamente dentro del motor cuando existe una restricción significativa en la presión de aceite, debido a la saturación del filtro o al arranque en frío (figura 2).

Generalmente los fabricantes de motores automotrices, han diseñado estas válvulas de alivio para abrir cuando la presión diferencial excede las 10 PSI, otros utilizan presiones de hasta por 30 PSI. Así algunos fabricantes de motores diseñan esta válvula integrada en el monoblock, mientras que otros prefieren que sea el filtro el que la lleve.

Los filtros automotrices han sido diseñados para soportar presiones significativamente superiores a la presión de operación normal de trabajo sin colapsarse, de ahí que cuando un filtro sufre un colapso, generalmente es el resultado de una obstrucción o de un mal funcionamiento de la válvula de alivio.

En ocasiones no es suficiente la obstrucción de la válvula para colapsar el filtro. La válvula reguladora de presión también puede obstruirse dando como resultado un incremento de presión en el flujo a través del filtro, aunque esta condición puede ser momentánea, rápidamente puede colapsarse el filtro si la válvula de alivio no puede liberar la presión excedente, debido al cambio repentino y por arriba de la presión de operación normal de trabajo.

Un filtro colapsado puede ocasionar la pérdida de la filtración y lubricación del motor, si esta condición se presenta, las válvulas reguladoras de presión y de alivio deberán ser inspeccionadas y reparadas o sustituidas por nuevas tan pronto como sea posible, previniendo de esta manera se presenten daños mayores.

El mal funcionamiento de la válvula de alivio y la válvula reguladora de presión y el subsiguiente colapso del filtro, puede no causar daños notables en el motor, pero en ocasiones tiene resultados catastróficos, llegando a producir serios sobrecalentamientos e inclusive desvielamientos por falta de una lubricación.

Las causas frecuentes que producen el mal funcionamiento tanto de la válvula reguladora de presión como de la válvula de alivio pueden ser:

- 1.- Superficies pegajosas causadas por el arranque en frío o por el uso de aceites altamente viscosos.
- 2.- Aceites excesivamente contaminados asociados a la condensación, mezcla de refrigerantes y la oxidación del propio aceite.
- 3.- Descuido del usuario al prolongar los intervalos para el cambio de aceite y filtros recomendados por el fabricante.
- 4.- Residuos de carbón arenoso que temporalmente atascan el libre movimiento de los componentes de la válvula.
- 5.- Repentinos cambios de aceleración con la presencia de cualquiera de las condiciones arriba mencionadas.
- 6.- La combinación de cualquiera de las causas anteriores. Descubrir un filtro colapsado, es un llamado para inspeccionar el estado de las válvulas de alivio y reguladora de presión en el motor. Así como revisar el funcionamiento del motor y la ejecución de los programas de mantenimiento.

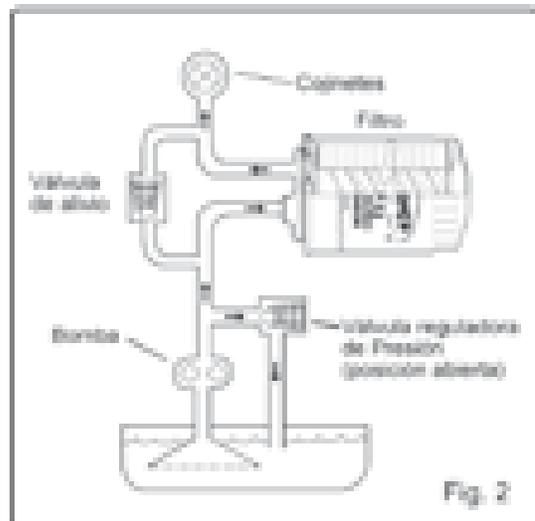
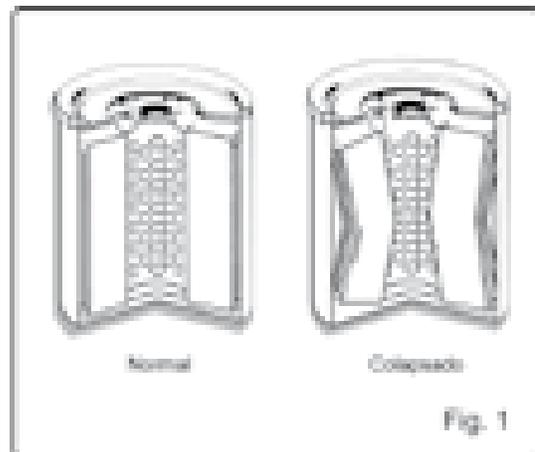

Filters with center support or element collapse.

COLLAPSE:

Term used to describe the damage to a filter whose appearance is seen crushing the central support for the filter media (Figure 1).

When we find a filter element where a collapse has occurred, the natural tendency is to think that something inside the filter does not work correctly, this being the cause of the damage. Generally this is not the cause of the damage, but a symptom of a problem inside the engine.

Automotive engines incorporate a check valve or relief valve between the inlet and outlet mass flow of oil, this valve allows the continuity of lubrication creating a bypass through which circulates oil without passing through the filter directly into the engine when there is a significant restriction in the oil pressure, due to saturation of the filter or cold start (Figure 2).

Generally automotive engine manufacturers have designed these relief valves to open when the differential pressure exceeds 10 PSI, others use pressures up to 30 PSI. Thus, some engine manufacturers have designed this valve integrated in the block, while others prefer to be the filter to take her.

The automotive filters are designed to withstand pressures significantly higher than normal operating pressure of work without collapsing, hence when a filter collapses is generally the result of a blockage or malfunction of the relief valve.

Sometimes it is not sufficient blockage of the valve to collapse the filter. The pressure regulating valve may also become clogged resulting in increased pressure on flow through the filter, although this condition could be momentary, the filter may collapse rapidly if the relief valve can not release excess pressure due to the change sudden and above the normal operating pressure of work.

A collapsed filter may result in loss of filtration and lubrication of the engine, if this condition occurs, the pressure control valves and relief must be inspected and repaired or replaced by new ones as soon as possible, thus providing submission damage.

The malfunction of the relief valve and pressure regulating valve and the subsequent collapse of the filter, may not cause significant damage to the engine, but it sometimes has disastrous results, leading to overheating and even cause serious desviamentos by lack of lubrication.

Common causes that cause the malfunction of both the throttle and the pressure relief valve may be:

- 1.- Sticky surface caused by the cold start or the use of highly viscous oils.
- 2.- Excessively contaminated oils associated with condensation, a mixture of coolant and oil oxidation own.
- 3.- Neglect of the user to extend the intervals for changing oil and filters recommended by the manufacturer.
- 4.- Sandy waste coal that temporarily stall the free movement of valve components.
- 5.- Sudden changes in acceleration in the presence of any of the above conditions.
- 6.- The combination of any of the above causes. Discover a collapsed filter is a call to inspect the state of relief valves and pressure regulator on the engine. Just as the engine performance review and implementation of maintenance programs.

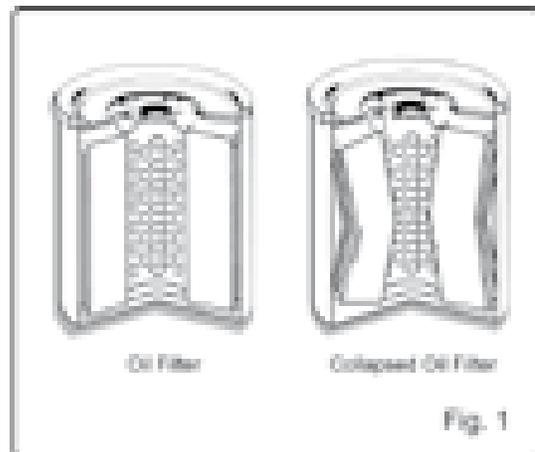

Fig. 1

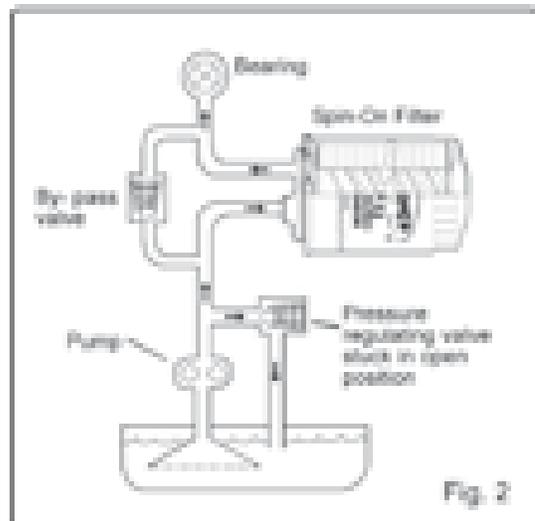

Fig. 2

GARANTIA



WARRANTY

GONHER DE MEXICO, S.A. DE C.V., garantiza los filtros contra cualquier defecto de fabricación durante el período de mantenimiento recomendado por los fabricantes del equipo en el cual se use filtros de la marca registrada **GONHER**.

En el caso de un daño al motor atribuible en forma directa a falla de un filtro **GONHER** que ha sido instalado en forma correcta, **GONHER DE MEXICO** pagará la reparación a una condición equivalente a la que existía antes de la falla. El daño deberá ser comprobado por un técnico autorizado por **GONHER DE MEXICO** antes de cualquier reparación.

GONHER DE MEXICO no es responsable por cualquier otro daño o perjuicio.

Las garantías otorgadas por fabricantes de equipos nuevos permanecen vigentes cuando se instalen filtros **GONHER** y tendrá vigencia por los Kms. u horas recomendados por los mismos.

Esta garantía podrá hacerse válida en **GONHER DE MEXICO, S.A. DE C.V.**, o cualquiera de los distribuidores autorizados.

SECOFI1446.

GONHER filters are guaranteed to be free from any defect in workmanship and materials during the service life recommended and if found to be defective will be replaced. Vehicle and engine warranties can not be voided solely due the use of **GONHER** filters.

In event of engines failure directly attributable to a **GONHER** filter defect, **GONHER** will restore engine to a condition equivalent to that existing just before the failure. However, **GONHER** is not liable for any other losses or expenses incurred due such defect.

GONHER DE MEXICO, S.A. DE C.V.
Av. Manuel Ordoñez No. 600 C.P. 66350
Santa Catarina, N.L., México
Tel: (8) 153-31-00 Fax: (8) 153-31-68

